

FUNCTIONAL STRUCTURE(S), FORM AND INTERPRETATION

The issue of how interpretation results from the form and type of syntactic structures present in language is one which is central and hotly debated in both theoretical and descriptive linguistics.

This volume brings together a series of eleven new cutting-edge essays by leading experts in East Asian languages which show how the study of formal structures and functional morphemes in Chinese, Japanese and Korean adds much to our general understanding of the close connections between form and interpretation. This specially commissioned collection will be of interest to linguists of all backgrounds working in the general area of syntax and language change, as well as those with a special interest in Chinese, Japanese and Korean.

Yen-hui Audrey Li is Professor of Linguistics and East Asian Languages and Cultures at the University of Southern California. Her research focuses on the comparison of grammatical properties in English, Chinese and other East Asian languages. Recent work has considered issues of order and constituency, scope interaction of quantificational expressions, as well as the distribution, structure and interpretation of different types of nominal expressions and relative constructions.

Andrew Simpson is a Senior Lecturer at the School of Oriental and African Studies, the University of London. His research interests centre on the comparative syntax of East and Southeast Asian languages, and his work addresses issues relating to processes of language change, DP-structure, the syntax of question formation and the interaction of syntax with phonology.

ROUTLEDGECURZON ASIAN LINGUISTICS SERIES

Editor-in-Chief: Walter Bisang, *Mainz University*

Associate Editors: R. V. Dhongde, *Deccan College*
Pune and Masayoshi Shibatani, *Kobe University*

Asia is the world's largest continent, comprising an enormous wealth of languages, both in its present as well as in its eventful past. The series contributes to the understanding of this linguistic variety by publishing books from different theoretical backgrounds and different methodological approaches, dealing with at least one Asian language. By adopting a maximally integrative policy, the editors of the series hope to promote theoretical discussions whose solutions may, in turn, help to overcome the theoretical lean towards West European languages and thus provide a deeper understanding of Asian linguistic structures and of human language in general.

VIETNAMESE-ENGLISH BILINGUALISM

Patterns of code-switching

Ho-Dac Tuc

LINGUISTIC EPIDEMIOLOGY

Semantics and grammar of language contact in mainland Southeast Asia

Nick J. Enfield

A GRAMMAR OF MANGGHUER

A Mongolic language of China's Qinghai-Gansu Sprachbund

Keith W. Slater

FUNCTIONAL STRUCTURE(S), FORM AND INTERPRETATION

Perspectives from East Asian languages

Edited by Yen-hui Audrey Li and Andrew Simpson

FUNCTIONAL STRUCTURE(S), FORM AND INTERPRETATION

Perspectives from East Asian languages

*Edited by Yen-hui Audrey Li
and Andrew Simpson*



First published 2003 by Routledge

Published 2017 by Routledge
2 Park Square, Milton Park, Abingdon, Oxon OX14 4RN
711 Third Avenue, New York, NY 10017, USA

Routledge is an imprint of the Taylor & Francis Group, an informa business

Editorial matter © 2003 Yen-hui Audrey Li and Andrew Simpson;
individual chapters © the authors

Typeset in Times New Roman by LaserScript Ltd, Mitcham, Surrey

The Open Access version of this book, available at www.tandfebooks.com,
has been made available under a Creative Commons Attribution-Non
Commercial-No Derivatives 4.0 license.

British Library Cataloguing in Publication Data
A catalogue record of this book is available from the British Library

Library of Congress Cataloging in Publication Data

Functional structure(s), form, and interpretation : perspectives from East Asian languages /
edited by Yen-hui Audrey Li and Andrew Simpson.
p. cm. – (RoutledgeCurzon Asian linguistics series)

Includes bibliographical references and index.

1. East Asia—Languages—Grammar. 2. Linguistics—East Asia. 3. Grammar,
Comparative and general—Syntax. I. Title: Perspectives from East Asian languages.
- II. Li, Yen-hui Audrey, 1954- III. Simpson, Andrew, 1962- IV. Series.

PL493.F86 2003
495—dc21
2002037040

ISBN 978-0-415-29745-5(hbk)

CONTENTS

<i>List of contributors</i>	vii
<i>Preface</i>	ix
PART I	
Functional structure and processes of interpretation in the DP/NP	1
1 NP as argument	3
YEN-HUI AUDREY LI AND YUZHONG SHI	
2 Copying variables	28
YOSHIHISA KITAGAWA	
3 Classifiers and the count/mass distinction	65
KEIKO MUROMATSU	
4 The demonstratives in modern Japanese	97
HAJIME HOJI, SATOSHI KINSUI, YUKINORI TAKUBO AND AYUMI UEYAMA	
PART II	
Grammaticalization and the diachronic development of functional structure	129
5 On the re-analysis of nominalizers in Chinese, Japanese and Korean	131
ANDREW SIMPSON	
6 Three types of existential quantification in Chinese	161
WEI-TIEN DYLAN TSAI	

CONTENTS

7	On the history of place words and localizers in Chinese: a cognitive approach	180
	ALAIN PEYRAUBE	
PART III		
	Clause level structures: processes of interpretation and principles of organization	199
8	Judgments, point of view and the interpretation of causee noun phrases	201
	S.-Y. KURODA	
9	A computational approach to case and word order in Korean	222
	WILLIAM O'GRADY	
10	Adjuncts and word order typology in East Asian languages	241
	THOMAS ERNST	
11	The distribution of negative NPs and some typological correlates	262
	C.-T. JAMES HUANG	

CONTRIBUTORS

Thomas Ernst, University of Massachusetts, Amherst.

Hajime Hoji, University of Southern California.

C.-T. James Huang, Harvard University.

Satoshi Kinsui, Osaka University.

Yoshihisa Kitagawa, Indiana University.

S.-Y. Kuroda, University of California at San Diego.

Yen-hui Audrey Li, University of Southern California.

Keiko Muromatsu, Asahikawa Medical College.

William O'Grady, University of Hawaii.

Alain Peyraube, CNRS and EHESS, Paris, France.

Yuzhi Shi, National University of Singapore.

Andrew Simpson, School of Oriental and African Studies, London.

Yukinori Takubo, Kyoto University.

Wei-Tien Dylan Tsai, National Tsing Hua University.

Ayumi Ueyama, Kyushu University.

PREFACE

In 1998, three members of the Department of East Asian Languages and Cultures at the University of Southern California, Professors Hajime Hoji, Nam Kil Kim and Yen-hui Audrey Li decided to organize a conference on the syntax of Chinese, Japanese and Korean in which various experts from around the world would be invited to present papers on aspects of the formal syntax of Chinese, Japanese and Korean. The basic idea behind this special conference was that speakers should address syntactic themes which would have a potential relevance for more than just one of the three languages and that the conference would provide a unique opportunity for specialists from all three languages to meet and exchange ideas. Despite the fact that the three major languages of East Asia, Chinese, Japanese and Korean have many common grammatical properties, there are surprisingly few occasions in which linguists from all three languages actually meet together and share ideas and information. It was also encouraged that papers presented at the conference should commonly attempt to address themes relating to either the interpretation and morphology of functional elements in syntax and/or aspects of the form and interpretation of NPs/DPs. Generally, the conference was organized in the spirit of mind that the detailed investigation of diachronic and synchronic properties of languages which share certain common properties should result in wider benefits for our general understanding of universal grammar and the ways that universal grammar may be visibly manifested. Publicly the aim of the meeting was signalled as below:

This workshop is an attempt to integrate the diachronic and synchronic study of Chinese, Japanese and Korean syntax, concentrating on issues of the structures and interpretations of nominal expressions and the syntax and morphology of function words.

Following the conference, a series of the papers presented there were written up, externally reviewed, revised, and then finally turned into the present volume. The result is a collection of essays which address the issue of the connection of form to interpretation in a variety of different ways. A number of authors defend the position that functional categories and their organization are of central

importance for matters of interpretation, while other chapters investigate form-interpretation correspondence relations from different perspectives and positions which do not assume the necessary presence or role of strictly functional categories. The term ‘functional structure(s)’ has accordingly been used in the title of the volume with the intention that it can be understood to refer either in the narrow sense to Chomskyeian-type functional structure/categories, or alternatively to much more general structures/constructions which encode functional interpretations, where the existence of functional categories is not assumed to be important or play a crucial role. Broadly, the volume is organized into three main parts, as detailed in brief below.

Part one of the book includes four chapters which examine issues relating to DPs/NPs. In ‘NP as argument’ Audrey Li and Yuzhi Shi examine how the presence or absence of certain functional structure in DPs/NPs accounts for clear differences in the distribution of plural morphemes in languages such as English and Chinese, and also how the DP/NP distinction in argument positions affects properties of relative clauses in these languages. Following this, Yoshihisa Kitagawa in ‘Copying variables’ presents arguments that the strict identity interpretation of phonetically empty DPs as well as E-type and donkey pronouns can be described as being due to the particular functional structure of bound traces of the form [_{DP} D(P) NP]. Keiko Muromatsu, in ‘Classifiers and the count/mass distinction’, considers how measure words and classifiers are structured inside the NP/DP and suggests that NPs/DPs may instantiate three kinds of nominal structure with different levels of functional-type complexity, this corresponding to different types of interpretation in NPs/DPs. Finally in this section, Hajime Hoji, Satoshi Kinsui, Yukinori Takubo and Ayumi Ueyama consider ‘The demonstratives in modern Japanese’ and propose a unified account of the ‘deictic’ and the ‘non-deictic’ uses of the *ko/so/a*-NPs in terms of (i) Ueyama’s (1998) D-indexing and (ii) the lexical marking of [Proximal]/[Distal]. It is argued that these factors constitute the only grammatical bases for the differences among *ko/so/a*-NPs.

Part two of the volume focuses on the diachronic development of functional structure. ‘On the reanalysis of nominalizers in Chinese, Japanese and Korean’ by Andrew Simpson first suggests that there is a common process of reanalysis found in East Asian languages in which functional elements in the nominal domain frequently become reanalysed as corresponding functional categories in the clausal domain. In ‘Three types of existential quantification in Chinese’, Wei-Tien Dylan Tsai similarly considers processes of grammaticalization and presents arguments that the Chinese element *you(-de)* has undergone reanalysis from the clausal domain into the nominal domain and now occurs as a new instantiation of the functional category D. The third chapter in this section, by Alain Peyraube: ‘On the history of place words and localizers in Chinese: a cognitive approach’, also concentrates on grammaticalization and charts the historical development of localizer functional-type morphemes from a cognitive perspective.

PREFACE

The final section of the book contains four chapters which look at a variety of synchronic issues relating to interpretation and the organization of functional vs. lexical material in the clause. In ‘Judgements, point of view and the interpretation of causee noun phrases’, S.-Y. Kuroda considers the mechanisms at work in the interpretation of causative structures and suggests that a highly significant factor here is whether the embedded clauses in such structures encodethetic judgements or categorical judgements. William O’Grady argues for ‘A computational approach to case and word order in Korean’ and re-examines the interpretation of scrambling. The chapter suggests a formal mechanism of feature-passing relating nominals to verbs that can be either upward or downward, with the former directionality being unmarked. Scrambling then occurs when there is a reversal of the unmarked direction of the feature-passing mechanism. The third chapter in this section, by Thomas Ernst, examines ‘Adjuncts and word order typology in East Asian languages.’ Alongside an in-depth analysis of the positioning of adjuncts, the chapter argues for broad differences in the linearization principles that affect functionally-related (Specifier) and lexically-related (complement) positions. Ernst suggests that a universal direction of linearization is characteristic of Specifiers (and related adjuncts), whilst linearization of complements (and related adjuncts) may be subject to cross-linguistic parametrization. Finally, the section is closed with ‘The distribution of negative NPs and some typological correlates’ by James Huang, which considers why certain functional types such as negative quantifiers may fail to occur in various languages.

As the editors of the book, we hope that this collection stimulates further interactions between linguists working on East Asian languages from both the synchronic and diachronic perspectives and that the various contributions of the volume will also be of good use for non-East Asian specialists working on the formal encoding of interpretation in syntactic structure. Finally, for invaluable help with reviewing the chapters in the book and providing suggestions for improving their contents and claims we would like to thank James Yoon and Yafei Li, and for considerable help with the preparation and editing of the volume our thanks also go to Walter Bisang, Hajime Hoji, Luther Liu, Jonathan Price, and Teruhiko Fukaya. The symposium where the papers were presented was made possible by the generous grants from the Chiang Ching-Kuo Foundation, the Japan Foundation and the USC-UCLA East Asian Studies Center.

Part I

FUNCTIONAL STRUCTURE AND
PROCESSES OF INTERPRETATION
IN THE DP/NP

NP AS ARGUMENT

Yen-hui Audrey Li and Yuzhi Shi

1. Introduction

The articulation of X'-theory, extending it to functional categories, has led to the revision of projections for nominal expressions: an argument nominal phrase does not have the straightforward structure [_{NP}...N...] with N(oun) heading a projection Noun Phrase (NP). Rather, it has a functional head, Determiner (D), which takes a complement NP and projects to a Determiner Phrase (DP) (see Szabolsci, 1983/84, Abney 1987, for instance).¹ NPs and DPs are two distinct categories: a DP generally is an argument and an NP, a predicate. D has the function of making a predicate into an argument (Chierchia 1998). Alternatively, an NP is a restriction for D to range over.² D is an operator ranging over a restriction or binding a variable in N (Longobardi, 1994, 633–334).

In languages requiring an article (a determiner) to occur with a noun, such as English, there is clear support for the existence of a DP/NP distinction. After all, one can hear an article with a noun in certain contexts and not in others. However, in languages that do not require an article, such as Chinese, there is no immediate support for adopting a DP/NP distinction. The same form, an NP without an article, occurs in both argument and predicative positions. Naturally, the following question arises: is distinguishing DPs from NPs necessary in such a language? Two approaches have been pursued. One is to maintain a one-to-one matching relation between form and meaning and claim that all languages have the same DP/NP distinction (see a recent representative work, Borer 2000). The other is to make syntactic structures reflect morphology more closely: if a language does not require a determiner to make an argument, a DP is not projected and an argument is still represented as an NP. Proper interpretations are obtained by a semantic 'type-shifting' rule which type-shifts an NP from a predicate to an argument (see Chierchia 1998). According to these approaches, then, an argument is either always projected as a DP or is projected as an NP which must undergo a semantic type-shifting rule.

Logically, however, an NP should be able to occur in an argument position without the application of a type-shifting rule, as long as it can be properly interpreted (or bound by an operator, see the paragraphs above).³ Recall that a D serves to make an argument the nominal expression containing an NP. A D is an operator binding a variable in an NP, i.e., an NP provides a restriction (variable) for an operator in D. Suppose a language can

generate an operator away from its restriction, i.e., not within the same nominal expression, while an operator-variable relation still holds, then an NP can occupy an argument position and still be properly interpreted without undergoing a semantic type-shifting rule. More concretely, let us consider the morphological composition of *wh*-words in various languages. In the works of Watanabe (1992), Cheng (1991), Aoun and Li (1993a, b), Tsai (1994), among others, some versions of the following idea have been put forward: languages may differ in the composition of their *wh*-phrases. Three different types of languages have been identified. One type is represented by English. In this language, a *wh*-word consists of a quantification and a restriction. The two parts function as a unit; i.e., they undergo syntactic processes such as movement as a unit. Japanese represents another type, whose *wh*-phrases also consist of a quantification and a restriction but the quantification part can be moved away from the restriction part. The third type is represented by Chinese, whose *wh*-words are only a restriction, bound by an operator outside the *wh*-expressions. The different behavior of these three types of *wh*-words are reflected in the formation of *wh*-interrogatives and the formation of non-interrogative universal and existential quantificational expressions. Regarding the formation of *wh*-interrogatives, which involves movement of a *wh*-quantifier to the peripheral position of the interrogative clause, this proposal accounts for the following facts, focusing on the comparison between English and Chinese:⁴

- (1) a. English moves *wh*-words to form *wh*-interrogatives because *wh*-words are quantificational.
 b. Chinese generates an operator (quantification) and a restriction in separate projections. The restriction is the *wh*-word and the quantification is a question operator generated in a question projection or in (Spec of) Comp (cf. Aoun and Li 1993a).

Because a *wh*-word in Chinese is only a restriction, it is not surprising that it does not have independent quantificational force and obtains a quantificational interpretation via a quantificational element in the context. For instance, it can be interpreted as a universal quantifier when licensed by the universal quantifier *dou*, as in (2a); it can be interpreted as an existential quantifier when licensed by an existential quantifier as in a conditional clause (2b); and it can be interpreted as an interrogative in the context of a *wh*-question (suggested by the optional root-clause particle *ne*), (2c).

- (2) a. *shenme dou hao*.
 what all good
 ‘Everything is good.’
 b. *ruguo ni xihuan shenme, wo jiu ba ta mai-xia-lai*.
 if you like what I then Ba it buy-down
 ‘If you like something, I will buy it.’
 c. *ta yao shenme (ne)?*
 he want what Question
 ‘What does he want?’

In contrast, a *wh*-word in English is quantificational. It has a fixed interpretation and does not have the range of interpretations illustrated in (2a-b).

Nonetheless, *wh*-words in Chinese share with those in English the possibility to properly bind or control another anaphor, bound pronoun or PRO, i.e., they both behave like arguments:

- (3) a. Who_i believes himself_i to be the best?
 b. Who_i wants [PRO_i to speak out]?
- (4) a. *shei_i dou bu gan ba ziji_i/ta_i de yisi shuo chulai.*
 who all not dare BA self/he De intention speak out
 ‘Nobody dares to speak out self’s/his intention.’
 b. *shei_i dou xiang [PRO_i qu].*
 who all want go
 ‘Everyone wants to go.’

In other words, Chinese, in contrast to English, illustrates a case where a restriction alone is generated in an argument position and functions like an argument.

If such an approach to cross-linguistic variations on the formation of questions and on the behavior of quantificational expressions based on variations in morphological compositions is correct, we expect to find more instances demonstrating that Chinese generates only a restriction in the place where English generates a quantification and a restriction as a unit. That is, following the semantic distinction between D and N, we expect to find instances where an NP in Chinese is generated in the positions where a DP is generated in English and both still function alike – as an argument.

We show in this work that NPs in Chinese indeed are allowed in argument positions and behave like arguments. There are interesting generalizations in this language suggesting that NPs are generated in argument positions, licensed by and interpreted with an operator outside the nominal expression. Such generalizations indicate that a semantic type-shifting rule to shift an NP-predicate to an argument need not apply in relevant Chinese cases, contrary to what Chierchia (1998) proposes. Moreover, these generalizations demonstrate that a null D and a DP are not always projected when a determiner does not occur overtly.⁵ Empirical supports for such generalizations come from the study on the plural/collective morpheme *-men* and the derivation of relative constructions in Chinese.

2. The plural/collective morpheme *-men*⁶

The first case in support of our claims involves generalizations concerning the plural/collective morpheme *-men* in Chinese. In order to account for the distribution of *-men* and its interaction with other constituents within a nominal expression, Li (1999a) suggests that the plural/collective marker *-men* represents a plural feature in the head position of a Number projection. This plural feature can be realized on an element that has undergone movement through an empty Classifier to D, movement being governed by the Head

Movement Constraint which essentially disallows a Head to move across another Head (Travis 1984). We elaborate on this proposal in the following paragraphs.

Based on the distribution and ordering of the constituents within a nominal expression, Li (1998, 1999a, b) argues that a full nominal phrase in Chinese has the following structure (see Tang 1990):

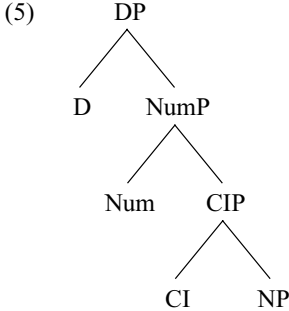

A noun is generated in N; a classifier in CI; the plural/collective in Num and a demonstrative or proper name or pronoun in D. If Classifier is not filled lexically (i.e., if a classifier lexical item is not present), an N can be raised to Num, combined with the plural/collective feature, realized as *-men*, and then, raised to D to check a [+definite] feature in D. This derives a well-formed [N-*men*].

- (6) *laoshi dui xuesheng-men hen hao.*
 teacher to student-MEN very good
 ‘The teacher is nice to the students.’

If Classifier is filled lexically (a classifier is present), an N cannot be raised and combined with *-men* in Num (the Head Movement Constraint), which accounts for the unacceptability of nominal expressions with the form *[D+] Num + CI + N-*men*]

- (7) **laoshi dui (zhe/na) san-ge xuesheng-men tebie hao.*
 teacher to these/those three-CI student-MEN especially good
 ‘The teacher is especially nice to (these/those) three students.’

An N can also just move up to Number when Classifier is empty and D is lexically filled (by a demonstrative, for instance). This captures the contrast in acceptability between [D + N-*men*] and *[D + Num + CI + N-*men*] expressions:

- (8) a. *laoshi dui zhe/na-xie⁷ xuesheng-men tebie hao.*
 teacher to these/those student-MEN especially good
 ‘The teacher is especially nice to these/those students.’
 b. **laoshi dui zhe/na ji-ge xuesheng-men tebie hao.*⁸
 teacher to these/those several-CI student-MEN especially good
 ‘The teacher is especially nice to these/those couple of students.’

- c. **laoshi dui zhexie/naxie ge xuesheng-men tebie hao.*
 teacher to these/those CI student-MEN especially good
 ‘The teacher is especially nice to these students.’

In (8a), the D is occupied by a demonstrative but the Classifier is empty. The noun can move up to Number and realize the plural feature *-men*. In (8b-c), the Classifier is occupied, N-to-Num movement is blocked by the intervening Classifier (the Head Movement Constraint) and the *-men* form is not possible.

There is a further important property of nominal expressions with *-men*: they must be interpreted as definite. The [N-*men*] expression in the following instance, for example, must be definite.

- (9) *ta hui dai xuesheng-men hui jia.*
 he will bring student-MEN back home
 ‘He will bring the students back home.’
 *‘He will bring (some) students back home.’

The definiteness constraint on nouns with *-men* can be further supported by the fact that they do not occur in existential constructions. Citing Rygaloff (1973) and Yorifuji (1976), Iljic (1994) stated that ‘N-*men* always refers to the definite. As a rule, one can neither posit nor negate the existence of N-*men*.’

- | | |
|-------------------------------|------------------------|
| (10) a. * <i>you ren-men</i> | cf. <i>you ren</i> |
| have person+MEN | have person |
| ‘there is/are some person(s)’ | |
| b. * <i>mei you ren-men</i> | cf. <i>mei you ren</i> |
| not have person+MEN | not have person |
| ‘there is nobody’ | |

As mentioned, a definite N-*men* is derived by moving an N through an empty Classifier, combined with *-men* in Number, and raised to D, which has a [+definite] feature. In order to derive the N-*men* form when D is occupied by a demonstrative, such as (8a), the noun moves up to Number (through an empty classifier) and realizes the plural feature *-men*. This account makes the following prediction: if an indefinite bare noun has a full nominal projection [D + Num + CI + N] with the D filled (such as filled by a null existential quantifier as proposed in Longobardi 1994, see the next paragraph), N in this case can still be raised to Num to combine with *-men* (and keep an indefinite interpretation) (cf. (8a)). The only difference between (8a) and an indefinite N-*men* would simply lie in the contents of D: D is a demonstrative/definiteness feature for definite expressions or a null existential quantifier for indefinite expressions. But this would be wrong, because N-*men* must always have a definite interpretation. In other words, the definiteness requirement on N-*men* does not follow straightforwardly from the analysis sketched so far.

The study on compositions of *wh*-words noted at the beginning of this work suggests the following solution. In the analysis of DPs in English, Longobardi (1994) proposes that a D can be [+definite] for a definite expression. For an indefinite expression, its D hosts a null existential quantifier binding a variable (restriction) in N. The existential quantifier is a default null operator occupying the D position when nouns occur without a definite determiner. Now let us turn to Chinese again. A D in this language can also be [+definite] and such a position can be lexically filled by a demonstrative, a pronoun, a proper name. If a demonstrative/pronoun/proper name is not generated in D, a [+definite] feature in D would be spelled out by combining with a raised N (interpreted as definite). This is supported by the distribution of *-men*, in relation to other categories within a nominal expression. When a nominal expression is indefinite, however, a default null existential operator need not be generated in D in Chinese as it is in English. Recall that Chinese allows an operator (quantification) to be generated away from its restriction. To derive an indefinite expression, a restriction in N can be bound by an operator outside the nominal expression, such as an existential closure (the one adjoined to VP as in Diesing 1992) or other available quantifiers in the contexts. That is, an indefinite noun can simply be labeled as an NP, bound by an operator outside the nominal expression. Projecting an indefinite noun as an NP, rather than a more complex structure, simply conforms to the general tendency in Chinese that a restriction can be generated separate from a quantification.⁹

When indefinite bare nouns are NPs and do not have a larger projection, the plural *-men*, which is in a projection larger than an NP, is not available to be combined with the bare noun. In contrast, a definite expression is a DP, as noted earlier. A DP can contain a number projection. A definite noun, therefore, can occur with *-men*. The difference in structures between definite and indefinite expressions, therefore, captures the definiteness effect on *-men* expressions.

In brief, the distribution of *-men* in Chinese led us to the conclusion that, although DPs in this language are generated for definite expressions, indefinite bare nouns in argument positions are simply projected as NPs. Just as the behavior of *wh*-words which shows that a restriction alone can be generated in an argument position, an indefinite expression (restriction only) is generated in an argument position without a full DP structure.

Next, we show that the properties regarding relative constructions in Chinese also argue for the existence of an NP projection in an argument position.

3. Relative constructions

Relative constructions have many interesting properties that have continued to inspire innovations and revisions of grammatical theories and analyses to characterize such properties. What concerns us here is the analysis according to which relative constructions can be derived by raising the Head¹⁰ to its surface position directly from within the relative clause – the promotion analysis (Schachter 1973, Vergnaud 1974, Kayne 1994). Such a promotion analysis for English relative constructions is supported by reconstruction effects involving idioms, anaphors, bound pronouns and interactions of scope-bearing elements (Schachter 1973, Bianchi 1999, Alexiadou et al 2000, among

others). We will show that a sub-pattern of Chinese relative constructions shows mixed reconstruction effects: reconstruction is available with respect to binding of anaphors and pronouns but not scope interaction. Such mixed reconstruction effects are accounted for structurally – what is raised is an NP, not a DP. They cannot be accommodated by alternative analyses such as resorting to the notion of chain binding. The conclusion, thus, confirms our claim that an NP can be generated in an argument position in Chinese.

3.1. The promotion analysis

In the early 70's, significant observations were made that the Head of a relative clause can be interpreted as if it is in the gap position inside the relative clause (reconstruction effects). This led to the proposal that the Head is moved from within the relative clause – the so-called promotion analysis. This analysis received much renewed interest after the work of Kayne (1994)'s antisymmetry approach to word order and phrase structure, which rules out, in principle, any right-adjunction structure in the grammar of natural languages. In essence, the promotion analysis may take the structure and derivation in (11), illustrated by an English example in (12) (see Kayne 1994, Bianchi 1999, 2000):

- (11) The promotion analysis

$$[_{DP} D [_{CP} DP_i [C [_{IP} \dots t_i \dots]]]]$$

- (12) $[_{DP} [_D \text{ the}] [_{CP} [_{DP} \emptyset] [_{NP} \text{ man}]_i] [C \text{ that}] [_{IP} t_i \text{ came here}]]]$

The raised phrase is a DP with a null D. Such a null D is licensed by the external D *the* in (12) (for the need to project a DP with a null D, see Borsley 1997, Bianchi 1999, 2000)

The promotion analysis, raising the Head to its surface position (Head-raising), is strongly supported by reconstruction effects. Take English relative constructions for instance. Arguments have been advanced for Head-raising based on the distribution of idiom chunks and the properties with respect to binding and scope interaction. Regarding idioms, it has been shown that a part of an idiom can occur as the Head of a relative relative which contains the other part of the idiom. This can be illustrated by the [V+O] idioms in the following examples. In these cases, the O part of the idiom is the Head of the relative clause and the V part is the verb of the relative clause. If the parts of an idiom need to be generated as a unit, such examples argue for the existence of a movement process (see Schachter 1973, 31–32).

- (13) a. The careful track that she's keeping of her expenses pleases me.
 b. The headway that Mel made was impressive.
 c. I was offended by the lip service that was paid to the civil liberties at the trial.

Reconstruction effects are further supported by the binding possibilities of the following examples from Schachter (1973, 32–33).

- (14) a. John_i painted a flattering portrait of himself_i.
 b. *Himself_i painted a flattering portrait of John_i.
 cf.
- (15) a. The portrait of himself_i that John_i painted is extremely flattering.
 b. *The portrait of John_i that himself_i/he_i painted is extremely flattering.
- (16) a. [John and Mary]_i showed a fleeting interest in each other_i.
 b. *Each other showed a fleeting interest in [John and Mary]_i.
 cf.
- (17) a. The interest in each other_i that [John and Mary]_i showed was fleeting.
 b. *The interest in [John and Mary]_i that each other_i showed was fleeting.

The distribution of bound pronouns also exhibits reconstruction effects:

- (18) a. I would like to collect the best pictures of his_i best friend that everyone_i will bring tomorrow.
 b. I would like to collect the best pictures of his_i best friend that I think everyone_i will bring tomorrow.

In addition, certain patterns illustrating scope interaction also argue for the availability of reconstruction: the Head nominal can be interpreted as having narrow scope with respect to another quantifier in the relative clause. Observe the following examples (see Bianchi 1999, 45–46, 122–123).

- (19) a. Every doctor will examine two patients.
 b. I phoned the two patients that every doctor will examine tomorrow.

(19a) contains an object QP *two patients*, which can have a narrow scope interpretation. That is, there can be twice as many patients as doctors. (19b), where the relativized nominal is preceded by a definite article, can have the same interpretation as (19a). This shows that *two patients* must be interpreted as if it is in the object position of the relative clause. It argues for Head-raising, i.e., the promotion analysis, as described in (11).

In brief, there is ample evidence that reconstruction in relative constructions is available. Taking reconstruction as a diagnostic for movement, the relative construction in English is accounted for by the promotion analysis.

3.2. Reconstruction in Chinese relativization

Turning to relative constructions in Chinese, we find that the evidence for movement seems to be conflicting. In support of a movement analysis, it seems possible for reconstruction to take place in some cases. For instance, there are examples containing idioms that support the existence of reconstruction of the Head, i.e., Head-raising applies. The following examples illustrate that a part of an idiom related to the relative clause can occur as a relativized Head:

- (20) a. *[[ta chi e; de] cu] bi shei dou duo.*¹²
 he eat **De vinegar** compare who all much
 ‘lit: The vinegar he eats is more than anyone else’s.’
 ‘His jealousy is more than anyone else’s.’
 b. *wo ting-bu-dong [[ta you e; de] mo].*¹³
 I listen-not-understand he **hu- De -mor**
 ‘Lit: I do not understand the -mor that he hu-ed.’
 ‘I do not understand his humor.’

A reconstruction effect is also manifested in the cases containing reflexives:

- (21) a. *wo jiao Zhangsan quan mei-ge-ren_i kai ziji_i de chezi lai.*
 I ask Zhangsan persuade every-Cl-one drive self De car come
 ‘I asked Zhangsan to persuade everyone to drive self’s car over.’
 b. *[[wo jiao Zhangsan quan mei-ge-ren_i kai t lai de] ziji_i de chezi].*
 I ask Zhangsan persuade every-Cl-one drive come De self De car
 ‘self’s car that I asked Zhangsan to persuade everyone to drive over’

So are the following cases which involve bound pronouns contained in a relativized Head:

- (22) a. *wo xiwang mei-ge xuesheng_i dou neng ba wo gei ta_i de shu dai lai.*
 I hope every-Cl student all can BA I give his book bring come
 ‘I hope every student_i can bring the book that I gave to him_i.’
 b. *ni hui kandao [[wo xiwang mei-ge xuesheng_i dou neng dai t lai de] wo gei ta_i de shu].*
 you will see I hope every-Cl student all can BA his book bring come De I give his book
 ‘You will see the book that I gave to him_i that I hope every student_i will bring.’
 c. *mei-ge-ren_i dou yiwei wo yijing mai-dao wo yao song gei ta_i de liwu.*
 every-Cl-one all think I already bought I will give to him De present
 ‘Everyone thought I already bought the present that I was going to give to him.’
 d. *[[mei-ge-ren_i dou yiwei wo yijing mai-dao t de] wo yao song gei ta_i de liwu].*
 every-Cl-one all think I already bought De I will give to him present
 ‘present that I was going to give to him that everyone thought I already bought’

However, in contrast to the English facts observed in the previous section, reconstruction is unavailable with respect to scope interaction.

- (23) a. *wo hui zhengli [[mei-ge-ren (dou) hui kan t de] (na) san-ben shu]* –same 3 books
 I will arrange every-Cl-one all will read De those three-Cl book
 ‘I will put the three books that everyone will read in order.’
 b. *wo hui zhengli [[ta xiwang mei-ge-ren hui kan t de] (na) san-ben shu]* –same 3 books
 I will arrange he hopes every-Cl-one will read De those three-Cl book
 ‘I will put the three books that he hopes that everyone will read in order.’
 c. *[[mei-ge-ren (dou) hui kan t de] (na) san-ben shu], wo hui zhengli.* –same 3 books
 every-Cl-one will all read De those three-Cl book I will arrange
 ‘The three books that everyone will read, I will put in order.’

- d. *[[ta xiwang mei-ge-ren hui kan t de](na)san-ben shu], wo hui zhengli.* –same 3 books
 he hopes every-Cl-one will read De those three-Cl book I will arrange
 ‘the three books that he hopes that everyone will read, I will put in order.’

The discussions in this section, summarized below, show that reconstruction effects are not quite consistent in Chinese relative constructions.

- (24) a. A relativized Head can be an idiom chunk related to the relative clause. Therefore, reconstruction is possible when idioms are involved.
 b. Reconstruction is possible for binding relations involving anaphors, bound pronouns.
 c. Reconstruction is unavailable for examples involving a Head QP interacting with another QP inside a relative clause with respect to scope interpretations.

It is surprising that reconstruction effects appear to be inconsistent in these Chinese relative constructions, in contrast to English relative constructions which exhibit reconstruction effects systematically. Why is it that QPs in Chinese behave differently from the other cases, and how can we make sense out of such seemingly incoherent reconstruction effects?

The reconstruction facts regarding binding and idioms argue for an analysis that derives the relative Head by movement. On the other hand, the QP scope interaction facts do not support direct movement to the Head. How can the two seemingly conflicting sets of facts be integrated? The answer lies in the morphosyntactic differences between these expressions. Note that the scope interaction facts discussed above involve QPs which contain number and classifier expressions. The occurrence of number and classifier expressions requires projections of Number and Classifier phrases which are a larger structure than an NP, given that Chinese nominal structures have the projection in (5), repeated below:

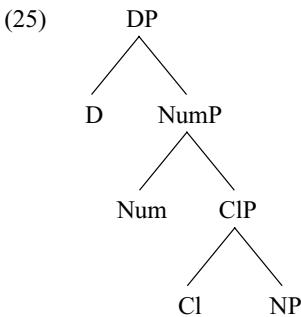

On the other hand, Li (2000) argues that a modifier, including a relative clause, can be left-adjoined to the NP Head in Chinese relative constructions. In other words, a modifier (including a relative clause) together with the NP it modifies can be projected as an NP. The object of [V + O] idioms can also be an NP, as such object idiom chunks are generally non-referential. This amounts to saying that, when the Head is a QP, it is a

projection larger than an NP; whereas the projection is an NP when the Head is the O part of a [V+O] idiom or an NP with a modifier.

Such an NP/non-NP distinction provides an answer to the apparent conflicting reconstruction effects just mentioned: what is reconstructed is an NP. An NP may be the O part of a [V + O] idiom or may have a modifier that contains an anaphor or a pronoun. In contrast, an NP cannot be a QP because of the lack of Number and Classifier projections (and consequent lack of Q or D projections). This amounts to saying that, if what is reconstructed is an NP, instead of a DP/QP, the seemingly inconsistent reconstruction facts summarized in (24) follow straightforwardly: the scope-bearing phrases that enter into scope relations are QPs/DPs, which necessarily contain a number+classifier expression and are projections larger than NPs; the other non-QP cases discussed do not contain a number+classifier expression and can be projected as NPs.¹⁴

The distinction between NP-reconstruction and DP-reconstruction not only captures the seemingly inconsistent reconstruction facts in Chinese but also accounts for cross-linguistic variations in reconstruction. English exhibits a full range of reconstruction effects with respect to idioms, binding and scope properties because a DP is reconstructed (see (11)). Chinese exhibits partial reconstruction effects because an NP is reconstructed. Why is there such a contrast? This, again, can be traced to the difference in nominal structures between these two languages. What is relativized is an indefinite nominal expression that is projected as an NP. Chinese projects an NP in cases of indefinite expressions. English necessarily projects a DP for a nominal expression in an argument position and what is relativized is always a DP.

3.3. *Chain binding?*

Our account for the availability of reconstruction with respect to binding/idioms and the absence of reconstruction with respect to scope bearing elements in Chinese relative constructions is a structural one: Chinese relative constructions are formed by NP raising and therefore exhibit NP reconstruction effects. Reconstruction of scope bearing elements is not available because it requires movement of a phrase with a larger projection than an NP. One may argue that this is not the only solution and that certain notion of ‘chain binding’ may be adequate, if relativization is a process of operator movement which coindexes an operator with the Head (Chomsky 1977, Safir 1986, Browning 1987, among others) and a chain is formed accordingly. In this section, we show that this alternative is not correct.

That there is a contrast between the availability of reconstruction with respect to binding and the unavailability of reconstruction with respect to scope interaction has been observed before. Cecchetto and Chierchia 1999 noted that certain inconsistency exists in reconstruction effects in clitic-left dislocation constructions in Italian. They noted the following contrast regarding the availability of reconstruction:

- (26) **A casa di Leo, pro (ci) va volentieri*
 To the house of Leo (he) there goes with pleasure

- (27) *In qualche cassetto, Leo ci tiene ogni carta importante* $\exists\forall$ *but* $*\forall\exists$
 In some drawer, Leo there keeps every important paper
 ‘Every important document Leo keeps in some drawer.’

(26) shows that reconstruction takes place to interact with Binding Theory (Binding Principle C in this case) and (27) shows that reconstruction does not take place for scope interaction. Cecchetto and Chierchia’s account for PP dislocation in such cases involves base-generation of the PP in its surface position, relating it to a clitic in the base. The latter must move to a sentence initial position in order to be interpreted. This is what derives the locality constraints on the distribution of these clitics. To account for the principle C effects in the context of PP dislocation, they appeal to the concept of chain-binding, adapting ideas developed in Barss 1986. Chain is defined as (Cecchetto and Chierchia 1999: 140):

- (28) A CHAIN $\langle\beta_1, \dots, \beta_n\rangle$ is a sequence of nodes sharing the same θ -role such that for any i , $1 \leq i \leq n$, β_i c-commands and is coindexed with β_{i+1}

and chain-binding, roughly as follows (Cecchetto and Chierchia 1999: 139):

- (29) In a chain $\langle XP_1, \dots, XP_n \rangle$ when a phrase YP c-commands a link XP_i of the chain, it counts for the purposes of Binding Theory as if it c-commanded every link of the chain.

In short, Cecchetto and Chierchia account for the contrast between (26) and (27) by appealing to an assumption that chain-binding interacts with Binding Theory but not with scope. If chain binding is indeed responsible for the contrast in reconstruction between binding properties and scope relations and relative constructions involve chain binding, our account for the reconstruction facts concerning Chinese relative constructions would not argue for the NP/DP distinction.

Choueiri (2002), however, argues that Cecchetto and Chierchia’s generalizations are not quite correct. She observes that the cases where chain-binding seems to interact with Binding Theory are actually based on wrong assumptions about the structural position of the relevant elements. When the structural positions are clarified, chain-binding in fact does not interact with Binding Theory. For lack of space, we do not repeat Choueiri’s arguments and examples here (interested readers are referred to her work, chapter 2). Instead, we would like to bring further evidence to show that chain-binding cannot be an adequate account. We will do so by showing that other possible derivations for relative constructions in Chinese, specifically, operator movement and resumption, do not allow reconstruction at all, in contrast to those discussed in the previous section, subsumed under NP-raising. Were chain-binding responsible for reconstruction effects in relative constructions, such facts are not expected.

3.3.1. Operator movement

Chinese relative constructions not only can be derived by NP Head-raising, other derivations are also available. For instance, in this language, an adjunct, just like an argument, can be relativized.

- (30) a. *lai zher de ren*
 come here De man
 ‘the man who came here’
- b. *ta zuo de gongzuo*
 he do De work
 ‘the work which he did’
- c. *ta xiu che de fangfa*
 he fix car De way
 ‘the way that he fixed the car’
- d. *ta likai de yuanyin*
 he leave De reason
 ‘the reason why he left’

For argument relativization, we showed that the examples in (30a-b) can be derived by NP-movement to the Head position. For adjunct relativization, however, what is relativized is not an NP category. It is a PP or Adv, as indicated by the following corresponding non-relative cases:¹⁵

- (31) a. *ta yong na fangfa xiu che.*
 he with that method fix car
 ‘he fixed the car in that way’
- b. *ta yinwei nage yuanyin likai-le*
 he because that-Cl reason leave-Asp
 ‘He left because of that reason.’

The Head of a relative construction containing adjunct relativization is still a nominal expression, not an Adv or a PP. Were NP Head-raising to apply to adjunct relativization, an Adv or PP would have to become an NP after movement. An Adv is not an NP. A PP is not an NP either. Moreover, we cannot claim that the object of P is moved directly to the Head position and the P is deleted subsequently. It is not clear that a P can simply be deleted after its object is moved. As noted in Ning (1993), there is an interesting contrast between topicalization and relativization in Chinese with respect to the distribution of prepositions. In contrast to acceptable relativization of a seemingly P-object, as in (30a,b) above and (32a’,b’) below, the corresponding topicalization is not acceptable, as in (32a,b). Instead, a P must occur with its object (33a-b).

- (32) a. **nage fangfa, ta xiu hao le nabu che.*
 that way he fix well Asp that-Cl car
 ‘That way, he fixed that car’

cf.

a'. *ta xiu hao nabu che de fangfa*
 he fix well that-Cl car De way
 'the way he fixed that car'

b. **nage yuanyin, ta bu xiu che.*
 that reason he not fix car
 'That reason, he does not fix cars.'

cf.

b'. *ta bu xiu che de yuanyin*
 he not fix car De reason
 'the reason he does not fix cars'

- (33) a. *yong nage fangfa, ta xiu hao le nabu che.*
 use that way he fix well Asp that-Cl car
 'In that way, he fixed that car'
- b. *wei na yuanyin, ta bu xiu che.*
 for that reason he not fix car
 'For that reason, he does not fix cars.'

Because of such a contrast between relativization and topicalization, Ning (1993) argues that topicalization is derived by directly raising the topic phrase, which can be a PP, to the peripheral position. When the adjunct is a PP, adjunct topicalization requires the entire PP to appear in the peripheral position. Relativization, on the other hand, is not derived by direct XP movement.¹⁶ It is derived by movement of an operator as proposed in Chomsky (1977), according to Ning. Such an operator in Chinese is equivalent to a *wh*-operator in English. A *wh*-operator can be an adjunct or equivalent of a PP, as illustrated by the English question/answer pairs involving *how* and *why*:

- (34) a. **How** did you do it? **With care.**
 b. **Why** did you do it? **For you.**

The operator is moved to the Spec of Comp position of a relative clause and the Head is base-generated in its surface position. The operator is then interpreted with the Head via some interpretive mechanism, such as predication (Chomsky 1977, Safir 1986, Browning 1987, among others). Alternatively, the operator is licensed by being in an agreement relation with the Head (Browning 1987): the two agree in phi-features and substantive features (those features typically occurring in N) such as [human], [place], [time] etc., which captures a matching relation between Head and operator expressions: *the person who, the thing which, the reason why*. . .

- (35) $[[_{CP} OP_i [_{IP} \dots t_i \dots] \text{Head}_i]$

In this representation, the trace is derived by movement of an operator, not by movement of the Head, which is base-generated at its surface position.

Support for the existence of operator movement comes from the relevance of locality conditions. The following examples show that adjunct relativization cannot leave a gap inside an island, even though a long-distance dependency relation is allowed:

- (36) a. *zhe jiu shi [[ta renwei [ni yinggai t_i zuo zhejian shi de] fangfa]_i*
 this exactly is he think you should do this matter De method
 ‘This is the way that he thinks you should do this work.’
 b. *zhe jiu shi [[ta renwei [nimen t_i yinggai likai] de] yuanyin]_i*
 this exactly is he think you should leave De reason
 ‘This is the reason why he thinks you should leave.’
- (37) a. **zhe jiu shi [[[[ta xihuan [t_i zuo zhejian shi] de] ren] de] fangfa]_i*
 this exactly is he like do this matter De person De method
 ‘This is the way that he likes the person that does the work (how).’
 c. **zhe jiu shi [[[[ruguo ta t_i shengqi] ni hui bu gaoxing] de] yuanyin]_i*
 this exactly is if he angry you will not happy De reason
 ‘This is the reason(x) that you will not be happy if he gets angry (because of) x’

The existence of some in-situ *wh*-adjuncts in relative constructions further supports the analysis of operator movement. Relevant cases are constructions with an in-situ *why* inside a relative clause, the relative Head being the noun ‘reason’. And, to a certain degree, *how* behaves similarly.¹⁷ We elaborate this further in the following paragraphs.

There is an interesting usage of *weishenme* ‘why’ and *zhenme* ‘how’ in Chinese relatives. They can occur ‘resumptively’ within a relative clause when the Head is *yuanyin/liyou* ‘reason’ for ‘why’, *fangfa* ‘method’, or *yangzi* ‘manner’ for ‘how’. This contrasts with other *wh*-words which cannot be so used.

- (38) a. *?[[ta ruhe/zhenme_i xiu che de] fangfa]_i, meiren zhidao.*
 he how fix car De method nobody know
 ‘Nobody knows the way (how) he fixed the car.’
 b. *[[ta weishenme_i bu lai de] yuanyin]_i, meiren zhidao.*
 he why not come De reason nobody know
 ‘Nobody knows why he fixed the car.’
 c. *[[ni kandao ta_i/*shei_i mama de] xiaohai]_i*
 you see he/who mother De child
 ‘the child whose mother you saw’
 d. **[[ni zai shenme shihou_i lai de] shihou]_i*
 you at what time come De time
 ‘the time when you came at what time’

These in-situ *wh*-words can be related to the Head noun across clausal boundaries:

- (39) a. *?zhe jiu shi [ta juede [ni yinggai ruhe/zenme_i xiu che] de] fangfa_i.*
 this exactly is he feel you should how fix car De method
 ‘This is the way_i (how_i) he feels you should fix the car t_i.’
 b. *zhe jiu shi [women renwei [ta weishenme_i mei lai] de] yuanyin_i.*
 this exactly is we thought he why not come De reason
 ‘This is the reason_i why_i we thought he did not come t_i.’

However, it is not acceptable to have such in-situ *wh*-words within an island:

- (40) a. **zhe jiu shi [[[ruguo ta weishenme_i shengqi] ni hui bu gaoxing] de] yuanyin_i]*
 this exactly is if he why angry you will not happy De reason
 ‘This is the reason that you will not be happy if he gets angry why’
 b. **zhe jiu shi [[[ruguo ta zenme_i xiu che] ni hui bu gaoxing] de] fangfa_i]*
 this exactly is if he how fix car you will not happy De method
 ‘This is the way that you will not be happy if he fixes cars how’

What is such an in-situ *wh* and why is it only restricted to *weishenme* ‘why’ and *zenme* ‘how’? We suggest below that these are the type of *wh*-words that are more quantificational than other *wh*-phrases.

As mentioned at the beginning of this work, a *wh*-word in Chinese generally is not inherently quantificational (see (2a-c)). It can have interrogative or non-interrogative interpretations, such as existential or universal readings, according to the contexts. It was therefore proposed that a Chinese *wh*-word does not contain Quantification and is interpreted according to its licenser. However, ‘why’ and ‘how’ do not occur as easily in the varieties of contexts that allow other *wh*-phrases(2a-c).

- (41) a. **ta hui weishenme hen hao ming ma?*
 he will why very good fortune Q
 ‘Will he get lucky for some reason?’
 b. *??ta hui zenme xiu che ma?*
 he will how fix car Q
 ‘Will he fix cars in some way?’
- (42) a. **ruguo ta weishenme hao ming, ni jiu hui yinwei na-ge yuanyin hao ming.*
 if he why good fortune you then will because that-Cl reason good fortune
 b. **ruguo ta zenme xiu che, ni jiu yinggai yong na-ge fangfa xiu che.*
 if he how fix car, you then should use that-Cl method fix car

Bare conditional contexts (see Cheng and Huang 1996) are the most acceptable:

- (43) a. *ta weishenme meiyou lai, wo jiu weishenme meiyou lai.*
 he why not come I then why not come
 ‘I did not come for the same reason he did not come.’

- b. *ta zenme xiu che, ni jiu yinggai zenme xiu che.*
 he how fix car, you then should how fix car
 ‘You should fix cars in the same way he fixes cars.’

The *wh*-phrases in cases like (2a-c) are viewed as variables or polarity items (restriction only) bound/licensed by some quantifier in the context. The much narrower distribution of *weishenme/zenme* indicates that such *wh*-words are the least variable-like among all the *wh*-words in Chinese. That is, they are more like operators (quantificational elements).¹⁸

When *weishenme/zenme* can be analyzed as operators in instances such as (38)-(40), they undergo movement covertly to the Spec of Comp position of a relative clause (the *wh*-operator movement analysis). This accounts for the locality condition on the distribution of such *wh*-words. The other *wh*-phrases are never operators themselves. They, therefore, do not have the same distribution as ‘why’, and ‘how’ and do not undergo movement. ‘Why’ and ‘how’ inside a relative clause therefore are more like an in-situ relative operator, as found in Hindi (Mahajan 2000).

The existence of such constructions provides further support for the availability of operator movement to derive a relative clause. The relevance of locality conditions and long-distance dependency relations argue for the existence of movement. Moreover, such cases do not allow reconstruction, which argues against movement to the Head position directly:

- (44) *[[*meige ren_i dou zhidao ni weishenme_j likai de*] [*gen ta_i(de) yiyang de yuanyin*]_{*j*}]
 every one all already know you why leave De with his same De reason
 ‘the reason that was the same as his that everyone already knew you left why’

Briefly summarizing, if the Head is directly moved from the relative clause, the Head and the gap in the relative clause must be of the same category. Because the Head is an NP, it indicates that what is moved is an NP and consequently the gap is an NP. An NP is not a PP or Adv. In contrast, an operator moved to the Spec of Comp can be the equivalent of a PP or Adv. Accordingly, when the gap is equivalent to a PP or Adv, it is not derived by NP movement to the Head position. It is derived by operator movement.

Significantly, even though NP-relativization and PP/Adv relativization both yield a gap in the relative clause, the gaps in these two constructions behave differently with respect to reconstruction. In contrast to the argument relativization cases in (30a-b) which allow reconstruction, the adjunct relativization cases in (30c-d) do not show reconstruction effects, as noted in (44). More examples showing the same contrast are provided below:

- (45) a. relativization from the subject argument position
*[meige xuesheng_i dou renwei t_j zui hao de] [ni gei ta_i de liwu]_{*j*}*
 every student all think most good De you give him De present
 ‘the present that you gave to him that everyone thought was the best’
 b. relativization from the object argument position
*[wo xiwang meige xuesheng_i dou neng dai t_j lai de] [wo gei ta_i de liwu]_{*j*}*
 I hope every student all can BA his book bring come De I give him De present
 ‘the present that I gave to him_i that I hope every student_i will bring’

(46) a. relativization of ‘how’ expressions

*[[wo xiwang meige ren_i dou neng xiu-hao che de] (na-ge) [wo gen ta_i ti-guo de
I hope every one all can fix-well car De that-Cl I with him mention-Asp De
fangfa]]
method

‘the method that I have mentioned to him that I hope everyone can fix the cars’

cf.

b. wo xiwang meige ren_i dou neng yong wo gen ta_i ti-guo de fangfa xiu-hao che.
I hope every one all can use I with him mention-Asp De method fix-well car
‘I hope everyone will use the method that I mentioned to him to fix cars.’

c. zhe jiu shi [[wo xiwang ta neng xiu-hao che de] (na-ge) [wo gen ta ti-guo de
this exactly is I hope he can fix-well car De that-Cl I with him mention-Asp De
fangfa]]
method

‘This is the method that I have mentioned to him that I hope he can fix the cars.’

(47) a. relativization of ‘why’ expressions

*[[wo yiwei meige ren_i dou bu neng lai de] (na-ge) [ni gaosu-guo ta_i mama de
I thought every one all not can come De (that-Cl) you tell-Asp his mother De
yuanyin]]
reason

‘the reason that you told his mother that I thought everyone cannot come’

cf.

b. meige ren_i dou yiwei wo hui yinwei ta_i mama bu yunxu bu lai.
every one all think I will because his mother not permit not come
‘Everyone thought I would not come because his mother did not permit to.’

c. zhe jiu shi [[wo yiwei ta bu neng lai de] (na-ge) [ni gaosu-guo ta mama de
this exactly is I thought he not can come that-Cl De you tell-Asp his mother De
yuanyin]]
reason

‘the reason that you told his mother that I thought he cannot come’

In brief, with NP relativization, the gap in a relative clause can be the trace derived by NP movement to the Head position. Reconstruction of the relative Head is available. In contrast, the gap in PP/Adv relativization cases is derived by operator movement and is not a trace derived by NP movement to the Head position. Therefore, reconstruction of the Head to the gap position should not be available. These structures and derivations are summarized below:

(48) NP relativization

[[_{CP} [_{IP} ... [_{NP} t_i] ...] [_{Head} NP]_i]

–direct NP movement to Head

–reconstruction of the Head to *t* possible

(49) Adjunct relativization

[[_{CP} OP_i [_{IP} ... [_{PP} t_i] ...] [_{Head} NP]]

–Head base-generated, OP movement to Spec of Comp

–reconstruction of the Head to *t* impossible

There are other relative constructions involving coindexing (chain-binding); yet, reconstruction is not available at all. This concerns the use of a resumptive pronoun in relative constructions.

3.3.2. Resumption

Relative constructions in Chinese can also be derived by a resumption strategy: the position from which relativization originates is filled by a resumptive pronoun. The following examples, for instance, contain a pronoun in the relative clause coindexed with the Head noun. Importantly, reconstruction is not available even with anaphors or bound pronouns:

(50) a. **wo xiang kan [[ni shuo meige ren_j hui dai ta_i hui lai de] [ziji_j de pengyou]_i]*

I want see you say every one will bring him back De self De friend

‘I want to see self’s friend that you said that everyone would bring back.’

b. **wo xiang kan [[ni shuo meige ren_j hui dai ta_i huilai de] [wo jieshao-guo gei ta_j de*

I want see you say every one will bring back over De I introduce-Asp to him De

pengyou]_i]

friend

‘I want to see the friend that I have introduced to him that you said everyone would bring back.’

In these instances, an overt pronoun occurs where relativization originates; i.e., a resumptive pronoun appears in the relative clause. Reconstructing the Head to the pronoun position is not available, as indicated by the unacceptability of the binding of the anaphor or the bound pronoun by the QP within the relative clause. This contrasts with the following cases where an empty category replaces the lexical pronoun and reconstruction becomes available:

(51) a. *wo xiang kan [[ni shuo meige ren_j hui dai ∅_i huilai de] [ziji_j de pengyou]_i].*

I want see you say every one will bring back De self De friend

‘I want to see self’s friend that you said that everyone would bring back.’

b. *wo xiang kan [[ni shuo meige ren_j hui dai ∅_i huilai de] [wo jieshao-guo gei ta_j de*

I want see you say every one will bring back De I introduce-Asp to him De

pengyou]_i].

friend

‘I want to see the friend that I have introduced that you said everyone would bring back.’

(50), involving resumptive pronouns, can be made acceptable by not forcing the reconstructed interpretation; i.e., reconstruction does not apply. Thus, if the index of the resumptive pronoun is changed to a different one, such as *k*, the sentences are acceptable; so is the following sentence which does not contain an anaphor or a bound pronoun.

- (52) wo xiang kan [[ni shuo Zhang hui dai ta; huilai de] [xiaohai]_i]
 I want see you say Zhang will bring him back De child
 ‘I want to see the child that you said that Zhang would bring back.’

The picture presented so far is this: a gap in an argument position of a relative clause allows reconstruction; whereas a resumptive pronoun does not allow reconstruction. However, the resumptive pronoun must also be coindexed with the Head. This provides further evidence showing that, even to interact with Binding Theory, reconstruction is available only when movement takes place.

We, thus, have seen two cases that can form chains but do not allow reconstruction of the Head: cases involving operator movement and cases involving resumption. Reconstruction of the Head is correlated with movement, not formation of chains. The reconstruction facts summarized in (24), consequently, argue for NP-movement. If an NP is moved from and reconstructed to an argument position in argument relativization cases, it must first be generated in an argument position. This, again, supports our claim that an NP can be base-generated in an argument position in Chinese.

4. Conclusion

Beginning with NP/DP distinctions, this work showed that the behavior of *wh*-words in Chinese should lead us to expect that it is possible to generate a restriction alone (represented as an NP) in an argument position, bound by an operator outside the nominal expression. The generation of an NP in an argument position is not unrestricted. It is only when an operator can be separated from a restriction that a restriction-only expression occurs in an argument position and that an NP in an argument position is projected. That is, a DP need not be projected in an argument position in languages like Chinese but is required in languages like English. The fact that an NP can be generated in an argument position in Chinese is further supported by the cases involving the plural marker *-men* and the derivation of various relative constructions in this language. The Chinese facts, in turn, suggest that this language does not utilize a semantic type-shifting rule to turn a predicate (NP) into an argument (DP) whenever an NP is in an argument position. Indeed, if such a rule applied, the correlation of NP projections with the behavior of *wh*-words cannot be established and we would lose the account for when an NP projection is available. Moreover, any NP/DP distinction in languages like Chinese would be lost (because an NP would be like a DP after type-shifting). We would also lose the account for the distribution of *-men*. Similarly, there would be no account for why reconstruction effects exhibited in Chinese relative constructions appear to be inconsistent (especially when chain-binding cannot provide an adequate account) and why English and Chinese relative constructions should differ in reconstruction effects in the way they do.

Notes

- 1 Subsequent developments have established a number of functional projections between DP and NP (see Cinque 1990, Picallo 1991, among others). Also see Carstens 1991, Valois 1991, Ritter 1991, 1995, Li 1998, among others, for a number projection, see Tang 1990, Li 1999a,b, Cheng and Sybesma 1999 for a classifier projection.
- 2 See Stowell (1989) for some complications.
- 3 However, this raises questions on how it should be analyzed in compositional semantics.
- 4 For discussions on Japanese *wh*-words along this line of research, see Cheng (1991), Watanabe (1992), Aoun and Li (1993a, b), Tsai (1994), Hagstrom (1998), Miyagawa (2001), among others.
- 5 Note that even in English, it is possible to interpret an indefinite nominal as a variable. Its interpretation can also be determined by a quantifier to be generated in a position separate from the indefinite expression (Lewis 1975, Kamp 1981, Heim 1982). For instance, the indefinites in the following sentences (from Diesing, 1992, 5) can vary in quantificational force depending on the context in which they appear.
 - (i) a. A contrabassoonist usually plays too loudly.
b. Most contrabassoonist play too loudly
 - (ii) a. Cellists seldom pay out of tune.
b. Few Cellist play out of tune.

To be noted, however, is that the indefinite noun phrases in such cases are still structurally headed by a determiner (an indefinite determiner which is *a* or null). In other words, even though, semantically, such indefinite noun phrases are interpreted as variables, their D position is occupied syntactically. English simply does not generate a restriction only in an argument position. Such a D may be occupied by an anaphoric element that is coindexed with the operator outside this DP (see Borer 2000).

- 6 *Men* has been termed as either a plural marker or a collective marker (cf. Chao 1968, Li and Thompson 1981, Iljic 1994). A nominal with a collective marker denotes a group anchored by one individual. For instance: *xiaozhang-men* ‘principal-collective marker’ denotes a group consisting of a principal and his/her guests or assistants (those in his/her group). A nominal with a plural marker expresses plurality of entities. For instance, *xiaozhang-men* ‘principal-plural marker’ means more than one principals (plural). It was suggested in Li (1999a) that the plural property is due to the realization of *-men* with an N and the collective property, *-men* with a D.
- 7 The demonstratives *zhe-xie* ‘these’, *na-xie* ‘those’ originated as *zhe/na-yi-xie* ‘this/that-one-Cl’. The frequent use of such expressions, however, have made it possible to drop the number *yi* and re-analyze *zhe/na-xie* as demonstratives in D position. Such re-analyzed demonstratives can take a classifier: *zhe/na-xie-ge xuesheng* ‘these/those-Cl student (these/those students)’.
- 8 This and the following sentence are acceptable without *-men*.
- 9 Questions arise as to how indefinite bare NPs and indefinite expressions of the form [Num + Cl + N], such as *san-ge-ren* ‘three-Cl-person’ are distinguished. What is clear is that, when there is an overt Number and Classifier, these categories must be projected. That is, expressions with a number and a classifier have Number and Classifier projections. What is not clear is whether D is also projected for such expressions. If it is preferable to maintain a unified structure, for instance, a D only hosting [+definiteness] in Chinese, these expressions will not project a D. However, they do need to be bound by an operator in order to become an individual-denoting expression. Further note that [Num + Cl + N] expressions can be quantificational expressions bearing a scope relation with other QPs. In such cases, it is possible to analyze the Num as a Q projection or Num is raised to a higher Q projection. Either way, a null D need not occur.
- 10 For convenience, we will use the capitalized ‘Head’ to refer to the nominal expression that is ‘modified’ by the relative clause, even though in the structure under the promotion analysis, like

the one in (11), the ‘Head’ is in the Spec of the CP, which is not the syntactic head of the projection.

11 Kayne suggests that an NP such as *man* in (i) below, undergoes raising:

(i) [_{DP} [_D the] [_{CP} [_{NP} man] [_C that [_{IP} came here]]]]

Borsley (1997), however, argues against NP raising because the trace generated by the movement behaves like an argument, i.e., a DP. Accordingly, Bianchi (1999) suggests that what is raised is a DP with a null D. Such a null D is licensed by an external D, the overt *the* in (ii). The NP associated with the null D also provides an NP for the external D to be interpreted with.

(ii) [_{DP} [_D the] [_{CP} [_{DP} ∅ man] [_C that [_{IP} came here]]]]

12 The idiom *chi-cu* ‘eat vinegar’, meaning ‘jealous’, has a [V + O] structure.

13 *You-mo* is a transliteration of the English expression ‘humor’. It takes on a [V + O] structure, as illustrated in (i) below, with the first syllable analyzed as a verb and the second as an object of the verb:

(i) *ta hen xihuan you nide mo.*
 he very like **hu-** your **-mor**
 ‘He likes to **humor** you.’

14 A number and classifier expression and even a demonstrative can still occur in those instances that allow reconstruction of the Head, such as the examples below. What matters is that, in these instances, what is reconstructed can still be just the NP part, excluding the demonstrative and classifier; i.e., only NPs are reconstructed. The relative clause is raised from an NP-adjoined position to a higher projection, and since NPs reconstruct in Chinese, reconstruction effects do appear (in this case, Binding Principle C), as expected:

- (i) a. *zhe jiu shi Zhangsan_i yiwei women yijing kan-guo de you guan ta_i fuqin de na-fen baodao*
 this exactly is Zhangsan think we already seen De have relation he father De that-Cl report
 ‘This is the report about his father that Zhangsan thinks that we have already seen.’
 b. **zhe jiu shi ta_i yiwei women yijing kan-guo de you guan Zhangsan_i fuqin de na-fen baodao*
 this exactly is he think we already seen De have relation Zhangsan father De that-Cl report
 ‘This is the report about Zhangsan’s father that he thinks that we have already seen.’
 c. **zhe jiu shi wo cai ta_i yiwei women yijing kan-guo de you guan Zhangsan_i fuqin de na-fen baodao.*
 report
 ‘This is the report about Zhangsan’s father that I guess he thinks that we have already seen.’
 d. *zhe jiu shi renshi ta_i de ren dou yiwei women yijing kan-guo de you guan Zhangsan_i fuqin de na-fen baodao*
 De that-Cl report
 ‘This is the report about Zhangsan’s father that the people that knows him think that we have already seen.’

These examples concerning the effect of Principle C manifested in relative constructions are especially interesting considering the distinction between argument and adjunct structures in English noted by Lebeaux (1988). For lack of space, we will not pursue this issue here.

15 Although time and place expressions often occur with the marker *zai* ‘at’, it is not clear that time and place expressions are true PPs and behave like adjuncts. Native speakers’ judgments

are uncertain. We will therefore only use canonical adjunct expressions ‘how’ and ‘why’ to distinguish adjuncts from arguments.

- 16 This only applies to adjunct relativization. Argument relativization is derived by Head-raising as shown in section 2.2.
- 17 The judgements concerning ‘how’ fluctuates more with different speakers, much like the fact that its acceptability in various non-interrogative usages also fluctuates. We will neglect such fluctuations for the rest of the discussions.
- 18 This does not rule out the possibility that they are ambiguous, however. For instance, the fact that they can occur in bare conditional contexts suggests that they can still function like variables (restrictions). The restrictive use, however, still requires much further investigation.

References

- Abney, Steven. (1987) The English noun phrase in its sentential aspect. Doctoral dissertation, MIT, Cambridge, Mass.
- Aoun Jopseph and Yen-hui Audrey Li. (1993a) *Wh*-elements in situ: Syntax of LF? *Linguistic Inquiry* 24, 199–238.
- Aoun Jopseph and Yen-hui Audrey Li. (1993b) On some differences between Chinese and Japanese *wh*-elements. *Linguistic Inquiry* 24, 365–372.
- Alexiadou, Artemis, Paul Law, Andre Meinunger and Chris Wilder (eds.). (2000) *The syntax of relative clauses*. John Benjamins Publishing Co., Amsterdam, Netherlands
- Barss, Andrew. (1986) Chains and anaphoric dependence. Doctoral dissertation, MIT, Cambridge, Mass.
- Bianchi, Valentina. (1999) *Consequences of Antisymmetry: headed relative clauses*. Mouton de Gruyter, New York.
- Bianchi, Valentina. (2000) The raising analysis of relative clauses: a reply to Borsley. *Linguistic Inquiry* 31, 123–140.
- Borer, Hagit. (2000) Exo-skeletal vs. endo-skeletal explanations: syntactic projections and the lexicon, to appear in Maria Polinsky and John Moore (eds.) *Explanation in Linguistic Theory*.
- Borsley, Robert D. (1997) Relative clauses and the theory of phrase structure. *Linguistic Inquiry* 28, 629–647.
- Browning, Marguerite A. (1987) Null operator constructions. Doctoral dissertation, MIT, Cambridge, Mass.
- Carlson, Gregory. (1977) Reference to kinds in English. Doctoral dissertation, University of Mass, Amherst, Mass.
- Carstens, Vicki. (1991) The morphology and syntax of determiner phrases in Kiswahili, Doctoral dissertation, University of California, Los Angeles, California.
- Cecchetto, Carlo and Gennaro Chierchia. (1999) Reconstruction in dislocation constructions and the syntax/semantics interface. In Kimary Shahin, Susan Blake and Eun-Sook Kim (eds.), *The Proceedings of the Seventeenth West Coast Conference on Formal Linguistics*. Center for the Study of Language and Information, Stanford, California.
- Chao, Yuen-Ren (1968) *A Grammar of Spoken Chinese*. University of California Press, Berkeley, CA.
- Cheng, L.S. Lisa. (1991) On the typology of *wh*-questions. Doctoral dissertation, MIT, Cambridge, Mass.
- Cheng, L.S. Lisa and C.-T. James Huang. (1996) Two types of donkey sentences. *Natural Language Semantics* 4, 121–163.
- Chierchia, Gennaro. (1998) Reference to kinds across languages. *Natural Language Semantics* 6, 339–405.
- Chomsky, Noam. (1977) On *wh*-movement. in *Formal Syntax*, In Peter Culicover, Thomas Wasow, Adrian Akmajian (eds.) Academic Press, New York, 71–132.
- Choueiri, Lina. (2002) Re-visiting relatives: issues in the syntax of resumption and restrictive relatives. Doctoral dissertation, University of Southern California, Los Angeles, CA.

- Cinque, Guglielmo. (1990) *Types of A'-dependencies*. MIT Press, Cambridge, Mass.
- Diesing, Molly. (1992) *Indefinite*. MIT Press, Cambridge, Mass.
- Hagstrom, Paul. (1998) Decomposing questions. Doctoral dissertation, MIT, Cambridge, Mass.
- Heim, Irene. (1982) The semantics of definite and indefinite noun phrases. Doctoral dissertation, University of Mass, Amherst, Mass.
- Iljic, Robert. (1994) Quantification in Mandarin Chinese: two markers of plurality. *Linguistics* 32, 91–116.
- Kamp Hans. (1981) A theory of truth and semantic representation, in J. Groenendijk, T. Janssen and M. Stokhof (eds.) *Formal methods in the study of language*, Mathematical Centre, Amsterdam, 277–321.
- Kayne, Richard. (1994) *The antisymmetry of syntax*. MIT Press, Cambridge, Mass.
- Lebeaux, David. (1988) Language acquisition and the form of grammar. Doctoral dissertation, University of Mass., Amherst, Mass.
- Lewis, David. (1975) Adverbs of quantification, in Edward Keenan (ed.) *Formal semantics of natural languages*, Cambridge University Press, Cambridge, 3–15.
- Li, Charles and Sandra Thompson, (1981) *Mandarin Chinese: a functional reference grammar*. University of California Press, Berkeley, CA.
- Li, Yen-hui Audrey. (1998) Argument determiner and number phrases. *Linguistic Inquiry* 29, 693–702
- Li, Yen-hui Audrey. (1999a) Plurality in a classifier language. *Journal of East Asian Linguistics* 8, 75–99.
- Li, Yen-hui Audrey. (1999b) Form and function correspondence: structures and interpretations of nominal expressions in Mandarin Chinese. In Yukinori Takubo (ed.) *Comparative syntax of Japanese, Korean, Chinese and English*, Report of the International Scientific Research Program, Ministry of Education, Science and Culture, Japan, 147–186.
- Li, Yen-hui Audrey. (2000) Universal constructions? relativization in English and Chinese, NACCL 12 proceedings.
- Longobardi, Giuseppe. (1994) Reference and proper names. *Linguistic Inquiry* 25, 609–666.
- Mahajan, Anoop. (2000) Relative asymmetries and Hindi correlatives. In Artemis Alexiadou, Paul Law, Andre Meinunger and Chris Wilder (eds.) *The syntax of relative clauses*. John Benjamins Publishing Co., Amsterdam, Netherlands, 201–230.
- Miyagawa, Shigeru. (2001) The EPP, scrambling and *wh*-in-situ. In Michael Kenstowicz and Ken Hale (eds.) *A life in Language*. MIT Press, Cambridge, MA, 293–338.
- Ning, Chun-yuan. (1993) Theory of relativization in Chinese. Doctoral dissertation, University of California, Irvine, CA.
- Nishigauchi, Taisuke. (1990) *Quantification in the theory of grammar*. Kluwer Academic Publishers, Dordrecht.
- Picallo, Carme. (1991) Nominals and nominalization in Catalan. *Probus* 3, 279–316.
- Ritter, Elizabeth. (1991) Two functional categories in noun phrases: evidence from modern Hebrew. In Susan Rothstein (ed.) *Syntax and Semantics 25: Perspectives on Phrase Structure*, Academic Press, New York, 37–62.
- Ritter, Elizabeth. (1995) On the syntactic category of pronouns and agreement, *Natural Language & Linguistic Theory* 13, 405–443.
- Rygaloff, Alexis. (1973) *Grammaire Elementaire du Chinois*, Presses Universitaire de France, Paris.
- Safir, Ken. (1986) Relative clauses in a theory of binding and levels. *Linguistic Inquiry* 17, 663–689.
- Schachter, Paul. (1973) Focus and relativization. *Language* 49, 19–46.
- Stowell, Tim. (1989) Subjects, specifiers and X-bar theory. In Mark Baltin and Anthony Kroch (eds.) *Alternative conceptions of phrase structure*. University of Chicago Press, Chicago, 232–262.
- Szabolsci, Anna. (1983/84) The possessor that ran away from home. *The Linguistic Review* 3, 89–102.

- Tang, Chih-chen Jane. (1990) Chinese phrase structure and the extended X'-theory. Doctoral dissertation, Cornell University, Ithaca, New York.
- Travis, Lisa. (1984) Parameters and effects of word order variation, Doctoral dissertation, MIT, Cambridge, Mass.
- Tsai, Wei-tien Dylan. (1994) On economizing the theory of A-bar dependency. Doctoral dissertation, MIT, Cambridge, Mass.
- Valois, Daniel. (1991) The internal syntax of DP and adjective placement in French and English, *NELS 21*, Proceedings of the 21st Conference of the Northeast Linguistic Society, Université du Québec a Montreal, 367–382.
- Vergnaud, Jean-Roger. (1974) French relative clauses. Doctoral dissertation, MIT, Cambridge, Mass.
- Watanabe, Akira. (1992) Subjacency and S-Structure movement of *wh*-in-situ. *Journal of East Asian Linguistics* 1, 255–291.
- Yorifuji, Atsushi. (1976) Men ni tsuite [A Study of the Suffix-*men*]. *Area and Cultural Studies* 26, 73–88.

COPYING VARIABLES*

Yoshihisa Kitagawa

1. Introduction

It is well known that ellipsis involving a proform as its part can exhibit flexibility in anaphoric interpretations – often in somewhat unexpected ways. In this work, I will attempt to show that when we clarify how anaphora involved as part of ellipsis comes to be represented in covert syntax, we will also have a better understanding of the way the so-called E-type anaphora (including donkey anaphora) is represented in covert syntax. In particular, I will first point out that ellipsis can provide a type of strict identity interpretation for a ‘reconstructed’ proform which is akin to the interpretation recognized in the E-type anaphora. I will then argue that the parallelism between the two constructions arises due to the involvement of the same operation of ‘reconstruction’ in the form of copying applying in covert syntax. It should be made clear at this point that the research presented in this work deals mostly with the syntactic aspects of these phenomena and leaves out their semantics. We will, in other words, attempt to answer the question what syntactic operations are responsible for the semantic characteristics of these constructions and how they should be represented at LF, but will leave unanswered the question how they should be represented semantically. In the final part, I will extend the proposed analysis to donkey anaphora, critically examining some alternative approaches.



The theoretical framework I will adopt in this work is one version of the minimalist program. I will, for instance, follow Chomsky (1995) and assume that grammar is constrained by various types of ‘minimalism’ imposed by the Bare Output Conditions and certain economy conditions. Clearly departing from the standard minimalist assumption, however, I will attempt to advocate an approach in which covert syntax can be driven by factors other than formal feature checking.¹ I will hypothesize, in particular, that covert syntax can be triggered by any factor that achieves legitimacy of syntactic objects at LF.

Implementing this working hypothesis, we can, for instance, offer a very simple account of the well-known ambiguity observed in VP-Ellipsis in (1).

- (1) John loves his wife, and Bill does [_{VP} e], too.

In particular, the two distinct interpretations of the second clause – ‘Bill loves his own wife’ (sloppy identity) and ‘Bill loves John’s wife’ (strict identity) – can be captured in

terms of the two distinct orders in which ‘linking’ (for syntactic binding) and ‘copying’ (for the reconstruction of the elided VP) can apply as covert syntactic operations (Kitagawa (1991b), cf. Williams (1977)). For instance, as illustrated by the derivation in (2) below, sloppy identity arises when nominal binding applies **after** the reconstruction of the VP takes place.

- (2) a. LF_i: John₁ [_{VP} loves his wife], and Bill does [_{VP} love **his wife**], too.

 b. LF_j: John₁ loves **his** wife, and Bill₂ does [_{VP} love **his wife**], too.

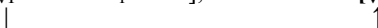

Sloppy identity arises in (1), in other words, when the VP containing an **unbound** proform is reconstructed at the ellipsis site. Strict identity arises, on the other hand, when the VP containing a **bound** proform is reconstructed. That is, when syntactic binding applies before VP-reconstruction applies, as illustrated by the derivation in (3).²

- (3) a. LF_i: John₁ [_{VP} loves **his** wife], and Bill does [_{VP} e], too.

 b. LF_j: John₁ [_{VP} loves his₁ wife], and Bill does [_{VP} love **his₁ wife**], too.

A virtually identical analysis permits us to capture the sloppy-strict ambiguity observed in the empty nominal (or DP-Ellipsis) construction in Japanese as in (4).³

- (4) *John-wa* [_{DP} **zibun-no** *ansyoo-bangoo*]-o *wasuretesimatteita ga*,
 -TOP self-GEN PIN.number-ACC forgot though
Okusan-wa [_{DP} e] *oboeteita*.
 Wife-TOP remembered
 ‘While John forgot his PIN number, his wife remembered { his / her } PIN number.’

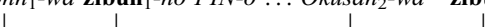
Here, the elided DP can be interpreted either as ‘John’s wife’s own PIN number’ (sloppy identity) or ‘John’s PIN number’ (strict identity), and each of these readings can be ascribed to the distinct order in which the two covert operations applied. When the reconstruction of DP takes place first, and then the syntactic binding of *zibun* ‘self’ does as in (5) below, an **unbound** proform is reconstructed at the ellipsis site, and sloppy identity arises.

- (5) a. LF_{i*}: *John-wa* [_{DP} *zibun-no PIN*]-o ... *Okusan-wa* [_{DP} **zibun-no PIN**]-o ...

 b. LF_k: *John*₁-wa **zibun**₁-no *PIN*-o ... *Okusan*₂-wa **zibun**₂-no *PIN*-o ...

When the order of application is reversed as in (6) below, on the other hand, a **bound** proform is reconstructed at the ellipsis site, and strict identity arises.⁴

- (6) a. LF_i: *John*₁-wa [_{DP} **zibun**₁-no PIN]-o ... *Okusan*₂-wa [_{DP} **e**] oboete...
- └──────────────────┘
- b. LF_k: *John*₁-wa [_{DP} *zibun*₁-no PIN]-o ... *Okusan*₂-wa [_{DP} **zibun**₁-no PIN]-o ...
- └──────────────────────────────────┘

Finally, this analysis allows us to assimilate certain interpretations of overt pronouns to those involved in the ellipsis constructions we have examined above. The sloppy identity of a ‘pronoun of laziness’ in the celebrated ‘paycheck sentence’ as in (7) below, for instance, arises when the reconstruction of the pronoun’s DP antecedent is followed by the syntactic binding of the contained pronoun as in (8) (cf. Jacobson (1980)). (For ease of explanation, we relate *the man* and *his* directly, disregarding *who* and its trace.)

- (7) The man who gave [_{DP3} **his**₁ paycheck] to his wife is wiser than the man who gave **it**₃ to his mistress.

- (8) a. LF_i: The man₁ who gave [_{DP} his paycheck] to his wife is wiser
└──────────────────────────────────┘
 than the man who gave [_{DP} **his paycheck**] to his mistress.
└──────────────────┘
↑
- b. LF_j: *The man*₁ who gave [**his**₁ paycheck] to his wife is wiser
└──────────────────┘
 than *the man*₂ who gave [**his**₂ paycheck] to his mistress.
└──────────────────┘
↑

While the pragmatics does not permit strict identity in (7), a similar sentence as in (9) below exhibits strict identity, and this interpretation can be derived when the syntactic binding takes place before DP-reconstruction does, as illustrated in (10).

- (9) The man who₁ had [₃ **his**₁ car] stolen suspects the teen-age boy who was staring at **it**₃ from a nearby truck when he left the parking lot.

- (10) a. LF_i: *The man*₁ who had [_{DP} **his**₁ car] stolen suspects the teen-age boy
└──────────────────┘
 who was staring at **it** ...
- b. LF_j: The man₁ who had [_{DP} *his*₁ car] stolen suspects the teen-age boy₂
└──────────────────────────────────┘
 who was staring at [_{DP} **his**₁ car] ...
└──────────────────┘
↑

Kitagawa (1995) argues that a similar covert reconstruction is involved even in the coreference between a name and a pronoun as in (11) below(, in which no ‘deictic’ use, i.e., neither physical nor psychological pointing, is intended for the use of a pronoun.)

- (11) a. LF_i: [*John*₁'s mother] saw *him*₁. ⇒
 b. LF_j: [*John*'s mother] saw *John*
 └──────────────────┘

In the same work, it was pointed out that this ‘LF-reconstruction’ approach to coreference allows us to formally assimilate ‘referential circularity’ as in (12) and ‘i-within-i’ violation as in (13).

- (12) *_i[*His*_i wife] admires [_i *her*_j husband]

- (13) *_i[*his*_i friend]

Note that, in this approach, the coreference between *His*_i and [_i *her husband*] in (12) results in a containment relation after reconstruction by LF-copy takes place as illustrated in (14).

- (14) LF: [[*her husband*](’s) wife] admires [her husband]
 └───┘

This representation eventually yields an infinitely regressive anaphoric relation, which seems to be precisely what is causing ‘i-within-i’ violation (cf. Higginbotham (1983: 404)). A working hypothesis underlying this covert reconstruction approach is that each and every nominal expression satisfies the Bare Output Conditions at LF only as a ‘fully interpretable’ contentful item like a referential expression, an operator or a bound variable. We then expect none of the anaphoric proforms to remain as they are but to undergo some covert syntactic process to turn themselves into legitimate objects at LF. When we try to extend this hypothesis to all types of proforms (with proper adjustments), we end up with postulating an approach which treats ellipsis and pronouns on a par.

Since this approach permits, for instance, a DP antecedent to be reconstructed onto an overt pronoun as in (8a), (10b), (11b) and (14), one may express a concern that it will eventually result in a clash between two lexical expressions. This concern, however, can be dismissed once we decide to: (i) adopt **covert** reconstruction (i.e., LF-copying) of the antecedent in all types of ellipsis constructions, and (ii) adopt the Bare Output Conditions of Chomsky (1995). First, covert reconstruction for ellipsis presupposes the postulation of phonetically empty proforms like [_{VP} *e*] and [_{DP} *e*], which are anaphorically related to their antecedents. In a sense, then, ellipsis is regarded as nothing but a type of anaphora involving a phonetically empty proform. The only distinction between the DP-Ellipsis as in (4) and the anaphora involved in (7), (9), and (11) therefore is that the former involves a phonetically empty proform while the latter involves a lexical (i.e., phonetically non-empty) proform. Furthermore, the Bare Output Conditions, one of the main tenets of the minimalist program, require the phonetic/phonological features of lexical items to be non-existent at the LF-interface. As far as the covert syntax is concerned, in other words, there should not exist any reason to discriminate between the phonetically empty proforms involved in ellipsis and overt proforms like pronouns of laziness. In both cases,

when an anaphoric relation is established between a proform and its **mutually non-c-commanding** antecedent (which perhaps presupposes agreement in one or more of their formal features like category, number, person and gender), the semantic features of the latter is reconstructed onto the former. Based upon such considerations, we can assimilate all of VP-Ellipsis in (1), DP-Ellipsis in (4) and pronouns in (7), (9) and (11), rejecting the view that ellipsis involves full reconstruction at LF while anaphora does not. Note that postulating PF-deletion for ellipsis does not permit us to assimilate pronouns in (7) and (9) to ellipsis. (We will discuss PF-deletion further below.) This provides the general background for the analysis proposed below.⁵

2. Strict identity in ellipsis

Let us now examine the interpretation of VP-Ellipsis in English as in (15) and (16).

- (15) [A statement made by the principal of a boys' school]
 In our school, **every student**_x [_{VP} respects **his**_x teacher], and the parents also expect me to [_{VP} e].
- (16) In this school, **every student**_x [_{VP} respects **his**_x teacher], but unfortunately, the principal doesn't [_{VP} e].

In both these sentences, the first clause involves a proform that is bound by a quantificational antecedent and is interpreted as a variable. When the VP in this clause is interpreted at the ellipsis site, the bound proform *his*_x contained in the VP exhibits a type of 'strict identity,' which includes an interpretation akin to that of the anaphorically used demonstrative *that* and/or *those*. Thus, the elided VP in (15) is interpreted roughly as 'respect **that/those** teacher(s).'⁶

Similar interpretations are obtained also when the antecedent VP contains a bound anaphor *each other* as a possessor as in (17) below, provided that the speaker permits 'couple-internal' reciprocity in its antecedent clause as in (18) to begin with.

- (17) [A statement made by a marriage counselor]
Every couple_x [_{VP} criticizes **each other**_x's odd habits], and quite often, I am also inclined to [_{VP} e].
- (18) **Every couple**_x criticizes **each other**_x's odd habits.

In (15)–(17), ellipsis follows either an infinitival marker *to* or a negated auxiliary verb. It therefore seems inappropriate to reduce the strict identity in (16), for instance, to the pragmatics-based interpretation of *do* as a main verb. The strict identity in question, in other words, seems to be made possible indeed by VP-Ellipsis rather than by the pragmatic control of 'deep anaphora' in the sense of Hankamer and Sag (1976)).⁷

Furthermore, when the bound proforms *their* and *each other* in (19a–b) below are reconstructed at the ellipsis sites, they are interpreted as 'about forty percent of the

students' and 'about forty percent of couples,' respectively, rather than as 'students' or 'couples'.

- (19) a. The survey indicates that, in our school, **about forty percent of the students**_x, quite mistakenly, [_{VP} consider **their**_x SAT scores as satisfactory], but as principal, I must say I cannot [_{VP} e].
 b. [A statement made by a marriage counselor]
About forty percent of couples_x [_{VP} complain about **each other**_x's appearance(s)] even when I can find absolutely no reason to [_{VP} e].

The reconstructed proform in each of these examples, in other words, is intended to refer to the members of the set linguistically specified by the quantified antecedent of the 'original' proform in the antecedent VP rather than to refer to the entire set of 'students' or 'couples,' which, one might claim, is contextually made available.

Moreover, the elided VP in (20) below is interpreted as 'like **each** contestant's performance.'

- (20) The contestants came up to the stage and performed one by one.
Every contestant_x seems to have [_{VP} liked **his**_x performance],
 but *each time*, the judge apparently didn't [_{VP} e].

The availability of this distributive interpretation at the ellipsis site also suggests that the strict identity here is based upon the interpretation of the proform bound by a quantificational element, and that a contextually available set reading as mentioned above is irrelevant. In short, the strict identity in question does **not** seem to arise because of the reference to the pragmatic context but rather due to some syntactically established anaphoric relation.⁸

Returning now to the sentences in (15)–(17), let us provide the observation that their non-elliptical counterparts as in (21) and (22) below are not well-formed. In particular, the proform showing up in the second clause cannot be legitimately bound by its antecedent in the first clause.

- (21) In our school, **every student**_x [_{VP} respects his_x teacher], but unfortunately, the principal doesn't [_{VP} respect ***his**_x teacher].
 (22) **Every couple**_x [_{VP} criticizes **each other**_x's odd habits], and quite often, I am also inclined to [_{VP} criticize ***each other**_x's odd habits].

What this indicates is that when the proforms in (15)–(17) are interpreted at the ellipsis site, they **cannot** undergo the process of syntactic binding in that position. The unsuccessful binding in (21) and (22) also suggests, first, that the ellipsis in (15)–(17) cannot be handled by PF-deletion applying to (21) and (22) as their base-generated and hence LF representations. Second, these ellipsis constructions cannot involve simple and full reconstruction of the **unbound** proform by any of LF-Copy, semantic or pragmatic

accommodation, or a version of the E-type strategy which regards proforms simply as descriptions in disguise.

One may try to account for the grammaticality of (15)–(17) by combining LF-Copy of the antecedent with the ‘vehicle change’ analysis proposed by Fiengo and May (1994). As illustrated in (23), for instance, vehicle change can yield a well-formed LF of (17) with *their* as the ‘pronominal correlate’ of (the trace of) *other*’s.

- (23) LF: **Every couple**_x [_{VP} criticizes **each other**_x’s odd habits], and quite often,
I am also inclined to [_{VP} criticize **their**_x odd habits]

Note that the locality constraint imposed on anaphor binding will be irrelevant at the ellipsis site in (23). A similar analysis applied to (24) below, however, would yield an incorrect result. Notice that vehicle change would incorrectly provide a well-formed LF as in (25) for the ungrammatical sentence (24).

- (24) ?***Every couple**_x [_{VP} criticizes **each other**_x], and quite often,
I am also inclined to [_{VP} e].

- (25) LF: **Every couple**_x [_{VP} criticizes **each other**_x], and quite often,
I am also inclined to [_{VP} criticize **them**_x]

We thus should not make an appeal to vehicle change to deal with the ellipsis in (16), either.⁹

Finally, suppose that one attempts to capture the strict identity in (15) by bringing the second clause containing the reconstructed proform into the domain of its antecedent in the first clause as illustrated in (26) below, along the line of ‘dynamic binding’ (Chierchia (1995), et al.). (The representation is simplified and the irrelevant details are omitted.)

- (26) \forall_x [_{IP} student (x) respect \wedge (x, x’s teacher) \wedge ... respect (I, x’s teacher)]

Even if the reconstructed anaphor in (17) can be brought into the binding domain of *every couple* in a similar way, however, the subject of the second clause *I* (or *PRO* bound by *I*) would remain to be the local binder of the reconstructed anaphor *each other*, and the locality constraint on anaphor binding would still remain unsatisfied.¹⁰ Moreover, quite importantly, it must be assumed that this strategy is not available when the proform to be ‘dynamically bound’ is base-generated as in (21). It therefore would remain unanswered why dynamic binding applies only when ellipsis is involved.

Let us now examine the interpretation of the empty nominal (i.e., DP-Ellipsis) in Japanese as in (27).

- (27) *siritu-daigaku-no dono kyoozyu-ga* [_{DP} *zibun-no gakusee*]-o
private-college-GEN which professor-NOM self-GEN student-ACC
suisensite-mo, Monbusyoo-wa [_{DP} e] *saiyoosi-nai-daroo.*
recommend-ever Ministry.of.Education-TOP employ-not-perhaps

‘No matter which professor of a private college may recommend self’s (= his or her own) student, the Ministry of Education will probably not employ those students.’

In this sentence as well, the first clause involves a proform bound by a quantificational antecedent, and the bound proform contained in the DP exhibits a type of ‘strict identity’ when this DP is interpreted at the ellipsis site. Thus, the elided DP in (27) is interpreted roughly on a par with *sono gakusee* ‘that student’ or *sono kyoozyu-no gakusee* ‘that professor’s student.’ Here again, the non-elliptical counterpart of (27) as in (28) below does not permit a similar interpretation (with or without prosodic reduction of *zibun-no gakusee-o* ‘self’s student-ACC’) since the proform *zibun* ‘self’ showing up in the second clause cannot be legitimately bound by its quantificational antecedent in the first clause.

- (28) *siritu-daigaku-no dono kyoozyu_x-ga* [_{DP} *zibun_x-no gakusee*]-o
suisensite-mo, Monbusyoo-wa [_{DP} **zibun_x-no gakusee*]-o *saiyoosi-nai-daroo*
 *self-GEN student-ACC

This fact forces us to reject the analysis of (27) which lets PF-deletion of an DP apply in the base-generated representation like (28). Any reconstruction of the unbound *zibun* or its dynamic binding will be also inappropriate.

One may also try to account for the grammaticality of (27) by reconstructing only the head nominal from the first clause and derive a representation as in (29), for instance, as in Hoji’s (1998) ‘Supplied N head’ analysis.

- (29) *siritu-daigaku-no dono kyoozyu_x-ga* [_{DP} *zibun_x-no gakusee*]-o
suisensite-mo, Monbusyoo-wa [_{NP = N} **gakusee**]-o *saiyoosi-nai-daroo*.
 student-ACC

‘No matter which professor of a private college may recommend self’s (= his or her own) student, the Ministry of Education will probably not employ **students**.’

Based upon the analysis of empty nominals as NPs rather than DPs, this approach attempts to reduce the strict identity in (27) to the definite interpretation a bare noun in Japanese can exhibit (among other interpretations), as exemplified by (30).

- (30) *John-wa reezaa purintaa-o tukatta.*
 -TOP laser.printer-ACC used
 ‘John used **the** laser printer(s) / a laser printer / laser printers.’

Tomioka (1998), for instance, attempts to derive the definiteness associated with the interpretation of an empty nominal as in (27) by letting the ‘iota’ operation apply to the reconstructed nominal head as in (29). When the representation as in (29) contains a base-generated bare nominal *gakusee* ‘student,’ however, this nominal does not exhibit the interpretation comparable to the empty nominal in (27), but is interpreted as the generic ‘**student**.’ The sentence therefore expresses that the Ministry of Education will probably not employ **any student** (as opposed to, for example, someone who has already

been teaching as a full-time faculty member.) Anyone who attempts to ascribe the strict identity in (27) to the flexible interpretation of bare nominals in Japanese, therefore, would have to explain the absence of a similar interpretation in its base-generated counterpart.

Moreover, the sentence in (27) makes up a quite natural discourse when it is followed by a sentence like (31).

- (31) *kokuritu-dai-no gakusee-zyanai-to-ne.*
 national university-GEN student-must.be
 ‘It’s got to be a student of a **national university**.’

The students referred to by the empty nominal in (27), in other words, must be those from **private colleges** rather than just ‘students.’ The only plausible source of such a reading in (27), however, seems to be the anaphoric relation established by *zibun*, which in turn is contained in the DP *zibun-no gakusee* ‘self’s student,’ the antecedent of the empty nominal. These facts suggest that the reconstructed content of the empty nominal in (27) is not just the head nominal but the entire DP.

To recapitulate so far, we have examined VP-Ellipsis in English as in (32) and (33) (= (15) and (17)) and DP-Ellipsis in Japanese as in (34) (= (27)), all of which can be descriptively characterized as in (35).

- (32) [A statement made by the principal of a boys’ school]
 In our school, **every student**_x [VP respects **his**_x teacher], and the parents also expect me to [VP e].

- (33) [A statement made by a marriage counselor]
Every couple_x [VP criticizes **each other**_x’s odd habits], and quite often, I am also inclined to [VP e].

- (34) *siritu-daigaku-no dono kyoozyu-x-ga* [DP *zibun-x-no gakusee*]-o
 private-college-GEN which professor-NOM self-GEN student-ACC
suisensite-mo, Monbusyoo-wa [DP e] *saiyoosi-nai-daroo.*
 recommend-ever Ministry.of.Education-TOP employ-not-perhaps
 ‘No matter which professor of a private college may recommend self’s (= his or her own) student, the Ministry of Education will probably not employ those students.’

- (35) a. A proform in the first clause is **c-commanded** by its quantificational antecedent and is interpreted as a **bound variable**.
 b. **Ellipsis** is involved in the second clause, and the ellipsis site is **outside** the **c-command** domain of its antecedent.
 c. The proform in the antecedent clause is successfully interpreted also at the ellipsis site despite the **lack of a c-commanding binder**.
 d. This **proform** is interpreted at the ellipsis site as a **definite** description of the members of the set defined by the quantificational antecedent of the original proform.

This definite description, moreover, can be quite comfortably paraphrased into an anaphorically used demonstrative expression like *that* or *those*.

Comparing (32)–(34) with their base-generated counterparts, we have also arrived at the interim conclusion that the derivation of these sentences does not involve any of PF-deletion, reconstruction of unbound proforms or head nominals, vehicle change, and dynamic binding.

This conclusion does not leave us too many options, but suggests, first, that the content of the elided phrase in each of (32)–(34) is **covertly reconstructed** from the antecedent clause, and second, that it is carried out **without** involving the reconstruction of the proform in its **unbound** state. I will therefore adopt the analysis in which the proforms in these sentences are **syntactically bound in the antecedent clause**, and then **covertly copied** into the ellipsis site.¹¹ Under this analysis, since the proform reconstructed at the ellipsis site in each of (32)–(34) has been already bound in the antecedent clause, it need not undergo the covert process of syntactic binding again. It thus escapes binding failure in the second clause of their base-generated counterparts, observed, for example, in (36) (= (21)).

- (36) In our school, **every student**_x [_{VP} respects his_x teacher], but unfortunately, the principal doesn't [_{VP} respect *his_x teacher], too.

This analysis is based upon the working hypothesis that a proform that has undergone syntactic binding maintains its bound status even after it is reconstructed elsewhere in the syntactic representation. This in fact is what we need to assume even for the strict identity involving non-quantificational antecedent of the proform, for example, for the strict identity of the reconstructed *each other* and *zibun* 'self' exhibit in (37) and (38) below, respectively. Recall that both *each other* and *zibun* must be bound to be well-formed at LF (See Footnote 4).

- (37) **They**₁ [_{VP} liked **each other**₁'s papers], and I did [_{VP} e], too.

- (38) *John-wa* [_{DP} **zibun-no** *ansyoo-bangoo*]-o *wasuretesimatteita ga*,
 -TOP self-GEN PIN.number-ACC forgot though
Okusan-wa [_{DP} e] *oboeteita*.
 Wife-TOP remembered
 'While John forgot his PIN number, his wife remembered { his / her } PIN number.'

Recall also that covert copying applies when a proform and its antecedent (and hence an 'elided' phrase and its antecedent as well) **do not c-command** each other.¹² Thus the proposed analysis allows us to capture all the descriptive characteristics of (32)–(34) described in (35) above except for (35d). It must be left unexplicated in this work how exactly the definiteness of the proform that is akin to the interpretation of an anaphorically used demonstrative expression arises at the ellipsis site in (32)–(34). Since the copying of a bound proform plays the central role in the proposed approach, however,

this result is not at all surprising. Note that when we adopt a discourse constraint like the Novelty Condition (Heim (1982)), a copied bound proform should never be allowed to be reintroduced into the discourse as an indefinite item.

The LF-derivation of (16) is provided in (39).

(39) a. *Syntactic Binding*:

LF_i: In our school, **every student**_x respects **his**_{xσ} teacher,

└──────────────────┘
but unfortunately, the principal doesn't [VP e]

b. *VP-Copy*:

LF_i: In our school, every student_x [VP respects his_{xσ} teacher],

└──────────────────────────────────┘
but unfortunately, the principal doesn't [VP respect **his**_{xσ} teacher]
└──────────────────────────────────┘

First, as in (39a), the syntactic binding of *his* takes place in the antecedent clause. Then, as in (39b), *his* as a bound proform (whose bound status is indicated by **a subscript-σ as a purely mnemonic marker rather than as part of a formal representation**) is copied into the ellipsis site as part of the copied antecedent **VP**.

The LF-derivation of the Japanese example (27) is also provided in (40) below, in which *zibun* as a bound proform is copied, this time as part of a copied **DP**-antecedent.

(40) a. *Syntactic Binding*:

LF_i: **siritu-daigaku-no dono kyoozyu**_x-ga [DP **zibun**_{xσ}-no gakusee]-o
suisensite **mo**, └──────────────────┘
Monbusyoo-wa [DP e] *saiyoosi-nai-daroo*.

b. *DP-Copy*:

LF_i: **siritu-daigaku-no dono kyoozyu**_x-ga [DP **zibun**_{xσ}-no gakusee]-o
suisensite **mo**, └──────────────────────────────────┘
Monbusyoo-wa [DP **zibun**_{xσ}-no gakusee]-o *saiyoosi-nai-daroo*.
└──────────────────┘

3. From ellipsis to E-type anaphora

At this point, it is appropriate to bring E-type pronouns as in (41) into the scene.

- (41) a. **Few congressmen** admire Kennedy(, and) **They** are very junior.
b. John owns **some sheep** and Harry vaccinates **them** in the Spring.
c. **A dog** came in. **It** lay down under the table.

E-type pronouns are known to exhibit the properties summarized in (42) (Evans (1977), Evans (1980)).

- (42) a. They have **quantified DPs** as their **antecedents**.

- b. They are **not c-commanded** by their antecedents.
- c. Yet, they are successfully interpreted as **definite** descriptions.

We cannot help noting that the properties of E-type pronouns stated in (42) have much in common with those of the ellipsis constructions in (32)–(34) stated in (35) above. In particular, both phenomena permit an item involved in operator-variable binding to be successfully interpreted in a remote position outside the c-command domain of the involved operator. Also, definiteness arises in the resulting interpretation in both cases, yielding an interpretation akin to that of the anaphorically used demonstrative expression *that* or *those*. I therefore would like to propose and argue that E-type anaphora and the ellipsis constructions in (32)–(34) are almost completely parallel – the syntactic derivation of both phenomena involves identical mechanisms, and they both yield the same type of strict identity, involving the copying of the projection of the category D(eterminer) in its bound state.

Near complete assimilation of the two phenomena can be achieved when we pay attention to the fact that they both involve a quantified element in the antecedent clause, which necessarily induces an operator-variable relation. The first thing we must do is to clarify how such a relation comes to be represented in covert syntax. Let us begin with the raising of the external argument under the Internal Subject Hypothesis. The first sentence in (41) above, for example, will be represented as in (43a) below after this operation takes place.

- (43) a. *Subject Raising:*

Few congressmen_y [_{VP} [**e**]_y admire Kennedy].

- b. *QR:*

LF: **Few**_x [[**D e**]_x congressmen]_y [_{VP} [**e**]_y admire Kennedy]

Let us then assume that a version of Quantifier Raising (QR) applies in covert syntax to the quantificational D(eterminer) head, leaving behind a variable as illustrated in (43b). Note that the operations in (43) accomplish in covert syntax what Heim's (1982) NP-Prefixing and Quantifier Construal do. Alternatively, we may also adopt Chomsky's (1995: 202 ff.) 'Copy plus Deletion' analysis of movement as illustrated in (44).

- (44) a. *Copy for Subject Raising:*

LF_j: [**Few congressmen**] [_{VP} [*Few congressmen*] admire Kennedy]

- b. *QR:*

LF_j: **Few**_x [[**D e**]_x congressmen] [_{VP} **Few**_x [[**D e**]_x congressmen] admire K.]

- c. *LF-deletion under Identity:*

LF_k: **Few**_x [[~~D e~~]_x congressmen] [_{VP} **Few**_x [[**D e**]_x congressmen] admire K.]

In this analysis, the subject raising copies the internal subject and reconstructs it in the external subject position, as illustrated in (44a). Each quantificational D then undergoes QR, as in (44b). Finally, as illustrated in (44c), part of each operator-variable construction in (44b) is deleted under identity in accordance with the Preference Principle for Reconstruction in (45) below, and derives a single operator-variable construction at LF.

(45) Minimize the restriction in the operator position. (Chomsky (1995: 209))

Under either analysis, QR leaves behind a DP which consists of a variable bound by an operator and an NP to be interpreted as the restrictor of this operator as in (46). (Again, the bound status of the variable is indicated by a **subscript-σ** as a **mnemonic marker**.)

(46) Few_x [DP [D e]_{xσ} [NP congressmen]]

In the rest of this work, we will refer to a DP of this type somewhat loosely as ‘**Bound Trace**’ (with the capitals B and T). We then can translate the presence of a quantificational element in (41a–c) into the presence of a ‘Bound Trace,’ and each such Bound Trace is identified as the antecedent of an E-type pronoun as illustrated in (47a–c).

(47) a. LF: Few_x [DP [D e_{xσ}] **congressmen**]_y admire K. **They**_y are very junior.
 b. LF: John owns some_x [DP [D e_{xσ}] **sheep**]_y and Harry vaccinates **them**_y . . .
 c. LF: A_x [DP [D e_{xσ}] **dog**]_y came in. **It**_y lay down under the table.

Suppose now that we are indeed correct in hypothesizing that the interpretation of a pronoun involves the covert copying of its antecedent **when no c-commanding relation exists** between them. Recall also that the Bare Output Conditions prohibit us from discriminating, in covert syntax, overt proforms from phonetically-empty proforms involved in ellipsis. We then can identify a point-by-point parallelism between E-type anaphora and the strict identity observed in the ellipsis constructions in (32)–(34). They both involve a DP as part or whole of the antecedent of some anaphoric item to be interpreted elsewhere in the discourse, and this DP consists of: (i) a projection of D (maximal or minimal) as a proform to be interpreted as a bound variable (e.g., [DP *his*_{xσ}] in (48a) and [D *e*_{xσ}] in (48c) below), and (ii) an NP functioning as the restrictor of the operator (e.g., [NP *teacher*] in (48a) and [NP *congressmen*] in (48c)).¹³

(48) a. VP-Ellipsis in (32): [DP [DP **his**_{xσ}] [NP teacher]]
 b. DP-Ellipsis in (34): [DP [DP **zibun**_{xσ}]-no [NP gakusee]]
 c. E-type Anaphora in (47): [DP [D e_{xσ}] [NP congressmen]]

Since the two phenomena now look parallel, not relating them would strike us as missing some generalization. I therefore would like to propose that our analysis of ellipsis constructions, which we concluded to involve the covert copying of a bound DP-proform, can and should be extended to the analysis of E-type anaphora as well. In particular,

I propose that the LF-derivation of an E-type pronoun involves the copying of a Bound Trace showing up earlier within the discourse. The LF-derivation of the example (41a) is illustrated in (49).

(49) a. *QR*:

LF_i: Few_x [**DP** [**D** e_{xσ}] **congressmen**]_y admire K. **They**_y are very junior.

b. *Copy*:

LF_j: Few_x [_{DP} [_D e_{xσ}] *congressmen*]_y admire K.

[**DP** [**D** e_{xσ}] **congressmen**]_y are very junior.

First, as in (49a), the quantificational D undergoes QR in the first clause. Then, as in (49b), the DP-antecedent containing the trace of the raised D, i.e., our ‘Bound Trace,’ is copied onto the E-type pronoun. The E-type pronoun, thus, comes to be interpreted as a definite description like ‘**those** congressmen,’ in accordance with the Novelty Condition. The copied bound variable of the form [_D e_{xσ}], in other words, is interpreted on a par with something like a demonstrative determiner used anaphorically, for example, like *that* in English or *so* in Japanese.

We can immediately mention a couple of empirical advantages. First, the contrast as in (50) is known to be recalcitrant to approaches which let E-type pronouns be interpreted based upon pragmatic contexts. Note that both sentences in (50) contain a pragmatically equivalent antecedent clause, and hence are predicted to equally allow the subsequent pronoun to be legitimately interpreted, contrary to the fact.

(50) a. *John has a wife* and **she** hates him.

b. **John is married* and **she** hates him.

(Evans (1977: 147))

In the syntactic copying approach like ours, the contrast follows naturally, since in (50a), there exists a Bound Trace to be copied as the antecedent of the pronoun after the indefinite undergoes QR, while in (50b), no relevant antecedent DP exists which can be copied onto the pronoun.

The proposed analysis involving DP-copy is also free from the overcopying problem as in (51) associated with other types of syntactic copying approaches like IP-copy by Heim (1990).

(51) A: **A man** jumped off the cliff.

B: **He** didn’t jump. **He** was pushed.

(Heim (1990: 172))

Heim’s IP-Copy would copy and adjoin an antecedent IP as in (52) to *he*, and incorrectly force this pronoun to be interpreted as something like ‘a man that jumped off the cliff.’

(52) [_{IP} a man₁ [_{IP} t₁ jumped off the cliff]]

The proposed approach also wins a theoretical advantage of maintaining a single syntactic operation of covert copying for the analysis of VP-Ellipsis, DP-Ellipsis, E-type pronouns, and in fact that of ‘coreferential’ pronouns in general.

4. Minimal variable binding and logical number

In this section, we will see first that the proposed approach to E-type anaphora encounters a potential problem. We will argue that this problem will be solved by postulating a type of economy condition of a general nature. It will then be pointed out that this economy-based solution will permit us to further broaden our empirical coverage thereby providing us with independent motivation for the proposed approach.

4.1 Overgeneration of operators

First, let us observe that (53a) and (53b) are not synonymous.

- (53) a. Few congressmen_x admire Kennedy. **They**_x are very junior.
 b. Few congressmen_x admire Kennedy. **Few congressmen**_{y/*x} are very junior.

In (53a), the pronoun *they* may be intended to denote the set of individuals defined by *few congressmen* showing up in the previous sentence. The two instances of *few congressmen* in (53b), on the other hand, cannot be intended to define the same set of individuals, although the two distinct sets of individuals they define may end up with overlapping partially or perhaps even completely.

What this contrast implies to the proposed approach to E-type anaphora is that, for the LF-derivation of (53a), we should not allow the covert computational process to duplicate the quantificational antecedent itself, while we still would like to have its Bound Trace to be copied. Since nothing we have postulated so far guarantees such selective application of covert Copy, we have a problem of overgenerating an operator at LF, as illustrated in (54).

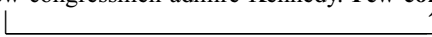
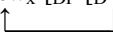
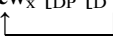
- (54) a. *Copy*:
 LF_j: Few congressmen admire Kennedy. **Few congressmen** are very junior

 b. *QR*:
 LF_k: **Few**_x [DP [D e]_{xσ} congressmen] admire Kennedy, and

Few_x [DP [D e]_{xσ} congressmen] are very junior

In this derivation, a covert operation first copies the quantificational DP *few congressmen* as in (54a) and then QR applies to both of the original and the duplicate of this operator as in (54b), yielding an LF-representation identical to that for (53b) – an undesirable consequence.

The restriction observed in (53b) actually seems to be a quite general crosslinguistic restriction imposed on the identity of two **base-generated** morphologically identical operators, as illustrated by the examples in (55).

- (55) a. *subete-no syoosya-ga aru daigaku-no subete-no gakusee_{x-o} husaiyoo-ni-sita*
 all trading firm-NOM one university-GEN all student-ACC didn't.hire
*ga, ikutukano ginkoo-wa aru daigaku-no subete-no gakusee_{y/*x-o} saiyoosita.*
 but, some banks-TOP one university-GEN all student-ACC hired
 'While all trading firms declined to hire any of the students of one university, some banks hired all of the students of **some other university**.'
- b. **Many people_x** were unhappy, and **many people_{y/*x}** left.
 c. **Someone_x** called. **Someone_{y/*x}** didn't leave a message.
 d. He has **a cat_x** and she hates **a cat_{y/*x}**. (cf. The Novelty Condition)

In the Japanese example (55a), for instance, the two instances of *aru daigaku-no subete-no gakusee* 'all the students of one university' must be intended to denote two different sets of students from distinct universities.

The examples in (55) again contrast with those in (56) below, in which a proform succeeds in establishing an anaphoric relation with a quantificational antecedent.

- (56) a. *subete-no syoosya-ga aru daigaku-no subete-no gakusee_{x-o}*
husaiyoo-ni-sita ga, ikutukano ginkoo-wa [e_x] saiyoosita.
 'While all trading firms declined to hire any of the students of one university, some banks hired **them**.'
- b. **Many people_x** were unhappy, and **they_x** left.
 c. **Someone_x** called. **He_x** didn't leave a message.
 d. He has **a cat_x** and she hates **it_x**.

It therefore seems to be generally true that more than one instance of a morphologically identical operator cannot be intended to denote an identical set in a single discourse. Here, I would like to propose that this generalization follows from the economy constraint imposed on operators as in (57).

- (57) *Minimal Variable Binding:*
 Variable binding is minimal – a 'single' operator establishes an operator-variable binding **only once in a derivation**.

The notion 'single' operator referred to in (57) is defined as in (58).

- (58) *'Single' Operator:*
 One or more instance of a morphologically identical operator constitutes a 'single' operator if they are intended to define an identical set.

When we assume that each instance of a quantificational element must undergo QR and binds its variable at LF, this economy constraint will yield the effect of prohibiting more

than one instance of a ‘single’ operator from showing up at LF, whether they are base-generated or derived by the application of covert Copy. We may then consider that the covert copying of the quantificational DP in (54a) is in fact legitimate, but the constraint (57) rules out the multiple operator-variable relations established by a ‘single’ operator as in (54b). We thus can free ourselves from the problem of overgenerating operators at LF in the analysis of E-type anaphora.¹⁴

The Minimal Variable Binding in (57) can be independently motivated in an interesting way. Observe, first, the paradigm in (59) below. (59a) indicates that a universally quantified element *every boy* must be treated as singular. (59b), on the other hand, suggests that *every boy* in fact is plural. Making the situation even more complicated, (59c) illustrates that *every boy* can be ambiguous between singular and plural. A universally quantified element, in other words, exhibits rather unpredictable restriction as well as flexibility in its number agreement with other items.¹⁵

- (59) a. **Every boy** { **is** / ***are** } happy.
 b. **Every boy** left. { ***He** / **They** } must be angry.
 c. **Every boy** knows that { **he** / **they** } should apologize.

A careful examination of this paradigm, however, will provide us with the following observations and generalizations. First, this paradigm in fact involves two distinct types of number agreement – ‘inflectional’ agreement in (59a) and ‘referential’ agreement in (59b) and (59c). It may be said, in other words, that *every boy* exhibits flexibility in referential agreement but not in inflectional agreement. This point can be confirmed when we observe that (59c) becomes ungrammatical when we alter the inflectional agreement while leaving the rest of the sentence intact as in (60).

- (60) *Every boy **know** that { **he** / **they** } should apologize.

The contrast between (59b) and (59c) further suggests that the flexibility in referential agreement is permitted **only when the antecedent c-commands the pronoun**.¹⁶ Furthermore, when we replace the quantificational subject *every boy* in (59c) with a non-quantificational subject as in (61a) and (61b) below, the referential agreement also becomes static. This suggests that the quantificational force of the antecedent is crucial in permitting the flexibility of referential agreement.

- (61) a. **That boy** knows that { **he** / ***they** } should apologize.
 b. **Those boys** know that { **they** / ***he** } should apologize.

All these observations follow when we extend the notion of linguistic number in the way described below, and combine it with the Minimal Variable Binding in (57).

First, we recognize what we will refer to as ‘overt number,’ which is the number associated with a ‘nominal’ lexical form in the lexicon (or in the numeration, if one opts for such an approach). This is perhaps the standard notion of linguistic number for syntacticians, and it has traditionally been regarded as relevant to both inflectional and referential agreement.

In addition to overt number, we recognize what we will refer to as ‘logical number.’ Logical number is activated by operator-variable binding and realized on the DP containing the trace of a raised D as a variable, and hence only quantificational elements can exhibit logical number in addition to its overt number. Since it is activated for the first time at LF, it is relevant only to meanings, contrary to overt number, which may be relevant to both meanings and forms.¹⁷ Logical number therefore plays a role in referential agreement but not in inflectional agreement, which has PF properties as its indispensable aspect. Overt number, on the other hand, is available both at PF and LF, and it can play a role in both inflectional and referential agreement.

If a nominal element is non-quantificational, overt number generally is the only possible type of number it may have, and it never exhibits flexibility in either inflectional or referential number agreement, as observed in (61).¹⁸ A lexical form of a quantificational nominal also has its overt number. *Every boy*, for example, is associated with singular number just like the non-quantificational *that boy* is. In the proposed number system, however, this will not be the end of the story. While a quantificational element exhibits overt number before it undergoes QR, it exhibits, or more precisely its Bound Trace exhibits, logical number after it undergoes QR. As a result, if there exists discrepancy between the overt number and the logical number of a quantificational element, a possibility arises for some flexibility in its referential agreement.

I believe that the flexible referential agreement observed in (59c) above is one such case, in which either of the **singular overt** number associated with the lexical form *every boy* and the **plural logical** number associated with its Bound Trace may play a role in the referential agreement involving this quantificational antecedent. How does this discrepancy between the overt number and logical number of *every boy* arise? In particular, what is the source of its plural logical number? The answer to this question seems to lie in the function of the operator-variable binding established by the application of QR as in (62).

(62) LF: $\text{Every}_x \text{ [DP [D e]}_{x\sigma} \text{ boy] left.}$
 \uparrow QR $_$

Roughly speaking, this operator-variable binding establishes plural eventualities by letting the quantifier *every* pick out all the members of a presupposed set defined by its restrictor *boy* in a given pragmatic context, which, at least in default cases, is **non-empty and non-singleton**. Subject to slight modification below, we ascribe the non-singleton status of such a presupposed set as the source of the plural logical number of a universally-quantified nominal expression like *every boy*.

When we combine this extended notion of number with the Minimal Variable Binding (57) adopted above, we can capture the otherwise puzzling agreement facts in the paradigm (59) quite straightforwardly. First, the static nature of the singularity of *every boy* observed in (59a) can be ascribed to its overt number, which is the only number relevant to the PF-reflection of inflectional agreement. Second, we can also capture the flexibility of referential agreement in (59c), in which *every boy* c-commands the pronouns. As illustrated in (63a) below, the singular pronoun *he* may agree with the lexical form *every*

boy, which exhibits singular overt number. While the plural pronoun *they* has no chance to legitimately agree with *every boy* itself, after this quantificational antecedent undergoes QR as in (63b), this pronoun may agree with its Bound Trace, which exhibits plural logical number. (Dotted lines indicate referential agreement.)

(63) a. *Referential agreement with overt number (before QR):*

LF: **Every boy** knows that **he** should apologize.
|-----|

b. *Referential agreement with logical number (after QR):*

LF: [Every_x [DP [D e] $_{x\sigma}$ **boy**] knows that **they** should apologize]]
|-----| |-----|

Finally, the absence of similar flexibility in referential agreement in (59b) also follows naturally. Recall that the pronouns are not c-commanded by their quantificational antecedent *every boy* in (59b), which is the structural condition for the application of covert Copy, as we have seen before. First of all, when the pronoun is plural as in (64a) below, legitimate referential agreement can take place only when the copied antecedent is plural. This situation can arise when *every boy* undergoes QR as in (64b), and the Bound Trace, which is plural, is identified with the plural pronoun *they* as in (64b), and copied as in (64c).

(64) a. **Everybody** left. **They** must be angry.

b. *QR:*

LF_i : Every_x [DP [D e] $_{x\sigma}$ **boy**] left. **They** must be angry.

c. *Copy:*

LF_j : Every_x [DP [D e] $_{x\sigma}$ *boy*] left. [DP [D e] $_{x\sigma}$ **boy**] must be angry.
|-----|

Crucially, when the Bound Trace is copied as in (64c), the Minimal Variable Binding (57) is satisfied, and the derivation converges.

When the involved pronoun is singular, as in (65a) below, on the other hand, it must agree with the lexical form *every boy*, which is singular, rather than with its Bound Trace, which is plural. The copying of the operator in its lexical form therefore is required, as in (65b).

(65) a. LF_i: **Every boy** left. **He** must be angry.

|-----|

b. *Copy:*

LF_j : *Every boy*_x left. **Every boy**_x must be angry.
|-----|

c. *QR:*

LF_k : Every_x [DP [D e] $_{x\sigma}$ *boy*] left. Every_x [DP [D e] $_{x\sigma}$ *boy*] must be angry.
|-----| |-----|

This derivation will eventually crash, however, failing to satisfy the Minimal Variable Binding (57) when both the original and the duplicate of *every body* undergo QR and establish more than one instance of operator-variable binding by a ‘single’ operator, as in (65c).

One of the anonymous reviewers of this volume poses an interesting and relevant question as follows – if the ellipsis constructions and the examples with the E-type anaphora are indeed parallel, as pointed out above, why is it that the non-elliptical sentence involving a base-generated pronoun *his* in the second clause of (66) below (= (21) above) does not permit a strict variable while its elliptical counterpart (67) (= (16)) does?

(66) In our school, **every student**_x [_{VP} respects his_x teacher], but unfortunately, the **PRÍncipal DÓESn’t** [_{VP} ↓respect *his_x teacher↓]. (= (21))

(67) In this school, **every student**_x [_{VP} respects **his**_x teacher], but unfortunately, the principal doesn’t [_{VP} e]. (= (16))

The approach we have just argued for allows us to give a straightforward answer to this question. As has already been pointed out above, it is impossible in (66) for the base-generated pronoun *his* in the second clause to be directly bound by the quantified element *every student*, with no c-command relation holding between them. If covert reconstruction is to apply to associate them, it must copy the singular *every student* rather than the plural Bound Copy onto *his*, which would fail to satisfy the Minimal Variable Binding just as in (65). We then predict that, if the pronoun to be base-generated in the second clause of (66) is the plural *their*, the sentence permits a strict variable and becomes grammatical, involving LF-copy of a Bound Trace just as in (64). The example in (68) below demonstrates that such indeed is the case. (The second clause in (68) requires prosodic reduction of the VP (enclosed by ↓___↓) following emphatic stress of the focused items (indicated by capitalized syllables), presumably to justify the repetition of redundant information carried by the VP in the second clause (Kitagawa (1999a)). Note that similar prosody does not improve (66).)

(68) In our school, **every student**_x [_{VP} respects his_x teacher], but unfortunately, the **PRÍncipal DÓESn’t** [_{VP} ↓respect **their_x teachers**↓].

Thus, the proposed covert copying approach incorporating the Minimal Variable Binding (57) and the extended number system permits us to capture the otherwise mysterious and arbitrary flexibility of number agreement observed in the paradigm (59) (as well as the contrast between (66) and (67)), thereby providing an independent piece of motivation for the notion ‘Minimal Variable Binding.’

4.2 Indefinites vs. \forall and Neg

The extended number system we have adopted has further virtues. It is often pointed out in the literature that indefinites need not observe a ‘scope-island,’ while other quantificational elements like *every* and *no* must, as illustrated by the paradigm in (69).¹⁹

- (69) a. **A** dog_x came in. **It**_x lay down under the table.
 b. **Every** dog_x came in. ***It**_x lay down under the table.
 c. **No** dog_x came in. ***It**_x lay down under the table. (Heim (1982: 13))

As has been noted sporadically in the literature,²⁰ and as has been observed in (59b) above, however, *every* and *no* also need not observe a ‘scope-island’ when the pronoun is plural. Some relevant examples are shown in (70).

- (70) a. **Every** dog_x came in. **They**_x lay down under the table.
 b. [A detective trying to prove that Mary is lying says]:
 The truth is that John wrote **no** article_{e,x}.
 Mary therefore cannot possibly have read **them**_x.
 c. If John owns **no** sheep_x, there is no way for Harry to vaccinate **them**_x.

Some researchers disregard such examples, claiming that plural pronouns involve some anaphoric relation distinct from E-type anaphora. Chierchia (1995: 4), for instance, states that ‘... every quantified noun phrase can make salient a set of entities (roughly, the set associated with its head noun). This set can then be referred to in subsequent discourse.’

Simply stating that the set associated with the head noun can be referred to by a plural pronoun, however, leaves many important questions unanswered. For instance, the second clause in (71) expresses multiple eventualities quite naturally as its primary reading.

- (71) Every dog_x came in one by one, and **they**_x lay down where they_x were supposed to.

Therefore, when we interpret (71), it is quite natural for us to imagine a chain of events in each of which a dog comes in and lies down wherever it wanted to, each dog ending up in a different place. When a plural nominal head is overtly expressed in the second clause as in (72) below, on the other hand, it is noticeably less natural to make a primary reading out of a similar distributive interpretation.

- (72) Every dog_x came in one by one, and **the dogs**_x lay down where they_x were supposed to.

The distributive interpretation in the second clause of (71) can be naturally ascribed to the existence of quantification in the first clause if the Bound Trace of *every / no* is copied onto *they*. If each plural pronoun in (70) simply refers to a set associated with the head nominal of its antecedent, on the other hand, the contrast between (71) and (72) would remain mysterious. This approach would also leave it unexplained why the head nouns do not yield similar plurality when they are quantified by existential quantifiers, as in (73).²¹

- (73) a. **A** dog_x came in. ***They**_x lay down under the table.
 b. **Some** dog_x came in. ***They**_x lay down under the table.

We can, on the other hand, capture all the facts in (69)–(73) in terms of referential number agreement when we postulate the logical number as in (74) below for the Bound Traces of the quantificational elements involved in these examples.

(74)

	Overt Number	Logical Number
<i>Every / No</i>	Singular	Plural
<i>Some / A</i>	Singular	Singular

Though in the opposite way, a negative D *no* behaves exactly like *every*, and picks out **none** of the members of the presupposed non-empty, **non-singleton** set. It therefore exhibits plural logical number just like *every*. The existential D’s *some* and *a*, on the other hand, do not involve any such non-singleton set in a given pragmatic context. They therefore exhibit singularity in both their overt and logical numbers. In all of (69)–(73) above, therefore, DPs containing *every* or *no* must referentially agree with a plural pronoun, while those containing *a* or *some* must referentially agree with a singular pronoun. A crucial basis of our analysis again is the corollary of the Minimal Variable Binding we have discussed—that is, these examples necessarily involve the copying of Bound Traces rather than the quantificational antecedents. Thus, the otherwise puzzling contrast between *every/no* and *some/a* follows straightforwardly in the proposed approach incorporating the Minimal Variable Binding and the extended number system.

Earlier, we identified, as the source of the plural logical number, a non-singleton status of a set presupposed by a quantifier. The following example suggests that we need to be a little more precise in making such a statement:

(75) Pick up **every book** on the desk, *if there’s any*, and bring { **them / *it** } back to me.

Note that the expression *if there’s any* indicates that the speaker does not presuppose the **actual** existence of any set of books on the desk. Yet, the plural pronoun *them* can be still anaphoric to *every book*. Incorporating this observation, we revise our generalization as in (76).

(76) The logical number of an operator is plural if the ‘**candidate**’ set it presupposes in a given pragmatic context is non-empty and non-singleton.

The intuitive idea behind this generalization is that the use of *every* and *no* presupposes the existence of a ‘candidate’ or ‘potential’ set of plural entities out of which the quantifiers select a designated quantity of the members, even if it does not presuppose the actual existence of such entities.²²

Finally, there are cases as in (77) below, in which E-type pronouns may show up **either** as singular **or** plural.

(77) *Every student turned in a paper*_x.
 a. **It**_x went into his or her folder.
 b. **They**_x were all identical. (Heim (1990))

The phenomenon here strikes us as contradictory to the number agreement analysis provided above, in which we assumed that the Bound Trace of an existential quantifier is singular in its logical number. If we examine the example in (77) carefully, however, we notice that there is an extra factor involved. The first clause contains a logically plural quantificational expression *every student* c-commanding the indefinite as the antecedent of the E-type pronouns. On the contrary, when we replace *every student* in (77) with the logically singular *some student* as in (78) below, a plural pronoun can no longer be anaphoric to the indefinite.

(78) **Some** student turned in a paper_x. { **It**_x / ***They**_x } went into her folder.

The source of plurality in (77b), in other words, indeed seems to be the presence of a higher logically plural quantificational expression. How can this extra factor turn the singular Bound Trace of an existential quantifier into plural? Although I am not ready to offer any definite answer to this question, it seems plausible for us to tentatively ascribe this phenomenon to the distributivity involved in the scopal interaction between universal and existential quantifiers. That is, when an existential quantifier takes its own scope within the scope of a universal quantifier, the logically singular Bound Trace of an existential quantifier may distribute under the logically plural universal quantifier, and such distributed entities may be referred to not only ‘individually’ as singular but also ‘collectively’ as plural, as graphically illustrated in (79).

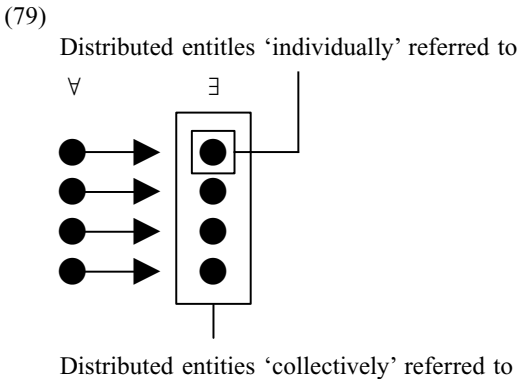

We still maintain, in other words, our position that the Bound Trace of an existential quantifier per se is logically singular.

We can confirm that this insight is leading us in the right direction when we examine the scope interaction of two quantificational expressions in an example like (80).

- (80) Every girl falls in love with **some prince**.
- a. **He**_x is distinctively noble and breath-takingly handsome.
 - b. **They**_x are distinctively noble and breath-takingly handsome.

Just as in the case of (77) above, the existentially quantified element in (80) can induce either singular or plural E-type anaphora when it is interpreted distributively under the scope of the universal quantifier. On the contrary, if we eliminate such distributivity by letting the existential quantifier in (80) take scope higher than that of the universal quantifier, perhaps with an emphatic stress on *some*, plural E-type anaphora as in (80b) no longer seems to be permitted. It therefore seems possible to ascribe the plurality an indefinite exhibits as in (77) while maintaining its logical singularity as postulated in (74).

5. From E-type anaphora to donkey anaphora

When we adopt a traditional view and regard the indefinite determiner $a(n)$ as an existential quantifier, donkey sentences share all of the properties of E-type pronouns stated above in (42). That is, they have **quantified DPs** as their **antecedents**, they are **not c-commanded** by their antecedents, yet they are successfully interpreted as **definite** descriptions. It seems only natural therefore to extend the proposed analysis of E-type anaphora to donkey anaphora, making a precedent of researchers like Cooper (1979), Lappin (1988/89) and Heim (1990). We thus propose that donkey anaphora involves covert copying of the ‘Bound Trace’ of an existential quantifier, as illustrated by the derivation in (81).

(81) a. *QR*:

LF_i: [Every farmer who a_x owns [DP [D $e_{x\sigma}$] donkey]_y] beats it_y

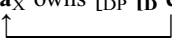

b. *Copy*:

LF_j: [Every farmer who a_x owns [DP [D $e_{x\sigma}$] donkey]_y] beats [DP [D $e_{x\sigma}$] donkey]_y

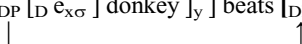

As in the case of E-type anaphora, we can immediately account for the contrast as in (82) below in this approach, which remains recalcitrant if the main properties of donkey anaphora are to be reduced to pragmatic factors.

(82) a. [*Every man who has a wife*] sits next to **her**.

b. *[*Every married man*] sits next to **her**. (Heim (1990: 165))

In (82a), there exists a Bound Trace to be copied as the antecedent of the pronoun after the indefinite determiner undergoes QR, while in (82b), no relevant antecedent exists which can be copied onto the pronoun. In what remains, I will first provide a brief overview of donkey anaphora, and then critically examine some alternative approaches, comparing them to our proposal when relevant. Such a process hopefully will help us clarify which of the observations concerning donkey anaphora should or should not be captured by formal grammatical devices.

In addition to the characteristics mentioned above, donkey anaphora is said to exhibit a few more puzzling properties. First, ‘maximality’ of interpretation is said to arise – an indefinite expression showing up in a donkey sentence as in (83) is interpreted as

universally quantified as indicated by the translation there (henceforth \forall -readings) (Geach (1962)).

- (83) [Every farmer who has **a donkey**] beats **it**.
 ‘Every donkey-owning farmer beats **every donkey** that s/he owns.’

The source of the universal force of the pronoun *it*, however, is not at all evident since its antecedent *a donkey* has traditionally been regarded as possessing existential force. Second, an ‘accessibility’ constraint is recognized – while a donkey pronoun need not be c-commanded by its indefinite antecedent, it still must be c-commanded by the lowest quantifier that c-commands that indefinite (Haik (1984)):

- (84) *[[*Everyone* who owns **a donkey**] came], and Mary bought **it**.

In (84), contrary to (83), the donkey pronoun *it* fails to be c-commanded by the universal quantifier *everyone*(, which c-commands the indefinite expression *a donkey*,) and as a result, it fails to function as a donkey pronoun.

One of the most celebrated analyses of donkey anaphora involves (syntactic) ‘unselective binding’ as in (85) (Kamp (1981), Heim (1982)). See also May (1985).

- (85) $\forall_{x, y}$ [farmer (*x*) \wedge donkey (*y*) \wedge own (*x*, *y*)] [beat (*x*, *y*)]
 ‘For **every pair** $\langle x, y \rangle$ such that *x* is a farmer, *y* a donkey, and *x* owns *y*, *x* beats *y*’

As indicated by the translation in (85), this analysis derives the universal quantification over a pair of variables, which solves the scope problem and yields maximality to the interpretation of indefinites. Despite the popularity of the syntactic mechanism involved in this analysis, however, its problems in the analysis of donkey anaphora is also well-known. For example, Pelletier and Schubert (1989) have pointed out that an existential rather than universal interpretation of the indefinite is possible in a donkey sentence like (86).

- (86) Every person who has **a dime** will put **it** in the meter.

A quite natural interpretation of this sentence is ‘Every person who has a dime will put in the meter **one of his/her dimes**’, which clearly permits the existential readings (henceforth \exists -readings) of the donkey pronoun, and hence does not involve maximality. Maximality, in other words, is not the norm but only a possibility associated with donkey anaphora. This state of affairs in (86), however, is totally unexpected by unselective binding of *a dime* and *it* by the universal quantifier *every*.

Another problem the unselective binding analysis encounters is what is known as a ‘proportion problem’ (Heim (1990)). In a donkey sentence as in (87a), for example, the operator *most* unselectively quantifying over a pair of variables would yield the interpretation in which donkey beating takes place with respect to **most** farmer-donkey **pairs**, as represented in (87b). (87a) therefore would be incorrectly true if nine farmers

that own one donkey each don't beat it and one farmer that owns fifty donkeys beats them all.

- (87) a. Most farmers that have a donkey beat it.
 b. **most** x, y [farmer (x) \wedge donkey (y) \wedge x own y] [x beats y]

Because of these and other problems the unselective binding encounters, I will refrain from regarding it as a viable approach to donkey anaphora.

Let us now direct our attention to the 'dynamic binding' approach, in particular, that proposed by Chierchia (1995). In a nutshell, this approach advocates a semantic process of bringing a sentence in a discourse into a previous sentence, as illustrated in (88).

- (88) a. [$S_1' \wedge p$]
 b. [$S_1' \wedge p$] \wedge [$S_2' \wedge p$] \Rightarrow [$S_1' \wedge S_2' \wedge p$]
-

Crucially, discourse sequencing is regarded here as an operation of conjunction, which has the effect of replacing a propositional variable p with a subsequent discourse. Chierchia claims then that the \exists -readings of donkey pronouns are derived semantically when the conservativity of determiners as illustrated in (89) below interacts with dynamic binding and induce 'dynamic conservativity.'

- (89) $D(P)(Q) \leftrightarrow D(P)(P \wedge Q)$
 e.g.) { Every / Some / No } man smokes iff { every / some / no } man is a man who smokes.

In the tripartite representation of a donkey sentence as in (90a) below, for example, the general conservativity of determiners as in (89) allows the indefinite *a dime* be reconstructed **within the nuclear scope**, as illustrated in (90b). The dynamic property of a conjunction operator \wedge then brings the nuclear scope *puts it in the meter* into the reconstructed restrictor, as illustrated by the arrow there, and permits the donkey pronoun to be bound by existential quantifier in its domain.

- (90) Every person who has **a dime** puts it in the meter.
 a. Every (person who has a dime) (puts it in the meter)
 b. Every (person who has a dime) ([person who has
a dime \wedge p] \wedge [puts it in the meter])
-

As a result, the representation will yield the interpretation 'Every person who has a dime is person who has a dime and puts it in the meter,' in which the indefinite as an existential quantifier binds the donkey pronoun outside the domain of the universal quantifier and yields the \exists -reading. The dynamic binding derivation of \exists -readings can be characterized by the following properties. First, since this approach treats the indefinite as existentially

quantified expression and it shows up outside the domain of the universal quantifier, there is no room for maximality presuppositions to arise. Second, \exists -readings of donkey anaphora arise when the nuclear scope containing the donkey pronoun is subordinated into the reconstructed restrictor, which originally was the domain of the universal quantifier. Donkey pronouns therefore must always be contained in the nuclear scope and necessarily satisfy the accessibility requirement when they yield \exists -readings. Finally, the dynamic binding derivation of \exists -readings of donkey anaphora is due to purely semantic operations, and therefore is insensitive to pragmatic factors.

Having acknowledged the possibility of anaphora across inaccessible domains as in (91) below, on the other hand, Chierchia pronounced that the dynamic binding approach must also be supplemented by what he labels as the ‘E-type strategy,’ in which E-type pronouns are regarded as **functions** from individuals to individuals, where the nature of function is **contextually** specified.

- (91) a. Either [Morrill Hall doesn’t have **a bathroom**] or **it** is in a funny place.
 (Barbara Partee)
 b. It is not true that [John doesn’t have **a car**]. **It** is parked outside.
 d. [John doesn’t have **a car** any more]. He sold **it** last month.

(92a–c) illustrate how the function of each E-type pronoun in (91) can be determined.

- (92) a. Either [Morrill Hall doesn’t have a bathroom] or **f (Morrill Hall)** is in a funny place.
 – **f**: a function from places into bathrooms located in those places
 b. It is not true that John doesn’t have a car. **f (John)** is parked outside.
 – **f**: a function from people into their cars
 c. John doesn’t have a car any more. He sold **f (John)** last month.
 – **f**: a function from people into the car they used to have

Chierchia then claims that \forall -readings of donkey anaphora are made possible by this pragmatic E-type strategy. In a donkey sentence like (93a) below, for example, the pronoun as function is **number neutral** and can have a **plural** entity, as indicated in (93b).

- (93) a. [Every man who has **a donkey**] beats **it**.
 b. $\forall x$ [[**man (x)** \wedge $\exists y$ [donkey (y) \wedge has (x, y)]] \rightarrow beats (x, **f (x)**)]
 – **f**: a function from men into the **donkey** (or **donkeys**) they own
 ‘Every man beats **the donkey or donkeys** he owns.’

As a result, the donkey pronoun can take the **maximal** set of donkeys owned by each man as its value, and yield the \forall -readings. The E-type strategy, in other words, is claimed to be responsible for **maximality** presuppositions in donkey anaphora contexts. Since the value of donkey pronouns is determined pragmatically, the E-type strategy is also predicted **not** to have to satisfy accessibility constraints.

The correlations between the type of interpretation and the compliance/rejection of accessibility constraints predicted in the dynamic binding approach, however, do not

seem to always obtain. In particular, the \exists -readings of donkey anaphora seems to be possible even when the accessibility condition is not satisfied:

- (94) a. [Every person who had **a dime**] asked the secretary, and she put **it** in the meter.
 b. John interviewed [every professor in our department who submitted **a paper** to LI], and wrote an article about their experiencing **its** rejection at least once.

Note that the sentence in (94a) is felicitous even when the person handed to the secretary ‘one of the dimes he or she had.’ Likewise, the professors mentioned in (94b) certainly may have some of their papers accepted. Such a breakdown of the correlation between the availability of \exists -readings and the satisfaction of the accessibility constraint casts doubt on the derivation of \exists -readings based upon the conservativity of determiners in the dynamic binding approach.

Attempting to support his E-type strategy and at the same time to argue against a syntactic copying approach, Chierchia also discusses the possibility of a single donkey pronoun’s being anaphoric to two NPs in a coordinate construction as in (95). (We suppress the DP-analysis momentarily here in order to synchronize our discussion with that of Chierchia’s.)

- (95) a. [[_{NP} Every boy that has **a dog**] and [_{NP} every girl that has **a cat**]] will beat **it**.
 (Chierchia (1995: 116))
 b. [$\forall x$ [**boy** (x) \wedge $\exists y$ [dog (y) \wedge has (x, y)]] \rightarrow beat (x, **f(x)**)] \wedge
 [$\forall x$ [**girl** (x) \wedge $\exists y$ [cat (y) \wedge has (x, y)]] \rightarrow beat (x, **f(x)**)]

He claims that the E-type strategy can handle this mismatch since, as illustrated in (95b), the pronoun *it* can be interpreted as the union of the two **number neutral** functions – one function from boys into dogs, and another function from girls into cats. The copying approach, on the other hand, allegedly has a hard time handling this anaphoric relation because two distinct indefinites would have to be copied onto a singular pronoun.

I believe, however, that the conclusion here has been drawn prematurely since the sentence in (95a) in fact is subject to two distinct syntactic analyses, and each construction seems to have distinct tolerance for the mismatch in question. As illustrated in (96a) below, the sentence can be analyzed as involving NP-coordination. At the same time, the same string of words can be analyzed as involving IP-coordination with its I’ elided as in (96b).

- (96) a. *NP-coordination*:
 [_{NP} Every boy that has **a dog**] and [_{NP} every girl that has **a cat**] // [_{I’} will beat **it**].
 b. *IP-coordination*:
 [_{IP} [_{NP} Every boy that has **a dog**] [_{I’} e]] // and [_{IP} [_{NP} every girl that has **a cat**] [_{I’} will beat **it**]].

Some speakers even report that each of the two constructions is associated with a distinct prosodic pattern, each involving a distinct position for a major pause as indicated by // in

(96a–b), respectively. Intuitively, the donkey anaphora in question seems to be permitted only when the sentence is ‘distributively’ interpreted involving more than one eventuality, which is also reflected by Chierchia’s semantic representation in (95b). Note then, that in the IP-coordination in (96b), the elided I’ (which contains a donkey pronoun) can be reconstructed at LF as in (97).

(97) LF: [IP [NP Every boy that has a dog] [I’ **will beat it**]] and [IP [NP every girl that has a cat] [I’ will beat it]]

In this LF-representation, donkey anaphora is permitted in **each conjunct**, and the problem of mismatch disappears. The LF representation here in fact straightforwardly reflects our intuition that distributivity induced by plural eventuality must be involved for the donkey pronoun in (95a) to be successfully interpreted.

We can demonstrate that the obviation of mismatch in question and the availability of IP-coordination correlate with each other. With the addition of two distinct (and incompatible) sentential adverbs as in (98a) below, we can force the sentence in (95a) to have IP-coordination involving I’-Ellipsis, which is interpreted on a par with the non-elliptical sentence (98b).²³

(98) a. [IP **Definitely**, [NP every boy that has a dog] [I’ **e**]] // and
 [IP **probably**, [NP every girl that has a cat]] [I’ will beat it]].
 b. [IP **Definitely**, [NP every boy that has a dog] [I’ **will beat it**]] // and
 [IP **probably**, [NP every girl that has a cat] [I’ will beat it]]

In the IP-coordination in (98a), the mismatch between the donkey pronoun *it* and two indefinite NPs (*a dog* and *a cat*) can be clearly obviated.

We can, on the other hand, ensure the involvement of NP-coordination with plural agreement between the coordinated subject and the verb as in (99).

(99) ^{2*}[NP [Every boy that has a dog] and [every girl that has a cat]] // [I’ **are beating it**].

In this sentence, the distributive interpretation associated with plural eventuality is not available, and the obviation of mismatch is not permitted. This makes a sharp contrast with the sentence involving singular agreement (and hence IP-coordination) as in (100) below.

(100) [IP [NP Every boy that has a dog] [I’ **e**]] // and [IP [NP every girl that has a cat] [I’ { **beats** / **is beating** } **it**]].

We can, in other words, also demonstrate that the obviation of mismatch in question and NP-coordination must be dissociated.

The same points can be even more clearly demonstrated when we examine Japanese, in which IP- (or possibly VP-)coordination and NP-coordination can be overtly distinguished, and they contrast in regard to donkey anaphora. In (101) below, in which

IP-coordination with I'-Ellipsis is signaled by the presence of two nominative markers *-ga*, donkey anaphora is quite readily accepted.

(101) *IP-coordination*:

Tuusan-syoo-kara-no-otassi-de, [IP [NP **arubaito-no gakusee-ni**
 MITI-from-GEN-notification-with, working student-DAT
denwa-ban-o saseteita subeteno zimusyo]-**ga** [I' e]], *sosite*
 made.receive.phone.calls all offices]-NOM and
 [IP [NP **huriitaa-ni miseban-o saseteita subeteno konbini**]-**ga**
 part-timer-DAT **made**.work.as.salesclerk all convenient.store-NOM
 [I' **soitu-o kubinisinakya-naranaku-natta rasi**]].
 that.brat-ACC had.to.fire I.heard
 'Because of the notification from the Minister of International Trade and Industry (MITI), all the offices that had **a working student** receive phone calls, as well as all the convenient stores that had **a part-timer** as a salesclerk had to fire **him**, I heard.'

In (102) below, in which NP-coordination is signaled by the presence of the conjunct *to* and a single nominative marker *-ga*, on the other hand, donkey anaphora seems much harder to obtain. As a result, the pronominal *soitu* 'the/that brat' must be pluralized to make the sentence natural.

(102) *NP-coordination*:

Tuusan-syoo-kara-no-otassi-de, [NP [NP **arubaito-no gakusee-ni**
 MITI-from-GEN-notification-with, working student-DAT
denwa-ban-o saseteita subeteno zimusyo]-**to**
 made.receive.phone.calls all offices-and
 [NP **huriitaa-ni miseban-o saseteita subeteno konbini**]]-**ga**
 part-timer-DAT **made**.work.as.salesclerk all convenient.store]-NOM
 { ***soitu-o** / ^{ok}**soitura-o** } *kubinisinakya-naranaku-natta rasi*
 that.brat-ACC / those.brats-ACC had.to.fire I.heard

I am therefore inclined to conclude that the donkey anaphora in (95a) is made possible by the covert reconstruction of a donkey pronoun involved in I'-Ellipsis, and that there is no need to make an appeal to the pragmatic E-type strategy to permit this construction.

Finally, let us observe the sentence in (103) below, in which donkey anaphora is permitted, again, when the involvement of two eventualities is detected.

(103) [[Every man who had **a dime**] and [every woman who had **a quarter**]] put **it** in the meter.

What attracts our attention most here is that this sentence can be interpreted with a rather clear \exists -reading 'Every man who had a dime put **one of his dimes** in the meter, and every woman who had a quarter put **one of her quarters** in the meter.' According to Chierchia, the success of donkey anaphora in this coordinated construction requires the adoption of

the pragmatic E-type strategy. The possibility of \exists -readings, on the other hand, would call for the purely semantic dynamic binding analysis. This contradiction suggests that there is something wrong with adopting either one or both of the dynamic binding and the pragmatic E-type strategy. We thus have reasonable doubt on Chierchia's hybrid approach to donkey anaphora.

Earlier, we proposed that all of VP-Ellipsis, DP-Ellipsis and E-type anaphora be analyzed as involving a syntactic process of covertly copying an item that functions as a variable bound by a quantificational antecedent. These 'copied bound variables' may take either the form of a bound proform or a Bound Trace ($[_D e_{x\sigma}]$). Based upon the interpretations common to such 'copied bound variables' in VP-Ellipsis, DP-Ellipsis and E-type anaphora, we have also characterized them as more or less on a par with a demonstrative *that* (or *those*) in their meanings. (104a)–(106a) below present representative examples of each such construction, (104b)–(106b) present their LF-representations after bound variables are covertly copied, and (104c)–(106c) present paraphrases of 'copied bound variables' with a demonstrative expression.

- (104) a. In our school, **every student**_x [_{VP} respects **his**_x teacher]_y, and the parents also expect me to [_{VP} e]_y.
 b. LF: In our school, every student_x [_{VP} respects his_x teacher]_y, and the parents also expect me to [_{VP} respect [_{DP} [_{DP} **his**_{xσ}] **teacher**]]_y
 c. In our school, every student_x [_{VP} respects his_x teacher_z], and the parents also expect me to respect **that teacher**_z.
- (105) a. *siritu-daigaku-no dono kyoozyu-x-ga* [_{DP} **zibun**_{x-no} *gakusee*]-o private-college-GEN which professor-NOM [_{DP} self-GEN student]-ACC
suisensite-mo, Monbusyoo-wa [_{DP} e] *saiyoosi-nai-daroo.* recommend-even Ministry.of.Education-TOP employ-not-perhaps
 'No matter which professor of a private college may recommend self's (= his or her own) student, the Ministry of Education will probably not employ those students.'
 b. LF: ... *Monbusyoo-wa* [_{DP} [_{DP} **zibun**_{xσ}]-no **gakusee**]_y *saiyoosi-nai-daroo* ... Min.of.Edu-TOP self-GEN student employ-not-perhaps
 c. ... *Monbusyoo-wa sono gakusee-y-o* *saiyoosi-nai-daroo.* ... Ministry.of.Education-TOP **that student**-ACC employ-not-perhaps
- (106) a. **Few congressmen**_y admire Kennedy. **They**_y are very junior.
 b. LF: Few_x [_{DP} [_D e_{xσ}] congressmen]_y admire Kennedy.
 [_{DP} [_D e_{xσ}] **congressmen**]_y are very junior
 c. Few congressmen_y admire Kennedy.
Those congressmen_y are very junior.

When we extend the same copying approach to the typical examples of donkey anaphora with \forall -readings and \exists -readings, we will obtain similar set of representations as in (107a–c) and (108a–c) below, respectively.

- (107) a. Every farmer who owns **a donkey**_x beats **it**_x.
 b. LF: [Every farmer who a_x owns [DP [D e_{xσ}] donkey]_y]
 beats [DP [D e_{xσ}] **donkey**]_y
 c. Every farmer who owns a donkey beats **that donkey**.
- (108) a. Every person who has a dime will put **it** in the meter.
 b. LF: [Every person who a_x has [DP [D e_{xσ}] dime]_y]
 put [DP [D e_{xσ}] **dime**]_y in the meter
 c. Every person who has a dime will put **that dime** in the meter.

Interestingly, the paraphrase with a demonstrative in (107c) can still exhibit \forall -readings and that in (108c) can still exhibit \exists -readings. This state of affairs is compatible with our approach, in which all instances of successful donkey anaphora are derived uniformly with the covert copying of a ‘Bound Trace,’ and the ‘copied bound variable’ has been observed to function like a demonstrative expression. The asymmetrical availability of \exists - or \forall -readings, in other words, is regarded in this approach as arising mainly from pragmatic factors, rather than a syntactic or semantic constraint.

6. Summary

In this work, I first pointed out that some ellipsis constructions exhibit a type of strict identity involving a bound proform, and argued that such an interpretation be derived by the covert copying of a bound proform. I then pointed out quite pervasive parallelism between such ellipsis constructions and E-type anaphora, and proposed to extend the covert copying approach from ellipsis to E-type anaphora. The proposed analysis crucially postulates the covert copying of a Bound Trace of the form $[_{DP} [_{D} e]_{x\sigma} NP]$, and the economy restriction imposed on the copied operators by the Minimal Variable Binding. It was also argued that the proposed approach can provide straightforward accounts for certain puzzles concerning agreement and quantifier scope when it is supplemented by the number system which distinguishes the overt number of the lexical form of a quantificational expression from the logical number of its Bound Trace. Finally, I have also explored the extension of the copying approach to donkey anaphora, while pointing out problems of some alternative analyses. It seems that the observations and generalizations we have presented in this work point toward the conclusion that when an item that functions as a variable bound by a quantificational expression is covertly copied at LF, it comes to function something akin to an anaphorically used demonstrative *that* (or *those*). Why this state of affairs obtains is certainly the question we must attempt to answer next, exploring its possible correlation to demonstrative expressions themselves. (See the last paragraph in Footnote 14 for a relevant observation.)

Notes

- * An earlier and shorter version of this work appeared as Kitagawa (2000). I am extremely grateful to Hajime Hoji, Nam-kil Kim and Audrey Li for providing me with an opportunity to further develop the materials I had. Since I submitted this work to these editors during the

summer of 1999, I have developed a new approach to some of the problems taken up in this work. For various (mainly practical) reasons, however, I have decided to have this work published virtually in its original form only with the addition of my responses to the reviewers' comments. Part of the new approach was presented in Kitagawa (1999a), and I plan to further elaborate on it in my future work. I would also like to express my gratitude to Yasuaki Abe, Yoshio Endo, Tom Ernst, Steven Franks, Leslie Gabriele, Hajime Hoji, Kyle Johnson, Hideki Kishimoto, Roger Martin, Alan Munn, Mamoru Saito, Yukinori Takubo, Chris Tancredi, Satoshi Tomioka, Ayumi Ueyama, and Barbara Vance for their invaluable comments and judgments. I am especially grateful to Leslie Gabriele for her advice concerning the semantic aspects of the work, and Steven Franks for his criticism and encouragement on the extension of the minimalist hypothesis. Thanks are also due to all the participants of my syntax seminars at Indiana University in spring 1998 and spring 2001. Part of this work was also presented at Kobe University, Kyushu University, Nanzan University and University of Massachusetts at Amherst. This work is in part supported by the COAS Faculty Research Grant from Indiana University.

- 1 See Kitagawa (1991b), Kitagawa (1994), Kitagawa (1995), Kennedy (1997) and Fox (2000) for the motivation for such covert syntactic operations.
- 2 See Kitagawa (1991b) for the motivations to adopt this particular approach, and also for arguments that sloppy identity is independent of λ -abstraction. Another possible derivation for strict identity is to reconstruct an unbound proform *his* and let it be coreferential with the antecedent *John* in the first clause. See Kitagawa (1991b) for an analysis which does not leave this as a possibility.
- 3 In this work, I will tentatively label the ellipsis construction in question as DP-Ellipsis since it will allow us to reduce all the anaphoric properties we will deal with below to the category D(eterminer). It certainly requires further scrutiny to determine what categorial status nominal expressions in Japanese, especially those without phonetic content, have.
- 4 As illustrated by the interpretive restriction in (i) below, *zibun* must be bound.
 - (i) [₂ **Kevin Kosunaa-ga turetekita bodiigaado**]-ga **zibun**_{2/*1}-no okusan-to odotta.
 Kevin Costner₁-NOM brought bodyguard-NOM self_{2/*1}-GEN wife-with danced
 'The bodyguard Kevin Costner brought danced with **self**'s (= his own) wife.'

Strict identity in (6), in other words, cannot be derived in the alternative way described in Footnote 2.

Otani and Whitman (1991), following Huang (1991), argue that the sloppy identity observed in (4) is due to the hidden existence of VP-Ellipsis in Japanese. Many serious problems of this 'Disguised VP-Ellipsis' approach have been pointed out, however, by Hoji (1998), Kim (1999) and Kitagawa (1999b).

- 5 Tomioka (1998) presents the examples in (i) below and points out that sloppy identity for pronouns of laziness in English have tighter restriction than that for the empty proforms in Japanese as in (4).
 - (i) a. Gary likes **his mother**. Tim likes **her**, too.
 – *her* = *Tim's mother
 - b. Gary lost **his ID** in the gym. Tim lost **it** in a classroom.
 – *it* = ???Tim's ID
 - c. Gary thinks **his teachers** are geniuses, but Tim thinks **they** are nuts.
 – *they* = ???Tim's teachers

With somewhat tighter sequencing of eventualities, and especially with genericity, as in (ii) below, however, sloppy identity becomes possible in similar discourses.

- (ii) a. Quite often, a young husband has not learned the proper way of expressing his affection to **his wife**, but an old man usually knows how to please **her**.
 – *her* = an old man's wife
- b. John and Bill have totally different policies concerning the upbringing of their own children. While John disciplines **his children** quite often, Bill tries to let **them** learn right from wrong on their own.
 – *them* = Bill's children
- c. Many dog lovers walk **their dogs** in the park, but of course there are thousands of people who have no choice but to walk **them** on the street.
 – *them* = the dogs of thousands of people.

Kitagawa (1999a) attempts to account for both these phenomena, making an appeal to the notion 'economy of lexical information' and postulating a purely syntactic version of Hoji's (1998) 'supplied N Head' analysis (See the analysis in (29) below) in addition to DP-Copy and VP-Copy. In that work, it is also pointed out that the same approach allows us to explain why Japanese exhibits DP-Ellipsis while English exhibits VP-Ellipsis to represent similar sloppy identity interpretations.

- 6 The singular (and distributive) reading 'that teacher' is obtained in (15) when *the parents* is interpreted as the parents of each student, and the plural (and group) reading 'those teachers' is obtained when *the parents* is interpreted as the parents of the students as a whole. Perhaps, grammar also permits sloppy identity here, although we will concentrate on strict identity in our discussion.
- 7 The pronoun *him* in (i) below cannot strictly refer to *Bill*.

- (i) Mary blamed **him**_{*1}, and **Bill**₁ did [_{VP} e], too.

As has been discussed in Kitagawa (1991b: 504–505), this puzzling interpretive restriction can be explained if the elided VP is reconstructed in covert syntax, and the resulting LF-representation is subject to the Condition B of the Binding Theory, as illustrated in (ii).

- (ii) LF: Mary blamed *him*₁, and **Bill**₁ did [_{VP} blame **him**_{*1}], too

VP-Ellipsis involving *do*, in other words, does in fact exhibit properties that can be captured if it involves syntactic reconstruction and binding rather than pragmatic control.

- 8 I am grateful to Hajime Hoji and Ayumi Ueyama for useful discussion on this issue.
- 9 Fiengo and May (1994: 269) report that the strict identity in question is possible in the antecedent-contained deletion as in (i).

- (i) **The men**₁ [_{VP} introduced **each other**₁ to everyone that *the women* did [_{VP} e]].

To my dismay, most of over ten speakers I have checked with reject such a reading, although they accept a sloppy identity interpretation. More importantly, all of them including the few who are not sure if strict identity is absolutely impossible in (i) find a similar sentence as in (ii) below ungrammatical.

- (ii) **The men**₁ [_{VP} introduced **each other**₁ to everyone that *I* { did [_{VP} e]
 wanted to [_{VP} e] }].

Note that the plural subject *the women* in (i) as the potential local antecedent of the reconstructed anaphor is replaced by the singular subject *I* in (ii). The ungrammaticality of (ii) then would lead us to the rejection of the vehicle change analysis in both (i) and (ii). See

Kitagawa (1991b: 527), however, for some ideolectal variations concerning sloppy identity involving *each other*. Note also that the ungrammaticality of (24) would remain unaccounted for in the pragmatic account of the strict identity in (17). Kitagawa (1991a) offers an account of the contrast between (17) and (24).

- 10 See Huang (1983) and Kitagawa (1994: 355–357), among others, for the discussion on the constraint that anaphors must be bound by the closest antecedent.
- 11 Covert copying is assumed to be applicable within a single discourse, if necessary, in an ‘interarboreal’ fashion across sentence and utterance boundaries. This may be regarded as another significant departure of our analysis from Chomsky’s narrowly defined ‘minimalist program.’ In an approach in which syntactic objects are generated ‘bottom-up’ rather than ‘top-down,’ such an analysis is not out of the question. Note also that PF deletion for ellipsis adopted by Chomsky must be applicable in a similar ‘interarboreal’ fashion.
- 12 Under Chomsky (1995) ‘Copy plus Delete’ analysis of movement, covert copy here can be regarded as a case of covert movement in which Copy applies without being followed by the application of Delete when neither the extraction site nor the landing site c-commands the other.
- 13 Depending on the analysis of quantificational determiners and possessors in the pre-nominal position, the two constructions may turn out to look even more parallel. See Abney (1987) for relevant discussion.
- 14 In the proposed approach, the Minimal Variable Binding in (57) does not rule out a sentence like (ia) below, whose semantics is often represented as in (ib), providing us with the impression that the operator can in fact establish more than one instance of operator-variable binding.

- (i) a. Every student respects **his** teacher.
 b. $\forall x$ [student (x) \rightarrow respect (x, x’s teacher)]

Whichever derivation in (ii) below we may adopt in the proposed approach, however, *every* establishes operator-variable binding only once in the derivation with its trace $[_D e]_{x_s}$, and the pronoun *his* establishes its variable status by being bound by $[_{DP} e]_y$ in (iia) and by $[_{DP} [_D e]_{x_s}]_{y_s}$ in (iib).

- (ii) a. $\text{Every}_{x_s} [_{DP} [_D e]_{x_s}] \text{student } [_y]_{y_s} [_{VP} [_{DP} e]_{y_s}] \text{ respects } \mathbf{his}_{y_s} \text{ teacher}$
 b. $\text{Every}_{x_s} [_{DP} [_D e]_{x_s}] \text{student } [_y]_{y_s} \text{ respects } \mathbf{his}_{y_s} \text{ teacher}$

We may also be able to develop an alternative to the proposed economy account, making an appeal to the notion ‘type-mismatch’ which Heim and Kratzer (1998) regard as the trigger for the QR of object QPs. Note that the covert reconstruction involved in (54a) copies the QP *few congressmen* (type $\langle\langle e, t \rangle, t \rangle$) onto the pronoun *they* (type $\langle e \rangle$). Either this mismatch may prohibit LF-copy itself or, it may rule out the resulting representation later. Then, in the legitimate case of LF-copy as in (49b), the bound D-variable ($[_D e]_{x_s}$) as the specifier of the Bound Trace ($[_{DP} [_D e]_{x_s}] \text{congressmen } [_y]_{y_s}$) is to be analyzed as an entity of the type $\langle\langle e, t \rangle, e \rangle$ since it maps an entity of the type $\langle e, t \rangle$ to that of a type $\langle e \rangle$. This result is compatible with our intuition that a strict variable exhibits an interpretation akin to that of an anaphoric demonstrative like *that*, which can be also analyzed as an entity of the type $\langle\langle e, t \rangle, e \rangle$ in a sentence like (iii).

- (iii) I know $[_{DP} \text{that } [_{NP} \text{congressman}]]$.

- 15 The use of *boy* in (59a–c) assures that *they* as a singular pronoun is not used in these examples simply to avoid the mention of gender as in (i).

- (i) Everyone knows that { **they** / **#he** } should apologize.

- 16 The so-called telescoping poses an exception to this generalization. It is quite possible that telescoping involves the covert copying of an N-projection rather than a DP. Such an analysis is

- compatible not only with the logical singularity a universal quantifier exhibits in telescoping but also with the fact that telescoping must be licensed by genericity in a broad sense. See Poesio and Zucchi (1992) and references therein for relevant discussion. Kitagawa (1999a) attempts to account for telescoping in the approach mentioned in Footnote 5 above.
- 17 cf. May's (1985) semantic number of quantificational elements.
- 18 Certain non-quantificational nominal expressions like *family*, *audience*, and *committee* may exhibit flexibility in their **overt** numbers since their singular forms can refer to either a unit or the members of the unit:
- (i) a. the **family** that **has** just moved in
 b. My **family are** all very well.
- 19 See, for instance, Fodor and Sag (1982), Heim (1982) and Chierchia (1995) for relevant discussion.
- 20 See, for example, May (1985) and Lappin (1988/89).
- 21 Providing examples like (i) and (ii) below, Lappin (1988/89) convincingly argues that the antecedent of a donkey pronoun (as a type of E-type pronoun) need not contain a weak D (contra Reinhart (1987)), and that there is no need for the quantifier containing the antecedent to c-command the donkey pronoun (contra Haik (1984)). Note that in (i) the set of *at least half the films at the festival* need not be identical for each critic:
- (i) Every critic who saw **at least half the films at the festival**_x liked **them**_x.
 (ii) John spoke to [every student who submitted a **paper**_x] about the possibility of publishing **it**_x.
- 22 The notion 'downward-entailing' operators does not seem to be relevant, either, since *at least n* and *many*, which are not downward entailing, can be (overtly as well as) logically plural. I am grateful to Leslie Gabriele for helping me clarify the relevant notion here.
- 23 The non-elliptical sentence here actually must be accompanied by proper prosodic reduction of the repeated I' (*will beat it*), and preferably by the presence of one of the 'same saying' operators *too* at the end of the sentence, to justify the repetition of the identical I'.

References

- Abney, S. (1987). *The English Noun Phrase in Its Sentential Aspect*. Doctoral dissertation, Massachusetts Institute of Technology.
- Chierchia, G. (1995). *Dynamics of Meaning: Anaphora, Presupposition, and the Theory of Grammar*. Chicago: The University of Chicago Press.
- Chomsky, N. (1995). *The Minimalist Program*. Cambridge, Massachusetts: The MIT Press.
- Fiengo, R. and R. May. (1994). *Indices and Identity*. Cambridge, Massachusetts: The MIT Press.
- Fodor, J. and I. Sag. (1982). Referential and Quantificational Indefinites. *Linguistics and Philosophy* 5, 355–398.
- Fox, D. (2000). *Economy and Semantic Interpretation*. Cambridge, Massachusetts: The MIT Press.
- Haik, I. (1984). Indirect Binding. *Linguistic Inquiry* 15, 185–223.
- Hankamer, J. and I. Sag. (1976). Deep and Surface Anaphora. *Linguistic Inquiry* 7, 391–428.
- Heim, I. (1982). *Semantics of Definite and Indefinite Noun Phrases*. Doctoral dissertation, University of Massachusetts, Amherst.
- Heim, I. and A. Kratzer. (1998). *Semantics in Generative Grammar*. Oxford: Blackwell Publishers, Inc.
- Higginbotham, J. (1983). Logical Form, Binding and Nominals. *Linguistic Inquiry* 14, 395–420.
- Hoji, H. (1998). Null Object and Sloppy Identity in Japanese. *Linguistic Inquiry* 29, 127–152.
- Huang, C. T. J. (1983). A Note on the Binding Theory. *Linguistic Inquiry* 14, 554–561.

- Huang, J. (1991). Remarks on the Status of the Null Object. In *Principles and Parameters in Comparative Grammar*, edited by Freidin, Robert, 56–76. Cambridge: MIT Press.
- Jacobson, P. I. (1980). *The Syntax of Crossing Coreference Sentences*. New York: Garland Publishing, Inc.
- Kennedy, C. (1997). Antecedent-Contained Deletion and the Syntax of Quantification. *Linguistic Inquiry* 28, 662–688.
- Kim, S. (1999). Sloppy/Strict Identity, Empty Objects, and NP Ellipsis. *Journal of Asian Linguistics* 8, 255–284.
- Kitagawa, Y. (1991a). Binding under the Internal Subject Hypothesis. In *Trends in Linguistics: State of the Art Report 16*, edited by Nakajima, Heizo, 205–259. Mouton de Gruyter.
- Kitagawa, Y. (1991b). Copying Identity. *Natural Language & Linguistic Theory* 9, 497–536.
- Kitagawa, Y. (1994). *Subjects in Japanese and English*. New York: Garland.
- Kitagawa, Y. (1995). ‘Affect’ in Binding and Coreference. In *FLSM VI, Proceedings of the Sixth Annual Meeting of the Formal Linguistics Society of Mid-America*, 130–142. Indiana University Linguistics Club.
- Kitagawa, Y. (1999a). Economy of Lexical Selection. Paper presented at LICSSOL 1 Economy in Language Design, Computation and Use, The Lyon Institute for Cognitive Science,
- Kitagawa, Y. (1999b). VP-Ellipsis vs. NP-Ellipsis. In *Linguistics: In Search of Human Mind A Festschrift for Kazuko Inoue*, edited by Muraki, Masatake and Enoku Iwamoto, 347–372. Tokyo: Kaitakusha.
- Kitagawa, Y. (2000). Ellipsis and E-type Anaphora. In *University of Massachusetts Occasional Papers in Linguistics* 24, edited by GLSA.
- Lappin, S. (1988/89). Donkey Pronouns Unbound. *Theoretical Linguistics* 15, 263–286.
- May, R. (1985). *Logical Form: Its Structure and Derivation*. Cambridge, Massachusetts: The MIT Press.
- Otani, K. and J. Whitman. (1991). V-Raising and VP-Ellipsis. *Linguistic Inquiry* 22, 345–358.
- Poesio, M. and A. Zucchi. (1992). On Telescoping. *Proceedings of the Second Conference on Semantics and Linguistic Theory* 347–366.
- Reinhart, T. (1987). Specifier and Operator Binding. In *The Representation of (In)definiteness*, edited by Reuland, E.J. and A. G. B. ter Meulen, 130–67. Cambridge: MIT Press.
- Tomioka, S. (1998). *The Semantics of Japanese Null Pronouns*. Manuscript, Universität Tübingen.
- Williams, E. (1977). Discourse and Logical Form. *Linguistic Inquiry* 8, 101–139.

CLASSIFIERS AND THE COUNT/MASS DISTINCTION*

Keiko Muromatsu

1. Introduction

Much research has been devoted to characterizing the count/mass distinction. The distinction has been claimed to be dichotomous since it is reflected in the grammar in the manner of the singular/plural distinction; accordingly, previous analyses have treated ‘count’ and ‘mass’ in a binary, ‘either or’ fashion (e.g. Chomsky 1965). In addition, there is a popular claim that all nouns are mass in classifier languages (e.g. Sharvy 1978, Gil 1987). In this article, I show that these are misconceptions and propose a more adequate analysis of the count/mass distinction.

This article is organized as follows. Section 2 presents the basic facts and demonstrates that dichotomous treatments of the count/mass distinction result in our missing a great deal of the nature of nominals. Section 3 proposes a new analysis from the perspective of numeral classifiers, as are observed in East Asian languages. Section 4 shows that classifiers are different from measure words, rejecting the widely accepted uniform treatment of these two kinds of elements (e.g. T’sou 1976, Allan 1977, Iljic 1994), a treatment that leads to the misconceptions mentioned above. Section 5 elucidates the different functions of nouns, measures, and classifiers, which work on our ‘mental space’. Section 6 provides evidence for a hierarchy in the noun system. Section 7, operating within the framework of the Minimalist Program (Chomsky 1993, 1995a, b), presents the internal structures of nominal expressions in terms of the hierarchical system, building on the foundation of syntax developed by Szabolcsi (1983), Kayne (1993), Hornstein, Rosen & Uriagereka (1994), and Uriagereka (1995).

2. The limit of dichotomous treatments

2.1. *The count/mass distinction*

A basic distinction among nouns divides them into one of two categories, count or mass. Consider the examples:

- (1) a. Mary bought a book.
- b. Mary bought books.
- c. *Mary bought book.

In (1) the noun *book* exhibits the singular/plural distinction by either combining with an indefinite article *a* for singular (1a), or with a plural marker *-s* for plural (1b). It is ungrammatical to use this noun without any specification in number (1c). On the other hand, nouns like *honey*, as shown in (2), do not exhibit such a singular/plural distinction, not taking either the indefinite article or the plural marker.

- (2) a. *Yogi ate a honey.
 b. *Yogi ate honeys.
 c. Yogi ate honey.

(2c), which corresponds to the ungrammatical (1c), is the form that is allowed for the noun *honey*. This difference in the behavior of the two nouns is generally recognized as the distinction between count and mass. *Book* is an example of count, and *honey* is an example of mass.

The count/mass distinction is also manifested in the choice of quantifiers. Count nouns combine with expressions such as *every*, *many*, *several*, while mass nouns take *much*, *a little*, etc.:

- (3) a. every book
 b. many books
 c. several books
 d. *much book(s)
 e. *a little book(s)
- (4) a. *every honey
 b. *many honey
 c. *several honey
 d. much honey
 e. a little honey

The influence of the count/mass distinction is not limited to the noun phrases, but extends to the sentence level, the subject noun phrases triggering a difference in the subject-predicate agreement:

- (5) a. The book is bought by Mary.
 b. The books are bought by Mary.
- (6) a. The honey is expensive.
 b. *The honey are expensive.

The above examples show that while count nouns trigger either singular or plural agreement on the verb *be*, mass nouns appear to agree only with the singular form of the predicate.

As we have just seen, the distinction between count and mass seems necessary, since the two exhibit some syntactic differences. The distinction appears to be dichotomous

since it is reflected in the grammar in the manner of the singular/plural distinction, and it is often treated by the binary feature system [\pm count]. The following subsection examines the binary feature system and reveals weaknesses in the approach.

2.2. *Weakness of the binary feature system*

In accordance with linguistic tradition, a noun is specified by the binary feature [\pm count] in the lexicon (Chomsky 1965):

- (7) a. book: [+ count]
- b. honey: [- count]

However, we also encounter examples like (8) and (9), where a given noun exhibits both natures, count and mass:

- (8) a. Put some apple in the salad.
- b. Put an apple in the salad

- (9) Mary had a little lamb. (8a, 9: Quine 1960, 91)

Apple differs in (8a) and (8b) in that the former is mass, while the latter is count. (9) is ambiguous, meaning either that Mary owned a small animal, or that Mary ate a small portion of lamb meat. This kind of noun is both count and mass, having a ‘dual life’¹.

Such dual-life nouns have two separate lexical specifications:

- (10) a. apple: [+ count]
- b. apple: [- count]

Abstract nouns, such as *peace*, *evil*, and *truth* are commonly included within the category of mass nouns, having the feature [- count] because they are uncountable (Jespersen 1933). The primary criterion of this distinction is whether given noun can be pluralized or not; abstract nouns cannot.

However, it is not intuitive to treat abstract nouns and mass nouns as the same. And so the feature [\pm concrete] is utilized to distinguish mass nouns from those that are abstract. For example, as shown in (11), the abstract noun *peace* is specified in the Lexicon as having a feature [- concrete] as well as the feature [- count]. The count noun *book* is also specified for the values of those two features:

- (11) a. peace: [- concrete] [- count]
- b. honey: [+ concrete] [- count]
- c. book: [+ concrete] [+ count]

By this system, the dual-life noun *apple* would be specified as follows:

- (12) a. apple: [+ concrete] [- count]
 b. apple: [+ concrete] [+ count]

This coding scheme for nouns has proved highly serviceable. But while there is no problem in a given noun having two separate feature specifications, the system nevertheless has a serious flaw, as we shall see in the next subsection.

2.3. *Lexical entailments*

Consider that it seems redundant for a count noun to have the specification [+ concrete], since this feature is to distinguish abstract nouns from mass nouns. If the two features are required for all kinds of nouns, they could in principle occur conjointly, thus predicting that there should exist nouns with the features combined as in (13d), which does not seem plausible:

- (13) a. abstract noun [- concrete] [- count]
 b. mass noun [+ concrete] [- count]
 c. count noun [+ concrete] [+ count]
 d. ? [- concrete] [+ count]

What seems to be happening in (13) is that there are implicational relations within a given noun. To see this, first consider the following sentences, which include the abstract noun *peace*:

- (14) a. Mary gave a peace sign.
 b. *The peace weighs six pounds.
 c. *John bought three peaces.

Among the three sentences above, (14b) is ungrammatical since the abstract noun *peace* is talked about with regard to its weight, treated as mass. In turn (14c) is also ungrammatical because the noun is counted, thus treated as count. Next consider the same patterns with the use of the mass noun *honey*:

- (15) a. Mary found a honey bee.
 b. This honey weighs six pounds.
 c. *John bought three honeys.

With the mass noun, only the count use in (15c) is ungrammatical, whereas (15b), which concerns the weight of honey, is grammatical; this is in contrast to the ungrammatical (14b) with the abstract noun *peace*. Finally, compare the above two cases with the one with the count noun *book*:

- (16) a. Mary is a book reviewer.
 b. This book weighs six pounds.
 c. John bought three books.

Book in (16a) is neither countable nor is it talking about massness, but rather it expresses a concept to modify the noun *reviewer*. *Book* in (16b) is talked about in regard of its massness, in particular its weight. And *book* in (16c) is used as countable. And all the three sentences are grammatical for the count noun *book*.

The examples (14) through (16) exhibit a gradation in grammaticality, and such gradation seems to suggest lexical entailments. A count noun can be accessed with regard to its concept, massness, and countability. A mass noun can be accessed with regard to its concept and massness, but not its countability. An abstract noun can be accessed only with regard to its concept, but not to massness or countability. These can be schematized as in (17). And compare this with what the binary feature system provides in (18). In the implicational scheme in (17), a noun of the sort in (17d), which is marked as ?, will be predicted not to exist since countability builds on concept and massness:

(17) a.	b.	c.	d.
abstract noun	mass noun	count noun	?
<hr/>			
concept	concept	concept	concept
	massness	massness	
		countability	countability
(18) a.	b.	c.	d.
abstract noun	mass noun	count noun	?
<hr/>			
[- concrete]	[+ concrete]	[+ concrete]	[- concrete]
[- count]	[- count]	[+ count]	[+ count]

The feature system, in order to prevent the occurrence of type (18d), requires a meaning postulate stipulating that a [+ count] noun is necessarily [+ concrete]. At the cost of such stipulation, we obtain the feature specifications (19) instead of (18):

(19) a.	b.	c.
abstract noun	mass noun	count noun
<hr/>		
[- concrete]	[+ concrete]	
[- count]	[- count]	[+ count]

The meaning postulate successfully eliminates (18d). However, (20) actually says more than the binary feature system-cum-meaning postulate:

(20) a.	b.	c.
abstract noun	mass noun	count noun
<hr/>		
concept	concept	concept
	massness	massness
		countability

(20) suggests not only the existence of the lexical entailments, but also of a hierarchy among the three kinds of noun. Abstract nouns are the simplest of the three, mass nouns are more complex, and count nouns are the most complex. The binary feature system, as

shown in (19) will not reveal such a hierarchical relationship among abstract, mass and count nouns, even in conjunction with the meaning postulate. Given the hierarchical nature of three kinds of noun, we now know why [+ count] entails [+ concrete].

Let us here review the binary feature system for the count/mass distinction: (i) It specifies the values of the feature [\pm count] in the Lexicon; (ii) a dual-life noun has two separate feature specifications; (iii) the system also employs the feature [\pm concrete] to distinguish mass nouns from abstract nouns, the latter being also uncountable; (iv) in order to avoid the unwanted combination of the two features, the costly meaning postulate is required, stipulating that [+ count] subsumes [+ concrete]. Even with all this apparatus, the hierarchical relationship among the three kinds of noun we found above is not expressed.

Besides the binary feature system, there have been various attempts to deal with the count/mass distinction, for example, by predicate logic, as well as the analyses by Ware (1975), Sharvy (1978), and Allan (1980). Their analyses vary with respect to the way the nouns are viewed and how the view selected is associated with the count/mass distinction. For instance, Sharvy (1978) considers all nouns as mass nouns, whereas Ware (1975) treats no nouns as count or mass, the particular occurrence of the noun determining the distinction.

Despite the differences in their analyses for the count/mass distinction, one problem they share in common is the dichotomous nature of that distinction. Namely, count nouns and mass nouns are treated on a par. And this kind of approach will not be able to deal with the hierarchy we found in the noun system, which suggests that countability resides on top of massness, which is what the meaning postulate supplies in the binary feature system. As long as the count/mass distinction is ‘either or’, the lexical entailments will not be captured.

Another thing common to the previous analyses is that they ignored abstract nouns. Any satisfactory account of the count/mass distinction must be able to deal with these. Our task is to seek a system that can explain the paradigm in (20) – both the lexical entailments, and the hierarchical relationship; this will be presented in the next section.

3. Proposal: a 3D-view

To express the hierarchy and the lexical entailments, I propose to analyze the three kinds of noun as being of different dimensionality, as schematized in spatial metaphor in (21):

- (21) a. ‘abstract noun’ b. ‘mass noun’ c. ‘count noun’
 1 Dimensional 2 Dimensional 3 Dimensional

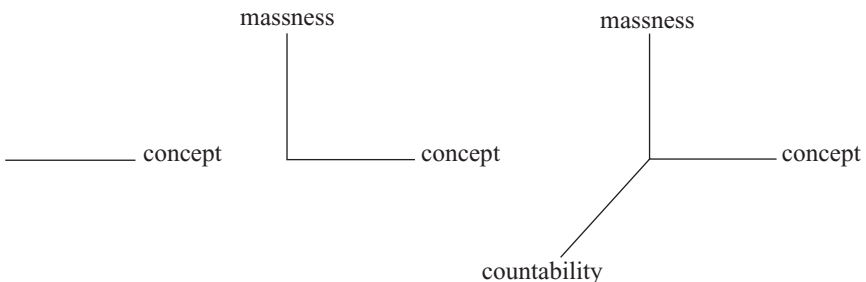

In this scheme, the entailments can be handled straightforwardly. For instance, returning to the example from Section 2.3, we can say the sentence (16b) (repeated here as 22a) because three-dimensional *book* subsumes massness (2D):

- (22) a. This book weighs six pounds. (= 16b)
- b. Mary is a book reviewer. (= 16a)
- c. *John bought three honeys. (= 15c)

Likewise, we can say (16a) (repeated here as 22b) because 3D *book* also subsumes concept, which is 1D. The scheme in (21) also predicts the ungrammaticality of (15c) (repeated here as 22c). (22c) is ungrammatical because according to (21b), a mass noun is only two-dimensional and lacks the axis that expresses countability, as compared to (21c), which is three-dimensional for count nouns.

It should be noted, though, that the dimensionality proposed here is not that of reality; rather it is our mental representation. It is often the case that pairs such as *footwear* and *shoe*, *clothing* and *clothes* are taken up as mysterious cases. They seem to refer to the same things, and yet they distinguish count and mass modes. The noun *furniture* is a notorious instance. *Furniture* has the form of a mass expression but has little to do with actual furniture, including tables and beds, which of course can be counted. What is important is that furniture is conceptualized as 2D.

Further, studies of language acquisition by Gathercole (1985, 1986) and Gordon (1985, 1988) find no support for the notion that children acquire the count/mass distinction as a distinction between names for objects vs. substances. Rather, these studies find that children base this distinction on syntactic cues, i.e. as quantificational and distributional distinctions.

It will be argued that the abstract/mass/count distinction has a syntactic basis, the three kinds of nominals having different internal structures with different levels of complexity. More specifically, I will argue that each axis that makes up a dimension is a syntactic object: a noun, a measure, a numeral classifier:

- (23) a. noun
1 Dimensional
- b. mass expression
2 Dimensional
- c. count expression
3 Dimensional

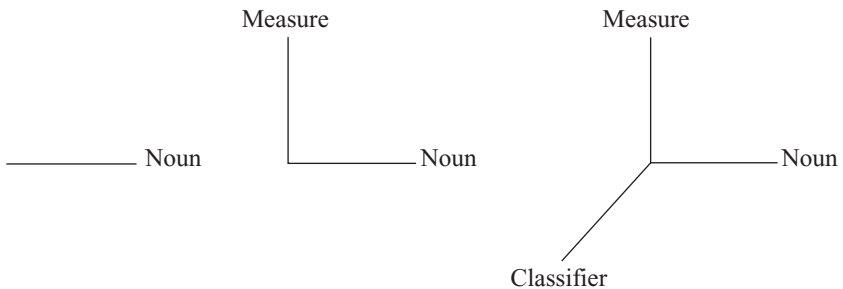

A bare noun provides a basic space, expressing concept. A measure works on the basic space, substantivizing it to make the space two-dimensional, making the expression mass.

A classifier works on the 2D space, individuating the mass, rendering the space three-dimensional, thus making the expression countable.

4. Classifiers and measures

4.1. The count/mass distinction and classifier languages

We started our discussion of the count/mass distinction by observing whether or not a given noun exhibits the singular/plural distinction. With respect to the singular/plural specification on nouns, there is a very interesting universal noted by Sanches & Slobin:

- (24) [I]f a language includes numeral classifiers as its dominant mode of forming quantification expressions, then ... it will *not* have obligatory marking of the plural nouns. (Sanches & Slobin 1973, 4)

Note that (24) does not deny the existence of expressions for plurality in numeral classifier languages, but it rather says that the plural marking is not mandatory.

Numeral classifiers are observed in the languages of East Asia, Southeast Asia, and the Pacific (Conklin 1981). Let us take Japanese as an example of a numeral classifier language, and consider some cases from this language:

- (25) *Mari wa hon o katta.*
 TOP book ACC bought
 ‘Mari bought a book/books.’

In (25), which is a grammatical sentence, the singular/plural distinction is not specified in the noun. The word *hon* ‘book’ does not show the distinction, and it can be interpreted either as ‘a book’ or ‘books’.

The Japanese language can distinguish singular from plural by specifying the actual number, and in doing so the use of a numeral classifier is obligatory:

- (26) a. *Mari wa hon o san satu katta.*
 TOP book ACC three CL bought
 ‘Mari bought three books.’
 b. **Mari wa hon o san katta.*
 TOP book ACC three bought
 ‘Mari bought three books.’

In any discussion of classifiers, it is customary to consider the measure construction in English, such as (27), as a case analogous to that of classifiers:

- (27) a. five liters of water
 b. two pounds of meat

The similarity between classifier constructions in classifier languages and measure constructions in non-classifier languages has led some linguists to treat classifiers and measures in a uniform way (T'sou 1976, Allan 1977, Iljic 1994, among several others).

These observations have given rise to the claim that in classifier languages, such as Japanese, all nouns are mass (Sharvy 1978). This is argued on the basis that a primary characteristic of mass nouns is that they call for an intervening measure to construct a numeral expression, and this is what classifiers seem to be doing to in classifier languages. Hence some claim that in such languages there is no count/mass distinction, whether it be grammatical (Greenberg 1977) or extragrammatical (Gil 1978).

Gil (1987, 267–268) asserts that ‘the count/mass parameter is largely extragrammatical, though possessing, in addition, some grammatical reflexes. . . . To the extent that the count/mass parameter is extragrammatical, this scenario supports a version of linguistic relativity whereby grammar determines worldview. . . . [T]he NP typology would provide support for one version of Whorf’s hypothesis of linguistic relativity.’ According to this view, for example, native speakers of English conceive of an individual animal called ‘cat’ as count, whereas native speakers of Japanese conceive it as mass, since the English noun *cat* is a count noun, while the Japanese noun *neko* ‘cat’ is a mass noun. This neo-Whorfian view should be rejected without further ado.

The question is whether or not all nouns in classifier languages are mass intragrammatically. A closer look at classifiers reveals that they are distinct from measures (cf. Downing 1984, Greenberg 1977), and this distinction is crucial to my analysis of nominals. In the next section, I present four major differences between the two.

4.2. Differences between classifiers and measures

4.2.1. Semantic selection

One difference between classifiers and measures is that they differ in the way they select nouns to combine with. Classifiers are so named because they provide ‘a semantic classification of the head noun’ (Greenberg 1977, 277). The classification ‘is based primarily on the parameters of animateness, shape or function which are attributed to the head noun’ (Adams & Conklin 1973, 1).

With regard to animateness, for example, human beings, animals, and birds are categorized separately in Japanese:

- (28) a. *kodomo go nin*
 child five CL[for humans]
 ‘five children’
 b. *uma go too*
 horse five CL[for large animals]
 ‘five horses’
 c. *inu go hiki*
 dog five CL[for small animals]
 ‘five dogs’

- d. *kanaria go wa*
 canary five CL[for birds]
 ‘five canaries’

In (28b) *too*, meaning ‘head’ classifies large animals. It is also used for counting horses, cows, tigers, bears, etc. And these nouns form a class by sharing the same classifier for enumeration.

Classification by shape includes such properties as long and flat. For example, long objects such as pencils, sticks, and trees are classified by the use of the classifier *hon* in Japanese:

- (29) a. *enpitu go hon*
 pencil five CL[for long objects]
 ‘five pencils’
 b. *kasa ni hon*
 umbrella two CL[for long objects]
 ‘five umbrellas’
 c. *banana yon hon*
 banana four CL[for long objects]
 ‘four bananas’

A group of nouns that share an associated classifier are categorized as belonging to the same group. From the perspective of classifiers, each of them serves as a label for a given kind of grouping. The choice of a classifier is semantically constrained, the primary parameters being animateness, shape or function.²

In contrast to classifiers, measures such as *pound* or *inch* can be applied to any noun with weight or extension, including countables (Greenberg 1977, Downing 1984). Consider the examples from Japanese:

- (30) a. *banana ni kiro*
 banana two kilogram
 ‘two kilograms of bananas’
 b. *kin ni kiro*
 gold two kilogram
 ‘two kilograms of gold’
 c. *mizu ni kiro*
 water two kilogram
 ‘two kilograms of water’

All the nouns in (30) are combined with the measure *kiro* ‘kilogram’, but there seems to be no semantic categorization common to them based on the parameters of animateness, shape or function. The noun *banana* ‘banana’ in (30a) is, as we saw above, one of the nouns that is associated with the classifier *hon*. *Kin* ‘gold’ in (30b) is metal and *mizu* ‘water’ in (30c) is liquid, neither of them having a classifier associated with it.

This is not to say that the measure words are not selective. What measures care about, however, is substance or material.³ *Banana* ‘banana’, *kin* ‘gold’, and *mizu* ‘water’ in (30)

are all substantive, and thus can be associated with weight. Another example is the measure *rittoru* ‘liter’, which can apply to a liquid substance, such as *mizu* ‘water’ and *wain* ‘wine’. Measures in Japanese do not have the function of classifying nouns, but rather select nouns in accordance with substance.

Next consider the measure construction in English:

- (31) a. a pound of bananas
 b. a pound of gold
 c. a pound of water

As is the case in Japanese, there seems to be no semantic classification common to the three nouns; what the applicability of measure *pound* is telling us rather is that the three nouns are all substantive.

In this subsection, I pointed out a difference between classifiers and measures from a semantic perspective: classifiers classify nouns qua form, animateness, or function, while measures are concerned with substance.

4.2.2. Syntactic selection

Turning now to the second difference between classifiers and measures, let us consider again the previous English examples in (31). The measure *pound* is applicable to a count noun, *banana*, as well as mass nouns, *gold* and *water*.

From this observation, the popular claim that all nouns in classifier languages are mass already seems doubtful. Consider the reasoning that motivates this claim. In non-classifier languages, a measure is not required for count nouns, while for mass nouns a measure is necessary in order to construct a numeral expression; indeed the primary characteristic of mass nouns is the requirement of a measure. In classifier languages, a classifier is mandatory for constructing a numeral expression. Based on the premise that measures in non-classifier languages and classifiers in classifier languages are of a piece, and the fact that the use of classifiers is obligatory, it seems to follow that all nouns in classifier languages are mass nouns. However, the above reasoning does not hold any longer, since even count nouns in non-classifier languages combine with measures as in (31a).

Keeping this in mind, let us next consider the case with Japanese. As mentioned in Section 4.1, Japanese, being a classifier language, does not exhibit the singular/plural distinction on nouns. However, comparison with English nouns reveals that classifiers categorize only nouns which correspond to English ‘count nouns’, while measures go with nouns that correspond to either ‘mass’ or ‘count’ nouns. Consider the examples in (30) again. (30) illustrates that the measure *kilo* ‘kilogram’ can go with nouns that are either ‘count’ or ‘mass’ in English. On the other hand, (32) shows that classifiers combine with nouns that are ‘count’ in English:

- (32) a. *banana ni hon*
 banana two CL[for long objects]
 ‘two bananas’

- b. *kuruma ni dai*
 car two CL[for machines]
 ‘two cars’
- c. *hon ni satu*
 book two CL[for books]
 ‘two books’

The nouns *kin* ‘gold’ and *mizu* ‘water’ in (30), which correspond to English ‘mass nouns’, cannot form classifier constructions since there is no classifier associated with them. Thus, it is apparent that there are nouns that are not associated with classifiers; they are not classified.

According to Dixon (1986) in a classifier language there are some nouns which cannot take numeral classifiers (e.g. names of time units and/or uncountable nouns), and there are many nouns that take more than one classifier. The next question to ask is what class of nouns takes classifiers and what class does not. As Dixon suggests, uncountable nouns do not; thus the existence of associative classifiers seems to provide the right cut between ‘count’ and ‘mass’ nouns in classifier languages.⁴

4.2.3. Syntactic differences

The third difference between classifiers and measures is their syntactic behaviors. Greenberg (1977) notes that a few languages exhibit a grammatical difference between measure constructions and classifier constructions: For example, measures take a different linking particle in Cebuano. We also find such a phenomenon in Mandarin Chinese. T’sou (1976) observes that in Chinese the modification marker *de* can be present with measures but not with classifiers:

- (33) Chinese: a. *san zhi ji*
 three CL chicken
 ‘three chickens’
- b. **san zhi de ji*
 three CL DE chicken (T’sou 1976, 1219)
- (34) Chinese:⁵ a. *yi bang tang*
 one pound sugar
 ‘a pound of sugar’
- b. *yi bang de tang*
 one pound DE sugar
 ‘a pound of sugar’

Another item of syntactic evidence comes from Thai: classifiers and measures behave differently with respect to adjectives. Consider the examples from Hundius & Kölver (1983) (Henceforth H&K):

THE COUNT/MASS DISTINCTION

- (35) Thai: a. *nók tua jàj*
bird CL big
'the big bird'
- Thai: b. *jaa khanaan jàj*
medicine portion big
'a big portion of medicine' (H&K 1983, 169–170)

In the classifier construction (35a), the meaning of the adjective is mapped onto the head noun, *nók* 'bird'. The classifier *tua* itself cannot be modified. On the other hand, in the measure construction (35b), the measure *khanaan* 'portion' can be modified by a suitable adjective (i.e. those that denote quantity or size).

In contrast to (35a), the meaning of the adjectives cannot be mapped onto the head noun in the measure construction as shown in (36a); instead, the adjective that modifies the head noun must immediately follow it, as in (36b):

- (36) Thai: a. **jaa khanaan khom*
medicine portion biter
- b. *jaa khom hannan nyη*
medicine bitter portion one
'a portion of bitter medicine' (H&K 1983, 170)

Japanese provides another instance of syntactic difference between classifiers and measures. When a classifier and a measure co-occur within a noun phrase, the grammaticality of the noun phrase changes depending on the position of the two items:

- (37) Japanese: a. *ni kg no meron san ko*
two kg GEN melon three CL
'three 2-kg melons'
- b. **san ko no meron ni kg*
three CL GEN melon two kg
'three 2-kg melons'

The ungrammaticality of (37b) is not a semantic one, since placement of the classifier and the measure would be appropriate if they occurred alone:

- (38) Japanese: a. *san ko no meron*
three CL GEN melon
'three melons'
- b. *meron ni kg*
melon two kg
'two kg of melons'

Therefore, the ungrammaticality of (37b) must be structural. The lack of interchangeability of measures and classifiers reveals the syntactic difference:

- (39) Japanese: a. NUM-MS GEN N NUM-CL (NUM = numeral)
 b. *NUM-CL GEN N NUM-MS
 c. NUM-MS GEN N
 d. NUM-CL GEN N
 e. N NUM-CL
 f. N NUM-MS

The foregoing examples from Chinese, Thai, and Japanese demonstrate the existence of differences in the syntactic behavior of the classifier construction and the measure construction.

4.2.4. *Typological perspective*

The fourth difference between measures and classifiers comes from a language universal. As we saw in Section 4.1, this language universal tells us that classifiers and the obligatory specification of plurality are in complementary distribution (Sanches & Slobin 1973). In short, classifiers make a typological distinction among world languages. However, we observe measure constructions even in non-classifier languages, such as English. Based on this typological consideration, classifiers and measures are not to be regarded as the same.

4.3. *The count/mass distinction in classifier languages*

Above I demonstrated that there is a clear distinction between classifiers and measures with respect to the four points for which I have provided linguistic evidence.

As mentioned earlier, some scholars maintain that classifier languages lack the count/mass distinction. Their viewpoint, which I believe is mistaken, derives from two misconceptions.

First, they consider measures and classifiers as the same, ignoring the classificational function of classifiers. Since the dominant feature of English mass nouns is that they require an intervening device for quantification – for example, *a pound of meat* – and since classifiers in classifier languages perform a similar task, they consider all nouns in classifier languages to be mass.

Second, the lack of singular-plural specification in classifier languages also makes nouns in these languages look like they are all mass – unlike in English, where the count/mass distinction is signaled clearly by number specification on nouns.

However, it is proven here that classifiers and measures are not identical. Further, considering the count/mass distinction from the perspective of classification, Japanese nouns that correspond to English count nouns, such as *book*, *car*, and *pencil*, have associated classifiers, and they can be counted. On the other hand, Japanese nouns that correspond to English mass nouns, such as *water*, *honey*, and *gold*, do not have associated classifiers, nor can they be categorized by them. Nor can they be counted.

This leads me to conclude that there is a count/mass distinction in classifier languages after all. Classified nouns correspond to English count nouns, whereas non-classified nouns correspond to English mass nouns. The grammatical claim that all nouns in classifier languages are mass is false, as is the claim that they have an extragrammatical basis. What classifier languages lack is not a class of count nouns but obligatory singular/plural specification on nouns, in accordance with the linguistic universal noted by Sanches & Slobin (1973).

5. Functions

This section investigates the function of classifiers and that of measures, which I claim to be correlated with countability and massness, respectively. It is also essential to consider what function bare nouns perform; we begin our discussion with this issue.

5.1. *The noun: a basic space*

I propose to characterize the function of nouns as providing a basic mental space, denoting quality. This constitutes the base of the hierarchy of nominal types.

We find bare nouns in the form of predicate nominals. Let us consider examples from Japanese. Compare (40a) and (40b):

- (40) a. *Sono ekitai wa mizu de aru.*
 that liquid TOP water be
 ‘That liquid is water.’
 b. **Sono ekitai wa 50cc no mizu de aru.*
 that liquid TOP GEN water be
 ‘That liquid is 50cc of water.’

As the example (40b) indicates, predicate nominals do not take measures.⁶ Nor do they take classifiers:

- (41) a. *Jiro to Taro wa gaka de aru.*
 and TOP painter be
 ‘Jiro and Taro are painters.’
 b. **Jiro to Taro wa futa-ri no gaka de aru.*
 and TOP two-CL GEN painter be
 ‘Jiro and Taro are two painters.’

In (41a), *gaka* ‘painter’ is without a classifier. When it appears with a classifier, as in (41b), the sentence is rendered ungrammatical. These examples suggest that a predicate nominal is classifier-less.⁷ I claim that Japanese bare nouns simply provide pure characteristic.

Just as in classifier languages, bare nouns in non-classifier languages, such as English, do not refer but rather denote mere quality (Jespersen 1954, among many others). Again we find bare nouns in the form of predicate nominals, just as we did in classifier languages:

- (42) a. The space shuttle is more rocket than airplane.
 b. He was not man enough to admit his mistake.

Bare nouns resemble adjectives in that they do not refer but rather denote mere qualities, as is well known in formal semantics:

- (43) a. John is tall.
 b. The hat is red.

In (43), it is not possible that the adjective *tall* or the adjective *red* refer to any entity. Likewise, in (44), neither the predicate nominal *artist* nor *businessman* refer to anybody, but rather provide the quality that Mary has:

- (44) Mary is more artist than businessman.

Jespersen (1924) makes the claim for the similarity between nouns and adjectives, as he uses the term ‘noun’ to cover both adjectives and substantives (the latter of which for us corresponds to nouns). He gives some interesting examples for his argument. In Finnish it seems that no distinction is possible between substantives and adjectives. A word like *suomalainen* simply belongs to the category noun, which is translated sometimes into English as the substantive ‘Finn’ or ‘Finlander’ or other times into the adjective ‘Finnish’. He also cites from Shakespeare:

- (45) Normans, but bastard Normans, Norman bastards.

Here *Norman* and *bastard* are used both as adjectival and as substantive, interchangeably.

From the above observation, we can conclude that in non-classifier languages also, a noun in the form of a nominal predicate is the simplest of all, having the form of a bare noun without any complex structure. It constitutes the base of the hierarchy of nominal types. It is only a one-dimensional space of quality.

In such a space, what can be done is to compare the degree of the quality that nouns denote. Predicate nominals can denote qualities that occur in varying degrees, which constitutes a further resemblance to adjectives. The following examples illustrate this property:

- (46) a. He was less statesman than warrior. (46a, Jespersen 1933, 130)
 b. She is more mother than wife.

In (46), none of the nouns refer; rather they denote qualities – more specifically, the *degree* of qualities. The degree is indicated by comparative expressions such as *less ... than*, and *more ... than*, which are usually taken by adjectives. (46b), for example, compares the degree of someone’s being a mother to that of her being a wife.

Adjectives also exhibit such a property:

- (47) a. She is as kind as she is honest.
 b. He was not so clever as he was wicked.
 c. The chair is more brown than the wall is white.⁸

In (47a), what is compared is the degree of kindness and the degree of honesty. In (47b) it is the degree of cleverness and that of wickedness. In (47c) what is compared is not the chair and the wall, but the degree of brownness and the degree of whiteness.

Given such similarity between predicate nominals and adjectives, it is no wonder that the paraphrases below are available:

- (48) a. I was fool enough to believe him.
 b. I was foolish enough to believe him.
- (49) a. He was not man enough to admit his mistake.
 b. He was not manly enough to admit his mistake.

And yet nouns and adjectives differ: the degree of bare nouns is, unlike that of adjectives, that of typicality. For example, consider (46b) again. By *more mother than wife*, we are comparing the degrees of the qualities that each bare noun, *mother* and *wife*, denotes; we are comparing the typicality of each quality.⁹

In this section, we found that bare nouns in both classifier and non-classifier languages provide quality. I considered predicate nominals to be one form that bare nouns can function as.

5.2. Function of measures: substantivization

Now we proceed to investigate the function of measures. As a starting point, let us examine measure constructions in Japanese:

- (50) a. *Kono eikitai wa benzin de aru.*
 this liquid TOP benzine be
 ‘This liquid is benzine.’
- b. **Kono eikitai wa 1 rittoru no benzin de aru.*
 this liquid TOP 1 liter GEN benzine be
 ‘This liquid is a liter of benzine.’
- c. *Jiro ga 1 rittoru no benzin o katta*
 NOM 1 liter GEN benzine ACC bought.
 ‘Jiro bought a liter of benzine.’

As we have seen in Section 5.1, the measure construction cannot serve as a predicate (50b). A predicate nominal must be a bare noun (50a). The measure construction, however, can appear as an object (50c).

The noun *benzin* ‘benzine’ is used differently in (50a) than in (50c). *Benzin* ‘benzine’ in (50a) denotes a quality and does not refer to any entity. In contrast, *benzin* in (50c)

refers to the liquid that Jiro actually bought, the amount of which is a liter. The fact *I rittoru no benzin* ‘a liter of benzine’ is a quantified expression (talking about the amount) by way of a measure expression, *I rittoru no* ‘a liter of’ seems the key to the difference.

I claim that what the measure *rittoru* ‘liter’ is doing here, combining with *benzin* ‘benzine’, is making the whole expression *I rittoru no benzin* ‘a liter of benzine’ in some sense material or substantive by ‘giving mass’ to the notion expressed by *benzin* ‘benzine’. A measure brings quantity to the bare noun *benzin*, building structure onto it. In other words, measures have the function of substantivization. By this materialization device, *I rittoru no benzin* ‘a liter of benzine’ somehow becomes ‘visible’ in our mental space for quantification purposes.

Now consider:

- (51) *Jiro ga benzin o katta.*
 NOM benzine ACC bought
 ‘Jiro bought benzine.’

Compared to *I rittoru no benzin* ‘a liter of benzine’ in (50c), *benzin* ‘benzine’ in (51) appears to be a bare noun, like the predicate nominal in (50a). However, the only difference between (50c) and (51) is in whether or not the exact amount of benzine is specified.¹⁰ However, in (50a), *benzin* ‘benzine’ only denotes quality and is of a different nature from *benzin* ‘benzine’ in (51). I take *benzin* ‘benzine’ in (51) to include an invisible measure, which builds the dimensionality to 2D.

The same reasoning as in the Japanese instance (50) applies to English examples in (52):

- (52) a. This meat is chicken.
 b. John bought a pound of chicken.

In (52), the noun *chicken* is used differently in (52a) than in (52b). *Chicken* in (52a) is a predicate nominal. It denotes a quality and does not refer to any entity. In contrast, *chicken* in (52b) refers to the meat that John actually bought and that weighs one pound. The fact that *a pound of chicken* is a quantified expression (talking about the amount) by way of a measure expression *a pound of* seems key to the difference.

I claim that, as is with the case with Japanese, a measure word brings quantity to the bare noun, building structure onto it. In other words, measure words have the function of substantivization.

The function of a noun is, as we saw in the previous section, to provide a basic mental space to be worked on. The function of a measure is to materialize this basic space so that the quality space becomes substantial. In this two-dimensional space, the materialized noun phrase is now quantifiable.

5.3. Function of classifiers: individuation

We next consider how classifiers are associated with countability. Considering the semantic difference between classifiers and measures, namely that classifiers classify

nouns qua form, while measures determine nouns qua material substance, the function of classifiers does not seem to be that of substantivization, as is that of measures.

As a starting point, let us consider the alternative interpretations of classifiers given by Quine (1969b). He gives two ways of interpreting them, though without providing any answer as to which one is right. One way is to view classifiers as constituting part of the numeral, thereby forming a suitable style for whatever is counted. Another way is to view them as constituting part of the noun, the classifier doing the job of individuation.

(53) illustrates these two interpretations:¹¹

- (53) *go too no usi*
 a. five CL GEN oxen ‘five oxen’
 b. five CL GEN cattle ‘five head of cattle’

The first view corresponds to the classifier being chosen so as to attach to the numeral *five*. This classifier induces the numeral *five* to take on the ‘animal gender’ (Quine 1969b, 36), with the result that this numeral-classifier pair is rendered suitable for counting big animals, such as oxen, as in (53a). If a different classifier had been chosen, it would have been suitable for counting slim objects, such as pencils and sticks.

On the second view, the Japanese word *usi* amounts to the English mass term ‘cattle’, as in (53b). The classifier *too* ‘head’ ‘applies to this mass term to produce a composite individuating term, “head of cattle”’; and the numeral applies directly to the individuating term ‘without benefit of gender’ (Quine 1969b, 36).

Quine asserts that the first way treats the Japanese word *usi* ‘as an individuating term true of each bovine, and the other [second] way treats that word rather as a mass term covering the unindividuated totality of beef on the hoof’ (Quine 1969b, 37).

I will argue that the second view is more adequate. To see this we must consider how a classifier individuates a mass term. My specific claim is that classifiers have the function of giving a structured form to an already materialized, but formless, mental space. By obtaining a form, the mass term is thereby individuated so as to become countable. Of course, without similarity of form, nothing can be counted.

Counting assumes the presence of separate objects (Wierzbicka 1985). Yet it is only a necessary condition, not a sufficient one. We need to know what counts as *one*. Intuitively, the association between form and what counts as an individual seems to be a correct one. To borrow Greenberg’s (1977, 283) celebrated example, ‘[i]f I cut a piece of meat in two, I have two pieces of meat, but if I cut a dog in two, I still have only one dog, a dead one’.

Further, as Frege (1950) argues, ‘we only think of things in terms of number after they have first been reduced to a common genus’. And as we saw in Section 4.2.1, classifiers perform precisely this task of categorization. Imagine that there are two CDs and three books. In Japanese, *CD* ‘CD’ is counted by the classifier *mai*, and *hon* ‘book’ is counted by the classifier *satu*. However, these two kinds of things are not counted together since they are not of the same kind, not sharing the same classifier.

Moreover, we have also seen that shape is one of the dominant parameters of classification. Thus there is a connection between form and counting.

In sum, a classifier makes a noun countable by virtue of its function; individuation is achieved by means of classification (i.e. categorization by virtue of form).

Quine (1969a, 8) says that ‘[t]o learn “apple” it is not sufficient to learn how much of what goes on counts as apple; we must learn how much counts as *an* apple, and how much as another. Such terms possess built-in modes of individuation’. I have shown that in classifier languages, a classifier performs this function of individuation: what a classifier provides is a linguistically structured form that constitutes an individual.

The question is how such a mode of individuation is provided in non-classifier languages and whether it is really built-in to the term itself. As for classifier languages, I claim that Quine’s ‘built-in modes of individuation’ are not built into each word but rather are provided by a classifier. In a non-classifier language like English, the ‘mode of individuation’ appears ‘built-in’ only because the classifier is invisible. And yet Quine’s (1969a) intuition can be captured in my view: only classified nouns combine with a classifier.

It is necessary to postulate an invisible classifier *pro* for the languages that are not considered classifier languages. For example, in English, I take *five pencils* to contain a classifier *pro*, whereas the equivalent expression in Japanese contains a classifier *hon*:

- (54) a. Japanese: *enpitu go hon*
 pencil five CL
 ‘five pencils’
 b. English: *five pro pencils*
 five CL pencils
 ‘five pencils’

The postulation of *pro* enables us to extend this explanation to non-classifier languages, considering that the count/mass distinction exists in these languages as it does in classifier languages. *Pro* will provide a parallel treatment of the hierarchy of the noun system in both language classes. The postulation of such a null element is costly. However, without such a device we would not only lose explanatory power but also would have to accept the neo-Whorfian view that English and Japanese are conceptually different (cf. Gil 1987).

It would be worthwhile at this point to make a clarification regarding classifiers and ‘abstract nouns’. One might question ‘abstract nouns’ being counted as *two ideas* and *several thoughts*.¹² It might seem problematic, but in fact it is consistent with the claim made here. In Japanese, too, one can say, for example, *futa-tu no aidia* ‘two ideas’ and *itu-tu no kangae* ‘five thoughts’. Here, we see the classifier *tu* occurring between the numerals and the nouns. *Futa-tu no aidia* ‘two ideas’ expresses two different concrete ideas that can be talked about. The two are distinguishable, and can be counted as two instances. *Futa-tu no aidia* ‘two ideas’ is no longer abstract, the bare noun *aidia* ‘idea’ having had its dimensionality built up to the level of 3D by the general classifier *tu*. This is just the same as *Ni-ko no ringo* ‘two apples’. Here the classifier *ko* brings the noun’s dimensionality to 3D. The two apples are distinguishable and can be counted as two instances. As for an ‘abstract noun’ *heiwa* ‘peace’, it cannot combine with any classifier in Japanese, and it cannot be counted. As mentioned in Section 4.2.2, there exist some nouns that are not associated with any classifiers; in other words, these nouns are not classified. Such nouns

cannot build their dimensionality to 3D. On the contrary, we saw in Section 5.1 that the noun *gaka* ‘painter’, which seems to be a ‘concrete noun’, can also express abstract concepts when it is bare (1D). To sum up, just as the count/mass distinction is not a property of a noun per se, but of the structure of the noun phrase, the count-abstract distinction is also not a property of a noun per se, but of the structure of the noun phrase.

6. Hierarchy in the noun system

In this section, I will prove that nouns, measure and classifiers apply hierarchically. Recall the dimensional scheme:

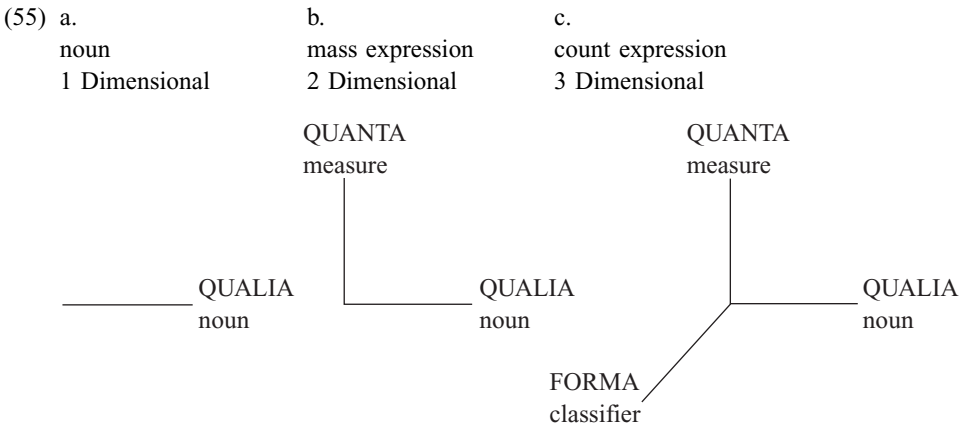

I characterize the function of nouns as providing a basic mental space, denoting quality: a bare noun provides the axis ‘Qualia’. It constitutes the base of the hierarchy of nominal types. Measures, providing an axis ‘Quanta’, work on this fundamental quality space, materializing it to generate a substantial space. In this two-dimensional space, the nominal expression is quantifiable. Classifiers operate to give a form to 2D, so that the expression is countable. The axis ‘Forma’ takes nouns to a three-dimensional space.

Importantly, there are no classifiers specifically associated with nouns that express abstract notions, such as ‘peace’ and ‘evil’. In other words, abstract concepts are not classified. Nor they can be used with measure phrases. The nouns that express abstract concepts remain at 1D. So-called mass nouns are really a composite of a bare noun and a measure word, being complex 2D expressions. So-called count nouns are even more complex, the result of a classifier adding the third dimension to 2D expressions.¹³

H&K (1983) also claim that bare nouns are purely conceptual labels, similar to my notion of Qualia, and that classifiers have the function of individuation. They also discriminate classifiers from measure words. However, for them there is no hierarchical relationship between the two. That is, they treat the function of measures and that of classifiers in a parallel fashion, both of them working on bare nouns.

As for the function of classifiers, Quine (1969b) is not the only one to consider individuation to be a function of classifiers. Ritchie (1971) also considers the semantic

content of classifiers as ‘individual’ or ‘instance’. Greenberg (1977) also takes such a view, considering a classifier as an ‘individualizer’ and ‘unit counter’. He considers that classifiers give many modes of quantification, expressed as ‘times one’, rather than ‘one’. However, his view crucially differs from mine in that he takes classified nouns without classifiers as collectives. In other words, for him, a classifier applies to a bare noun, which is a collective noun. In contrast, I take a classifier to apply to a mass expression, which subsumes a qualia noun (a bare noun). Greenberg (1977) also distinguishes measure words and classifiers, but he does not discuss mass nouns.

My view crucially differs from these previous analyses in that my system posits a hierarchical relationship between mass and count. Mass and count in my system are not treated in a parallel fashion as dichotomous categories; nor can the hierarchical relationship between them be reversed, mass subsuming count. It is still necessary to prove that classifiers and measures are not to be treated on a par, but rather that classifiers apply hierarchically higher than measures. This issue will be discussed in the following subsections.

Another respect in which I differ from other authors is that I apply this 3D-view not only to classifier languages, but also to non-classifier languages, such as English. In other words, all languages possess classifiers, and all languages have the dimensional scheme as expressed in (55).

6.1. Lexical entailments

The first argument for hierarchy comes from the lexical entailments we encountered in Section 2.3. In fact, this was the primary motivation for the proposed scheme. In Thai, 3D nominals combine with *laaj* ‘many’, while 2D nominals combine with *mâak* ‘much’

- (56) Thai: a. *rôm laaj khan*
 umbrella many CL
 ‘many umbrellas’
 b. *nâamman mâak*
 oil much
 ‘much oil’
- (H&K 1983, 179)

According to the lexical entailments, it is predicted that a noun that can be built up to 3D can also be built up to 2D. And we see examples of such representations in Thai:

- (57) Thai: a. *mii nákrían laaj khon*
 have student many CL
 ‘There are many students.’
 b. *mii nákrían mâak*
 have student much
 ‘There are lots of students.’
- (H&K 1983, 179)

H&K (1983) note that while (57b) implies that the quantifiers of the students are too large to assess in figures, (57a) suggests that the students are perceived individually.

We find a parallel case in non-classifier languages such as Spanish:

- (58) Spanish: a. *En donde yo nací hay muchos toreros.*
 ‘Where I was born there are many bullfighters’.
 b. *En donde yo nací hay mucho torero.*
 ‘Where I was born there are much bullfighter’ (sic).
 (Uriagereka 1995, 281)

However, we do not see the reversed case where 2D nominals combine with expressions that select 3D nominals, such as numerals, *many*, and so on.

6.2. Co-occurrence of measures and classifiers

The argument in this case is based on patterns of co-occurrence of measures and classifiers. Our dimensional system predicts that abstract nouns will not occur either with a measure or a classifier. This prediction is borne out. There exist no classifiers specifically associated with nouns that express abstract concepts:

- (59) Japanese: a. **100g no heiwa*
 GEN peace
 ‘100 of peace’
 b. **futa-tu no heiwa*
 two-CL GEN peace
 ‘two peaces’

The hierarchical system also predicts that mass expressions go with measures but not with classifiers:

- (60) Japanese: a. *5 rittoru no mizu*
 5 liter GEN water
 ‘5 liters of water’
 b. **futa-tu no mizu*
 two-CL GEN water
 ‘two waters’

As for count expressions, measures and classifiers should both be applicable:

- (61) Japanese: a. *15kg no inu*
 GEN dog
 ‘a 15-kg dog’
 b. *ni hiki no inu*
 two CL GEN dog
 ‘two dogs’

Moreover, both of them are predicted to co-occur within a simple noun phrase, as we see in (62):

- (62) Japanese: *ni hiki no 15kg no inu*
 two CL GEN GEN dog
 ‘two 15-kg dogs’

The Japanese data above support the proposed hierarchy.

6.3. Hierarchy and the ‘universal grinder’

Pelletier (1975) postulates an interesting device called the ‘universal grinder’. This grinds something up into a homogenous mass and spits it onto the floor. After the application of this machinery, sentences which include the mass-use of nouns, such as the following, can be obtained:

- (63) a. There is steak all over the floor.
 b. There is man all over the floor. (Pelletier 1975, 6)

Here, *steak* and *man* mean ‘steak-stuff’ and ‘man-stuff’, not having count senses. Pelletier (1975, 5) claims that ‘At any rate, there can be made a *prima facie* case that nothing is immune from the grinder treatment’, saying that every noun has both a count and a mass sense.

In addition to a man and a steak, he also considers grinding unicorns. However, since they do not have physical extension in the real world, he regards them as ungrindable. However, he says ‘it is not necessary that the object actually be grindable, but only that a normal sentence use the word in a mass sense’ (p. 6). And he gives the following sentence:

- (64) If there were any unicorns and if we were to put one into grinder, there would be unicorn all over the floor. (Pelletier 1975, 6)

He says that grinding numbers is a harder example, and gives the following sentence:

- (65) If numbers were physical objects, and if we were to put one into the grinder, there would be number all over the floor. (Pelletier 1975, 6)

These ideas raise several questions. In spite of Pelletier’s somewhat odd claim that it is not the object, but the word-sense, that is ‘grindable’, he forces the unicorn in (64) into existence, and numbers in (65) to be, absurdly, physical objects so that they can be readily grindable.

Of course, if we are going to use the counterfactual mode in (64) or (65) to test our various predictions, then anything goes. For instance, we could say that ‘if John were the name of the liquid, and the liquid fell on the floor, there would be John all over the floor’.

But this is hardly illuminating. If John is the mode of a noun, and even if there is man all over the floor (say, after John has a bomb explode in his hands) we cannot say that there was John all over the floor. This is presumably because *John* names a higher dimensionality space, and not the lower dimensionality space of *man* that we use to refer to whatever resulted from the explosion.¹⁴

It is of course interesting that numbers in particular should be such a difficult case for the ‘universal grinder’. From our perspective, the difficulty stems directly from the fact that numbers are abstract; they are 1D. In contrast, *unicorns* is 3D regardless of the relevant issue of the animal’s existence. The ‘universal grinder’ can be thought of as a conceptual (or perhaps grammatical) operation that lowers dimensionality to the 2D level, in essence rendering a mass term. If all this is correct, we again encounter hierarchy in the noun system: 3D (count) → 2D (mass) → 1D (abstract).¹⁵

Once again, we see that we are just discussing mental constructs, and strictly not their real world referents.

6.4. Children’s use of much and many

The fourth argument for the proposed hierarchy derives from children’s use of *many* and *much*. Gathercole (1985, 1986) reports that children rarely make mistakes in using *many*. However, *many* is often underextended in use: *much* is frequently used where *many* is required, well beyond their seventh birthday. Gathercole does not report the reversed error of *many* being used with mass nouns.

The proposed hierarchical system conforms to children’s use of *much* with plural count nouns: A 3D nominal subsumes a measure, which can be modified by *much*. The dimensional system also predicts that, in contrast, children do not combine a 2D nominal with *many*, since 2D nominals do not possess a classifier to be modified by *many*.

7. Syntax

In this section, I propose a syntactic structure for the nominals under discussion, and sketch some consequences that follow from the analysis.

7.1. Some background

Szabolcsi (1983) submits an interesting proposal for Hungarian possessive structure, claiming that possessors move, for which she provides supporting data from several sources, including agreement facts and the behavior of *wh*-possessors. Kayne (1993) extends her analysis to English possessives, arguing that not only the possessor, *John* (66c), but also the possessed, *a sister*, move (66b):

- (66) a. [_{DP} [_D (the)] [_{AgRP} John [[_{Agr} ’s] [sister]]]]
 b. [_{DP} a sister_i [_D of] [_{AgRP} John [[_{Agr} ’s] [t_i]]]]
 c. John_i has [_{DP} [t_i] D/P⁰ [_{AgRP} [t_i] [Agr⁰ a sister]]]

Hornstein et al. (1994) postulate a small clause that embodies a predication relation ‘Integral’ under the Agr projection. They claim that an Integral Relation holds in part-whole expressions, partitives, and inalienable possession, among others. Using recent development of the Minimalist Program, Uriagereka (1995) proposes the two features, reference and context, which drive movement of the subject and the predicate of the small clause. In this way the paradigm in (67) is derivable from one source: *City* and *poor neighborhoods* start out from the same small clause where the basic relation among them is expressed:

- (67) [_{SC} city [poor neighborhoods]]
- a. the poor neighborhoods of the city
 - b. a city of poor neighborhoods
 - c. the city’s poor neighborhoods

(67a, b, c) can be syntactically represented as in (68a, b, c), respectively. Depending on the movement, the surface manifestation will be different. What is interesting in regard to his analysis is that reference is determined as the consequence of a syntactic process. The noun phrase in (68a) is talking about poor neighborhoods, while the one in (68b) is about a city. The reference of the whole expression moves to the specifier of R: The referential site is attracting the feature [+r]. In addition to this, (68c) differs from (68a) and (68b) in that *the city* has a contextual character. Uriagereka (1995), following Higginbotham (1988), assumes that the Q introduces a context variable C, and incorporates the mechanism into syntax. *The city* moves to the Spec of Q (68c):

(68) a.

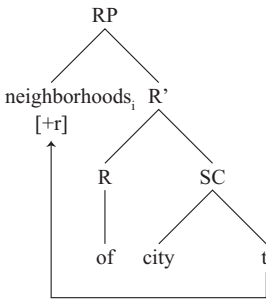

b.

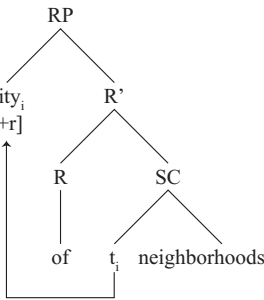

c.

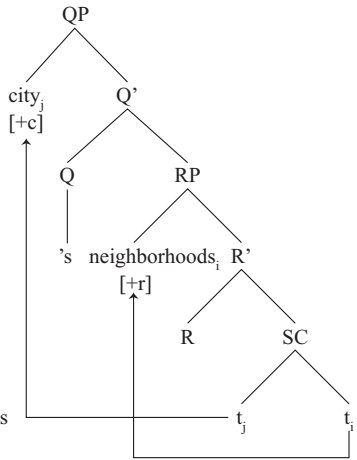

7.2. *Nominal expressions and the syntax of Integrals*

I propose that dimensionality is built in the form of the Integral small clause. The syntactic structures in (69) correspond to the nominal dimensional space in (55):

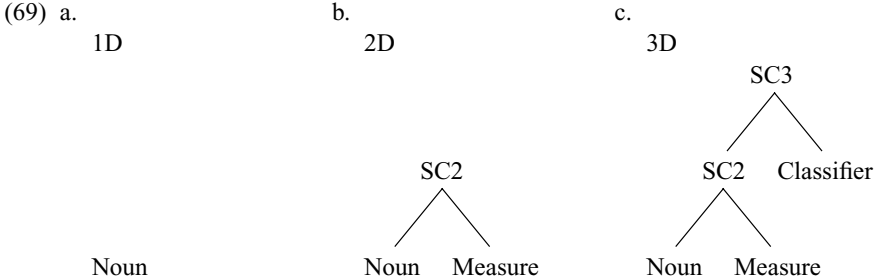

In this scheme, the lexical entailments are structural, giving rise to hierarchically nested levels of complexity. (69) also represents nouns as being neither count or mass per se, taking the stance of Allan (1980) that the count/mass distinction is a property of noun phrases.

Attributing this type of syntax to the nominal expressions under consideration yields welcome results. Greenberg (1975, 29) observes that ‘there is considerable variation in many languages in the order of the Head Noun ↔ Classifier Phrase construction’. Such variation is also seen in Japanese:

- (70) Japanese: ‘Jiro sold three cars.’
- a. *Jiro wa san dai no kuruma o utta.*
TOP three CL GEN car ACC sold
- b. *Jiro wa kuruma o san dai utta.*
TOP car ACC three CL sold

Such variation has sparked several lines of research. For example, within the framework of Standard Theory and GB, there has been interesting research by Okutu (1969), Inoue (1978), Kamio (1983), Ueda (1986), and Miyagawa (1989), among others. And yet the factor underlying the different positions has not been carefully analyzed.

Within the Minimalist Program, we can reasonably claim that the same core structure is involved, and that the difference in meaning correlates with certain features that may also affect syntax. Even though the noun phrases in (70) both depict ‘three cars’, their interpretations differ. (70a) and (70b) differ in reference. (70a) is talking about three individual cars, being paraphrasable as ‘three machines that are cars’. On the other hand, (70b) is about cars, the entire noun phrase paraphrasable as ‘cars, of which the number is three’. Considering that certain nominal expressions require reference, certain classifiers carry the reference feature [+r], and this is checked in the domain of R, via movement, as shown in (71). Thus reference is not intrinsic to the lexical representation, but is added in the syntactic derivation:

(71) a.

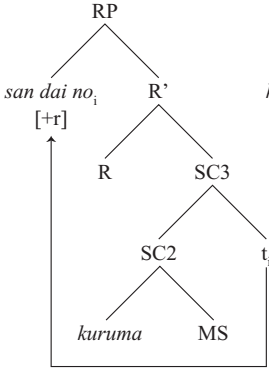

b.

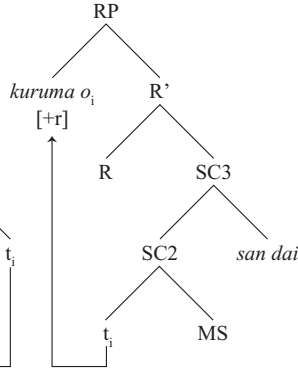

c.

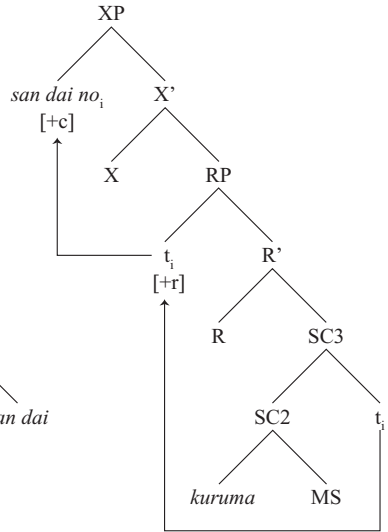

As for (70a), the noun phrase also has a specific interpretation in the sense of Enç (1991) and Uriagereka (1993): Specific noun phrases are linked to previous discourse, involving context, for which I assign the structure in (71c). On the other hand, (71a,b) are nonspecific without the context feature [+c]. The specific-nonspecific distinction resides in the architecture of noun phrases.¹⁶

The hierarchical structure I propose also has an interesting consequence for the issue of the selection of adjectives and ordering of adjectives. This issue will be addressed in future work.

8. Conclusion

Going beyond the traditional dichotomy of count nouns versus mass nouns, this chapter has argued for a three-dimensional view of nominal expressions: abstract, mass and count expressions are held to be of different dimensionality, having hierarchically different internal structures. Such dimensionality is built in the form of the Integral small clause.

Notes

* I am most grateful to Juan Uriagereka for extensively discussing the issues with me. I am also indebted to Norbert Hornstein and Dave Lebeaux for careful comments and suggestions. I would also like to thank the organizers, Hajime Hoji, Nam Kil Kim, and Audrey Li, as well as the audience of the Symposium on Diachronic and Synchronic Studies on the Syntax of East Asian Languages held at the University of Southern California in 1998. I also appreciate the anonymous comments and suggestions of two reviewers. Special thanks to Tom Frost for suggestions on English style.

- 1 This terminology is from Pelletier and Schubert (1989).
 2 Such a tight classificational relationship between a noun and a classifier does not preclude a given noun being associated with more than one classifier. If a noun has several features enabling it to fit into several different classes, then it can belong simultaneously to each of those classes. For example, in Japanese:

- | | |
|---|--|
| ia) <i>denwa ni dai</i>
telephone two CL[for machines]
‘two telephones’ | ib) <i>denwa ni hon</i>
telephone two CL[for long objects]
‘two telephone calls’ |
|---|--|

In (ia), classifier *dai* tells us that *denwa* ‘telephone’ belongs to the category of machine. In contrast, in (ib), the same noun *denwa* ‘telephone’ belongs to the category of long objects, which is expressed by the classifier *hon*. But the associability of a given noun with more than one classifier does not mean that the relationship between classifiers and nouns is loose; it still involves classification.

- 3 This was pointed out to me by Juan Uriagereka (p.c.).
 4 It is appropriate here to make a clarification regarding numeral classifiers. In discussions of noun classification, there is a tendency for most authors to take up languages with noun classes along with numeral classifier languages. In this article, however, the discussion is confined to numeral classifiers, as there are several grammatical reasons to regard the two as separate and distinct.

According to Dixon (1986) there are three criteria for distinguishing the two. Here I present the criterion that is relevant in the present context. In a language having noun classes, all nouns are obligatorily classified into one or another of a small number of classes. On the other hand, there tends to be a rather large number of numeral classifiers in a classifier language – ‘at least a score or so, with over 100 being common (e.g. Cambodian – Jacob, 1968: Vietnamese – Hoà, 1957) and even 400 attested (Tzeltal – Berlin 1968)’ (Dixon 1986, 106).

- 5 Thanks to Yi-ching Su for the examples in (34)
 6 It is possible to say (i):

- i) *Sore wa 50cc no mizu de aru.*
 that TOP GEN water be
 ‘That is 55cc of water.’

However, note that this example is an instance of an identificational sentence rather than a predicative one.

- 7 When the subject is singular, the predicate nominal is also classifier-less as in (ia). And yet the example in (ib) is still grammatical with the classifier. However, (ib) conveys a different meaning from (ia), a meaning which is somewhat idiomatic:

- | | |
|---|---|
| ia) <i>Jiro wa gaka de aru.</i>
TOP painter be
‘Jiro is a painter.’ | ib) <i>Jiro wa hito-ri no gaka de aru.</i>
TOP one-CL GEN painter be
‘Jiro is nothing but a painter.’ |
|---|---|

- 8 I owe this example to Juan Uriagereka.
 9 The question naturally arises as to what the exact difference is between nouns and adjectives. While this is beyond the scope of the present chapter, our perspective provides a relevant consideration: While nouns can provide a basic mental space to be worked on, adjectives do not and seem to work on the space provided by nouns. See Muromatsu (1996, 1998, 2001, 2002).
 10 In fact (51) is ambiguous; it also has a meaning ‘Jiro engaged in the event of benzine-buying’. Here *benzin* ‘benzine’ is one-dimensional and functions as a modifier of the event.
 11 Quine (1969b) does not use actual Japanese words, but I will provide them here.
 12 An anonymous reviewer posed this question.

- 13 Analogous to the mass/count distinction based on measures and classifiers, we can distinguish event nominals by the kind of measures and classifiers they use. The parallel between the count/mass distinction and telicity/atelicity has been noticed by Leech (1969). We can apply this distinction to verbal nominals, thus, for example *an hour of* is a time-measure, and *time* is a time-classifier, the latter being similar to ‘cardinal count adverbials’ of Mourelatos (1978). It might be possible to consider verbal aspect from the perspective of the telicity of verbal nouns plus light verbs; I leave this for future research.
- 14 This was pointed out to me by Juan Uriagereka (p.c.).
- 15 There are at least three environments in the grammar where a noun has both a count and a mass manifestation. The first is where a noun can express both a single object and the material constituting it, as in the case of *apple*, *lamb*, and *stone*. This is the 2D vs. 3D case we have been discussing, and it is the only case where the universal grinder is applicable. Second, an apparent ‘mass noun’ can be counted when containers or servings are involved, e.g. *two coffees*. Third, an apparent ‘mass noun’ can be counted when referring to its kind. For example, when a mass-expression such as *metal* is pluralized, as e.g. *three metals*, it is talking about three kinds of metal. In fact, there exists a classifier for KIND or TYPE in Japanese. And such classifiers also exist in Thai, being used for generic noun phrases in the language. Research on the KIND classifier is called for and is a topic for future research.
- 16 See Muromatsu (1997a, b, 1998) for more detailed discussion on some consequences that follow from the analysis.

References

- Adams, K. & N. F. Conklin. (1973). Toward a theory of natural classification. *CLS* 9, 1–10.
- Allan, K. (1977). Classifiers. *Language* 53, 285–311.
- Allan, K. (1980). Nouns and countability. *Language* 56, 541–567.
- Chomsky, N. (1965). *Aspects of the theory of syntax*. Cambridge, Mass.: MIT Press.
- Chomsky, N. (1993). A minimalist program for linguistic theory. *The view from Building 20*, edited by K. Hale & S. J. Keyser, 1–52. Cambridge, Mass.: MIT Press
- Chomsky, N. (1995a). Bare phrase structure. *Government and binding theory and the minimalist program*, edited by G. Webelhuth, 383–439. Cambridge, Mass.: MIT press.
- Chomsky, N. (1995b). *The minimalist program*. Cambridge, Mass.: MIT press.
- Conklin, N. F. (1981). *The semantics and syntax of numeral classification in Tai and Austronesian*. Doctoral dissertation, University of Michigan.
- Dixon, R. M. W. (1986). Noun classes and noun classification in typological perspective. *Noun classes and categorization*, edited by C. Craig, 105–112. Amsterdam: John Benjamins.
- Downing, P. (1984). *Japanese numeral classifiers: A syntactic, semantic, and functional profile*. Doctoral dissertation, University of California, Berkeley.
- Enç, E. (1991). The semantics of specificity. *Linguistic Inquiry* 22, 1–25.
- Frege, G. (1950/1884). *The foundations of arithmetic*, Translated by J. L. Austin. Oxford: Blackwell.
- Gathercole, V. (1985). ‘He has too much hard questions’: The acquisition of the linguistic mass-count distinction in *much* and *many*. *Journal of Child Language*, 12, 395–415.
- Gathercole, V. (1986). Evaluating competing linguistic theories with child language data: The case of the mass-count distinction. *Linguistics and Philosophy* 9, 151–190.
- Gil, D. (1987). Definiteness, noun phrase configurationality, and the count/mass distinction. *The representation of (in)definiteness*, edited by E. Reuland & A. ter Meulen, 254–269. Cambridge, Mass.: MIT Press.
- Gordon, P. (1985). Evaluating the semantic categories hypothesis: The case of the count/mass distinction. *Cognition* 20, 209–242.
- Gordon, P. (1988). Count/mass category acquisition: Distributional distinctions in children’s speech. *Journal of Child Language* 15, 109–129.

- Greenberg, J. H. (1975). Dynamic aspects of word order in the numeral classifier. *Word order and word order change*, edited by C. N. Li, 27–45. Austin: University of Texas Press.
- Greenberg, J. H. (1977). Numeral classifiers and substantial number: Problems in the genesis of a linguistic type. *Linguistics at the crossroad*, edited by A. Makkai et al., 257–300. Padova, Italy: Liviana Editrice.
- Higginbotham, J. (1988). Contexts, models, and meanings: a note on the data of semantics. *Mental representations: The interface between language and reality*. Edited by R. M. Kempson, 29–48. Cambridge: Cambridge University Press.
- Hornstein, N., S. Rosen & J. Uriagereka (1994). Integrals. *University of Maryland working papers in linguistics* 2, 70–90.
- Hundius, H. & U. Kölver (1983). Syntax and semantics of numeral classifiers in Thai. *Studies in Language* 7, 207–222.
- Iljic, R. (1994). Quantification in Mandarin Chinese: Two markers of plurality. *Linguistics* 32, 91–116.
- Inoue, K. (1978). Nitieitaishoo nihongo no bunpoo-kisoku. Tokyo: Taishukan.
- Jespersen, O. (1924). *The philosophy of grammar*. London: George Allen and Unwin.
- Jespersen, O. (1933). *Essentials of English grammar*. London: George Allen and Unwin.
- Kamio, A. (1983). Meisiku no koozoo. *Nihongo no kihon koozoo*, edited by K. Inoue, 77–126. Tokyo, Sanseido.
- Kayne, R. S. (1993). Toward a modular theory of auxiliary selection. *Studia Linguistica* 47, 3–31.
- Leech, G. N. (1969). *Towards a semantic description of English*. Bloomington: Indiana University Press.
- Miyagawa, S. (1989). *Structure and case marking in Japanese* [*Syntax and Semantics* 22]. San Diego: Academic Press.
- Mourelatos, A. P. (1978). Events, processes, and states. *Linguistics and Philosophy* 2, 415–434.
- Muromatsu, K. (1995). The classifier as a primitive: Individuation, referability, and argumenthood. *University of Maryland working papers in linguistics* 3, 144–180.
- Muromatsu, K. (1996). Adjective position and individual-level/stage-level predicates. *Proceedings of TACL Summer Institute of Linguistics 1996 (TACL 3)*, 73–84. Tokyo Metropolitan University.
- Muromatsu, K. (1997a). Two types of existentials: Evidence from Japanese. *Lingua* 101, 124–169.
- Muromatsu, K. (1997b). The context feature and specificity. *Proceedings of TACL Summer Institute of Linguistics 1997 (TACL 4)*, 85–96. Tokyo Metropolitan University.
- Muromatsu, K. (1998). *On the syntax of classifiers*. Doctoral dissertation, University of Maryland.
- Muromatsu, K. (2001). The count/mass distinction and the ordering of adjectives. *MIT working papers in linguistics* 37, 193–209. Cambridge, MA: MIT Working Papers in Linguistics.
- Muromatsu, K. (2002). Adjectives ordering as the reflection of a hierarchy in the noun system: A study from the perspective of numeral classifiers. *Linguistic variation yearbook vol. 1*, edited by P. Pica & J. Rooryck, 177–204. Amsterdam: John Benjamins.
- Okutu, K. (1969). Suuryooteki gyoogen no bunpoo. *Nihongo Kyooiku* 14, 42–60.
- Pelletier, F. J. (1975). Non-singular reference: Some preliminaries. *Philosophia* 5. Reprinted in *Mass terms: Some philosophical problems*, edited by F. J. Pelletier, 1–14. Dordrecht: D. Reidel.
- Pelletier, F. J. & L. K. Schubert (1989). Mass expressions. *Handbook of philosophical logic*. Vol. 4, edited by D. Gabbay & F. Guentner, 327–407. Dordrecht: D. Reidel.
- Quine, W. V. O. (1960). *Word and object*. Cambridge, Mass.: MIT Press.
- Quine, W. V. O. (1969a). Speaking of objects. *Ontological relativity and other essays*, 1–25. New York: Columbia University Press.
- Quine, W. V. O. (1969b). Ontological relativity. *Ontological relativity and other essays*, 26–68. New York: Columbia University Press.
- Ritchie, W. C. (1971). On the analysis of surface nouns. *Papers in Linguistics* 4, 1–16.
- Sanches, M. & L. Slobin (1973). Numeral classifiers and plural marking: An implicational universal. *Working papers in language universals* 11, 1–22. Stanford, Calif.: Stanford University.

- Sharvy, R. (1978). Maybe English has no count nouns: Notes on Chinese semantics. *Studies in Language* **40**, 37–52.
- Szabolcsi, A. (1983). The possessor that ran away from home. *The Linguistic Review* **3**, 89–102.
- T'sou, B. K. (1976). The structure of nominal classifier system. *Austroasiatic studies, part 2*, edited by P. N. Jenner, L. C. Thomson & S. Starosta, 1215–1247. Honolulu: University Press of Hawaii.
- Ueda, M. (1986). On quantifier float in Japanese. *University of Massachusetts occasional papers in linguistics* **11**, 263–309.
- Uriagereka, J. (1993). Specificity and the name constraint. *University of Maryland working papers in linguistics* **1**, 121–143.
- Uriagereka, J. (1995). Warps: Some thoughts on categorization. *University of Maryland working papers in linguistics* **3**, 256–308.
- Ware, R. X. (1975). Some bits and pieces. *Synthese* **31**.
- Wierzbicka, A. (1985). Oats and wheat: The fallacy of arbitrariness. *Iconicity in syntax*, edited by J. Haiman, 311–342. John Benjamins.

THE DEMONSTRATIVES IN MODERN JAPANESE*

*Hajime Hoji, Satoshi Kinsui, Yukinori Takubo
and Ayumi Ueyama*

1. Introduction

Japanese has three demonstrative prefixes *ko-*, *so-*, *a-*, as exemplified in (1).¹

- (1) a. *ko-no hito* ‘this person’
 b. *so-no hito* ‘that person’
 c. *a-no hito* ‘that person’

In this chapter, we refer to NPs such as (1) (and those NPs in note 1) as *ko/so/a-NPs*. *Ko/so/a-NPs* can be used either in the context of (2a) or (2b), much as in the case of *this NP* and *that NP* in English.

- (2) a. where the object being referred to is visible in the speech location²
 b. where the object being referred to is not visible in the speech location

Let us call their uses in the contexts of (2a) and (2b) their *deictic use* and *non-deictic use*, respectively.³

Ko/so/a-NPs are most often characterized in regard to their deictic uses. (3) shows one of the standard descriptions, which is based on Matsushita 1978: 233–235, originally published in 1930.⁴

- (3) The standard characterization of the *deictic uses* of *ko/so/a-NPs*:
 a. A *ko-NP* is used for referring to something near the speaker.
 b. A *so-NP* is used for referring to something closer to the hearer.
 c. An *a-NP* is used for referring to something at a distance from both the speaker and the hearer.

One influential characterization of the *non-deictic uses* of *so/a-NPs* is (4).

- (4) Kuno’s (1973: 290) characterization of the *non-deictic uses* of *so/a-NPs* (slightly adapted):
 a. A *so-NP* is used for referring to something that is not known personally to either the speaker or the hearer or has not been a shared experience between them.

- b. An *a*-NP is used for referring to something (at a distance either in time or space) that the speaker knows both s/he and the hearer know personally or have experience in.⁵

Kuno 1973 thus characterizes the non-deictic uses of *so/a*-NPs in terms of the speaker/hearer's knowledge of the object referred to by demonstratives. Notice that his characterization of the non-deictic *so/a*-NPs cannot be related to the standard characterization of their deictic uses given in (3), as pointed out by Kuroda (1979: 92–93) and further discussed in Takubo & Kinsui 1996: 68.⁶

Independently of (3) and (4), the generalization in (5) has been pointed out in works such as Hoji 1991 among others.

- (5) A *so*-NP can be 'bound' by a quantificational NP, while an *a*-NP cannot.

Although (3) and (5) might appear not to be related with each other, it seems worth considering what fundamental properties underlie the demonstratives, and how (3) and (5) can possibly be derived from them. This chapter discusses the demonstrative system in modern Japanese in some depth, and argues that while (5) reflects the formal properties of the demonstratives more or less directly, (3) results in part from complex interactions between their formal properties and some pragmatic considerations, such as how the speaker 'views' the world. The chapter also examines the non-deictic uses of the demonstratives in general, and concludes, based on Kuroda 1979 and Takubo & Kinsui 1996, and contra Kuno 1973, that the same formal properties underlie the demonstratives in their deictic as well as non-deictic uses.

The chapter is organized as follows. In section 2, we will briefly review the theory of reference and anaphora proposed in Ueyama 1998. The notion which plays the most crucial role in expressing (5) in theoretical terms is called *D-index*. According to Ueyama 1998, a D-indexed NP is strictly 'referential' and it has to be understood in connection with a specific individual known to the speaker, hence it cannot give rise to a covariant interpretation. Ueyama 1998 thus claims that (5) is derived from (6).

- (6) a. A *so*-NP cannot be D-indexed (at least when the target object is not visible at the scene).
 b. An *a*-NP must be D-indexed.

In section 3, we will argue, on the basis of a variety of empirical data, that (6) should be extended to (7); and in section 4, we will make the claims in (8).

- (7) a. A *ko*-NP must be D-indexed.
 b. A *so*-NP cannot be D-indexed (at least when the target object is not visible at the scene).
 c. An *a*-NP must be D-indexed.
- (8) a. A *ko*-NP is linguistically marked as [Proximal].
 b. An *a*-NP is linguistically marked as [Distal].

NPs marked [Proximal] (i.e., *ko*-NPs) provide a means, so to speak, for the cognitive agent (the speaker) to express objects that s/he construes cognitively as *proximal*, and NPs marked [Distal] (i.e., *a*-NPs) objects that s/he construes cognitively as *distal*. Whether a given object is construed cognitively as *proximal* or *distal*, however, is a matter outside grammar. We will demonstrate that the choice between *ko*-NPs and *a*-NPs, both in their deictic and non-deictic uses, is contingent upon other non-linguistic factors, including how the speaker views the world. We will also make an attempt to account for why *so*-NPs can be used deictically in the presence of a hearer, suggesting that the presence of the hearer can give rise to a situation in which construing an object as *distal* results in a conflict between the speaker's 'point of view' and the hearer's 'point of view'; but see note 14. The use of a *so*-NP in such cases, we suggest, is possible precisely because *so*-NPs are marked neither as [Distal] nor as [Proximal]. After addressing a few of the remaining issues in section 5, we will conclude the chapter in section 6 by providing a summary of its major results and also briefly addressing the general research orientation adopted in the present study. Appendix briefly discusses Kuroda 1979, which can be understood as having laid the foundation for the approach pursued here.

2. Ueyama 1998

Ueyama advances a theory of anaphoric relations and NP types, in which *so*-NPs and *a*-NPs are formally distinguished, providing a means to express the generalization in (5) in theoretical terms. Ueyama's theory assumes the following three types of individual-denoting NPs.

- (9) a. D-indexed NPs (e.g. John_{D-3})
- b. 0-indexed NPs (e.g. he)
- c. I-indexed NPs (e.g. [that student]_{I-5})

The distinction crucial in this article is between (i) D-indexed NPs on the one hand and (ii) I-indexed and 0-indexed NPs on the other. A D-indexed NP is inherently referential and hence does not require a linguistic antecedent, while 0-indexed NPs and I-indexed NPs require a linguistic antecedent. We record the distinction in (10).

- (10) a. D-indexed NPs do not require a linguistic antecedent.
- b. 0-indexed and I-indexed NPs require a linguistic antecedent.

Ueyama 1998 argues extensively that (11a) and (11b) hold in Japanese as long as we exclude the *deictic* cases (i.e., the cases in which the target object is visible at the scene of conversation) and the cases in which the *a/so*-NP is not used to refer to an individual.⁷

- (11) a. *A*-NPs are D-indexed.
- b. *So*-NPs are either I-indexed or 0-indexed.

Let us summarize the relevant part of her arguments.

D-indexed NPs are the NPs which are to be understood in connection with an individual which is known to the speaker by direct experience, and the relevant connection is established independently of other NPs.⁸ Two NPs are said to stand in the relation of *co-D-indexation* if they carry the same D-index, and co-D-indexation is one of the bases for so-called ‘coreference’.

As illustrated in (12) and (13), an *a*-NP need not have a linguistic antecedent but its referent should be known to the speaker by direct experience.

- (12) (*Situation*: The detective is looking for a man. He somehow believes that the man should be hiding in a certain room. He breaks into the room and asks the people there.)

[**A-itu**/**#So-itu**]-*wa do-ko-da?*

that-guy-TOP which-place-COPULA

‘Where is [**he**]?’

(based on Ueyama 1998: section 4.2 (10)&(20))

- (13) (*Situation*: A wife told her husband on the phone that someone had called him. He has no idea who the person is. He asks her.)

[**So-itu**/**#A-itu**]-*wa nante itteta?*

that-guy-TOP what said

‘What did [**he**] say?’

(based on Ueyama 1998: section 4.2 (16)&(23))

A *so*-NP, on the other hand, cannot independently refer to an individual (when the object is not visible at the scene) even if the object is known to the speaker by direct experience; see (12). If there is a linguistic antecedent, however, a *so*-NP can refer to an individual that the speaker does not know at all; see (13). Ueyama 1998 thus expresses the insight in Kuroda 1979, Takubo 1984, Takubo & Kinsui 1996, 1997 concerning the fundamental property of *a*-NPs and *so*-NPs as in (14) (see also Appendix).

- (14) a. *A*-NPs must be D-indexed.
 b. *So*-NPs cannot be D-indexed.

Let us turn to another well-known difference between *a*-NPs and *so*-NPs, which has to do with a covariant interpretation; see (5). Consider the examples in (15).

- (15) a. **Toyota-sae-ga** [{**so-ko**/***a-soko**}-*no ko-gaisya*]-*o suisensita*.
 Toyota-even-NOM that-place-GEN child-company-ACC recommended
 ‘*Even Toyota* recommended [*its* subsidiary].’
- b. **Do-no zidoosya-gaisya-ga** [{**so-ko**/***a-soko**}-*no ko-gaisya*]-*o*
 which-GEN automobile-company-NOM that-place-GEN child-company-ACC
suisensita no?
 recommended COMP
 ‘*Which automobile company* recommended [*its* subsidiary]?’
- c. **Do-no zidoosya-gaisya-ga** [{**so-no**/***a-no**} **zidoosya-gaisya-no**
 which-GEN automobile-company-NOM that-GEN automobile-company-GEN

- ko-gaisya]-o suisensita no?*
 child-company-ACC recommended COMP
 ‘Which automobile company recommended [that automobile company’s subsidiary]?’
- d. (based on Ueyama 1998: ch. 5 (80))
 [*Hon-o hiraita hito]-wa minna {so-re/*a-re}-o kaw-anakerebanaranai.*
 book-ACC opened person-TOP all that-thing-ACC buy-must
 ‘[Everyone who has opened **a book**] must buy **it**.’

The relevant observations are summarized in (16).

- (16) a. *A*-NPs cannot give rise to a covariant interpretation.
 b. *So*-NPs can give rise to a covariant interpretation.

(16a) follows directly from (14), given that D-indexed NPs are to be understood ‘as referring to’ an individual which is known to the speaker by direct experience. (16b) is also expected if we assume that a necessary condition for an NP to give rise to a covariant interpretation is the absence of a D-index. Under the theory in which (9) exhausts the types of individual-denoting NPs, (14) means (11), leading us to conclude that a covariant interpretation is possible only for an NP that is I-indexed or 0-indexed.

- (11) a. *A*-NPs are D-indexed.
 b. *So*-NPs are either I-indexed or 0-indexed.

Ueyama 1998 argues that although both 0-indexed NPs and I-indexed NPs can be construed as bound variables, the two cases must be distinguished, observing that they are subject to different sets of conditions, as indicated in (17).

- (17) a. A 0-indexed NP is not licensed if it is not c-commanded by its antecedent at LF.
 b. An I-indexed NP is not licensed if it precedes its antecedent at PF.

Given (11) and (17), we expect (18).

- (18) Suppose that X neither c-commands Y at LF nor precedes Y at PF:
 a. If Y is an *a*-NP, X and Y can be anaphorically related.
 b. If Y is a *so*-NP, X and Y cannot be anaphorically related.

The contrast between (19) and (20) indicates that this is indeed a correct prediction.⁹

- (19) [*A-soko-o tekitaishiteiru kaisya]-ga mata Kyozin-no*
 that-place-ACC be.hostile company-NOM again Giants-GEN
ninki-ga sagaru yooni kakusakusiteiru rasii.
 popularity-NOM go.down to be.scheming seem
 ‘It seems that [the company which is hostile to **it**] is scheming again so that the popularity of **the Giants** may go down.’

- (20) ?*[**So-ko-o** *tekitaisiteiru kaisya*]-ga mata **Kyozin-no**
 that-place-ACC be.hostile company-NOM again Giants-GEN
ninki-ga sagaru yooni kakusakusiteiru rasi.
 popularity-NOM go.down to be.scheming seem
 ‘It seems that [the company which is hostile to **it**] is scheming again so that the
 popularity of **the Giants** may go down.’

The covariant interpretation of the sort indicated in (15) above also fails to obtain in the configuration noted in (18), as illustrated in (21); see Ueyama 1998 for the motivation for the postulation of the two distinct conditions in (17) and Hoji et al. 1999 for further discussion.

- (21) a. ?*[**So-ko-no** *oya-gaisya*]-ga **A-sya-ni-sae** *Toyota-o*
 that-place-GEN parent-company-NOM A-company-DAT-even Toyota-ACC
suisensita.
 recommended
 ‘[**Its** parent company] recommended Toyota to *even Company A*.’
 b. ?*[**So-ko-no** *oya-gaisya*]-ga **do-no** **zidoosya-gaisya-ni**
 that-place-GEN parent-company-NOM which-GEN automobile-company-DAT
Toyota-o suisensita no?
 Toyota-ACC recommended COMP
 ‘To *which automobile company* did [**its** parent company] recommend Toyota?’

3. The Grammatical difference between *a/ko-* and *so-*: the D-index

3.1. Extending Ueyama’s theory to *ko-NPs*

One would naturally wonder how *ko-* is to be categorized in Ueyama’s (1998) theory. We propose that *ko-NPs* are D-indexed and that (11) can be generalized as (22).

- (22) The distinction among *ko-NPs*, *so-NPs*, and *a-NPs*:
 a. *Ko-NPs* and *a-NPs* are D-indexed.
 b. *So-NPs* are either I-indexed or 0-indexed.

We maintain that the distinction in (22), the essential content of which is hinted at in Kuroda 1979 and suggested more explicitly in Tanaka 1981, is the only formal difference among *ko-*, *so-*, and *a-*. In this section, we will present evidence for (22).

3.2. The non-deictic use of *a-NPs* and *ko-NPs*

3.2.1. The linguistic antecedent requirement

In (12), repeated here, *a-itu* is interpretable without a linguistic antecedent, but *so-itu* is not.

- (12) (*Situation*: The detective is looking for a man. He somehow believes that the man should be hiding in a certain room. He breaks into the room and asks the people in the room.)
 [A-itu/#So-itu]-wa do-ko-da?
 that-guy-TOP which-place-COPULA
 ‘Where is [he]?’ (based on Ueyama 1998: section 4.2 (10)&(20))

Likewise, *ko-no purozyekuto* ‘this project’ in (23) can also be used without a linguistic antecedent, in contrast to a *so*-NP such as *so-no purozyekuto* ‘that project’, as observed originally in Kinsui & Imani 2000: 129.

- (23) (*Situation*: The president of a company has called an executive meeting regarding a certain important project. As soon as everyone has arrived, he directly plunged into the issue.)
Buraun-kun, [{ko-no/#so-no} purozyekuto]-wa itu hazimaru-nokane?
 Brown-Mr. this-GEN/that-GEN project-TOP when start-Q
 ‘When will **this project** start, Mr. Brown?’

Thus, not only *a*-NPs but *ko*-NPs can be used non-deictically without a linguistic antecedent, in sharp contrast to *so*-NPs.

In addition, an *a*-NP can be related to ‘its antecedent’ that does not c-command or precede it, as illustrated in (19) above. As indicated in (24) below, a *ko*-NP too can be related to ‘its antecedent’ that does not c-command or precede it.

- (24) (*Situation*: The remaining members of the anti-government movement have gathered at one of their hideouts just after they had failed in their attempt to bomb the embassy. No one dares to say anything, but at last the leader begins to talk.)
 [{Ko-no/*So-no} keikaku-o saisyoni kangaedasita mono]-ga taisikan
 this-GEN/that-GEN plan-ACC first proposed person-NOM embassy
bakuha keikaku-no zikkoo sekininsya-ni naru bekidatta.
 bombing plan-GEN execution leader-DAT become should.have
 ‘The person who first proposed **this plan** should have become the execution leader of **the embassy bombing plan.**’

Given the theory of Ueyama 1998, this leads us to conclude that *ko*-NP can be D-indexed. The observations in this subsection, summarized in (25), are precisely what we expect, given (22).

- (25) a. *A*-NPs and *ko*-NPs:
 A linguistic antecedent is not necessary.
 Even if there is an apparent antecedent for an *a*-NP or a *ko*-NP in the same sentence, it is not necessary for the former to c-command the latter at LF, or precede it at PF.
 b. *So*-NPs:
 A linguistic antecedent is necessary.
 The linguistic antecedent must either (i) c-command the *so*-NP at LF or (ii) precede it at PF.

3.2.2. Covariant interpretations

We have seen evidence that *ko*-NPs can be D-indexed. A question remains as to whether they *must* be D-indexed. We wish to argue that they must, on the basis of the following observation. Consider (26).

- (26) a. **Do-no zidoosya-gaisya-mo** [{so-no/*ko-no} **zidoosya-gaisya-no**
 which-GEN automobile-company-MO that-GEN/this-GEN automobile-company-GEN
ko-gaisya]-o *suisensita*.
 child-company-ACC recommended
 ‘*Every automobile company* recommended *{that/this} company*’s subsidiary.’
- b. **Kanarinokazu-no zidoosya-gaisya-ga** {so-no/*ko-no}
 quite.many-GEN automobile-company-NOM that-GEN/this-GEN
zidoosya-gaisya-no *ko-gaisya-o* *suisensita*.
 automobile-company-GEN child-company-ACC recommended
 ‘*(Each of) quite many automobile companies* recommended *{that/this} company*’s
 subsidiary.’
- c. **Toyota-sae-ga** [_{CP} *CIA-ga* {so-ko/*ko-ko}-o *sirabeteiru to*]
 Toyota-even-NOM CIA-NOM that-place/this-place-ACC is.investigating COMP
happyoosita.
 announced
 ‘*Even Toyota* has announced that the CIA is investigating *it*.’

As indicated, *ko*-NPs, as in the case of *a*-NPs, fail to give rise to a covariant interpretation, in contrast to *so*-NPs; see section 5.1. Under the assumption that a necessary condition for an NP to give rise to a covariant interpretation is that it be either 0-indexed or I-indexed, this observation indicates that *ko*-NPs are necessarily D-indexed, since it is assumed under this theory that an individual-denoting NP must be D-indexed, I-indexed or 0-indexed, and there is no other possibility.

3.3. Further evidence for the distinction between *a/ko-* and *so-*

In this section we will present further evidence in support of the proposed distinction between *ko-* and *a-* on the one hand and *so-* on the other. Consider first the examples in (27)–(29), adapted from Hoji 1995.

- (27) a. **do-no sinzoo-gekai-ga so-no isya-no** *kanzya-o turetekite mo* ...
 which-GEN heart-surgeon-NOM that-GEN doctor-GEN patient-ACC bring-MO
 ‘No matter *which heart specialist* should bring *that doctor*’s patient (to me), ...’
- b. ***do-no isya-ga so-no sinzoo-gekai-no** *kanzya-o*
 which-GEN doctor-NOM that-GEN heart-surgeon-GEN patient-ACC
turetekite mo ...
bring-mo
 ‘No matter *which doctor* should bring *that heart specialist*’s patient (to me), ...’

- (28) a. **do-no sinzoo-gekai-no kanzya-ga so-no isya-no sigoto-o**
 which-GEN heart-surgeon-GEN patient-NOM that-GEN doctor-GEN work-ACC
hometa tositemo ...
 praise even.if
 ‘No matter *which heart specialist’s* patient should praise *that doctor’s job, ...*’
- b. ***do-no isya-no kanzya-ga so-no sinzoo-gekai-no sigoto-o**
 which-GEN doctor-GEN patient-NOM that-GEN heart-surgeon-GEN work-ACC
hometa tositemo ...
 praise even.if
 ‘No matter *which doctor’s* patient should praise *that heart specialist’s job, ...*’
- (29) a. [[**do-no sinzoo-gekai-to ronsoositeita**] *otoko*]-mo *kyuuni so-no*
 which-GEN heart-surgeon-with was.disputing man-MO suddenly that-GEN
isya-no sigoto-o home-hazimeta
 doctor-GEN work-ACC praise-started
 ‘[Every man [who was disputing with *a heart specialist*]] has suddenly begun praising *that doctor’s job.*’
- b. *[[**do-no isya-to ronsoositeita**] *otoko*]-mo *kyuuni so-no*
 which-GEN doctor-with was.disputing man-MO suddenly that-GEN
sinzoo-gekai-no sigoto-o home-hazimeta
 heart-surgeon-GEN work-ACC praise-started
 ‘[Every man [who was disputing with *a doctor*]] has suddenly begun praising *that heart specialist’s job.*’

The status of the (b) examples can be attributed to a condition like (30), as suggested in Takubo & Kinsui 1998, based on the formulation of Condition D in Ueyama 1998: 204.¹⁰

(30) Condition D’ (to be revised later):

Nominal expressions α and β must be disjoint in reference if $\alpha \supset \beta$ and α precedes β , where $\alpha \supset \beta =_{\text{def}} \{x : x \text{ is } N_\alpha\} \supset \{x : x \text{ is } N_\beta\}$, with N_γ designating that part of γ that represents the ‘descriptive content’ of a nominal expression γ .

Now consider the examples in (31).

- (31) a. (*Situation*: The leader of the anti-government movement has called an underground meeting in order to designate the members who will put into action the plan of bombing the embassy, which they have been working on for a couple of weeks. Every member is waiting for him to speak. The leader begins the meeting by making the following statement.)
 [{**Ko/#A/*So**}-no **keikaku-o saisyoni kangaedasita mono**]-o **kondono**
 this/that/that-GEN plan-ACC first proposed person-ACC upcoming
taisikan bakuha keikaku-no zikkoo sekininsya-ni siyoo.
 embassy bombing plan-GEN execution leader-DAT I.nominate

‘I nominate the person who first proposed *this plan* to be the execution leader of *the upcoming embassy bombing plan*.’

- b. (*Situation*: After the failure of the bombing at the embassy ten years ago, the group of anti-government guerillas became too weak, and they have decided to dissolve their organization. No one dares to speak a word at the meeting, except for the leader.)

[{[#]ko/a/*so}-no keikaku-o saisyoni kangaedasita mono]-ga 10-nen
 this/that/that-GEN plan-ACC first proposed person-NOM 10-year
 mae-no taisikan bakuha keikaku-no zikkoo sekininsya-ni naru
 before-GEN embassy bombing plan-GEN execution leader-DAT become
 bekidatta.

should.have

‘The person who first proposed *that plan* should have become the execution leader of *the embassy bombing plan ten years ago*.’

Note that {ko/a/so}-no keikaku in (31) is neither preceded nor c-commanded by its antecedent; hence the status of (31) with so- is as expected. That (31) is much better with ko/a- than with so- is consistent with our proposal that ko-NPs and a-NPs are D-indexed. Recall that coreference between two co-D-indexed NPs can obtain without satisfying the PF precedence condition or the LF c-command condition.

Now consider (32).

- (32) (*Situation*: An anti-government guerilla leader begins an underground meeting by making the following statement.)

a. [Keikaku-o saisyoni kangaedasita mono]-o {ko/??a/*so}-no taisikan
 plan-ACC first proposed person-ACC this/that/that-GEN embassy
 bakuha keikaku-no zikkoo sekininsya-ni siyoo.
 bombing plan-GEN execution leader-DAT I.nominate

‘I nominate the person who first proposed *the plan* to be the execution leader of *{this/that} embassy bombing plan*.’

b. [Keikaku-o saisyoni kangaedasita mono]-ga {??ko/a/*so}-no taisikan
 plan-ACC first proposed person-NOM this/that/that-GEN embassy
 bakuha keikaku-no zikkoo sekininsya-ni naru bekidatta.
 bombing plan-GEN execution leader-DAT become should.have

‘The person who first proposed *the plan* should have become the execution leader of *{this/that} embassy bombing plan*.’

Here, the so-NP is preceded by ‘its (intended) antecedent’. Hence the PF precedence condition is satisfied in (32). We maintain that what is responsible for the status of (32) with the so-NP is Condition D’, just as in the case of (27b), (28b), and (29b). What is of particular interest is that (32) seems much better with ko/a- than with so-. This suggests that ko-NPs and a-NPs are not subject to Condition D’, in contrast to so-NPs. This in turn provides further evidence for the proposed distinction between ko-NPs and a-NPs on the one hand and so-NPs on the other. Given that the relevant distinction is expressed in terms of D-indexing, as in (22), we can restate (30) as (33).

(33) Condition D':

Nominal expressions α and β must be disjoint in reference if $\alpha \supset \beta$ and α precedes β , unless α and β are co-D-indexed, $\alpha \supset \beta =_{\text{def}} \{x : x \text{ is } N_\alpha\} \supset \{x : x \text{ is } N_\beta\}$, with N_γ designating that part of γ that represents the 'descriptive content' of a nominal expression γ .

4. On the deictic uses of *ko/so/a*-NPs

4.1. Problem

We have proposed the distinction among *ko*-NPs, *so*-NPs, and *a*-NPs, as in (22), repeated here.

(22) The distinction among *ko*-NPs, *so*-NPs, and *a*-NPs:

- a. *Ko*-NPs and *a*-NPs are D-indexed.
- b. *So*-NPs are either I-indexed or 0-indexed.

We would now like to address how (22) should be related with the standard characterization of the deictic uses of these NPs, repeated in (3).

(3) The *standard characterization of the deictic uses of ko/so/a-NPs*:

- a. A *ko*-NP is used for referring to something near the speaker.
- b. A *so*-NP is used for referring to something closer to the hearer.
- c. An *a*-NP is used for referring to something at a distance from both the speaker and the hearer.

4.2. *A*-NPs as [Distal] and *ko*-NPs as [Proximal]

We propose (34).

(34) *Ko*-NPs and *a*-NPs are marked, linguistically, as [Proximal] and [Distal], respectively, and must correspond to what the speaker construes as *proximal* and *distal*, respectively.

We would like to entertain the hypothesis that all the differences among *ko*-, *so*-, and *a*-, at least in the core cases, can be attributed to (22) and (34). Given (34), we can restate (3a) and (3c) as in (35).

(35) a. A *ko*-NP is used for referring to something that is construed by the speaker as being *proximal*.
 b. An *a*-NP is used for referring to something that is construed by the speaker as being *distal*.

The deictic uses of *ko*- and *a*- can thus be directly accounted for by (34), without making reference to the notion the *hearer*.¹¹

Under the proposal that the relevant distinction between *proximal* and *distal* in (34) is a cognitive, rather than grammatical, distinction, we expect (36).¹²

- (36) The felicitousness of a *ko*-NP and an *a*-NP in a given sentence, hence the choice between the two, can be affected by non-grammatical factors.

In this section, we will present evidence in support of (36).

Let us first consider the choice between *ko*- and *a*- in their deictic uses. Consider first the example in (37), intended as utterances directed to the hearer who is standing by the speaker.

- (37) a. [Pointing to someone standing 10 meters away]
 {A/?Ko}-no hito-wa amerikazin desu.
 that/ this-GEN person-TOP American be
 ‘{That/This} person is an American.’
 b. [Pointing to someone the speaker has his/her arm around]
 {Ko/#A}-no hito-wa amerikazin desu.
 this/ that-GEN person-TOP American be
 ‘{This/That} person is an American.’

Although the contrast in (37) can be due to the physical proximity to the speaker of the person who is being referred to, the physical proximity does not always determine the choice between *ko*- and *a*- in their deictic uses. Suppose that the speaker has ordered someone to stand 10 meters away and explains to the hearer who this person is. In this situation, the utterance in (38) seems acceptable, with either *a*- or *ko*-, despite the fact that the distance between the speaker and the person referred to remains the same.

- (38) {A/Ko}-no otoko-wa [(wasi-ga kondo amerika-kara turetekita)
 that/ this-GEN man-TOP I-NOM this.time America-from brought
 amerikazin] zya.
 American be
 ‘{That/This} man is an American (that I have brought from America this time).’

The subtle contrast in (39) also suggests that something about the speaker’s knowledge affects the choice between *ko*- and *a*- in their deictic uses.

- (39) [Pointing to a dog sitting 10 meters away]
 a. {A/#Ko}-no inu-wa hasukii desu ka?
 that/ this-GEN dog-TOP Husky be Q
 ‘Is {that/this} dog a Husky?’
 b. {A/?Ko}-no inu-wa hasukii desu yo.
 that/ this-GEN dog-TOP Husky be PARTICLE
 ‘{That/This} dog is a Husky.’

Similarly, (40) seems worse than (38), in the same situation.

- (40) {A/??Ko}-no kata-wa do-ko-no kuni-no kata desu ka?
 that/this-GEN person-TOP which-place-GEN country-GEN person be Q
 ‘Which country is **{that/this} person** from?’

Now consider (41).

- (41) [Pointing to a tall tree 20 meters away standing all by itself in a large field]
 a. {A/Ko}-no ki-wa kasinoki desu.
 that/this-GEN tree-TOP oak be
 ‘**{That/This} tree** is an oak.’
 b. {A/Ko}-no ki-wa nan-no ki desu ka?
 that/this-GEN tree-TOP what-GEN tree be Q
 ‘What tree is **{that/this} tree?**’

The status of (41b) does not seem very different from that of (41a). The choice between *ko-* and *a-* in (41) thus seems independent from the speaker’s knowledge, unlike examples such as (37)–(40). Now compare (41) with (42).

- (42) [Pointing to a tall tree standing 20 meters away, surrounded by many other trees]
 {A/??Ko}-no ki-wa kasinoki desu.
 that/this-GEN tree-TOP oak be
 ‘**{That/This} tree** is an oak.’

The relevant factor in determining the choice between *ko-* and *a-* in (41)–(42) seems to be conspicuousness of some sort. In the case of (41), the tree in question is conspicuous while it is not so conspicuous in (42). A more extreme case is given in (43).

- (43) [Pointing to a gigantic spaceship covering the entire sky, as in the movie *Independence Day*]
 {Ko/#A}-re-wa do-ko-kara kitanda!
 this/that-thing-TOP which-place-from came
 ‘Where does **{this/that}** come from!’

It thus seems that various factors contribute to the determination of the choice between *ko-* and *a-* in their deictic uses, which we have tried to characterize in terms of the speaker’s knowledge and conspicuousness of some sort (which seems to be much affected by the visual information available to the speaker, as we have just observed). Our contention is that these, and most likely other, considerations determine whether the speaker construes a given object as *distal* or *proximal*. Once it is determined how the speaker chooses to construe the object cognitively, the choice between a *ko*-NP and an *a*-NP is a matter of compatibility between a linguistic form and the speaker’s cognitive intention. *Ko*-NPs and *a*-NPs are linguistically marked [Proximal] and [Distal], by

hypothesis, and hence the relevant compatibility is achieved only when *ko*-NPs and *a*-NPs are chosen to express *proximal* and *distal*, respectively.

The examples below illustrate that the choice between *ko*- and *a*- in their non-deictic uses is also much affected by non-grammatical factors. First consider (44).

(44) a. (=31a))

(*Situation*: The leader of the anti-government movement has called an underground meeting in order to designate the members who will put into action the plan of bombing the embassy, which they have been working on for a couple of weeks. Every member is waiting for his words. The leader begins the meeting by making the following statement.)

[{**Ko**/[#]**A**/***So**}-**no keikaku-o saisyoni kangaedasita mono**]-**o kondono**
 this/that/that-GEN plan-ACC first proposed person-ACC upcoming
taisikan bakuha keikaku-no zikkoo sekininsya-ni siyoo.
 embassy bombing plan-GEN execution leader-DAT I.nominate

‘I nominate the person who first proposed *this plan* to be the execution leader of *the upcoming embassy bombing plan*.’

b. (*Situation*: A group of guerillas are scheming to attack the government in some way. Many plans have been proposed over several meetings, but most of them do not have an appropriate person who will actually carry them out. Suddenly, one of the guerillas recalls that there is one feasible plan left, which was proposed at the first meeting; it was almost forgotten since it was suggested at the first meeting two weeks ago.)

[{[#]**Ko**/**A**/***So**}-**no keikaku-o saisyoni kangaedasita mono**]-**o kondono**
 this/that/that-GEN plan-ACC first proposed person-ACC upcoming
taisikan bakuha keikaku-no zikkoo sekininsya-ni siyoo.
 embassy bombing plan-GEN execution leader-DAT I.nominate

‘I nominate the person who first proposed *that plan* to be the execution leader of *the upcoming embassy bombing plan*.’

As expected, the *so*-NPs in (44) are disallowed since there is no linguistic antecedent for them; see (25a). What is of interest is the choice between *ko*- and *a*- in (44). The identical sentence is used in (44a) and (44b), but different pragmatic contexts are given for them. It seems that the situation in (44a) makes it more appropriate for the speaker to construe the relevant plan as *proximal*. The situation in (44b), by contrast, seems to make it more appropriate for the speaker to construe it as something *distal*. Since the relevant difference is not due to grammatical factors, however, we do not expect the contrast between (44a) and (44b) to obtain uniformly among speakers, although the contrast as indicated seems fairly clear to most speakers. We observe a similar contrast in (45) as well.¹³

(45) a. (=31b))

(*Situation*: After the failure of the bombing at the embassy ten years ago, the group of anti-government guerillas became too weak, and they have decided to dissolve their organization. No one dares to speak a word at the meeting, except for the leader.)

[{[#]Ko/A/*So}-no keikaku-o saisyoni kangaedasita mono]-ga 10-nen
 this/that/that-GEN plan-ACC first proposed person-NOM 10-year
 mae-no taisikan bakuha keikaku-no zikkoo sekininsya-ni naru
 before-GEN embassy bombing plan-GEN execution leader-DAT become
bekidatta.
 should.have

‘The person who first proposed *that plan* should have become the execution leader of *the embassy bombing plan ten years ago.*’

- b. (*Situation:* The group of anti-government guerillas failed in the embassy bombing plan ten years ago. They still keep the inside map of the embassy on the wall of their hiding place. One day, the remaining members are staring at the map in silence. Someone murmurs abruptly.)

[{Ko/[#]A/*So}-no keikaku-o saisyoni kangaedasita mono]-ga 10-nen
 this/that/that-GEN plan-ACC first proposed person-NOM 10-year
 mae-no taisikan bakuha keikaku-no zikkoo sekininsya-ni naru
 before-GEN embassy bombing plan-GEN execution leader-DAT become
bekidatta.
 should.have

‘The person who first proposed *this plan* should have become the execution leader of *the embassy bombing plan ten years ago.*’

We have argued that the choice between *ko*-NPs (which are marked [Proximal]) and *a*-NPs (which are marked [Distal]) is determined whether the speaker perceives the object in question as *proximal* or *distal*, and that the decision is made on the basis of various considerations. The crucial point of contention here is that this holds uniformly for their deictic uses as well as their non-deictic uses.

4.3. Deictic *so*

One of the main theses pursued in this chapter is that *so*-NPs are either I-indexed or 0-indexed, and never D-indexed; see (22a). This has the consequence that they always require a linguistic antecedent. The deictic use of *so*-NPs, as in (46), therefore seems to pose a serious challenge to this claim.

- (46) a. *Sumimasen-ga, so-no hon-o totte kudasai.*
 excuse.me-but that-GEN book-ACC take please
 ‘Excuse me, but could you get me **that book** (next to you)?’
 b. *So-no otoko-wa dare da?*
 that-GEN man-TOP who be
 ‘Who is **that man** (next to you)?’

One might suggest that the deictic *so*-NPs are D-indexed. Such an approach however would lead to distinct treatments of the deictic and the non-deictic uses of the demonstratives. In this section, we would like to maintain that *so*-NPs are never

D-indexed, and suggest a uniform treatment of the deictic and the non-deictic uses of the demonstratives.

As observed earlier, the well-known generalization concerning the deictic *so-* is as in (3b), repeated below, along with (3a) and (3c).

- (3) The standard characterization of the *deictic uses* of *ko/so/a*-NPs:
- a. A *ko*-NP is used for referring to something near the speaker.
 - b. A *so*-NP is used for referring to something closer to the hearer.
 - c. An *a*-NP is used for referring to something at a distance from both the speaker and the hearer.

As an illustration of (3b), consider the situation in (47).

- (47) John is sitting in a white chair at one end of a room, looking at a red chair placed at the other end of the room. He is all by himself.

John can refer to the red chair as *ko-no isu* ‘this chair’ or *a-no isu* ‘that chair’, depending upon whether he perceives it as *proximal* or *distal*; see the discussion in section 4.2. When there is someone sitting in the red chair, however, the same options do not seem to be available to John; he can no longer refer to the red chair as *a-no isu* ‘that chair’ if his utterance is directed to this person. It is interesting to observe that, contrary to the standard generalization in (3), the use of *ko-no isu* ‘this chair’ in this situation does not seem to be totally impossible, in sharp contrast to that of *a-no isu*, which is simply impossible.

To observe the relevant contrast between *a-no isu* and *ko-no isu* more clearly, let us consider a few more situations, starting with (48).

- (48) A tyrant is sitting in a white chair at one end of a room in his palace, looking at a red chair placed at the other end of the room. He is all by himself.

As in (47), the tyrant can refer to the red chair as *ko-no isu* ‘this chair’ or *a-no isu* ‘that chair’, depending upon whether he perceives it as *proximal* or *distal*. Now, suppose one of his men is sitting in the red chair. The tyrant talks to his man.

- (49) (*Yoku kike.*) {**Ko-no/So-no/*A-no**} *isu-wa naa,* *wasi-ga Pekin-kara*
carefully listen this/that/that chair-TOP PARTICLE I-NOM Beijing-from
mottekaetta nozuya.
bring.back PARTICLE
‘(Listen carefully.) {**This/That**} **chair** is what I have brought back from Beijing.’

As we discussed in section 4.2, whether the speaker construes a given object as *proximal* or *distal* is affected by a number of non-grammatical factors. While this is true even in the absence of the hearer, additional factors seem to be introduced by the presence of the hearer. That is to say, it seems that whether the speaker construes a given object as

proximal or *distal* is affected by the ‘relative proximity’ between the speaker and the hearer, as it is understood by the speaker. Since the ‘relative proximity’ is a matter the speaker determines, the speaker seems to have the option of taking (virtually) everything in the world as *proximal* if s/he so wishes. The use of *ko-no isu* ‘this chair’ in (49) is thus not unexpected.

Now, why is *a-no isu* ‘that chair’ not acceptable in (49)? We would like to suggest that the clear unacceptability of *a-no isu* in (49) is due to the conflict between the two ‘points of view’, so to speak, as described in (50).¹⁴

(50) The speaker construes the relevant object (=the red chair) as *distal*, and the speaker thinks that the hearer would construe the relevant object (=the red chair) as *proximal*.¹⁵

We suggest that when the situation as given in (50) arises, the *a*-NP (i.e., *a-no isu* ‘that chair’), which by hypothesis is marked linguistically as [Distal], cannot be used to express the object that is cognitively construed as *distal*.

Now, if the use of *a*-NPs is not allowed under (50), how can the speaker refer to the object in question? Although the *ko*-NP is potentially usable, it would be an expression of the speaker’s cognitive understanding of the object as *proximal*, and that is NOT the speaker’s intention here. The speaker cannot express his/her cognitive understanding of the object as *distal* either, because of the ‘conflict’, just noted. The only option s/he has is then to express his/her cognitive understanding of the object in question as neither *proximal* nor *distal*, and the speaker can do this with a *so*-NP. *So*-NPs, by hypothesis, are not marked as either [Distal] or [Proximal]. According to Ueyama’s theory, however, *so*-NPs are either I-indexed or 0-indexed, and as the result, need a linguistic antecedent. We suggest that a marked operation creates, on the basis of ‘visual contact’ with an object, what corresponds to a linguistic expression that can serve as an antecedent for an I-indexed *so*-NP and that this is what underlies the deictic use of *so*-NPs.

Deictic *so*-NPs never appear in a monologue. In a monologue, no conflicts of the sort under discussion arise. So the speaker has no reason to invoke, and hence cannot invoke, the marked operation. The description of the deictic *so*-NPs in the literature always makes a crucial reference to the *hearer*, as discussed in section 1. According to the account of the deictic *so*-NPs suggested here, this is because the conflicts of the sort under discussion arise only in the presence of the hearer; but see note 14.

5. Remaining issues

5.1. On the possibility of covariant interpretations with *ko*-NPs

In section 3.2.2, we concluded, on the basis of examples like (51), that *ko*-NPs do not give rise to a covariant interpretation.

(51) a. (=26a)

Do-no	zidoosya-gaisya-mo	[{so-no/*ko-no}	zidoosya-gaisya-no
which-GEN	automobile-company-MO	that-GEN/this-GEN	automobile-company-GEN

ko-gaisya]-o suisensita.
 child-company-ACC recommended
 ‘*Every automobile company* recommended {*that/this*} *company*’s subsidiary.’

b. (=26b))

Kanarinokazu-no zidoosya-gaisya-ga {so-no/*ko-no}
 quite.many-GEN automobile-company-NOM that-GEN/this-GEN
zidoosya-gaisya-no ko-gaisya-o suisensita.
 automobile-company-GEN child-company-ACC recommended
 ‘(*Each of*) *quite many automobile companies* recommended {*that/this*} *company*’s subsidiary.’

There are, however, examples like (52), noted in Tanaka 1981.

- (52) *Mukasi-wa konnahuuni kangaeteitano. Dareka sutekina okoto-no hito-o*
 before-TOP such.way I.thought some nice male-GEN person-ACC
mitukete, ko-no hito-to sekaizyuu-o ryokoosite mawaritaina tte.
 find this-GEN person-with around.world-ACC travel around.want COMP
Imazya yume-ne.
 now dream-PARTICLE
 ‘I used to dream to myself like this. I would find *a nice man* and travel around the world with *this man*. Now it is just a dream of the past.’ (Tanaka 1981: (58))

Given the impossibility of the covariant interpretation in (51), and given the absence of c-command in (52), the relevant interpretation in (52) cannot be that of pure bound variable anaphora.

We seem to have only two clear options. One is to treat *ko*-NPs as either D-indexed or I-indexed. This option, however, would lead us to expect (53a) to be as acceptable as (53b), under the relevant readings; see (51).

- (53) a. *Do-no NP-ga [ko-no-NP-no ...] ... V...*
 b. *Do-no NP-ga [so-no-NP-no ...] ... V...*

The other option is to continue to assume *ko*-NPs to be always D-indexed and somehow allow them to have a covariant interpretation of the sort observed in (52). We would like to adopt the latter option and suggest that examples like (54) in English are also to be analyzed in a similar way.

- (54) (J. Uriagereka (p.c. September, 2001))
 Every family who has *a George* thinks *this George* is a genius.

Space limitation however prevents us from elaborating on the relevant analysis here.

Given the preceding discussion, we should be able to determine the nature of the interpretations of the *ko*-NP in examples like (52) and *this NP* in examples like (54) by examining whether the availability of the relevant readings is sensitive to (i) the LF

c-command condition, (ii) the PF precedence condition, and (iii) Condition D'. We wish to address these issues in a separate work.¹⁶

5.2. *Further issues*

The relevant concepts that we have used most crucially are as in (55).

- (55) a. D-index, I-index and 0-index
 b. [Distal] and [Proximal]

One might naturally wonder how these concepts manifest themselves in languages other than Japanese. Hoji et al. 1999 discusses reconstruction effects in English in regard to bound variable anaphora and addresses how the grammar of English exhibits properties associated with I-index and 0-index, and their discussion indicates that the notions in (55a) are in fact part of the grammar of English.

Recall that *ko*-NPs and *a*-NPs are marked as [Proximal] and [Distal], and must correspond to what the speaker construes as *proximal* and *distal*, respectively. Whether the speaker construes a given object as *proximal* and *distal* is, however, affected a great deal by non-grammatical factors; see section 4.2. The choice between *this* and *that* in English also seems to be sensitive to the considerations of the sort we discussed in section 4.2 in regard to the choice between *proximal* and *distal*. Not a particularly surprising result. We in fact expect that the demonstrative systems in many languages can be characterized in terms of (55) (cf. Kinsui et al. 2002) although the demonstratives of some languages might be differentiated along the dimensions not mentioned in (55).

6. Concluding remarks

The major results of this chapter can be summarized as follows.

- (56) Both the deictic and non-deictic uses of the demonstratives in modern Japanese can be described on the basis of their linguistic characterization as given in (57).
- (57) a. A *ko*-NP must be D-indexed; and it is marked as [Proximal].
 b. A *so*-NP cannot be D-indexed (and it is neither [Proximal] nor [Distal]).
 c. An *a*-NP must be D-indexed; and it is marked as [Distal].

It thus seems plausible that a linguistic object is marked [Proximal] or [Distal] only if it is D-indexed; and if such is indeed the case, it would provide us with a connection between (55a) and (55b), and hence between (i) the general properties of *ko/so/a*-NPs on the one hand and (ii) the fact that a *so*-NP can be 'bound' by a quantificational NP, while an *a*-NP and a *ko*-NP cannot.

It is significant to note that the properties in (57) are expressed in terms of theoretical primitives that we maintain are available in UG. Given the view, which we adopt, that the grammar is an autonomous system, the relevant concepts in (57) must be independent

from pragmatic considerations. The linguistic markings [Proximal] and [Distal] are thus understood to exist independently of the speaker and the hearer.

It is a matter of course, however, that language can be put to use. When it is used, the outputs of the generative procedure will be assessed, so to speak, by the cognitive agent (the speaker) as to their compatibility with his/her cognitive intentions. NPs marked [Proximal], i.e., *ko*-NPs, provide a means, as it were, for the cognitive agent (the speaker) to express objects that s/he construes cognitively as *proximal*, and NPs marked [Distal], i.e., *a*-NPs, objects that s/he construes cognitively as *distal*. As we have discussed in section 4.2, whether a given object is construed cognitively as *proximal* or *distal* is a matter outside grammar. It is for this reason that the choice between a *ko*-NP and an *a*-NP is contingent upon how the speaker views the world and other non-linguistic factors, both in their deictic and non-deictic uses. It is also for this reason that the bases for the relevant choice seem to become even more difficult to comprehend in the presence of the hearer, which presumably introduces additional non-linguistic factors in the cognitive agent's (i.e., the speaker's) determination in regard to whether to construe a given object cognitively as *proximal* or *distal*.

The choice between a *so*-NP on the one hand and a *ko*- or *a*-NP on the other, however, is controlled linguistically and is not affected by non-linguistic factors, as long as we consider their non-deictic uses (in sharp contrast with the choice between *ko*-NPs and *a*-NPs). In their deictic uses as well, *so*-NPs differ from *a*-NPs and *ko*-NPs; in a monologue, the former cannot be used to refer deictically to a specific object, while the latter two can.

This leaves us with a puzzle: why are *so*-NPs usable deictically in the presence of a hearer? Orthogonal to this puzzle, we believe, is the question: how 'flexible' is the relevant part of the cognitive system that allows the cognitive agent to construe an object as *proximal* or *distal*? Our account of why *so*-NPs are usable in the presence of a hearer consists of two parts. One is that the presence of the hearer can give rise to a situation in which construing an object as *distal* results in conflicts between the speaker's point of view and the hearer's point of view; but see Appendix. The other is that there is a marked operation that gives rise to what can serve as an antecedent for a *so*-NP on the basis of some visual information.

The presence of the hearer creates a complex array of factors in regard to how to assess the relevant compatibility between the output of the generative procedure and the cognitive intentions. It seems clear therefore that we have a significantly better chance of discovering the properties of the language faculty proper if we concentrate on linguistic phenomena that do not get affected by the presence of the hearer. For similar reasons, one can concentrate on the distribution of bound variable anaphora, as opposed to that of coreference, to obtain insight into the formal properties of the language faculty; cf. Reinhart 1983: chap. 7. The empirical demonstration of the formal similarities of *a*-NPs and *ko*-NPs as discussed above has in fact been made possible as the result of works on anaphora such as Ueyama 1998 and Hoji et al. 1999, which pursue this general line of thinking.

We must however also recognize the importance of understanding the properties of the cognitive system that interfaces with grammar. After all, our introspective judgments, which at the moment are the most reliable source of empirical data in linguistic science

(at least the part of it that deals with ‘meanings’), are based not only on our grammatical knowledge but also on the relevant cognitive considerations. It is in fact studies on cognitive aspects of the relevant phenomena such as Kuroda 1979 and Takubo & Kinsui 1996, 1997 that have laid the foundation for Ueyama’s (1998) theory. It is thus hoped that further studies on these topics in the general directions we have taken will lead us to a better understanding of not only the language faculty proper but also the relevant cognitive aspects of the human mind.

Appendix: On Kuroda’s characterizations of demonstrative NPs

Kuroda 1979 can be understood as having laid the foundation for the approach pursued here. In this appendix, we will review the relevant aspects of Kuroda 1979.¹⁷

Let us first consider (4), repeated here.

- (4) Kuno’s (1973: 290) characterization of the *non-deictic uses* of *so/a*-NPs (slightly adapted):
- a. A *so*-NP is used for referring to something that is not known personally to either the speaker or the hearer or has not been a shared experience between them.
 - b. An *a*-NP is used for referring to something (at a distance either in time or space) that the speaker knows both s/he and the hearer know personally or have experience in.

Kuno’s proposal is based on observations like the following.¹⁸ The acceptability markings are Kuno’s (1973).

- (58) *Kinoo*, **Yamada-san-ni** *hazimete aimasita*. {A/*so}-no **hito**,
yesterday Mr.Yamada-DAT first.time met DISTAL/NEUTRAL-GEN person
zuibun kawatta hito desu-ne.
very eccentric person is-SFP
‘I met **Mr. Yamada** for the first time yesterday. **That man** is a very strange person, isn’t he?’
(Kuno 1973: 283, (5)A)

- (59) *Kinoo* **Yamada-toyuu** **hito-ni** *aimasita*. {*A/so}-no
yesterday Mr.Yamada-was.called person-DAT met DISTAL/NEUTRAL-GEN
hito, *miti-ni mayotte komatteita node, tasukete agemasita.*
person way-in lose.was in.trouble because helping gave (the favor of)
‘Yesterday, I met **a man by the name of Yamada**. Since **he** lost his way and was having difficulties, I helped him.’
(Kuno 1973: 284, (6)A–1)

According to Kuno, *a-no hito* is more appropriate than *so-no hito* in (58) because the speaker (presumably) knows that the person under discussion is known to both the speaker and the hearer.¹⁹ In (59), on the other hand, *so-no hito* is more appropriate than *a-no hito* because the use *-toyuu* in *Yamada-san-toyuu-hito* ‘(a) person named Mr. Yamada’ indicates that the speaker assumes that the hearer does not know the person in question.

Kuroda (1979), however, argues as in (60).

- (60) The truly crucial factor in regard to the choice between the demonstratives *so-* and *a-* is not whether the speaker and hearer are familiar with the referent; rather, it is whether the speaker approaches/regards the referent as an object of conceptual knowledge or as an object of direct knowledge.²⁰ (Kuroda 1979: 102)

His proposal can be summarized as in (61).

- (61) Kuroda's (1979) characterization of *a-* and *so-*: (based on Kuroda 1979: 97)
 a. *A*-NPs are to express an object of direct knowledge.
 b. *So*-NPs are to express an object of conceptual knowledge.

The most compelling argument for (60) and (61), and against the relevance of the 'hearer' in regard to the choice between the the demonstratives *so-* and *a-* (in their non-deictic uses), is based on the example in (62).

- (62) *Kyoo Kanda-de kazi-ga atta yo.*
 today Kanda-LOC fire-NOM was SFP
A-no kazi-nokotodakara hito-ga nanninmo sinda to omou yo.
 DISTAL-GEN fire-because.of person-NOM many died QM think SFP
 'There was **a fire** in Kanda today. Having enough knowledge of **that fire**, I believe that more than a few people got killed.' (Kuroda 1979: 101)

Kuroda (1979) states:

- (63) This example may not sound perfect. Since the hearer does not in this case have the knowledge of the fire in Kanda, the speaker should not be able to use *ano kazi* [according to Kuno's (1973) characterization of the use of *so-* and *a-*]. If we replace *ano kazi* with *sono kazi*, however, complete unacceptability results. I suspect that we can perhaps accept [(62)] as it is, once we compare it with this impossible alternative [with *sono kazi*]. The use of *ano kazi no koto dakara* implies that the speaker makes the inference – based on his/her direct knowledge [of the fire] which the concept 'the fire in Kanda' alone would never have given rise to – that people must have been killed [in the fire].²¹ (Kuroda 1979: 101)

The 'meaning' of *X no koto dakara ...* is something like 'Having enough direct knowledge of X, I believe I am entitled to make the inference about X that ...'. Recall that Kuroda claims that *so-* is chosen when 'the speaker approaches/regards the referent as an object of conceptual knowledge' rather than 'as an object of direct knowledge.' Given the 'meaning' of *X no koto dakara*, we thus expect that the *X* of *X no koto dakara* cannot be a *so*-NP, due to the 'meaning' of ... *no koto dakara*. Kuroda's (1979: 99) example in (64) confirms this expectation.

- (64) **Yamada-san toyuu hito-o matteiru no desu.**
 Mr. Yamada so.named person-ACC am.waiting COMP be
 ***So-no hito-nokotodakara kitto okuretekuru desyoo.**
 NEUTRAL-GEN person-because.of certainly will.come.late perhaps
 ‘I am waiting for **a/the person named Mr. Yamada**. Knowing **him** well, I suspect that he will probably be late.’ (Kuroda 1979: 99)

The ‘meaning’ of *X toyuu hito* is ‘(a) person named X’; cf. (59). If *X toyuu hito* ‘(a) person called X’ is used to introduce an individual that is not shared by the speaker and the hearer in one way or another, the speaker who utters (64) either (i) does not know, hence is not familiar with, the person named Mr. Yamada, or (ii) thinks that the hearer does not know, and hence is not familiar with, the person named Mr. Yamada. Under Kuno’s characterization of the uses of *so-* and *a-*, given in (4), we would therefore predict that *so-no hito* should be used rather than *a-no hito* in (64). As we have just observed in (64), however, *so-no hito* is not allowed in (64). The use of *a-no hito* in place of *so-no hito* makes (64) acceptable, as indicated in (65), which is based on Kuroda’s (1979: 99) example.²²

- (65) **Yamada-san toyuu hito-o matteiru no desu.**
 Mr. Yamada so.named person-ACC am.waiting COMP be
A-no hito-nokotodakara kitto okuretekuru desyoo.
 DISTAL-GEN person-because.of certainly will.come.late perhaps
 ‘I am waiting for **a/the person named Mr. Yamada**. Knowing **him** well, I suspect that he will probably be late.’

Kuroda’s proposal in (61) has led to the *D-domain* and *I-domain* distinction in Kinsui & Takubo 1990, 1992 and Takubo & Kinsui 1996, 1997.²³ It is proposed in these works that the domain of discourse is ‘the cognitive interface between linguistic expressions and knowledge-base’ and the domain of discourse is divided into ‘I-domain and D-domain’ (Takubo & Kinsui 1996: 59). ‘D-domain is the domain of direct experiences related to reference by demonstration’ whereas ‘I-domain is the domain of indirect experiences related to reference by description’ (Takubo & Kinsui 1996: 65)²⁴ Takubo & Kinsui (1996: 72) conclude that ‘the *a-*demonstratives are markers that give an instruction to search in the D-domain for the object of reference’ and ‘the *so-*demonstratives are markers that give an instruction to search in the I-domain for the object of reference.’ Ueyama’s (1998) distinction between D-indexed and ‘non-D-indexed’ NPs draws from the insights of Kuroda (1979) and Takubo & Kinsui (1996, 1997). Our proposal, which extends Ueyama’s theory to cover *ko-*, can thus be considered as indirectly extending (the spirit of) Kuroda’s proposal in (61) to cover *ko-*.

Our account of the deictic *so-*NPs, however, departs from Kuroda’s conceptually (although the empirical difference between the two is not obvious at least at the moment; see the discussion below). Our account makes crucial reference to the cognitive difference between *proximal* and *distal* (hence between *ko-* and *a-*, because of (i) their lexical markings as [Proximal] and [Distal], respectively, and (ii) the relation between

these lexical markings and language use). We suggest in effect that the deictic use of *so*-NPs is possible only when neither *ko*-NPs nor *a*-NPs are usable.²⁵

Recall that (50) (p. 113) contains ‘the speaker thinks that the hearer would construe the relevant object as *proximal*.’ Having to make reference to what the speaker assumes that the hearer thinks seems problematic, to the extent that it is not obvious how the speaker can tell what the hearer might think. Not making reference to what the hearer thinks, Kuroda’s proposal does not face this problem. The reference to what the hearer thinks, however, can be avoided if we state the relevant portion of (50) as ‘the speaker thinks that *s/he* would construe the relevant object as *proximal* if *s/he* were where the hearer is.’

Our account of the deictic *so*-NPs, incorporating the change just suggested, and Kuroda’s can be summarized as follows.

Our account

- (66) An *a*-NP (i.e., *a-no NP*), which by hypothesis is marked linguistically as [Distal], cannot be used to express an object construed as in (67).
- (67) The speaker construes the relevant object as *distal*, and the speaker thinks that *s/he* would construe the relevant object as *proximal* if *s/he* were where the hearer is.
- (68) Given the first conjunct in (67), the speaker cannot use an expression that is linguistically marked as [Proximal], i.e., *ko-no NP*.
- (69) When neither *a-* nor *ko-* is usable, *so-* is used, because *so-* belongs to the same morphological and syntactic class as *a-* and *ko-*.

Kuroda’s account

- (70) (= (61))
- a. *A*-NPs are to express an object of direct knowledge.
 - b. *So*-NPs are to express an object of conceptual knowledge.
- (71) The visual contact with an object O is sufficient for giving direct knowledge of O to the person who sees O.
- (72) If the object O is by the hearer (*kikite no soba*), the speaker must accept that the hearer is in a better position than the speaker in regard to the recognition of O and must accept that the hearer can therefore have some direct knowledge of O that the speaker cannot attain.
- (73) (72) forces the speaker to present O as something other than his/her own direct knowledge.

(74) Hence *so*-NPs are used in these cases.

Let us consider (75).

- (75) a. *Kimi-no sugu yoko-ni aru a-no hon-o hiraite kudasai.*
 you-GEN right.away side-LOC exist that-GEN book-ACC open please
 ‘Please open **that book** that is right next to you.’
 b. **/#Kimi-ga ten: motteiru a-no hon-o hiraite kudasai.*
 you-NOM is.holding that-GEN book-ACC open please
 ‘Please open **that book** that you are holding.’

Under Kuroda’s account, we would have to understand the notion of ‘being by’ in such a way that the book in question need not be considered as ‘being by’ the hearer in (75a) but it does in (75b). In other words, the notion of ‘being by’ (*soba*) that is relevant in (72) cannot simply be based on physical distance. Similarly, under our account, the speaker must think that s/he would construe the object in question to be *proximal* in (75b) but not in (75a), if s/he were the hearer. It therefore does not seem clear exactly when the object is (considered to be) ‘by’ the hearer (under Kuroda’s account) or when ‘the speaker thinks that s/he would construe the relevant object as *proximal* if s/he were the hearer’ (under our account).²⁶

While we accept Kuroda’s (70) (=61), we do not accept the claim in (76), which in effect is made in Kuroda 1979: sec. 5.

(76) The non-deictic use of *so*-NPs is possible without a linguistic antecedent.

(76) goes directly against (77), which is one of the major consequences of Ueyama’s (1998) theory of anaphoric relations and the lexical specifications of *so*.²⁷

(77) The non-deictic use of *so*-NPs is not possible without a linguistic antecedent.

Before we proceed, some terminological clarification is perhaps in order. Kuroda uses (78) instead of (79).²⁸

- (78) a. *dokuritu-teki yooahoo* ‘independent use’
 b. *syooooo-teki yooahoo* ‘anaphoric use’

- (79) a. deictic use
 b. non-deictic use

Kuroda’s (78a) and (78b) do not quite correspond to (79a) and (79b), respectively. His (78a) and (78b) seem to correspond to (80a) and (80b) instead.

- (80) a. the use without (what appears to be) a linguistic antecedent
 b. the use with (what appears to be) a linguistic antecedent

Given that (80a) includes the deictic use, (81) thus seems to be a more accurate statement than (76) of what is intended in Kuroda 1979.

(81) The use without (what appears to be) a linguistic antecedent is possible for *so*-NPs.

(81) by itself however seems trivial since *so*-NPs can be used deictically. But Kuroda's attempted demonstration of (81) is, or rather would, be significant since he conducts the relevant experiment by excluding the hearer. Given that the deictic *so*- is not possible in the absence of the hearer, the possible *so*- in (81) is necessarily non-deictic *so*-. If we incorporate this aspect of his experiment in the relevant statement, (81) will therefore become (82), and we seem to revert to (76), after all.

(82) The use without (what appears to be) a linguistic antecedent is possible for non-deictic *so*-.

With the terminological clarification just given, we will continue to represent Kuroda's claim in question as in (76).

In support of (76), Kuroda provides (83) and (84).

(83) [Suppose that it has been discovered through a careful medical examination that the speaker has a stomach ulcer. (Assuming that the speaker does not have any pain or any symptom, this means that the speaker has learned about the existence of the ulcer not by his/her own direct experience but by some conceptual understanding.) When s/he wakes up, the thought of the ulcer comes to mind. S/he wonders (*omou*):]

*Ittai so-re-wa donna iro-o siteiru nodarooka*²⁹

on-earth that-thing-*TOP* what.kind color-ACC is.doing I.wonder

'I wonder what kind of color **that** is.'

(84) [Having been asked to write an essay, the speaker is wondering whether he should take on the task. Something vague comes to mind, but the speaker does not quite understand what it is. It is not clear to him how the topic might develop [which is understandable if he does not quite understand what it is (*imada sore-ga dono yoo na koto de aru ka yoku wakaranai*)]. But he thinks that once he decides to write on it (*sono koto*) [i.e., on some vague topic although he does not quite understand what it is] and starts thinking (about it) a little, the idea will perhaps start shaping itself. He thinks:]

So-no koto-demo kaite miyooka.

that-GEN thing-*PRT* write shall.I

'Shall I write about **that**?'

It is not clear how acceptable (84) is; we and the speakers we have consulted with do not find it acceptable. In regard to (83), speakers' reactions seem mixed. Kuroda's (1979) remarks in his section 6 suggest that what he has in mind is a situation where the speaker has been notified of the existence of the ulcer but does not feel any physical discomfort. The acceptability of (83) (for some speakers) can then be understood as being due to the

possibility, to varying degrees, of some linguistic expression(s) (at some point in the past) serving as a linguistic antecedent for the *so-NP* in (83). In an attempt to examine the validity of (76), we might conduct a thought experiment as follows. The speaker, who is an expert him/herself in the field that deals with ulcers, just received a set of numerical figures that indicate the results of the test that has been performed to check his/her medical condition. By looking at the figures by him/herself, s/he can immediately tell, because of his/her expertise, that s/he has an ulcer, despite the fact that s/he does not have any physical discomfort whatsoever. S/he wonders about the color of the ulcer, and utters (85); see note 29.

- (85) #*Ittai {so/a}-no kaiyoo-wa donna iro-o siteiru nodarooka.*
 on-earth that-GEN ulcer-TOP what.kind color-ACC is.doing I.wonder
 ‘I wonder what kind of color **that ulcer** is.’

The knowledge of the ulcer s/he has thus acquired cannot be direct knowledge, and that explains the unacceptability of (85) with *a-no kaiyoo*. If knowledge is either direct knowledge or conceptual knowledge, it must therefore be conceptual knowledge. If (76) were to hold, (85) should therefore be acceptable with *so-no kaiyoo*. Such however does not seem to be the case. We thus conclude at this point that (76) cannot be upheld and continue to maintain (77).

Notes

- * We would like to thank Yuki Kuroda for his pioneering work on the topic dealt with here as well as his comments and discussion. We are also grateful to Tami Kaplan and two anonymous reviewers for their comments and suggestions on an earlier version of this publication. The comments and suggestions by Bill McClure, Emi Mukai, and Kiyoko Kataoka on the pre-final version of this chapter have also resulted in much improvement. The content of this chapter has been presented at various places, including USC (1998–2001), ATR (November 2000), and Nanzan University (December 2000), and we would like to thank the audiences there for their feedback. The regular disclaimers apply.

This work has been supported in part by (i) Grant-in-Aid for Scientific Research: International Scientific Research (Joint Research), ‘Comparative Syntax of Japanese, Korean, Chinese and English,’ Project No. 08044009, Japanese Ministry of Education, Science and Culture, April 1996–March 1999 and (ii) Grant-in-Aid for Scientific Research (B), Japan Society for the Promotion of Science, ‘Theoretical and empirical studies of ellipsis: Toward the establishment of generative grammar as an empirical science,’ Grant No. 12410128.

- I A more exhaustive paradigm of Japanese demonstratives is given in (i).

(i)	<i>Ko-</i>	<i>So-</i>	<i>A-</i>
	<i>ko-re</i> ‘this thing’	<i>so-re</i>	<i>a-re</i>
	<i>ko-tira</i> ‘this way’	<i>so-tira</i>	<i>a-tira</i>
	<i>ko-tti</i> ‘this way’	<i>so-tti</i>	<i>a-tti</i>
	<i>ko-ko</i> ‘this place’	<i>so-ko</i>	<i>a-soko</i>
	<i>ko-itu</i> ‘this guy’	<i>so-itu</i>	<i>a-itu</i>

- 2 Replacing ‘visible’ with ‘perceptible’ would broaden the empirical coverage of (2a) to cases involving noise, smell, and so on, discussed in Kinsui 2000 among others, making the distinction between the two uses of demonstratives descriptively more adequate. A more satisfactory characterization of the relevant distinction, however, would also have to involve some articulation of the notion ‘perceptible.’ In this chapter, we will concentrate on what seems to us to be the most elementary distinction in regard to the uses of the demonstratives and plan to discuss in separate works how the line of thinking pursued here can be extended to more complex cases.
- 3 The discussion of the non-deictic uses of a *ko/so/a*-NP has often focused on examples in which the NP in question is understood to be related to another NP, and for this reason, the term *anaphoric use* has sometimes been employed in the literature, instead of *non-deictic use*; cf. Kuno 1973: ch. 24, for example. Throughout the chapter, we will use *non-deictic* rather than *anaphoric*.
- 4 The earliest works we know of that make the relevant observations are Aston 1872: 24, 1873: 13, which are discussed in Furuta 1980.

- (i) *Sore* is properly speaking a pronoun of the second person, and mostly refers to something situated near to, or in some way connected with the person addressed, while *kore* is of the first person, and relates to objects close to, or connected with the speaker. (Aston 1872: 24)
- (ii) *Sore, sono* is the demonstrative pronoun of the second person; *are, ano* of the third person. *Kore, kono* refer to something present before the speaker’s eyes; *are, ano* to something a little way off, or not in sight. *Sore, sono* refer to the immediate subject of conversation: *are, ano* to something else. (Aston 1873: 13)

- 5 The descriptive statements in (4) are not totally unlike Matsushita’s (1930/1978: 234) given in (i).

- (i) The speaker assumes that the hearer is acquainted with the referent identified by an *a*-NP, otherwise a *so*-NP or a *ko*-NP must be used.

Matsushita’s (i) is intended to cover both the non-deictic uses and the deictic uses of the Japanese demonstratives. Kuno (1973) however argues that (i) is applicable only to the ‘anaphoric’ uses.

- 6 Kuno (1973: 282) endorses the characterization of the deictic uses of *ko/so/a*-NPs in (3).

- 7 For example, the *a*-NP in (i) is individual-denoting, while that in (ii) is not.

- (i) **A-no** *hito-wa ko-nakatta.*
that-GEN person-TOP come-didn’t
‘That person did not come.’
- (ii) **A-nna** *hito-wa ko-nakatta.*
that-like person-TOP come-didn’t
‘Such a person did not come.’

- 8 More concretely, it is assumed in Ueyama 1998 that outside Grammar there is a set of ordered pairs of a natural number (index) and an individual, which is called σ^D . (i) is one such example.

- (i) $\sigma^D = \{ \langle 1, \text{John} \rangle, \langle 2, \text{Mary} \rangle, \langle 3, \text{Bill} \rangle, \dots \}$

Using the notation $\sigma^D(n)$ to refer to the individual paired with the number n in σ^D , we say that a D-indexed NP is mapped to $\sigma^D(n)$.

- 9 Obviously (19) and (20) do not show that the two conditions in (17) are necessary. See Ueyama 1998: ch.3 and Hoji et al. 1999 for further discussion.
- 10 Lasnik’s (1991) condition in (i), which is called *Condition D* in Huang 1988, is formulated in Ueyama 1998: 204 as in (ii).

(i) A less referential expression may not bind a more referential one. (Lasnik 1991: 19 (51))

(ii) Condition D:

Nominal expressions α and β must be disjoint in reference, if $\alpha < \beta$ and α c-commands β , where $\alpha < \beta$ iff (a) for every x , x an individual which can be referred to by the use of β , x can be referred to by the use of α , and, (b) for some y , y an individual which can be referred to by the use of α , y cannot be referred to by the use of β .

11 We will return to (3b) in the next section.

12 We assume that *ko-* and *a-* are linguistically marked as [Proximal] and [Distal], and in this sense the distinction between *ko-* and *a-* is linguistic. What is cognitive is the difference between *proximal* and *distal*.

13 The differences between *ko-* and *a-*, which we have observed in section 4, also show up in a monologue.

- (i) [In a monologue, thinking about one's own pain.]
 {*Ko*^{??/*?}/*A*/**So*}*-no itami-wa doko-kara kiteru nokanaa*
 this/ that/that-GEN pain-TOP where-from originate I.wonder
 'I wonder where {this/that} pain originates.'
- (ii) [In a monologue, thinking about one's own pain.]
 a. {*?*^{??/*?}/*Ko*/*A*/**So*}*-no itami-wa doko-kara kiteita no ka naa*
 this/that/that-GEN pain-TOP where-from originated I.wonder
 'I wonder where {this/that} pain originated.'

14 In works subsequent to the completion of the draft of this chapter, we propose (e.g., in Hoji et al. 2000) a somewhat different analysis of the deictic use of *so*-NPs as well as *ko/a*-NPs, dispensing with the crucial use of 'points of views', especially that of the hearer. The presentation of the new analysis, however, would require considerable space and it has to wait for a separate occasion.

15 Recall that whether the speaker construes a given object as *proximal* or *distal* is affected by a number of non-grammatical factors. Recall further that we assume that the speaker has the option of taking (virtually) everything in the world as *proximal* if s/he so wishes. We can ask whether the speaker also has the option of taking (virtually) everything in the world as *distal* if s/he so wishes. It seems that the speaker does not have as free an option of taking everything in the world to be *distal* as s/he does of taking everything in the world *proximal*. We have the option of referring to a star in the sky as *ko-no hosi* 'this star' or *a-no hosi* 'that star', but we do not seem to have the option of referring to a pen that we are holding in our hands as *ko-no pen* 'this pen' or *a-no pen* 'that pen'. It seems that we must refer to it as *ko-no pen* 'this pen', no matter how we try to adjust the way we view the world. The notion *proximal* thus seems to have primacy of some sort over the notion *distal*.

As noted, the choice between *distal* and *proximal* can be affected by various factors, including the way the speaker views the world as well as the physical distance between the object and the speaker. The speaker, we might say, has all the relevant information about the way s/he views the world, which affects whether s/he construes an object as *distal* or *proximal*, when the option is available. When it comes to how the speaker thinks the hearer construes a given object, the speaker presumably has much less information as to the way the hearer views the world. Hence it seems reasonable to assume that the relevant choice is determined mostly on the basis of the physical distance between the object and the hearer. These considerations, combined with the primacy of *proximal* over *distal*, thus lead us to conclude that in the situation given for (49) above, the speaker is highly likely to think that the hearer construes the red chair as *proximal*. See Appendix for further discussion.

16 One might suggest that the relevant interpretation for the *ko*-NP in examples like (i), based on The Constitution of Japan: Article 9, second sentence, is also an instance of a covariant interpretation.

- (i) *Zenkoo-no mokuteki-o tassuru tame, riku- kai- kuu-gun*
 preceding.paragraph-GEN aim-ACC accomplish to land- sea- air-force
sonota ikanaru senryoku-mo ko-re-o hozisi-nai.
 other every war.potential-MO this-thing-ACC maintain-not
 ‘In order to accomplish the aim of the preceding paragraph, *no matter what kind of war potential*
 (land, sea, air forces, and so on) we shall never maintain *this*.’

We would, however, like to adopt Mikami’s (1972: 184–186) suggestion that this use of *ko*-NP is quite limited and can be considered as falling outside the core aspects of modern Japanese.

Mikami observes that the Asahi Newspaper (July 5, 1954: page 1) quotes Article 9 as in (ii), without *ko-re*, and suggests that the use of *ko-re* as in (i) is limited to the special style of translation from Chinese (*Kanbun-kundoku*).

- (ii) *Zenki-no mokuteki-o tassuru tame riku- kai- kuu-gun*
 above.noted-GEN aim-ACC accomplish to land see air-force
sonota-no senryoku-wa hozisi-nai.
 other-GEN war.potential-TOP maintain-not
 ‘In order to accomplish the aim noted above, as for land, sea and air forces, as well as other war
 potential, we shall never maintain.’

Mikami (1972: 186) also cites the statistical results reported by Ide (1952: 7–12) in regard to the uses of *kore* and *sore* in question, in support of his suggestion noted above.

- 17 Kuroda 1979 is written in Japanese: its French version has appeared as Kuroda 1985.
 18 Essentially the same observations are made in Matsushita 1978: 234–235; see note 5.
 19 This can presumably be inferred from the use of the sentence-ending particle *ne*, (one of) the main discourse function(s) of which is to solicit an agreement from the hearer.
 20 This is our English translation of the relevant passage. Kuroda (1979: 97) points out that Kuno (1973) provides remarks such as ‘indirect knowledge does not belong to the category of [being familiar with him],’ ‘in the absence of direct knowledge, the *so*-series is used,’ and so on, and that [Kuno] thus seems to add to the concept of ‘being familiar with or not’ the concept of ‘whether it is direct knowledge or indirect knowledge.’ (The contents in the quotations here are also our translations of the relevant passage from Kuroda 1979.)
 21 This is our translation of the relevant passage.
 22 Kuroda (1979: 99) states that ‘the use of *ano hito no koto dakara* [in (i)] is possible because the speaker understands that the hearer’s direct knowledge about Mr. Yamada suffices to provide the hearer with the basis for the speaker’s inference, even if [the basis is] not presented to the hearer conceptually.’ (This is our translation of the relevant passage.)

- (i) (Kuroda 1979: 99)
Yamada-san-o matteiru no desu.
 Mr. Yamada-ACC am.waiting COMP be
A-no hito-nokotodakara kitto okuretekuru desyoo.
 DISTAL-GEN person-because.of certainly will.come.late perhaps
 ‘I am waiting for **Mr. Yamada**. Knowing **him** well, I suspect that he will probably be late.’

The acceptability of (65), however, suggests that the use of *a-no hito nokotodakara* in (i) does not necessarily mean that (the speaker understands that) the hearer knows the basis for the speaker’s inference. The speaker can utter (65) when he knows Mr. Yamada well and at the same time knows that the hearer does not know Mr. Yamada at all, i.e., when it cannot be understood that the hearer has access to the basis for the speaker’s inference. The acceptability of (65) thus seems to provide confirmation for Kuroda’s thesis that a proper description of (the non-deictic

uses of) *a-* and *so-* does not require the concept *the hearer*, perhaps in a way stronger than what is presented in Kuroda 1979.

Takubo & Kinsui (1996: 60–62) address the so-called ‘paradox of mutual knowledge’ and propose that ‘the description of the use of a linguistic form should not include assumptions about the hearer’s knowledge.’ (The materials in the quotation is our translation of the relevant passage.)

- 23 The distinction is also based on the dichotomy of ‘knowledge by acquaintance’ and ‘knowledge by description’ introduced in Russell 1912.
- 24 The phrases in the quotation in this sentence are our translation of the relevant passage.
- 25 We expect that our account, or an extension of it, can capture Mikami’s observation that *ko-* and *so-* contrast with each other, but *a-* and *so-* do not. Mikami (1972: p. 172, p. 178) points out that there are many idiomatic expressions in which *a-* and *ko-* (or *so-* and *ko-*) are contrasted as in (i), but the *a-so* combination does not work in cases like (i).
- (i) a. **a-ti ko-ti** ‘here and there’, **a-tira ko-tira** ‘here and there’, **a-nna ko-nna-de** ‘after this and that, with all this’, **a-re ko-re kangaeta sue** ‘after thinking about this and that’, ...
 b. **so-o ko-o siteiru uti ni** ‘while doing this and that’, **so-ko ko-ko-ni** ‘here and there’, ...
 We must leave further discussion to a separate occasion.

26 See note 14.

27 We are suppressing the qualification that (77) holds only of individual-denoting *so*-NPs; see note 7.

28 The term *deictic* here makes crucial reference to ‘visible (to the speaker)’. See (2) and the remarks that follow it.

29 We have been informed that few speakers of English would consider ‘What color is the ulcer?’ to be an appropriate question and the English translation given in (83) is likely to be considered as a literal translation of a Japanese metaphor. The original sentence in (83), however, does not have a flavor of a metaphor and is not a particularly strange Japanese sentence, apart from the issue of its felicitousness under situations of the sort given in (83).

References

- Aston, William G. (1872) *A Grammar of the Japanese Written Language*, Phoenix, London.
- Aston, William G. (1873) *A Short Grammar of the Japanese Spoken Language*, Trübner and Co., London.
- Furuta, Toosaku (1980) ‘*Ko/so/a/do-* Kenkyuu no Nagare (A History of the Research on *Ko/so/a/do-*)’, *Zinbun-kagaku-ka Kenkyuu* 71, pp. 173–187, Tokyo Daigaku Kyooyoo-gakubu Zinbunkagakuka.
- Hoji, Hajime (1991) ‘*KARE*’, in C. Georgopoulos & R. Ishihara, eds., *Interdisciplinary Approaches to Language: Essays in Honor of S.-Y. Kuroda*, Kluwer Academic Publishers, Dordrecht, pp. 287–304.
- Hoji, Hajime (1995) ‘Demonstrative Binding and Principle B’, *NELS* 25, pp. 255–271. GLSA, University of Massachusetts, Amherst.
- Hoji, Hajime, Satoshi Kinsui, Yukinori Takubo, & Ayumi Ueyama (1999) ‘Demonstratives, Bound Variables, and Reconstruction Effects’, Proceedings of the Nanzan GLOW, The Second GLOW Meeting in Asian, September 19–22, 1999, pp. 141–158.
- Hoji, Hajime, Satoshi Kinsui, Yukinori Takubo, & Ayumi Ueyama (2000) ‘On the “Demonstratives” in Japanese’, Seminar on Demonstratives, held at ATR (Advanced Telecommunications Research Institute International). November 29, 2000.
- Huang, C.-T. James (1988) ‘Comments on Hasegawa’s Paper’, in W. Tawa, and M. Nakayama, eds., *Proceedings of Japanese Syntax Workshop: Issues on Empty Categories*, Japanese Program Connecticut College, New London, Connecticut.

- Ide, Itaru (1952) 'Bunmyaku-sizigo to Bunsyoo (Anaphora and Discourse),' *Kokugo Kokubun*, Vol. 21. No. 8, pp. 1–22, Kyoto University.
- Kinsui, Satoshi (2000) 'Sizisi: tyokuzi saikoo (Demonstratives: Deixis Reconsidered)' Akira Nakamura, ed., *Gendai Nihongo Hikkei (Handbook of Modern Japanese Linguistics)*, Bessatsu Kokubungaku, No. 53, Gakutoosya, Tokyo, pp. 160–163.
- Kinsui, Satoshi & Ikumi Imani (2000) *Imi to bunmyaku (Meanings and Contexts)*, Iwanami, Tokyo.
- Kinsui, Satoshi, Tomoko Okazaki & Migyon Jo (2002) 'Sizisi no Rekisiteki/Taisyooengogakuteki Kenkyuu–Japanese/Korean/Turkish– (A Historical and Comparative Linguistic Research of Demonstratives–Japanese/Korean/Turkish–)', Naoki Ogoshi & Hideki Kimura (eds.) *Comparative Linguistics, The Science of Language*, 4, University of Tokyo Press, Tokyo, pp. 217–247.
- Kinsui, Satoshi & Yukinori Takubo (1990) 'Danwakanri Riron kara Mita Nihongo no Sizisi (Discourse Management Analysis of the Japanese Demonstratives),' *Advances in Japanese Cognitive Science*, Vol. 3 pp. 85–116, the Japanese Cognitive Science Society.
- Kinsui, Satoshi, and Yukinori Takubo (1992) 'Nihongo Sizisi Kenkyuusi kara/e (From/Toward a History of Research on Japanese Demonstratives),' In S. Kinsui & Y. Takubo, eds., *Sizisi (Demonstratives)*, pp. 151–192, Hituzi Syobo, Tokyo.
- Kuno, Susumu (1973) *The Structure of the Japanese Language*, The MIT Press, Cambridge.
- Kuroda, S.-Y. (1979) '(Ko) So, A nituite (On (ko-), so- and a-),' in *Eigo to Nihongo to (English and Japanese)*, Kurosio Publishers, Tokyo, pp. 41–59. (Reprinted in S. Kinsui & Y. Takubo, (1992) eds., *Sizisi (Demonstratives)*, pp. 91–104, Hituzi Syobo, Tokyo. Page references are to the reprinted version.)
- Kuroda, S.-Y. (1985) 'La sémantique des démonstratifs japonais,' *Linguisticae Investigationes* 9, pp. 69–82.
- Lasnik, Howard (1991) 'On the Necessity of Binding Conditions,' in R. Freidin, ed., *Principles and Parameters in Comparative Grammar*, The MIT Press, Cambridge, pp. 7–28.
- Masuoka, Takashi & Yukinori Takubo (1992) *Kiso Nihongo Bunpoo (The Basic Grammar of Japanese)*, Kurosio Publishers, Tokyo.
- Matsushita, Daizaburoo (1930) *Kaisen Hyoozyun Nippon Bunpoo (Revised Standard Japanese Grammar)*, Tyuubunkan Syoten, Tokyo (Reissued by Benseisya, Tokyo, 1978).
- Mikami, Akira (1972) *Gendai Gohoo Sinsetu (The New Theory on Modern Japanese)*, Kurosio Publishers, Tokyo. (Originally published in 1955.)
- Reinhart, Tanya (1983) *Anaphora and Semantic Interpretation*, Croom Helm, London.
- Russell, Bertrand (1912) *Problems of Philosophy*, Oxford University Press, London.
- Takubo, Yukinori (1984) 'Sitteiru Koto to Siritai Koto (What we know and what we want to know),' *Conference Handbook of the First Annual Meeting of the Japanese Cognitive Science Society*, pp. 58–59.
- Takubo, Yukinori & Satoshi Kinsui (1996) 'Hukusu no Sinteki-ryooiki niyoru Danwa-kanri (Discourse Management in terms of Multiple Mental Domains,' *Cognitive Studies: Bulletin of the Japanese Cognitive Science Society*, Vol. 3, No. 3, pp. 59–74.
- Takubo, Yukinori & Satoshi Kinsui (1997) 'Discourse Management in terms of Mental Spaces,' *Journal of Pragmatics*, Vol. 28, No. 6. pp. 741–758, Elsevier Science, Amsterdam.
- Takubo, Yukinori & Satoshi Kinsui (1998) 'On the Relation between the Deictic and the Non-Deictic Use of the Japanese Demonstratives,' a talk presented at a Symposium on Diachronic and Synchronic Studies on Syntax of East Asian Languages, University of Southern California, November 6–8, 1998.
- Tanaka, Nozomi (1981) 'Kosoo o meguru Syomondai (Problems in Demonstratives),' in Tanaka, Nozomi & Isamu Shooho, *Nihongo no Sizisi (Demonstratives in Japanese)*, pp. 1–50, Kokuritu Kokugo Kenkyuusyoo.
- Ueyama, Ayumi (1998) *Two Types of Dependency*, Doctoral dissertation, University of Southern California, distributed by GSIL publications, USC, Los Angeles.

Part II

GRAMMATICALIZATION AND THE DIACHRONIC DEVELOPMENT OF FUNCTIONAL STRUCTURE

ON THE RE-ANALYSIS OF NOMINALIZERS IN CHINESE, JAPANESE AND KOREAN

Andrew Simpson

1. Introduction

Grammaticalization is commonly assumed to be a process of categorial re-analysis in which a lexical descriptive element turns into a morpheme with a predominantly functional role. Frequently this process would seem to convert a lexical head into a member of the particular functional structure dominating that head, as for example when verbs with clear descriptive content become re-analyzed as aspectual or modal verbs occurring in functional heads projected over the VP. In this sense grammaticalization may be taken to be the result of a combination of movement and re-analysis – movement of a morpheme from a lexical head position to a higher functional head position and then eventual re-analysis of the morpheme as being base-generated in the latter functional head. Such a view of grammaticalization is proposed in Simpson (1998), Roberts & Roussou (1999) and Wu (2000) and naturally proceeds in a simple upwards or ‘vertical’ direction in a tree following the path of movement (e.g. lexical verbs frequently re-analyze as instantiations of the higher modal-aspectual functional heads projected over VP). In Simpson & Wu (1998) it is suggested that grammaticalization may also occur in an essentially ‘horizontal’ direction and that a Chinese nominalizer of type D^0 (*de*) is currently undergoing re-analysis as a new instantiation of a clausal head (past tense/ T^0); such a change does not result from any upwards movement but from the horizontal/lateral re-analysis of a functional element in the nominal domain as a functional element in the clausal domain. In this chapter I would like to suggest that this basic type of horizontal re-analysis argued for in Simpson & Wu (1998) which re-categorizes nominalizers as clausal functional heads is actually quite widespread as a phenomenon in Chinese, Japanese and Korean and possibly significant as a general areal feature of such languages. Due to differences in the surface typological properties of Chinese, Japanese and Korean it will be shown that the hypothetical re-analysis process is interestingly revealed by different types of evidence, and that there is also indication of certain cross-linguistic variation in the way that the nominal elements become re-analyzed in the clausal functional structure. As a result, the phenomenon is one which both intriguingly unites Chinese, Japanese and Korean cutting across their typological differences, and one which also clearly gives rise to certain parametric variation in its actual realization.

The chapter is essentially structured into two main sections focussing on re-analysis phenomena in matrix and subordinate clause types. Section 2 first concentrates on the re-analysis of nominalizers in matrix clauses when these occur with copula elements. The section begins with a review of Simpson & Wu's (1998) arguments for the re-analysis of Chinese *de* and then suggests that similar re-analysis is occurring in structures in Japanese and Korean in a way which in fact also reveals more about the underlying change in Chinese. Section 3 then turns to subordinate clause contexts and argues for the re-analysis of nominalizing elements in relative clauses in Japanese and Korean; the hypothesis of such changes is suggested to allow for a broader insight into the potential nominal structure of relative clauses and how genitive case may be licensed on the subjects of relative clauses. The chapter is closed with a consideration of certain other nominalizer re-analysis phenomena and speculations on why it is that the re-analysis of nominal functional elements as clausal functional heads should actually be so commonly found. Throughout the chapter the attempt is made to show that there is much to be gained from comparative work contrasting Chinese with Japanese and Korean, and that despite apparent dissimilarities among these languages the various typological differences found can actually be used to good advantage in the study of a single phenomenon.

2. The re-analysis of nominalizers embedded under copulas

2.1. Chinese *de*

Simpson & Wu (1998) examines the syntax of the so-called '*shi-de* construction' in Mandarin Chinese, forms such as (1) in which the copula *shi* precedes a VP-type clausal constituent and the particle *de* occurs in sentence-final position:

- (1) *wo shi zuotian mai piao de*
 I BE yesterday buy ticket DE
 'It was yesterday that I bought the ticket.'

As indicated in the gloss, *shi-de* sentences have an interpretation similar to English cleft-sentences and highlight a focused constituent immediately following the copula against a strongly presupposed background represented by the residue of the sentence. Commonly there is undeniable contextual information leading to the appropriate use of *shi-de* forms, and *shi-de* sentences are often used as explanations of some apparent state, the focussed element functioning to clarify or add some additional information relating to the presupposed background event/contextually apparent state (see here de Francis 1963, Chao 1968, Kitagawa & Ross 1982 among others).

The strong presupposition which results from use of the *shi-de* construction is essentially like a speaker's guarantee of the occurrence of the background event. Rather naturally, this strongly favours past time interpretations and example (2) below only permits a past time interpretation. In example (3) where *de* is present only a past time interpretation is again possible, and when it is omitted only a non-past future oriented meaning is available:

- (2) *wo shi zuo qi-che qu Beijing de*
 I BE sit train go Beijing DE
 ‘It was by train that I went to Beijing.’
- (3) *wo shi gen Zhangsan qu Beijing (de)*
 I BE with Zhangsan go Beijing (DE)
 with *de*: ‘It was with Zhangsan that I went to Beijing.’
 without *de*: ‘Its with Zhangsan that I’m going to Beijing.’

Despite the heavy preference for a past time interpretation, it is however possible to override this with the use of future time adverbials and modal elements such as *hui* or *cai-yao* ‘will’ as in (4), in which case the interpretation is that there is a strong guarantee that the event will take place:

- (4) *wo shi mingtian ??*(cai yao) qu Beijing de*
 I BE tomorrow only will go Beijing DE
 ‘It’s tomorrow that I’m going to Beijing.’

Syntactically, in Paris (1979), Li & Thompson (1981) and other works it has been assumed that the element *de* both here and in other relative clause structures is a nominalizer, and that *shi-de* forms therefore critically incorporate nominalizations of a clausal/VP constituent.¹ Li & Thompson (1981, p. 587) write that: ‘The *shi..de* construction is a special sentence type in which a nominalization is used. Structurally, it consists of a subject followed by the copula verb *shi* “be” followed by a nominalization.’ In Kitagawa & Ross (1982) it is additionally suggested that a null PRO element occurs following the *de* of *shi-de* constructions; such a proposal accords well with the observation that *de* elsewhere always precedes a nominal element (modified by the clause introduced by *de*), and is argued by Kitagawa & Ross to be the syntactic encoding of the strong link to context present in *shi-de* forms – the PRO is suggested to be anaphorically controlled by some element contextually present in the discourse.² Simpson & Wu (1998) furthermore show that there is overt morphological evidence in Burmese in support of such a general possibility; in structures fully equivalent to *shi-de* forms in Burmese there is indeed a lexically overt dummy head-noun present in such structures. *Shi-de* forms might therefore reasonably be concluded to have a structure in which the copula *shi* embeds a CNP-type clausal nominalization headed by some null contextually controlled NP element largely as suggested in Kitagawa & Ross.

Despite the clear naturalness of such an analysis, Simpson & Wu (1998) suggest that there are reasons to believe that *shi-de* structures and *de* in particular are currently undergoing re-analysis away from an original nominalization base. Specifically it is noted that if the sequence following *shi* were to be a CNP-type nominalization one would not expect for certain patterns common in *shi-de* forms to be possible. First of all it is found that *wh*-adjuncts freely occur between the copula and *de* and so inside what might seem to be a CNP, as illustrated in (5):

- (5) *ni shi* [_{XP}[*zenme/weishenme lai*] *de*]
 you BE how/why come DE
 ‘How/why did you come?’

Wh-adjuncts such as *weishenme* ‘why’ and *zenme* manner ‘how’ normally cannot occur in CNPs, however, as seen in (6) and (7):

- (6) *_{[DP} [*ta zenme lai*] *-de shuofa*] *bu hao*?
 he how come DE claim not good
- (7) **ta shi* [_{[DP} *weishenme lai*] *de ren*]?
 he BE why come DE person

Secondly, adverbs such as *zuotian* ‘yesterday’ may occur external to the posited nominalization in *shi-de* forms and yet still refer to the event inside the CNP, as in (8):

- (8) *zuotian wo shi* [_{DP}[*lai mai che*] *de*]
 yesterday I BE come buy car DE
 ‘Yesterday I came to buy the car.’

This is also unexpected as adverbials normally seem unable to refer into DPs. In (9) for example, ‘yesterday’ cannot refer to the time of Bill’s betraying Sue:

- (9) Yesterday John discussed [_{DP} Bill’s betrayal of Sue]

Thirdly, in addition to the regular positioning of the object of the main verb preceding *de* as in (10), northern dialects of Mandarin allow for the apparently optional positioning of the object following *de* as seen in (11). If *shi-de* forms embed CNPs, it is unexpected that the object of the verb inside the CNP should be able to rightwardly extract out of such an island constituent:

- (10) *wo shi zuotian mai piao de*
 I BE yesterday buy ticket DE
 ‘It was yesterday that I bought the ticket.’
- (11) *wo shi zuotian mai de piao*
 I BE yesterday buy DE ticket
 ‘It was yesterday that I bought the ticket.’

Assuming that *shi-de* forms originated as nominalizations embedded by the copula *shi* but have since undergone some kind of re-analysis into structures with properties different from CNPs, Simpson & Wu focus on the object alternation in (10/11) above as a potential clue to the underlying synchronic structure of *shi-de* sentences. (10) and (11) are represented schematically in (12), with the (a) form being found in all dialects of

Mandarin and the (b) pattern occurring predominantly in northern areas (in addition to the (a) form):

- (12) a. V – Ob – *de*
 b. V – *de* – Ob

Assuming that the more restricted (b) form is somehow derived from the fully common (a)-type sequence, it might seem that there are two obvious ways of relating (a) to (b). The first of these would be to suggest that the object moves rightwards over the nominalizer *de*, the second that the nominalizer *de* itself moves leftwards over the object. Although one might initially be tempted to suppose that the (b) forms result from rightward object-movement similar to Heavy NP Shift (HNPS), this possibility is actually rather problematic to maintain. First of all there is the noted problem that rightward extraction out of a CNP-type island might be expected to violate Subjacency, and secondly, rightward-movement is commonly associated with some kind of focus and stress, as in (13):

- (13) John gave t_i to Mary [everything he possessed]_i/*it_i

In Chinese, however, the object actually cannot be focused following *de* as the focus always immediately follows the copula. As simply part of the pre-supposed background information, it is therefore rather odd to imagine that the object might be subject to a particular stylistic rightward movement. Furthermore it is found that when the object is heavy, as for example a clause, the clearly stated preference is actually for the object to precede *de* and not to occur in final position, this then being completely the opposite to classic HNPS type patterns.

It therefore seems more likely that it is the nominalizer *de* which undergoes movement in the (b)-type forms. Striking confirmation that this is in fact what is taking place is found when one looks at double object constructions and the position of *de*. As shown below schematically in (14) and with an example in (15), it is possible for *de* to precede both indirect object and direct object:

- (14) NP shi Adv/PP V *de* IO DO

- (15) *wo shi zuotian gei de tamen san-ben-shu*
 I BE yesterday give DE they 3-CL-book
 'It was yesterday that I gave them three books.'

This patterning would seem to indicate that it really is *de* which is changing position and not the direct object – here *de* is seen to shift leftward over both the direct object and the indirect object.³ If this is indeed right, then it would appear that *de* is targeting the verb and arguably moving to attach itself as an enclitic on the verb (*de* being clearly an enclitic element in all its occurrences). Assuming this to be so, the question arises why this should be happening. Significantly a similar kind of movement is in fact diachronically attested

elsewhere in Chinese. The sentence-final verb *liao* ‘to finish’ historically developed into a perfective aspect morpheme and in doing so re-positioned itself over the object of a verb attaching to the verb as an enclitic/suffix *-le*, this schematically illustrated in (16):

- (16) V Object *liao* →
 V-le/*liao* Object

It therefore could be reasonably argued that *de*, from being originally a nominalizer, is in northern dialects of Mandarin *en route* to becoming a verbal suffix in a way similar to *le*. This naturally leads one to ask what kind of verb-related properties might be responsible for triggering such a re-analysis. Here Simpson & Wu point to the strong preference for past time interpretations found with the *shi-de* construction noted in (2) and (3) above. Such an association with past time reference is actually so strong that although the occurrence of *de* might sometimes seem optional, when a past time adverb such as *zuotian* ‘yesterday’ occurs with the copula *shi* as in (17) *de* may in fact absolutely not be omitted:

- (17) *wo shi zuotian qu Beijing *(de)*
 I BE yesterday go Beijing DE

Simpson & Wu therefore argue that the most natural assumption to make is that *de* is currently undergoing re-analysis from being a nominalizer to instantiate the verbal category of (past) tense, and that this consequently explains its movement to encliticize to the verb.

There is also interesting additional support for such an analysis. Above it was noted that the preference for a past time interpretation in *shi-de* sentences essentially might seem to have the strength of a generalized conversational implicature; as a simple implicature it can be over-ridden with future adverbs and modals as in example (4) and a non-past reading is available. Significantly, Simpson & Wu observe that such a non-past interpretation is actually NOT possible in the (b) type forms when *de* precedes the object and is right-adjacent to the verb, even when future adverbs and modals are in fact present as in (18). This is exactly what one would expect if the [V-*de* object] order is indeed the surface reflection of re-analysis of *de* as past tense; instantiating past tense, *de* as a suffix/enclitic on the verb is quite incompatible with a future-type reading:⁴

- (18) **wo shi mingtian hui qu de Beijing*
 I BE tomorrow will go DE Beijing

Consequently there is good evidence that the element *de* has undergone re-analysis from being a nominalizer to become a new tense morpheme. Such a change explains not only the re-positioning of *de* and the clear effects this has on interpretation, it will also account for the earlier-noted fact that *wh*-adjuncts may occur embedded to the right of the copula *shi* and that adverbs to the left of *shi* may be interpreted as modifying the main verb – from being a CNP island configuration *shi-de* forms have been re-interpreted as simple (past) tensed clauses which are not islands for *wh*-adjuncts and adverbial construal.

Concerning the categorial status of *de*, Simpson and Wu note that nominalizers are essentially functional elements which convert a verbal/adjectival constituent into one with nominal properties. Assuming nominal constituents to be DPs, this is then basically taken to suggest that nominalizers are either D^0 elements or some other lower head in the functional structure of a DP. In Chinese for a variety of reasons Simpson & Wu suggest that the nominalizer *de* is indeed a D^0 , this reflecting not only its current functional role but also its likely early D^0 origin as a demonstrative pronounced as *zhi*, as in (19):⁵

- (19) *zhi er chong you he zhi*
 these two worm again what know
 ‘And what do these two worms know?’ (Zhuang 1.10)

The change in modern day Mandarin *shi-de* structures is therefore suggested to be a case of horizontal/lateral re-analysis taking place between the functional structure of a DP and the functional structure of a clause. The D^0 head *de* in a DP becomes re-categorized as instantiating the T^0 head of a clausal constituent. Rather than there being upwards grammaticalization in the functional structure projected by a single lexical VP/NP, here the direction of re-analysis interestingly proceeds in a horizontal manner, an element in the referential locus of the DP (D^0) being re-interpreted as instantiating the (temporal) referential locus of the clause (T^0).

2.2. Japanese *no*

Turning now to Japanese, one finds that there are sentence types with copulas and nominalized clauses which appear to correspond very closely to *shi-de* structures in Chinese. These are referred to in Kuno (1973) as the ‘explanatory *no desu*’ construction and consist in the combination of a clause followed by the element *no* and the copula *desu* as in (20). Example (21) shows that *no* is elsewhere clearly a clausal nominalizer and occurs followed by case-markers indicating that it converts a clause into a DP:

- (20) *Taroo-wa kinoo kita no desu*
 Taroo-TOP yesterday came NO BE
 ‘I came yesterday/It was yesterday that I came.’
- (21) *Taroo-ga tsuita no-o shitte imasu ka*
 Taroo-NOM arrived NO-ACC knowing be Q
 ‘Did you know that Taroo has arrived?’

The use of the explanatory *no desu* construction would also appear to be highly similar to that of the *shi-de* construction; *no desu* forms are commonly used to explain certain apparent circumstances and a situation or event whose truth is presupposed knowledge shared by both speaker and hearer, adding in explanation which may often be a time or place clarification. Kuno (1968) characterizes *no desu* and *no desu ka* (*no desu* based questions) in the following way:

‘*No desu* gives some explanation for what the speaker has said or done or the state he is in. *No desu ka* asks for the hearer’s explanation for what the speaker has heard or observed.’ (p. 232)

Noting the syntactic and semantic similarity between *shi-de* sentences and explanatory *no desu* forms, and that *no desu* forms: ‘... always refer to something in the context or speech situation and are only appropriate when there is something in the context for the speaker to refer to.’ (p. 35), Kitagawa & Ross suggest that there is a null PRO element present in *no desu* structures anaphorically referring to some contextually salient entity, essentially just as in *shi-de* sentences. Japanese *no desu* forms are then basically conceived of as CNPs as in Chinese.

In the light of what has been argued for in Simpson & Wu (1998) with regard to *de* in *shi-de* forms, one might however wonder again about the synchronic status of *no* in the *no desu* construction and ask whether it really is a nominalizer embedded in a PRO-headed CNP type structure, or whether it perhaps might also have undergone some kind of re-analysis similar to *de*. Due to the verb-final word-order in Japanese, if there were to be any re-analysis of *no* into the verbal-clausal functional domain one would not expect to find the type of evidence present in Chinese where the nominalizer *de* moves over the object to attach to the verb; in Japanese the element *no* already is adjacent to the verb and so re-analysis into the verbal functional structure should actually be quite easy in this respect. There are however two other clues which suggest that *no* might indeed have undergone the same fate as Chinese *de* and been re-analyzed in the verbal functional domain. The first of these, not so significant in isolation, is that *no* in *no desu* sentences optionally permits contraction and loss of its vowel nucleus as seen in example (22):

- (22) *kinoo kita-n/no desu yo*
 yesterday came-NO BE EMPH
 ‘I/he came yesterday.’

Although Osaka dialects of Japanese may permit this kind of contraction with other more clearly nominal uses of *no* such as pseudo-cleft sentences, standard Tokyo Japanese does not, and *no* must occur in its full form in nominalization structures such as (23):

- (23) [*Taroo-ga Mary-to kekkon shita*] *no-o/*n-o shitte imasu ka*
 Taroo-NOM Mary-with marry did NO ACC knowing be Q
 ‘Did you know that Taroo got married to Mary?’

This might therefore seem to indicate that *no* in these *no desu* sentences is not the same as the nominalizer occurring in other forms. Stronger confirmation of this suspicion comes from evidence which is not available in Chinese and patterns of nominative/genitive *ga/no* case conversion. In relative clauses and simple clausal nominalizations genitive case is available as an optional colloquial alternative to nominative *ga*, as shown in example (24):

- (24) *Taroo-no/-ga kekkon-shita no-o shitte iru?*
 Taroo-GEN/-NOM got-married NO-ACC knowing-be
 ‘Did you know that Taroo got married?’

The occurrence of genitive case here is natural if the clause final *no* is indeed a nominalizer providing the genitive case licensed in all DPs. Supposing now that the element *no* in *no desu* structures were to be the same nominalizing element as that in nominalizations such as (24), it is clearly expected that *ga/no* conversion should also be available in such structures. However, contra such an expectation it is found that *no* in *no desu* sentences in fact does not license genitive case on the subject of the embedded clause, as seen in (25):

- (25) **Watashi-no kinoo kita no desu*
 I-GEN yesterday came NO BE
 intended: ‘I came yesterday.’

A simple explanation of this fact can be suggested to be that *no* has indeed lost its earlier nominalizer status in synchronic *no desu* forms and like *de* in the *shi-de* construction has been re-analyzed from the nominal functional structure to instantiate a functional head in the verbal-clausal domain. No longer being a nominalizer and converting a clause into a DP constituent, genitive case is simply no longer available for any subject of that clause.⁶

Assuming that the loss of genitive-case and the possibility of reduction of the vowel nucleus do indicate re-analysis of *no* as suggested, a natural question which arises is whether the re-analysis and re-categorization process is really fully parallel to what was argued for in Chinese. Here the immediate answer is that it cannot in fact be exactly the same as in Chinese, and that the differences found with *no* in Japanese may actually suggest that there is more to the re-analysis process in Chinese than originally assumed.

Critically in Japanese it is found that the verb preceding *no* does already carry a tense specification, which may be either past or non-past. Consequently it cannot be the case that *no* is undergoing re-analysis as an instantiation of past tense as suggested for *de* in Chinese. In (22) above it is seen that the verb stem *ki-* carries the past tense suffix *-ta* in addition to *no* and that *no* can therefore not be re-analyzing as past. This is further confirmed by examples such as (26) where the verb is in a non-past form and the future-oriented adverb ensures that there is no past time reading:

- (26) *(boku-wa) ashita iku no desu*
 (I-TOP) tomorrow go NO BE
 ‘I’m going tomorrow.’

One therefore needs to reflect again upon the hypothetical re-analysis of *no*. If it is indeed true that *no* has undergone re-analysis into the verbal functional structure, it cannot be as past tense but must instead instantiate some other clausal head. If *no* furthermore occurs as a verbal suffix attached outside the tense suffix as seen in (22) and

(26), Mirror Principle type ordering effects in suffix sequences would suggest that *no* corresponds to a functional head which is structurally higher than tense/T⁰.⁷

Here I believe it is useful to recall the effect on interpretation that the use of *no* results in in the *no desu* construction. As with *shi-de* forms, *no desu* sentences essentially provide some explanation (new information) of a contextually salient background situation or event (a strongly presupposed event/situation), and *no desu* forms are only appropriate when the speaker is fully committed to the truth of the background pre-supposition. This is particularly clear when the new information/explanation is just a sub-part of the clause preceding *no*, as for example in (20) where the speaker asserts that his obvious arrival took place on the preceding day. In this sense *no desu* forms may be characterized as a mechanism with which the speaker explicitly strengthens his/her commitment to the truth of a presupposition shared by speaker and hearer, allowing for the new information/explanation to be clearly highlighted against this background. Such an aspect of the interpretation of *no desu* forms then indicates that *no* is arguably associated with the notion of evidentiality – a speaker may only appropriately use a *no desu* form if he/she has strong/undeniable evidence available that the background presupposition/event is indeed true. Aoki (1986) in fact refers to *no* as an evidential marker, noting a slightly different use of *no desu* forms and stating that: ‘An evidential *no*, or more informal *n*, may be used to state that the speaker is convinced that for some reason what is ordinarily directly unknowable is nevertheless true.’ (p. 228). Aoki points out that sentences such as (27) are felt to be quite unacceptable without the addition of *no desu/da* as one can normally not know that another person is feeling hot inside:

- (27) *kare-wa atsui *(no da)*
 he-TOP hot NO BE
 ‘(I know that) he is hot.’

Assuming evidentiality to be a sub-type of epistemic mood, it can therefore be suggested that in Japanese *no* has been re-analyzed not as past tense but as an instantiation of the head of a higher MoodP dominating tense/TP and representing speaker assertion of the truth of a statement. Such a proposal is represented in (28) below:

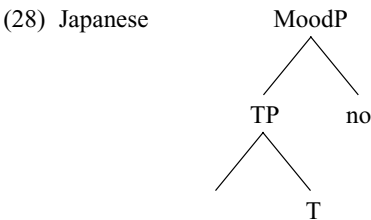

If the above is plausible, it may now lead to a natural reassessment of the re-analysis of Chinese *de*. As the use of *de* would basically seem to cause the same type of interpretation that occurs with Japanese *no*, namely speaker commitment to the truth of a

commonly held background presupposition, it might be suggested that *de* has undergone re-analysis not only as an instantiation of a T^0 tense head, but also as a marker of evidentiality like Japanese *no*. This would effectively be equivalent to assuming that *de* is actually re-analyzed as instantiating two distinct functional heads, (past) tense and (epistemic) mood/evidentiality.

The possibility that a single functional morpheme might in fact correspond to more than a single functional head position is neither odd nor particularly novel (see e.g. Koopman 1996), especially when it is assumed that movement may relate a single morpheme to two (or more) functional heads. Here a brief comparison of the C-system in Japanese and English can be used as an example illustrating the general idea. In Japanese (and many other languages) one finds the co-occurrence of both overt Q-morphemes (*ka/ka-doo-ka*) and embedding complementizers (*to* ‘that’ under verbs of communication and thought), whereas in English only a single embedding Q-morpheme occurs in indirect yes/no questions ‘whether’:

- (29) *Taroo-wa [Mary-ga kuru (ka-doo-)ka] to kikimashita.*
 Taroo-TOP Mary-NOM come Q C asked
 ‘Taroo asked whether Mary was coming.’
 literally: ‘Taroo asked that whether Mary was coming.’

- (30) John asked (*that) whether Mary was coming.

If the evidence in Japanese indicates that there are in fact at least two distinct complementizer positions present in the C-systems of languages (a lower Q-position and a higher simple embedding complementizer position), then one might expect that these two positions would also be present in languages such as English. As English has however only a single overt morpheme ‘whether’ where Japanese has two, it could be suggested that English ‘whether’ functions both as a Q-marker and an embedding complementizer. Supposing such a dual role might result from ‘whether’ being related to both C-positions via movement, (31a/b) can then be suggested to represent the relevant difference between Japanese and English, with ‘whether’ raising from Q^0 to C^0 at some point in the derivation:

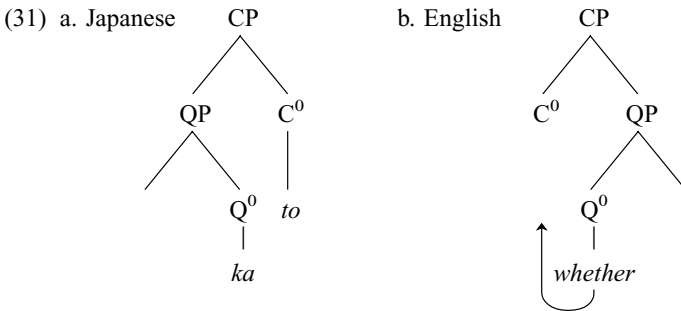

Given now that Chinese *de* in the *shi-de* construction arguably both has the interpretation of a past tense morpheme and also results in the evidentiality type reading found with Japanese *no*, it can be suggested that when *de* is re-analyzed in the verbal functional structure it actually fulfils the roles of both tense/T⁰ and evidentiality/Mood⁰. At some point in the derivation, *de* as a suffix can then be suggested to be licensed/checked against both T⁰ and Mood⁰ as in (32):

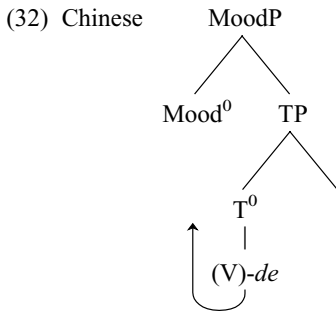

Aside from being supported by a consideration of Japanese *no*, such a more sophisticated analysis of the re-categorization of Chinese *de* has the advantage that it is also able to explain certain restrictions on the distribution of *de*. Supposing that *de* were indeed to have been re-analyzed as a simple new instantiation of past tense, one would expect that it should in principle be able to occur in all environments where a past time/tense interpretation is possible. This turns out not to be true however, and whereas *de* is perfectly acceptable in matrix and other embedded clauses, it may not occur in relative clause structures, as shown in (33):

- (33) **[zuotian mai de che] de nei-ge-ren jiushi wo gege*
 yesterday uy DE car DE that-CL-person be I brother
 intended: 'That person who bought the car yesterday is my brother.'

The unacceptability of structures such as (33) can be explained if it is assumed that the MoodP which licenses interpretations of evidentiality is simply not projected inside relative clause structures and that the evidential function of *de* can therefore not be licensed (formally its evidential 'features' remain unchecked). Functionally the absence of the relevant MoodP from relative clauses would be quite understandable as in many languages subordinate structures such as relative clauses do not support the full range of propositional attitude projections available in other non-embedded environments.

Consequently it can be seen that the cross-linguistic comparative analysis of *de* and *no* is instructive in many ways. First of all, given the SVO word order of Chinese combined with the clause-final position of *de* as a nominalizer one finds particularly clear evidence that *de* in 'situational/explanatory' copula-related structures is undergoing re-analysis, *de* overtly re-positioning itself right-adjacent to the verb as a new verbal suffix. As the re-positioning furthermore clearly correlates with a forced past time interpretation, it is

rather simple to conclude that *de* is indeed becoming a new past tense morpheme. In Japanese due to the SOV head-final nature of the language, such kind of clear re-positioning evidence is not available as a clue to any re-analysis of *no* in structures with interpretations similar to *shi-de* forms. The conclusion that *de* is undergoing a significant change in Chinese does however prompt one to look for other possible indications of re-analysis with *no*, and interestingly one finds that there is evidence from case-marking phenomena (and nucleus reduction) that *no* may indeed be undergoing re-analysis as a new clausal head in a way quite similar to Chinese *de*. Due to the lack of a contrastive case system and an equivalent of *ga/no* conversion in Chinese such case-related evidence of change would clearly not be available as a clue to the re-analysis of *de*. The occurrence of such evidence in Japanese does however arguably add support to the general idea that nominalizers such as *de* may indeed be re-analyzing as functional heads in the clausal domain, and also shows how the contrastive typological properties of Chinese and Japanese can in fact be useful in the analysis of a single phenomenon. Finally, an examination of the potential change in Japanese was shown to lead to a significant re-assessment of the change argued for in Chinese and suggest that the re-analysis in Chinese may actually have been more complex than originally imagined. Such a re-appraisal of the change with *de* as instantiating both tense/T⁰ and Mood⁰ then allowed for an explanation of restrictions on its distribution which would otherwise remain unaccounted for in a simple equation of *de* with past tense.

2.3. Korean *kes*

I now turn briefly to Korean and the element *kes*. The role of *kes* as an element used in the nominalization of clauses similar to Japanese *no* in sentences (23/24) is illustrated in examples (34) and (35) below:⁸

- (34) *na-nun [ku-ka o-ass-ta-nun]-kes-ul molla-ess-ta*
 I-TOP he-NOM came KES-ACC did.not.know
 ‘I didn’t know that he came.’
- (35) *[totwuk-i ton-ul hwumchin] kes-un yeki loputhe ta*
 robber-NOM money-ACC stole KES-TOP here from BE
 ‘Its from here that the robber stole the money.’

Although it is not clear whether *kes* occurs in any fully parallel analogue to the Chinese *shi-de* and Japanese *no desu* construction,⁹ there does exist a construction making use of *kes* and the copula which interestingly seems to show signs of re-analysis and the incorporation of nominal *kes* into the verbal functional structure in a way somewhat similar to *de* and *no*. This is illustrated in example (36):

- (36) *Yeng-gwuk-ulo ttena-ss-ul-ke-eyo/kes-ieyo*
 England-to left-IRR-KES-BE
 ‘He must have left for England.’

The use of such a construction is not the same as the *shi-de* or *no desu* patterns but it does nevertheless clearly relate to evidentiality and speaker commitment to the truth of a situation, introducing a probable future or a probable past (see King & Yeon 1997). Syntactically it is formed with a verb which may carry past tense or appear bare added to the irrealis marker *-(u)l*, the element *kes* and the copula in some speech level form, i.e. plain, polite or formal style:

- (37) *mek-ul-ke-eyo/ke-pnida*
 eat-IRR-KES-BE/KES-BE
 ‘He will (probably) eat.’

While it is clear that a sub-part of this construction historically was the element *kes* pronounced with a final [s] or [sh]-coda depending on the type of following vowel, in the contemporary speech of most speakers, this element is now regularly pronounced in a reduced form without the final sibilant and a full form pronunciation with [s/sh] is rejected.¹⁰ Such obligatory reduction of the coda of the original element then allows for the plausible speculation that *kes* has undergone re-analysis when it occurs with the copula in this modal type construction and is no longer a simple nominalizer element. A natural assumption in the light of what has been seen with Chinese *de* and Japanese *no* and one which might seem to coincide with speaker’s intuitions is that *kes* here has been incorporated into the verbal string and in so doing has ceased to function specifically as a nominalizing type/nominal element. While it may be conceded that there is still certain evidence of the bi-clausal origin of the construction with honorific agreement occurring on the lexical verb rather than on the copula, as seen in (38), this does not in fact imply that *kes* necessarily retains its earlier nominalizer status:

- (38) *neykthai-lul may-shi-l-ke-eyo*
 tie-ACC wear-HON-IRR-KES-BE
 ‘He will (probably) wear a tie.’

Instead, it might seem likely that this construction is another instance where one of the *de/no/kes* nominalizer type paradigm co-occurring with a copula is on the way to switching from a nominal-functional status to incorporation into the verbal functional domain and a connection to the notion of epistemic modality and speaker perspective. If this is indeed so, Korean might in fact now also be able to add to our understanding of the patterning in Chinese and in Japanese and possibly suggest that it is not just a bare nominalizing element such as *de* or *no* in isolation which is responsible for the particular epistemic interpretation attested. In Korean it is rather clearly the addition of the irrealis morpheme *-(u)l* which critically results in the relatively decreased strength of evidentiality and the prediction-type reading in examples such as (36–38). Assuming this to be correct and a general property of evidential nominalizer + copula constructions, it potentially adds credence to earlier suggestions noted in Kitagawa & Ross (1982) and Simpson & Wu (1998) that *de* originally receives its evidential force **indirectly** from a contextually salient entity binding an empty nominal PRO head

selected by *de* and that it is consequently not *de* in isolation which results in the guarantee-type interpretation.¹¹

3. The re-analysis of nominalizers in relative clauses

Section 2 considered the interaction of nominalizers with copulas in constructions encoding evidentiality and epistemic modality. Evidence was presented indicating that the Chinese D⁰ element *de* is re-analyzing into the verbal functional domain as tense and mood, and there were also hints that Japanese *no* and possibly also Korean *kes* may well have met with similar fates. I would now like to suggest that this basic path of horizontal nominalizer re-analysis from the functional structure of a DP into the functional structure of a clause is a process which has also occurred in relative clause structures in Japanese and Korean and that nominalizers present in such environments as D⁰ elements have been re-categorized as instantiations of higher clausal functional heads. Such changes can be argued to be revealed in the changing patterns of the licensing of genitive-case relative clause subjects as discussed in Whitman (1998), and lead to the assumption that there are two distinct potential sources of genitive case in languages with nominalized DP relative clauses. Before starting in to consider the relevant data, I would like to acknowledge that the spirit of certain of the general conclusions reached in this section coincides in part with a suggestion made in Whitman (1998) that the loss of genitive-marking is connected to the status of a relative clause as a nominalization. How such a general idea is technically interpreted and the focus of interest will nevertheless be noted to be rather different from Whitman's interesting account.

In Japanese it is well-known that subjects in relative clauses may appear in either nominative or genitive case, as in (39), this being commonly referred to as *ga/no* conversion:

- (39) *Taroo-ga/-no katta hon*
 Taroo-NOM/-GEN bought book
 'the book that Taroo bought'

A similar alternation exists also in Korean, but appears to be subject to more restrictions than in Japanese. Various linguists such as Yoon (1991) and Sohn (1997) have noted that in modern Korean the only subject DPs which can be marked with genitive case in relative clauses are those which essentially bear a potential possessor-type relation with the head-noun, or a relation in which there is a very close association between the subject and the head-noun, as for example in (40):¹²

- (40) *na -uy sal-te-n kohyang*
 I -GEN live-RET-N hometown
 'the hometown where I used to live ('my old hometown)'

Yoon (1991) notes that (41) below is perfectly acceptable with the verb *ip-ta* 'wear' but not with the verb *po-ta* 'see' as only 'wearing' satisfies the close association-type relation:

- (41) [*John-uy ip-nwun/*po-n*] *os*
 John-GEN wear-N/see-N clothes
 ‘the clothes that John wore/*saw’

(42) from Sohn (1997) is similarly argued to be unacceptable because there is no possession type relation existing between the head-noun *salam-tul* ‘persons’ and the genitive-marked NP *ku-umak-uy* ‘that music’ (i.e. the music does not possess the people):

- (42) [*ku-umak-i/*-uy kamdongsikhi-n*] *salam-tul*
 that music-NOM/-GEN move-N person-PL
 ‘the people who the music moved.’

Whitman’s (1998) research into middle Korean however shows that this kind of restriction on genitive subjects might appear to be just a property of modern Korean. In middle Korean the relation between a genitive subject and the relative clause head-noun seems to be thematically unconstrained, in the same way that it is unconstrained in modern Japanese and a subject need not stand in a possessor-type relation with the relative clause head-noun to be marked with genitive case. (42) below is an example Whitman gives from middle Korean which would not be acceptable in present-day speech:

- (43) *I pali-y ey mwolgay-lul [na-y totni-n-o-n] stoh]-ey skola-la*
 this bowl-in GEN sand-ACC I-GEN go-PR.MOD.AD place-GEN spread-IMP
 ‘Spread this sand in the places where I go.’ (Sekpo sangcel, 24: 9b)

In addition to the thematic ‘possessor’ restriction in modern Korean, it is also not possible for a genitive subject in modern Korean relative clauses to be preceded by an adverb such as *ecey* ‘yesterday’ which refers to the action of the relative clause, as in (44). This is in sharp contrast to modern Japanese where a sentential adverb may indeed precede a genitive subject, as shown in (45):

- (44) [*ecey John-i/*John-uy sa-n]-chayk* (Sohn 1997)
 yesterday John-NOM/John-GEN buy-N book
 ‘the book that John bought yesterday.’

- (45) [*kinoo Hanako-no katta*] *hon-wa Bottyan desu* (Nakai 1990)
 yesterday Hanako-GEN bought book-TOP Bottyan BE
 ‘The book which Hanako bought yesterday is Botchan.’

These two facts might seem to point to the same conclusion and suggest that the genitive case possible with relative clause ‘subjects’ in modern Korean is assigned by the D^0 head selecting the relative clause head NP₁ in a simple structure such as (46). In (46) DP₂ is the possessor-specifier of DP₁, and the CP is the relative clause:

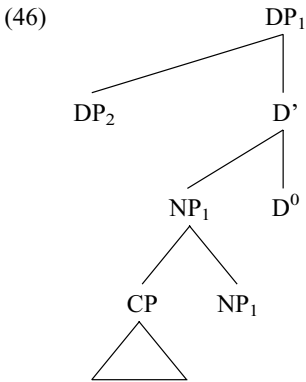

This will straightforwardly account for the restriction that the genitive ‘subject’ DP₂ must precede any sentential adverb which is part of the CP relative clause and also allow for a natural understanding of the possessor-type thematic restriction on DP₂ – the genitive case assigned here is licensed by the D⁰ selecting for the head-noun/NP₁ and restricts the case-assignee to precisely those standard genitive possessor-type relations which could also be licensed in the full absence of the relative clause (i.e. a genitive-marked ‘subject’ will be acceptable only when the same DP could also stand in a genitive relation to the relative clause head-noun without the relative clause being present). In (46) it may be assumed that the genitive ‘subject’ DP₂ controls a real *pro* subject inside CP.¹³

Previously however, this relation of the genitive DP to the relative clause head-noun/NP appears to have been unrestricted, and it is clearly unrestricted in modern Japanese, so a natural question now is to ask how the un/restricted distinction between modern Korean and middle Korean/modern Japanese should be captured. One possible route of explanation, I believe, is to pursue the connection between gerund-type nominalizations and the occurrence of genitive subjects in relative clauses. It is well-known that nominalizations of certain types cross-linguistically license thematically-unrestricted genitive subjects. This is seen in English gerunds and Korean type III gerund nominalizations and also in a number of nominalizations formed with *no* in Japanese, as for example in (47) and (48), (47) being a simple clausal nominalization, (48) a pseudo-cleft type structure also formed with the element *no* and allowing for optional genitive case on the subject in place of nominative:

(47) *Hanako-ga [Taroo-no tsuita] no-o mita*
 Hanako-NOM Taroo-GEN arrived NO-ACC saw
 ‘Hanako saw Taroo arrive.’

(48) *[Taroo-no katta] no-wa hon desu*
 Taroo-GEN bought NO-TOP book BE
 ‘What Taroo bought was a book.’

Supposing one assumes that the nominalizer *no* here is a functional head of type D^0 just as Chinese *de* is, it can be suggested that the subjects in (47) and (48) have their genitive case licensed/checked directly in SpecDP by *no* (either overtly or at LF; in either case it may be assumed that the genitive case-marker *no* is attached to the subject DP as an inflectional suffix in the lexicon, in line with current Minimalist views). Because there is no ‘head’ N(P) in such pure nominalizations, there will be no possessor-like semantic restrictions on genitive subjects and genitive subjects will be thematically-unrestricted, as noted. (49) is an approximation of the underlying structure assumed for nominalizations such as (47) above (the brackets around the genitive-marked subject DP_2 are intended to indicate that the occurrence of DP_2 in SpecDP₁ checking its genitive case has not been here determined to be overt or covert):

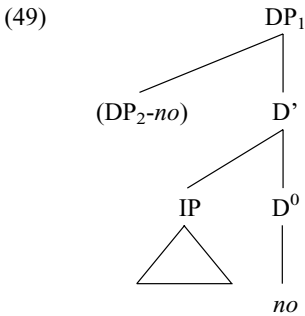

The critical lack of any thematic restriction on the genitive subject DP_2 in such structures contrasts with the genitive case which is licensed by D^0 when D^0 selects for a noun/NP with clear semantic content in relative clause structures such as (46). There the occurrence of the head-noun/NP results in the possessor-like restriction on a DP licensed genitive case in SpecDP; in nominalization structures such as (49) there simply is no NP present to impose similar restrictions.¹⁴ The important point to bear in mind then is that bare-nominalizers such as *no* having no intrinsic semantic content can be taken not to semantically/thematically constrain the type of DP assigned genitive case in SpecDP, whereas the genitive case assigned/checked in a SpecDP projected over a semantically contentful head-noun/NP in relative clauses naturally will impose such restrictions.

Above it was noted that Korean and Japanese are both languages which currently have, or previously had thematically unrestricted genitive subjects in relative clauses. A further piece of information which can now be used to help explain the genitive-case marking patterns is the observation that Korean and Japanese are also both languages which either currently have, or previously had some kind of special ‘adnominal’ morphology on verbs in relative clauses (this meaning that verbs appear in relative clauses with suffixes which do not occur in other non-embedded clauses). Importantly now Whitman (1998) points out that various Korean linguists such as Lee (1961) and Hong (1990) have argued that the adnominal morphology present on verbs in relative clauses in Korean should in fact be analyzed as being the addition of nominalizers to the verb.¹⁵ If this is correct, it can be

suggested that the (relative) clauses to which such nominalizers are attached in final position are clausal nominalizations and therefore significantly expected to license their own thematically unrestricted genitive subjects. Assuming as before that nominalizers are nominal functional heads which are either D^0 elements or otherwise part of an extended functional structure which projects up to a DP (with the associated genitive case being licensed/checked in SpecDP), this basically leads to the conclusion that relative clause structures in some languages in fact involve a DP nominalized clause embedded within a DP rather than there being just a simple CP relative clause. (50) below is one hypothetical representation of such a structure, with D_2^0 assumed to be the head-position containing the relevant nominalizer, NP the head-noun/NP, and RC the relative clause:

(50)

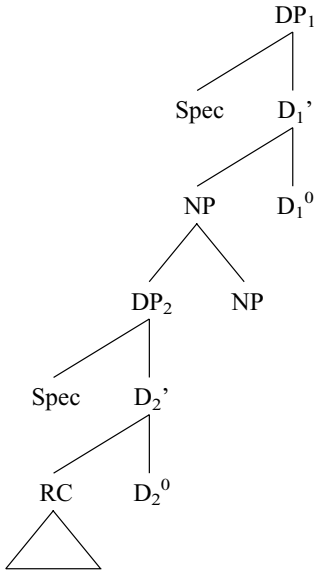

An alternative might be to assume some kind of simple juxtaposition structure as in (51) possibly similar to the structure of correlatives in languages such as Gujarati:¹⁶

(51)

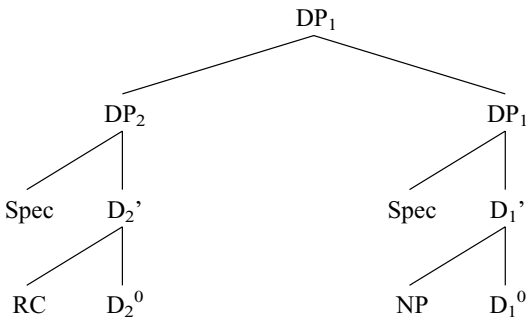

Indeed, in old English there seems to be evidence that relative clauses in certain languages may start out as the juxtaposition of two DPs. In example (52) both the relative clause noun-head and the relative clause are case-marked with genitive case assigned by the matrix verb, indicating that they are actually both DPs (with some kind of case-sharing effect):

- (52) Hi adulfon gehwylcne dael paes wrytgeardes paes pe paer aer undolfen was
 they dug each part that.GEN garden.GEN that.GEN c there before not-dug was
 ‘They dug every part of the garden that had been left undug before.’
 lit. ‘... of that garden, that one left undug. (c.1050, Gregory’s dialogues)

In either analysis (50) or (51), the nominalized relative clause DP_2 will significantly license its own genitive case in $SpecDP_2$ quite independently of the head-noun/NP and the possessor-type genitive case licensed in $SpecDP_1$. Consequently such genitive case will not be thematically constrained and there will not be any restrictions on the type of subject carrying such genitive case. In fact, in nominalized relative clause constructions of the type schematized above, there will actually be two independent sources of genitive case – one made available by the D_1^0 regularly projected over the head noun/NP, and a second provided by the nominalization of the relative clause with the nominalizer assumed to be located in D_2^0 . These two independent genitive cases can be called ‘outer restricted genitive case’ and ‘inner unrestricted genitive case’ respectively.

Assuming this much will now allow for a relatively simple explanation of the historical change in Korean. In middle Korean, relative clause genitive subjects appear to have been thematically-unrestricted and so can be suggested to have been licensed as inner unrestricted genitives by the putative D_2^0 nominalizer of the relative clause (the adnominal morphology on the verb in final position in the relative clause). Turning to modern Korean, one finds that relative clause genitive subjects are now thematically restricted, indicating (under present assumptions) that only an outer genitive can be licensed by the D_1^0 head projected in the functional structure immediately dominating the relative clause noun-head. However, special adnominal morphology is still strongly present on the verb, and as such morphology has been assumed to instantiate a D^0 nominalizer, it might well be expected to license a thematically unrestricted inner genitive subject, contra observation. A way of accounting for this apparent contradiction without abandoning the basic mode of explanation is now to suggest that there has been a critical re-analysis of the same basic type as that suggested earlier in Chinese and Japanese, and that a D^0 nominalizer (here the adnominal morphology) has again significantly undergone a category shift from the nominal domain into the higher functional structure projected by the verb. Undergoing re-analysis out of the nominal domain the unrestricted genitive case which is licensed by the gerund-like nominalization-structure and the D_2^0 head automatically disappears and ‘subject’ DPs may only be assigned the outer restricted genitive licensed by D_1^0 in the nominal functional structure dominating the relative clause noun-head.

If this is indeed what has possibly occurred in Korean relative clauses, the next question which arises is how genitive subjects are licensed in modern Japanese relative

clauses. As noted earlier, Japanese also used to have special adnominal morphology in its relative clauses, verbs appearing in the attributive form with suffixes which contrasted with the conclusive forms of other clauses. This system of opposition is well-documented as having later got restructured into a general tense system which then did not manifest any difference between matrix and subordinate clauses (see e.g. Shibatani 1996, Takeuchi 1998). If one now supposes that the older attributive adnominal forms were possibly just like middle Korean adnominal suffixes and therefore by hypothesis D^0 nominalizers, the re-organization of the attributive forms into a tense system would then actually constitute another good case of a nominalizer being re-analyzed as a tense-form, precisely as suggested for the D^0 -to- T^0 conversion in contemporary Chinese. If this is so however, one now needs to try to understand how thematically unrestricted genitive case continues to be available for subjects of relative clauses in Japanese. If the earlier D^0 nominalizer (the attributive adnominal suffix) which would have licensed an inner unrestricted genitive has undergone re-analysis as tense, one might not expect to find unrestricted genitive subjects occurring in relative clauses, as these are otherwise only licensed in clear nominalizations such as (47). Here I would like to suggest that there are actually two potential explanations for the continued persistence of unrestricted genitive subjects.

The first of these is to suggest that the re-analysis of clause-final D^0 nominalizers into tense-morphemes is actually a process which is still only optional in Japanese relative clause structures. In the case of the suffixal ending of non-past verb-forms, this morphology essentially corresponds to the original adnominal attributive suffixes (modern non-past tense forms deriving from the earlier attributive endings in the re-organisation to a full system of tense); consequently it can be suggested that the original attributive nominalizer ending may simply remain un-reanalyzed, and as a D^0 continue to license (unrestricted) genitive case. As for the past tense forms found in relative clauses, a similar account may also be given. The re-organization of both attributive and conclusive forms into a global tense system essentially resulted in the creation of a tense position/ T^0 /TP in relative clauses. Non-past tense forms resulted from the re-analysis of attributive adnominal suffixes and past tense forms resulted from the re-analysis of conclusive aspectual suffixes. Both tense forms can critically be taken to have been re-analyzed into a position which was previously instantiated by a D^0 nominalizer. In the case of the conclusive suffixes which became re-analyzed as past tense, it can now be suggested that this re-analysis into the T^0 position as tense is also possibly still optional in relative clauses and that what appears to be past tense in relative clauses is actually still the older un-reanalyzed aspectual suffix. If the past tense suffix is in fact actually an aspectual suffix, it can consequently be assumed that no T^0 /tense position is necessarily projected and instead this position may be instantiated as a D^0 head occupied by a phonetically null nominalizer. Reason to believe that there may not have been necessary re-analysis into a full tense system inside relative clauses is the interesting fact that the 'past tense' morpheme in relative clauses in fact need not always result in a past time meaning and can instead correspond simply to perfective/completive aspect which is fully compatible with a future reading, as seen in (53) from Nakamura (1994):

- (53) [*ashita ichiban hayaku kita*] *hito-ni kore-o ageru*
 tomorrow most early came person-DAT this-ACC give
 ‘I will give this to the person who comes (*lit.* came) first tomorrow.’

This future-oriented interpretation of the past tense morpheme is restricted to relative clauses and therefore suggests that re-analysis of attributive and conclusive forms as tense may still be optional in this environment. Supposing this to be so, it can therefore be maintained that the earlier D⁰ nominalizer position hypothesized to exist in relative clauses has not in fact been necessarily re-analyzed as a T⁰/tense head and is consequently still potentially present to license unrestricted genitive case.

A second possible way of accounting for the unrestricted genitive case available for Japanese relative clause subjects might be to suggest that when the posited attributive form nominalizer became re-analyzed into the tense system, the nominalizer position might not have simply disappeared but instead may have been retained and occupied by a new null nominalizer element. Elsewhere where the attributive form was re-analyzed and its hypothetical nominalizer status was lost, a new overt nominalizer was in fact inserted in a renewal process common in language development. Horie (1993) compares the classical Japanese example in (54) with its adnominal verb-form and no apparent nominalizer with a modern Japanese equivalent with *no* in (55). When the adnominal suffix became reinterpreted as non-past tense, the new nominalizing element *no* is seen to be added in:

- (54) [*te tatake-ba yamabiko-no kotauru*] *ito urusai*
 hand clap-as echo-GEN answer.ADN very annoying
 ‘It is very annoying that there is an echo when he claps his hands.’
 (Genji monogatari, 11thC)

- (55) [*te-o tatakū-to kodama-ga kotaeru*] *no-wa taihen huyukai-da*
 hand-ACC clap when echo-NOM answer NO-TOP very annoying be

In fact it is hard to see how the verb-form in (54) can actually be labelled as having ‘adnominal’ morphology as it does not appear to precede any kind of nominal; the most natural explanation for the genitive subject in (54) would seem to be that the adnominal morphology is indeed a nominalizer attached to the clause and that when this becomes re-analyzed as a tense morpheme, *no* is inserted to replace it. Consequently, if there is indeed productive replacement of certain nominalizers which have undergone re-analysis with new nominalizing elements, it would not be unreasonable to speculate that a null nominalizer might have been introduced into relative clauses following re-analysis of the attributive ‘nominalizers’ and it is this D⁰ element which is basically responsible for the possibility of unrestricted genitive subjects.¹⁷

Ultimately then it can be argued that the differing patterns of genitive case licensing in earlier and contemporary forms of Japanese and Korean can be given a rather natural account if it is assumed both that unrestricted genitive case is assigned by D⁰ nominalizing elements and that such heads may over time be re-analyzed as instantiations

of heads in the higher clausal functional structure, just as has arguably occurred with nominalizers in copula constructions.¹⁸ In the case of Japanese at least, it has been speculated that if the adnominal endings found on verbs in classical Japanese are assumed to have been clause-peripheral D⁰ nominalizers (as in Korean), then their clear re-analysis into tense elements would also constitute another interesting case of the D-to-T conversion phenomenon reported in Chinese. Before concluding this section now, I would like to stay just a little longer on this theme of D-to-T conversion and briefly present one last CNP type case in Japanese where there might again seem to be evidence of such a D-to-T re-analysis.

As mentioned earlier on and noted in Kitagawa & Ross (1982), the distribution of Chinese *de* and Japanese *no* is quite similar. One regular difference however concerns the occurrence of *no* and *de* following clausal constituents. In adult Japanese *no* occurs following a clause (a relative clause, nominalization, head-internal relative clause etc) only when there is no other head-noun following *no*. This contrasts with Chinese (and children's Japanese, see Murasugi 1991) where *de* does co-occur with an overtly-realized relative clause head. Such differences lead Simpson & Wu (2000) to suggest that *no* is actually base-generated in N⁰ and then raised to D⁰, whereas *de* is inserted directly into D⁰ and so allows a discrete instantiation of the N⁰ position. (56) below schematizes the patterns found:

- | | |
|-------------------|--------------------------|
| (56) a. Chinese | ✓ [clause] <i>de</i> ∅ |
| | ✓ [clause] <i>de</i> NP |
| b. adult Japanese | * [clause] <i>no</i> NP |
| | ✓ [clause] <i>no</i> ∅ |
| c. child Japanese | ✓ [clause] <i>no</i> NP |
| | ✓ [clause] <i>no</i> ∅ |

One apparent counter-example to this generalization over adult Japanese however is constituted by forms such as (57) and (58) where *no* is legitimately followed by an overt head-noun in an appositive CNP type structure, these examples being first noted in Kitagawa & Ross (1982):

- (57) [*kane-o haratte*]-*no-ageku*
 money-ACC paying-NO consequence
 'the consequence of having paid money'

- (58) [*kare-ga kureba*]-*no-hanashi*
 he-NOM come-if NO talk
 'the talk which would become relevant if he came'

Interestingly, as pointed out in Murasugi (1991), what consistently characterizes these examples is that the verb in the CNP is un-tensed, i.e. not in any regular past or non-past tense-form. It can therefore be suggested that the generalization in (56b) about nominalizer *no* actually is correct, and that the exceptional patterning in (57/58) in fact

results from *no* having undergone re-analysis into T^0 when T^0 is not occupied by a regular tense morpheme. Such a re-analysis would then be very similar both to the conversion of Chinese *de* into tense and the hypothesized re-analysis of Japanese (D^0) attributive nominalizers into tense.

An interesting related case is found elsewhere in relative clauses in Hebrew. Siloni (1995) notes that the Hebrew definite determiner *ha* occurs in relative clauses in a position preceding the VP as in (59). Significantly this is only possible in participial relative clause structures where there is no overt instantiation of tense:

- (59) *'ish ha-kore 'iton ba-rexov*
 man **the**-reading newspaper in.the-street
 'a man reading a newspaper in the street'

In order to explain this distributional constraint, it can be suggested that the D^0 determiner like other cases of D^0 nominalizer elements examined here is actually re-analyzed into the verbal functional structure and specifically into the tense position, hence being incompatible with anything but a tenseless participial complement. What is perhaps different between the Japanese and Hebrew cases in (57–59) and the D-to-T conversion of Chinese *de* is that in the former instances and particularly Hebrew, the nominalizer/determiners do not bring with them into the tense position any of the referentiality they might be associated with in the nominal system. Thus whereas the discourse-operator determined referentiality of Chinese D^0 -nominalizer *de* is re-interpreted as past tense, the definiteness present in Hebrew *ha* is quite absent in its use in participial relatives and Siloni describes such relatives as having an 'understood tense (which) is determined externally by the context'. The same can be said of the Japanese example (57) (and possibly also (58)). What the introduction of the nominal functional elements into T^0 seems to do in these cases is simply to provide an element in T^0 which can be anaphorically controlled by some higher tense operator, much as English *to* is also controlled in English infinitival clauses.¹⁹

4. Summary

The aim of this chapter has been to suggest that nominalizers occurring in Chinese, Japanese and Korean (and possibly other languages) frequently undergo categorial re-analysis and grammaticalize in a horizontal direction from a role in the functional structure of a DP to instantiate some functional head in the clausal functional structure projected above VP. The particular view of nominalizers assumed here is that these purely functional elements may be either D^0 heads directly embedding a clause and outputting a DP constituent (essentially like determiners in Spanish, see footnote 5), or possibly some lower functional head which naturally projects up to a DP. Considering the two principal environments of copula constructions and relative clauses, it was observed that Japanese, Korean and Chinese provide a variety of evidence indicating re-analysis, and that the re-categorization of nominalizers as instantiations of clausal functional heads would arguably seem to be surprisingly common.

Having concluded that there is indeed such frequent re-analysis of this general type, it is natural at this point to speculate on why this might be so. Here I would like to suggest the frequency of the change in fact can largely be attributed to the particular types of copula and relative clause environment where the nominalizers occur and to the roles played by the nominalizers in the structure. One important functional role of nominalizers is to embed a constituent of a certain type in a larger structure; in the case of a clausal nominalization, a nominalizer allows the clause to occur as the nominal argument of an embedding predicate. Considering this role and its interaction with copulas and relative clause structures, it can first of all be noted that copula-type verbs are typically found to be weakly-selective elements in the sense that they often accept a variety of category types as complements (e.g. DPs, AdjPs, VPs, PPs etc) and do not just tolerate nominal arguments. One can therefore imagine that in copula constructions the pressure for a nominalized clause to remain a DP rather than some other categorial type is markedly less than in other environments where a verb directly selects for only nominal arguments.²⁰ This combined with the fact that a nominalized clause is already largely clausal in its internal structure should naturally make the possibility of nominalizer re-analysis as clausal heads significantly easier than in other constructions. The situation is similar in relative clause environments. Relative clauses are commonly assumed to be optional modifiers adjoined to NPs and hence clearly not selected by any element; consequently there is no pressure by any selecting head for a relative clause to necessarily remain as a DP rather than switch to some other categorial type (i.e. with re-analysis of the embedding nominalizer as a clausal head). Again as in copula environments this lack of a rigid selection relation might naturally be expected to make the potential re-analysis of nominalizers more easily available in relative clauses.²¹

The re-analysis of nominalizers as clausal types is arguably also assisted by the fact that when such morphemes originally function as nominalizers they may often have no obvious **inherent** meaning. In the case of *de* and *no* in copula environments, essentially following Kitagawa & Ross (1982), it was assumed that the strong evidentiality interpretation which use of these elements results in is one which is basically inherited via the association of *de/no* with some discourse operator (and mediated by the binding of a PRO selected by *de/no*). With the occurrence of Japanese *no* in T⁰ in examples such as (57) and (58), its interpretation was again taken to be determined by some secondary element, namely a higher c-commanding +finite T⁰. Consequently, if the interpretation associated with such nominalizer elements is perhaps frequently due to anaphoric control by some secondary element and nominalizers are without inherently fixed semantic values, one might expect that this lack of inherent meaning would naturally allow for categorial re-analysis. Nominalizers simply being heads whose semantic content (if any) is determined from an outside source, if the controlling operator source were to change, this should directly result in a different type of interpretation of the nominalizer and quite possibly a re-orientation of the inherited meaning from being of a nominal character to an interpretation associated more with clausal functional heads.

Notes

- 1 Concerning relative clauses Li & Thompson (1981, p. 116) state the following: ‘A relative clause is simply a nominalized clause placed in front of a noun to modify it.’ and assume that *de* is the nominalizer of the (relative) clause.
- 2 Kitagawa & Ross refer to Chao (1968) as suggesting that *shi-de* sentences may often be translated with phrases such as ‘such is the case’ or ‘this kind of situation’ as in (i):

- (i) *Ta shi zuotian qu de*
 he BE yesterday go DE
 ‘It’s the case that he went yesterday.’

They suggest that this may be taken to indicate that there is indeed a phonologically null PRO equivalent to the noun ‘case/situation’ present following *de*.

- 3 The alternative is to assume that both direct object and indirect object move rightwards, which seems rather unlikely. Rightwards object-shift has never before been attested to occur with both direct and indirect object at the same time.
- 4 When *de* occurs sentence-finally and a non-past time reading is possible with adverbs and modals, it is assumed that *de* is still a nominalizer. Simpson & Wu thus take *de* in sentence-final position to have a potentially ambiguous status, either occurring as a nominalizer or as past tense. When *de* attaches to the verb, it is however unambiguous and only past tense.
- 5 It is clear that D⁰ determiners fulfil the role of nominalizing clauses in other languages. The example below is from Spanish, the simple determiner *el* ‘the’ functioning to nominalize the following clause:

- (i) [_{DP} *el* [_{CP} *que Juan haya ganado el concurso*]] *garantiza nuestro triunfo*
 the that Juan has won the competition guarantees our triumph
 ‘That Juan has won the competition guarantees our victory.’

- 6 Kitagawa & Ross attempt to suggest that the lack of genitive *no* in *no desu* forms results from Bedell’s early (1972) account of *ga/no* conversion. Following Bedell they assume that genitive marking occurs when a subject NP from within a relative clause is raised outside of the relative clause and receives the genitive case licensed by the relative clause head-noun. In the case of *no desu* sentences, they claim that raising of a subject out of a PRO-headed relative clause would result in an illegitimate structure in which PRO is forced to bind the trace of the raised subject and that *ga/no* conversion is therefore impossible in *no desu* sentences. Because the same considerations should however result in illegitimate structures in regular relative clauses and the relative clause head-noun having to bind the trace of a raised subject, it is also predicted that *ga/no* conversion should not even occur in simple relative clauses. As this is clearly false, such an attempted account of the lack of *ga/no* conversion cannot be maintained.
- 7 That is, cross-linguistically it is found that suffixes closer to the verbal stem consistently relate to functional heads which are lower than those licensing outer suffixes, see here Baker (1985).
- 8 In addition to its occurrence in (34) and (35), *kes* also occurs in many other environments where Chinese *de* and Japanese *no* are found. As in Japanese, *kes* occurs in head-internal relative clauses (i), children’s (externally-headed) relative clauses (ii) and pseudo-clefts (iii) (data here is taken from Whitman, Lee & Lust 1991):

- (i) *kuriko [appa ssu-nun]-ke ankyeng-un ...*
 then papa wear-ing KES glasses-TOP
 ‘And the glasses that papa wears ...’
- (ii) *[chayk pily-e ka-n]- kes nayil kac-ko o-kyess-upni-ta*
 book borrow go-PAST KES tomorrow bring-ing come-FUT-POL-DEC
 ‘I will bring back the book that I borrowed tomorrow.’

- (iii) [*nae-ka mekko-iss-nun*]-*kes*
 I-NOM eat-ing be KES
 'what I am eating'

This is similar to the occurrence of Chinese *de* in adult (externally-headed) relative clauses, pseudo-clefts, and children's internally-headed relative clauses (Chiu 1998).

- 9 A reviewer of the chapter points out that there is a structure which occurs in narratives in Korean which may be structurally quite like the *shi-de/no desu* construction, with *kes* combining with the copula as in (i) below:

- (i) *Cheli-ka mikwuk-ey ka-ss-te-n kes-i-ess-ta.*
 Cheli-NOM USA-to go-PAST-RETR-N KES-BE-PAST-DECL
 'It so happened that Cheli went to the USA.'

However, as it is not clear whether the full spectrum of meanings present in such structures parallels those with colloquial *shi-de* and *no desu*, I simply note this pattern here without further analysis and thank the reviewer for this potentially useful information.

- 10 King & Yeon (1997, p. 253) maintain that for some speakers *kes* may still optionally be pronounced in its full form as in (i). Other speakers strongly reject pronunciation of the final [s/sh] sibilant:

- (i) %*mek-ul-kes-ieyo/kes-ipnida*
 eat-IRR-KES-BE
 'He will (probably) eat.'

- 11 Such indirect evidential force is then later taken to become an inherent part of the meaning of *de* when it is re-analyzed as tense/mood. This would then parallel a hypothetical collapsing of Korean *-(u)l* and *kes* as a single epistemic marker after re-analysis in the verbal functional structure.
- 12 Note that much of the Korean data here comes from sources quoted in Whitman (1998).
- 13 Whitman (1998) rejects the possibility of a base-generated structure such as (46) and suggests instead that the genitive DP is 're-structured' from inside the relative clause to the possessor/SpecDP position. This is done primarily for two reasons. First of all it is noted that structures in which a genitive possessor DP precedes a relative clause with an overt subject are degraded:

- (i) *?*John-uy [Mary-ka pilli-n] chayk*
 John-GEN Mary-NOM borrow-AND book
 intended: 'John's book that Mary borrowed.'

Secondly, if a *pro* subject were to be possible in the relative clause controlled by a preceding DP possessor, it is argued that one might expect that examples such as (41) with the verb *po-ta* 'wear' would be acceptable contra what is observed. Without going in to detail here, in the first case I believe it might be possible to suggest that the apparent unacceptability may be due to phonological reasons and that there is a preference for heavier/longer modifying constituents to precede shorter modifying elements in DPs. This is certainly true in parallel structures in Chinese (as noted in Tsao 1997). When the subject of the relative clause is overt, this makes it heavier than the preceding genitive expression and so sequences such as (i) may be felt to be unbalanced. When the subject is hypothetically a *pro* however as in (46), the relative clause may not be heavier than the possessor DP and so the possessor occurs more naturally preceding the relative clause. In the second case (41), I believe that there may be a simple semantic problem here; the English translation of (41) is very odd in the intended meaning: '??John's clothes that he saw'. A similar case in Whitman (1998) also indicated as bad in Korean for the same reason translates into English as: '??John's noodles that he ate' again semantically very strange. If such

examples are therefore unacceptable for inherent semantic reasons, they do not constitute arguments specifically against a base-generated structure such as (46) with a *pro* subject.

- 14 In Simpson & Wu (2000), it is actually suggested that the Japanese nominalizer *no* functions both as an N^0 and a D^0 , being base-generated as a semantically empty noun in N^0 and then raising up to D^0 . This contrasts with Chinese *de* which is taken to be base-generated directly in D^0 , and allows for an explanation of certain differences in the distribution of *de* and *no* in nominal constructions. Here it may be noted that even if *no* is an N^0 (as well as a D^0), because it has no semantic content it imposes no semantic restrictions on a genitive subject DP.
- 15 In modern Korean the hypothetical nominalizers are commonly collapsed together with tense in complex morphological forms; Whitman (1995) however shows that if one adds a retrospective mood morpheme it becomes possible to separate the relative clause verb-form into its stem, tense, mood and a distinct element *-n* as in (i); *-n* therefore corresponds to the suggested clausal nominalizer:

- (i) [*Chelswu-ka ecey pro manna-ass -te -n*]-*salam*
 Chelswu-NOM yesterday meet-PAST-RET-N person
 'the person Chelswu met yesterday' (Whitman 1995)

- 16 In structures such as (51) the first DP may be assumed to contain a *pro* co-referring with DP_1 , this resulting in the relative-clause type interpretation.
- 17 On the topic of empty nominalizers and genitive subjects, it can be noted that classical Chinese seems to have permitted genitive subjects both in relative clauses and in simple nominalizations, but in neither case is there any overt nominalizing morpheme; it must therefore be concluded that the nominalizing morpheme is phonetically null. This is illustrated in (i) and (ii) from Pulleyblank (1995):

- (i) [*Wang-zhi suo sha*]-*zhe*
 king-GEN SUO kill-those
 'those whom the king killed'
- (ii) [*Wang-zhi lai*]
 king-GEN come
 'the coming of the king/the king's coming'

- 18 As noted in the beginning of this section, Whitman (1998) also suggests that there is an important connection between the loss of adnominal morphology and the change in patterns of genitive-marked subjects, and following other researchers, Whitman also assumes that the adnominal suffixes in Korean and Japanese were indeed nominalizers. However, in the actual account Whitman develops, no real connection is ultimately made between the presence/absence of nominalizers and the possibility of genitive case. Specifically, because modern Japanese relative clauses are seen to show no signs of overt nominalizers and the earlier adnominal morphology on the verb appears to have been lost, an analysis of the unrestricted genitive case possible in such environments is given in which no nominalizing element occurs in the structure and nominalizers hence have no role in licensing this unrestricted genitive case. As such an analysis is suggested to apply also to middle Korean and the unrestricted genitive case found in that period, it is clear that the diachronic loss of unrestricted genitive case in Korean is actually not formally connected to any change in the change of status of adnominal morphology/nominalizers. Put in other words, a general mechanism for the licensing of unrestricted genitive is posited which is fully independent of any nominalizer/adnominal morphology (in order to allow for modern Japanese where adnominal morphology has been lost but unrestricted genitive case still occurs); taking this to be the mechanism which licensed unrestricted genitive in middle Korean, the loss of such a mechanism (and unrestricted genitive) must therefore actually be assumed to be formally independent of any changes in the status of nominalizers/adnominal morphology. The present approach, by way

of contrast, sees the role of nominalizers as central in the licensing of genitive case and as instantiating (or projecting further functional structure up to) D^0 heads. When such nominalizers hypothetically undergo re-analysis as instantiations of clausal heads, the ability to license genitive case is then automatically and naturally lost. Furthermore, in modern Japanese to account for unrestricted genitive case it was argued that the re-analysis of adnominal morphology is actually not complete, and nominalizing elements are in fact suggested to still be present in such structures. Consequently, although the analysis here might seem to agree with certain initial suggestions in Whitman (1998) that the change in relative clause genitive case-licensing relates to the change in status of adnominal morphology/nominalizers, further examination reveals important differences in the interpretation of such a hypothesis. While the present account closely pursues the relevance of nominalizer re-analysis to the genitive paradigm and argues that it reflects a wider paradigm of nominalizer change, Whitman's engaging analysis ultimately shifts its focus to a development of a wider 'anticipatory spellout' theory and in the end no longer makes clear how the re-analysis of nominalizers and the loss of genitive case actually would be related.

- 19 Having assumed that Chinese *de* and Japanese *no* were originally interpreted as being anaphorically linked to an element in the discourse (via a PRO element), it would seem that these cases are in fact rather similar, and the nominalizers simply provide elements which may be optionally bound and controlled by some other temporal/discourse operator (in other cases of course the same morphemes may simply serve as semantically empty embedding elements either in the nominal or clausal domain). The difference among those nominalizers which are associated with a certain interpretation would reduce to whether the operator-binding is syntactically effected (as with Japanese *no* and Hebrew *ha* in T^0 being bound by a higher +finite T^0), or whether the binding becomes grammaticalized as part of the necessary meaning of the morpheme (as with Chinese *de* coming to instantiate past tense).
- 20 Note in this regard too that copulas often do not assign any overt Case to their complements whereas other verb-types do. Consequently nominalized complements of copulas are not so clearly signalled as nominal categories, this facilitating re-analysis as simple clausal elements.
- 21 If a Kaynean analysis of relative clauses is adopted where there is a selection relation between a D^0 head and the relative clause, it can be suggested that the obvious optionality of relative clause modification must somehow make this a weaker selectional relation than in other head-argument pairings.

References

- Aoki, H. (1986) Evidentials in Japanese. *Evidentiality: the linguistic encoding of epistemology*, edited by W. Chafe & J. Nichols, 223–237. Ablex, New Jersey.
- Baker, M. (1985) The Mirror Principle and morpho-syntactic explanation. *Linguistic inquiry*, 16: 3.
- Bedell, G. (1972) On *no*. *UCLA papers in syntax 3, studies in east Asian syntax*, edited by: G. Bedell 1–20.
- Chao, Y-R. (1968) *A grammar of spoken Chinese*. University of California Press, Berkeley.
- Chiu, B. (1998) *Relative Clauses in Child Chinese*. Manuscript, National Taiwan University.
- de Francis, J. (1963) *Beginning Chinese*. Yale University Press.
- Hong C. (1990) *Kwuk.e chey-e-hwa kwumun uy yenkwu*. Kolye tayhahyo (Korea University), Mincwuk munhwa yenkwu.se, Seoul.
- Horie, K. (1993) From zero to overt nominalizer NO: a syntactic change in Japanese. *Japanese/Korean Linguistics 3*, edited by S. Choi, 305–323. CSLI, Stanford.
- King, R. & J-H. Yeon. (1997) *Korean: a foundation course*. SOAS, London.
- Koopman, H. (1996). The spec-head configuration. *Syntax at Sunset, UCLA working papers in linguistics*, edited by E. Garrett & F. Lee, 30–45. University of California at Los Angeles.
- Kuno, S. (1973) *The structure of the Japanese language*. MIT Press, Cambridge, MA.
- Lee K-M. (1961) *Kwuk.e-sa kaysel*. Mincwung sekwan, Seoul.

- Murasugi, K. (1991) *Noun Phrases in Japanese and English: A study in syntax, learnability and acquisition*. Doctoral dissertation. University of Connecticut.
- Nakai, S. (1980) A reconsideration of *ga/no* conversion in Japanese. *Papers on linguistics* 13, 279–320.
- Nakamura, A. (1994) Some aspects of temporal interpretation in Japanese. *Formal approaches to Japanese linguistics 1. MIT Working Papers in Linguistics 24*, edited by M. Koizumi & H. Ura, 231–246. MIT, Cambridge, MA.
- Pulleyblank, E. (1995) *Outline of classical Chinese grammar*. UBC press, Vancouver.
- Roberts, I. & A. Roussou. (1999) A Formal Approach to Grammaticalization. Ms, University of Stuttgart & University of Cyprus.
- Shibatani, M. (1996) *The languages of Japan*. Cambridge University Press.
- Siloni, T. (1995) On participial relatives and complementizer D⁰: a case study in Hebrew and French. *Natural language and linguistics theory*, 13: 445–487.
- Simpson, A. & X-Z.Z. Wu (1998) *From D-to-T: determiner incorporation and the creation of tense*. Manuscript, SOAS/USC.
- Simpson, A. & X-Z.Z. Wu. (2000) The grammaticalization of formal nouns and nominalizers in Chinese, Japanese and Korean. (2001) in: *Language Change in East Asia*, 160–188, ed. by T. E. McCauley, Curzon: London.
- Sohn, K-W. (1997) Notes on the so-called nom-gen conversion. *Prospects of language studies in the 21st century*, 533–41, linguistics society of Korea, Seoul.
- Takeuchi, L. (1998) *The history and structure of Japanese: from Yamatokotoba to Nihongo*. Manuscript, SOAS, London.
- Tsao, F-F. (1997) *Complement and Adjunct Distribution and the Two-place Nominal in Chinese*. Paper presented at the 9th North American Conference on Chinese Linguistics, Victoria.
- Watanabe, A. (1996) Nominative-genitive conversion and agreement in Japanese: a cross-linguistic perspective. *Journal of East Asian linguistics*, 5: 373–410.
- Whitman, J. K-O. Lee, & B. Lust. (1991) Continuity of the principles of Universal Grammar in first language acquisition: the issue of functional categories. *NELS 21, Proceedings of the 21st Conference of the Northeast Linguistic Society*, 383–398.
- Whitman, J. (1998) *Genitive marking of relative clause subjects in Korean and the nominal status of adnominal clauses*. Paper presented at the 11th International Conference on Korean Linguistics, University of Hawaii, Manoa.
- Wu, Z-X.Z. (2000) *Grammaticalization and the development of functional categories in Mandarin Chinese*. Doctoral dissertation, USC.
- Yoon, J-Y. (1991) On genitive relative constructions in Korean. in: *Harvard Studies in Korean Linguistics IV*, edited by S. Kuno, 447–57.
- Zhuang – Zhuangzi yinde (A concordance to Chuang Tzu), Harvard-Yenching Institute Sinological Index Series, supplement no. 20 Peiping: Yenching University Press, 1947. Reprint, Cambridge, MA: Harvard University Press, 1956.

THREE TYPES OF EXISTENTIAL QUANTIFICATION IN CHINESE*

Wei-Tien Dylan Tsai

1. A puzzle

Chinese *you* ‘have’, when construed as existential, is traditionally analyzed as a modal verb or an auxiliary (see Y.-C. Li 1972, R. Cheng 1978, Huang 1988, L. Cheng, 1991, Tsao & Y. Cheng 1997, among many others). Nevertheless, problems arise when we take a closer look at *you* in terms of both its syntactic distribution and semantic interpretations. There are actually three variants of existential *you*, presentational *you* in (1a), partitive *you* in (1b), and specific plural *you* in (1c):¹

- (1) a. *you ren lai-le.*
have person come-Inc
‘There is/are a person/people coming.’
- b. *you-de ren lai-le.*
have-DE person come-Inc
‘Some of the people are coming.’
- c. *you-(yi)-xie ren lai-le.*
have-one-some person come-Inc
‘Some people are coming.’

When presentational *you* and partitive *you* are instead put in a postverbal object position, the sentences are simply out, as evidenced by (2a,b) respectively:

- (2) a.* *Akiu pian-le you ren.*
Akiu cheat-Prf have person
‘Akiu cheated someone.’
- b.* *Akiu pian-le you-de ren.*
Akiu cheat-Prf have-DE person
‘Akiu cheated some of the people.’
- c.? *Akiu pian-le you-(yi)-xie ren.*
Akiu cheat-Prf have-one-some person
‘Akiu cheated some people.’

Specific plural *you*, in contrast, may marginally appear postverbally, as evidenced by (2c). On the other hand, while presentational *you* is systematically blocked from preverbal object positions, partitive *you* and specific plural *you* are allowed in the same position, as shown by the contrast between (3) and (4, 5):

- (3) a.* *Akiu dui you ren bu manyi.*
 Akiu to have person not satisfied
 ‘Akiu is not satisfied with someone.’
 b.* *Akiu ba you ren pian-le.*
 Akiu BA have person cheat-Prf
 ‘Akiu cheated someone.’
 c.* *Akiu bei you ren pian-le.*
 Akiu by have person cheat-Prf
 ‘Akiu was cheated by someone.’
- (4) a. *Akiu dui you-de ren bu manyi.*
 Akiu to have-DE person not satisfied
 ‘Akiu is not satisfied with some of the people.’
 b.? *Akiu ba you-de ren pian-le.*
 Akiu BA have-DE person cheat-Prf
 ‘Akiu cheated some of the people.’
 c.? *Akiu bei you-de ren pian-le.*
 Akiu by have-DE person cheat-Prf
 ‘Akiu was cheated by some of the people.’
- (5) a. *Akiu dui you-(yi)-xie ren bu manyi.*
 Akiu to have-one-some person not satisfied
 ‘Akiu is not satisfied with some people.’
 b. *Akiu ba you-(yi)-xie ren pian-le.*
 Akiu BA have-one-some person cheat-Prf
 ‘Akiu cheated some people.’
 c. *Akiu bei you-(yi)-xie ren pian-le.*
 Akiu by have-one-some person cheat-Prf
 ‘Akiu was cheated by some people.’

In this chapter, we argue that while presentational *you* counts as a sentential unselective binder, partitive *you* and specific plural *you* are to be treated as determiners. Section one examines the status of *you* from a historical perspective, proposing that the partitive and specific plural readings derive from a pronominal construal of *you* in Archaic Chinese as a result of grammaticalization. In section two, we show that the presentational reading is only one of a few construals licensed by sentential unselective binding, which may range over either individuals or events. Section three proceeds to taking on the issue where the specificity and the plurality come from in presence of *youxie*-NP. In section four, we argued for a head-first analysis of *youde*-NPs, which is independently motivated by a structural distinction between measure words and genuine classifiers in Chinese.

2. Predicate *you* on the fly: a historical perspective

To start with, we summarize the spectrum effects observed throughout (1–5) as follows:

Table 6.1 *you*-reanalysis

	<i>you</i> -NP	<i>you-de</i> -NP	<i>you-(yi)-xie</i> -NP
NP1: internal subjects	ok	ok	ok
NP2: <i>dui</i> -NPs	*	ok	ok
NP3: <i>bei</i> -NPs	*	?	ok
NP4: <i>ba</i> -NPs	*	?	ok
NP5: postverbal objects	*	*	?

On the surface, it looks as if Chinese *you* has undergone a downward incorporation into the argument NP to its right: the closer the argument is, the more likely the incorporation will succeed. This supposedly diachronic process is visualized in the tree diagram (6):²

(6)

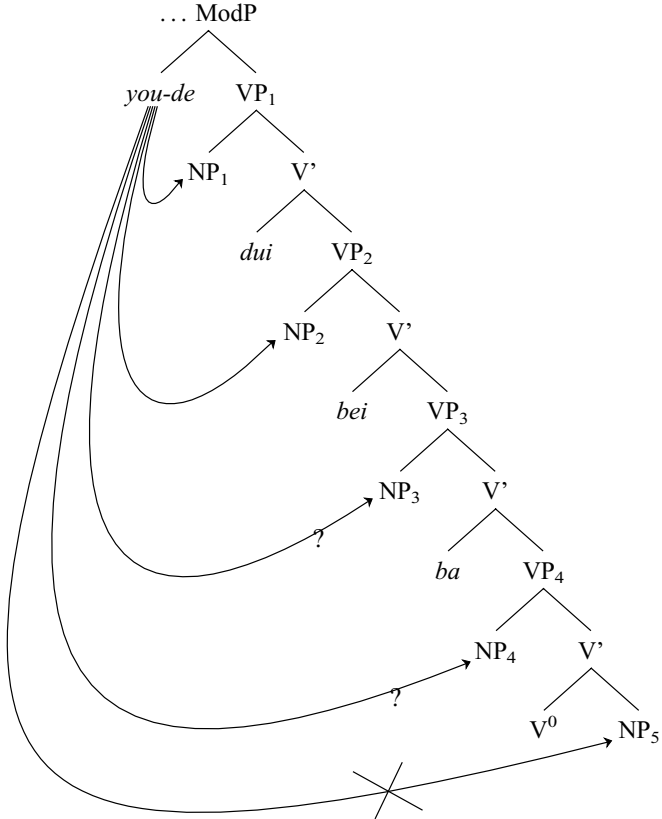

Here we may well explore the intuition by claiming that the chance of *you* being incorporated into an argument NP to its right should be rated against the distance in-between. However, it is unclear how to formulate the idea in a productive manner, and there is no evidence whatsoever for a downward movement in the historical development of Chinese.

In this chapter, we would like to try out an alternative based upon some solid historical fact: In Archaic Chinese, predicate *you* has evolved into a pronoun, akin to *some* in English. Grammaticalization of this sort started as early as the pre-Qin period, as evidenced by (7) and (8) (cf. Yang & He 1992):

(7) *ri you shi zhi.* (from *Shijing* [The Book of Odes])
 sun have eat it
 ‘The sun, someone ate it.’

(8) *you yun zi tian.* (from *Yijing* [The Book of Change])
 have fall from sky
 ‘Something fell from the sky.’

In light of this observation, we assimilate partitive *you* to its English counterpart, as illustrated in the following diagram:

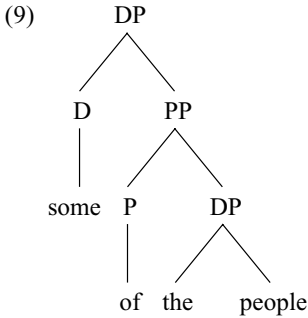

Under this approach, partitive *you* is treated as a pronoun, occupying a D position, while the remain material in a *youde*-NP is analyzed as a PP complement, as illustrated below:

(10) *first approximation:*

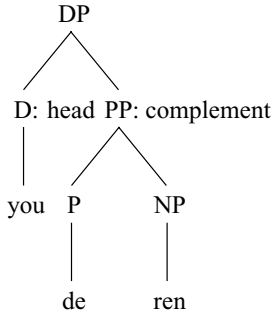

We may reasonably assume that this is the first step of the historical development. Here I will take *you* as the de facto head of the entire DP, followed by a PP complement. Nonetheless, this cannot be the entire story, as there is no evidence whatsoever to support the preposition status of *de*. We will return to address this issue in section four.

Now how about specific plural *you*? It is generally accepted that a D can be occupied either by a determiner (when followed by a NumP) or by a pronoun (when standing alone or followed by a PP). It is therefore highly possible that partitive *you* has undergone further grammaticalization, changing into a genuine determiner. The result is the specific construal in question:

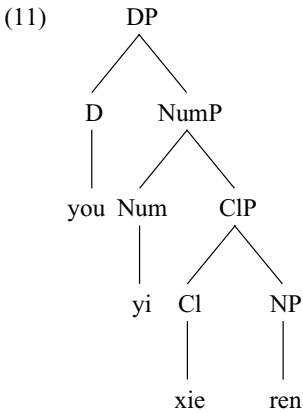

The position is supported by that the fact that specific plural *you* behaves very much like typical determiners such as *mou* ‘certain’ in (12b), *zhe* ‘this’ in (12c), and *na* ‘that’ in (12d):

- (12) a. *you-(yi)-xie (*de) ren lai-le.*
 have-one-some DE person come-Inc
 ‘Some people are coming.’
 b. *mou-(yi)-xie (*de) ren lai-le.*
 certain-one-some DE person come-Inc
 ‘Certain people are coming.’
 c. *zhe-(yi)-xie (*de) ren lai-le.*
 this-one-some DE person come-Inc
 ‘These people are coming.’
 d. *na-(yi)-xie (*de) ren lai-le.*
 that-one-some DE person come-Inc
 ‘Those people are coming.’

When expressing plurality, all of the above determiners cooccur with *yi-xie* ‘one-some’, and cannot take the modifier marker *de*. The plurality of a *you-xie* NP is then attributed to *yi-xie*. We will examine its property more closely, and provide a fine-grained semantics in section three.

Questions remain when we consider the general word order in Chinese nominals: Do we really want to say that Chinese NPs could be head-first as sketched in (10)? As a matter of fact, Huang (1995) has proposed that, as Chinese evolved into its modern age, the head-parameter setting also changed, shifting from head-final to head-first. The diachronic evidence comes from Mei's (1991) observation that a verb-complement compound like *ya-si* 'crush-die' are intransitive in Ancient Chinese, but transitive in Modern Chinese, as illustrated in the following derivation:

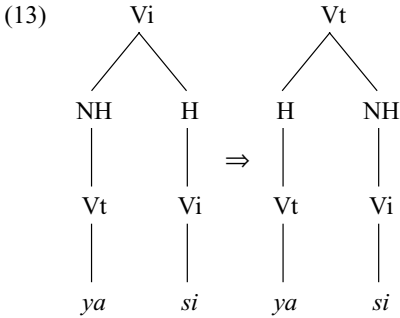

The idea is that if we view the transitivization as a change of headness, everything will fall out naturally. That is, since Ancient Chinese is head-final, the intransitive verb *si* 'die' is the head, and the entire compound inherits its intransitivity. On the other hand, modern Chinese is head-first, and it is the transitive verb *ya* 'crush' which counts as the head. As a result, the entire compound becomes transitive. On the synchronic front, Huang elicits support from Y. Li's finding that a verb-complement compound can only be intransitive in Japanese, which is a typical head-final language. This is shown by the contrast between (14a) and (14b):

- (14) a. *John-wa Mary-o naguri-korosi-ta.*
 John-Top Mary-Acc beat-kill-Past
 'John beat and killed Mary.'
- b.* *John-wa Mary-o naguri-shin-da.*
 John-Top Mary-Acc beat-die-Past
 'John beat Mary, and she died.'

All in all, it seems safe to assume that Chinese has shifted into the head-first setting in a gradual and subtle manner. What is lacking here is a fine-grained syntax and semantics of the three types of *you*, which is imperative for making our case here. We will begin with presentational *you* in the next section.

3. *You* as an unselective binder

An ideal testing ground for the quantificational property of presentational *you* is so-called Taiwanese Mandarin. Standard Mandarin, a dialect spoken around the Beijing area,

employs a suffix *-le* to express perfective aspect, as in (15a), whereas perfective *you* only occurs optionally in negation, as in (15b):

- (15) a. *Akiu qu-le Beijing.*
 Akiu go-Prf Beijing
 ‘Akiu has gone to Beijing.’
 b. *Akiu mei (you) qu Beijing.*
 Akiu not have go Beijing
 ‘Akiu has not gone to Beijing.’
 c. *Akiu you qu Beijing.* (Taiwanese Mandarin)
 Akiu have go Beijing
 ‘Akiu has indeed gone to Beijing.’

This phenomenon of functional replacement has been noted long time ago by Wang (1965). Now under the influence of Taiwanese, a dialect of Southern Min, *you* is ‘resurrected’ as an aspect marker in Taiwanese Mandarin, behaving in line with perfective *have* in English. Since here perfective *you* serves as an existential quantifier ranging over a Davidsonian event argument rather than the subject NP (cf. (1a)), it would be interesting to see whether it is ‘unselective’ enough to license other elements in a given sentence.

The answer seems to be positive. First consider (16a), a typical Taiwanese Mandarin sentence:

- (16) a. *Akiu you chi dongxi.* (Taiwanese Mandarin)
 Akiu have eat thing
 ‘Akiu has indeed eaten something’
 (non-specific reading + perfective aspect)
 b. $you_E, \exists_x, chi(Akiu, dongxi(x), E)$

The postverbal object *dongxi* ‘thing’ gets a typical existential closure reading, which means that it is interpreted as non-specific. On the other hand, *you* triggers existential quantification over the event argument associated with *chi* ‘eat’, which licenses the perfective reading of (16a), as illustrated by (16b).³ When object shift occurs, as in (17a), *you* quantifies over the fronted NP instead, and the perfective aspect is replaced by a generic tense, as in (17b):⁴

- (17) a. *Akiu you dongxi chi.*
 Akiu have thing eat
 ‘There is something for Akiu to eat.’
 (non-specific reading + generic tense)
 b. $Gen_E, you_x, chi(Akiu, dongxi(x), E)$

Crucially, *you* patterns with existential closure in licensing the non-specific reading of (17a), a sure indication of the presence of unselective binding.

Another piece of evidence has to do with the fact that *youde*-NPs and *youxie*-NPs require contrastive focus construals when object shift occurs:

- (18) *Akiu you-de dongxi chi, *(you-de dongxi bu chi).*
 Akiu have-DE thing eat have-DE thing not eat
 ‘Akiu eats some of the things, and does not eat the others.’
- (19) *Akiu you-(yi)-xie dongxi chi, *(you-(yi)-xie dongxi bu chi).*
 Akiu have-one-some thing eat have-some thing not eat
 ‘Akiu eats some things, and does not eat some other things.’

The *youde*-NP of (18) as a whole is under focusing, where *you* ‘have’ is an integrated part of the focused constituent. The same thing happens to the *youxie*-NP in (19). Our theory thus predicts that *you*-NPs cannot appear in contrastive focus constructions, since the unselective binding (i.e., non-specific) construal of (17a) is incompatible with contrastive focusing. This is indeed the case, as evidenced by (20):⁵

- (20) **Akiu you dongxi chi, you dongxi bu chi.*
 Akiu have thing eat have thing not eat
 ‘There is something which Akiu eats, and there is something which Akiu does not eat.’

Moreover, since the *you*-NP is not a constituent, the preverbal object should be able to shift further. This prediction is again borne out by the definite construal of *dongxi* ‘thing’ in (21a):

- (21) a. *Akiu dongxi you chi.* (Taiwanese Mandarin)
 Akiu thing have eat
 ‘Akiu has indeed eaten the thing.’
 (definite reading + perfective aspect)
- b. *you_E chi(Akiu, ι_x dongxi(x), E)*

Being scoped over by *dongxi*, *you* again serves as an unselective binder of the event argument, as illustrated by the semantic representation (21b). The bare NP object, on the other hand, get interpreted as definite.⁶

This versatility of *you* confirms that unselective binding works in a sentential magnitude for Chinese (Tsai 1994, 1999). Similar conclusions has been drawn by Huang (1998) and Lin (1997) concerning lexical operators such as *mei* ‘have-not’ and *ge* ‘each’ respectively.

4. *You* as a strong determiner

To understand the behavior of specific plural *you*, it is imperative to understand the syntax and semantics of its sidekick *yi-xie* ‘one-some’. Our hunch here is that *yi-xie* NPs are essentially collective, i.e., either as members of a group, as in (22), or as a single unit, as shown by the contrast between (23a) and (23b):

(22) *zhe-(yi)-xie xuesheng pici piping.*
 this-one-some student mutually criticize

‘Members of this group of students criticized each other.

(23) *zhe-(yi)-xie xuesheng he na-(yi)-xie xuesheng pici piping.*
 this-one-some student and that-one-some student mutually criticize

a. This group of students and that group of students criticized each other.

b.# This group of students criticized each other, and that group of students criticized each other

In other words, when *yi-xie* appears before a noun, the noun behaves just like a collective noun in English.

In light of the above observation, we would like to entertain the possibility that *yi* ‘one’ serves a collective operator rather than a cardinal predicate, mapping the plurality associated with *-xie* ‘some’ into an atom, i.e., aggregating members of the set of students into a single unit. This operation results in the group interpretation (cf. Link 1983, 1984, Landman 1989a,b). Similar usage can be found in the sentential adverbial *yi* of (24):

(24) *ta yao yi tong jiang-hu.*

he want one rule river-lake

‘He want to unite the lands as one.’

It follows that what *you* contributes to a *youxie*-NP is the specificity, which in turn qualifies it as a strong quantifier in Milsark’s (1974) sense.

5. *You* as a partitive determiner

Now how about partitive *you*? As noted by Gennaro Chierchia (p.c.), in a English partitive construction, *some* can be decomposed into *some* and an implicit head noun denoting the relation ‘part-of’, as illustrated below:

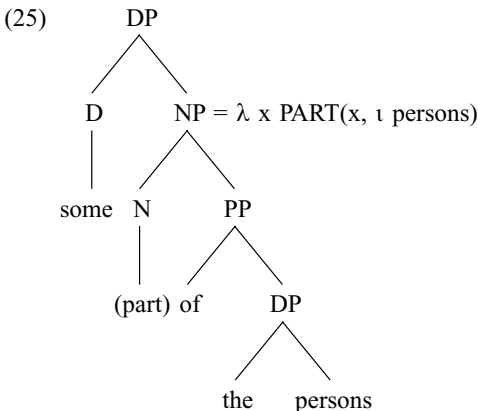

The same analysis, in our opinion, carries over to its Chinese counterpart but with a twist, as represented by the following diagram:

(26) *second approximation*:

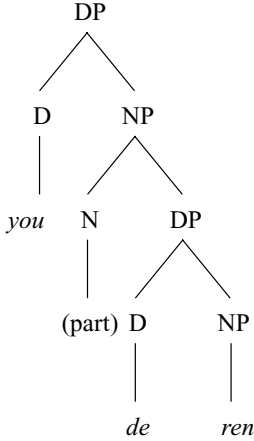

Here we adopt Simpson's (2001) view that *de* should be treated as a 'bleached' determiner in a nominal projection, which is supported by typological correlations from Japanese and languages of the Tibeto-Burman group. At the first glance, this move seems to be a long shot, as it is widely held that Chinese NPs are head-final. In the following discussion, we will demonstrate that there is strong evidence suggesting that Chinese NPs are not uniformly head-final. First compare (27a,b):

- (27) a. *san ge ren*
 three Cl person
 'three persons'
- b. *san bang (de) rou*
 three pound DE meat
 'three pounds of meat'

There are essentially two groups of classifiers in Chinese. The first group are classifiers in the true sense, as in (27a), which are unique to the so-called classifier languages (cf. Tang 1990, Cheng & Sybesma 1998, A. Li 1999). The other may be called measure words, as in (27b), which co-occurs with an optional *de*, and can be found across languages. The intuition we would like to explore here is that the *de facto* head of (27a) is *ren* 'person', denoting individuals, whereas that of (27b) is *bang* 'pound', denoting quantities, as illustrated by (28a,b) respectively:

THREE TYPES OF EXISTENTIAL QUANTIFICATION IN CHINESE

(28) a.

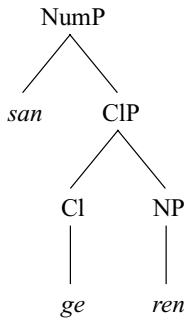

b.

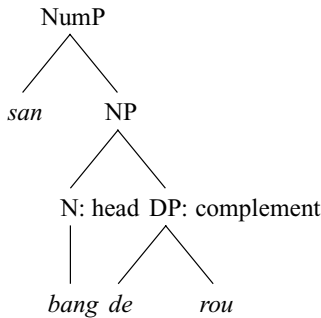

Under this view, classifiers are essentially functional categories, individuating a mass denotation into countable atoms or minimal parts, given that Chinese nouns are uniformly mass a la Chierchia (1995). On the other hand, measure words are lexical categories, expressing quantities or amounts with respect to some form of measurement.⁷ It follows that the phrase-final noun of (27b) can be nothing but the head of the complement of *bang* ‘pound’, as in (28b).

As Jim Huang (p.c.) points out, the following sentence is ambiguous between the individual reading of (29a) and the amount reading of (29b):

(29) *Akiu zuotian he-le san-bei shui.*

Akiu yesterday drink-Prf three-cup water

a. ‘Akiu drank three cups of water yesterday.’ (denoting individuals)

b. ‘Akiu drank three servings of water yesterday.’ (denoting quantities)

The intuition can be further sharpened by considering the contrast between (30) and (31), whose interpretations correspond to (29a) and (29b) respectively:

(30) *Akiu zuotian ba san-bei (*de) shui he-le.*

Akiu yesterday BA three-cup DE water drink-Prf

‘Akiu drank three specific cups of water yesterday.’ (denoting individuals)

- (31) *Akiu yi-tian he san-bei (de) shui.*
 Akiu per-day drink three-cup DE water
 ‘Akiu drinks three cups of water per day.’ (denoting quantities)

In (30), the BA-construction requires a specific object, and thereby disambiguate the sentence. Only the individual reading is available. By contrast, the generic context of (31) is incompatible the individual reading, and prefers the amount reading.

An even stronger argument for our treatment can be built upon the distribution of Chinese demonstrative. First we distinguish two types of demonstratives in Chinese, one is contrastive, as in (32a); the other is appositive, as in (32b):

- (32) a. *wo yao jian na-ge Akiu, bu shi zhe-ge Akiu.*
 I want meet that-CL Akiu not be this-CL Akiu
 ‘I want to meet that Akiu, not this Akiu.’ (contrastive)
 b. *jiao na-ge Akiu lai zher!*
 ask that-CL Akiu come here
 ‘Ask that Akiu to come here.’ (appositive)

Now the prediction is that a quantity-denoting nominal should be unable to take a contrastive demonstrative, since there is no such notion as ‘this quantity’ vs. ‘that quantity’ if we are talking about exactly the same amount. This is indeed the case. First compare (33a,b):

- (33) a. *wo zuotian mai-le san dai mi.*
 I yesterday buy-Prf three bag rice
 ‘I bought three (specific) bags of rice yesterday.’ (denoting individuals)
 b. *wo zuotian mai-le san dai (de) mi.*
 I yesterday buy-Prf three bag DE rice
 ‘I bought (the amount of) three bags of rice yesterday.’ (denoting quantities)

Dai ‘bag’ functions as a classifier in (33a), resulting in the specific reading. On the other hand, *dai* is a measure word in (33b), hence the amount reading. The same distinction is maintained between (34a,b), where the demonstrative can only be interpreted as contrastive in the former, and appositive in the latter:

- (34) a. *wo yao na san dai mi.*
 I want that three bag rice
 ‘I want those three bags of rice.’ (individuals → contrastive)
 b. *wo yao na san dai (de) mi.*
 I want that three bag DE rice
 ‘I want that rice, the amount of which is three bags.’ (quantities → appositive)

It is therefore established that the individual readings are compatible only with a contrastive demonstrative, while the quantity readings get along only with a appositive

one. We also correctly predict that the typical measure word *bang* ‘pound’ is blocked in the presence of a contrastive demonstrative:

- (35) a. *wo yao na san bang (de) rou.*
 I want that three pound DE meat
 ‘I want that meat, the amount of which is three pounds.’
 b. **wo yao na san bang (de) rou, bu shi zhe san bang (de) rou.*
 I want that three pound DE meat not be this three pound DE meat
 ‘* I want these three pounds of meat, not those three pounds of meat.’

Furthermore, it may well be the case that measure words like *bei* ‘cup’ or *dai* ‘bag’ are on the fly to their true classifierhood: As illustrated by (36), *bei* ‘cup’ becomes a genuine classifier by raising to a classifier head, and the remnants collapse into one single head noun:

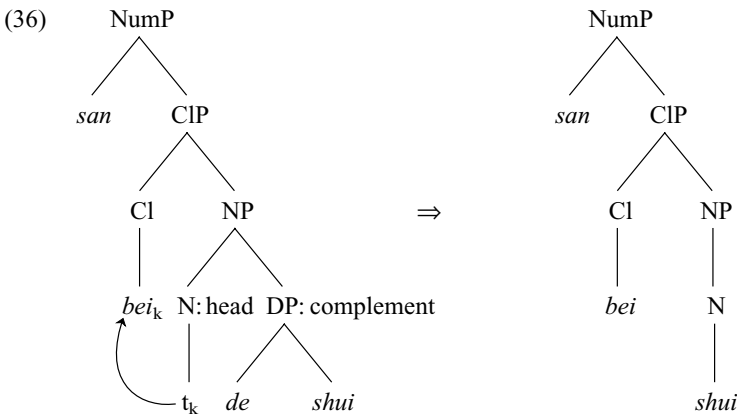

If *bei* stays in-situ, then it remains as a measure word, resulting in the quantity interpretations:⁸

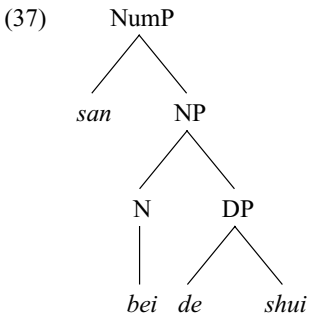

The last piece of evidence comes from the syntactic behavior of *-men*, a plural/collective suffix for [+human] NPs. A. Li (1998) argues quite forcefully that *-men* serves

as the head of a number projection (NumP), standing higher than CIP but lower than DP. Now consider the third person plural pronoun *ta-men* ‘they’, which is formed by adjoining the plural suffix *-men* from Num to D, as sketched below:

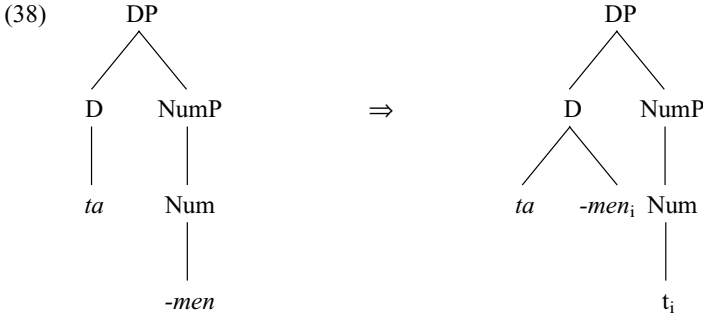

This proposal correctly predicts that sentences like (39a,b) are bad:

- (39) a.* *wo dui san-ge xuesheng-men tebie hao.*
 I to three-CL student-MEN especially nice
 ‘I am especially nice to three students.’
 b.* *wo dui xuesheng-men san-ge tebie hao.*
 I to student-MEN three-CL especially nice

(39a) is ruled out because *-men* cannot undergo lowering to its right, as sketched below:

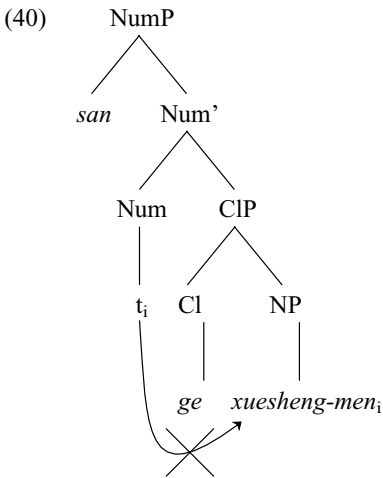

(39b) is ruled out in violation of relativized minimality, where the successive head movement skips an intervening head, i.e., the classifier *ge*, as illustrated in (41):

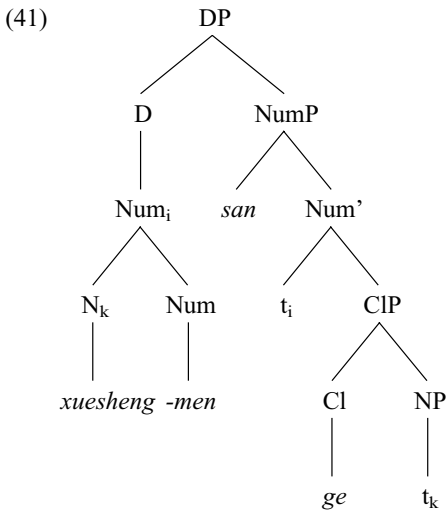

Moreover, her analysis correctly rules in sentences like (42):

- (42) *wo dui ta-men san-ge tebie hao.*
 I to he-MEN three-CL especially nice
 'I am especially nice to them three.'

As illustrated below, nothing gets in the way of the Num-to-D raising:

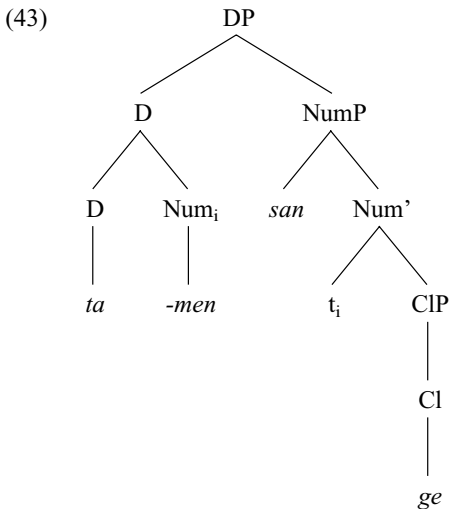

If Li's treatment proves to be on the right track, the following contrast between measure words and classifiers receives a straightforward account under our approach. That is, (44b) is ruled out along with (39a) for reasons just mentioned:

- (44) a. *na san-ge xuesheng hen youxiu.*
 that three-CL student very outstanding
 ‘Those three students are very outstanding.’
 b.* *na san-ge xuesheng-men hen youxiu.*
 that three-CL student-MEN very outstanding

In contrast, when we substitute a measure word *zu* ‘group’ for the classifier *ge* in (44b), the sentence improves dramatically, as evidenced by (45b):

- (45) a. *na san-zu xuesheng hen youxiu.*
 that three-group student very outstanding
 ‘Those three groups of students are very outstanding.’
 b. *na san-zu (de) xuesheng-men hen youxiu.*
 that three-group DE student-MEN very outstanding

The phenomena receives a straightforward account once we adopt the view that the subject NP of (45b) assumes the following structure:

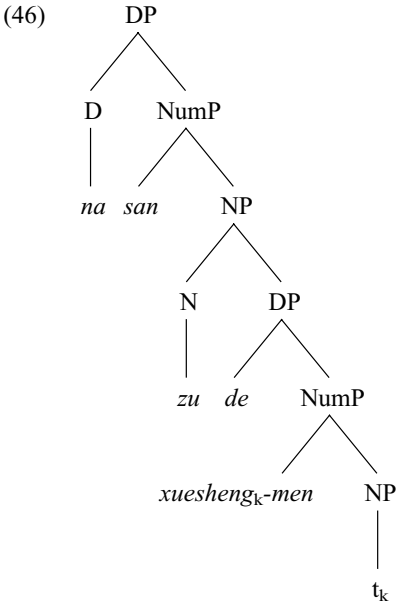

Here *xuesheng-men* ‘students’ is viewed as a subcategorized complement of the measure word *zu*, and *-men* as part of the complement DP. In contrast to the invalid derivation in (40), where the classifier *ge* creates a blocking effect for head movement, nothing prevents N from joining Num in the complement DP of (46).

6. Conclusion

To sum up, we now have a much clearer picture of what's going on in the three types of Chinese existential constructions, which can be decomposed as follows:

<i>you</i> NP	→ sentential operator ... bare NP	(presentational)
<i>you-de</i> NP	→ determiner + (part) + DP complement	(partitive)
<i>you-(yi)-xie</i> NP	→ determiner + collective operator + head noun	(specific plural)

Nevertheless, this only provides a partial account of the dilemma we encountered in section one: At one end of the spectrum, presentational *you* counts a sentential unselective binder, and therefore cannot be adjacent to an object except when subject raising and object shift both occur (cf. (17)). At the other end, since *you* has become an integrated part of a *youxie*-NP, it may appear in virtually any NP position. The gray area surrounding *youde*-NPs, however, does not have an obvious solution from the fine-grained syntax presented in section four. In other words, the synchronic analysis cannot be the whole story. It should be supplemented by our finding on the diachronic front: In comparison with specific *you*, partitive *you* is only halfway grammaticalized. The ambiguous structural status of *you* in (26) should be correlated with its 'on-the-fly' character from a historical point of view. In other words, the downward incorporation envisioned in (6) is only an illusion, which is created by the gradual change of the categorial status of *you*, that is, existential predicate → pronoun → determiner.

Notes

* I benefit greatly from discussions with Claire Chang, Lisa Cheng, Gennaro Chierchia, One-soon Her, Jim Huang, Andrew Simpson, Feng-fu Tsao, Yuen-mei Yin, and anonymous reviewers. I would also like to express my gratitude to Hajime Hoji and Audrey Li for their help and encouragement.

1 The abbreviations used in this chapter are glossed as follows: Acc: accusative case; Inc: inchoative aspect; Past: past tense; Prf: perfective aspect; Top: topic marker.

2 Here I treat *dui* 'to', *ba*, and *bei* 'by' as light verbs in Chinese, along the line of Feng (1995), Ting (1995), Tsai (1995), and Huang (1999).

3 See Huang (1988) for an analysis of perfective *you* in the same spirit.

4 One reviewer questions the validity of treating *you* as an unselective binder, based on the following data:

- (i) *Akiu you zhezhi ji chi.*
Akiu have this chicken eat
- (ii) *Akiu zuo dongxi chi.*
Akiu cook thing eat

(i) shows that the fronted object NP can also be definite, and one may wonder what *you* quantifies over in this case. It is also suggested that *you* can be analyzed as a possessive verb, in line with *zuo* 'cook' in the serial verb construction (ii). Nevertheless, there are two arguments against taking the above approach: Firstly, while (ii) can be paraphrased as (iii), there is no way for (17a) to be interpreted the same way, as evidenced by the deviance of (iv):

- (iii) *Akiu zuo dongxi lai chi.*
 Akiu cook thing come eat
 'Akiu will cook something in order to eat.'
- (iv)* *Akiu you dongxi lai chi.*
 Akiu have thing come eat
 'Akiu has something in order to eat.'

The quantificational reading of *dongxi* in (ii) is thus licensed by existential closure under the irrealis tense. Secondly, (i) actually has a factual flavor, and cannot stand alone, as illustrated by (v) and (vi):

- (v) *Akiu you zhezhi ji chi, jiu gou le.*
 Akiu have this chicken eat then enough Inc
 'It will be enough given that Akiu can eat this chicken.'
- (vi) *Akiu you zhezhi ji chi shi yinwei ta fu-le qian.*
 Akiu have this chicken eat be because he pay-Prf money
 'The reason Akiu can eat this chicken is because he has paid the money.'

Here *you* does not quantify over an argument, but predicates upon a proposition instead, asserting the truth of the proposition. There is also an issue as to which syntactic category *you* falls into when construed as an unselective binder. Our view is that *you* occupies a light verb position in syntax, while serving as an operator in semantics. This is by no means surprising, since all the epistemic modal verbs have this sort of property.

- 5 Note that (20) may improve when a partitive reading is intended. This is because, for some Chinese speakers, *de* can be dropped under contrastive construals like (18). Hence the confusion.
- 6 As for how the bare NP receives the definite interpretation, see Cheng & Sybesma (1999) and A. Li (1997) for a syntactic treatment à la Longobardi (1994).
- 7 In essence, we are saying that there is no mass-count distinction for Chinese classifiers, contra Cheng & Sybesma's (1998, 1999) proposal to distinguish classifiers from massifiers (mass classifiers).
- 8 For a comprehensive discussion of the historical development of Chinese classifiers, see Peyraube (1997).

References

- Cheng, Lisa L.-S. (1991) *On the Typology of Wh-questions*, PhD Dissertation, MIT.
- Cheng, Lisa L.-S. and Rint Sybesma (1998) 'Yi-wan Tang, Yi-ge Tang: Classifiers and Massifiers,' *Tsing Hua Journal of Chinese Studies*, New Series 28, 385–412.
- Cheng, Lisa L.-S. and Rint Sybesma (1999) 'Bare and Not-so-bare Nouns and the Structure of NP,' *Linguistic Inquiry* 30, 509–542.
- Cheng, Robert L. (1978) 'Tense Interpretation of Four Taiwanese Modal Verbs,' in Cheng, R., Y.-C. Li & T.-C. Tang (eds.) *Proceedings of Symposium on Chinese Linguistics, 1977 Linguistic Institute of the Linguistic Society of America*, 243–266.
- Chierchia, Gennaro (1995) 'Plurality of Mass Nouns and the Notion of Semantic Parameter,' ms., University of Milan.
- Feng, Sheng-li (1995) 'GB-Theory and the Passive Construction in Chinese,' *Studies in Chinese Linguistics* 1, 1–28.
- Huang, C.-T. James (1988) 'Shuo Shi he You [On "Be" and "Have" in Chinese],' *The Bulletin of the Institute of History and Pilology* 59, 43–64.
- Huang, C.-T. James (1995) 'Historical Syntax Meets Phrase Structure Theory: Two Notes on the Development of Verb-Complement Constructions,' paper presented at the Joint Meeting of the

THREE TYPES OF EXISTENTIAL QUANTIFICATION IN CHINESE

- 4th International Conference on Chinese Linguistics and 7th North American Conference on Chinese Linguistics, The University of Wisconsin-Madison.
- Huang, C.-T. James (1998) 'More on the Distribution of Negative NPs,' paper presented in A Symposium on Diachronic and Synchronic Studies of Syntax of East Asian Languages, University of Southern California.
- Huang, C.-T. James (1999) 'Chinese Passives in Comparative Perspective,' to appear in *Tsing Hua Journal of Chinese Studies*.
- Landman, Fred (1989a) 'Group I,' *Linguistic and Philosophy* 12, 559–605.
- Landman, Fred (1989b) 'Group II,' *Linguistic and Philosophy* 12, 723–744.
- Li, Audrey Y.-H. (1997) 'Structures and Interpretations of Nominal Expressions,' ms., USC.
- Li, Audrey Y.-H. (1999) 'Plurality in a Classifier Language,' *Journal of East Asian Linguistics* 8, 75–99.
- Li, Yafei (1993) 'Structural Head and Aspectuality,' *Language* 69, 481–504.
- Li, Ying-Che (1972) 'Sentences with *be*, *exist*, and *have* in Chinese,' *Language* 48, 573–583.
- Lin, Tzong-Hong (1997) 'Quantificational Force Parameter and the Determiner *Ge* in Chinese,' paper presented at the Workshop on Interface Strategies in Chinese: Syntax and Semantics of NPs, LSA Linguistics Institute, Cornell University, 1997.
- Link, Godehard (1983) 'The Logical Analysis of Plurals and Mass Terms: a Lattice Theoretic Approach,' in Bauerle, Schwarze, and von Stechow (eds.), *Meaning Use, and the Interpretation of Language*, de Gruyter, Berlin.
- Link, Godehard (1984) 'Hydras. On the Logic of Relative Clause Constructions with Multiple Heads,' in Landman and Veltman (eds.), *Varieties of Formal Semantics*, GRASS 3, Foris, Dordrecht.
- Longobardi, Giuseppe (1994) 'Reference and Proper Names,' *Linguistic Inquiry* 25, 609–666.
- Mei, Tsulin (1991) 'Cong Han dai de *dong-sha*, *dong-si* lai kan dongbu jieyou de fazhan – jian lun zhongguo shiqi qici de shi-shou guanxi de zhonglihua [On the V-"kill" and V-"die" structures in the Han dynasty and the development of V-Complement structures – the neutralization of the thematic status of the initial constituent in the sentence in Medieval Chinese],' *Yuyanxue Luncong* 16, 112–136.
- Milsark, Gary (1974) Existential Sentences in English, PhD Dissertation, MIT.
- Peyraube, Alain (1997) 'On the History of Classifiers in Archaic and Medieval Chinese,' in B. T'sou, A. Peyraube and L. Xu (eds.) *Studia Linguistica Sinica*, Hong Kong City University, Hong Kong.
- Simpson, Andrew (2001) 'Definiteness Agreement and the Chinese DP,' *Language and Linguistics* 2, 125–156.
- Tang, C.-C. Jane (1990) *Chinese Phrase Structure and the Extended X'-Theory*, PhD Dissertation, Cornell University.
- Ting, Jen (1995) *A Non-uniform Analysis of the Passive Construction in Mandarin Chinese*, PhD Dissertation, University of Rochester, New York.
- Tsai, W.-T. Dylan (1994) *On Economizing the Theory of A'-Dependencies*, PhD Dissertation, MIT.
- Tsai, Wei-Tien Dylan (1995) 'Visibility, Complement Selection and the Case Requirement of CP,' *Journal of East Asian Linguistics* 4, 281–312.
- Tsai, W.-T. Dylan (1999) 'On Lexical Courtesy,' *Journal of East Asian Linguistics* 8, 39–73.
- Tsao, Feng-Fu and Ying Cheng (1997) 'Tan Min Nan Yu You De Wu Zhong Yong Fa Ji Qi Jian De Guan Xi [On Five Usages of Southern Min *you* and their relations],' in Tsao, Feng-Fu (ed.) *Taiwanxueze Hanyuyanjiu Wenji*, Tianji Renming Chubanshe, Tianji.
- Wang, William S.-Y. (1965) 'Two Aspect Markers in Mandarin,' *Language* 41, 457–470.
- Yang, Bo-Jun and Le-Shi He (1992) *Gu Han Yu Yu Fa Ji Qi Fa Zhan* [Classic Chinese Grammar and its Development], Yuwen Chubanshe, Beijing.

ON THE HISTORY OF PLACE WORDS AND LOCALIZERS IN CHINESE: A COGNITIVE APPROACH*

Alain Peyraube

1. Introduction

The study of spatial reference is important not only from a pure linguistic point of view, as it is a crucial domain of language, involving syntactic, semantic and pragmatic factors of a rare complexity, but also because it can shed light on a fundamental category of human cognition: the space. The general claim is that the mind is in some sense compartmentalized; that is that human conceptual understanding about space, for instance, is likely to be quite different in character, structure, and development from understanding about language. See Wellman & Gelman (1992).

The evolution of Chinese place words (*chusuoci*) and localizers (*fangweici*) shows interesting episodes on the problem of lexical polysemy, which is probably the most difficult problem of spatial reference.

After briefly presenting a general framework of the expression of spatial and locative configurations in human languages (Section 2) and sketching an analysis of place words and localizers in Contemporary Chinese (Section 3), this chapter will focus on the historical evolution of these words from Archaic Chinese (Section 4) to Late Medieval Chinese (Section 7), through the different stages of the Pre-Medieval (Section 5) and Early Medieval periods (Section 6).

2. The components of spatial reference

Klein and Nüse (1997) identify three main components of spatial reference: structure of space, semantic content and contextual dependency.

2.1. Structure of space

There exists an ordinary perceptive space, at work in daily perceptions and behaviors, which can be characterized by three properties:

- (i) it is made from smaller units called « sub-spaces »;
- (ii) a 2-dimensional structure can be defined for a sub-space, the simple topological structure, i.e. the sub-space can be – totally or partially – included in another sub-space.

The topological relations are, for instance, the following: IN, PARTLY IN, IN CONTACT WITH, PART OF THE SURFACE, etc.;

- (iii) there is also a 3-dimensional (vertical, horizontal, transversal) structure, to which correspond the following dimensional relations: ABOVE-BELOW, RIGHT-LEFT, IN FRONT OF-BEHIND, etc.

2.2. Semantic content

This second component refers to the meaning of spatial expressions in language. There is a spatial relation between two objects, the first of which, called « theme », is localized in relation to the latter, called « relatum ». The spatial relation between these two objects is expressed by a relation-word (a locative preposition or a localizer, in the Chinese case), which is, most often, polysemic.

How can the different meanings of this relation-word be analyzed, as polysemy is the most difficult problem to solve? Three different approaches can be suggested:

- Infinite polysemy. One can consider that there is no uniform meaning, and thus all the occurrences of the word have to be listed one by one.
- Total contextualization. Isolated words do not have an autonomous meaning, for the meaning is entirely dependent of the context.
- Nucleus and operations. One assumes that there is a « nucleus meaning » which can be precisely described and which is modifiable through semantic operations. Often motivated by textual constraints, they lead to a specific usage. One can suppose that this nucleus meaning corresponds to a specific but frequent and typical usage, a kind of prototype.

The hypothesis I will adopt here is the « nucleus + operations » one. There is a nucleus meaning from which specific interpretations can be derived in context. This derivation can nevertheless take two different ways:

- a. the proper lexical meaning, basic meaning, is general. In a specific utterance, contextual information adds specifications which lead to the correct and particular interpretation. For instance, the crucial question for the Chinese *shang* 'on' will be to know if the object (relatum) has or has not a contact surface: this question is a very general one, compatible with all possible interpretations of *shang*.
- b. The lexical meaning itself is specific. It represents a typical interpretation, a prototypical meaning. The specific meaning in context is then given through reinterpretations. The crucial question for *shang* will be to know if the spatial features of the relatum [ABOVE, IN CONTACT WITH, ...] are in accordance with the specific meanings. If not, a reinterpretation of the meaning will be required, implying a cognitive effort.

These two models (prototype and basic meaning) operate with two elements: the nucleus meaning of the relation-word (as it is stocked in the memory of the speaker) and the

relative conceptualization of the objects, i.e. how the speaker conceptualizes the theme and the relatum.

They can be characterized as follows:

	Nucleus	Operations
Prototype-Model	Specific meaning (Prototype)	Reinterpretations
Basic meaning-Model	General meaning (Basic meaning)	Additions

The basic meaning model is obviously not the right one to account for the localizers in Chinese, especially in Medieval Chinese, as we will see. Yet it is preferred in cognitive psychology. Chronometric experiments measuring the cognitive efforts have been made, the results of which are not compatible with the prototype model. See Klein and Nüse (1997).

2.3. Contextual dependency

The interpretation of an utterance is always the result of some kind of interaction between two types of information: the semantic content of individual words on one hand, and contextual information on the other. This interaction needs to be clarified.

For instance, the semantic content of the word *zheli* 'here' is delimited by a sub-space which includes the position of the speaker, itself coming from the context. For other expressions such as *qianmian* 'in front of', *houmian* 'behind', *zuobianr* 'on the left of' or *youbianr* 'on the right of', it is more complicated. The meaning does not depend only on the position of the speaker, but also on his point of view.

3. Place words and localizers in Contemporary Chinese

3.1. Place words (chusuoci)

Place words are substantives which can be objects of verbs, or of prepositions of place or movement, such as the verbs *lai* 'come to', *qu* 'go to', *zai* 'to be at', *dao* 'arrive at', or the prepositions *zai* 'at', *dao* 'to', *cong* 'from', *wang* 'toward', etc. See Chao (1968, 520 sq.), Peyraube (1980, 10 sq.). Substantives which are not place words usually cannot occupy such positions. Thus, one cannot say * *dao men qu* [to door go] 'go to the door', but one can say *dao xuexiao qu* [to school go] 'go to the school'. While 'school' is a place word, 'door' is not.

Place words can be:

- (i) place names, such as *Zhongguo* 'China', *Taipei* 'Taipei';

- (ii) nouns with a locative value, i.e. nouns for places used as place names, such as *xuexiao* ‘school’, *fanguanr* ‘restaurant’, *tushuguan* ‘library’;
- (iii) disyllabic localizers or position words (*fangweici*), such as *litou* ‘inside’, *youbianr* ‘the right side’, *zhongjianr* ‘middle’;
- (iv) ordinary nouns followed by monosyllabic or disyllabic localizers, such as *zhuozi shang* [table on] ‘on the table’, *shan beihou* [mountain back] ‘at the back of the mountain’;
- (v) locative pronouns such as *zher* ‘here’, *nàr* ‘there’ and *nâr* ‘where’.

If, most of the time, place words are related to verbs or prepositions of place or movement, they are not restricted to such verbs or prepositions. They can be objects of other verbs as well. For example, *wo kanbujian men beihou* [I cannot-see door behind] ‘I can’t see behind the door’.

3.2. Localizers (*fangweici*)

They express the relative position of things. They can be monosyllabic or disyllabic. They form a closed subclass.

3.2.1. The monosyllables consist of the following localizers: *shang* ‘up’, *xia* ‘down’, *qian* ‘front’, *hou* ‘back’, *li* ‘inside’, *wai* ‘outside’, *zuo* ‘left’, *you* ‘right’, *dong* ‘east’, *xi* ‘west’, *nan* ‘south’, *bei* ‘north’, *zhong* ‘middle’, *jian* ‘in, middle’, *pang* ‘side’, *nei* ‘inside, within’. As place words, they only occur in certain fixed phrases based largely on Classical Chinese (as in *Shang you tiantang, xia you Su Hang* [above there-is heaven below there-is Suzhou Hangzhou] ‘Above there is heaven, below there are Suzhou and Hangzhou’), or as objects of the prepositions *wang, xiang* or *chao* ‘to, toward’, as in *wang li zou* [to inside move] ‘move forward’. See Wen Lian (1959, 8), Chao (1968, 525), Peyraube (1980, 31).

Most of the time, monosyllabic localizers follow ordinary nouns, changing them into place words. See (iv) above. This is especially the case for the two localizers *shang* and *li*, the versatility of the others being quite low in the spoken language. Thus, they are sometimes considered as adjectives (*Ma shi wen tong*, chapter 3), adverbs (Lü Shuxiang 1947), adverbs (Li Jingxi and Liu Shiru 1955), suffixes (Cartier 1970, 1972) or even pronouns (Alleton 1973, Rygaloff 1973). Usually they are treated as a subclass of nouns. Some linguists, however, call them postpositions, as they are translatable into prepositions, though substantive in form (Hagège 1975, 220 sq., Peyraube 1980, 53 sq.).

3.2.2. Disyllabic localizers are formed by adding a suffix (usually *bianr, mianr* or *tou*) or a prefix (*yi* or *zhi*) to the monosyllables. Almost everybody would agree that disyllabic localizers are a subclass of nouns. Different from the monosyllables, they can be used alone as place words and they can be subjects or objects, or combined with nouns to express the position. The following Table 7.1 – where the combinations in brackets are either belonging to a literary style or mainly used to express something else than the place or the position – shows the different combinations.

Table 7.1 Localizers

	<i>bianr</i>	<i>mianr</i>	<i>tou</i>	<i>yi</i>	<i>zhi</i>	two-localizers	other-comb.
<i>shang</i>	+	+	+	()	()	(<i>shangxia</i>)	
<i>xia</i>	+	+	+	()	()	(<i>shangxia</i>)	<i>dixia</i>
<i>qian</i>	+	+	+	()	()	(<i>qianhou</i>)	<i>tourli</i>
<i>hou</i>	+	+	+	()	()	(<i>qianhou</i>)	<i>beihou</i>
<i>li</i>	+	+	+			(<i>liwai</i>)	
<i>wai</i>	+	+	+	()	()	(<i>liwai</i>)	
<i>zuo</i>	+	+				(<i>zuoyou</i>)	
<i>you</i>	+	+				(<i>zuoyou</i>)	
<i>dong</i>	+	+	+	()	()	<i>dongxi</i> <i>dongnan</i> <i>dongbei</i>	
<i>xi</i>	+	+	+	()	()	<i>xinan</i> <i>xibei</i> <i>dongxi</i>	
<i>nan</i>	+	+	+	()	()	<i>dongnan</i> <i>xinan</i>	
<i>bei</i>	+	+	+	()	()	<i>dongbei</i> <i>xibei</i>	
<i>zhong</i>					()	<i>zhongjian</i>	<i>dangzhong</i> <i>dangzhongjian</i>
<i>jian</i>					()	<i>zhongjian</i>	<i>dangjian</i> <i>dangzhongjian</i>
<i>pang</i>	+						
<i>nei</i>				()	()		

What is the historical evolution of place words and localizers since the Archaic period? The next sections will try to draw the general outlines of such an evolution through the different stages of the Chinese language.

4. Archaic period

In Archaic Chinese (Early Archaic, 11th–5th centuries BC. and Late Archaic, 5th–2nd c. BC., which represents the Classical Chinese par excellence), place words and localizers have the following characteristics: (i) there are no fundamental differences between ordinary nouns and place words; (ii) localizers are only monosyllabic; (iii) a preposition (most of the time *yu*) is generally needed to introduce a place word when the place word is not a direct object of a verb of place or movement.

4.1. No differences between ordinary nouns and place words

In Classical Chinese, substantives which are not subcategorized as place words (as above in 3.1) can be objects of verbs or prepositions of place or movement. Examples:

- (1) *bu zhi Yao zhi zi er zhi Shun*
 negation go Yao det.-part. son but go Shun
 ‘(The princes) went not to the son of Yao, but to Shun.’
- (2) *Zi Zhang shu zhu shen*
 Zi Zhang write it+at sash
 ‘Zi Zhang wrote them (these words) on his sash.’
 [*zhu* = *zhi* ‘it’ + *yu* ‘at’]
- (3) *tu you e piao er bu zhi fa*
 road there-be hungry body and negation know start
 ‘There are people dying from famine on the road and you don’t even know how to start
 (issuing the stores of your granaries).’
- (4) *furen xiao yu fang*
 princess laugh at room
 ‘The princess laughed in (her) room.’
- (5) *gong hong yu che*
 prince die at chariot
 ‘The prince died in the chariot.’

In other words, the ordinary nouns *zi* ‘son’ (1), *shen* ‘sash’ (2), *tu* ‘road’ (3), *fang* ‘room’ (4) or *che* ‘chariot’ (5) can be used in Classical Chinese as place words without being followed by any localizer.

Thus, there is no significant difference in Classical Chinese between ordinary nouns and place words. The same situation prevails for the pronouns. Demonstrative pronouns and locative pronouns have the same form: *ci* ‘this, here’ and *bi* ‘that, there’ (in Contemporary Chinese, we have *zhe* ‘this’ and *na* ‘that’ for the demonstratives, and *zheli* or *zher* ‘here’ and *nàli* or *nàr* ‘there’ for the locatives).

There are also, of course, cases of place words which are, as in Contemporary Chinese, formed by ordinary nouns followed by localizers. Examples:

- (6) *wang zuo yu tang shang*
 king sit at hall aloft
 ‘The king was sitting aloft in the hall.’
- (7) *wang li yu zhao shang*
 king stand at pond on
 ‘The king was standing by a pond.’
- (8) *ze shi fang si shi li wei jing yu guo zhong*
 thus this square four ten li be pitfall at kingdom middle
 ‘Thus those forty square li are a pitfall in the middle of the kingdom.’

(9) *Meng Sun li yu fang wai*

Meng Sun stand at room outside

‘Meng Sun was standing outside the room.’

(10) *she qi zuo yue yu che xia she qi you bi yu che zhong*

shot-(an arrow) his left pass at chariot under shoot his right die at chariot inside

‘He shot (the one who was on) his left and he fell down under the chariot, he shot (the one who was) on his right and he died inside the chariot.’

However, as observed by Li Chongxing (1992), when such monosyllabic localizers occur after nouns, they express a real and needed meaning of position. The need is semantic and not syntactic. In examples (6) to (10), the localizer cannot be dropped out for obvious semantic reasons. If we compare (4) and (9), for instance, we realize that the localizer *wai* ‘outside’ in (9) could be dropped, but the meaning would then be very different: ‘Meng Sun was standing in the room’, instead of ‘Meng Sun was standing outside the room.’ In example (6) – whose translation has been taken from Legge (1861) as well as the one for ex. (7) –, if one deletes the localizer *shang* ‘aloft’, the meaning will be ‘The king was sitting in the hall.’

4.2. Localizers are only monosyllabic

Localizers exist in Chinese since the Pre-Archaic period (14th–11th c. BC.), i.e. the language of the oracle bone inscriptions. Zhao Cheng (1988, 269–272) makes an inventory of seven of them: *dong* ‘east’, *nan* ‘south’, *xi* ‘west’, *bei* ‘north’, *zhong* ‘middle’, *zuo* ‘left’ and *you* ‘right’. *Shang* and *xia* are also attested in the language of the oracle bone inscriptions, but their meaning is probably respectively ‘Heaven’ and ‘earth’, and not ‘above’ and ‘below’.

These seven localizers are still used during the Early Archaic and Late Archaic periods, together with some others, namely *shang* and *xia*, meaning then ‘above’ and ‘below’, *nei* ‘inside’, *wai* ‘outside’, and, to a less extent, *qian* ‘front’ and *hou* ‘back’, which appeared later, though not as late as *li*, which Chu Zexiang (1996) dates back to the 4th or 5th c. AD. See also Yang Bojun and He Leshi (1992, 89–92).

Apart from very rare and marginal exceptions (for instance two examples of *waimian* ‘outside’ in the *Mozi* [but this text dated to 3rd c. B.C. displays several original phenomena not attested in other texts of the same period ; see Peyraube 1988, 101, and Zhang Wanqi 1998]), these localizers are always monosyllabic and, contrary to Contemporary Chinese, they can be used alone to express the place (*chusuo*). Thus, they can be subjects, objects or even adverbials. They are used both (i) as place words like the disyllabic localizers in Contemporary Chinese (see ex. 11–14), and (ii) as position words following nouns (see examples above, 6–10). Examples:

(11) *zhan zhi zai qian hu yan zai hou*

look them be-at front suddenly then be-at behind

‘Looking at them, they are in front of me, but suddenly they then appear behind.’

- (12) *Zhou gong ju dong er nian*
 Zhou prince live east two year
 ‘Prince Zhou lives in the east since two years.’
- (13) *jin bai hu shang*
 now worship at above
 ‘Now, the practice is to worship above (the hall).’
- (14) *Jin hou zai wai shi jiu nian yi*
 Jin prince be-at outside ten nine year part.
 ‘The Prince of Jin has been outside for nineteen years.’

4.3. The place words are often introduced by a preposition

If the ordinary nouns in Classical Chinese do not need to be necessarily followed by a localizer to be place words, as it is the case for Contemporary Chinese, there are nevertheless two conditions for ordinary nouns to be used as place words: (i) they must be objects of verbs of place or movement, and/or (ii) they must be introduced by a locative preposition, *yu*, or less often *hu*, *zhu* or even *zhi* (*zhi* can be considered sometimes as an equivalent of *zhu*, according to Li Chongxing 1992), as shown in the examples 1, 2, 4, 5 above. There are some exceptions, especially when the nouns used as place words are subjects (as in example 3) or in some other cases when the nouns are taken to have a locative value and are used as place names, as in:

- (15) *shu wu mu jia*
 plant my tomb catalpa
 ‘Plant catalpas in front of my tomb.’

Even when the place words are formed of nouns + localizers, it is still rare to have the preposition *yu* deleted. An exception is:

- (16) *Han Jue zhi zhi ma qian*
 Han Jue take strap horse in-front-of
 ‘Han Jue took a strap in front of the horses.’

Only when the verb has the third person or demonstrative pronoun *zhi* as its object, the preposition *yu* seems not needed, as in:

- (17) *Zichan shi xiao ren mu zhi chi*
 Zichan order filed-officer man keep it pond
 ‘Zichan ordered his field-officer to keep it (the fish) on the pound.’

However, as hypothesized by Li Chongxing (1992), one can assume, in these cases, that a locative preposition *yu* has been deleted before the noun *chi* ‘pond’ (in ex. 17), or even consider that *zhi* might be an equivalent of the fusion word *zhu* = *zhi* ‘it’ + *yu* ‘to’.

5. Pre-Medieval period

In Pre-Medieval Chinese, which roughly corresponds to the Han period (206 BC–220 AD), the characteristics of place words and localizers have changed. These changes can be summarized as follows: (i) ordinary nouns are no longer used as place words, or, at least, it is not as easy as it was in Late Archaic; (ii) the locative preposition *yu* is no longer needed to introduce a place word which is not the object of a verb of place or movement; (iii) localizers become functional words though they still express a clear and precise position of things. Moreover, disyllabic localizers start to be used at the end of the period.

5.1. Less and less ordinary nouns used as place words

Starting in Pre-Medieval, place words tend to differ from ordinary nouns. Ordinary nouns simply cannot freely be used as place words: a localizer after the noun is more and more necessary to change it into a place word. Consequently localizers are increasingly frequent as time goes on.

Place names and nouns for places used as place names, however, do not need to be followed by a localizer to count as place words.

Some examples of place words in the *Shi ji* (1st c. BC.) which are formed by Nouns + Localizers and which probably could not have been used as place words without a localizer are:

- (18) *Huang gong yu furen Cai Ji xi chuan zhong*
 Huang prince and spouse Cai Ji have-fun boat in
 ‘The prince Huang and his spouse Cai Ji had fun in a boat.’
- (19) *nai qiu Chu Huai wang sun Xin min jian*
 then seek Chu Huai king grandson Xin people among
 ‘Then, (Xiang Liang) sought Xin, grandson of the king Huai of Chu, among the people.’
- (20) *Kongzi qu Cao shi Song yu dizi xi li da shu xia*
 Kongzi leave Cao go Song with disciple practice rite big tree under
 ‘Kongzi left Cao and went to Song to practice the rites with his disciples under a big tree.’
- (21) *chu chao ze bao yi shi Zhao Dun suo*
 leave court then carry-in-the-arms with go Zhao Dun place
 ‘(She) left the court and then, carrying (her child) in her arms, went with (him) at Zhao Dun.’

In this last example, there is no localizer after the personal noun Zhao Dun, but a noun expressing a place (*suo* ‘residence’), which shows that the personal name can no longer be used as a place word, as it was before (see ex. 1). It is obvious if one compares this

example taken from the *Shi ji* with the similar one extracted from the *Zuo zhuan* (5th c. B.C.), where the personal name Zhao (Dun) is used as a place word:

- (22) *chu chao ze bao yi shi Zhao shi*
 leave court then carry-in-the-arms with go Zhao family
 ‘(She) left the court and then, carrying (her child) in her arms, went with (him) at Zhao.’

5.2. *The locative preposition is no longer necessary to introduce place words*

In Archaic Chinese, when ordinary words were used as place words, they were either objects of verbs of place or movement, or introduced by the locative preposition *yu*. As, beginning in the Han period, ordinary nouns are no longer freely used as place words without being followed by a localizer, the preposition *yu* is often not needed. Examples:

- (23) *Xi yu Qin jiang Yang Xiong zhan Bai Ma*
 Xi and Qin general Yang Xiong fight Bai Ma
 ‘Xi and the general of Qin, Yang Xiong, fought at Bai Ma.’
 [In this example, the place word is a place name]
- (24) *sha Yi Di jiang nan*
 kill Yi Di river south
 ‘(He) killed Yi Di at the south of the river.’
 [The place word is a noun followed by a localizer. Actually there is another example in the same chapter of the *Shi ji* where the preposition *yu* is present : *sha Yi Di yu jiang nan*]

There are still cases, of course, where both the locative preposition *yu* and a localizer following the noun are present, as in:

- (25) *zhong gua yu Chang’an cheng dong*
 plant melon at Chang’an city east
 ‘(He) planted melons on the eastern side of the Chang’an city.’

However, according to Li Chongxing (1992), in chapter 8 of the *Shi ji* (*Gao zu ben ji*), there are 80 place words which are not introduced by the locative preposition *yu*, and only 14 which are introduced by *yu*. If one compares this situation to the one prevailing in Late Archaic Chinese, there is no doubt that there has been some change. Such a change, as said before, is mainly due to the fact that ordinary nouns and place words are now differentiated. As the place word is now formed by a noun and a localizer, the locative preposition is not necessarily needed.

5.3. *Localizers become functional words and some disyllabic localizers start to be used*

Localizers in Pre-Medieval start to play an important grammatical role, as one of their main functions is to follow nouns and transform them into place words. They tend to

behave like functional words though they still express a real and precise position, having what Lǚ Shuxiang (1984: 294) calls a « precise position character » (*dìngxiāngxìng*): ‘on’, ‘under’, ‘in’, ‘outside’, ‘in front of’, ‘behind’, ‘left’, etc. In the case of the localizers *zhong* or *jian* ‘in’, this meaning of a precise position is somewhat blurred. Examples:

- (26) *shi shi Huan Chu wang zai ze zhong*
that time Huan Chu take-refuge (be)-at marsh in
‘At that time, Huang Chu took refuge in the marsh.’
- (27) *yu kong zhong zuo yinyue*
at air in make music
‘(They) made music in the air.’
- (28) *bu fu huan zai shi jian*
negation again return at world in
‘(He will) not return to the world any more.’

In the following example, *shang* does not mean ‘bank’, as would be the case in the Classical Chinese of the Archaic period, but simply ‘on (the surface of)’:

- (29) *zhi jiang jiang shang you yi yu fu cheng chuan*
arrive-at river river on there-be one fish man steer boat
‘Arrived at the river, there was a fisherman steering a boat on the river.’

Another important change which began in Pre-Medieval is the appearance of disyllabic localizers. They are still not frequent, but their occurrences are not so rare. *Shangtou*, for instance, is used on several occasions in Zheng Xuan’s (127–200) commentaries of the *Shi jing*. There are also several examples of disyllabic localizers in Late Han vernacular Buddhist translations of the 2nd c. AD: *shangtou* in *Chang a han shi baofa jing* (Taisho 13) translated by An Shigao, *shangtou* and *houtou*, but also *zuomian* in *Xiu xing benqi jing* (Taisho 184) by Kang Mengxiang and Zhu Dali.

These disyllabic localizers are used alone as subjects or objects, as in Contemporary Chinese. Example:

- (30) *shangtou you*
above there-be
‘There are (some) above.’

Disyllabic localizers are not yet used after nouns. Monosyllabic localizers are still preferred to follow nouns and transform them into place words.

6. Early Medieval period

During the Six Dynasties period (220–581), i.e. in Early Medieval Chinese: (i) there are less and less ordinary nouns used as place words; (ii) some monosyllabic localizers start

to express a « vague position » meaning (undifferentiated localization); (iii) locative pronouns start to be different from demonstrative pronouns.

6.1. Place words

They can be place names (or nouns for place used as place names), monosyllabic or disyllabic localizers, ordinary nouns followed by localizers or pronouns. Examples:

- (31) *Taizu beng yu Luoyang*
 Taizu pass-away at Luoyang
 ‘Taizu passed away at Luoyang.’
 [The place word *Luoyang* is a place name]
- (32) *shang you wan ren zhi gao xia you bu ce zhi shen*
 above there-be ten-thousand ren det.-part. height below there-be negation fathom
 det.-part. depth
 ‘Above there is a height of ten thousand ren, below there is an unfathomable depth.’
 [The monosyllabic localizers *shang* and *xia* are used as place word subjects. For more examples see Zhang Zhende et al. 1995]
- (33) *Yuan zi du liang zai hou*
 Yuan personally take-charge-of provision (be)-at rear
 ‘Yuan personally took charge of the provisions in the rear.’
 [The localizer *hou* is a place word object of the verb *zai*]

An example of an ordinary noun used as a place word is:

- (34) *zai wang yu che er sha zhi*
 carry king at chariot and kill him
 ‘(He) carried the king in the chariot and killed him.’

However, this kind of example become quite rare. Usually, for being qualified as place words, ordinary nouns must be followed by a localizer, as in the following examples:

- (35) *yu Ben mu qian yanyin*
 at Ben mother in-front-of feast
 ‘(They) feast in front of Ben’s mother.’
 [As shown by ex. 35 there are many locative PPs introduced by *yu* in Early Medieval which are preverbal, a situation which really began in the Late Han period, ca. 200 AD. See Peyraube 1994]
- (36) *zai chuan zhong tan qin*
 (be)-at boat in play lute
 ‘(He) was in the boat and played the lute.’

- (37) *mu Wang furen zai bi hou ting zhi*
 mother Wang lady (be)-at wall behind listen them
 ‘(His) mother Lady Wang was behind the wall listening to them.’
- (38) *ke zhi zhe men wai*
 can throw to door outside
 ‘(It) can be thrown out of the door.’

In all the above examples, the localizers are monosyllabic. However, there are now few cases of place words formed by nouns + disyllabic localizers; one can find several examples in the Buddhist translations of the period, for instance in the *Chu yao jing* (ca. 4th c.):

- (39) *shu zai ping litou*
 mouse be-at bottle inside
 ‘The mouse is in the bottle.’
- (40) *xun chu men waitou*
 search go-out door outside
 ‘(He) went outside to search.’

Some other examples of *waimian* and *zuomian* can be found in the *Xian yu jing* (ca. 445)

There are also examples of compound localizers formed by two monosyllabic localizers (see Liu Shizhen 1992):

- (41) *zai ta xibei yi bai bu*
 (be)-at pagoda northwest one hundred step
 ‘It is one hundred steps away from the northwest of the pagoda.’

6.2. Localizers expressing an undifferentiated localization

In the Pre-Medieval period, the meaning of some localizers began to be blurred (see ex. 26–28). In Early Medieval Chinese, this tendency strengthens considerably. Several monosyllabic localizers no longer express any longer a « precise position » (the *dingxiangxin* of Lü Shuxiang 1984, 294) but a « vague position » (*fanxiangxing*). The grammatical function of the localizer then completely overrides its original semantic value. This is the second tide of the grammaticalization of position words: Noun > *dingxiangxin* localizer > *fanxiangxin* localizer. The cases of *shang* and *zhong* are particularly prominent, but also involved are cases of *qian* ‘in front of’, *xia* ‘under’, *bian* ‘on the side of’, *tou* ‘at the head of’, etc. See Li Chongxing (1992). Examples:

- (42) *Changwen shang xiao zai zhe che zhong ... Wenruo yi xiao zuo zhe xi qian*
 Changwen still tiny carry at carriage in ... Wenruo also tiny sit at knee in-front-of
 ‘Changwen was still tiny and was carried in the carriage ... Wenruo, who was also tiny was seated on (his) lap.’

- (43) *sui chang da you bao zhe xi shang*
 even-so grew big still hold at knee on
 '(And) even so (he) was fully grown, (he) still used to hold (him) on his lap.'

Qian and *shang* are used in 42 and 43 to express the same « vague position ».

- (44) *fu mi yi dou song zhe shi zhong*
 carry-on-the-back rice one dou deliver to temple in
 '(He) carried one dou of rice on his back and delivered (it) to the temple.'

Zhong is especially often used as an undifferentiated localizer, though it may still have a « precise position » meaning: 'inside' or 'among' or even 'between', as in:

- (45) *kou zhong han jiao tu zhe zhang zhong*
 mouth in keep-in-the-mouth chew spit at palm inside
 '(He) chewed it inside the mouth and then spit it out into his palms.'
- (46) *shi wu bai ren zhong you yi ren zui shang zhihui*
 this five hundred people among there-be one man most top intelligence
 'Among these five hundred people, there (must) be one who is most intelligent.'
- (47) *you ren yu yan sheng si zhi zhong wu chang ku kong wu wo*
 there-be people say say live dead det.-part. between negation constant bitterness
 emptiness negation I
 'Somebody said that between being alive and dead, there is no constant bitterness
 and emptiness, nor is there the self.'

6.3. Locative pronouns

In Early Medieval, the demonstrative pronouns *ci* 'this' and *bi* 'that' – and their variants – are still often used to express the place, thus having the meaning of respectively 'here' and 'there', especially when the locative pronoun is an object of the locative verb *zai* 'to be at'.

However, and this is indeed a new situation starting, there are also cases where the demonstrative *ci* is followed by either a noun meaning 'place' or a monosyllabic localizer, in order to acquire a locative meaning: *ci di* [this place], *ci chu* [this place], *ci zhong* [this in] or *ci jian* [this in], all meaning 'here'. Examples:

- (48) *ci chu you bai mei xiao ta*
 this place there-be hundred classifier small pagoda
 'Here there are one hundred of small pagodas.'
- (49) *ci zhong kongdong wu wu*
 this in empty negation thing
 'Inside this, it is empty without anything.'

7. Late Medieval

The Late Medieval period (6th–13th c.) is mainly characterized by (i) the appearance of the locative pronouns *zheli* ‘here’ and *nali* ‘there’, which are still common today in Contemporary Chinese, and (ii) the use of almost all the monosyllabic localizers to express an undifferentiated localization, i.e. a very « vague position », which later became uncommon and is still unusual today.

7.1. *Zheli and nali*

The demonstrative pronouns *zhe* ‘this’ and *na* ‘that’ started to be used around the 9th century, at the end of the Tang dynasty (See Wu Fuxiang 1996). But, unlike *ci* and *bi*, they have never been used as locative pronouns at the same time. The localization is still expressed by either *ci* ‘here’, *bi* ‘there’ or *he* ‘where’ – or their variants – as well as their combinations with a noun meaning ‘place’, for instance *chu*, like in the preceding period. Examples:

- (50) *junzi shi hechu zhi ren*
 you be what+place det.-part. people
 ‘Where are you from?’
- (51) *min duo yu shichu qi qiu yuze*
 people most at this+place pray ask-for rain
 ‘The people (then) mostly (came) here to pray for rain.’

However, very shortly after the appearance of *zhe* and *na*, the locative pronouns *zheli* ‘here’ and *nali* ‘there’ emerged to express the localization. Examples:

- (52) *Shitou yue wo zheli you daozi*
 Stone say I here have knife
 ‘(Monk) Stone said: I have knives here.’
- (53) *zheli you er san bai shiseng*
 here there-be two three hundred monk
 ‘There are two or three hundred monks here.’
- (54) *heshang you shenme shi dao zheli*
 monk have what affair come here
 ‘Why did you (the monk) come here?’

In the *Zu tang ji* (dated 952), from where the above examples are taken, the locative pronouns *zheli* and, to a lesser extent, *nali*, are already common: 126 occurrences of *zheli* and 10 occurrences of *nali* for only 12 occurrences of *ci* and 13 occurrences of *bi* used as locative pronouns (see Li Chongxing 1992, Wu Fuxiang 1996).

7.2. Localizers under the Tang dynasty (618–907)

The following considerations and analysis are mostly taken from Wang Ying (1995) who has studied the use of localizers in 1928 Tang poems included in the anthology *Tang shi bie cai*.

The following monosyllabic localizers are attested, with the number of their occurrences: *shang* (319), *xia* (167), *qian* (178), *hou* (29), *li* (122), *nei* (19), *wai* (157), *zuo* (6), *you* (7), *zhong* (423), *jian* (110), *dong* (116), *nan* (113), *xi* (133), *bei* (120), *pang* (25), *ze* (8), *bian* (103), *tou* (96), *di* (23).

Disyllabic localizers are not yet frequent: only 3 occurrences for *shangtou*, 3 for *qiantou*, 5 for *zhongjian* (and 1 for *zhongyang*), 1 for *dongbian* (and 1 for *dongmian*, 1 for *dongtou*), 1 for *nanbian* (1 for *nanmian* and 2 for *nantou*), 1 for *xibian* (and 3 for *xitou*), 1 for *pangze* and 1 for *zepan*.

The monosyllabic localizers are used (i) as adverbials before a verb, (ii) after a preposition forming with it a locative PP used as adverbial or as complement, (iii) after nouns, transforming them into place words. (iii) is by far the most common use of the localizers under the Tang, which explains why Ota (1958) calls the localizers « post-auxiliary nouns » (*houzhu mingci*).

7.3. The undifferentiated localization of the monosyllabic localizers

What is very interesting in Wang Ying's analysis is that he notices that almost all monosyllabic localizers can express an undifferentiated localization, a very vague position, a phenomenon already noticed by the Qing philologist Yu Yue (1821–1907).

Thus, for instance, the localizer *dong* 'east' is sometimes used to express the meaning of *wai* 'outside', or *xi* 'west' is used for *nei* 'in'.

As a matter of fact, if one compares the different editions of some texts, it is not rare to find different localizers in different editions. In Wang Fanzhi's poems, we find: *qian* 'in front of' used for *bian* 'at the side of', *xia* 'below' for *nei* 'in', *dong* 'east' replaced by *xi* 'west', *tou* 'at the head of' replaced by *shang* 'on, above', *zhong* 'in, middle' replaced by *bian* 'at the side of', *li* 'in, inside' replaced by *tou* 'at the head of', *bian* 'at the side of' replaced by *qian* 'in front of', and even *xia* 'under, below' replaced by *shang* 'on, above' or *dong* 'east' replaced by *xi* 'west', i.e. some localizers are replaced by their antonyms!

Examples: *hai xitou* = *hai nantou* (sea west = sea south) in 55, *lin shang* = *lin wai* (forest on = forest outside) in 56, *li shang* = *li xia* (li-tree on = li-tree under) in 57.

(55) *jie luxing mao luo jin hai nantou (xitou)*

bamboo-stick travel ox-tail-decoration fall entirely sea south (west)

'(He) traveled with his bamboo stick decorated with ox-tail (so much so that) the ox-tail decorations all fell on the southern (western) end of the sea.'

(56) *lin wai (shang) jiu jiang ping*

forest beyond (on) Jiu Jiang flat

'The Jiujiang river was flat beyond the forest.'

(57) *zi yan li shang (xia) si*

purple swallow li-tree on (under) cry-out

‘Purple swallows cried out on (under) the li-tree.’

This situation shows that the concrete meaning of some monosyllabic localizers has often been, through a process of grammaticalization, completely bleached, and that these monosyllabic localizers have become real functional markers indicating a very vague position and having simply a syntactic function of transforming the nouns to which they are attached into place words.

The meaning of « precise position » (*dingxiangxing*) of the monosyllabic localizers is, however, still kept. Wang Ying gives the following figures for the two most common localizers of the period, *bian* and *wai*: 73 of them express a precise position and 30 of them express an undifferentiated localization for *bian*, 108 expressing a precise position and 49 an undifferentiated localization for *wai*.

Such a situation can be accounted for in the following terms:

For each localizer, there is a nucleus meaning, which can be precisely described, the one corresponding to a precise position. This meaning, however, is modifiable through semantic operations, motivated or not by textual constraints. Other interpretations can then be derived.

As for the two models discussed in Klein and Nüse (1997) and detailed in Section 2, the basic meaning model is apparently not the right one complying with the medieval Chinese situation. It is not likely that Chinese localizers could obtain specific and particular interpretations by adding some features to a general or basic meaning.

Things seemed to have worked in the opposite way. The lexical meanings of *shang*, *xia*, *qian*, *hou*, etc. are to be considered as specific, representing a typical interpretation: ‘up’, ‘down’, ‘front’, ‘back’, etc. Other uses in context are then derived through reinterpretations. If the spatial features of the relatum (for instance ABOVE, IN CONTACT WITH, in the case of *shang*) are not in accordance with the specific meaning, a reinterpretation is needed, as the speaker conceptualizes differently the theme and the relatum. This reinterpretation implies a cognitive effort.

As the evolution of Chinese localizers has been « precise position or specific meaning » (*dingxiangxing*) > « vague position or general meaning » (*fangxiangxing*), the prototype model has been involved.

8. Conclusion

A few conclusive remarks can be made from the above sketch.

- 8.1. To be qualified as place words, common nouns or personal names do not need to be followed by a localizer in Classical Chinese. Localizers do exist after nouns, but they then always express a precise and concrete localization (*dingxiangxing*).
- 8.2. When they are not direct objects of locative verbs or verbs of movement, the place words are most often introduced by a locative preposition.
- 8.3. Beginning in the Pre-Medieval period, the preposition *yu* is often not needed to introduce place words, but localizers following ordinary nouns or personal names

start to be necessary to qualify them as place words. Disyllabic localizers also start to be used towards the end of the period.

- 8.4. There are less and less ordinary nouns used as place words in the Early Medieval times. Moreover, some monosyllabic localizers express an undifferentiated localization, a vague position (*fanxiangxing*). Finally, demonstrative pronouns are not as frequently used as locative pronouns; they often need to be followed by a noun indicating a place or a position.
- 8.5. The locative pronouns *zheli* 'here' and *nali* 'there', still used today in Contemporary Chinese, appear in the Late medieval period. Also during that period, the use of monosyllabic localizers which express an undifferentiated localization spreads out. It later concerns almost all localizers, which therefore can often be used one in place of another.
- 8.6. The evolution has been *dingxiangxing* > *fanxiangxing*, i.e. from a specific and prototype meaning of localizers to a general one through reinterpretations. The Prototype model instead of the Basic meaning model has been applied.

Note

- * This research has benefited from the National Science Foundation Grant SBR-9421410. I am also indebted to Audrey Y. Li and Jim C. Huang for their valuable comments on a very preliminary version of this chapter, when delivered at the Symposium on Diachronic and Synchronic Studies on Syntax of East Asian Languages, held at the University of Southern California, November 6–8, 1998.

References

- Alleton, V. (1973). *Grammaire du chinois*. Paris: PUF.
- Cartier, A. (1970). Les suffixes nominaux marquant le lieu. Paper delivered at the Congress of Sinologists. Senigalia, Italia.
- Cartier, A. (1972). Les indicateurs de lieu en chinois. *La linguistique* 2.8.
- Chao, Yuen Ren (1968). *A Grammar of Spoken Chinese*. Berkeley and Los Angeles: University of California Press.
- Chu, Zexiang (1996). Hanyu kongjian fangwei duanyu lishi yanbian de jige tedian. *Gu hanyu yanjiu* 1, 57–61.
- Hagège, C. (1975). *Le problème linguistique des prépositions et la solution chinoise*. Louvain: Peeters.
- Klein, W. & R. Nüse (1997). La complexité du simple: l'expression de la spatialité dans le langage humain, *Langage et cognition spatiale*, edited by M. Denis. 1–23. Paris: Masson.
- Legge, J. (1861). *The Chinese classics*. Taipei: Southern Material Center, Inc., 1983 (Reprint).
- Li, Chongxing (1992). Chusuoci fazhan lishi de chubu kaocha. *Jindai hanyu yanjiu*, edited by Hu Zhu'an, Yang Naisi and Jiang Shaoyu. 24–63. Beijing: Shangwu yinshuguan.
- Li, Jingxi and Liu, Shiru (1955). *Zhongguo yufa jiaocai*. Beijing: Wushi nian chubanshe.
- Liu, Shizhen (1992). *Wei-Jin Nan Bei chao lishi yufa*. Nanjing: Nanjing daxue chubanshe.
- Lü, Shuxiang (1947). *Zhongguo wenfa yaolüe*. Shanghai: Shangwu yinshuguan.
- Lü, Shuxiang (1984). *Hanyu yufa lunwen ji*. Beijing: Shangwu yinshuguan.
- Ma shi wen tong* (1898). Beijing: Shangwu yinshuguan (Reprint 1983).
- Ota, Tatsuo (1958). *Chungokugo Rekishi Bunpo*. Tokyo: Konan Shoin.
- Peyraube, A. (1980). *Les constructions locatives en chinois moderne*. Paris: Langages croisés.

- Peyraube, A. (1988). *Syntaxe diachronique du chinois – évolution des constructions datives*. Paris: Collège de France.
- Peyraube, A. (1994). On the History of Chinese Locative Preposition. *Zhongguo jingnei yuyan ji yuyanxue* 2, 361–87.
- Rygaloff, A. (1973). *Grammaire élémentaire du chinois*. Paris: PUF.
- Wang, Ying (1995). Tang shi fangweici shiyong qingkuang kaocha . *Lü Shuxiang xiansheng jiushi huadan jinian wen ji*. 207–213. Beijing: Shangwu yinshuguan.
- Wellman, H. M. & S. A. Gelman (1992). Cognitive development: fundamental theories of core domains. *Annual Review of Psychology* 43, 337–375.
- Wen, Lian (1959). *Chusuo, shijian he fangwei*. Shanghai: Jiaoyu chubanshe.
- Wu, Fuxiang (1996). Dunhuang bianwen de jin zhishici. *Yuwen yanjiu* 3, 30–36.
- Yang, Bojun and He, Leshi (1992). *Gu hanyu yufa ji qi fazhan*. Beijing: Yuwen chubanshe.
- Zhang, Wanqi (1998). Liangci mei de chansheng ji qi lishi yanbian. *Zhongguo yuwen* 3, 208–217.
- Zhang, Zhende et al. (1995). *Shi shuo xin yu yuyan yanjiu*. Sichuan: Bashu shushe.
- Zhao, Cheng (1988). *Jiaguwen jianming cidian*. Beijing: Zhonghua shuju.

Part III

CLAUSE LEVEL STRUCTURES:
PROCESSES OF INTERPRETATION
AND PRINCIPLES OF
ORGANIZATION

JUDGMENTS, POINT OF VIEW AND THE INTERPRETATION OF CAUSEE NOUN PHRASES

S.-Y. Kuroda

‘Point of view is grammaticalization of the mind.’

Carol Tenny [Personal communication]

1. Introduction

As is well-known, two causative constructions, the *o*- and the *ni* – causative, have been recognized in Japanese since the nineteen sixties. Likewise two causative constructions have long been recognized in Romance languages, and they have been a subject of the intensive study among Romance syntacticians. Recently, John Moore has made an interesting discovery: the preinfinitival causee argument of the Spanish causative construction obeys the same constraint as the subject of a categorical judgment. Moore has proposed that the two Spanish constructions can be distinguished by assuming that the embedded clauses present different types of judgments; the causative construction Moore calls the *hacer*₁ causative takes athetic judgment as its complement clause, and the one he calls the *hacer*₂ causative takes a categorical judgment as its complement clause. In the *hacer*₂ construction the causee argument is pre-infinitival.

In this chapter, I will first notice that Moore’s observation on the pre-infinitival causee argument in Spanish generalizes to the causee argument of the *ni*-causative in Japanese. Starting from this observation, I will investigate the semantics of the *ni*-causative and I will maintain that the *ni*-causative involves the causer’s point of view. More specifically, the *ni*-causative can implicate the causer’s categorical judgment which attributes to the causee (the subject of the judgment) the understanding that the causer and the causee mutually intend an event (an action by the causee) to be actualized.

My analysis of the *ni*-causative, then, shares with Moore’s analysis of the *hacer*₂ causative the claim that the syntactic subject of the embedded sentence represents the subject of a categorical judgment. But this categorical judgment is not the one that could be expressed by the embedded clause, and in this respect, my analysis of the *ni*-causative differs from Moore’s analysis of the *hacer*₂ causative. My analysis is not incompatible with an additional proposal that the embedded clause of the *ni*-causative itself also expresses a categorical judgment, as does the embedded clause of the *hacer*₂ causative. But I leave this proposal as an open inquiry.

2. Categorical andthetic judgments¹

In Kuroda (1972a, 1972b, 1973), I maintained that in Japanese CATEGORICAL JUDGMENTS are expressed by topic *wa* sentences and THETIC JUDGMENTS by nontopicalized sentences. The terms CATEGORICAL JUDGMENT and THETIC JUDGMENT were taken from Anton Marty, the eminent Austro-German linguist-philosopher. My primary objective in those papers was historical; I wished to relate modern linguists' concern to an undeservedly forgotten page in the intellectual history of the origin of the 20th century philosophy. Thanks to the interest shown by some modern linguistic semanticists, notably by Ladusow (1994) and Horn (1989), these terms, categorical andthetic judgment, have been re-introduced in the vocabulary of the contemporary linguistic discourse. Nonetheless, those terms might still sound unfamiliar and obscure to the modern ear. In Kuroda (1965), I used the terms PREDICATIONAL JUDGMENT and (NON-PREDICATIONAL) DESCRIPTION, instead of categorical judgment andthetic judgment, respectively. These earlier terms would perhaps be more descriptive and suggestive of the content of the concepts intended for these pairs of terms. However, I will use the former set of terms in the following discussion, conforming to the now common usage of these terms.²

3. Categories of predicates and noun phrase functions

3.1. Preliminary remarks

Leaving terminological matters aside, let us consider the functional contrast of noun phrases that are contained in categorical judgments andthetic judgments. I noted in the earlier work that the subject of a categorical judgment must be functionally definite, i.e., syntactically definite or, if indefinite, interpreted as generic (Kuroda 1965: 40, 42; 1972b: 160f), while noun phrases in nontopicalized sentences can be either definite or indefinite specific. This functional contrast correlates with a similar contrast observed in connection with the interpretation of bare noun phrases at subject position of individual-level and stage-level predicates, as pointed out by Carlson (1980) and later elaborated by Kratzer, Diesing and others.

For our descriptive purpose of showing the functional difference of noun phrases in categorical andthetic judgments, let us use the contrasting terms STRONG/WEAK, instead of DEFINITE/INDEFINITE, following Milsark (1974) and Diesing (1992: 58), and much recent work. However, we do not need the full range of this dichotomy in the present work. More specifically, we need to deal only with bare noun phrases with or without numerals, not with those quantificational determiners, even though the original intent of Milsark introducing these dichotomous terms was to subcategorize determiners. Thus, for our present purposes we may understand that a noun phrase is STRONG, if it is generic or partitive, and WEAK if it is existential or cardinal.

I also noted in earlier work that sentences whose main predicates are verbs in the present tense or are adjectives 'that denote certain constant or inherent qualities' (but not those 'that denote something more or less transient in nature') [Kuroda 1965: 41, 44] are predominantly predicational. One might put this in the recent terminology thus: sentences with individual-level predicates are categorical. Note that the individual-level/

stage-level dichotomy of predicates does not correspond to the categorical/thetic dichotomy of judgments; sentences with a stage-level predicate can represent either a categorical or a thematic judgment.

3.2. Stage-level predicates

Now, observe (1) and (2). The predicate *available* is a stage-level predicate. The subject noun phrases, *firemen* and *two firemen*, can be interpreted either as strong or weak. Both (1) and (2) are ambiguous, as indicated. (1) and (2) can be rendered in Japanese as (3) and (4), respectively. One might say the ambiguity in the English sentences is resolved by the contrast of the two particles, *wa* and *ga*. But this way of describing the Japanese fact is misleading. The correct way to put it is: the ambiguity is resolved by the contrast of the two sentence patterns, the *wa*-topicalized sentence and nontopicalized sentence. The *wa*-topic phrase must be interpreted as strong, while a noun phrase in a nontopicalized sentence, even in subject position, can be weak; that's why the *ga*-version of (3) and (4) can translate the weak interpretation of (1) and (2), respectively.³

- | | |
|--|--|
| (1) + <i>firemen are available</i> | Generic; Existential/Cardinal |
| (2) + <i>two firemen are available</i> | Generic/Partitive;
Existential/Cardinal |
| (3) a <i>syooboosi wa (itumo) taiki-site-iru</i>
fireman (always) ready-do-be
'firemen are (always) available' | Generic |
| b <i>syooboosi ga (asokoni) taiki-site-iru</i>
fireman (there) ready-do-be
'firemen are available (there)' | Existential/Cardinal |
| (4) a <i>syooboosi wa (itumo) hutari taiki-site-iru</i>
fireman (always) two ready-do-be
'two firemen are (always) available' | Generic |
| b + <i>syooboosi ga hutari (asokoni) taiki-site-iru</i>
fireman two (there) ready-do-be
'two (of the) firemen are available there' | Partitive, Existential/Cardinal |

3.3. Individual-level predicates

Next, consider (5) and (6). The predicate *altruistic* is an individual-level predicate. Its subject noun phrase must be interpreted as strong, and must be either generic or partitive. Hence, (5) is not ambiguous; neither is (6), if it is acceptable at all, with the interpretation indicated in parentheses. The Japanese sentences that translate (5) and (6) have *wa*-phrases as subjects.⁴

- | | |
|-------------------------------------|---------|
| (5) = <i>firemen are altruistic</i> | Generic |
|-------------------------------------|---------|

- (6) ?*two firemen are altruistic* ?Partitive
 (Cf: two of the firemen are altruistic) Partitive
- (7) a *syooboosi wa kensinteki-de aru* Generic
 fireman devoted-be
 ‘firemen are devoted’
 b **syooboosi ga kensinteki-de aru*
 fireman devoted-be be
- (8) a *syooboosi wa hutari kensinteki-de aru* Partitive
 firemen two devoted be
 ‘two (of the) firemen are devoted’
 b **syooboosi ga hutari kensinteki-de aru*
 firemen two devoted be

3.4. Summary

The following table summarizes the above observation:

Stage-level predicates	Bare NP subjects
categorical judgment	Strong (Generic/Partitive)
(sentence <i>wa</i> -topicalized)	
thetic judgment	Strong (Partitive), Weak (Existential/Cardinal)
(nontopicalized)	
Individual predicates	
categorical judgment	Strong (Generic/Partitive)
(sentence <i>wa</i> -marked)	

Now, imagine a syntactic configuration where a clause can appear. Assume that in this configuration a clause with a stage-level predicate has its subject interpreted only as strong. Then, this constraint on the noun phrase cannot be one imposed by the predicate of the clause. One might predict that this position is a site exclusively for the subject of a categorical judgment.

A CRITERION FOR A GRAMMATICAL SITE FOR CATEGORICAL JUDGMENTS: A site for the subjects of clauses where stage-level predicates allow only the Strong interpretation is a site for subjects of categorical judgments.

Let us call such a site a ‘C-site.’

For the sake of symmetry, one may also formulate the following criterion:

A CRITERION FOR A GRAMMATICAL SITE FOR THETIC JUDGMENTS: A site for the subjects of clauses where stage-level predicates allow only the Weak interpretation is a site for subjects of thetic judgments.

One may call such a site a ‘T-site.’

In spite of the formal symmetry between these two criteria, there exists an important difference in significance. If a sentence expresses a categorical judgment, it imposes on its subject noun phrase the constraint that it be interpreted strongly. The individual predicate imposes on its subject the same constraint, but the stage-level predicate does not. Thus, if in a syntactic configuration, this constraint is imposed on the subjects of stage-level predicates, a natural conjecture is that this configuration requires that the subject position expresses the subject of a categorical judgment.

In contrast, thethetic judgment does not require that any noun phrase in it be weak. Hence the above criterion for a T-site is stronger than follows from the general property ofthetic judgments. If such sites exist, their functional significance should rather be characterized as sites that exclude categorical judgments, not as sites exclusively forthetic judgments. Now, it is remarkable that T-sites indeed exist: the criterion for T-sites is nothing but the definiteness constraint, which has drawn much theoretical attention in recent literature. Primary concerns of the present chapter, however, are about C-sites; the issue concerning the relation betweenthetic judgments and the definiteness constraint, important though it is, is left aside in this study.

4. Categorical/thetic in Spanish Word order in simple sentences

Mejías-Bikandi (1993) identified C- and T-sites for Spanish. He considered two word-order configurations for independent clauses in Spanish, one the subject following the verb, *V SX*, and the other the subject preceding the verb, *S VX*. Mejías-Bikandi observed that the subject of a stage-level predicate can be interpreted only as weak in the verb initial word order, while in contrast it can be interpreted only as strong in the subject initial word order. Compare (9) and (10). *Tres niñas* is existential in (9) and partitive in (10).

(9) *V SX* word order

jugaban tres niñas al truco
played three girl hopscotch

Weak: Existential

‘there were three girls playing hopscotch’

(10) *S VX* word order

TRES NIÑAS jugaban al truco
three girls played hopscotch

Strong: Partitive

‘three (of the) girls played hopscotch’

Similarly, in (11) with the word order *V SX*, the subject is interpreted as existential. On the other hand, *un tren* in (12) cannot be interpreted as existential; it can perhaps be interpreted as partitive, but a singular indefinite noun can be interpreted as generic in Spanish, and so this interpretation overshadows the partitive reading; the stage-level predicate is then shifted to an individual-level counterpart.

- (11) VSX word order
llega un tren al anden Weak: Existential
 arrive a train at-the platform
 ‘a train arrives at the platform’
- (12) SVX word order
UN TREN llega al anden Strong: Generic
 a train arrive platform
 ‘A train (generic) arrives at the platform’

In summary, Mejías-Bikandi found a contrast in Spanish that corresponds to the so-called *wa-ga* contrast in Japanese:

The sentence with a *ga*-marked subject: VSX →thetic judgment → *weak*
 The sentence with *wa*-marked subject: SVX → categorical judgment → **STRONG**

5. Spanish causatives

John Moore (1997) identified another C-site in Spanish. It is a site for a clause embedding in a causative construction. In Spanish we can distinguish two causative constructions, *hacer*₁ and *hacer*₂. This contrast of the two causative constructions reminds us of a similar contrast in Japanese, *o-* and *ni-*causatives.⁵

For the interest of space, I will only summarize Moore’s conclusions. I refer the reader to Moore’s paper for the arguments that substantiate them. We can distinguish two possible word orders for Spanish causative forms: *Cr hacer VXCe* and *Cr hacer Ce VX*.

- (13) *VXCe*
Pedro le hizo pagar los tragos a un marinero
 made pay drink sailor
 ‘Pedro made a sailor pay for the drink’
- (14) *CeVX*
hicimos a Marta leer los libros
 we-made read books
 ‘we made Marta read the books’

The first word order is structurally ambiguous between the *hacer*₁ construction and *hacer*₂ construction, while the second word order represents exclusively the *hacer*₂ construction.

We are particularly interested in the interpretation of indefinite causee argument. The causee argument of the *hacer*₁ construction imposes no restriction; an indefinite noun phrase at the causee argument can be either weak or strong. In contrast, the causee argument of the *hacer*₂ construction must be strong. This fact is reflected in the following contrast:

NP HACER <i>VXCE</i> : Structurally ambiguous	Weak, Strong
(15) <i>Pedro le hace</i> [_{VP} <i>cazar ratones a un gato</i>] 'Pedro makes a cat (existential, ?partitive) hunt mice'	Existential
(16) <i>hicimos</i> [_{VP} <i>cazar ratones a tres gatos</i>] 'we made three cats (?three of the cats) hunt mice'	Cardinal
(17) ? <i>Pedro le hace</i> [_{IP} <i>cazar ratones A UN GATO</i>] 'Pedro made cats (generic) hunt mice'	Generic
(18) ? <i>hicimos</i> [_{IP} <i>cazar ratones A TRES GATOS</i>] 'we made three of the cats hunt mice'	Partitive
NP HACER <i>CEVX</i> : Structurally unambiguous	Strong
(19) <i>Pedro hace A UN GATO cazar ratones</i> 'Pedro makes a cat (generic) hunt mice'	Generic
(20) <i>hicimos A TRES GATOS cazar ratones</i> 'we made three of the cats hunt mice'	Partitive

From these observations, Moore draws the following conclusion:

MOORE'S GENERALIZATION: The causee site for the infinitive complement of *hacer*₂ is a categorical-site.

6. Japanese causatives

6.1. Basic facts

Let us now go to Japanese. In Japanese productive causatives (as opposed to lexical causatives) are formed by the bound morpheme (verb) *-sase*.⁶ It is well-known that, as with Spanish *hacer*, two different causative sentence structures are constructed with *-sase*. However, the distinction of the two structures is apparent phonetically only when an intransitive verb is embedded under the causative verb: the causee argument (i.e., the subject of the embedded verb) is case-marked accusatively by *-o* or datively by *-ni*. Compare (21) with (22) and (23) with (24):

- (21) *Yamada-san wa Tanaka o tukai ni ik-aseta*
Yamada-san Tanaka errand go-made
'Mr. Yamada made Tanaka go on errands'
- (22) *Yamada-san wa Tanaka ni tukai ni ik-aseta*
Yamada-san Tanaka errand go-made
'Mr. Yamada made Tanaka go on errands'

(23) *Katoo wa Satoo o mise e hasir-aseta*
 store to run-made
 ‘Katoo made Satoo run for errands’

(24) *Katoo wa Satoo ni mise e hasir-aseta*
 store to run-made
 ‘Katoo made Satoo run for errands’

These two causative constructions are known as the *o*-causative and the *ni*-causative. These structures are semantico-functionally different. We will come back to the semantic side of the issue later. With a transitive base verb, there is no phonetic distinction between the two constructions. The causee (i.e., the embedded subject) is necessarily marked datively by *ni* and the embedded direct object accusatively by *o*. Whether the two distinct causative constructions exist underlyingly even with transitive base verbs, which merge into one and the same surface construction type, is debatable. We could ignore this question and restrict ourselves to the causative form with an intransitive base verb, and will do so. To summarize schematically, we have:

BASE VERB TRANSITIVE	
One phonetic form	Cr ga Ce ni O o V saseru
BASE VERB INTRANSITIVE	
Two phonetic forms	Cr ga Ce o V saseru Cr ga Ce ni V saseru
Two underlying representations	
<i>o</i> -causative:	Cr ga [Ce V] _{VP} saseru
<i>ni</i> -causative:	Cr ga [Ce V] _{IP} saseru

6.2. Interpretations of the Causee argument

Now, I would like to claim that the subject of the embedded clause of the *ni*-causative construction is a C-site, just like that in the Spanish *hacer*₂ construction is. Consider the following pair (25)–(26):

(25) *Yamada-san wa se-no hikui hito o tukai ni ik-aseta*
 Mr. Yamada height low person errand for go-made
 ‘Mr. Yamada made a short person go on errands’
 (Mr. Yamada sent a short person on errands)

(26) *Yamada-san wa se-no hikui hito ni tukai ni ik-aseta*
 Mr. Yamada height low person errand for go-made
 ‘Mr. Yamada made a short person among them go on errands’
 (Mr. Yamada sent a short person among them on errands)

(25) can be simply a description of a scene where Yamada sent a person for errand, and this person was (or, could happen to be) a short person. In contrast, (26) cannot be quite

that neutral. The sentence would sound natural, for example, in a context where for some reason or other, Mr. Yamada chose a short person among the possible alternatives. Compare the pair (25)–(26) with the following pair:

(27) *Smith-san wa nihongo ga wakaru gakusei o mise e hasir-asete*
 Smith Japanese understand student store to run-made
 ‘Smith made a student who understands Japanese run to the store’

(28) *Smith-san wa nihongo ga wakaru gakusei ni mise e hasir-asete*
 Smith Japanese understand student store to run-made
 ‘Smith made a/the student who understands Japanese among them run to the store’

Imagine there is a shop in Santa Monica run by a Japanese owner and Japanese is better understood than English there. Mr. Smith decided to dispatch a student who can speak Japanese to do errands. Either (27) or (28) is adequate for describing the situation, but (28) makes the point that Mr. Smith chose one who understands Japanese from among other alternative choices. The modifying clause *nihongo ga wakaru* ‘who understands Japanese’ in (28) makes it easier to grasp this selective connotation than *se ga hikui* ‘short’ in (26), because it is easier to imagine a situation where one who understands Japanese is sent to a store than to imagine one for sending a short person to a store. In this respect, (28) is a better example to illustrate the connotation of the *ni*-causative. In contrast, just on the same ground, but reversing the roles, (25) with the modifier *se ga hikui* ‘short’, is better than (27) with the modifier *nihongo ga wakaru* ‘who understands Japanese,’ to illustrate the neutral, merely existential connotation of the causee noun phrase. For, the modifier *nihongo ga wakaru* ‘who understands Japanese,’ by its meaning alone, without the help of the constructional meaning of the *ni*-causative, is more likely, in the syntactic context given in these examples, to imply the existence of a good reason to choose someone with this qualification. Not so with the modifier *se ga hikui* ‘short,’ and hence it is easier with it to grasp an unbiased neutral reading. Thus, all told, to get the semantic/functional contrast between the *o*-causative and the *ni*-causative, it is not only necessary to compare paired *o*- and *ni*-causative forms in each set, but it is also helpful to pair these two paired examples.⁷

To sum up, the *ni*-causative imposes the AMONG reading on bare noun phrases in the causee argument. This AMONG reading is not partitive interpretation in the usual sense, but shares a common feature with it. The partitive interpretation can be taken as a special case of the among reading where a choice is made from among alternatives of the same kind. Then, it is natural to count noun phrases with the AMONG reading as strong noun phrases.

Now, let us consider examples with numeral quantifiers:

(29) *Yamada-san wa se-no hikui hito o hutari tukai ni ik-asete*
 height low person two errand for go-made
 ‘Mr. Yamada made two short persons go on errands’
 (‘Mr. Yamada sent two short persons on errands’)

- (30) *Yamada-san wa se-no hikui hito ni hutari tukai ni ik-asete*
 height low person two errand for go-made
 ‘Mr. Yamada made two short persons go on errands’
- (31) *Smith-san wa nihongo no wakaru gakusei o hitori mise e hasir-asete*
 Smith Japanese understand student one-person to store to run-made
 ‘Smith made a student who understands Japanese run to the store’
- (32) *Smith-san wa nihongo no wakaru gakusei ni hitori mise e hasir-asete*
 Smith Japanese understand student one-person to store to run-made
 ‘Smith made one of the students who understands English among them run to the store’

We first concentrate on the reading of these sentences in which the host nouns and the associated numerals are pronounced as forming a phonological unit without a pause between them. With this reading, we can assume that the numerals are inside the host noun phrases and not really ‘floating’, even though they may appear to be so, being at post-case-marked position. We agree to call numerals in this context pseudo-floating. Pseudo-floating numerals are, as a general rule, construed indefinite, without further constraint, that is, either as existential, cardinal or partitive. And indeed that is what we get with the *o*-causative forms, (29) and (31), with the numerals being construed either as existential, cardinal or partitive and without any additional pragmatic conditions imposed.

In contrast, the *ni*-causative forms, (30) and (32), seem to require partitive construal and additional connotation of ‘choosing among possible alternatives.’ The implied possible alternatives could either be of the same kind (‘short people’ and ‘students who understand Japanese’) or not; in the former case, the reading of the numerals is purely partitive, in the latter case, it is partitive accompanied with an added AMONG reading connotation. Thus, (30) connotes ‘Mr. Yamada chose two of the short persons available, possibly among other possible alternatives and made them go on errands.’

Thus, we can conclude that the causee argument of the *o*-causative form does not impose any constraint on pseudo-floating numerals, while the causee argument of the *ni*-causative imposes the ‘strong’ reading on pseudo-floating numerals.

If we put clear pause between the host nouns and the associated numerals, or separate them with an adverbial, we get real ‘floating’ numerals.

- (33) *Yamada-san wa se-no hikui hito o, hutari tukai ni ik-asete*
 height low person two errand for go-made
 ‘Mr. Yamada made two short persons go on errands’
 (‘Mr. Yamada sent two short persons on errands’)
- (34) *Yamada-san wa se-no hikui hito o, isoide, hutari tukai ni ik-asete*
 height low person hurriedly two errand for go-made
 ‘Mr. Yamada made two short persons go on errands hurriedly’
 (‘Mr. Yamada sent two short persons on errands hurriedly’)

- (35) *Yamada-san wa se-no hikui hito ni, hutari tukai ni ik-aseta*
 height low person two errand for go-made'
 'Mr. Yamada made TWO SHORT PERSONS go on errands'
- (36) *Yamada-san wa se-no hikui hito ni, isoide, hutari tukai ni ik-aseta*
 height low person hurriedly two errand for go-made
 'Mr. Yamada made two short persons go on errands hurriedly'
- (37) *Smith wa nihongo ga wakaru gakusei o, hitori mise e hasir-aseta*
 Smith Japanese understand student one-person store to run-made
 'Smith made a student who understands Japanese run to the store'
- (38) *Smith wa nihongo ga wakaru gakusei o, isoide, hitori mise e hasir-aseta*
 Smith Japanese understand student one-person to store to run-made
 'Smith made a student who understands Japanese run to the store'
- (39) *Smith wa nihongo ga wakaru gakusei ni, hitori, mise e hasir-aseta*
 Smith Japanese understand student 1.person store to run made
 'Smith made one of the students who understands English among them rush to the store'
- (40) *Smith wa nihongo ga wakaru gakusei ni isoide hitori mise e hasir-aseta*
 Smith Japanese understand student in-rush 1-person store to run-made
 'Smith made one of the students who understands English among them rush to the store'

In these forms, either *o*-causative or *ni*-causative, numerals are construed as partitive. But it is a general rule that real 'floating' numerals are construed as partitive. Hence, this fact does not imply anything particular about the causee argument position, either of the *o*-causative or the *ni*-causative.⁸

From the preceding observations, I conclude:

THE EXTENSION OF MOORE'S GENERALIZATION TO JAPANESE NI-CAUSATIVES: The complement site of the *ni*-causative is a categorical cite.

7. The semantics of the *ni*-causative

7.1. Spanish *hacer*₂

It is remarkable that both Spanish and Japanese have two causative constructions and that the embedded clause of one of them is a C(ategorical)-site. However, it is yet to be determined if these C-sites are functionally equivalent. Initial indications, if anything, seem to suggest that they are not. There is even a formal difference between the Spanish and the Japanese causative constructions that host these C-sites. The Spanish *hacer*₂ construction marks the causee argument accusatively; and it does so even when the embedded verb is transitive.

Moore characterizes the semantic distinction of the two Spanish causative constructions in terms of direct and indirect causation, following Strozer (1976), and others. ‘Direct causation’ is defined as ‘lack of agentivity and sentience on the part of the causee’ (Treniño 1994), ‘attenuated agentivity and physical manipulation’ (Shibatani 1973, 1976), ‘lack of volitionality on the part of the causee’ (Ackerman and Moore 1999). It is important to note that the direct causation, as Moore uses the term, presupposes ‘potential volitionality to suspend.’ With this understanding of direct causation, Moore attributes direct causation to *hacer*₂; in contrast, *hacer*₁ is neutral with respect to the distinction between direct and indirect causation, unless other factors intervene. To reconfirm this point, observe the following contrast. (I add Japanese equivalents for later reference.)

(41) *NP hacer VXCe*

Indirect Causation

ese maestro hará odiar las matemáticas a Pedro
 ‘that teacher will make *Pedro* hate mathematics’
ano sensei wa Pedro o suugaku ni unzari-s-aseru
 that teacher mathematics disgust make

(42) *NP hacer CeVX*

Direct Causation

#ese maestro hará a Pedro odiar las matemáticas
 ‘that teacher will make *Pedro* hate mathematics’
 **ano sensei wa Pedro ni suugaku ni unzari-s-aseru*
 that teacher mathematics disgust make

(42) is odd because the direct causation entailed by *hacer*₂ presupposes potential volitionality to suspend, but the embedded verb *odiar* ‘hate’ excludes volitionality on the part of its subject, i.e., the causee. In contrast, *hacer*₁ by itself does not impose either direct or indirect causation, but the semantics of *odiar* excludes a direct causation reading in (42).

Direct causation implies ‘a greater degree of force applied to the causee’ (Strozer), and for that the subject of the embedded clause must be singled out as a patient in the embedding structure. It is a common practice in the generative grammar tradition to have recourse to the object control (Equi-NP) construction in order to single out the embedded subject syntactically. However, Moore convincingly argues against the object control analysis of the *hacer*₂ construction on syntactic grounds. Besides, the object control verb like *forzar* does not impose on the controller (and hence the embedded subject) a strong interpretation for indefinite noun phrases: the clause embedding of an object control verb is not a C-cite. The object control construction fails to account for the syntactic and functional characteristics of the *hacer*₂ construction. But, as Moore reasons, the embedded clause of *hacer*₂ represents a categorical judgment, and this representation fulfills the role of singling out the causee argument as the subject of a categorical judgment.

7.2. Japanese causatives and direct causation

The Japanese *ni*-causative selects a volitional causee argument, while the *o*-causative does not impose such a selectional restriction on the causee argument, as indicated by the grammatical and ungrammatical Japanese sentences given as translations in (41) and (42), respectively.

In this respect, we see a parallelism between the Spanish *hacer*₂ causative and the Japanese *ni*-causative. However, I am not convinced that the contrast between direct and indirect causation (or, the contrast between direct causation and lack of that implication) is the best means to capture the functional contrast between *o*- and *ni*-causative pairs like those given above. I doubt we can say that the Japanese *ni*-causative necessarily involves attenuated, let alone, suspended volitionality.

To be sure, the *ni*-causative appears to entail not only volitionality on the part of the causer, as expected, but, I believe, also volitionality on the part of the causee. The contrast between the *o*- and *ni*-causative in this respect can be seen with a verb which normally does not involve the volition of the subject but can under special circumstances. One such verb is *korobu* ‘fall down.’ Compare:

- (43) a *Katoo o korob-ase-yoo*
 b *Katoo ni korob-ase-yoo*
 fall down cause let-us
 ‘Let us cause Katoo to fall down’

(43a) does not entail the involvement of the causee Katoo volition. In contrast, (43b) entails the involvement of the causee’s volition, though not necessarily willingness. Imagine a situation where we want to show that speed bumps in a narrow street without side-walks are dangerous for pedestrians, and have chosen Katoo to tumble down at a bump intentionally. The volitionality involved in such a case might indeed be described as attenuated. To this extent, Moore’s characterization of the functional value of *hacer*₂ is compatible with my intuition on the meaning of the *ni*-causative. But, if ‘direct causation’ means that the causer’s volition is more directly responsible for the caused event than the causee’s and this feature of direct responsibility is what distinguishes the two causatives in Japanese, as exemplified in (43), it is the *o*-causative rather than the *ni*-causative that must be identified with direct causation.

7.3. The *ni*-causative and propositional attitudes

Be that as it may, let us follow Moore’s lead and pursue the significance of the hypothesis that the causee of the *ni*-causative is a C-site. We must ask what the content of the categorical judgment might be of which this C-site is the subject.

A judgment is a cognitive act, a mental event that takes place in someone’s mind. When we state, of some independent sentence, that it represent a categorical orthetic judgment, what is meant is that a token of this sentence represents a judgment made by the speaker. More generally, sentences representing a judgment can be found embedded at

a site for propositional attitudes. A token of such a sentence expresses a judgment claimed by the speaker to have been made by someone to whom propositional attitudes are attributed. For example, consider

- (44) *Masao wa syooboosi wa kensinteki de aru to omotte iru*
 firefighters devoted are think
 ‘Masao thinks firefighters are devoted’

The embedded sentence expresses a categorical judgment, ‘firefighters are devoted,’ which the speaker attributes to Masao. Masao is taken as one who judges.

The *ni*-causative is not a usual type of a construction that indicates propositional attitudes; its main verb is not a propositional attitude predicate. Nonetheless, I would like to propose that it involves propositional attitudes of the matrix subject, the causer. Consider (32), which I repeat here.

- (45) *Smith-san wa nihongo no wakaru gakusei ni hitori mise e hasir-asete*
 Smith Japanese understand student one-person store to run-made
 ‘Smith made a student who understands Japanese run to the store’

The *ni*-causative (45) implies that Smith chose one of the students who understands Japanese from among other possible candidates. Given this implicature, it is natural, if not absolutely necessary, to interpret that the speaker’s selection of the modifying phrase ‘who understands Japanese’ expresses the speaker’s understanding of why Smith chose this particular person. It is, thus, natural to assume that the speaker of (45) attributes propositional attitudes to the causer, inasmuch as the speaker can implicate that it is the causer who identifies the causee as one of the students who understand Japanese. The question still remains, though, as to whether the speaker attributes an act of categorical judgment to the causer, and what the categorical judgment is. We put this question aside for awhile and continue to dwell on the problem of how the causee is characterized.

Continue to imagine the same utterance context for (45). Assume that the person who was chosen by Smith happened to have the last name Tanaka, but Smith did not know this last name. (Smith could have known the causee only by the first name.) The speaker could have uttered the following sentence, instead of (45), with the intention of implying that Smith chose Tanaka from among other possible candidates, without, however, any implicature this time as to why Tanaka was chosen.

- (46) *Smith-san wa Tanaka ni mise e hasir-asete.*
 store run-make
 ‘Smith made Tanaka run to the store’

Under the present assumption, the speaker cannot attribute to the causer’s propositional attitudes the selection of the name Tanaka for the causee argument in this utterance. Thus, the descriptive content of the causee noun phrase does not entail, but can implicate, as the case may be, propositional attitudes of the causer. But this is a familiar situation with

de dicto/de re ambiguity of an argument position inside an embedded clause for propositional attitudes. Consider, for example, ‘John was afraid that a man with a knife would attack him’ might implicate, but does not entail, that a man with a knife was registered in John’s consciousness. Neither does ‘John was afraid that Bill would attack him’ entail that John knew that Bill was Bill.

Nonetheless, the fact that the *ni*-causative (45) can have the above mentioned implicature, according to which the descriptive content of the noun phrase at the causee argument can be attributed to the causer, suggests that it is a part of the propositional attitudes of the causer expressed in the sentence. What could the content of the propositional attitudes in question be?

7.4. *The ni-causative and mutual intention*

In general, when the causer A intends to have causee B do something, it is not necessarily the case that B is made aware of A’s intention. But in the case of the *ni*-causative, my hypothesis is that the causer intends the causee to be aware that the causee was made to do what s/he was. (The causer, though, may use an intermediary agent to the effect that the causee may not realize who the ultimate causer is. For the sake of simplicity of exposition, I ignore this complication. The reader may wish to supplement relevant occurrences of ‘causer’ with ‘or perhaps someone else’ to appreciate the complication to be ignored here.) By means of the *ni*-causative form, the speaker reports that the causer held (or, holds) this intention. The speaker also reports at the same time that the causer executed (or, will execute) this intention. The speaker’s report, then, entails that the causer judges that the causee understands that the causer intends the causee to do what the causer wants. The causee intentionally acted (if the tense of the sentence is past), or will act (if the tense of the sentence is future), as wanted. Thus, the causee knew (or, will know) that the causee’s action was (will have been) intended by both the causer and the causee. We might, then, hypothesize that according to the speaker, the causer makes a categorical judgment attributing this knowledge to the causee as its subject.

The *o*-causative does not have this connotation; the causer may contrive to get the causee to do something, or to be in some state, without the causee suspecting that the causer (or, for that matter, anybody else) intends that to happen. In this respect, the *ni*-causative, but not the *o*-causative, shares a semantic characteristic with the verb ‘ask’; if you ask somebody to do something, they are made aware that you intend them to do so.

The implicature of the *ni*-causative form could be stronger. The causer and the causee mutually understand that the intended act of the causee is executed with mutual agreement; it is mutual knowledge between the causer and the causee that both intend the act to be done. The causee knows that the causer intends the act to be done; the causer knows that the causee knows the causer intends the act to be done; the causee knows that the causer knows that the causee knows that the causer intends the act to be done; etc, etc. By the *ni*-causative, then, the speaker can assert that the causer attributes this mutual knowledge to the causee. This attribution, so we might hypothesize, is what constitutes an implied categorical judgment, made by the causer, about the causee.

So far, I have concentrated on *ni*-causative forms of which the causee argument is quantified with a numeral quantifier. I have claimed that such a quantifier requires the AMONG reading. But I do not intend to claim that the AMONG reading is required of the causee argument of the *ni*-causative form in general. Indeed, semantics or pragmatics can exclude the possibility of such an AMONG reading. The reason I have so far treated examples with numeral quantifies is that they force the AMONG reading, and with the AMONG reading, we can see more easily how the speaker might select a noun phrase for the causee argument position on the basis of the causer's propositional attitudes. This helps to understand how the causer's propositional attitudes might be involved in the semantic function of the *ni*-causative. But the AMONG reading is not a necessary semantic component of the *ni*-causative form; to see this point, consider the following examples:

- (47) *Torre kantoku wa Irabu o nage-tuzuke-saseta*
 Torre manager Irabu pitch-continue-made
 'Manager Torre made Irabu continue pitching'
- (48) *Torre kantoku wa Irabu ni nage-tuzuke-saseta*
 Torre manager Irabu pitch-continue-made
 'Manager Torre made Irabu continue pitching'

Irabu is in trouble at a crucial moment of the game. Torre is worried and feels he has to make a decision. Torre goes up to the mound, calms Irabu down, asks him if he's ok, and if he wants to continue; Irabu nods, Torre pats him and leaves: Torre let Irabu continue. One can either say (47) or (48). The difference is quite subtle. Nonetheless, (47) sounds a simpler, more objective description. According to the above formulation of the semantics of the *ni*-causative, (48) implies that Irabu knows that Torre wants him to continue and that Torre knows that he knows.⁹

In any case, in these contexts, there is possibly no one other than Irabu who can CONTINUE to pitch. There can be no connotation that Torre chose Irabu from among other possible candidates to CONTINUE to pitch.

Or, consider a situation in which a father decided to let a son go to an art school, in spite of initial reservation about it:

- (49) *Titi-oya ga musuko ni bityutu-gakkoo e ik-aseru koto ni sita*
 father son art-school go-cause COMP decided
 'the father decided to let the son go to the college of fine arts'

Here, too, no question of choosing among other possible candidates is involved. Nonetheless, some degree of mutual understanding concerning the father's and the son's decision is implied.

As a first step, let me give a description of the cognitive content of the *ni*-causative form as follows:

- (50) NI-CAUSATIVE: the causer *Cr* causes the event *E* described by the embedded sentence by means of a mutual intention that the causee *Ce* have it happen.¹⁰

where

- (51) MUTUAL INTENTION (held by A and B): Both A and B intend event E to happen and they mutually-judge that they do.
- (52) MUTUAL JUDGMENT (by A and B): A and B make the same judgment and the fact that they do is mutual knowledge between them.

If a *ni*-causative sentence involves a categorical judgment about the causee, a crucial question that must be posed is: who makes that judgment? Assume (50) is on the right track to describe the semantic function of the *ni*-causative. Note that (50) says both causer and causee are ones who make a judgment. The causer judges, among other things, that the causee knows that both the causer and the causee intend *CeXV* to happen and the causee also knows that the causer knows that, too. The causee also judges, among other things, that the causer knows that both the causer and the causee intend *CeXV* to happen, and the causer also knows that the causee knows that, too. These judgments by the causer and the causee can each be categorical, in fact, must be categorical; these judgments attribute certain knowledge to the causee or the causer. To sum up, (50) implies that the causer makes a categorical judgment about the causee and the causee makes a categorical judgment about the causer.

7.5. The semantics of the *ni*-causative

This much is cognitive/metaphysical fact, given (50). The linguistic question is how this fact is linguistically coded in the *ni*-causative construction. We have determined earlier that the causee argument is a C-site. This suggests that a categorical judgment about the causee is implied in the *ni*-causative. We can take this as an indication that the causer's judgment about the causee is implied in the *ni*-causative construction.

Another question must be raised: Is the causee's categorical judgment about the causer not also implied in the *ni*-causative? If it is, indefinite noun phrases at the causer argument must be interpreted only as strong. I believe that is not the case. The causer argument of the *ni*-causative can take weak noun phrases:

- (53) *Amerika-zin ga hutari (sorezore) nihongo no wakaru gakusei o mise e hasir-asete*
 American two-person each Japanese understand student store run-made
 'Two Americans (each) made a student who understands Japanese run to the store'
- (54) *Amerika-zin ga hutari (sorezore) nihongo no wakaru gakusei ni mise e hasir-asete*
 American two-person each Japanese understand student store run-made
 'Two Americans (each) made a student who understands Japanese run to the store'

Here, the noun phrase *Amerika-zin ga hutari* can be taken as existential. From above considerations, I maintain that the *ni*-causative designates the causer argument as one who makes a categorical judgment, but not the causee. The *ni*-causative entails that the

causer makes a categorical judgment of which the subject is the causee (i.e., a categorical judgment attributing a property – in fact, a kind of knowledge, to the causee). This judgment presupposes that the causee is represented cognitively as a substratum (*hypokeimenon*) – a stable bearer of attributes, and this in turn requires that the linguistic term that denotes the causee must be definite or, if indefinite, strong. Let us incorporate this information in the semantics of the *ni*-causative form:

- (55) The NI-CAUSATIVE FORM states that the causer *Cr* causes the event *E* described by the embedded sentence by means of a mutual intention that the causee *Ce* have it happen; it implies that the causer makes a categorical judgment attributing the knowledge of the mutual intention to the causee.

8. The *ni*-causative and point of view as point of judgment

There is a significant, but not at all plausible consequence of the semantic claim made in (55). The *ni*-causative construction is claimed to entail a categorical judgment of the causer about the causee, but this judgment is not one that would be expressed by a clause of which the causee is the subject, for example:

- (56) *nihongo no wakaru gakusei wa mise e hasiru*
 Japanese understand student store run
 ‘The student who understands Japanese run to the store’¹¹

The content of the categorical judgment in question is not linguistically coded, that is, it can not be compositionally deciphered from lexical items contained in the sentence and the way they are arranged in it. It must be of a very complicated conceptual structure that almost defies an adequate representation in human language.

Be that as it may, there is an aspect in our contention that is fairly solid in intuitive grasp of the meaning of the *ni*-causative construction. To express a judgment is one way point of view is linguistically represented. To identify the causer as one who makes a categorical judgment is to indicate that the causer’s point of view is represented.

To say that sentences, or parts thereof, represent A’s point of view means that they present content of A’s consciousness. I introduced the term ‘point of view’ in this sense in linguistic theorizing and description in Kuroda (1973), borrowing the concept from literary criticism. Since then, however, as Iida (1996: 64) correctly points out, ‘the term *point of view* has been used loosely [in linguistic literature], and the intended notion varies considerably from one author to another: it refers to various notions like *perspectivity*, *empathy*, and *logophoricity*.’ I use the term here in the sense I originally intended.¹²

The *ni*-causative sentence as an independent sentence presents the speaker’s point of view in the ordinary speech. But it also contains a presentation of the causer’s point of view. This is a conclusion to be drawn from the preceding hypothesis on the semantic function of the *ni*-causative, and this conclusion, I believe, fits well with intuitive understanding of the meaning of the *ni*-causative, even though the content of the categorical judgment attributed to the causer might be elusive to clear understanding and

might defy succinct description, and one might dispute the validity of the description made above.

9. Conclusion

Let me formulate general statements about the basic concepts employed above and apply them to the description of the *ni*-causative construction.

0. In ordinary discourse, a matrix sentence represent the speaker's point of view.

1. A judgment presupposes someone who judges. In ordinary discourse a matrix declarative sentence represents a judgment, and the one who judges is the speaker.

2. The grammatical structure of a sentence may designate sub-point of view in addition to the matrix point of view.

3. The grammatical structure of a sentence may entail a judgment attributed to (made by) a sub-point of view of the sentence. The grammatical structure can represent the substratum (*hypokeimenon*) which the (categorical) judgment is about, but the content of the judgment may not necessarily be expressed by a linguistic representation.

Applied to *ni*-causatives:

2. The *ni*-causative designates the causer (matrix subject) as a sub-point of view.

3. The causer makes a categorical judgment. The categorical judgment attributes the causee (the subject of the judgment) the knowledge that the causer and the causee mutually intend something and that they mutually judge that they do.

Notes

- 1 I would like to express my gratitude to John Moore, whose work on Spanish causatives directed my attention to the problems in Japanese causatives discussed in this chapter and who read an early draft and provided me with valuable comments. I would also like to thank Richard Larson for his comments and suggestions. The following notations at the heads of examples are used. +: ambiguous in relevant respects; =: nonambiguous in relevant respects; #: odd. In addition to conventional abbreviation, the following are used. Ce: Causee; Cr: Causer. Japanese sentences given as if translation under Spanish/English examples (and vice versa) are not necessarily optimally correct translations of the corresponding Spanish/English sentences; I took the liberty of choosing Japanese to indicate relevant grammatical points optimally with as much naturalness as possible at the expense of semantic/pragmatic equivalence.
- 2 A more recent and comprehensive exposition of these notions, the reader is referred to Kuroda (1992), Chapter 1 'Judgment forms and sentence forms.'
- 3 Here we consider only those interpretations of Japanese bare noun phrases that correspond to possible interpretations of English bare noun phrases. More specifically, a Japanese bare noun phrase can translate an English noun phrase with a definite article, thus interpreted as definite specific. Such interpretations are irrelevant to the issue we are concerned with in this chapter and excluded and left unmentioned in the following discussion. Thus, the *ga* version of (3) is in fact ambiguous, either existential or definite specific, but we are not concerned with the latter.
- 4 (7b) and (8b) can be accepted with focus interpretation imposed on the *ga*-phrase. Note that either weak or strong noun phrases can be focussed. (3b) and (4b) can also be interpreted with focus on the *ga*-phrase; thus, if we include focus readings, these Japanese sentences are ambiguous and the English sentences (1) and (2) are three-ways ambiguous. We exclude focus interpretation from our consideration, as they are irrelevant to what follows.

- 5 According to Moore, the contrast in Spanish seems to be more common in Peninsular dialects than Latin American dialects. The phenomenon is somewhat subtle and complicated. Its proper description requires careful argument. I am not going into details here. I refer the reader to Moore's work for details.
- 6 The reader is referred to Kuroda (1993) and references cited therein for various treatments of Japanese causatives and theoretical and descriptive controversies surrounding this topic.
- 7 Needless to say, the first contrast relates to the theoretical/descriptive point we are concerned with; the second contrast is a matter of exposition.
- 8 For the distinction between the existential/cardinal reading and the partitive reading of the so-called floating quantifiers, see Kitagawa and Kuroda (1992).
- 9 Torre decides to let Irabu continue. However, instead of him going to the mound Torre could dispatch the pitching manager to talk with Irabu. Then, from Irabu's point of view, Irabu may not know if it's Torre's decision or the pitching manager's decision that he is allowed to continue pitching. From Torre's point of view, however, the pitching manager is serving as his instrument. But (48) is as appropriate in this scenario as in the previous one.
- 10 If we want to accommodate the possibility that the causer may act through an intermediary, we need to have a more complicated form:

(57) *Ni-causative*: the causer Cr causes event E described by the embedded sentence by causing the causee to believe that an intermediary causes the event E by means of a mutual intention that the causee Ce have it happen.

In what follows, however, I ignore this complication.

- 11 I leave this English gloss tenseless, even though it is ungrammatical as it stands.
- 12 Iida (1996) makes a valuable contribution by bringing to our attention the confusion surrounding these terms in an explicit form (*op. cit.*: 13ff). In particular, she sorts out and differentiates certain terms that tend to have been confused or identified loosely with the notion of point of view by introducing the terms SOURCE, SELF and PIVOT. Some clarification, though, is in order concerning the concept of nonreportive style, which I introduced in connection with the discussion of point of view. Iida correctly characterizes the reportive and the nonreportive style: 'The reportive style is the style in which sentences are understood as a report from a narrator's point of view. The *nonreportive* style, on the other hand, represents the point of view of a character and consequently (in some sense) that person's consciousness.' (*op. cit.*: 34) However, she also states at another point: 'According to Kuroda, the nonreportive style is defined as a style where an omniscient narrator adopts the point of view of the referent of the subject, and where the narrator is able to enter into this character's mind.' (*op. cit.*: 35) In Kuroda (1973), I initially presented the omniscient narrator theory and the multi-consciousness theory as two possible alternatives to account for the nonreportive style. Iida's last quoted passage would be a correct account of the nonreportive style in the omniscient narrator theory. But I argued for the multi-consciousness theory as the right theory for linguistic reasons. The characterization of 'nonreportive' in Iida, p. 13, table (27) seems off the mark, too; Iida identifies 'nonreportive' with 'logophoric' and characterizes it as having an internal 'speaker' as the SOURCE (The SOURCE is defined as the individual in a given situation who makes the report.) But the point of introducing the concept of nonreportive style is to deny the existence of a 'reporter' internal to the narrative. Furthermore, the point of the multi-consciousness theory is to deny the existence of a 'reporter' altogether, either internal to or transcendent of the narrative. For a more extensive and thorough discussion on these points than found in Kuroda (1973), the reader is referred to Kuroda (1976).

References

- Ackerman, Farrell and John Moore (1999). Syntactic and paradigmatic dimensions of causee encodings. *Linguistics and Philosophy* 22: 1–44.

- Carlson, Gregory (1977). *Reference to kinds in English* Doctoral dissertation, Univ. of Mass. at Amherst.
- Diesing, Molly (1992). *Indefinites*. Cambridge: MIT Press.
- Horn, Lawrence (1989). *A natural history of negation*. Chicago: Chicago University Press.
- Iida, Masayo (1996). *Context and Binding in Japanese*, Stanford: CSLI Publications, Center for the Study of Language and Information.
- Kamio, Akio (1983). Meishiku no kozo. *Koza gendai no genjo 1: Nihongo no kihon kozo*, edited by Kazuko Inoue, 77–126. Tokyo: Sanseido.
- Kitagawa, Yoshihisa and S.-Y. Kuroda (1992). *Passive in Japanese*, Manuscript. Bloomington: Indiana University and San Diego:UCSD.
- Kuroda, S.-Y. (1965). *Generative grammatical studies in the Japanese language*, Doctoral dissertation, MIT.
- Kuroda, S.-Y. (1972a). Anton Marty and the transformational theory of grammar. *Foundations of Language* 9: 1–37.
- Kuroda, S.-Y. (1972b). The categorial and the thetic judgment. *Foundations of language*. 9: 153–185.
- Kuroda, S.-Y. (1973). Edmund Husserl, Grammaire Générale et Raisonnée, and Anton Marty. *Foundations of language* 10.2: 169–195.
- Kuroda, S.-Y. (1976). Reflections on the foundations of narrative theory. *Pragmatics of language and literature*, edited by Teun van Dijk, 108–140. Amsterdam: North Holland Publishing Company.
- Kuroda, S.-Y. (1992). *Japanese syntax and semantics: Collected papers*. Dordrecht/Boston/London: Kluwer Academic Publishers.
- Kuroda, S.-Y. (1993). Lexical and productive causatives in Japanese: an examination of the theory of paradigmatic structure. *Journal of Japanese linguistics* 15: 1–82.
- Ladusaw, William A. (1994). Thetic and categorial, stage and individual, weak and strong, *SALT* 4.
- Marty, Anton (1908). *Untersuchungen zur Grundlegung der allgemeinen Grammatik und Sprachphilosophie*. Halle a. S.: Max Niemeyer.
- Marty, Anton (1918). *Gesammelte Schriften, II. Band, 1. Abteilung*. Bern: Verlag A. Francke.
- Marty, Anton (1965). *Psyche und Sprachstruktur*. Bern: Verlag A. Francke.
- Mejías-Bikandi, Errapel (1993). *Syntax, discourse, and acts of the mind: A study of the indicative/subjunctive contrast in Spanish*. Doctoral Dissertation, UCSD.
- Milsark, G. L. (1977). Toward an explanation on certain peculiarities of the existential construction in English. *Linguistic Analysis* 3: 1–29.
- Moore, John (1997). Judgement types and the structure of causatives. Manuscript, San Diego: UCSD.
- Shibatani, Masayoshi (1973). *A linguistic study of causative constructions*, Dissertation, University of California, Berkeley.
- Shibatani, Masayoshi (1976). A grammar of causative constructions: Conspectus.’ *Syntax and Semantics 6: The grammar of causative constructions*, edited by Masayoshi Shibatani, 1–40. New York: Academic Press.
- Strozer, Judith R (1976). *Clitics in Spanish*, Dissertation, University of California, Los Angeles.
- Treviño, Esther (1994). Las causativas del Español con complemento infinitivo. *Estudios de Lingüística y Literatura*, XXVII, El Colegio de México, México, D.F.

A COMPUTATIONAL APPROACH TO CASE AND WORD ORDER IN KOREAN*

William O'Grady

1. Introduction

It is commonly observed that languages with morphological case tend to have relatively free word order and that languages with relatively free word order often have morphological case. The functional motivation for this correlation is intuitively clear, of course: by helping encode the grammatical roles of a sentence's constituents, case subsumes at least part of the function of word order. This raises important questions about the nature of the structural information that case carries and about its precise role in the sentence formation process.

The principal purpose of this chapter is to explore these questions with respect to Korean. I take as my starting point the theory of case put forward in O'Grady (1991), a theory whose consequences have so far been explored primarily for sentences with canonical SOV order. I will try to show that a 'computational interpretation' of the case generalizations proposed in my earlier work provide interesting insights into a number of facts associated with so-called 'scrambling', a central phenomenon in the syntax of Korean.

I will begin my discussion by briefly outlining the system of structure building that I wish to adopt and the place of case in that system. I will then turn my attention to scrambling in Korean, focusing for the most part on patterns in which a complement of a verb appears to the left of the subject in the same clause. My discussion will include a variety of phenomena that are manifested in those patterns, including anaphor binding, scope, and 'anti-scrambling' effects.

2. Sentence structure and case

As explained in detail in O'Grady (1991) and elsewhere, I take the view that sentences are built by a series of simple combinatorial operations of the type posited for many decades in categorial grammar. The basic operation in this sort of computational system is **application**, which combines an argument-taking category (called a **functor**) with an argument of the appropriate type. In (1), for instance, an intransitive verb (IV) combines with a nominal argument to create a sentential category. The material in angled brackets beneath the IV category label provides information about its argument dependencies. As each of the functor's argument dependencies is satisfied, it is canceled or 'checked off'.

I indicate this here by copying the referential index of the argument onto the corresponding symbol in the verb's argument grid, as in Stowell (1981) and Starosta (1988).

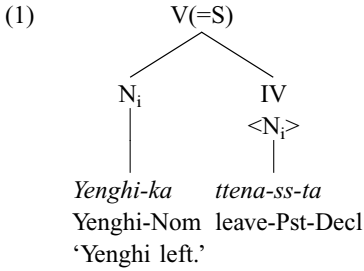

As indicated in (1), I take a 'sentence' to be a verbal projection – more specifically a verbal category with no unsatisfied argument dependencies. Comparable views are widely held in the literature on syntactic theory – e.g., in categorial grammar (Bar-Hillel 1953), generalized phrase structure grammar (Gazdar et al. 1985: 61), head-driven phrase structure grammar (Pollard 1988: 398), construction grammar (Fillmore 1988: 43), and occasionally even government and binding theory (Grimshaw 1997: 376).

I assume that 'category labels' provide information about the category membership of component words and phrases, but not about 'bar level'. Thus, N stands for both 'noun' and 'noun phrase', V for both 'verb' and 'verbal phrase', and so on. This practice is common in categorial grammar (e.g. Dowty 1982), dependency grammar (Starosta 1988), some versions of government and binding theory (Speas 1990: 44) and – more recently – the 'minimalist program' (Chomsky 1995).

Where a sentence contains a transitive verb (TV), the combinatorial operations apply in sequence from the bottom up – first combining the verb with its 'internal' argument (the theme). The unsatisfied dependency on the 'external' argument (the agent) is then passed up to the resulting phrase (via inheritance) for resolution by a second combinatorial operation. Since this phrase exhibits a dependency on a single nominal argument, it is by definition intransitive.

(2) First operation

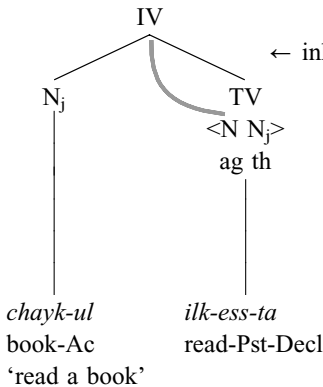

(3) Second operation

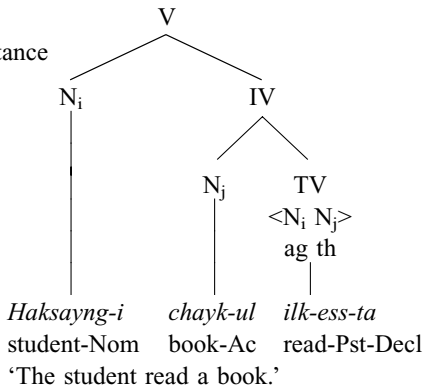

The key idea put forward in my 1991 book is that case encodes information about combinatorial relations – especially the type of category with which the case-bearing nominal combines. Let us formulate this hypothesis as follows.

(4) **The Korean case ‘rules’**

- The nominative marks an N that combines with an intransitive verbal category.
- The accusative marks an N that combines with a transitive verbal category.

I assume that a verbal category is transitive if (a) it exhibits a dependency on two nominal arguments (i.e., it has an argument grid of the form <N N>) and (b) it carries the semantic feature [agentive] in the sense of Youngjoo Kim (1990, 78). All other verbal categories are intransitive.¹

The example in (3) above provides a very simple illustration of how case might work, with the accusative marking a nominal that combines with a transitive verb and the nominative appearing on a nominal that combines with an intransitive verbal category (the verbal phrase *chayk-ul ilk-ess-ta* ‘read the book’).

If the general approach embodied in (4) is right, then case provides instructions to language users and language learners about how to build sentence structure. In particular, it provides very precise information about the categories with which particular nominals combine. This in turn has a very wide range of consequences for how we look at Korean sentence structure. Before exploring some of these consequences, however, I would like to consider a technical issue whose solution may have interesting consequences of its own.

The issue in question has to do with how information about the function of case should be incorporated into the grammar. That is, how can the generalizations in (4) above be converted into something ‘computational’? One possibility is that case markers are themselves functors – that is, they have argument grids of their own,² as illustrated in (5) and (6). (I use a check mark to indicate the resolution of a dependency that does not involve a thematic arguments; k = case.)

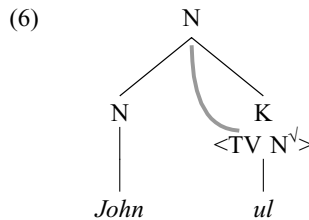
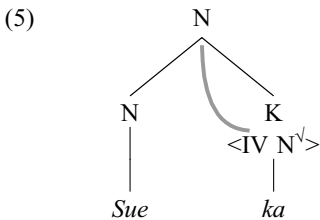

The key idea here is that case markers have two dependencies – one involving the nominal with which they combine and the other involving a verbal category (an IV in the case of the nominative and a TV in the case of the accusative). As (5) illustrates, the case particle combines first with the nominal, satisfying one of its dependencies and creating a nominal phrase that inherits the unsatisfied dependency on an IV. This dependency is then resolved by combination with an intransitive verbal category, as illustrated below.

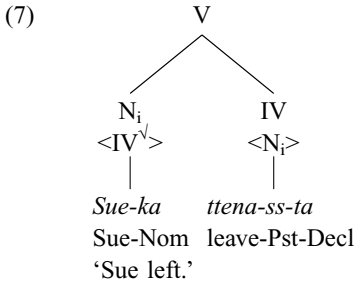

Similarly, in the case of (6), the accusative suffix combines first with the noun, creating a nominal phrase that inherits the dependency on a TV. This dependency must then be resolved by combination with a transitive verb, in the manner illustrated below.

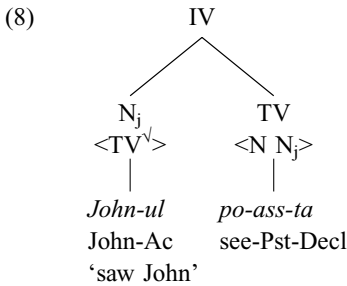

A conceptual advantage of this approach is that it gives us a way to capture the intuition that case is in some sense the mirror image of agreement: with agreement, a verb looks for a nominal of a particular type; with case, a nominal looks for a verb of a particular type.

As I tried to show in my 1991 book, this approach to case reveals much about the workings of Korean syntax. I will now attempt to extend the range of the theory even further by considering its relevance for our understanding of scrambling – a core problem in the study of Korean word order and a phenomenon which is almost as central to the syntax of Korean as is case marking itself.

3. Clause-internal scrambling

For the purposes of initial discussion, I will concentrate on scrambling patterns in which one or more of a verb's complements occurs to the left of the subject within the same clause. Sentence (9) provides a simple example of such a pattern.

- (9) *I chayk-ul haksayng-i ilk-ess-ta.*
 this book-Ac student -Nom read-Pst-Decl
 'The student read this book.'

I deliberately set aside for now 'VP-internal' scrambling (i.e. variation in the relative ordering of a verb's complements), which seems to involve a quite different type of phenomenon (e.g. Miyagawa 1997), as well as so-called 'long-distance' scrambling (i.e. scrambling across a clause boundary; but see section 4).

Scrambling over the subject raises two questions for the type of computational system I am proposing.

- a) What special properties, if any, does the verb have? This question arises because, given the argument hierarchy (i.e. $ag > \dots > th$), we would expect the verb to combine with its theme argument before its agent argument – which clearly does not happen in the case of scrambling (assuming, as I do, that there are no movement operations or empty categories).
- b) What special properties, if any, does the scrambled nominal have? This question arises because, on the view that I have put forward, an accusative-marked nominal should combine with a transitive verb – which it appears not to do in scrambling structures.

With respect to the first question, I propose that an operation of **postponement** licenses a delay in the search for one or more of the verb's lower arguments, allowing the combinatorial system to set aside a particular 'early' argument dependency in order to operate on other dependencies first. Let us represent this as follows.³ (For reasons of expository simplicity, argument grids for case are not represented unless they are directly relevant to the point at hand.)

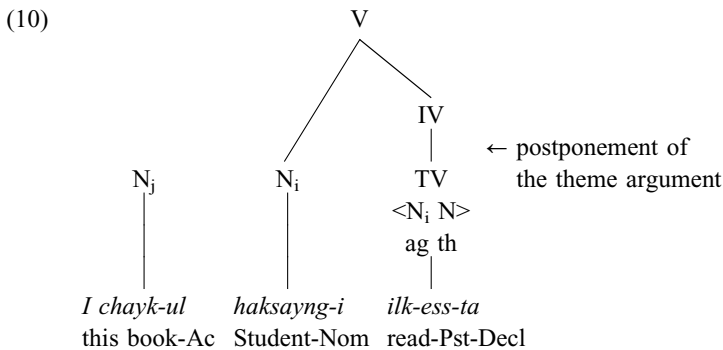

Here, the postponement operation applies to the theme argument dependency of the TV *ilk-ess-ta* 'read', temporarily setting it aside and leaving an IV category with a dependency on a single nominal argument (the agent). Combination with *haksayng* 'student' satisfies this dependency while at the same time licensing the nominative case on the nominal.

At this point, the postponed dependency must be satisfied. But how? One obvious possibility is that the postponed theme argument dependency is inherited upward to a point in the syntactic representation where it can be satisfied by combination with *i chayk* 'this book'.

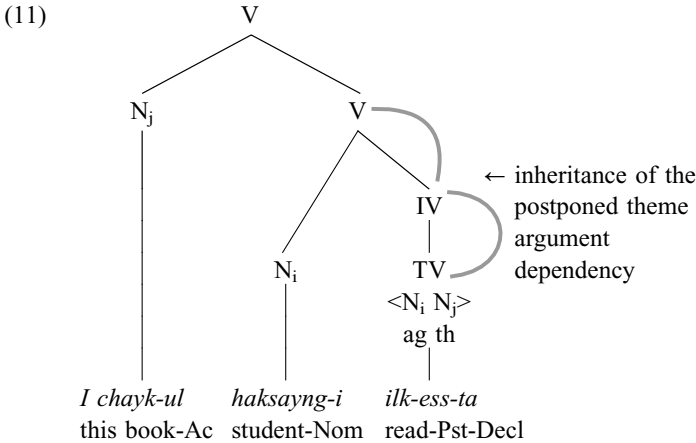

Unfortunately, this idea encounters a major problem with respect to case. In particular, we must ask how we are to license the accusative case on the direct object, given our claim that this suffix introduces a dependency on a TRANSITIVE verb. As things now stand, the phrase with which the ‘scrambled’ direct object combines (*haksayng-i ilk-ess-ta* ‘the student read’) exhibits a dependency on a single nominal argument (the postponed dependency inherited from the verb) and therefore should have the properties of an intransitive verbal category. This incorrectly predicts that the scrambled phrase should bear the nominative case.

- (12) **I chayk-i haksayng-i ilk-ess-ta.*
 this book-Nom student-Nom read-Pst-Decl
 ‘The student read this book.’

Clearly something is wrong here. I believe that the solution to this problem can be found in a parallel problem which arises in the interpretation of reflexive pronouns such as *caki(casin)*, to which I now turn.

The interpretation of reflexive pronouns

Following an idea put forward in O’Grady (1997) and in the spirit of a proposal made within the framework of GPSG (e.g. Kang 1988), I take the position that anaphors introduce a referential dependency, which I will represent with the help of the ‘variable index’ x . Referential dependencies are resolved in essentially the same way as categorial dependencies are – i.e. by combination in a configuration of the following type.

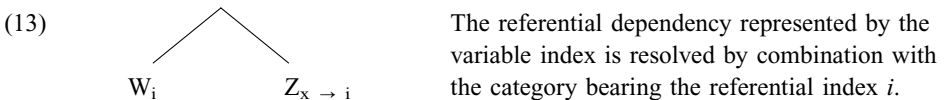

In many patterns, including the one that follows, the referential dependency is resolved with the help of inheritance – just as many categorial dependencies also are.

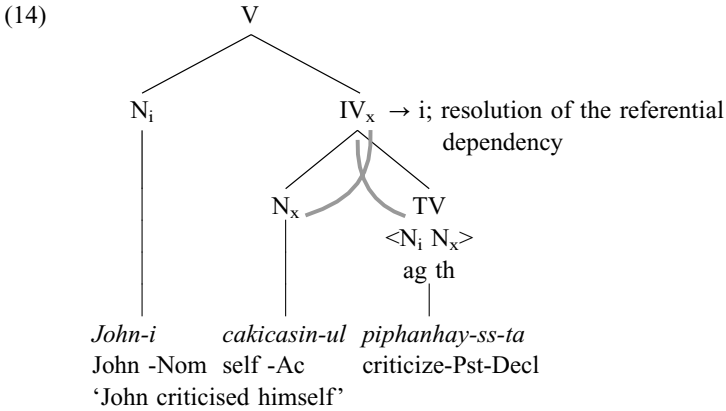

In (14), combination of the TV with its first argument satisfies the verb’s dependency on a theme argument, but it cannot resolve the referential dependency introduced by the reflexive pronoun since the verb bears no index. So, the referential dependency is inherited by the resulting phrase, along with the verb’s dependency on an agent argument. Both dependencies are subsequently satisfied by combination with the subject nominal *John*.

Next, consider the pattern exemplified in (15), which is ungrammatical on the coreferential interpretation.

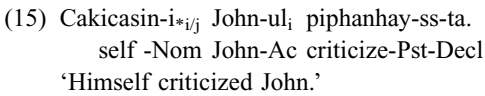

The relevant structure resembles (16).

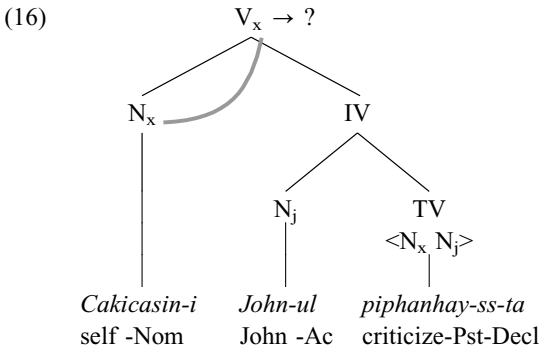

Here, the reflexive pronoun, which is in the subject position, combines with the verbal phrase *John-ul piphanhay-ss-ta* ‘criticized John’. Since this phrase does not bear a referential index (the index on *John* does not introduce a dependency and therefore is not inherited by the larger verbal phrase), the referential dependency associated with the reflexive pronoun cannot be satisfied clause-internally. (However, because Korean reflexives permit discourse antecedents, the anaphor is able to refer to someone not mentioned in the sentence.)

This brings us to the scrambled pattern in (17), in which the fronted direct object reflexive can take the lower subject as its antecedent.

- (17) ?*Cakicasin-ul_i John-i_i piphanhay-ss-ta.*
 self -Ac John-Nom criticize-Pst-Decl
 ‘John criticized himself.’

At first glance, this is puzzling. Given that inheritance is upward, as illustrated in (14), it should not be possible for the index representing the referential dependency introduced by the reflexive pronoun to ‘make contact’ with the index on the nominal *John*. How can this sentence be acceptable then?

One possibility is simply this: *scrambling involves the reversal of inheritance direction*. Thus, whereas feature-passing is upward in the unmarked situation, it runs **DOWNWARD** in the case of the dependencies associated with ‘scrambled’ nominals. In fact, on this view, scrambling is reduced to precisely this property – the reversal of inheritance direction on the scrambled constituent. Setting aside for now the question of what licenses combination of the scrambled nominal with the rest of the sentence and how it comes to be identified as the verb’s theme argument, we can posit a representation resembling (18) for the sentence in (17). The ‘↓’ indicates that feature-passing runs in a downward direction in the case of the scrambled nominal.

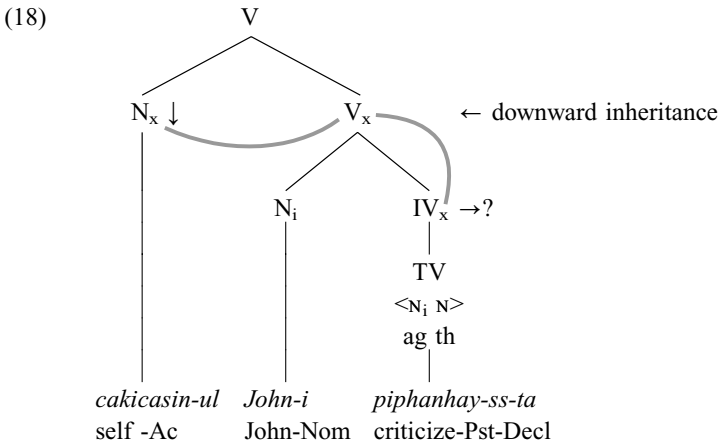

Here, the referential dependency is passed down the tree to a point where it occurs in the usual binding configuration (see (13) above) and makes contact with the index associated with *John*, at which point it can be resolved.

Of course, the downward option is not available in the case of ‘non-scrambled’ patterns such as (16) since, by hypothesis, downward inheritance is equated with scrambling. In (16), feature-passing can proceed only in an upward direction, precluding the possibility of a binding relation between the subject reflexive pronoun and the direct object nominal, as desired.

Case reconsidered

If the idea just outlined is right, a parallel solution suggests itself for the dependency introduced by the accusative case marker: it too could be resolved by downward feature passing, which will eventually lead to the TV, as shown in (19).

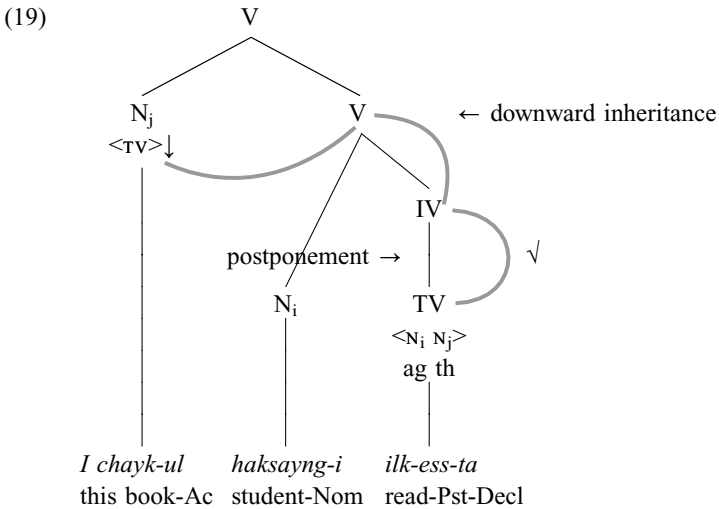

Licensing of the nominative case here is unproblematic, since *haksayng* ‘student’ combines directly with the intransitive verb created by the postponement operation (see the discussion of (10) above). In contrast, the dependency introduced by the accusative case suffix must be dealt with less directly – in particular, it must be passed down through the syntactic representation until it makes contact with the transitive verb, at which time it is resolved (as indicated by the check mark).

This is presumably also the point at which the unsatisfied theme argument dependency in the verb’s grid is resolved. In fact, it seems reasonable to suppose that this is done via the ‘computational path’ that is created as the case-introduced dependency makes its way down through the syntactic representation to the transitive verb.

This makes a good deal of sense. Intuitively, case markers establish a relationship between the nominal on which they appear and a verb – a fact that I have tried to capture

‘computationally’ by positing argument grids for case morphemes (e.g., <TV N> for the accusative, as in (8) of section 2 above). In the case of canonical word order, it is relatively easy for case markers to do their job since they stand directly between the nominal with which they themselves combine and the category with which that nominal then combines. In (20), for instance, the accusative morpheme stands between the nominal *i chayk* ‘this book’ and the transitive verb with which it combines; similarly, the nominative marker stands between the nominal *haksayng* ‘student’ and the intransitive verbal category with which it combines.

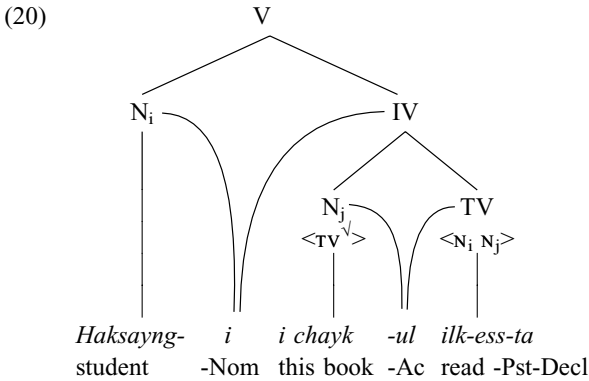

In the case of scrambled word order, however, matters are more complicated. As illustrated in (19), it is up to the case marker to ‘bring together’ the nominal and the verbal category. I have implemented this idea computationally by assuming that downward inheritance of the case dependency creates a computational path that links the displaced nominal and the verb, ultimately allowing the unsatisfied argument dependency in the verb’s grid to be satisfied by the ‘scrambled’ nominal.

To the extent that this analysis is successful, it supports the computational approach to case outlined in section 2. This is because the accusative case in scrambled patterns does not signal literal combination with a transitive verb (contrary to the case generalizations put forward in my 1991 book). Crucially, though, it does fulfill the slightly more abstract function posited by the computational theory of case, since it introduces a dependency on a transitive verb. Moreover, like other dependencies, this dependency can be satisfied with the help of inheritance, including (it seems) downward inheritance.

Some independent evidence for this perspective comes from the inadmissibility of case on the initial nominal in ‘left-dislocation’ constructions such as the following, as observed by Ahn (1998).

- (21) *Ku chayk(??-ul), Mary-ka kukel ilk-nun-ta.*
 that book -Ac Mary-Nom it.Ac read-Prs-Decl
 ‘That book, Mary is reading it.’

The unacceptability of the case marker is to be expected in the system I propose. This is because the relationship between the ‘fronted’ nominal *ku chayk* ‘that book’ and the rest of the sentence is mediated by the resumptive pronoun *kukel* ‘it’, which introduces a referential dependency that is inherited upward in the usual manner. A case suffix on *chayk* is therefore not required to establish its status as theme argument of the transitive verb and such a marker is in fact avoided – perhaps because of the computational cost associated with downward inheritance.

Scope

Scope provides still further evidence that scrambling can and should be reduced to a change in inheritance direction. To begin, consider the contrast between the following two sentences.

- (22) *Motun salam-i nwukwunka-lul cohaha-n-ta.*
 every person-Nom someone-Ac like-Prs-Decl
 ‘Everyone likes someone.’ (ambiguous: $\forall > \exists$, or $\exists > \forall$)

- (23) *Nwukwunka-ka motun salam-ul cohaha-n-ta.*
 someone-Nom every person-Ac like-Prs-Decl
 ‘Someone likes everyone.’ ($\exists > \forall$ only)

The first sentence is ambiguous, allowing the existential quantifier to have either narrow or broad scope with respect to the universal quantifier. However, the second sentence has only one interpretation, with broad scope for the existential quantifier.

We can account for these facts in a straightforward manner if we assume that the existentially quantified nominal *nwukwunka* ‘someone’ exhibits an optional interpretive dependency. Without the dependency, it is interpreted discursively and is taken to refer to someone inferrable from the context. With the dependency, it is subjected to interpretation by grammatical mechanisms that parallel those used for the resolution of referential dependencies associated with reflexive pronouns. In particular, I assume that the ‘scope configuration’ is as follows:

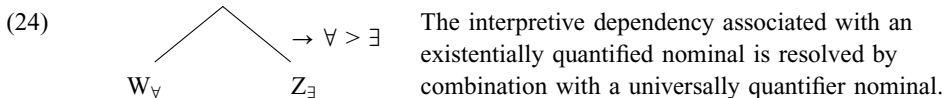

In a sentence such as (22), the interpretive dependency introduced by the existentially quantified nominal is resolved with the help of inheritance – just as categorial and referential dependencies can be. This is illustrated in (25).

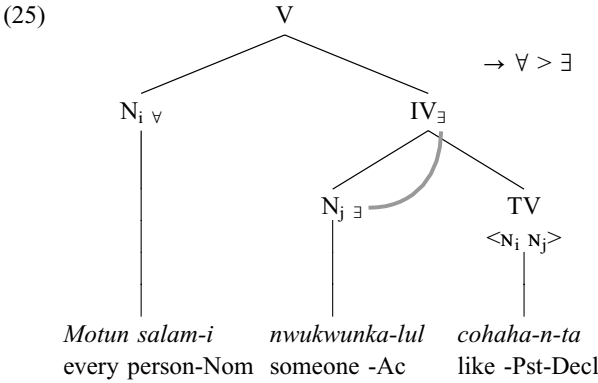

Combination of the TV with its direct object resolves the verb's dependency on a theme argument, but not the interpretive dependency introduced by the existentially quantified nominal. So, that dependency is inherited by the resulting phrase (along with the verb's dependency on an agent argument). As (25) illustrates, this creates the very configuration required for narrow scope since the interpretive dependency associated with the \exists feature is now in a position to be satisfied by combination with the quantified subject nominal *motun salam* 'every one'.

Now consider the pattern in (23), which has only the broad scope interpretation for *nwukwunka* 'someone'. As depicted in (26), the existentially quantified nominal is in subject position and the \exists feature associated with it cannot make contact with the \forall feature on the universally quantified nominal in object position. Since the \forall feature does not introduce a dependency, it does not undergo feature passing. And since the subject is not a 'scrambled' constituent, its feature cannot be passed downward through the syntactic representation. Deictic interpretation is therefore the only option and we are left with just the broad scope reading for the existentially quantified nominal, as desired.

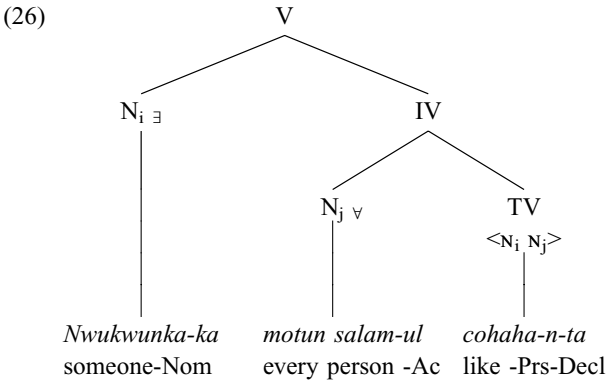

Matters are different in the case of the scrambled pattern exemplified in (27).

- (27) *Nwukwunka-lul motun salam-i cohaha-n-ta.*
 someone -Ac every person-Nom like-Prs-Decl
 'Everyone likes someone.' (ambiguous: $\forall > \exists$, or $\exists > \forall$)

This sentence is ambiguous. The discursal reading for *nwukwunka* 'someone' is straightforward, reflecting the interpretation that is always available for this word. Crucially, though, a narrow scope reading is also possible even though *nwukwunka* precedes and is structurally higher than the universally quantified nominal. This is to be expected on the view that scrambling involves the reversal of inheritance direction. As illustrated in (28), the \exists feature associated with the scrambled *nwukwunka* 'someone' is passed downward through the syntactic representation to a point where it makes contact with the \forall feature on the universally quantified *motun salam*, thereby satisfying its dependency and acquiring a narrow scope interpretation.

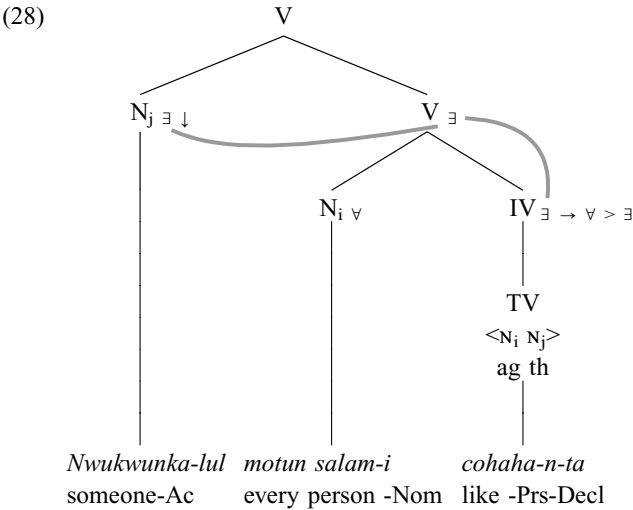

Equally interesting is (29), the scrambled counterpart of (23) above.

- (29) *Motun salam-ul nwukwunka-ka cohaha-n-ta.*
 every person-Ac someone-Nom like-Prs-Decl
 'Someone likes everyone.' (ambiguous: $\forall > \exists$, or $\exists > \forall$)

Although (23) permits only a broad scope interpretation for *nwukwunka*, (29) is ambiguous – allowing a narrow scope reading for the existentially quantified nominal. This too is expected, as (30) helps show.

(30)

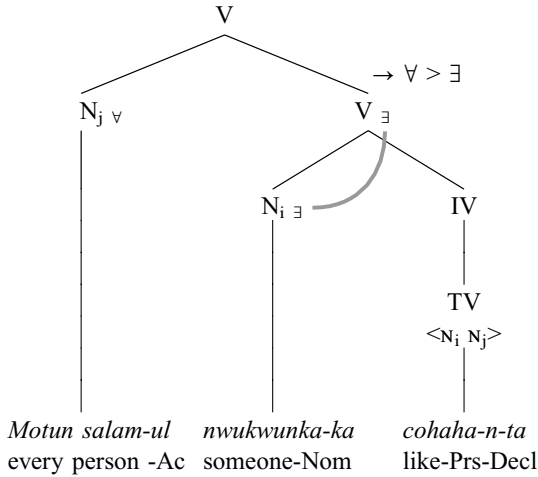

Here, the \forall feature cannot be passed downward (despite scrambling) since it does not involve a dependency of any sort. Crucially, though, the \exists feature *nwukwunka* can be passed UPWARD to a position where it enters into the ‘scope configuration’ with *motun salam*. There, it receives the narrow scope interpretation that is not available in the SOV pattern, where the universally quantified nominal occupies a lower position in phrase structure and is therefore not accessible via feature passing.

4. Locality effects

Downward inheritance is clearly the marked option for human language. Not only is it employed infrequently (OSV patterns are numerically rare), it requires an extra computational step. In particular, the case marker must create a computational path to link the displaced nominal and the verb, thereby allowing the verb to discharge the corresponding argument dependency (see the discussion of (19) above). No such step is required in the case of canonical SOV patterns, as noted in the discussion of (20) above.

Not surprisingly, there is reason to believe that the processing mechanisms responsible for implementing downward inheritance strongly favor short computational paths. As a result, they try to associate a displaced element with the first category of the appropriate type that is encountered while moving downward through the syntactic representation.

- (31) The Immediacy Preference
 - Dependencies undergoing downward inheritance should be resolved at the first opportunity.

While it is not impossible for the processing mechanisms to proceed beyond the point favored by the Immediacy Preference, sentences formed in this manner typically have a marginal character and may require specific contexts in order to sound natural.

As illustrated in (35), downward inheritance of the IV dependency associated with the nominative case on the scrambled nominal is blocked by the IV category in the matrix clause.

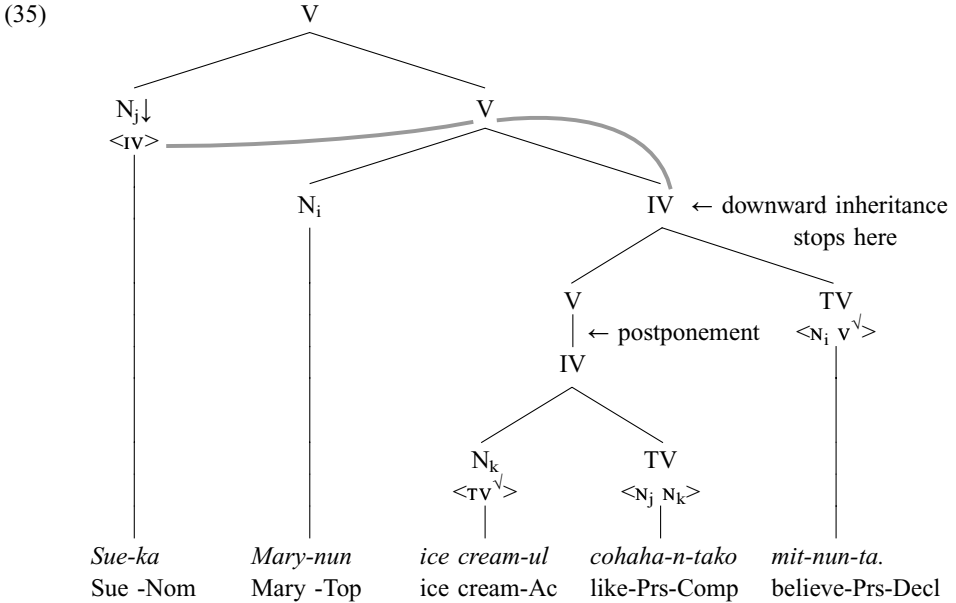

This impedes the creation of the computational path between the scrambled nominal and the intransitive verbal category in the embedded clause with which it is supposed to be associated. As a result, the embedded verb’s subject dependency cannot be resolved.

Of course, no such problem arises where an (accusative-marked) direct object is scrambled. Since the only transitive verb in this structure occurs in the lower clause, downward inheritance of the case-introduced dependency is unimpeded by locality considerations.

- (36) *Ice cream-ul Mary-nun [Sue-ka _ cohaha-n-tako] mit-nun-ta.*
 ice cream-Ac Mary-Top Sue-Nom like-Prs-Comp believe-Prs-Decl
 ‘Mary believes that Sue likes ice cream.’

Finally, consider the contrast illustrated in (37), based on an observation by Young-Suk Lee (1993, 91).

- (37) a. *Emma-ka apeci-eykey [Minho-ka Swunhi-eykey chayk-ul cwu-ess-tako]*
 mother-Nom father-Dat Minho-Nom Swunhi-Dat book-Ac give-Pst-Comp
 malhay-ss-ta.
 say-Pst-Decl
 ‘Mother said to father that Minho gave a book to Swunhi.’

- b. **Swunhi-eykey emma-ka apeci-eykey [Minho-ka chayk-ul _ cwu-ess- tako]*
 Swunhi-Dat mother-Nom father-Dat Minho-Nom book-Ac give-Pst-Comp
malhay-ss-ta
 say-Pst-Decl
 'To Swunhi, mother said to father that Minho gave a book.'

Sentence (37b), with the dative from the embedded clause 'scrambled' to sentence-initial position, is unacceptable. This follows straightforwardly in the analysis I put forward. A dative-marked nominal exhibits a dependency on a 'dative verb' – i.e., a verbal category with an argument grid of the following type.

(38) <N PP_{Dat} ... >

The first such verb that it would encounter on its downward path is the matrix verb *malhay-ss-ta* 'said' and the Immediacy Preference therefore forces its association with that verb. This yields an unacceptable result not only because it does not give the intended interpretation, but also because the dative argument dependency associated with the *malha-ta* 'say' has already been satisfied by *apeci-eykey* 'to father'.

No such problem arises in sentences such as the following, in which the matrix predicate is not a dative verb.

- (39) *Swunhi-eykey emma-ka [Minho-ka chayk-ul _ cwu-ess-tako]*
 Swunhi-Dat mother-Nom Minho-Nom book-Ac give-Pst-Comp
sayngkakhay-ss-ta.
 think -Pst-Decl
 'To Swunhi, mother thought that Minho gave a book.'

Since downward inheritance can continue into the embedded clause in this structure without running afoul of the Immediacy Preference, the sentence is acceptable.

Space does not permit a more extensive discussion of locality effects here and much remains to be done in this regard, particularly with respect to the broader range of subjacency phenomena discussed in the literature. I set these matters aside for eventual future consideration.

5. Conclusion

It is widely acknowledged that information can and must be passed through syntactic representations. In most work on this subject, the relevant computational mechanisms – variously known as inheritance, feature-passing, percolation, and movement – transmit information along a unidirectional upward path.⁵ The view I have put forward here differs from this tradition in allowing downward feature-passing as a marked option for elements that have been 'scrambled'. In fact, in the view I adopt, scrambling is reduced precisely to the reversal of inheritance direction. As I have tried to show, facts involving the interpretation of anaphora and scope in OSV and SOV patterns provide independent support for this view of word order options.

Within this sort of computational system, case has a special role to play. Because case markers are functors, they introduce dependencies that must be resolved, either by direct combination with a verbal category of the appropriate type or by inheritance. A key part of the proposal about word order that I have put forward here is that the appearance of case markers on ‘scrambled’ nominals leads to the downward inheritance of the dependencies on verbal categories that they introduce. This in turn creates a ‘computational path’ between the nominal and the verb with which it is associated, establishing the long-distance relation that is needed to make scrambled patterns interpretable and to enable them to fulfill their discourse and pragmatic functions.

Notes

* I am grateful to Miho Choo, Kyoungkook Kim, an anonymous referee, and members of the audience for their comments. I also thank the conference organizers, Nam-Kil Kim, Hajime Hoji and Audrey Li, for their hospitality

1 According to this definition, dyadic predicates such as *mwusep-ta* ‘be afraid’ and *coh-ta* ‘be fond of’ are intransitive since they fail the usual tests for agentivity (e.g., they do not permit imperatives or propositives, and they cannot occur as complement of *nolyekha-ta* ‘try’, as Kim observes). It is therefore not surprising to find that both of their nominal arguments are marked by the nominative.

- (i) *Nwu-ka holangi-ka mwusep-ta.*
 someone-Nom tiger-Nom fear-Decl
 ‘Someone is afraid of tigers.’

2 In more formal terms, the claim is that case markers are a sign of type raising, as James Yoon (p.c.) has observed. Thus an accusative-marked nominal is converted from an argument to a functor that combines with a TV to give an IV [(S/NP)/((S/NP)/NP)] while a nominative-marked nominal is converted from an argument to a functor that combines with an IV to give an S [S/(S/NP)].

3 Postponement is independently required for the formation of relative clause patterns, as illustrated below.

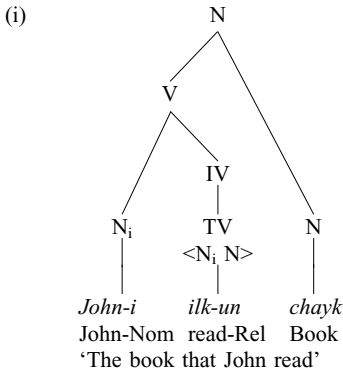

Here, the theme argument dependency is postponed, creating an IV that can combine with the subject nominal. The resulting sentential category then inherits the postponed argument

- dependency, which is subsequently satisfied by combination with the nominal *chayk* 'book', the 'head' of the relative clause.
- 4 Miho Choo informs me that a pause after the matrix subject can significantly improve their status.
- 5 An exception to this tendency is found in the idea of 'reconstruction', which has been implemented in various ways (see, e.g., Saito 1992, Huang 1993, and Boškovic & Takahashi 1998).

References

- Ahn, H.-D. (1998). Case deletion and feature movement. Paper presented at the Symposium on Diachronic and Synchronic Studies of Syntax of East Asian Languages. University of Southern California, November 1998.
- Bar-Hillel, Y. (1953). A quasi-arithmetical notation for syntactic description. *Language* 29, 47–58.
- Bošković, Z. & Daiko T. (1998). Scrambling and last resort. *Linguistic Inquiry* 29, 347–66.
- Chomsky, N. (1995). *The minimalist program*. MIT Press.
- Dowty, D. (1982). Grammatical relations and Montague grammar. *The nature of syntactic representations*, edited by P. Jacobson & G. Pullum, 79–130. Boston: Reidel.
- Fillmore, C. (1988). The mechanisms of 'Construction Grammar'. *Proceedings of the Fourteenth Annual Meeting of the Berkeley Linguistics Society*, 35–55.
- Gazdar, G., E. Klein, G. Pullum and I. Sag. (1985). *Generalized phrase structure grammar*. Cambridge, MA: MIT Press.
- Grimshaw, J. (1997). Projections, heads, and optimality. *Linguistic Inquiry* 28, 373–422.
- Huang, C.-T. J. (1993). Reconstruction and the structure of VP: Some theoretical consequences. *Linguistic Inquiry* 24, 103–38.
- Jo, M.-J. (1985). Constituents in fixed word order and a 'governed' non-theta position in Korean. *Harvard Studies in Korean Linguistics* 1, 79–87.
- Kang, B. (1988). Unbounded reflexives. *Linguistics and Philosophy* 11, 415–56.
- Kim, Y. (1990). *The syntax and semantics of Korean case: The interaction between lexical and syntactic levels of representation*. Ph.D. dissertation. Harvard University.
- Lee, Y.-S. (1993). *Scrambling as obligatory case-driven movement*. Ph.D. dissertation. University of Pennsylvania.
- Miyagawa, S. (1997). Against optional scrambling. *Linguistic Inquiry* 28, 1–25.
- O'Grady, W. (1991). *Categories and case: The sentence structure of Korean*. Philadelphia: John Benjamins.
- O'Grady, W. (1997). *Syntactic development*. University of Chicago Press.
- O'Grady, W. (1998). Korean case: A computational approach. *Proceedings of the 11th International Conference on Korean Linguistics*, edited by B. Park & J. Yoon, 1–19. Seoul: ICKL.
- Pollard, C. (1988). Categorical grammar and phrase structure grammar: An excursion on the syntax-semantics frontier. *Categorical grammars and natural language structures*, edited by R. Oehrle, E. Bach & D. Wheeler, 391–415. Boston: Reidel.
- Saito, M. (1985). *Some asymmetries in Japanese and their theoretical implications*. Ph.D. dissertation. MIT.
- Saito, M. (1992). Long-distance scrambling in Japanese. *Journal of East Asian Linguistics* 1, 69–118.
- Speas, M. (1990). *Phrase structure in natural language*. Boston: Kluwer.
- Starosta, S. (1988). *The case for lexibase*. London: Pinter.
- Stowell, T. (1981). *Origins of phrase structure*. Doctoral dissertation, MIT.
- Wood, M. (1993). *Categorical grammars*. New York: Routledge.
- Yoon, J. H. S. (1998). RE: 'Korean case: A computational approach'. Paper presented at the 11th International Conference on Korean Linguistics. Honolulu, July 1998.

ADJUNCTS AND WORD ORDER TYPOLOGY IN EAST ASIAN LANGUAGES

Thomas Ernst

1. Introduction¹

1.1. Two hypotheses

One current hypothesis about word order typology in principles-and-parameters grammar attempts to show that all languages have the same order in the base, and that the difference between head-initial and head-final word order types arises from parameterization with respect to movement possibilities (see, for example, Kayne 1994, Zwart 1997, and Fukui & Takano 1998, among many others). This is opposed to a more traditional view in which the parameterization is more direct, in terms of leftward or rightward direction for complements. The idea that all languages share the same base is often known as the Universal Base Hypothesis, and in practice it has been allied with what I will call the Linear Correspondence Hypothesis, or LCH (echoing Kayne's 1994 Linear Correspondence Axiom, or LCA), the idea that linear order is uniquely determined by some version of asymmetric c-command. In Kayne's version, Specs always asymmetrically c-command heads, and heads always asymmetrically c-command complements, so UG forces all languages to have Spec-Head-Complement order, corresponding to the traditional SVO type.

However, I believe there has sometimes been a misperception of the Universal Base Hypothesis: on the common current assumption that linear order is irrelevant until PF, it is more properly called the 'Universal Linearization Hypothesis', and it really has little to do with the base, in the sense of D-Structure (in GB: Chomsky 1981, Chomsky 1986) or Numeration made up of simple merges only (in Minimalism: Chomsky 1995). One might reserve 'Universal Base Hypothesis' for the claim that all languages share the same **hierarchical** location of heads and complements. This shift favors what I think is a healthy perspective on the word order typology debate: starting from a universal hierarchical base, one can argue about whether linear order is parameterized in terms of a simpler linearization algorithm and more complex movements, as Kayne and his successors propose, or in terms of a simpler theory of movements with more complex linearization.

In this chapter I will focus on the different distribution of adjuncts in East Asian languages (mostly Chinese) and fairly regular SVO languages like English, to argue that

different word order types are the result of relatively simple movements along with parameterization of PF linearization. I will call this the **Parameterized Direction Hypothesis (PDH)**, and will continue to call the Kaynean view, with more complex movements and simpler linearization, the **Linear Correspondence Hypothesis (LCH)**. My main goal in this chapter is to provide evidence that the PDH is superior to the LCH for East Asian languages, and therefore that they ought to be analyzed as being directly parameterized as head-final.

2. Some basic facts about adjunct distribution

There are four basic facts which will figure in the argumentation below.

2.1. *Scope and constituency*

First, when a sentence has two preverbal adjuncts, the first one takes scope over the second. This is shown in 1–2, where the a and b sentences differ (see Andrews 1983, Ernst 1994, Ernst 2002a, for discussion):

- (1) a. Karen occasionally has reluctantly bought fur clothing.
 b. Karen reluctantly has occasionally bought fur clothing.

- (2) a. *Lao Li changchang guyi xie-cuo.*
 Old Li often purposely write-wrong
 ‘Old Li writes (it) wrong on purpose often.’

- b. *Lao Li guyi changchang xie-cuo.*
 Old Li purposely often write-wrong
 ‘Old Li writes (it) wrong often on purpose.’

(Chinese)

In 1a it occasionally happened that Karen reluctantly bought fur clothing, while in 1b she is reluctant about occasionally buying fur clothing. 2 is similar: only in 2b is the frequency of writing part of the agent’s intent. This scope effect is widely assumed to come from asymmetric c-command, with the first adjunct c-commanding the second.² The same facts hold in reverse for two postverbal adjuncts, as in the glosses for 2, or in 3; here the second adjunct takes scope over the first one:³

- (3) a. The minister visited out of courtesy several times.
 b. The minister visited several times out of courtesy.

Finally, when a sentence has one preverbal and one postverbal adjunct, as in 4, as a general rule either scope is possible, depending on the adjunct and the context:

- (4) a. Julia didn’t take her medicine twice again.
 b. Danielle frequently buys a newspaper because her work demands it.

In 4a, one possible reading is that once again, Julia did not take her medicine twice (here *again* takes scope over negation). In 4b, the *because*-clause may optionally take scope over *frequently*, in which case it is the demands of work that make Danielle buy newspapers frequently. Again, these scope facts are usually taken to be indicative of c-command relationships, implying right-adjunction for 3–4, or the equivalent of right-adjunction in Kaynean approaches.

These apparent hierarchical relationships are confirmed by constituency tests. To take 3a as an example, examine 5:

- (5) The minister visited out of courtesy several times,
 (a) and the senator did ____, too.
 (b) but the senator did ____ only once.
 (c) but the senator did ____ out of mere obligation.

The gap in 5a corresponds to *visit out of courtesy several times*; in 5b it is *visit out of courtesy*, and in 5c it is *visit*. If the rightmost adjunct c-commands the one to its left, along with the verb, these facts fall out on the traditional assumption that VP-ellipsis interprets gaps as verbal constituents minimally containing the verb and its internal arguments.

2.2. The possibility of postverbal adjuncts

Second, in general, head-initial languages permit adjuncts after the verb, while head-final languages do not; both types allow preverbal adjuncts (as is common, I ignore cases of right-dislocation, or postverbal ‘afterthoughts’):

- (6) a. *Elle a préparé des plats pareils fréquemment l'année dernière.*
 she has prepared some dishes similar frequently the year last
 ‘She prepared such dishes frequently last year.’ (French)
 b. *Mi wnaeth o yfed cwrw am awr ar bwrpas.*
 art did drink beer for hour on purpose
 ‘He drank beer for an hour on purpose.’ (Welsh)
 c. *Bafana ba-natse tjwala masinyane kabili.*
 boys drank alcohol quickly twice
 ‘The boys drank liquor quickly twice.’ (Siswati)
- (7) a. *(Kanojo-wa) tokidoki mizukara lunch-o nuita (*tokidoki/*mizukara).*
 she-TOP occasionally willingly lunch-ACC skip.PAST
 ‘She has occasionally willingly given up her lunch hour.’ (Japanese)
 b. *Chelswu-nun elisekkeyto coyonghi wa-ss-ta (*elisekkeyto/*coyonghi).*
 Chelswu-TOP foolishly silently come-Pst-Dec
 ‘Chelswu foolishly approached silently.’ (Korean)
 c. *Raam-ne zaruur vah kitaab dhyaan se paRhii thii (*zaruur/*dhyaan se).*
 Ram_{ERG} certainly that book care with read_{PERF-fem} be_{PST-fem}
 ‘Ram certainly read that book carefully.’ (Hindi)

2.3. *Adjunct subclasses in head-initial languages*

Third, in the (head-initial) languages where adjuncts may occur after the verb, we must distinguish the adjuncts (a) which do indeed occur postverbally, (b) those which can never do so but instead must be preverbal, and (c) those which may occur on either side of the verb. (In all cases I will ignore both sentence-initial position, which I and others take to be instances of topicalization (see Rizzi 1997, Alexiadou 1997, for example), and sentence-final position with comma-intonation.) As detailed in Ernst (2002b), the crucial factors deciding whether an adjunct is preverbal or postverbal, or both, are semantic and phonological/morphological; here, however, it is only necessary to observe that adjuncts may be (derivatively) classified in one of these three types.

Obligatorily preverbal adjuncts include predicational adverbs like *probably*, *surprisingly*, *cleverly*, and *honestly* on their non-manner readings, exemplified in 8, and a subset of functional adverbs including *just*, *only*, *scarcely*, and *never*, which I call ‘Lite’ adverbs, as they tend to be short and allow no modifiers (in 9).

- (8) a. Albert has (probably) eaten a sandwich (*probably).
 b. Dave (cleverly) will disguise his identity (*cleverly). (on clausal reading)
- (9) a. They had (scarcely) arrived (*scarcely) when the china fell off the shelf.
 b. Gabriela will have (just) finished the exam (*just).

Adjuncts which can be either pre- or postverbal come from the same two semantic groups as those in 8–9: other functional adjuncts, like *often*, *still*, *again*, *twice*, *yet* which are not morphologically Lite (see 10) and predicational adverbs with manner readings (see 11):

- (10) a. Fred (often) thinks about Jacaltec inflectional prefixes (often).
 b. They haven’t (yet) managed to convince us (yet).
- (11) a. Toni has (tightly) controlled their budget (tightly).
 b. The assistants were (carefully) refilling the containers (carefully) according to the instructions.

The final, obligatorily postverbal group is largely characterized by ‘heaviness’, the adjuncts being either PP’s or CP’s. This group includes participant PP’s like *with a hammer*, *to the store*, *on the beach*, or *for your uncle*, which designate potential/optional arguments of V like instruments, beneficiaries, and so on (see 12). The others are clausal (CP) adjuncts like *because of her*, *if they decide to go*, *unless it explodes*, denoting cause, purpose, and a variety of other semantic roles (see 13):

- (12) a. Louise (*with a hammer) cracked the piggy bank (with a hammer).
 b. She (*for the maestro) composed the piece (for the maestro).

- (13) a. Cats will (*if they fall) land on their feet (if they fall).
 b. Jimmy (*because he loves whiskey) will have another drink (because he loves whiskey).

2.4. R-movement

I will term movements like Heavy Shift, extraposition, and possibly scrambling ‘R-movement’; examples are given in 14:

- (14) a. I thought over t_i carefully yesterday [all that the committee had done] $_i$.
 b. [A woman t_i] came into the room [that we all had seen before] $_i$.
 c. He had [more swiftly t_i] understood his role [than anyone else on staff] $_i$.

As many have noted (e.g. Rochemont & Culicover 1990, Saito & Fukui 1998) and will be discussed below, they have notably different properties from the more widely-studied A’-movements like WH-movement and topicalization, including the facts that R-movement accords with the direction of the complement (compare 14 with 15b, with the presumed base sentence in 15a; see Hawkins 1990) and permits fairly free interpolation with adverbial adjuncts (as in 16):

- (15) a. *Mary-ga kinoo John-ga kekkonsi-ta to it-ta.*
 Mary yesterday John married that said
 ‘Mary said that John got married yesterday.’
 b. *Kinoo John-ga kekkonsi-ta to Mary-ga it-ta.*
 yesterday John married that Mary said
 ‘Mary said that John got married yesterday.’ (Japanese)
- (16) a. The archers were aiming t_i [so obviously t_j] [at us] $_i$ now [that no one could doubt their intentions] $_j$.
 b. We are [better t_i] prepared t_j today [to fight a technological war in an alien environment] $_j$ [than we were nearly a decade ago] $_i$.

3. A parameterized direction hypothesis theory

3.1. Directions

The version of the PDH I propose rests on the idea that there are two notions of direction in UG, schematized in 17:

- (17) a. Functional-direction (F-dir): L
 b. Complement-direction (C-dir): {L, R}

These are primitives, and do not always correspond directly to functional categories and complements. Functional-direction (F-dir) is universally leftward. It is associated with a

cluster of properties which I will call the ‘F-complex’, including functional or operator-type meanings, movement triggered by LF factors, and morphological lightness, which of course means empty elements (covertness) at its most extreme. Among other things, we can derive the universal leftwardness of Spec positions (assuming that they indeed are universally leftward), if we define Spec as a type of adjunction licensed by some functional feature [+F], with licensing by [+F] always following F-dir (on this idea see also Ernst (1991), Kayne (1994), Alexiadou (1997), and Saito & Fukui (1998)). Complement-direction (C-dir) is parameterized to yield head-initial and head-final languages. The distribution of adjuncts is dependent on the combination of values for these two directions in a given language: if C-dir is leftward, then both directions are leftward and adjuncts must also be to the left of their heads, producing a head-final language. If C-dir is rightward, then both leftward- and rightward-direction are possible in a language, and in principle adjuncts may be on either side of V, yielding head-initial languages. These basic ideas are formalized in 18, with their effects fleshed out in 19:

(18) Directionality Principles:

- a. F-dir is universally L(eftward). All licensing by functional features [+F] follows F-Dir; all items so licensed are (by definition) in Spec.
- b. C-dir is parameterized: {L, R}
- c. Adjuncts: (i) Adjoined according to C-dir in VP
(ii) Adjoined according to either F-dir or C-dir in functional projections (according to lexical and prosodic specifications)

(19) Linearization at PF (implementation of Directionality Principles):

All XP's are to the left of heads unless overridden by the head-initial parameterization, i.e. if C-dir = R, then:

- a. All complements and other elements in VP are [+R] (= right of the head)
- b. Adjuncts in functional projections are potentially assigned [+R] (according to lexical and prosodic specifications)

[+F] items always are linearized by F-dir, so that Specs are always to the left of heads even in head-initial languages, where C-dir is parameterized as rightward. 19 treats OV languages as unmarked in a certain sense, being the result of the simplest formulation of direction as uniformly leftward. This gives the correct distribution of uniformly preverbal adjuncts in these head-final languages (see 20a, with examples in 7). But if C-dir is R (see 20b and 6), then complements are linearized to the right, as are all adjuncts in lexical projections (VP); in functional projections, adjuncts can be either to the left or right in principle, falling into the three groups discussed above.

- (20) a. OV: C-dir = L, F-dir = L (so everything is to the left of V)
b. VO: C-dir = R, F-dir = L (so adjuncts in VP are to the right of V; adjuncts above VP are essentially unspecified by the major parameter)

3.2. *Predictions*

These principles yield the four data sets discussed above. First, given traditional right adjunction of adjuncts, the scope and constituency facts fall out straight-forwardly, if scope is what generally determines the hierarchical position of adjuncts (Ernst 1998, Cinque 1999, Frey & Pittner 1999). For head-initial languages, a postverbal scope-taking adjunct will be mapped onto base structure in a hierarchical position appropriate for that scope, will c-command any other adjuncts between it and the verb, and thus will take scope over it. The principles for determining scope are quite straightforward from the syntactic point of view. Likewise, if there are to be deletions, pro-forms like *do so*, or coordinations based on a sentence having two or more postverbal adjuncts, they will follow the constituent structure set up by successive right adjunctions, in exactly the same way as for left-adjoined adjuncts.

Second, as required, OV languages restrict adjuncts to preverbal position while VO languages allow them postverbally in principle, as 20 shows. There is no need to say that preverbal adjuncts are in Spec; both left-adjoined adjuncts and Spec positions are to the left of heads by virtue of F-direction. Moreover, the Kaynean objection to directional parameterization, i.e. that there is no mirror image to SOV languages (or there are very few such VOS languages), is met here. That objection takes an overly simplistic view of the PDH, assuming that head direction applies to all nonheads. But 18 correctly predicts the **partial** asymmetry of language by recognizing the rigidity of leftward F-direction, and allowing only C-direction to be parameterized. More importantly, this version of the PDH makes strong and clear predictions about the general typological patterns of adjunct distribution as reflecting the union of the two primitive directions for a given language.

Third, there are provisions for adjuncts to be marked for the three distributional groups, with those which are postverbal in head-initial languages marked [+R]. Here 19 makes no particular predictions; it simply allows right-adjoined adjuncts to be marked as such.

Fourth and finally, R-movement in head-initial languages involves right-adjunction, as is traditional, so it can be characterized as having different properties from WH-movement, topicalization, and the like, assuming that the latter are movements to Spec positions. As a result, the rightward-moved phrases will have adjunct properties (e.g. barring extraction from them after movement) and will lack whatever properties are characteristic of Spec positions (e.g. Relativized Minimality effects). Given other assumptions to be discussed below, they also will allow variable order with respect to other adjuncts and show different bounding properties.

3.3. *'Mixed' languages*

There are at least two groups of well-known languages which show 'mixed' properties for the distribution of complements and adjuncts, with respect to the more regular types predicted by 18. The first is made up of basic SOV languages such as Dutch, German, and Hindi, which show typical OV properties within VP and possibly IP (depending on the analysis), but head-initial properties for CP; in case of the first two, V-to-C movement

combines with head-initial CP's to produce the well-known V2 effect. 21 provides examples (see also Zwart 1996 for Dutch data):

- (21) a. *Ich weiß, daß der Direktor sie nicht feuerte.*
 I know that the director her not fired
 'I know that the director didn't fire her.' (German)
- b. *Siitaa-ne kahaa thaa [ki raam aayaa he].*
 Sita-ERG say-PERF be-PAST that Ram come-PERF be-PRES
 'Sita had said that Ram has come.' (Hindi)

For these languages, the head-initial CP correlates with the possibility of having certain phrases, most notably CP complements, in postverbal position, in some cases obligatorily. 22 illustrates this:

- (22) a. *Er hat [häufiger t_i] protestiert, [als ich zugestimmt habe]_i.*
 he has more-frequently protested than I agreed have
 'He has protested more frequently than I have agreed to.' (German)
- b. *Siitaa-ne vah gaanaa gaayaa [jo giitaa-ne use sikhaayaa thaa].*
 Sita-ERG that song sing-PERF which Gita-ERG her teach-PERF be-PAST
 'Sita sang that song that Gita had taught her.' (Hindi)

The second group consists only of Chinese (as far as I know), which can roughly be characterized as head-initial with respect to complements, but head-final for adjuncts:

- (23) a. *Xiaozhang hui (*hen duo heiban) mai hen duo heiban.*
 principal will very many blackboard buy very many blackboard
 'The principal will buy a lot of blackboards.'
- b. *Xiaozhang mingtian yiding hui mai heiban (*mingtian) (*yiding).*
 principal tomorrow definitely will buy blackboard tomorrow definitely
 'The principal will definitely buy blackboards tomorrow.'

- (24) *Xiaozhang ba heiban zhuang de hen kuai.*
 principal BA blackboard install DE very fast
 'The principal installed the blackboards quickly.'

Actually, Chinese allows one type of manner adverbial postverbally, as in 24; this means that it can be described as a mixed type in terms of the Directionality Principles if we allow an exception to the last clause in 18c, shown in 25, restricting adjuncts in functional projections to left-adjoined positions, as if Chinese were an SOV language at that level. (This is essentially a reformulation of James Huang's Phrase Structure Constraint (Huang 1982); see discussion in Li 1990, Tang 1990, Ernst 1996b.)

- (25) Marked option for directional licensing of adjuncts:
 c. Adjuncts: (i) Adjoined according to C-dir in VP
 (ii) Adjoined according to F-dir in functional projections

This still allows manner adverbials like those in 24 to be placed after the verb, because of the first clause in 25; at the same time, all higher adjuncts, which are allowed to be postverbal in English, must be placed before the verb by virtue of the second clause in 25. But note that Chinese also has a head-final CP, if we adopt the common view that sentence-final particles like *ma* for yes-no questions, *ne*, etc., are in Comp (e.g. *Ta lai-le ma?* ‘She come Q’ for ‘Did she come?’; see Tang 1998: 42 for discussion). We therefore can link the leftward position of the complement of Comp with the leftward position of adjuncts above VP in Chinese.

Considering the ‘mixed’ languages together, then, 26 represents a hypothesis about how the Directionality Principles can accommodate such cases:

(26) Exceptional Directionality:

C-dir for CP may exceptionally be specified as different from C-dir for VP (i.e. the main parameter value for the language). If so, adjuncts and extraposed phrases potentially follow CP’s C-dir in functional projections.

With 26 it is possible to capture the fact that when a language permits the direction of complements to differ for lower and higher levels of structure, the potential distribution of adjuncts follows suit in some way.

4. Overview of general typological arguments for the PDH over the LCH

4.1. Introduction: Cinquean and Larsonian analyses

The ‘Cinquean’ approach to cases like 6 (e.g. Alexiadou 1997, Cinque 1999) depends on ‘intraposition’. This is the process by which some clausal projection, such as VP or some higher functional projection, is raised over intervening material to land in a higher Spec position (Kayne 1994: 72). For each postverbal adjunct, intraposition applies once; so for the base structure 27 we can derive 28, by first raising VP into SpecYP, and then raising YP into SpecWP.

(27) Carol has [_{WP} [_{XP} willingly [_{YP} [_{ZP} frequently [_{VP} gone]]]]

(28) Carol has [_{WP} [_{YP} gone_j frequently t_j]_i [_{XP} willingly t_i]]

The VP *gone* first intraposes into SpecYP, and then the whole YP *gone frequently* intraposes into SpecWP. The constituency facts are captured directly, with, for example, the YP *gone frequently* being deletable in ellipsis (e.g. ... *and Carol has done so willingly*). As for scope relations, though they are not as straightforward as in theories permitting right-adjunction, one can capture scope facts via reconstruction to something resembling 27 at LF. Some feature (call it [+Intrap]) must trigger intraposition, and the moved phrase must bear some feature identifying it as the one that moves. This is because if any constituent moves other than the complement of the head which triggers the movement, the result is ungrammatical.

It is sometimes assumed, following Larson (1988) and Kayne (1994), that multiple postverbal adjuncts are attached progressively lower as one goes to the right. For example, on this ‘Larsonian’ view, in 29 *slowly* c-commands *yesterday*, which in turn c-commands the *because*-clause; and there is no overt movement of adjuncts, or of VP’s or the like around adjuncts, to yield different orders:

(29) Kim awoke slowly yesterday because she had taken a decongestant.

The numerous problems of this sort of structure have been well documented, for example in Ernst (1994), Pesetsky (1995), and Ernst (1999). I will not do justice to them here, but will merely mention the main reasons why only the Cinquean version of the LCH for adjuncts is considered below.

First, examine constituency facts, as shown by the ellipsis possibilities for 29:

- (30) Kim awoke slowly yesterday because she had taken a decongestant, and
 (a) Alice did __ today because she had a hangover.
 (b) Alice did __ because she had a hangover.
 (c) Alice did __, too.

In 30a the gap corresponds to *awoke slowly*, in (b) it is *awoke slowly yesterday*, and in (c) *awoke slowly yesterday because she had taken a decongestant*. None of these are constituents for the Larsonian view of 29, which thus makes the wrong predictions, while they are constituents on a traditional, right-branching structure.

Second, in a string of postverbal adjuncts with scope properties, those to the right take scope over any to the left, so that in 29 the *because*-clause has wide scope over everything that precedes. If we continue to assume that c-command at LF is the main determinant of scope relations, then positing the base structure in 29 requires some sort of rule of adjunct-raising at LF to get the facts right. As discussed in Ernst (1999), such a rule ends up being laden with many complications and ad hoc stipulations. For example, 31 shows the configuration required at LF for 29:

(31) [Because she had taken a decongestent [yesterday [Kim awoke slowly]]

The *because*-clause must be the highest adverbial, with *yesterday* next and *slowly* lowest. Thus something must ensure that the raising process inverts the adjuncts in precisely this way, rather than, say, raising *yesterday* above *because*. Moreover, to represent proper scope in sequences like 1–2 c-command relationships must **not** be altered, so the raising process must somehow be restricted to postverbal adverbials.

Third, this strictly Larsonian approach requires some way to establish base orders like that in 29, such as an expanded θ -Hierarchy, as in 32:

(32) Agent > Theme > Goal > Location > Manner > Frequency > Cause > Time

But (among other problems), 32 must be parameterized for head-direction in just the way that the Larsonian framework tries to eliminate, since OV languages like German and

Japanese typically show precisely the reverse order for such adjuncts from that in 31, as in 33, where the manner adverb must follow the causal phrase. Importantly, this means the theory no longer posits a universal base.

- (33) *Kanojo-wa* (**yukkurito*) *tukarete-ita-node* (*yukkurito*) *aru*ita.
 she-TOP slowly tired-PAST-because slowly walked
 ‘She walked slowly because she was tired.’

Thus the Larsonian version of the LCH faces too many difficulties to be adopted as a theory of adjunct licensing, not least of which being that it cannot really be an instance of a theory claiming a universal base order. The Cinquean version is free of these defects.

4.2. *Restrictive theories of movement and selection*

Part of the appeal of the LCH is that it promised to simplify grammatical theory and make it more restrictive by banning right-adjunction. However, the cost is an equal or greater loss of simplicity and restrictiveness in the theories of movement and selection. First, as many people have pointed out (e.g. Rochemont & Culicover 1997, Haider 1997), there is no plausible motivation for intraposition; it has no morphological or semantic correlate, as required by a restrictive theory of movement. Intraposition’s function in cases like 28 is just to derive the normal, canonical (often obligatory) surface order of postverbal adjuncts. (The same point holds for R-movements, e.g. Heavy Shift: the extraposed element is raised to a Spec position, and the rest of the VP or other relevant clausal projection is in turn raised above this Spec.) On the PDH there is no question of motivation, as there is no movement, so a more restrictive theory of movement triggers is preserved. Moreover, for Heavy Shift and other cases of apparent rightward movement, intraposition **must** follow the raising of the ‘extraposed’ element to Spec. I know of no theory of why these movements would have to be linked. On the PDH there is only one movement, so these questions do not arise.

4.3. *Linking the distributions of complements and adjuncts*

The most basic typological generalization for adjuncts when they are low in clausal structure (within VP) is that they match the direction of complements; and at least one option for adjuncts higher up in clausal structure is determined by the direction of complements. For example, as shown in 7a, the SOV language Japanese requires preverbal direct objects and preverbal adjuncts; English has postverbal direct objects, (canonically) postverbal manner adjuncts, and some postverbal adjuncts high in the clause (e.g. the *because*-clause in 29). This link between complement and adjunct position is predicted directly by the Directionality Principles.

However, on LCH theories, the direction of complements is determined by some combination of V-raising and object-shift (raising of complements to Spec positions). Kayne (1994) takes SVO order as basic and attributes SOV to object-shift, with a landing site above the canonical position of the verb; Fukui & Takano (1998) take SOV as basic, with SVO derived from V-raising over the object. Regardless of the details, on this

approach adjunct distribution still has to be determined by whether intraposition applies or not; the two phenomena are not inherently linked. 34–35 show this schematically, using the Kaynean version to represent the LCH:

(34) LCH theory with intrapositions

<u>Type</u>	<u>Complements</u>	<u>Adjuncts</u>
SVO	O doesn't raise	Intrapositions apply (adjuncts may be to R)
SOV	O raises	Intraposition does not apply (adjuncts to L)

(35) PDH theory with directionality parameters

<u>Type</u>	<u>Complements</u>	<u>Adjuncts</u>
SVO	C-Dir: R	C-Dir: R (adjuncts may be to R)
SOV	C-Dir: L	C-Dir: L (adjuncts to L)

In 34 there is no obvious link between the possibility of object shift and the possibility of intraposition. Given the features discussed above, we would have to say that the presence of the movement-trigger for object-shift somehow requires the absence of the trigger for intraposition [+Intrap], and that the absence of the object-shift trigger requires the presence of [+Intrap] (the point holds in a slightly different form if SOV is basic, as for Fukui & Takano (1998); see Ernst 2002b).

Given these results, the PDH allows a more restrictive and explanatory theory, capturing the link between complement position and adjunct position directly, while the LCH does not.

4.4. Clustering of R-movement properties

Movements like extraposition and Heavy Shift show a cluster of properties marking them as different from WH-movement and topicalization, and the PDH is superior to the LCH in explaining this cluster. 36 summarizes the relevant properties (see Ernst 1999 and Saito & Fukui 1998):

(36) <u>Phenomenon</u>	<u>Leftward Movement</u>	<u>Rightward movement</u>
(a) direction	leftward	rightward (for VO)
(b) multiple movement	impossible/very restricted	possible
(c) bounding	not clause-bounded	bounded by clauses/ ext. projections
(d) category of moved XP	no restrictions	restrictions possible

Above I alluded briefly to two ‘complexes’ in UG: a ‘C-complex’ characterized by overt elements rather than covert elements, complements rather than Specs, PF principles rather than LF principles; and an ‘F-complex’ representing (at its extreme) covert elements, Specs, and LF conditioning. The two very different types of A’-movement seem to fit quite well each within one of these, WH-movement and topicalization with the F-complex and R-movement in the C-complex. Both the PDH and the LCH can explain

the differences, assuming that each type has a movement trigger ([+R] for R-movement, [+F] for WH/topicalization) associated with one of the complexes: [+R] with the C-complex, and [+F] with the F-complex.

Both approaches can explain properties (b) and (d). For (b), illustrated by the contrast between 37 and 16b, regardless of how we formulate constraints on crossing movements (e.g. in terms of Rizzi's 1990 Relativized Minimality or the Minimal Link Condition of Chomsky 1995), if they apply to movements triggered by [+F] only, then R-movement is exempt from them and allows multiple movements.

(37) *Where_i did they say what_j she put t_j t_i ?

Categorial restrictions are illustrated in German (Haider 1997: 125–126), where a CP is postposed in 38 and a PP in 22a (they may also topicalize) but AP's, DP's, and VP's may be topicalized but not postposed (39):

(38) *Er hat [die ganze Nacht t_i] geschlafen, [die er im Verlies zubrachte]_i;*
 he has the whole night slept which he in dungeon spent
 'He slept the whole night that he spent in the dungeon.'(CP)

(39) a. *[Stolz auf sie] ist er gewesen.* b. **Er ist gewesen [stolz auf sie]*
 proud of her has he been(AP)
 c. *[Eine NP] wurde hier geworden.* d. **Hier wurde verschoben [eine NP].*
 an NP was here moved(NP)
 e. *[Nach Rom gefahren] ist er nicht.* f. **...daß er nicht ist [nach Rom gefahren].*
 to Rome travelled has he not(VP)

Facts like these can be explained by saying that R-movement, but not leftward movement, is subject to weight constraints, determined partially by category (see Ernst 2002b for discussion), a PF phenomenon, and [+F] movements may not be conditioned by anything from the C-complex.

So far, the PDH and LCH do an equally good job. But the theories are distinguishable by how they deal with the direction of movement and bounding. The PDH explains direction of movement straightforwardly on the defining assumption that the C-complex is associated with complements and C-dir: R-movement follows the parameter value for C-dir in a given language (more specifically, C-Dir in CP). Thus English allows extraposition and Heavy Shift to the right; Japanese/Korean requires scrambling and Heavy Shift to the left; the mixed languages German, Dutch, Hindi, and Chinese allow R-movement in the C-dir as defined for CP (rightward for the first three, leftward for Chinese). The other A'-movements are triggered by [+F], which is part of the F-complex, and thus follow F-dir and always yield leftward movement to Spec positions.

On the LCH, the apparent rightward movement of extraposition and Heavy Shift is the result of intraposition. But why should intraposition be associated with the C-complex? This is only an accident as far as the LCH is concerned; though some technical solution might be proposed, LCH theories do not have a conceptually-motivated way to connect

surface direction with the other properties. As for bounding, I know of no well-established theory of R-movement bounding (though the best proposals have been made in the work of Rochemont and Culicover).⁴ However, as they point out (Rochemont & Culicover 1997: 296), the combination of movement triggered by [+R] and intraposition once again introduces significant problems for bounding theory that PDH avoids. For example, Heavy Shift is not allowed out of a PP (see 40a), while WH-movement is (cf. *What did they read from (quietly)?*), but the LCH has no easy way to distinguish what are for it two leftward movements; nor does it account for the impossibility of long movement of such heavy phrases (see 40b):

- (40) a. *They read [_{PP} from t_i] quietly [several of the books recommended by Phil].
 b. *They said [that they would memorize t_i] loudly [several of the books recommended by Phil]_i.

(Rochemont & Culicover (1997) would account for 40a–b by means of their Rightward Movement Constraint.) A more serious problem is that the raising corresponding to R-movement is obligatorily followed by intraposition, the properties of which make it part of the C-complex. Yet while R-movement creates islands for [+F]-movement, as 41a illustrates, intraposition has precisely the opposite property, permitting further leftward [+F] movement, as shown in 41b:

- (41) a. ??What_i did they [read t_i yesterday [all those studies of t_i]]?
 b. Where_i did they [put t_i t_j yesterday]_k [all those boxes of party favors]_j t_k ?

In 41b, after R-movement raises the heavy direct object *all those boxes of party favors*, out of VP, intraposition raises the remnant VP *put where yesterday*, out of which extraction of *where* is possible. Thus intraposition represents an exception to the cluster of properties represented by R-movement, since it is strictly local, yet it allows further extraction from the moved phrase. It is unclear how one could capture the fact that it is not a barrier to extraction, as it seems it should be given its other properties. Doing without intraposition, as the PDH does, avoids this problem entirely, since the only actual movement is the one triggered by [+R].

5. Arguments for the PDH from Chinese

5.1. Two theories

As noted above with respect to 23, Mandarin Chinese shows mixed typological properties in that its complements have basic positions after V, in line with head-initial languages, yet almost all adjuncts are preverbal, like head-final languages:

- (42) a. *Xiao Wang kan-le (yige xiawu) dianying (yige xiawu).*
 Xiao Wang see-PRF an afternoon movie an afternoon
 ‘Xiao Wang watched movies all afternoon.’

- b. *Xiao Wang pao de hen qiguai.*
 Xiao Wang run DE very strange
 ‘Xiao Wang runs strangely.’

37 shows the two cases of postverbal adjuncts: duration or frequency DP’s (in 37a), and manner adverbials marked by *de* in 37a. Though the adjunct status of the manner phrases is controversial, I will proceed here assuming they are indeed adjuncts; only one out of four subparts to the overall argument depend on this (see Ernst 1996a, 1999 for arguments for their adjunct status).

Above I proposed to handle these facts with 25c, a restriction on the linearization of adjuncts in SVO languages triggered by a split in C-dir in Chinese, rightward in VP but leftward for functional projections. Head-initial languages normally permit either F-dir or C-dir to operate in the second clause of 18c, allowing adjuncts in functional projections to be on either side of V in principle. But the restriction in 25c makes Chinese act like an SOV language in this respect.

The prediction of this version of the PDH for Chinese is that any adverbial in VP should be able to occur postverbally. Only two of them actually do, but as discussed in Ernst (1999), this may be taken as the result of all other potentially VP-adjoined adverbials being morphologically Lite, and thus restricted to preverbal positions. (Many adjuncts often taken as adjoined to VP, such as instrumental PP’s, temporal adverbials, and the like, are assumed here to be adjoined to the first functional projection above VP, corresponding to Bowers’ 1993 PredP or Chomsky’s 1995 *v*P. They must therefore be preverbal in Chinese.) Some representative examples are given in 43, where English allows some of the short functional (Lite) adverbs to occur postverbally, but Chinese does not:

- (43) a. Jane comes back {again/occasionally/still}.
 b. *Zhangsan {you/ ouer / bai} huilai-le {*you/*ouer/*bai}.*
 Zhangsan again/occasionally/in-vain return-Prf
 ‘Zhangsan came back again/occasionally/in vain.’

Thus the main difference between Chinese and English within VP is merely that Chinese adverbs that can occur in VP are generally Lite, so Chinese has fewer postverbal adverbs than English. But it is still the case that, abstracting from this morphological consideration, Chinese permits right-adjoined adjuncts in VP.

Turning now to the LCH, if right-adjunction is not allowed, how can these facts be handled? It might be possible to invoke intraposition, but there is little advantage in doing so for 42a (nor has it ever been proposed, to my knowledge), and for 42b it would not produce the right results. Rather, a more likely solution within the LCH is that for Chinese, V raises just high enough to get above the arguments, but not so high as to go above even the lowest adjuncts (Fukui & Takano 1998; cf. also Tang 1998). This is schematized in 44 (for a V with NP and PP complements) where, crucially, V moves to the node Y (I take adjuncts as adjoined, but the point also holds if they are in Spec positions):

- (44) [_{XP} S-AdvS [_{YP} VP-AdvS [_{YP} V_i [_{VP} NP t_i PP]]]]

On this view, as in Cinque (1999) and much other current work, the base order of adjuncts and verbal arguments is assumed to be given by UG for all languages, arranged hierarchically, left to right. The postverbal manner phrase in 42b must be accommodated by claiming that it is an argument of V and appears in a Spec or complement position within VP. The position of the duration/frequency adverbial also would be accounted for by licensing it in some Spec position within VP (Soh 1998; see Huang 1997 for an alternative analysis conforming to this sort of LCH).

5.2. Argument #1: Postverbal manner expressions

The PDH analysis sketched in 18 accounts straightforwardly for the postverbal position of the manner phrase in 42b, since this is a normal position for such adjuncts in head-initial languages. By contrast, the only way the LCH can easily account for this is to say that these expressions are really complements. But as shown in Ernst (1996a), the evidence for this is rather weak. They are completely optional, have normal manner semantics (as opposed to the characteristic semantics of secondary predicates, as claimed in Tsai 1994, and Tsai 1995, among others), occur in the normal position for manner adverbials in SVO languages, and follow all complements in base structure.⁵ To uphold an analysis in which they are complements, one must claim that their marker *de* is some sort of verbal suffix or part of a verbal compound *V+de*. But sentences like 45 are counterevidence to this claim, since we would expect a putative *V+de* combination to take aspect markers or to be questioned by means of the V-not-V question pattern, but they do not show this behavior. Thus the LCH suffers ultimately from having to treat these phrases as exceptional, one way or another, while the PDH treats them fairly naturally.

- (45) a. **Ta pao-de-le hen qiguai.* b. **Ta pao-de-bu-pao-de qiguai?*
 s/he run-DE-PRF very strange s/he run-DE-not-run-DE strange
 ‘S/he ran strangely.’ ‘Does s/he run strangely?’

5.3. Argument #2: Constraints on adjunction sites

The second reason to prefer the PDH for Chinese turns on the fact that both English and Chinese require verbs and (non-heavy) direct objects to be adjacent, while Japanese does not, yet English and Japanese permit adverbs between V and a subcategorized PP, while Chinese still does not:

- (46) a. *Tony bought quickly a book.
 b. Tony slid quickly onto the chair.
- (47) a. **Lao Tang mai de hen kuai yiben shu.*
 Old Tang buy DE very fast a-CL book
 ‘Old Tang quickly bought a book.’
 b. **Lao Tang hua de hen kuai dao yizi shang.*
 Old Tang side DE very fast to chair on
 ‘Old Tang slid quickly onto the chair.’

- (48) a. *Taroo-wa hon-o isoide katta.*
 Taroo-Top book-ACC quickly bought
 ‘Taroo quickly bought a book.’
 b. *Taroo-wa isu-ni isoide nokkatta.*
 Taroo-Top chair-to quickly got-on
 ‘Taroo got onto the chair quickly.’

I assume (with Johnson 1991, Bowers 1993, Ernst 2002b) that the old ‘Case-adjacency’ constraint on accusative case assignment (Stowell 1981, Chomsky 1981) does not exist, and that its effect follows from (a) raising of objects to a Spec position in some VP or VP-shell, and of V to a functional head just above this, and (b) an independent ban on adverbs adjoined to this projection, between V and its object. (For Japanese, as shown in 48a, I will assume that this movement may be a subcase of scrambling.) The crucial question is therefore: how are adjuncts banned from this position, between verb and object?

Most attempts to do this are no better – and often worse – than the Case-adjacency requirement. For example, Johnson and Bowers stipulate in an ad hoc fashion that adjuncts in the relevant VP only may adjoin to V’. Others assume that objects are in SpecAgrOP and agreement projections cannot host adverbs; but this cannot easily account for the same effect with double objects (as in **Georgia gave Newt lovingly a cigar*). This is because a VP-adjunction site intervenes between the two objects, even if each object is in the Spec of its own AgrOP (on the assumption that an AgrP projection is associated with one lexical projection).

The PDH predicts these patterns quite simply: in head-initial languages like English and Chinese, adverbs may not left-adjoin to VP (or its shells), by 18c–i, so in cases like 46a/47a the verb and its object are always adjacent. Japanese, being head-final, allows left-adjunction to any projection (above the base positions of arguments). Cases like 46b can be accounted for by permitting rightward movement of PP as a subcase of Heavy Shift (see Ernst to appear-b), a movement forbidden in Chinese and Japanese by virtue of their being head-final in CP, which blocks R-movement. 49 illustrates this in Chinese, with a heavy direct object to the right of a postverbal manner expression (read without a pause after *keqi* ‘polite’):

- (49) **Guorong wen de hen keqi nei-xie hen nan huida de wenti.*
 Guorong ask DE very polite that-PL very hard answer of question
 ‘Guorong asked politely those difficult-to-answer questions.’

By contrast, the LCH does not predict these patterns well. If adjunction to VP is uniformly banned, as is necessary on this account to keep all adjuncts preverbal in Chinese, and V-raising in English and Chinese is to the same point, then the LCH does not account for the contrast in 46b and 47b, i.e. why English allows adverbs between V and PP but Chinese does not. Alternatively, if V-raising differs in the two languages, with English verbs raising higher than in Chinese, then we can account for the (b) sentences, but there is no longer any good account for 46a. That is, if English verbs can raise over an adverb, then they raise into projections where adverbs may be left-adjoined, and once

again we have to fall back on stipulations to keep verb and object adjacent. And the LCH approach most likely **must** say that English and Chinese differ in the height of V-raising, since its only hope of getting the general typological facts about adjuncts right is to use different landing sites for V to condition intraposition, triggering it for higher landing sites as in English, but blocking intraposition for low landing sites, in Chinese and Japanese. Therefore, it appears that the LCH approach to Chinese inevitably entails a rather stipulative approach to constraints on adjunction.

5.4. Argument #3: Direction of movement

As noted in above, R-movements conform to the head-direction for typologically regular languages: rightward in head-initial languages like English, and leftward in head-final languages like Japanese and Korean. Since Chinese is basically head-initial but disallows rightward movements, how can this be predicted?

On a theory recognizing the parameterization of head-direction, the direction of R-movement can be linked to this, as I outlined earlier for the PDH (see Saito & Fukui 1998: 446ff. for one version). For typologically regular languages this is easy; for less regular languages, Heavy Shift/extraposition can be associated with C-direction in CP, extending 26 to account for landing sites as well as base positions, either leftward or rightward. If so, these processes apply to the right in normal VO languages and to the left in regular OV languages (as in 15–16). Among the mixed languages, German is correctly predicted to allow extrapositions to the right, as illustrated in 38 (the same holds for Dutch), and Chinese can only have Heavy Shift/extraposition to the left, since its CP is head-final. Leftward movement of this sort is indistinguishable from clause-bounded topicalization, as in 15a for Japanese, since R-movement is generally clause bounded and heavy items are likely to be topicalized. Schematically, these predictions are shown in 50:

(50)		<u>Languages</u>	<u>C-dir in CP</u>	<u>Movement</u>
	Extrap'n/Heavy-Shift:	Japanese/Chinese	left	left
	(according to 26)	English/German	right	right

Thus Chinese behaves here like a head-final language at the upper levels of structure.

How can the LCH embodied in 44 accomplish the same predictions? Given a basic Spec-Head-Complement order, LCH analyses generally invoke raising of IP to SpecCP to account for IP-C order (Kayne 1994: 54); and as noted earlier intraposition is used to derive the effects of extraposition/Heavy Shift:

(51)	<u>Languages</u>	<u>CP</u>	<u>Extraposition/Heavy Shift</u>
	Japanese/Chinese	IP raises	No intraposition
	English/German	IP doesn't raise	Intraposition applies

The LCH theory can link the two effects as in 51, but as shown in section 4.3 for object shift and intraposition, there is no principle requiring either that they be linked or that they should be linked in this particular way. More generally, we now have three different sorts

of preposing rules that must be correlated: (a) movement of IP to SpecCP, (b) intraposition of predicates to a position above adjuncts and now (c) intraposition of predicates to a position above ‘extraposed’ or ‘heavy-shifted’ phrases. On the PDH theory these are all linked by one parameterization, for rightward position of nonheads in CP, while on the LCH they are unrelated in principle. This constitutes evidence for the PDH.

6. Summary and conclusion

In this chapter I have contrasted two approaches to word order typology with respect to how they handle the cross-linguistic patterns of adjunct distribution. The PDH, via the Directionality Principles of 18, embodies the claim that all languages require Specs to the left of heads, and are parameterized as to whether complements go to the left or right; in a parallel way, languages always allow some adjuncts to the left of heads, and allow them to the right if and only if the language in question allows complements to the right. I showed that this system, allowing right adjunction but with minimal or no movement of adjuncts, accounts not only for this distributional pattern, but also for the other phenomena outlined in section 2, including scope and constituency facts and the different properties of rightward movement with respect to leftward movement.

With respect to Chinese and its contrasts with Japanese/Korean and English, I gave three arguments for the PDH over the LCH. First, the LCH analysis incorrectly predicts that manner expressions in Chinese are either uniformly preverbal, or that postverbal ones have complement properties, while the PDH correctly allows for postverbal manner phrases. Second, if the LCH is to capture differences between English and Chinese, it ends up resorting to stipulative conditions on adjunction, unlike the very general conditions allowed under the PDH. And finally, the LCH does not do a good job in accounting for the direction of R-movement in Chinese, at least without complicating the cross-linguistic account of this phenomenon. The PDH predicts this neatly.

I conclude that evidence from cross-linguistic adjunct distribution supports taking word order typology as parameterized for head-direction at PF, with a correspondingly simpler derivation in terms of movements (the PDH), rather than in terms of complex movements and a simpler linearization algorithm (the LCH).

I end with one final comment. The Kaynean/Cinquean program was based mostly on data from heads, complements, and Specs. Since Specs are always leftward, and so many complements move into Spec positions, this gave the impression that there was a simple correspondence between hierarchy and linear order. In fact, I think the LCH program is not too far off the mark for arguments. But I think I have shown that it indeed way off the mark for adjuncts. The proposals I have made capture both sets of data, and preserve a theory with a high degree of restrictiveness.

Notes

- 1 I owe thanks to Masa Deguchi, Shizhe Huang, Audrey Li, and Yukiko Morimoto; but all errors or omissions remain mine alone. This chapter was written before Ernst (2002b), which represents a refinement of the ideas herein.

2 Here and below I will consistently abstract away from the few cases where a verb has raised over two left-adjoined adverbs, so that of the resulting two postverbal adverbs, the leftmost one c-commands and has scope over the one to its right, e.g. (i), from French:

- (i) *Il parle probablement très vite.*
 he speak probably very quickly
 ‘He probably speaks very quickly.’

3 In a very small number of cases, the first of two postverbal adjuncts may take wide scope, as in (i); these should be treated as relatively exceptional phenomena (see Ernst 2002b).

- (i) a. Jill ate pepperoni-pineapple pizza only twice.
 b. The FBI agent knocked intentionally on the door.

4 Culicover & Rochement (1990), Rochemont & Culicover (1990), Rochemont (1992), Rochemont & Culicover (1997).

5 Tsai (1994) claims that extraction from the postverbal manner expression is possible, as in (i), and that this is evidence that they are complements. However, such sentences are not perfectly acceptable, which accords better with treating them rather as cases of extraction from an WH-island rendered more acceptable by pragmatic and other mitigating factors (as in *?What_i were they wondering how to fix t_i?*). See Ernst (1996a), pp. 126–127, for discussion.

- (i) *?Zemmeyang_i (a), ta niurou dun de t_i?*
 How PRT s/he beef stew DE
 ‘How did he stew the beef?’

Tsai (1994, 115–116)

References

- Alexiadou, A. (1997). *Adverb Placement*. Amsterdam: John Benjamins.
 Andrews, A. (1983). A Note on the Constituent Structure of Modifiers. *LI 14*, 695–697.
 Bowers, J. (1993). The Syntax of Predication. *Linguistic Inquiry 24*, 591–656.
 Chomsky, N. (1981). *Lectures on Government and Binding*. Cambridge: MIT Press.
 Chomsky, N. (1986). *Barriers*. Cambridge, MA: MIT Press.
 Chomsky, N. (1995). *The Minimalist Program*. Cambridge, MA: MIT Press.
 Cinque, G. (1999). *Adverbs and Functional Heads: a Cross-Linguistic Perspective*. Oxford: OUP.
 Culicover, P., & Rochement, M. (1990). Extraposition and the Complement Principle. *LI 21*, 23–48.
 Ernst, T. (1991). A Phrase Structure Theory for Tertiaries. In S. Rothstein (Ed.), *Perspectives on Phrase Structure: Heads and Licensing* (Vol. 25, pp. 189–208). New York: Academic Press.
 Ernst, T. (1994). M-Command and Precedence. *Linguistic Inquiry 25*, 327–335.
 Ernst, T. (1996a). Chinese Evidence for Semi-Arguments. *Studies in the Linguistic Sciences 26*, 117–132.
 Ernst, T. (1996b). On Adjunct Case in Chinese. *CLAO 25*, 167–197.
 Ernst, T. (1998). Scope Based Adjunct Licensing, *NELS 28* (pp. 158–172). Amherst: GLSA.
 Ernst, T. (1999). Adjuncts, the Universal Base, and Word Order Typology, *NELS 29* (pp. 209–223). Amherst, MA: GLSA.
 Ernst, T. (2002a). Manners and Events. In C. Tenny & J. Pustejovsky (Eds.), *Events as Grammatical Objects* (pp. 335–358). Stanford: CSLI.
 Ernst, T. (2002b). *The Syntax of Adjuncts*. Cambridge: Cambridge University Press.
 Frey, W., & Pittner, K. (1999). Zur Positionierung der Adverbiale im deutschen Mittelfeld (On the Positioning of Adverbials in the German Middle Field). *Linguistische Berichte 176*, 489–534.
 Fukui, N. (1993). Parameters and Optionality. *Linguistic Inquiry 24*, 399–420.

- Fukui, N., & Takano, Y. (1998). Symmetry in Syntax: Merge and Demerge. *JEAL* 7, 27–86.
- Haider, H. (1997). Extraposition. In C. Beerman, D. LeBlanc, & H. van Riemsdijk (Eds.), *Rightward Movement* (pp. 115–151). Amsterdam: John Benjamins.
- Hawkins, J. (1990). A Parsing Theory of Word Order Universals. *Linguistic Inquiry* 21, 223–261.
- Huang, C.-T. J. (1982). *Logical Relations in Chinese and the Theory of Grammar*. Ph.D. dissertation, MIT, Cambridge, MA.
- Huang, C.-T. J. (1997). On Lexical Structure and Syntactic Projection, *Chinese Languages and Linguistics III: Morphology and Lexicon* (pp. 45–89). Taipei: Academia Sinica.
- Johnson, K. (1991). Object Positions. *Natural Language and Linguistic Theory* 9, 577–636.
- Kayne, R. (1994). *The Antisymmetry of Syntax*. Cambridge, MA: MIT Press.
- Larson, R. (1988). On the Double Object Construction. *Linguistic Inquiry* 19, 335–391.
- Li, A. Y.-H. (1990). *Order and Constituency in Mandarin Chinese*. Dordrecht: Kluwer.
- Pesetsky, D. (1995). *Zero Syntax*. Cambridge, MA: MIT Press.
- Rizzi, L. (1990). *Relativized Minimality*. Cambridge, MA: MIT Press.
- Rizzi, L. (1997). The Fine Structure of the Left Periphery. In L. Haegeman (Ed.), *Elements of Grammar* (pp. 281–337). Dordrecht: Kluwer.
- Rochemont, M. (1992). Bounding Rightward A'-Dependencies. In H. Goodluck & M. Rochemont (Eds.), *Island Constraints* (pp. 373–397). Dordrecht: Kluwer.
- Rochemont, M., & Culicover, P. (1990). *English Focus Constructions and the Theory of Grammars*. Cambridge: Cambridge University Press.
- Rochemont, M., & Culicover, P. (1997). Deriving Dependent Right Adjuncts in English. In D. Beerman et al (Eds.), *Rightward Movement* (pp. 279–300). Amsterdam: John Benjamins.
- Saito, M., & Fukui, N. (1998). Order in Phrase Structure and Movement. *LI* 29, 439–474.
- Soh, H. L. (1998). *Object Scrambling in Chinese*. Ph.D. dissertation, MIT.
- Stowell, T. (1981). *Origins of Phrase Structure*. Ph.D. dissertation, MIT, Cambridge, MA.
- Tang, C.-C. J. (1990). *Chinese Phrase Structure and the Extended X' Theory*. Ph.D. dissertation, Cornell University, Ithaca, NY.
- Tang, S.-W. (1998). *Parametrization of Features in Syntax*. Ph.D. dissertation, UC-Irvine, Irvine.
- Tsai, M.-c. (1995). *La Modification Adverbiale et l'Ordre des Mots en Chinois*. Thèse de doctorat, Université Paris VII, Paris.
- Tsai, W.-T. D. (1994). *On Economizing the Theory of A-Bar Dependencies*. Ph.D. dissertation, MIT, Cambridge, MA.
- Zwart, J.-W. (1996). *Morphosyntax of Verb Movement*. Dordrecht: Kluwer.
- Zwart, J.-W. (1997). The Germanic SOV Languages and the Universal Base Hypothesis. In L. Haegeman (Ed.), *The New Comparative Syntax* (pp. 246–267). London: Longman.

THE DISTRIBUTION OF NEGATIVE NPS AND SOME TYPOLOGICAL CORRELATES

C.-T. James Huang

1. The Problem

In English, a negative indefinite pronoun like *nobody* distributes like any other noun phrase, in that it can occur in any position in a sentence where a normal noun phrase or pronoun can occur: as a subject, an object, an object of preposition, a possessive specifier, etc., as illustrated in (1).

- (1) a. Nobody loves her.
 b. She loves nobody.
 c. She has spoken to nobody today.
 d. She depends on nobody's support.

This is also true of other negative NPs like *no president*, *not a single time*, etc., as seen in (2).

- (2) a. She has spoken to not a single soul.
 b. At no time has she spoken to me.
 c. The election of no president will please his opponent.
 d. She has required that no linguistic book be put on the reading list.
 e. She has recommended that we read no linguistic book.

Each of these sentences can be alternatively expressed with the sentential negation *not* and a separate indefinite noun phrase at a distance, either a negative polarity item (NPI) like *anybody*, *any linguistic book*, or 'minimizers' (Horn 1989) like 'a single time'. Let us refer to the following as examples of the 'discontinuous' strategy:

- (3) a. She does not love anybody.
 b. She has recommended that we not read any linguistic book.
 c. She has not spoken to anybody today.
 d. She did not speak to a single soul.

The fact that a negative NP or quantifier behaves like any other NP is, of course, nothing of any special interest, since a negative NP is an NP and is therefore expected

to behave as one such. The relevant state of affairs becomes more interesting when we consider other languages. Japanese presents an extreme contrast, where one cannot find a counterpart to *nobody*, *nothing*, *nowhere*, *no president*, etc., in any syntactic position. The sentences in (1) and (2) would have to be rendered in discontinuous forms as in (4):

- (4) a. ‘Nobody saw me’
dare-mo boku-o mi-nak-atta
 anybody I-Acc see-Not-Past
 [Lit. It did not happen that anybody saw me.]
- b. ‘I saw nobody’
boku-wa dare-mo mi-nak-atta
 I-Top anybody see-Not-Past
 [Lit. I did not see anybody.]
- c. ‘Hanako saw nothing.’
Hanako-wa nani-mo mi-nak-atta.
 Hanako-top anything see-Not-Past
 [Lit. Hanako did not see anything.]
- d. ‘Hanako read no book.’
Hanako-wa dono hon-mo yoma-nak-atta.
 Hanako-Top any book read-Not-Past
 [Lit. I did not read any book.]

In (4a–b), for example, negation is solely expressed by the verbal suffix *nak*, and the indefinite pronoun *dare-mo* would be suitably translated as ‘anybody’ or ‘everybody’. The same is true of (4c–d), where *nani-mo* and *dono hon-mo* would approximate the meanings of ‘anything’ and ‘any book’, respectively.

Thus, while English has negative pronouns and NPs, Japanese does not have any. This naturally raises the question of how this difference can be stated in an optimal theory of grammar and linguistic typology. An easy ‘solution’ might be simply to state that these two languages differ in the content of their lexicons: the English lexicon has negative pronouns, but the Japanese lexicon does not; or that English has a negative quantifier that can modify a noun or noun phrase, but Japanese does not. This is simply a restatement of the fact but surely not a solution, however, as it would beg the question of why the two languages should differ precisely in this way but not, say, the other way around. This simplistic view also runs into a problem when we consider a language – Mandarin Chinese – that exhibits a distributional pattern of negative pronouns and NPs somewhere between the two extremes represented by English and Japanese. In Mandarin, counterparts of ‘nobody’ (*meiyou ren*) or ‘not a single book’ (*meiyou yiben shu*) can appear as subjects of sentences but not as objects:

- (5) a. *meiyou ren kanjian wo.*
 No person saw me.
 ‘Nobody saw me.’

b. **wo kanjian-le meiyou ren.*

I saw no person.

(6) a. *meiyou yiben shu tidao ta.*
no one book mention he
'Not a single book mentioned him.'

b. **ta tidao meiyou yiben shu.*
he mention not one book

A negative object is allowed if placed in a preverbal topic or adjunct position (see 7). Or the discontinuous strategy will be needed (8):

(7) a. *meiyou yiben shu ta kanguo.*
not one book he read
'No book has he read.'

b. *ta meiyou yiben shu kanguo.*
he not one book read
'He has read no book.'

(8) a. *ta meiyou kanjian renhe ren.*
he not see any person
'He did not see anybody.'

b. *ta meiyou tidao renhe yiben shu.*
he not mention any one book
'He has not mentioned any book.'

The same restrictions apply to quantificational temporal expressions that normally appear in postverbal position:

(9) a. *ta xiao-le yi-zheng tian.*
he laughed one-whole day
'He laughed for a whole day.'

b. **ta xiao-le meiyou yi tian.*
He laughed not one day

c. *ta meiyou yi-tian xiaoguo.*
he not one day laughed
'On not one day did he laugh.'

(10) a. *ta zhi tiaoguo yi ci.*
he only danced one time.
'He danced only once.'

b. **ta tiaoguo-le meiyou yi ci.*
he danced not one time

c. *ta meiyou tiaoguo yi ci.*
he not danced one time
'He did not dance once.'

- d. *ta meiyou yi ci tiaoguo.*
 he not one time danced
 'He did not dance once.'

In addition, a negative NP cannot occur as the object of a preposition (as in (11)) or as a possessor modifying another NP (as in (12)):¹

- (11) a. **ta ba meiyou ren da-si le.* vs. *ta meiyou ba renhe ren da-si.*
 he BA no person kill asp he not BA any person kill
 'He did not kill anybody.'
- b. **ta bei meiyou ren qipian le.* vs. *ta meiyou bei renhe ren qipian.*
 he by no person cheat asp he not by any person cheat
 'He was not cheated by anyone.'
- c. **ta gen meiyou ren chuqu wan le.* vs. *ta mei gen renhe ren chu-qu wan.*
 he with no person go-out play asp he not with any man go-out play
 'He did not go out with anyone.'
- (12) a. **wo tou-le meiyou ren de shu.* vs. *wo meiyou tou renhe ren de shu.*
 I stole no person 's book I not steal any person 's book
 'I did not steal anyone's book.'
- b. **wo zhan-le meiyou ren de pianyi.* vs. *wo meiyou zhan renhe ren de pianyi.*
 I took-asp no person 's advantage I not take anyone 's advantage
 'I did not take advantage of anyone.'

Note that the restrictions on negative NPs we are observing clearly do not apply to positive NPs, which can freely occur in postverbal positions:

- (13) *ta kanjian-le ren/yi-ge ren/na-ge ren le.*
 he see-perf person/one person/that person asp
 'He saw some people/someone/that person.'

The descriptive generalization about Mandarin Chinese is then that negative pronouns or NPs corresponding to *nobody*, *nothing*, *nowhere*, *not a single book*, etc., can occur in the position of a topic, a subject, or a preverbal adjunct; they cannot occur as a postverbal object of the verb, the object of a preposition, a postverbal complement, or as a possessive determiner.

This descriptive generalization about Mandarin seems to apply to some other dialects as well, but appears not to apply when we consider Taiwanese. In the following examples, expressions like 'no book, no money, no job, no wife' appear quite comfortably in postverbal position:

- (14) *goa chaikhi thak bo chhe*
 I morning read no book
 'I read no book this morning.'

(15) *i than bo chiN, chhuei bo thaolo, tongjen ma chhua bo boh.*
 he earn no money found no job of-course and marry no wife
 ‘He earned no money, found no job; of course he also married no wife.’

(16) *i ti kong saN, goa long sa bo liao-a mng.*
 he at say what I all grasp no cottage door
 ‘Whatever he is talking about, I am grasping no cottage door. (I’m totally lost.)’

The facts we have reviewed so far can be summarized tentatively in the following table:

(17) Distribution of Negative NPs (tentative):

	Preverbal	Postverbal
English	yes	yes
Japanese	no	no
Mandarin	yes	no
Taiwanese	yes	yes

The problem now of course is what explains this cross-linguistic pattern.

2. The Origin of Negative NPs

2.1. Taiwanese

There is reason to believe that the tentative summarizing statement about Taiwanese given in (17) is actually not correct. In particular, the examples given in (14)–(16) show only that the language has *apparent* cases of postverbal *nobody*, *no job*, etc. It is a fact of Taiwanese that *bo* (literally ‘not-have’) and the affirmative form *u* ‘have’ may each be used to form a resultative compound with the preceding verb expressing the successful execution (or lack thereof) of an action or the (non) attainment of a desired result. (The counterparts *meiyou* and *you* in Mandarin and other northern dialects typically do not allow this usage.) Thus in the examples in (14)–(16), and indeed in all examples with apparent postverbal *nobody*, etc., the possibility exists that the negative *bo* ‘not-have’ forms a resultative compound with the preceding verb, but does not occur in construction with the following bare nominal to form a negative NP. That this is indeed the case in these examples is supported by substantial evidence.² First, the following examples show that the negative *bo* forms a constituent with the preceding verb:

(18) a. Q: *lin chaikhi khuaN wu chhe bo?*
 you morning read have book no
 ‘Did you guys succeed in reading books?’

b. A: *i khuaN wu, goa khuaN bo.*
 he read have I read no
 ‘He did, I did not.’

(19) *li chiN tan bo, taolo a chhuei bo,*
 you money earn not-have job also found not-have
biangong boh ma chhua bo.
 needless-say wife and marry not-have
 ‘You have been unsuccessful in money-making, also in job-hunting, then needless to say you are also unsuccessful in [your efforts to] get married.’

Second and more crucially, note that apparent postverbal negative NPs are found only with accomplishment verbs, or activity verbs turned into accomplishments by the addition of the resultative portion *bo* ‘not-have’ (as in (14)–(16)). They are not acceptable with statives which cannot be turned into accomplishments.

(20) a. **goa ai bo lang.* cf. *goa chhuei bo lang.*
 I love no person I found no person
 Intended: ‘I love no one.’ ‘I found no one.’
 b. **i bat go-e lang, goa bat bo lang.*
 he know 5-CL person I know no person
 Intended: ‘He knows 5 people, but I know none.’

Given these facts, the obvious generalization about Taiwanese is that it patterns with Mandarin Chinese as far as the distribution of negative NPs is concerned, and so the table in (17) should therefore be revised as follows:

(21) Distribution of Negative NPs

	Preverbal	Postverbal
English	yes	yes
Japanese	no	no
Chinese languages	yes	no

2.2. The Syntactic Origin of Negative NPs

I suggest that an explanation of the cross-linguistic pattern (21) is readily available from the analysis of K.-K. Christensen (1991) of negative NPs in Norwegian. Christensen observes that, in a perfective sentence like (22), the positive NP *en bok* ‘a book’ can occur postverbally (see (22a)), but the negative *ingen bøker* ‘no books’ cannot (22b). A negative object would have to be preposed as in (22c), or the discontinuous strategy ‘not ... any books’ must be used (22d):

- (22) a. *Jon har kjøpt en bok.*
 Jon has bought a book
 ‘Jon has bought a book.’
 b. **Jon har kjøpt ingen bøker.*
 Jon has bought no books
 ‘Jon has bought no books.’
 c. *Jon har ingen bøker kjøpt.*
 John has no books bought
 ‘Jon has no books bought.’
 d. *Jon har ikke kjøpt noen bøker.*
 John has not bought any books
 ‘John has not bought any books.’

The same restriction is observed with Icelandic *engar bökur* ‘no books’:

- (23) a. **Jón hefur keypt engar bökur.*
 Jón has bought no books
 b. *Jón hefur engar bökur keypt.*
 Jón has no books bought
 ‘Jón has bought no books.’

This pattern is immediately reminiscent of the pattern observed above for Mandarin, again calling for a principled account. But the pattern in these Scandinavian languages is even more intriguing. Thus, although a postverbal negative NP is not permitted in a perfective sentence like (22b) and (23a), it sits comfortably following a simple-past main verb.

- (24) *Arne kjøpte ingen bøker*
 Arne bought no books
 ‘Arne bought no books.’

To make it even more perplexing, when the grammatical (24) is embedded in a complement clause (e.g., under ‘John regrets that ...’), it becomes bad again (25), yielding to the discontinuous form (26):³

- (25) **Jon beklager at Arne kjøpte ingen bøker.*
 John regrets that Arne bought no books
 (26) *Jon beklager at Arne ikke kjøpte noen bøker.*
 John regrets that Arne not bought any books
 ‘John regrets that Arne did not buy any books.’

The same pattern is illustrated in (27)–(29):

- (27) *Arne så ingen.*
Arne saw nobody
'Arne saw nobody.'
- (28) **Jon beklager at Arne så ingen.*
John regrets that Arne saw nobody
- (29) *Jon beklager at Arne ikke så noen.*
John regrets that Arne not saw anybody
'John regrets that Arne saw nobody.'

Similar contrasts obtain between main clauses and relative clauses:

- (30) *Jón leser ingen romaner*
John reads no novels
'John reads no novels.'
- (31) **Dette er en student som leser ingen romaner.*
this is a student who reads no novels
- (32) *Dette er en student som ikke leser noen romaner.*
this is a student who not read any novels.
'This is a student who doesn't read any novels.'

Instead of the discontinuous strategy (e.g., (32)), the preposing strategy can also save the negative NP:

- (33) *Dette er en student som ingen romaner leser.*
this is a student who no novels reads.
'This is a student who reads no novels.'
- (34) *Ingen romaner har Jon lest.*
no novels has John read.
'John has read no novels.'

The subject position, being preverbal, can of course also host a negative NP:

- (35) *Ingen studenter leser romaner.*
no students read novels
'No student reads novels.'

These patterns indicate then that postverbal *nobody* is acceptable in a simple tensed root clause, but not when embedded under an aspectual auxiliary or as part of an embedded

clause (even without an auxiliary). Christensen's generalization is that postverbal negative NPs are grammatical just in case there is also accompanying V2, i.e., when the main verb has been moved to C in CP. She accounts for this fact by adopting Klima's (1964) early analysis of English *nobody* as being syntactically derived from the conflation of *not anybody* under adjacency. The distribution of *nobody* in Norwegian simply reflects the range of environments where *not* and *anybody* are brought to be adjacent by syntactic transformations. Specifically, assume the following underlying structure for the grammatical *Jon så ingen* 'John saw nobody':

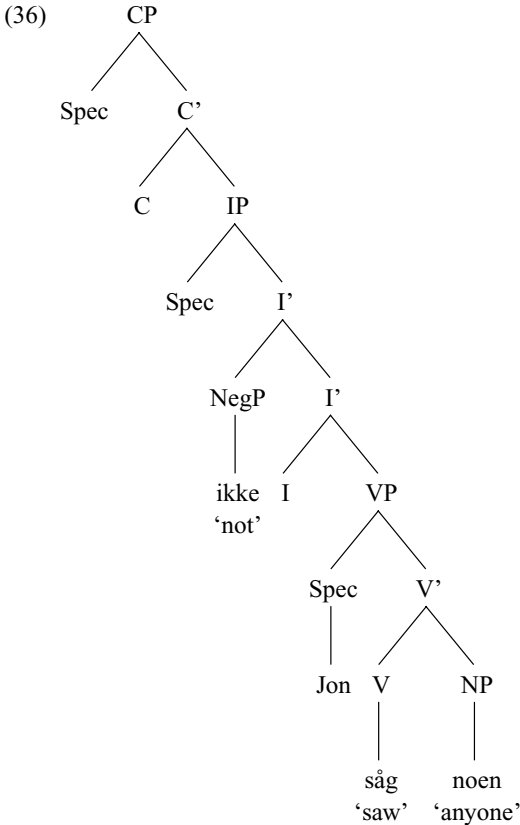

The subject *Jon* moves to the first position in the clause, SpecCP, and the main verb moves from V to I to C, ending up in second position:

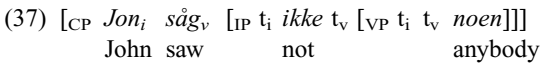

This gives rise to a string in which *ikke* and *noen* are phonetically adjacent, and a process of 'conflation' turns it into *ingen* 'nobody' (presumably, the string reanalyzes

(e.g., verb movement), or (b) by preposing the polarity item across the intervening material.

3. Distribution of Negative NPs across Languages

It appears that the basic insight of Christensen's analysis for Norwegian provides an answer to the questions raised above concerning the distribution of Negative NPs across a number of languages. First, the distribution of negative NPs in Chinese essentially mirrors the Norwegian pattern. A postverbal *meiyou ren* 'nobody' is always ruled out for the simple reason that, in Chinese, the verb does not move to I and, hence, also not to C.⁶ The result is that a postverbal polarity item 'any person' is always separated by the verb from the negative licenser. In other words, the discontinuous strategy is required:

- (41) [_{IP} Zhangsan_i [_{I'} ... *meiyou* [_{VP} t_i *kanjian renhe ren*]]]
 Zhangsan not see any person

The same account also explains why a negative NP cannot follow *ba*, *bei*, or prepositions like *gen* (see (11)). Since these items (whether analyzed as coverbs or prepositions) do not raise beyond the negative element in the underlying structure any more than verbs do:

- (42) [_{IP} *ta* [_{I'} ... *meiyou* [_{VP} *ba renhe ren* [_{VP} *da-si*]]]]].
 he not BA any person kill
 'He did not kill anybody.'

the occasion never arises for *meiyou* and *renhe ren* to conflate, under adjacency, into *meiyou ren* 'nobody', hence the ungrammaticality of (11a), etc. The lack of negative possessive phrases is explained in the same way. On the other hand, a negative NP readily occurs in subject position, or in a sentence in which the object is preposed:

- (43) [_{IP} Zhangsan [_{I'} ... *meiyou* [_{VP} *yiben shu*_i [_{VP} *kuan-guo* t_i]]]]]
 Zhangsan not one book read-exp
 'Zhangsan has read not a single book.'

In sum, Chinese and Norwegian are the same in that they allow negative NPs only where they could be derived from an adjacent sequence of sentential negation Neg followed by a 'minimizing' or polarity QP. The two languages differ in how that sequence may come about: in Norwegian, an adjacent sequence may be created (i) either by vacating the verb between Neg and the polarity QP, (ii) or by fronting the QP to Neg, but in Chinese only the latter strategy is available.⁷

This same account also explains why Japanese does not have negative NPs at all. A typical negative sentence in Japanese has the negative element occurring after VP, as head of NegP:

(44)

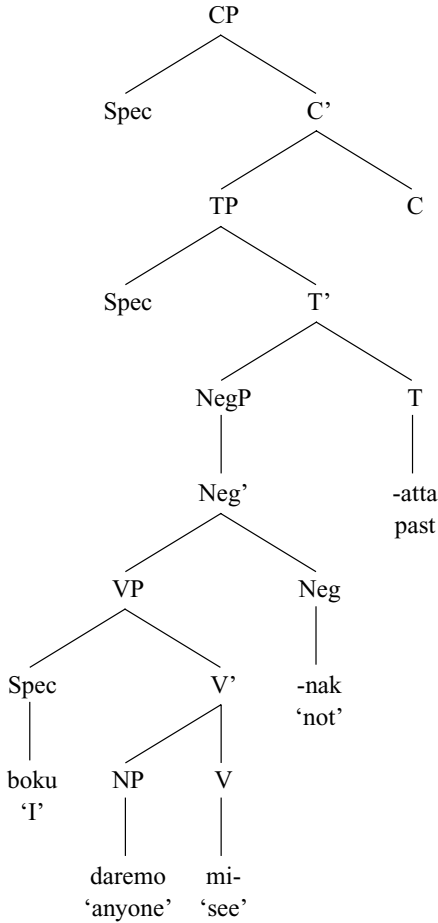

In order to create the equivalent of ‘nobody’, an adjacent string consisting of *dare-mo* ‘anybody’ and *nak-* must be available, either by V movement or by QP movement. Whether or not Japanese has V to I to C movement is a controversial issue (cf. Fukui and Takano (1998) and Miyagawa (2001), among others). If V does not move, it intervenes between ‘anybody’ and ‘not’. If it does, notice for a fact that the movement is vacuous – the verb does not move around Neg, but simply left-adjoins to it. So again there is no adjacency. What about QP movement? This does not help either, since movement of *daremo* (as XP movement in general in Japanese) is leftward, and simply moves ‘anybody’ further away from Neg. Hence, there is no chance to make a negative NP.

The account for Norwegian, Chinese, and Japanese adopted above does not explain the seemingly free distribution of negative NPs in English. R. Kayne (1996), however, observes that there is a slight difference between (45a–b) and (45c):

- (45) a. Nobody loves me. (Benign)
 b. I don't love anybody. (Benign)
 c. I love nobody. (Suggests a different register)

Klima (1964) shows that although *no* occurs in construction with *book* as part of an NP, the first half of each example below involves sentential negation:

- (46) a. John read no book today, not even a single page.
 b. John read no book today, and Bill didn't, either.
 c. John read no book today, did he? (*Didn't he?)
 d. John read no book today, and neither did Bill.

These facts might motivate a similar syntactic account in the terms described above. The following two sentences present no problem:

- (47) a. Nobody loves me.
 b. John is nobody.

For (47a), Neg is adjacent to the subject in Spec, VP. We can assume that *Neg + anybody* → *nobody* applies and then *nobody* moves to Spec, IP. For (38b), auxiliary *be* vacates itself between *not* and *anybody*, enabling conflation to occur. The situation with (48) is different however:

- (48) John saw nobody.

Unlike auxiliaries *be* and *have*, main verbs do not move to I in English, as is well known since Pollock (1989) (after Emonds 1978). This being so, how does *neg saw anybody* give rise to *saw nobody*? Based on Kayne (1996, 1998), we can derive (48) as follows. First, from (49a), *anybody* is preposed, leading to (49b), which undergoes contraction, giving rise to (49c). Then the remaining VP containing the verb and the trace of *anybody* is preposed, giving rise to (49c), the representation for (48):

- (49) a. John not [_{VP} saw anybody] (underlying source)
 b. John not [anybody_i [_{VP} saw t_i]] (QP-movement)
 c. John nobody_i [_{VP} saw t_i]] (*not + any* → *no*)
 d. John [_{VP} saw t_i] nobody_i t_{VP} (VP remnant movement)

The hypothesis that Remnant VP movement applies extensively in English also helps to derive the following (50) as in (51):

- (50) John has seen nobody.

- (51) a. John [not [has [_{VP} seen anybody]]]. (Underlying source)
 b. John [has [not [t_{has} [_{VP} seen anybody]]]]. (*has* moves to I)
 c. John [has [not [t_{has} [anybody_i [_{VP} seen t_i]]]]]. (QP movement)

- d. John [has [nobody [_{VP} seen t_i]]]. (not + any → no)
- e. John [has [[_{VP} seen t_i]_{VP} [nobody_i t_{VP}]]] (VP remnant movement)

For a sentence like (52) which is ambiguous as indicated, the two readings can be derived syntactically from different underlying sources as in (53) and (54):

- (52) John has required that you talk to nobody.
 - a. John has required that No_x (you talk to x).
 - b. No_x (John has required that you talk to x).
- (53) a. John has required that you not [_{VP} talk to anybody]. (underlying source)
 - b. John has required that you not [anybody_i [_{VP} talk to t_i]]. (QP movement)
 - c. John has required that you nobody_i [_{VP} talk to t_i]. (not + any → no)
 - d. John has required that you [[_{VP} talk to t_i]_{VP} nobody_i t_{VP}]. (VP remnant movement)
- (54) a. John not has [_{VP} required that you talk to anybody]. (underlying source)
 - b. John has not t_{has} [_{VP} required that you talk to anybody]. (has moves to I)
 - c. John has not t_{has} anybody_i [_{VP} required that you talk to t_i]. (QP movement)
 - d. John has nobody_i [_{VP} required that you talk to t_i]. (not + any → no)
 - e. John has [_{VP} [_{VP} required that you talk to t_i]_{VP} nobody_i t_{VP}]. (VP remnant movement)

If this is the correct account of English,⁸ what we have seen is that the distribution of negative NPs is determined by (at least) the following factors: (i) V movement, (ii) QP movement, (iii) Remnant VP movement.

	<i>I to C</i>	<i>V to I</i>	<i>QP-mv't</i>	<i>Remnant VP Mv't</i>
English:	some	some	yes	yes
Norwegian	yes	yes	some	no
Chinese	no	no	some	no
Japanese	no	no	none that matters	no

Generally, the more things move around, the more likely it is for ‘nobody’ to appear. The differences among languages with respect to the distribution of ‘nobody’ are then reduced to their differences with respect to the typology of movement. This view allows us to explain the cross-linguistic patterning of the distribution itself: for example, why, given their differences in movement possibilities, the facts of English and Chinese could not be reversed, with ‘nobody’ occurring freely in Chinese but only preverbally in English.

4. Some Typological Correlates

We now expect that the cross-linguistic distribution of negative NPs should be correlated to other patterns that also reflect the typology of movement. In the rest of this chapter I shall show that this expectation is fulfilled.

First, the typology of *nobody* has a general correlation with general word-order typology. As far as V movement goes, a standard view is that its existence and extent account for the major word order typology of the world's languages. The higher the verb moves, the earlier it will be linearized with other elements of the sentence.⁹ Thus the extent of V movement gives rise to the word order typology that characterizes the following languages as follows, with Chinese, Japanese being the 'right-side' languages and German, French and English being more on the 'left-side':

- (55) German > French > English > Mandarin > Japanese
 Norwegian Taiwanese Korean

Because V movement is one important way in which *not* and *any* are brought in adjacency, it is correctly predicted that other things being equal, right-side languages have less occurrences of *nobody*. (Norwegian and English have more than Chinese and Japanese.¹⁰)

Secondly, the typology of *nobody* also correlates with the synthetic-analytic typology in traditional classifications. Because we analyze *nobody* as being 'synthesized' of *not* and *anybody* under adjacency, we expect that languages with more occurrences of 'nobody' are relatively more *synthetic* and those with less or no such occurrences are more *analytic*. This is indeed the case, as the left-side languages in (55) are more synthetic than the right-side languages.¹¹ Syntheticity comes about not only as a result of inflection as a function of V to I movement; the creation of *nobody* itself is a similar phenomenon.

Thirdly, the typology of *nobody* correlates with the typology of *wh*-movement. Tsai (1994) argues convincingly that Huang's (1982) *wh*-movement parameter (between overt and covert *wh*-movement languages) should be viewed as a parameter between languages with *wh*-words that are 'operator-variable complete,' and those with *wh*-words that are not. For example, a *wh*-word in English (but not in Chinese) may have overt internal structure showing existential or universal quantification, as in *somewhat* and *whatever*. Such words may be analyzed as having an internal structure each containing a variable internally bound by an existential quantifier *some* or a universal quantifier *ever*, as follows:

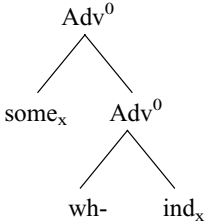
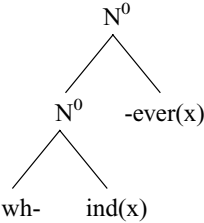
- (56) a.  b. 
- Diagram (56) a. shows a tree with root Adv⁰ branching to some_x and Adv⁰. The lower Adv⁰ branches to wh- and ind_x.
- Diagram (56) b. shows a tree with root N⁰ branching to N⁰ and -ever(x). The lower N⁰ branches to wh- and ind(x).

In view of this, Tsai postulates the following internal structure for interrogative *what*, with a covert word-internal Question Operator binding a variable within the word:

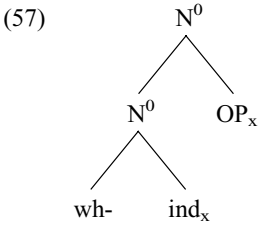

Because of this complex internal structure, *what* in English is inherently interrogative and contains the relevant feature which makes its overt movement to Spec, CP obligatory. On the other hand, in Chinese, a *wh*-word is not inherently interrogative, nor does it show any evidence of any internally complete quantificational structure (unlike *somewhere* and *wherever*). Rather, a *wh*-word is indeterminate, devoid of any quantificational force (without being bound by any word-internal operator). A Chinese *wh*-word, instead, is a variable bound (and licensed) by an external element in the sentence. In the case of a *wh*-word to be used interrogatively, it is bound (and licensed) by a Q-Operator directly base-generated in the relevant Spec, CP. (See also Aoun and Li 1993 and Watanabe 1992.)

Under Tsai's conception, then, the interrogative phrase is continuous/synthetic in English (and other left-side languages) containing both operator and variable within the same word, whereas it is discontinuous/analytic in Chinese (and other right-side languages) with the operator separated from the variable at a distance. In the discontinuous strategy, base-generation of a null operator in Spec, CP precludes (overt) *wh*-movement. Hence the 'continuous languages' have *wh*-movement, while the 'discontinuous' languages do not. Recall that 'nobody' is a continuous/synthetic strategy, and 'not ... anybody' a discontinuous/analytic strategy. There is consequently a correlation between the typology of 'nobody' and the typology of *wh*-movement.

Another difference between English-type and Chinese-type languages concerns the distribution of 'binominal *each*' (Safir and Stowell 1987), as illustrated in the (b) sentence below:

- (58) a. John and Bill bought three books each.
 b. They got two prizes each at the drawing.

These sentences with sequences like *three books each*, *two prizes each* involve the continuous strategy for these expressions. The discontinuous strategy is also commonly used:

- (59) a. John and Bill each bought three books.
 b. They each got two prizes at the drawing.

Interestingly, Chinese does not permit 'binominal *each*'. For the corresponding expressions, only the discontinuous strategy gives licit results:

- (60) a. *Zhangsan gen Lisi ge mai-le san-ben shu.*
 Zhangsan and Lisi each buy-perf three-CL book
 ‘Zhangsan and Lisi bought three books each.’
 b. *tamen ge chou-dao-le liang-ge jiangpin*
 they each draw-get-perf 2-CL prize
 ‘They each drew two prizes.’
- (61) a. **Zhangsan gen Lisi mai-le san-ben shu ge*
 Zhangsan and Lisi buy-perf 3-CL book each
 b. **tamen chou-dao-le liang-ge jiangpin ge*
 they draw-get-perf 2-CL prize each

We can see this difference as yet another correlation to the difference in the distribution of negative NPs. In the spirit of Kayne (1998) we can derive the continuous binominal *each* sentences from their discontinuous counterparts. For example, (58a) may be derived from (59a) by moving the VP to a Spec position before *each*. On the other hand, since VP movement of the sort is not available in Chinese, no grammatical sentences of the form in (61) can be derived.

Finally, the distribution of negative NPs may be correlated to parametric variations in quantifier scope interpretation. It was pointed out in Huang (1982) that although English sentences exhibit quantifier scope ambiguities, Chinese quantificational sentences do not:

- (62) a. Everyone bought a book. ($\forall > \exists$ or $\exists > \forall$)
 b. Someone bought every book. ($\exists > \forall$ or $\forall > \exists$)
- (63) a. *mei-ge ren dou mai-le yi-ben shu*
 everyone all buy-perf one-CL book
 Unambiguous: $\forall > \exists$
 b. *(you) yi-ge ren mai-le mei-yi-ben shu*
 (have) someone buy-perf every-CL book
 Unambiguous: $\exists > \forall$

In Huang (1982) it was suggested that the non-ambiguity of the Chinese examples follows from a general Isomorphic Principle (IP) requiring that the relative scope order of quantifiers correspond to their c-command relationship in overt syntactic structure. Thus if QP1 c-commands QP2 then QP1 has scope over QP2. (For the ambiguities in English, it was suggested that this derived from restructuring (or vacuous rightward movement of quantifiers), an option not available for right-side languages.) Aoun and Li (1989) showed that the IP should be modified so as to take into account the existence of movement (see also Kuroda 1965, Hoji 1985) Their modified principle says that QP1 may have scope over QP2 if QP1 c-commands QP2, or a trace of QP2. In the spirit of Kayne (1998) we may now attribute the ambiguity of the English sentences to the existence of multiple movements in the overt component, according to which both subjects and objects (as well as VP remnants) are moved away from their base positions. The general lack of

quantificational ambiguity in Chinese, again, corresponds to the lack of such multiple movements in the language.

5. Summary

In this chapter we have seen that interesting variations exist across languages in the distribution of negative NPs, and that these variations may be accounted for by adopting the view that negative NPs are syntactically derived from underlyingly discontinuous strings of sentential negation and related polarity items or minimizing noun phrases, by a process that reanalyzes the string under adjacency into a nominal constituent. The cross-linguistic differences are then derived from independent differences among languages with respect to whether they have processes that bring to adjacency such sequences for the purported reanalysis to take place. We saw that this view provides a step toward explaining why the observed linguistic variations are what they are, in a way that a simple stipulation of the observed facts does not. The ‘typology of negative NPs’ is directly correlated to the typology of verb-movement, etc.

It has also been shown that the cross-linguistic variations in the distribution of negative NPs is just one facet of a large pattern of variation between syntheticity and analyticity. With respect to word order, the left-side languages have their verbs moved higher than the right side languages. The left-side languages permit a relatively wider distribution of negative NPs than the the right-side languages. Only left-side languages have binominal *each*, and only they have (traditional) *wh*-movement. And in the matter of quantifier scope interpretation, whereas left-side languages exhibit considerable freedom in scope permutation, right-side languages exhibit scope rigidity.

Notes

- 1 There is increasing evidence that *ba* and *bei* are higher verbs (or light verbs) but not prepositions. The same point could be made, however, with clear prepositions like *gen* ‘with’, *cong* ‘from’, etc.
- 2 The existence of apparent postverbal negative NPs in Taiwanese was pointed out by Robert Cheng at the IsCLL 5 Conference. The point that such cases are not genuine postverbal NPs was also pointed out by Ting-chi Tang.
- 3 I am indebted to Eric Drewery and Ingvar Fløysvik, for providing me with important data from Norwegian as used here, and from Nynorsk, where virtually identical patterns obtain. I also thank Lynn Santalmann and Christoph Harbsmeier for sharing related patterns and variations from other Scandinavian languages.
- 4 Movement of the verb instead of the auxiliary *har* into C is ruled out by minimality requirements, i.e., the Head Movement Constraint (Travis 1984).
- 5 These sentences are often felt to be archaic or literary in usage.
- 6 See Huang (1997) for demonstration that while a verb in Mandarin may move to a higher verb position, a verb never moves into I or C.
- 7 Concerning Mandarin, one might reasonably suggest that the language (like Japanese) does not have a negative NP. All the putative negative NPs are simply a sequence of *mei you* ‘not have’ followed by a polarity NP that does not reanalyze into a negative NP constituent. My assumption is that it should be possible to optionally regard such a sequence as having reanalyzed into an NP, based on two considerations. First, native speakers tend to equate *nobody*

with *meiyou ren* (say, in word-for-word translation), even without realizing that *meiyou ren* does not occur postverbally. Second, it was pointed out to me (by a member of the audience when I presented this material at Havorford College) that postverbal *meiyou ren* is used by some young speakers, and also in pop song lyrics. For related discussion, see Tsai (1997).

- 8 One well known consequence of Kayne's theory, in this respect as in general, is that syntactic derivations involve far more movement operations than meet the eye. An alternative would be to assume that while *nobody* may have been derived historically in a post-syntactic fashion, reanalysis has taken place so that it is now a lexical word.
- 9 Assuming that V does not move at all in Japanese, as in Fukui and Takano (1998).
- 10 Other things being equal. Recall that English has more occurrences of *nobody* than Norwegian does because of its extensive use of remnant VP movement.
- 11 Agglutination (a property of head-final languages like Japanese) preserves the analyticity of given strings. In Fukui and Takano (1998) it is argued that functional heads successively cliticize (downward) to the left without altering the linear order among the heads.

References

- Aoun, Joseph and Audrey Li (1989) 'Scope and constituency,' *Linguistic Inquiry* 20, 141–172.
- Aoun, Joseph and Audrey Li (1993) 'On some differences between Chinese and Japanese *wh*-elements,' *Linguistic Inquiry* 24, 365–372.
- Christensen, K. K. (1986) 'Norwegian *ingen*: a case of post-syntactic lexicalization,' in Ö. Dahl & A. Holmberg (eds.) *Scandinavian Syntax*. Institutionen för lingvistik, Stockholms universitet.
- Emonds, Joseph (1978) 'The verbal complex V'-V in French,' *Linguistic Inquiry* 9, 151–175.
- Fukui, Naoki and Yuji Takano (1998) 'Symmetry in syntax: merge and demerge,' *Journal of East Asian Linguistics* 7, 27–86.
- Hoji, Hajime (1985) *Logical Form Constraints and Configurational Structures in Japanese*, Ph.D. dissertation, University of Washington.
- Horn, Laurence (1989) *A Natural History of Negation*, The University of Chicago Press, Chicago.
- Huang, C.-T. James (1982) [1998] *Logical Relations in Chinese and the Theory of Grammar*, Ph.D. dissertation, MIT; published in 1998 by Garland Publishing, New York.
- Huang, C.-T. James (1997) 'On Lexical Structure and Syntactic Projection,' *Chinese Languages and Linguistics* 3, 45–89.
- Kayne, Richard (1996) Lectures on Grammatical Theory, Girona Summer Institute in Linguistics, University of Girona.
- Kayne, Richard (1998) 'Overt vs. covert Movement,' *Syntax* 1, 128–191.
- Klima, Edward (1964) 'Negation in English,' in J. Fodor and J. Katz (eds.) *The Structure of Language*, 264–323, Prentice-Hall, Englewood Cliffs.
- Kuroda, S.-Y. (1965) *Generative Grammatical Studies in the Japanese Language*, Ph.D. dissertation, MIT.
- Miyagawa, Shigeru (2001) 'The EPP, scrambling and *wh*-in-situ,' in M. Kenstowicz (ed.) *Ken Hale: A Life in Language*, pp. 293–338, MIT Press, Cambridge, Massachusetts.
- Pollock, Jean-Yves (1989) 'Verb-movement, universal grammar and the structure of IP,' *Linguistic Inquiry* 20, 365–424.
- Travis, Lisa (1984) *Parameters and Effects of Word Order Variation*, Ph.D. dissertation, MIT.
- Tsai, W.-T. Dylan (1994) *On Economizing A-bar Dependencies*, Ph.D. dissertation, MIT.
- Tsai, W.-T. Dylan (1997) 'On *you*, *you-de*, *you xie*, etc.' ms., National Tsing Hua University.
- Watanabe, Akira (1992) 'Subjacency and S-Structure movement of *wh*-in-situ,' *Journal of East Asian Linguistics* 1, 255–292.