

Synthèses

Grasslands and herbivore production in Europe and effects of common policies

Christian Huyghe, Alex De Vlieghe, Bert van Gils, Alain Peeters, coord.



éditions
Quæ

Grasslands and herbivore production in Europe and effects of common policies

Christian Huyghe, Alex De Vlieghe,
Bert van Gils, Alain Peeters, coord.

Grasslands and herbivore production in Europe and effects of common policies

Christian Huyghe, Alex De Vlieghe,
Bert van Gils, Alain Peeters,
coord.

Acknowledgements : The research leading to these results has received funding from the European Community's Seventh Framework Programme under the grant agreement n° FP7-244983 (MULTISWARD).



© Éditions Quæ, 2014

ISBN : 978-2-7592-2157-8

ISSN : 1777-4624

Éditions Quæ
RD 10
78026 Versailles Cedex, France
<http://www.quae.com>

Contents

Executive summary	7
Introduction	14
Definitions and data	15
Definitions	15
Data	19
Chapter 1. Importance of the grassland area and grassland-based systems in Europe and their spatial distribution	21
Present acreage of grasslands and annual forage crops in Europe	21
Spatial distribution	29
Grasslands in organic farming	33
Changes in grassland acreage in Europe	34
Biomass productivity from permanent and temporary grasslands	54
Chapter 2. Importance and changes in grazing animal production operations in Europe and their spatial distribution	57
Herbivore herds in Europe	57
Animal production	59
Changes in livestock populations	66
Changes in animal production and animal performance	73
Chapter 3. Importance and changes in grassland-based systems	83
Farm types	83
Changes in the number of animal holdings	83
Interviews with farmers and interactions between farmers and research	95
Chapter 4. Grasslands for alternative production	139
Energy production	139
Green biorefinery and biochemicals production	143

Chapter 5. Grasslands and ecosystem services	145
Introduction	145
Environmental issues related to grasslands	147
Grassland-based biodiversity issues	152
Landscape related issues	159
National case studies	159
Chapter 6. Grasslands in the economic supply chain: related industries ..	227
Forage seed industry	228
Interview with Beat Boller, Chairman of Eucarpia and senior forage breeder at Agroscope, Switzerland	235
Chapter 7. Common Agricultural Policy: brief history, structure and influence on grasslands	239
History	239
The two pillars of the CAP	241
Obligation of maintenance of the permanent grassland area	242
Agri-environmental scheme	243
Less Favoured Areas	244
Consequences of the abolition of the milk quotas	245
Other policies	246
CAP effect on grasslands and grassland farms	248
CAP: the way forward	254
Interview with Jean-François Louineau, Director of Administrative Services, Regional Council, Poitou-Charentes, France	259
Conclusions	263
Changes in the structure of the grassland area and grassland-based systems	263
Changes in production processes	264
Changes in the structure of animal production	265
Effect of scientific research, public and private farmer’s advisory services ...	266
Effect of professional teaching	266
Sociological driving forces	267
Economic driving forces	267
Political driving forces	268
References	273
Annex 1	285

Executive summary

European grasslands have been significantly reduced during the last thirty years in favour of the production of green maize and other annual crops. But permanent and temporary grasslands still cover 33% and 6%, respectively, of the total utilised agricultural area (UAA) in 2007. The percentage of UAA used as grassland varies considerably between countries and regions. Data collection for grasslands is difficult because different countries have various grassland systems and definitions. Semi-natural grassland, for example, is classified differently in many countries. Forage maize developed considerably since the 1960s in parallel with the import of protein-rich feedstuffs, soybean especially. Since then, energy and protein productions from grasslands were progressively replaced by maize and soybean, respectively. Legume forage crops are of variable importance in European countries, but legumes have a large potential everywhere and can contribute to sustainable herbivore husbandry.

Organic farming is growing significantly (3.6% UAA in 2007). Permanent grassland represents 47% of the whole organic area in the EU-27. This higher share in UAA in comparison with conventional farming (31%) can be explained by the relatively greater ease in managing organic grasslands compared to organic annual crops (weeding and crop protection, for instance, are not so crucial in grasslands), the need to increase nitrogen and protein autonomy of farms and the combination of organic and agri-environmental payments for permanent pastures.

Grassland productivity is affected by several factors: soil characteristics, climatic conditions—particularly total and seasonal distribution of rainfall and temperature—altitude, latitude and management. A spatial distribution of grassland productivity across regions in Europe is presented in several figures in the text.

The total EU-27 livestock in 2007 (132.56 million livestock units) is divided as follows: 41% monogastric animals and 59% grazing livestock, of which 82% are cattle and 18% sheep, goats and equidae. In the EU-27, 75% of cows are dairy breeds and 25% are beef cattle. Grazing livestock density is an indicator of the intensity of grassland use and of the pressure of livestock farming on the environment. Manure produced by livestock contributes to greenhouse gas and NH₃ emissions in the atmosphere and nutrient leaching into water. A higher density means a higher amount of manure per ha UAA, which increases the risk of N-leaching. An excessively low livestock density increases the risk of land abandonment in extensive livestock systems or the need for industrial fertilisers in arable cropping systems. Farming practices also impact the environment. Sheep and goats represent about 12% of the grazing livestock in EU-27, with higher concentrations in the Mediterranean countries, the United Kingdom and Romania. Equines contribute to less than 5% of the grazing livestock but are more common in central and northern Europe.

The increasing cost of fossil fuels and environmental concerns about climate change also influence agrofuel production and demand. Grassland and fodder areas compete with arable land for first-generation bio-fuels like bioethanol (maize, wheat, barley, sugar beet), biodiesel (oilseed rape extraction) and methane (biogas).

Combustion of grassland biomass is less favourable than other crops or residues such as straw because of the NO_x , SO_2 and HCl emissions and ash content. Combustion of grassland biomass is carbon negative and provides a net energy gain even at very low biomass yield levels. Intensification of management for this purpose is thus not recommended.

Biorefinery is a concept that involves using green biomass (pasture) as raw material to produce high value biochemicals from the liquid fraction and lower value products for energy generation from the grass fibre fraction. The grass resource could be semi-natural or cultivated grassland or verge grass that is not needed for traditional use (i.e., forage for herbivores). The general challenges in biomass processing are the transportation costs, the use of dry or wet products, the choice of a central or mobile unit, and the choice between storage for a year-long period versus a campaign during the growing season.

Traditional grassland management has resulted in large areas of semi-natural grasslands in Europe. During the past century, these surfaces have declined because land use has intensified and some land has been abandoned by agriculture and usually reforested. Today, in intensified agricultural regions, semi-natural grasslands represent only a low percentage of the total grassland area, mostly in locations that are less suitable to agriculture. Moreover, overall grassland surface has declined. These shifts are threatening European biodiversity in all its aspects, as well as the ecosystem functions related to them.

Grasslands can act as a carbon sink. Several studies have shown a steady increase in soil organic carbon in grassland soils, where over time the carbon levels rise above those of arable soils. However, carbon losses happen much faster after ploughing up the sward. This illustrates the importance of conservation of grassland surfaces and sward longevity for climate mitigation. On the other hand, emissions of N_2O from grassland soils and CH_4 from grazing ruminants partially counterbalance the mitigating effects of carbon sequestration.

Grasslands can also mitigate soil erosion and pollution. They provide a dense rooting system and a permanent soil cover. Ploughing grasslands is seen as one of the causes of increased erosion problems in some European regions. Organic nutrients and pollutants left on the grassland surface decompose quickly due to intensive biological activity. Grassland thus acts as a biological filter for the migration of various chemicals towards surface and groundwater systems. Grassland-based systems also use much lower levels of pesticides than arable systems.

One of the most important functions of (semi-natural) grasslands in Europe is supporting high biodiversity levels. Grasslands are crucial not only for a great variety of plant species but also for many species of farmland birds, butterflies, beetles, etc. Many species are rarely found in other vegetation types. Moreover, the grassland soil fauna can amount to several tonnes per hectare. Agriculturally improved permanent and temporary grasslands, even lower in biodiversity than semi-natural grasslands,

can be essential for the survival of bird species. Intensive permanent grasslands host higher biomass and diversity of soil life than arable land. Lastly, grasslands contribute to an attractive landscape as they are perceived as a rather natural landscape feature and preferred over other land uses such as settlements or arable fields. Semi-natural grasslands especially tend to improve the “naturalness” of a landscape as they show the increased colour and structure that is often associated with low-intensity land use. For this reason, grassland areas are beneficial for tourism and outdoor recreation.

European grasslands are characterised by multiple functions and provide multiple services and benefits which are increasingly recognised by the society and notably by the European Union (EU).

The importance of the grassland area in all European countries is not easy to assess for several reasons that are developed in the book. The permanent grassland area decreased significantly but at the same time the importance of the grassland area and of the different grassland types is not yet well documented at a European level. This book aims to clarify and quantify more precisely the importance and the changes in grasslands and grassland-based systems in the EU and to synthesise the role of socio-economic and political driving forces in this evolution. The reasons for the decline of the grassland area are also analysed.

Permanent grasslands cover over 57 million ha in the EU-27 (2007), temporary grasslands about 10 million ha. Together, they occupy about 39% of the European UAA. These grasslands are the basis of feed for about 78 million livestock units (LU) of grazing livestock. They are managed by about 5.4 million holders, or about 40% of all European farm managers. Among these farms managing permanent grasslands, 41% have an European size unit (ESU) lower than one (very small farms).

The estimation of losses of the permanent grassland area is difficult. In the EU-6, these losses are estimated at about 30% and 7 million ha between 1967 and 2007 (Eurostat). However, there were major differences in evolution trends between countries. Losses were very high in Belgium, France, Germany, Italy and the Netherlands. Surfaces remained almost stable in Luxembourg and the United Kingdom and Ireland. Surface losses calculated from the FAOSTAT database are estimated at about 15% and 10 million ha for the EU-13 (EU-15-Belgium and Luxembourg) between 1961 and 2007. These losses are clearly underestimated notably because of changes in survey methods over time in some countries (e.g., Greece, Italy, Portugal). The variation of the temporary grassland area can only be calculated for short periods due to a lack of data. Between 1990 and 2007 (Eurostat), the temporary grassland surface increased in 11 EU countries. It seems that this surface stabilised between 2001 and 2007. It is likely that temporary grassland areas used through cutting decreased over the last twenty years while grazed temporary grassland areas rose in some countries (Belgium, the Netherlands).

The dairy cow population fell by 10 million head in the EU-9 between 1975 and 2007 (drop of 40% from 1975 levels). This decline started after the implementation of the milk quotas in 1984. Inversely, suckling cow and sheep populations increased by about 3 and 8 million head respectively, over the same period in the EU-9. In the former communist countries, cattle and sheep numbers declined sharply, by at least 50%, in the 1990s and started to stabilise or increase slowly in the first years of

the 21st century. The total number of agricultural holdings in the EU-9 was reduced by almost 50% in thirty years (1975–2007). The decline of dairying specialists was very high (72%) while cattle rearing and fattening specialists and sheep, goats and other grazing livestock specialists remained much more stable (3% decline and 15% increase, respectively). The size of grazing livestock holdings nearly doubled during that period.

Certain **sociological driving forces** support the use of grasslands. There is an increasing demand from society to reward farmers for the multiple services that grasslands offer and for a sustainable management of associated public goods such as biodiversity and carbon stocks. However, other sociological forces lead to grasslands being replaced by annual crops. A steady decline in beef and sheep meat consumption per capita by European citizens in favour of pork and poultry meat has been observed. Despite export markets, this influenced the production. For instance, between 1995 and 2008 in the EU-27, cattle meat production decreased by about 9% while pork meat increased by 17%. If less ruminant meat is consumed and the grassland area does not change, an extensification of grassland management is possible, but it is more likely that a higher demand for monogastric meat will bring about the replacement of a part of the grassland area by crops or other land uses.

Economic driving forces have different effects on grassland use: certain factors lead to the replacement of grasslands by annual crops, while others promote grasslands. Compared to annual forage crops (forage maize and fodder beet), product costs per hectare are similar for grass silage and much lower for grazed grasslands; grass silage has higher costs per kg of dry matter and per energy content and grazed grasslands lower. All types of grasslands, and especially grazed grasslands, have lower costs per kg of crude protein. In late 2008, farm commodity prices dropped considerably. Milk prices were particularly affected, threatening the profitability of dairy farms integrated in industrial production chains. Products such as high quality cheeses protected by Protected Designation of Origin (PDO) and organic labels held out much better than raw milk. The crisis had almost no impact on the profitability of dairy farms producing this type of dairy product. This was a clear sign that quality labels can have a positive effect on the income stability of dairy farms. Furthermore, quality product-based systems use on average more grass in livestock feeding than more intensive dairy farms; quality labels thus have a positive effect on grassland-based systems.

Several Common Agricultural Policy (CAP) instruments are of special importance: direct payments and the respect of the ‘Good Agricultural and Environmental Conditions’ (GAEC) in the cross-compliance principle, milk quotas, investment aids, agri-environmental measures (AEM), less favoured area (LFA) allowances and diversification support. Some have not been favourable to the maintenance of grassland. Firstly, before the CAP reform of 2003, a higher proportion of the budget (especially from Pillar 1) was spent per hectare of arable land, including silage maize than on grasslands and for field crop specialist holdings than for grazing livestock specialist holdings. This difference was partly compensated by some Pillar 2 expenditures but an overall imbalance remained. This difference still existed even after 2003, although to a lesser extent. Secondly, the implementation of the milk quotas in 1984 has supported milk prices by controlling production in the EU.

High milk prices have encouraged dairying systems using high inputs of chemical fertilizers, concentrate feeds and mechanised methods for silage production at the expense of grazing. These tendencies were largely reinforced by the convenience of managing dairy herds indoors particularly with cows calving in autumn and fed with maize silage and by the decrease of the price of cereals after the CAP reform of 1992. It has reduced the number of dairy cows, leading to a decreased stocking rate in some cases or the development of suckling cows or sheep systems independently or in complement to dairy systems in other cases. National and regional rules for quota transfers have helped some Member States (e.g., France and Italy) to maintain dairy production in LFA. Quota transfers in Germany gave rise to a concentration of dairy production in regions with a high proportion of permanent grasslands in the UAA. In a first step, milk quotas have encouraged farmers to lower their production costs and produce more milk per cow on the basis of grass and forage maize, which are cheaper than concentrates. Thirdly, the effect of milk quotas was combined with those of the CAP reforms of 1992 and 2000, causing a significant drop in cereal prices (about 50%), thereby again encouraging dairy farmers to use cereals in animal feeding, often at the expense of grass. Fourthly, farmers also tried to reduce their production costs by increasing milk yield per cow (lower maintenance costs per litre), but by doing so they tended to use more maize silage and more concentrates at the expense of grass grazing and grass silage. This was because they did not trust the capacity of their high-yielding cows to produce enough milk from grass. This trend, resulting from a combination of policy decisions and breeding progress of dairy breeds, led to a decrease in the grassland proportion in the UAA in dairy farms.

Rural Development (RD) support are *a priori* more favourable to the maintenance of permanent grassland areas and the support of specialist grazing livestock holdings than Pillar 1 support measures, especially AEM and LFA allowances. More than half of grazing livestock farmers operate in LFA. LFA payments contributed significantly to their income and helped keep farmers in these areas. For instance, in France between 1979 and 1995, LFA payments appeared to have had a positive impact on changes in the number of holdings, agricultural area (including the permanent grassland area), number of cattle and dairy cows and available labour in mountain areas. AEM also have a significant impact on the income of grazing livestock specialists. In several Member States, AEM aimed to promote grassland areas and limit increases in forage maize and cash crop areas, but were unable to reverse the general trend. However, they most likely slowed the reduction rate of permanent grassland areas, the decline of grassland biodiversity and the simplification of landscapes. Although there were exceptions in some regions and Member States, organic farming remained marginal and did not change the main evolution trends in EU agriculture. Pluri-activity and diversification activities are also supported by the second pillar budget. Income provided by these activities can be of great importance for holders of grazing livestock farms and is thus an indirect support to the maintenance of permanent grassland areas.

After the reform of 2003, the perverse effects of Pillar 1 subsidies on the grassland area were reduced. Premiums were no longer linked with crop or animal types but to the eligible area. This eliminated the 'maize premium' that encouraged farmers to use this forage crop at the expense of grasslands. The use of grasslands was also

no longer indirectly supported through animal premiums but directly through area payments (the system was, however, applied with a certain flexibility among Member States according to the re-nationalisation principle). The reform radically changed the context and the way farmers think about their forage system. After 2003, the forage maize area started to decrease in some countries where this forage crop is proportionately high in the UAA (Belgium, the Netherlands, France) but not in several others like Germany, for instance where silage maize is increasingly used for biogas production. The major impact of decoupling was the increase of the median direct payments per farm (+76%) and per ha (+64%) of dairying specialists, and which, over the short term, was a higher support to grassland areas. In the meat sector, about 60% of the suckling cow herd of the EU-15 still benefited from coupled payments in 2010. This possibility for Member States to retain coupled payments appears to be an efficient system for protecting cattle rearing and fattening holdings as well as sheep and goat specialist holdings. Surprisingly, in Member States with fully decoupled payments—such as Germany—suckling cow numbers remained stable while sheep numbers declined slightly. Grazing livestock specialists remain highly dependent on single payments, more so than all other farm types. Most grazing livestock specialist farms would not be profitable without financial support.

Harmonisation of direct payments per hectare will change the situation, with the most intensive farms attracting more per-hectare subsidies, calculated on a historical basis. Changes underway in payment harmonisation should support more extensive systems going forward. Since these systems rely more on permanent grasslands than intensive systems do, this measure should also help stabilise grassland areas.

The cross-compliance rule on the protection of permanent grasslands aims to reduce and even avoid further conversion of permanent grasslands into arable land. The proportion of grasslands in the UAA is calculated at regional or national levels. Land use changes can thus occur at farm and sub-regional levels in Member States that do not impose strict rules at the farm or plot level. The grassland proportion is calculated based on the difference between grasslands converted to arable land and arable land converted to grasslands. However, protection is not at all complete. For instance, old permanent grasslands and species-rich grasslands can be replaced by newly resown, species-poor grasslands. Moreover, the cross-compliance rule has been an incentive for a rapid conversion of grassland before restrictions at the farm level were implemented. Nevertheless, permanent grassland area has increased since 2003 in 11 Member States (the Czech Republic, Denmark, Estonia, Finland, Greece, Luxembourg, the Netherlands, Poland, Slovenia, Spain and Sweden) and in the Wallonia region (Belgium). In three Member States (Austria, Hungary and Lithuania) and in the Flanders region (Belgium), it has decreased slightly.

Overall, the 2003 reform has been positive on the permanent grassland area. The surface appears to have stabilised (EU-6) or increased slightly (EU-15, EU-27) between 2003 and 2007 (Eurostat). However, since then, a decline has been noted again, mainly because of high grain prices, which, when combined with high subsidies, encourage European exports to the global market.

Over a fifty-year period, the successive EU CAP reforms led to modernisation of the sector, increased farm sizes, a dramatic decline in farmer numbers, specialised production, intensification of grassland and stockbreeding, higher production

volumes, a rise in grassland and animal yields, lower legume use (more than 80% reduction in sown legume-based mixtures between 1960 and 2010 in France), a drop in the grassland area and its proportion in the UAA, and diminishing diversity of landscapes, grassland species and communities, domestic animal breeds and local products. The Nitrates Directive had a significant influence on farm structures and practices of intensive livestock systems by regulating the stocking rate and the management of nitrogen.

The political changes in Central and Eastern Europe in the 1990s brought about tremendous changes in the use and management of grasslands in these countries. The structure of agricultural production was very different between countries before 1989. The political transition period resulted in even larger differences. Farmers' attitudes towards the new political conditions were diverse. However, large areas of permanent grassland were abandoned in many countries and cattle and sheep populations decreased dramatically in all countries. The accession of new Member States to the European Union in 2004 and 2007 has started to produce some effects. Since statistics are available only until 2008, it is still early to analyse evolution trends. However, it would appear that the recent stabilisation or increase in cattle and sheep populations is due to this political change.

The structure of European agriculture has changed dramatically over the last fifty years. A large part of red meat production and consumption was replaced by white meat production. One possible explanation is that since the early 1960s, no taxes are levied on imports of protein-rich feedstuff in the EU. As a result, it became more profitable to feed livestock with imported feed than with local grassland forage. Soybean and cereal grains were increasingly used for producing meat and milk. European consumers ate progressively more grain-based monogastric meat than grass-based ruminant meat. This affected product quality: grain-based meats are higher in total and saturated fats, lower in omega3 fatty acids and have a higher omega6/omega3 ratio than grass-based meats, with possible impacts on human health. The development of this global forage system also caused environmental destruction. The Amazon rainforest, Cerrado and Pampas of South America were largely converted into soybean fields. Permanent grasslands regressed in Europe, replaced by green maize and cereals that complement soy in animal feeding. All these changes led to massive biodiversity losses on both sides of the Atlantic and N and P pollution in waters in Europe from slurry spreading in pig and poultry production areas. Europe became perilously close to not being able to sustain its protein needs, which is of strategic importance. New policies are needed to cope with these challenges. The solution most certainly implies decreased white meat production and consumption, new development of forage legumes, redeployment of grassland areas by paying farmers for ecosystem goods and services, development of short marketing chains and high quality animal products.

Introduction

Grassland is the main survival resource for about one billion people worldwide. In industrialised Europe, grassland covers some 30% of the agricultural area and forms the basis for a strong ruminant livestock sector. Grassland performs a broad range of functions that benefit humans. In addition to the production of herbage for livestock, grassland contributes to the maintenance of biodiversity, sequesters carbon into soil, cleans surface and groundwater, and provides an attractive environment for recreation and leisure activities, among others. Grassland farming, the intensity of management and use, and the production of goods and environmental services at a given site are strongly affected by global markets, international societal developments, information exchange and climate change. These factors seriously challenge the multi-functionality of grassland. In Europe, pressure on land use is high and it is important to establish the possibilities and constraints of combining grassland functions.

This book aims to determine the importance, roles and utility of grasslands in Europe at the catchment and landscape levels. It examines this issue from economic, agronomic and environmental perspectives.

It inventories the spatial localisation of grasslands within landscapes as well as the spatial and temporal interactions between grasslands, arable crops and other elements of the landscape. This is done for different farming systems and different pedo-climatic and socio-economic conditions in Europe.

Peeters (2010) reviewed literature and economic data to assess the impact of past agricultural policies on the promotion of sustainable systems in Europe including grassland use. This study and the present literature overview about the current distribution and the multiple functions of grassland have been developed by mutual agreement.

Definitions and data

» Definitions

In the narrowest sense, ‘grassland’ may be defined as ground covered by vegetation dominated by grasses, with little or no tree cover. UNESCO defines grassland as ‘land covered with herbaceous plants with less than 10% tree and shrub cover’. According to FAO, grasslands are the largest habitat type in the world with an area estimated at 40.5% of the earth’s landmass (EC, 2008).

Under wet conditions, such as those found in most temperate climates, grassland communities only exist because they experience regular defoliation by herbivores, either domestic or wild, or by mowing. They are thus secondary vegetation. Under drier (the steppes of Hungary or Ukraine, for instance) or colder (Inner Mongolia, above the tree line in Alpine environments) conditions, the soil and climate conditions make it impossible for succession by shrubs and trees. In this case, grasslands are natural vegetation. Natural grasslands are restricted to limited areas in Europe.

Eurostat, the statistical office of the European Union, has developed a classification for fodder and grassland types to distinguish differences in forage and grassland systems (Table 1).

In the EU, **permanent grassland** is defined as follows: land used to grow grasses or other herbaceous forage naturally (self-seeded) or through cultivation (sown) and that is not included in the crop rotation of the holding for five years or longer; it may include other species suitable for grazing provided that the grasses and other herbaceous forage remain predominant (COM(2011) 625). Except for grasslands in wet valleys and those above the arborous stratum, most so-called permanent grasslands were actually sown, at a time when animal production had to be boosted.

In the Eurostat database, ‘permanent grasslands and meadows’ include rough grazing. Rough grazing is defined as ‘low-yielding permanent grassland, usually on low-quality soil (for example on hilly land and at high altitudes), usually unimproved by fertiliser, cultivation, reseeding or drainage, which can normally be used only for extensive grazing and are normally not mown or are mown in an extensive manner and which cannot support a large density of animals’. The majority of them can be considered as rangelands and grazed common lands. It is not always clear if for each country ‘grazed common land’ or all ‘rough grazing’ are included in the Eurostat database ‘permanent grassland and meadow’.

Table 1. Eurostat classification of the fodder area.

Fodder crops and grass
Fodder roots and brassicas
Forage plants
Temporary grass
Green maize
Leguminous plants
Permanent grassland and meadow: Total
Pasture and meadow
Rough grazing
Permanent grassland and meadow not used for production, eligible for subsidies

Source: http://epp.eurostat.ec.europa.eu/statistics_explained/index.php/Glossary:Fodder_area.

A ley is an area of land where grass is grown temporarily instead of permanently or in rotation with crops (Oxford Dictionary). **Temporary grassland** is a typical crop in the Atlantic and Continental parts of Europe and in southern Scandinavia. The EU definition of temporary grassland is ‘grass plants for grazing, hay or silage included as a part of a normal crop rotation, lasting at least one crop year and less than five years, sown with grass or grass mixtures. The areas are broken up by ploughing or other tilling or the plants are destroyed by other means as by herbicides before they are sown again. Mixtures of predominantly grass plants and other forage crops (usually leguminous), grazed, harvested green or as dried hay are included.’ Depending on the country, temporary grassland may be maintained for a very short time or for a longer period (Reheul *et al.*, 2007). In Denmark, this type of grassland is managed for about two to four years and in Ireland for at least four years, but usually for much longer. In the Mediterranean area, the term ‘temporary grassland’ is not in use but is replaced by ‘artificial grassland’ containing wheat/barley or some forage grasses or legumes that are grazed during one or two seasons, respectively. This term is ambiguous, as artificial grassland has been used in the rest of Europe to describe, since the middle of the 18th century, the pure stands of forage legumes, such as lucerne, red clover or sainfoin. The term ‘artificial’ also implies an idea of not being ‘natural’, but non-natural grasslands can be semi-natural or ‘improved’ permanent grasslands or recently sown grasslands. This term should no longer be used.

Fodder crops from arable land may include annual or perennial crops. Perennial fodder crops, or temporary grasslands, include grasses, legumes and grass/legume mixtures such as grass/clover, despite their separate classification in the Eurostat classification.

The total **fodder area** includes arable fodder crops (e.g., temporary grasslands, green cereals (C3 cereals, green maize and sorghum), fodder roots (including fodder beet), fodder brassicas, fodder Compositeae (sunflower)) and permanent grasslands.

Utilised agricultural area, abbreviated as **UAA**, (or **agricultural area**, abbreviated as **AA**) describes the area used for farming. It includes the following land categories: – arable land;

- permanent grassland;
- permanent crops;
- other agricultural land such as kitchen gardens (even if they only represent small areas of total UAA).

As such, utilised agricultural area does not include unused agricultural land, woodland and land occupied by buildings, farmyards, tracks, ponds, etc.

Arable land, in agricultural statistics, is the land which is worked (ploughed or tilled) regularly, generally under a system of crop rotation.

Land cover is the actual distribution of forests, water, desert, grassland and other physical features of the land, including those created by human activities. **Land use**, on the other hand, characterises the human use of a given land cover type.

A Working Group has been established by the European Grassland Federation and the EC MULTISWARD project (Peeters *et al.*, 2013). It includes 22 experts from 13 countries (Belgium, Bulgaria, France, Germany, Italy, Poland, Rumania, Slovakia, Spain, Sweden, Switzerland, the Netherlands, United Kingdom).

In 2013, it defined **grasslands** as ‘land devoted to the production of forage for harvest by grazing/browsing, cutting, or both, or used for other agricultural purposes such as renewable energy production. The vegetation can include grasses, grass-like plants, legumes and other forbs. Woody species may also be present. Grasslands can be temporary or permanent.’

Regarding management types of grasslands, two categories have been identified:

- **Meadows**, grasslands that have been harvested predominantly by mowing over the last five years¹ or since the establishment of the sward if it is less than five years old.
- **Pastures**, grasslands that have been harvested predominantly by grazing over the last five years² or since the establishment of the sward if it is less than five years old.

The Working Group defined:

- **Permanent grasslands**, as grasslands used to grow grasses or other forage (self-seeded or sown and/or reseeded) and that have not been completely renewed after destruction by ploughing or spraying (herbicide) for ten years or longer. They can be agriculturally-improved, semi-natural or no longer used for production.
- **Temporary grasslands**, as grasslands sown with forage species that can be annual, biennial or perennial. They are sown on arable land and can be integrated in crop rotations or sown after another grassland vegetation. They are kept for a short period of time (from a couple of months to usually a few years). They can be established with pure sowings of legumes, pure sowings of grasses or grass/legume mixtures.

It proposed definitions for:

- **Agriculturally-improved permanent grasslands**, permanent grasslands on good or medium quality soils, used with more frequent defoliations, higher fertilisation rates, higher stocking rates and producing higher yields than semi-natural grasslands.

1. In case of recent change in the management strategy (more recently than five years), the new management type must be taken into account.

2. In case of recent change in the management strategy (more recently than five years), the new management type must be taken into account.

Semi-natural grasslands, low-yielding permanent grasslands, dominated by indigenous, naturally occurring grass communities, other herbaceous species and, in some cases, shrubs and/or trees. These mown and/or grazed ecosystems are not substantially modified by fertilisation, liming, drainage, soil cultivation, herbicide use, introduction of exotic species and (over-)sowing.

The following structure was suggested for the classification of grassland terms into statistical databases (Table 2).

Table 2. Classification of fodder crops and permanent grasslands into the Utilised Agricultural Area (UAA) (Peeters *et al.*, 2013).

1. Arable land
1.1. Fodder crops
1.1.1. Temporary grasslands
1.1.1.1. Pure legume sowing
1.1.1.2. Grass/legume mixtures
1.1.1.3. Pure grass sowing
1.1.2. Green cereals
1.1.2.1. Green oats, spelt, triticale, rye and other C3 cereals
1.1.2.2. Green maize and sorghum
1.1.3. Fodder roots (including fodder beet)
1.1.4. Fodder brassicas
1.1.5. Fodder <i>Compositae</i> : sunflower
1.2. Fallow lands
1.2.1. Grazed fallow lands
1.2.2. Non-grazed fallow lands
1.3. Other crop types
2. Permanent grasslands
2.1. Agriculturally-improved permanent grasslands ¹
2.2. Semi-natural grasslands
2.2.1. Pastures, including rangelands, rough grazing, wood pastures, etc.
2.2.1.1. Sole use
2.2.1.2. Common land
2.2.2. Traditional hay meadows
2.3. Permanent grasslands no longer used for production
3. Permanent crops
4. Other agricultural land such as kitchen gardens

¹ Almost always under single use but occasionally common land.

These definitions recognise the existence of silvopastoral systems, like the dehesa/montado and other Mediterranean grazed ecosystems, as permanent grasslands and make them identifiable in statistics and eligible for subsidies. It introduces semi-natural grasslands into the typology that allows data to be recorded about their evolution and to define policies for the conservation of this species-rich and threatened ecosystem. The category 'Forage crops/Leguminous plants' has been clustered with the category 'Forage crops/Temporary grass' to creating the new category 'Forage crops/Temporary grasslands'. This clarifies the concept, especially for legume/grass mixtures and recognises 'Leguminous plants' as grasslands.

The terms 'meadows' and 'pastures' are clearly defined. This clarification was needed since these terms were used in recent years with different meanings.

►► Data

The data used in this book comes from several main sources, Eurostat and related publications, FAOSTAT, and national data.

The information was thoroughly cross-checked to ensure its validity.

Full details of data sources, availability and processing is provided in Annex 1 at the end of this book.

Chapter 1

Importance of the grassland area and grassland-based systems in Europe and their spatial distribution

► Present acreage of grasslands and annual forage crops in Europe

Acreage of permanent grasslands

Permanent grasslands are important to the territory and the farming systems of the European Union. In 2007, they covered 57 million ha (Eurostat; > 65 million ha according to FAOSTAT; Tables 3 and 4), or about 13% of the EU-27 territory and 33% of its utilised agricultural area (UAA) (36% UAA in EU-15 and 25% in EU-12-NMS; Table 8). Arable land (including forage crops: 4.3%) covered 24% and forest 41% of EU-27 territory. The importance of permanent grasslands varies considerably between countries. In 2007, over half of UAA was covered by permanent grassland in Ireland (76%), the United Kingdom (63%), Slovenia (59%), Austria (54%), Luxembourg (52%) and Portugal (51%). In former communist countries in central and eastern Europe, the proportion of UAA is usually lower than the

Table 3. Land use in the EU-27.

	Total territory	Total AA	UAA	Permanent grassland	Arable land	Permanent crop	Other surfaces of AA (including wooded areas)	Forest
Surface (million ha)	433	215	172	57	104	11	43	177
Proportion (%)	100	49.8	39.9	13.1	24.1	2.5	9.9	40.9

AA = Agricultural Area; UAA = Utilised Agricultural Area.

Source: Eurostat 2010 (Farm Structure Survey 2007); European Commission (2009a) and authors' calculations. Data: 2007 (except forest data, which is from 2005).

European average, such as in Bulgaria (9%), Hungary (12%) and Poland (21%) (Table 9). Romania is an exception: the country has a large permanent grassland area and its proportion in the UAA corresponds to the EU-27 average (33%). This variability reflects differences in ecological conditions, production systems, living standards, history and policies among countries. Five countries contribute 64% of the total permanent grassland area of the EU-27 (2007): the United Kingdom (17%), France and Spain (15%), Germany (9%) and Romania (8%).

Table 4. Agricultural area of the EU-27 (2007).

	'000 ha	% UAA	
Total area of agricultural holdings	215 396		
Utilised Agricultural area (UAA)	172 485		
Arable land	104 341	60.5	
Forage crops	18 745		10.9
Permanent grassland and meadows	56 791	32.9	
Permanent crops	10 963	6.4	
Other area	42 911		
Wooded area	30 980		
Total (UAA) or proportion (% UAA)	172 095	100.0	10.9

Source: Eurostat 2010 (Farm Structure Survey 2007); European Commission (2009) and authors' own calculations.

The permanent grassland area includes about 16.9 million ha of common lands in the EU-27 territory (10% UAA, 2007), mainly in hilly, mountainous and Mediterranean areas (Table 8 and Table 9). These grasslands generally have low biomass production but high nature and landscape value. Spain (33.3%), the United Kingdom (24.8%), France (8.1%), Portugal (7.5%) and Italy (5.5%) contribute 79% of the total common land area of the EU-27.

Areas of extensive grazing (% UAA where livestock density < 1 livestock unit (LU)/ha of fodder area) represent about 20% in the EU-15 and about 25% in the EU-12-NMS; these areas are increasing in both divisions of the EU-27 (Table 5).

Table 5. Areas of extensive grazing (% UAA) (% UAA where livestock density < 1 LU/ha of fodder area).

	EU-27	EU-15	EU-12-NMS
2005	21.3	19.6	25.7
2007	22.8	21.5	26.1

Source: Eurostat (FSS/land use) in European Union (2008a and 2009a).

The permanent grassland surface in the European Union (17 million ha) can be compared with the surfaces in the Russian Federation (92 million ha; 43% UAA) and in Ukraine (9 million ha; 19% UAA) (FAOSTAT: 2007 data).

Acreage of common lands

Common land consists mainly of permanent grassland, although other land cover such as horticulture or arable land also occurs. The majority of common land is used for grazing animals. Common land is part of the UAA and the permanent grassland and meadow category in the Eurostat system. According to Eurostat, ‘common land is the land not belonging directly to any agricultural holding but it is land on which common rights apply.’ These traditional rights allow people to graze livestock on it or to collect firewood. Eurostat further develops the definition: ‘The area used by each holding is not individualised. In general terms, common land is utilised agricultural area (UAA) owned by a public authority or entity (state, parish, farmers’ association etc.) over which another person is entitled to exercise rights of common, and these rights are generally exercisable in common with others. Common land can be organised in various ways as is shown by the practices in different EU Member States:

– Under common law in Ireland, land held in commonage is seen as a tenancy in common. Each tenant holds an undivided share in the property and has a distinct and separate interest in the property. The ownership is divided into notional shares, rather like shares in a company. Commonage is not physically divided so no one person owns any particular part of the property. In a sense it is communally owned and operated and third parties must treat the co-owners as a single unit for transactions in respect of the land.

– In France common land units are individual or legal units providing common land. Units providing common land are not producing agricultural products but service including land, livestock care, fences maintenance. Those units are legal units. These units can receive subsidies just as farms.

– In the United Kingdom common land is land owned by one person or entity over which another person is entitled to exercise rights of common (e.g., grazing animals), and these rights are generally exercisable in common with others’ (Eurostat: http://epp.eurostat.ec.europa.eu/statistics_explained/index.php/Common_land_statistics_-_backgrounds).

Table 6. Livestock numbers and common land grazing based on the 2010 Survey on Agricultural Production Methods.

Country	Total livestock	Grazing livestock	Common land grazing	
	LU	LU	% of total livestock	% of grazing livestock
Austria		1 546 550		24.2
Bulgaria	1 149 470	744 430	58.7	80.4
Croatia	1 020 180	487 160	21.5	33.6
Greece	2 406 520	1 826 710	50.4	60.7
Ireland	5 787 400	5 303 690	15.1	15.4
Romania	5 444 180	3 106 480	46.1	63.0
Spain	1 4830 940	6 312 600	11.3	23.9

Table 7. Common land area (in ha) (2000–2010). Adapted from Eurostat 2013.

	% UAA in 2010	2000	2010
Austria ¹	9	413 659	252 872
Bulgaria	19	-	858 563
Cyprus ²	1	-	805
France	3	-	749 492
Greece	49	-	1 698 949
Hungary ²	2	-	73 975
Ireland	8	-	422 415
Italy	5	653 113	610 165
Portugal	3	70 690	127 660
Romania	12	-	1 497 764
Slovenia	2	22 786	8 221
Spain ²	7	2 554 595	1 727 617
United Kingdom	8	1 199 474	1 195 246

¹ Data for 2000 also include a negligible number of holdings (holdings which pass a specific national threshold) which were not included in the 2010 data; ² Data cover only the part of common land for which data were available; - : not existing. Data on common land were not collected.

Source:

http://epp.eurostat.ec.europa.eu/statistics_explained/index.php/Common_land_statistics_-_backgrounds

Although in many countries the area of common land has decreased drastically over the last centuries, there is still a surprising amount of common land in Europe that survived, and common land grazing is still very important in some countries. Even in more productive landscapes, such as in southern England, common land makes up a large proportion of the remaining semi-natural pasture land.

In the 2010 Survey on Agricultural Production Methods (SAPM) information was requested about grazing on common land (Table 6). In Bulgaria, Greece and Romania in particular, common land grazing is very important, with at least 50% of grazing livestock grazing for more than one month on common land. Additionally, in countries like Ireland, Spain and Austria, grazing on common land occurs frequently.

Table 7 shows the importance of common lands in several EU countries and changes in acreage.

Acreage of temporary grasslands

Data on permanent grasslands do not include temporary grasslands that are cropped on the arable land area. Temporary grasslands are combined with green maize, fodder beet, other annual forage crops and forage legumes in the ‘forage crops’ statistical category (Tables 8 and 9). Forage legumes (most likely a majority of lucerne in pure stand or in mixtures) are separated from the temporary grassland area in the Eurostat database (it has only a significant importance in Austria and Hungary). Temporary grasslands area varies considerably among countries: they represent 6%

Table 8. Composition of the UAA and the total fodder area ('000 ha) in the EU-27, Norway and Switzerland.

	UAA	Total fodder area	Total permanent grassland area	Rough grazing area	Forage crop area	Temporary grassland area	Forage maize area	Forage legume area*
Austria	3 189	1 971	1 730	816	244	63	82	72
Belgium	1 374	762	511	0	252	81	164	1
Bulgaria	3 051	348	280	82	98	69	22	-
Cyprus	146	43	2	0	42	1	1	-
Czech Republic	3 518	1 303	909	16	411	8	173	-
Denmark	2 663	674	201	27	471	262	145	1
Estonia	907	450	273	0	222	217	1	-
Finland	2 292	692	38	20	658	652	0	0
France	28 836	12 497	7620	1 360	4 877	3 436	1 441	280
GD								
Luxembourg	131	91	68	0	23	12	12	1
Germany	16 932	6 922	4 839	135	2 087	330	1 466	0
Greece	4 076	1 068	820	532	260	150	16	24
Hungary	4 229	732	504	450	238	9	91	176
Ireland	4 139	3 815	3 130	439	685	648	18	24
Italy	12 744	5 208	3 452	923	1 796	947	220	78
Latvia	1 774	1 026	640	537	385	369	5	8
Lithuania	2 649	1 201	819	0	405	0	21	-
Malta	10	5	0	0	5	0	0	-
Netherlands	1 914	1 242	821	24	423	196	222	6
Poland	15 477	3 958	3 271	82	837	315	372	-
Portugal	3 473	2 136	1 781	1 267	358	54	92	0
Romania	13 753	4 691	4 540	232	784	189	37	-
Slovakia	1 937	746	551	47	244	49	81	12
Slovenia	489	340	288	48	51	22	26	0
Spain	24 893	9 114	8 650	5 630	705	122	101	71
Sweden	3 118	1 621	487	47	1 134	1 087	11	0
United Kingdom	16 130	11 425	10 080	4 187	1 338	1 144	146	16
Norway	1 032	678	412	149	266	253	0	0
Switzerland	1 062	796	632	130	162	119	43	-
EU-6	60 763	27 201	17 953	2 443	9 279	4 329	3 599	466
EU-12	116 137	55 433	42 614	14 524	13 098	6 710	4 118	602
EU-15	124 737	59 716	44 870	15 407	15 134	8 512	4 210	675
EU-12-NMS	47 939	14 842	12 078	1 494	3 722	1 247	830	196
EU-27	172 676	74 558	56 948	16 901	18 855	9 759	5 040	871

Data: 2007, except France, 2012; Switzerland, 2005; forage legumes (all countries), 2000. *: estimated and included in temporary grasslands.

Source: Eurostat and authors' own calculations.

Table 9. Composition of the forage area (% UAA or total grassland area) in the EU-27, Norway and Switzerland.

	Total fodder area	Total permanent grassland	Rough grazing	Forage crops	Temporary grassland	Green maize	Forage legume	Temporary grassland (% permanent + temporary grasslands)
	(% UAA)							
Austria	61.8	54.3	25.6	7.7	2.0	2.6	2.3	3.5
Belgium	55.5	37.2	0.0	18.3	5.9	11.9	0.1	13.6
Bulgaria	11.4	9.2	2.7	3.2	2.2	0.7	-	19.7
Cyprus	29.4	1.3	0.0	28.5	0.6	0.6	-	30.3
Czech Republic	37.0	25.8	0.4	11.7	0.2	4.9	-	0.9
Denmark	25.3	7.6	1.0	17.7	9.9	5.4	0.0	56.6
Estonia	49.7	30.1	0.0	24.5	23.9	0.1	-	44.3
Finland	30.2	1.7	0.9	28.7	28.4	0.0	0.0	94.4
France	43.3	26.4	4.7	16.3	11.9	5.0	0.9	31.1
GD								
Luxembourg	69.7	52.2	0.0	17.7	8.9	8.8	0.4	14.6
Germany	40.9	28.6	0.8	12.3	1.9	8.7	0.0	6.4
Greece	26.2	20.1	13.1	6.4	3.7	0.4	0.6	15.4
Hungary	17.3	11.9	10.6	5.6	0.2	2.1	4.2	1.7
Ireland	92.2	75.6	10.6	16.5	15.7	0.4	0.6	17.2
Italy	40.9	27.1	7.2	14.1	7.4	1.7	0.6	21.5
Latvia	57.8	36.1	30.3	21.7	20.8	0.3	0.5	36.6
Lithuania	45.3	30.9	0.0	15.3	0.0	0.8	-	0.0
Malta	45.4	0.0	0.0	45.4	0.0	0.0	-	-
Netherlands	64.9	42.9	1.2	22.1	10.2	11.6	0.3	19.3
Poland	25.6	21.1	0.5	5.4	2.0	2.4	-	8.8
Portugal	61.5	51.3	36.5	10.3	1.6	2.7	0.0	3.0
Romania	34.1	33.0	1.7	5.7	1.4	0.3	-	4.0
Slovakia	38.5	28.5	2.4	12.6	2.5	4.2	0.6	8.2
Slovenia	69.6	59.0	9.8	10.5	4.5	5.3	0.0	7.1
Spain	36.6	34.7	22.6	2.8	0.5	0.4	0.3	1.4
Sweden	52.0	15.6	1.5	36.4	34.9	0.3	0.0	69.1
United Kingdom	70.8	62.5	26.0	8.3	7.1	0.9	0.1	10.2
Norway	65.7	39.9	14.5	25.8	24.5	0.0	0.0	38.0
Switzerland	75.0	59.6	12.2	15.3	11.2	4.0	-	15.8
EU-6	44.8	29.5	4.0	15.3	7.1	5.9	0.8	19.4
EU-12	47.7	36.7	12.5	11.3	5.8	3.5	0.5	13.6
EU-15	47.9	36.0	12.4	12.1	6.8	3.4	0.5	15.9
EU-12-NMS	31.0	25.2	3.1	7.8	2.6	1.7	0.4	9.4
EU-27	43.2	33.0	9.8	10.9	5.7	2.9	0.5	14.6

Data: 2007, except France, 2012; Switzerland, 2005; forage legumes (all countries except France), 2000.
Source: Eurostat and authors' own calculations.

of the UAA in the EU-27 and 3% in the EU-12-NMS; 15% of the total (permanent and temporary) grassland area in the EU-27 and 9% in the EU-12-NMS. They cover a significant area in northern Europe (35% in Sweden, 28% in Finland, 24% in Estonia and Norway, 21% in Latvia, 10% in Denmark), Ireland (16%), Switzerland (11%), the Netherlands (10%) and France (10%) (Table 9). They also account for large areas of some regions such as in the Po Valley (Italy), Brittany (France), the lowlands of the United Kingdom and the Belgian Ardennes. The former communist countries, however, have little temporary grassland acreage (0.2% in the Czech Republic, 0.2% in Hungary, 1.4% in Romania, 2.0% in Poland, 2.2% in Bulgaria, 2.5% in Slovakia, 4.5% in Slovenia).

Acreage of green maize and annual forage crops

Green maize occupied less than 3% of UAA in the EU-27 in 2007 but accounted for a relatively large percentage of UAA in Belgium (11.9%), the Netherlands (11.6%), Luxembourg (8.8%) and Germany (8.7%) (Table 9). About 60% of the EU-27 green maize area is located in France and Germany.

Land cover

Figure 1 (Plate 1) is based on data from the CORINE Land Cover (CLC) database developed in 2002 and describes land cover (as well as some land use). Figure 2 (Plate 2) presents the area of permanent grassland in these European countries in 1995 (EC, 2008a).

Arable land (including temporary grasslands), permanent crops, pastures and heterogeneous agricultural areas are in the agricultural class and represent about 47% of the total EU-27 area. The forest and artificial classes represent 30% and 4% of the total EU-27 area, respectively. Shrub and/or herbaceous vegetation associations, inland wetlands and open spaces with little or no vegetation are classified under the 'nature' category (15% of the total area). Grasslands as defined in the broadest sense are classified under the agricultural group, as well as the nature group to a smaller degree.

The Land Use/Cover Area frame Statistical (LUCAS) survey, a large scale and fully harmonised land survey, was conducted in 2009 in 23 EU Member States and resulted in a unique dataset (Table 10) (Eurostat, 2010a). These results correspond well with the CLC 2000 database when divided into three groups: 1) agriculture (cropland + grassland), 2) forest + nature (forest and other woodland, shrubs, water and wetland) and 3) artificial area (constructed and other artificial areas).

On average, 20% of the EU-23 area is covered by natural or agricultural grasslands, but major differences exist among countries. Grassland rich countries are Ireland (64%), the United Kingdom (42%), the Netherlands (38%) and Belgium (33%), while Finland (3%), Sweden (4%), Greece (13%), Portugal (14%) and Spain (14%) have much lower proportions. Finland and Sweden are two-thirds covered by forests (68% and 66% respectively). Forests also cover more than 50% of the national area in Slovenia, Estonia and Latvia. The largest shares of shrubs are found in Greece (21%), Spain (14%) and Portugal (11%). These shrub areas are in fact partly grazed.

The highest shares of land covered by crops are observed in Denmark (48%), Hungary (47%), Poland (36%) and the Czech Republic (35%).

The Netherlands (13%) and Belgium (10%) have the largest shares of constructed land and other artificial areas.

Other sources may give slightly different figures according to the methodologies used.

Based on the data in Table 8, the proportion of grassland in the agricultural area can be estimated in the two following ways:

- Grassland / (grassland + cropland) = 45%
- Grassland + shrubland / (grassland + shrubland + cropland) = 52%
- These estimations are higher than data provided by the Farm Structure Survey (FSS), which states area at about 33%.

Table 10. Land cover in 2009, in % of total area.

	Forest and wooded land	Cropland	Grassland	Shrub land	Water and wetland	Constructed and other artificial areas	Bare land
EU (23 states)	39	24	20	6	5	4	2
Austria	47	17	23	2	3	5	3
Belgium	26	27	33	1	2	10	1
Bulgaria	-	-	-	-	-	-	-
Cyprus	-	-	-	-	-	-	-
Czech Republic	38	35	20	1	2	4	1
Denmark	18	48	22	1	3	6	1
Estonia	55	12	19	1	11	2	1
France	32	30	27	3	2	5	1
Germany	34	33	23	1	2	7	1
Greece	33	24	13	21	2	3	3
Hungary	23	47	20	2	3	4	1
Ireland	12	5	64	6	8	4	1
Italy	33	33	16	5	3	7	2
Latvia	52	12	25	2	5	2	1
Lithuania	37	24	31	1	4	3	1
Luxembourg	36	22	31	1	1	8	1
Malta	-	-	-	-	-	-	-
Netherlands	12	24	38	1	11	13	1
Poland	33	36	24	1	2	3	1
Portugal	46	19	14	11	2	5	4
Romania	-	-	-	-	-	-	-
Slovenia	63	11	18	2	1	3	1
Spain	32	30	14	14	1	4	5

Source: Eurostat, 2010a.

» Spatial distribution

Agricultural land use

In 2008, the total utilised agricultural area (UAA) covered 178 million ha or 41% of the total area in the EU. This illustrates the importance of agriculture in European societies. The share of UAA in the total area varies greatly from country to country, from less than 10% in Finland and Sweden to more than 60% in the United Kingdom, Denmark, Hungary and Ireland (Table 11, Figure 3).

Permanent grassland totalled 55 million ha (31% UAA), while arable land accounted for 105 million ha (59% of UAA) and permanent crops only 12 million ha (7% UAA).

The permanent grassland area is significant in Ireland (75% UAA) and the United Kingdom (67% UAA), Slovenia (58% UAA), Austria (55% UAA) and Luxembourg (52% UAA). The top five countries in terms of total hectares are the United Kingdom (11 million ha), France (7.6 million ha), Germany (4.8 million ha), Italy (4.5 million ha) and Romania (4.5 million ha); they make up 62% of the total permanent grassland area in the EU-27.

Within a country, the percentage of UAA used as grassland can vary considerably by region, such as in Germany (Figure 4, Plate 3). In mountainous areas of a country, grasslands account for large areas, while in the lowlands, grasslands can cover significantly less UAA.

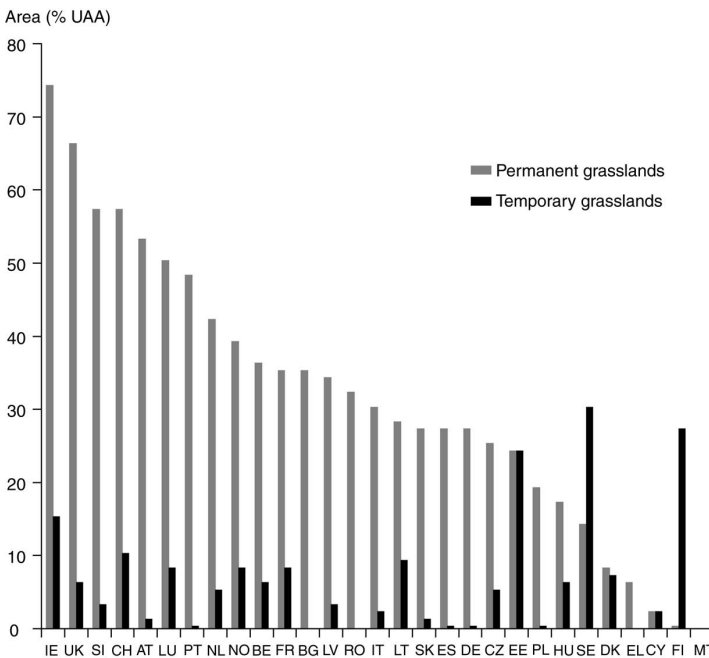

Figure 3. Utilised agricultural area (UAA) and share of permanent and temporary grasslands in the EU-27.

Source: Eurostat, 2009.

Table 11. Agricultural land use in 2008.

Country	Total area	UAA	Arable land	Land under permanent crop	Permanent grassland	Temporary grassland
	1000 ha	% total area	% UAA	% UAA	% UAA	%UAA
EU-27	432 525	41	59	7	31	5
Austria	8 387	38	43	2	54	2
Belgium	3 053	45	61	2	37	7
Bulgaria	11 100	46	60	4	36	0
Cyprus	925	15	73	24	3	3
Czech Republic	7 887	45	73	1	26	6
Denmark	4 310	63	92	0	9	8
Estonia	4 523	18	74	1	25	25
Finland	33 842	7	99	0	1	28
France	54 909	50	67	4	36	9
Germany	35 710	47	70	1	28	1
Greece	13 196	30	52	28	7	0
Hungary	9 303	62	77	3	18	7
Ireland	7 029	61	25	0	75	16
Italy	30 132	48	51	18	31	3
Latvia	6 459	28	64	0	35	4
Lithuania	6 530	41	70	1	29	10
Luxembourg	259	51	47	1	51	9
Malta	32	33	77	13	0	0
Netherlands	3 735	52	55	2	43	6
Poland	31 265	52	74	2	20	1
Portugal	9 191	40	32	21	49	1
Romania	23 839	58	63	3	33	0
Slovakia	4 904	40	69	1	28	2
Slovenia	2 027	24	37	5	58	4
Spain	50 537	48	52	20	28	1
Sweden	45 030	7	85	0	15	31
United Kingdom	24 410	69	33	0	67	7
Norway	32 380	3	60	0	40	9
Switzerland	4 128	26	40	2	58	11

Source: Smit *et al.*, 2008, Eurostat 2010b, Jeangros and Thomet (2004), authors' own calculations.

The permanent grassland area includes about 16.9 million ha of rough grazing in the EU-27 territory (10% UAA, 2007), mainly in hilly, mountainous and Mediterranean areas. These grasslands usually have high nature and landscape value. Of the total rough grazing area in the EU-27, five countries hold about 79%: Spain (33.3%), the United Kingdom (24.8%), France (8.1%), Portugal (7.5%) and Italy (5.5%) (Peeters, 2009).

Species used in forage crops and temporary grasslands

The species used in temporary grassland strongly depends on the life span of the grassland. If the grassland is used for no more than two years, Italian ryegrass (*Lolium multiflorum* Lam.) and hybrid ryegrass (*Lolium x hybridum* Hausskn.) are usually used. In some cases these species are combined with red clover. If the ley lasts for longer periods, perennial grasses, combined with white clover or lucerne are preferred, as indicated in Table 12. Other forage crops include maize.

Maize for silage is a very important crop in Europe, with 5.3 million ha, or 3.0% of UAA (Table 9). About 58% of the total area is cultivated in Germany and France. Green maize is very important with regard to UAA in Belgium (13.1% UAA), the Netherlands (12.5% UAA), Luxembourg (9.9% UAA) and Germany (9.7% UAA). It is used mainly for forage, but Germany uses green maize on a large scale to generate biogas. In 2009, 0.5 million ha of maize (30% of the green maize area) was cultivated for this purpose in Germany (Knapp *et al.*, 2010).

Legume forage crops are of variable importance in most of the European countries. The Eurostat database is incomplete for these crops. For example, there is data on grass/clover for only about half of the countries. The lack of data is most likely because grass/clover mixtures are not distinguished from the pure grass mixtures used in temporary grasslands. Species like lucerne and other legumes cultivated in pure stands (sainfoin and red and sweet clovers) probably had little or no importance in the countries where no data were delivered.

The area of grass/clover mixtures and pure stands of red clover is very high in Latvia (7.7% UAA), Estonia (5.3% UAA) and Lithuania (4.4% UAA). In terms of number of hectares, Germany (213 000 ha), Latvia (141 000 ha), Romania (118 000 ha) and Lithuania (117 000 ha) are the only countries with more than 100 000 ha of this crop.

In Switzerland, grass/clover mixtures have a long tradition and have always formed the backbone of forage production. In the last thirty years the area under grass/clover leys increased by 15% and is four times greater than the area of maize for silage. Leys are almost exclusively sown with grass/clover mixtures (Peyraud *et al.*, 2009).

Lucerne, well known for its drought resistance, has considerable coverage in Italy (712 500 ha), Romania (323 700 ha), Spain (240 000 ha), France (227 000 ha), Bulgaria (148 000 ha) and Hungary (134 200 ha). In these countries, lucerne is often produced in specialised areas, either because of the development of a dehydration industry with large factories—such as in France (Champagne-Ardenne) or in Spain (Ebra Valley)—or because of its link with specific animal production (sheep and goats in south-western France; dairy cows in Italy).

Table 12. Green maize, lucerne, clover and grass/clover mixtures in Europe (2009).

	UAA	Green maize		Clover + mixture		Lucerne	
	1 000 ha	1 000 ha	% UAA	1000 ha	% UAA	1 000 ha	% UAA
EU-27	178 633	5292	3.0	-	-	-	-
Austria	3 170	80	2.5	72.4	2.3	13.	0.4
Belgium	1 371	180	13.1	4.4	0.3	0.0	0.0
Bulgaria	5 106	56	1.1			148	3.0
Cyprus	141	0.1	0.0	-	-	0.8	0.6
Czech Republic	3 573	166	4.6	46.5	1.3	69	1.9
Denmark	2 694	169	6.3			5.4	0.2
Estonia	805	1.8	0.2	42.7	5.3	10.8	1.3
Finland	2 301	0	0.0	14.7	0.6	-	-
France	27 455	1444	5.3	-	-	227	0.8
Germany	16 927	1646	9.7	213.4	1.3	41.3	0.2
Greece	3 985	2.2	0.1	0.0	0.0	0.0	0.0
Hungary	5 786	74	1.3	4.8	0.1	134.2	2.3
Ireland	4 274	21	0.0	-	-	-	-
Italy	14 493	261	1.8	-	-	712;5	4.9
Latvia	1 828	9.8	0.5	140.7	7.7	-	-
Lithuania	2 671	19	0.7	117.3	4.4	4.6	0.2
Luxembourg	131	13	9.9	-	-	-	-
Malta	10	0	0.0	-	-	-	-
Netherlands	1 927	240	12.5	-	-	5.7	0.3
Poland	16 164	420	2.6	36.6	0.2	25.5	0.2
Portugal	3 676	103	2.8	-	-	-	-
Romania	13 707	32	0.2	118.2	0.9	323.7	2.4
Slovakia	1 957	77	3.9	8.0	0.4	50.5	2.6
Slovenia	493	26	5.3	3.4	0.7	2.4	0.5
Spain	24 005	93	0.4	-	-	240	1.0
Sweden	3 062	16	0.5	-	-	-	-
United Kingdom	16 770	166	1.0	-	-	-	-
Norway	1 036	0	0.0	-	-	-	-
Switzerland	1 061	38	3.6	-	-	-	-

Source: Eurostat and authors' own calculations.

Other forage legumes (sainfoin and sweet clover) cover a significant area in Romania (146 000 ha), Greece (133 000 ha), Latvia (101 800 ha), Spain (73 500 ha) and the Czech Republic (65 000 ha). They are less important in Slovakia (37 400 ha), Estonia (25 700 ha), Poland (19 200 ha) and Hungary (11 700 ha) (Eurostat, 2009).

In more northern parts of Europe, where green maize is neither popular nor possible, the use of whole-crop small grain cereals for silage gains more ground. Whole-crop cereal silage is made from autumn or spring sown crops such as wheat, barley, oats or triticale (a hybrid of wheat and rye). It is harvested at a more mature growth stage than traditional arable silage and with dry matter concentrations between 35% and 60%.

► Grasslands in organic farming

Organic farming, also called ‘ecological’ or ‘biological’ agriculture, is a clearly defined system of production that has specific food quality, human health, environmental, animal welfare and socio-economy aims. It is derived more from a consumer perspective than from a producer perspective.

The area under organic farming in the EU-27 has increased significantly (+ 7.4% per year) over the 2000–2007 period, to 7.2 million ha or 3.6% UAA (EC, 2010). Figure 5 (Plate 4), based mainly on the results of the 2007 Farm Structure Survey, provides the share of the organic area in the UAA at the regional level in the EU. It shows that there is a rather strong heterogeneity within most Member States. The map reflects the fact that organic farming is particularly present in regions with extensive livestock production systems based on permanent grassland. This concerns mountainous and semi-mountainous regions in alpine areas and other parts of the EU. The importance of the organic sector is generally lower in plains areas, where more intensive conventional production systems prevail.

Permanent grassland represents 30.3% of the UAA in the EU-27, whereas it represents 47.1% of the whole organic area. This can be explained by the higher reliance on grazing on permanent pastures in organic production systems than in conventional farming. Organic farms include also a higher proportion of mixed farms and specialised grazing livestock farms than conventional ones. Permanent pastures are often eligible for agri-environmental organic payments and are easier to manage and less at risk to be converted to organic production than other crops. Green fodder represents 10.3% of all UAA, and 16.5% of the organic area in the EU-27. It is estimated that around 50% of green fodder consisted in temporary grassland with mainly grass/legume mixtures. Such mixtures make it possible to provide nitrogen from symbiotic fixation.

Indeed, grassland, and in particular forage legumes, play a major role in almost all organic systems, where nitrogen is the most important nutrient for most crops, and organic farming principles place strong emphasis on building soil fertility with minimal use of non-renewable resources. In organic systems, N is supplied by mineralisation of soil-N, application of organic manures (e.g., slurry, farmyard manure) and last but not least, from atmospherically-derived N₂ fixed by legumes: white and red clover,

lucerne, sainfoin, birdsfoot trefoil and alsike clover (dependant on pH and soil humidity). Legumes are mainly combined with the grass species, commonly used in conventional farming in the region. Generally, several grass species are combined in a seed mixture and changes in the mixture depend largely on use intensity and the management regime.

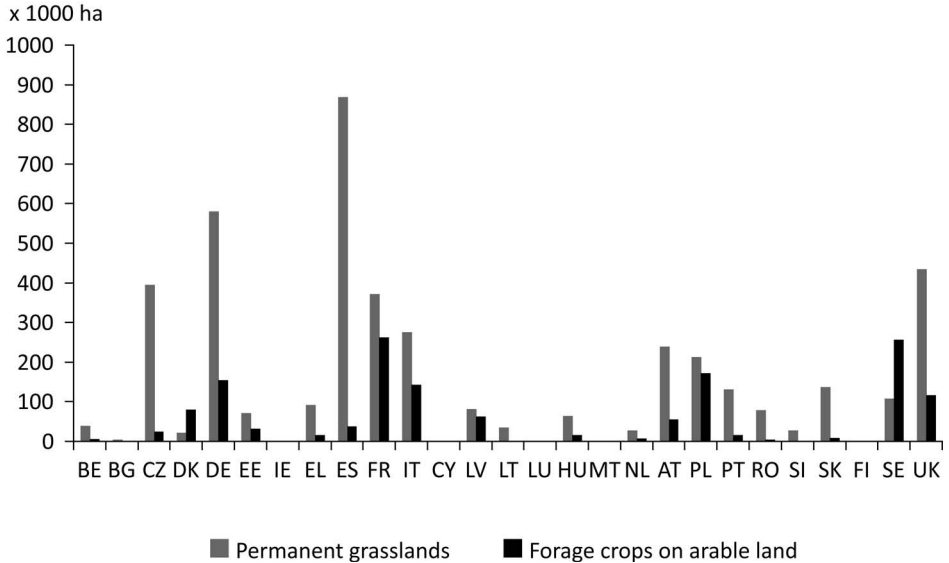

Figure 6. Organic farming area under permanent pastures and green fodder in 2011 in EU-27.

Source: Eurostat.

► Changes in grassland acreage in Europe

Variation in acreage of permanent grasslands

Between 1967 and 2007, about 7.1 million ha of permanent grasslands (about 30% of 1967 levels) were lost just in the EU-6 (Table 16; Eurostat). In the EU-9, 5.5 million ha were lost between 1975 and 2007. These figures are underestimated since the reunification of Germany added about 1 million ha to the total in 1990/91. In Belgium, France, Italy and the Netherlands, the decline exceeded 30% of these countries' grassland surfaces between 1967 and 2007. In Denmark, it was more than 30% between 1971 and 2007. In Ireland, surfaces fell 24% between 1975 and 2007. They were, however, remarkably stable in Luxembourg (5% increase between 1967 and 2007) and in the United Kingdom (a decrease of only 4% between 1971 and 2007). In Portugal, the surface rose steadily from 0.8 to 1.8 million ha since 1993. In Spain, it increased suddenly between 1987 and 1990 and then remained practically stable until 2007. In Bulgaria, permanent grasslands

nearly tripled between 2005 and 2007. These three important increases are most likely due, at least partly, to changes in the data recording and statistical methods. In Greece, the surfaces fluctuated significantly over the 1983–2007 period without showing a clear trend. The increase in surfaces in Portugal and Spain, undoubtedly due in part to changes in survey methods, considerably influences the evolving trend in the EU-12 and EU-15. Surface losses are consequently underestimated in these groups of countries.

Between the 1965–2007, 1975–2007 and 1990–2007 periods in the EU-13 (EU-15-Belgium and Luxembourg; FAOSTAT), grassland area was significantly reduced (from 65, 63 and 58 to 55 million ha, respectively, in other words a reduction of –15%, –13% and –6%, respectively)³.

Eurostat reports a sharp drop in grassland areas (> 10%) in Belgium, France, Ireland, Italy and the Netherlands between 1990 and 2007 (Eurostat). This decline was moderate (≤ 10%) in Denmark and Luxembourg. In Spain and the United Kingdom, there was a moderate increase (≤ 10%), and a strong rise in Greece and Portugal (> 10%). The average variation of the grassland area in these countries is an overall decrease of about 5% of the grassland area during this period (Table 13). During the same period, the UAA varied much less (a few percent of 1990 levels), except in Greece (+11%), Italy (–15%) and Portugal (–13%) (Table 11).

Table 13. Changes in the UAA and permanent grassland area ('000 ha) and the proportion of the permanent grassland area in the UAA (%) between 1961 and 2007 in 19 EU countries (EU-27-Belgium, Czech Republic, Slovakia, Estonia, Latvia, Lithuania, Luxembourg and Slovenia).

	1961	1965	1970	1975	1980	1985	1990	1995	2000	2005	2007
Total UAA ('000 ha)	210 490	208 114	204 562	200 215	198 201	195 628	193 425	186 876	184 133	178 524	176 675
Permanent grassland area ('000 ha)	75 542	75 343	74 990	74 261	73 082	70 995	70 362	68 295	67 173	65 947	65 522
Permanent grassland area/UAA (%)	35.9	36.2	36.7	37.1	36.9	36.3	36.4	36.6	36.5	36.9	37.1

Source: FAOSTAT.

Based on data from the FAOSTAT database, the conclusions are slightly different between the early 1990s and 2007 (Table 13 and 16). The decline in grassland area was considerable (> 10%) in Cyprus, Estonia, Finland, France, Germany, Greece, Hungary, Ireland, Italy, Latvia, Poland, Slovakia, Sweden and Switzerland; it was moderate (≤ 10%) in Austria, Bulgaria, the Netherlands, Romania and Slovenia. There was a moderate increase (≤ 10%) in Spain and the United Kingdom, and a significant increase (> 10%) in the Czech Republic, Denmark, Lithuania and Portugal.

3. It must be noted that FAOSTAT estimates the total permanent grassland area of 18 countries of the EU-27 at 65 million ha (55 million ha for the EU-15) while Eurostat estimates the same surface for the 27 countries of the EU-27 at 57 million ha (45 million ha for the EU-15).

The main difference between the two databases concerns Denmark (moderate decline according to Eurostat; large increase according to FAOSTAT) and Greece (significant increase or sizeable decrease, respectively).

The decline in permanent grassland area is due to urbanisation, conversion to arable land and afforestation. Marginal grasslands and rangelands tended to be abandoned, especially in mountainous and Mediterranean areas.

According to Eurostat, the drop in permanent grassland area seems to have slowed or even stopped after 2003 (Table 16). This trend is not so clear in the FAOSTAT database (Table 18).

After 1989 and the fall of communist regimes, many agricultural areas and especially grassland areas were abandoned in countries in transition. It is estimated that at least 30% of grassland areas were abandoned in Bulgaria and Romania. In fact, in some regions of these countries, including in mountainous areas, a majority of grasslands were abandoned.

In the Russian Federation and in Ukraine, the permanent grassland area increased respectively by 5% (from 87.9 to 92.1 million ha) and 6% (from 7.5 to 7.9 million ha) between 1992 and 2007 (FAOSTAT).

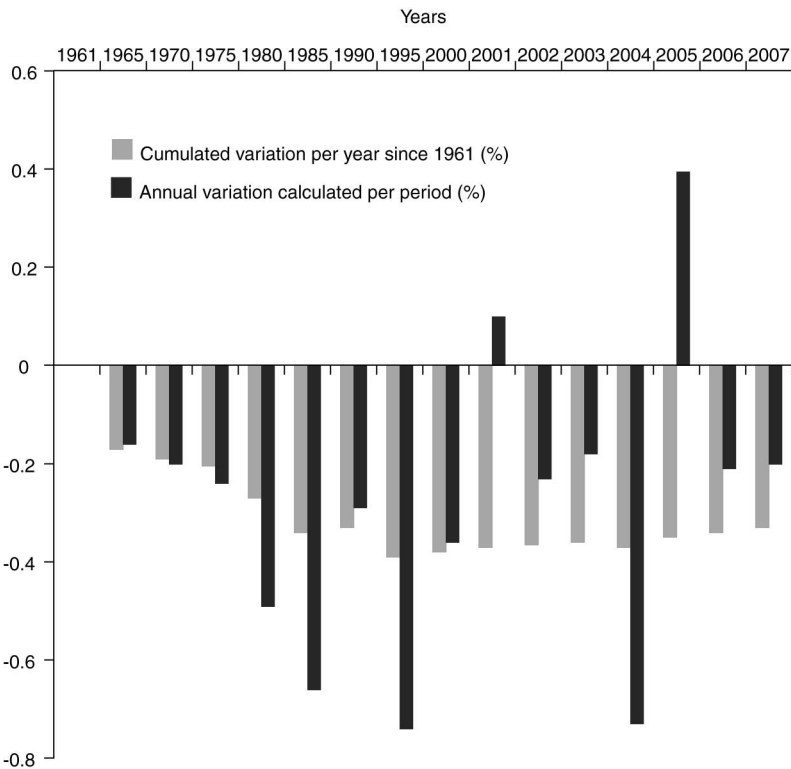

Figure 7. Rate of variation of the permanent grassland area between 1961 and 2007 in the EU-15-BE-LU.

Source: FAOSTAT.

Rate of variation

In the Eurostat database, the rate of decline was high in the 1971–75, 1985–87 and 1990–93 periods. The rate of variation was positive (increase) between 1987 and 1990 because of the German reunification. Since 2005, there has been a positive trend in the variation rate of surfaces in the EU-9, 12, 15 and 27. This means that the grassland area has tended to increase in these groups of countries, at least slowly. In the EU-6, the variation rate is still negative but is lower than in former periods.

The FAOSTAT database shows that the annual rate of decline was particularly high during the 1975–80, 1980–85 and 1990–95 periods (Figure 7). One year after protection of the permanent grassland area was added to the cross-compliance principle in 2003, the decline was significant but partly made up in 2005. From then, the rate of decline was lower.

Changes in the proportion of the permanent grassland area in the UAA

Beyond the analysis of the acreage in absolute values, it is important to analyse their contribution to the agricultural area. This was measured as percentage of UAA. Because of the stability of the arable land in the EU over the last decades, the conclusions are very similar to the analysis based upon the actual acreages.

According to Eurostat, the proportion of the permanent grassland area in the UAA decreased by about 25% in the EU-6 between 1967 and 2007 (from a proportion of 39% to 29% UAA; Table 13). This means that the grassland area decreased faster than the rest of the agricultural area (Tables 14 and 15). Belgium, Germany, France and the Netherlands lost 10% or more of this proportion. In the EU-12, this proportion remained almost stable between 1990 and 2007. That is partly due to an increase in the United Kingdom, relative stability in Italy and a strong increase in Portugal between 1997 and 2000. The 1985–1993 period recorded the fastest rate of decrease of this proportion. The rate became positive in all EU groups after 2005.

According to FAOSTAT, the proportion of the permanent grassland area in the UAA remained almost stable between 1965 and 2007 (40% and 38%) in the EU-13 (EU-15-Belgium and Luxembourg) and in a selection of 18 EU countries (Table 17). The decline of the proportion of the permanent grassland area in the UAA (%) between 1961 and 2007 was strong ($> 10\%$) in Austria, Cyprus, Finland, France, Germany, Greece, Hungary, Ireland, Italy, Poland, Spain, Sweden and the Netherlands; it was moderate ($\leq 10\%$) in the United Kingdom. There was a moderate increase ($\leq 10\%$) in Denmark and Romania and a considerable increase ($> 10\%$) in Bulgaria and Portugal. Despite a reduction of about 10 million ha of the permanent grassland area in 19 EU countries (Table 13), the proportion of the permanent grassland area in the UAA increased slightly (36% to 37%).

A focus on the 1990–2007 period shows on average a faster decline in the permanent grassland area compared to the UAA in 11 EU countries (Tables 14 and 15) (Eurostat). Portugal is a noticeable exception.

Table 14. Variation of the UAA in 11 EU countries between 1990 and 2007.

Countries	1990 (‘000 ha)	1990	1995	2000 (% of 1990)	2005	2007
Belgium	1 345	100	101	104	103	102
Denmark	2 779	100	98	95	97	96
France	28 186	100	100	99	-	-
Greece	3 661	100	98	98	109	111
Ireland	4 442	100	97	100	95	93
Italy	14 947	100	98	87	85	85
Luxembourg	127	100	100	101	102	103
Netherlands	2 011	100	99	101	97	95
Portugal	4 006	100	98	96	92	87
Spain	24 531	100	103	107	101	101
United Kingdom	16 499	100	100	96	97	98
Total	102 532	100	100	98	-	-

Source: Eurostat; Remark: data for other EU countries are not available.

Table 15. Variation of the permanent grassland area in 11 EU countries between 1990 and 2007.

Countries	1990 (‘000 ha)	1990	1995	2000 (% of 1990)	2005	2007
Belgium	573	100	86	88	91	89
Denmark	219	100	182	74	90	92
France	9 563	100	92	87	-	-
Greece	658	100	89	92	125	125
Ireland	3 840	100	84	87	80	82
Italy	4 106	100	92	83	82	84
Luxembourg	69	100	98	93	98	99
Netherlands	1 072	100	97	92	75	77
Portugal	838	100	122	166	211	212
Spain	8 448	100	97	111	102	102
United Kingdom	9 711	100	98	96	101	104
Total	39 098	100	95	96	-	-

Source: Eurostat; Remark: data for other EU countries are not available.

The analysis since the middle of the 20th century may be misleading. Indeed, it does not provide any information on the general trend over longer periods of time. Such long-term data are not available in all countries; longer analyses are only possible in a few case studies.

Long-term data are available for France, as statistical surveys of grasslands were initiated at the beginning of the 19th century, but on a basis which makes it difficult to separate temporary and permanent grasslands. The grasslands were identified by their management, and in particular, the water management applied to promote growth. Querré (1845) provided an interesting description for Brittany in the early 19th century where the management of winter drainage and summer irrigation were key elements.

It appears from the statistical survey that the acreage of grasslands steadily increased during the 19th century and that production was higher due to better water and fertiliser management. Normandy merits special focus, as it is now famous for its permanent grasslands and the Normandy dairy cow breed. An analysis made by P. Brunet at the Museum of Normandy described the change in grasslands all over the 19th century (Figure 8, Plate 4) and clearly shows the sharp increase since the middle of this century.

The reason for such development is that Normandy is the closest region to Paris: milk could be produced here and transported to Paris to feed the capital's expanding population. However, this was only possible once train transport became available. The railway plan was approved in 1852 and began operating in 1858 between Paris and Cherbourg, crossing all of Normandy.

Table 16. Changes in the permanent grassland area ('000 ha) and annual variation (%) in the EU-27 between 1966 and 2007. Germany includes the ex-GDR since 1990/91.

	1966	1970	1975	1980	1985	1990	1995	2000	2005	2007	Ratio between 2007 and the reference year (%)	Difference between 2007 and the reference year ('000 ha)
Austria							1 936	1 916	1 788	1 730		
Belgium	758	727	699	667	636	573	491	507	519	511	67.5	-247
Bulgaria									107	280		
Cyprus									0	2		
Czech Republic									875	909		
Denmark		300	279	263	221	219	398	161	198	201	67.0	-99
Estonia									237	273		
Finland							17	26	26	38		
France	12 101	12 330	11 239	11 381	10 416	9 563	8 804	8 316	8 131	8 105	67.0	-3 996
GD Luxembourg	65	69	73	71	70	69	68	64	68	68	105.1	+3
Germany	5 294	5 114	4 924	4 729	4 472	5 265	5 169	5 114	4 929	4 839	91.4	-455
Greece					885	658	584	605	824	820		
Hungary								590	469	504		
Ireland			4 102	3 959	3 961	3 840	3 228	3 333	3 065	3 130	76.3	-972
Italy	5 450	5 423	4 747	4 499	4 427	4 106	3 758	3 418	3 347	3 452	63.3	-1 998
Latvia								463	599	640		
Lithuania									891	819		
Malta									0	0		
Netherlands	1 294	1 282	1 241	1 172	1 133	1 072	1 041	985	809	821	63.4	-473
Poland									3 020	3 271		
Portugal						838	1 024	1 390	1 769	1 781		

	1966	1970	1975	1980	1985	1990	1995	2000	2005	2007	Ratio between 2007 and the reference year (%)	Difference ('000 ha)
Romania									4 530	4 540		
Slovakia						783		530	551			
Slovenia						285		288				
Spain					8 448	8 199		9 368	8 653	8 650		
Sweden						413		373	509	487		
United Kingdom	10 502	9 384	10 212	9 779	9 711	9 491		9 358	9 809	10 080	96.0	-422
Norway						390		410	412			
Switzerland								632				
EU-6	24 962	24 945	22 923	22 519	21 154	20 648	19 331	18 404	17 803	17 796	71.3	-7 166
EU-9			36 688	36 953	35 115	34 418	32 448	31 256	30 874	31 207	85.1	-5 481
EU-12						44 363	42 255	42 620	42 120	42 457	101.4	+576
EU-15							44 621	44 935	44 444	44 713	100.2	+92
EU-27								55 984	56 791		100.7	+402
EU-6: annual variation ('000 ha)	-4.3	-505.5	-80.8	-262.0	+150.4	-111.2	-284.5	-104.1	-3.3			
Annual variation rate (average between 2 dates) (%)												
EU-6	-0.02	-2.03	-0.35	-1.21	+0.74	-0.57	-1.48	-0.58	-0.02			
EU-9			+0.14	-1.00	+0.28	-0.54	-1.14	-0.37	+0.54			
EU-12					+1.98	-0.14	+0.17	+0.21	+0.40			
EU-15						+0.15	+0.15	+0.21	+0.30			
EU-27							-0.36	-0.36	+0.72			

The reference year is the first year of record.

Source: Eurostat; European Communities (2000); authors' own calculations.

Table 17. Changes in the proportion of the permanent grassland area in the UAA (%) and annual variation (%) in the EU-27 between 1966 and 2007. Germany includes ex-GDR since 1990/91.

	1966/67	1970/71	1975	1979/80	1985	1990	1995	2000	2005	2007	Ratio between 2007 and reference year	Difference
Austria							56.5	56.6	54.8	54.3		
Belgium	47.7	47.5	47.7	47.0	46.2	42.6	36.2	36.4	37.5	37.2	78.0	-10.5
Bulgaria									3.9	9.2		
Cyprus									0.3	1.3		
Czech Republic									24.6	25.8		
Denmark		10.1	9.4	9.0	7.8	7.9	14.6	6.1	7.3	7.6	74.6	-2.6
Estonia									28.6	30.1		
Finland							0.8	1.2	1.1	1.7		
France	40.3	41.3	38.2	39.0	36.6	33.9	31.1	29.9	29.4	29.3	72.7	-11.0
GD Luxembourg	48.5	51.5	54.1	55.0	56.0	54.5	53.2	50.5	52.3	52.2	107.6	+3.7
Germany	42.0	40.6	39.9	38.9	37.7	30.9	30.2	29.8	28.9	28.6	68.0	-13.4
Greece					21.6	18.0	16.3	16.9	20.7	20.1		
Hungary								12.9	11.0	11.9		
Ireland			80.8	78.4	79.3	86.5	74.6	75.0	72.6	75.6	93.6	-5.2
Italy	30.5	31.6	28.8	28.4	28.2	27.5	25.6	26.2	26.3	27.1	88.8	-3.4
Latvia								32.3	35.2	36.1		
Lithuania									31.9	30.9		
Malta									0.0	0.0		
Netherlands	58.2	59.8	59.5	57.6	55.9	53.3	52.1	48.6	41.3	42.9	73.7	-15.3
Poland									20.5	21.1		
Portugal						20.9	26.1	36.0	48.1	51.3		
Romania									32.6	33.0		

	1966/67	1970/71	1975	1979/80	1985	1990	1995	2000	2005	2007	Ratio between 2007 and reference year	Difference
Slovakia								36.2	28.2	28.5		
Slovenia								58.7	58.1	59.0		
Spain						34.4	32.5	35.8	34.8	34.7		
Sweden							13.5	12.1	16.0	15.6		
United Kingdom		59.3	57.0	60.3	58.1	58.9	57.7	59.2	61.5	62.5	105.4	+3.2
Norway								37.5	39.6	39.9		
Switzerland								59.6				
EU-6	38.7	39.3	37.0	37.0	35.6	32.4	30.4	29.9	29.2	29.3	75.6	-9.5
EU-9			42.5	43.1	41.7	39.4	37.3	37.0	36.9	37.3	87.8	-5.2
EU-12						37.1	35.3	36.1	36.2	36.6	100.4	+0.2
EU-15							34.7	35.4	35.6	35.8	103.2	+1.1
EU-27									32.5	32.9	100.7	+0.2
Annual variation rate (average between 2 dates) (%)												
EU-6		+0.4	-1.5	0.0	-0.8	-1.9	-0.8	-0.3	-0.2	+0.08		
EU-9				+0.3	-0.6	-1.3	-0.7	-0.2	0.0	+0.58		
EU-12						+0.6	-0.5	+0.7	+0.6	+0.46		
EU-15								+0.7	+0.5	+0.41		
EU-27									-0.2	+0.54		

The reference year is the first year of record.

Source: Eurostat; European Communities (2000); authors' own calculations.

Table 18. Changes in the permanent grassland area ('000 ha) in 18 EU countries between 1961 and 2007.

	1961	1965	1970	1975	1980	1985	1990	1995	2000	2005	2007	Ratio between 2007 and 1961	Difference between 2007 and 1961
	('000 ha)												(%)
Austria	2 296	2 256	2 215	2 181	2 040	1 986	1 995	1 940	1 920	1 810	1 790	78.0	-506
Bulgaria	1 054	1 230	1 483	1 612	2 004	2 035	2 003	1 962	1 804	1 891	1 835	174.1	781
Cyprus	5	5	5	5	5	5	5	4	2	1	1	20.0	-4
Denmark	343	325	299	277	252	220	217	398	358	368	350	102.0	7
Finland	100	120	150	160	164	132	122	113	26	33	34	34.0	-66
France	13 134	13 459	13 394	13 403	12 850	12 200	11 380	10 566	10 124	9 907	9 899	75.4	-3 235
Germany	6 651	6 889	6 632	6 282	5 989	5 818	5 618	5 282	5 048	4 929	4 875	73.3	-1 776
Greece	5 210	4 824	5 245	5 251	5 255	5 255	5 255	5 260	4 675	4 600	4 600	88.3	-610
Hungary	1 459	1 304	1 281	1 275	1 294	1 246	1 186	1 148	1 051	1 057	1 017	69.7	-442
Ireland	4 047	4 167	4 287	4 479	4 617	4 673	4 605	3 356	3 333	3 115	3 213	79.4	-834
Italy	5 075	5 138	5 250	5 204	5 126	4 981	4 868	4 405	4 353	4 402	4 186	82.5	-889
Netherlands	1 287	1 287	1 326	1 286	1 198	1 164	1 097	1 048	1 012	980	821	63.8	-466
Poland	4 146	4 264	4 217	4 125	4 046	4 069	4 060	4 047	4 083	3 387	3 271	78.9	-875
Portugal	838	838	838	838	838	838	838	1 024	1 490	1 769	1 824	217.7	986
Romania	4 208	4 316	4 418	4 446	4 467	4 398	4 728	4 890	4 949	4 685	4 533	107.7	325
Spain	12 500	12 100	11 600	11 088	10 739	10 296	10 300	10 966	11 462	11 320	11 100	88.8	-1 400
Sweden	684	684	700	720	725	572	568	500	447	513	488	71.3	-196
United Kingdom	12 505	12 137	11 650	11 629	11 473	11 107	11 517	11 386	11 036	11 180	11 516	92.1	-989
EU-15-BE-LU	64 670	64 224	63 586	62 798	61 266	59 242	58 380	56 244	55 284	54 926	54 696	84.6	-9 974
Total	75 542	75 343	74 990	74 261	73 082	70 995	70 362	68 295	67 173	65 947	65 353	86.5	-10 189
Cumulated variation per year since 1961 (%)													
EU-15-BE-LU		-0.172	-0.186	-0.207	-0.277	-0.350	-0.335	-0.383	-0.372	-0.342	-0.335		
Annual variation calculated between two periods (%)													
EU-15-BE-LU		-0.172	-0.199	-0.248	-0.488	-0.661	-0.291	-0.732	-0.341	0.389	-0.203		

Note: data for other EU countries are not available for this period.

Source: FAOSTAT and authors' own calculations.

Table 19. Changes in the proportion of the permanent grassland area in the UAA (%) in 18 EU countries between 1961 and 2007.

	1961	1965	1970	1975	1980	1985	1990	1995	2000	2005	2007	Ratio between 2007 and reference year	Difference
Austria	56.7	56.6	56.9	57.5	55.5	56.6	57.0	56.5	56.6	55.5	55.2	97.4	-1.5
Bulgaria	18.6	21.2	24.7	27.1	32.4	33.0	32.5	31.8	32.3	35.9	35.9	193.0	17.3
Cyprus	2.4	2.4	2.2	2.5	2.9	3.1	3.1	2.8	1.4	0.6	0.6	25.0	-1.8
Denmark	10.9	10.7	10.1	9.4	8.7	7.8	7.8	14.6	13.5	13.6	13.1	120.2	2.2
Finland	3.6	4.3	5.5	6.1	6.5	5.5	5.1	5.0	1.2	1.5	1.5	41.7	-2.1
France	38.0	39.6	41.2	41.4	40.5	38.8	37.2	35.2	34.1	33.5	33.6	88.4	-4.4
Germany	34.3	35.3	34.9	33.4	32.3	31.9	31.2	30.5	29.6	28.9	28.8	84.0	-5.5
Greece	58.5	55.6	57.3	57.6	57.2	57.2	57.0	57.4	54.8	55.2	55.6	95.0	-2.9
Hungary	20.6	18.8	18.6	18.8	19.5	19.1	18.3	18.6	18.0	18.0	17.5	85.0	-3.1
Ireland	71.8	73.6	75.6	78.4	80.6	81.9	81.5	76.5	75.5	72.4	75.1	104.6	3.3
Italy	24.5	25.1	26.0	29.7	29.2	29.1	28.9	28.7	27.8	29.9	30.1	122.9	5.6
Netherlands	55.6	57.1	60.5	61.8	59.3	57.7	54.7	53.4	51.7	51.0	51.7	93.0	-3.9
Poland	20.4	21.4	21.6	21.5	21.3	21.5	21.6	21.7	22.2	21.3	20.2	99.0	-0.2
Portugal	21.6	21.5	21.3	21.2	21.1	21.0	21.1	26.1	38.9	48.1	52.2	241.7	30.6
Romania	28.8	29.2	29.6	29.7	29.9	29.3	32.0	33.0	33.3	33.0	33.5	116.3	4.7
Spain	37.6	37.0	36.1	34.7	34.4	33.5	33.8	36.9	38.5	38.8	38.7	102.9	1.1
Sweden	16.1	17.8	18.7	19.3	19.6	16.4	16.6	15.3	14.2	16.0	15.6	96.9	-0.5
United Kingdom	63.2	62.0	61.8	62.6	62.1	61.1	63.3	65.5	65.1	65.9	65.3	103.3	2.1
EU-15-BE-LU	39.8	40.0	40.5	41.0	40.5	39.8	39.7	39.9	39.7	40.1	40.4	101.5	0.6
All countries	35.9	36.2	36.7	37.1	36.9	36.3	36.4	36.5	36.5	36.9	37.0	103.3	1.2
Cumulated variation per year since 1961 (%)		0.165	0.206	0.223	0.097	0.004	-0.007	0.009	-0.005	0.016	0.033		
EU-15-BE-LU		0.165	0.237	0.249	-0.247	-0.345	-0.056	0.102	-0.104	0.571	0.336		
Annual variation calculated between two periods (%)													
EU-15-BE-LU													

Note: data for other EU countries are not available for this period.
Source: FAOSTAT and authors' own calculations.

Changes in rough grazing acreage

The area and the proportion of rough grazing appeared stable between 1990 and 2007 when 11 EU countries are taken into account (Table 20). However, survey methods obviously changed for Greece, Italy and Portugal. The rough grazing area varied between 327 000 ha and 532 000 ha in Greece, 0 ha and 923 000 ha in Italy and 350 000 ha and 1 267 000 ha in Portugal between 1990 and 2007. When these three countries are not included in the total, the area and the proportion in the UAA declined by about 10% during this period. It seems also that the area is underestimated in several countries, for instance in Mediterranean areas. Areas such as wooded grasslands and rangelands, grazed fallow lands and large surfaces of common land are not taken into account in official statistics.

Table 20. Changes in the rough grazing area ('000 ha) and its proportion in the UAA (%) in 11 EU countries (Belgium, Denmark, France, Greece, Italy, Ireland, Luxembourg, Portugal, Spain, the Netherlands, the United Kingdom) or 8 EU countries (11 EU countries-Greece, Italy and Portugal) between 1990 and 2007.

	1990	1993	1995	1997	2000	2003	2005	2007	Ratio between 2007 and 1990	Difference ('000 ha or %)
Surface ('000 ha)										
11 EU countries	13 831	13 130	13 165	13 420	13 213	14 334	14 365	14 240	103.0	409
11 EU-Greece, Italy and Portugal	13 154	12 507	12 475	12 709	11 931	11 987	11 861	11 518	87.6	-1 636
Proportion in the UAA (%)										
11 EU countries	13.5	12.9	12.8	13.1	13.1	14.3	14.5	14.4	106.6	0.9
11 EU-Greece, Italy and Portugal	12.8	12.3	12.2	12.4	11.8	12.0	12.0	11.6	90.7	-1.2

Source: Eurostat.

Changes in temporary grassland acreage

The total temporary grassland area can be considered as stable in 14 EU countries between 2001 and 2007 (FAOSTAT; Table 21). It increased by about 17% between 1990 and 2007 in 11 EU countries (Eurostat). These grasslands include different sward types; some are sown mainly for grazing (perennial ryegrass or tall fescue-based swards, with or without legumes and especially white clover), others are mainly cut (swards including different proportions of meadow fescue, orchard grass, perennial or Italian ryegrass and timothy, with or without legumes such as red clover

Table 21. Changes in the temporary grassland area ('000 ha) in 14 EU countries between 2001 and 2007.

	2001	2002	2003	2004	2005	2006	2007
Austria	65	69	73	74	77	73	62
Bulgaria	91	90	88	82	66	53	65
Denmark	437	430	444	432	464	474	471
Estonia	-	265	176	154	202	164	181
Finland	664	638	629	620	620	625	654
France	-	-	3 026	3 049	3 054	3 114	3 145
Germany	1 581	1 540	1 589	1 719	1 805	1 956	2 088
Hungary	-	-	12	21	19	14	12
Ireland	775	755	748	783	786	775	683
Lithuania	236	227	224	267	502	-	-
Romania	976	1 156	1 224	558	820	859	763
Slovenia	22	22	16	21	20	22	22
Spain	-	-	1 089	1 049	1 068	1 093	-
United Kingdom	1 205	1 230	1 201	1 246	1 193	1 137	1 176
TOTAL	-	-	10 539	10 075	10 696	-	-

Source: FAOSTAT.

or lucerne). The choice of species when sowing these temporary grasslands is fully determined by the planned management and use. The proportion of the temporary grassland area in the total (permanent + temporary) grassland area was also practically stable during this period (FAOSTAT; Table 22). This is confirmed over a longer period (1990–2007) by Eurostat (slight increase from 43.6% to 44.5%; Table 23).

There are very active breeding programs in Europe for these species, making it possible to offer new varieties to farmers. The main breeding objectives are biomass productivity, resistance to several diseases and pests, and feeding value of the harvested biomass.

In most European countries, the location of temporary grasslands has changed over time, with regions becoming specialised in animal production and more temporary grasslands being established in these dedicated regions. However, at the European scale, Sweden is an exception: over the last century, the regional distribution of temporary grasslands, as well as dairy cows, remained stable. This has been well documented by Jansson (2011). As later emphasised and explained in the interview with Nilla Nilsson-Linde, distributions have been very stable and the grasslands and dairy cow herds remained in all districts.

As can be seen in Figure 9 (Plate 5), the proportion of ley farming in cultivated land showed little variation. Only in southern Europe does the proportion of leys increase slightly. In comparison to most European countries, grasslands remained in most parts of the country, without any specialisation of production. This makes it possible to get the best out of mixed farming.

Table 22. Changes in the proportion of temporary grasslands area in the total (permanent + temporary) grassland area (%) in 14 EU countries between 2001 and 2007.

	2001	2002	2003	2004	2005	2006	2007
Austria	3.3	3.5	3.7	3.9	4.1	3.9	3.3
Bulgaria	4.8	4.9	4.7	4.4	3.4	2.8	3.4
Denmark	53.8	53.0	53.6	53.9	55.8	57.0	57.4
Estonia	-	-	39.6	39.5	46.7	45.8	45.6
Finland	96.4	95.9	95.7	95.7	94.9	94.6	95.1
France	-	-	23.0	23.3	23.6	23.9	24.1
Germany	24.0	23.7	24.2	25.9	26.8	28.6	30.0
Hungary	-	-	1.1	1.9	1.8	1.4	1.2
Ireland	19.4	19.1	19.0	20.2	20.1	20.0	17.5
Lithuania	16.2	15.9	18.7	21.8	36.0	-	-
Romania	16.5	18.9	19.8	10.4	14.9	15.6	14.4
Slovenia	6.7	6.7	4.9	6.8	6.2	7.2	6.9
Spain	-	-	8.9	8.6	8.6	9.0	-
United Kingdom	9.7	9.9	9.6	10.0	9.6	8.9	9.3
Total	-	-	16.8	16.3	17.1	-	-

Source: FAOSTAT.

Table 23. Changes in the temporary grassland area ('000 ha) and its proportion in the UAA (%) in 11 EU countries (Belgium, Denmark, France, Greece, Italy, Ireland, Luxembourg, Portugal, Spain, the Netherlands, the United Kingdom) between 1990 and 2007.

	1990	1993	1995	1997	2000	2003	2005	2007	Ratio	Difference
									between 2007 and 1990	
	('000 ha)								(%)	('000 ha)
Surface	5 582	6 284	6 436	6 467	6 613	6 342	6 466	6 523	116.8	941
	(%)								(%)	(%)
Proportion in the UAA	5.4	6.2	6.3	6.3	6.6	6.3	6.5	6.6	121.0	1.2

Source: Eurostat.

Changes in acreage of forage legumes

As mentioned before, the acreage of forage legumes grown in pure stands is much more limited than temporary grasslands and often located in a few European countries regions. As such, it is of interest to do case studies in order to precisely define these changes and understand the mechanisms that underpin them.

Forage legumes were essential to historical farming methods. Intensification of livestock farming has replaced forage legume species with maize silage and grasses that are intensively fertilised with mineral nitrogen. In France, for example, the acreage of lucerne and red clover has decreased by 75% over the last thirty years. These legumes covered 1.0 million ha in 1970 but only 321 000 ha in 2003, while maize silage increased from 350 000 ha to 1.4 million ha in the same time (Peyraud *et al.*, 2009). The major sown legume is white clover (*Trifolium repens*) and is also present in permanent grassland.

However, forage legumes are making a comeback, which is evident in the data on European seed markets. Legumes constitute one of the pillars of future livestock farming systems because of their high environmental and economical performances, both under organic and non-organic conditions. The main environmental advantage of legume-based crop husbandry is the reduction of the fossil energy required to synthesise N fertilisers and to transform other protein sources into useful cattle feed. The current production of meat, milk and eggs relies on non-forage protein imports and represents about 25% of the total amount of protein consumed by each animal. Imported feed components have high transportation costs, tremendous environmental impact and their quality and safety can be extremely variable. A greater reliance on ‘home-grown’ legume-based protein sources would improve the feed traceability, enhance consumer confidence in the final market product and promote ecologically sound farming systems (De Vliegheer and Carlier, 2008; Carlier *et al.*, 2008).

In this section, we will look at the example of lucerne in France. When considering the data from the last four decades, what is most striking is the constant decline of pure legumes, which are mainly lucerne. Moreover, a quarter of lucerne acreage is used for the dehydration industry. In fact, this situation is part of a long tradition. It is important to measure the changes over a much longer period than illustrated in Figure 10.

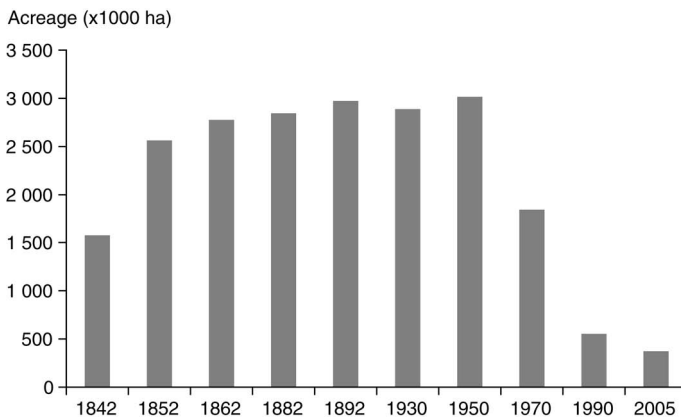

Figure 10. Acreage of forage legumes crops in France over the last 160 years.

The acreage of pure forage legumes stands started to increase in the mid-1700s, when agronomists realised that their use in cereal rotations was a very effective

way to increase grain production (this positive effect was explained later by a better nitrogen status of the grain crops). Sainfoin was the first forage legume to be grown, introduced from Switzerland to the Burgundy region. Very rapidly, red clover and lucerne were also used. The lucerne cultivation was made possible by the discovery of the first Flemish types, obtained by hybridising two different types. One was the lucerne population initially introduced from the Arabic peninsula to the warm regions of the Mediterranean basin. They had good yield potential but showed low persistency because of poor frost resistance and winter survival due to their low autumn dormancy. The second group was composed of wild populations of the subspecies *Medicago sativa* ssp. *falcata*, which has prostrated, yellow-flowered plants with very good frost resistance due to a strong autumn dormancy. The hybridisation generated populations that were very well adapted to the French and European climate, offering the possibility to produce large quantities of forage. This good-quality forage was of particular interest for the armies to feed their horses. This encouraged the production in fertile regions and strongly impacted farming systems. In particular, it led to the disappearance of an old system of grazing rights, named 'vaine pâture', in which all ruminants were allowed to graze on all fields once cereal crops had been harvested and on spontaneous fallow lands. Such fallow lands were transformed into leys by legume sowings after the harvest of the last annual crop of the rotation.

The expansion of forage legumes was reported by Gilbert in 1788 who wrote a precise report on legume cultivation in the Paris Basin for the Royal Agricultural Academy, where he described the presence of lucerne, sainfoin and red clover, depending on the soil characteristics. Statistical data from 1887 indicated that the acreage of forage legumes cultivated for hay reached 1.6 million ha, 2.8 million ha and 3.1 million ha in 1842, 1862 and 1882, respectively.

Until 1946, forage legumes and lucerne acreages remained fairly constant. Lucerne reached about 1.2 million ha, red clover 500 000 ha and sainfoin 600 000 ha, accounting for a total of 2.3 million ha (Figure 11). This large area of forage legumes grown for haymaking already existed in the previous century. Forage legumes played a key role in the sustainability of the farming systems, both as a source of quality, protein-rich hay and as a source of nitrogen, either through their nitrogen residues when ploughed or through manure.

After the Second World War, the entire agricultural industry was mobilised to strengthen food production that was dramatically lacking in Europe. Lucerne as a source of forage increased to support animal production, and especially milk production. The maximum acreage was achieved in 1961.

Immediately after this peak, a sudden decline began, explained by the profound changes France experienced from quick industry expansion and the subsequent labour requirement. Because agriculture and rural areas were the main sources of potential labour, an 'exodus' of workers led to strong reductions in most high-labour activities, such as haymaking. It was at this time that the dehydration industry took off: this was industry's answer to labour constraints. The development of this industry was supported by a special CAP programme for dried forages. In France, Spain and Italy, it was mainly used for lucerne dehydration, while in northern Europe, this was mainly dedicated to grass dehydration (Figure 12).

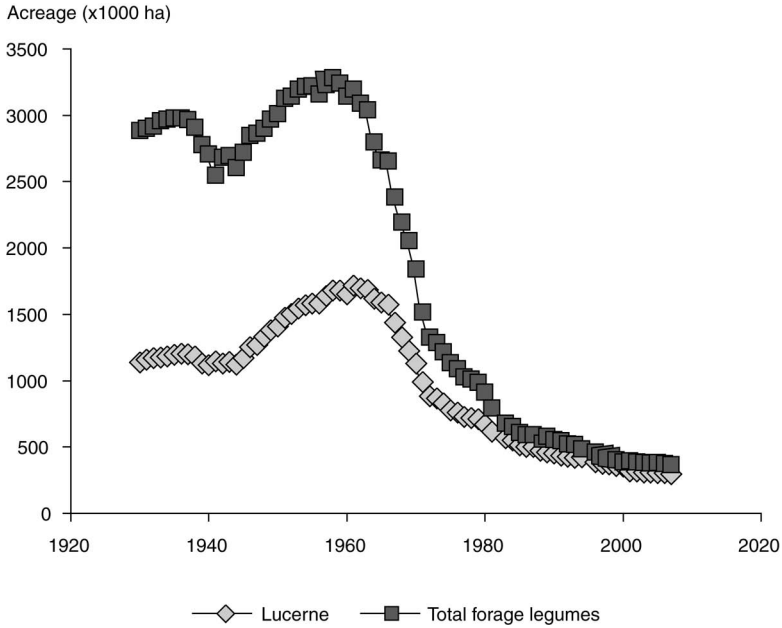

Figure 11. Changes in the acreage of lucerne and forage legumes in France since 1930.

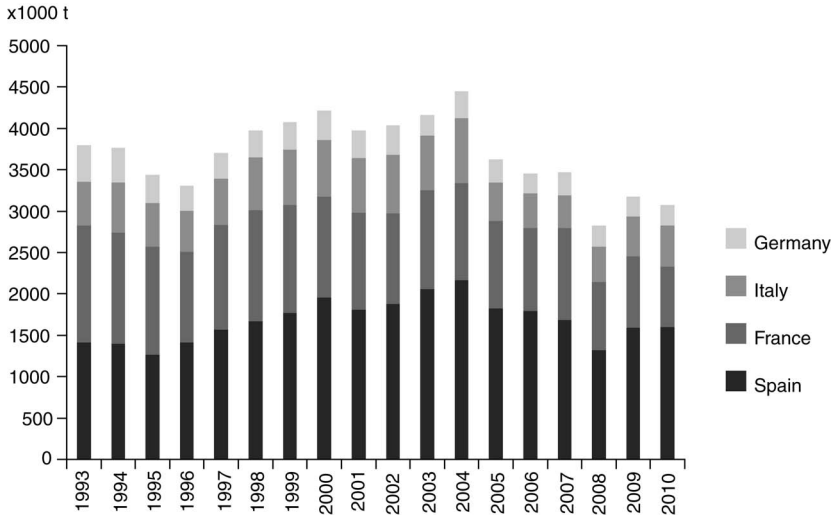

Figure 12. Variation in production of dehydrated forages in four European countries.

The use of nitrogen fertilisers also became widespread at this time. Farmers began to understand that N-fertilisers were much easier to use as a source of nitrogen than legumes; their effect was immediate. Additionally, the cost of these fertilisers was low despite the high quantity of fossil energy they require for their synthesis.

Farmers used them more and more and excessive fertiliser use was not rare. After the first oil crisis in 1973, the use of N fertilisers was improved and farm advisers insisted on a sustainable use of all nitrogen sources, including organic manures and legumes.

The rate of legume decline slowed after 1973 and occurred both in regions specialised in dehydration and where lucerne was used on farms as hay (Voisin *et al.*, 2013). There are three reasons for this:

– In dehydration areas, economic competition with cereals was very strong. Because of differences in economic returns between cereals and lucerne harvested as forage, farmers tended to increase the proportion of cereals, forgetting the benefits of lucerne for crop rotations. Forage dehydration in Europe benefits from special economic support measures that have been modified over the last few decades. However, environmental conditions, especially the ability to achieve pre-drying at the field scale to save energy for drying, result in differential dynamics among European countries, with a significant increase in Spain (Figure 12).

– Where forage legumes are harvested as hay, these are used as a source of digestible fibres and, above all, protein. However, one peculiarity of forage crops is that they can be substituted by concentrates and cereals. Lucerne was replaced by soybean meal, which is mainly used in milk production since milk yield per cow, goat or ewe steadily increased with its use.

– The mid-1970s were marked by a strong development of forage silage. Early machines had a limited power and the capability of fine chopping was reduced. There was no practice of pre-drying. In these conditions, maize was well adapted because of its high grain proportion. Most perennial forage grasses were satisfactorily adapted because of their high sugar content, but lucerne was not. Indeed, the absence of sugar (a water-soluble carbohydrate) leads to poor acidification after ensiling and thus poor forage conservation and forage quality.

Lucerne acreage was influenced by various forces, biomass production, consumption, labour requirements and the availability of other feeds. As we will see later in the book, some forces are still a factor in production today.

The reduction in the lucerne acreage does not occur similarly in all areas. A more detailed analysis is available in the French case study by Schott *et al.* (2008), with a special focus on the Seine basin (Figure 13, Plate 6). This Figure shows that the smaller lucerne acreage led to its production being concentrated to a small area where the acreage exceeds 5% of the total agricultural area, while it disappeared from the rest of the basin. This raises a major question regarding the agronomic and environmental benefits that could be generated by the presence of lucerne in these production systems mainly targeting grain production.

Changes in acreage of annual forage crops

Over the last decades, annual forage crops have experienced considerable expansion in Europe. The main annual forage crops are green maize and annual ryegrass. The increase is due to the conjunction of three main trends.

A strong demand for production of feed stocks and non-feed use

The first trend is a strong demand for annual forage crops because large amounts of biomass can be produced from them over short periods of time and in much simpler production systems than with perennial crops. This increasing demand was first due to the sharp rise in livestock numbers and in animal performances requiring high quality feed with a very high voluntary intake. This is obvious when considering that milk production per cow has shown a steady increase in most European countries. Farmers who have large dairy herds with high yielding cows want to reduce uncertainty. They would prefer to have consistent availability of large feed stocks with high quality. Secondly, demand has increased due to the possibility of using some annual forage crops for biogas production. This is especially true in northern Germany where production of biogas for heating and producing electricity is highly supported. As a consequence of this type of policy, German acreages of annual forage crops have increased considerably in recent years. In 2012, green maize reached 2.57 million ha, with 0.9 million ha being devoted to the biogas production (http://www.biogas.org/edcom/webfvb.nsf/id/DE_PM-20-12).

Annual forage crops and availability of protein feed to supplement diets

For feeding high yielding animals, silage from both maize and annual Italian ryegrass (*Lolium multiflorum*) has high energy content, making these very convenient feed sources for animals requiring high-energy diets. Moreover, both plant species are high in water-soluble carbohydrates, which makes it possible to easily produce silage with good conservation properties (very quick drop of pH value) when the dry matter content of the initial plant material exceeds 30%. For maize, this means that the varieties must have a phenology that fits well with the environmental conditions of the cultivation site. For annual Italian ryegrass, a short period of wilting before ensiling may be necessary.

However, both species also have a low protein content, especially for green maize, a C4 species with a high grain content. This low protein content is a limiting factor for feeding animals, but it may be easily corrected through the use of concentrates with high protein content. This is the case with soybean, rapeseed or sunflower cakes. Furthermore, these cakes, obtained after oil extraction, have low protein solubility, making them very suitable for ruminant feed. This does, however, make the European animal production systems more dependent on imports of protein-rich feedstuffs.

Breeding of varieties with high agronomic value

Major variety improvements in breeding have been achieved to boost the agronomic values of annual fodder species, especially with a view making them adaptable to a range of diverse geographic conditions and their high agronomic performances under this range of conditions.

This is especially the case with green maize and the development of hybrids adapted to the wet and cool environments of western and northern Europe. Maize was first

introduced in Europe in the 16th and 17th centuries and was mainly used in the southern regions of Europe, such as Po Valley in Italy and south-western France, where local adapted landraces were selected.

When production of double and F1 hybrids started in the late 1950s, pure lines were selected from the local landraces and hybrids with high agronomic performance were selected and registered. These techniques, along with using exotic flint germplasm from North America, made it possible to breed for varieties adapted to a short growing period in cool environments. Maize could then be grown in western and northern Europe, where it is now well established and where high biomass production potential is reported.

In 2010, green maize acreage totalled 4.7 million ha in Europe, with Germany and France as the main producing countries (Figure 14, Plate 7).

►► Biomass productivity from permanent and temporary grasslands

Data on actual grassland productivity and its spatial distribution are scarce. Grassland productivity is affected by botanical composition, soil characteristics, climatic conditions (particularly total and seasonal distribution of rainfall and temperature), altitude and latitude and depends on specific management (Peeters and Kopec, 1996; Pfimlin *et al.*, 2005; De Vlieghe and Carlier, 2007).

Europe has various types of grasslands, ranging from desert types in south-eastern Spain to steppic and mesic types, as well as humid grasslands/meadows, which dominate in northern and north-western Europe.

Smit *et al.* (2008) presented spatial data of grassland productivity across regions in Europe, based on an extended set of regional, national and international statistics for Europe over a ten-year period (1995–2004) (Figure 15, Plate 7). The study focused on the productivity of permanent grassland used for both grazing (pastures) and cutting (meadows). This study was one of the first attempts to synthesise grasslands yields at the European scale, but it provided only a partial view on grassland productivity since it is based exclusively on yields recorded in statistics. For instance, in Belgium, only production harvested for conservation was taken into account. All the biomass grazed by animals (the majority of the production) was not included in the so-called ‘grassland productivity’ of Smit *et al.* (2008).

According to this study, the highest level of productivity is achieved in the Netherlands, Flanders, western France, north-western Spain, Ireland, Wales and England, northern Germany and south-western Norway. *Lolium perenne* and *Poa* species are the dominant grass species in these areas. In conditions of good moisture supply and without severe winters, perennial ryegrass is a very competitive and flexible species with a high yield and feeding value and is well adapted to grazing, provided that it receives fertiliser inputs and is well managed. This species was the first grass species on which breeding efforts were concentrated. Breeding was carried out in breeding stations located where perennial ryegrass is the predominant species. The aim was

to produce varieties with greater winter hardiness and better performance under dry conditions. This breeding effort was then expanded to a wide range of grass species.

Productivity is lowest in the Mediterranean zone (mainly 35°N–44°N latitude), which is characterised by generally mild and wet winters and long-lasting summer droughts. Grassland is subject to severe moisture stress and irrigation results in much higher yields. Growth is largely confined to the winter rainy season (October–April). Mediterranean grasslands are characterised by high plant species diversity consisting of grass species, annual plants and herbs. In more mountainous areas, (e.g., Spain, the Balkans and northern Greece), grass yield is slightly higher.

The northern Scandinavia and Iceland region, with its tundra vegetation, is another area with low yield potential. Timothy (*Phleum pratense*) and meadow fescue (*Festuca pratensis*) are the major species sown in Finland, Sweden, Norway and the Baltic countries.

In central Europe, the dominant grass species are oat grass (*Arrhenatherum elatius*), cocksfoot (*Dactylis glomerata*), meadow fescue (*Festuca pratensis*), red fescue (*F. rubra*), timothy (*Phleum pratense*) and meadow grass (*Poa pratensis*).

A coordinated experiment organised by A.J. Corrall under the auspices of the FAO Lowland Grassland Sub-network measured the production and productivity of cutting grasslands according to a standardised protocol at 32 European sites (Corrall and Fenlon, 1978). The results have been synthesised by Peeters and Kopec (1996). This experiment showed the potential of production of grasslands all over Europe.

Lee (1983) gathered considerable production data about most European countries. He compared the yields obtained in agriculture with those recorded in research stations using highest average fertilisation rates. He mapped out the European production potential by using these data as well as the climate, soil and topographic parameters related to the relevant zones.

Hume and Corrall (1986) attempted to create this type of map by using the data of a meteorological network and a grass growth model. This model was able to take into consideration water stress.

Jones and Carter (1992) also drew up a map of annual rainfed herbage yields. They used a grass growth model for grazed grasslands, based on radiation and temperature. The effect of soil moisture deficit in depressing potential dry matter yields was calculated. They assumed a change in sward status from reproductive to vegetative simultaneously across all of Europe.

A synthesis of all this information has been made (Peeters and Kopec, 1996). The results are presented in Figure 16 (Plate 8).

As expected, major differences in the annual productions are recorded between sites. The highest yield for ryegrass reaches almost 20 t DM/ha in Germany (Kiel) whereas the lowest yield is only 2 t in Portugal. The most productive sites (i.e., those where production exceeds 15 t DM/ha) are situated in north-western France, Belgium, the Netherlands, northern Germany, Ireland and the United Kingdom. All these stations are located on the Atlantic side of Europe between 52° and 57° of latitude. The less productive sites are situated at high or low latitudes of Europe. At high latitudes, as in Iceland, production is obviously limited by low temperatures and low

levels of photosynthetically active radiation. At low latitudes, as in Portugal, water stress limits production during summer. The average annual production recorded for this four-week cutting regime was rather high, varying between years from 10 to 14 t DM/ha, all sites included. The maximum production recorded after four weeks of regrowth reached 8.4 t DM/ha, but this value was exceptional. However production records of 4 t to 5 t DM/ha have been noted in many sites after four weeks of growth. A production of 4 t DM/ha can be considered as an average value during the period of maximum productivity.

Among legumes, the highest biomass productivity of pure stands was obtained from lucerne and sainfoin in alkaline or neutral soils, while red clover yields high biomass in acidic soils. Mean dry matter yields of 13 t DM/ha/year are reported by the dehydration industry in France, with a slightly increasing trend (Figure 17).

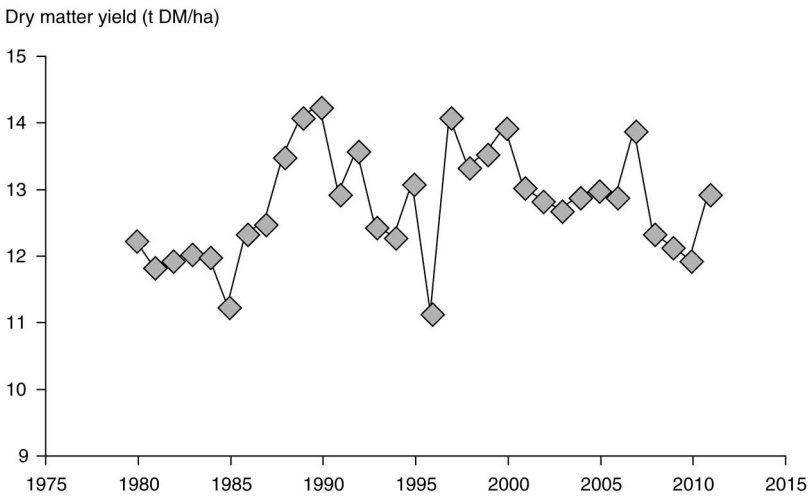

Figure 17. Dry matter yield of lucerne in Champagne-Ardennes region (France) over the last three decades.

Source: Draaf.

In the Baltic countries and in Scandinavia, other forage legumes were successfully tested for biomass production as pure stands. This is especially true for *Galega orientalis*.

Importance and changes in grazing animal production operations in Europe and their spatial distribution

► Herbivore herds in Europe

Livestock numbers

There were about 134 million LU of total livestock (grazing livestock + monogastric animals) and 78 million LU of grazing livestock in the EU-27 in 2007 (Table 24). The vast majority is located in the EU-15. The largest numbers of grazing livestock are found in France, the United Kingdom and Germany (15, 11 and 10 million LU, respectively). France, Germany, Spain, the United Kingdom, Poland and Italy include 67%, 68% and 66% of total livestock, total grazing livestock and total monogastric animals, respectively (in LU), of the EU-27 (Table 25).

Composition of the livestock population

The total EU-27 livestock (in LU) in 2007 accounted for 59% of grazing livestock and 41% of monogastric animals (Table 24). Of the grazing livestock population (in LU) in the EU-27, 82% are cattle and 14% are small ruminants (sheep and goats), horses making up the remaining 4%. Dairy cows account for 31% and other cows (mainly suckling cows) for 16% of total LU of grazing livestock. Two-thirds of cows are dairy cows and one-third other cows. Dairy cows represent 50% or more of grazing livestock in Lithuania, Latvia, Poland, Estonia and the Netherlands. Suckling cows account for a large proportion (> 20% of the grazing livestock units) in EU-15 countries: Portugal, Belgium, France, Spain, Luxembourg and Ireland. Belgium, France, Luxembourg, Greece, Ireland, Portugal and the United Kingdom have balanced populations of dairy and suckling cows. In all other countries, dairy cows are more numerous (sometimes much more so) than suckling cows (especially in all former communist countries). In Spain, the opposite situation prevails. Sheep and goats represent 20% or more of grazing livestock (in LU) in Greece, Cyprus, Spain, the United Kingdom, Portugal and Bulgaria.

Table 24. Proportion of different categories of LU in total livestock or grazing livestock units (%).

	Total grazing livestock	Total cattle	Dairy cows	Other cows	> 2 years cattle	Sheep + goats
	(% Total livestock)	(% Grazing livestock)				
Austria	60	93	35	18	9	2
Belgium	51	98	27	28	16	1
Bulgaria	63	63	45	2	4	20
Cyprus	39	44	24	3	2	54
Czech Republic	52	96	39	14	10	1
Denmark	26	95	46	9	8	1
Estonia	67	94	51	4	9	4
Finland	60	95	43	6	6	1
France	67	92	25	28	16	6
GD Luxembourg	88	97	28	23	16	0
Germany	54	93	42	8	10	1
Greece	78	25	8	9	2	73
Hungary	29	75	38	8	6	17
Ireland	91	89	20	21	21	10
Italy	56	84	34	11	11	13
Latvia	66	94	57	3	5	2
Lithuania	65	93	59	2	6	0
Malta	34	86	48	0	7	7
Netherlands	46	91	50	3	4	5
Poland	43	94	57	1	6	0
Portugal	62	75	22	29	7	21
Romania	65	57	41	1	5	19
Slovakia	55	90	43	9	10	8
Slovenia	66	91	34	14	7	4
Spain	45	64	15	26	11	32
Sweden	69	89	30	15	10	2
United Kingdom	79	66	18	15	11	30
Norway	71	71	28	7	5	25
EU-12-NMS	51	80	48	3	6	9
EU-15	60	82	27	18	12	15
EU-27	59	82	31	16	11	14

Source: Eurostat 2010 (Farm Structure Survey 2007) and authors' own calculations.

Stocking rates

It is important to consider the stocking rates as they are related to the management of the animal production system and especially the feeding system. Indeed, for a similar potential of biomass production, the stocking rates tend to be lower where grazing makes up a major share of the diets. Thus, a large difference between the livestock pressure per ha of fodder crops and per ha of grassland indicates the importance of forage crops in that country.

The average stocking rates (LU/ha) in the EU-27 in 2007 were about 0.8 for the total livestock per ha UAA, 0.45 for the grazing livestock per ha UAA, about 1.0 for the grazing livestock per ha of the total fodder area and about 1.4 for the grazing livestock per ha of the permanent grassland area. Average differences between EU-15 and EU-12-NMS are considerable, especially for the grazing livestock per ha UAA or per ha of permanent grassland. The highest stocking densities are found for the total livestock per ha UAA in the Netherlands (3.35), Belgium (2.76), Denmark (1.7) and Ireland (1.4); for the grazing livestock population per ha UAA in the Netherlands (1.5), Belgium (1.4) and Ireland (1.3); for the grazing livestock population per ha total fodder area (grasslands and fodder crops) in Belgium (2.5), the Netherlands (2.4), Bulgaria (2.3) and Greece (1.9). Certain countries (Cyprus, Denmark, Finland) with a small proportion of permanent grassland in the UAA present high stocking rates of grazing livestock per ha of permanent grasslands. When those countries are excluded, Belgium and the Netherlands exhibit the highest stocking rates for this ratio, at 3.75 and 3.56, respectively.

However, in large countries where there are diverse soil and climate conditions, the average stocking rate varies widely, from very intense to very extensive farming practices with corresponding stocking rates.

►► Animal production

The principal aim of most European grassland systems is to support animal production for milk and/or meat. Animal products provide about a quarter of the energy in the diets of people living in developed countries together with essential fatty acids, vitamins and minerals. In European countries, over the last few decades, calories from animal products in human diets have increased significantly, as shown by Figure 18 (Plate 8) with regard to France.

Dairy herds and milk production

In Europe, cattle make up the majority of herbivore production. Cows are either dairy cows, which are raised for milk, and suckling cows, which feed their calves in herds and are raised for meat. Dairy cows are predominant in most European countries. However, in France, the United Kingdom, Ireland and Belgium, herd sizes are similar for both types. In Spain and Portugal, there are more suckling cows than dairy cows (Figure 19).

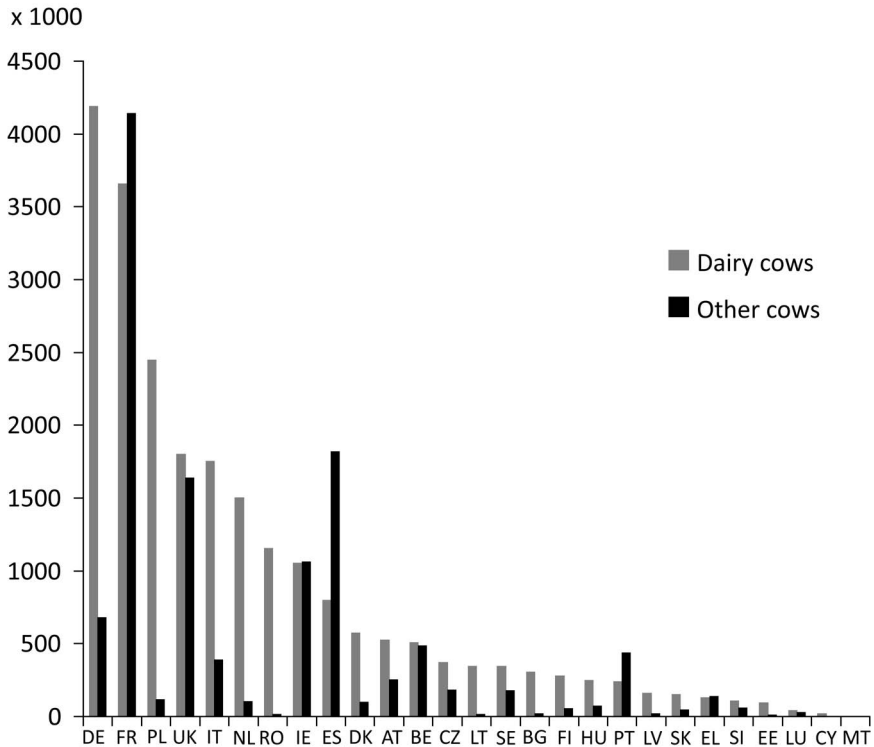

Figure 19. Number of dairy and other cows in EU-27 in 2007.

Source: Eurostat, 2008a.

The general spatial pattern of milk productivity, calculated by dividing milk production data by UAA, across Europe was similar to grassland productivity in the study of Smit *et al.* (2008). The relationship between grassland and milk productivity was $R = 0.57$ ($P < 0.001$). This means that grassland productivity plays an important role in the milk productivity in European regions.

Grazing livestock density (LU/ha fodder area or LU/ha grassland; Table 25 and Figure 20) is an indicator of the intensity of grassland use and the pressure of livestock farming on the environment. Livestock contributes to greenhouse gas and nutrient emissions into water and air through rumination, manure and urine production. A higher density means a higher amount of available manure per ha UAA, which increases the risk of N-leaching. An excessively low livestock density increases the risk of land abandonment in extensive livestock systems or the need for industrial fertilisers in arable cropping systems. Of course, farming practices also influence the impact on the environment.

Within the EU-27, the situation of the dairy sector varies from region to region with large differences of production density among regions (Figure 21, Plate 9). This difference is reflected by diversity of the production systems in terms of:

- Economic importance of countries or regions specialised in dairy production: in Estonia, dairy farming represents 33% of the value of agricultural production; this

Table 25. Overview of the grazing livestock in the EU-27 and Norway in 2007.

	Total	Cattle		Sheep, goats, equidae	Density	
	LU ⁽¹⁾ millions	LU millions	LU % total	LU millions	LU/ha total fodder area	LU/ha grassland
EU-27	132.56	63.98	58.7	13.82	1.04	1.22
Austria	2.46	1.39	60.3	0.09	0.88	0.83
Belgium	3.79	1.87	50.6	0.05	2.53	3.17
Bulgaria	0.92	0.41	60.6	0.15	1.09	1.46
Cyprus	0.25	0.04	39.0	0.05	2.24	-
Czech Rep	2.04	1.03	52.3	0.04	0.81	0.93
Denmark	4.58	1.13	25.9	0.06	1.74	2.66
Estonia	0.31	0.19	67.0	0.01	0.52	0.52
Finland	1.15	0.65	59.9	0.04	0.99	1.03
France	22.5	13.9	67.4	1.26	1.21	1.22
Germany	17.95	9.11	54.3	0.64	1.41	1.95
Greece	2.61	0.52	78.2	1.52	1.93	7.37
Hungary	2.1	0.52	32.1	0.15	0.66	0.86
Ireland	5.9	4.78	91.2	0.6	1.37	1.38
Italy	9.89	4.64	56.0	0.89	0.93	1.13
Latvia	0.46	0.29	65.8	0.01	0.33	0.42
Lithuania	0.9	0.55	63.8	0.03	0.56	0.55
Luxembourg	0.16	0.14	87.9	0	1.54	1.77
Malta	0.05	0.01	33.1	0	3.89	-
Netherlands	6.42	2.65	45.6	0.28	2.34	3.12
Poland	10.74	4.43	43.7	0.26	1.15	1.38
Portugal	1.99	0.94	62.2	0.3	0.54	0.68
Romania	4.2	1.66	69.5	1.26	0.62	0.64
Slovakia	0.71	0.36	56.5	0.04	0.53	0.69
Slovenia	0.54	0.33	65.7	0.03	1.05	1.17
Spain	14.33	4.07	44.6	2.32	0.77	0.90
Sweden	1.74	1.09	68.0	0.09	0.77	0.84
United Kingdom	13.88	7.29	78.7	3.64	0.97	0.98
Norway	1.27	0.64	70.7	0.26	1.41	1.89

¹ LU = livestock unit, is a reference unit which facilitates the aggregation of livestock from various species and age as per convention, based on the nutritional or feed requirement of each type of animal. Source: Eurostat and authors' own calculations. LU data 2007.

Figure rises to 39% in Franche-Comté (France) and in Vorarlberg (Austria), but is less than 1% in some regions.

– Production systems: for instance, the average milk quota per holding ranges between 10 and 900 tonnes, with an average yield per cow between 3 200 and 8 000 litres; the farm structure can be very different among countries. Indeed, more than 90% of farms are very small holdings (1-2 ESU) in Romania and Slovakia, while almost 90% of holdings are of family size (between 10 and 100 ESU) in France, Ireland and Sweden.

– Prices paid to producers (Stypinski *et al.*, 2009).

In 2005, half of European production was achieved in 11% of the territory (EC, 2008).

The competitiveness of the holdings depends on the dairy livestock farming system, itself determined by interactions between soil, climate, land use and agricultural structures. Yield potential of forage crops and especially grassland plays an important role in the competitiveness of the dairy sector.

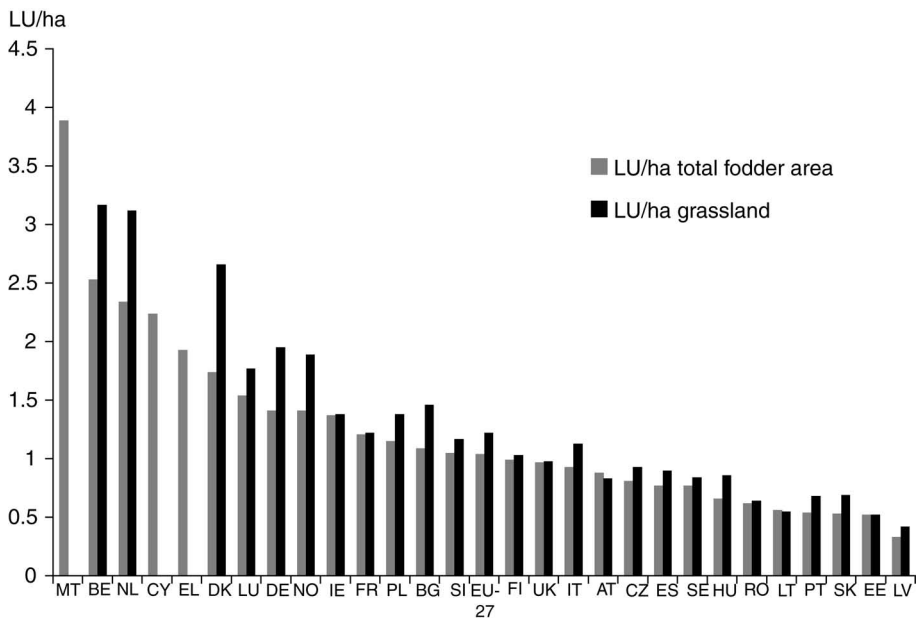

Figure 20. Grazing livestock density in the EU-27 and Norway (2007).

Source: Eurostat and authors' own calculations.

Meat production

The spatial distribution of suckling cows (the majority of 'other' cows) and the national distribution of the slaughtered carcasses in the EU-27 are indicators of the importance of meat cattle production. Suckling cows are of special importance in France, Spain, the United Kingdom and Ireland and to a smaller degree in Germany, Belgium, Italy and Portugal (Figure 19). In the other countries, they are of minor

importance in terms of meat production, but suckling grazing cows may be more significant for other reasons, such as for good nature conservation management. The spatial distribution of meat production in the EU-27 in 2009 shows the same tendency as the distribution of suckling cows (Figure 22).

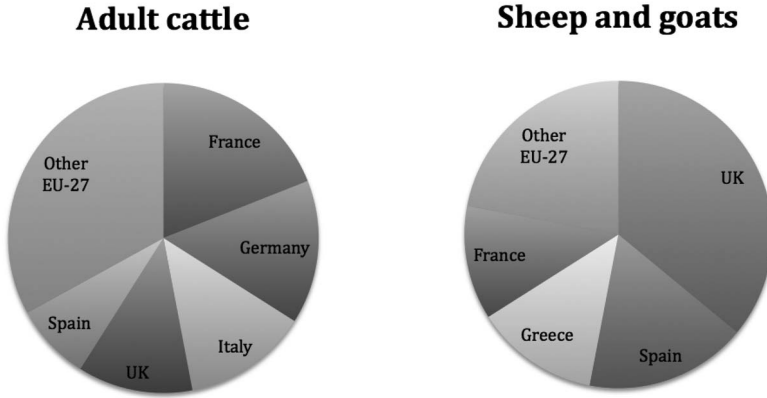

Figure 22. Meat production of adult cattle, and sheep and goats in the EU-27 in 2010.

Source: Eurostat, 2012.

Sarzaud *et al.* (2008) described the diversity of the beef farming systems and their location over the European countries and areas. Three large areas can be grouped together according to the beef production prevalence and its implication in land use:

Mediterranean, Mountainous and Scandinavian areas represent 43% of the territory and the grasslands (EU-15) and 32% of the suckling cow herds. Pastoral systems are dominant in mountain pastures with variable levels of productivity. These are the main areas of beef calving with rustic or local breeds.

Grassland areas include permanent pastures from Ireland, the British Isles and grassland plains in Benelux, Germany and the northern part of the French Massif Central where the climate is relatively humid. Some 37% of the suckler cows are found on 19% of the EU-15 territory. Beef products are based on grass with cow-calf enterprises (France) and cow-calf and steer fattening with grazing feeding on permanent pastures (Ireland and the United Kingdom). These areas are still not very intensive and beef production is often combined with sheep flocks in order to improve productivity. It should be noted that Irish and British beef farming systems are genuine grassland-based beef production, with rearing and finishing of steers and heifers 'on the farm' and with self-sufficient feeding on pastures. This management is specific to favourable grassland areas.

Agronomic soil quality allows crop production in the Forage Crop and Grasslands and Crops and Livestock areas. Herbivore feeding is based on grass and maize silage in Galicia (Spain), western part of France and Belgium. It allows dairy production as well as calving and fattening of beef. The farms are rather intensive and combine dairy activity with beef production, and especially beef fattening. In the plains, border

and crop areas, livestock production is less present and is often managed in addition to field crops. In the Po Valley (Italy), irrigated maize cultivation is the basis of bull diets in integrated fattening enterprises. In the Sachsen plains in Germany or on the border of the French plains, fattening is based on industrial crop by-products or, for some herds, obligatory pastures. Their future depends highly on the competitiveness with other types of production, including bio-energy crops.

Sheep and goats represent about 12% of the grazing livestock herd in the EU-27, with higher concentrations in the Mediterranean countries, the United Kingdom and Romania (Figure 23). The United Kingdom, Spain and Greece supply about two-thirds of the sheep and goat meat in Europe. About 59% of goats are grazed in Greece (37.2%) and Spain (21.6%).

Equines contribute to less than 5% of the grazing livestock but are more frequent in Romania, Hungary, Poland, Lithuania and Sweden (Osterburg *et al.*, 2010).

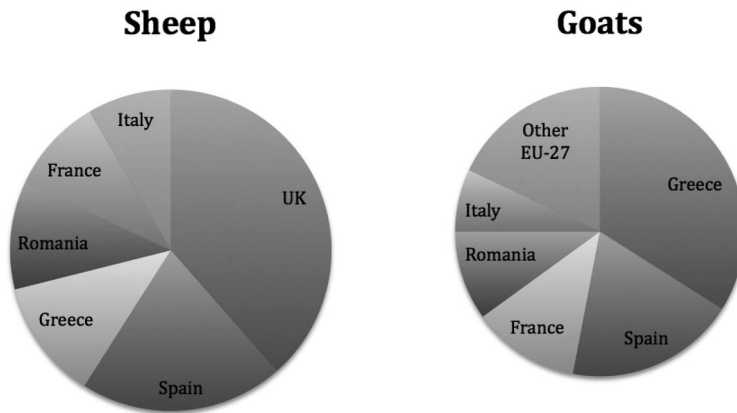

Figure 23. Sheep and goat population in EU-27.

Source: Eurostat, 2008b.

Livestock production in organic farming

Figure 24 shows livestock in organic farming in Europe is presented for the 2009-2011 period. Data more recent than 2011 are not available for most European countries. The figure shows large differences among countries and animal species.

On average, in countries where there is significant production of both sheep and cattle, the proportion of organic production is larger for sheep than for cattle. Indeed, sheep are able to make the most of grasslands produced in less intensive areas where conversion to organic farming occurred earlier. Inversely, organic production of pigs was very limited in all European countries in 2011, due to the low organic production of cereals and protein crops. Cattle have an intermediate position.

The highest proportions of organic sheep were produced in Baltic countries, Slovenia and Austria, while for cattle, the highest proportion was in Austria, where consumption of organic milk is very popular.

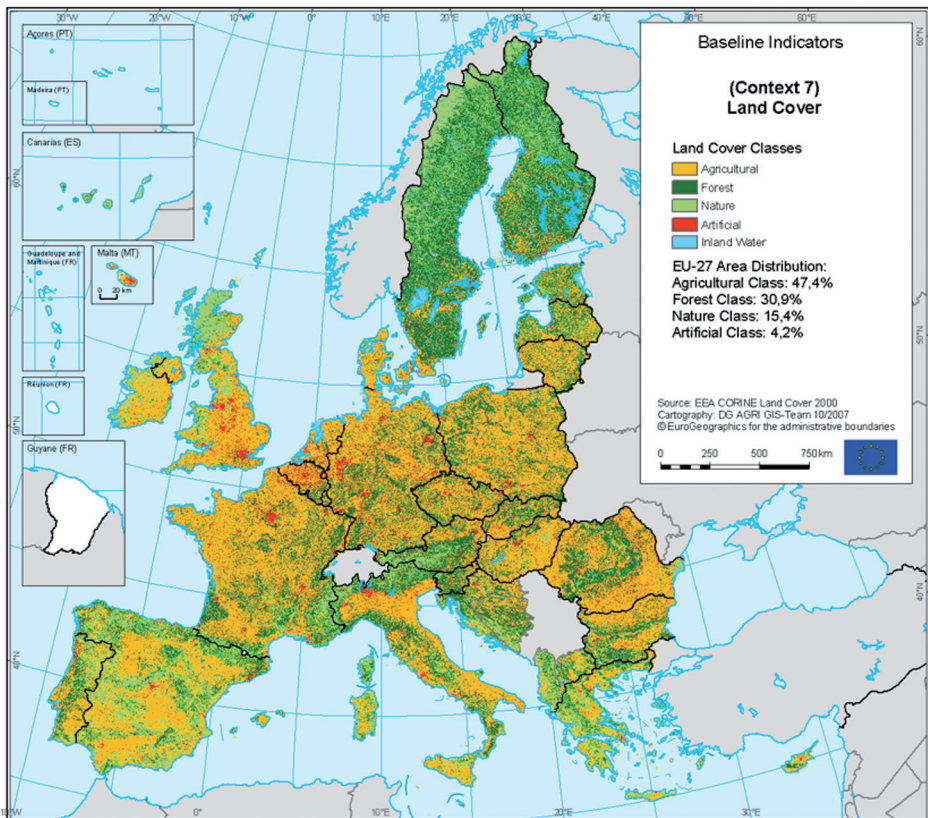
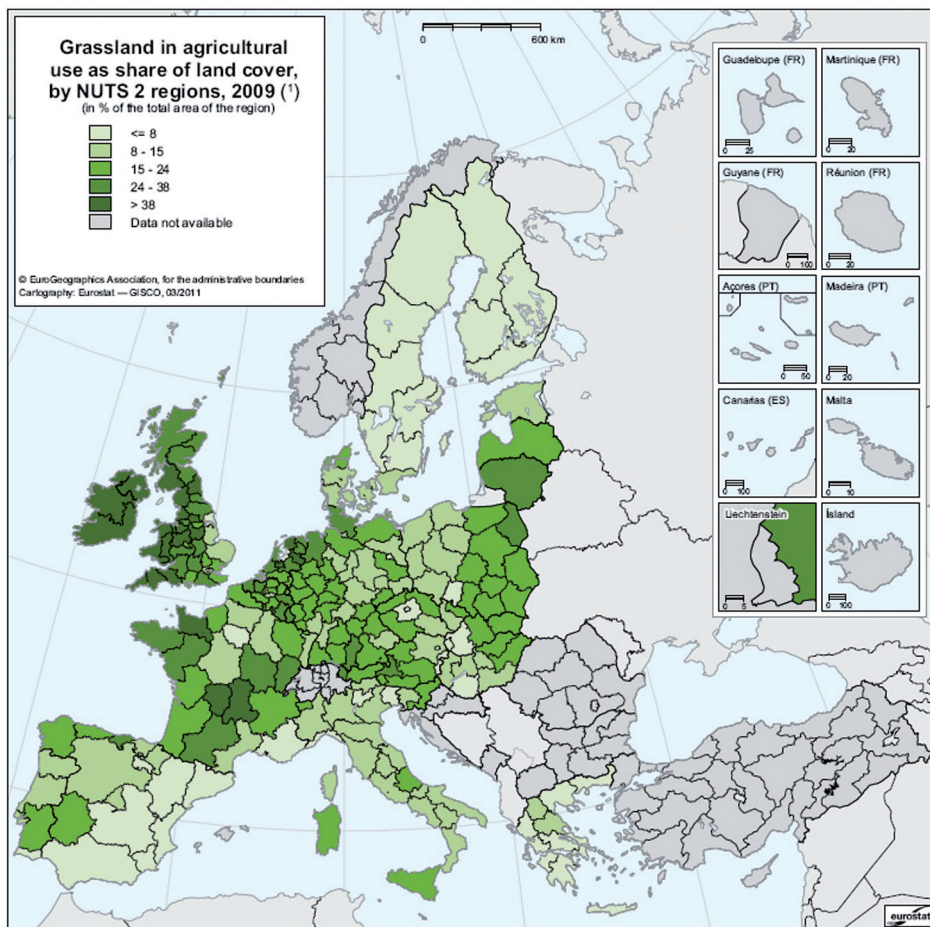

Figure 1. Land cover in EU-27 Member States.
 Source: EEA CORINE Land Cover 2000; EC, 2008b.



(*) Bulgaria, Cyprus, Malta and Romania were not included in the LUCAS 2009 survey.

Figure 2. Area under permanent grassland in EU-27 countries (1995).
Source: EC, 2008b.

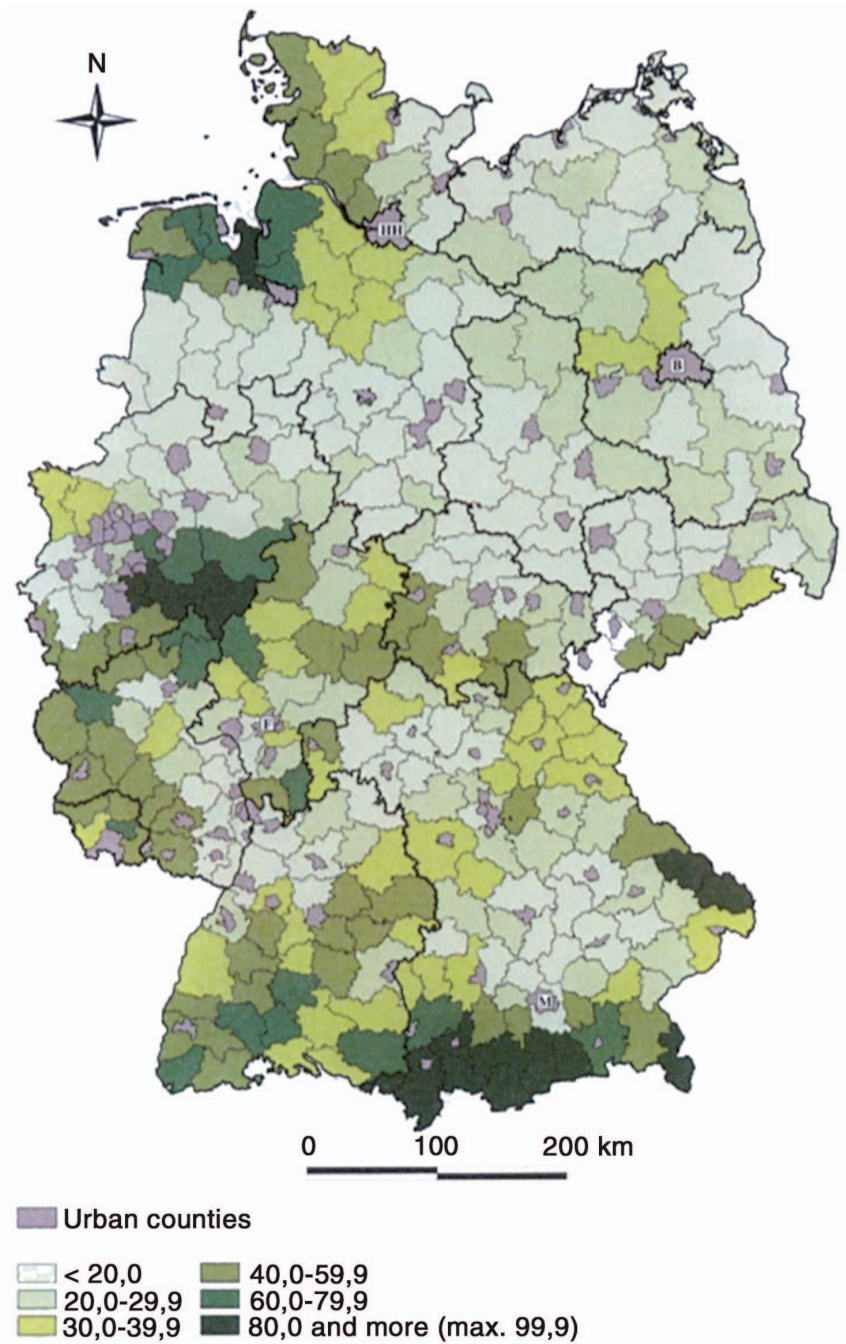

Figure 4. Spatial distribution of permanent grassland in Germany in % UAA (2007).
 Source: 23rd Meeting of the European Grassland Federation – West-Coast Tour, 31 August 2010.

Plate 4

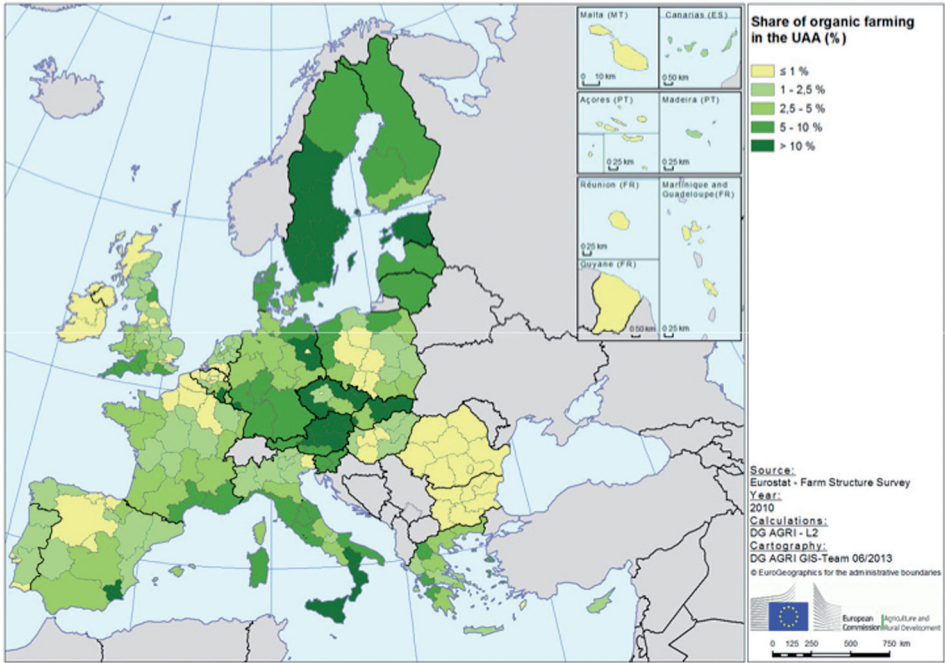

Figure 5. Share of the organic area in the total UAA in 2010 at the regional level (%).
 Source: EC, 2013.

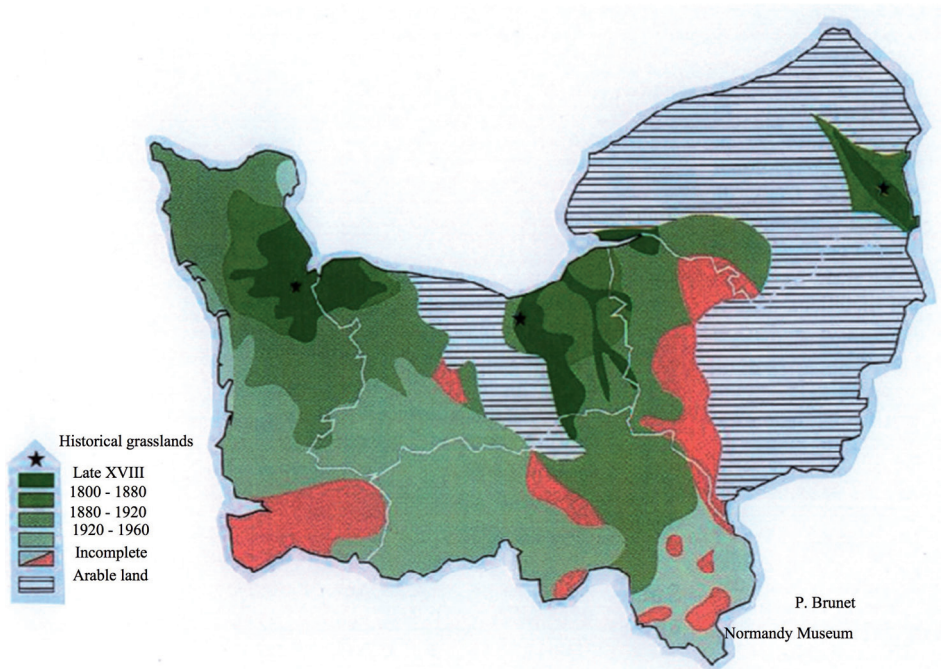

Figure 8. Grassland areas in Normandy (France) in the last two centuries.
 Source: P. Brunet, Normandy Museum.

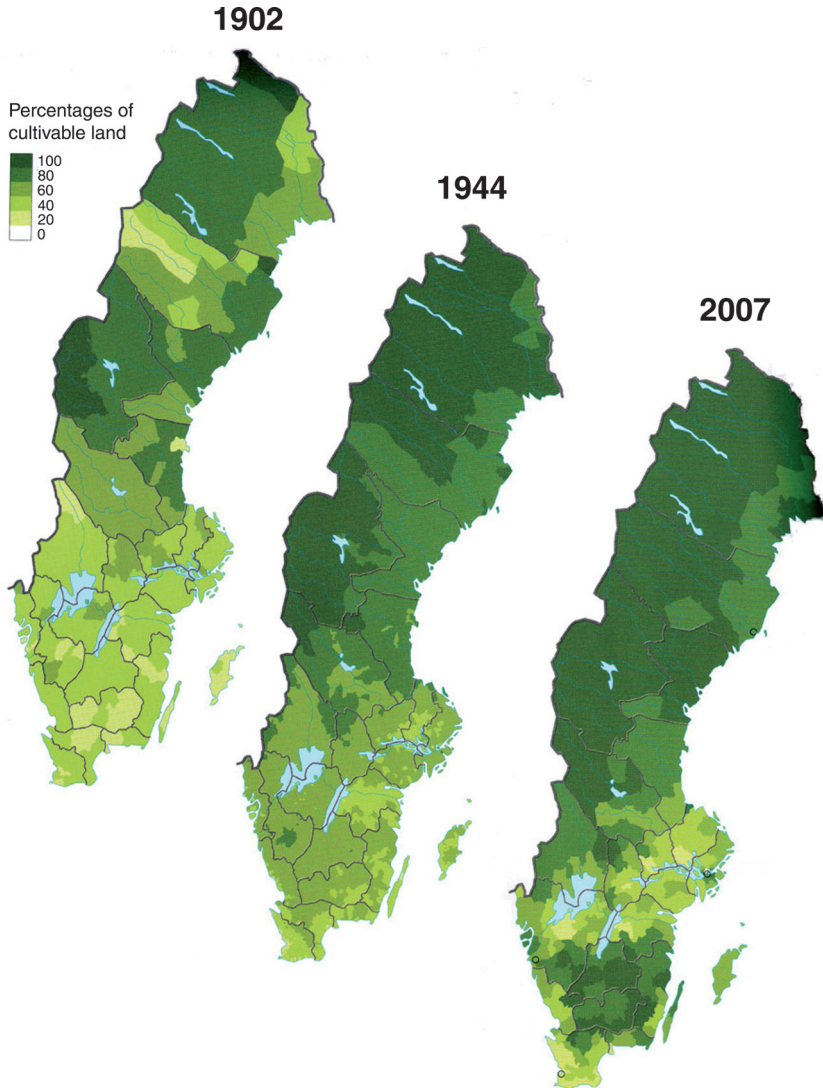

Figure 9. Distribution of ley farming in Sweden in 1902 and 2007. It indicates the percentage of cultivable land used for leys.
Adapted from Jansson, 2011.

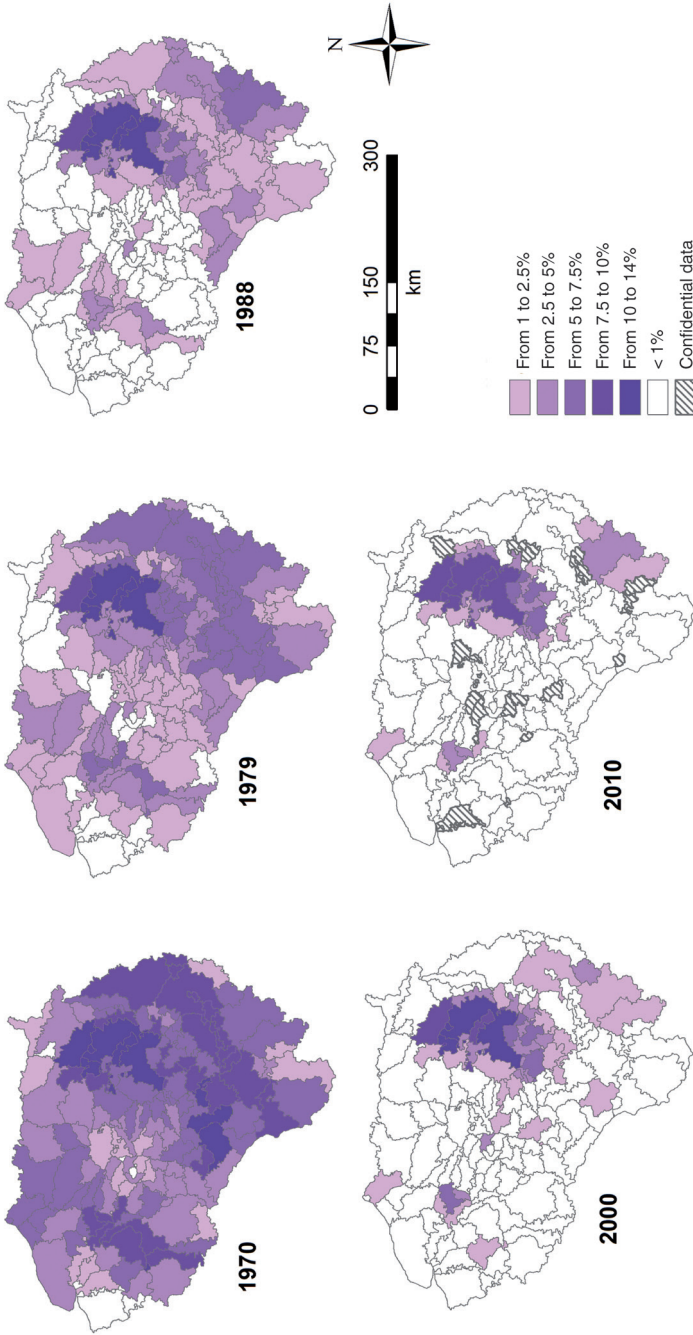

Figure 13. Lucerne production in the Seine basin from 1970 to 2010.
Source: Schott *et al.*, 2009; Mignolet *et al.*, 2012.

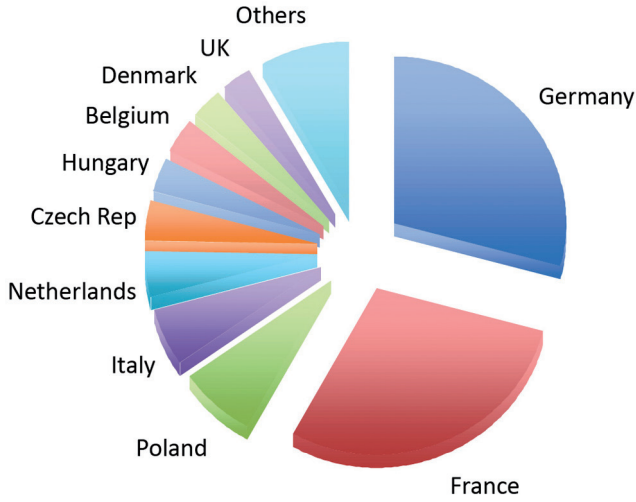

Figure 14. Acreage of green maize in various European countries in 2010. Acreage is given in millions of hectares.
Source: CEPM.

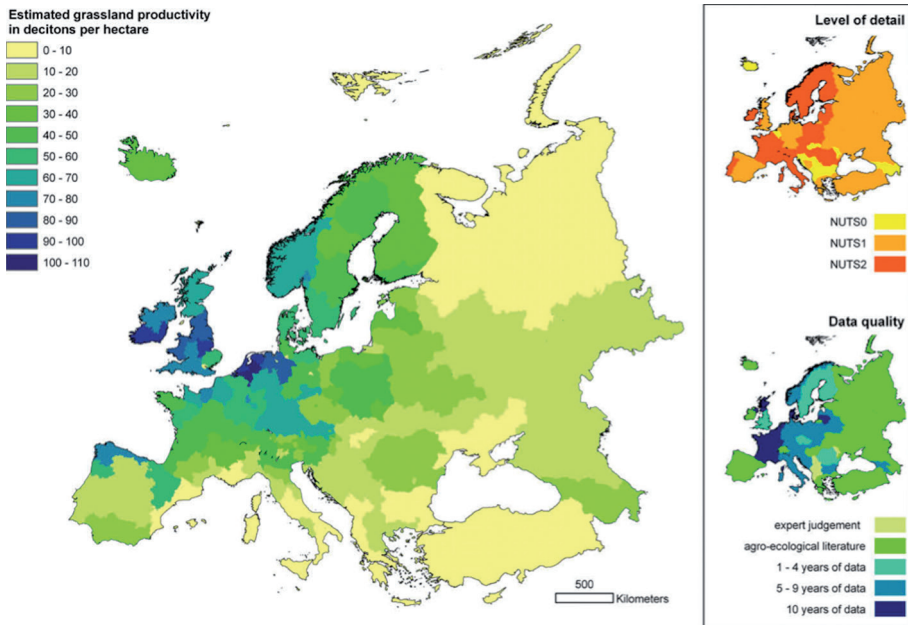

Figure 15. Spatial distribution of grassland productivity in Europe.
Adapted from Smit *et al.*, 2008.

Plate 8

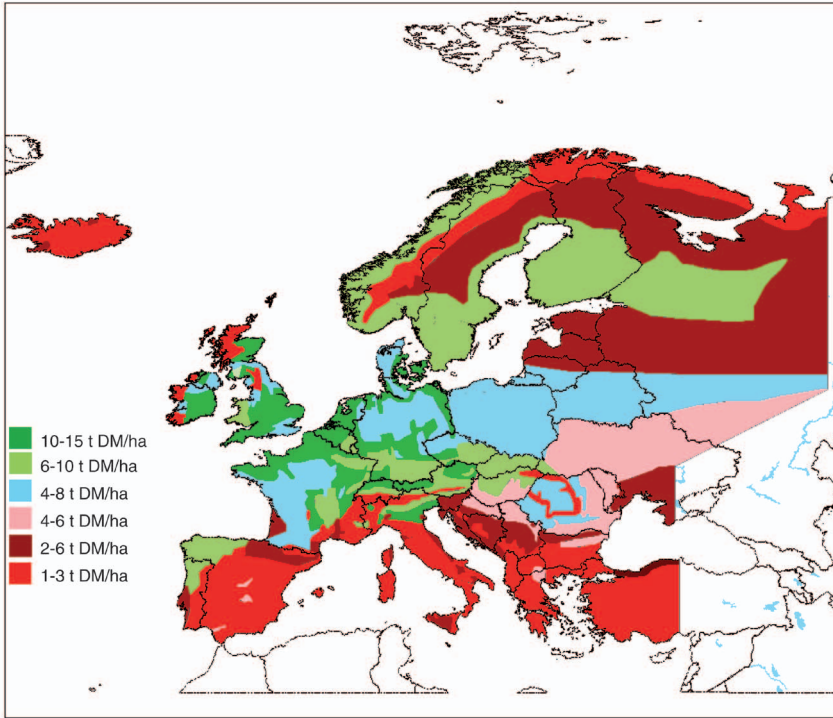

Figure 16. Production potential (annual yields in t DM/ha) of mown and heavily fertilised grasslands.

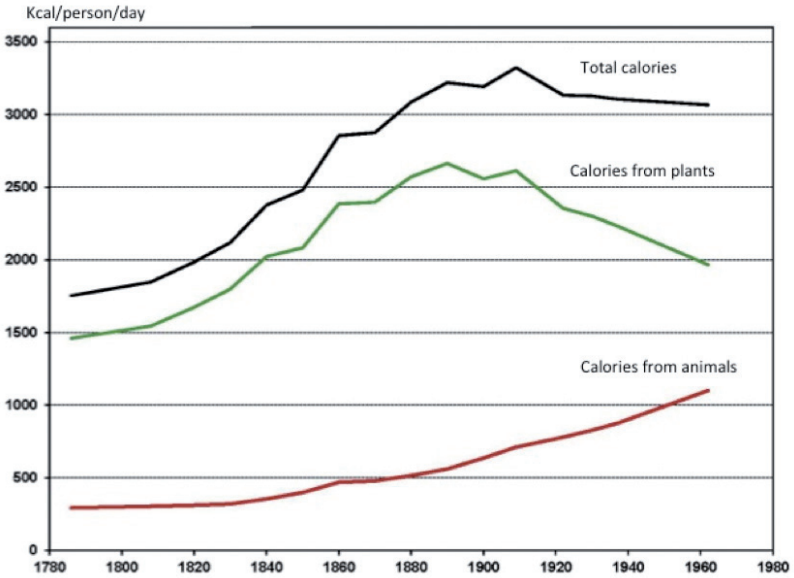

Figure 18. per capita consumption of calories from animal and plant origin in France over the last two hundred years.

Adapted from Combris and Soler, 2011.

Production of cows' milk on farms, by NUTS 2 regions, 2011 (*)
(tonnes per km²)

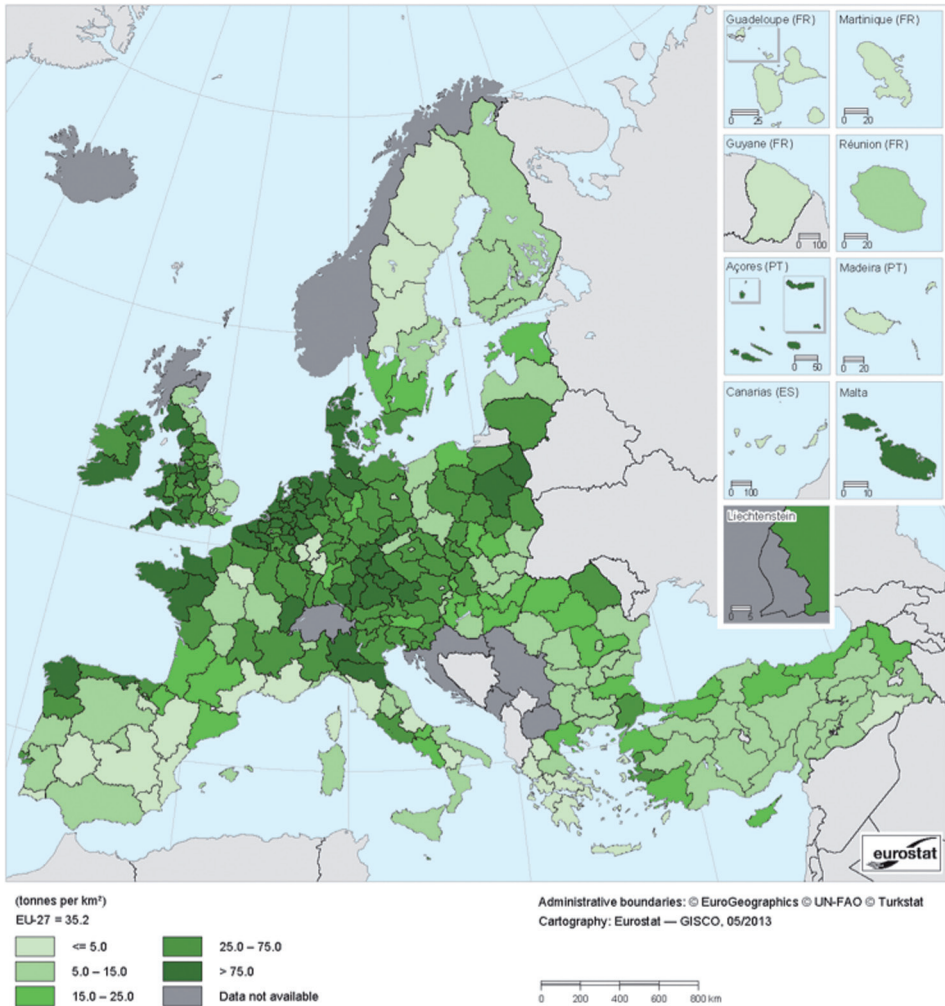

Figure 21. Milk production density in the EU-27 in 2011.

EU-27, excluding Malta; Estonia, Cyprus, Latvia, Lithuania and the United Kingdom (see exceptions), 2010; Luxembourg and Shropshire and Staffordshire (UKG2), 2009; Malta, 2008; Région de Bruxelles-Capitale/Brussels Hoofdstedelijk Gewest (BE10) and Greater Manchester (UKD3), 2006; Tees Valley and Durham (UKC1), Northumberland and Tyne and Wear (UKC2), West Midlands (UKG3), East Anglia (UKH1), Essex (UKH3), Inner London (UKI1) and Outer London (UKI2), 2005; Turkey, 2004; Spain, provisional; based on total area for those Member States for which land area is not available. Source: Eurostat (agr_r_milkpr) and (demo_r_d3area).

Plate 10

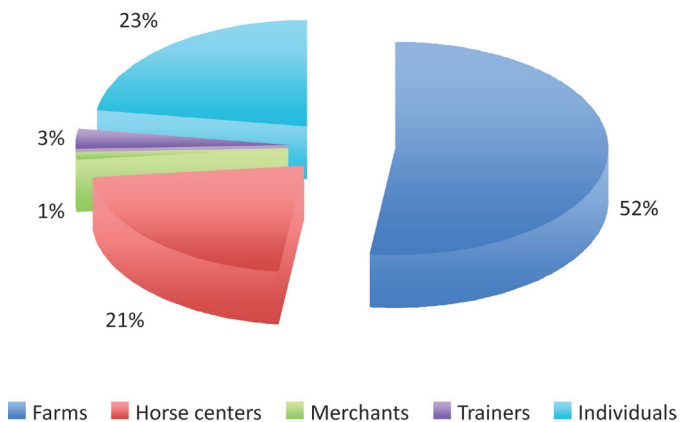

Figure 29. Site where sport horses are kept in France in 2010.
Source: IFCE-OESC.

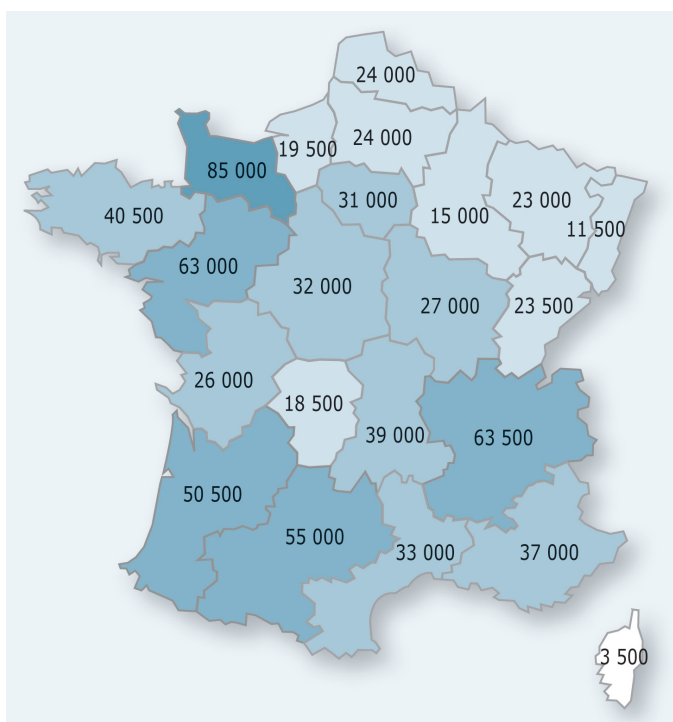

Figure 30. Distribution of the horse population (in number of heads) in the various administrative regions in France.
Source: IFCE-OESC; Observatoire économique et social du cheval de l'Institut français du cheval et de l'équitation, 2011.

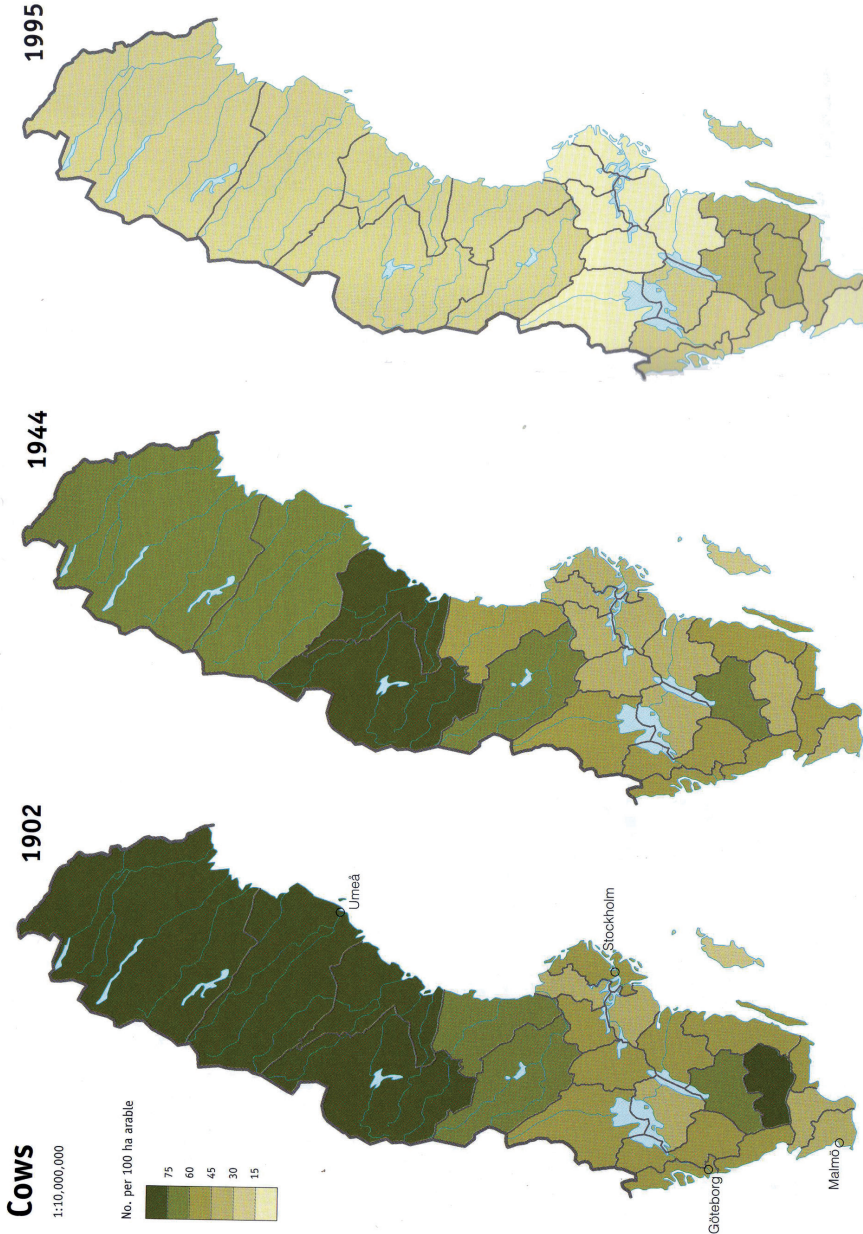

Figure 31. Distribution of the dairy cows (expressed in number of cows per 100 ha of arable land) in Sweden in 1902 and 1995. Adapted from Jansson, 2011.

Plate 12

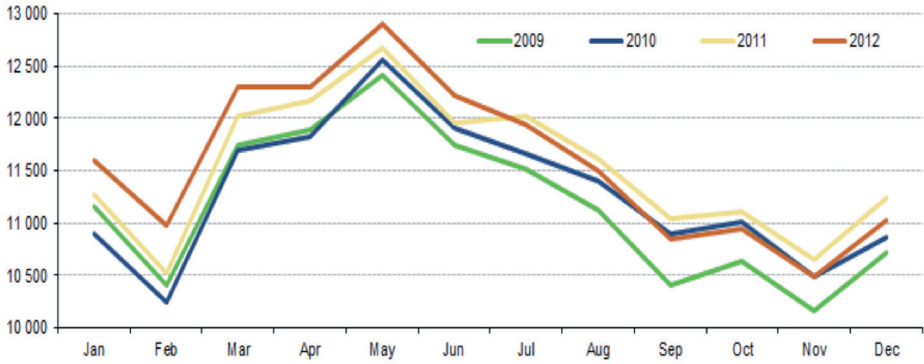

Figure 32. Changes in the monthly milk delivery of cow's milk to the dairy industry in the EU-27 over three decades (in 1 000 tonnes).

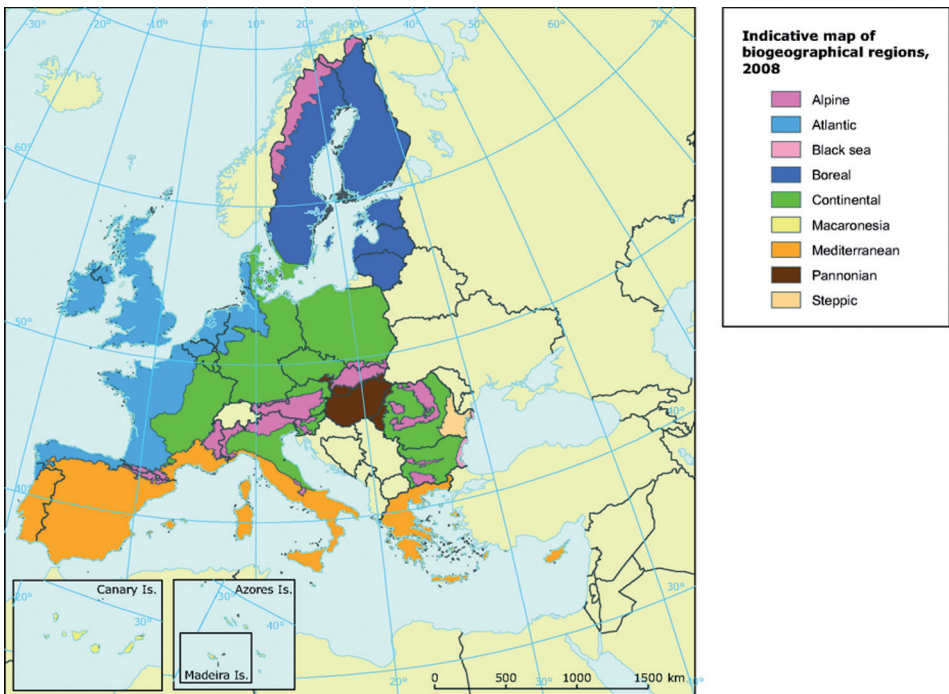

Figure 41. The biogeographical regions in Europe.

Source: EA 2009, <http://www.eea.europa.eu/data-and-maps/figures/biogeographical-regions-in-europe>.

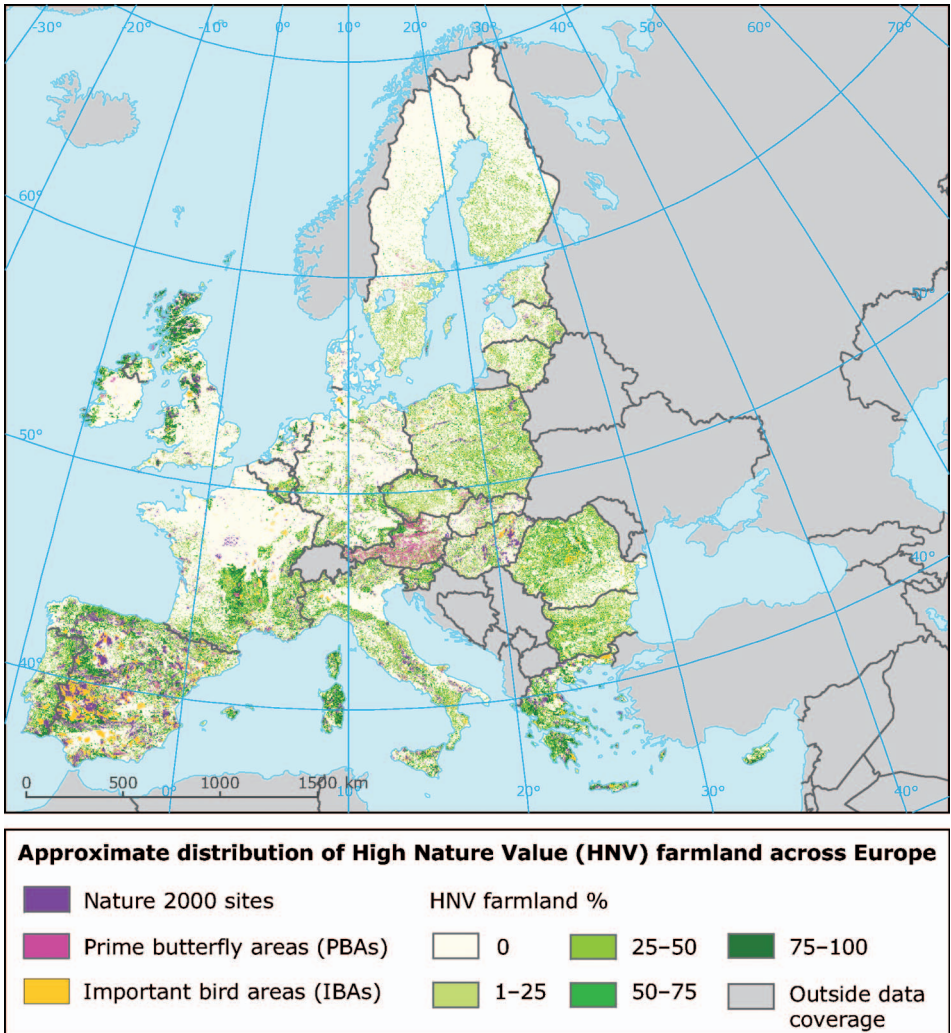

Figure 42. Approximate distribution of High Nature Value (HNV) farmland across Europe.
 Source: EEA website, 2010.

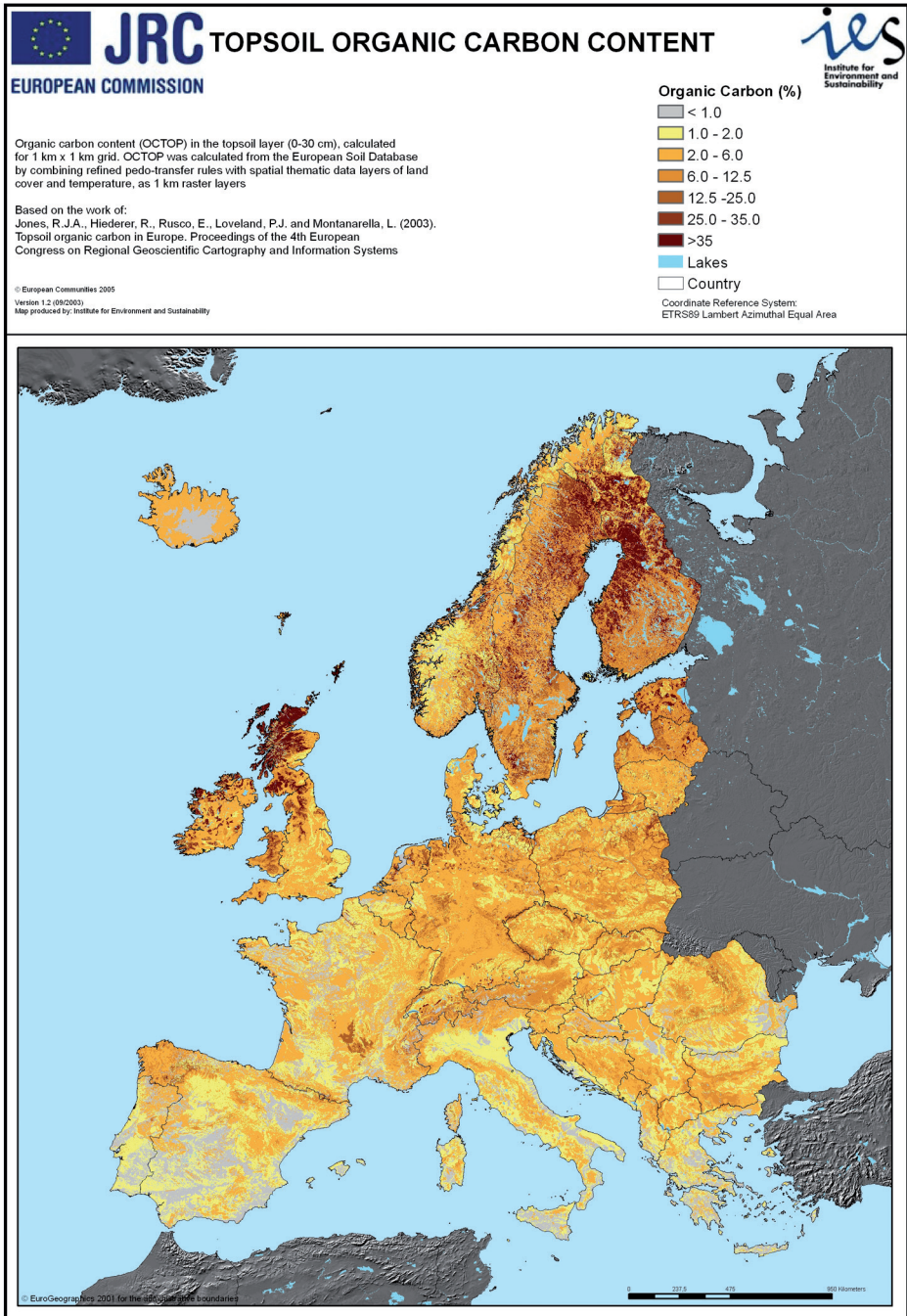

Figure 43. Organic carbon content (%) in the surface horizon of soils in Europe.
 Source: http://eussoils.jrc.ec.europa.eu/esdb_archive/octop/octop_download.html European Commission – Joint Research Centre, Institute for Environment and Sustainability. © European Union.

Pan European Soil Erosion Risk Assessment - PESERA

These data have been prepared by the PESERA Project, European Commission funded fifth framework project - contract "QLK5-CT-- 1999-01323". Further details are described in:

"Pan-European Soil Erosion Risk Assessment: The PESERA Map, Version 1 October 2003. Explanation of Special Publication Ispra 2004 No.73 (S.P.I.04.73)."
 Kirkby, M.J. et al. (2004). European Soil Bureau Research Report No.16, EUR 21176, 18pp. and 1 map in ISO B1 format.

Office for Official Publications of the European Communities, Luxembourg

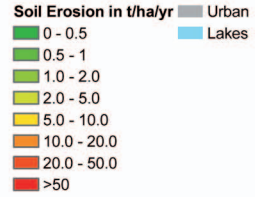

© 2005 Copyright, JRC, European Commission

Model run: PESERA103, October 2003, with Global Correction
 Map produced by: Institute for Environment and Sustainability



Coordinate Reference System:
 ETRS89 Lambert Azimutal Equal Area



Figure 44. Pan European soil erosion risk assessment. Map built with the PESERA Model.
 Source: Joint Research Centre. © European Union.

Plate 16

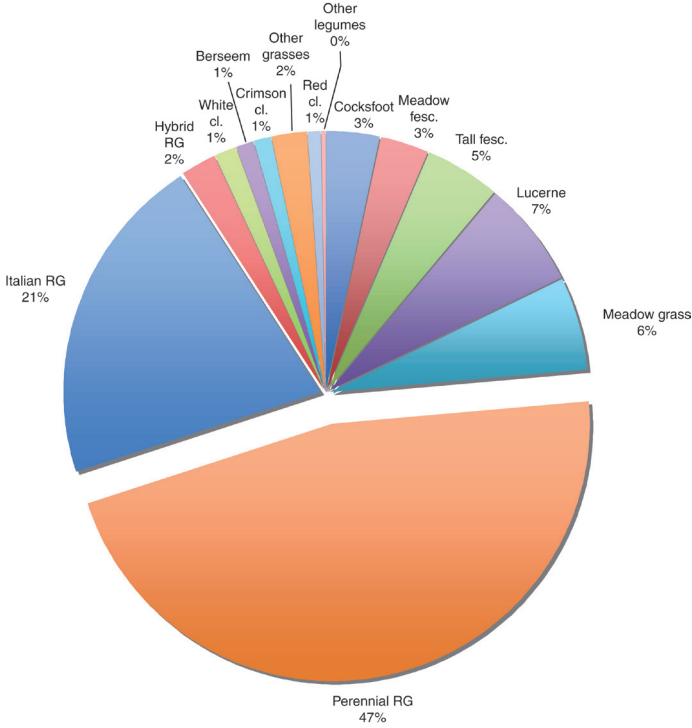

Figure 47. Share of seed production for species in EU-27 (average over the 1997–2008 period).

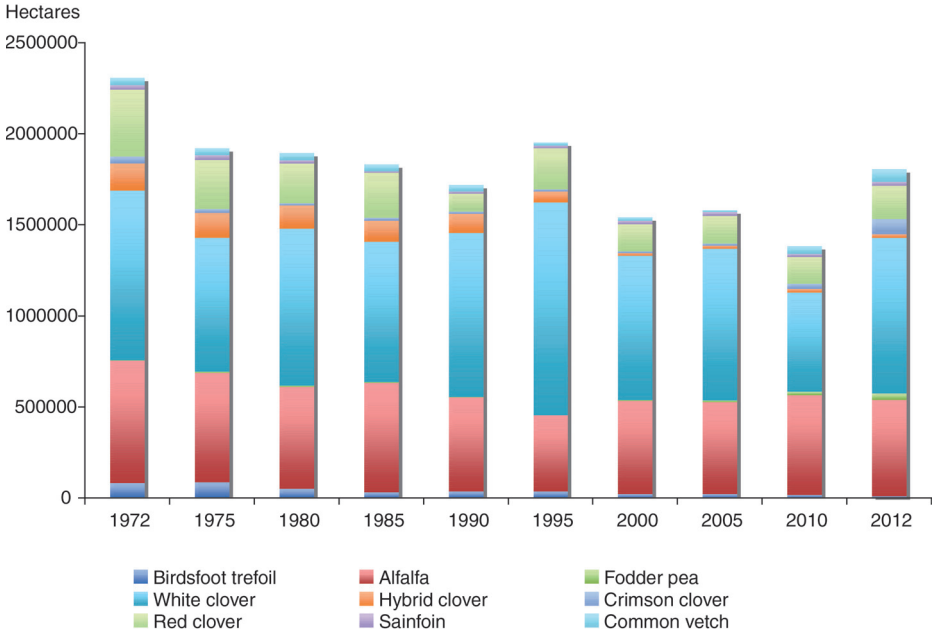

Figure 49. Estimated forage legume equivalent area in France over the last four decades.

Data from 2011 may give an incomplete view of the organic livestock production because this type of production is rising quickly. In France, dairy cows in organic farming accounted for 2.9% of production in 2011, up from just 1.6% in 2008. Similarly, organic sheep totalled 3.5% in 2011, up from 2.3% in 2008.

The trend is the same in most European countries.

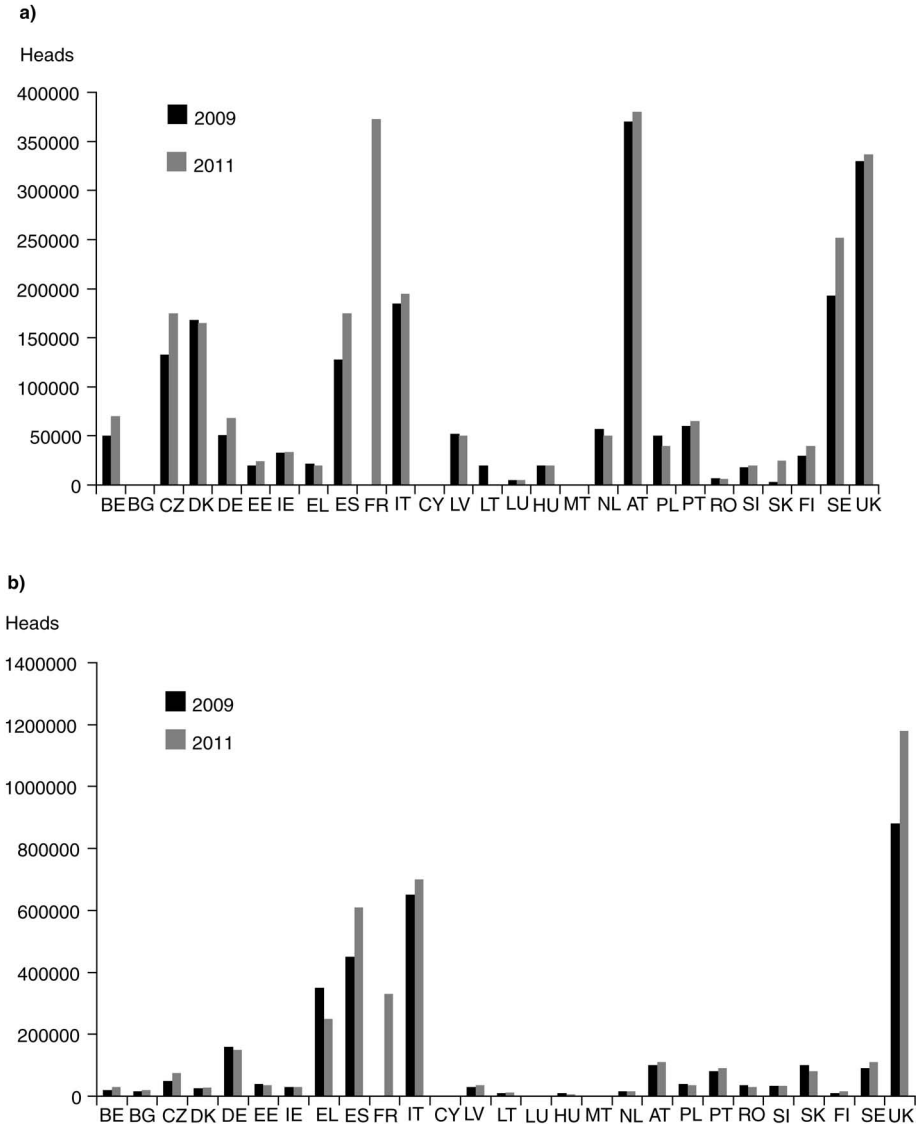

Figure 24. Number of organic cattle (a) and sheep (b) in 2009 and 2011 in the EU.

Source: Eurostat data on the basis of Council Regulation (EC) No 834/2007 on organic production (online data code: food in porg3). Data for DE from BLE study Strukturdaten im ökologischen Landbau in Deutschland 2011. Data for AT for 2011, from Grüner Bericht 2012. Estimated data for CY, IE, LT and LU (2011).

► Changes in livestock populations

Cattle

In most EU-9 countries, the dairy cow population was almost stable between 1975 and 1983 (Table 35). It started falling when milk quotas were introduced in 1984. Between 1975 and 2007, there was a drop in the EU-9 of about 10 million dairy cows (40% of 1975 dairy cow levels). During this period, the dairy cow population fell sharply (about 50%) in Belgium, Denmark, France and Luxembourg. The decline was about 30-40% in Ireland, Greece, Italy, the Netherlands (Figure 25) and the United Kingdom. Germany saw a decrease in the dairy cow population from 1985; after the reunification, the population increased in 1990, only to drop again later. This explains why the resulting decline is 'only' 24% in Germany. In Italy, the population declined a bit later, starting from 1987 and at a faster rate after 1990. Between 1987 and 2007, the population was reduced by 50% in Spain and by 30% in Portugal. The general process of decline is still happening, even in the EU-27. The rate of decline was very fast (about 2% per year or more) during the periods 1985-87, 1990-93 and 1997-2005. In the EU-15 and especially in the EU-6, the rate of decline slowed between 2005 and 2007.

The 'other cows' (mainly suckling cows) population showed an opposite trend (Table 36). The population increased by about 3 million cows between 1975 and 2007 in the EU-9. The replacement of the dairy cow population was thus not total; only about one-third of the LU of the dairy cow population was replaced by other cows in national herds. The increase in suckler cow numbers did not necessarily occur on dairy farms. To a large extent, it was due to size increases in suckler cow herds on specialist beef cattle farms. It is also explained by the fact that the number of beef farms declined more slowly than those of dairy farms. However, herds were almost completely—or more—replaced in Belgium, Greece, Ireland, Luxembourg and Portugal. About the half of the dairy cow population was replaced in Germany and France (Figure 25). In Italy and the United Kingdom (Figure 27), the population of other cows declined (–35%), although the dairy cow population also declined (–40%). The other cows population started to increase from 1983 to 85 in the EU-6 and after 1987 in the EU-9. The rate of increase was high (about 2% per year or more) in the periods 1983-85, 1987-1995 and even 1987-97 in the EU-12 and EU-15. The rate of increase slowed after 1997 and even became negative (rate of decrease) in the 2000-03 period. After 2005, the rate of increase was about 0.30%-0.50% per year.

Sheep and goats

The sheep population increased by about 8 million head between 1975 and 2007 in the EU-9 (Table 37). The increase was very significant in the United Kingdom (5.8 million) and in Greece (3.4 million), it was considerable in Germany and in Ireland, with about 1.5 million head in both countries. France's sheep population declined by 1.7 million over this same period. Populations almost doubled in Denmark, Germany and the Netherlands. In Italy and Portugal, populations

remained stable, and in Spain, declined slightly. After initially increasing between 1975 and 1993, the population started to fall between 1993 and 1997 according to EU groups. The rate of increase was very fast (about 2% per year or more) between 1983 and 1985, and especially so between 1987 and 1990. After 1995, the variation rate was almost always negative (rate of decline) in all EU groups. In the EU-15, the population declined by 16.5 million head between 1995 and 2007 and by 5 million in the EU-27 between 2003 and 2007.

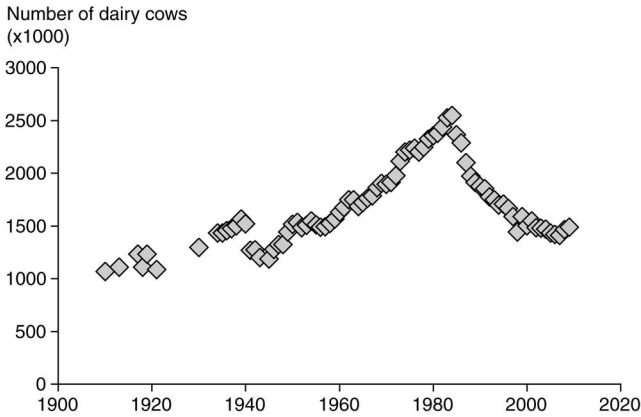

Figure 25. Changes in the number of dairy cows in the Netherlands over the last century.

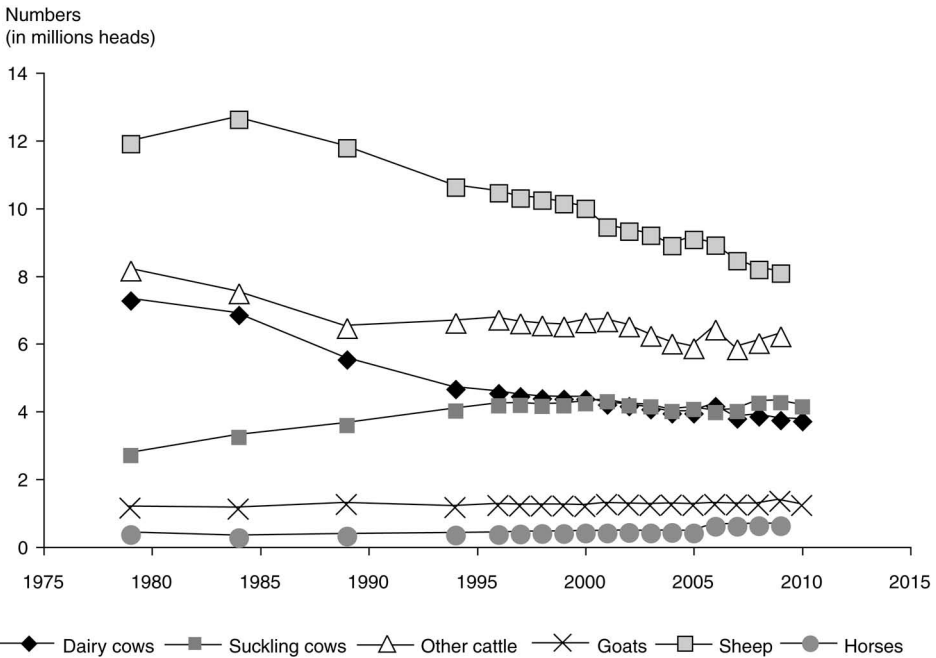

Figure 26. Changes in numbers of ruminants and herbivores (millions of heads) in France between 1979 and 2010.

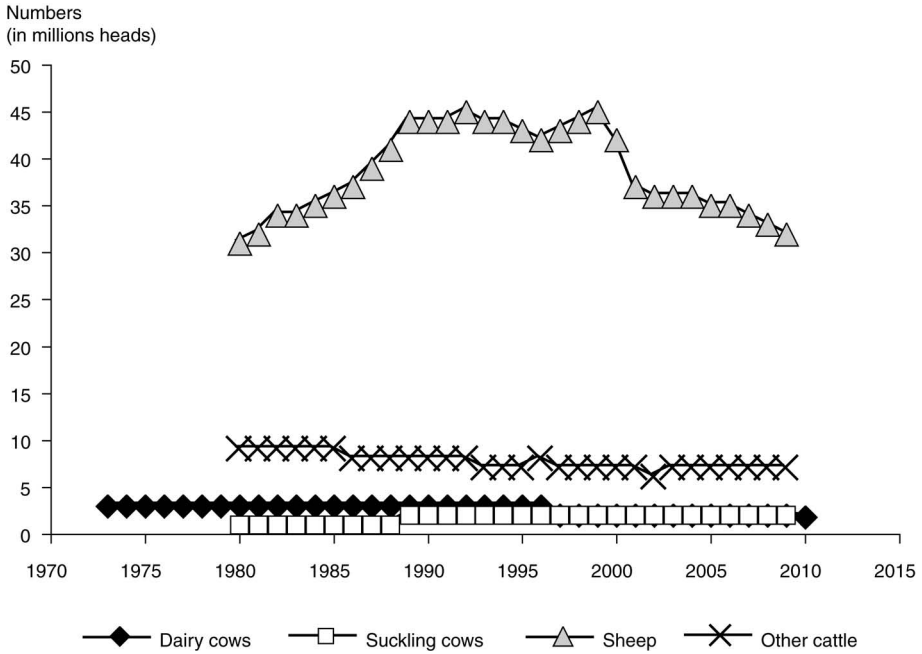

Figure 27. Changes in numbers of ruminants and herbivores (thousands of heads) in the United Kingdom between 1970 and 2009.

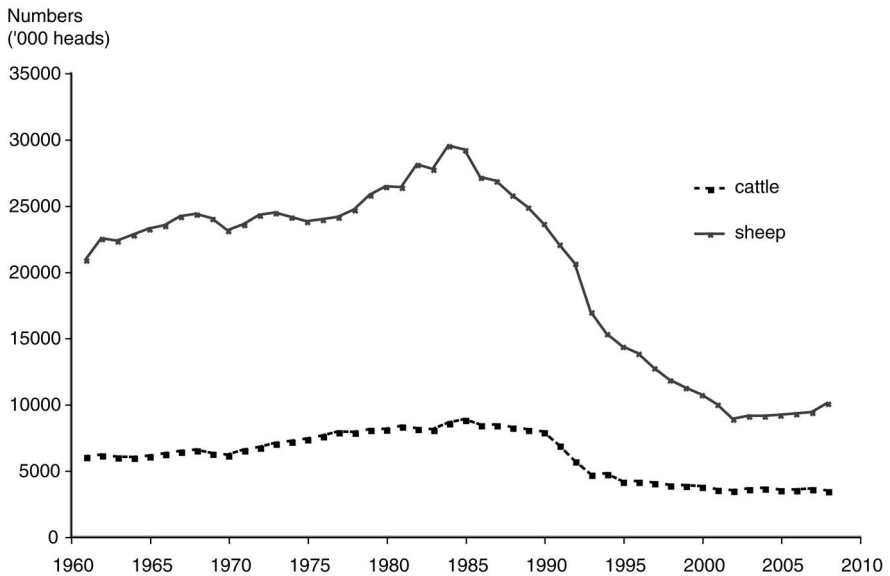

Figure 28. Changes in total cattle and sheep numbers ('000 heads) in Bulgaria and Romania between 1961 and 2008.

Source: FAOSTAT and authors' own calculations.

The former communist countries (Bulgaria, Czech Republic, Czech Republic, Slovakia, Hungary, Poland, Romania, Slovakia) have known specific variation rates (Table 26 to Table 32, and Figure 28). Cattle and sheep populations increased progressively from 1961 until the 1980s. Peak numbers were usually observed between 1982 and 1989. Just after the political regime changes in 1989, these maxima were followed by slow declines until 1990–92. Between 1991 and 2002, numbers dropped sharply. After this period, they became relatively stable or decreased slowly until 2007. The total number of cattle and sheep fell by about 50–60% and 50%, respectively (except in Bulgaria, where sheep numbers plummeted by 80%), between 1989 and 2008. Cattle and sheep numbers appeared to rise again after 2007. In Bulgaria and Hungary, goat numbers

Table 26. Changes in livestock numbers ('000 heads) between 1961 and 2008 in Bulgaria.

	1961	Maximum in	Period 1	Period 2	Period 3	2008/1989 (%)
Cattle	1 452	1982: 1 807	Slow decline until 1990: 1 613	Sharp decline in 1991–1995: 638	Relative stability afterwards until 2008: 602	37
Goats	246	1984: 506	Slow decline until 1990: 433	Sharp increase 1991–1999: 1 048	Decline afterwards until 2008: 495	114
Sheep	9 333	1984: 10 978	Slow decline until 1991: 7 938	Sharp decrease 1992–2002: 1 571	Relative stability afterwards until 2008: 1 526	18

Source: FAOSTAT.

Table 27. Changes in livestock numbers ('000 heads) between 1961 and 2008 in Hungary.

	1961	Maximum in	Period 1	Period 2	Period 3	Period 4	Period 5	2008/1989 (%)
Cattle	1 957	1982: 1 945	Slow decline until 1992: 1 420	Sharp decline in 1993– 1995: 910	Slow decline afterwards until 2008: 705			42
Goats	66	1971: 80	Sharp decline in 1972 and 1975: 15	Stability until 1990: 16	Sharp increase 1991–2000: 189	Sharp decline in 2001– 2002: 90	Slow decline afterwards until 2008: 67	429
Sheep	2 643	1983: 3 180	Decline until 1993: 1 752	Sharp decrease 1994– 1995: 947	Increase afterwards until 2008: 1 231 (sharp increase in 2001 and 2004)			56

Source: FAOSTAT.

Table 28. Changes in livestock numbers ('000 heads) between 1961 and 2008 in Poland.

	1961	Maximum in	Period 1	Period 2	Period 3	2008/1989 (%)
Cattle	9 168	1978: 13 115	Slow decline until 1989: 10 733	Sharp decline in 1991–1993: 7 643 and in 1998–2002: 5 533	Stability afterwards until 2008: 5 757	54
Sheep	3 494	1986: 4 991	Slow decline in 1987– 1990: 4 158	Sharp decrease 1991–2001: 343	Relative stability afterwards until 2008: 324	7

Source: FAOSTAT.

Table 29. Changes in livestock numbers ('000 heads) between 1961 and 2008 in Romania.

	1961	Maximum in	Period 1	Period 2	Period 3	2008/1989 (%)	
Cattle	4 530	1985: 7 039	Slow decline until 1990: 6 291	Sharp decline in 1991–2001: 2 879	Relative stability afterwards until 2008: 2 819	44	
Goats	404	1989: 1 078	Sharp decline in 1992–2001: 538	Slow increase afterwards until 2008: 865		80	
Sheep	11 500	1985: 18 637	Decline until 1990: 15 435	Sharp decrease 1991–2002: 7 251	Relative stability afterwards until 2007: 7 678	Sharp increase in 2008: 8 469	52

Source: FAOSTAT.

Table 30. Changes in livestock numbers ('000 heads) between 1961 and 1992 in Czechoslovakia.

	1961	Maximum in	Period 1	Period 2	2008 (Czech R. + Slovakia)/1989 (Czechoslovakia) (%)
Cattle	4 387	1984: 5 190	Slow decline in 1985–90: 5 129	Sharp decline in 1991–92: 4 347	37
Goats	616	1961: 616	Continuous decline between 1961 and 1982: 616 to 52	Relative stability afterwards in 1983–1992: 52–53	107
Sheep	646	1987: 1 104	Slow decline 1988–91: 1 030	Sharp decrease in 1992: 886	52

Source: FAOSTAT.

Table 31. Changes in livestock numbers ('000 heads) between 1993 and 2008 in the Czech Republic.

	Period 3	Period 4	Period 5
Cattle	Sharp decline in 1993–2000: 2 512–1 574	Slow decline afterwards until 2008: 1 363	
Goats	Stability 1993–95: 45	Sharp decline in 1996–2002: 14	Slow increase afterwards until 2008: 17 (sharp increase in 2005–06)
Sheep	Sharp decline 1993–2000: 254–84	Slow increase afterwards until 2008: 183 (sharp increase in 2005–06)	

Source: FAOSTAT.

Table 32. Changes in livestock numbers ('000 heads) between 1993 and 2008 in Slovakia.

	Period 3	Period 4
Cattle	Sharp decline until 1994–2000: 1 203–664	Slow decline afterwards until 2008: 502
Goats	Sharp increase 1993–2000: 20–51	Slow decrease afterwards until 2008: 37
Sheep	Sharp decline 1993–1999: 572–326	Relative stability afterwards until 2008: 362

Source: FAOSTAT.

increased considerably during the 1990s, then began to drop slowly in the early 2000s. In total, goat numbers increased by 14% and 29%, respectively in those two countries between 1989 and 2008. Slovakia has shown a similar trend since 1993. Cattle have been partly replaced by goats in Bulgaria during the 1990s.

Horses

The horse population in Europe shows a very contrasting pattern.

Horses as an agricultural production for meat or as draught animals are progressively disappearing. Romania, with 805 000 head, accounts for 22% of total horse populations and is the main producer of horse meat. Its horse population has quickly declined: for instance, it lost 3.5% of its horse herd just in 2010 due to a change in Romanian regulations.

Inversely, horses used for recreation and sport are increasingly numerous. In 2010, they accounted for a total population of 1.0 million head in Germany, 0.95 million head in Great Britain and 0.9 million head in France (Table 33).

There are between 250 000 and 300 000 horses in Sweden; the figures are continuing to rise, and the horse market has become the fourth largest source of income for Swedish farmers. The number of horses in Finland now exceeds 60 000 and is growing by some 5% a year. These increases are mainly from horses used in riding and recreation. With this growth comes an increased demand for feed, and more farmers are now specialising in producing forage for horses.

Table 33. Total number of horses in a selection of European countries in 2000 and 2007, density of horses and agricultural land and feed production required for horses. The figures are based on an assumption that the horse is in normal training with an energy requirement of 84 MJ/day, and has a stabling period of 270 days and a grazing period of 95 days. The feeding plan in stable includes 5.2 kg hay, 3 kg straw and 1.5 kg oats. Hay, oat and straw yields are based on statistics from the respective countries in the FAO (2007).

Member State	Total horse number (2000)	Total horse number (2007)	Horses/1000 persons (2007)	Horses/100 ha (2007)	Area needed to produce horse feed (ha/horse)	UAA to produce horse feed (%)
Austria		100 000	12.1	11.9	1.39	4.3
Belgium	250 000	300 000	28.5	98.3	0.90	19.4
Czech Rep		64 126	6.3	8.1	1.49	2.2
Denmark		150 000	27.6	34.8	1.11	6.4
Estonia		4 900	3.7	1.1	1.64	1.0
Finland		77 000	14.6	2.3	1.35	4.6
France	452 000	900 000	14.3	16.3	1.05	1.6
Germany	1 000 000	1 000 000	12.1	28.0	0.99	5.8
Greece		27 000	2.4	2.0	2.21	10.4
Hungary		60 000	6.0	6.4	1.87	1.9
Ireland		80 000	19.0	11.4	0.75	1.4
Italy	323 000	300 000	5.1	10.0	1.78	3.6
Latvia		13 600	5.9	2.1	2.00	1.6
Luxembourg		4 490	9.7	17.3	1.20	4.2
Netherlands	400 000	400 000	24.5	96.3	1.04	21.6
Norway		45 000	9.6	1.4	1.37	6.0
Poland		320 000	8.4	10.2	1.66	3.3
Serbia		35 000	17.5	3.4	2.02	1.3
Slovakia		8 000	1.5	1.6	1.67	1.9
Slovenia		22 000	11.0	10.9	2.00	3.1
Spain	260 000	559 598	12.8	11.1	1.73	1.5
Sweden	253 000	280 000	30.9	6.2	1.18	10.3
UK		1 000 000	16.6	41.0	0.87	0.4
Total		5 750 714				

Source: Equus, 2001; Liljenstolpe, 2009.

Horses present two particular differences when compared to other herbivores. The first is that only part of them live on farms, as illustrated in France (Figure 29, Plate 10). Most of the operations have only one or a few animals. This means that the owners are not involved in the same farmers' groups and therefore may

not have access to the same level of information regarding grassland management. Moreover, special attention must be paid regarding hygienic feed quality for horses. Indeed, the animals are very susceptible to dust and the presence of mycotoxins, which can cause Chronic Obstructive Pulmonary Disease, leading to a severe reduction in their activity. Clinical signs may vary, ranging from exercise intolerance to mucus secretion or chronic cough, and expiratory dyspnea (Lowell, 1990; Mair and Derksen, 2000). Such symptoms frequently occur when horses are fed hay, and the condition can be especially severe when certain grass species, such as *Holcus lanatus*, which have a very hairy epidermis, are present in the swards. Round-baled silage is one solution which is well tolerated by horses (Spordnly and Nilsson-Linde, 2011).

The second difference is that the horses are not located in the same regions as the main ruminant herds. Thus, they exploit pastures with a different botanical and chemical composition. Horse-grazed pastures may also be in regions specialised in grain production; these paddocks then play a key role in biodiversity preservation in these landscapes. France again provides an example (Figure 30, Plate 10) where large horse herds are present in the south-west of the country where ruminant populations, especially cattle, have dramatically fallen.

Changes in spatial distribution

The distribution of animals, especially in dairy production, has changed in most countries. They are concentrated in a few regions where the milk density is now very high.

However, as for the ley farming distribution, Sweden is characterised by a very stable distribution over the last century (Figure 31, Plate 11). The density of cows per hectare of arable land significantly decreased but this is to be related to the mean milk yield per cow. Indeed, the mean milk yield per cow was about 1 500 kg milk per cow in 1900; it rose to 7 800 kg in 2000 and 8 400 kg in 2012.

►► Changes in animal production and animal performance

The last few decades have seen major changes in animal performance, associated with either a change in animal breed or to a strong genetic advances on traits such as productivity. These changes have consequences on the diet composition and the animals and, as a result, affect the use of grasslands and fodder crops.

Milk production

In this section, and with regard to grasslands, it is important to note two key points. The first is related to the seasonality of production and the second to yield per animal, which depends both on changes in animal genetic potential and diet.

Seasonality

The seasonality of production refers to the distribution of milk collected by the industry throughout the year. It is the result of a compromise between industry requirements and farmers' ability to produce milk using available feed resources.

On average in Europe, there is a strong seasonality of the milk production collected by the industry (Figure 32, Plate 12). This seasonality has been stable over the last few years.

Adjustment between production potential and industry requirements may be achieved through national regulations and through milk prices paid to the farmers. By way of example, we will discuss the situations in two countries, France and Ireland.

As shown in Figure 33, monthly milk delivery in France has evened out over the years. In 1983, there was a strong seasonality, with a peak in May and low production in late summer due to drought and low biomass production in the grasslands. In recent years, deliveries have become nearly constant. This makes it possible for the factories to use their facilities on a continuous basis and achieve low production costs. The change in deliveries was obtained through a modulation of the milk price paid to the farmers. But it has also affected diet composition, with much less milk being produced from grazing cows and more from cows fed with conserved feeds, especially green maize complemented with soybean oilseed cakes.

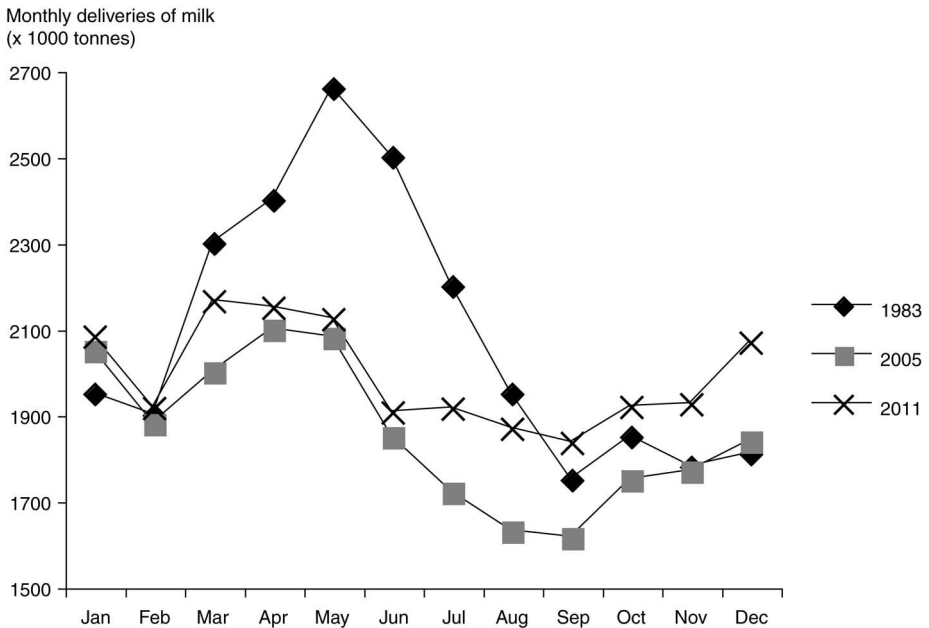

Figure 33. Changes in the monthly milk delivery of cow's milk to the dairy industry in France over three decades (in millions of litres).

Source: Scees, Office de l'élevage, CNIEL.

The situation in Ireland is completely different, as illustrated in Figure 34. Indeed, there is a very strong seasonality which has remained unchanged for several decades. This is because the climatic conditions of Ireland are extremely favourable to biomass production from grasslands and because grazing can occur almost year round. Moreover, there is little variation between years. Consequently, the production cost of milk from grazing cows is low. A similar situation is seen in New Zealand, where the industry may collect no milk during the winter months. Considering this favourable situation for milk production in Ireland, the government promotes additional increases in grazing-based milk production and improve the competitiveness of Irish dairy products on the international market.

However, this has consequences on the industrial facilities that are under-utilised in the winter months. It also influences the type of dairy products produced. The large quantity of milk at the peak period must be processed into products with long shelf lives that can be easily stored and transported over long distances. Butter and milk powder are two such products.

The seasonality of production may be analysed through a simple criterion: the peak to trough months' ratio (ratio between the month with the highest milk delivery and the month with the lowest). For Ireland, this ratio was 8.9 in 2002; it has remained nearly stable, dropping only to 8.7 in 2010. In comparison, Denmark and Netherlands had a ratio of only 1.1 in 2004.

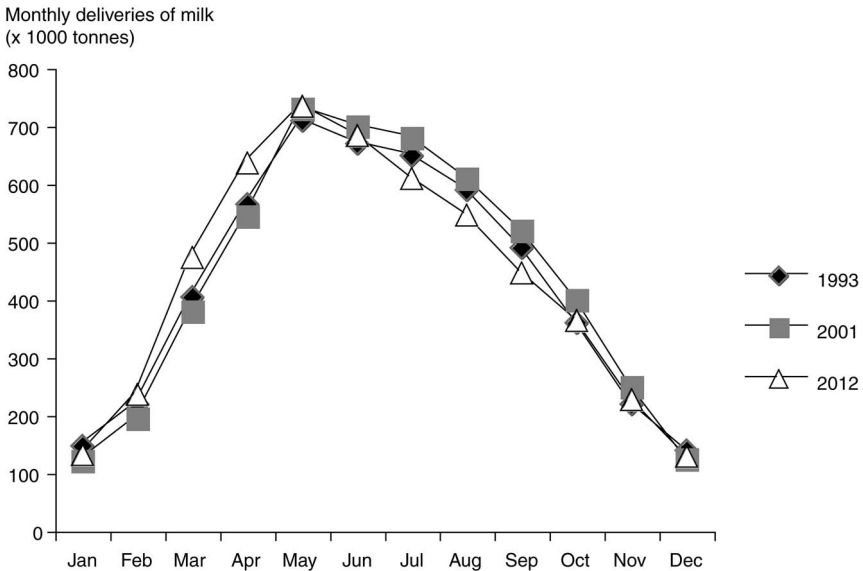

Figure 34. Changes in the monthly milk delivery of cow's milk to the dairy industry in Ireland over three decades (in millions of litres).

Animal performance

Animal performances have increased dramatically. The milk yield per dairy cow rose steadily in most countries. Performances can be analysed in two ways.

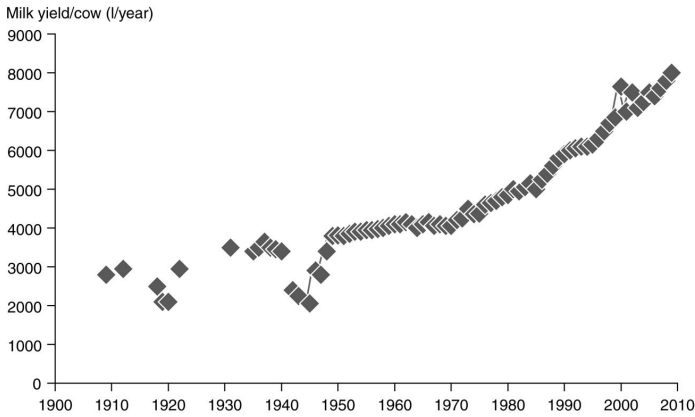

Figure 35. Mean milk yield per dairy cow in the Netherlands over the last hundred years. Source: Dr. Ir. Agnes van den Pol-van Dasselaar.

The first method involves the use of national statistics and a simple ratio of the total milk production to the number of dairy cows. Data is available for a very long period of time for the Netherlands (Figure 35) and for the last four decades for the United Kingdom (Figure 36). In the case of the Netherlands, the only periods when yield increases were interrupted were during the First and Second World Wars.

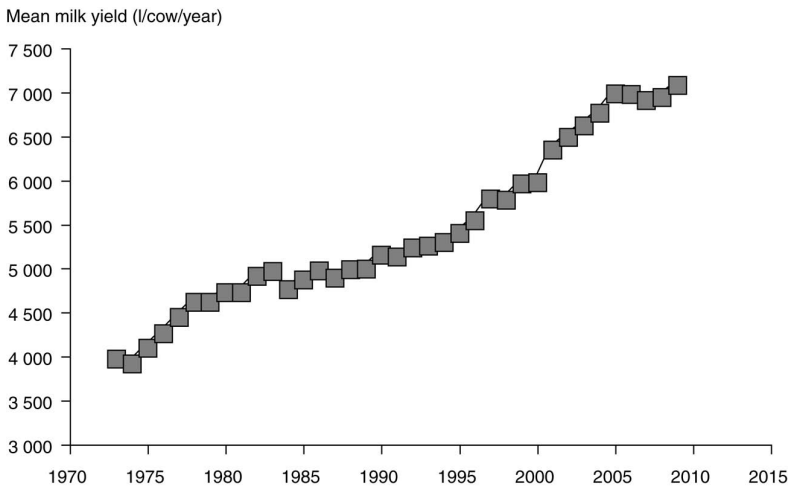

Figure 36. Mean milk yield per dairy cow in the United Kingdom over the last forty years.

The second method is to analyse the most productive herds using a specific survey. Such data may be collected from the national survey system or from the ICAR database. This is illustrated in Figure 37 for three countries: France, Ireland and Poland. A steady increase in observed in France and Poland, both with a similar rate, while the rise is more limited in Ireland.

The changes in per animal yield are related to two main factors. The first is the significant progress in the animals' genetic potential, especially with regard to the large

share of the Prim’Holstein breed in European dairy herds. The genetic potential of this breed—as well as with other dairy breeds—is constantly improving thanks to a continuous breeding effort; it will improve further when genomic selection is used. Other traits, such as reproduction, are now considered in addition to milk potential.

The second factor is the improvement of animal diets, which are more concentrated in energy and protein; this is especially true when animals are fed with silage and protein concentrates. It is less obvious under grazing, even though the more productive animals show higher voluntary intake under grazing. Furthermore, significant improvements were achieved in improving forage digestibility and sugar content of grass cultivars and a more stable proportion of white clover to ensure a high level of protein supply to the animals. The slower gain in diet quality under grazing explains why the milk production per cow of the most productive herds is lower in Ireland, where grazed grass is the main feed, than in France and Poland, where the proportion of milk from stocks is higher.

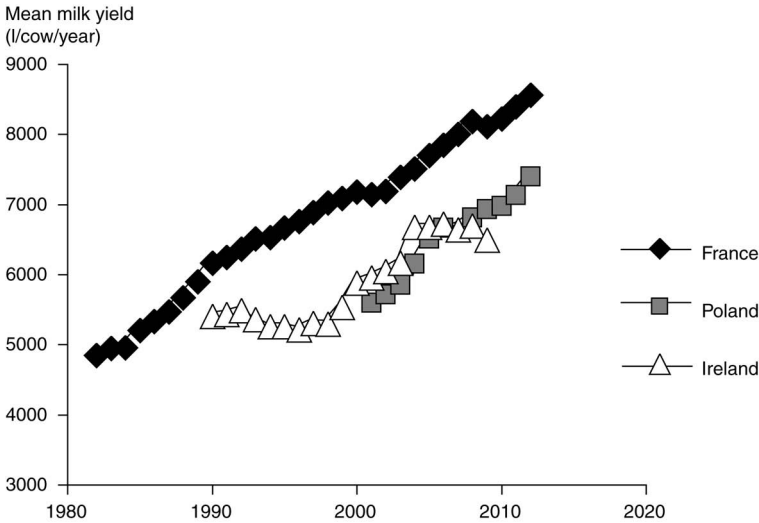

Figure 37. Mean milk yield per dairy cow in France, Ireland and Poland over the last decades.

Source: National statistics, ICAR database.

Changes in animal breeds in Europe

One of the reasons for these sharp increases in milk production is that herds have been specialised and a small number of breeds are used. These are usually the most productive breeds where most genetic breeding efforts are invested. Indeed, dairy cattle breeds are now very specialised in Europe and the number of breeds have strongly declined over the last few decades, while a very strong genetic improvement has been recorded for specialised breeds (see section below).

Holstein-Friesian: Friesians were imported into the east coast ports of England and Scotland, from the lush pastures of North Holland, during the 1800s until live cattle importations were stopped in 1892, as a precaution against endemic foot and mouth

disease on the European Continent. They were so few in number that they were not included in the 1908 census in the UK. Today, the Holstein-Friesian breed produces 80% of Europe's milk production and is found all over the United States. It has one of the highest milk yields of all cows.

Normande: The Normande breed has its origins in cattle that were brought to Normandy by the Viking conquerors in the ninth and tenth centuries. For over a thousand years these cattle evolved into a dual-purpose breed to meet the milk and meat needs of the residents of north-western France. The current herd book in France was started in 1883. Though the breed was decimated by the Allies invasion of Normandy during the Second World War, there are currently 0.48 million Normande dairy cows in France. Their present role in France is to provide rich milk for the cheese industry while maintaining their excellent carcass quality.

Simmental: The Simmental is among the oldest and most widely distributed of all cattle breeds in the world. Although the first herd book was established in the Swiss canton of Berne in 1806, there is evidence of large productive red and white cattle found much earlier in ecclesiastical and secular property records of western Switzerland. These red and white animals were highly sought after because of their "rapid growth development; outstanding production of milk, butter, and cheese; and for their use as draught animals". They were known for their imposing stature and excellent dairy qualities. As early as 1785, the Swiss Parliament limited exports because of a shortage of cattle to meet their own needs. The Swiss "Red and White Spotted Simmental Cattle Association" was formed in 1890. Since its origin in Switzerland, the breed has spread to all six continents. Total numbers are estimated between 40 and 60 million Simmental cattle worldwide; more than half are in Europe. The spread was gradual until the late 1960s. Records show that a few animals were exported to Italy as early as the 1400s. During the 19th century, Simmental were distributed through most of eastern Europe, the Balkans, and Russia, ultimately reaching South Africa in 1895. Guatemala imported the first Simmental into the Western Hemisphere in 1897, with Brazil following suite in 1918 and Argentina in 1922. The breed is known by a variety of names, including "Fleckvieh" in Germany, Austria and Switzerland as well as in many other European countries. The "Pie Rouge", "Montbeliarde" and "Abondance" breeds in France (totalling 0.7 million head) and "Pezzata Rossa" breed in Italy originate from the Simmental. The Simmental name is derived from their original location, the Simme Valley of Switzerland: 'thal' or 'tal' means valley in German, thus the name literally means "Simme Valley".

Braunvieh: 'Braunvieh' is a German word meaning brown cattle. There were at least 12 types of brown cattle found in the mountains of Switzerland during the 1600s. These animals showed a wide variation in type and size depending on where they were raised and form the basis of the modern Braunvieh breed. Focused selection began in the canton of Schwyz. By the 19th century, breeders began to export these animals to surrounding regions. A breeders society, Schweizerischer Braunviehzuchtverband, was formed in Switzerland in 1897. In 1974, Braunvieh accounted for 47% of all cattle in Switzerland, second only to Simmental.

The most important breeds of beef cattle in Europe are, in order of importance:

– **Hereford.** Originating from Herefordshire, in the South-West of England, this breed had initially a triple purpose: milk, meat and pulling. It is now specialised

in meat production. Robust, resistant, it is possible to get good meat production on young animals. The finishing of oxen and heifers is possible as early as 18 months, with good percentage of fat. The herd book was created in 1878, but the present conformation was defined at the beginning of the 19th century. Worldwide, the Hereford herd has more than 200 millions heads located in 56 countries. It is the largest beef cattle breed worldwide, and is especially present in the UK, North and South America (it was first introduced in the USA in 1840), South Africa and Australia. The breeding scheme combining natural mating and artificial insemination aims at improving the growth performance

– **Charolais**. From its original region, near Charolles, in Saône-et-Loire, France, this breed was progressively used in most French regions. This large-sized breed shows a high potential for growth and high maternal qualities, with one calf per year and high milk production (for a beef breed). It well valorises medium-quality grasslands, and is very efficient in producing meat. Its genetic breeding started at the end of the 19th century and is presently based upon 200 000 suckling cows. Every year, 500 bulls are selected. This breed is now present in more than 70 countries under all climates and latitudes.

– **Limousin**. This beef cattle breed originates from the Limousin region, in the North-West part of Massif Central, France, in a region with a lot of permanent grasslands. This large sized breed has high meat quality and easy calving. It produces a range of products from calf meat to heavy heifers. In France, this breed contributes 25% of the PDO meat under label Rouge Boeuf Limousin Blason Prestige. A full genetic breeding program is dedicated to this breed combining natural mating and artificial insemination. The objectives are a constant improvement of meat yield while preserving its maternal quality and easy calving. This breed is now present in many countries, under all latitudes and climates. It is used in hybridization programs in the tropics with Brahman.

– **Angus**, or **Aberdeen Angus**, originates from the North-East of Scotland, near Aberdeen. From the middle of the 18th century, crosses were performed to achieve the present Aberdeen Angus breed. Genetically horn-less, this breed has high butchery values, both in intensive and extensive production. Showing an easy calving, this breed is often used in crosses to improve the quality of the carcass, the milk production of the suckling cows and to introgress the horn-less gene. This breed is particularly present in the USA, Canada, Argentina, New Zealand and in Europe, including the Nordic countries.

– **Belgian Blue**. This breed was selected in Belgian Walloonie from local breeds. Initial matings were made with Shorthorn bulls to achieve a mixed type. But, today, the priority is clearly given to meat production. Bulls show a very massive muscle structure with weights up to 1 300 kg. The Belgian Blue's sculpted, heavily muscled appearance is known as "double-muscling". The double-muscling phenotype is a heritable condition which results in the increased number of muscle fibers rather than the normal enlargement of individual muscle fibers. This particular trait is shared with another breed of cattle known as Piedmontese. Both of these breeds have an increased ability to convert feed into lean muscle, which causes these particular breeds' meat to have a reduced fat content. The Belgian Blue is named after their typically blue-grey mottled hair colour, however its colour can vary from white to black. The modern beef breed was developed in the nineteen fifties (1950) by Professor Hanset, working at an artificial insemination centre in Liege province.

The breed's characteristic gene mutation was maintained through line breeding to the point where the condition was a fixed property in the Belgian Blue breed. They have an improved feed conversion ratio. The neonatal calf is so large that Caesarean sections are routinely done, leading to a lock-in situations.

– **Blonde d'Aquitaine.** This breed was created in 1962 by gathering three branches of blond breeds from South-West of France. This robust breed with an easy calving shows a high growth potential, a very high yield at slaughtering and a high meat yield. The breeding scheme combines natural mating and artificial insemination and aims at improving the growth performance.

Many local breeds, whether specialised in meat production or used for both milk (cheese production) and meat production, exist and efficiently contribute to preserving genetic diversity.

Animal genetic improvements and long-term changes

The genetic value of the animal breeds is closely watched and gains in genetic value can be analysed. Genetic progress is ensured through artificial insemination, which is now the most common practice in dairy herds. In beef cattle, genetic gain is mainly achieved by purchasing bulls.

There has been a regular, strong genetic improvement in milk production for most breeds. Genetic gains depend on the best males and on financial investment; the herd size of a given breed is therefore a major factor in the gains achieved. As illustrated in Figure 38 for France, the genetic gain, expressed here in kg milk/year, has been much higher for Holstein-Friesian than for Brune, a breed related to the Braunvieh with a small number of cows in France.

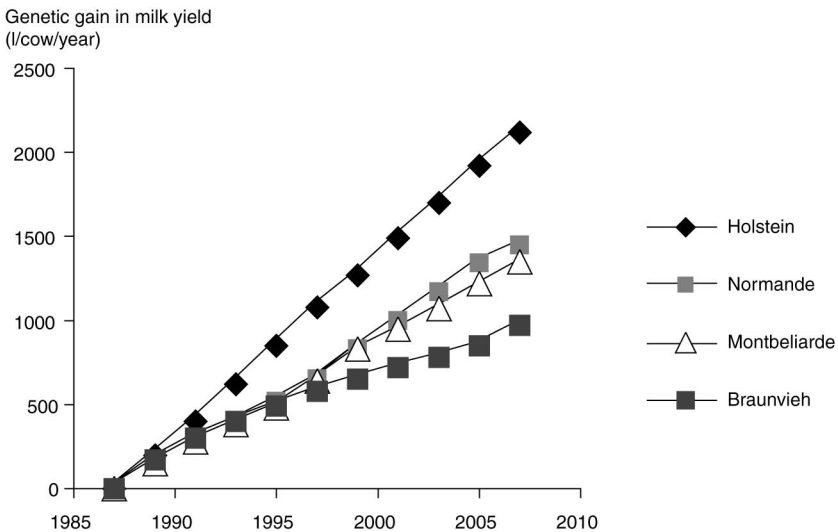

Figure 38. Genetic gains in milk production of dairy cow herds of four different breeds in France, expressed as a difference (kg milk/year) with the value in 1987.

Source: Office de l'élevage, France Génétique Élevage, 2008.

Breeding indices can vary among countries. They all combine milk production, milk quality, animal fertility and adaptation. In Europe, most breeding schemes do not take into account the ability of the animal breeds to get the most out of various sources of feed, and especially grasslands through grazing. However, several studies from Ireland compared breeds for their ability to do this (Prendiville *et al.*, 2007). An economic assessment showed that dual-purpose breeds such as Montbeliarde performed better from an economic point of view than a highly specialised breed (Holstein-Friesian) in most economic scenarios (Evans *et al.*, 2004). The Holstein-Friesian's low fertility presented a major weakness. A special selection was made in New Zealand among Holstein-Friesian for their adaptation to milk production based on grazed grasslands.

Genomic selection was first conceived by Lande and Thompson (1990) and funded by Meuwissen *et al.* (2001). It is now routinely applied in dairy cattle (Hayes *et al.*, 2009). With this technology, both sexes can be selected (against only the male gender when testing on a progeny basis); selection can be made at a very early stage and a wide range of traits can be considered. It was first applied in Holstein-Friesian and has been progressively used with other dairy breeds such as Simmental (Neuner and Gotz, 2009) and Norwegian Red (Luan *et al.*, 2009). It is also used in suckling breeds such as Angus (Rolf *et al.*, 2010).

However, the diversity of these breeds is often questioned, with all breeds showing low effective population sizes. In four countries where such analysis was performed on the Holstein-Friesian breed in the 1990s, the effective population size ranged from 39 to 52 (Taberlet *et al.*, 2011; Table 34). Genetic resources are being lost in ruminant species due to traditional breeds being replaced by high performance industrial breeds across the globe, and because of genetic diversity losses from these industrial breeds. New technologies could be used to properly preserve genetic diversity (Taberlet *et al.*, 2011).

Table 34. Example of effective population sizes in the Holstein-Friesian cattle breed.

Country	Period	Census population size	Effective population size (Ne)
United States	1999	8 500 000	39
France	1988–1991	2 500 000	46
Denmark	1993–2003	3 700 000	49
Germany	1999	2 200 000	52

Source: Taberlet *et al.*, 2011.

The genetic gains in beef cattle are less pronounced than in milk production due to the process of accretion that determines milk production. The size of the animals in meat breeds is regularly increasing, explained in part by increasing daily weight gains.

Under European conditions, and except during the dry seasons, the quality of biomass available in grasslands is high enough to support the growth of the animals, both young calves through their mother's milk production or later when the young animals are fed solely through grazing.

Importance and changes in grassland-based systems

►► Farm types

All EU-27 holdings can be classified into eight main categories (EU codes): ‘Specialist field crops’ (FT 10), ‘Specialist horticulture’ (FT 20), ‘Specialist permanent crops’ (FT 30), ‘Specialist grazing livestock’ (FT 40), ‘Specialist granivores’ (FT 50), ‘Mixed cropping’ (FT 60), ‘Mixed livestock holdings’ (FT 70) and ‘Mixed crops-livestock’ (FT 80). In 2007, two-fifths (42%) of total farm holdings owned grazing livestock and about one-sixth (16%) were specialist grazing livestock farms. These farms represented 21% and 10%, respectively, of the total labour force. About 42% of the total holdings are located in less favoured areas.

►► Changes in the number of animal holdings

There were some clear trends in the structure of agricultural holdings since 1975 (EU-9; Tables 38 and 39):

- The total number of agricultural holdings decreased dramatically over thirty years (from 5.8 million in 1975 to 3.2 million in 2007, i.e., a 46% decline).
- Specialist grazing livestock holdings declined faster than specialist field crop holdings (declines of 46% and 33%, respectively); consequently, there has been a substantial increase in the proportion of holdings specialised in crop productions over the last thirty years.
- Specialist dairying underwent a very sharp decline that was much higher than for specialist cattle rearing and fattening holdings (72% and 3%, respectively).
- Specialist cattle rearing and fattening and specialist sheep, goats and other grazing livestock holdings were almost stable over a thirty-year period. The former remained nearly stable over the entire period, with a decrease of 3%, while the latter saw an overall increase of 15%; numbers rose until 1995, when they began to decline.

- In the specialist grazing livestock classification, the specialist sheep, goats and other grazing livestock categories exceeded all others.
- Specialist granivore holdings performed relatively well, with a lower-than-average decline (–37%).
- Mixed livestock holdings almost disappeared, with falling nearly 90% (when granivores are included in this holding type, the decline is somewhat lower at 74%).
- Mixed cropping and mixed crop-livestock holdings decreased significantly, with a decline ranging from 68% to 76%.

These figures show a clear trend towards specialisation, with sharp declines in mixed cropping, mixed livestock and mixed crop-livestock holdings compared to specialist holdings (field crops, grazing livestock and granivores). In 2007, specialist field crops and grazing livestock holdings represented 22% and 27%, respectively, of the total holdings, while mixed cropping, mixed livestock and mixed crop-livestock totalled 6%, 2% and 6%, respectively. Production is also concentrated on larger farms. The size of specialist livestock farms increased by a factor of 1.8 between 1975 and 2007. Dairying; cattle-dairying, rearing and fattening; and mixed crop-livestock holdings (dairy activities make up a significant part of this last category) nearly doubled in size between 1975 and 1997. These three farm types were of higher-than-average size at 36 ha, 45 ha and 37 ha, respectively, compared to specialist field crops (26 ha) and grazing livestock holdings (30 ha). There is a notable concentration of dairy cows on large farms. For example, in 1997, herds with a minimum of 50 dairy cows housed 48% of dairy cows, compared with 2% in 1975 (European Communities, 2000).

Changes in the economic characteristics of holdings

In 1997, 10% of the EU-15 farms produced two-thirds of the total standard gross margin (SGM). Half of all holdings generated 95% of SGM. The economic weight of the other half of agricultural holdings was therefore very small. These holdings nevertheless played a significant role in terms of land management and landscape conservation.

The SGM/ha of specialised field crop products and in mixed livestock arable farms doubled in the EU-9 between 1979 and 1997. Between 1987 and 1997, the SGM per ha of mixed farms increased at half the rate (+7%) of specialised holdings (+14%) (European Communities, 2000; Eurostat, 2010 (Farm Structure Survey 2007)).

Change in the human structure of the holdings

In addition to the changes in the number of holdings in all European countries, the human structure has changed as well. The key factors in these developments are:

- An increasing number of farmers are men with spouses who work outside the farm. This severely restricts available labour resources on the farms and affects the farm's relationship with the local area.

- An increasing number of holdings have employees, modifying the availability of labour resources on the farm throughout the year.
- The legal structure of the farms has changed: there is a smaller proportion of family farms and a greater proportion of companies.
- Farmers’ education levels are progressing rapidly across Europe, increasing their abilities to implement innovations and work with extension services.

Generally speaking, there is trend towards an increasing number of work units in the countries with larger herd sizes. This is especially important with regard to milk production, with a large variation along the trend (Figure 39). Four countries show a much higher number of work units than expected: Hungary, Slovakia, Estonia and the Czech Republic. There is no obvious link between the country position in this graph and the main source of forage in the animal diets.

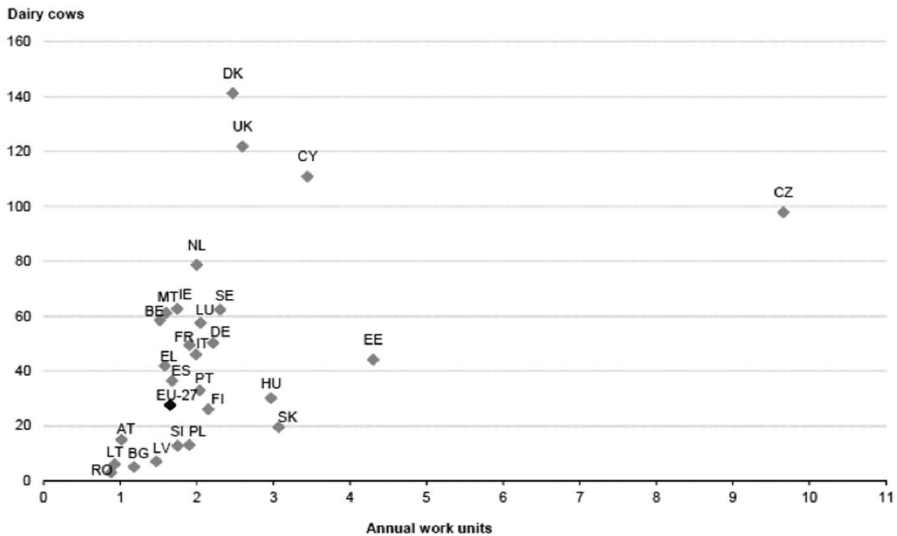

Figure 39. Relationship between the number of work units and number of dairy cows among EU-27 countries.

Source: Eurostat.

Table 35. Changes in the number of dairy cows ('000 heads) and annual variations in the EU-27 between 1975 and 2007. Germany includes the ex-GDR since 1990/91.

	1975	1979/ 80	1985	1990	1995	2000	2005	2007	Ratio between 2007 and 1975 (%)	Difference between 2007 and 1975 (‘000 heads)
	(‘000 heads)									
Austria					706	697	536	522		
Belgium	990	977	970	842	688	616	549	524	52.9	-466
Bulgaria							357	350		
Cyprus							24	23		
Czech Republic							441	417		
Denmark	1 102	1 071	896	762	702	640	564	545	49.5	-557
Estonia							115	108		
Finland					396	364	319	296		
France	7 551	7 270	6 609	5 304	4 624	4 193	3 884	3 815	50.5	-3 736
GD										
Luxembourg	74	68	68	61	49	45	39	40	54.1	-34
Germany	5 365	5 429	5 567	6 058	5 217	4 765	4 236	4 076	76.0	-1 289
Greece			222	205	184	154	168	157	73.2	-58
Hungary						361	287	265		
Ireland	1 477	1 615	1 684	1 331	1 312	1 177	1 082	1 058	71.6	-419
Italy	2 912	2 577	2 782	2 642	2 173	1 896	1 860	1 891	64.9	-1 021
Latvia						193	172	182		
Lithuania							494	398		
Malta							7	8		
Netherlands	2 259	2 369	2 367	1 878	1 708	1 650	1 433	1 468	65.0	-791
Poland							2 854	2 768		
Portugal				406	382	356	287	273		
Romania							1 658	1 587		
Slovakia						230	193	177		
Slovenia						142	131	124		
Spain				1 598	1 357	1 242	1 002	975		
Sweden					481	449	393	370		
United Kingdom	3 290	3 288	3 147	2 845	2 555	2 335	2 065	1 953	59.4	-1 337
Norway						313	265	253		
Switzerland							619			
EU-9	25 020	24 664	24 090	21 722	19 029	17 318	15 713	15 371	61.4	-9 649
EU-12				23 930	20 952	19 070	17 170	16 776	66.1	-8 598
EU-15					22 535	20 579	18 418	17 963	79.7	-4 571
EU-27							25 151	24 371	93.7	-1 629
Annual variation rate (%)										
EU-9		-0.36	-1.68	-1.57	-1.29	-2.17	-1.90	-1.09		
EU-12				-1.90	-1.23	-2.16	-2.14	-1.15		
EU-15						-2.13	-2.17	-1.23		
EU-27							-1.63	-1.55		

Source: Eurostat; European Communities (2000); authors' own calculations. The reference year is the first year of record.

Table 36. Changes in the number of suckling cows ('000 heads) and annual variations in the EU-27 between 1975 and 2007. Germany includes the ex-GDR since 1990/91.

	1975	1979/ 80	1985	1990	1995	2000	2005	2007	Ratio between 2007 and 1975 (%)	Difference between 2007 and 1975 ('000 heads)
	('000 heads)									
Austria					210	176	271	268		
Belgium	74	130	172	315	479	540	534	545	735.8	+471
Bulgaria							11	16		
Cyprus							0	3		
Czech Republic							140	154		
Denmark	87	72	54	71	122	122	101	106	121.8	+19
Estonia							5	9		
Finland					30	28	35	43		
France	2 669	2 832	3 431	3 753	4 165	4 314	4 148	4 277	160.2	+1 608
GD	5	12	15	20	31	32	32	33	656.4	+28
Luxembourg										
Germany	125	147	172	383	598	788	747	743	594.4	+618
Greece			123	90	92	111	170	189	212.1	+100
Hungary						30	47	56		
Ireland	665	465	408	817	959	1 187	1 168	1 116	167.8	+451
Italy	625	317	481	313	658	446	609	601	96.1	-24
Latvia						1	5	11		
Lithuania							9	12		
Malta							0	0		
Netherlands	0	0	46	117	146	91	152	89		+89
Poland							30	57		
Portugal				256	292	341	372	371		
Romania							67	46		
Slovakia							29	31		
Slovenia							57	55		
Spain				1 195	1 482	1 780	1 564	1 670		
Sweden					154	165	177	186		
United Kingdom	1 952	1 534	1 320	1 583	1 766	1 829	1 765	1 694	86.8	-258
Norway						37	56	61		
Switzerland							83			
EU-9	6 202	5 509	6 099	7 373	8 925	9 350	9 255	9 203	148.4	+3 001
EU-12				8 912	10 791	11 583	11 361	11 432	145.4	+3 572
EU-15					11 186	11 952	11 843	11 929	106.6	+743
EU-27							12 244	12 381	102.1	+256
Annual variation rate (%)										
EU-9		-2.79	+4.89	+6.25	+1.66	+0.46	+0.62	-0.29		
EU-12				+4.46	+2.18	+0.95	-0.11	+0.31		
EU-15						+0.95	+0.19	+0.36		
EU-27							+0.49	+0.56		

The reference year is the first year of record.

Source: Eurostat; European Communities (2000); authors' own calculations.

Table 37. Changes in the number of sheep ('000 heads) and annual variations in the EU-27 between 1975 and 2007. Germany includes the ex-GDR since 1990/91.

	1975	1979/ 80	1985	1990	1995	2000	2005	2007	Ratio between 2007 and 1975 (%)	Difference (‘000 heads)
	('000 heads)									
Austria					354	339	315	328		
Belgium	116	120	161	189	156	160	152	151	129.8	+35
Bulgaria							1 449	1 434		
Cyprus							254	244		
Czech Republic							149	173		
Denmark	72	54	70	143	145	143	173	157	217.4	+85
Estonia							66	83		
Finland					152	100	87	119		
France	10 180	13 121	11 181	11 071	10 057	9 416	8 805	8 447	83.0	-1 733
GD	6	4	5	7	8	8	10	9	155.7	+3
Luxembourg										
Germany	955	959	1 068	2 501	1 980	2 724	2 642	2 461	257.7	+1 506
Greece			7 215	8 258	8 328	8 753	9 066	10 080	150.9	+3 398
Hungary						1 287	1 405	1 232		
Ireland	3 755	3 301	4 405	8 888	7 995	6 892	6 240	5 345	142.3	+1 590
Italy	6 453	6 427	7 522	8 722	10 668	6 808	6 991	6 790	105.2	+337
Latvia						37	44	71		
Lithuania							41	53		
Malta							11	9		
Netherlands	760	895	814	1 690	1 674	1 401	1 363	1 369	180.2	+609
Poland							326	336		
Portugal				2 926	2 780	2 930	2 533	2 340		
Romania							7 604	8 532		
Slovakia						307	307	348		
Slovenia						96	131	136		
Spain				17 501	19 019	20 927	19 660	18 759		
Sweden					461	437	471	509		
United Kingdom	27 887	29 858	35 461	43 939	43 331	41 899	35 321	33 728	120.9	+5 841
Norway						2 325	2 423	2 267		
Switzerland							446			
EU-9	50 184	54 739	60 687	77 151	76 015	69 451	61 698	58 456	116.5	+8 272
EU-12				105 836	106 142	102 060	92 957	89 634	94.8	-4 869
EU-15					107 109	102 936	93 831	90 590	84.6	-16 519
EU-27							105 618	103 240	95.4	-4 926
EU-6 annual variation ('000 heads)		+611	+546	+1 121	-208	-1 289	-729	-368		
Annual variation rate (%)										
EU-9		+2.27	+2.62	+6.59	-0.83	-2.34	-1.66	-2.63		
EU-12				+4.00	-0.29	-0.92	-1.54	-1.79		
EU-15						-0.94	-1.52	-1.73		
EU-27							-1.18	-1.13		

The reference year is the first year of record.

Source: Eurostat; European Communities (2000); authors' own calculations.

Table 38. Changes in the number of holdings, total surface ('000 ha) and average holding size (ha) per holding type in the EU between 1975 and 2007.

	1975	1979/80	1983	1985	1987	1990	1993	1995	1997	2000	2003	2005	2007	2007/Ref year (%)	Holding size in 2007 (ha)
Specialist field crops															
Holdings															
EU-15				1 605	1 536	1 410	1 314	1 248	1 167	73	33				
EU-12		1 824	1 680	1 457	1 426	1 296	1 216	1 136	1 066	58	34				
EU-9	1 049	1 143	1 128	1 148	1 165	1 104	979	1 021	966	871	808	752	700	67	37
Surface															
EU-15				39 467	41 382	40 788	40 383	39 831	39 095	99					
EU-12		34 803	33 580	34 882	36 905	38 628	37 711	37 261	36 442	103					
EU-9	17 678	19 758	20 753	21 634	23 033	23 278	24 742	26 055	27 325	27 305	27 001	26 580	26 122	148	
Specialist grazing livestock															
Holdings															
EU-15				1 711	1 557	1 460	1 338	1 287	1 241	73	39				
EU-12		1 775	1 756	1 607	1 533	1 385	1 302	1 194	1 153	62	40				
EU-9	1 583	1 575	1 491	1 471	1 396	1 310	1 233	1 205	1 085	1 013	938	899	862	54	40
Surface															
EU-15				48 595	48 136	45 699	46 236	48 564	47 764	98					
EU-12		41 968	44 938	44 923	44 608	44 164	41 813	42 348	44 855	105					
EU-9	35 766	37 610	37 699	37 487	36 011	36 303	36 248	36 183	35 805	34 563	35 530	35 467	34 694	97	
															...

...	1975	1979/80	1983	1985	1987	1990	1993	1995	1997	2000	2003	2005	2007	2007/Ref year (%)	Holding size in 2007 (ha)
Specialist dairying															
Holdings															
EU-15				576	526							312	54		
EU-12			710	642	483	435						262	37		
EU-9	786	766	721	658	610	517	433	395	359			223	28		
Surface															
EU-15				17 275	16 870										
EU-12			16 049	15 570	15 315	15 060	14 637								
EU-9	14 378	15 972	16 597	15 978	15 323	14 728	14 463	14 203	13 788						
Specialist cattle rearing and fattening															
Holdings															
EU-15				335	328							326	97		
EU-12			315	304	302	306						295	94		
EU-9	246	254	267	275	267	253	253	267	256			239	97		
Surface															
EU-15				9 064	9 585										
EU-12			7 020	7 141	8 023	8 647	9 160								
EU-9	5 766	5 912	6 313	6 576	6 161	6 172	6 821	7 181	7 499						
Cattle-dairying, rearing and fattening combined															
Holdings															
EU-15				96	84							59	62		
EU-12			146	105	78	70	62					45	31		
EU-9	239	178	148	130	103	74	60	57	51			41	17		

	1975	1979/80	1983	1985	1987	1990	1993	1995	1997	2000	2003	2005	2007	2007/Ref year (%)	Holding size in 2007 (ha)
(numbers in '000 or surface in '000 ha)															
Surface															
EU-15								3 193	3 041						
EU-12					2 889	2 631	2 583	2 678	2 588						
EU-9	5 289	4 114	3 425	3 148	2 542	2 398	2 424	2 546	2 468						
Sheep, goats and other grazing livestock															
Holdings															
EU-15								705	620			543		77	
EU-12					604	705	697	669	582			499		83	
EU-9	311	377	355	408	416	466	488	487	420			358		115	
Surface															
EU-15								19 063	18 640						
EU-12					16 012	19 597	19 002	18 223	17 779						
EU-9	10 333	11 613	11 364	11 785	11 986	13 005	12 540	12 253	12 050						
Specialist granivores															
Holdings															
EU-15								111	91	101	104	94	93	84	21
EU-12					127	101	104	98	78	91	91	82	84	66	21
EU-9	87	78	75	82	81	63	74	70	53	55	57	53	54	63	23
Surface															
EU-15								1 435	1 143	1 356	1 782	1 694	1 928	134	
EU-12					912	818	1 341	1 212	892	1 150	1 526	1 468	1 746	191	
EU-9	450	521	574	621	644	595	1 054	947	684	835	1 048	1 016	1 238	275	...

...	1975	1979/80	1983	1985	1987	1990	1993	1995	1997	2000	2003	2005	2007	2007/Ref year	Holding size in 2007	
	(numbers in '000 or surface in '000 ha)														(%)	(ha)
Mixed cropping holdings																
Holdings																
EU-15					1 020	808	692	614	598	537	434	435	411	65	13	
EU-12	620	568	542	505	487	414	367	339	315	280	212	201	197	32	13	
EU-9																
Surface																
EU-15					7 883	6 942	7 174	6 736	6 989	6 346	5 728	5 603	5 388	77		
EU-12	5 475	4 512	4 175	4 134	3 937	3 570	4 065	3 764	3 679	3 215	2 727	2 730	2 635	48		
Mixed livestock holdings																
Holdings																
EU-15					472	312	257	236	193	180	144	140	125	50	28	
EU-12					218	165	149	126	97	87	64	65	57	12	35	
EU-9	464	277	229	254	218	165	149	126	97	87	64	65	57	12	35	
Surface																
EU-15					5 164	4 027	4 685	4 060	3 487	3 389	3 414	3 436	3 345	65		
EU-12					3 456	2 722	3 412	2 766	2 305	2 103	2 066	2 047	2 036	31		
EU-9	6 626	4 477	3 705	3 828	3 456	2 722	3 412	2 766	2 305	2 103	2 066	2 047	2 036	31		
Mixed livestock, mainly grazing livestock																
Holdings																
EU-15					364	239	184	170	146				81	45		
EU-12					166	123	98	82	68				78	22		
EU-9	377	222	179	193	166	123	98	82	68				35	9		
Surface																
EU-15					3 870	2 932	3 010	2 661	2 613							
EU-12					2 590	1 977	2 118	1 788	1 585							
EU-9	5 460	3 605	2 843	2 904	2 590	1 977	2 118	1 788	1 585							

	1975	1979/80	1983	1985	1987	1990	1993	1995	1997	2000	2003	2005	2007	2007/Ref year	Holding size in 2007 (ha)
	(numbers in '000 or surface in '000 ha)														
Mixed livestock, mainly granivores holdings															
Holdings															
EU-15					108	73	73	66	42			44	42	39	
EU-12	87	55	50	61	52	42	51	44	29			22		26	
EU-9															
Surface															
EU-15					1 294	1 095	1 675	1 399	1 006						
EU-12	1 166	872	862	924	867	745	1 295	978	720						
Mixed crops-livestock															
Holdings															
EU-15					807	660	535	512	452	441	357	357	322	58	43
EU-12					479	412	353	336	298	265	207	209	190	24	55
EU-9	782	598	527	502											
Surface															
EU-15					14 742	13 887	15 220	15 490	15 435	14 804	13 740	13 552	12 756	87	
EU-12					11 512	10 659	12 062	12 346	12 408	11 728	11 097	11 156	10 522	69	
EU-9	15 320	13 572	12 291	11 689											

Note: Farm types were defined until 2000 on the basis of standard gross margin (SGM) (http://ec.europa.eu/agriculture/nica/detailtf_en.cfm?TF=TF14&tf_Version=11990) and afterwards on the basis of standard output (SO) (http://ec.europa.eu/agriculture/nica/detailtf_en.cfm?TF=TF14&tf_Version=13185). The definition of farm types differs slightly between the two systems. Moreover, the results for similar farm types can be quite different. Therefore, it does not make sense to compare the results of these two methodologies. In the table, data are presented until 2007 because Eurostat continued to calculate both types of results up until this year but then stopped. Later comparisons are no longer possible.

The reference year is the first year of record.

Source: European Communities, 2000; Eurostat 2010 (Farm Structure Survey 2007) and authors' own calculations.

Table 39. Changes in the number of holdings and average holding size per holding type in the EU-9 between 1975 and 2007.

	(numbers in '000)										Proportion total holdings (2007)			Holding size		
	1975	1979/80	1985	1990	1995	2000	2005	2007	2007/1975	(%)	(%)	1975	1997	2007	1997/1975	2007/1975
												(ha)	(ha)	(ha)	(%)	(%)
Specialist field crops	1 049	1 143	1 148	1 104	1 021	871	752	700	67	22	22	17	26	37	151	222
Specialist grazing livestock	1 583	1 575	1 471	1 310	1 205	1 013	899	862	54	27	27	23	30	40	133	178
Specialist dairying	786	766	658	517	395		223	28	28	7	7	18	36		197	
Specialist cattle rearing and fattening	246	254	275	253	267		239	97	97	8	8	23	27		115	
Cattle-dairying, rearing and fattening combined	239	178	130	74	57		41	17	17	1	1	22	45		203	
Sheep, goats and other grazing livestock	311	377	408	466	487		358	115	115	11	11	33	25		76	
Specialist granivores	87	78	82	63	70	55	53	54	63	2	2	5	14	23	261	437
Mixed cropping holdings	620	568	505	414	339	280	201	197	32	6	6	9	11	13	126	151
Mixed livestock holdings	464	277	254	165	126	87	65	57	12	2	2	14	22	35	154	249
Mixed livestock, mainly grazing livestock	377	222	193	123	82		35	9	9	1	1	14	22		150	
Mixed livestock, mainly granivores	87	55	61	42	44		22	26	26	1	1	13	22		167	
Mixed crops-livestock	782	598	502	412	336	265	209	190	24	6	6	20	37	55	187	282

Source: European Communities, 2000; Eurostat 2010 (Farm Structure Survey 2007) and authors' own calculations. See note from Table 35.

► Interviews with farmers and interactions between farmers and research

Interviews with farmers

This section provides examples of farms exploiting various types of grasslands in a wide range of environmental conditions and for a broad range of production. The farmers analyse the potential of grasslands and the challenges they face to get the most out of their grasslands.

This section contains 16 interviews:

- Mr and Mrs Florencio Gómez, Cantabria, Spain;
- Mr Antón Álvarez, Sevilla, Asturias, Spain;
- Mr and Mrs Olivier Houard, Wallonia, Belgium;
- Mr Eddie O'Donnell, Golden, Co. Tipperary, Ireland;
- Mr and Mrs Gilles Amiot, Poitou-Charentes, France;
- Mr Alphons Stienezen, Gelderland province, the Netherlands;
- Mr and Mrs Reinhard and Hildegard Schmalengruber, Styria province, Austria;
- Mr and Mrs Anders and Anna Carlsson, Halland, Sweden;
- Mr Eric Bonnabry, Auvergne, France;
- Mr Henryk Brzóška, Wielkopolskie province, Poland;
- Mr and Mrs Niko and Ema Lesjak, Mozirje, Slovenia;
- Mr and Mrs Roland and Anita Hensler, Baden-Wuerttemberg, Germany;
- Azienda Agricola Nascimben Valter e C., Friuli Venezia Giulia, Italia;
- Farm Samsa, Rural Park Altire del Polazzo, Friuli Venezia Giulia, Italy;
- Mr and Mrs Pascal and Edith Capele, Brittany, France;
- Mr Miroslav Greško, self-governing region of Banská Bystrica, Slovakia.

This section clearly documents the many conditions under which grasslands are grown and used, illustrating the importance of considering biophysical conditions when assessing the performances of grasslands and evaluating the impact of policies. It also demonstrates how the farmers have adapted their management to their environment, by optimising grassland management, animal husbandry techniques, the use of animal products or the search for new economic possibilities.

Without a doubt, these examples show that farmers are very committed to the management of their farm, their grasslands and their animals. They not only take into account agronomic and economic performances, but environmental issues as well. The social dimension is often present both through the workload but also the farm's integration in the economic and social conditions of the regions in which they are located. These are very good examples of the outstanding richness of the study of grasslands in Europe.

Mr and Mrs Florencio Gómez, Polaciones, Cantabria, Spain

Florencio Gómez and his wife Silvia Camafreita run a sheep farm in the municipality of Polaciones (administrative region of Cantabria, Spain). Cantabria is located within

Europe's Atlantic biogeographical region. The whole municipality of Polaciones (90 km²) is part of a Natura 2000 Site of Community Importance (SCI 'Valles Altos del Nansa y Saja y Alto Campóo'; ES1300021). Major habitats characterising this site are dry and wet heathlands and acidophilus beech forests. Wolves and bears are the most remarkable wild mammals existing in the area. Polaciones is one of Cantabria's most unpopulated municipalities, with a density of 2.8 inhabitants per km². Around 60% of the active population works on livestock farms.



The 38-year-old Florencio inherited his family sheep herd ten years ago. In addition to cattle, his family had always owned sheep and he remembers having sixty sheep some twenty years ago. When he took charge of the sheep farm, the herd had approximately one hundred animals. He has always kept sheep from the Latxa breed, which is autochthonous and perfectly adapted to the wet climate and rough vegetation of the mountains of northern Spain. In terms of livestock, farm production and management has always been based on a single annual winter lambing period adapted to the strong photoperiod effect on the anoestrus of the Latxa breed. Lambs are kept with their mother up until the beginning of summer, when they are sold for meat. Outside of the lambing season, the herd usually grazes in the permanent grasslands and shrub vegetation communities that characterise the mountainous agro-ecosystem of Polaciones valley.

Slowly but steadily, the farm has grown both in terms of land managed and livestock numbers over the last ten years. Today, the herd has 300 animals: 235 ewes, 50 ewe lamb replacements and 15 rams. Some rams are regularly bought from other farms, but the ewes are almost always replaced from within the herd. In terms of pastureland, the farm manages 30 ha of privately owned permanent meadows, and has grazing rights for higher common land belonging to the village where the farmers live. This common land covers nearly 600 ha, 38% of which is forest (beech and oak) and 54% of which is dominated by heath-gorse-bracken mosaics. Only 5% of this common land is grassland, mainly of the *Violion* kind. The abundance of shrub vegetation on common land reflects the decreasing importance of this resource, the sharp drop in rural populations living directly from the land and changes to the livestock systems currently practised, in particular, the dramatic decline in the number of small ruminants, sheep and goats.

In terms of manpower, Florencio takes care of all farm activities. Silvia helps him with the extensive paperwork needed to apply for subsidies and for regional farm inspections. In summer, Silvia, Florencio and Florencio's brother, who owns a beef cattle farm, work together to mow the meadows and produce hay for both farms. Silvia also has a part-time job.

The objective of the farm has always been to sell lambs. They initially sold the lambs at five months of age, at the end of spring. They now sell lambs at three months to satisfy the demand of their main client, a restaurant and catering chain based in the city of Santander that specialises in local and organic foods. Since Florencio took control of his farm, they have always sold directly to the final customer, thereby avoiding intermediaries.

Shortly after commencing his career as a professional sheep farmer, and taking advantage of the low external inputs required by his family's livestock farm and other farms in the valley, Florencio and other neighbouring farmers decided to become organic livestock enterprises. Florencio and Silvia have continued with this type of farming system ever since.

All the meadows of Polaciones are permanent grasslands, and most of them are still species-rich grasslands. The late (summer) hay cutting regime, low doses of solid manure fertilisation, 'open grazing' management from autumn to spring, and proximity to forest patches and hedges ensure these species-rich grasslands are maintained. As a result of the relatively recent introduction of bale silage making and the change from manure to slurry production on some cattle farms, many of these swards are becoming less diverse and increasingly dominated by a few grass species. The future regional plan to limit properties in Polaciones to fewer lots of larger dimensions is also a threat to the traditional open grazing system still used today.

The valley's other important forage component is the common land. Grasslands here are permanent and mainly correspond to the *Violion* and *Cynosurion* phytosociological alliances. As previously mentioned, the common land used by Florencio and Silvia's sheep has little grassland, and is dominated by heath-gorse-bracken patches, generally in mosaic with herbaceous vegetation. The presence of these shrubs can be explained by abandonment, improper management (mainly uncontrolled burning) and the lack of livestock with good grazing capacity.

Outside of the lambing period in January and February, and as long as the land is not covered with snow, the herd is left to graze during the day as much as possible. During the lambing period, ewes go outside for a few hours, but stay with their lambs in the stable most of the time. From September to December and in March, the sheep and other livestock herds share the open fields close to the villages where Florencio and Silvia have some meadow lots (altitudes of 800–1 000 metres above sea level). This traditional agricultural system ensures good maintenance and fertilisation of all the grasslands close to the villages, and also provides a significant part of herds' nutritive needs. In April, meadows are closed to grazing and the herds move to the common rangelands at higher altitudes. From April to May, the sheep graze on the lower part of the common land (900–1 100 m) and, from June to September, they move to grasslands at higher altitudes (up to 1 400 m). At night, the herd is always shut into barns, except during summer. The herd is always watched over by an additional "small herd" of guarding dogs (today seven Mastin dogs), which keep a constant eye out for wolf attacks. Expenditure on dog food is not insignificant.



Each of Florencio and Silvia's meadows are fertilised with their own solid organic manure once every three years, normally in autumn, when it is still possible to distribute it mechanically. The doses applied at each application are around 5 t (DM) of sheep manure per hectare, which could account for up to a maximum of 150 kg N/ha.

Mowing starts in June, when the weather is more reliable and livestock is already in high altitude areas and needs less care. In good years, Florencio and his family finish mowing in early August, but in wet and cloudy summers like in 2011, work continues until the end of September. All of their meadows are cut just once a year. All the cut forage is conserved as hay, making small square bales of 15–20 kg each. Last summer, they produced around 8 000 bales.

The grazing system characteristic of these mountains, featuring regular use of common resources and even the sharing of private resources, makes it difficult to calculate a single farm's stocking rates. If one sheep is equivalent to 0.14 LU in private meadows, the current stocking rate for Florencio's farm would be 1.4 LU/ha. This value would have to be revised to take into account the open grazing system practised during half of the year. On the common land, when the additional presence of 350 cows and 80 horses is considered, the stocking rate would be 1.3 LU/ha, although the variability in the quality and productivity of existing forage resources makes it difficult to evaluate possible situations of under and over-grazing at more detailed spatial scales.

Milk production is only used for lamb feeding. Milk production in non-improved Latxa is around 50 l per lactation. An important genetic improvement programme developed mainly in the Basque Country shows the potential of the Latxa breed with respect to milk production with average production of over 150 l per lactation. Ewes are first mated when they are one and a half years old. The breed and the management technique promote few twin births, which are generally not desired by the farmer, as they increase the labour required during the lambing period. The annual lamb mortality rate is 10%. Ewes on the farm are kept for an average of six years.

One month before lambing and during the first two months of lactation, ewes' feed is supplemented with an average of 300 g/d of whole oat grain. The cereal is bought directly from an organic cereal farmer in Castilla (100 km away). During this period,

sheep also receive an average of 3 kg hay per animal. Lambs are reared without any additional supplementation apart from what their mothers receive. From two months of age, their grazing intake starts to be significant, which is reflected positively in the quality and organoleptic properties of their meat.

In the last few years, lambs have been killed at 3 months of age (8–10 kg carcass weight) without any final fattening period. Lambs are slaughtered at an abattoir 40 km from the farm. The farmer transports the lambs himself, in groups of 20 lambs each time on average. From the abattoir, the meat is sent to the farm's main client in Santander (105 km from the abattoir). This company processes and conserves the meat for future use in its restaurants and catering business. It markets the product emphasising its origin and production methods (www.deluz.es). Florencio and Silvia are very proud of their farm business. They consider that their initial decisions to rear sheep (instead of opting for the mainstream beef cattle system) and to adopt organic standards were worth it, in terms of productivity, acceptance of their unique products in the market and societal recognition for conserving mountain agro-ecosystems. This last aspect accounts for much of the farm's monetary income, as they receive support for some of the agri-environmental measures currently implemented in the Cantabria region: maintenance of natural meadows, grazing in communal summer pastures and organic farming. They have also worked with regional authorities on various research and practical projects that aim to restore nearby species-rich *Nardus* grasslands (priority habitat 6230 in Directive 92/43) through sheep-targeted grazing management.

The couple plans to continue increasing the number of animals and area managed. They fix a maximum mid-term target of around 600 sheep, which would require investing in a new stable and renting more meadowland. They are also thinking about introducing goats to their herd, as there is an important feeding niche for this type of livestock in the common land (heath and gorse). There is also considerable demand for goat kid meat in the current market. In addition, they are starting to receive offers for their organic products from potential buyers, which would allow them to diversify their pool of clients. In terms of equipment and forage management, they are starting to consider investing in silage making machinery, in order to improve the efficiency of one of the chief livestock system challenges in this oceanic mountain region, a major producer of good, conserved forage.

Finally, the question of inheritance has not yet come up, as they still do not have any children. Nevertheless, they enjoy their profession and would be happy if future descendants carried on their activity.

Authors and photographers: Juan Busqué, María V. Campos, Rommel Moros, Gema Maestro and Manuel J. Mora, Centro de Investigación y Formación Agrarias. Gobierno de Cantabria (www.cifacantabria.org)

Mr Antón Álvarez Sevilla, La Braña, Biedes, Las Regueras, Asturias, Spain

The Xalda is an endangered sheep breed mainly located in Asturias (northern Spain). This breed has a marked cultural and aesthetic importance. The Xalda sheep may be considered a Celtic sheep breed, like the French Ouessant and the British Black Welsh and Moorit. In 1980, barely 800 pure-bred reproductive females remained. During

the 1990s, breeders undertook a major effort to recover isolated herds and individual animals by starting pure breed mating. Since 1992, breeders have been members of the Association of Sheep Farmers of the Xalda breed (ACOXIA, www.xalda.com), which is responsible for the breed's herd book.

Xalda sheep are typically small and white, black or, less frequently, dark grey in colour. Black and grey animals frequently have spots on their foreheads. There is no wool on the face (except a little tuft on the head) or on the legs below the knee and hock. The rams are typically horned and the females are polled (hornless).

Antón Alvarez started in 1982 with 25 ewes and one ram of the native Xalda sheep breed on 2.5 ha of land. He is the owner of the farm and manages the farm by himself. Today, the farm has 9 ha of grassland with five paddocks, and the flock includes 136 ewes and 2 rams of the Xalda breed. Lambs are sold for meat at 5 months of age with a 7.5–8 kg carcass weight. All milk production is for the lambs.



There are only permanent, extensive and species-rich grasslands and no forage crops. The grassland type is of the Molinio-Arrhenatheretea class and the Arrhenatheretalia order, with plant communities denominated as xerophytic grasslands and meadows. These communities are excellent as grazed or mowed grasslands suitable for use in farming. They are found in Eurosiberian mesophytic grasslands that penetrate the areas of heaviest rainfall and occupy soils that do not completely dry out in summer. The most characteristic species are *Agrostis capillaris*, *Anthoxanthum odoratum*, *Cynosurus cristatus*, *Dactylis glomerata*, *Festuca group rubra* and *Trifolium repens*, among others.

In terms of rotational grazing management, the flock is kept in fenced paddocks all year long. The stocking rate is 2.1 LU/ha grassland for animal nutrition. Sheep manure is the only source of fertiliser. During summer, 2 ha are cut once for hay and 250 rectangular 30 kg hay bales are harvested (3750 kg hay/ha). The farmer has almost no machinery and pays a contractor for cutting and baling the hay.

At the end of September, the farmer uses Gales breed ponies (seven females and one male) to clean the grassland of species with low nutritive value.

The ewes are always in paddocks, except in winter (December to March) when lambing. During the lambing period, the ewes are placed every night in “lambing sheds” without roofs to keep out predators, mainly foxes. The farmer manages one or two groups of animals during the year: in June he separates the male lambs (from the ewes and the ram) to be sold at five to six months of age. These male lambs are kept isolated in a paddock. Of all male lambs from the ACOXA association, 3% are selected for breeding. Ewes may lamb once (December to March) or twice (December to March and July to August). One ewe usually has one lamb per birth. A Xalda ewe can give birth up to 13 to 16 years.

Lambs only eat milk and grass and no concentrates. The lambs are sold to different Asturian groups: Crivencar (www.crivencar.com) and Tierra Astur (www.tierra-astur.com), part of the Slow Food International organisation.

The native Xalda sheep breed has made considerable progress. In 1982, only one farmer was a member of the ACOXA association; today there are 170 farmers. In 2003, the Spanish Patent and Trademark organisation approved a ten-year grant for the private ‘Xalda lamb’ brand. This ensures product traceability for the consumer. The most important milestone with respect to the defence and promotion of the race was reached in 2007 when the Slow Food International organisation approved the Xalda sheep as part of the so-called ‘Arca del Gusto’ (Ark of Taste). The ACOXA association’s challenge is to create a flock of 8 000 breed ewes to ensure the Xalda breed avoids extinction.

Mr Álvarez wants to increase his farm area to manage around 200 ewes and will continue this way of marketing the lambs. So far a successor (in the family) has not been found.



Author and photographer: Jose Alberto Oliveira Prendes, University of Oviedo, Mieres, Spain

**Mr and Mrs Olivier Houard,
Bomal sur Ourthe, Luxemburg province, Wallonia, Belgium**



The farm was established in 1754. In 2000, Olivier Houard started managing it part-time with his father. At that time, the cattle herd included about 100 Belgian Blue (BB) beef cows and 40 Holstein dairy cows. In 2000, he set up a butcher's shop in order to carve his own carcasses and sell the meat, hoping to reduce intermediaries and increase his income. In 2002, he converted farm buildings listed as part of the Walloon region's architectural heritage into guest rooms and a cottage. In 2007, he opened a restaurant on his farm, and in 2008, he took charge of the entire farm. At that time, he decided to open a shop on the farm, where he could sell his own products such as meat, eggs and other local products from other farms (for example, cheese). The herd of dairy cows was sold at the same period, because of the considerable manpower required for all these activities.

In 2012, the farm covered 120 ha. This area includes 87 ha of permanent grasslands, 18 ha of forage maize and 15 ha of cereals (spelt, winter wheat and winter barley). The BB beef herd includes 105 cows, 45 heifers and 30 young bulls.

BB cows are artificially inseminated in order to improve herd genetics at a faster rate. All animals have the 'double-muscle' gene. Heifers first calve at between two and two and a half years of age. Calving is always by caesarean and takes place year round. Cows are usually retired after four calves at about six years of age. Calves are weaned just after birth, which facilitates a faster oestrus recurrence in cows. Moreover, BB cows do not produce enough milk for calves. These are first fed with milk powder, then with hay and corn. The first year, they do not graze but are kept indoors. Then, only heifers graze while bulls stay in the stable. Bulls are put in lots of four. Each lot is made up of either fattening or breeding bulls. Four to five breeders are sold each year. Each month, two 18-month-old bulls are slaughtered at a nearby slaughterhouse for use on the farm. Their live weight is about 650 to 700 kg with a carcass weight of about 500 kg. The selling price (2012) was €3.3/kg carcass.



Two kinds of concentrates are used. The first one (farm concentrate) consists of 20% spelt (*Triticum spelta*) produced on the farm as well as other supplements and vitamins provided by the mill. The second concentrate contains 19% protein and vitamins. It is only used for fattening bulls.

In summer, cows and heifers graze. Pregnant cows are fed with spelt and a protein supplement one month before calving. Heifers are fed with 2 kg of farm concentrate each day. Fattening bulls do not graze but receive maize silage, hay, straw and 12 kg of each kind of concentrate per day all year round. In winter, cows are fed solely on maize and wilted grass silage.



The herd grazes from early May until mid-November. It is split into three groups: pregnant cows, dry cows and heifers. Two grazing methods are used. The frontal stocking method is used on 22 ha divided into 14 plots for the 45–50 dry cows. This method is used for checking the return of heat. The plots assigned to pregnant cows and heifers are managed using a rotational grazing method. Under this system, 20 cows graze on 3 ha every day.

The permanent grasslands are cut between grazing periods and depending on grass availability. Forty hectares are harvested in the beginning of May, about 25 to 30 ha in mid-June and about 15 ha between the end of August and beginning of September.

Fertiliser is spread before the first cut, between the end of April and the beginning of May. A complex fertiliser (18–6–5) is used and, after the first cut, a pure nitrogen fertiliser (27–0–0). Half the fodder is preserved as hay and half as silage. Hay is given priority, when possible.

Income from activity diversification is reinvested in these activities or in new projects. In the future, Mr Houard does not want to expand the farm's land area. In the past 10 years, meat prices have remained stable while feeding, fertiliser and fuel prices have constantly gone up. The cost of agricultural production has become too high. Consequently, agri-tourism is playing a bigger role on the farm. The next project is to build new, higher-end guest rooms in the old milking building.

Author and photographer: Alain Peeters, RHEA, Belgium

Mr Eddie O'Donnell, Golden, Co. Tipperary, Ireland

Eddie O'Donnell began farming in partnership with his father, Denis, in 2005. At that time the holding was 58.7 ha with 70 dairy cows and followers. The milk quota owned was 363,687 litres. In 2006, another farm was bought with an associated quota, and further land was also leased this year. Eddie started to milk cows on this second leased to grow his herd size. In 2009, additional land was leased attached to the home milking block, while some land that had previously been leased was dropped. Milk quota was also purchased through the milk quota exchange, primarily from Kerry Group Plc. In 2011, 210 cows were milked altogether between the home farm and the leased farm. The current land base is now 121 ha and the milk quota owned is 1 072 877 litres. Milk is supplied to Dairygold Co-operative and Kerry Group Plc. The farm currently has 225 dairy cows, 70 in-calf heifers, 100 0–1-year-old heifers and 15 bulls. There are 2.5 labour units on the farm.

The entire herd is under spring calving, with cows calving from 1 February to end of April. Milk production per cow is 5500 kg/cow/lactation at 4.10% fat and 3.60% protein. Approximately one-third of the dairy cows are Jersey × Holstein-Friesian (50/50), with the remainder being Holstein-Friesian. The breeding season on the farm is 13 weeks, starting on 25 April. Artificial insemination is used for the first 9 weeks, and after that a Jersey or Friesian stock bull is used. Heifers calve at 22–24 months of age. Bull calves are sold off the farm as soon as possible after birth. Cull cows are usually fattened and sold to a meat factory.

The farm is entirely under grass except for 4.5 ha of kale sown annually at the end of May and grazed *in-situ* by young stock (0–1 year olds) over winter. The grass species

sown on the farm is perennial ryegrass (*Lolium perenne* L.) with cultivars such as Tyrella, AstonEnergy, Portstewart and Navan sown in recent years. Seed mixtures are used with a mix of diploid and tetraploid cultivars. Ninety percent of the farm has been reseeded in the last four years and the policy on the farm is to reseed at least 15% annually to maintain productive high quality swards.

Cows are turned out to grass full-time (day and night) on 1 February, once they calve. Cows remain full-time at grass until 15 November, after which they are housed by night and out at grass during the day until 26 November. On-off grazing is used during very wet weather when soils become very soft. This involves turning cows out to grass for approximately three hours after morning and evening milking, and standing them off the paddock in a shed for the remainder of the day. The target farm closing grass cover is 500–550 kg DM/ha, and the target opening farm grass cover is 650–700 kg DM/ha, though this will vary depending on grass growing conditions over winter. Rotational grazing is practised on this farm. The first rotation commences on 1 February and is completed on 1 April. From 1 April to 25 August cows graze in an 18–20 day rotation. From 25 August, rotation length is increased and peak farm grass cover is achieved at 1 100 kg DM/ha on 1 October.

The farm is walked each week to measure farm grass cover (i.e. the quantity of grass available on each paddock). A grass budget and grass wedge are then completed so that grass surpluses or deficits can be identified early and appropriate action taken. The farm grows about 14.5 t DM/ha annually.

Between 300 and 400 kg of concentrate are fed per cow each year. This varies depending on grass supply, especially in spring when most of the concentrates are fed.

Approximately 240 kg N fertiliser per ha are applied each year between 15 January and 15 September. Slurry is recycled onto both grazing ground (especially in early spring) and silage ground. Silage ground is grazed in early spring and is then closed with first cut silage harvested around 26 May; second cut silage is made around 20 July, and surplus grass is removed from the grazing area as baled silage. Between 70% and 75% of the silage is made as first cut, with second cut and bales making up the rest.



The farm stocking rate is 2.5 LU/ha. On the milking platform (i.e. the area that the milking cows graze), the stocking rate is higher than 4 LU/ha from mid-April until around 20 June, after which it drops to 3.5 LU/ha until after second cut silage is made. The overall annual milking platform stocking rate is approximately 2.6 LU/ha.

A five-year plan has been in place on the farm since 2006. It is reviewed annually and renewed approximately every three years. The five-year plan is used to steer the business and set targets. Two key areas which will be focused on in the future are (1) making the farming operation more efficient, and (2) learning how to better manage labour employed on the farm.

The main challenge on the farm is milking cows in two separate milking parlours. Quota constraints have limited the expansion of the farm and it is hoped that once quotas disappear in 2015 the true potential of the farm can be realised.

Away from the farm, Eddie has been actively involved in the young farmers' organisation, Macra na Feirme, in the past. In 2006, he was named the FBD Young Farmer of the Year. He also won a Macra Leadership Award in 2007, and has won All Ireland titles in Farm Skills Competitions and Know your Agriculture. He is a council member of the Irish Grassland Association and is currently the chairman of the Blackwater Discussion Group.

Author and photographer: Deidre Hennessy, Teagasc, Ireland

Mr and Mrs Gilles and Catherine Amiot, Chey, Deux Sèvres, Poitou-Charentes region, France

Mr and Mrs Amiot started their farming activity in 1987, on a 50 ha farm mainly oriented towards goat milk production. They work in close collaboration with a neighbour who is also involved in goat milk production and uses a similar production system.



After stopping their rabbit production in 2009, the Amiot's increased their goat herd to 300 goats of the Alpine and Saanen breeds (50/50), one-third with artificial insemination and a 30% replacement rate. Mean milk production is 800 l/goat, and the milk which was previously sold to a cooperative is now mainly sold to a local cheese factory (Fromagerie des Gors in Melle, for the production of Chabichou and goat cheeses). While births were mainly in January and February, the herds will now be divided into two flocks with births in early spring and autumn, in order to meet the milk needs of the cheese factory.



The farm is located in the Poitou-Charentes region of France, near the springs of the Sèvre Niortaise River at an altitude of 155 m. The clay soils, named red soils, are either shallow (flint red soils) or deep. The soil water capacity ranges between 50 and 100 mm for these two soils types, respectively. The climate is influenced by the Atlantic Ocean, with mild and wet winters followed by warm and often dry summers. The sunshine duration is very high. These conditions are favourable to agricultural and forage production. For instance, on the deep red soils, the dry matter production of lucerne exceeds 10 t/ha every year.

Unlike at most goat farms in the region, goats now graze during the day and are fed fresh forage in the barn at night. Previously, they were fed maize silage and lucerne hay. Fresh forage is distributed using a forage loader wagon. The grazing period starts in early March and ends in October or November depending on the autumn drought or the parasitic risk. For unseasoned goat flocks (autumn births), there is no grazing during the mating period.

This dual feeding system using grazing and fresh forage in the barn is a very efficient way of meeting animal requirements and reducing parasitic risk, which is critical when grazing is the sole feeding method. Presently, a single anthelmintic treatment is administered when goats dry up.

In addition to fresh forages, goats are given ad libitum lucerne hay for high quality dietary fibre and concentrate up to 600–750 g/goat/day. This concentrate supplement includes 400 g of cereal grains (50% maize and 50% triticale) and 200 g to 350 g of production concentrate at 18% protein. When fresh forages have low N content, an N supplement is added.

The farm rotation includes temporary grasslands that are either grazed or harvested, artificial grasslands (for lucerne hay production) and annual crops (maize, triticale and sunflower). To get high quantities of fresh forage in early spring, Mr and Mrs Amiot

also sow, in autumn, short duration forage crops with Italian ryegrass. Additionally, intermediate crops provide an extra source of biomass. In this respect, an agreement has been reached with a cereal farm nearby. Rotational grazing is the rule to maximise available biomass.

For a long time, the grasslands mainly featured cocksfoot, which performs extremely well in these soil and climate conditions, with a persistence of over eight years. However, this grass species is very vigorous and hence detrimental to the persistence of other species and especially legumes. Currently, the Amiets primarily use multi-species swards combining grasses (tall fescue and perennial ryegrass) and legumes (white clover for grazing and lucerne when cut for fresh feeding). Thus, converting the cocksfoot grassland into multi-species grasslands makes management easier and better meets animal requirements. This leads to an increase in milk production and reduces the digestive problems that often occur in goat production when transitioning between paddocks.

Moreover, the proportion of legumes makes it possible to reduce mineral N fertilisation, which is now only 30 N in early spring to avoid excess legumes. Compost produced from manure is sprayed on annual crops and helps reduce N fertilisation, which is now below 100 N/ha.

The landscape is an open field landscape, typical of the region. This makes it impossible to provide shade on all grazed paddocks. The goats, especially the Saanen goats, are vulnerable during hot and dry summer periods. As a consequence, special care is taken of the animals, and grazing duration is reduced.

Mr Amiot takes care of soil management and tilling when establishing grasslands or annual crops, in order to preserve soil structure and avoid compaction. As a consequence of the adapted management of rotations and soil structure, grain yields of annual crops are maintained or even improved (in the case of sunflower), with lower N fertilisation and pesticide use.





The main expectation for multi-species swards is to achieve technical and economic performance while ensuring high energy and the farm's protein self-sufficiency in addition to reducing risks when transitioning between paddocks. It is also necessary to consider environmental preservation and workload, as the present system combining grazing and fresh feeding in the barn has more constraints. The management of multi-species swards is complex and requires considerable technical know-how. Partnerships with research and extension services must lead to the implementation of decision-making tools, especially during the planning period (when choosing species, variety, sowing rates and management techniques). Paddock management is carried out in such a way as to meet daily animal requirements. The economic and environmental performance of the Amiot's farming system is a result of its complexity, and thus their technical expertise. Research must provide simple management tools for complex issues.

Author and photographer: Christian Huyghe, INRA, Lusignan, France

Mr Alphons Stienezen, Kilder Montferland, Gelderland province, the Netherlands

In the early 1930s, Alphons' grandfather bought this farm. At that time, the farm had 1.5 ha of agricultural land and five dairy cows and was run part-time. Alphons' father continued running the farm part-time. When Alphons took over in 2004, the farm had about 45 ha of agricultural land (10 ha maize, 35 ha grasslands) and 40 dairy cows. Alphons runs his farm part-time; he also works 30 hours a week for a company that sells agricultural seeds and plant protection products. The majority of the farm is situated on sandy soil. Only 10 ha of permanent grassland is located on clay soil.

On the 35 ha land area, temporary grassland kept for six to eight years, followed by one year of maize. Maize grassland is sown using a mixture of between 40% and 60% tetraploid ryegrass, 15% timothy and 25%–45% diploid ryegrass. The species are selected for persistence. Every year *Stellaria*, *Taraxacum* and *Rumex* are sprayed.

In spring, the grassland is harrowed. Moles are controlled when needed. The grasslands receive about 300 kg N/ha/yr (N manure utilisation included). Alphons emphasises that the manure is applied in *early* spring to profit most from N utilisation. Manure is spread to promote growth of the first two cuts. Nitrogen fertilisation decreases rapidly toward autumn. Other nutrients, such as P, K, S, Mg and lime are applied in line with Dutch fertilisation guidelines for grassland and fodder crops (www.bemestingsadvies.nl). Soil is analysed every four years. On average, there are five cuts/ha/yr. First, grass is mown completely for silage. After this first cut, dairy cows graze continuously on 10 ha of grassland, which is situated near the farm. Approximately 50% of dry matter intake is fresh grass. Then the other 15 ha is mown completely for silage. After this second cut, young animals graze part of this area and the other part is mown. The first and second cuts are ensiled on top of each other (silage stack). The third cut is ensiled separately, and the fourth and fifth cuts are again ensiled on top of each other (silage stack). After the fifth cut, grassland is prepared for winter. “Mown today, ensiled tomorrow” is Alphons’ rule for making silage. The grass is cut with a mower-conditioner, optionally tedded, then raked and ensiled using lactic acid additives. These additives are also used when ensiling silage maize. The 10 ha of permanent grassland is extensively used as hay land. There are one or two cuts a year, usually taking place in the middle of July (from the beginning of July until the beginning of August).



At sowing, the maize receives manure (45 m³/ha) adjusted with a P-K fertiliser. Whether the maize is harvested for maize or corn depends on the stock of feed on the farm and fodder prices on the market.

Over the years the animal bred has developed from a Maas-Rijn-Ijssel type to a Red Holstein Friesian type. Alphons uses the triple A system for breeding. The average age at calving is 26 months. The average milk production is 9 000 kg milk/cow/yr with 4.40% fat and 3.55% protein. Concentrate costs an average of €0.04/kg milk. For every 10 dairy cows, 11 young female animals are kept. The excess female animals are sold

as pregnant heifers at an age of about 26 months. Young bulls are sold at the age of fourteen days. The dairy cows are fed a mixed ration of concentrates, grass silage, maize silage and hay ad libitum year round.



In winter, the farmer feeds the stacked silage and, in summer, silage from cut three. Silage from cuts four and five is for young animals and dry cows. Alphons says, “To get good milk production from grass silage, it is essential that young animals are fed roughage [silage and hay] in order to develop the rumen function.”

Alphons is pleased with the good quality fodder that he obtained in 2011 despite the rainy weather. His challenge is to manage the farm so that cows are in good condition and no health problems occur. When the cows do well it is possible for Alphons to combine his farm with his outdoor job. His objectives for the future are to increase the herd size to about 60 cows as soon as the EU quota system ends in 2015, and to install a milking robot.

Authors and photographer: M.W.J. Stienezen, A. van den Pol-van Dasselaar, G. Holshof, Wageningen Livestock Research, Wageningen, the Netherlands

Mr and Mrs Reinhard and Hildegard Schmalengruber, Aigen im Ennstal, Styria province, Austria

Reinhard Schmalengruber inherited the farm from his parents in 1984 and has built up the Thonnerhof (most Austrian farms have their own name) to be a modern mountain farm. The Thonnerhof, located in the municipality of Aigen im Ennstal at 1000 m above sea level is an organic dairy farm that is typical of grassland farming in mountainous regions of Austria. Twenty hectares of permanent grassland (mown or grazed two to three times per year) is used for agriculture, of which 19 ha is his own property. With the exception of the leased area that is located in the valley, the meadows and pastures

surrounding the farmhouse are extremely steep (with gradients of up to 50%). It really is incredibly challenging to farm the grassland. Most of the area is managed with special and very expensive machinery, which can only be used during dry conditions mostly along the slope line. The Thonnerhof has 295 points in the so-called mountain farm cadastre system, which classifies mountain farms in Austria according to the difficulties of management (steepness, distances, infrastructure, etc.). The Thonnerhof is in the system's highest bracket but there are farms in Austria with even more cadastre points (maximum of 570).

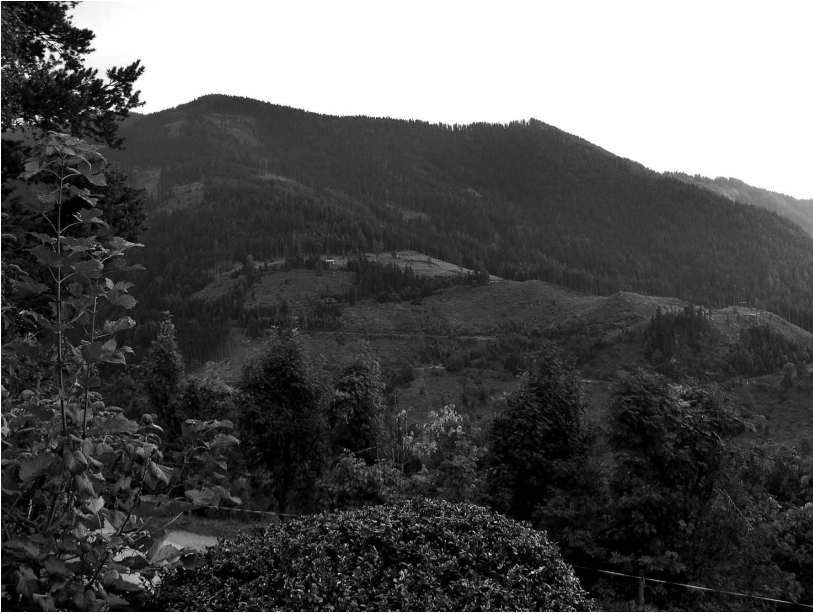

The Schmalengrubers manage a herd of 14 dairy cows (Simmental — this is still the main cattle breed in Austria) with heifer calves (bull calves are sold at the age of two weeks to fattening farms). The farm milk quota is 60 000 kg per year and milk is collected at the farm and taken daily to the dairy company at Stainach (15 km away). In summer, the cattle are out to grass and receive additional hay. In winter, the ration consists of hay, silage and concentrates (maximum of 500–600 kg of a mixture of cereals per cow and year). Milk production is therefore mainly based on home-grown forage, which has to be of high quality. The grassland is fertilised with slurry, spread with a special hose system in spring and after each cut. Some stable manure from young stock is applied in the autumn. In 2008, the existing stable was rebuilt and transformed from a stanchion barn to a loose housing stable with an automatic manure removal system. Now milking is done in a swing-over parlour.

The Schmalengrubers are still full-time farmers but also rely on other sources of income, for example from farm holidays and forestry. They manage 50 ha of their own forest — they do nearly all the work themselves. Round timber is sold to sawmill companies and pulpwood goes to the paper industry or to local heating stations. For 40 years, farm holidays have been central to total farm income. Over the last few years, there has been some investment in this area and today the Schmalengrubers offer holiday flats — guests are warmly welcomed and spend their holidays in a beautiful, quiet location with an incredible view of the Enns Valley and surrounding mountains. Traditional

home-made products such as yoghurt, soft cheese and rye doughnuts are served to the guests and a special children's programme is offered, including a children's zoo and an educational forest programme to teach children about the function of forest ecosystems (Mr Schmalengruber is a certified trainer in this field of activity).



Mr Schmalengruber also is the vice-chairman of the regional agricultural chamber and is actively fighting for the maintenance of mountain farming both to keep up the wonderful cultural landscape and the existing infrastructure.



In disadvantaged mountainous regions, it has become more and more difficult to find successors who are willing to keep on farming under such challenging site conditions. The Schmalengruber family has three sons who alongside with their professional activity or education are still very involved in farm work. The youngest son Roland is attending an agricultural school and is highly motivated to follow his parents as a mountain farmer.

Author Erich Pötsch, Agricultural Research and Education Centre Raumberg-Gumpenstein, Austria

Photographer: Alex De Vlieghe

Mr and Mrs Anders and Anna Carlsson, Skogsgård, Getinge, Halland, Sweden

Anders Carlsson inherited Skogsgård farm from his parents in 1995. At that time, the holding was a typical 70 ha dairy farm with 30 ha of forest. In 1992, Anders and his parents built a new barn for 100 cows with a milking parlour. Anders and his wife Anna started organic production in 1995, with the organic milk first delivered to Arla Foods in July 1996. As of 2012, the farm had 140 cows (8 000 l ECM, 3.9% fat, 3.3% protein/cow and year) and 30 ewes on marginal areas, and the family farms a total of 205 ha arable land (in 2010, about 31 ha spring wheat/oats, 2 ha winter wheat, 4.5 ha mangolds and 168 ha temporary grassland for silage and grazing), 70 ha of which is owned and the rest rented, plus 30 ha semi-natural grassland and 30 ha forest. All crops are certified according to KRAV organic standards, adapted to the IFOAM Basic Standards, and all crops produced are used as feed on the farm. The stocking rate varies with the season, and ranges from 2 to 6 LU/ha. The farm has two to three full-time employees, cooperates with neighbouring farmers for harvesting and hires a contractor for seed drilling and slurry spreading.

Anders is very interested in dairy breeding and he chooses commercial semen and carries out artificial insemination himself. Most of the cows are Holstein, but there are also some Ayrshires and crosses with Fleckvieh, a breed that is not very common in Sweden. It was chosen due to the need for a cow that performs well both in terms of milk and meat production, could be grazed during summer, and could be slaughtered at a premium price in autumn. The breed has performed well on the farm, and there is now a market for the cross-bred livestock produced. Most replacement heifers are fed on roughage in winter and grazed on semi-natural grassland in summer to calve between October and May, at about 2.5 years of age. Most of the young bull calves are sold to an organic farmer as steers at three months, and the others are sold at 90 kg live weight. A few bulls are also sold for breeding purposes.

On the arable land, temporary (two-year) grass leys consisting of perennial ryegrass, timothy, red and white clover, and herbs (chicory and caraway) are followed by spring wheat and rapeseed, vetch or oats as green fodder, winter cereals and spring cereals, possibly mixed with peas. The cereals are undersown as either forage or catch crops (Italian ryegrass and white clover) to combat nutrient losses and weeds. The catch crop is either cut or grazed in the autumn. Due to the farm's location on the western coastline of Sweden (56°49'N; 12°44'E), it receives considerable rainfall (900 mm/year), and the fields are between 20 m and 95 m above sea level. Consequently,

it is often difficult to weed-harrow in spring. The temporary grass leys for grazing are renewed every four to six years depending on sward status, undersown in combined spring cereals or conserved as whole-crop silage. No red clover is included in these mixtures, but there are usually several varieties of the same forage species. Much attention is paid to obtaining high-quality silage by spreading and pre-wilting the grass before ensiling. In general, no additives are used, but propionic and formic acid may be added if needed. Most of the forage is conserved as silage in clamps, but round bales are made on marginal areas far from the farm centre and on pasture areas rejected by animals. In addition, some hay is conserved, forming a valuable complement to the silage.



Cattle slurry (20 tonnes, 24 kg $\text{NH}_4\text{-N}$, 56 kg total N/ha) is applied twice a year to the temporary grassland intended for silage, preferably in spring and directly after the first cut. Some chicken manure is bought for rented land far from the farm centre. There are some restrictions on intensity of management that influence farm operations. One consequence of the EU Nitrates Directive is that at least 60% of arable land has to be covered with a crop or cover crop in autumn and winter. There are also regulations on stocking rates and manure management. As regards spreading manure, a maximum of 170 kg N/ha/year is permitted, i.e. at least 112 ha are needed at Skogsgård. From 2013, there will also be a restriction on P fertiliser application of a maximum of 22 kg P/ha/year, i.e. at least 128 ha will be needed at Skogsgård. Furthermore, manure spreading is not permitted between 1 November and 28 February in Sweden. Due to the proximity to the sea, there are further restrictions in the region where the farm is located. For example, the amount of plant nutrients applied must be adjusted to match the actual crop grown, the pre-crop (cover crop or green manure), soil properties (organic matter content), manure (animal species, technique and time of spreading), etc.

The first cut is usually taken in the first week of June, followed by three to four cuts until about 20 September, depending on the year. Anna and Anders are very interested

in developing their grazing management. The grazing period starts in mid-April and ends in October, depending on the weather. A grazing calendar is used to plan the farm's grazing management and to evaluate the grazing profit. The cows consume on average 13 to 18 kg DM/day. A rotational grazing system is practised with a rotation of 18 to 23 days, which aims to ensure grazing grasses at the three-leaf stage. It is important to graze the whole paddock before moving to the next. Electric fences are a flexible system and the cows graze according to the back-fencing system shown below. The areas rejected by animals are cut some time during the season, but the grazing paddocks are not topped. The increasing number of dock plants is a problem, and they have mainly been picked by hand until now. Grazing represents a non-negligible amount of the feed ration in the summer. The cows only get 2 to 4 kg cereals or faba beans at milking, correlated to the clover content in the pasture. This feed ration results in production of 40 to 45 kg ECM/day for some cows, but on average milk yield is 22 to 28 kg ECM/day. During the winter, the cows get a mixture of forage, whole-crop silage, mangolds, crushed grain, faba beans and minerals, complemented with some hay. The cows consume about 19 to 20 kg DM/day, of which 28% is cereals and beans.

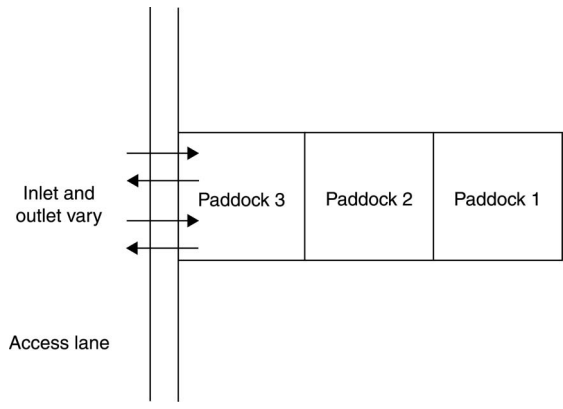

Since 2003, the strong interest in animal breeding has resulted in Anders and Anna participating in agricultural shows, both locally and nationally, with great success. This is a real challenge in organic production and an excellent tool for marketing long-living animals with good performance in the Holstein, Ayrshire and Fleckvieh breeds. One of Skogsgård's main goals is to utilise grazing as efficiently as possible, especially in autumn, to drive milk production with high concentrations of fat and protein. It is difficult to obtain sustainable swards when grazing in late autumn. An ongoing project is to build a house for the young cattle and a feed store, and to make some changes in the dairy cow barn. The overall aim of these investments is to reduce labour intensity and improve feed logistics. It is also crucial to have enough acreage for fodder production in the future.



Author and photographer: Nilla Nilsson-Linde, Swedish University of Agricultural Science, Uppsala, Sweden

Mr Eric Bonnabry, Condat en Combrailles, Auvergne, France

Eric took over his father's typical family farm in the Combrailles region in the early 1990s. This area is known to have a high density of agricultural workers despite the tough conditions created by a semi-mountainous environment (at 800 m altitude). At the time, the farm was 55 ha and had 25 suckling cows and about 150 ewes.

The farm grew as opportunities for land extension arose and the production system was simplified. Being fond of cow breeding, Eric chose to get rid of the sheep and focus on cattle. Today, he manages a 75 Charolais cow-calving system on 125 ha. He is married and now has three children. Mrs Bonnabry has a job and does not work on the family farm.



The farm is situated in a grassland area and has 50 ha of permanent pastures, mostly located on wet soils. Sixty hectares of temporary grasslands lie on areas which are suitable for mechanisation. They are included in a five-year rotation system with 15 ha of triticale.

When possible, fields with good natural drainage are planted with lucerne, but the dominant sown species are tall fescue and white clover. "If we don't renew the pastures, there is no grass here," says Eric. He believes it allows him to obtain enough forage and handle situations where his stocking rate is above 1.2 LU/ha (as it has been these past few years). To satisfy fodder needs for winter, about half of the acreage needs to be cut during spring. That means 20 ha of silage at the end of May, and 40 ha for hay in June. Regrowth after silage is generally cut to get high quality hay. There is sometimes a third cut of lucerne in autumn, which is stored



as wrapped silage bales. All of the pastures to be cut receive organic fertilisation of about 15 t/ha of manure.

Herd management is based on a short indoor mating period and artificial insemination from February to March. This ensures that the calving period mainly occurs in November and December. In April, calves follow the mothers out to pasture for all of spring and part of summer before being weaned in August.

The grazing herd is divided into 6 six groups. Each grazes a sward organised using a rotational system. Moving animals from one place to another is not difficult, given the rather compact field pattern mostly divided into two blocks 1 km apart. In summertime, calves receive additional refined feed in feed troughs.

Having reached what he considers a fairly good farm size considering the available workforce, Eric is looking to take the next step. His main goal is now to reduce production costs by achieving feed autonomy and avoiding purchases of refined feed, currently necessary to ensure animals receive sufficient protein. He would therefore like to improve fodder quality, yield being less important given the decreased stocking rate of 1.1 LU/ha. One option is to increase legume production, either by modifying the cropping pattern or managing multi-species grasslands, for which Eric requires technical support. To obtain this support, he joined a farm network interested in improving grassland management. The main idea is to anticipate grass growth in line with the 'sum of temperatures' method, and work out the best way of making daily decisions on this basis. "These are good indicators for monitoring grazing management, and therefore improving grassland use", says Eric. However, he adds, "Currently, there are too many regulatory constraints related to permanent grasslands; in the end, they prevent effective overall management." He concludes, "This job is fascinating, but you have to be able to make a living from it."



Author and photographer: Jean-Pierre Farrie, Institut de l'Elevage, Paris, France

Mr Henryk Brzóska, North-west region, Wielkopolskie province, Poland

Henryk Brzóska inherited his farm from his parents in 2002. At that time, the farm area comprised 16 ha, including 9 ha of arable land and 7 ha of meadows and pastures. He also owned a herd of 23 horses of the French 'Selle Français' breed. He is the only breeder of this horse breed in Poland. In 2012, Mr Brzóska added to the farm area by leasing 20 ha of meadows and pastures. The farm's machinery includes: two tractors (a Lamborghini 70 and Same 110), three trailers, three vehicles for horse transport, two tedder-rake machines as well as a hay and round bale silage press. At the moment, Mr Brzóska employs two people on the farm, which now has 47 horses.



Permanent meadows are cut twice: in the second half of June and towards the end of August, for use as hay or, in unfavourable weather conditions, as wilted silage. Meadows and pastures are fertilised with 40 kg P₂O₅, 60 kg K₂O and 90 kg N during the vegetation season. Racehorses are not allowed out onto pastures and are fed forage in the stable. From April until the end of September, horses intended for sale graze on paddocks surrounding the stable and the racecourse. In permanent pastures, swards are multi-species. In paddocks with wet soil *Festuca arundinacea* is the dominant species, and in paddocks with optimal moisture levels *Lolium perenne* is dominant. Herbs make up more than 20% of the sward's botanical composition. Examples include: *Achillea millefolium*, *Plantago lanceolata*, *Daucus carota*, *Cichorium intybus*, *Pastinaca sativa* and *Carum carvi*.

The parent herd of racehorses is made up of six mares and two stallions. At the present time, the stud comprises 14 racehorses, of which five are being prepared to participate in competitions. Deciding which horses will become racehorses and which will be sold takes place at the age of three and. From then on, racehorses begin training and, when they reach the age of four years, they start participating in races. Horses receive 7 to 8 kg of concentrates containing oats, barley, wheat, maize, bran, broad beans and

supplements of molasses and linseed oil. Linseed oil supplementation stimulates intestinal peristalsis and prevents colic. In the morning and in the evening, horses are fed about 6 kg of good quality hay.

Mr Brzóska's son is a member of the Polish national team in the class of senior riders and is ranked as one of the Polish team's ten best riders.

Plans for the near future include continuing the construction of a sports hall with a manège, purchasing more trailers for horse transport as well as modernising the racecourse.



Author and photographer: Piotr Golinski, University of Life Sciences, Poznan, Poland

Mr and Mrs Niko and Ema Lesjak, Šmihel nad Mozirjem 5, 3330 Mozirje, Slovenia

More than seven generations of the Lesjak family have managed this mountain farm in the Upper Savinjska Valley (North Slovenia). The farm is traditionally passed down from generation to generation, and this tradition continues today. The previous owners, Ivan and Marija Lesjak, inherited the farm from Ivan's parents in 1978. At the time, the farm (as it is today) had 20 ha of forest and 10 ha of agricultural land, of which 7 ha was permanent semi-natural grassland and 3 ha was arable land, where they cultivated crops such as wheat, oat, corn, potatoes, millet and buckwheat. However, the most important agricultural activity was livestock breeding. Ivan's parents bred Marijadvor cattle, but when Ivan inherited the farm this breed was replaced with the Slovenian Brown cattle breed. The traditional composition of the herd on the farm (four dairy cows, four oxen and four heifers) also changed due to the elimination of oxen. Today, the herd has increased to up to 18 to 20 cattle (14 dairy cows, the rest are heifers). Young bulls are sold.

The management of semi-natural grassland, which provides roughage for herd (concentrates are purchased), has not changed considerably over the last forty years. The grassland area has increased slightly due to the decrease of arable land. The grassland area is divided into three large paddocks with continuous stocking (grazing and forage production for winter). Each paddock is grazed or cut three times per year.

The herd is out to pasture throughout the growing season. In the past, most winter forage was hay. Today some silage is used, but hay still makes up a large proportion of winter forage. Hay is made in the barn using a cold-air drying system. The farm uses mainly organic fertilisers. When Ivan and Marija worked the farm, most income came from animal husbandry, which was based on the production of milk sold to a cooperative. There was also some income from the forest.



Today, the Lesjak family is proud of their farm and farming practices, which ensure botanically diverse swards with high natural value and long-living animals that produce 4 000 to 5 000 kg milk per animal lactation. They are also proud of their beekeeping and their old meadow orchard with traditional varieties of apple and pear trees. They are proud of the healthy food they produce, evident in the fact that Ivan's father, who passed away several years ago, lived to the age of 104. He was always in a good mood and in good health.

Following Slovenia's integration into the EU, changes in agriculture are making it difficult for small Slovenian farms to survive by simply selling traditional agricultural products. Change is needed, and the Lesjak family decided to opt for agri-tourism. Today the farm, which is already in the hands of Ivan's son Niko and his wife Ema, welcomes organised groups of overnight guests (up to fifty people), providing them with an entertainment venue and catering service. Their healthy and delicious home-made food, much appreciated by guests, allows them to sell nearly everything produced on the farm. They also offer farm-stay accommodation (rooms). For guests from urban areas, the Lesjaks' farm is an ideal opportunity to learn more about living on a hill farm. The farm's location in the beautiful Upper Savinjska Valley makes it an excellent base point for short day trips (on foot, by bike or by car) to many attractive destinations. There are also winter skiing resorts nearby. The family would like to earn more income from agri-tourism activities. It would allow Ema to quit her job off the farm. She wants to focus her efforts on the farm and spend more time with her children, the next generation of the Lesjak family.



Author and photographer: Branko Kramberger, University of Maribor, Slovenia

Mr and Mrs Roland and Anita Hensler, Breitnau bei Titisee-Neustadt, Baden-Wuerttemberg, Germany

Roland Hensler took over the Holzhof farm from his father-in-law Alois Faller in 2002. It is situated at 1 030 m above sea level in the southern area of the Black Forest. The holding was a typical 50 ha dairy farm with about 50 Holstein cows. As early as 2001, Roland opted to switch from conventional farming to an organic farming system and he now operates in line with organic farming guidelines. By 2011, the farm had 50 ha of agricultural land and 30 ha of forest. It also manages 1.5 ha of nature reserves. The dairy herd produces 7 700 l milk/cow/year and obtains this high performance mostly from grassland. The farm's main advantage is that around 50 ha of grassland are located in the near vicinity of the farm house, which is favourable to grazing. The use of the farm's own grass for milk production is very successful. Milk production for the Holstein herd is around 330 000 kg. Only 900 kg of concentrates per cow is used annually which means that yearly milk production from grass is more than 5 000 kg, a very impressive figure.

Most of the grassland is managed as continuous grazing in seven paddocks. Importantly, white clover is common. As perennial ryegrass lacks a winter variety, this grass species is not very persistent in the area. For the past five years, Hensler has operated a full grazing system, which means that he tries to maximise grass intake. The cows graze 15 ha of pasture at the beginning of vegetation. During the main growing season, the pasture is restricted to 5 ha. One issue the farm must deal with is the low temperatures typical of the long and hard winters in the Black Forest mountains.

Roland therefore requires conserved forage and optimised stables, together with the economic advantages of the full grazing system. Half of forage consumption is conserved. Eighty per cent of the first cut is harvested and ensiled by a contractor. For the second and third cuts, 50% and 20%, respectively, are conserved as hay or silage in indoor tower silos and one clamp silo.



In order to maximise grass intake by grazing, the calving season is very short and in spring. This means the farmer must have enough space for calving cows and rearing young animals. Roland has extended his exercise pen in the old farm building and now has a very good calving and rearing area. Animal rearing is managed naturally. Milking cows are also used as foster mothers. For two days, the calves stay with their mothers and are fed with colostrum. Later, calves are put in a special area where they suckle twice a day with two or three other calves.



One of the farm's specialties is fertilising grassland with near-ground slurry application via pipelines. Consequently, between the farmyard and the grassland, 1.8 km of underground pipes have been installed. The advantage of this system is that soil compaction caused by heavy slurry tanks can be avoided or at least minimised. Slurry can also be better utilised during fertilisation without sward damage. Additionally, the slurry can be diluted simply by adding water. This increases the absorption of nitrogen by the grass sward, reduces contamination of the grass and leads to higher nutrient efficiency.

Author and photographer: Martin Elsaesser, Bildungs- und Wissenszentrum Aulendorf, Germany

Azienda Agricola Nascimben Valter e C., San Vito al Tagliamento 23, Località Cragnutto (PN), Friuli Venezia Giulia, Italia

Valter Nascimben inherited the farm from his father in 1978. It was originally part of the possessions of the aristocratic Zuccheri family. The farm is medium to small in size, and the primary activity is cattle husbandry. Upon acquisition, it had an area of 13.5 ha, including 1.5 ha of grasslands and pastures and 1.5 ha of vineyards. The remaining hectares were maize crops. For a short period, tobacco was cultivated. The cattle assets consisted of an average of 18 Pezzata Rossa cows, including 12 lactating cows and 6 replacement heifers. Over the years, the farm grew in terms of surface area and herd size. Currently, the farm owns 22 ha of land, and leases a further 31 ha (about 30 ha are cultivated with maize, 6 ha with soya bean (cv. Hilario), 6 ha with lucerne and 11 ha with vineyards). An additional 40 ha are on loan for maintaining grasslands in an area running alongside the Tagliamento River (formerly lucerne crops, this area has been transformed into permanent grassland managed under extensive conditions).



Except for a maize quota (20%) that is sold to the local farmers' association, all forage, cereals and grains produced are used for animal feed. Some maize is stored as silage, while forage is preserved either as silage (approximately 40% of lucerne production) and hay (three cuts per year in the permanent grasslands, five cuts per year in lucerne). All wine production is contributed to the 'Cantina Produttori di Ramuscello e San Vito' cooperative, of which Mr Nascimben is currently vice president.

There are currently 160 dairy cows, 75 of which are lactating (80% Pezzata Rossa, 20% Italian Friesian) with replacement cows (heifers) accounting for the rest. The type of breeding is free stall with a 0.2 ha pasture always available for the animals. As far as cattle feed is concerned, only soya bean flour and vitamin integrated core are purchased from outside, in addition to feed suitable for calves being weaned and for the dry period.

Average milk production is 7 800 kg/year. All milk is delivered to the 'Cooperativa Venchiaredo' for processing into dairy products. In the future, Mr Nascimben plans to purchase a milking robot.



The farm is mainly managed by the family, which monitors the different stages of production and actively participates in all activities on integrated farming in the region. This includes initiatives such as 'Agritour', which works with schools to present farms with environmental goals to young students.

Family members have always believed in the cooperative system as a way of banding together and providing mutual aid for local farms. As evidence of its environmental focus, the farm also invested in a 44 kW photovoltaic system, which has been fully operational since March 2011. Looking ahead, the family is considering whether to build a plant producing biogas from sewage and waste biomass. This project would involve other local farms and companies. In order to further consolidate the farm's position in the rural area and local community, the Nascimben family is planning to launch rural tourism activities (bed & breakfast, agri-tourism), with the creation of an educational farm programme.



*Author: Mauro Scimone, University of Udine, Italy
Photographer: Carlo Peresson*

Farm Samsa, Rural Park Altire del Polazzo, Fogliano-Redipuglia, Friuli Venezia Giulia, Italy

The Samsa farm, better known as Rural Park Altire del Polazzo, is located in the Karst plateau, in an environmentally protected area (SCI and SPZ), near Fogliano-Redipuglia, in the Province of Gorizia. The farm is family-managed, and family members are also workers (there are no permanent employees). They alternate doing different tasks. So far, the Samsa family has been active in sheep and goat breeding. The current generation's grandparents began farming the pastures of the Karst plateau in the early 1900s. After World War II, the grandfather settled in Polazzo, once the current border between Italy and Slovenia had been established. Paolo Samsa began breeding activities in 1950, with cattle and donkeys, in addition to sheep. In 1996, the farm received the organic farm label and, in February 2012, was awarded the Ecolabel certification.

Current activities include organic farming, agri-tourism and educational farming. Organic farming is without doubt the main activity, with the other activities developing over time. The farm owns more than 22 cows and a Pezzata Rossa breed bull, 102 ewes and 2 rams of the Karst breed, 8 sheep, 12 donkeys of the Miatta breed, 5 hives, 1 horse and 2 dogs. The cattle and sheep breeds were selected as they are native to the region and at risk of extinction. They are very well suited to the unique conditions of the Karst plateau. It is hoped that these activities will help support native species and protect the Karst landscape.

The farm does not have a proper shed, but a semi-enclosed box that gives animals shelter from the cold. The rotational grazing area of 86 ha (of around 98 ha) is divided



into sub-areas where animals graze for a given time period (about 0.5 LU/ha). Most of the year, animal feed is local forage; in winter, it is mixed with organic lucerne, supplied by a local farm. There is no sewage system, since grazing ensures slurry is distributed as fertiliser. This also helps seed spreading, thus ensuring that the pasture is continually renewed. Meat and sausage products such as vienna sausages and donkey bologna are produced using different types of meat from older animals. The little milk that is produced is usually given to guests. Agri-tourism activities were launched in 1995. Since then, the family has opted to apply rather strict standards: agri-tourism facilities can only be used in spring and autumn, they must be reserved and are only available for groups of between 15 and 70 people. This decision was made mainly because of time constraints, lack of staff and in view of building a network with other local restaurants, as well as for the maintenance of high standards.

The educational farm programme and local know-how have been combined with the restaurant. The “package” also includes a trip around the park on the Agribus, where



participants learn about local history, breeding, and the Karst plateau. The educational farming programme teaches visitors about the area through food, contact with animals and careful observation of the landscape and the environment in all its forms. It is also possible to rent apartments during summer, or to camp. The greatest problems encountered are pasture weeds, which are removed, and the *Ailanthus* shrub, which is not grazed and releases toxic substances lethal for grass roots. Other challenges are the icy winters and the availability of males for reproduction, both for cattle and Karst sheep. A possible solution would be to crossbreed with males from Slovenia, but this is difficult because Slovenian farmers fear the spreading of pneumonia, which affects only male sheep. Another issue is the lack of slaughterhouses in the province, as most only handle pigs. Future perspectives include the maintenance of biodiversity through both animal and plant breeding, the opening to the German-Austrian market (already taking place), the approach to the green economy through a photovoltaic system for electricity (about 44 kW), and the building of a swimming pool and a sauna.



Author: Mauro Scimone, University of Udine, Italy

Photographer: Jean-Pierre Farié, Angelo Vianelli

Mr and Mrs Pascal and Edith Capele, La Craupinière, La Selle Guerchaise, Ille et Vilaine, Brittany, France

Pascal Capèle set up on Edith's parents' dairy farm in 2000 and Edith kept her job as an economic advisor in agriculture. Previously, Pascal had been an advisor at the Loire Atlantique Chamber of Agriculture, and managed a grass-grazed dairy systems network. In 1996, he wrote a paper on farmers' knowledge and experience named "Back to Grass". His work experience was a precious asset when he decided to follow in the footsteps of his father-in-law. At the time, the farm area was 40 ha, with 28 ha set aside for producing the forage for the dairy herd (18 ha of grass and 12 ha of maize for silage) and 12 ha of cereals and rape. The herd had 35 to 40 Holstein dairy cows and replacement heifers, and the milk yield was 8 000 kg of milk.



In 2000, Pascal and Edith decided to develop a grass-grazed based system to minimise production costs, reinforce home-produced feeds and free up time to spend with their three young boys. Today, the farm covers 48 ha with 92% used for forage production. The remaining 4 ha are sown in wheat. The grain and straw produced are used for the dairy production system. The 40 meadow ha contain multi-species grass: perennial ryegrass, tall fescue, meadow fescue, timothy and white, red and hybrid clover. The meadow is kept in grass for ten years, followed by one or two years of maize and one of cereals.



In 2006, Pascal and Edith decided to introduce Simmental cows, which are better suited to the forage system, to increase beef products (calves, culled cows) and limit health problems such as mastitis. Currently, the Simmental (50%) and Holstein (50%) animals

are managed as pure breeds. The milk quota is 295 000 l for a dairy herd of 45 cows. The total lactation milk yield is 7 000 kg on average with 41.7 g/kg of fat and 32.5 g/kg of protein content. The replacement rate is about 34%, with a first calving age of 28 to 30 and 34 to 36 months for the Holstein and Simmental heifers, respectively. The calving period is spread over the year and the aim is to avoid calving from mid-December to the end of February. The reproductive performance is interesting, with a 51% first-service success and an interval of 383 days between calving. All year long, the two breeds are managed with the same feeding strategy and concentrate allocation is estimated at 650–700 kg per lactation.



The grazing season traditionally starts in February with turnout only between the two milkings. In March, the cows stay out day and night, and the entire grass area is grazed once before 1 April. Early in April, the grass and maize silos are closed and grass is the only feed for cows and heifers. At this time, part of the area is closed off and cut in early May and harvested as silage or big bale hay (10 to 15 ha depending on grass growth). Later, in June, another 10 to 15 ha are cut as hay. Sward quality and high durability are important to Pascal, which is why he selects the paddock for cutting to obtain at least one cut per paddock per year. On average, 75% of the grass area is cut at least once per year. The maize silo is reopened in mid-August to compensate for decreasing grass growth in summer due to frequent drought periods. Three to five kilos of maize silage may also be used to increase dairy cows' energy supply and limit the mobilisation of



their body reserves. During the grazing season, the level of concentrate is constant, with a maximum level fixed at 2 kg/cow/day. A rotational grazing system is used with 5 to 6 day-paddocks. Sometimes, in spring, fences are used to create one-day paddocks as part of a strip grazing system. During grazing in spring the stocking rate is 2.8 LU/ha of grass, and in autumn the overall stocking rate is 1.75 LU/ha of grass. In winter, the dairy cows' ration is mixed, with 50% maize silage and grass conserved as hay or silage. The level of concentrate is very low, with 1.5 kg of soya bean meal and 1 kg of cereals. The dairy cows' annual feeding plan is composed of 1 t of maize silage DM, 2.4 t of conserved grass and 2.5 t of grazed grass.

Pascal and Edith are confident about the farm's economic performance: next year, they plan to have Edith become an associate and leave her advisor job. The farm area will be extended to 57 ha (45 ha of meadow, 8 ha of maize and 4 ha of cereal crops) and the herd size increased to 55 dairy cows (60% Simmental). A new milking parlour will be built in 2012. The oldest son is currently at agriculture school and he is keen to become a dairy farmer. The grass-based dairy system appears to be successful and an opportunity to create rural jobs.

Author and photographer: Luc Delaby, INRA, Rennes, France

Mr Miroslav Greško, Banská Bystrica part Podlavice, Central Slovakia, Self-Governing region of Banská Bystrica, Slovakia

The Banská Bystrica part Podlavice Agricultural Holding was established in 1970. At the time, the holding had 1 100 ha of UAA and 100 head of cattle, 120 pigs and 650 sheep. During the 1970s and 1980s, the UAA increased to 2 100 ha with 560 head of cattle and 900 sheep. Pig breeding was discontinued due to its low profitability. The holding operates in two alpine national parks: the Vel'ká Fatra National Park and the Nízke Tatry National Park, where the altitude ranges from 850 m to 1 574 m above sea level. Upland and mountain conditions are reflected in the holding structure and intensity of agricultural production (168 ha of arable land, 77 ha of temporary grasslands and 1 210 ha of permanent grasslands). The Slovak Spotted herd has been reduced to 364 head (dairy cows, suckling cows, heifers, calves and



a bull), while the number of sheep (Tsigai with Lacaune crossbreed) has increased to 1 191 heads. Calves and lambs are sold at six weeks of age depending on the price offered by companies.

The majority of grasslands are grazed (880 ha). Grazing starts on 15 April and ends on 30 November. During winter, cattle and sheep are kept indoors. Calves are kept indoors all year round. Dairy and suckling cows graze pastures in the vicinity of the farm. Remote permanent grasslands are grazed with sheep. Meadows are cut once annually at the end of May.



Since 2004, the holding has been involved in the Rural Development Plan. Protected grassland habitats (1 100 ha) include thermophilous, mesophilous and hygrophilous grasslands. The majority of grasslands are thermophilous pasture communities, especially *Festuca rupicola*. The endemic Carpathian species *Campanula serrata* occurs in grasslands and vulnerable species like the fire lily (*Lilium bulbiferum*), heath spotted orchid (*Dactylorhiza maculata*) and *Trollius altissimus* are abundant in mountain meadows and pastures.

The holding managers are open to new ideas and challenges. It sells cow's and sheep's milk and animal products (cheese, traditional Slovak dairy products) directly to consumers in shopping centres in Banská Bystrica. One of the holding's main challenges is to supply new technologies and new machinery for agricultural production. It cooperates with research institutions (GMARI), universities and the State National Conservancy of the Slovak Republic environmental organisation to increase the effectiveness of animal production with respect to the mountain environment and protection of nature.



Author and photographer: Jozef Cunderlik, Grassland and Mountain Agriculture Research Institute, Banská Bystrica, Slovakia

Interview with Nilla Nilsson-Linde, scientist at Uppsala University of Agricultural Sciences and Research Officer at SLF, the Swedish Farmers' Foundation for Agricultural Research



1- Could you introduce yourself, your background and past and present activities?

I work part of my time at the SLU – Uppsala (Swedish University of Agricultural Sciences, www.slu.se) in research, education and contracted education, with a main focus on forage production and grasslands. I organised the EGF 2008 conference (European Grassland Federation) held in Uppsala. The rest of my time is spent at SLF, the Swedish Farmers' Foundation for Agricultural Research (www.lantbruksforskning.se) as a research officer. We link farmers to research and vice versa, through funding of research projects. I also work as Secretary at the Swedish Grassland Society.

I also run a farm with my family, mainly for the forestry aspect but also to take care of the semi-natural grasslands. So I have one foot in different fields.

2- You work as a scientist at the Swedish University of Agriculture in Uppsala. What are the research priorities of the Swedish public research on grasslands, forages and herbivore nutrition?

This is an important question. There are three university sites involved in forage and grasslands in Sweden—Skara, Umeå, Uppsala—and they belong to different faculties.

As in many countries, we work with home-produced proteins in order to achieve more protein autonomy. We work on protein crops, but we also consider forage as a major protein resource. Forage production and the impact of forage conservation on forage and protein quality are major issues.

For crop production, we work a lot with legumes, and especially differences among legumes for quality. Lucerne receives increasing investments. After a boom in the

1980s, interest waned due to winter conditions, but now it is once again rising. We have to learn more about lucerne establishment and weed control, and especially dock weed. Variety testing is also run by SLU. One of the key traits is adaptation to winter, particularly the periods of transition between freezing and thawing, which is a peculiarity of our Nordic climate. Extending the duration of testing period beyond the classic two-years duration in the main crops is an important issue and it was made possible thanks to financial support from SLF. In most trials we test pure stands, but we also test varieties in mixtures to analyse the ability of varieties to withstand competition.

We have also developed an advisory system to inform farmers about how to farm without losing too many nutrients. This led to the 'Focus on nutrients' action, the main targets of which are mainly nitrogen and phosphorus. It has been underway for ten years now. We held a workshop on the results of this action to demonstrate the breakthroughs. This had a strong impact on the economic performance of farms as well as on environment.

The relationship between semi-natural grasslands and biodiversity is also an important topic for Sweden.

3- You also work for the Swedish Farmers' Foundation for Agricultural Research (SLF). Could you describe the activities of SLF? How do you identify farmers' priorities?

It is important to meet both the farmers and the researchers. SLF organises a workshop, and every three years we renew the research programmes, e.g. according to the results of these workshops. We also work with the farmers, advisors and researchers gathered in advisory groups who evaluate the on-going projects and decide which new projects will be promoted and funded. One committee has been devoted to forage production, from production to animal nutrition, since 2005. To be funded, a project must be scientifically high ranked but also relevant to the industry which is providing funds to SLF (www.lantbruksforskning.se).

Part of SLF's funds are from industries, especially the milk (5 SEK per ton of milk), and meat industries. There are also public funds for environment preservation, raised through green taxes from fertiliser and pesticide markets. Some difficulties have emerged in 2012 since the green taxes are removed. Indeed, the Swedish government decided not to these public funds anymore. So, we have spent time and made lobbying efforts to secure and save this funding system with more from the private sector and a new source from the public sector. There is a major risk for lack of funding research on forage production independently of the industry.

According to SLF, the priorities for forage production over the next decade should focus on the following:

- Climate change needs research. The combination of winter conditions and latitudes must be considered. Will the climate become drier or wetter? We need the right plant material that can withstand the winter conditions. There is a need to create and to test it.
- Protein: we have not yet solved the question about how to replace protein from soybean.
- Forage quality is still an issue.
- Maize has become a very popular crop in Sweden in recent years. However, farmers have decreased their acreage as it is still a risky crop in Sweden. Again, the weather and latitude make for a challenging combination.

– The law regulating grazing is rather complicated requiring a lot of documentation. Many feel that it has led to a lock-in situation since the product price does not reflect these animal welfare efforts. Animals must graze 2-4 months outside depending on latitude, with access to pastures for at least six hours a day for dairy cows. These rules influence farm economy. We therefore need more research on grazing, as well as educating the advisory sector. Good advisors are lacking in this sector to develop sustainable systems with added value for the society. It is even more challenging for large herds.

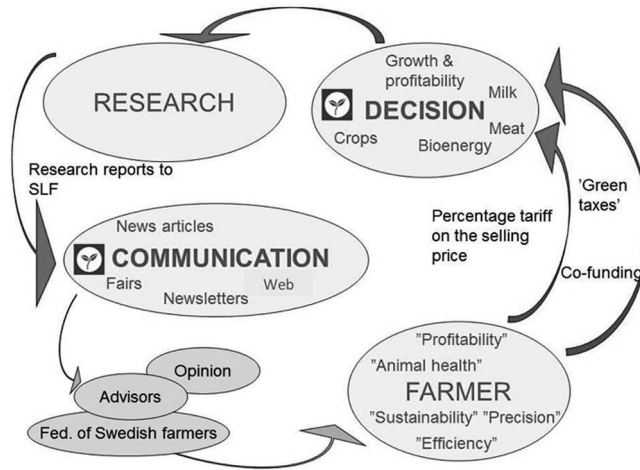

At the European level, the European Innovation Partnership in combination with the future research framework, Horizon 2020, looks to be very promising. We must find out how to be more involved in this new approach. It could be a new source of funding for SLF and actions promoted by SLF. It will also be a way to influence research and development priorities and to establish international partnerships, not only for fundamental research as is often the case today, but also for applied research.

4- Sweden has several unique differences in terms of forage and grasslands. One is the very large horse population. What are the consequences of this horse population on grassland management and on extension activity in Sweden?

Indeed, there are many horses, mainly in small herds.

Riding schools do not grow their forage, so there are large hay and silage markets. Hay and silage have to be transportable. For the small stables, there are small bales. This has influenced production. Timothy is a palatable grass for horses. It can be fed as the sole feed for horses that do not have high activity levels. For mares, you need high quality forage with more protein.

On most of the small farms with horses, hay production management can vary widely, from up to four cuts to just two. There are very extensive ways to produce hay. However, with the right plant materials, it is still possible to achieve the right quality.

5- For forage harvest and storage, the majority of Swedish farmers choose to use round bales. Could you tell us why?

It is easy to manage, as one person can do it alone. Little investment is required. It fits very well with the landscape and farm structure. Indeed, fields are often small

and sometimes far from the farm. In such conditions, round bales are much easier to handle than large scale ensiling operations. Moreover, the harvest may be carried out fairly independently from the weather.

It also offers the possibility to keep several forage qualities separate. This means that it is then easier to formulate a diet.

And last, but not least, it dramatically reduces losses, both in the fields and on the farms during storage and distribution.

6- During the last century, the distribution of cattle over Sweden has changed very little, although there has been a large increase in animal performance. Is there a national Swedish policy to stabilise the geographic distribution of dairy herds and associated grassland production? What are the consequences on extension services?

The milk price can be more than 30% higher in less favored areas. However I don't really believe this is due to a policy, but rather is mainly a result of tradition. In Sweden, you inherit a dairy farm, you do not buy it.

This influences the action of extension services. Artificial insemination, previously run by the extension services, will be replaced by the farmers doing it themselves. Thus, advisory services train the farmers. There is a monthly visit by the extension services, and this could be a problem due to distances, which are increasing between the big farms.

The head of one of the most northern dairy industries told us about their policy for getting their milk and about the long distances they travel to collect the milk. Until now, it was worth covering long distances, instead of importing it from the south of the country. And the conditions for forage production are very good in the north. So there is still a very positive distribution of milk production around the country.

7- The multi-sward project aims to identify the key long-term objectives for grasslands in Europe. What is the share of multi-species swards in Sweden? Where do farmers get the information?

In Sweden, nearly 100% of sown grasslands are multi-species grasslands, with usually three to five species, sometimes with several varieties of the same species. According to Soegaard *et al.* (2007), the main species are timothy, meadow fescue, red clover and white clover.

Farmers have different needs when choosing which species to sow in their grasslands. Most of them rely on their cooperatives. Researchers and advisors and some farmers try to teach the cooperatives.

The Swedish Grassland Society deals with this question and we try to combine theory and practices. Scientists are not always pleased with what is on the markets. Companies do not always rely on research but an independent test is essential. The advisors are very important in this dialogue. The Grassland Society has an important role to play in the melting pot between academy and industry.

At SLU, we have a special organisation that started in 2005, named Field Research, which consists of eight different themes, one being forage production. There are two meetings a year, with presentations on the most recent research findings. It also helps identify gaps in the research programmes and to harmonize experimental methodology. Such an arena is good to communicate on these themes, with all stakeholders.



8- To conclude, in your personal opinion and based upon your dual positions, what would you identify as the key stakes for grasslands, in Sweden but also in Europe?

I would like to mention three points:

- A budget for research is necessary, with a special focus on the key challenges of climate change and protein supply.
- Communication and dissemination of research results to producers. Too many results do not reach the farmers. The university should be more involved in this dissemination chain.
- Ecosystem services from grasslands are important and society must be made aware and needs to pay for it. Farmers are, to some extent, red-listed organisms, but they have to be compensated for the ecosystem services they provide through their activity, especially when they preserve grasslands with high environmental quality.

Grasslands for alternative production

» Energy production

Biogas (methane)

The post-productivism period in agriculture emphasises environmental management and ‘production of nature’. This will create opportunities for non-traditional farm income such as the production of renewable energy from energy crops (Marsden and Sonnino, 2008).

Rising fossil fuel prices and environmental concerns about climate change are also boosting crop-based agrofuel production and demand. Higher global demand for food has not yet had an impact on dairy and ruminant meat products in the EU but agrofuel production has already put pressure on the European grassland area. Reductions in cattle herds can free up grasslands for agrofuel production.

Grassland and fodder area competes with arable land for first generation agrofuels like ethanol (maize, wheat, barley, sugar beet), biodiesel (oilseed rape extraction) and methane (biogas maize). Grasslands—especially High Nature Value grasslands—are converted into intensive agrofuel production on arable land. This results in more pollution from fertilisers and pesticides, which threaten biodiversity and increases greenhouse gas emissions (GHG). Bioethanol and biodiesel release more GHGs during cropping, transportation and processing than the amount of CO₂ equivalent they fix. Effective agrofuels should be carbon negative.

Lignocellulosic agrofuels, called second generation agrofuels, can be produced from annual and perennial crops like maize silage, C₄ grasses (*Miscanthus* spp. in Europe), *Populus* and *Salix* spp. as well as from temporary (high yielding grass species and lucerne) and permanent grassland and crop wastes such as straw. For this purpose, marginal agricultural land can be used, with an extensive management (moderate or no input of fertilisers and pesticides). Unfortunately, in this situation, grassland with high biodiversity could also be converted into another permanent crop.

Grassland biomass can be transformed into energy by anaerobic digestion, resulting in biogas production (methane). A biomass digester can ferment a wide range of biomass sources. This is why 'green gas' has a large potential. When slurry is combined with maize or grass silage for example, the system is called co-digestion. Methane yields are the result of the biomass yield (kg organic dry matter per ha, or ODM/ha) and the specific methane production rate (kg CH₄/ kg ODM; Taube *et al.*, 2007). Species and cultivars have little effect on the methane production rate but the differences in ODM yield are significant. The development stage seems to have more influence: methane production appears to decrease with maturity and cutting number ranking. Harvesting grass/white clover at the vegetation stage of 'ear emergence' results in the highest methane yield. Harvesting at a later stage reduces methane yield up to 25% (Amon *et al.*, 2005). Mature grassland biomass from extensively used grasslands shows substantially lower specific methane yields (Prochnow *et al.*, 2008) Carbon nitrogen ratios of 15-30:1 are most suitable for anaerobic digestion (<http://webarchive.nationalarchives.gov.uk/>). High crude protein content has a negative effect, which is a weakness for lucerne in this context (Eder, 2006). The potential methane yield of intensive grassland would be 5 000 m³/ha, but this is more closely related to the biomass production (see chapter on grassland production) and less so to the species potential of methane yield per ton of organic matter. Maize and whole crop small grain cereals have comparable methane production rates but usually higher biomass yields. Methane yields from maize range from 4 000 to 10 000 m³/ha. As a result, permanent grasslands are converted to maize whenever possible and grass silage for this purpose is mainly restricted to swards that cannot be ploughed and in marginal environments. In this context, the use of permanent pasture for agrofuel is encouraged by cross-compliance regulations requiring the ration of permanent pasture to arable land to remain constant. Grasslands are also known to act as a significant carbon sink, and as such, ploughing grassland to produce agrofuel does not lead to a sustainable agrofuel (Singh *et al.*, 2010a). The use of grass silage as a source of biomethane through anaerobic digestion is receiving greater attention in the scientific press (Paavola *et al.*, 2007; Prochnow *et al.*, 2008; Nizami *et al.*, 2009, Singh *et al.*, 2010b; Schmalzer *et al.*, 2010; Sölter *et al.*, 2010).

Maize silage and slurry are the most common substrates used for biological gas facilities in Belgium, Germany and Austria. The higher competitiveness of maize with respect to methane yield performance and its cost effectiveness is confirmed in a survey on the use of co-substrates in Germany. While maize is fermented in 90% of the biogas plants, grasses are less common, with a share below 50% (Weiland, 2007). It can be assumed that the concentration areas across Germany of biogas plants such as those in Bavaria and Lower Saxony will encounter a shortage of available maize substrates. Especially in such areas, a new business field for grassland enterprises can flourish and can substitute the use of grassland by animal husbandry (Hasselmann and Bergmann, 2007). In Germany (6 000 biogas plants in 2011), the demand for biomass has increased enormously and cattle farmers complain about the high prices for forage and rent of the land. Although maize for forage or bioenergy can grow in monoculture for many years, crop rotation is better for several reasons. Sugar beet is a very promising energy crop for digestion because beets digest very quickly, interrupt the monoculture of maize and provide

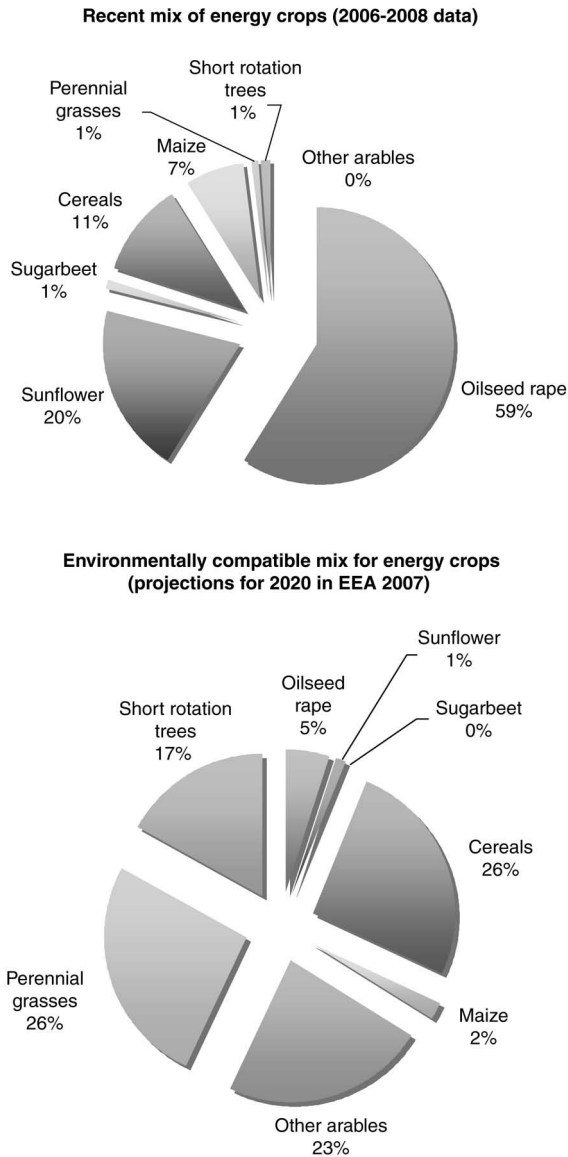

Figure 40. Mix of energy crops, 2006–2008, and EEA scenario for environmentally compatible energy cropping in 2020.

Source: EEA, 2013.

an estimated per ha energy yield of 150% more than maize (Opperwal, 2010). Arable energy crops will be strong competitors for grassland in the future. Maize and beet cropping requires more energy than grass production and their carbon balance is lower. In Germany, 1.75 million ha were used for energy production in 2009: 1.0 million to grow rapeseed and 0.5 million to grow maize for biogas production (Knapp *et al.*, 2010). These values increased to a total acreage of maize of 2.57 million ha, with 0.9 million ha being devoted to biogas plants (http://www.biogas.org/edcom/webfvb.nsf/id/DE_PM-20-12).

The characteristics and management practices of wheat, grain maize, potatoes, sugar beet and oilseed rape lead to a relatively higher negative impact on the environment (EEA, 2006). Unfortunately, these crops dominate biofuel and feedstock production in most EU regions. In contrast, the ‘environmentally compatible’ energy cropping scenario developed by the EEA for 2020 includes a much larger share of perennial grasses and short rotation trees (under coppice management) in a total energy crop mix of about 40% of the total (Figure 40, down). In the environmentally compatible scenario, oilseed rape accounts for approximately 5% of the planned energy crop mix, with maize contributing 2% and sunflower 1%. Furthermore, these crops are projected to disappear completely in the earlier EEA outlook for environmentally compatible energy cropping in 2030 (EEA, 2006).

Where energy crops have replaced previous set-aside or fallow land, negative impacts on farmland bird communities in particular are to be expected. Furthermore, grasslands are also converted for biomass cropping, such as for maize production for biogas in Germany. Whereas energy cropping leads to a more intensive exploitation of traditional agricultural landscapes, under extensive management it can affect elements of high conservation value (e.g., field borders and structural elements of the agricultural landscape).

Heat generation (combustion)

Combustion of grassland biomass is less favourable than other crops or residues such as straw because of ash production and NO_x, SO₂ and HCl emissions (Tonn *et al.*, 2009). But alternative uses for grassland biomass are needed, particularly in the areas of Europe where semi-natural grasslands are dominated by mown grasslands that are difficult to conserve by grazing and with a low nutritive value and low animal performance. Even where these grasslands are still managed under agri-environmental or conservation schemes, the disposal of the harvested biomass may pose considerable problems (Elsässer, 2003). A life-cycle analysis of heat generation using biomass from semi-natural grasslands in central Europe was made and several conclusions can be drawn. First, the combustion of grassland was carbon negative and provided a net energy gain even at very low biomass yield levels. Second, the main environmental challenge pertains to the N losses—mainly NO_x—from the ecosystem. Third, more intensive management, especially N fertiliser application, should not be recommended from the perspective of bioenergy generation (Tonn *et al.*, 2009). An extensive grassland management system with one late cut and a low level of fertilisation is favoured for grass as a solid biofuel (Prochnow *et al.*,

2009). Spring harvesting of standing hay could reduce these contents but yield is then considerably lower (Hadders and Olssen, 1997). C₄ grasses are better than C₃ grasses because of lower ash contents. C₄ grass cropping (*Miscanthus*) could be effective in this context.

Grass combustion is possible for stand-alone biomass-firing or co-firing with other fuels. Market prices for grass and possible subsidies for land use are crucial for profitability (Prochnow *et al.*, 2009).

Biomass can be separated into a liquid fraction for biogas production and a solid fraction (press cake) for combustion (IFBB). This system presents the advantages of higher specific methane yields of the pressed fluid than whole silage, reduced concentrations of elements that are detrimental to combustion, and lower chlorine emissions (Richter and Wachendorf, 2010).

►► Green biorefinery and biochemicals production

Green biorefinery could offer an alternative use of grasslands. This is an integrated refinery concept using green biomass (pasture) as raw material to produce high value biochemicals from the liquid fraction and lower value products or energy generation from the grass fibre fraction. The grass resource could be natural or cultivated grassland or verge grass in surplus of the traditional use (forage for herbivores). From this standpoint, it could be an alternative concept for sustainable grassland utilisation. High value biochemicals can be extracted from the liquid grass fraction, such as lactic acid, which can be used for plastic production in the form of polylactic acid (PLA). Protein and amino acids can be extracted for applications such as animal feed or cosmetics. These proteins can replace (GMO) soy protein in animal production. The grass fibre fraction can be utilised for lower value products such as building materials, insulation material, horticulture substrate, biocomposites, pulp and paper or energy generation via biogas (heat or electricity). The residual grass slurries or 'side' streams can then be fed into an anaerobic digester to produce biomethane gas, which can be compressed and used as transport fuel. O'Keefe *et al.* (2009) gave an overview of the recent European research activities on green biorefinery on the lab and pilot scale. This report concerned fresh grass as well as grass silage. The concept has been successfully demonstrated in Germany, Austria, Switzerland and Denmark. Austria and Germany have examples of 'green biorefineries' at various stages of technological implementation. Policy measures have proved to be crucial for supporting the development of biotechnologies, as they guarantee a fixed income for a specific period.

Because of livestock reductions from CAP reforms, a large surplus of grass can be made available in Ireland. As a result grass, could be one of Ireland's most valuable biomass resources for the future (O'Keefe *et al.*, 2009). The general challenges in biomass processing are transportation costs, the use of dry or wet products, the choice of a central or a mobile unit, and choosing between storage for a year-long period versus a campaign during the growing season (Keijsers and Mandl, 2010).

Grasslands and ecosystem services

►► Introduction

In Europe, traditional low-input pastoral and haymaking management of grasslands have existed for many centuries (Pärtel *et al.*, 2005) and have created diverse semi-natural ecosystems and landscapes. As such, most grasslands in Europe are generally considered to be of anthropogenic rather than natural origin (Wilkins *et al.*, 2003). The resulting semi-natural grasslands present high species diversity (Pärtel *et al.*, 2005), with many species being unique to these habitats (Dahms *et al.*, 2008). In addition to providing biodiversity conservation, grasslands also fulfil many valuable ecosystem functions, such as carbon sequestration and soil protection. Permanent grasslands and extensively managed, low-input grasslands clearly perform better in fulfilling these ecological functions (Table 40). The many ecosystem services provided by semi-natural grasslands are presented in Table 41.

Table 40. The multi-functionality of grasslands (reproduced from Sarzeaud *et al.*, 2008).

Type of grass	Practices	Biodiversity	Landscape effect	Water quality	Erosion prevention	Carbon storage	Product quality
Annual fodder	1	*	*	*	*	*	*
	2	*	*	**	*/**	*	*
Temporary meadows	3	*	**	*/**	**	**	**
	4	*/**	**	***	***	**	***
Permanent meadows	3	**	***	**	**	***	**
	4	***	***	***	***	***	***
Grasslands with ecological value	5	*/***	****	***	***	****	****

1: Maize with no crop rotations; 2: maize with crop rotation; 3: intensive management; 4: reasoned fertilisation; 5: wet or dry meadows; * little impact; **** high impact.

Source: French Livestock Institute (2007).

Table 41. The final services and goods provided by semi-natural grasslands

Service group	Final ecosystem service	Goods and benefits
Provisioning		Possibly fuel Food (crops)
Cultural	Environmental settings: valued species and habitats, agricultural heritage, archaeological heritage, grazing for rare livestock breeds, ecological knowledge, training areas	Physical and psychological health, social cohesion, recreation and tourism, UK research base, UK military training
Regulating	Climate regulation: sequestration and storage of carbon and other greenhouse gases	Avoidance of climate stress
Provisioning	Water quantity: storage of water and recharging of aquifers Purification: reduced pollution and storage of pollutants	Potable water, water for food production, flood protection Clean air, clean water, clean soils
Regulating	Wild species diversity: plant genetic diversity, seed for restoration projects	Genetic resources, bioprospecting, recreation and tourism, ecological knowledge

Source: UK National Ecosystem Assessment, 2011.

During the last century in many European regions, grassland management has broken with traditional management of previous centuries. On the one hand, land use intensification has caused major changes, including—amongst others—high inputs of fertiliser and frequent cutting and re-sowing of grasslands, or conversion to arable land (Dauber *et al.*, 2006; Plantureux *et al.*, 2005; Walker *et al.*, 2005). N fertiliser input in particular has risen sharply. For example, in the United Kingdom during the second half of the 20th century, from N fertiliser use went from < 5 kgN/ha to 135 kgN/ha on average on grasslands (Wilkins *et al.*, 2003). These shifts towards intensification are especially prominent in north-western Europe (Donald *et al.*, 2002). On the other hand, land abandonment also caused a loss in grassland habitats, as they need a minimum of management (or natural grazing, or fires) for their continued existence (Pärtel *et al.*, 2005). Land abandonment is more prominent in the Mediterranean region and mountainous areas (Peeters, 2009; De Aranzabal *et al.*, 2008; Plantureux *et al.*, 2005), as well as some in continental regions in eastern Europe.

These shifts are still taking place. Whereas intensification mostly occurs in large parts of the older EU member states, this is now of major concern for new member states (Butler *et al.*, 2010; Donald *et al.*, 2002). Apart from changing land use and management, grassland areas in certain EU member states have dropped sharply (12.8% overall reduction between 1990 and 2003 (EC, 2008b)). Arable farming is perceived to be more profitable by farmers (e.g., Mathieu and Joannon 2003). Together with intensification and abandonment of grasslands, the surface area reductions are threatening all aspects of European biodiversity, from genetic diversity to landscapes (Pärtel *et al.*, 2005), as well as the related ecosystem functions.

This study identifies five main biogeographical regions: Atlantic, Mountainous (Alpine), Continental, Boreal and Mediterranean. Figure 41 (Plate 12) shows the different biogeographical regions in Europe (EEA, 2009).

European policymakers realised that protecting grassland surface and stimulating their ecological management is important in conserving biodiversity. The Natura 2000 network for instance, will conserve a significant proportion of EU (semi-) natural grasslands. Additionally, the majority of High Nature Value farmland consists of semi-natural grassland (EEA report, 2004). From Figure 42 (Plate 13), it is clear that the highest proportions of High Nature Value farmland are located in the Mediterranean and Continental regions.

► Environmental issues related to grasslands

Grasslands provide numerous ecosystem functions, many of which are related to the soil ecosystem. This section focuses on the role of grasslands in greenhouse gas balance and the mitigation of soil erosion and pollution.

Greenhouse gas balance

The Kyoto Protocol, launched by the United Nations Framework Convention on Climate Change, aims to reduce emissions from fossil fuel and enhance carbon sequestration. In the reduction targets, carbon sequestration by agricultural soils is also accountable under Article 3.4 of the Protocol. Grasslands can make an important contribution as they can act as carbon sinks (Peeters, 2010; Smit and Kuikman, 2005; Gibon, 2005). However, under certain climate conditions (e.g., droughts or heat waves), grasslands can temporarily switch from carbon sinks to carbon sources, as shown by Nagy *et al.* (2007) in Hungary during the heat wave of 2003.

Most of the soil organic carbon (SOC) content of grassland is not in the biomass, but in the soil (EC, 2008b). This is because a large part of the grassland biomass production is located in the root biomass, unlike many arable production systems. Because the root biomass is concentrated in the top surface layer (0 m–30 m), so is the majority (75%–80%) of the SOC content (Mestdagh, 2005; Jones and Donnelly, 2004). Belowground C generally has lower turnover rates, since most of the SOC is produced by plant (root) litter degradation into more persistent organic compounds (Jones and Donnelly, 2004).

For European soils, a modelling approach shows that conversion of arable land to grassland leads to an estimated increase in SOC content at a magnitude of 1.44 t C/ha/yr, whereas existing grasslands still build up SOC content at a rate of 0.52 t C/ha/yr and arable lands lose SOC at a rate of 0.84 t C/ha/yr (Vleeshouwers and Verhagen, 2002). Calculations by Janssens *et al.* (2005) showed comparative results with a build-up of SOC under grasslands of 0.6 t C/ha/yr and a loss of 0.7 t C/ha/yr for arable soils, on average and for a European context (Table 42).

Table 42. Country-specific carbon balances and their uncertainties (both in g C/m² total land area/yr) of grasslands, forests, croplands and peatlands for individual European countries. Positive figures are carbon gains, negative are carbon losses.

Country	Grassland (SD)	Forest (SD)	Cropland (SD)	Peatland (SD)	Total (SD)					
Albania	1.8	1.8	5.2	2.1	-10.9	5.5	0.2	1.0	-3.7	6.2
Austria	25.5	25.9	89.9	36.0	-16.2	5.0	0.1	1.0	99.3	44.6
Belarus	8.9	9.0	49.7	19.9	-20.4	11.1	-59.1	30.0	-20.9	38.7
Belg.+Lux.	15.8	12.4	12.7	5.1	-9.1	19.8	-9.1	5.0	10.3	24.4
Bosnia-Herc.	6.8	6.9	41.0	16.4	-31.4	5.2	0.2	1.0	16.7	18.6
Bulgaria	6.8	6.9	43.6	17.4	-19.8	17.6	-0.3	1.0	30.3	25.7
Croatia	6.7	6.8	30.4	12.2	-15.4	8.9	0.2	1.0	21.9	16.5
Czech Republic	6.6	6.7	49.4	19.8	-35.8	22.0	-0.7	1.0	19.5	30.4
Denmark	2.6	2.6	11.6	4.7	-39.9	22.8	-6.0	15.0	-31.8	27.8
Estonia	2.2	2.2	34.7	13.9	-39.7	20.5	-26.2	13.0	-29.0	28.1
Finland	5.6	4.3	25.6	10.2	-5.5	3.2	-12.8	6.0	12.9	13.0
France	12.0	4.7	25.9	10.4	-19.1	8.2	-0.7	1.0	18.2	14.1
Germany	13.6	6.4	64.5	25.8	-28.3	21.7	-604	3.0	43.3	34.4
Greece	2.8	1.9	5.2	2.1	-10.1	3.4	-0.5	1.0	-2.6	4.5
Hungary	6.3	6.4	37.5	15.0	-44.8	25.0	-6.4	1.0	-7.4	29.9
Ireland	21.2	55.9	6.4	2.6	-12.3	5.0	-52.7	26.0	-37.4	61.9
Italy	12.7	2.9	31.7	12.7	-19.5	9.3	-2.8	1.0	22.1	16.0
Latvia	2.9	2.9	48.8	19.5	-44.1	22.8	-7.9	4.0	-0.3	30.4
Lithuania	3.2	3.3	38.2	15.3	-60.8	31.4	-2.4	1.0	-21.7	35.1
Macedonia	2.8	2.8	0.0	0.0	-12.0	6.0	0.0	1.0	-9.2	6.7
Moldova	4.8	4.9	12.5	5.0	-49.0	27.4	0.0	1.0	-31.7	28.3
Netherlands	18.4	23.0	21.6	8.6	-25.4	21.0	-47.1	23.0	-32.5	39.7
Norway	3.6	3.6	16.5	6.6	-2.2	1.1	-0.6	1.0	17.3	7.7
Poland	8.5	8.6	32.0	12.8	-36.9	22.6	-26.2	13.0	-22.5	30.3
Portugal	-4.5	4.9	17.9	7.2	-28.1	13.0	-2.0	1.0	-16.7	15.6
Romania	11.1	11.3	56.4	22.6	-30.7	17.2	-0.2	1.0	36.6	30.5
Serbia and Montenegro	11.4	11.6	28.9	11.5	-25.8	14.8	0.2	1.0	14.7	22.1
Slovakia	12.2	12.4	127.9	51.1	-24.7	15.2	-0.7	1.0	114.7	54.8
Slovenia	3.7	3.7	142.5	57.0	-8.2	4.7	0.5	1.0	138.4	57.3
Spain	20.7	5.0	8.9	3.6	-4.7	10.5	-0.4	1.0	24.4	12.2
Sweden	1.2	3.3	29.7	11.9	-6.5	1.7	0.4	1.0	24.8	12.5
Switzerland	40.1	40.7	29.5	11.8	-10.5	5.3	-0.3	1.0	58.8	42.7
Ukraine	10.5	10.6	22.3	8.9	-39.1	21.9	-11.4	5.0	-17.8	26.4
United Kingdom	24.2	19.9	10.6	4.2	-13.7	10.3	-27.5	13.0	-6.3	26.2

Source: Janssens *et al.*, 2005.

Table 43. National estimates for carbon content (t C/ha) in the surface layer (0-30 cm) of grassland, arable land and forest.

Cropland type	Location	SOC content T C/ha (0-30 cm)	Author
Grassland	Netherlands	103	Kuikman <i>et al.</i> (2002)
Arable land	Netherlands	92	Kuikman <i>et al.</i> (2002)
Forest and nature areas	Netherlands	69	Kuikman <i>et al.</i> (2002)
Grassland	Belgium	79	Lettens <i>et al.</i> (2005)
(arable) cropland	Belgium	50	Lettens <i>et al.</i> (2005)
Forest	Belgium	91	Lettens <i>et al.</i> (2005)
Arable land	Switzerland	54.2	Leifeld <i>et al.</i> (2005)
Temporary grassland	Switzerland	56.9	Leifeld <i>et al.</i> (2005)
Permanent grassland ¹	Switzerland	63.6	Leifeld <i>et al.</i> (2005)
Permanent grassland ²	Switzerland	59.7	Leifeld <i>et al.</i> (2005)
Cropland	France	45	Arrouays <i>et al.</i> (2001)
Grassland and forest	France	70	Arrouays <i>et al.</i> (2001)

¹ On favourable land (> 1 ha and slope < 20%); ² On unfavourable land (< 1 ha and/or slope > 20%).

Guo and Gifford (2002) reviewed the literature for the influence of land use changes on soil C stocks and reported the results of a meta analysis of these data from 74 publications. The meta analysis indicates that soil C stocks decline after land use changes from pasture to tree plantation (-10%) and pasture to crop (-59%). Soil C stocks increase after land use changes from native forest to pasture (+8%), crop to pasture (+19%).

It is obvious from Table 43 that SOC content is generally higher in grasslands than in arable lands. Arable lands in intensive agricultural systems in temperate regions of Europe contain roughly 50 t C/ha on average in the upper soil surface (0 cm–30 cm; Lettens *et al.*, 2005; Vleeshouwers and Verhagen, 2001). Vleeshouwers and Verhagen (2001) calculated an equilibrium content of 114 t C/ha for permanent grasslands on Dutch soils (0 cm–30 cm), which is in line with results of other authors such as Hopkins *et al.* (2009), who describe long-term experiments on grasslands in the United Kingdom. Arrouays *et al.* (2001) mentioned SOC content for all types of grasslands (0 cm–30 cm) in France of 70 t C/ha on average, as do Rotar and Vidican (2005). These results also show that variation in SOC content under grasslands can be high, with an important influence of climate and soil management.

Soil management influences SOC in different ways. Organic fertilisers can lead to a build-up of SOC if maintained over several years and in sufficient amounts (e.g.,

Hopkins *et al.*, 2009). Furthermore, grassland longevity is of major importance. Renewal or conversion of grassland is generally accompanied by ploughing up the old sward. This disturbance leads to a quick decomposition of soil organic matter and thus reduction of SOC (Freibauer *et al.*, 2004). Moreover, SOC losses occur much faster after returning grassland to arable use than the build-up when establishing grassland (Soussana *et al.*, 2004a). The abovementioned arguments illustrate the importance of long-term grasslands for sequestration and conservation of SOC. However, a ley system with temporary grassland included is more efficient in maintaining SOC than exclusive arable land use (Soussana *et al.*, 2004a).

When comparing the organic carbon content of soils in Europe (Figure 43, Plate 14), regions with high surface shares of forests, permanent and semi-natural grassland/peatland have the highest content (e.g., large parts of the Boreal and Mountainous regions). Soils in large areas of the Atlantic, Continental and Mediterranean regions have a rather low organic carbon content.

Although grasslands make a positive contribution in carbon sequestration, the role of other greenhouse gases related to grassland management, N_2O and CH_4 , should not be neglected. N_2O is emitted by grassland soils and CH_4 is emitted by livestock during grazing (Soussana *et al.*, 2004b). N_2O losses from the soil originate from processes of nitrification and denitrification, and are enhanced by high available mineral N due to fertilisation. A mean of 2.0 kg N_2O -N/ha/yr emission was estimated for grasslands, with 0.25 t CO_2 -C/ha/yr equivalent (Freibauer *et al.*, 2004, in Soussana *et al.*, 2004b). CH_4 fluxes in grassland soils are usually negligible, but emissions by ruminants by means of enteric fermentation are not: every day, a cow produces between 300 litres and 700 litres of methane, leading to mean yearly emissions of 80 kg to 100 kg CH_4 per animal (for dairy cattle in Europe). Most of the CH_4 production on grasslands thus depends on stocking rates. Enteric fermentation is responsible for 29% of total EU-15 CH_4 emission (Soussana *et al.*, 2004b). As such, it is estimated that CH_4 and N_2O emissions counterbalance 70% to 80% of the European grassland carbon sink (Ciais *et al.*, 2010).

Mitigation of soil erosion (and runoff)

Soil erosion is a major problem in some European regions. Hengl *et al.* (2007) mention soil erosion problems in several countries in south-eastern Europe (e.g., Albania, the former Yugoslav Republic of Macedonia, Bosnia and Herzegovina, and others), but many countries in other regions also suffer from the consequences of soil erosion, albeit to a lesser degree (Table 44). High erosion rates are expected in areas dominated by vineyards, the hilly loess areas in western and central Europe (2–10 t/ha/yr) and the agricultural areas located in the piedmont areas of the major European mountain ranges (Cerdan *et al.*, 2010). Soil erosion is considered the main environmental problem associated with agriculture in Mediterranean environments because of the heavy rains in autumn or winter after the fields have been tilled in preparation for sowing (Boualal and Goméz-MacPherson, 2010).

Table 44. Estimated mean and total erosion rates aggregated per biogeographical region.

	Mean erosion rate (t/ha/yr)	Std. dev.	Area (ha)	Total erosion (t/yr)	% of total EU erosion
Continental	1.8	6.8	131 587 000	240 443 662	43.5
Steppic	1.6	4.5	3 753 200	6 127 549	1.1
Pannonian	1.3	5.1	13 418 200	17 924 702	3.2
Mediterranean	1.3	5.1	91 142 700	118 726 127	21.5
Atlantic	1.2	3.6	77 065 900	93 502 515	16.9
Black sea	1.0	4.5	1 092 610	1 097 560	0.2
Alpine	0.9	4.9	43 677 800	37 788 329	6.8
Boreal	0.5	1.8	82 634 500	37 457 888	6.8
None	0.1	0.1	849	109	0.0

Reproduced from Cerdan *et al.*, 2010.

Grasslands positively mitigate soil erosion and runoff through a permanent cover of the soil and a dense rooting system. Estimated average erosion rates, in a European context, are much lower for grasslands (0.30 t/ha/yr) than for arable lands (3.6 t/ha/yr; Cerdan *et al.*, 2010). As long as plant cover is maintained, these problems are usually negligible (Jankowska-Huflejt, 2006; Fullen *et al.*, 1998). Ploughing grasslands is one of the reasons for the observed increase in soil erosion and runoff, as has been shown in certain areas of France (Mathieu and Joannon, 2003; Souchère *et al.*, 2003) and the Czech Republic (Van Rompaey *et al.*, 2009).

In several EU member states, erosion measures are part of agri-environmental schemes. The measures are often compensated and mandatory on cultivated areas highly prone to erosion; this is the case on about 10 000 ha in Flanders. One of the recommended measures is the instalment of grassland buffer strips. In some countries, it is compulsory to install grassland on parcels with a high slope; one such example is in the Netherlands on land with slopes exceeding 18%.

The greatest risks due to water erosion occur in the Mediterranean region (large parts of Spain, Portugal, Italy and Greece), but it can also be a problem in Sweden (Figure 44, Plate 15). There is some similarity to Figure 43: regions with very low soil organic carbon content seem to be more prone to erosion. The presence of hills, mountains and slopes also makes a significant contribution to water erosion.

Mitigation of pollution

Several substances and chemicals occurring on grasslands cause pollution and eutrophication of soil and water bodies. In an agricultural context, through the application of nutrients and pesticides, pollutants can be unintentionally spread to the environment, mainly through leaching, runoff and erosion.

With regard to nutrients, the focus is on nitrogen and phosphorus compounds, while other pollutants common on grasslands are herbicides. In grasslands, apart from (local) weed control, sward renewal can be accompanied by an herbicide

treatment in intensive farming systems. But in general, pesticide use and the risk of environmental pollution are much lower in grassland systems than with annual crops (Peeters, 2009). Pollutants such as phosphorus and pesticides bind to soil particles, reaching surface waters through runoff and erosion (Stoate *et al.*, 2009; Jankowska-Huflejt, 2006; Wilkins *et al.*, 2003). Because of the mitigating effect of (permanent) grasslands on runoff and erosion, pollution from these substances can be reduced.

Nutrients and pollutants left on the surface of grassland are quickly decomposed due to an intensive biological activity of soil micro-organisms associated with grassland ecosystems (Jankowska-Huflejt, 2006). However, phosphate and nitrate pollution of surface waters can occur in grasslands when animals have access to rivers or from manure applications on slopes, during rainy periods or in winter (Peeters, 2009). Nevertheless, grasslands can be viewed as biological filters and barriers for the migration of various chemicals towards surface and groundwater systems (Jankowska-Huflejt, 2006). As such, they are important tools to comply with the limit of 50 mg N/L in both surface and ground waters, as set out in the 1991 EU Nitrates Directive (Wilkins *et al.*, 2003).

► Grassland-based biodiversity issues

As mentioned previously, centuries of traditional management of low intensity grazing and haymaking systems resulted in semi-natural grasslands with a unique and high species diversity (Dahms *et al.*, 2008; Pärtel *et al.*, 2005). Today, throughout Europe, (semi-natural) grassland ecosystems are crucial for maintaining biodiversity (EC 2008b; Pärtel *et al.*, 2005; Veen *et al.*, 2001; Bignal *et al.*, 1996).

The increasing land use intensity has caused a severe decline in biodiversity related to the agricultural landscape (Peeters 2009; Donald *et al.*, 2006; Plantureux *et al.*, 2005), replacing many specialist species by a handful of thriving generalist species (Walker *et al.*, 2005).

The preserved semi-natural grassland areas, even if not very numerous, often retained important natural value (Dauber *et al.*, 2006), with a considerable percentage of plant and animal species that are rarely found in other vegetation types (Isselstein *et al.*, 2005). Due to the vulnerability to both intensification and abandonment, semi-natural grasslands are among the most vulnerable ecosystems (Veen *et al.*, 2001). They are thus protected in many ways. Semi-natural and low-input grasslands account for up to 31 habitats in Annex I of the Habitats Directive (EC, 2008b), and they cover a substantial area of the High Nature Value farmland (Andersen *et al.*, 2004). Moreover, permanent grassland area is protected by EU legislation and several national agri-environmental schemes focus on grasslands for protecting biodiversity (Isselstein *et al.*, 2005).

Although intensively managed grasslands support less biodiversity, from an ecological point of view they are often preferred over other agricultural land uses. The highest number of species per unit of surface is found in mixed landscapes dominated by grasslands, despite intensive management (Plantureux *et al.*, 2005). As such, even

intensified grasslands are considered positive for biodiversity compared to other agricultural land uses, such as arable farming of fodder crops (Peeters, 2009).

Grassland vegetation

Unimproved semi-natural grasslands resulting from extensive, traditional grassland management can support high biodiversity, including many endemic species (Peeters, 2009; Bugalho and Abreu 2008; Pärtel *et al.*, 2005; Veen *et al.*, 2001). These grasslands are often referred to as ‘species-rich’ grasslands. Through variations in management style, climatic and abiotic conditions, semi-natural grasslands display tremendous variety (Veen *et al.*, 2001).

The botanical richness of semi-natural grasslands can be overwhelming. In four alpine hay meadow communities, Marini *et al.* (2007) found 159 species in 56 plots measuring 10 m by 10 m. Diaz-Villa *et al.* (2003) observed 113 species in 0.1 ha plots in grasslands under evergreen oak cover in Spain. In the Laelatu wooded meadow in Estonia, Sammul *et al.* (2003) detected 76 species in one square metre. However, the highest plant species richness in grasslands in Europe is probably found in dry and calcareous (or limestone) grasslands in north-western Europe (Brückmann *et al.*, 2010; Phoenix *et al.*, 2008), where up to 80 plant species per square metre are found (EC, 2008b). Soil chemical composition is a key factor that determines grassland diversity and its botanical composition (Janssens *et al.*, 1998).

Through agricultural intensification over the last fifty years, stocking rates, cutting frequency, fertiliser use, resowing, etc. have become increasingly high (Peeters, 2009). As a result of these economic improvements, plant species richness (and overall biodiversity) has fallen dramatically in grassland swards (Peeters, 2009; Isselstein *et al.*, 2005).

Low biodiversity in grasslands is enforced starting with the seed mixtures used for the instalment or renewal of grassland swards. In intensively managed grasslands, the predominant species in (both temporary and permanent) swards is often perennial ryegrass (*Lolium perenne*). Wilkins *et al.* (2003) mention that some 80% of the grass seeds sold in maritime areas in north-west Europe are of this single species. Furthermore, they describe the decline of traditionally used species such as white clover (*Trifolium repens*), red clover (*Trifolium pratense*), lucerne (*Medicago sativa*), cocksfoot (*Dactylis glomerata*), among others. In some regions the traditional use of certain species is still maintained; for instance, timothy (*Phleum pratense*) and meadow fescue (*Festuca pratense*) are still of major importance in the Boreal region.

After establishment, other species can spontaneously create populations in the sward, if they can withstand agricultural management. As such, long-term and permanent swards may have high contents of mainly grass species of *Agrostis* spp., *Poa trivialis*, *Dactylis glomerata*, and others (Wilkins *et al.*, 2003). Yet, intensive management of grassland can delay the spontaneous colonisation of the sward by new species. High nutrient availability and frequent cutting favour fast-growing, competitive species such as perennial ryegrass. Moreover, germination and establishment of seedlings is negatively affected by fertilisers covering

the soil surface that thus smother the sward (Plantureux *et al.*, 2005). Certain practices can enhance diversity of species-poor grasslands and deal with several constraints; success is variable (Pywell *et al.*, 2007).

The botanical composition of pasture vegetation is strongly influenced by management (Stybnarova *et al.*, 2009). In case of remaining semi-natural pastures, botanical composition is the result of traditional agricultural activities such as haymaking or herding (Peratoner *et al.*, 2009; Maurer *et al.* 2006; Isselstein *et al.*, 2005). Plant species richness declines as fertiliser application rises, especially nitrogen (e.g., Zechmeister *et al.*, 2003). Nitrogen fertiliser levels—even when far below those applied on intensively managed grasslands—cause significant losses in sward plant diversity, with half of the number of plant species eliminated for fertilisations between 20 and 50 kg N/ha/yr (Plantureux *et al.*, 2005). The most common practice for biodiversity restoration in intensively managed grasslands is to reintroduce extensive management of grazing and/or cutting (Walker *et al.*, 2005; Tallowin and Jefferson, 1999). The impact of grazing management on grassland biodiversity has been documented in many studies (e.g., Rook and Tallowin, 2005). Nutrient depletion can be accelerated by haymaking. However, atmospheric nutrient deposits are increasing and are believed to slow down extensification effects on biodiversity (Plantureux *et al.*, 2005).

Land use intensification poses a threat to botanical diversity in grassland swards, but so does land abandonment. This is due to the phenomenon of rural abandonment (Bugalho and Abreu, 2008) or abandonment of parcels with little agricultural value (e.g., on steep slopes or in marginal areas, Marini *et al.*, 2007). Ceasing grassland management means vegetative succession progresses with the encroachment of shrubs and other woody species (Pärtel *et al.*, 2005; Fischer and Wipf, 2002), leading to the disappearance of many typical grassland species.

A very complex set of factors explains the diversity of grassland vegetation, and includes both environmental factors such as climate and soil, management practices like sowing or resowing, fertilisation and grazing/cutting. These management factors will influence diversity either directly or indirectly (e.g., soil composition). The same set of factors will influence the hosted diversity (invertebrates, small mammals, birds). Effects may also be mediated by vegetation diversity, vegetation structure and the available food web (Brown and Tallowin, 2009; McCracken and Tallowin, 2004; Vickery *et al.*, 2001).

Today, in regions with intensified agriculture, (temperate) semi-natural grasslands only persist on a low percentage of the total grassland area. Their preservation is a primary goal for nature conservation (Isselstein *et al.*, 2005), such as through the Habitats Directive (1992) or the international treaty drawn up at the Ramsar Convention on Wetlands (1971). Semi-natural grasslands have persisted mainly on locations that are less suitable to agriculture because of biotic and abiotic constraints (Pärtel *et al.*, 2005). Yet, large areas of semi-natural grasslands still exist in other regions, primarily in eastern Europe. Veen *et al.* (2001) registered around 2 million ha of semi-natural grasslands in both Romania and Poland. According to the same authors, to European standards, Slovenia has an exceptionally high percentage (53.6%) of semi-natural grasslands within the total agricultural area.

EUNIS habitat classification

The EUNIS habitat classification is a hierarchical classification of habitats. Classification is based on general vegetation science with additions of abiotic features. The EUNIS habitat classification gives a comprehensive overview of European habitats.

For the purposes of EUNIS, a ‘habitat’ is defined as: ‘a place where plants or animals normally live, characterised primarily by its physical features (topography, plant or animal physiognomy, soil characteristics, climate, water quality, etc.) and secondarily by the species of plants and animals that live there’ (Davies *et al.*, 2004).

‘The EUNIS Habitat classification has been developed to facilitate harmonised description and collection of data across Europe through the use of criteria for habitat identification. It is a comprehensive pan-European system, covering all types of habitats from natural to artificial, from terrestrial to freshwater and marine habitats types. It is built to link to and correspond with other major habitat systems in Europe. It cross-references all EU Habitats Directive habitat types used for EU Member States’ (<http://eunis.eea.europa.eu/habitats.jsp>).

The EUNIS classification has four formal levels.

The first level of the EUNIS habitat classification has ten major habitats (Table 45); the second features 54 habitats. The second level habitats related to grasslands are presented in Table 46.

Table 45. EUNIS major habitats (first level).

A	Marine habitat
B	Coastal habitats
C	Inland surface water habitats
D	Mire, bog and fen habitats
E	Grassland and tall forb habitats
F	Heathland, scrub and tundra habitats
G	Woodland and forest habitats and other wooded land
H	Inland unvegetated or sparsely vegetated habitats
I	Regularly or recently cultivated agricultural, horticultural and domestic habitats
J	Constructed, industrial and other artificial habitats

Table 46. Second level EUNIS habitats related to grassland.

EUNIS code	Level	EUNIS name	Description
E	1	Grasslands and lands dominated by forbs, mosses or lichens	Non-coastal land which is dry or only seasonally wet (with the water table at or above ground level for less than half of the year) with greater than 30% vegetation cover. The vegetation is dominated by grasses and other non-woody plants, including mosses, macro-lichens, ferns, sedges and herbs. Includes semiarid steppes with scattered [<i>Artemisia</i>] scrub. Includes successional weedy vegetation and managed grasslands such as recreation fields and lawns. Excludes regularly tilled habitats (I1) dominated by cultivated herbaceous vegetation such as arable fields.
E1	2	Dry grasslands	Well-drained or dry lands dominated by grass or herbs, mostly not fertilised and with low productivity. Included are [<i>Artemisia</i>] steppes. Excluded are dry Mediterranean lands with shrubs of other genera where the shrub cover exceeds 10%; these are listed as garrigue (F6).
E2	2	Mesic grasslands	Lowland and montane mesotrophic and eutrophic pastures and hay meadows of the boreal, nemoral, warm-temperate humid and Mediterranean zones. They are generally more fertile than dry grasslands (E1), and include sports fields and agriculturally improved and reseeded pastures.
E3	2	Seasonally wet and wet grasslands	Unimproved or lightly improved wet meadows and tall herb communities of the boreal, nemoral, warm-temperate humid, steppic and Mediterranean zones.
E4	2	Alpine and subalpine grasslands	Primary and secondary grass- or sedge- dominated formations of the alpine and subalpine levels of boreal, nemoral, Mediterranean, warm-temperate humid and Anatolian mountains.
E5	2	Woodland fringes and clearings and tall forb stands	Stands of tall herbs or ferns, occurring on disused urban or agricultural land, by watercourses, at the edge of woods, or invading pastures. Stands of shorter herbs forming a distinct zone (seam) at the edge of woods.
E6	2	Inland salt steppes	Saline land with dominant salt-tolerant grasses and herbs. Excludes saline scrubland, listed under F6.8 xero-halophile scrubs.
E7	2	Sparsely wooded grasslands	Grasslands with a wooded overstorey that normally has less than 10% cover.

Source: Davies *et al.*, 2004.

Grassland fauna

Not only are there a great variety in plant species, but a considerable number of animal species also occur in open grasslands and are rarely found in other vegetation types (Isselstein *et al.*, 2005). Examples are certain species of farmland birds (Donald *et al.*, 2002) or butterflies (Sang *et al.*, 2010).

Farmland birds have different habitat requirements, depending on foraging and anti-predation strategy. Some prefer open landscapes whereas others prefer landscapes with woody edges (Sanderson *et al.*, 2009). Several farmland bird species depend on grassland habitats or mixed landscapes (grassland and arable farming) to survive (Sanderson *et al.*, 2009; Whittingham and Devereux, 2008).

Among the most common grassland bird species of the lowland, the following can be cited: *Alauda arvensis*, *Anthus campestris*, *Anthus pratensis*, *Carduelis cannabina*, *Ciconia ciconia*, *Corvus frugilegus*, *Emberiza citrinella*, *Falco tinnunculus*, *Galerida cristata*, *Hirundo rustica*, *Lanius collurio*, *Lanius minor*, *Limosa limosa*, *Motacilla flava*, *Passer montanus*, *Perdix perdix*, *Saxicola rubetra*, *Saxicola torquata*, *Streptopelia turtur*, *Sturnus vulgaris*, *Sylvia communis*, *Vanellus vanellus*.

Populations of many farmland bird species declined greatly across Europe during the last quarter of the twentieth century (Donald *et al.*, 2002). A driving force behind this change is increased farming intensity, with high nutrient input producing dense swards that can be frequently cut starting in spring, not to mention the drainage of wetlands and other factors. Research points out that a strong negative relationship exists between farmland bird occurrence and agricultural intensity (Donald *et al.*, 2006). However, land abandonment can also cause farmland bird populations to drop, which occurred when grazing management was ceased in Swedish semi-natural grasslands (Pärt and Söderström, 1999). Today, many endangered bird species are protected by the EU's oldest piece of nature legislation: the Birds Directive (1979).

Butterflies are another species group that is often linked to herbaceous vegetation. Specialist butterfly species rely on a only few or even just one host plant species and thus are bound to certain grassland communities, (e.g., calcareous grasslands; Brückmann *et al.*, 2010). Many (specialist) butterflies are endangered because of the disappearance of their habitats such as former pastures (Pöyry *et al.*, 2005). Aviron *et al.* (2007) found that grassland areas that are extensively managed do not necessarily contain higher species diversity, but do contain more specialist species (in terms of host plants) and species with low dispersal ability. This could be explained by the higher plant species richness of extensively managed grasslands and the difference in cutting management (later cuts), although some authors doubt plant species richness as an explanation (Sang *et al.*, 2010).

In addition to butterflies, grasslands shelter a great variety of other invertebrate species, including snails (Boschi and Baur, 2008), ants (Pihlgren *et al.*, 2010), beetles (Woodcock *et al.*, 2007) and small mammals (Aschwanden *et al.*, 2007). Many of these species rely on extensively managed or semi-natural grasslands for their existence and populations are negatively affected both by intensification (fertilisation) and abandonment of extensive pasture management.

Soil ecosystem

Grasslands generally support a rich soil ecosystem through the supply of substantial amounts of organic matter mainly through root litter degradation. Soil fauna can be subdivided in macrofauna, mesofauna, microfauna and microflora. Table 47 shows the average biomass and taxonomic diversity of soil biota on sandy soils measured by the Biological Indicator System for Soil Quality in the Netherlands (Rutgers *et al.*, 2008, 2009).

Table 47. Average biomass and taxonomic diversity of soil biota on sandy soils of 87 dairy farms in the Netherlands.

Classification by body width	Biota	Soil layer (cm)	Fresh biomass (kg/ha)	Number of taxa
Macrofauna ¹ (> 2 mm)	Earthworms	0-20	475	4.6
Mesofauna ¹ (100 μ m-2 mm)	Enchytraeids	0-15	22.4	8.2
	Mites + Collembola ³	0-7.5	1.6	26
Microfauna ² (< 200 μ m)	Nematodes	0-10	9.8	32
Microflora	Bacteria	0-10	1898	nd
	Fungi	0-10	286	nd

¹ Samples collected from grassland only; ² Samples collected from both grassland and arable land of the same dairy farm; ³ Converted from abundance to fresh biomass according to Didden *et al.* (1994); Nd: not determined.

Source: Rutgers *et al.*, 2008, 2009 in Van Eekeren 2010.

Soil fauna biomass under grasslands can be substantial (Table 43). Soil biota play an important role in ecosystem services and production, and particularly grasslands, through water regulation, nutrient supply, etc. (Van Eekeren, 2010). Whereas in arable fields the focus is more on bacterial communities, fungi fulfil a more important part in grassland soil ecosystems with increasing populations and genetic diversity with sward age (Plassart *et al.*, 2008).

Many soil biota species (or groups) are more abundant in permanent grasslands than in temporary grasslands or arable fields. For instance, Van Eekeren (2010) found significantly more earthworms, total biomass and species richness in permanent grasslands than in temporary grasslands and arable land. Nematodes, with the exception of bacterivorous species, also showed a preference for grasslands over arable land. Microbial biomass was 50% higher in permanent grasslands than for arable land.

The soil food web is strongly affected by agricultural management, especially by fertilisation and soil perturbations like ploughing. For instance, the application of manure on grasslands appeared to be more beneficial for protozoa, bacterivorous and fungivorous nematodes than chemical fertilisers (Forge *et al.*, 2005). In general, intensification of grasslands tends to promote low diversity but not necessarily low density of soil fauna (Plantureux *et al.*, 2005). Also, in cases of high nutrient availability, bacterial populations and bacterial feeding fauna are favoured, often at the expense of (arbuscular) mycorrhizal fungi (Denef *et al.*, 2009; Bradley *et al.*, 2006; Plantureux *et al.*, 2005).

Because grassland restoration—especially permanent—positively impacts soil microbiota biomass and activity and improves soil structural stability, it can be considered an efficient method of soil conservation (Plassart *et al.*, 2008).

» Landscape related issues

Not only are grasslands key factors in ecological functions for the environment and biodiversity, but they also provide an attractive landscape. They even play an important role in the maintenance of landscapes of value, landscape amenity and cultural heritage (Gibon, 2005). Grasslands can be open landscapes or combined with hedgerows or wooded edges, as is the case in the enclosure landscapes in north-eastern Spain (Llausas *et al.*, 2009).

An important reason for the positive perception of grasslands is that they are perceived as a rather “natural” landscape feature by many, as opposed to settlements or arable fields. Schüpbach *et al.* (2008) evaluated landscape aesthetics in Switzerland and found that grasslands score better for the perception of the ‘naturalness’ factor (Hoisl *et al.*, 1988). Moreover, low-intensity land use further improves the naturalness factor of a landscape. As such, semi-natural grasslands that show more colour and structure, often associated with low-intensity use, score higher for naturalness.

Furthermore, high quality landscapes are also beneficial for outdoor recreation and tourism (Peeters, 2009; Bugalho and Abreu, 2008; Wilkins *et al.*, 2003), providing a social and even an economic return. Various research and development initiatives support the idea that landscape management and planning will become an increasingly important feature in rural development (Gibon, 2005).

» National case studies

Grasslands, and especially permanent grasslands, play a key role in areas where there are important environmental issues at stake. In this section, we document examples from various countries all over Europe showing how grasslands are managed to preserve the environment and improve farm profitability.

The case studies are introduced by data summarising grassland production and utilisation at the national level. They focus on regions where soil and climate conditions are severe and where grasslands and associated animal production offer the possibility of obtaining both good economic performance and environmental benefits. To do so, farmers have adapted their practices to get the best out of their local natural resources. They use traditional know-how cultivated by the local communities and innovative practices and technologies developed by agricultural extension services. They also often offer animal products in local markets, with consumers appreciating the high quality of the products that is a direct result of good grassland management. Grasslands, their management and the products produced from them have a very high cultural value that may be identified through a Protected Designation of Origin (PDO) label.

The economic viability of the farms is also possible thanks to special financial support and agri-environmental measures that recognise the environmental services provided by those farms and the managed grasslands.

France

Grasslands of the French Atlantic littoral marshes

Authors: Daphné Durant, Sarah Chadefaux, Eric Kernéis, Saint-Laurent de la Prée, Experimental Unit, Inra

French Atlantic littoral marshes cover an area of roughly 300 000 ha. Among these, 100 000 ha consist of mudflats and salt marshes (the shore) that are subjected to the ebb and flow of the tides (intertidal zone). Salt marshes (5 000 ha) are usually mown or grazed by sheep. The other 200 000 ha are protected from the sea by sea walls and sluices.

About 5 000 ha are managed with salt water for oyster farming, aquaculture or salt production. The remaining area is managed with freshwater and consists of a) “dry marshes”, *i.e.* polders with controlled water levels; they are mainly used for agriculture (field crops and grasslands), and b) “wet marshes”, located in the upstream part of the marshes, which are unprotected from river flooding. Although some areas are cultivated (e.g., maize), they mainly consist of small areas of grasslands surrounded by ash trees, and are sometimes only accessible by boat. Some of these grasslands are used for poplar plantation.

This case study deals with some of these Atlantic littoral marshes, including the well-known Marais Poitevin. The Marais Poitevin is the second largest wetland in France after the Camargue (Mediterranean coast). It covers roughly 96 000 ha and spans two regions, Poitou-Charentes and Pays de Loire. For the purposes of the study, the perimeter of marsh coverage includes four departments: Loire Atlantique, Charente-Maritime, Vendée and Deux-Sèvres. This perimeter is representative of the marshes of the Atlantic coast because of similar characteristics such as climate, tidal regimes and plant communities (Photo 1, Plate CS1). However, these marshes differ from those of the Camargue (Rhône River Delta) where freshwater marshes cover a smaller area. Conversely, the Camargue is dominated by brackish lakes and

Table CS1. Departmental statistical evolutions in Charente-Maritime, Deux-Sèvres, Vendée and Loire Atlantique (1989-2010).

	1989	1992	1995	1998	2001	2004	2007	2010
Charente-Maritime								
Land use ('000 ha)								
Total AA	453	448	449	448	447	447	449	445
Permanent grassland	63	53	48	47	48	48	49	48
Rangeland	3	3	3	3	3	2	3	3
Temporary grassland	29	30	29	27	24	24	26	27
Annual forage crops	18	11	12	16	11	12	10	10
Number of animals ('000 heads)								
Suckling cows	27	28	26	26	28	25	26	26
Dairy cows	44	36	34	32	32	30	26	23
Sheep	34	21	17	14	15	15	16	15
Goats	27	24	20	23	24	27	27	26
Horses (regional data)	12	12	12	15	18	18	18	18



France

© European Environment Agency (EEA),
Corine land cover 2000 by country.



Photo 1. Wet grasslands grazed by a herd of cattle (Maraîchine breed) in the dry marshes. © Inra / E. Kerneis.

Plate CS2



Photo 2. Landscape of the wet marshes. © Inra / E. Kerneis.



Photo 3. Adder's-tongue Spearwort (*Ranunculus ophioglossifolius*). © Inra / E. Kerneis.



Photo 4. Seashore Iris (*Iris spuria* subsp. *maritima*). © Inra / E. Kerneis.



Photo 5. Lapwing. © Inra / G. Renaud.

Plate CS4



Greece

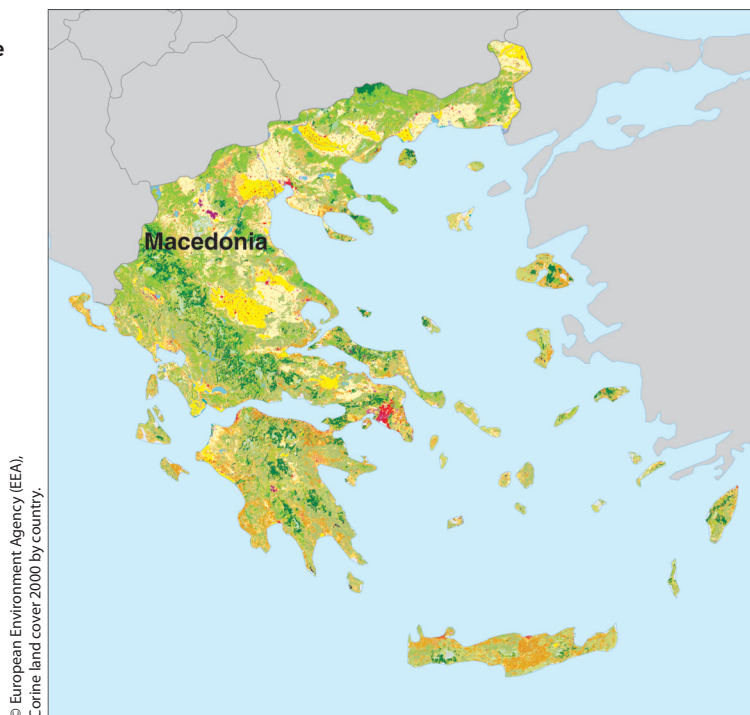

Photo 6. Sheep and goats grazing in temporary grasslands in Central Macedonia. © Maria Yiakoulaki, Aristotle University of Thessaloniki.



Photo 7. Goats grazing in kermes oak shrublands of Central Macedonia. © Maria Yiakoulaki, Aristotle University of Thessaloniki.



Hungary

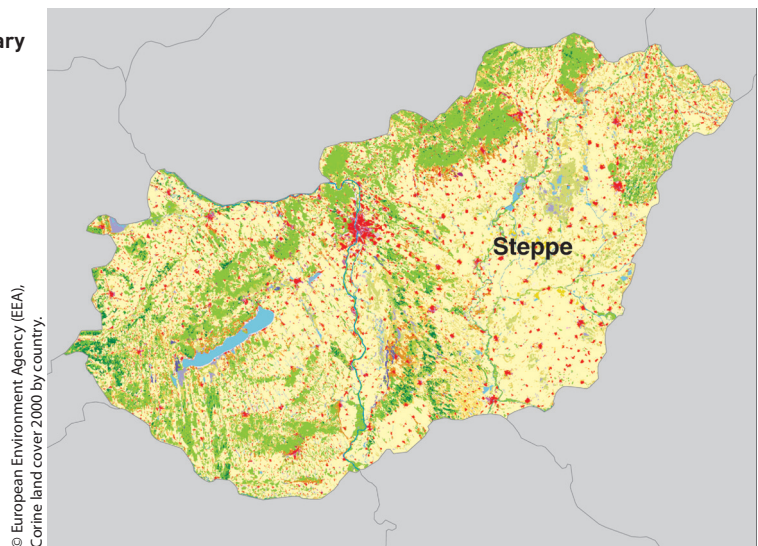

© European Environment Agency (EEA),
Corine land cover 2000 by country.

Plate CS6



Photo 8. Cows of a local breed grazing typical steppic vegetation. © Geza Nagy, University of Debrecen.



Photo 9. Local breeds of cattle and sheep.
© Geza Nagy, University of Debrecen.





Italy



Photo 10. Grazing sheep in Sardinia. © Claudio Porqueddu, CNR-ISPAM.

Plate CS8



Photo 11. Golden oat grass (*Trisetum flavescens*) subalpine tall sward. © Giampiero Lombardi.



Photo 12. Matgrass (*Nardus stricta*) alpine grassland. © Giampiero Lombardi.



Photo 13. Dairy cattle grazing a *Festuca gr. rubra* subalpine grassland. © Giampiero Lombardi.

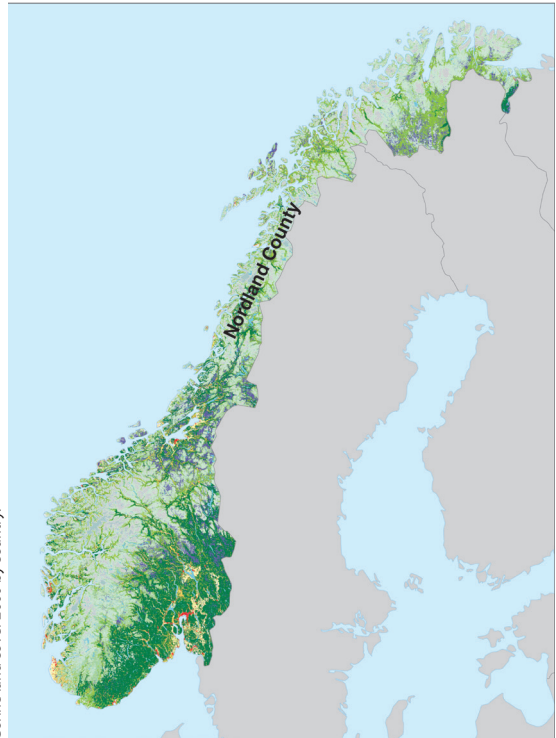

© European Environment Agency (EEA),
Corine land cover 2000 by country.

Plate CS10



Photo 14. Norwegian White sheep at the Arctic Circle. © Vibeke Lind, Bioforsk Nord Tjøtta.



Photo 15. Norwegian Red cow breed. © Vibeke Lind, Bioforsk Nord Tjøtta.



Poland

© European Environment Agency (EEA),
Corine land cover 2000 by country.



Photo 16. The Tatra Mountains. © Halina Jankowska, Institute of Technology and Life Sciences.

Plate CS12



Photo 17. Most permanent grasslands are harvested for hay production. © Halina Jankowska, Institute of Technology and Life Sciences.



Photo 18. Sheep grazing in the Tatra Mountains. © Halina Jankowska, Institute of Technology and Life Sciences.



Photo 19. Oscypek (PDO) hard sheep's milk cheese.
© Halina Jankowska, Institute of Technology and Life Sciences.



Portugal

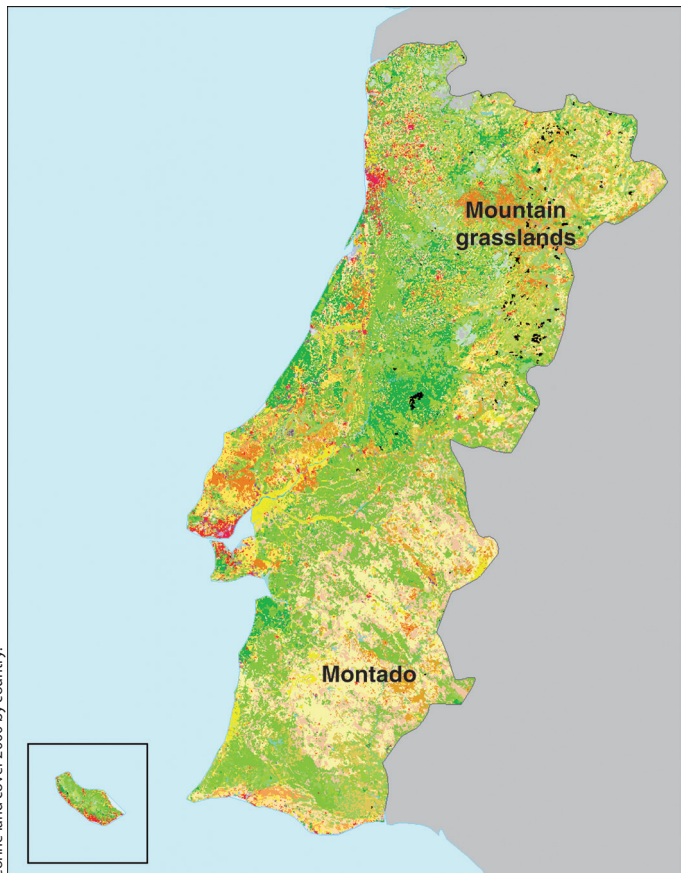

© European Environment Agency (EEA),
Corine land cover 2000 by country.

Plate CS14



Photo 20. Holm oak (*Quercus rotundifolia*) montado (dehesa) (Alentejo, Portugal). © Carlos Aguiar, Escola Superior Agrária de Bragança.



Photo 21. *Trifolium subterraneum* grassland. © Carlos Aguiar, Escola Superior Agrária de Bragança.



Photo 22. Montanheira Alentejana pig breed fattening. © Carlos Aguiar, Escola Superior Agrária de Bragança.



Photo 23. Mesotrophic mountain meadow (Trás-os-Montes, Portugal). © Carlos Aguiar, Escola Superior Agrária de Bragança.

Plate CS16



Romania

© European Environment Agency (EEA),
Corine land cover 2000 by country.

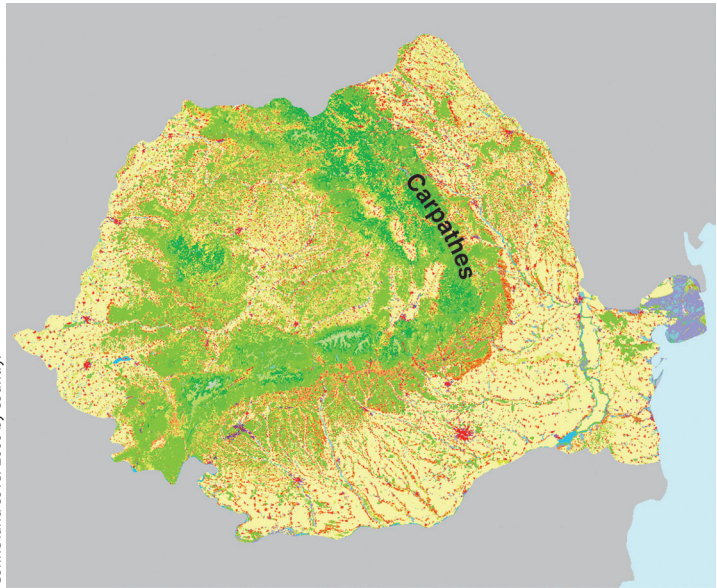

Photo 24. Grazing sheep in Romania. © Veronica Sărățeanu, Banat's University of ASVM.

	1989	1992	1995	1998	2001	2004	2007	2010
Deux-Sèvres								
Land use ('000 ha)								
Total AA	471	469	467	464	461	459	457	451
Permanent grassland	138	117	102	98	94	92	90	86
Rangeland	5	5	5	5	5	5	5	5
Temporary grassland	80	84	82	83	81	81	85	83
Annual forage crops	58	50	44	40	35	36	29	28
Number of animals ('000 heads)								
Suckling cows	91	104	106	106	106	100	103	104
Dairy cows	60	54	48	44	42	41	39	37
Sheep	525	398	366	370	360	343	305	251
Goats	240	229	225	235	246	247	250	262
Horses (regional data)	12	12	12	15	18	18	18	18
Vendée								
Land use ('000 ha)								
Total AA	532	526	525	526	522	517	512	508
Permanent grassland	122	118	110	94	96	94	95	91
Rangeland	23	26	33	37	35	33	30	29
Temporary grassland	101	99	103	113	117	114	118	119
Annual forage crops	97	82	73	64	66	56	57	61
Number of animals ('000 heads)								
Suckling cows	154	155	171	162	155	146	146	143
Dairy cows	110	93	90	83	88	82	80	78
Sheep (regional data)	353	293	265	211	192	202	193	179
Goats	87	86	95	110	113	114	132	158
Horses (regional data)	33	38	40	43	46	48	48	48
Loire Atlantique								
Land use ('000 ha)								
Total AA	457	442	437	430	430	426	431	428
Permanent grassland	123	116	102	92	94	96	82	82
Rangeland	13	12	16	11	14	15	10	10
Temporary grassland	123	137	136	141	134	128	151	152
Annual forage crops	76	58	58	50	56	51	50	52
Number of animals ('000 heads)								
Suckling cows	60	63	70	72	72	69	73	73
Dairy cows	168	141	133	126	135	124	123	121
Sheep (regional data)	353	293	265	211	192	202	193	179
Goats	87	86	95	110	113	114	132	158
Horses (regional data)	33	38	40	43	46	48	48	48

Source: Agreste. Annual Agriculture Statistics.

low-lying and upper salt plains ('sansouires') where the flora is especially adapted to cope with more saline conditions (woody and herbaceous halophytes such as sea lavender, glasswort, tamarisk or reeds). We focus here on the grasslands of the dry and wet marshes of the French Atlantic coast.

Environment

The climate is of mild Atlantic type (qualified as thermo-Atlantic) and is characterised by 800 mm of rainfall per year and a mean annual temperature of 15°C. Rainfall distribution is quite uneven throughout the year, with a water surplus in winter and a summer drought from June until the rains return in autumn. In dry marshes, soils are derived from the filling of marine gulfs (fluvial and marine sediments). Because these hydromorphic soils are composed of clay, more or less saline/sodic, over large thicknesses, they are waterlogged in winter and can undergo a pronounced desiccation in summer. In wet marshes, soils are mainly humus-rich and peat (calic peat bogs).

Grassland type and management

Wet grasslands are criss-crossed by a network of freshwater ditches. In dry marshes, thermo-Atlantic sub-halophilic grasslands are used for cutting and/or grazing, mainly by suckling cattle, dairy cattle and horses. Grasslands are characterised by a high but seasonal productivity as soil and climatic conditions induce specific constraints on grass production: in winter, the fields are inaccessible because they are flooded, and thus the turnout date occurs in late March to early April. Grass growth is usually halted by water deficits in summer and low temperatures in winter. Plant rooting depth is limited by the high water level in the soil during wet periods. A short grass growth period occurs from April to June and drought occurs from July to September. The peak biomass production is thus in June, with an average of 5 t DM/ha (this can vary from 2 to 8 t DM/ha). Fertilisation is low and generally does not exceed 60 kg N per ha per year. In wet marshes, eutrophic wet meadows produce grass later in spring (the turnout date occurs in April) but more continuously in summer due to the high water retention capacity and hydraulic conductivity of soils. Since they are not easily accessible to cutting machines, grasslands are not cut but essentially grazed, with little or no fertilisation.

Dairy and meat sectors, products and marketing

Table CS1 shows statistical data (1989–2010) of land use and animal production available for each of the four departments (Agreste). The department scale has been privileged here since the existing data related to marshes are generally not sufficient to construct this kind of time series statistics. However, according to data from agri-environmental measures, it is obvious that marshes substantially contribute to agricultural production: wet grasslands represent on average 10% of total utilised agricultural area of the four departments and approximately 60% of permanent grasslands. Farms exploiting marshes account for around 16% of the total number of farms.

In the marshes of the Charente-Maritime and Vendée departments, most of the wet grasslands are grazed by suckling cattle (Photo 2, Plate CS2), while in Loire-Atlantique, suckling farming shares the area with dairy systems. In Charente-Maritime, marshes provide grazing land for more than half of beef production. Around half of the farms in this department are involved in cattle farming, whereas sheep and goat husbandry are less widespread (only 5% of farms). A quarter of the farms are cattle farming specialists (9% dairying and 16% suckler farming) and 23% use mixed crop-livestock

farming systems. Herds are made up of different breeds. Beef cattle breeds largely dominate: about 40% of farms raise Charolais, 30% raise Limousin and 15% raise Blonde d'Aquitaine (Mériaux and Peres, 2006, 2010; Mériaux and Mousseau, 2010; Mériaux *et al.*, 2011a, 2011b). Some local breeds originate from Atlantic coast wetlands (e.g., Maraîchine or Nantaise breeds) and have become neglected as wetlands were put under intensive crop and livestock production. The largest part of production consists of six to eight month-old calves, which are exported to the Italian beef industry, for instance, where they are fattened for slaughter (finishing). In Charente-Maritime, 65–85% of farms handle this type of product. About 30% of farms fatten animals to produce 18-month-old bulls. Other products include milk calves (4 to 5 months) and finished three-year-old bulls sold at the local market.

Half of the breeders sell animals directly to retailers and a third to independent livestock producer groups. Other outlets are supermarkets or small traditional butchers, although the latter only account for a small part of beef production. There are economic benefits associated with a direct-to-consumer marketing strategy; for instance, farmers can fetch better prices for their products. Despite the additional time required to package and sell beef products through on-farm stands or local farmers markets, 10–20% of the farms in the Charente-Maritime marshes use this type of outlet.

Changes in the statistics per category (areas, livestock, holdings), in the management and reasons for these changes

Before the 1960s, grassland-based extensive livestock farming constituted the traditional and dominant farming system in the Atlantic marshes. In the 1970s, however, an agricultural intensification plan was implemented on these marshes thanks to the massive application of a new technique of drainage applied to hydromorphic clay soils. This improved drainage was facilitated by local and national policy measures, such as subsidies covering 40%–60% of the investment costs. The resulting large-scale land

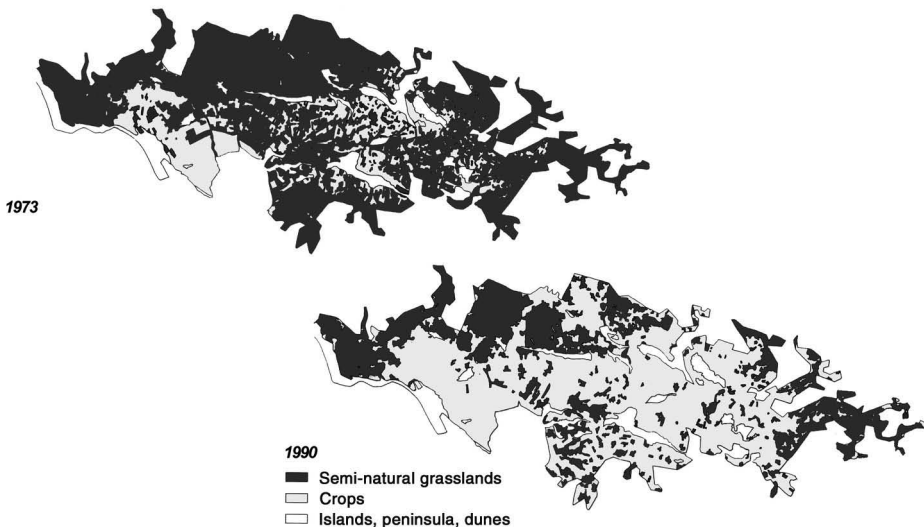

Figure CS1. Evolution of land use of the Marais Poitevin between 1973 and 1990.

Source: Parc Inter-Régional du Marais Poitevin.

use transformations caused a reduction in wildlife habitats, particularly wet grasslands, which were converted into crop fields (e.g., wheat, maize, sunflower). For instance, in the Marais Poitevin, more than half of wet grasslands disappeared in twenty years (Duncan *et al.*, 1999; see Figure CS1). At the same time, an agricultural revolution occurred: agricultural chemicals combined with mechanisation led to increased productivity. These two phenomena accelerated the decline of extensive livestock farming, which became less competitive. This trend has been followed by a decline in the number of holdings (with a 2% annual decrease in farm numbers). In the Charente-Maritime department for instance, the number of cattle farms dropped from 9574 in 1979 to 2290 in 2000 (Miossec *et al.*, 2003) and are now concentrated in marshes. Farming systems have thus evolved towards more intensive, larger and more specialised farms, for instance by increasing the proportion of crops or forages in the crop rotation (Steyaert, 2006). In the early 1990s, reduced drainage subsidies and the 1992 CAP reform (which made permanent grasslands eligible for subsidies) limited and, in some cases, reversed the decline of wet grasslands in marshes (i.e., some crop land was converted back to grasslands).

Habitat evolutions

Plants

Atlantic coastal marshes are at the intersection of three biogeographical regions in France: the Atlantic, Continental and Mediterranean regions. Because environmental factors (clay/peat soils, salinity and hydromorphy gradients) as well as farming practices are extremely varied, these grasslands feature very rich and diverse flora. Most of these grasslands are classified as (see LPO and CA17, 2010):

– Thermo-Atlantic sub-halophilic grasslands (EU 15 code 1410 or Corine biotope 15.52), listed in Annex I of the threatened habitats of Europe. They represent a rare type of grassland in Europe that is limited to the dry marshes of the French coastline between the Loire and Gironde rivers. Microtopography of fields and clay soils with contrasting humidity and salinity ensure a combination of plant communities: hygrophilous plants such as the common spike-rush (*Eleocharis palustris*), floating sweet-grass (*Glyceria fluitans*), creeping bentgrass (*Agrostis stolonifera*) and tubular water-dropwort (*Oenanthe fistulosa*); meso-hygrophilous plants like the saltmarsh rush (*Juncus gerardi*) and divided sedge (*Carex divisa*); and mesophilous vegetation including the meadow barley (*Hordeum secalinum*), cocksfoot (*Dactylis glomerata*) and French oat-grass (*Gaudinia fragilis*). Some species in particular are part of regional or national plant heritage, such as Adder's-tongue spearwort (*Ranunculus ophioglossifolius*) (Photo 3, Plate CS2), seashore iris (*Iris spuria* subsp. *Maritima*) (Photo 4, Plate CS3) and bigflower clover (*Trifolium michelianum*). When land is abandoned for agricultural purposes, hygrophilous and mesophilous communities evolve towards reedbeds (Corine Biotopes code 53.1) and scrub (Corine Biotopes code 31.81), respectively (Mériaux *et al.*, 2009).

Eutrophic wet meadows (Code Corine biotopes 37.2) make up the majority (up to 80%) of grasslands in the wet marshes with *Cyperaceae* species such as great pond-sedge (*Carex riparia*), hairy sedge (*Carex hirta*) and brown sedge (*Carex disticha*); grasses such as tall fescue (*Festuca arundinacea*), creeping bentgrass (*Agrostis stolonifera*), rough-stalked meadowgrass (*Poa trivialis*), Italian ryegrass (*Lolium multiflorum*), perennial ryegrass (*Lolium perenne*) and many dicotyledons. These communities host heritage plant species like snake's head fritillary (*Fritillaria meleagris*) and gratioler (*Gratiola officinalis*). When land is abandoned for agricultural purposes, plant communities evolve towards Megaphorbia (EU 15 Code: 6430, Code Corine Biotopes 37.7).

Animals

Wet grasslands are important habitats for bird populations. They provide migration and wintering sites for waterbirds (Duncan *et al.*, 1999) as well as breeding areas for many bird species, such as wildfowl, waders and passerines. Both livestock grazing and mowing have a significant impact on their use of grasslands (Durant *et al.*, 2008). Factors threatening bird populations include decreasing water levels, agricultural intensification, loss of grasslands and poplar plantations. Wader population decline has been the most considerable in the Marais Poitevin, in particular for the lapwing *Vanellus vanellus* (Photo 5, Plate CS3) whose populations fell from 3 000 to 5 000 pairs in 1960 to fewer than 400 pairs in 1991 (Spitz 1964; Sériot and Blanchon 1993). However, suitable grassland habitats can still be found along the western Atlantic coast for the reproduction of the Montagu's harrier *Circus pygargus*, or the black tern *Chlidonias niger*, one of the most endangered birds in France. Marshes also support many mammalian species, including some that are threatened or protected at national or European levels, such as the otter *Lutra lutra* and the European mink *Mustela lutreola*. Because of the presence of both open water and vegetated areas, marshes are also particularly important habitats for amphibians and water-dwelling reptiles. Some insects such as the longhorn beetle *Rosalia alpina* are of particular concern; as an emblematic insect species, it benefits from special protection. But invasive non-native species also pose a major threat to overall animal biodiversity in these habitats and managing these species is a major concern, as is the case with the coypu *Myocastor coypus*, the muskrat *Ondatra zibethicus* (agricultural damage by feeding on crops or erosion of ditch edges) or the American mink *Neovison vison*.

Agricultural development and importance of CAP support

Today, cropping activities in marshes remain heavily supported by the Common Agricultural Policy (CAP) and market forces. Consequently, crop farms and intensive livestock farms increasingly rely on maize silage to feed highly productive herds. One of the main issues is that grazing-based cattle rearing provides low and even negative incomes and is largely dependent on the European agri-environmental measures of the Rural Development Programme (RDP) (Steyaert 2006). These measures include subsidies given to farmers to compensate for production losses due to the implementation of more environmentally-friendly agricultural practices. These agri-environmental contracts (five-year voluntary farming contracts) are, even now, aimed at maintaining permanent wet grasslands as well as supporting extensive livestock practices (e.g., limits on fertilisation or stocking rates in grasslands, delayed cutting dates). Livestock farms also receive support through subsidy payments to farmers working in disadvantaged areas such as marshes (i.e., a bonus called 'Compensatory Indemnities for Natural Disadvantages' (ICHN in France)). This subsidy is limited to 50 ha per farm and represents an important additional source of income for many wetlands farmers, and aims to enable many of them to continue their activity. Even if the primary objective is to support farmers' incomes, the ICHN has a significant positive impact on the environment, mainly through the preservation of grasslands and biodiversity.

Agri-tourism, diversification and pluri-activities

Given these current economic difficulties, small and medium-sized farms have tremendous opportunities to benefit from the coastal areas as touristic regions to undertake complementary activities. The presence of large cities nearby makes it

possible to diversify farming activities towards agri-tourism. Agri-tourism takes a variety of forms, including accommodation (e.g., campsites on farms, cottages, bed and breakfasts), sport and recreational services (e.g., fishing, horse riding, biking) and direct-to-consumer sales of agricultural products (mainly beef, but also poultry, fruits, vegetables, cheese, wine, cognac and more). For instance, in some sectors of the Charente-Maritime marshes (Brouage or Seudre-Oléron), 10% of farms are engaged in on-farm direct sales, and about 7% take part in touristic diversification (data summarised from Mériaux and Peres 2006, 2010; Mériaux and Mousseau 2010; Mériaux *et al.*, 2011a, 2011b).

Organic farming and quality product policy

Over the past ten years, agricultural organisations, in association with naturalists, have been working on different ways of promoting products from the marshes based on their landscape and heritage value. The current issue for producers in marshes, which are scattered across different rural territories with different identities, is to protect the unique features of their products. There is, for example, no Protected Designation of Origin (PDO) in beef production in the marshes of the French Atlantic coast. Farmers' major needs are related to organising, better promoting and adding value to differentiated high-quality beef production ("marsh-raised meat"). Some farmers' associations try to preserve and promote local cattle breeds with a view to add value to wet grasslands and offer products identified with this territory. For instance, the Association for the promotion of the Maraîchine breed included 1 100 cows from 65 farms in 2010. Some Maraîchine breeders sell meat cut and packaged directly to consumers or to traditional butchers, ensuring that goods produced are sold at a higher price. Similar initiatives have been identified by small groups of breeders aiming to emphasise the link between cattle rearing and environmental protection. They launched new brands such as "The Breeder and the Bird" near Angers or "The beef meat of the Brière regional park" with the goal of coupling biodiversity conservation and traditional livestock farming.

Organic farming seems to be a good way to promote and add value to marsh-based products, but in practice is not a widespread agricultural production system. For instance, in the Marais Poitevin and Charente-Maritime marshes, only 2% of farms are organic (Bio Sèvres 2008), with about half of them raising cattle. Indeed, organic farmers face two major challenges: a) limited market and distribution channels (in the Pays de Loire and Poitou-Charente regions, organic products are primarily marketed through small breeder cooperatives) and b) knowledge of production methods specific to organic farming.

Natura 2000 and other environmental policy tools

Because of their high biological value, the marshes of the French Atlantic coast are home to many protected areas such as national nature reserves (Vendée: Baie de l'Aiguillon, Saint Denis du Payré; Charente-Maritime: Moëze-Oléron, marais d'Yves, Lilleau des Niges; Loire Atlantique: lac de Grand-lieu, marais de Müllembourg) or the Brière regional nature park in the Loire Atlantique department. The well-known inter-regional park of the Marais Poitevin is among the most important Natura 2000 sites of the region (there are 38 in Charente-Maritime, ten in Vendée). In the early 1990s, pilot sites were established to implement agri-environmental measures to deal with important marsh-related ecological and agricultural issues. In this context, some current research studies are examining the relationship between grazing and

mowing practices in wet grasslands and waterbird conservation. They will document how various grassland management practices, particularly through grazing, provide sward structure requirements for ground-nesting birds such as waders (Durant *et al.*, 2008). Marshes also benefit from the LIFE nature conservation programme financed by the European Union. Wetland habitats have benefited from several programmes, such as the Rochefort marshes site (2006–2011). These management plans have been implemented in Special Protection Areas and Special Areas of Conservation included in the Natura 2000 Network and are aimed at launching actions to conserve biodiversity (e.g., the bittern *Botaurus stellaris*, the corn crake *Crex crex*) and maintain or restore natural habitats (e.g., peatlands, marshlands).

Prospects for the development of the area

Today, the permanent grasslands and grazing livestock farms of the Atlantic coast are concentrated in the marshes. Society recognises the role of wet grasslands in the preservation of biodiversity and landscapes, and therefore the multiple functions of agriculture. However, livestock farming in marshes remains economically unviable and under threat. One such threat is the shift in recent decades toward larger farms, making land settlement often difficult for young farmers, especially for cattle and dairy. A study carried out in 2008 in Marais Poitevin showed that goat milk production is a promising area for young farmers because of favourable market conditions and low investment costs (Wang 2008). Other sectors are less lucrative than cropping or dairying, although these remain the main source of production in the marshes. Moreover, some areas of the marshes suffer from land abandonment. In recent years, poor management (lack of grazing management or mechanical clearing) has led to these grasslands being invaded by bramble and scrub which are often the first species to encroach into grassland areas. As a result, degraded, weed-infested grasslands have appeared and species diversity (fauna and flora) has diminished. Climate change is also a potential issue. Coastal grasslands, many of which are located under the high tide line and are protected from the ocean by sea walls, are directly threatened by a rise in sea levels. In February 2010, Cyclone Xynthia flooded thousands of hectares of marshes, showing how parts of these grasslands could be returned to salt meadows.

Until now, the agri-environmental measures have prevented wet grassland abandonment and conversion. However, even if current Water Act regulations prohibit new conversions of wet grasslands to cropland, this situation could arise in the future if economic arguments favouring cropping activities on these fertile soils continue to grow. Wet grassland maintenance requires continued and even strengthened financial support through the CAP or European/national measures (e.g., ICHN). In this framework, wet grassland conservation depends on a trade-off between environmental protection and economic performance, as well as on ways to give value to quality products from marshes, given that environment services rely upon animal production in these unique conditions.

References

- Bio Sèvres, 2008. État des lieux de l'agriculture biologique sur le Marais Poitevin – Phase 1. Rapport d'étude issu de la convention Parc Inter-régional du Marais Poitevin, Agrobio Poitou-Charentes, GAB85, 84 p.
- Blanchard B., 2010. Elevage en Marais de Loire-Atlantique : Enjeux et perspective, ODASEA et Chambre d'Agriculture de Loire Atlantique, Rapport de stage, 31 p.

- Duncan P., Hewison A.J.M., Houte S., Rosoux R., Tournebize T., Dubs F., Burel F., Bretagnolle V., 1999. Long-term changes in agricultural practices and wildfowling in an internationally important wetland, and their effects on the guild of wintering ducks. *Journal of Applied Ecology*, 36, 11-23.
- Durant D., Tichit M., Fritz H., Kerneis E., 2008. Field occupancy by breeding lapwings *Vanellus vanellus* and redshanks *Tringa totanus* in agricultural wet grasslands. *Agriculture, Ecosystems and Environment*, 128, 146-150.
- Kung N., 2002. Document d'Objectifs du site Natura 2000 Marais Breton, Baie de Bourgneuf, Ile de Noirmoutier et Forêt de Monts, ADASEA Vendée.
- LPO, CA17, 2010. Ligue pour la Protection des Oiseaux - Chambre d'Agriculture de Charente-Maritime. Document d'Objectifs - Natura 2000. ZSC n°FR5400429 "Marais de Rochefort", ZPS n°FR5410013 "Anse de Fouras, Baie d'Yves, Marais de Rochefort".
- Meriau S., Peres B., 2006. Inventaire de l'activité agricole dans le Marais de Rochefort Nord, Chambre d'Agriculture de la Charente Maritime.
- Meriau S., Peres B., 2010. Document d'Objectifs - Natura 2000. ZSC n°FR5400429 "Marais de Rochefort", ZPS n°FR5410013 "Anse de Fouras, Baie d'Yves, Marais de Rochefort".
- Meriau S., Mousseau J., 2010. Inventaire socio-économique du site Natura 2000 Basses vallées de la Charente, Chambre d'Agriculture de la Charente Maritime.
- Meriau S., Gueron M., Hartz J., Mocquery E., 2011a. Inventaire socio-économique du Document d'Objectif Natura 2000 du site Marais de la Seudre, île d'Oléron, Chambre d'Agriculture de la Charente Maritime.
- Meriau S., Gueron M., Hartz J., Mocquery E., 2011b. Diagnostic socio-économique du Document d'Objectif Natura 2000 Marais de Brouage, Chambre d'Agriculture de la Charente Maritime.
- Meriau S., Terrisse J., Chalmel R., 2009. Evolution de la qualité biologique des prairies de marais. *Life Marais de Rochefort*. 8 p.
- Miossec G., Meriau S., Steyaert P., 2003. Eleveur de bovin sur les prairies des Marais Atlantiques, Forum des Marais Atlantiques. 336 p.
- Seriot J., Blanchon J.-J., 1993. Distribution, déterminisme des stationnements et de l'installation de l'avifaune des communaux et des prairies humides du Marais Poitevin. LPO - BirdLife International, 52 p.
- Spitz F., 1964. Notes sur l'avifaune nicheuse de la région de Saint-Michel-en-l'Herm, Vendée). *Oiseau et R.F.O.*, 34, 51-67.
- Steyaert P., 2006. Trajectoire d'exploitation d'élevage en marais : entre contrainte et quête d'identité, L'élevage en prairies naturelles humides, Actes du colloque de Fontenay-le-Comte, Aestuarina, p. 169-176.
- Wang A., 2008. Analyse diagnostic de l'agriculture des Marais desséchés du Sud Vendée, Rapport de DAA, AgroParisTech, 128 p.
- Ximenes M.C., Fouque C., Barnaud G., 2007. "Etat 2000 et évolution 1990-2000 des zones humides d'importance majeure", document technique IFEN-ONCFS-MNHN-FNC.
- Statistical data: <http://agreste.agriculture.gouv.fr/page-d-accueil/article/donnees-en-ligne>. Accessed on 02.03.2013.

Greece

Rangelands and grazing systems of Central Macedonia

Authors: Yiakoulaki M.D. and V. Papanastasis, Department of Range Science, School of Forestry and Natural Environment, Aristotle University of Thessaloniki, Thessaloniki, Greece

Rangelands are the largest natural land resource of Greece. They occupy more than five million hectares, corresponding to about 40% of the whole country area. According to Greece's National Statistical Service, they are not included in the agricultural area, but are classified under a different land use, mainly for livestock grazing (NSSG, 2005). Their importance lies in the fact that they can provide forage to 8.9 million sheep, 4.9 million goats and 670 thousand head of cattle for about six to seven months per year. Nevertheless, their productivity relative to other land uses (e.g., agricultural lands) is quite low.

The total rangeland area decreased by 67 680 ha (1.3%) between 1960 and 1990. This can be attributed to the conversion of a part of rangelands to arable land. However, it is not known if these areas are still used for livestock husbandry.

The majority of rangelands (75%) are state-owned, communally grazed areas. This means that the villager who owns domestic animals can freely (without any controls) utilise the rangelands that are allocated to the village where he resides. The system of communal grazing is considered as the main reason for rangeland degradation and their reduced productivity (Papanastasis, 1981).

There are two main livestock production systems based on the utilisation of rangelands: a) the sedentary extensive system under which the animals have a permanent base (the shed) usually located near the farmers' village from where they move every morning to rangelands and return back at night, and b) the transhumant or nomadic system in which the animals change their base from the lowlands in winter to the forest and sub-alpine ranges in summer. This system has rapidly regressed over the last decades (NSSG, 2005).

Arable land (includes arable cultivated land and fallow land for one to five years) increased by 56 200 ha (1.5%) from 1960 to 2008. Permanent and temporary grasslands also rose by 19 450 ha (7.6%) and 17 756.3 ha (32.6%), respectively. This substantial expansion of permanent and, especially, of temporary grasslands suggests that there is a growing demand by farmers for higher quality forage, which can be supplied by these areas, and exemplifies a trend towards livestock production intensification. This trend became more apparent after Greece joined the EU in 1981, when subsidies to livestock farmers started to be provided and helped them to invest on forage production in arable lands.

The number of animals changed considerably during the 1960–2008 period. Cattle decreased by 42%. Dairy and suckling cows specifically decreased (-49.1% and -47.7%, respectively) from 1965 to 2008. Small ruminants are the most important livestock for Greece, as they make up 91% of the total number of ruminants. The number of sheep declined by 465 558 (4.9%) while the number of goats grew by 211 383 (4.2%) between 1960 and 2008. Over the same period, horse numbers dramatically dropped by 298 663 (91%), most likely due to the mechanisation and intensification of agricultural production.

The Farm Structure Survey of 2007 recorded 860 152 agricultural holdings (5% more than in 1999) with a simultaneous increase in the holding size to the total UAA of a little over 7% between 1999 (average holding size to total utilised area at 4.4 ha) and 2011 (at 4.7 ha). This increase in holdings is the result of the appearance of new/young farmers and the allocation of new additional land to agriculture in rural areas. To some extent, this increase is due to the splitting up of the existing holdings into smaller ones in line with current inheritance legislation (Country Greece Profile, 2008).

Holdings belonging to cattle-rearing and fattening specialists and to mixed livestock-mainly granivores rose by 64% and 60.7%, respectively, from 1999 to 2007. However, holdings belonging to mixed crops-livestock and to specialist field crops decreased by 35.8% to 21.5%.

Central Macedonia includes seven prefectures: Imathia, Thessaloniki, Kilkis, Pella, Pieria, Serres and Chalkidiki, with an area of about 18 811 km² (NSSG, 2005). It ranges from sea level up to 2909 m. Bioclimatically, the area can be regarded as Mediterranean sub-humid, with cold to very cold winters and hot and dry summers (Mavromatis, 1980).

Environment

Vegetation types related to livestock husbandry are mainly kermes oak (*Quercus coccifera*) shrublands (*Phillyrea latifolia-Quercus coccifera* community and *Juniperus oxycedrus-Quercus coccifera* comm.) with high floristic diversity (almost 66 species per 70 m², with more than five *Trifolium* species per 100 m²) (Fotiadis *et al.*, 2001). Grassland vegetation types such as *Festuco-Brometea* and *Thero-Brachypodietea* are commonly found in openings and in field edges (Horvat *et al.*, 1974; Dafis *et al.*, 1997).

Dairy and meat sectors, products and marketing

Rangelands amount to 481 740 ha or 26% of the area of Central Macedonia and have a mean stocking rate of about 1.10 LU/ha (Photo 6, Plate CS4) (Agricultural Statistics of Greece, 2003). This is a high stocking rate compared with their grazing capacity (Papanastasis, 1977). However, overstocking is not uniformly distributed over the whole area but rather is confined to certain parts, particularly near settlements (villages) and in animal concentration points such as around watering troughs and sheds (Lorent *et al.*, 2008; Roeder *et al.*, 2007). As a result, large areas of rangelands are understocked. The dominant livestock species are sheep, followed by goats and cattle. Animals graze in rangelands but also utilise alternative resources, including temporary pastures of annual winter cereals during early spring and cereal stubble fields after crop harvesting during summer to early autumn (Yiakoulaki *et al.*, 2003; Yiakoulaki and Papanastasis, 2005). In coastal areas, where evergreen shrublands usually grow, goats graze during the winter period as well (Vrahnakis *et al.*, 2005). Sheep and goat flocks are pure or mixed and raised for milk and meat while cattle are raised for meat (Caballero *et al.*, 2009). Grazing animals are permanently herded. Milk is used for feta cheese, kasseri yellow cheese and yoghurt.

Central Macedonia generally reflects national statistics. Total rangeland area of the region fell by 5419 ha (10%) between 1960 and 1990. This decrease may be attributed to the conversion of a part of natural grasslands to arable lands (Papanastasis and Chouvardas, 2005). Agricultural land and permanent grasslands, on the contrary, increased by 12% and 14.6%, respectively, from 1960 to 2008, whereas temporary grasslands did not change much.

The number of cattle, dairy and suckling cows dropped by 36%, 40% and 34%, respectively, from 1965 to 2008. Goats and sheep increased by 45% and 9.7%, respectively. The greater increase in goats in comparison to sheep is probably related to the higher net income they provide to farmers (Kitsopanidis *et al.*, 2009). On the contrary, horses dramatically decreased over the same period by 57 930 (91.4%).

The above changes indicate a gradual shift of livestock production from rangelands to the more productive agricultural areas. The gradual abandonment of grazing in rangelands in favour of utilising permanent and temporary grasslands and especially concentrates bought from the market with subsidy money leads to intensification of livestock production. As a result, there is an encroachment of shrubs on grasslands (Zarovali *et al.*, 2007) and a gradual forest expansion leading to homogenised landscapes. Due to mosaic reduction, there is also a diminished plant and animal diversity. More bird species were found in the open oak shrublands of Lagadas county than in the dense ones (Papoulia *et al.*, 2003) and higher plant diversity in grasslands than in kermes oak shrublands (Photo 7, Plate CS5) (Papadimitriou *et al.*, 2004).

In the 2007 Farm Structure Survey, 123 704 agricultural holdings were recorded (5.5% more than in 1999). They occupied about 732 961 ha of UAA, an increase of 13.4% compared to 1999.

Specialist cattle-rearing and fattening; sheep, goats and other grazing livestock; and mixed livestock-mainly granivores holdings increased by 35.6%, 29.3% and 21.4%, respectively, from 1999 to 2007. However, holdings of combined field crops-grazing livestock; combined cattle-dairying, rearing and fattening; mixed livestock-mainly grazing livestock; and field crop specialists decreased by 44.7%, 31.4%, 22.5% and 21.1%, respectively. This is because young people are not motivated to stay in the rural areas of Central Macedonia and continue working on livestock-related farms. For dairy farms, the decline may be attributed to the replacement of local breeds with improved ones which are more productive in addition to the restrictions in milk production imposed by EU quotas.

Agricultural development and importance of CAP support

In the past, the CAP supported animal production, leading to the increase in livestock numbers in many parts of Greece, including in the studied area. Under the current single payment policy, animal numbers do not vary much but animal production is extremely vulnerable to market changes. It has been found that without European subsidies, livestock farmers could not earn an income (Kitsopanidis *et al.*, 2009) and livestock husbandry would most likely vanish, especially in the marginal and mountainous areas. In order to survive under a no-subsidy regime in the future, farmers should be involved in environmental programmes and ask for support under both the first and the second pillars. Livestock should be considered as a management tool for maintaining a viable and healthy rural landscape.

Greece has an advantage regarding organic livestock farming due to the rich rangeland flora, mainly in mountainous areas, which can result in special products. However, the lack of required infrastructure poses limits to organic practices. Organic livestock husbandry is directly linked to organic arable agriculture since grazing animals are complemented by organically cultivated feedstuffs. There are also problems with market access, which needs to be further improved. On the other hand, there is a demand for PDO products, especially from the mountain areas. Therefore, there are prospects for the development and promotion of quality rangeland products.

Natura 2000

In Central Macedonia, there are 49 protected areas in the Natura 2000 network. For the majority of them, livestock husbandry is a traditional practice. Animal products (milk, cheese, meat) coming from these sites have an added value and should be protected by labels of origin.

Diversification and pluri-activity are very limited in Greece (less than 5%). As there are no data for these activities it is difficult to properly assess the type of diversification occurring in Greek farms.

References

- Agriculture Statistics of Greece, Primary Sector Statistics, 2003. National Statistical Service of Greece, Athens, Greece.
- Caballero R., Fernández-González F., Pérez Badia R., Molle G., Roggero P.P., Bagella S., D'Ottavio P., Papanastasis V.P., Fotiadis G., Sidiropoulou A., Ipkoudis I., 2009. Grazing systems and biodiversity in Mediterranean areas: Spain, Italy and Greece. *Pastos*, XXXIX (1), 7-152.
- Country Profile Greece, 2008. National reporting to the seventeenth session of the commission for sustainable development of the United Nations, UNCSD 17, Athens, Greece, pp 58.
- Dafis S., Papastergiadou E., Georgiou K., Babalonas D., Georgiadis T., Papageorgiou M. Lazaridou T., Tsiaousi V., 1997. *Directive 92/43/EEC - The Greek "Habitat" Project Natura 2000: An overview*. Greek Wetland and Biotope Centre (EKBY). Thessaloniki, Greece. (In Greek)

- Fotiadis G., Vrahnakis M.S., Mantzanas K., Chouvardas D., Papanastasis V.P., 2001. Vegetation study of *Q. coccifera* pseudomaquis in the area of Lagadas, central Macedonia (Greece). *Scientific Annals, School of Forestry and Natural Environment, Aristotle University of Thessaloniki*, 44, 463-474. (In Greek with English summary)
- Horvat I., Clavač V., Ellenberg H., 1974. *Vegetation Südosteuropas*, Stuttgart, Germany.
- Kitsopanis G., Zioganas M., Derva E., Papanastasis V.P., 2009. Profitability of sheep and goat husbandry in the County of Lagadas prefecture of Thessaloniki. *Georgia-Ktinotrofia*, 3, 60-70. (In Greek)
- Lorent H., Evangelou C., Stelmes M., Hil J., Papanastasis V., Tsiourlis G., Roeder A., Lambin E.F., 2008. Land degradation and economic conditions of agricultural households in a marginal region of northern Greece. *Global Planet Change*, 64, 198-209.
- Mavromatis G., 1980. Bioclimate of Greece; correlating climate and natural vegetation, bioclimatic maps. *Dassiki Erevna*, 1, 54-63. (In Greek)
- NSSG (National Statistical Service of Greece), 2005. *Agricultural Statistics of Greece*. National Statistical Service of Greece, Athens. (In Greek)
- Papadimitriou M., Tsougrakis Y., Ispikoudis I., Papanastasis V.P., 2004. Plant functional types in relation to land use changes in a semi-arid Mediterranean environment. In: *Ecology, conservation and management of Mediterranean climate Ecosystems* (Arianoutsou M., Papanastasis V.P., eds), 10th MEDECOS Conference, 25 April to 1 May, 2004, Rhodes, Greece, Millpress, Rotterdam, pp. 1-6.
- Papanastasis V.P., 1977. Meaning and determination of grazing capacity in practice. In: *Scientific Announcements. Forest Research Institute of Thessaloniki Miscellaneous Publications*, 7, 168-176.
- Papanastasis V.P., 1981. Rangelands in Greece. *Rangelands*, 3, 241-241.
- Papanastasis V.P., Chouvardas D., 2005. Application of the state-and-transition approach to conservation management of a grazed Mediterranean landscape in Greece. *Isr. J. Plant Sci.*, 53 (3-4), 191-202.
- Papoulia S., Kazantzidis S., Tsiourlis G., 2003. The use of shrubland vegetation by birds in Lagadas, Greece. Proceedings of the 3rd Conference of the Hellenic Range and Pasture Society, Karpenisi Greece, pp. 117-123. (In Greek, English summary)
- Roeder A., Knemmerle T., Hill. J., Papanastasis V.P., Tsiourlis C.M., 2007. Adaption of a grazing gradient concept to heterogeneous Mediterranean rangelands using cost surface modelling. *Ecological Modelling*, 204, 387-398.
- Vrahnakis M.S., Fanlo R., Papanastasis V.P., 2005. Effects of goat grazing on maquis-type shrublands. In: *Animal Production and Natural Resources Utilization in the Mediterranean Mountain Areas* (Georgoudis A., Rosati A., Masconi C., eds), EAAP publication No. 115. Wageningen Academic Publishers, The Netherlands, 120-123.
- Yiakoulaki M.D., Papanastasis V.P., 2005. Diet selection of sheep and goats grazing on cereal stubble in Northern Greece. In: E. Molina Alcaide, H. Ben Salem, K. Biala, P. Morand-Fehr (eds). Sustainable grazing, Nutritional utilization and quality of sheep and goat products. *Options Méditerranéennes*, Série A, No 67, 225-250.
- Yiakoulaki M.D., Zarovali M.P., Ispikoudis I., Papanastasis V.P., 2003. Evaluation of small ruminant production systems in the area of Lagadas County. *Proceedings of the 3rd Panhellenic Rangeland Congress "Range Science and Development of Mountainous Regions"*, 395-402. (In Greek with English summary)
- Zarovali M.P., Yiakoulaki M.D., Papanastasis V.P., 2007. Effects of shrub encroachment on herbage production and nutritive value in semi-arid Mediterranean grasslands. *Grass and Forage Science*, 62, 355-363.

Hungary

The Hungarian steppe

Author: Geza Nagy, Debreceni Egyetem, Agricultural Centre

Hungarian grasslands are associated with the technical term 'Puszta', which is a steppe biome on the Great Hungarian Plain (Alföld) around the Tisza River in the eastern part of Hungary, as well as in western Hungary and in the Austrian Burgenland. The Hungarian Puszta is an enclave of the Eurasian Steppe. Puszta means 'plains', a vast wilderness of grasses and bushes, historically utilised by free range grazing of large

herds of sheep and cattle. Although a small proportion of the country's grassland area is not part of the typical Puszta area (mid- and highland grasslands), the environmental conditions and present management practices on these grasslands are very similar to those on the Puszta. Thus, grassland management on the Puszta is essentially synonymous with that of the total grassland area in Hungary.

Hungarian permanent grassland management can be considered as specific to the European context. Extensive farming is predominant on the majority of grassland areas. Grazing agriculture has declined over the last half century. Only two-thirds of the total grassland area is currently under regular use. Consequently, grassland farming represents only a small part of the national agro-economy (approximately 1% of the gross agricultural value added). Hungary holds approximately one million hectares of grasslands, representing just 18% of the total AA (Table CS2). Grasslands are scattered all over the country and make up different proportions in local land use at the level of statistical sub-regions.

Table CS2. Country data in 2009 in Hungary.

	('000 ha)
Agricultural area (AA)	5783.3
Arable land	4501.6
Cereals	2904.7
Forage crops	219.6
Forage maize	87.1
Temporary grasslands	-
Permanent grasslands and meadows	1004.2
Grasslands and meadows	100.0
Rangelands	904.2
Permanent crops	181.5
Other areas	3520.1
Forests	1895.6
Others	1624.5

Both ecological and socio-economic conditions have contributed to the relatively small importance of grasslands in Hungary. The continental climate is too hot and dry in mid-summer, which inhibits continuous grass growth throughout the season. This climate does, however, favour most arable crops. Therefore, the intensification of Hungarian agriculture that began in the 1960s has focused on arable cropping (chiefly cereals and corn) and granivore production over the last few decades.

The major trends in grazing agriculture since the 1960s may be summarised as follows:

- Total grassland area has declined by 30% for two reasons: the conversion of grasslands to arable land and an overall reduction in agricultural land (e.g., investment on grasslands in road systems, local industry and housing).

- There has been a remarkable reduction of herbivore livestock, for two reasons: the replacement of dual-purpose (milk and beef) cows by high yielding Holstein Frisian dairy cows and new market conditions following the socio-economic transition and EU accession.

- Farm-size structures have undergone radical changes and the number of holdings after the socio-economic transition has increased. The former large farm system has been replaced by a mixed farm-size system, as a result of land privatisation. The majority of the new private family farms are now specialised in arable cropping instead of mixed or livestock farming.
- The so-called backyard dairy production (one to two cows held on the croft of rural family houses), which was based on grazing and was common in rural areas, has been terminated due to EU dairy hygienic norms and market reasons.

Environment

The overall environmental conditions may be considered as poor, marginal conditions with regards to the requirements for good grass growth.

Soil

Hungarian grasslands represent the Western part of the steppe. As in many areas of this ecosystem, a significant conversion of grasslands to arable land occurred in the Carpathian Basin, even in historical times. The topographic conditions (flat surface) supported this conversion. Today, all grassland plots located on fertile soil have been converted to arable land and grasslands remain exclusively on marginal soils. Most typical soils under grasslands are sodic/saline soils (cc. 31%), clay and heavy clay soils (cc. 35%) and sand and peat soils (cc. 20%). Poor drainage and low nutrient availability of these soils explain the low productivity of grasslands under these conditions.

Climate

Hungary belongs to the continental climatic zone. This climate has a relatively short, hot and dry growing season, which means climatic constraints for grass growth. Mid-late summer especially is hot and dry, so the majority of grasslands burn up during this period. In general, rainfall/water supply is considered to be a critical element for grass production. The mean annual rainfall is less than optimal by 130–150 mm per year and its distribution throughout the season is uneven and extremely variable, which does not fit the demands of high and regular grass growth.

Vegetation

The productivity and botanical composition of grassland vegetation reflects the poor soil and moisture conditions of Hungarian grasslands. The average annual dry matter production is approximately 1.5 t DM/ha. This amount is extremely low, compared to the relative productivity of most arable crops in the country. In contrast, the grassland biodiversity is high due to the extensive management of semi-natural grasslands.

Grassland types and management

The most common grassland types in Hungary are fine leaved fescue grasslands (*Festuca pseudovina*, *F. sulcata*, *F. rupicola*, etc.), which are well adapted to the poor environmental conditions (drought and poor soils). They are suitable only for extensive grazing (Photo 8, Plate CS6). Grasslands with better water supply (deeper flat surfaces, valleys, high rainfall mountain grassland) have taller grass types with more productive associations, including bent grass (*Agrostis* spp.), foxtail (*Alopecurus pratensis*) and tall fescues (*Festuca pratensis*, *F. arundinacea*) species of much higher agricultural value.

Their biomass production is suitable both for cutting and grazing. In most years, the first harvest of these grasslands is taken as hay.

The area of cultivated grassland (renovation of old natural grasslands, low rates of fertilisers, targeted utilisation by grazing and/or cutting) is limited in the steppe region (approximately 100 000 ha in Hungary from the 1 000 000 ha in total).

Dairy and meat sectors

The domestic dairy industry is based on arable crops (maize silage and lucerne hay) and concentrates. Both milk production and heifer rearing is managed intensively in off-yard systems with a total mix ratio nutrition system. Grazing in heifer rearing and dry cow feeding may occur rarely in some places, but intake from pasture is considered only a supplement. The beef sector has declined since dual-purpose cattle were replaced by specialised milk and beef breeds. Hungary has an EU quota of 117 000 head of suckling cows. The beef industry, which requires inexpensive feeding systems, is based on grazed pasture and arable by-products (e.g., maize stalks).

Local breeds of cattle and sheep

The EU common market and agricultural policy presented real challenges for Hungarian livestock/herbivore products and their marketing after the country's accession to the EU. Because of production problems (relatively high costs) and market concerns (depressed prices), the number of holdings and animals, as well as animal production, have decreased steeply; however sheep and goat numbers have not (Table CS3).

Table CS3. Changes in national statistics

	1960	1970	1980	1990	2000	2009
Land use ('000 ha)						
Total AA	7 141.1	6 875.1	6 626.5	6 473.1	5 853.9	5 783.0
Permanent grassland	-	50.0	300.0	150.0	100.0	100.0
Rangeland	1437.9	1 231.3	994.2	1 035.6	951.2	904.2
Temporary grassland	-	-	-	-	-	-
Number of animals ('000 heads)						
Cattle	1 963	1 911	1 918	1 571	805	700
Dairy cows	849	763	765	630	391	312
Suckling cows	-	-	-	-	-	-
Sheep	2 250	2 316	3 090	1 865	1 287	1 223
Goats	72.3	36.2	15.0	34.2	106.0	58.0
Horses	490	223	120	76	75	61

Products and marketing

Labelled products and their marketing from grazing agriculture are not common in the country. Although organic dairy, beef, pork and poultry products are present on the market, they represent only very limited share of total sales. Animal farming and the production of these products are based on range-type grazing systems (Photo 9, Plate CS6).

Habitat evolutions

Range-type conditions on the steppe support high nature value ecosystems. Plant and animal communities are diverse on the steppe, which provides habitats for both. For this reason, grasslands are important to nature conservation areas. One-fifth of the total grassland area has been declared as nature conservation land. According to the national nature conservation classification system, the protected grasslands in the country are: loess, sand, saline/sodic, rocky-mountain, sloping steppe meadows, mountain humid grasslands and wet meadows. These systems provide habitats for the majority of the protected species in the country. Grassland communities are home to 76% (393 out of 516) of the protected plant species and 77% (40 out of 52) of the strictly protected plant species. Of the protected or strictly protected animal species, 43.2% (344 out of 795) cannot survive without grassland ecosystems. According to the updated Red List of Hungary, 31 species of large mammals, 106 species of birds and 148 species butterflies could not survive without the maintenance of range-type grassland ecosystems.

Agricultural development

Agricultural development in Hungary has been determined by the CAP since 2004. The CAP's first and second pillar payments have helped maintain competitiveness and ensured the sustainability of grassland agriculture. Since joining the EU, first pillar payments (SAPS, or single area payment system) have been introduced to grassland areas. These payments have contributed to the maintenance of the steppe, because regulations on good farming practices reintroduced the regular use of grasslands by grazing and/or cutting. This has slowed down or stopped the undesirable succession of grassland communities occurring at the end of the 1990s as a result of the under-utilisation of many grassland areas.

Second pillar payments (approximately 30% of the total CAP budget) are also important in grazing agriculture on the steppe. Some 59% (approx. 521 000 ha) of less favoured areas (LFA) in the country are grasslands, and 22% (approx. 442 000 ha) of Natura 2000 areas in Hungary are grasslands as well. Among agri-environmental scheme (AES) areas (1 150 000 ha in total), grasslands (308 000 ha) accounted for 26.3% in 2010 (New Hungarian Rural Development Program 2007–2013, Mid-Term Report, Budapest, 2010. December).

Payments for grasslands in LFA (approx. 521 000 ha), for Natura 2000 grasslands (approx. 172 000 ha) and for AES grasslands (approx. 308 000 ha) comprise about one million hectares. However, because of some overlapping of these areas, compensation payments covered about 70% of the total grassland area (17.3% of the AA) in the country. The amount of payments per hectare was below the EU average and could therefore not be considered as sufficient (true compensation) in most cases. However, such payments are key elements in the sustainable use of steppe ecosystems.

Organic farming

In 2010, 3.2% of the total grassland area was under organic farming. However, due to the extensive farming systems, the majority of Hungarian grasslands, primarily on the Puszta, could be suitable to organic farming. Constraints to the development of organic farming are the lack of an organised market, relatively higher product prices compared to the low purchasing power of Hungarian society and the reluctance of farmers to adopt non-conventional farming. In 2010, some 20 000 livestock units

were organically farmed (predominantly cattle and sheep; approximately 2% of the total number). Grasslands are particularly important in organic animal production, because these farming systems are exclusively range-type systems based on grazing.

Quality product policy

The quality product policy has been a new challenge for grazing agriculture because European common market conditions regulate sales of its products. EU food safety and security regulations define the framework for this policy. It has been recognised that optional quality certification (e.g., PDOs) presents marketing advantages for products. Some local products from steppe grazing agriculture have received trademark protection and qualification (e.g., organic beef from Hortobágy, Mangalica pork).

Natura 2000 and other environmental policy tools

These tools exist in steppe grazing agriculture to a great extent. EU regulations have considerable influence on these measures. Sometimes, the considerations of local conditions, which are extremely different from overall European conditions, are neglected and therefore conflicts may arise between farmers and authorities (for instance, some hundred hectares of grassland in one block cannot be cut before mid-July, despite only some smaller parts of it possibly having ground-nesting bird populations). Specific research and investigations may assist in developing locally adapted regulations for environmentally- and nature reservation-friendly measures.

Agri-tourism, diversification and pluri-activities

Agri-tourism is a developing branch of the rural economy in Hungary. Attractions for visitors include landscapes, local ecology and biodiversity, rural culture and local foods connected to grazing agriculture. Agri-tourism focused on steppe regions represents a crucial share of national park activities located on the country's plains. Diversification of local rural economies and the development of pluri-activities have been general objectives of the different development programmes in the country. Locally, there have been several notable results (traditional food products from grazing agriculture such as sheep's milk cheese, touristic enterprises on traditional family farms). However, their effects on the overall economic development at a national scale are still limited. The potential for pluri-activities in steppe grazing agriculture is considered high. The overall economic development in the region may further its development.

Prospects for the development of the area

The new Hungarian agriculture and rural development concept underlines several key aspects, which are closely connected to grazing agriculture, including that on steppe grasslands. These aspects are: development of organic farming, maintenance of High Nature Value areas, development and compensation of farming practices in High Nature Value and Natura 2000 areas, introduction of a new animal husbandry programme focused on ancient Hungarian animal breeds (primarily Grey Cattle and Racka sheep) and based on grazing, increasing food quality and safety controls including PDO rules, development of agri- and eco-tourism offering Hungarian products and services from the steppe (landscape, eco-food products and shepherd culture).

Italy

Authors: Giampiero Lombardi, Michele Lonati, Davide Cugno, AGROSELVITER Department, University of Turin, Via L. da Vinci 44, I-10095, Grugliasco (TO), Italy

Total fodder area in Italy is about 6.5 million ha (ISTAT, 2011; data 2007), equivalent to 50% of total Italian agricultural area (AA) and 20% of total country surface area.

Permanent meadows and pastures cover 3.4 million ha, or 50% of the total fodder area. About half are located in the southern regions and main islands, where the proportion of permanent pastures reaches 95% of the total fodder area. In the northern regions, permanent pastures account for 60% of fodder area (35% of national fodder area), with permanent meadows still widespread due to more favourable soils, land morphology and precipitation distribution.

The majority of permanent meadows and pastures is located in the mountains (60%) or the hills (33%). In the lowlands, they cover only 260 000 ha, a small surface area in comparison with arable crops (about 3 million ha including temporary grasslands and other green forages). In the Alpine mountains, 90% of the AA is covered by permanent meadows and pastures. This proportion decreases to 50% in the Apennine mountains, without differences among northern, central and southern regions.

Because permanent meadows and pastures are mainly concentrated in mountainous and more marginal areas, their productivity is affected by environmental constraints (mainly summer drought in Mediterranean regions and a short growing season in temperate regions). Average annual yield is 830 forage units/ha, with a significant variability between meadows (2 400 forage units/ha) and pastures, which produce 400 forage units/ha, a value comparable with emerging country data (Giardini and Vecchietini, 2003). The above-mentioned mean value is one-fifth and one-seventh of the temporary grassland and ley average productivity, respectively.

The 6.5 million ha fodder area in Italy is exploited by 351 000 agricultural holdings (88% livestock holdings), or 21% of the total number of agricultural holdings in Italy. On average, each farm has about 9 ha, but important differences among mountainous (13 ha/farm), hilly (8 ha/farm) and lowland areas (6 ha/farm) exist.

Concerning the share of livestock holdings by reared species, 47% of them raise cattle (20% dairy cattle), 24% sheep, 11% goats, and 33% hogs. There are considerable differences among northern, central and southern Italy: 54% of cattle farms are located in the northern regions (50% rearing dairy cattle), where 4.2 million cattle are bred (1.3 million dairy cattle). Most of the small ruminant farms (60%) are established in the southern regions, where 5.6 million head are bred (87% sheep, 13% goats).

Significant differences between northern and southern regions are also seen in the number of heads per farm: an average of 54 (northern) and 28 (southern) head of cattle are bred per farm. The number of dairy cattle per farm in northern Italy is double that in southern regions (33 vs. 17), while there are one-third the number of small ruminants in northern regions compared to southern regions (31 and 14 vs. 106 and 39, for sheep and goats, respectively).

With regards to the altitudinal distribution of cattle livestock holdings⁴, 74% of them are located in marginal areas (34% in the mountains and 40% in the hills). However,

4. Analyses of data from Fifth General Census of Agriculture (ISTAT, 2000); more recent data are not available.

these holdings account for less than half of the national livestock figures, and there are major differences between northern and central-southern regions that are most likely due to the farming system in place. In fact, in northern Italy, 44% of livestock holdings are concentrated in the Po Plain, where they intensively raise 78 cattle per farm, feeding animals with maize silage and forage from temporary grasslands. Moreover, intensively-managed farms are generally sedentary. The number of heads per farm decreases with altitude: hill farms rear an average of 35 head of cattle per farm, while the average for farms in the mountains is just 19. Permanent grasslands supply most of the forage to feed the animals and transhumance is practised by the majority of extensive farms during summer, with herds moving from the valley floors to the summer pastures.

Sheep farms are mostly concentrated in marginal areas (40% of 97 000 holdings in the mountains, and 54% in the hills), where 63 heads per farm are raised. Lowland farms (about 6 000) raise a larger number of animals (172) on a more intensive basis.

Over the last fifty years the structure of agricultural holdings has been highly affected by socio-economic changes. A generalised reduction of agricultural surfaces has been observed all over the country, but while the AA declined by 30%, the surface of permanent grasslands and meadows was cut in half.

Over the same period, the number of agricultural holdings decreased by 66% (such a reduction has become more pronounced since the early 1990s). Dairy farms were especially affected by drastic structural change, with their numbers declining by 80% between 1980 and 2007, while the number of dairy cows declined by only 35% during the same period. The heads per farm increased dramatically, from 8 in 1982 to 22 in 2007. The number of sheep and goat farms dropped by 47% and 71%, respectively, while the number of heads of both the species was almost stable (though there have been fluctuations over the last thirty years). Such changes resulted in an increase in heads per farm.

These figures support the hypothesis of a shift in agricultural holdings from a “family” structure to an “enterprise” structure. This shift is more pronounced for specialised and intensive activities such as dairy cattle breeding, which is increasingly moving away from permanent grassland exploitation, and less pronounced for extensive activities such as sheep breeding. In this framework, professional farmers often discontinued extensive livestock breeding, particularly in disadvantaged areas, as shown by the reduction of permanent grassland areas.

Mountain areas of the Marche Region (Central Apennine)

Paride D'Ottavio and Rodolfo Santilocchi, Dipartimento di Scienze Agrarie, Alimentari ed Ambientali, Università Politecnica delle Marche, Ancona, Italy

Study area and grazing system

In the Marche Region, the total AA covers 73% of the total regional surface (9366 km²). A large majority of this surface (70% of AA) is located below 700 m of altitude and used for intensive arable farming (58% of AA), mostly for rain-fed cereals (mainly wheat and barley) and temporary grasslands (30% and 12% of AA, respectively). The mountain areas have a similar proportion of croplands (chiefly winter cereals and temporary grasslands) and permanent grasslands, with a majority of surfaces (50% of AA) being woodlands (D'Ottavio *et al.*, in press).

The climate is characterised by mean annual temperatures between 10.9°C and 14.1°C, rainfall between 840 mm and 930 mm in the mountain and hill-plain areas, respectively (minimum values in July, maximum in November).

As in many other Mediterranean countries, the traditional grazing system in the Marche Region maintains most extensive features (Caballero *et al.*, 2009). The potential area of the grazing operation is estimated at 1400 km² (around 15% of the regional surface), mostly in the marginal lands of the mountain and high-hill areas. The grazing system is mainly based on cattle and sheep breeding, which, in mountain areas, largely graze natural and semi-natural grasslands (11% of AA) on the dominant calcareous substrates. The clearing of pre-existing forests (up to 1750–1800 masl) (Pedrotti, 1969) extended croplands and mainly sustained grazing activities. Cattle (generally sedentary) and sheep (both sedentary and transhumant) mostly graze from April/May to October/November, according to vertical movements (Caballero *et al.*, 2009). In the 45 municipalities located in the Marche Region mountain areas (mean surface area of approx. 6720 ha), the grazinglands are mostly private, with some public and collective property. Most landless resident farmers (some 40% and 30% of the total farms and animals, respectively) rent grasslands, paying a grazing fee to the municipalities or collective bodies. The other, mostly transhumant, farmers (some 60% and 70% of the total farms and animals, respectively) use private areas or rent private and public grasslands, or collective ones when not required by the few resident farmers still remaining in the mountain municipalities. Stocking on mountain grasslands is unevenly distributed over the region. Some 800 cattle and 2000 sheep farms in the regional mountain areas rely on grazing allotments, but in many municipalities, there are under-stocked or unused grasslands (D'Ottavio and Scotton, 2002b).

The institutional framework affecting grazing operations in the Marche Region involves different bodies at different levels. Other private organisations provide technical and administrative assistance, with particular regard to the complex procedure for obtaining support under the regional Rural Development Programme (RDP). The regional government provides marketing support and promotes quality labels and designations of origin of the livestock products (Regione Marche, 2010). 'Casciotta d'Urbino' and 'Formaggio di Fossa e Sogliano' are the main Protected Designation of Origin (PDO) cheeses; 'Vitellone bianco dell'Appennino Centrale' is the Protected Geographical Indication (PGI) for the meat of the grey podolic breeds (Chianina, Marchigiana, Romagnola) of Central Apennine; 'Agnello del Centro Italia' is the PGI under registration for lamb meat, currently identified by a quality label ('Agnello della Marca') used only at the regional level. These quality products have undergone significant decreases in total production (–0.5% and –5.7% for cheeses and meat in 2008, respectively) and marketing (–3.3% for meat products in 2008) in recent years mostly due to price rises (Arzeni, 2010). In both the low- and highlands, a large number of farms have introduced or increased their income and production from pluri-activities. Most of the activities were aimed at direct selling of farm products and differentiating the production of crops and livestock (D'Ottavio *et al.*, 2008).

Trends and drivers of change in mountain grazing systems

The grazing system in the Marche Region was once characterised by a large number of animals, mainly sheep. In the 16th century in the municipalities of Ussita, Castel

Sant'Angelo sul Nera and Visso (22 580 ha, in the Sibillini Mountains), numbers reached up to 65 000 sheep (Chierici, 1987). These were mainly transhumant towards the lowlands of Latium or the Adriatic coast, today still used as wintering areas. The present system can be considered a modified form of traditional land use regimes dating back before the early 1950s.

Table CS4. Changes in statistics for mountain areas in the Marche Region.

	1961	1970	1982	1991	2000	2010
Land use ('000 ha)						
Total AA	282.0	258.0	234.4	235.3	208.6	-
Utilised AA	173.5	141.9	123.3	114.7	104.0	-
Arable lands	85.0	66.8	61.3	58.1	53.3	-
Cereals	41.0	30.0	30.5	26.5	24.4	-
Temporary grasslands	40.8	32.2	28.7	24.9	20.1	-
Permanent grasslands	87.6	71.8	57.8	53.2	47.0	-
Number of animals ('000 heads)						
Cattle	57.0	44.7	30.9	23.5	18.0	16.0
Sheep	105.2	84.2	68.4	71.8	48.2	27.3
Goats	1.7	1.0	2.0	1.5	1.4	1.6
Equidae	3.7	2.5	2.3	2.7	2.0	0.5
Number of holdings ('000)						
All farms	23.3	18.6	12.9	13.2	9.7	-
Arable lands	23.2	16.3	11.9	11.7	6.9	-
Cereals	19.1	12.8	8.9	7.2	4.6	-
Temporary grasslands	18.4	13.2	9.2	7.8	4.4	-
Permanent grasslands	15.2	9.6	5.4	5.2	3.1	-
Cattle	11.1	6.6	2.7	1.5	0.8	0.7
Sheep	9.4	4.8	2.1	1.5	0.7	0.5
Goats	0.9	0.3	0.3	0.3	0.2	0.2
Equidae	3.1	1.8	0.8	0.6	0.4	0.2
Average holding size (ha)						
Total AA	12.1	13.8	18.2	17.8	21.6	-
Utilised AA	7.5	7.6	9.6	8.7	10.8	-
Arable lands	3.7	4.1	5.2	5.0	7.8	-
Cereals	2.1	2.4	3.4	3.7	5.3	-
Temporary grasslands	2.2	2.4	3.1	3.2	4.5	-
Permanent grasslands	5.8	7.5	10.8	10.2	15.1	-

Source: Italian National Statistical Institute (Istituto Nazionale di Statistica, ISTAT).

A significant decrease in the total AA and UAA occurred from 1960 to 2000 in the mountain areas of the region (Table CS4). This trend is mostly related to the progressive reduction of the number of farms no longer in service and thus no longer registered for assessment by the census. With regard to the single land uses,

an important change was the progressive decline of arable lands, both in terms of winter cereals and of temporary grasslands (mainly lucerne meadows). A decrease in permanent grasslands (pastures and meadows) and an increase in woodlands were recorded over the same period. Especially since 1970, some 20 000 ha of arable land have been abandoned, leading to grassland succession. At the same time, the abandonment of permanent grasslands allowed for shrubby overgrowth, increasing woodland surfaces.

The number of all farm types dropped considerably from 1960 to 2000 in the region's mountain areas. This trend led to an increase in farm size over time, although the sharp growth in the total AA per farm compared to a smaller rise in UAA per farm reflected an increase in the area no longer utilised. The growth in area per farm was much more consistent for farms with permanent grasslands: from 1961 to 2000, surface area nearly tripled. This result appears to be directly linked to the significant drop in cattle and sheep numbers (the most important species in the region) and livestock farms that traditionally use mountain pastures during the summer. From 1961 to 2010, herd numbers appear to have been cut by more than half.

These changes appear related to the crisis of traditional agriculture and breeding that occurred in concomitance with high demographic decline in the mountain areas from 1950 to 1970, and the loss of most of the agricultural workforce. At the regional level, from 1970 to 2010 the percentage of people employed in agriculture dropped from 30% to 3% of the population. Currently, the workforce employed in grazing operations is made up almost exclusively of immigrants (Arzeni, 2010; Regione Marche, 2010).

In Central Apennine, there are a great number of grasslands of the class *Festuco-Brometea*, order *Brometalia erecti*. Semi-natural dry grasslands on calcareous substrate of the *Festuco-Brometalia* class are frequently very rich in orchids (Biondi, 2007). These formations are Natura 2000 priority habitats (EC, 1992) and linked to grazing operations. When no longer used, their natural dynamics lead the development of shrub communities of the class *Rhamno-Prunetea*.

Grazing system changes over the last fifty years sharply reduced stocking rates, modified grazing management and caused the abandonment of pastoral practices in large tracts of the Central Apennines. These factors changed the environmental, agronomic and landscape characteristics of the grasslands (D'Ottavio *et al.*, 2000, 2004; D'Ottavio and Scotton, 2002a). Among these, intensive grassland encroachment by shrubs (mainly by *Juniperus communis* and *J. oxycedrus*, *Spartium junceum* and *Rosa canina*) and trees is widespread. Today, vegetation dynamics require rigorous management to promote grassland conservation (D'Ottavio *et al.*, 2008).

In the Central Apennines, several endangered animal species are highly dependent on an open landscape structure. Among them are several endangered passerine species, like the rock sparrow (*Petronia petronia*), ortolan bunting (*Emberiza hortulana*) and red-backed shrike (*Lanius collurio*), which are found on traditional farming and pastoral systems. The long-term effects of land abandonment are likely to be a loss of habitat for farmland birds (Scozzafava and De Sanctis, 2006).

Starting in the 1980s, legislation and the administrative framework may have influenced the observed patterns, making the conservation of grasslands increasingly problematic. The measures adopted by the Marche Region for the protection of juniper (*Juniperus*

communis) offer a telling example. Over a twenty-year period of intensive vegetation dynamics, large shrub-dominated grasslands turned into woodlands due to this strict protection, which was ceased in 2005 (D'Ottavio *et al.*, 2010). However, stocking rate limits (0.2–4 LU/ha) set by the 2010 CAP are applied locally without taking into account the grassland characteristics. Further issues affecting the management of permanent grasslands in the mountain areas are related to the application of a strict grazing calendar according to altitude (Ministero dell'Agricoltura e Foreste, 1965a, b). These requirements were justified up until fifty or sixty years ago when stocking rates were very high or high-altitude grasslands were still cut for hay production. Today, many areas are abandoned or under-stocked and the imposition of strict limits appears inadequate (D'Ottavio *et al.*, in press). These measures, also adopted by the Marche Region's RDP 2007–2013, do not assure the long-term conservation of the grasslands exposed to over- and under-stocking.

Prospects for the sustainable development of the grazing system

Technical and institutional adjustments are required in the studied area to produce positive effects on both grazing systems and grassland conservation. The main factors for the support and development of grazing systems in the Marche Region include: promoting public awareness on ecosystem services generated by grazing systems to gain acceptance for allocating public resources to sustainable grazing systems; improving the identity and marketing of livestock products (e.g., lamb meat and Pecorino cheese) linked to the sustainable management of the territory; improving grazing regulations (i.e., revision of the strict grazing calendar) and institutions with technical and managerial support; improving grazing infrastructures for better quality of life and work conditions for shepherds; and planning of sustainable grazing management (with special regard to protected areas).

References

- Arzeni A., 2010. *Il sistema agricolo e alimentare nelle Marche*. Rapporto 2009. Regione Marche – Assessorato Agricoltura, Istituto Nazionale di Economia Agraria (INEA) – Sede regionale per le Marche, Osservatorio Agroalimentare delle Marche. Ancona, 437 p.
- Biondi E., 2007. Vegetation and priority habitats. In: *Biodiversity in Italy* (Blasi C., Boitani L., La Posta S., Manes F., Marchetti M., eds), Palombi Editore, Roma, 202-219.
- Caballero R., Fernández-González F., Pérez Badia R., Molle G., Roggero P.P., Bagella S., D'Ottavio P., Papanastasis V.P., Fotiadis G., Sidiropoulou A., Ipioudis I., 2009. Grazing systems and biodiversity in Mediterranean areas: Spain, Italy and Greece. *Pastos*, XXXIX (1), 7-152.
- Chierici S., 1987. Proprietà terriera e allevamento nella valle dell'Ussita nei secoli XIV- XVI. Atti del XX Convegno di Studi Maceratesi Ambiente e società pastorale nella montagna maceratese. Ussita, Centro Studi Maceratesi, Macerata, pp. 17-37.
- D'Ottavio P., Scotton M., 2002a. Modalità di utilizzazione di pascoli ovinii nel Parco Nazionale dei Monti Sibillini (Appennino Centrale). *Monti e Boschi*, 5, 18-25.
- D'Ottavio P., Scotton M., 2002b. Stocking rate distribution and grazing management systems adopted by sheep farms in the territory of Castelluccio di Norcia (Monti Sibillini National Park, Central Italy). Proceedings of the 2nd International Congress "Environment and identity in the Mediterranean", Corte (France), 3-5 July 2002, 543-557.
- D'Ottavio P., Scotton M., Ziliotto U., 2000. Legumes in mountain pastures of Monti Sibillini (Central Apennines, Italy) grazed by sheep. *Grassland Science in Europe*, 5, 286-288.
- D'Ottavio P., Scotton M., Ziliotto U., 2004. Forage selection by sheep in extensive grazing systems in the Monti Sibillini National Park (Central Apennines, Italy). *Options Méditerranéennes. Serie A: Séminaires Méditerranéens*, 61, 189-192.

D'Ottavio P., Trobbiani P., Rismondo M., Iezzi G., Piergiovanni R., Sargenti P., Santilocchi R., Roggero P.P., 2010. Management and legislation affecting the conservation of mountain grasslands subjected to common use in Central Apennine. *Grassland Science in Europe*, 15, 106-108.

D'Ottavio P., Trobbiani P., Roggero P.P., in press. Trends and drivers of change in mountain grazing systems: a case study in Central Apennine. Regional. *Regional Environmental Change*.

D'Ottavio P., Trobbiani P., Santilocchi R., 2008. L'allevamento e l'alimentazione. P. 61-85. In: Regione Marche (Ed.). Progetto Marchal: La marchigiana: una razza da esportare. Regione Marche, Ancona. P. 109.

EC (European Commission), 1992. Council Directive 92/43/EEC on the conservation of natural habitats and of wild fauna and flora. *European Community Gazette*, 206, 1-50.

ISTAT, 1985. Popolazione residente e presente dei comuni dal 1861 al 1981. Roma.

Ministero Agricoltura e Foreste, 1965a. Nuove prescrizioni di massima e di polizia forestale per la provincia di Macerata. Camera di Commercio Industria e Agricoltura, Macerata.

Ministero Agricoltura e Foreste, 1965b. Nuove prescrizioni di massima e di polizia forestale per la provincia di Ascoli Piceno. Camera di Commercio Industria e Agricoltura, Ascoli Piceno.

Pedrotti F., 1969. Introduzione alla vegetazione dell'Appennino centrale. *Mitt. Ostalp.-din. Pflanzensoz. Arbeitsgem.*, 9, 21-57.

Regione Marche, 2010. <http://agri.marche.it>. Accessed on March 2012

Scozzafava S., De Sanctis A., 2006. Exploring the effects of land abandonment on habitat structures and on habitat suitability for three passerine species in a highland area of Central Italy. *Landscape Urban Plan.*, 75, 23-33.

Sardinian grasslands and rangelands

Porqueddu Claudio, CNR-ISPAAM, 07100 Sassari, Italy

Environment

Sardinia has a Mediterranean climate, characterised by hot and dry summers and mild winters, with precipitation concentrated in autumn and spring. However, the rainfall distribution shows a marked intra- and inter-annual variability, and the dry season can extend from April to November, especially in the southern areas of the island. Rainfall and mean annual temperatures vary from 400–500 mm and 17°C along the coasts and 1000–1200 mm and 12–13°C at the inland peaks (Chessa and Delitala, 1996). The island has a prevailing mountainous and hilly territory, with the highest peak in the Gennargentu relief reaching 1834 m, although the mean altitude is relatively low at 380 m (Ginesu, 1993). The soils are derived from very different lithological types (metamorphic, granite, limestone, acid and basic volcanic rocks) and have a variegated constitution, but in general are poorly developed (Aru, 1993). Sardinian vegetation is dominated by the presence of evergreen forests of holm and cork oaks (*Quercus ilex*, *Q. suber*) and deciduous oaks (*Q. pubescens*) in addition to drought-tolerant sclerophyllous shrubs constituting the Mediterranean maquis.

Grassland type and management

Approximately half of the regional surface is covered with permanent and temporary pastures. Grasslands represent 85.2% of UAA while permanent hay meadows have a limited relevance (0.83% of AA) (ISTAT, 2010). Sometimes, in favourable years, a portion of pasture is rested from grazing in winter and is mown for hay production in spring. Sardinian forage systems are extremely variable, but we can distinguish four basic system types: *silvo-pastoral system*, where livestock graze year round on wild feed resources such as grasses, shrubs and trees, sometimes in communal lands (Photo 10, Plate CS7), sometimes in mixed grazing (sheep or goats and beef cattle); *agro-pastoral systems*, based mainly on sheep grazing in natural and improved pastures but where

farmers may need to provide additional feed resources during the winter season with annual forage crop mixtures (e.g., oat/vetch), commercial fodders and supplements or short-distance transhumance and, in some cases, use forage within olive plantations or vineyards; *cereal-farming systems*, where sheep consume mostly cultivated rainfed winter cereals and their by-products (stubble, straw) and graze permanent pastures, usually confined to marginal lands; and *fodder crop systems*, where livestock, dairy cows and dairy ewes are fed with hay and silage and do not graze. These systems are widespread in irrigated plains, where water availability allows for double cropping, commonly consisting of Italian ryegrass cultivation in October preceding that of maize or sorghum in May, in rotation with lucerne or white clover meadows, and where crop rotation is extended for a period of five years (Porqueddu and Sulas, 1998).

Dairy and meat sectors, products and marketing

Sardinia is the main national producer of sheep milk, sheep meat (suckling lamb) and goat milk, respectively holding 65%, 17% and 46% of the national market share. It is a relatively small producer of cow's milk and meat (ISTAT, 2010).

Cow's milk is partly destined for direct human consumption and partly processed into mozzarella cheese, butter, soft cheese and yoghurt. Over 90% of the regional production of cow's milk is processed, transformed and distributed by one cooperative in the regional market. All sheep's milk produced is processed into cheese, mainly in dairies owned by a number of private companies or cooperatives (73 in total). Of these, just five or six companies effectively control almost the entire production of sheep's milk cheese (Idda *et al.*, 2010). In 2010, cheese production was about 48 050 t, with 91.5% hard cheese, 3.7% fresh cheese, 2.4% semi-hard cheese and 2.4% soft cheese (ISTAT, 2010). Among the final products, the PDO Pecorino Romano is of a consistently high quality, and is sold as grating cheese in consolidated commercial channels, with 60% of production exported to overseas markets, particularly to the United States. The other cheeses have a high qualitative and distribution heterogeneity (Idda *et al.*, 2010).

With respect to the meat industry, the beef production chain is based almost exclusively on the sale of six-month-old calves to fattening centres on the Peninsula, since Sardinia lacks adequate finishing facilities. The sheep meat chain is based on the sale of suckling lambs to large retailers that absorb 65% of regional production. The majority of sheep meat (60%) ends up on the peninsula, while the remaining share of meat is consumed locally.

Evolution of the statistics per category (areas, livestock, holdings), evolution of the management and reasons for these evolutions

Although still deeply rooted, in the last decades the agro-pastoral culture of Sardinia has weakened due to the transition from an agricultural society to an urban society. This decline is aggravated by the economic integration with the rest of Europe; the crisis in the market for cereals and sheep's milk, the price of which has remained unchanged for the last twenty years; and, most recently, the effects of CAP policies (decoupling unfavorable to farmer income); the increasing costs of technical means; and the Bluetongue and Scrapie outbreaks. As a result, large areas have been abandoned or removed from agro-pastoral activities in favour of the tourist market and urban sprawl along the coast. These considerations explain the decrease in the total agricultural area and the ongoing drop in the number of holdings and livestock, especially beef cattle and horses. The reduced number of holdings had a positive effect on the average

Table CS5. Changes in regional statistical.

	1961	1970	1980	1990	2000	2007	2009
Land use ('000 ha)							
Total AA	2 224	2 161	2 263	1 355	1 014	1 072	
Permanent grassland		980	1 257	789	525	614	
Rangeland (rough grazings)				0	0	154	
Temporary grassland (forage plants)		76	113	186	201	206	
Number of animals ('000 heads)							
Cattle	231	260	319.8	307.8	250.3	270.7	251.1
Dairy cows			98.7	82.8	34.0	39.3	34.6
Sheep	2 678*	2 884*	3 021	3 131	2 809	2 909	3 505
Goats			281	229	209	252	235
Horses	56	39	34			13.40	11.59
Number of holdings ('000)							
<i>FT 10 (Specialist field crops)</i>				13.47	11.82	7.88	
<i>FT 40 (Specialist grazing livestock)</i>				21.3	19.71	15.25	
<i>FT 41 (Specialist dairying)</i>					0.6	0.31	
<i>FT 42 (Specialist cattle-rearing and fattening)</i>					3.06	2.21	
<i>FT 43 (Cattle dairying, rearing and fattening combined)</i>						0.04	0.42
<i>FT 44 (Sheep, goats and other grazing livestock)</i>						16.01	12.32
<i>FT 50 (Specialist granivores)</i>				0.92	0.43	0.98	
<i>FT 60 (Mixed cropping)</i>				10.75	6.9	5.5	
<i>FT 70 (Mixed livestock holdings)</i>				4.21	1.1	2.2	
<i>FT 71 (Mixed livestock, mainly grazing livestock)</i>					0.81	1.02	
<i>FT 72 (Mixed livestock, mainly granivores)</i>					0.29	1.19	
<i>FT 80 (Mixed crops-livestock)</i>				7.4	4.3	3.07	
<i>FT 81 (Field crops-grazing livestock combined)</i>					1.55	0.77	
<i>FT 82 (Various crops-livestock combined)</i>					2.75	2.3	
Average holding size (ha)							
<i>FT 10 (Specialist field crops)</i>				8.33	10.33	10.70	
<i>FT 40 (Specialist grazing livestock)</i>				38.56	32.25	48.11	
<i>FT 41 (Specialist dairying)</i>					38.18	59.87	
<i>FT 42 (Specialist cattle-rearing and fattening)</i>					45.56	73.47	
<i>FT 43 (Cattle dairying, rearing and fattening combined)</i>					77.25	36.17	
<i>FT 44 (Sheep, goats and other grazing livestock)</i>					51.32	68.98	
<i>FT 50 (Specialist granivores)</i>				3.45	5.16	12.64	
<i>FT 60 (Mixed cropping)</i>				7.17	6.10	6.94	
<i>FT 70 (Mixed livestock holdings)</i>				25.58	21.95	26.78	
<i>FT 71 (Mixed livestock, mainly grazing livestock)</i>					42.81	45.25	
<i>FT 72 (Mixed livestock, mainly granivores)</i>					8.72	25.35	
<i>FT 80 (Mixed crops-livestock)</i>				17.82	22.03	16.72	
<i>FT 81 (Field crops-grazing livestock combined)</i>					54.06	50.00	
<i>FT 82 (Various crops-livestock combined)</i>					21.07	14.02	

* Data are the totals of goats and sheep.

Source of statistical data: Eurostat, ISTAT.

holding size and the increase in areas under permanent grasslands and pastures, suggesting a farming system reconversion towards more extensive systems. In any case, as they were in the past, most agricultural activities are still conducted in less favoured areas (70% of AA, 60% of total holdings) and in mountain areas (18% of AA, 17% of total holdings) (Eurostat, 2007). The number of sheep, on the contrary, has varied over the years, but essentially confirms the strong propensity of the island for this economic sector, due to the rusticity, high milk productivity and adaptability to harsh environments of the Sarda breed. Currently, Sardinia holds 3 245 902 head, representing 43.4% of the national sheep numbers (ISTAT, 2010) (Table CS5).

Habitat evolutions

Plant communities. Sardinia is considered a hotspot for plant diversity in the Mediterranean region (Médail and Quézel, 1999). Sardinian flora includes 2400 taxa (where therophytes dominate), 10.6% of which are endemics (APAT, 2006; Agnesi *et al.*, 2010), 5% are exclusive to the island and 4% are common to Sardinia, Corsica and some Tyrrhenian areas. Sardinian flora includes evergreen tree formations (*Quercus ilex*, *Quercus suber*), deciduous leaf forests (*Quercus pubescens*, *Castanea sativa*) and shrubs of considerable ecological importance constituting the Mediterranean maquis, such as the strawberry tree (*Arbutus unedo*), mastic tree (*Pistacia lentiscus*), wild olive tree (*Olea europea* subsp. *sylvestris*), rock-roses (*Cistus* spp.), myrtle (*Myrtus communis*), *Phyllirea* spp., heath (*Erica* spp.), brooms (*Genista* spp.), rosemary (*Rosmarinus officinalis*), spurge (*Euphorbia dendroides*), and junipers (*Juniperus oxycedrus* and *J. phoenicea*). This is an ideal habitat for many animals, including insects and other invertebrates. In degraded lands, the Mediterranean maquis is replaced by garrigue. Typical species are thorns, thyme, rockrose, strawflower, and spurge. Pastures and open landscapes are part of the mosaic in woodlands and shrublands, except in the Nurra and Campidano plains where they dominate. Forest cover is what remains after the extensive deforestation that occurred in the second half of the 19th century, when timber was required for railway construction. In addition to cereal cultivation, extensive sheep breeding also began at this time, promoted by some cheesemakers who arrived on the island from the Lazio region. EU and regional environmental policies later promoted land reforestation; Sardinia now has the largest forest-covered surface of all Italian regions (1 213 250 ha, 50.36% of regional surface) (INFC, 2007). Nevertheless, constraints such as recurring wildfires, climate change, human settlement and abandonment of agricultural lands expose some areas to the risk of desertification.

Animal communities

The insularity of Sardinia allowed unique fauna to develop, including endemic species. Many different mammals can be found here, such as the moufflon (*Ovis musinon*), which is perhaps the most evocative species of the island; the white donkey (*Equus asinus* var. *albina*); the Sardinian deer (*Cervus elaphus corsicanus*), the Giara horse (*Equus caballus*), the wild rabbit (*Oryctolagus cuniculus* subsp. *huxleyi*), the wildcat (*Felis silvestris lybica*), the Sardinian dormouse (*Glis glis melonii*), the hare (*Lepus capensis* subs. *mediterraneus*), the marten (*Martes martes*), the weasel (*Mustela nivalis*), the fox (*Vulpes vulpes* subs. *ichnusae*) and several bat species including the rare Sardinian eared bat (*Plecotus sardus*). The most common wild mammal, however, is the wild boar (*Sus scropha*). As for birds, those worthy of mention are the golden eagle (*Aquila chrysaetos*), the griffon (*Gyps fulvus*), the peregrine falcon (*Falco peregrinus*), the Sardinian partridge (*Alectoris barbara*) and the little bustard (*Tetrax tetrax*). Sardinia also has several wetlands that are important habitats for migratory birds, including pink flamingoes (*Phoenicopterus ruber*). As with

the flora, various factors threaten wildlife, in particular poaching, human disturbance and habitat alterations due to agricultural intensification (Bulgarini *et al.*, 1998). With regard to insects, a number of endemic species are present, one of which is the Sardinian swallowtail butterfly (*Papilio hospiton*). Some species of Lepidoptera defoliators have a negative impact as forest defoliators (*Limantria dispar*, *Malacosoma neustria*, *Tortrix viridana*, *Euproctis chrysorrhoea*) and are considered a true scourge of the oak woods.

Agriculture development and importance of CAP supports

Until a few years ago, the Common Agricultural Policy for price and market support kept the majority of Sardinian agricultural systems (pastoral systems in particular) alive, although under low-income conditions. With the CAP reform and the introduction of decoupling, farms received smaller payments and the economic crisis in the animal sector forced many farmers to abandon their agricultural activity. At the moment, the only chance of survival for many farms, especially in less favoured areas, is the financial support from the second pillar of the CAP.

The Rural Development Programme (RDP) 2007–2013 drawn up by Sardinian Administration allocated 37% of the budget (586 million euros) to the first axis, which focuses on improving competitiveness of the agro-forestry sector, and 45% to the second axis (about 700 million euros), which aims specifically to achieve the protection and expansion of agro-forestry systems with high natural value; safeguard the environment and improve animal welfare; and reward farmers working in mountainous and disadvantaged areas.

Agri-tourism, diversification and pluri-activities

Sardinian agro-pastoral farms have always managed multiple functions and diversified their activities, even before the European Directives and Regulations outlined, promoted and funded them. Typically, many agro-pastoral farms supplement their income by breeding one to three horse mares and selling the young horses, which are highly appreciated at a national level and are widely used in competitive racing. Beekeeping is another traditional activity often found in multi-functional and agro-pastoral farms. A close link exists between agriculture and traditional handicraft in Sardinia, where products are full of recurring symbols related to the natural environment or make use of agro-pastoral by-products (sheep wool for traditional carpets, ram's horn for knives). Moreover, shepherds play a basic role in preserving and managing the landscape (although not paid for it) and in preserving biodiversity with the conservation on farms of some landraces (e.g., black sheep).

The extensive nature of farming, the low population density and the concentration of rural people in small villages (it is still uncommon for rural families to reside on their farms), allowed the preservation of a wild and impressive environment that could be integrated with the tourism system. The agri-tourism sector in particular has grown rapidly over the past two decades, with a peak of 810 accommodations in 2010. It is often associated with horseback riding or teaching activities to children (teaching farms), for which the Regional Administration established a special register where operators must attend a training course to be listed. The current economic crisis has seriously affected the interior of the island, where depopulation was already a severe problem, and forced the adoption of rural development measures under the third axis of the RDP to make rural areas more attractive and encourage people to live there. These measures aim to develop activities in non-agricultural sectors and preserve the rural heritage.

Organic farming and quality product policy

Sardinia boasts a remarkable diversity of agricultural and food products, which represent a resource to invest in because they are a vehicle of cultural identity, economic and social development, preservation and environmental characterisation. Currently, there are seven Protected Designations of Origin (PDO) and Protected Geographical Indications (PGI) foods, 20 PDO and 15 PGI wines and 174 food products identified as “traditional” (although still not registered as Traditional Speciality Guaranteed) by the Italian Ministry of Agriculture and Forestry, but the weight of companies producing high quality products (organic products) places Sardinia in 13th place in the national ranking and the areas involved in organic production total 117 657 ha (10.6% of national areas) (SINAB, 2010). In practice, the importance of agricultural quality production is quite limited. The crops under organic management are mainly forage crops (83%), followed at some distance by cereals and protein crops. The RDP 2007–2013 introduced some measures in the first and second axes to enhance the production and supply of quality products but financial resources are considered insufficient by many.

Natura 2000 and other environmental policy tools

There are large areas of the Sardinian territory that are subject to various forms of protection, namely two National Parks, three Regional Parks, 60 wildlife reserves, other protected areas subjected to hydrogeological constraints, state-owned forests and reforestation sites, five marine protected areas and a UNESCO-protected Geomineral Park. In response to the Habitats Directive and the Directive on the conservation of wild birds, 15 Special Protection Areas and 92 Special Areas of Conservation have been identified covering 427 183 ha belonging to the Natura 2000 Network. In addition, a regional law focuses on the protection of wildlife and the practice of hunting, an activity traditionally very common in Sardinia. The RDP 2007–2013, in the second axis, introduced specific measures to ensure soil protection, biodiversity preservation and greenhouse gas emission reductions, and more specifically, subsidy payments to farmers working in mountain regions, unfavoured areas, and Natura 2000 Network sites, which are added to the agri-environmental payments.

Prospects for the development of the area

There is a strong potential for the development of agri-environmental activities. The key areas focus on sustainable exploitation of natural resources—in particular grasslands—to produce quality food and non-food products and environmental services. The spread of intensive farming systems led to the overexploitation of pastures, causing losses in natural resources and reduced dairy product quality, since the massive use of fodders and forages standardises their organoleptic features. The spread of extensive farming systems could, however, improve product quality, strengthening the links between products and individual territories, food security, agricultural biodiversity and cultural heritage (Porqueddu *et al.*, 2003). The further development of rural tourism and eco-tourism (bird watching, mountain biking), in combination with the appreciation and remuneration of the role that farmers play in the management and conservation of natural resources, would improve their incomes and guarantee a future for pastoral activities. In this framework, the improvement of farmers’ technical knowledge and the transfer of information from research to farmers is of vital importance and rural development policies should encourage it.

References

- AAVV, 2010. L'agricoltura nella Sardegna in cifre 2009, INEA pp 84. Médail F., Quézel P. 1999. Biodiversity hotspots in the Mediterranean Basin. Setting global conservation priorities. *Conserv. Biol.*, 13 (6), 1510-1513.
- Agnesi S., Alonzi A., Angelini P., Arcangeli A., Bellucci V., Capogrossi R., Ciccarese L., Condor R., Dalù M., Di Nora T., Ercole S., Esposito D., Finocchiaro G., Florian D., Forconi V., Genovesi P., Giovannelli V., Gori M., Guccione M., Guido M., Laureti L., Lucci S., Natalia M.C., Pace E., Paris P., Piccini C., Sannino R., Sestili P., Tunesi L., 2009. *Biodiversity and natural, agricultural and forest areas*. In Key topics – Italian Environmental Data Yearbook 2009, 55-94.
- APAT, 2006. *La protezione delle specie della flora e della fauna selvatica: quadro di riferimento legislativo regionale*. Rapporti 75/2006, 258 pp.
- Aru A., 1993. I suoli delle aree montane. In *Montagne di Sardegna*. Carlo Delfino Editore, 67-78.
- Bulgarini F., Calvario E., Fraticelli F., Petretti F., Sarrocco S., 1998. *Il libro rosso degli animali vertebrati in Italia*. Dossier WWF Italia: 53-98.
- Chessa P., Delitala A., 1996. *Il Clima della Sardegna*. In Collana di Agrometeorologia per la Sardegna. SAR, Sassari (Italy), 200 pp.
- Floris F., Morfino C., Muscas F., Piras F., Serra G., Fiori M., 2009. L'agricoltura nella Sardegna in cifre 2009. INEA, 84 pp
- Ginesu S., 1993. Aspetti geomorfologici delle montagne sarde. In *Montagne di Sardegna*. Carlo Delfino Editore, 27-56.
- Idda L., Furesi R., Pulina P., 2010. L'allevamento ovino in Sardegna tra crisi di mercato e politiche per il rilancio. *Agriregionieuropa*, 6 (23), 1-8.
- Piano di Sviluppo Regionale 2007-2013 della regione Sardegna. www.regionesardegna.it, accessed on April 2013.
- Porqueddu C., Parente G., Elsaesser M., 2003. Potential of grassland. Optimal forage systems for animal production and the Environment. Proceedings of the 12th General Meeting of the European Grassland Federation, Pleven, Bulgaria. *Grassland Science in Europe*, 8, 11-19.
- Porqueddu C., Sulas L., 1998. Mediterranean grassland systems. Ecological Aspects of Grassland Management. Proceedings of the 17th General Meeting of the European Grassland Federation, Debrecen Agricultural university, Hungary. *Grassland Science in Europe*, 3, 335-345.
- SINAB, 2010. Agricoltura biologica in cifre al 31.12.2010. pp 9. Updated to 13.09.2011. Available online: www.sinab.it.

Sources of statistical data

www.istat.it, accessed on April 2013.

http://www.sian.it/inventarioforestale/jsp/home_en.jsp, updated to 10.12.2008. Accessed on April 2013.

<http://epp.eurostat.ec.europa.eu/portal/page/portal/eurostat/home/>, accessed on April 2013.

www.sinab.it, accessed on April 2013.

Aosta Valley (north-west Piedmont)

Authors: Giampiero Lombardi, Michele Lonati, Davide Cugno, AGROSELVITER Department, University of Turin, Via L. da Vinci 44, I-10095, Grugliasco (TO), Italy

North-west Italy is a wide area (about 35 000 km²) on the south-western edge of the Alps. It includes three administrative regions (Aosta Valley, Piedmont, and Liguria, Figure CS2), each with their specific environmental and socio-economic characteristics. Unlike Liguria, Piedmont and Aosta Valley have a large proportion of mountain grasslands of total AA, which are still play important for livestock husbandry and the regional economy. Although they share several land structure features, the two regions' grassland systems are analysed separately in the following chapters due to differences in land management and agricultural policies that have affected the livestock sector and grasslands.

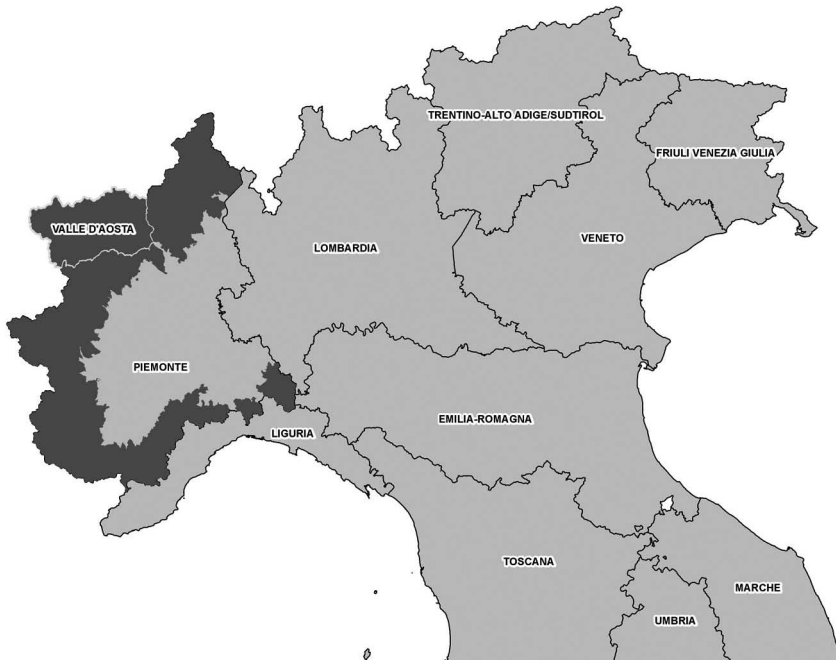

Figure CS2. Map of the studied area in the Aosta Valley.

Specificities of the mountain area

The studied area lies entirely within the Piedmont administrative region and covers about 1.36 million ha (24% of the regional surface) of mountain territory.

The altitude of the area ranges from 500 m to 4600 masl (Nordend peak, 4609 m – Monte Rosa massif), but generally grasslands are not found above 3000 masl.

Mountains extend along the border with Switzerland (northern part of the region), France (western part), and Liguria (southern part). Watersheds and slopes draw valleys mostly arranged radially towards the plain.

The lithology is extremely complex and varied; crystalline massifs are predominant, but they alternate with calcareous rocks of sedimentary origin (limestones, dolomites, schists, etc.), especially in the south-west part of the region. The lithological variability results in important soil variability: alfisols, inceptisols, entisols, mollisols and spodosols (USDA, 1999) are often found together in the same valley.

With reference to climate, the highest precipitation (rainfall above 2000 mm/year) falls in the northern part of the region and in the western esalpic districts. Rainfall decreases from the esalpic to the endalpic districts, where the lowest precipitation and a marked continentality at the head of the valleys occur. It has a bimodal distribution with two maxima, in spring and autumn, with the absolute minimum during winter and summer in the northern and southern districts, respectively. Average temperatures are generally below 10°C at the mountain belt and decrease with altitude, reaching values below 0°C above 2000 m. During the growing season, the temperature above 1000 m declines by -0.7°C each 100 m of drop in altitude (Biancotti *et al.*, 1998). The

average temperatures are close to 10°C between 1000 and 2000 m, and lower than 7-8°C above 2000 m, where frost occurs even during summer.

These complex orography, lithology, soil and climatic conditions result in a wide variability of vegetation. Eleven main woodland types and more than 90 grassland types have been inventoried by Camerano *et al.* (2004) and Cavallero *et al.* (2007), respectively.

Grassland types and management

In the studied area, permanent meadows and pastures cover 286 000 ha (ISTAT, 2011; data 2007), i.e. 93% of the AA. Permanent meadows are widespread, especially in the valley floors and on gentle slopes, or where steep slopes were shaped by man during centuries of building terraces and embankments. They are mown for hay (mountain meadow silage is still uncommon) two to three – sometimes up to four- times during spring and summer, and generally grazed once during autumn. Cutting and grazing decreases with altitude and fertility to one cut and one grazing at the subalpine belt, the upper altitude limit for meadows. Mowing and fertilisation in rather homogeneous ecologic conditions have had a considerable effect on meadow vegetation composition, which has four main types: *Bromus erectus* and, from the low altitudes to the subalpine belt, *Lolium* spp., *Arrhenatherum elatius* and *Trisetum flavescens* (Photo 11, Plate CS8).

Pastures are generally found on steeper slopes at the mountain and subalpine belts where meadows still are exploited. These days, however, often all of the herbaceous lands at the subalpine and alpine belts are exclusively grazed. Seven vegetation types account for 70% of grazing land: *Nardus stricta* (17%), *Festuca paniculata* (15%), *Festuca* gr. *rubra* and *Agrostis tenuis* (12%), *Festuca scabriculum* (8%), *Brachypodium rupestre* (7%), *Trifolium alpinum* and *Carex sempervirens* (5%), and *Festuca* gr. *ovina* (5%) (Photo 12, Plate CS8). A combination of environmental factors and grazing practices has resulted in another 80 minor types.

In accordance with ISTAT data, permanent meadows and pastures are exploited by 10 600 agricultural holdings. The resulting average grassland area is 27 ha per farm, or more than three times the mean regional farm size. There are 7 000 livestock holdings established in the mountains, with 60% raising cattle (18% specialising in dairy cows, 23% in cattle rearing and fattening, and 14% combined) and 40% small ruminants and horses. About 87 000 heads of cattle (19 300 dairy cows belonging to 1 300 specialist dairy farms and 7 400 suckling cows belonging to 1600 cattle rearing and fattening farms) and 89 400 small ruminants (70% sheep and 30% goats, 3 100 farms) are reared. The number of heads in the mountains corresponds to 10% of cattle and 50% small ruminant livestock production in the region.

Regional statistics change when analysing the regional agricultural registry data (update 2009): in fact, the number of livestock holdings in the mountains is remarkably lower (4800 vs. 7000). The proportion of cattle, small ruminant and horse farms is similar, as well as the number of dairy cattle, but a higher number of suckling cows (14 200 vs. 7400) and a lower number of small ruminants (72 500 vs. 89 400) are reported.

Transhumance from the valley floor to the summer quarters, where animals graze pastures for 80–150 (but up to as many as 180) days, is a common practice (95% of cattle and 98% of small ruminants), except for farms generally established in the

northern districts that breed very productive lactating cows. Traditionally, cattle graze more favorable areas (Photo 13, Plate CS9), while the more remote areas with poor vegetation are generally grazed by sheep and goats.

Evolution of the statistics per category

In Piedmont, as well as in the other Italian regions, the structure of mountain agricultural holdings has been strongly affected by socio-economic changes during the last 50 years. The total AA, permanent grasslands, meadows and temporary grasslands decreased by 40%. Such figures are lower than those for the Italian mountains overall.

The number of agricultural holdings decreased by 90–95% (the reduction was on average more pronounced than for the entire country). This reduction occurred between the 1960s and the 1990s and essentially stopped in the early 2000s.

Moreover, the number of heads generally decreased, with wide discrepancies between animal species or classes: in 1961, the number of cattle was about double current numbers, but whilst dairy cows were reduced by 80%, the number of suckling cows, which underwent considerable fluctuations, is now triple compared to 1961 levels. The trend of goat numbers is similar to that of cattle, while sheep numbers, which also experienced major fluctuations, are currently 20% lower than the first available data (1982).

In the Piedmont area, land use and farm structure changes are clearly correlated with the abandonment that affected other European mountain regions. Only activities for which limited/non-specialised labour is required have been moderately affected. Over the last ten years, statistics show a stabilisation or a reversing of negative tendencies, most likely due to growing consumers' interest in typical mountain products.

Dairy and meat production

Dairy cattle and dairy sheep and goats from mountain farms yield about 9% of regional milk production. Nearly the entirety of this production is processed into 2800 t/year of dairy products (95% from cow milk), accounting for 86% of regional dairy production (Brun *et al.*, 2005). This includes six PDO cheeses and about 60 typical dairy products (PAT, *Prodotti Agroalimentari Tipici*, MiPAF, 2010).

Mountain grasslands are also an important source for cattle, sheep and goat meat production, but as such animals are generally finished in the lowlands, data to quantify the role of mountain feeding are not available.

Agriculture development, importance of CAP supports (1st and 2nd pillars)

In Piedmont, Community support in rural areas is essential to agricultural activities; in fact it has a relative weight on net farm income between 30% and 60%, depending on the farm specialisation (the lowest value refers to combined cattle-dairying, rearing and fattening holdings, the highest to the specialist field crop holdings; Borri *et al.*, 2010). In 2009, 60% of the agricultural holdings received some Community support, totalling 366 million euros.

The payment per hectare of AA generally decreases with altitude (IRES Piemonte, 2011): on average, specialised dairy and cattle-rearing and fattening farms in the lowlands receive 760 and 890 euros/ha, respectively, and 95 and 140 euros/ha, respectively,

in the mountains. Consequently, extensive mountain farms, which play a key role in environment-biodiversity conservation, generally receive low subsidies.

Two recent analyses (IRES Piemonte, 2011; Borri *et al.*, 2010) both show the primary role of the CAP's first pillar, which makes up almost 90% or more of total Community support. Within the first pillar, the impact of historic support entitlements, the distribution of which remained unchanged even after first pillar reforms, remains predominant (80%). The weight of second pillar – 48 million euros of RDP payments during the reference year 2009 (Regione Piemonte, 2011) – while not negligible is low, though it has a tendency to increase over time (up to 135 million euros in 2011).

Under the framework of the RDP 2007–2013 (Axis 2, agri-environmental measures), Piedmont regional offices have implemented specific actions to boost extensive farming systems for their positive environmental effects, and specifically to improve grassland multi-functionality as a result. The monetary value of such measures amounted to about 3.8 million euros during the period 2009–2011, or less than 5% of agri-environmental payments. The impact of organic farming measures, which account for 10% of the agri-environmental payments and could have positive effects on grasslands, is insignificant for mountain areas.

Conclusions and perspectives for the area

The studied area is characterised by a remarkable heterogeneity of climate, orography, soil, vegetation, etc. The landscape quality of the area depends mainly on the mosaic of forests and grasslands, which are almost always of anthropogenic origin. Consequently, grassland exploitation is essential to maintain such semi-natural environments. The role of extensive livestock farms has been underestimated for many years: inappropriate management, reduced financial support to agricultural holdings, reduced farm competitiveness resulting in the abandonment or degradation of large areas. The conservation of traditional farming systems by improving agricultural practices and the promotion of the grassland-ecosystem services (local products, sustainable tourism, wildlife, etc.), integrated with specific Community support, may ensure the preservation of the natural and cultural heritage of Piedmont mountains over the medium and long terms.

References

- Borri I., Borsotto P., Cagliero R., Peiretti G., Trione S. (2010). Le aziende agricole piemontesi attraverso la RICA: dati strutturali e risultati economici. Quaderni RICA,
- Brun F., Mosso A., Xausa E. (2005). La montagna in cifre: rapporto statistico sulle terre alte del Piemonte. Regione Piemonte, 71 pp.
- Camerano P., Gottero F., Terzuolo P., Varese P. (2008). Tipi forestali del Piemonte. Regione Piemonte Ed. BLU Edizioni, Turin (Italy).
- Cavallero A., Aceto P., Gortier A., Lonati M., Lombardi G., Martinasso B., Tagliatori C. (2007). I tipi pastorali delle Alpi piemontesi. Alberto Perdisa Editore (Bologna) 467 pp.
- Giardini A., Vecchietini M., 2003. Generalità sulle colture da foraggio. In: *Coltivazioni erbacee: foraggiere e tappeti erbosi*. R. Baldoni and L. Giardini Eds. Patron Editore (Bologna, Italy), 21-31.
- IRES Piemonte, 2011. Riforma del Primo Pilastro della PAC 2014-2020: prime elaborazioni e riflessioni per il Piemonte. IRES provisional document, 22 pp.
- ISTAT, 2011. <http://dati.istat.it>. Accessed on April 2013.
- ISTAT, 2000. <http://www.istat.it>. Accessed on April 2013.
- USDA Soil Survey Staff (1999). *Soil Taxonomy: A Basic System of Soil Classification for Making and Interpreting Soil Surveys*. USDA Agriculture Handbook n.436, 871 pp.

Norway

Author: Vibeke Lind, Bioforsk North, Tjøtta

Norwegian grasslands at the Arctic Circle

Environment (soil, climate, vegetation)

Norway, in the north-western corner of Europe, is characterised by an elongated shape that covers 13° latitude from 58°N to more than 71°N. Norway is dominated by the Scandinavian mountains with an average elevation of 460 m above sea level and with more than 32% of the mainland located above the tree line. The climate in Norway is more temperate than would be expected for such high latitudes; this is mainly due to the North Atlantic Current. The coast experiences mild winters with average temperatures around 0°C while the inland climate is colder, with average temperatures reaching -13°C. Norway's climate shows large variations except for a small area along the north-eastern coast in Finnmark, where all areas below the tree line (populated areas) have a temperate or subarctic climate (Köppen, from Meteorologisk Institutt). Some areas of Vestlandet and southern Nordland are Europe's wettest, with annual precipitation of 3575 mm; annual precipitation can exceed 5 000 mm in mountain areas near the coast. Precipitation is heaviest in autumn and early winter along the coast, while April to June is the driest period. The innermost parts of the long fjords are somewhat drier, with annual precipitation between 300 and 750 mm (http://met.no/met/vanlig_var/nedbor.html). Forest covers 37% of the country with *Picea* spp. and *Pinus* spp. as the dominant species (79% of all forests).

Grassland type and management

The percentage of the AA in Norway is about 3.5% of the total land area (SSB, 2010). In the studied region (Nordland County), the AA amounts to about 1.6% of the total land area, or 6% of the total AA area of Norway. In this area, permanent grasslands account for almost 90% of the AA, while the figure is 66% for the entire country. In addition to the AA, there are available areas for grazing in the mountains. The areas of rangeland make up about 50% of both Norway's total land area and the studied area (Pers. comm. Y. Rekdal). Permanent

Table CS6. Norway Country data in 2009.

	('000 ha)
Agricultural area (AA) (available mountain pasture areas not included)	1 015.2
Arable land	839.9
Cereals	310.1
Forage crops	528.9
Forage maize	46.1
Temporary grasslands	482.8
Permanent grasslands and meadows	175.3
Grasslands and meadows	175.3
Rangelands (available mountain pasture areas), about 50% of all area of Norway	16 190
Other areas	
Forests	6 915.4

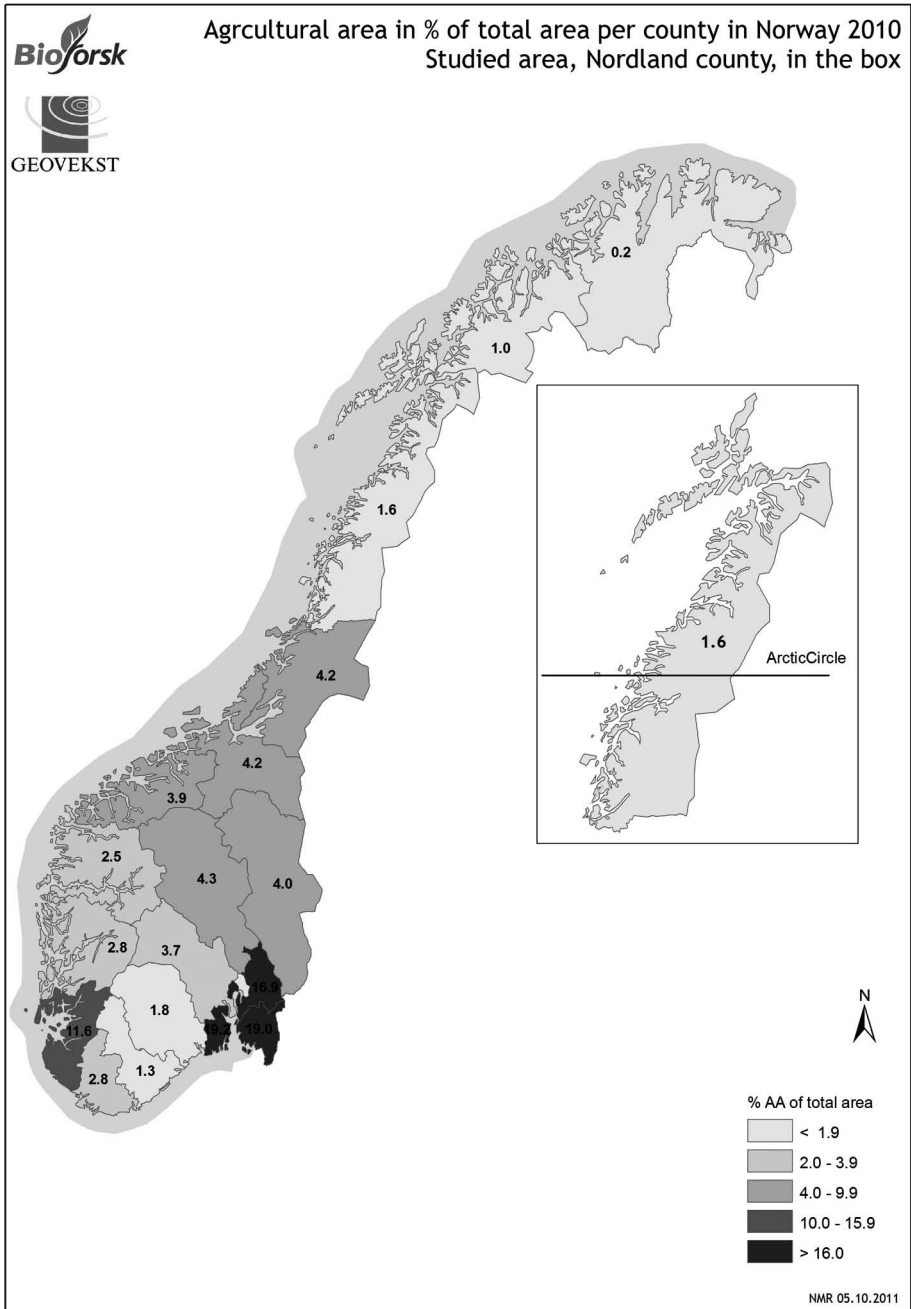

Figure CS3. Agricultural area in Norway.

grasslands in Norway are mainly grazed by sheep and cattle. In addition to sheep grazing rangeland in mountainous areas, livestock also graze permanent grasslands during spring and autumn. Suckler cows graze with their calves during spring, summer and autumn, while milking cows graze for a minimum of eight weeks during the summer. Due to climate, the grazing season in Norway ranges between 220 (south) and 160 (north) days per year; the animals are kept indoors the rest of the year. Permanent grasslands used for sheep grazing in spring and autumn are cut for silage once during summer.

Evolution of the statistics per category (areas, livestock, holdings) and reasons for these evolutions

As is the case in the EU, the structural changes in Norwegian agriculture are towards larger and fewer units. However, the total AA and the permanent and temporary grassland areas have not changed over the past fifty years. The number of holdings has decreased, in particular the number of milking cows and horses, although the total number of cattle has

Table CS7. Changes in national statistics.

	1959	1969	1979	1989	1999	2009
Land use ('000 ha)						
Total AA	984.5	955.3	953.5	991.1	1038.3	1015.2
Permanent grassland	175.0	158.5	123.2	109.3	151.1	175.3
Rangeland*						16 190
Temporary grassland	482.9	458.4	415.7	438.5	487.7	482.8
Number of animals ('000 heads)						
Cattle		971.9	970.1	949.4	1 033.1	
Dairy cows	594	436.3	372	334	313	239
Suckling cows				6.6	36.8	66.5
Sheep	1 751	1 840	1 952	2 183	2 325	2 250
Goats	99	91.1	80.6		78.6	69.5
Horses	116	40.6	24.5	17.4	27	34
Number of holdings ('000)						
FT 10		140.8	99.2	72.1	55.8	
FT 40		83.1	54.0	38.6		36.5
FT 41	148	82	39	28	20.5	15.9
FT 42				1.5	5.5	5.1
FT 43	4.1	9.9	14.9	8.1	2.0	0.5
FT 44	108	72.6	46.2	30.4	23.4	15.7
FT 50	170.6	90.6	32.3	14.2	9.9	4.5
FT 60					0.9	
FT 70					1.4	
FT 71					2.8	
Average holding size (ha)						
FT 10	5.0	6.2	7.6	10.0	14.7	21.3

*Rangeland: Available area in mountains for grazing. About 50% of the total area of Norway (pers. comm. Yngve Rekdal).

remained almost the same. The main reason for this is an increased number of suckling cows and holdings raising cattle for meat. On the south-west coast of Norway, the number of sheep has decreased dramatically in recent years. Studies (e.g., Austrheim *et al.*, 2008) have examined factors such as technology, human capital, finances, institutions, farmers' values and family dynamics, which influence farm exit/entry and composition. However, in others parts of Norway, the number of sheep has increased; this is also seen in areas where predation by wolverines (*Gulo gulo*), Scandinavian brown bear (*Ursus arctos*) and lynx (*Lynx lynx*) has increased. Projects are underway to map the reasons for these differences between regions. Within the dairy farming sector, the average holding size is increasing and many farmers have joint operations. Costs related to new buildings in addition to low prices for products, lack of labour and the desire for more spare time for family are the chief reasons for this change. Joint operations for suckling cow and sheep production have not yet appeared due to building constraints. However, when sheep are gathered in the autumn, many farmers work together. The average holding size within each farming system is not given in the Norwegian statistics.

Nordland County

Environment (soil, climate, vegetation)

The studied area is long and narrow. It is located in the middle of Norway and is part of the Northern Norway region. Nordland County is about 800 km long running north to south and covers almost five degrees of latitude (from 65 to 69.5 degrees). The landscape consists of many fjords with steep slope mountains close to the sea. Between the sea and the mountains there is typically a flat land area dominated by agriculture. The east of the county, towards the border of Sweden, is dominated by mountains. A large archipelago with more than 18 000 islands and inlets (<http://www.visitnordland.no/index.php?c=167&kat=Fakta+om+Nordland>) dominates the coast; the coastline area here makes up a quarter of Norway's total coastline, with a total length of 14 000 km. The climate near the sea is mild compared to the latitude due to the North Atlantic Current, with average winter temperatures of 0°C. In the mountainous areas, however, it is much colder (-25°C in winter). The Polar circle crosses the county, which means midnight sun in summer in the northern part of the county and complete darkness during winter. Most rock is limestone and the region has a large number of caves. Marble is found several places in the county and is exported all over the world. A large glacier (Svartisen) is located in the middle of the region. Due to the mild climate, the vegetation is very diverse; among many other species, 24 of the 35 orchid species that grow in Norway are found in Nordland County.

Grassland types and management

Grasslands are mainly dominated by *Festuca* spp. (e.g., *F. rubra*, *F. pratensis*), *Poa* spp. (e.g., *P. pratensis*) and *Trifolium* spp. (e.g., *T. repens*, *T. pratense*) in addition to herbs and weeds. Grasslands are managed by grazing and cut for winter feed. In most places along the coast, two cuttings during the summer are normal, while one cutting is more common in the inland due to the short growing season. There is a high need for winter feed for all ruminants, and it is common to store cuttings for silage production in round bales. Along the coast, the indoor feeding period is about 200 days (from the end of September until the beginning of May), while in some regions the indoor period is one month longer. This is mainly in the spring (May and June) due to ice and snow cover in some areas. Hay production is less common nowadays due to cost and work related to drying since the summer can be very wet.

Dairy and meat sectors, products and marketing

Both the dairy and meat sectors are dominated by farmers' cooperatives ('Tine' dairy company; 'Nortura' meat company) who are both responsible for gathering and distributing the products nationally (www.tine.no; www.nortura.no). Logistics are complicated due to long distances within the county, with some farmers living on islands and others living close to the factories. The southern part of the county has a high production of both dairy milk and meat from cattle and sheep. Two dairy factories and two slaughter houses are located in this region while the dairy factory in the northern part of the county closed a few years ago. The dairy factory in Sandnessjøen receives and processes organic milk as one of the two dairy factories in Northern Norway. The range of products has increased in the past decade, mostly due to a rise in small scale farming (NOU, 2011). Despite higher prices, the demand for a variety of products has also increased and consumers are more aware of quality and local specialties. The most common breed of sheep is the Norwegian White, a seasonal breed which goes into heat in December (Photo 14, Plate CS10). Lambs are born in May and graze with their dams all summer, mainly on mountain pastures, until they are slaughtered at the age of five to six months with an average carcass weight of 20 kg. The dominating dairy cow is the Norwegian Red (Photo 15, Plate CS10). Calves are intensively raised on concentrate and grass silage until they reach a carcass weight of 250 to 300 kg, typically at the age of 18 months. Calves from beef cattle are typically born in the spring and graze with their dams during their first summer. Until they reach slaughter weight they are fattened on concentrate and grass silage. Hereford, Limosin and Charolais are the dominating breeds of beef cattle in Nordland County.

Evolution of the statistics per category (areas, livestock, holdings), evolution of the management and reasons for these evolutions

The changes in the agricultural structure in Nordland County follow the pattern of Norway, with fewer and larger units, often with joint operations within the dairy sector. However, total milk and meat production (both from sheep and cattle) seems to be stable despite the structural changes. In some areas of Nordland County, sheep farmers are experiencing increased predation, mostly by bears, lynx and wolverines. Some farmers lose as much as half of their stock during summer grazing. Ethical questions have been raised and a ban on mountain grazing has been suggested as a preventive measure. This has led to abandoned areas, inversion of shrubs and trees and declining pasture values. Large efforts are being made to prevent conflicts between predators and domesticated animals. Tourism has also suffered from the structural changes (Hansen, 2009).

Habitat evolutions

Plant communities

Nordland County has a large variety of plant communities reflecting the diversity of environmental conditions between the warmer lowlands close to the sea and the colder mountain region towards the Swedish border. Mountains are characterised by alpine and subalpine vegetation with *Betula pubescens* and *Picea abies* as the dominant tree species. The forest (coniferous and mixed) covers about one-third of the total area and the tree line is now higher than fifty years ago due to a warmer climate and the abandonment of former grazing areas (SSB, 2010). In Nordland County there are seven national parks, 18 protected areas and 175 nature reserves, an indication of the wide

variety of plant communities represented in the county. Coastal heathland is a unique community also represented in the county.

Animal communities

The Scandinavian brown bear, lynx, wolverine and red fox (*Vulpes vulpes*) are predators in the region. Other large mammals are elk (*Alces alces*), roe deer (*Capreolus capreolus*) and reindeer (*Rangifer tarandus*, both wild and semi-domesticated). Reindeer are important to the Sami population in the region. Golden eagles (*Aquila chrysaetos*) are found in the mountain areas while sea eagles (*Haliaeetus albicilla*), seagulls (*Larus* spp.), puffins (*Fratercula* spp.) and cormorant (*Phalacrocorax* spp.) are found along the long coastal line. One of the largest sea eagle populations is found in Nordland County near the Saltstrommen maelstream outside the county capital of Bodø. Unfortunately, puffins are threatened and the population is declining. This is mainly due to a lack of fish near the islands where they nest during summer. The list of endangered species drawn up by the Norwegian environmental authorities includes the great horned owl (*Bubo bubo*) and several butterfly species (e.g., *Malacodea regelaria* and *Xestia sincera*) (http://nordland.miljostatus.no/msf_themepage.aspx?m=3050#28046).

Agriculture development

CAP support (first and second pillars)

The agriculture industry in Norway and Nordland County depends on subsidies. The subsidies are paid directly to farmers on the basis of their production, number of animals, land use and farm size. Norway is divided into different subsidy zones defined on a climate basis. Because farmers in the far north have to work in less favoured areas compared to farmers in the south, farmers in the north get higher subsidies per unit (milk, meat, grass) than farmers in the south. This policy aims to keep farmers and agriculture in all areas of the country. Every year the farmers' organisation negotiates with the government (Ministry of Agriculture and Food) about the level of the subsidies. The target prices of agricultural products are approved; subsidies are typically changed in line with policy objectives.

Organic farming and quality product policy

Organic farming is gaining ground in Norway, but slowly. The aim of the Ministry of Agriculture and Food is to increase organic production and consumption to 20% by 2020. However, there is a wide gap between this objective and actual production: average production in 2011 was around 4% (both in terms of surface and farms) and consumption lower than the offers of organic products. However, in some production systems (e.g., sheep production) and in some areas, the 20% target has been reached. Nordland County has an offensive strategy to expand the production of organic products and to convert farms from conventional farms into organic farms.

Due to the strong purchasing power of the Norwegian people, product quality is high. However, farmers are not compensated for high meat quality, in contrast with dairy products. Consumers seem to be willing to pay more for products of high quality in the future. The number of small scale farms has increased over the past decades and it is increasingly possible to find products marked with labels of origin or as a local speciality in supermarkets. Prices are higher with expectations of high-quality products.

Natura 2000 and other environmental policy tools

Because Norway is not a member of the EU, it does not take part in Natura 2000 programmes. However, a large project to identify and describe important conservation areas is underway. Several areas have been pointed out for nature conservation and the policy tool for this project is currently being developed. The number of national parks, protected areas and nature reserves has increased over the past few years and there is a high need for programmes and a strategy for their implementation. It is necessary to map the impact of tourism and people with vehicles (snow scooters in the winter and ATVs in the summer) to prevent damage to important habitats. There is a need for people to be informed of restrictions in relation to a certain status of an area, and especially to know how to move around and use natural areas in a way that benefits everyone. Such guidelines have not yet been drawn up for all areas, but the aim is to make guidelines available as soon as possible.

Agri-tourism, diversification and pluri-activities

More and more farmers are changing their production systems to small-scale farming and tourism. Some farmers also use their farms in cooperation with local schools or open their farms to children with special needs. The shift from pure farming to more diverse farm-related activities is a consequence of relatively lower income for farmers compared to other professions in Norway. Additionally, there is a high demand from the public social system for the placement of children with special needs and the model of using farms/farmers to serve this need has proved positive for all those involved.

Prospects for the development of the area

The climate and conditions in Nordland County and in particular in the southern part of the county are well suited to agriculture. Farmers are optimistic and there has been a great amount of investment on farms in the past years. The profitability of farming appears to be increasing thanks to the recruitment of young people.

References

- Austrheim G., Solberg E.J., Mysterud A., Daverdin M., Andersen R., 2008. Deer and livestock grazing extensive pastures in Norway from 1949-1999. Report Zoology Ser 2, vitenskapsmuseet, NTNU (in Norwegian).
- Hansen B., 2009. Preventive measures to prevent loss of lambs on pasture in Lyngsalpene and Kjosens-Fastdalen grazing group. Bioforsk Rapport 45/2009, 28 p. (in Norwegian).
- Köppen. http://metlex.met.no/wiki/K%C3%B6ppens_klimaklassifikasjon, accessed on June 2013.
- Nordland County, <http://fylkesmannen.no/enkel.aspx?m=23616>; <http://no.wikipedia.org/wiki/Nordland#Landskap>, accessed on June 2013.
- NOU, 2011. Food, power and powerlessness – relative strength in chain of value for food. Departementets servicesenter, Informasjonsforvaltning. 128 p. (in Norwegian).
- SSB, 2010. Statistics of Norway. http://www.ssb.no/jordbruk_en/, accessed on June 2013.

Poland

Authors: H. Jankowska-Huflejt, M. Kopacz, A. Kuźniar and B. Wróbel, Institute of Technology and Life Sciences, Falenty (Warsaw)

About 90% of Poland's permanent grasslands are located in river valleys and terrain abatements; only 10% are in mountain regions (Figure CS4). Permanent grasslands in Poland occupy an area of 3 180 000 ha (GUS, 2010 r.) and cover about 10% of the

country's land area and about 20% of UAA. Meadows make up 77% and pastures 23% (Table CS8). This is a relatively small area compared to other EU countries, which average over 30% of AA. Moreover, in the last ten years, permanent grasslands have decreased by nearly one million hectares. This is mainly due to the declining profitability of animal production and a lack of demand for the foods produced. The spread of maize cultivation for feeding dairy cow is also a factor: meadows and pastures with stabilised water conditions at the highest altitude sites are ploughed.

Table CS8. Changes in the area and permanent grassland utilisation structures in Poland.

Specification	Years										
	1996	2000	2001	2002	2003	2004	2005	2006	2007	2008	2009
Area, in millions ha	4.13	3.85	3.8	3.56	3.27	3.37	3.39	3.22	3.27	3.18	3.18
Percent of AA in:	23.1	21.9	21.7	21.1	20.2	20.6	21.3	20.2	19.8	19.7	19.7
meadows	14.82	14.2	14	15	14.5	14.6	15.9	15	15.4	15.2	15.3
pastures	8.28	7.7	7.7	6.1	5.7	6.0	5.4	5.2	4.4	4.5	4.4

Source: Central Statistical Office of Poland (GUS).

There is a close relationship between quantitative-qualitative status, permanent grassland use and the number of livestock animals for which meadow-pasture swards constitute basic feed. This is demonstrated by the decrease in livestock animals and stocking rates (mainly cattle and sheep, but horses as well, Table CS9) which took place during the late 1990s and early 2000s and led to insufficient productive utilisation of permanent grasslands.

Table CS9. The number of livestock animals ('000 heads) and stocking rates (heads per 100 ha of AA) in Poland.

Species	1980		2004		2007		2009	
	Heads	Stocking	Heads	Stocking	Heads	Stocking	Heads	Stocking
Cattle	12 649	66.8	5 353	32.8	5 405.5	33.6	5 700	35.4
Dairy cows		31.4		17.1		16.9		16.7
Sheep	4 207	222.2	318	1.9	315.6	1.95	286	1.8
Horses	1 780	9.4	320	3.1	500	3.1	298	1.8

Source: GUS.

Animal production began to drop in 1980 (beginning of system transformation in Poland) due to an unfavourable balance between production costs, agricultural product prices and imported EU-subsidised milk and dairy products.

When Poland joined the EU in 2004, the cattle stocking rate was half what it was in 1980, almost one-fifth for horses and one-twelfth for sheep, at barely 1.9 heads/ha of AA (Table CS9). Additional payments for agricultural production, especially after Poland's adhesion to the EU, brought about some favourable changes. On the whole, the cattle stocking rate increased from 32.8 in 2004 to 35.4 head/100 ha of AA in 2009.

In the cattle rearing sector, the number of dairy cows has decreased while beef cattle numbers have risen. With regards to milk production, the farms that had not reached

required veterinary standards went out of business and an additional limit was imposed on Poland through a limited milk quota. However, a recent drop in the number of milk cows has not affected total milk production. Indeed, in 2009 the average milk yield per cow reached 4596 litres, an increase of approximately 1430 litres over 1990 levels. [Produkcja upraw rolnych i ogrodnich w 2009 r., GUS 2010].

Rising milk yields were achieved through progressive restructuring and the consolidation of milk production, in addition to advances in farm fodder production, better breeding material and higher quality cattle feed. Animal rearing constraints led to less fodder production from permanent grasslands and more crop cultivation on arable lands. In 2009 over 3.1% of AA (498 400 ha of arable land) lay fallow. On farms without animals, arable land is not used for the cultivation of fodder crops but for cereals and other commodity crops due to the market and demand for them in this region. Average meadow yield is low (4.9 t/ha in 2009, Table CS10); hay makes up a majority of production (65% of yield) while no silage is produced. Pasture area has decreased: in 2009, hectareage was half what it was in 1996 (Table CS10).

Table CS10. Hay yields from permanent grasslands – t/ha and usage structure of meadow hay yield.

Usage	Years					Mean over the period
	2005	2006	2007	2008	2009	
Meadow	4.28	3.85	5.18	4.84	4.92	4.61
Utilisation of meadow yields – composition						
- for foods	60.8	50.3	76.3	74.4	74.6	67.3
- other purposes *	23.2	34.3	12.8	17.0	14.1	20.3
- not used	16.0	15.4	10.9	8.6	11.3	12.4
Pasture **	3.12	2.76	3.56	3.48	4.08	3.40

*Compost, bedding, cutting under direct payment framework; ** green mass converted to hay using 0.2 coefficient
Source: GUS.

On average, only 67% of meadows are used for fodder, while 9% to 16% are not mowed at all, despite payments being introduced for cutting (Table CS10) [Produkcja upraw rolnych i ogrodnich w 2005 r.; 2006 r.; 2007 r., GUS].

Forest is increasingly encroaching on grass areas, with trees and shrubs causing soil degradation, especially with regards to organic matter content and field capacity (mainly due to manure deficiency). This is a key issue because of the large share of light/medium and acidic soils in Poland.

The Tatra Mountains

The highest mountain range in the Western Carpathian Mountains (with the highest peak of 2499 m) is located in the Tatra district in the Małopolska region (Figure CS4). The Tatras occupy an area of 785 km² of which about 175 km² (22.3%) lie in Poland and 610 km² (77.7%) in Slovak territory. The Tatras have a similar landscape to that of the Alps, although on a significantly smaller scale. The Tatra district covers an area of 471.62 km², with 65 500 residents (2010), and a population density of about 139

people/km². The characteristics of grasslands in the Tatras were based on the data from the Tatra district.

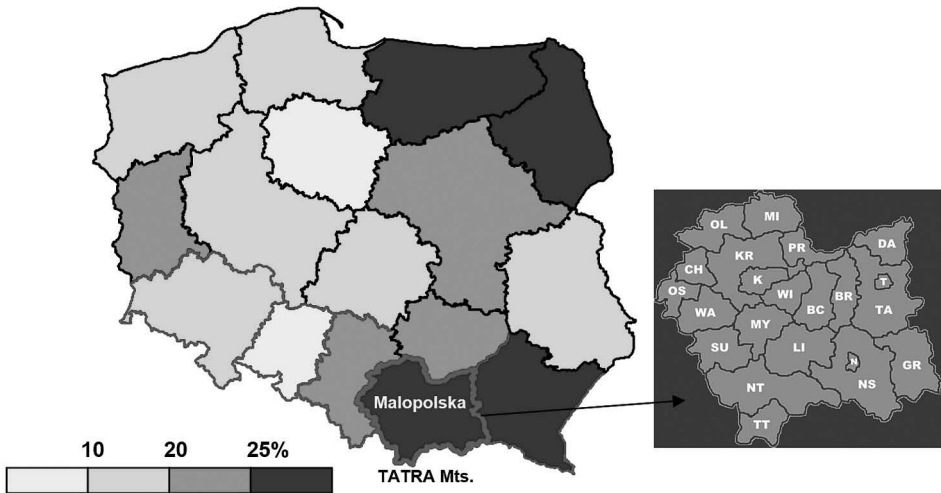

Figure CS4. Share of permanent grasslands in UAA in Poland and location of the studied area (Tatra Mountains) in relation to the administrative division (2009).

Source: Authors' studies based on GUS data.

Environment (soil, climate, vegetation)

The geological structure of the Tatra Mountains is typical for mountainous areas of Alpine corrugation. The Tatras have distinctive areas, with sedimentary limestone rock on the western side and crystalline rocks and metamorphic-granites, which are resistant to weathering, at high altitudes.

Soils

Above the upper forest line, large areas are covered by rock lithosols, debris regosols, shallow soils, weakly-formed rankers and rendzina. Lithosols and regosols dominate in the crystalline section of the Tatras, while protorendzina and debris is common in the calcareous section. In a non-limestone area of the Tatras, podzolic soils and acidic soils (pH 4.0 to 5.0) occur and are mostly well formed and characterised by the presence of spruce trees in the subalpine zone. Rendzinas occupy a large area over the carbonate rocks, and are shallow or medium shallow (ca. 0.5 m) with a well-formed humus level. Brown soils are found together with rendzinas in the upper zones of the Tatras and beech wood in the lower zone. Small areas are covered by gley soils (near springs) and peat soils (in areas with overgrown postglacial ponds). Alluvial soils are well formed in the main valleys, such as the Chochołowska Valley (Komornicki and Skiba, 1996). The climate of the Tatra Mountains has alpine features of moderate climate in the vertical zones (from substratum), which include a zone of arable land (up to an altitude of 900 masl); a lower forest zone (mixed forest – beech and beech-spruce, up to 1150 to 1300 masl); an upper forest zone (coniferous spruce up to 1550 masl); a subalpine zone (shrubbery of dwarf mountain pine, up to 1800–2000 masl); an alpine zone (mountain pasture, above 2000 masl); and a zone of pikes (above the border of mountain pasture-meadows to the peak) (Photo 16, Plate CS11). Average annual

air temperatures vary from about 6°C in the foothills of the Tatras to about -4°C at the peaks (Kostrakiewicz, 2003). There is considerable variability in weather, with characteristic air temperature inversions in the winter (warmer temperatures at higher altitudes) and snowstorms in the middle of the summer. The warmest month is July, with an average temperature of 7.5°C at Kasprowy Peak, and the coolest month is February, with an average temperature of -8.5°C. Winter at the Zakopane Resort lasts from the end of November to the end of March, while at an elevation equal to that of Kasprowy Peak, it lasts from the middle of October to the beginning of May. A local foehn wind, called 'halny' is common. This strong, warm and dry wind blows most frequently in spring and autumn with windspeeds of over 50 m/s. It may bring in precipitation (rain or snow), overturn trees and cause avalanches. In the highest mountain zones, snow cover lasts over 290 days per year. The permanent snow line begins at an altitude of 2200 masl, but glaciers do not form because the high Tatra peaks are too steep for snow to accumulate.

Precipitation

Precipitation is highest in July and storms are frequent, with an average of ten stormy days during the month. The highest daily (24 hr) recorded precipitation in the Polish territory was 300 mm (30 June 1973 in Hala Gąsienicowa). The maximum recorded depth of snow cover on the peak in Poland was 355 cm in Kasprowy Wierch (April 1996).

Grassland type and management

Vegetation cover in the mountain permanent grasslands is more diverse than in the lowlands. This is due to a range of ecological factors and sward utilisation methods (Jankowska-Huflejt, Zastawny, 2001). In the lower valleys, meadows and pastures are home to plant communities that mainly include meadow grass (*Poa*), meadow fescue (*Festuca pratensis*), meadow foxtail (*Alopecurus pratensis*), timothy (*Phleum pratense*) and many other grasses. Legume-papilionaceous plants are rare, and notably absent from heavily fertilised areas with monk rhubarb (*Rumex alpinus*) associations, which is fond of nitrogen and can be found near grazing lands. In poorer soils, after removing spruce forest, poor grass vegetation appears with characteristic clusters of mat-grass (*Nardus stricta*). In spring, glades are covered in purple when the crocuses (*Crocus*) bloom in mowed meadows. The crocuses could not grow if the meadows were not grazed by sheep, the manure of which is also essential for the sword lily (*Gladiolus imbricatus*) and common bent grass (*Agrostis vulgaris*). According to the typology defined by Jagła *et al.* (1971), the most important associations that determine total fodder production of the meadows and pastures are the *Lolio-Cynosuretum*, *Gladiolo-Agrostidetum* and natural and sown communities of *Arrhenatheretum elatioris*. Mown meadows achieve the highest yields with the *Arrhenatheretum elatioris* and *Lolio-Cynosuretum* association in pastures. The lowest yield is obtained with communities of *Nardus stricta*, which is nevertheless beginning to disappear as a result of utilisation. Under the impact of mineral fertilisation [e.g., at the rate of 100–120 kg of N, 30–40 kg of P and 60–80 kg of K per ha], it is possible to achieve satisfactory yield increases from these communities as well as improved fodder quality. However, transforming degraded communities of *Nardus stricta* requires radical farming methods such as full cultivation and, wherever possible, penning and sowing performant species of grasses and legumes (Jankowska-Huflejt and Zastawny, 2001; Twardy, 1998). The present state of permanent grasslands and the method of their agricultural utilisation are closely related to the number of livestock animals for which fodder is produced

(Jankowska-Huflejt *et al.*, 2009). However, livestock numbers are still lower than in previous years, and under the framework of the agri-environmental programmes, only some of the grasslands are mowed. Currently, the most serious habitat threat is secondary succession, which is taking place in under-utilised meadows. The habitat is being overtaken by shrubs, herbs and bilberry associations, depending on the edaphic conditions and ecological patterns.

Isolated cases of spreading fern-bracken fern (*Pteridium aquilinum*) have been observed on a large scale. A modified plant association occurred after the Tatra National Park was created and where sheep grazing was forbidden. Other recent threats to meadows include the progressive spread of villages, the sale of land and the transformation of meadows into recreational and summer plots in the most attractive areas. Generally in those cases, grasslands are cut once a year, rarely twice. This demonstrates a very extensive utilisation and shows that in the future perspective grasslands will mainly fulfill environmental functions instead of a productive one (Jankowska, 2011). The forage from permanent grasslands is collected mainly for hay (61% of the area in 2009) (Photo 17, Plate CS12). Almost 12% of the harvest from meadows goes to silage, a relatively high proportion compared to the country's overall average, and the rest is fed as green fodder or grazed as pasture.

Dairy and meat sectors, products and marketing

The Tatra region is an area of extensive production due to geographic and climatic conditions. Sheep grazing has been widespread in the mountain pastures for many years. There is a strong cheese manufacturing industry, while the meat and skins are exported. Current limits on agricultural production in the whole country are reflected in similar trends in this area. Employment in the agricultural sector makes up 28% of the labour force, with services accounting for 62.9% and the industrial sector the remaining 9.1% (2003). The division of production operations has led to a decline in dairy animal husbandry profitability. In 2010 the purchase price of milk in the Małopolska mountain region was 92.04 Polish zloty (PLN) per 100 litres excluding VAT, compared to an average in Poland of PLN 106.58. Milk production is still lower than potential dairy product consumption, offering a possible area for development of economically viable dairy farms in Poland.

Sheep production is a "niche" market of the animal production sector with many opportunities for development (Photo 18, Plate CS12). Given the interest in healthy foods raised using traditional and environmentally-friendly practices, there has been a recent push to promote certified regional and traditional products. For example, 'oscypek', a hard cheese produced mainly in the Podhale and Tatra regions, once served as payment between farmers and senior shepherds (Photo 19, Plate CS13). Today, it is appreciated as a delicacy even on European tables. In 2007 and 2008, the regional products of the Tatra district, including sheep's milk cheeses, were added to the list of EU regional products. Another regional product obtained from mountain sheep is Podhale lamb meat. Its unique flavour is influenced by extensive husbandry practices where sheep flocks are fed by natural local feed harvested from unfertilised pastures with considerable botanical diversification and specific vegetation. Among these species are many plants with healing properties used in folk medicine. One way these products are promoted is through the European Fairs of Regional Products held in Zakopane. The objective is to popularise the European Union principles concerning the advancement and quality protection of food products and feature their diversity. Local flavours are an important aspect regional culture.

Changes in the statistics per category (areas, livestock, holdings), in the management and reasons for these changes

Agricultural lands covered about 50% of the total area of the Tatra district in the 1980s; now they make up just 30%. The share of arable land and permanent grasslands is 10% and 71% of agricultural land, respectively. Forests cover 67% of the total county area. Forest hectareage has increased by 2.5% since the 1980s as a result of both self-sowing of agriculturally abandoned land and intended afforestation. There has been a marked change in the proportion of meadows to pastures. In the 1960s, pastures accounted for 81% of permanent grassland area, but have gradually been overtaken by meadows; in 2005, they occupied only 10% of permanent grasslands. Animal breeding was most intensive at the beginning of the 1980s, with some 20 000 cows and over 40 000 sheep at the time. The number of livestock drastically decreased in the region, as in the rest of the country, in the years that followed. In 2005, livestock totalled 5 450 cows and 13 370 sheep. The number of pigs also declined, from 4 980 in 1980 to just 660 in 2005. Most farms in Poland are small: of 8000 farms, 70% farms are smaller than 2 ha and 34% are smaller than 1 ha. Only a few farms have more than 15 ha. The mean surface area is 2.3 ha per farm, and among those larger than 1 ha, the mean area is 3 ha. Despite small areas, the farms are very fragmented. A quarter of the farms use six or more separate plots, a situation that does not encourage agricultural development and progress in these areas (Jankowska-Huflejt, 2011). This factor, combined with generally low-intensity agriculture, makes labour inputs per unit of plant and animal production higher by 30–50% and 20–30%, respectively, than the inputs in lowland agriculture.

Cultural pasturage has been carried out on mountain pastures in the Tatra National Park and in the Gorce Mountains since 1980, when it was shown that the ban on grazing introduced in the 1960s had resulted in pastures being overgrown by cowberries, raspberries and trees. Cultural pasturage is subject to many conditions: senior shepherds must have a licence, the number of grazing sheep and cows is limited to prevent environmental degradation, and only local breeds of sheep and cows are allowed to graze with the assistance of Polish Tatra sheepdogs. Traditional tools and clothing are obligatory, as is the use of the local dialect by shepherds.

Habitat changes

Plant communities

About 1300 species of vascular plants are found in the Tatra Mountains; 200 of these are found only in Poland, 40 are endemic and never encountered elsewhere. Many are endangered species. There are about 700 species of bryophytes (80% of species in Poland), some 1 000 species of fungi and 870 species of lichens. Over 70% of endemic plants grow in the zones of dwarf mountain pine, mountain pasture and pikes or on swards, screes and gravel. Characteristic endemic and subendemic plants include carnation (*Dianthus nitidus*); Tatra larkspur (*Delphinium oxysepalum*); *Erigeron hungaricus*, *Erysimum wahlenbergii*, Tatra saxifraga (*Saxifraga perdurans*), (*Soldanella carpatica*), scurvy Tatra grass (*Cochlearia tatrae*) and tussock-grass (*Poa nobilis*). Some are endemic to Tatras: fescue (*Festuca aglochis*), *Erigeron hungaricus* and common lady's-mantle (*Alchemilla*). Only in the Tatras are such endemic plant associations such as *Festuca* (on limestone and dolomite), bent grass and saxifrage found in the zone of dwarf mountain pine and mountain pastures. There are numerous relict plants, the most well-known being mountain avens (*Dryas octopetala*) and reticulate willow (*Salix reticulata*), which grows on granite rock. In areas where snow cover is exceptionally long, the dwarf willow

(*Salix herbacea*) – one of the smallest species of willow, with a height of 5–8 cm – may be found. An interesting group of pale endemic plants can be encountered solely in the Western Carpathians, the origin of which dates from the Pliocene (i.e. previous glaciations). Tatra larkspur (*Delphinium oxysepalum*), saxifraga (*Saxifraga wahlenbergii*) and camation (*Dianthus nitidus*) are among the oldest species in the Tatras. Glades and Tatra valleys have distinct plant associations, which include mainly alpine timothy grass and numerous herbs, such as cornflower, mixed flower, meadow parsnip, caraway, and the rare sword lily (*Gladiolus imbricatus*). However, the most well-known protected species are edelweiss (*Leontopodium alpinum*), crocus (*Crocus* spp.), carline (*Carlina* spp.) and Swiss stone pine (*Pinus cembra*). In the alpine zone, the humus-rich soils are are overgrown with abundant grass associations such as the Tatra association of reed grass (*Calamagrostis*). Gentian (*Gentiana punctata*) also grows here; in limestone areas, the association of *Carpathian fescue* with Michale timothy grass and camation (*Dianthus speciosus*) may be also found. The association most common to rocky swards in the calcareous areas of the dwarf pine and mountain pasture zones is based on fescue. It includes, among others, French honeysuckle (*Hedysarum obscurum*), crazy weed (*Oxytropis*, a Carpathian endemic plant) and, rarely, tragacanth (*Astragalus* spp.). In the stratum transition zones, fescue, fiorin, buttercup (*Ranunculus* spp.) and bent grass (*Agrostis* spp.) can be found, as well as alpine lily and anemone.

The Tatra Mountains were included in the Natura 2000 network since the programme's start in Poland thanks to multitude of habitats and species from both of the EU directives. Not only was the Tatra National Park designated an International Biosphere Reserve by UNESCO in 1993, but it also meets the criteria for OSO and SOO natural areas. This is proof of its unique natural value.

Animal communities

The animal world of the Tatra Mountains is incredibly varied with distinct differences by zone. The area is inhabited by lowland species and mammals not encountered beyond the Tatra district. Lowland species include deer and roe deer (*Cervus elaphus* and *Capreolus capreolus*), hares (*Lepus europaeus*), foxes (*Vulpes vulpes*), wild boars (*Sus scrofa*), lynx (*Lynx lynx*) and brown bears (*Ursus arctos*), as well as many species of small rodents, shrews (*Sorex*) and chiropters (*Chiroptera*). These mammals live mostly within the subalpine forests. Only bears and lynx, dangerous predators in the Tatras which are becoming increasingly rare, and deer are found up to the dwarf mountain pine zone in summer. Some smaller rodents are found in the peak zone. Lynx and wild cats are protected species. The brown bear is the most impressive animal to be found in the forest zone. The Tatras are home to many pine martens, least weasels and ermines. Sites that are unique to Poland and priceless from a European perspective are those where isolated Tatra population are met (species from Appendix II of the Habitat Directive) including: Tatra chamois, alpine marmot (*Marmota marmota*), common vole (*Microtus arvalis*) and pine vole (*Pitymys*). Chamois, a symbol of the Tatra National Park, can be easily observed. Interesting cave chiropters may be observed: barbastelle (*Barbastella barbastellus*), pond bat (*Myotis dasycneme*), Bechstein's bat (*Myotis bechstein*) and brown bat (*Myotis myotis*).

- Tatra birds

Many common species nest in the lower forest zone, including the capercaillie (*Tetrao urogallus*), eagle owl (*Bubo bubo*), red kite (*Milvus milvus*), spotted eagle (*Aquila*),

goshawk (*Accipiter gentilis*), falcon (*Falco* spp.), buzzard (*Buteo buteo*) and some species of woodpecker (*Dendrocopos* spp.) and owls (*Asio* spp.). In the upper zones, there is a smaller range of fauna. Typical high-mountain species are rock pipit (*Anthus petrosus*) and alpine accentor (*Prunella collaris*), which live in the mountain pastures at the upper limit of the dwarf pine zone. In the peak zone, the very rare wallcreeper (*Tichodroma muraria*) nests, whereas the very rare golden eagle (*Aquila chrysaetos*) may be observed. The Tatra Mountains are one of the most important Polish refuges for the black grouse (*Lyrurus tetrix*), capercaillie (*Tetrao urogallus*), eagle owl (*Bubo bubo*), Tengmalm's owl (*Aegolius funereus*), pygmy owl (*Glaucidium passerinum*), three-toed woodpecker (*Picoides tridactylus*) and blue-throat (*Luscinia svecica*), species which are all mostly threatened by habitat changes. During the hatching period, the area is home to the country's only population of dotterels (*Eudromias morinellus*), alpine accentors (*Prunella collaris*) and wallcreepers (*Trichodroma muraria*) (species from Appendix I of the Bird Directive).

- Tatra amphibians and reptiles

Noteworthy amphibians and reptiles include the spotted salamander (*Salamandra salamandra*), newt (*Triturus* spp.) and common northern viper (*Vipera berus*). As is the case for all amphibian species, these species are threatened by the progressive disappearance of reproduction sites.

- Threats

The most significant threats are the fragmentation of refuges by the numerous tourist paths and the permanent disturbance of animals by massive numbers of tourists moving through the Tatra National Park. The exploration of caves during bats' hibernation period has had a negative impact on the animals.

Agricultural development and the importance of CAP support

The Tatra district as a whole is one of Poland's less favoured areas. Traditional sheep and cattle grazing is facing a strong recession. Urban pressures associated with the dynamic development of tourism in unfavourable to the needs of traditional sheep breeding. Changes in livestock are reflected in the structure of agricultural lands in this area. It remains to be seen whether current subsidies will suffice to stimulate animal breeding and proper grassland management, and whether they will provide satisfactory compensation for management in less favourable conditions. The productive functions of grasslands are being limited in favour of environmental functions stimulated by subsidies. A better solution would be to combine subsidies with the production of feed for ruminants and their stock. Indeed, permanent pastures must be grazed by cattle, sheep and horses, but grazing must be a tool for achieving ecological and not productive goals. Limits apply mainly to the period and frequency of grazing the same plants. Packages that aim for the "protection of endangered bird species and natural habitats" only control fertilisation and mowing and grazing intensity. In some cases, the limits contradict the general principles of grassland management. Moreover, one-sided grazing hinders the growth of certain tall grasses and facilitates that of typically low plants, mainly pasture weeds. Similarly, merely mowing over several years without normal animal production does not bring about the expected environmental benefits. Species composition changes and leads to the domination of tall grasses and weeds, which in turn alters the habitat conditions for protected animals. The requirement for first cutting to take place after 1 July is difficult for farmers, because it worsens fodder quality and therefore decreases income. Moreover, the delayed mowing facilitates the ripening and spreading of weed seeds.

Because many small farms are made up of highly fragmented plots, profits are low compared to the high organisational efforts and difficult work required. In general, Polish farms situated in zones of environmental limits had better indices (farm income, economic size, surface area in ha) and greater capital than farms outside these zones. Subsidies make up 42% of farmers' income (Niewęglowska, 2009). Profitability in terms of land use and labour measured according to the 2008 standard gross margin is better for lowland farm (PLN 2746.64/ha AL and PLN 45 483.72/person) than for mountain farms (PLN 2567.66/ha and PLN 20 877.52 /person), despite higher subsidies given to the latter (58.4% of the gross margin for mountain farms, compared to 34.0% for lowland farms) (Jankowska-Huflejt, Prokopowicz, 2011).

Agri-tourism, diversification and pluri-activities

Although just a small part of the vast Carpathian range, the Tatra Mountains are the highest and most valuable massif between the Alps and the Caucasus and feature a characteristic alpine landscape and typical climatic and plant cover zones. There are at least 17 bird species from Appendix I of the Bird Directive, and 31 habitat types, 15 animal species and seven plant species from Appendix II of the Habitat Directive. The presence of relicts and endemics makes the Tatra Mountains unique compared to other regions of the country. The mountains are characterised by diverse hydrology. The area has numerous springs, creeks and waterfalls, and there are more than 30 lakes and abundant ground waters. The Tatra Mountains feature 600 caves, and the corridors of the largest caves are 17 km long. The region is an excellent place for tourism, with a good tourist base and numerous mountain trails that are frequently visited by tourists in both summer and winter. Most of the Tatra Mountains on the Polish side are part of the Tatra National Park with strictly protected flora and fauna. The Tatra district is 42.46% urbanised, a high percentage considering its rural character. This is a result of a high housing density in the town of Zakopane and a large number of tourists through the region, with up to several million tourists a year. The county is one of the most attractive tourist regions in Poland, and offers a treasury of mountain tradition and culture with unique natural value. It is a wonderful place for mountain tourism and winter sports and the tourist season lasts practically year round. There are 300 km of signed trails of varying difficulty, 110 km of signed walking lanes, 150 chair and T-bar lifts, 30 bicycle lanes including five in the Tatra National Park, and some are turned into cross-country skiing runs in winter. There is an "Oscypek Trail" which leads to the 15 most popular shepherds' huts and "The Trail of Cultural Heritage" that lets tourists visit artists' studios and the workshops of local craftsmen who cultivate regional design and traditions. Folk craft is well developed and the goods made from wood, skin, wool, glass paintings and metal works are produced under the common trademark "Marka Tatrzańska" granted since 2008. Folk and mountain culture is vigorously cultivated through the organisation of many cultural events and activities by 59 different regional musical groups.

There has been a dynamic development of environmental infrastructure over the last 25 years. Sewer systems have been extended almost tenfold, from less than 80 km to 660 km. The work was mainly carried out in the second half of the 1990s but is still continuing. The number of inhabitants using the system increased twofold. Natural habitats found in the Tatra Mountains and listed in Appendix I of the Habitat Directive include the unique Polish segments of the mountain spruce-Arolla pine forests, eutric screes and one of the largest areas of siliceous screes.

Organic farming and quality product policy

Organic production in the mountain regions is an opportunity for the development of small- and medium-sized farms. The natural conditions, agricultural structure and social considerations are favourable, confirmed by an increasing number of organic farms. Meadows and pastures make up the largest share of UAA. In 2009 and 2010, they constituted over 42% of AA. Since 2004, after Poland joined the EU and subsidy payments were introduced, the number of organic farms almost doubled, and in 2009, they totalled 2197 households.

Most organic farms in this region are small farms and view this type of production as a chance for increased income and market survival. However, in the Tatra district, there is not much interest in organic agriculture. As of 2006, there were only 12 organic farms in the district, although as many as 301 agri-tourist farms were recorded. By comparison, by the end of 2007 there were 534 organic farms being operated in the Limanowa district of the same region. The number of organic product processing plants is an important indicator of organic production development. Unfortunately, by the end of 2008, there were only 13, though processing does widen the assortment of products and extends their shelf life compared to unprocessed agricultural products, contributing considerably to the development of organic agriculture. The “Marka Tatrzańska” trademark was developed as a strategy for the Tatra district. Its symbol provides a guarantee of product quality and goes hand-in-hand with preserving the traditions of the region, be they music, handmade objects or mountain architecture. It creates a recognisable product description, enabling customers to immediately identify the quality, composition and local production, and has an influence on the perception of the region.

Natura 2000 and other environmental policy tools

The Tatra Mountains, despite their relatively small range, constitute the highest and most valuable massif between the Alps and Caucasus and feature characteristic alpine landscapes and a typical pattern of climatic-vegetation zones. Because of the multitude of habitats and species from the lists of the EU Bird and Habitat Directives, they have been included in the Natura 2000 network (PLC 120001). The Tatras were also designated as UNESCO International Biosphere Reserve in 1993 when the programme began in Poland. The Natura 2000 programme in the Tatra district includes the northern part of the Polish Tatra Mountains, covers an area of 21 018 ha and is located entirely within the Tatra National Park. It includes both the birds and habitats of the Natura 2000 network. The Minister of the Environment established a special bird conservation area here in July 2004, and a special habitat conservation area was approved by the European Commission as an Area of Importance to the EU in January 2008. Currently, the Tatra district is a national leader with regards to respecting legally protected regions. However, as with any new programme, the Natura 2000 programme raises a series of questions and concerns about how objectives are chosen and their added value. Nevertheless, the introduction in all EU countries of a consistent ecological Natura 2000 network could be an important tool in the conservation of European wildlife. In addition to uniform environmental protection rules, legal standards and oversight, uniform financing mechanisms are also needed. Reliable information campaigns are necessary, and perhaps even the creation of a fund to compensate losses incurred by the local communities because of development difficulties in Natura 2000 areas. In Poland, network areas were often chosen without consulting the local authorities. Specific national requirements are more restrictive than the EU regulations. Compromises

will have to be made regarding policy decisions that would offer necessary protective functions that take into account local social and economic needs.

Prospects for the development of the area

Agricultural production in mountain areas is inherently less efficient and requires greater expenditure, making it a less competitive sector with low profit potential. Like for Alpine countries, agriculture in mountain areas must be regarded as a cornerstone

Table CS11. Changes in regional statistical – land use and the number of livestock animals in the Tatra district.

Year	Utilised Agricultural Area					Forest and woodlands	Other lands	Cattle	Pigs	Sheep	Horse
	Total	Arable land	Orchards	Mea-dows	Pastures						
						('000 ha)					
						('000 heads)					
1960	11.43	2.76	0.00	1.58	7.09	19.75	2.32	16.00	0.90	1.70	0.30
1970	11.82	4.73	0.00	1.97	5.13	19.78	1.90	16.00	0.90	1.80	0.30
1980	19.68	9.08	0.00	9.40	1.20	21.83	5.71	22.41	4.98	41.24	3.30
1990	19.58	8.76	0.01	9.69	1.13	21.83	5.80	18.83	2.31	35.69	2.27
2000	17.52	6.09	0.02	9.45	1.97	24.60	5.04	10.10	1.23	20.75	1.19
2005	15.32	1.52	0.02	13.02	0.76	25.31	6.53	5.45	0.66	13.37	0.57

Table CS12. Land use: basic data for Poland, the Małopolska region and the Tatra district in 2009 ('000 ha).

Land use	Poland	Małopolska	Tatra district*
Agricultural area (AA)	16 119.6	690.7	15.32
Arable lands - sown	12 105.8	433	1.52
Fallow (mostly arable lands)	499.71	31.1	
Orchards	338.51	15.9	0.017
Permanent meadows	2463.07	173.7	13.02
Permanent pastures	717.32	44.3	0.764
Permanent grasslands	3180.39	218	13.79
Cereals	6889.2		26.3
Maize – grains-corn	273.9		near 0
Forage crops in:	1069.3		near 0
Maize – green forage	419.8		near 0
Temporary grasslands	-		
Grasslands and meadows			
Rangelands			
Permanent crops			
Other areas (other agricultural lands)	494.87	389.9	
Forest and woodlands	9272.6	437.4	25.31

* 2005 rok

of land utilisation in order to preserve its natural and cultural value and existing infrastructure. It provides an opportunity, especially for organic farms, for achieving broader environmental and landscaping goals through the productive management of permanent grasslands. Due to the natural conditions, agricultural production for market should be based on milk-meat ruminant breeds and rely on self-produced fertilisers and forage from grasslands and fodder crops. Sheep breeding remains a niche market of animal production and has development potential.

But agriculture is often considered separate from the environment, a phenomenon that also occurs in mountain areas. Depending on the animal selection and animal herding technologies, the cost of feeding and maintaining cattle and sheep herds may significantly exceed production income. When production costs, including expenses to meet the Code of Good Agricultural Practice (2004) requirements, animal welfare, environmental protection, sanitary-veterinary, registration and tagging of animals, are all taken into account, small farmers abandon livestock production. It is carried out by people with rooted traditions without alternative possibilities of earning a living than from extensive livestock production. For small farms, this means a small herd of animals with less earning potential than other sources of income. There are some mountain villages where only one farmer keeps dairy cows and the nearest creamery is about 100 km away.

Nevertheless, mountain agriculture that includes a large proportion of permanent grasslands may provide incomes for many rural households who do not produce for the market. Their objectives will be food self-reliance, maintenance of social function, preservation and transfer of local tradition and culture.

While the highest parts of the mountains are experiencing increasing depopulation, a positive process is the development of a non-agricultural initiative. A possible source of development is rural tourism and related services, such as the organisation of events for tourists, catering and souvenir production. However, agricultural production is a basic and necessary function that needs to be supported, especially through the use of permanent grasslands. They provide important services for the cultural landscape, natural biodiversity, protection against erosion, impact on water circulation and quality, to name but a few.

Table CS13. The number, sum totals and average area of farms according to group size in 1996 and 2002 in the Tatra district.

Years	Total	< 1 ha	Above 1 ha							
			Total	1-2 ha	2-3 ha	3-5 ha	5-7 ha	7-10 ha	10-15 ha	≥ 15 ha
The number of farms according to area										
1996	7 756	2 089	5 667	2 595	1 369	1 205	338	118	32	10
2002	8 169	2 451	5 718	2 829	1 366	1 103	296	90	21	13
The total area of the farms according to size (ha)										
1996	19 880	1 153	18 727	4 589	4 173	5 591	2 327	1 120	439	488
2002	18 879	1 590	17 289	4 858	3 968	4 938	1 974	851	272	428
Average area of farms according to size (ha)										
	Total	< 1 ha	Total	1-5 ha				5-15 ha		≥ 15 ha
1996	2.6	0.6	3.3	2.8				8.0		48.8
2002	2.3	0.6	3.0	2.6				7.6		32.9

The **Polish FADN** (Farm Accountancy Data Network) does not include farms under 2 European size units (ESU); such farms in Poland account for over 66% of the total number of farms (holdings). The farms from this region show little economic strength. About 89% of them were classed with an economic magnitude below 8 ESU, and as many as 69% of the farms have fewer than 10 ha of utilised agricultural area at their disposal.

References

- http://ine.eko.org.pl/index_areas.php?rek=65, accessed on March 2013.
- http://www.tatry_geograficzna_charakterystyka_obszaru.html, accessed on March 2013.
- <http://www.tatrypolskie.com/>, accessed on March 2013.
- Jagła S., Kopec S., Kostuch R., 1971. Charakterystyka i możliwości produkcyjne ważniejszych zbiorowisk roślinnych górskich użytków zielonych. Wydaw, RRZD Wysoka-Wrocław.
- Jankowska-Huflejt H., Prokopowicz J., 2011. Porównanie wpływu czynników produkcyjno-ekonomicznych na rozwój górskich i nizinnych łąkarskich gospodarstw ekologicznych w latach 2004-2009. *Journal of Research and Applications in Agricultural Engineering*, 55 (3).
- Jankowska-Huflejt H., 2011. Obecna rola trwałych użytków zielonych w kształtowaniu i rozwoju obszarów wiejskich w Polsce na przykładzie górskich województw małopolskiego i podkarpackiego. Ekspertyza wykonana na zlecenie Ministerstwa Rolnictwa i Rozwoju Wsi (umowa nr 332/2011), maszynopis, s. 32. Kodeks Dobrej Praktyki Rolniczej, 2004.
- Komornicki T., Skiba S., 1996. Gleby. [w:] Przyroda Tatrzańskiego Parku Narodowego. Wyd. TPN, Kraków-Zakopane, s. 215-226.
- Kostrakiewicz L., 2003. Klimat. Godlewski B. [red., praca zbior.]: Zespół zbiorników wodnych Czorsztyn-Niedzica i Sromowce Wyżne im. G. Narutowicza. Monografia. Wyd. RZGW i IMiGW Kraków, s. 14-18.
- Mirek Z., Piękoś-Mirkowa H.: Kwiaty Tatr. Przewodnik kieszonkowy. Warszawa: MULTICO Oficyna Wyd., 2003.
- Niewęglowska G, 2009. Szanse i ograniczenia gospodarstw położonych w strefie ograniczeń środowiskowych na podstawie danych polskiego FADN. *Journal of Agribusiness and Rural Development*, 2 (12), 147-156.
- Niskonakładowa produkcja rolnicza z wykorzystaniem pasz z użytków zielonych w Karpatach Polskich, 2001. red. nauk. H. Jankowska-Huflejt, J. Zastawny, Wydaw. IMUZ.
- Produkcja upraw rolnych i ogrodniczych w 2009 r., GUS 2010
- Rocznik statystyczny rolnictwa, 2009, 2010. Statistical Yearbook of Agriculture, Warszawa, GUS.
- Twardy S., 1998. Pozatechniczne sposoby renowacji runi pastwisk górskich. Łąkarstwo w Polsce. Wyd. PTL, Poznań, 1, 185-194.
- Twardy S., 2008. Karpackie użytki rolne jako obszary o niekorzystnych warunkach gospodarowania.

Portugal

Authors: Carlos Aguiar (Escola Superior Agrária de Bragança, Bragança), I. Seita Coelho (Instituto Nacional de Investigação Agrária e Pescas, Lisbon)

Grasslands in Portugal encompass a wide range of heliophilous herbaceous vegetation usually dominated by Poaceae species. Poor permanent grasslands, such as rangelands, include numerous types of annual and perennial rough grazed grasslands. Meadows and the *Poa bulbosa*/*Trifolium subterraneum* Mediterranean swards have a more intensive management, are more productive and their biomass is more palatable and has a superior feed value compared to other grassland and rangeland types.

The oligotrophic poor annual grasslands (vegetation class *Helianthemetea*) inhabit clearings of pyrophytic low shrublands (e.g., *Cistus* and *Erica*) over leptosols, or recently disturbed nutrient poor soils. Their carrying capacity rarely exceeds

0.2 LU/ha and is correlated with late spring rains. Subnitrophilous Mediterranean grasslands (order *Thero-Brometalia*; e.g., *Bromus* sp.pl. or *Stipa capensis* communities) tend to occur in abandoned agricultural land or in intensively trampled and grazed areas, having a larger expression in dry to semi-arid territories. Mesoxerophilous oligotrophic poor perennial grasslands of *Agrostis* sp.pl. (classes *Nardetea* p.p. or *Stipo-Agrostietea castelanae*) prefer deep, well-drained, phosphorus deprived acid soils, and are likely to establish mosaics with *Ulex* sp.pl. or tall *Cytiseae* shrub communities. These rangelands are less diverse (although rich in endemics of *Armeria*, *Centaurea* sect. *Centaurea* and *Ornithogalum* species), more productive (ca. 0.6-0.7 LU/ha), and their biomass production peak is one to one and a half months after that of poor annual grasslands. Mosaics of mountain *Nardus stricta* (class *Nardetea* p.p.) grasslands with *Erica tetralix*/*Genista anglica* higrophilous heathlands—two Natura 2000 priority habitats—require moister soils. Less relevant for livestock grazing are the psammophilous communities of *Agrostis truncatula* subsp. pl. or *Corynephorus canescens*, the *Festuca* oligotrophic grasslands (e.g., *Festuca summilusitana*), and the deep-rooted tall grasslands of *Pseudarrhenatherum longifolium*, *Celtica* (*Stipa*) *gigantea*, *Stipa tenacissima* or *Hyparrhenia* sp.pl. calcicolous *Brachypodium phoenicooides* grasslands have a high nature conservation value even though they are uncommon in Portugal. With a few exceptions (e.g., orotemperate *Festuca henriquesii*/*Nardus stricta* grasslands) grazing can delay but not prevent secondary succession or the recurring use of fire, shrub shredding or soil disturbance to promote herbaceous vegetation in Portuguese rangelands.

Poa bulbosa/*Trifolium subterraneum* (class *Poetea bulbosae*) Mediterranean summer-dry, mat or cushion-like grazed swards attain their ecological optimum in meso-Mediterranean acid rock-derived soils, in the southern Portugal 'montado' parkland. Meadow vegetation (class *Molinio-Arrhenatheretea*) is extraordinarily diverse in Portugal. The water and nutrient requirements, both in Mediterranean and in temperate environments, relegates meadows to concave physiographies with wet, thick, mesoeutrophic regosols or fluvisols. The most valued meadows (alliances *Cynosurion* and *Arrhenatherion*) are grazed with cattle and cut for hay. Wet meadows (order *Molinietalia caeruleae*; e.g., *Juncus effusus*/*J. acutiflorus* communities), Mediterranean meadows (order *Holoschoenetalia vulgaris*; e.g., *Scirpoides holoschoenus* communities) and river bed summer green C3 (e.g., with *Festuca ampla*) and C4 grasslands (with *Cynodon dactylon* or *Paspalum* sp.pl.) are extensively grazed. The mountain meadows of northern and central Portugal and the *Poetea bulbosae* pastures of the montados are discussed in the presented case studies.

In twenty years, between 1989, just after EU adhesion, and the 2009 'Surveys on the Structure of Agricultural Holdings and on Agricultural Production Methods', there was a reduction in the number of agricultural holdings and in the UAA in Portugal of 50% and 8.7%, respectively. The foremost changes in land use were a drop in the arable land area (from 2 330 365 ha to 1 134 497 ha) and the expansion of permanent grasslands (from 736 651 ha to 1 721 578 ha; 19.5% of the area of continental Portugal in 2009), through the spreading of rangeland indigenous vegetation to formerly cultivated land. On the contrary, temporary grasslands lose relevance (from 73 920 to 31 652 ha). Poor permanent grasslands are now the principal component of the Portuguese UAA. Between 1989 and 2009 there was a slight increase in the number of cattle (2.1%; 1 430 285 animals in 2009), and a considerable decrease in the number of sheep (24.2%;

2 219 639 animals in 2009) and goats (41.6%; 420 711 animals in 2009). This decline in small ruminant numbers has led to greater extensification in rangeland grazing, mainly in the central and northern Portugal mountains. However, this trend cannot be generalised to the montado grasslands.

Grasslands of the wooded parkland of the South of Portugal, the 'montado'

Authors: Jorge Capelo, Carlos Aguiar, I. Seita Coelho

A specific type of grazed wooded parkland, named 'montado' in Portuguese and 'dehesa' in Spanish, attains, in Portugal, over a million hectares according to the 2006 Portuguese Forest Inventory. These are more or less sparsely wooded lands, either of live- or cork-oak (*Quercus rotundifolia* and *Q. suber*, respectively) (Photo 20, Plate CS14) where an extensive agricultural system with fallow land was established from the Middle Ages, with the largest historical expression since the 19th century. A fairly dense mono-specific tree-layer of oaks was inherited from a former dense natural forest that was either burnt or cleared, increasing the proportion of clearings typically to more than 40% of the area, among even-spaced trees. Tree species other than live- or cork-oaks were eliminated, as well as the shrub, climber and herb-layers. Successional evolution to a meta-stable zoo-anthropic permanent grassland developing underneath the canopy was carried out with sheep grazing, fitted in a cereal-based long and low soil disturbance rotation system. Even-spaced *Quercus* trees produced large quantities of acorns, between 400 and 700 (1000) kg/ha-1, that were used in pig fattening. In addition, such parklands were managed to produce forest products such as cork, charcoal (from tree pruning), game and more recently, wildlife and ecosystem services associated with biodiversity, leisure and aesthetics.

Live-oak parklands are more frequent in the southern half of Portugal, away from the sea, in dry (rainfall \leftarrow 500 mm per year) continental (meso-Mediterranean bioclimate) climate areas, either in silicate- (sandstone, granite and schist, excluding loose sands) or limestone-derived soils. Cork-oak parks mainly occur in the littoral half of southern Portugal (Figure CS5), which experiences higher rainfall (\rightarrow 500 mm per year) and a hotter and mild frost climate (thermo-Mediterranean and lower meso-Mediterranean bioclimates), in diversified substrata (including pleistocenic loose sands), except in limestone-derived soils. Both systems include high-scrub seral stages (e.g., *Quercus coccifera*, and *Arbutus unedo*) and low shrub stages dominated by *Cistus*, *Ulex* and/or *Erica*. The shrub vegetation is regularly eliminated, in general with heavy disk harrows, as it competes with pasture, increases the risk of wildfire and fosters barking (cork extraction) and tree pruning.

The actual grasslands of the montado system can be broadly categorised into four main types. Among the most frequent species in the Mediterranean *P. bulbosa*/*T. subterraneum* swards (class *Poetea bulbosae*) are *Astragalus cymbaearpos*, *Bellis annua* subsp. pl., *B. sylvestris*, *Carex divisa*, *Erodium botrys*, *Hypochaeris radicata*, *Leontodon tuberosus*, *Onobrychis humilis*, *Plantago serraria*, *Poa bulbosa*, *Ranunculus bullatus*, *Trifolium subterraneum* subsp. pl., *T. nigrescens*, *T. suffocatum* and *T. tomentosum*. In pre-industrial pastoral systems, *Poetea bulbosae* grasslands were grazed by large transhumant sheep flocks from the first autumn rains until the end of April or early May. This type of grassland has two biomass productivity maxima, in autumn and in spring, and can achieve 0.75 LU/ha.

Sown permanent *T. subterraneum* grasslands (Photo 21, Plate CS14) are an easy and increasingly important way to restore *Poetea bulbosae* grasslands that can double their original dry matter annual yields if a minimum P fertilisation is applied and management is improved. In case of sowing, other legume species are often used in combination with *T. subterraneum*: *T. michelianum*, *T. vesiculosum*, *T. resupinatum*, *Medicago polymorpha*, *Biserrula pelecinus* and *Ornithopus compressus*. The late-phenology *Agrostis castellana*/*Festuca ampla* (class *Stipo-Agrostietea castellanae*) meadows, adapted to deep soils or wet depressions, are another grassland type dependent on grazing. In general, grasslands with a larger perennial plants component (e.g., *Poa*, *Agrostis* or *Festuca*) have a higher expression in more continental areas (meso-Mediterranean bioclimate). The third grassland type is the oligotrophic poor annual grasslands (class *Helianthemetea guttati*) with *Anthyllis lotoides*, *Brachypodium distachyon*, *Coronilla repanda*, *Trifolium angustifolium*, *T. boconnei*, *T. cherleri*, *Plantago belardii*, *Tuberaria guttata*, *Ornithopus compressus*, *O. pinnatus* and *Vulpia* sp. pl. Annual grasslands do not rely on grazing and emerge as a result of tillage, often after nitrogen leaching after a single rainy season. The fourth, and nowadays the most common type of grassland, are semi-nitrogen-prone annual plant communities (order *Thero-Brometalia*). These are, in fact, 'weed' grass dominated communities that consume the mineral nitrogen briefly available after crop harvest, introduced in the system via organic soil matter mineralisation after soil disturbance, or by chemical fertilisers and outsourcing feed. Its most common species are *Bromus tectorum*, *B. rigidus*, *B. matritensis*, *Holcus setigulumis* and *Vulpia alopecurus*.

A. Holm oak distribution

B. Cork oak distribution

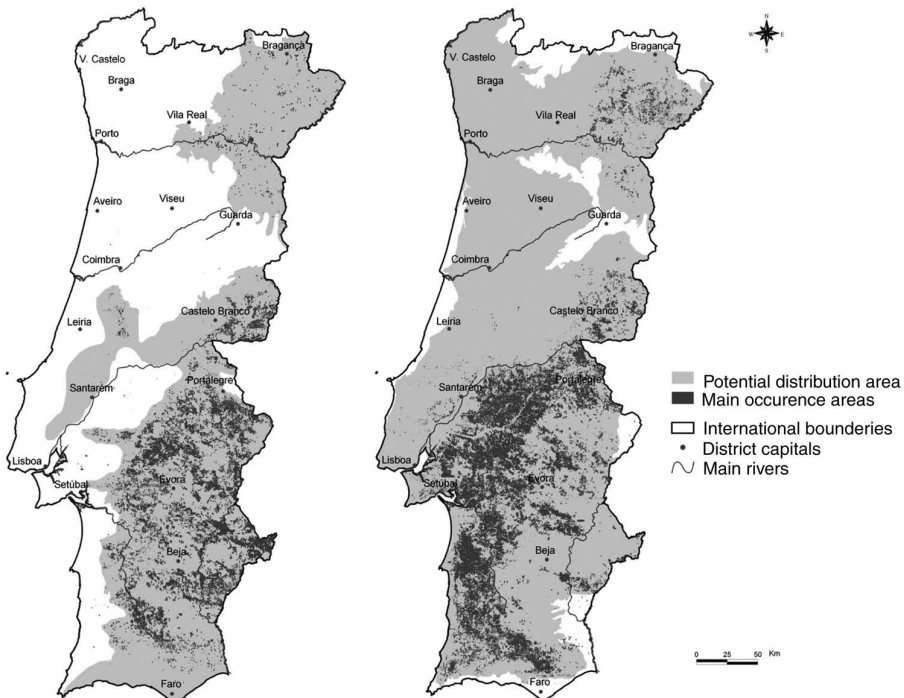

Figure CS5. Distribution of (A) live-oak (*Quercus rotundifolia*) and cork-oak (*Q. suber*) (B) in Continental Portugal.

Source: Capelo J., Catry F. (In: J. Sande Silva, ed., Os Montados, Árvores e Florestas de Portugal III, 2007).

In the traditional montado, the superposition of two grazing types occurs. The 'montanheira' consists of the Alentejana pig breed fattening with *Quercus* acorns (Photo 22, Plate CS15). Expansion peaked in the 1960s, vanishing completely ten years later from montado landscapes due the arrival of the African Swine Fever in 1957 and to a sudden reduction in pig fat demand. The montanheira is returning to the montado, this time focused on the production of quality products: it already embraces four Protected Designation of Origin and 19 sausage Protected Geographical Indication labels. With the artificial price policies launched at the end of the 19th century, the wheat campaign of 1929–1937 and agriculture mechanisation, there was a huge retreat of montado grasslands that compelled ovine grazing of cereal stubs and fallows. The intensification of cereal rotations caused significant soil disturbance and led to area reduction of the most valuable grassland types, particularly of the mosaics of *Poa bulbosa*/*Trifolium subterraneum* swards and *Agrostis castellana*/*Festuca ampla* grasslands, and to a banalisation of the flora. After four decades of retreat, there was a noteworthy rise in sheep numbers all over Portugal with the adhesion to the EU in 1985. Cereals, on the contrary, underwent a severe decline. The 2002 CAP reform reduced sheep subsidies that have gradually been substituted by cattle subsidies for montado grasslands use. Cattle have a high and negative impact on montado grasslands structure through soil compaction and the nutrient inputs coming from imported feed. Soil compaction promotes temporary wet soil plants (e.g., *Chaetopogon fasciculatus*) and compacted soil plants (e.g., *Plantago coronopus*); nutrient inputs benefit nitrophilous species, among them thistles (e.g., *Galactites tomentosa*, *Onopordum* sp.pl. or *Carduus* sp.pl.) and the low-nutritive value grass *Stipa capensis*.

Montado systems define a specific type of habitat in the Natura 2000 Network: habitat *6310. More than half of the Portuguese bird populations considered important to natural conservation such as the black-winged kite (*Elanus caeruleus*), the booted eagle (*Aquila pennata*), the great spotted cuckoo (*Clamator glandarius*) and the Iberian imperial eagle (*Aquila adalberti*)—a vulnerable Iberian and Northern Africa endemic species—depend on the montado. Agri-environmental measures had an encouraging effect on the conservation of this ecosystem. In fact, the 'Extensive Pasture Systems' support, between 1994 and 1992, covered 1582 land owners and 143 509 ha of montado, 64.5% of the measure's support targeted areas in continental Portugal. The live-oak montados support measure reached 1394 landowners and 76 623 ha over the same period. Unfortunately, agri-environmental measures lost importance after the PAC reform of 2002, due to decoupling, payment delays and increased eligibility restrictions.

Mountain grasslands

Authors: Carlos Aguiar, Jaime Pires, Maria Ester Fernández Nuñez, Orlando Rodrigues

For practical purposes, the 700 m contour line is frequently used to differentiate lowlands from mountains in Continental Portugal (Figure CS6). Above 700 m, the climatophilous natural potential forests of *Quercus robur*, *Q. pyrenaica* and/or *Betula celtiberica* are essentially devoid of termophilous plants, and the traditional vineyards/olive tree/wheat Mediterranean agriculture systems are replaced by chestnut/meadows/potato/rye mountain agriculture systems. Defined in this way, mountains occupy 11% of the Portugal continental land surface concentrated in the northern half of the country. With a few exceptions, Portuguese mountains are granitic or schist peneplain stretches dissected by river erosion, pushed up in the Pleistocene, with a temperate climate in the north-west, and a Mediterranean climate towards the south and east. These physiographic characteristics create various grassland spaces: rivers



Figure CS6. Areas above 700 masl in continental Portugal.

headwaters, convex mountain tops and steep valley slopes colonised by oligotrophic rangelands (described above) that, because of extensive grazing and fire promoted lixiviation, were until recently the main source of plant nutrients in valley or gentle slope plateaus meso-eutrophic meadows and agriculture areas.

Mountain meadows are cut once a year, from late June at lower altitudes, to the beginning of August in mountain tops at 1400 m. Traditional hay has a low crude protein content (6%–8%) because farmers have a preference for late cutting dates in order to reduce rain risks during haymaking. After cutting, haymaking meadows are usually grazed with cattle until early spring (middle or end of April). In fertile soils near farmers' homes, recurrent eutrophic summer irrigated meadows are found, which are cut five to eight times a year for green fodder. Meadow management also comprises manual weed uprooting, water channel clearing, wall repair and hedge tree pruning to keep away nitrophilous shade tolerant unpalatable plants (e.g., *Bromus sterilis* and several *Galium*, *Geranium* and *Torilis* species). Meadows are fertilised by farmyard manure or mineral fertilisers. Irrigation via contour ditches irrigation or wild flooding is used to push productive *Molinio-Arrhenatheretea* grasslands up-slope to the detriment of meso-xerophilous poor grasslands. Winter irrigation known as 'rega de lima' is a common practice designed to reduce late frost effects and start vegetation growth earlier in the season. Annual meadow dry matter yields are highly variable, from about 4 t DM/ha/year in dry *Agrostis castellana/Gaudinia fragilis* meadows, to 14 t DM/ha/year in eutrophic summer irrigated meadows, with 8–10 t DM/ha/year as a reference. Most meadow biomass is fed to beef cattle. In traditional mountain agricultural systems, sheep and goats graze in rangelands.

Meadows are mosaics of herbaceous perennial vegetation (Photo 23, Plate CS15). In the low hemeroby parkland landscapes of the temperate north-western Portugal mountains, these mosaics can include megaforbic shade tolerant communities (class *Galio-Urticetea*), a *Festuca rothmaleri* meadow (alliance *Arrhenatherion*), a mesotrophic species rich meadow dominated by *Holcus lanatus* (alliance *Cynosurion cristati*), a rush community (order

Molinietalia) and a fen (class *Scheuchzerio-Caricetea fuscae*). Relevant regional vascular endemics find their ecological optimum in these mosaics—e.g., *Ceratocarpus claviculata* subsp. *picta* and the superb *Paradisea lusitanica*—together with other uncommon species at the national scale such as *Arnica montana* subsp. *atlantica* or *Polygonum bistorta*. In Mediterranean mountains, the most diverse meadow mosaics may include a dry *Agrostis castellana*/*Gaudinia fragilis* grassland (class *Stipo-Agrostietea castellanae*), an *Arrhenatherum elatius* subsp. *bulbosum* meadow (alliance *Arrhenatherion*), a mesotrophic species rich *Holcus lanatus* meadow (alliance *Cynosurion cristati*), one or two rush communities (order *Molinietalia*), and an annual (class *Cardamino hirsutae-Geranietea purpurei*) and at least two perennial (class *Galio-Urticetea*) shade tolerant communities. Threatened species such as *Carex pallescens*, *Euphrasia hirtella*, *Dactylorhiza purpurea* or *Vicia onobrichioides* can only be found in these complex Mediterranean meadows. Prey (e.g., roe deer and wild boar) of the largest Iberian wolf population forage in far-off meadows in the north-eastern Portugal mountain areas. These complex mountain meadows are also an essential habitat component of more than 50% of the rarest Portuguese diurnal butterflies, among them *Brenthis ino*, *Lycaena hippothoe*, *Melitaea diamina*, *Pyrgus alveus*, *P. serratulae*, and the myrmecophilous *Maculinea alcon*. Five of the fifteen accepted Portuguese cattle breeds have their origin in mountainous regions with large meadow areas.

Dairy and meat sectors linked with mountain meadows have remained quite stable in recent years, although there is a tendency towards declining cattle numbers and dairy cattle being replaced by beef cattle. Simultaneously, over the last ten years (1999–2009) the number of holdings with cattle decreased by about 51%, implying a larger average size of the production units. Production systems have also changed. The waning of rye and potato crop importance following EU adhesion freed up agricultural land for feed crops. Triticale, Italian ryegrass and oat/vetch mixtures are widely cultivated on today's mountain farms. In pre-industrial agricultural systems the number of cattle per holding depended on the available meadow area; today it depends on the existing arable land area. Consequently, remote meadows are being abandoned or planted with trees (e.g., hybrid poplars). Many meadows located close to villages were converted to arable cropping or intensified through irrigation and mineral nutrient use. Unfortunately, for methodological reasons this intensification–extensification trend is difficult to grasp in Portuguese agricultural statistics.

Meadow abandonment is preceded by careless management, recognisable by the invasion of undesirable species like *Brachypodium rupestre*, *Mentha suaveolens* or nitrophilous shade tolerant species. Sometimes farmers try to control these species with fire and ploughing, leading to impoverished meadow flora. Shrub and tree encroachment is common and occurs very rapidly after abandonment, although is slower in nutrient poor meadows with a high continuous cover of mat forming grasses (e.g., *Agrostis* × *fouilladei*). Intensification reduces phytocenotic and species diversity. While competitors (e.g., *Dactylis glomerata* s.l., *Holcus lanatus*, *Lolium perenne* or *Ranunculus repens*) gain dominance, megaphorbs reliant on late cutting dates and low stature, annual, oligotrophic, xerophilic, fen, wet meadows and fringe plants, and their communities, become less common or extinct.

The EU support under the 'Programme for the Rural Development of Mainland Portugal (2007–2013)', the 'Management of the Integrated Territorial Interventions' measure, and the agri-environmental 'support action for the maintenance of high nature value meadows' are key policy instruments in meadow conservation in Portugal. However, current meadow abandonment trends cannot be overcome without tax policies that encourage an agriculture soil market and greater awareness of the social costs of land abandonment.

Romania

Author: Veronica Sărățeanu, Banat's University of Agricultural Sciences and Veterinary Medicine, Timișoara

Romanian Carpathian grasslands

Grasslands in Romania make up about 33% of total AA. Romanian Carpathian grasslands cover about 2.8 million ha (57% AA) of the total Romanian grassland surface area, which totals approx. 4.9 million ha (3.4 million ha of grazed pastures and 1.5 million ha of hay meadows). These grasslands are an important natural resource for livestock production systems. Figure CS8 shows the grassland surface distribution in the 41 counties (plus the municipality of Bucharest) in 2009. The greatest surface covered by grasslands is in the Carpathian Mountain arch and the Transylvanian Plateau, where every county has between 100 000 and 350 000 ha of grassland when both grazed pastures and hay meadows are taken into account.

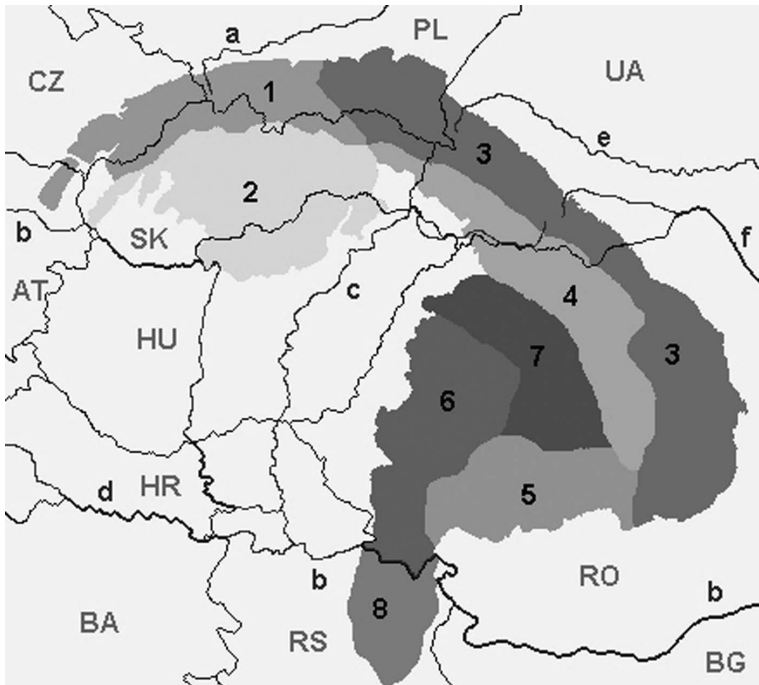

Figure CS7. Map of the main divisions of the Carpathian Mountains.

Divisions of the Carpathians, in black numbers: 1: Outer Western Carpathians; 2: Inner Western Carpathians; 3: Outer Eastern Carpathians; 4: Inner Eastern Carpathians; 5: Southern Carpathians; 6: Western Romanian Carpathians; 7: Transylvanian Plateau; 8: Serbian Carpathians.

Rivers, in lower case letters: a: Vistula; b: Danube; c: Tisza; d: Sava; e: Dniester; f: Prut.

Countries (ISO 3166-1 alpha-2 codes), in upper case letters: CZ: Czech Republic; PL: Poland; UA: Ukraine; AT: Austria; SK: Slovakia; HU: Hungary; RO: Romania; HR: Croatia; BA: Bosnia and Herzegovina; RS: Serbia; BG: Bulgaria.

Source: <http://upload.wikimedia.org/wikipedia/commons/0/00/Mapcarpat2.png>, accessed on 15.09.2011.

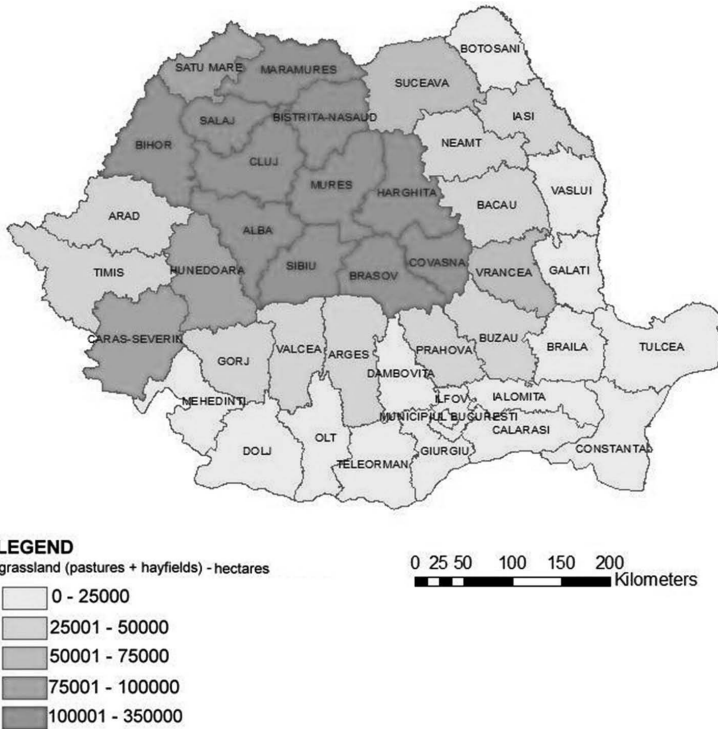

Figure CS8. Distribution of grasslands in the 41 Romanian counties (2009 statistical data).

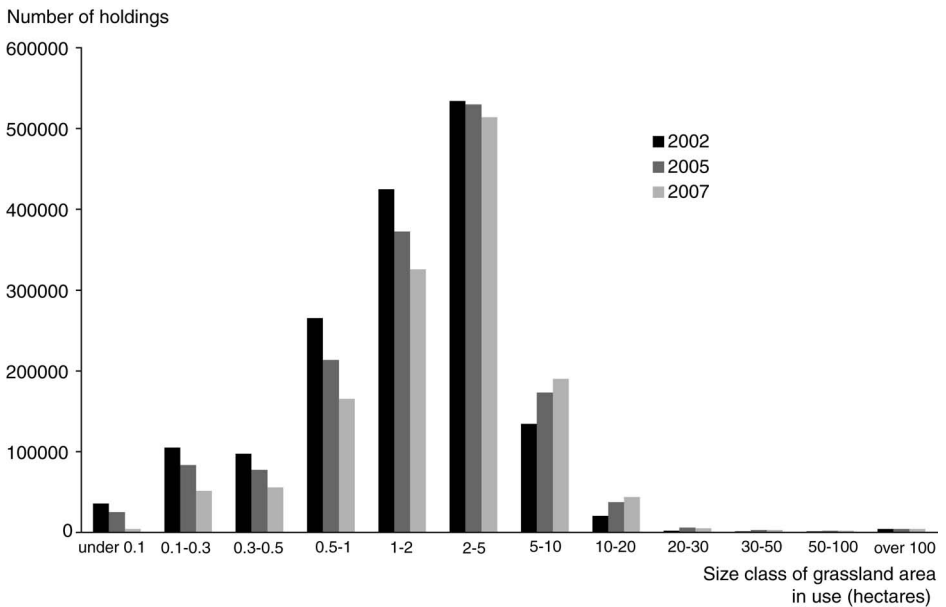

Figure CS9. Size classes of grassland holdings in Romania in 2002, 2005 and 2007.

Source: Romanian Statistical Year Book, 2009.

Ownership situation

Almost all grasslands in mountain areas are under private ownership and regulated through land property titles. The surfaces under state ownership are small and usually rented for long periods of time or used in common by the local communities, with the animals' owners paying a fee for their use to the municipality. The situation of grassland ownership has changed over the last two decades. In just a few years after the end of the communist period, almost half of the entire surface of grasslands was owned by the state, private ownership accounting for 2.47 Mha out of a total of 4.77 Mha of grasslands in 1991. This was because many mountain grasslands were never included in collective farms; for this reason, their management has remained unchanged for centuries. This explains why, in the area of the Romanian Carpathians, grasslands were and still are managed in an extensive manner and chemical fertilisers or over-sowing were almost never applied. The 'Land Fund Law 18/1991' regulated the recovery of land ownership, but in fact its application has been delayed in most situations for at least ten years because of problems with land property titles. Most grassland holdings have 2–5 ha (Figure CS9).

Situation of grazing animals

Grasslands are strongly influenced by the specific management practices of every region and by natural factors, both of which have a considerable influence on plant biodiversity. One of the most important factors that influences the use intensity of grasslands is linked to changes in livestock numbers (Figure CS10).

The higher number of sheep during years under socialism was mainly applicable to the collective farms, most of which had low production. After the socialist farms were dissolved, the animals were given back to people in variable numbers at community levels. In most cases, the new livestock owners received a few sheep and had no idea how to manage them, or had jobs in factories and so most animals were slaughtered for meat. In about ten years, sheep numbers declined significantly to almost half of the initial levels. Changes are similar in the case of cattle for the same reason.

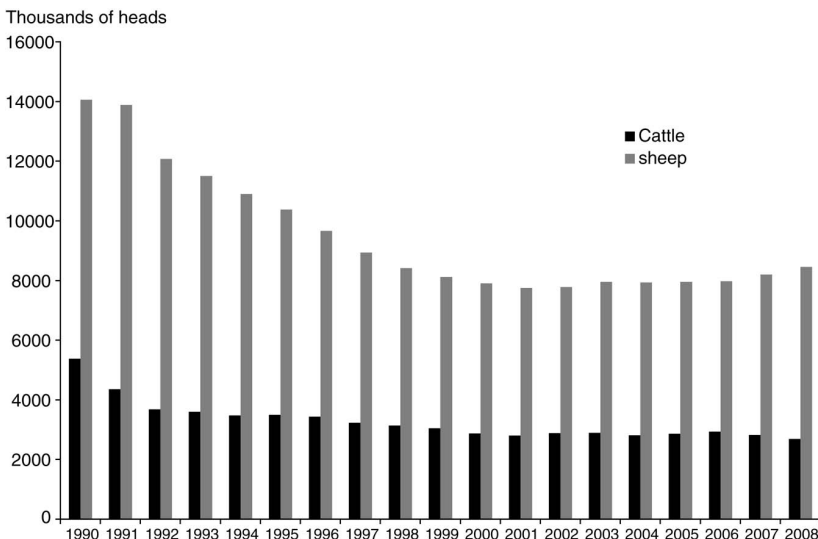

Figure CS10. Changes in livestock numbers in Romania between 1990 and 2008.

Source: *Romanian Statistical Year Book*, 2009.

It is estimated that permanent grasslands provide at least 60% of the forage necessary for cattle and 80% for sheep (Photo 24, Plate CS16) (Marușca *et al.*, 2010). The main complements used for feeding of grazing livestock are: lucerne hay, maize silage, cereals and other concentrates.

Biodiversity

Among the 783 natural and semi-natural habitats described in Romania, about 60% are permanent grasslands. The total number of plant species identified in these habitats is about 3700, of which 70% are permanent grassland vegetation. These numbers are very high compared to other European grassland figures but, among these species, 74 are extinct, 485 are threatened by extinction, 200 are vulnerable, 23 are declared as natural monuments and 1235 are rare species (Marușca *et al.*, 2010).

Most grassland surfaces in the Romanian Carpathians are eligible for the High Nature Value grassland payments, but often landowners are not properly informed of this opportunity. There are also deficiencies in evaluation criteria because many were defined in other countries and are not always adapted to local conditions. For example, in the Polish Carpathians, many grasslands are over-sown with *Alopecurus pratensis*, but in the Romanian Carpathians this species is always native.

Biodiversity can be properly managed by farmers, both directly and indirectly. They can have a direct effect on biodiversity by exploiting the land in a sustainable manner to produce high quality products, while they can indirectly manage it by developing additional activities such as tourism for their products and the landscape. This is a complex approach because farmers must know how to maintain biodiversity at a high level and use it correctly. The benefits of well-managed biodiversity can be both environmental and socio-economic.

Management

An average of 120 grazing days is reported for the Romanian Carpathians in the highlands and 150 days in the lowlands. Not all sheep flocks and cattle herds are moved upland from the lowlands. Today, they are generally sedentary, with farmers preferring to keep flocks in the lowland area year round because they feel it is more profitable. In the past, small flocks were herded by one shepherd. The grazing calendar in the mountain area was the following: animals started grazing in the forest area of the mountain in May and were kept there for two to three weeks (until snow begin melting in the highlands), after which they were taken up in the alpine area until early September. They were then brought down again to the forest area for two to three weeks, when grazing stopped at the end of September.

As a consequence of the abandonment of transhumance, lowland pastures are now overgrazed and most mountain pastures are used only occasionally or are even abandoned. This determines the major differences between stocking rates at different altitudes. Grassland vegetation and production are highly variable. Predators are sometimes a problem in the mountains, mainly brown bears (*Ursus arctos*; Romania has the largest population in Europe) and wolves (*Canis lupus*).

Grassland socio-economic role

One serious problem caused by the application of the Land Fund Law is the fragmentation of the land into small plots. Often, grassland owners have few or no animals and are not

interested in managing their land or keeping the grassland unused, in many cases for long periods of time. Land fragmentation affects traditional pastoral practices such as transhumance: it is now difficult to move animals from one pasture to another without crossing other people's properties.

Transhumance is just one of many ancient customs in traditional pastoral life. In most areas of the Romanian Carpathians, a century-old custom takes place at the end of May. Shepherds get together with the animal owners to negotiate the future income from milk production of every sheep before they take the flocks to the highlands. The event is a holiday for the entire community (Ștefan, 2011). The end of the grazing period in the highlands is also celebrated in late September with holidays, festivities and market days.

Today, when still practised, transhumance is usually limited to distances of 30–80 km from the depression and sub-mountain areas to the mountain grasslands; the animals are fed during the cold season with hay and small quantities of cereals and concentrates. Classic transhumance refers to greater distances (100–500 km) from the plains to the mountains; its purpose is to efficiently use all available forage resources of mountain grasslands, stubble fields, etc. Traditional transhumance is still used by farmers from the sub-mountain area who own very large flocks (Pădeanu, 2007).

Policy

The national grazing policy and regulations need to be improved. Changes are necessary to adapt the regulations to the situation that occurred after the fall of the communist regime. One of the most important objectives is to implement measures for owners who are receiving subsidies but not using the land.

With regards to the present situation, there are crucial points to consider to improving the socio-economic status of farmers. One idea is to encourage farmers to work together and re-establish the transhumance practice. Such collaboration could be a solution for moving flocks over different properties. There is also a need to encourage young people to stay in mountain areas and to maintain the local sheep breeding traditions, as most mountain areas have an ageing population. Another important future strategy could be the development of proper support tools for the promotion of farmers' products on the internal and external markets, helping them to sell their products in a profitable manner. Today many farmers are producing just enough for their household subsistence.

European regulations, which are applicable in Romania, stipulate that sheep and goats are allowed to be moved by foot or transported in agricultural vehicles over distances up to 50 km. For distances greater than 50 km, the vehicles need to be specially equipped, which is costly. Without consistent financial support, many farmers will give up transhumance and animal breeding, thereby leading to greater numbers of people leaving the mountain area and causing serious economic losses (Pădeanu, 2007).

References

- Legea 18/1991, Legea fondului funciar, http://www.cdep.ro/pls/legis/legis_pck.htp_act?ida=1290, accessed on 16.08.2011.
- Legea nr. 72/2002, Legea zootehniei, http://www.dreptonline.ro/legislatie/lege_zootehniei.php, accessed on 16.08.2011.
- Marușca T., Mocanu V., Cardașol V., Hermenean I., Blaj V.A., Oprea G., Tod M.A., 2010. Ghid de producere ecologică a furajelor de pajști montane, Editura Universității Transilvania, Brașov, 176 pp.

Măsura Plăți de Agro-Mediu – PNDR, <http://www.fonduri-structurale-europene.ro/pndr/masura-plati-agromediu.html>, accessed on 16.08.2011.

Pădeanu I., 2007. Transhumanța la răscruce de drumuri, *Ferma nr. 2* (46), <http://www.revista-ferma.ro/articole-traditie/transhumanta-la-rascruce-de-drumuri.html>, accessed on 16.08.2011.

Romanian Statistical Year Book 2009, <http://www.insse.ro/cms/rw/pages/anuarstatistic2009.en.do>, accessed on 16.08.2011.

Ștefan D., 2011. Boteitul oilor, ediția a X-a, <http://evenimentefocsani.blogspot.com/2011/05/boteitul-oilor-editia-x.html>, accessed on 16.08.2011.

Grasslands in the economic supply chain: related industries

Grasslands and the associated animal production are parts of a large supply chain, which includes both input industries and animal product industries (Huyghe *et al.*, 2005). The input industries may be separated into three categories related to fertilisers, machinery and seed (covered in more detail in the following section).

The fertiliser production sector does not focus specially on grasslands, because the same products are used as on annual grain crops. From 1950 to 1980, this industry actively sought to increase the mean level of nitrogen and phosphorous fertilisation, thereby significantly contributing to a huge surge in biomass production, especially in terms of grassland biomass harvested to produce silage. This input was a very efficient resource in launching the Forage Revolution. This is no longer the case, as the mean nitrogen fertilisation level has started to decrease (Huyghe *et al.*, 2009).

The machinery industries are very efficient in developing new technologies that transform forage production and harvest or animal husbandry. These technologies are reducing the workload for the farmers and make their activity more secure, especially by reducing the variability of forage quality among years and seasons (Vignau-Loustau and Huyghe, 2008; Huyghe and Delaby, 2013). Among these technologies, it is worth mentioning several examples that had the most substantial impacts:

– Hay cutting machines with conditioners. Various types of conditioners have been developed to take into account the distinct characteristics of different species to preserve their quality. As tractor power has increased, conditioners have gotten bigger, thereby impacting the acreage that can be handled on a farm.

– Round balers. Round balers were first patented in the mid-1970s and rapidly replaced the machines producing small square bales. Farmers were able to reduce both their workload when making hay and the difficulty of the work. Moreover, the same machines can now be used to produce haylage when round bales of semi-dried forage (45%–55% DM) are wrapped into plastic foils. Round-baled silage is the main mode of forage conservation in Nordic countries such as Sweden.

– Barn drying. The barn drying process makes it possible to considerably improve the quality of the forage because all plant organs are preserved. Forage is harvested rapidly after cutting, thereby shortening exposure time to weather conditions. This greatly reduces the risk of quality deterioration, a main expectation of farmers. However, equipment cost is high. As a result, it is mainly used where prices fetched for the animal products is very high (PDO cheese, for instance).

– Milking robots. The milking robot has had a strong impact on grassland and grassland management. Because this technology implies continuous access of the cows to the robot, it is difficult, although not impossible, to combine with grazing. Consequently, these machines are only used where dairy cows are fed with maize silage or grass silage based diets.

►► Forage seed industry

History of grass breeding and seed production in Europe

Fallows were used for soil fertility restoration in Europe from the start of farming between 5000 and 6000 years ago (Ammerman and Cavalli-Sforza, 1971; Zohary, 1986). From the 16th century, fallows began to be improved by farmers sowing mixtures of grasses and legumes instead of letting wild plants colonise the soil after a cropping period. These two types of plants provided better forage than that from natural regeneration, and the legumes improved soil fertility thanks to symbiotic fixation of nitrogen with bacteria of the genus *Rhizobium*. Several grass species, including perennial ryegrass (*Lolium perenne*) and red clover (*Trifolium pratense*), were often used in these mixtures in north-western Europe and notably in Belgium and the United Kingdom, where this technique developed strongly (Peeters, 2004). The rotation based on the succession of crops and forage plants was called ‘ley farming’ (Stapledon and Davies, 1948).

The English name ‘timothy’ for *Phleum pratense* comes from Timothy Hanson who introduced it to Maryland (USA) in 1720. Seeds of that species were thereafter exported to England in 1760 under the name of timothy (Leafe, 1988). Most seeds used until the 18th century were collected in the wild. In grazed pastures, the use of *Lolium perenne* spread in England around 1650 along with other grasses used to create swards of various life spans, but mainly to establish permanent pastures. *Lolium perenne* was not immediately recognised as the most valuable species. Seeds of meadow foxtail (*Alopecurus pratensis*), crested dog’s tail (*Cynosurus cristatus*), sweet vernal-grass (*Anthoxanthum odoratum*) and even annual meadow grass (*Poa annua*) were used in sowings. Towards the end of the 18th century, production of *Lolium perenne* seed was widespread in England. Nevertheless, systematic grass breeding did not really begin until 1919, when R.G. Stapleton and T.J. Jenkin began to work with several species including *Lolium perenne* (Leafe, 1988) in Great Britain. This was the start of forage plant breeding that gave rise to the forage seed industry.

The forage seed industry has been around for a very long time, both in Europe and the world. The procedure of seed control and certification was first developed for certain grassland species in Switzerland. Indeed, thanks to the efforts and the pioneering work of Friedrich Gottlieb Stebler, and following a federal decision on March 1st 1877, a seed control unit was created and started its activities on January 1st 1878 (Lehmann, 2003). This was then rapidly implemented in France and Hungary. The reason for this push was the fact that most seeds were of pure quality, as they were mainly collected from hay. Quality progressed rapidly as a result of

the regulations because specialised productions were planted. The seed market has been organised and structured. Surprisingly, the International Seed Federation, which was established in 1924, worked solely with forage species until 1950. It now covers all species.

Forage species are the second largest sector of the international market, just after maize hybrids. The main reasons for this are:

- There are only a few regions in the world where climatic conditions are suitable for obtaining high seed yield. Western Europe is one of these regions for forage grasses, lucerne and clovers; the north-western United States for grasses and lucerne, which is also produced in Canada; and New Zealand for white clover.
- Forage seeds are light but with high value per kg.
- Forage seeds can be stored during low periods (several years) with no loss in germination rate, if the seeds have a high initial quality.

Seed production and seed markets of the various species in Europe

Seed production may be understood through the process of seed certification. Certification occurs through the control of seed fields and of the seed after processing and cleaning.

Seeds are characterised according to species; in some cases, it is also possible to identify the varieties. Many species are listed as forage seeds, as evident in the European Directive 66/401/EEC. However, this list also includes protein crops such as lupins or annual forage legumes such as vetches. These species were not taken into account in the present analysis. The list also includes species that are used for turf. When turf is the predominant use, as is the case for fine-leaved fescues (sheep fescue, *Festuca ovina*; red fescues, *Festuca rubra*, *Festuca heterophylla*), the production of these species was not taken into account.

Characterisation is more difficult for dual-purpose species, such as tall fescue or perennial ryegrass. For those species, the only way to know the final use is by identifying the varieties. This was not possible in the present study at the European scale. Consequently, the data presented below for tall fescue (*Festuca arundinacea*) and perennial ryegrass (*Lolium perenne*) seed production includes both grassland and turf uses.

The share of production of the different countries is presented in Figure 45 for the year 2007. Forage grass and legume seed production is mainly located in five countries: Denmark, France, Germany, the Netherlands and Italy. The Czech Republic and Poland follow. Seed production is closely related to environmental conditions; optimum conditions for seed production differ from those for biomass production. As a consequence, it is necessary to identify the various grass and legumes, as optimum conditions are different, especially between perennial grasses and lucerne.

Grass seeds are predominant as a whole and their production is especially high in Denmark, Germany, the Netherlands and France. Production of forage legume seeds occurs mainly in Italy and France, where the main species is lucerne.

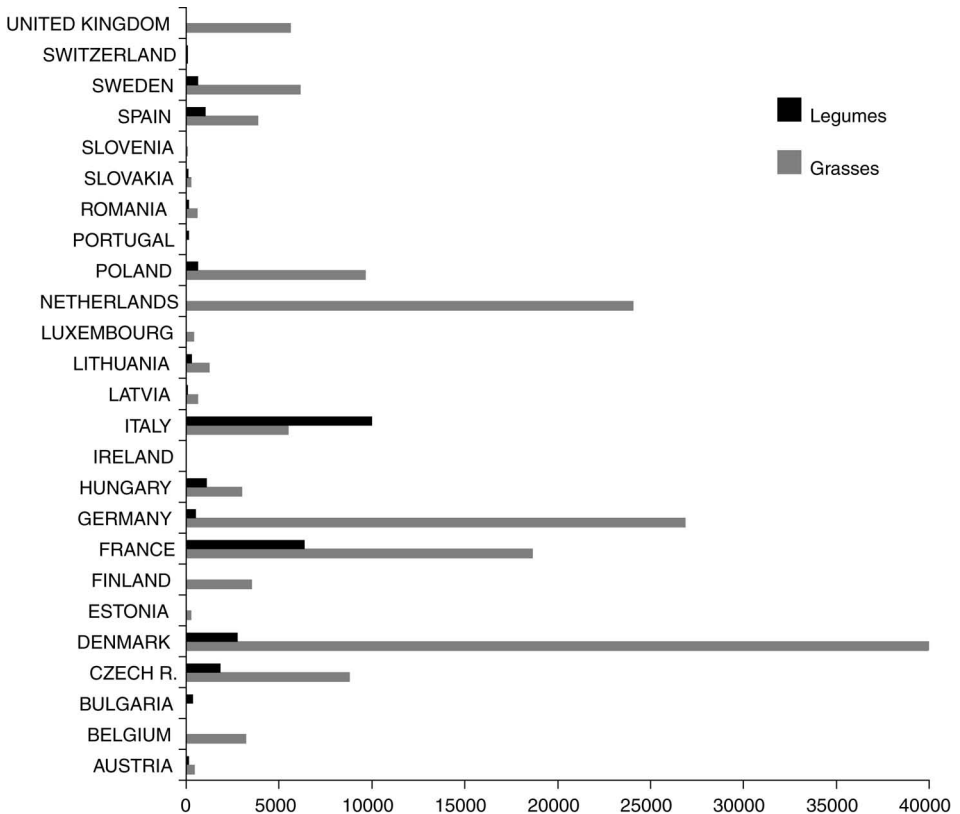

Figure 45. Mean annual seed production in the various countries in Europe between 2007 and 2009 (in t). The value of grass seed production for Denmark is 101 300 t.

Source: National Certification Agencies.

Seed production is mainly performed in specialised fields with adapted agronomic practices. As a consequence, it is susceptible to economic and environmental factors. As most productions are planted under contracts with seed industries, the acreage of forage seed production depends on new temporary grasslands being sowed. Farmers choose which long-lived species, such as tall fescue, to sow based on the state of their pastures and the need for renovation. Short-lived species such as Italian ryegrass, which is mainly used for producing grass silage stocks, are sown when stocks at the farm level are low. Variations in Italian ryegrass seed market are more pronounced than for any other species. Seed industries monitor these decisions closely and anticipate their need for seeds by signing new contracts.

But seed production also depends on the environmental conditions—particularly water supply—at the time of ear emergence as well as seed maturation in the northern countries.

As Figure 46 shows, seed production varied considerably over the last ten years (from 164 000 t to 234 000 t); this was especially true for grasses contributing 92% to total production.

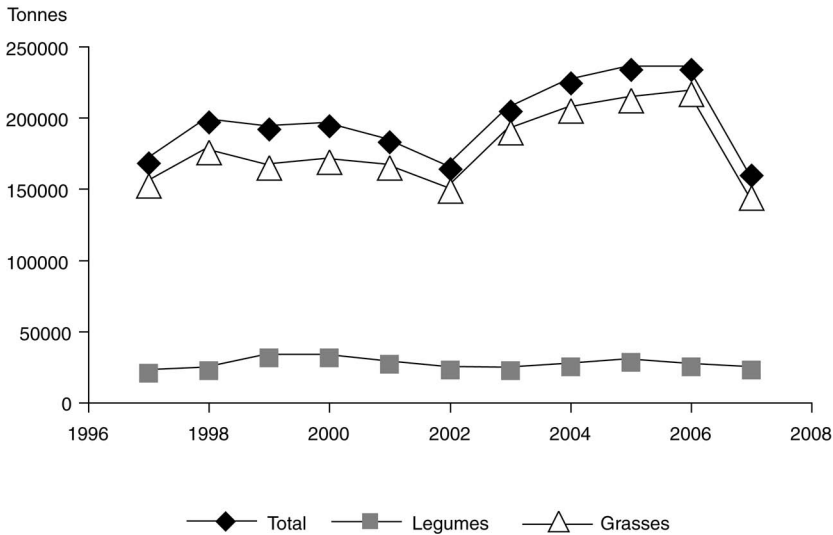

Figure 46. Variation in seed production of grasses and forage legumes over ten years in the EU-27.

At the species level, it appears that over the 1997–2007 period, perennial ryegrass was the most important species, with an average of 47% of total production in the EU-27 (Figure 47, Plate 16). However, this is a biased result, since it was impossible to separate uses for forage and turf for this species. It is followed by Italian ryegrass and meadow grass (*Poa pratensis*). The seed production and market of tall fescue and cocksfoot are still limited, although these species are well adapted to dry summers and have attracted interest in Europe due to climate change.

Among legumes, lucerne (*Medicago sativa*) is by far the main production. Environmental conditions, as well as the landscape structure, are well suited to lucerne seed production. Indeed, this species requires insect pollination for flower triggering. In the European environments, wild pollinators—mainly wild bees—nesting in the non-perturbed soils of field margins are able to ensure pollination. In other environments, such as in the north-western United States and western Canada (Alberta) where a large quantity of lucerne seeds are produced, pollinators—mainly megachiles—must be supplied, at considerable cost. As a consequence, the European landscape structure provides a source of competitiveness for lucerne seed production.

Based on the data from the National Certification agencies, most of the seed production stay on the European markets, especially for grasses, with a considerable amount of trade amongst countries. Indeed, for grasses, the average annual production between 2007 and 2009 was 206 680 t, while average annual imports were only 34 480 t, partly balanced by annual average exports of 14 400 t. For legumes, these values were 27 700 t, 11 155 t and 6 005 t, respectively.

Seed market and share of species

Analysis of seed sales is very informative in assessing the composition of temporary grasslands and forage crops.

Long-term data are available for France and are presented in Figure 48. These data show contrasting patterns. Italian ryegrass is a species with low persistency that is able to produce large amounts of good quality biomass over short periods, especially under high nitrogen fertilisation. It is mainly used for silage production. The seed market for this species was particularly important in the 1970s when high nitrogen fertilisation was used in the French production systems and abundant silage was produced. This market progressively declined. In recent years, it has moved in cycles. This is explained by the fact that this species is sown when stocks of silage and hay get too low on farms, such as after dry summers.

The perennial ryegrass market followed a completely different pattern, rising steadily between 1970 and 1990. This increase was first due to the expansion of perennial ryegrass as a turf species and the fact that it was not possible to separate the turf and forage uses in this graph. The second explanation for this development was the increasing use of perennial ryegrass for sowing temporary grasslands in mixture with white clover to be used for grazing. Towards the end of the period, there is a slight decrease, which can be explained by the upturn in other species, such as cocksfoot and tall fescue, both perennial grass species being well suited for sowing grasslands with a high productivity and tolerant to drought stress.

The small seeded forage legume species belong to the genera *Medicago*, *Onobrychis* and *Trifolium*. They are used to sow temporary grasslands (lucerne, white clover or red clover), but also short-living stands (*Trifolium alexandrinum* or *incarnatum*). The market for these species dropped steadily from the beginning of the period covered

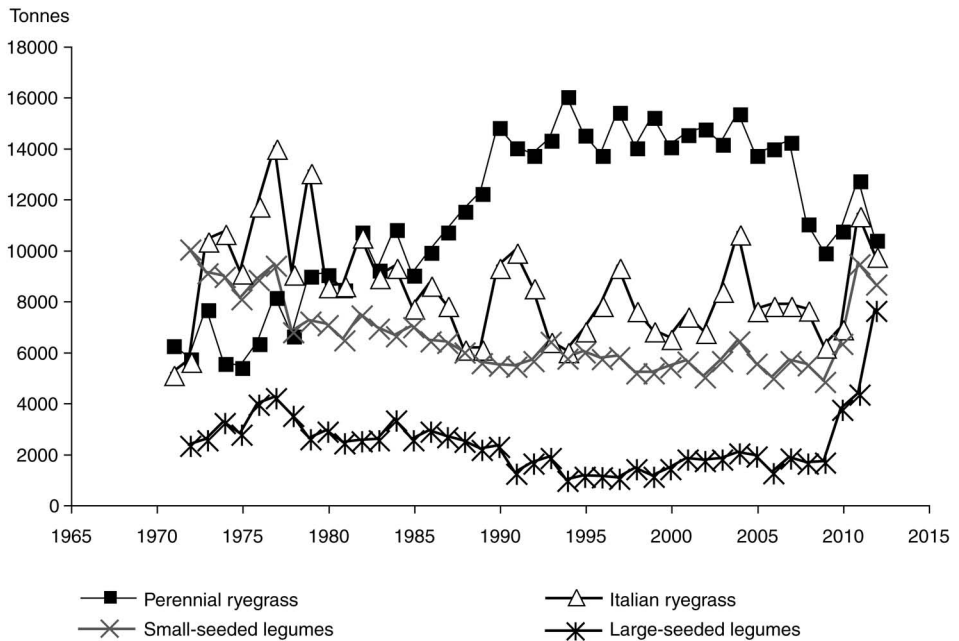

Figure 48. Annual seed sales of perennial ryegrass, Italian ryegrass, small-seeded forage legumes and large-seeded forage legumes.

Source: GNIS-SOC.

here, was mainly a consequence of reduced acreage of lucerne and red clover in pure stands. In recent years, the trend is very different because these forage legumes are increasingly being used in mixtures with grasses, either for temporary grasslands or annual crops.

The same pattern may be seen for large-seeded forage legumes. These are mainly fodder peas and vetches. The surge in the recent years is a result of their considerable use in the production of forage in mixture with cereals, such as rye, triticale and oat, making it possible to produce abundant biomass with little or no nitrogen fertilisation.

From this graph, forage legume acreage can be estimated based on the mean seed rate of the various species when sown in pure stands, and on the persistency of the various species. For instance, lucerne is sown at 20 kg of seeds per ha and has a mean persistency of 3 years, while fodder vetch is sown at a rate of 60 kg/ha and has a persistency of 1 year.

The legume equivalent acreage appears to be very high, reaching nearly 2 million ha, and greatly exceeds the acreage of artificial grasslands (i.e., pure stands of lucerne; Figure 49, Plate 16). White clover accounts for a majority of this legume acreage. The estimated legume equivalent acreage tended to decrease, but as for the seed market, recent years show a very positive trend.

Seed mixtures

The decision of the European Commission 2004/371/EC of 20 April 2004 outlined 'the conditions for the production, the inspection of the production and labelling of seed mixtures intended for use as fodder plants in addition to the conditions set out in Directive 66/401/EEC. This decision established requirements for the firms producing mixtures, information regarding declaration of the mixtures to the national authorities, conditions of inspections and labelling.

This decision provides guidelines for a well-established practice where certain grassland seeds are marketed as mixtures. In practice, a vast majority of temporary grasslands shows swards with a broad botanical composition. Most of the mixtures are made on farms, while a given amount is produced by companies before marketing.'

In France, where local legislation permits this practice, the quantity of seeds marketed as mixtures has progressively increased and presently accounts for 14% seed markets. This percentage is much higher in Switzerland where it contributes a total of 95-97% (Albert Gyoin, pers. comm.).

Marketing of mixtures has a long tradition in Switzerland, where one of the first publications related to grassland mixtures was published by Stebler (1895). Currently, an extensive set of standard mixtures was established and is regularly tested. The recommended lists of mixtures are published by the Swiss Grassland Society and the mixtures are marketed with an ADCF-approved label. The seed quality must fulfil the requirements for control and seed certification. The last release was published by Mosimann and Frick (2008).

The mean number of components in mixtures was fairly stable through the early 1900s, but has increased in the last thirty years. The major cause of change is related to the dominant species in the marketed mixtures (Table 48). This table shows that mixtures containing legumes are being used more frequently. Perennial ryegrass, a species well adapted to fertile environments and predominantly used for grazing, now makes up a greater proportion of mixtures, while species suited to less fertile environments, such as tall oat grass and golden oat grass, are less present in the mixtures.

Table 48. Proportion of mixtures including the different forage species in Switzerland.

Species	1900 ^a	1955 ^b	1980 ^c	2008 ^d
White clover (<i>Trifolium repens</i>)	25	32	35	53
Tall oat grass (<i>Arrhenatherum elatius</i>)	35	26	5	11
Golden oat grass (<i>Trisetum flavescens</i>)	50	26	10	21
Perennial ryegrass (<i>Lolium perenne</i>)	15	37	25	53

^a Stebler, 1895; ^b Frey, 1955; ^c Anonymous, 1979; ^d Suter *et al.*, 2004.

The seed mixtures were developed depending on the expected duration of the swards and on the environmental conditions, considering especially whether they are relevant to perennial ryegrass. The exploitation regime has then to be adapted to every mixture and the subsequent production and feed quality can then be estimated.

Seed control and variety testing

A significant breeding effort is made by many breeding companies in Europe, which are among the largest and most efficient worldwide. Major firms include DLF-Trifolium (DK), Barenbrug (NL), Eurograss (D), RAGT (F). There are also public research institutes running practical breeding programs and releasing varieties such as ILVO (B), IBERS (UK), Teagasc (IR), Poznan University (PL) or Agroscope (CH).

Once registered, varieties are multiplied and sold by a large number of companies. This involves a very large number of farmers who are specialised in seed production, which requires special skills and experience.

Species with a compulsory registration in a national catalogue are listed in the Directive 66/401/EEC. It lists more than forty grass or legume species, showing the wide range of diversity that is available for sowing temporary grasslands with legume swards.

To be registered, varieties must pass distinctness, uniformity and stability (DUS) tests as set out by the International Union for the Protection of New Varieties of Plants (UPOV⁵) ensuring that the material is new compared to varieties already listed, notoriously known or under test. They must also fulfil Value for Cultivation

5. <http://www.upov.int/portal/index.html.en>

Use (VCU) testing requirements. These tests take into account production characteristics, agronomic traits (phenology, frost and disease resistance, lodging susceptibility), and for some species feeding value. The balance between the various components is debated at the national level in each member state and is estimated through a special trial network. This makes it possible to consider the soil and climate conditions of the country. These tests and trials are run under the auspices of the national examination offices. Once listed in the European catalogue, a variety may be sold and cultivated throughout the EU-27.

Before commercialisation, the seeds are certified. This means that they are controlled for variety identity and for germination rate. Even if species may show small variations, they are usually expected to achieve a germination rate above 85%.

► Interview with Beat Boller, Chairman of Eucarpia and senior forage breeder at Agroscope, Switzerland

Beat Boller graduated from ETH Zurich, where he received a degree in Agronomy and a PhD in plant sciences on white clover physiology. After completing a postdoc at Minnesota University with Gary Heichel, Boller was appointed as a researcher at ETH to work on nitrogen fixation of white and red clover, using ^{15}N -based study to estimate the N fixation of legumes in grass mixtures. Seven years later, he became a plant breeder with Agroscope (1989), with the goal of breeding legumes and grasses. More than fifty varieties were listed from his breeding program in Switzerland and Europe. He is strongly committed to Eucarpia, the European Association for Research on Plant Breeding which promotes knowledge exchange between plant breeders. He organised a Eucarpia conference and he is presently the chairman of the Forage and Amenity Species division. He is also member Eucarpia's executive committee.



1- In your opinion, how important are grasslands and forage crops for agriculture in your country and in Europe—both now and in the future—with regard to sustainable agriculture?

Good question. First, a Swiss perspective, where grasslands are of major importance as they contribute 75% of farmland. I expect that grasslands will even increase at the expense of grain crops and that Switzerland will continue to produce grassland-based animal products.

Forage-based milk production is very important in Switzerland and uses less concentrate than in neighbouring countries. Grassland forage contributes about 80% to 85% of dairy products today and I hope this figure will reach 90% in the near future. Most consumers care about this type of production mode, but some do not. Farmers clearly play the key role in the general importance of grasslands in Switzerland. But consumers are very interested in local and national products, and a similar situation is found for wine.

Grasslands are recognised as important for ecosystem services provided by agriculture and as such play a key role in sustainable agriculture. Switzerland implemented a true environmental policy with support to grasslands. Switzerland has a lot of mixed farms, with temporary grasslands and leys included in rotational systems.

Presently, in some European countries, we see a transition from concentrate-based dairy production to a more forage-based and grasslands-based milk production. Ireland is a very good example of such a situation. However, in other regions, there is a trend to keep cows in barns and to feed them with silage. And this leads to competition for farmland use.

In the EU, but much less so in Switzerland, a strong emphasis is put on using intensively managed grasslands and forage crops to produce energy through anaerobic fermentation. The European trend can be seen as positive as grasslands have less impact on the environment (leaching, biodiversity). But, on the other hand, it is known that human population demand will increase and will compete with energy production.

2- What is the role of plant breeding and the plant breeding and seed companies in the implementation of such multi-functional grasslands?

The aim of plant breeding is to provide varieties with a good adaptation. Plant breeders and seed companies exploit the potential of new varieties and species diversity to get the best out of grasslands.

In forage-based milk and meat production, we need excellent varieties with reliable performance. The chemical composition traits will play an increasing role, to reduce the need of concentrates.

The fact that they are perennial species, but seed propagated, is a peculiarity that slows down the annual rate of improvement, but does not compromise the relevance of plant breeders' work, as the yield is not the only trait of relevance.

The improvement of biomass yield is difficult due to the difficulty of assessing it on an individual plant basis. But, disease resistance or chemical composition may be assessed on an individual plant basis without bias.

In comparison with other cultivated species, the close relationship with the wild populations and landraces makes it possible to easily introduce new material and genetic diversity in our breeding programs.

3- What will be the key selection objectives and selection criteria for forage crop breeding in the next ten years? How would you balance biomass production, feeding value and adaptation?

All three are important, but adaptation is the prerequisite to the other two. In the context of climate change, this will become increasingly important and could be a limiting factor. Feeding value is more important than biomass production, especially

in species which are adapted to a changing climate, such as cocksfoot, which is well adapted to dry summers, but with a feeding value that is lagging behind. It is also the case for red clover, which is of lower quality than white clover.

A key trait is a rapid regrowth after cutting for good production and good adaptation to intensive management and intensive grazing.

Another important criterion is disease resistance, as new diseases are emerging due to climate change, such as crown rust in ryegrass in Ireland where it was absent. Anthracnose in red clover is becoming increasingly widespread and this led us to change varieties under multiplication and marketing.

4- Can you tell us more about the range of species under breeding? What are the breeding objectives and their importance in future agricultural systems for legumes, secondary grasses and herbs (like chicory)?

We have seen a lot of recent developments in molecular technologies which seem to be mature for use in actual breeding. But this requires a huge investment to create knowledge and genomic resources. This will advocate for reducing the number of species under breeding and to focus our breeding to a limited number of target species.

However, we see limits in the adaptation in the selected species. For instance, perennial ryegrass shows poor adaptability to drier conditions and its range of adaptation will be difficult to extend. So, we need to exploit the difference among species if we want to provide grasslands with the best adapted varieties. There will still be room for minor grasses and legumes, especially for adaptation to marginal conditions, where grasslands may be a keystone for sustainable farming.

For herbs, it is still up in the air whether they can provide some benefits and if they can really be a complement to grass and legumes. As legumes fix nitrogen in excess, they complement grasses very well and their chemical composition is very complementary too. It is not yet clear whether herbs are relevant to intensive farming and have to be considered in breeding. However, the role of herbs is obvious in natural grasslands where legumes sometimes show poor persistency.

5- How do you take into account long-term objectives such as climate change (mitigation or quality traits of particular interest to climate change such as water soluble carbohydrates)?

Our present breeding work will be available twenty years from now. It is thus very difficult to anticipate the needs. In my daily work, I have in mind the long-term objectives and I am also aware of uncertainty. The only relevant option is to keep the objectives very broad and open. We will have to cope with drier summers and more varying climatic conditions. We will need more adaptation and we must continue working on more robust varieties and species, with lower requirements. It falls on publicly funded research to keep on working on robust species even if they are not of the highest economic importance today. But I am optimistic that breeding can keep pace with the rhythm of climatic change.

Mixtures are without a doubt a way to achieve better adaptation, making the best of the growing conditions and being able to adapt to harsher conditions thanks to the range of species present in the mixtures. Complementarity also exists for adaptation.

The Swiss experience shows the importance of investigating the capability of species and varieties to produce good mixtures that behave well under most conditions, at

least those that can be anticipated for grass swards. This requires the understanding of species behaviour and the effect of seed dosage in mixtures.

6- What are your views on the preservation of genetic diversity of forage species and what could be the role of grasslands for an in situ preservation?

Genetic diversity in permanent grasslands is very broad and can be exploited. But, we do not know whether this true for all regions—this has to be investigated. Although most European grasslands have been established by humans and exist thanks to human management, they have a lot of genetic diversity. It is difficult to set of border between long-term temporary grasslands and permanent ones.

The diversity is large, not always well described. There are a lot of accessions, but partly endangered because of their poor characterisation. In situ preservation has a major role in genetic diversity preservation. Acknowledging this role would justify efforts to preserve them.

Common Agricultural Policy: brief history, structure and influence on grasslands

» History

The Common Agricultural Policy (CAP) was effectively implemented in 1962. It found its roots in the Treaty of Rome of 1957 (notably Articles 38 to 47). At that time, its goal was to increase agricultural productivity, ensuring a fair standard of living for the agricultural community, stable markets and an affordable supply of food at a reasonable price for European consumers (Article 39 of the Treaty). It also aimed to achieve strategic food self-sufficiency for the EU. The CAP offered subsidies and guaranteed prices to farmers. These measures developed into a comprehensive framework of ‘Common Market Organisations’ (CMOs) for several crop and livestock products. The EU’s internal market was protected on the basis of ‘community preference’ through taxes at the border of the common market.

In the 1960s and 1970s, the CAP provided financial assistance for farm restructuring, for example by supporting farm investment. Three directives were adopted in 1972 on farm modernisation, measures to encourage the cessation of farming and on socio-economic guidance and occupational training for farmers. Farms could become bigger and invest in machinery and equipment. Farmers could improve their management and technology skills. The programme of early retirement favoured the increase of farm sizes. Subsidies and guaranteed prices constituted very efficient incentives for farmers to produce and intensify their production. In 1975, specific support measures were designed for less favoured areas (LFAs). They aimed to maintain farming in mountain and other marginal areas where production conditions were difficult. This was a boost to grassland-based systems since these regions are predominantly livestock production regions and grassland the dominant land use.

The CAP was very successful at reaching its goals. In the early 1980s, the EU had to deal with almost permanent surpluses of the major farm commodities. Some of which were exported with the help of subsidies; a large part of these surpluses had to be stored within the EU. These measures were expensive, distorted some world markets and became unpopular in the society. In order to reducing surpluses, production limits were implemented in some sectors, notably for dairy production by the adoption of milk quotas in 1984.

In 1992, an important reform was undertaken, the so-called ‘MacSharry Reform’. It involved a dramatic reduction of prices to bring them closer to global market prices. Price support payments were cut for beef, cereals and milk, but cuts for milk were delayed until 2006. It was intended to compensate farmers’ income loss by paying direct aid on a surface or per animal head basis. Several rural development measures were introduced, notably to encourage environmentally sound farming through the agri-environmental scheme. Agri-environmental measures (AEM) were designed to encourage farmers to protect and improve the environment on their farms. Farmers receive a payment in return for a service. Their commitment to improving the environment was only rewarded if it went beyond the application of usual ‘Good Agricultural and Environmental Practices’ (GAEP). This mechanism was called the ‘cross-compliance’ principle.

In 1999, the new principle of CAP functioning was reinforced through the adoption of the so-called ‘Agenda 2000’ reforms. These reforms aimed to encourage farmers to adapt to the market and improved incentives to farms in an environmentally sensitive way. They added a major new element—a comprehensive rural development policy—spurring many rural initiatives while also helping farmers to diversify, improve their product marketing and restructure their businesses if needed. The CAP’s budget was also capped to keep expenses in check. The diversification of activities in rural areas such as the development and marketing of high quality products, rural tourism, environmental conservation or cultural heritage supplemented agricultural income and opened up new prospects for rural life.

In 2002/03, a review of the situation in the arable, beef and dairy sectors was undertaken during the mid-term review of the Agenda 2000 application. In 2003, a further fundamental reform was agreed to on this basis. This reform represented a complete change in the way the EU supported its agricultural sector. The different elements of the reform entered into force in 2004 and 2005.

The negotiations at the World Trade Organisation (WTO) and the EU enlargement had important effects on the CAP reform. Due to the relatively high levels of income support for European farmers and the protection of the EU market, the EU tried to change the paradigm of CAP spending to avoid criticism from its WTO partners. Reforms were also motivated by a desire to cut CAP expenses prior to enlargement to new Member States. A gradual introduction of the direct CAP payments was introduced to farmers in the candidate countries. This started at 25% in 2004, rising to 100% by 2013.

The CAP reform of 2003 sought to make European agriculture more market-oriented and give a stronger focus to environmental protection. It introduced four new principles into the previous systems: decoupling, cross-compliance under the first pillar, modulation and partial re-nationalisation. On the basis of the decoupling principle, farmers were given a single payment instead of the separate payments they had

received for cattle, sheep, cereals and many other crops. Payments were based on historical production levels. Some Member States chose to maintain certain 'coupled' payments, for instance for the suckling cow, goat and sheep premiums. The modulation consisted in reducing direct payments to large farms to finance the new rural development policy (transfer of budget from the first to the second pillar of the CAP). The rate of modulation increased by 3% a year up to a maximum of 20%. Cross-compliance required that farmers respect environmental, food safety, animal and plant health and animal welfare standards, as well as the obligation to keep all farmland in 'Good Agricultural and Environmental Conditions' (GAEC), including the obligation to maintain the proportion of permanent grassland in the AA (see below).

A 'Health Check' of the CAP examined the effect of this reform and proposed new solutions for the future. The EU agriculture ministers reached a political agreement in 2008. The main conclusions were the abolishment of arable set-aside, a gradual increase in milk quotas leading up to their abolition in 2015 and the conversion of market intervention into a safety net. Market intervention (EU purchase of excess supply) is used as a safety net when food prices are unsustainably low. Modulation was increased to transfer direct payments to farmers to the Rural Development Fund. This was justified by the need to face new challenges and opportunities including climate change, better water management, the conservation of biodiversity, and the production of green energy. Member States were also able to assist farmers producing milk; beef, goat and sheep meat; and rice in disadvantaged regions or vulnerable types of farming, as well as to support risk management measures such as insurance schemes for natural disasters and mutual funds for animal diseases. Investment aid for young farmers under Rural Development was increased.

The CAP spending in the EU budget has dropped from a peak of nearly 70% in the 1970s to 42% in 2010 and 39% in 2013. For the 2007–2013 period, the total budget of the EU-27 for agriculture amounts to €362 855 million (41.9% of the total EU-27 budget), €293 105 million of which is allocated to the policy on markets and direct aid (Pillar 1; 81% of total CAP expenditure) and €69 750 million for the Rural Development Policy (Pillar 2; 19% of total CAP expenditure) (Kowalkowska, 2005; Massot, 2008).

At the EU-27 level, the highest expenses in Pillar 2 are agri-environmental payments (23%; axis 2), modernisation of agricultural holdings (11%; axis 1), and payments for less favoured areas (7% in mountain areas and 7% in other areas; axis 2) (European Union, 2009).

►► The two pillars of the CAP

The CAP budget is split into two pillars. Pillar 1 includes market and income support measures. They cover direct payments to farmers (income support) and market subsidies such as buying products for public storage, surplus disposal schemes and export subsidies. Income support is by far the most important policy of the CAP (56% of total CAP expenditure in 2006). Total Pillar 1 expenditure represents about 80% (80.8% or €293 billion for the 2007–2013 period) of the total CAP budget (OJ C139 of 14 June 2006). Since 2007, funding for Pillar 1 measures comes from the European Agricultural Guarantee Fund (EAGF; European Communities, 2006).

Pillar 2, or the Rural Development Policy, consists of three vertical (thematic) axes and one horizontal axis called LEADER. Since 2007, its funding is provided by the European Agricultural Rural Development Fund (EARDF). Axis 1 aims to improve the competitiveness of the agricultural and forestry sectors. It focuses on knowledge transfer, modernisation, innovation and quality in the food chain, and on priority sectors for investment in physical and human capital. It includes notably funding for the setting up of young farmers, early retirement of farmers and farm workers, use by farmers and forest holders of advisory services and farm modernisation (investments). Axis 2 seeks to improve the environment and the countryside, with a focus on biodiversity, the preservation and development of High Nature Value farming and forestry systems, water resources and climate change. It includes the LFAs, AEMs and Natura 2000 payments. Axis 3 is targeted at improving the quality of life in rural areas and encouraging diversification. It should contribute to the creation of employment opportunities and conditions for growth. One objective is to promote capacity building, skills acquisition and organisation for local strategy development. It also helps to ensure that rural areas remain attractive for future generations, in particular in the more remote rural areas facing depopulation. It includes support for diversification into non-agricultural activities; the creation and development of micro-enterprises; encouragement of tourism activities, village renewal and development; and the conservation and upgrading of rural heritage. Axis 4 or the LEADER axis finances the implementation of the local development strategies of 'Local Action Groups', built around one or more of the three thematic axes. To ensure overall balance in the programme, minimum funding for each axis is required: 10% for Axis 1, 25% for Axis 2, 10% for Axis 3 and 5% for the LEADER axis (European Union, 2008; European Communities, 2006). The EU's Rural Development Policy is co-financed by Member States and in some cases by private investors. The maximum Community co-financing rate (at the level of the axis as a share of total eligible public expenditure) is fixed at 50% (75% in Convergence regions) for Axes 1 and 3, at 55% (80% in Convergence regions) for Axes 2 and 4 and at 85% for all axes in outermost regions. Several measures, mainly from Axis 1, require a private contribution. For the 2007–2013 period, the real EU co-financing rate is estimated to be about 61% (European Union, 2008).

►► **Obligation of maintenance of the permanent grassland area**

The obligation of maintenance of the permanent grassland area at or above a threshold level follows the rules of Regulations 1782/2003 and 796/2004. The proportion of permanent grassland must not decrease to the detriment of land under permanent grassland by more than 10% relative to a 'reference year'. All EU-15 Member States appear to have adopted 2003 as their reference year. France is an exception, choosing the reference year is 2005 as did six of the EU-10-NMS Member States (the Czech Republic, Estonia, Hungary, Lithuania, Latvia and Poland). In most Member States the level of permanent grassland is calculated annually using the information

provided by farmers in their annual aid application. In order to implement the rule, Member States have introduced a set of 'trigger levels'. The trigger level is a level of permanent grassland decline which prompts action in order to prevent the ratio of permanent grassland from decreasing by more than a certain amount. In general, Member States have set dual 'trigger levels': one at a lower level (e.g., 0% or 5% reduction) where precautionary action is taken and another at an upper level (e.g., 7.5% or 10% reduction) where more substantial action is taken. In most Member States, when an action is taken, the land that was converted from permanent grassland is the land that must be re-established as permanent grassland. Derogations apply in some Member States with various types of requirements; examples include after an Environmental Impact Assessment (United Kingdom) or the respect of a minimum proportion of permanent grassland at farm level, maximum size, slope or altitude criteria of the plot to be converted (Austria). In Germany grassland that has been established as part of an agri-environmental scheme is exempt from the rule (Alliance Environnement, 2007).

The protection of the permanent grassland area can be considered as a recognition of the positive impact of grasslands compared to crops for biodiversity, landscape, carbon storage in soil organic matter, soil fertility, water quality protection and ground water reserve replenishment.

► Agri-environmental scheme

The agri-environmental scheme (Regulations EC 2078/92 and EEC 1257/99) dates back to the early 1990s. Some Member States tested AEMs as early as in the 1980s. The idea was adopted by the EU in 1985 in Article 19 of the Agricultural Structures Regulation, but remained optional at first for Member States. In 1992, it was introduced for all Member States as an 'accompanying measure' to the Common Agricultural Policy (CAP) reform. AEMs involve paying farmers to protect and improve the environment on their farms. Farmers are rewarded only if their efforts go beyond the standard 'Good Farming Practices' (GFP), which are set out in a code formalised in national legislation. These GFPs are set out in a code formalised in national legislation. At the EU level, the maintenance of the present grassland area is included in the GFPs. Farmers sign a contract with their local administration and are paid for the additional cost of implementing the measures and for any losses of income, especially due to reduced production. AEMs are adapted to local farming systems, ecological conditions and environmental issues, which vary considerably throughout the EU; they are drawn up at the national, regional or local level. This makes the agri-environmental strategy a flexible tool. AEMs have two main objectives: reducing environmental risks associated with modern farming and preserving biodiversity and cultivated landscapes. They are based on the following principles: they are optional for farmers; they are site-specific, they can be adapted to different agronomic and environmental circumstances; they have a minimum duration of five years since environmental issues require a structured and long-term approach; AEM contracts must compete with the most profitable land use, so payment levels must be sufficiently high

to attract farmers; agri-environmental payments may only be made for actions above the reference level of mandatory requirements defined by GFP codes (an application of the ‘Polluter Pays Principle’ to agriculture); Member States have a wide degree of discretion in how to design and implement AEMs. The agri-environmental policy is reported to the World Trade Organisation. Since agri-environmental payments are ‘limited to the extra costs or loss of income involved’, they are classified in the ‘Green Box’, which implies that agri-environmental payments are not considered to be trade-distorting (Anon., 2005). AEMs include the support of the conversion to organic farming (OF) and in some Member States to the maintenance of OF. This type of farming has developed rapidly since the implementation of the AEMs, with more than 5.8 million ha (3.4% of the AA) and almost 140 000 organic farms in 2004 (EEA, 2007b). Some grassland-specific examples of AEM are given in Table 49.

Table 49. AEM types and environment parameters where positive effects are expected.

Measure types	Soil quality	Water quality	Water quantity	Agricultural biodiversity	Wild biodiversity	Landscape
Input (fertiliser, pesticide) reduction	x	x			x	
Organic farming	x	x		x	x	x
Extensification of livestock	x	x		(x)	x	x
Conversion of arable land to grassland and rotation measures	x	x	x		x	x
Actions in areas of special biodiversity interest		(x)	(x)		x	x
Genetic diversity				x		(x)
Maintenance of existing extensive systems	(x)	(x)			x	x
Farmed landscape					x	x
Water use reduction		x	x			

x: primary effect; (x): secondary effect.

Source: Anon., 2005.

►► Less Favoured Areas

Three types of LFA were defined: mountain/hill areas (ex Article 18), areas in danger of abandonment of land use (ex Article 19), areas affected by specific handicaps (ex Article 20). Their importance in the EU is described in Tables 50 and 51. In the farms represented in FADN, 54% are located in LFA, 16% in LFA-Mountain and 38% in LFA-Other than mountain. However, only about half of them are beneficiaries of the LFA scheme.

Table 50. Proportion of the different categories of LFA and non-LFA in the UAA (%) in 2005.

	Non-LFA	LFA mountain/hill (ex Article 18)	LFA other (ex Article 19)	LFA specific handicap (ex Article 20)
EU-27	46.0	15.6	35.5	2.9
EU-15	41.9	18.8	36.6	2.7
EU-12-NMS	44.2	6.2	44.4	5.2

Source: European Union, 2009.

Table 51. Proportion of farm holdings located in mountain and other LFA out of total agricultural holdings (%).

	2005		2007		
	EU-27	EU-15	EU-10-NMS	EU-2-NMS	EU-27
Mountainous area	16.8	26.0	4.1	18.5	20.4
Other less favoured area	42.3	53.4	45.1	28.5	48.3

Source: FSS in European Commission, 2009b.

► Consequences of the abolition of the milk quotas

In order to reduce surpluses, production limits were implemented in dairy production through the adoption of milk quotas in 1984. This policy was able to stabilise milk prices over a long period of time. In a general context of liberalisation and under pressure from some Member States, which wanted to increase their production, it was decided to phase out milk quotas after a 'soft landing' period. They are set to expire in 2015.

Many studies attempted to evaluate the effect of this reform on farm profitability. For instance, Kempen *et al.* (2011) simulated results on the basis of the CAPRI model. Their conclusions indicate that the abolition of the milk quota regime is likely to increase milk production on average by 4.4% in the EU-27, and to push raw milk prices down by -10%. Agricultural income would drop by -1.6% on average, since increasing production cannot compensate for lower milk prices. These results are in line with results of other recent studies. The reduced income could, however, have important consequences for individual farms and is an additional threat to livestock systems.

With regard to the environment, the analysis of Kempen *et al.* (2011) showed an increase in dairy herds causing higher N losses. However, the higher N losses are quite moderate (0.66%–1.41%). Higher dairy cows numbers are attenuated by a simultaneous decline of suckler cows. There is only a small rise in gaseous losses (NH₃, N₂O, NO_x, CH₄). However, the study pointed out specific problems in some regions due to increased nitrate leaching (the Netherlands, Belgium, north-western Germany, Brittany (France) and Galicia (Spain)). Meanwhile, animal density and agricultural income are expected to remain fairly stable in marginal areas at the spatial resolution of the analysis, suggesting that the quota abolition does not involve a marked increase

in the risk of land abandonment. The CAPRI results do not reveal strong impacts of the milk quota reform on cattle herds in regions dominated by grasslands.

►► Other policies

Adhesion to the EU

The dates of adhesion of Member States to the EU influenced their agricultural policies. After adhesion, Member States adopted the CAP (in any case after 1963). These dates are: 1957 (Belgium, France, Italy, Luxembourg, the Netherlands, the Federal Republic of Germany), 1973 (Ireland, the United Kingdom, Denmark), 1981 (Greece), 1986 (Spain, Portugal), 1990 (Länders of the former German Democratic Republic through German unification), 1995 (Finland, Sweden, Austria), 2004 (Estonia, Latvia, Lithuania, Poland, the Czech Republic, Slovakia, Hungary, Slovenia, Cyprus, Malta), 2007 (Bulgaria and Romania). These dates must be kept in mind for the interpretation of the changes in grasslands and grassland-based systems in each country.

Political changes in central and eastern Europe

Other important dates to keep in mind when interpreting the effect of policies are: 1989 (fall of the Berlin Wall and collapse of the communist regimes in central and eastern Europe), 1990 (3 October, German unification) and 1993 (1 January, separation of Czechoslovakia into Czech Republic and Slovakia).

Natura 2000

Two directives have an impact on EU permanent grassland area, even if their application concerns all EU areas, including those outside of the AA classification, such as woodlands, wetlands and coastal and marine areas. They are the 1979 Bird Directive (79/409/EEC) and the 1992 Habitat Directive (92/43/EEC). Both focus on biodiversity conservation. These directives are the legal basis for the Natura 2000 network that now covers almost 20% of the EU land mass and about 10% of UAA (Table 52). Because socio-economic activities are maintained in this network when applicable, farming can be affected. It is estimated that approximately 16% of the habitats in Natura 2000 areas depend on a continuation of extensive farming practices, and especially the continuation of extensive grassland management (EEA, 2007a). Cooper *et al.* (2009) estimated that more than 18% of EU-27 grassland area is located within the Natura 2000 network. Measures must be taken to maintain or

Table 52. Proportion of the Natura 2000 network in the UAA (%).

	EU-27	EU-15	EU-12-NMS
1	11.3	11.2	11.6
2	9.9	9.4	11.2

Source: (1) EEA Natura 2000 geodatabase (ETCBD) + Corine Land Cover 2000 in the European Union (2008); (2) Natura 2000 spatial dataset (Mid 2009) + Corine Land Cover 2000 in the European Union (2009).

restore, at a favourable conservation status, natural habitats and species of wild fauna and flora of Community interest. Network management financing is coordinated with existing aid instruments. The support of farming activities inside Natura 2000 sites is thus part of the CAP financial support and structural interventions, since they are part of rural and regional development policies. This creates a strong relationship between AEM and Natura 2000 implementation on agricultural land.

Quality Product Policy

The promotion of products of local origin was introduced in 1992 with several labels: PDO (Protected Designation of Origin), PGI (Protected Geographical Indication) and TSG (Traditional Speciality Guaranteed) (EC No 1898/2006) and OF. Healthy food, superior taste and positive effects on the environment are the main expectations of the consumers when they see these labels. Organic farming legislation started in the EU in 1991 (regulation EEC 2092/91, completed and revised several times since); OF is supported by legislation and direct payments.

Nitrates Directive

The Nitrates Directive (Directive 91/676/EEC) is mandatory for farmers. Under this directive, Member States must identify on their territory surface and ground waters affected or which could be affected by pollution, as well as vulnerable zones which contribute to pollution. They must define a code of GFPs to be implemented by farmers. They must design and implement action programmes for each vulnerable zone. These action programs must include the measures prescribed in the GFP codes. They must also include measures to limit the spreading on arable land and grasslands of any fertiliser containing nitrogen and set limits for livestock manure spreading. These limits imply a controlled stocking rate on the farm area. Farmers are also required to have the storage capacity for their manure in order to be able to spread it under optimal conditions. For slurry storage, this capacity amounts to about six months in many regions. Member States must monitor water quality, applying standardised reference methods to measure the nitrogen compound content.

The percentage of the territory designated as Nitrate Vulnerable Zone and Gross Nutrient Balances are summarised in Table 53.

Table 53. Percentage of the territory designated as Nitrate Vulnerable Zone and Gross Nutrient Balances (kg/ha) in the EU-27.

	Nitrate Vulnerable Zone	Gross Nutrient Balances in 2002–2004	
	(% Territory in 2008)	Surplus of Nitrogen (kg/ha)	Surplus of Phosphorus (kg/ha)
EU-12 -NMS	24.6	n/a	n/a
EU-15	46.4	83	10
EU-27	40.9	n/a	n/a

n/a : not available.

Source: DG ENV in European Union (2008); OECD Environmental indicators for agriculture Vol. 4, 2006 in European Union (2009).

High Nature Value Farmland

The identification and conservation of High Nature Value (HNV) farmland was given high priority in the Kiev Resolution on Biodiversity (2003). It was agreed to identify all HNV areas by 2006 and that a significant proportion of these areas would be under biodiversity sensitive management by 2008. A map of HNV farmland prepared for the European Environment Agency is currently available, but a limited proportion of HNV farmland is designated as protected sites. According to Paracchini *et al.* (2008), 31.9% of the UAA of the EU-27 is in HNV. Management of these areas has yet to be implemented (Baldock *et al.*, 1995 and 1996; EEA, 2004 and 2007b).

► CAP effect on grasslands and grassland farms

With regard to grasslands and grassland farms, several CAP instruments are of special importance: direct payments and the respect of GAEC in the cross-compliance principle, milk quotas, investment aids, AEMs, LFA allowances and diversification support.

Pillar 1

Before the CAP reform of 2003, a higher proportion of the budget was spent per hectare of arable land than on grassland and for field crop specialist holdings than for grazing livestock specialist holdings. This difference was partly—although not entirely—offset by some Pillar 2 expenditure. In France, the incentive to convert permanent grassland into annual crops, including green maize, is clearly illustrated by the difference between the premium for cereals and green maize that was about €300/ha and the AEM on permanent grassland and the so-called ‘Prime à l’herbe’ (Grass premium) that was about €30/ha in the late 1990s. The statistics on the changes in the permanent grassland area (Chapter 1) reveal the result of such a policy: the area fell by 33% in forty years (Eurostat).

After the 2003 reform, these perverse effects of subsidies on the grassland area disappeared since the premiums were no longer crop specific. The reform radically changed radically the context in which farmers consider their forage systems. The difference in total direct payments between field crop specialists and grazing livestock specialists has also been reduced considerably since 2003.

According to FADN data, the median EU direct payments (DP) per farm in the EU in 2006 amounted to €2 160. In terms of DP per ha, the median DP in the EU-25 was €160/ha. In the EU-15, the highest median DPs per farm were, in descending order, dairying specialists (€12 490), mixed producers (€10 200), other grazing livestock specialists (€9 060) and field crop specialists (€6 340) (Table 54). The median DP level per ha was very similar for dairying specialists, mixed producers, field crop specialists and other grazing livestock producers (€290–€330/ha). Granivore specialists had a median DP per ha of €250/ha and other permanent crop specialists of €210/ha.

Table 54. Median DP in the EU-15 per type of farming and change after decoupling.

	Direct payments per farm			Direct payments per ha		
	2004	2006	Change (%)	2004	2006	Change (%)
Field crop specialists	4 840	6 340	31	280	300	7
Horticulture specialists	0	0	0	0	0	0
Wine specialists	0	0	0	0	0	0
Other permanent crop specialists	990	1 000	1	220	210	-5
Dairying specialists	7 110	12 490	76	200	330	64
Other grazing livestock specialists	8 140	9 060	11	280	290	3
Granivore specialists	2 600	3 080	18	270	250	-7
Mixed farming (Mixed cropping, Mixed livestock holdings, Mixed crops-livestock)	8 820	10 200	16	300	310	3
EU-15	3 320	3 950	19	230	260	13

Source: European Commission, 2008b.

Comparison of the 2004 and 2006 data shows the effect of decoupling. The major impact was the increase of the median DP per farm (+76%) and per ha (+64%) of dairying specialists (European Commission, 2008b).

In the meat sector, about 60% of the suckling cow herd of the EU-15 still benefited from coupled payments in 2010 (Osterburg *et al.*, 2008). This possibility for Member States to retain coupled payments appears to be an efficient system for protecting cattle rearing and fattening holdings as well as sheep and goat specialist holdings. Surprisingly, in Member States with fully decoupled payments—such as Germany—suckling cow numbers remained stable while sheep numbers declined slightly (Osterburg *et al.*, 2010).

Grazing livestock specialists' dependence on single payments remains very high, and is higher than all other farm types. Most grazing livestock specialist farms would not be profitable without financial support. For instance, the dependence of English farm types in 2007/08 (as a percentage of farm business income) is highest for grazing livestock specialists in LFAs (about 155%) and in lowlands (about 130%). In comparison, all farm types and cereal specialists have a dependence of only 50% and dairying specialists just 40% (Defra, Farm Business Survey accounts, 2007/8 in Buckwell (2009)). This shows how vulnerable grazing livestock specialists are compared to other farm types.

Milk quotas have supported price levels by controlling production in the EU. They have also limited the expansion of dairy systems. National and regional rules for quota transfers have helped some Member States (e.g., France and Italy) maintain dairy production in LFAs (Alliance Environnement, 2007). Quota transfers in Germany led to dairy production being concentrated in regions with a high proportion of permanent grasslands in the UAA (Osterburg *et al.*, 2010). In late 2008, farm commodity prices dropped considerably. Milk prices were particularly affected,

threatening the profitability of dairy farms integrated in industrial production chains. Products such as high quality cheeses protected by PDO and organic labels resisted much better than raw milk.

Harmonisation of direct payments per hectare changed the situation, with the most intensive farms attracting more per-hectare subsidies, calculated on a historical basis. In Germany in 2006, dairy farms benefited from about €550/ha for extensive farms and about €680/ha for intensive farms. For other cattle farms (beef cattle farms), the difference is even higher, around €550 and €930/ha, respectively. Intensive farms received about 50% (dairy) or 100% (other cattle) more direct payments per hectare than extensive farms. More price support is also allocated per hectare for intensive than for extensive farms. While more AEM and LFA payments (Pillar 2) were paid per hectare to extensive farms, this did not make up for the difference of Pillar 1 support. Planned changes to payment harmonisation should support more extensive systems in the future. Since these systems rely more on permanent grasslands than intensive systems do, this measure should also help stabilise the grassland area.

The cross-compliance rule on the protection of permanent grasslands was implemented to reduce and even avoid further conversion of permanent grasslands into arable land. The proportion of grasslands in the UAA is calculated at regional or national levels. Land use changes can still occur at farm and sub-regional levels in Member States that do not impose strict rules at the farm or plot level. The grassland proportion is calculated based on the difference between grasslands converted to arable land and arable land converted to grasslands. However, protection is not at all complete. For instance, old permanent grasslands and species-rich grasslands can, for instance, be replaced by newly resown, species-poor grasslands. According to Osterburg *et al.* (2010), the cross-compliance rule has been an incentive for a rapid conversion of grassland before restrictions at the farm level were implemented. In several regions, including in German Länders, the proportion of grassland has decreased by more than 5% between 2003 and 2009.

The overall result of the 2003 reform on the permanent grassland area has, however, been positive. The surface area appears to have stabilised (EU-6) or increased slightly (EU-15, EU-27) between 2003 and 2007 (Chapter 4).

Milk quotas and price effects

The implementation of the milk quotas in 1984 combined with the continuous growth in dairy cow production potential through breeding significantly impacted the structure of dairy systems. In the countries where the quotas was very strict (e.g., France and Germany until 2004), farmers produced the same amount of milk with fewer cows. This freed up surfaces for other activities, such as cereals, fattening of young animals, suckling cow herds, granivores). This was particularly true in France, where quotas were linked to the land. Dairy farmers diversified their productions. In other countries where quotas could be sold (e.g., Belgium, Denmark, the Netherlands, the United Kingdom), some farmers were able to buy new production rights and increase their production with an even higher specialisation. Other farmers who could not buy new rights diversified their activities like in France and Germany.

Milk quotas had also diverse effects on the management of grasslands and the use of green maize and concentrates. The stabilisation of milk prices did not encourage some farmers to improve their grassland management. They based their per cow yield increases on higher concentrate use and, when possible, on green maize. However, good managers had already understood by the late 1980s that they needed to reduce their production costs through better grassland management and use since they could no longer increase their income by simply producing more. The 1992 reform that pushed cereal prices down sharply again encouraged farmers to use these feeds in larger amounts in dairy cow feeding. This had a negative effect on the grassland area.

Another factor led farmers to use more green maize at the expense of grass and to convert grasslands to maize fields: the seasonal variability of milk prices. To avoid a peak of milk production in spring and ensure stable operations at dairy factories, dairy companies offered higher prices for winter milk in several countries (e.g., Belgium, Denmark, France, the Netherlands). Consequently, farmers in these countries replaced hay with other conserved feed of a higher feeding value (grass and maize silage) to increase per cow dairy yield during the housing period. It is, however, noteworthy that seasonal milk prices have not been adopted in some countries, such as Ireland. This allows for an optimal use of grasslands and low production costs through maximum grazing.

The 2009 milk crisis provided a very strong incentive to lower production costs. This should have encouraged better grassland use. However, many dairy farms were forced out of business; the land then became available for other farmers to manage it through different production (e.g., cereals). As a result, these farmers converted grasslands into arable land.

Pillar 2

Rural Development (RD) payments are *a priori* more favourable for the maintenance of permanent grassland area and the support of specialist grazing livestock holdings than Pillar 1 support payments (at least before 2003), and especially AEM and LFA allowances.

RD support in the EU-25 (EU-27-Bulgaria and Romania) amounts to an average of €1 337/annual work unit (AWU) or €61/ha (2000–2006 Farm Accountancy Data Network (FADN) data; EU and national section). Agri-environmental measures are the major component of RD support; on average, they make up 45% of total RD support at €607/AWU, while LFA allowances equal €437/AWU (33%) and investment subsidies total €263/AWU (20%). The other measures involve only small amounts per farm. On a per hectare basis, the average LFA payment is about €20/ha; the average agri-environmental payment is €29/ha in the EU-15 and €12/ha in the EU-10-NMS countries (Cyprus, the Czech Republic, Estonia, Hungary, Lithuania, Latvia, Malta, Poland, Slovakia, Slovenia) and the average investment subsidy is about €12/ha. Approximately one-third (35%) of the EU-25 farms covered by FADN are RD recipients: 23% receive LFA support, 18% agri-environmental payments and 6% investment subsidies. There are wide differences between

Member States. Some have high levels of RD support, such as Austria, Slovenia, and Luxembourg (high proportion of RD recipients and high average RD support, greater than first pillar support). In others, RD support generally accounts for less than 50% of total direct support, as is the case in Denmark, Spain, Italy and Greece (low proportion of RD recipients and low average RD support, less than first pillar support) (European Commission, 2009b).

On average for the EU-25, Dairying specialists and Other grazing livestock specialists receive the highest RD support per AWU (€2 799 and €3 384/AWU, respectively; Table 55). It corresponds to 44% and 36% respectively of their average 1st Pillar direct payments. Field crops farms receive the highest average 1st Pillar direct payments per AWU (€9 504/AWU). For Grazing livestock farms, the main components of RD support are AEM and LFA. Dairying specialist farms receive on average €109/ha in RD support, of which €48/ha in AEM payments (44% of RD support), €40/ha in LFA payments (37%) and €19/ha in investment subsidies (18%). Other Grazing livestock farms receive on average €86/ha, with €39/ha and €35/ha, respectively, for MAE and LFA payments.

Table 55. Comparison of Pillar 2 (RD) support with Pillar 1 direct payments (€/AWU and €/ha) per farming type (average 2000–2006) in the EU-25.

	Total Pillar 2		Pillar 1 direct payments	
	per AWU	per ha	per AWU	per ha
Field crop specialists	1 062	33	9 504	295
Dairying specialists	2 799	109	6 358	247
Other grazing livestock specialists	3 384	86	9 428	239
Granivore specialists	761	69	3 682	332
Mixed farming	1 356	52	7 160	276
Total EU-25	1 337	61	6 001	274

Source: European Commission (2009b).

Less Favoured Areas (Pillar 2)

LFA payments contribute significantly to grazing livestock farmers' income since more than half of them are operating in these areas. Payments are not negligible, though much lower than those from the first pillar (Pflimlin *et al.*, 2005; Röeder *et al.*, 2007).

For the 2004–05 period in the EU-25, LFA payments per AWU were €2 651/AWU for the LFA-Mountain beneficiaries in the EU-14 (EU-15-the Netherlands) and €1 489/AWU in the EU-9-NMS (EU-12-NMS-Bulgaria, Cyprus and Romania). They averaged €1 941/AWU for LFA-Other than mountain beneficiaries in the EU-14 and €685/AWU in the EU-9-NMS. For the LFA-Mountain beneficiaries, LFA payments amount to an average of 18% of farm income (Farm Net Value Added, FNVA) in the EU-14 and 37% in the EU-9-NMS. For the LFA-Other than mountain beneficiaries, they equal 10% of farm income in the EU-14 and 13% in

the EU-9-NMS. Specialist grazing livestock are the main farm type beneficiaries (% of total) in all LFA types in the EU-23. The highest levels of average LFA payment per AWU are obtained for grazing livestock specialists (€2 538/AWU) and the field crops specialists (€2 122/AWU). For the LFA-Mountain, the average LFA payment per AWU goes up to €3 866/AWU for the specialist field crops and €3 166/AWU for the specialist grazing livestock. The average share of LFA payments in FNVA is 19% for the LFA-Mountain and 10% for the LFA-Other than mountain (European Commission, 2008c).

Bazin (2003) concluded that, in France between 1979 and 1995, LFA payments seemed to have had a positive impact on changes in the number of holdings, agricultural area (including permanent grassland area), number of cattle and dairy cows and labour. While these indicators decreased faster in mountain areas than in lowland areas in previous periods (before the implementation of LFAs in 1975), during the 1979–1995 period, these indicators dropped at the same rate or more slowly in mountain areas than in the plains.

Agri-environment (Pillar 2)

In 2000–2003, an average of €16.30 were spent per ha AA in the EU-15 for AEM. An average of €89 were paid to EU farmers per ha through AEM contracts. In 2002, the share of agricultural land enrolled in AEM in the EU-15 reached about 25% of AA but varied from less than 5% in the Netherlands and Greece to more than 80% in Austria, Sweden, Finland and Luxembourg (EEA, 2006). AEM included the support of the conversion to organic farming (OF) and in some Member States to the maintenance of OF. OF is characterised by a mixed farming (crop and animal husbandry) and is based on a large use of grassland and forage legumes. It has developed rapidly since the implementation of the AEM in 1992, with more than 7 million ha—3.9% of AA—and almost 156 000 organic farms in 2007 (Table 56).

Table 56. Importance of organic farming in the EU-27 in 2007.

	UAA under organic farming (ha)	Share of UAA under organic farming (%)
EU-27	7 134 778	3.9
EU-15	5 826 021	4.5
EU-12-NMS	1 308 757	2.5

Source: Eurostat; LU, PL, PT: Institute of Rural Studies, University of Wales, Aberystwyth, © Nicolas Lampkin, in European Union (2009).

Diversification and pluri-activity

According to the European Union (2008), ‘pluri-activity is defined as the existence of other gainful activities for the farmer i.e., the existence of any other activity than farm work carried out for remuneration. It includes non-agricultural activities carried out on the holding itself (such as accommodation of tourists), or on another holding (farm work on another holding is included too), as well as employment in

a non-agricultural enterprise. Diversification is assessed at the level of the holding, and refers to the creation of any gainful activities that do not comprise any farm work but are directly related to the holding by using its resources or products and have an economic impact on the holding.'

In 2005, more than one-third of EU-27 family farm managers (36%) had another gainful activity in non-agricultural sectors, ranging from less than 20% in Belgium to nearly 75% in Slovenia. Overall, pluri-activity of farmers seems to be more widespread in the northern and eastern Member States than in the western and southern ones. One of the key opportunities in terms of pluri-activity comes from tourism. Meanwhile, farm diversification is more widespread in western and northern Europe, for instance in Finland (29%), France (25%), the United Kingdom (24%), Germany (22.5%), the Netherlands (22.5%), Austria (21.4%) and Denmark (18.4%), and seems less developed in eastern and southern Member States as well as in Ireland. Pluri-activity is mainly a feature of small farms, whereas diversification occurs more frequently on large holdings. At EU-27 level, diversification of production is not as common as pluri-activity, with only 12% of holdings carrying out a diversification activity. Farmers involved in permanent cropping or field cropping are more available to choose pluri-activity, while farmers dealing with livestock may be more attracted to on-farm diversification. In 2005 in the EU-15, the share of families having pluri-activities was about 15% for dairying specialists, 37% for both cattle rearing and fattening and sheep, goats and other grazing livestock specialists, and 30% for field crop specialists (about 30% of total farms). Diversification activities are much less common. About 15% of mixed crops-livestock holdings, 14% of grazing livestock holdings and 13% mixed livestock holdings had a diversification activity in 2005. As for tourism, the development of diversification is mainly linked to farms specialised in grazing livestock, because these farms specialised may be located in places rated as attractive for such activities. Mountain, coastal or pleasant countryside areas may provide critical advantages in attracting potential clients. Product processing is by far the most frequent activity in grazing livestock farms. Tourism comes in second (European Union, 2008).

Pluri-activity and diversification activities are supported by the second pillar budget. Income from these activities can be of great importance for grazing livestock farm holders and is thus an indirect support of the permanent grassland area.

► CAP: the way forward

In October 2011, the EC presented a proposal for CAP reform after 2013 (European Commission 2011a and 2011b). The Commission, the Council and the European Parliament (EP) came to a political agreement on this reform in September 2013.

Member States will allocate up to 70% of their Direct Payments national envelope to a new Basic Payment Scheme. In addition to the Basic Payment Scheme, each holding will receive a payment per hectare as part of a compulsory 'greening' component. This greening component will support farmers for respecting agricultural practices beneficial for the climate and the environment. Member States will use 30% of their national envelope related to the first pillar of the CAP in order

to pay for this. Failure to respect the greening requirements will result in reductions and penalties. Areas under organic farming are recognised to provide environmental benefits. They will be considered as fulfilling the conditions for receiving the greening payment, without any additional requirements. The three basic practices of the 'greening' component are:

- Maintaining permanent grassland
- Crop diversification (at least 2 crops or 3 crops according to farm size)
- Ensuring an 'ecological focus area' of at least 5% of the arable area of the holding (i.e., field margins, hedges, trees, fallow land, landscape features, biotopes, buffer strips, afforested area).

The 'greening equivalency' system foresees that when environmentally beneficial practices are already in place they can be considered to replace the greening requirements. For example, agri-environmental schemes may incorporate practices that are considered equivalent. To avoid "double funding" of such measures, the payments through Rural Development Programmes must take into account the greening requirements.

The reform aims to move towards a fairer distribution of direct payment support. The national envelopes for direct payments for each Member State will be progressively adjusted so that there is not such a wide gap between Member States in the average payment per hectare. Within Member States, the amounts available to farmers receiving more than the regional/national average will be adjusted. Member States also have the right to use a redistributive payment for the first hectares whereby they can take up to 30% of the national envelope and redistribute it to farmers on their first thirty hectares. Capping will limit payments that very large farms can receive.

Member States may grant an additional payment from Pillar 1 for areas with natural constraints. This support must be limited to 5% of the national envelope. Part of the budget will target young farmers and small farms. Member States will have the possibility to spend limited but not negligible amounts of their envelope on 'coupled' payments linked to a specific product, including 'protein crops'. Limited transfer will be allowed between Pillars 1 and 2 or Pillars 2 and 1. The cross-compliance principle is maintained but simplified. All direct payments, certain RD payments and certain vineyard payments will continue to be linked to the respect of a number of statutory requirements relating to environment, climate change, good agricultural condition of land, human, animal and plant health standards and animal welfare.

New ideas have been introduced with regard to the former CAP. More fairness in the distribution of support is certainly a factor that could increase EU cohesion, support small farmers' incomes in the new Member States and that of extensive farmers in all Member States, and be used for improving the environment and protecting biodiversity and landscapes. A successful transition of new Member States' economies is vital for all EU countries. CAP mechanisms should target farmers in these countries to help them develop a modern and sustainable agriculture while protecting the environment and biodiversity. Capping is also a tool that can help distribute aid to farmers who need it most.

If a consensus can be reached on the objectives, mechanisms for achieving them can be discussed.

The budget devoted to greening is significant (about 30% of the national direct payment envelopes) and could triple the amount spent on agri-environment compared to the present situation if the budget of agri-environmental measures is maintained. The three measures of the greening component—maintaining permanent pasture, crop diversification and maintaining an ‘ecological focus area’ of at least 5% of farmland—are welcome in their principle. Supporting permanent pastures is highly justified for the various reasons mentioned above. The environmental benefits of this measure will be limited, however. It is very likely that the current greening measure proposals will not deliver important environmental benefits because they are too general and not targeted. Moreover, they will apparently not include training, monitoring or evaluation of the results. It has been shown that only targeted measures are effective for biodiversity restoration and conservation (see, for instance, Bretagnolle *et al.*, 2011). General and broad measures, like those of the management rules of Pillar 1, are not. Non-contractual agri-environmental actions will most likely not deliver significant results. Most measures require long-term adoption to achieve consistent results. The one-year basis of the EC proposal is too short; multi-annual commitments should be considered.

The definition of permanent grassland by European Commission (2011a)—‘land used to grow grasses or other herbaceous forage naturally (self-seeded) or through cultivation (sown) and that has not been included in the crop rotation of the holding for five years or longer’—does not take into account the vast grazed areas that include high proportions of trees and/or shrubs and that have been used for centuries in different areas of Europe, from Sweden to the south of Spain and Greece. Grazed woodlands, *Calluna* heather and other *Ericaceae* communities in the lowlands and in mountains, Mediterranean matorral, the Spanish dehesa and the Portuguese montado for instance would be excluded from support; but they are among the most precious and biologically rich, grazed ecosystems of Europe. They also store carbon in higher amounts than other grazed ecosystems. On the other hand, large areas of grasslands are regularly resown without being part of crop rotations. The soil cover is always grass but the vegetation is not permanent grassland. These grasslands provide significantly fewer environmental benefits and are species-poor. The definition should only include grasslands that are not regularly ploughed or chemically destroyed and reseeded. The greening measure for grassland and rangeland conservation should specifically target semi-natural grasslands, in other words, ‘low-yielding permanent grasslands, dominated by indigenous, naturally occurring grass communities, other herbaceous species and, in some cases, shrubs and/or trees. These mown and/or grazed ecosystems are not substantially modified by fertilisation, liming, drainage, soil cultivation, herbicide use, introduction of exotic species and (over-)sowing’. Forestland that produces, at least periodically, understorey vegetation that is grazed and Mediterranean grazed wooded areas (dehesa and montado types, for example) should also be included. Compared to semi-natural grasslands, a lower level of subsidies should support more agriculturally-improved permanent grasslands. The definition of agriculturally-improved permanent grasslands implies more frequent defoliations and higher stocking rates and productions than semi-natural grasslands. Legume-based temporary grasslands could be supported too, at a lower rate than agriculturally-improved permanent grasslands. Simple maintenance

rules should be defined in the support system and controlled by a credible monitoring and evaluation procedure.

The environmental objectives and management of the ‘ecological focus area’ have not been defined. Terms like ‘field margins, hedges, trees, fallow land, biotopes, buffer strips, afforested area’ are rather vague, and while the biodiversity of these areas can be of high value, it can also be of low value, sometimes with harmful elements. These areas should be carefully defined, in-field and on field edges, include all types of ecological infrastructures that are beneficial to biodiversity and their management should be checked and the results evaluated. This implies higher levels of control than with the present first pillar measures and an implementation philosophy more like the second pillar.

A priority of the greening component should be to support farming systems that provide public environmental goods and services. High Nature Value (HNV) farming systems are one of them. Most HNV farming systems are grassland-based livestock systems. Their survival is threatened by low profitability. HNV farmland is often managed by small farmers who the reform would like to support. However, there are very few specifics regarding HNV in the EC proposal. While it is recognised as one of the main objectives of the Rural Development Programme, there is no mention of any tool specifically focused on it. This tool could possibly be integrated in a first pillar component (Beaufoy and Marsden, 2011).

No clear environmental objectives are linked to an additional first pillar payment for areas with natural constraints. These payments could be merged with those of the Less Favoured Areas scheme of the Rural Development Programme and used to finance HNV farming on a simple, clear and effective basis. This would provide a stronger content and a clearer environmental objective to the LFA programme (the current definition: ‘a broad-scale mechanism for maintaining the countryside in marginal areas’ is very general and has limited environmental relevance).

Farmers adopting appropriate management practices in Natura 2000 areas should receive additional support in the green measures of Pillar 1. This support should be complementary to existing Pillar 2 payments for Natura 2000. Such actions would create the conditions for safeguarding these high biological value habitats. Many HNV farmlands are located in Natura 2000 areas. The combination of support payments from both programmes should be managed in an adequate way.

The cross-compliance principle and the Good Agricultural and Environmental Conditions (GAEC) definition must provide a strong foundation on which other schemes can be built. They must be based on the polluter pays principle. This includes the Birds and Habitats Directives, the Water Framework Directive, the Sustainable Use of Pesticides Directive and any new environmental directives on soils drawn up in the future. Because of their very nature, they must be respected by all producers. Adequate penalties (in the form of taxes, i.e., charges on over-fertilisation, species or habitat destruction and habitat degradation) or other financial sanctions (proportional reduction in compensatory payments or investment aid) should be applied if the measures not respected. Below a certain level of GAEC, farmers should not be allowed to operate and should cease any practices that are harmful to the environment.

All Rural Development Programmes should have clear objectives that include environmental objectives such as the AEMs, LFAs, investment in physical and human capital and the LEADER axis. Special attention should be paid to the avoidance of distortion effects of these policies, especially investment support and LEADER approach, on the environment.

Although the current agri-environmental scheme has positively affected the environment by slowing down degradation, maintaining conditions or restoring biodiversity and landscapes, results have been limited, as recognised in the EU Biodiversity Strategy. There are several reasons for this, including issues with national or regional scheme design, the targeting of the measures, the way they are implemented, not providing sufficient farmer advisory services, low administrative capacity, low payment levels and an insufficient budget. This is an argument for the budget for agri-environmental measures to be increased rather than decreased, but the proposals of the EC do not guarantee this increase. Improving the efficiency of agri-environmental measures is also necessary. Result-oriented agri-environmental measures instead of mean obligation measures are likely to be more efficient when applicable (Matzdorf *et al.*, 2008; Oppermann, 2003; de Sainte-Marie, 2009; Wittig *et al.*, 2006). In each country, agri-environmental measures should be better targeted. According to Hart and Baldock (2011), ‘from an environmental perspective, the more tailored the measures are to specific environmental needs and the more they are targeted at the locations in which action is needed, the more effective and efficient they are likely to be in achieving their objectives’. Providing more farmer advisory services and training on agri-environmental measures and increasing monitoring and evaluation will require greater administrative efforts and a somewhat larger share of the budget, but these conditions are necessary for ensuring effectiveness, efficiency and good value for public money (Hart and Baldock, 2011).

A new regulatory mechanism could be created to ensure a better redistribution of subsidies between farms in times of high prices for certain productions that temporarily do not need high support to remain competitive. The reduced support on these productions could be used for supporting others that need it. These transfers could be organised at farm levels.

Independently of the reform proposals and the previous comments, the CAP needs a paradigm shift. The CAP budget should move from a predominant income support scheme (Pillar 1) to a public goods production support scheme. This will give new legitimacy to this policy. The largest part of the CAP budget could be used to supporting the production of ecosystem goods and services, with a priority on biodiversity and landscape conservation and restoration, carbon storage and water quality protection. Improved agri-environmental measures should remain the reference and a source of inspiration for this scheme. The remaining part of the CAP budget could be reserved to stabilise income in case of high price volatility (crisis reserve).

These proposals could give a new future to grassland-based systems. Their support is justified by the ecosystem goods and services that they produce in higher amounts than certain other farming systems. This would increase the value for money of the CAP to taxpayers.

► Interview with Jean-François Louineau, Director of Administrative Services, Regional Council, Poitou-Charentes, France

Jean-François Louineau is the Deputy General Director of the Poitou-Charentes Regional Council, in charge of environment, agriculture, sea and fishery policies. He has a degree in ecology and worked as the director of an NGO in environmental protection for twenty years.

1- What is the importance of grasslands and their associated herbivore production in the Poitou-Charentes region?

Beyond the economic figures, grasslands have a cultural importance, related to landscapes that are typical of a large part of the region, such as the hedged farmland with a predominant and historical animal production. This is also the case of the coastal wetlands that are large grasslands systems. These coastal landscapes have experienced changes similar to the continental zones, but are very important for the local population. In other places, grasslands are associated with the valleys, such as the Charente River. Even though maize acreage has increased, grasslands are part of the traditional landscapes along with poplars.

But in reality, in less than two generations, grasslands lost the importance they had in agriculture. This is due to the implementation of drainage and the destruction of hedges.

People living in rural areas and working in agriculture have lost touch with the role that grasslands play in the territory. Activities have quickly disappeared. Animal production on grasslands and grazing is decreasing. Most animal production now takes place on constructed lots.

Production based on silage and protein concentrates has expanded as its relationship to the land and grasslands is less visible. For instance, when you drive across the countryside here, you do not see the goat production, which is very important in the region.

As a consequence, it is difficult to promote a policy to support grasslands and grassland-based production. Indeed, for the farmers and citizens who are younger than forty, the role of grasslands is not obvious. However, this is essential, because a policy for grasslands and more generally agriculture must be shared and accepted by the community.

2- What are the prerogatives of a Regional Council for agricultural production, economy and environment preservation?

French regions have no particular prerogative in agriculture and other primary activities such as fisheries. But three basic prerogatives make it possible for a region to be involved in agricultural issues: country planning, economic development (especially because of the related industries), and environmental issues, as the regions can take initiatives in this domain.

Because of the relationship between agriculture and environmental excellence, the Poitou-Charentes Regional Council promotes agricultural models that positively

contribute to environmental preservation. For the French regions, there is a clause of general competency that makes it possible to support the agricultural sector through the primary production chain and food industry. French regions are not involved in the management of the Common Agricultural Policy but they may develop initiatives for local agriculture.

The budget allocated to agricultural activities is limited and was developed to promote or support innovative productions or organisations. Initiating and anticipating are key. Promoting new approaches meets the expectations of French society and will make it possible to achieve real developments. When applied to grasslands where the region has no prerogative, this approach means supporting some key players, such as NGOs involved in environmental preservation, but without causing conflicts with other stakeholders such as farmers.

With the new CAP, regions could have greater prerogatives.

3- What are the main concerns and objectives with regard to grasslands for the members of the Regional Council?

There are several important issues with regard to grasslands:

Employment and rural development. We know that with the same level of investment and a similar turnover, animal production generates more employment than grain production. We must not let our rural territories become abandoned. There are residential migratory fluxes towards rural zones, but major agricultural activity is a must. And this is relevant to grassland-based production.

– Our region is diverse from a soil and geological point of view. This offers possibilities for territory-based production. Grasslands and animal production contribute to such productions, making it possible to have a strong economic activity and considerable exports. Exporting grains does not contribute to the local character and richness of our agriculture. Typical local products must be a pillar of our sustainable agriculture. This is why we support the renewal of the PDO Poitou-Charentes butter.

– Our region has a structural weakness regarding its water supply, and climate change will only make it worse. Rainfall is decreasing and we have no way to store water. We rely on connections with neighbouring regions to provide water. Our water resources are also fragile from a quality standpoint. Intensive irrigation-based farming is not viable with regard to water. Grassland-based production helps us maintain an agricultural activity without irrigation and contributes to water quality. If all grasslands were converted to intensive annual cropping systems, we would not have a sufficient supply of drinkable water.

– We are a coastal region, with four rivers and a wild estuary. All these basins are connected to the sea. We have a large oyster production on the coastline. There is also a large continental plateau, with large salt licks, that plays a key role in fish reproduction and juvenile growth in the Gascoigne Gulf. This is especially true for sole. Pesticides from agriculture have a negative impact on sole breeding and oyster survival. Thus, when agricultural production systems are developed, they must include these issues because of the connection between the two sectors through the quality and quantity of draining water. Grasslands again have a positive influence, as they improve water quality.

– Grassland systems improve the economic performance of farms and the environmental services provided by agriculture. They could be better supported through the second CAP pillar: carbon storage, biodiversity protection, landscape preservation,

production of wood for bioenergy from hedged landscapes. Grassland systems could contribute more to these issues than agroforestry. To a lesser extent, the CAP could also contribute to the preservation of local breeds.

– Feed self-sufficiency of farms through virtuous systems. Autonomy could be achieved at the territory scale if farms worked together. By including grassland systems, efficient systems required low fertiliser and pesticide inputs could be developed. Reduced energy costs would make farms more profitable. To move forward in this direction and improve farms' energy autonomy, we look into technologies for barn drying of forages. There are technologies that can help improve forage quality and therefore grassland productivity or absorption by the animals. There is a basic relationship between feed self-sufficiency and energy autonomy, and not only in the grazing systems. Better use of grasslands must take into account new technologies for forage conservation, which then lead to better forage quality. In addition to barn drying, a dehydration unit based on a biogas plant is operated by 24 farmers. From a strategic point of view at the farm scale, it is possible to find synergies between new energy sources and feed self-sufficiency.

– Partnerships between farmers and research must be encouraged. The strong collaboration between the local research centre and farmers' organisations reaffirms our commitment and our investment in this direction.

Conclusions

► Changes in the structure of the grassland area and grassland-based systems

The main findings of this book can be summarised by several important trends described below.

Permanent grasslands cover over 57 million ha in the EU-27 (2007) and temporary grasslands about 10 million ha. Together, they make up about 39% of the European UAA. These grasslands are the basis of food for about 78 million LU of grazing livestock. They are managed by some 5.4 million holders, or about 40% of all European farm managers. Of these farms managing permanent grasslands, 41% have an ESU lower than one (very small farms).

The permanent grassland area has decreased continuously in most EU countries over the last fifty years. Estimating the total loss of the permanent grassland area is difficult. In the EU-6, these losses are estimated at about 30%—7 million ha—between 1967 and 2007 (Eurostat). Surface losses calculated from the FAOSTAT database are estimated at approximately 15%—10 million ha—for the EU-13 (EU-15-Belgium and Luxembourg) between 1961 and 2007. These losses are clearly underestimated.

The variation of the temporary grassland area can only be calculated for short periods of time because of a lack of data. Between 1990 and 2007, the temporary grassland surface increased in 11 EU countries (Eurostat). This surface appeared to stabilise between 2001 and 2007. It is likely that cutting temporary grassland areas decreased during the last twenty years while grazed temporary grassland areas increased in some countries.

The dairy cow population fell by 10 million head in the EU-9 between 1975 and 2007 (40% drop from 1975 levels). This decline started after the implementation of the milk quotas in 1984. Inversely, suckling cow and sheep populations increased by about 3 and 8 million head, respectively, over the same period in the EU-9. In the former communist countries, cattle and sheep numbers declined sharply, by at least 50%, in the 1990s and started to stabilise or increase slowly in the first years of the 21st century.

The total number of agricultural holdings in the EU-9 was reduced by almost 50% in thirty years (1975–2007). The decline of dairying specialists was very high (72%) while cattle rearing and fattening specialists and sheep, goats and other grazing livestock specialists remained much more stable (3% decline and 15% increase, respectively). The size of grazing livestock holdings nearly doubled during that period.

► Changes in production processes

Two major trends characterised the changes in the grassland area and grassland-based systems since the beginning of the CAP: intensification and land abandonment. In the lowlands, widespread nitrogen fertilisation of grasslands began from the 1960s. Stocking rates, frequency of cutting for conservation, fertiliser use, drainage, irrigation, resowing and over-sowing with improved cultivars, weed control with herbicides progressively increased. The number of plant species (and biodiversity in general) fell dramatically in grassland swards while forage yields rose and feeding quality improved. At the same time, farm and farmer numbers dropped and farm sizes increased. This altered the traditional landscape as plot sizes grew and, as a direct consequence, led to a decrease in field margins and hedgerow networks.

The importance of cutting temporary grasslands and especially lucerne-based swards declined across Europe, even in grassland regions (sown legume-based mixtures dropped by more than 80% between 1960 and 2010 in France). In the 1950s and 1960s, this trend was reinforced by the decline of agricultural labour, making traditional haymaking processes extremely challenging (Huyghe, 2009). The use and the proportion of legume species in swards (especially *Trifolium repens* in grazed swards) also fell due to widespread use of nitrogen fertilisers.

As production became more specialised, mixed farming gradually disappeared. Some regions specialised in arable crops while others specialised in animal husbandry.

Animal breeds were specialised for milk or meat production, while dual-purpose breed populations were reduced. Dairy systems were concentrated in the lowlands (74% EU dairy cows) especially in Atlantic climates (regular rainfall and mild temperatures are ideal for grass growth) or in mid-range altitudes in mountain areas (11% EU dairy cows; Pflimlin *et al.*, 2005). Beef cattle systems occupied more marginal soils and climates. As a consequence of specialisation, animal yields increased. In dairy systems, annual production rose from an average of 4 500 l per cow and per year in the 1970s to 7 500 l/cow in 2010. In some herds and cows, annual yield is now up to 10 000 to 12 000 l/cow. This steady increase in dairy yields of about 1% per year was possible thanks to international efforts to breed a restricted number of dairy breeds, among which the Holstein breed undoubtedly dominates. As a result, populations of many less performing breeds decreased.

Yield increases also brought about changes in animal feeding. More concentrates were used at the expense of green forages. The implementation of milk quotas in 1984 slowed down this trend, at least for good managers, because limited production volumes meant production costs had to be reduced to maintain or increase farm income. This was achieved through better utilisation of green forage, which is less expensive than concentrates. Each cow had to produce more milk on a grass- and

maize-based diet. It was also achieved by a higher production per cow for decreasing the share of maintenance feeding needs. However, high-yielding cows are very sensitive to feeding quality. Grazing is also more difficult to manage under rainy and dry weather conditions. Farmers tend not to trust grass quality and grass intake potential of these high-yielding cows and instead keep them partially indoors or systematically complement grass grazing with maize silage. This tendency, caused by the combined effects of milk quotas and breeding progress of dairy breeds, led to a decrease of the grassland proportion in the UAA. After 1992, the drop in cereal prices incited dairy farmers to incorporate higher amounts of cereals in cattle feeding, again at the expense of grass grazing and grass silage. In the ‘forage crop’ and ‘grassland and maize regions’, farmers used increasing quantities of maize silage in dairy cow feeding and converted grasslands into maize fields. In the ‘grassland region’, farmers’ adopted a slightly different strategy: they used less maize but more concentrates. They also tried to cut production costs through better use of grazing and grass silage. In the ‘wet mountain region’, farmers have smaller herds, use more green forages including grass, and can increase their income by selling high-quality cheeses promoted through a ‘Protected Designation of Origin’ (PDO) system at higher prices. In beef production systems, a small number of good conformation breeds also emerged. Local traditional breeds tended to be progressively crossed with three dominant breeds: Charolais, Limousin and Belgian Blue. Grazing remained the basis of suckling cow systems and animals were fed in winter mainly with hay and haylage. Concentrates and maize silage were restricted mainly to bull fattening. Fattening of older bulls disappeared almost in favour of young bulls. In Mediterranean regions, where most sheep and goats are located, the number of grazing animals decreased leading to a large abandonment of dry rangelands.

All these system changes caused landscape and wildlife diversity and complexity to suffer. In the ‘forage crop region’ and in some intensive parts of the ‘grassland and maize region’, farmers faced criticism for their negative impacts on the quality of ground- and surface waters. This was particularly true when intensive dairy farming was linked to pig and/or poultry production. In this context, organic manure production often exceeds the amount of nitrogen that crops and grasslands can absorb under “good agricultural and environmental conditions”. Measures had to be taken to reduce nitrate and phosphate pollution.

►► Changes in the structure of animal production

The structure of European agriculture has changed dramatically over the last fifty years. A large part of red meat production and consumption was replaced by white meat production. One possible explanation is that since the early 1960s, no taxes are levied on imports of protein-rich feedstuff in the EU. As a result, it became more profitable to feed livestock with imported feed than with local grassland forage. Soybean and cereal grains were increasingly used for producing meat and milk. European consumers ate progressively more grain-based monogastric meat than grass-based ruminant meat. This affected product quality: grain-based meats are higher in total and saturated fats, lower in omega3 fatty acids and have a higher omega6/omega3 ratio than grass-based meats. The impacts on human health are not

negligible. The development of this global forage system also caused environmental destruction. The Amazon rainforest, Cerrado and Pampas of South America were largely converted into soybean fields. Permanent grasslands regressed in Europe, replaced by green maize and cereals that complement soy in animal feeding. All these changes led to massive biodiversity losses on both sides of the Atlantic and N and P pollution in waters in Europe from slurry spreading in pig and poultry production areas. Europe became perilously close to not being able to sustain its protein needs, which is of strategic importance. New policies are needed to cope with these challenges. The solution most certainly implies decreased white meat production and consumption, new development of forage legumes, redeployment of grassland areas by paying farmers for ecosystem goods and services, development of short marketing chains and high quality animal products.

►► **Effect of scientific research, public and private farmer's advisory services**

The fundamental changes in management and production efficiency of grasslands, livestock and holdings since the 1960s would not be possible without significant research efforts. The results of these efforts were disseminated by public and private advisory services. This process interacted with the political and economic conditions created, most notably by the CAP, and which were favourable to these changes. It must not, however, be forgotten that political and economic conditions alone cannot produce such dramatic changes. If technical progress in grassland management was slower than that of annual crops, it is likely that the permanent grassland area would have decreased even faster than it did.

It must be recognised that private seed sellers of cereals and green maize were often more aggressive than public or semi-public advisory services in charge of promoting permanent grasslands. Annual forage crops were sometimes associated with a certain idea of modernity while permanent grasslands were seen as a more conservative and less efficient way of producing forages. Even if that was not true, and a better use of green forage from grasslands was often more profitable than from annual crops, this image had a negative impact on the grassland area.

►► **Effect of professional teaching**

Farmers' education levels have increased continuously over past fifty years. Many young farmers were able to obtain technical degrees in agriculture. This was a very efficient way to disseminate new management techniques and contributed to a more efficient use of grasslands. The productivism context of technical teaching promoted the use of mechanisation, fertilisers, concentrates and green maize. This led to the spreading of a conservative image of grasslands while green maize and imported concentrates were seen as progress. Moreover, very often students receive little information about grassland management. These factors added to the decrease in grassland area.

► Sociological driving forces

Certain sociological driving forces support the use of grasslands. There is an increasing demand from society to reward farmers for the multiple services that grasslands offer and for a sustainable management of associated public goods such as biodiversity and carbon stocks.

However, other sociological forces lead to grasslands being replaced by annual crops. A steady decline in beef and sheep meat consumption by European citizens in favour of pork and poultry meat has been observed. For instance, between 1995 and 2008 in the EU-27, meat production in the EU-27 has fallen in terms of tonnes of animals slaughtered for cattle (−8.6%), sheep (−18.2%) and goats (−21.0%) while the number of pigs slaughtered has increased (16.5%; European Commission, 2009a). If less ruminant meat is consumed and the grassland area does not change, an extensification of grassland management is possible, but it is more likely that a higher demand for monogastric meat will bring about the replacement of a part of the grassland area by crops or other land uses.

► Economic driving forces

Economic driving forces have different effects on grassland use: certain factors lead to the replacement of grasslands by annual crops, while others promote grasslands. Compared to annual forage crops (forage maize and fodder beet), product costs per hectare are similar for grass silage and much lower for grazed grasslands; grass silage has higher costs per kg of dry matter and per energy content and grazed grasslands lower. All types of grasslands, and especially grazed grasslands, have lower costs per kg of crude protein (Deprez *et al.*, 2007).

The significant rise in wheat prices in 2007 strongly encouraged farmers to convert grasslands into arable fields. Cereal prices are still high and are expected to remain so over the medium term; the incentive to destroy grasslands will thus be maintained. In this context, it is valid to ask whether the payment of subsidies to cereal producers should continue at today's levels, since these subsidies do not necessarily ensure their activities are profitable. In contrast, a large part of specialist grazing livestock farmers need these subsidies to survive, especially beef farmers. The CAP could therefore play a more effective role in income redistribution between different categories of farmers.

In late 2008, farm commodity prices dropped considerably. Milk prices were particularly affected, threatening the profitability of dairy farms integrated in industrial production chains. Products such as high quality cheeses protected by Protected Designation of Origin (PDO) and organic labels held out much better than raw milk. This was a clear sign that quality labels can have a positive effect on the income stability of dairy farms. Furthermore, quality product-based systems use on average more grass in livestock feeding than more intensive dairy farms; quality labels thus have a positive effect on grassland-based systems.

►► Political driving forces

Common Agricultural Policy

With regard to grasslands and grassland farms, certain CAP instruments are of special importance: direct payments and the respect of the ‘Good Agricultural and Environmental Conditions’ in the cross-compliance principle, milk quotas, investment aids, agri-environmental measures (AEM), less favoured area (LFA) allowances and diversification support.

Before the CAP reform of 2003, a higher proportion of the budget (especially from Pillar 1) was spent per ha of arable land than on grasslands and for field crop specialist holdings than for grazing livestock specialist holdings. This difference was partly compensated by some Pillar 2 expenditures an overall imbalance remained. This difference still existed even after 2003, although to a lesser extent. Indeed, the 1st Pillar payments on average over the 2000–2006 period were for “Field crop specialists” 295 €/ha; for “Dairying specialists” 247 €/ha and for “Other Grazing livestock specialists” 239 €/ha.

The milk quotas implemented in 1984 have supported price levels by controlling the production in the EU. They have also limited the expansion of dairy systems and have even reduced the number of dairy cows. This has in turn led to stocking rate decreases in some cases or the development of suckling cow or sheep systems independently or in complement to dairy systems in other cases. National and regional rules for quota transfers have helped some Member States (ex.: France and Italy) to maintain dairy production in LFA. Quota transfers in Germany led to dairy production being concentrated in regions with a high proportion of permanent grasslands in the UAA. Milk quotas have encouraged good managers to reduce their production costs and produce more milk per cow using grass- and maize-based diets that are cheaper than concentrates. The growing use of artificial insemination combined with breeding progress would have led to the same result in any case. When farmers used more maize and decreased grassland areas too much, they were left with no choice but to buy protein-rich concentrates (e.g., soybean meal), which increased production costs.

With the CAP reforms of 1992 and 2000 cereal prices dropped significantly (about 50%) to levels closer to the global market prices. Once again, dairy farmers went back to using cereals in animal feeding, often at the expense of grass.

Rural Development (RD) support measures are *a priori* more favourable to the maintenance of the permanent grassland areas and the support of specialist grazing livestock holdings than Pillar 1 support measures (at least before 2003), especially AEM and LFA allowances. LFA payments contributed significantly to grazing livestock farmers’ income and helped keep farmers in these areas. More than half of grazing livestock farmers operating in LFAs. Payments are not negligible, though much lower than those from the first pillar. For instance, in France between 1979 and 1995, LFA payments appeared to have had a positive impact on changes in the number of holdings, agricultural area (including the permanent grassland area), number of cattle and dairy cows and available labour in mountain areas. AEM have

also a significant impact on the income of grazing livestock specialists. They represent about 23% of total Pillar 2 expenditure. In 2002, the share of agricultural land enrolled in AEMs in the EU-15 reached about 25% of the UAA. In several Member States, AEM aimed to promote grassland areas and limit increases in green maize and cash crop areas, but were unable to reverse the general trend. However, they most likely slowed the reduction rate of permanent grassland areas, the decline of grassland biodiversity and the simplification of landscapes. Although there were exceptions in some regions and Member States, organic farming remained marginal and did not change the main evolution trends in EU agriculture. Pluri-activity and diversification activities are also supported by the second pillar budget. Income provided by these activities can be of great importance for holders of grazing livestock farms and is thus an indirect support to the maintenance of permanent grassland areas.

After the reform of 2003, the perverse effects of Pillar 1 subsidies on the grassland area were reduced. Premiums were no longer linked with crop or animal types but to the eligible area. This eliminated the ‘maize premium’ that encouraged farmers to use this forage crop at the expense of grasslands. The use of grasslands was also no longer indirectly supported through animal premiums but directly through area payments (the system was, however, applied with a certain flexibility among Member States according to the re-nationalisation principle). The reform radically changed the context and the way farmers think about their forage system. The major impact of decoupling was the increase of the median direct payments per farm (+76%) and per ha (+64%) of dairying specialists, and which, over the short term, was a higher support to grassland areas. In the meat sector, about 60% of the suckling cow herd of the EU-15 still benefited from coupled payments in 2010. This possibility for Member States to retain coupled payments appears to be an efficient system for protecting cattle rearing and fattening holdings as well as sheep and goat specialist holdings. Surprisingly, in Member States with fully decoupled payments—such as Germany—suckling cow numbers remained stable while sheep numbers declined slightly. Grazing livestock specialists remain highly dependent on single payments, more so than all other farm types. Most grazing livestock specialist farms would not be profitable without financial support.

Harmonisation of direct payments per hectare changed the situation, with the most intensive farms attracting more per-hectare subsidies, calculated on a historical basis. Changes underway in payment harmonisation should support more extensive systems going forward. Since these systems rely more on permanent grasslands than intensive systems do, this measure should also help stabilise grassland areas.

The cross-compliance rule on the protection of permanent grassland aims to reduce and even avoid further conversion of permanent grassland into arable land. The proportion of grassland in the UAA is calculated at regional or national levels. Land use changes can thus occur at farm and sub-regional levels in Member States which do not impose strict rules at farm or plot level. The grassland proportion is calculated based on the difference between grasslands converted to arable land and arable land converted to grasslands. However, protection is not at all complete. For instance, old permanent grasslands and species-rich grasslands can be replaced by newly resown, species-poor grasslands. Moreover, the cross-compliance rule has

been an incentive for a rapid conversion of grassland before restrictions at the farm level were implemented. Nevertheless, according to Alliance Environnement (2007), permanent grassland area has increased since 2003 in 11 Member States (the Czech Republic, Denmark, Estonia, Finland, Greece, Luxembourg, the Netherlands, Poland, Slovenia, Spain and Sweden) and in the Wallonia region (Belgium). In three Member States (Austria, Hungary and Lithuania) and in the Flanders region (Belgium), it has decreased slightly. In Ireland and Scotland (United Kingdom) the proportion is stable.

Overall, the 2003 reform has been positive on the permanent grassland area. The surface appears to have stabilised (EU-6) or increased slightly (EU-15, EU-27) between 2003 and 2007 (Eurostat).

Over a fifty-year period, the successive EU CAP reforms led to modernisation of the sector, increased farm sizes, a dramatic decline in farmer numbers, specialised production, intensification of grassland and stockbreeding, higher production volumes, a rise in grassland and animal yields, lower legume use, a drop in the grassland area and its proportion in the UAA, and diminishing diversity of landscapes, grassland species and communities, domestic animal breeds and local products.

European environmental policies

The Nitrates and Water Framework Directive had a significant influence on farm structures and practices of intensive livestock systems by regulating the stocking rate and the management of nitrogen. Developing a sufficient storage capacity for slurry represented a significant financial investment for livestock farms (especially dairy farms) that was partly supported by public aid (Pillar 2 of the CAP and complementary support from Member States). The thresholds for manure spreading and stocking rates per hectare was a signal to farmers that intensification has limits. Derogations for higher manure spreading on grassland than for arable land have been obtained for some Member States such as Denmark, Germany, the Netherlands and the Wallonia region (Belgium). These derogations are an incentive for intensive farms to maintain their permanent grassland area since they can spread more manure on grassland than on arable land.

The Natura 2000 network is nearly complete but management agreements with landowners and managers are still under intense, and sometimes difficult, debate.

Political changes in central and eastern Europe

The fall of the Berlin Wall in 1989 and the political changes in central and eastern Europe in the 1990s brought about tremendous changes in the use and management of grasslands in these countries.

The structure of agricultural production was very different between countries before 1989. In Poland, small private farms dominated the sector while large cooperatives were the rule in Bulgaria, Czechoslovakia, East Germany and Romania for instance. The political transition period led to even bigger differences. For example, in Romania, large cooperatives were largely returned to their former owners or their

heirs while in Slovakia large cooperatives remained as they were. Farmers' attitudes towards the new political conditions were diverse. However, some common trends are visible. Some of these trends do not appear in the official statistics. In Bulgaria, Romania and Slovakia, large permanent grassland areas (> 30%) were abandoned. Keenleyside *et al.* (2004) estimated that, in 2002, the proportion of agricultural land classified as abandoned (actually recorded as fallow land) was 10.1% in Estonia, 21.1% in Latvia, 10.3% in Lithuania, 26.7% in Hungary and 17.6% in Poland. Cattle and sheep populations decreased dramatically in all countries. In some countries like in Bulgaria, Hungary and Slovakia, goat numbers increased, especially on small farms; small producers tried to overcome the negative effects of fewer dairy cows by establishing dairy production based on these small ruminants, including through subsistence farming. Abandoned grasslands were partly colonised by shrubs and trees; the lowlands of Bulgaria are just one example. This change can still be reversed, but in some regions the cost of grassland restoration is likely to be high.

The reunification of Germany led to fast changes in the eastern part of the country. The permanent grassland area decreased by more than 20% between 1990 and 1992 but then increased again (Osterburg *et al.*, 2010).

The adhesion of new Member States to the European Union in 2004 and 2007 has started to produce some effects. Since statistics are available only until 2008, it is still early to analyse evolution trends. However, it would appear that the recent stabilisation or increase in cattle and sheep populations is due to this political change.

Quantitative and qualitative changes

This book describes mainly quantitative changes in grasslands. Very little statistical information is available on the qualitative changes in grasslands such as soil organic matter (carbon storage), soil fertility, vegetation and arthropod population changes. However, it is widely known that tremendous changes occurred in grassland vegetation and in the grassland ecosystem as a whole (Anonymous, n.d.; Silva *et al.*, 2008) and that biodiversity losses in general were considerable (Firbank *et al.*, 2008; Henle *et al.*, 2008) over the last fifty years.

References

A

Allen V., Batello C., Berretta E.J., Hodgson J., Kothmann M., Li X., McIvor J., Milne J., Morris C., Peeters A., Sanderson M., 2011. An International Terminology for Grazing Lands and Grazing Animals. *Grass and Forage Science*, 66, 2-28.

Alliance Environnement, 2007. Evaluation of the application of cross compliance as foreseen under Regulation 1782/2003. Part I: Descriptive Report and Part II: Replies to evaluation questions. Institute for European Environmental Policy (IEEP) and Oréade-Brèche: 181 and 143 pp. Downloadable from: http://ec.europa.EU/agriculture/eval/reports/cross_compliance/

Ammerman A., Cavalli-Sforza L.L., 1971. Measuring the rate of spread of early farming in Europe. *Man*, 6, 674-688.

Amon T., Kryvoruchko V., Amon B., Zolitsch W., Pötsch E., 2005. Biogas production from maize and clover grass estimated with the methane energy value system. <http://www.nas.boku.at/filedamin/-/H93>

Andersen E., Baldock D., Bennett H., Beaufoy G., Bignal E., Brouwer F., Elbersen B., Eiden G., Godeschalk F., Jones G., McCracken D., Nieuwenhuizen W., van Eupen M., Hennekens S., Zervas G., 2004. Developing a High Nature Value Farming area indicator – Final report. HNV farming project. 75 p.

Anonymous, n.d. Dry and mesic grassland habitats - pressures and state, 16 pp.

Anonymous, 1979. Standardmischungen für den Futterbau. Revision 1980. *Mitteilungen für die Schweizerische Landwirtschaft*, 27(12), 217-227.

Anonymous, 1986. Graslandterminologie. Commissie Graslandterminologie in het Nederlandse taalgebied. Edited by the Ministry of Agriculture Brussels, 17 p.

Anonymous, 2005. Agri-environment Measures. Overview on General Principles, Types of Measures, and Application. European Commission,

Directorate General for Agriculture and Rural Development, 24 pp.

Arrouays D., Deslais W., Badeau V., 2001. The carbon content of topsoil and its geographical distribution in France. *Soil Use and Management*, 17, 7-11.

Aschwanden J., Holzgang O., Jenni L., 2007. Importance of ecological compensation areas for small mammals in intensively farmed areas. *Wildlife Biology*, 13, 150-158.

Atkinson P.W., Fuller R.J., Vickery J.A., Conway G.J., Tallowin J.R.B., Smith R.E.N., Haysom K.A., Ings T.C., Asteraki E.J., Brown V.K., 2005. Influence of agricultural management, sward structure and food resources on grassland field use by birds in lowland England. *Journal of Applied Ecology*, 42, 932-942.

Aurousseau B., Bauchart D., Faure X., Galot A.L., Prache S., Micol D., Priolo A., 2007. Indoor fattening of lambs raised on pasture: (1) Influence of the stall finishing duration on lipid classes and fatty acids in the *longissimus thoracis* muscle. *Meat Science*, 76, 241-252.

Aviron S., Jeanneret P., Schüpbach B., Herzog F., 2007. Effects of agri-environmental measures, site and landscape conditions on butterfly diversity of Swiss grassland. *Agriculture, Ecosystems and Environment*, 122, 295-304.

B

Baldock D., Beaufoy G., Clark J., 1995. The nature of farming. Low intensity farming systems in nine European countries. Report IEEP/WWF/JNRC, London/Gland/Peterborough.

Baldock D., Beaufoy G., Brouwer F., Godeschalk F., 1996. Farming at the margins: Abandonment or redeployment of agricultural land in Europe. IEEP/LEI-DLO, London/Den Haag.

Baritz R., De Neve S., Barancikova G., Gronlund A., Leifeld J., Katzensteiner K., Koch F.J., Palliere C., Romanya J., Schaminee J., 2004. Land use practices and soil organic matter. *In:*

Thematic Strategy for soil protection (Van Camp L., Bujarrabal B., Gentile A.R., Jones R.J.A., Montanarella L., Olazabal C., Selvaradjou S.K., eds), III: 439-465. EU DG Joint Research Centre, EUR 21319 EN/3.

Bazin G., 2003. Principles and issues of the mountain agricultural policies in France (in French). Académie d'Agriculture, 12 pp.

Beaufoy G., Marsden K., 2011. *CAP reform 2013 - last chance to stop the decline of Europe's High Nature Value farming?* EFNCP, BirdLife International, Butterfly Conservation Europe, WWF, 35 pp.

Bigal E.M., McCracken D.I., Corrie H., 1996. Defining European low-intensity farming systems: the nature of farming. *Wader Study Group Bulletin*, 80, 62-68.

Boschi C., Baur B., 2008. Past pasture management affects the land snail diversity in nutrient-poor calcareous grasslands. *Basic and Applied Ecology*, 9, 752-761.

Boulal H., Gómez-Macpherson H., 2010. Dynamics of soil organic carbon in an innovative irrigated permanent bed system on sloping land in southern Spain. *Agriculture, Ecosystems and Environment*, 139, 284-292.

Bouma J., Varallyay G., Batjes N.H., 1998. Principal land use changes anticipated in Europe. *Agriculture, Ecosystems and Environment*, 67, 103-119.

Bradbury R.B., Kirby W.B., 2006. Farmland birds and resource protection in the UK: Cross-cutting solutions for multi-functional farming? *Biological Conservation*, 129, 530-542.

Bradley K., Drijber R.A., Knops J., 2006. Increased N availability in grassland soils modifies their microbial communities and decreases the abundance of arbuscular mycorrhizal fungi. *Soil Biology and Biochemistry*, 38, 1583-1595.

Bretagnolle V., Gauffre B., Meiss H., Badenhausser I., 2011. The role of grassland areas within arable cropping systems for the conservation of biodiversity at the regional level. In: *Grassland productivity and ecosystem services* (Lemaire G., Hodgson J., Chabbi A., eds), CABI, Wallingford, UK, 251-260.

Brückmann S.V., Krauss J., Steffan-Dewenter I., 2010. Butterfly and plant specialists suffer from reduced connectivity in fragmented landscapes. *Journal of Applied Ecology*, 47, 799-809.

Buckwell A., 2009. Elements of the post 2013 CAP. European Parliament, Directorate General for Internal policies, Policy Department B: Structural and Cohesion Policies, Agriculture, 37 pp.

Bugalho M.N., Abreu J.M., 2008. The multi-functional role of grasslands. *Options Méditerranéennes, Series A*, 79, 25-30.

Butler G., Nielsen J.H., Slots T., Seal C., Eyre M.D., Sanderson R., Leifert C., 2008. Fatty acid and fat soluble antioxidant concentrations in milk from high- and low-input conventional and organic systems: seasonal variations. *Journal of the Science of Food and Agriculture*, 88, 1431-1441.

Butler S.J., Boccaccio L., Gregory R.D., Vorišek P., Norris K., 2010. Quantifying the impact of land-use change to European farmland bird populations. *Agriculture, Ecosystems and Environment*, 137, 348-357.

C

Carlier L., De Vliegheer A., Rotar I., 2005. Importance and functions of European grasslands. *Bulletin USAMV-CN*, 61, 17-26.

Carlier L., Rotar I., Vlahova M., Vidican R., Petkova D., De Vliegheer A., 2008. The potential contribution of leguminous forage crops in sustainable cattle husbandry. *Bulletin UASVM, Agriculture*, 65, 15-28.

CEAS, EFNCP (European Forum on Nature Conservation and Pastoralism) (2000) *The Environmental Impact of Dairy Production in the EU: Practical Options for the Improvement of the Environmental Impact.* Report for DG Environment, European Commission.

Cerdan O., Govers G., Le Bissonnais Y., Van Oost K., Poesen J., Saby N., Gobin A., Vacca A., Quinton J., Auerswald K., Klik A., Kwaad F.J.P.M., Raclot D., Ionita I., Rejman J., Rousseva S., Muxart T., Roxo M.J., Dostal T., 2010. Rates and spatial variations of soil erosion in Europe: A study based on erosion plot data. *Geomorphology*, 122, 167-177.

Ciais P., Soussana J.F., Vuichard N., Luysaert S., Don A., Janssens I.A., Piao S.L., Dechow R., Lathière J., Maignan F., Wattenbach M., Smith P., Ammann C., Freibauer A., Schulze E.D., and the CarboEurope Synthesis Team, 2010. The greenhouse gas balance of European grasslands. *Biogeosciences Discussions*, 7, 5997-6050.

Combris P., Soler L.G., 2011. Consommation alimentaires : tendances de long terme et questions sur leur durabilité. *Innovations Agronomiques*, 13, 149-160.

Cooper T., Hart K., Baldock D., 2009. The Provision of Public Goods Through Agriculture in the European Union, Report Prepared for DG Agriculture and Rural Development, Contract

No 30-CE-0233091/00-28, Institute for European Environmental Policy, London.

Corrall A.J., Fenlon J.S., 1978. A comparative method for describing the seasonal distribution of production from grasses. *Journal of Agricultural Science, Cambridge*, 91, 61-67.

Cropper M.R., Del Pozo-Ramos M., 2006. Impacts of CAP reforms on animal production systems. *Grassland Science in Europe*, 11, 615-623.

D

Dahms H., Lenoir L., Lindborg R., Wolters V., Dauber J., 2008. Restoration of seminatural grasslands: what is the impact on ants? *Restoration Ecology*, 18, 330-337.

Dauber J., Bengtsson J., Lenoir L., 2006. Evaluating effects of habitat loss and land-use continuity on ant species richness in seminatural grassland remnants. *Conservation Biology*, 20, 1150-1160.

Davies C.E., Moss D., Hill M.O., 2004. Eunis Habitat Classification Revised, 2004. http://eunis.eea.europa.eu/upload/EUNIS_2004_report.pdf.

De Aranzabal I., Schmitz M.F., Aguilera P., Pineda F.D., 2008. Modelling of landscape changes derived from the dynamics of socio-ecological systems. A case study in a semi-arid Mediterranean landscape. *Ecological Indicators*, 8, 672-685.

de Sainte-Marie C., 2009. Favoriser la biodiversité par des mesures agri-environnementales à obligation de résultat. Les prairies fleuries du Massif des Bauges (Savoie), Inra éditions.

De Vliegheer A., Carlier L., 2007. The effect of the age of grassland on yield, botanical composition and nitrate content in the soil under grazing conditions. *Grassland Science in Europe*, 12, 51-54.

De Vliegheer A., Carlier L., 2008. Potential of fodder legumes under intensive farming conditions in Flanders. *Grassland Science in Europe*, 13, 236-238.

Denef K., Roobroeck D., Manimel Wadu M.C.W., Lootens P., Boeckx P., 2009. Microbial community composition and rhizodeposit-carbon assimilation in differently managed temperate grassland soils. *Soil Biology & Biochemistry*, 41, 144-153.

Deprez B., Parmentier R., Lambert R., Peeters A., 2007. Les prairies temporaires : une culture durable pour les exploitations mixtes de Moyenne Belgique. Ministère de la Région

Wallonne, DGA (Belgium). *Les dossiers de la recherche agricole*, 2, 86 pp.

Dewurst R.J., Shingfield K.J., Lee M.R.F., Scollan N.D., 2006. Increasing the concentrations of beneficial polyunsaturated fatty acids in milk produced by cows in high-forage systems. *Animal Feed science and technology*, 131, 168-206.

Diaz-Villa M.D., Marañón T., Arroyo J., Garrido B., 2003. Soil seed bank and floristic diversity in a forest-grassland mosaic in southern Spain. *Journal of Vegetation Science*, 14, 701-709.

Diden W.A.M., Marinissen J.C.Y., Vreeken-Buijs M.J., Burgers S.L.G.E., de Fluiter R., Geurs M., Brussaard L., 1994. Soil meso- and macrofauna in two agricultural systems: factors affecting population dynamics and evaluation of their role in carbon and nitrogen dynamics. *Agriculture, Ecosystems and Environment*, 51, 171-186.

Donald P.F., Pisano G., Rayment M.D., Pain D.J., 2002. The common agricultural policy, EU enlargement and the conservation of Europe's farmland birds. *Agriculture, Ecosystems and Environment*, 89, 167-182.

Donald P.F., Sanderson F.J., Burfield I.J., van Bommel F.P.J., 2006. Further evidence of continent-wide impacts of agricultural intensification on European farmland birds, 1990-2000. *Agriculture, Ecosystems and Environment*, 116, 189-196.

E

Eder J., 2006. Maisanbau für die Biogasanlage. Insitut für Pflanzenbau und Pflanzenzüchtung, Freising, Deutschland. <http://www.lfl.bayern.de/ipz/gruenland/18480/index.php>

EEA (European Environment Agency), 2004. High nature value farmland. Characteristics, trends and policy challenges. Office for Official Publications of the European Communities, 26 pp.

EEA (European Environment Agency), 2006. Integration of environment into EU agriculture policy, the IRENA indicator-based assessment report. EEA Report No 2/2006, 60 pp.

EEA (European Environment Agency), 2007a. Estimating the environmentally compatible bioenergy potential from agriculture. EEA Technical report, 134 pp.

EEA (European Environment Agency), 2007b. Europe's Environment. The fourth assessment. EEA, 452 pp.

- EEA (European Environment Agency), 2009.** Annual European Community greenhouse gas inventory 1990–2007 and inventory report 2009. Annex 2b CRF tables of EU-27.zip. Downloadable from <http://www.eea.europa.eu/publications/european-community-greenhouse-gas-inventory-2009>.
- Elsässer M., 2003.** Möglichkeiten der Verwendung alternative Verfahren zur Verwertung von Grünlandmähgut: Verbrennen, Vergären, Kompostieren. *Berichte über Landwirtschaft*, 81, 512–526.
- Equus, 2001.** The horse industry in the European Union, 49 p.
- EUNIS, 2006.** EUNIS Habitat types, <http://eunis.eea.europa.eu/habitats-code-browser.jsp?habCode=E#factsheet>
- European Commission, 2008a.** Agricultural statistics, Main results, 2006–07, Pocketbooks 147 pp.
- European Commission, 2008b.** Direct payments distribution in the EU-25 after implementation of the 2003 CAP reform based on FADN data. European Commission, Directorate-General for Agriculture and Rural Development, 22 pp.
- European Commission, 2008c.** Overview of the less favoured areas farms in the EU-25 (2004–2005). European Commission, Directorate-General for Agriculture and Rural Development, 99 pp.
- European Commission, 2009a.** Agricultural statistics, Main results, 2007–08. Pocketbooks, 126 pp.
- European Commission, 2009b.** Rural development (2000–2006) in EU farms. European Commission, Directorate-General for Agriculture and Rural Development, 49 pp.
- European Commission, 2011a.** Proposal for a Regulation of the European Parliament and of the Council establishing rules for direct payments to farmers under support schemes within the framework of the common agricultural policy. COM(2011) 625/3, 104 pp.
- European Commission, 2011b.** Proposal for a Regulation of the European Parliament and of the Council on support for rural development by the European Agricultural Fund for Rural Development (EAFRD). COM(2011) 627/3, 143 pp.
- European Communities, 2000.** Farm Structure. Historical results. Surveys from 1966/67 to 1997. EUROSTAT, Theme 5, Agriculture and Fisheries, 161 pp.
- European Communities, 2006.** The EU Rural Development Policy 2007–2013. European Commission, Fact sheet, 21 pp.
- European Communities, 2008a.** LIFE and Europe's grasslands. Restoring a forgotten habitat. LIFE focus, 54 p.
- European Communities, 2008b.** Rural development in the European Union, 378 p.
- European Communities, 2010.** An analysis of the EU organic sector, 80 p.
- European Union, 2008.** Rural development in the European Union. Statistical and economic information. European Union, Directorate-General for Agriculture and Rural Development, 378 pp.
- European Union, 2009.** Rural development in the European Union. Statistical and economic information. European Union, Directorate-General for Agriculture and Rural Development, 403 pp.
- Eurostat, 2008a.** EU cattle population in December 2007 and production forecasts for 2008. *Statistics in focus* 49/2008, 11 p.
- Eurostat, 2008b.** EU sheep and goat population in December 2007 and production forecasts for 2008. *Statistics in focus* 67/2008, 7 p.
- Eurostat, 2009.** Agricultural statistics edition 2010, main results 2007–2008, 126 p.
- Eurostat, 2010a.** Results on EU land cover and use published for the first time. New release 145 October 4th, 3p.
- Eurostat, 2010b.** Agricultural statistics edition 2010, main results 2008–2009, 180 p.
- Evans R.D., Dillon P., Wallace M., Garrick D.J., 2004.** An economic comparison of dual-purpose and Holstein-Friesian cow breeds in a seasonal grass-based system under different milk production scenarios. *Irish Journal of Agricultural and Food Research*, 43, 1–16.

F

- FAO, 2010.** Challenges and opportunities for carbon sequestration in grassland systems. A technical report on grassland management and climate change mitigation. *Integrated Crop Management*, Vol. 9–2010.
- Firbank L.G., Petit S., Smart S., Blain A., Fuller R.J., 2008.** Assessing the impacts of agricultural intensification on biodiversity: a British perspective. *Phil. Trans. R. Soc. B.*, 363, 777–787.
- Fischer M., Wipf S., 2002.** Effect of low-intensity grazing on the species-rich vegetation of tradi-

tionally mown subalpine meadows. *Biological Conservation*, 104, 1-11.

Forge T.A., Bittman S., Kowalenko C.G., 2005. Responses of grassland soil nematodes and protozoa to multi-year and single-year applications of dairy manure slurry and fertilizer. *Soil Biology & Biochemistry*, 37, 1751-1762.

Freibauer A., Rounsevell M.D.A., Smith P., Verhagen J., 2004. Carbon sequestration in the agricultural soils of Europe. *Geoderma*, 122, 1-23.

Frey E., 1955. Neue Standardmischungen für den Futterbau. *Mitteilungen für die Schweizerische Landwirtschaft*, 3(9), 129-142.

Fullen M.A., Zhi W.B., Brandsma R.T., 1998. A comparison of the texture of grassland and eroded sandy soils from Shropshire, UK. *Soil and Tillage Research*, 46, 301-305.

G

Gibon A., 2005. Managing grassland for production, the environment and the landscape. Challenges at the farm and the landscape level. *Livestock Production Science*, 96, 11-31.

Guo L.B., Gifford R.M., 2002. Soil carbon stocks and land use change: a meta analysis. *Global Change Biology*, 8, 4, 345-360.

H

Haselmann H., Bergmann H., 2010. Grassland and its economic use as a renewable energy source in biogas plants. *Grassland Science in Europe*, 12, 572-575.

Hart K., Baldock D., 2011. *Greening the CAP: delivering environmental outcomes through pillar one*. Institute for European Environmental Policy (IEEP): 26 pp.

Hatch D., Easson L., Goulding K., Haygarth P., Shephard M., Watson C., 2002. Grassland re-sowing and grass-arable rotations in the United Kingdom. In: *Grassland re-sowing and grass-arable crop rotations*, the EGF Working Group Report 1, 93-104.

Hayes B.J., Bowman P.J., Chamberlain A.J., Goddard M.E., 2009. Invited review: Genomic selection in dairy cattle: Progress and challenges. *Journal of Dairy Science*, 92, 433-443. DOI: 10.3168/jds.2008-1646.

Hengl T., Panagos P., Jones A., Tóth G., 2007. Status and prospect of soil information in south-eastern Europe : soil databases, projects and applications. Publication of the Joint Research Centre, Institute of Environment and Sustainability, 188 p.

Henle K., Alard D., Clitherow J., Cobb P., Firbank L., Kull T., McCracken D., Moritz R.F.A., Niemela J., Rebane M., Wascher D., Watt A., Young J., 2008. Identifying and managing the conflicts between agriculture and biodiversity conservation in Europe—A review. *Agriculture, Ecosystems and Environment*, 124, 60-71.

Hoisl R., Nohl W., Zekorn S., Zollner G., 1988. Development of a procedure to evaluate the aesthetic impacts of land consolidation measures-empirical basis. *Zeitschrift für Kulturtechnik und Flurbereinigung*, 29, 217-226.

Hume C.J., Corral A.J., 1986. A quantitative study of the effects of climate variability and climatic change on herbage production from intensively managed grassland in Western European countries. Final report EC- contract N° CLI-058-81-UK, 37 p.

Humphreys J., Casey I.A., 2002. Grassland renovation in Ireland. In: *Grassland re-sowing and grass-arable crop rotations*, the EGF Working Group Report 1, 79-92.

Huyghe C., 2009. Evolution des prairies et cultures fourragères et de leurs modalités culturales et d'utilisation en France au cours des cinquante dernières années. *Fourrages*, 200, 407-428.

Huyghe C., Delaby L., 2013. *Prairies et Systèmes Fourragers*, Editions La France Agricole, 530 p.

Huyghe C., Duru M., Peyraud J.L., Lherm M., Gensollen V., Bournoville R., Couteaudier Y., 2005. *Prairies et cultures fourragères : au carrefour des logiques de production et des enjeux environnementaux*, Inra éditions, 209 p.

I

IEEP (Institute of European Environmental Policy), 2007. Evaluation of the environmental impacts of CAP (Common Agricultural Policy) measures related to the beef and veal sector and the milk sector. Report prepared for DG Agriculture.

IPCC (Intergovernmental Panel on Climate Change), 2000. *Land Use, Land-Use Change, and Forestry* (R.T. Watson, I.R. Noble, B. Bolin, N.H. Ravindranath, D.J. Verardo, D.J. Dokken, eds), Cambridge University Press, UK.

Isselstein J., Jeangros B., Pavlu V., 2005. Agromonic aspects of biodiversity targeted management of temperate grasslands in Europe – A review. *Agronomy Research*, 3, 139-151.

J

Jankowska-Huffejt H., 2006. The function of permanent grasslands in water resources protection. *Journal of water and land development*, 10, 55-65.

Janssens F., Peeters A., Tallowin J.R.B., Bakker J.P., Bekker R.M., Fillat F., Oomes M.J.M., 1998. Relationship between soil chemical factors and grassland diversity. *Plant and Soil*, 202, 69-78.

Janssens I.A., Freibauer A., Schlamadinger B., Ceulemans R., Ciais P., Dolman A.J., Heimann M., Nabuurs G.-J., Smith P., Valentini R., Schulze E.-D., 2005. The carbon budget of terrestrial ecosystems at country-scale – a European case study. *Biogeosciences*, 2, 15-26.

Jansson U., 2011. Agriculture and Forestry in Sweden since 1900. A Cartographic Description. Stockholm: Royal Swedish Academy of Agriculture and Forestry 2011 (National Atlas of Sweden), Stockholm, Sweden.

Jeanros B., Thomet P., 2004. Multi-functionality of grassland systems in Switzerland. *Grassland Science in Europe*, 9, 11-23.

Jones M.B., Carter T.R., 1992. European grassland production in a changing climate. In: *Proceedings of the 14th General Meeting of the European Grassland Federation*, pp. 97-110.

Jones M.B., Donnelly A., 2004. Carbon sequestration in temperate grassland ecosystems and the influence of management, climate and elevated CO₂. *New Phytologist*, 164, 423-439.

K

Keenleyside C., Veen P., Baldock P., 2004. Land abandonment in the New Member States and candidate countries and the EU Common Agricultural policy. Background document from the Seminar on Land Abandonment and Biodiversity in the New EU Member States and Candidate countries in Relation to the EU Common Agricultural Policy held in Sigulda, Latvia, on October 7-8, 2004.

Kempen M., Witzke P., Pérez Domínguez I., Jansson T., Sckokai P., 2011. Economic and environmental impacts of milk quota reform in Europe. *Journal of Policy Modelling*, 33, 29-52.

Knapp M., Rösch C., Jörisen, J., Skaska J., 2010. Strategies to reduce land use competition and increasing the share of biomass in the German energy surplus. 18th European Biomass Conference and Exhibition – Lyon, 10 p. <http://www.kit.edu>

Kowalkowska B., 2005. 4.1.5. Rural development policy. European Parliament Fact Sheets. Downloadable from http://www.europarl.europa.eu/facts/4_1_5_en.htm?textMode=on

Krauss J., Bommarco R., Guardiola M., Heikkinen R.K., Helm A., Kuussaari M., Lindborg R., Öckinger E., Pärtel M., Pino J., Pöyry J., Raatikainen K.M., Sang A., Stefanescu C., Teder T., Zobel M., Steffan-Dewenter I., 2010. Habitat fragmentation causes immediate and time-delayed biodiversity loss at different trophic levels. *Ecology Letters*, 13, 597-605.

Kuikman P., De Groot W., Hendriks R., Verhagen J., De Vries F., 2002. Stocks of C in soils and emissions of CO₂ from agricultural soils in the Netherlands. *Alterra-rapport 561*. 45 p.

L

Lande R., Thompson R., 1990. Efficiency of marker-assisted selection in the improvement of quantitative traits. *Genetics*, 124, 743-756.

Leafe E.L., 1988. Introduction: the history of improved grasslands. In: *The grass crop. The physiological basis of production* (Jones M.B., Lazenby A., eds), Chapman and Hall Limited, 1-23.

Lee J., 1983. The spatial pattern of grassland production in Europe. In: *Proceedings of the 9th General Meeting of the European Grassland Federation*, 11-20.

Lehmann J., 2003. Von der Kontrollstation zum Nationalen Zentrum für Agrarökologie: Zur Geschichte der landwirtschaftlichen Forschungsanstalt Zürich-Reckenholz 1878-2003. *Schriftenreihe der FAL*, 46, 176 S.

Leifeld J., Bassin S., Fuhrer J., 2005. Carbon stocks in Swiss agricultural soils predicted by land-use, soil characteristics and altitude. *Agriculture, Ecosystems and Environment*, 105, 255-266.

Lelyon B., Chatellier V., Daniel K., 2010. Impact of decoupling and price variation on dairy farmers' strategy. Overview of theoretical and real effects. OECD Conference, Evaluation of CAP Reform at Disaggregated Level, 18 pp.

Letten S., Van Orshoven J., Van Wesemael B., Muys B., Perrin D., 2005. Soil organic carbon changes in landscape units of Belgium between 1960 and 2000 with reference to 1990. *Global Change Biology*, 11, 2128-2140.

Liljenstolpe C., 2009. Horses in Europe. Swedish University of Agricultural Sciences, Uppsala, 28 p.

- Llausas A., Ribas A., Varga D., Vila, J., 2009.** The evolution of agrarian practices and its effects on the structure of enclosure landscapes in the Alt Emporda (Catalonia, Spain), 1957-2001. *Agriculture, Ecosystems & Environment*, 129, 73-82.
- Lowell F.C., 1990.** Observations on heaves. An asthma-like syndrome in the horse. *Allergy proc.*, 11, 147-150.
- Luan T., Woolliams J.A., Lien S., Kent M., Svendsen M., Meuwissen T.H.E., 2009.** The Accuracy of Genomic Selection in Norwegian Red Cattle Assessed by Cross-Validation. *Genetics*, 183, 1119-1126.
- ## M
- McCracken D.I., Tallowin J.R., 2004.** Swards and structure: the interactions between farming practices and bird food resources in lowland grasslands. *Ibis* (London), 146, Suppl.2, 108-114.
- MacDonald D., Crabtree J.R., Wiesinger G., Dax T., Stamou N., Fleury Ph., Gutierrez Lazpita J., Gibon A., 2000.** Agricultural abandonment in mountain areas of Europe: Environmental consequences and policy response. *Journal of Environmental Management*, 59, 47-69.
- Mair T.S., Derksen F.J., 2000.** Chronic Obstructive Pulmonary Disease: a review. *Equine Veterinary Education*, 12, 35-44.
- Marini L., Scotton M., Klimek S., Isselstein J., Angelo P., 2007.** Effects of local factors on plant species richness and composition of Alpine meadows. *Agriculture, Ecosystems and Environment*, 119, 281-288.
- Marsden T., Sonnino R., 2008.** Rural development and the regional state: denying multi-functional agriculture in the UK. *Journal of Rural Studies*, 24, 422-443.
- Martin B., Hurtaud C., Graulet B., Ferlay A., Chilliard Y., Coulon J.-B., 2009.** Herbe et qualités nutritionnelles et organoleptiques des produits laitiers. *Fourrages*, 199, 291-310.
- Massot A., 2008.** Common Agricultural Policy. European Parliament, Factsheet on the European Union. Downloadable from <http://www.europarl.europa.eu/parliament/expert/displayFtu.do?language=en&id=73&ftuId=the me4.html>
- Mathieu A., Joannon A., 2003.** How farmers view their job in Pays de Caux, France. Consequences for grassland in water erosion. *Environmental Science and Policy*, 6, 29-36.
- Matzdorf B., Kaiser T., Rohner M.S., 2008.** Developing biodiversity indicator to design efficient agri-environmental schemes for extensively used grassland. *Ecological Indicators*, 8, 256-269.
- Maurer K., Weyand A., Fischer M., Stöcklin J., 2006.** Old cultural traditions, in addition to land use and topography, are shaping plant diversity of grasslands in the Alps. *Biological Conservation*, 130, 438-446.
- Meuwissen T.H.E., Hayes B.J., Goddard M.E., 2001.** Prediction of total genetic value using genome-wide dense marker maps. *Genetics*, 157, 1819-1829.
- Mignolet C., Schott C., Benoît M., Meynard J.M., 2012.** Transformations des systèmes de production et des systèmes de culture du bassin de la Seine depuis les années 1970 : une spécialisation des territoires aux conséquences environnementales majeures. *Innovations Agronomiques*, 22, 1-16.
- Mosimann E., Frick R., 2008.** Mélanges standard pour la production fourragère. Révision 2009-2012. *Revue Suisse Agriculture*, 40, 5, 1-12.
- ## N
- Nagy Z., Pintér K., Czóbel Sz., Balogh J., Horváth L., Fóti Sz., Barcza Z., Weidinger T., Csintalan Sz., Dinh N.Q., Grosz B., Tuba Z., 2007.** The carbon budget of semi-arid grassland in a wet and a dry year in Hungary. *Agriculture, Ecosystems and Environment*, 121, 21-29.
- Neuner S., Gotz K.U., 2009.** Strategies for integrating genomic selection into the breeding program for Simmental Cattle. *Zuchtungskunde*, 81, 312-327.
- Nizami A., Korres N., Murphy J., 2009.** A review of the integrated process for the production of grass biomethane. *Environmental Science and technology*, 43, 8496-8508.
- ## O
- Observatoire économique et social du cheval de l'Institut français du cheval et de l'équitation, 2011.** *Annuaire ECUS 2011*, Institut français du cheval et de l'équitation, 64 p.
- Oppermann R., 2003.** Nature balance scheme for farms—evaluation of the ecological situation. *Agriculture, Ecosystems and Environment*, 98, 463-475.
- Oppewal J., 2010.** Suikerbiet gooit hoge ogen in vergister. *Boerderij*, 8, 30-32.
- Osterburg B., Isermeyer F., Lassen B., Röder N., 2010.** Impact of political drivers on the grassland

use in the EU. *Grassland Science in Europe*, 15, 14-29.

Osterburg B., Nitsch H., Laggner A., Wagner S., 2008. Analysis of policy measures for greenhouse gas abatement and compliance with the convention on biodiversity, MEACAP project, WP6 D16a, Report Prepared for DG Research, Brussels.

P

Paavola T., Lehtomäki A., Seppälä M., Rintala J., 2007. Methane Production from reed canary grass. CROPGEN Publication. Jyväskylä, Finland.

Paracchini M.L., Petersen J.E., Hoogeveen Y., Bamps C., Burfield I., van Swaay C., 2008. High Nature Value Farmland in Europe - An Estimate of the Distribution Patterns on the Basis of Land Cover and Biodiversity Data. EUR 23480 EN – Joint Research Centre – Institute for Environment and Sustainability, Scientific and Technical Research series, 87 pp.

Pärt T., Söderström B., 1999. The effects of management regimes and location in landscapes on the conservation of farmland birds breeding in semi-natural pastures. *Biological Conservation*, 90, 113-123.

Pärtel M., Bruun H.H., Sammuli M., 2005. Biodiversity in temperate European grasslands: origin and conservation. *Grassland Science in Europe*, 11, 1-13.

Peeters A., 2008. Public demands on intensive grassland systems and agri-environmental policies of OECD members. *Multifunctional Grassland in a Changing World*, 1, 15-31.

Peeters A., Hopkins A., 2010. Climate change in European grasslands. *Grassland Science in Europe*, 15, 72-74.

Peeters A., Kopec S., 1996. Production and productivity of cutting grasslands in temperate climates of Europe. *Grassland Science in Europe*, 1, 59-73.

Peeters A., 2004. *Wild and sown grasses. Profiles of a temperate species selection: ecology, biodiversity and use*, FAO & Blackwell Publishing, Italy, 311 pp.

Peeters A., 2009. Importance, evolution, environmental impact and future challenges of grasslands and grassland-based systems in Europe. *Grassland Science*, 55, 1-13.

Peeters A., 2010. Socio-economic and political driving forces. 7th Framework Programme, Multisward deliverable D5.1, 64 p.

Peeters A., Beaufoy G., Canals R.M., De Vliegheer A., Huyghe C., Isselstein J., Jones G., Kessler W., Kirilov A., Mosquera-Losada M.R., Nilsdotter-Linde N., Parente G., Peyraud J.-L., Pickert J., Plantureux S., Porqueddu C., Rataj D., Stypinski P., Tonn B., van den Pol – van Dasselaar A., Vintu V., Wilkins R., 2013. Grassland term definitions and classifications adapted to the diversity of European grassland-based systems. European Grassland Federation and the EC MULTISWARD project, 9 pp.

Peratoner G., Figl U., Gottardi S., Bodner A., Werth E., Kasal A., 2009. Temporal variability in the forage production of a protected area with heterogeneous vegetation types. In: *Proceedings of the 15th of the European Grassland Federation Symposium*, Brno, Czech Republic.

Peyraud J.L., Le Gall A., Lüscher A., 2009. Potential food production from forage legume-based systems in Europe: an overview. *Irish Journal of Agricultural and Food research*, 48, 115-135.

Pfimlin A., Arnaud J., Gautier D., Le Gall A., 2003. Les légumineuses fourragères une voie pour concilier autonomie en protéines et préservation de l'environnement. *Fourrages*, 174, 183-203.

Pfimlin A., Buczinski B., Perrot C., 2005. Proposition de zonage pour préserver la diversité des systèmes d'élevage et des territoires européens. *Fourrages*, 182, 311-329.

Phoenix G.K., Johnson D., Grime J.P., Booth R.E., 2008. Sustaining ecosystem services in ancient limestone grassland: importance of major component plants and community composition. *Journal of Ecology*, 96, 894-902.

Pihlgren A., Lenoir L., Dahms H., 2010. Ant and plant species richness in relation to grazing, fertilisation and topography. *Journal for Nature Conservation*, 18, 118-125.

Plantureux S., Peeters A., McCracken D., 2005. Biodiversity in intensive grasslands: effect of management improvement and challenges. *Agronomy Research*, 3, 153-164.

Plassart P., Vincelas M.A., Gangneux C., Mercier A., Barray S., Laval K., 2008. Molecular and functional responses of soil microbial communities under grassland restoration. *Agriculture, Ecosystems and Environment*, 127, 286-293.

Pointereau P., Coulon F., Girard P., Lambotte M., Stuczynski T., Sanchez Ortega V., Del Rio A., 2008. Analysis of Farmland Abandonment and the Extent and Location of Agricultural Areas that are Actually Abandoned or are in Risk to be Abandoned. Institute for Environment and Sustainability, Joint Research Centre, EC, 205 pp.

Potts S.G., Woodcock B.A., Roberts S.P.M., Tscheulin T., Pilgrim E.S., Brown V.K., Tallowin J.R., 2009. Enhancing pollinator biodiversity in intensive grasslands. *Journal of Applied Ecology*, 46, 369-379.

Pöyry J., Lindgren S., Salminen J., Kuussaari M., 2005. Responses of butterfly and moth species to restored cattle grazing in semi-natural grasslands. *Biological Conservation*, 122, 465-478.

Prendiville R., Buckley F., Byrne N., Rath M., 2007. Milk production, body condition score at breeding and reproductive efficiency of first lactation Holstein-Friesian, Jersey and Holstein-FriesianxJersey cows under Irish grass-based production circumstances. *Journal of Animal Science*, 85, 194-194.

Prochnow A., Heiermann M., Idler C., Linke B., Plöchl M., Amon T., Langeveld H., Hobbs P., 2008. Biogas yields from grassland. *Grassland Science in Europe*, 13, 727-729.

Prochnow A., Heiermann M., Plöchl M., Amon T., Hobbs P., 2009. Bioenergy from permanent grassland – a review: 2. Combustion. *Bioresource Technology*, 100, 4945-4954.

Pywell R.F., Bullock J.M., Tallowin J.B., Walker K.J., Warman E.A., Masters G., 2007. Enhancing diversity of species-poor grasslands: an experimental assessment of multiple constraints. *Journal of Applied Ecology*, 44, 81-94.

R

Reheul D., De Vliegheer A., Bommelé L., Carlier L., 2007. The comparison between temporary and permanent grassland. *Grassland Science in Europe*, 12, 1-13.

Richter F., Wachendorf M., 2010. A comparison of different conversion techniques for the production of energy from permanent grasslands. *Grassland Science in Europe*, 15, 274-276.

Röeder N., Hennessy T., Stilmant D., 2007. Impact of the CAP-reform of 2003 on the use of pastoral land in Europe. *Grassland Science in Europe*, 12, 445-462.

Rolf M.M., Taylor J.F., Schnabel R.D., McKay S.D., McClure M.C., Northcutt S.L., Kerley M.S., Weaber R.L., 2010. Impact of reduced marker set estimation of genomic relationship matrices on genomic selection for feed efficiency in Angus cattle. *BMC Genetics*, 11, 24.

Rook A.J., Tallowin J.R.B., 2005. Grazing and pasture management for biodiversity benefit. *Animal Research*, 52, 181-189.

Rotar I., Vidican R., 2005. The storage of carbon in systems of meadows. *Bulletin of the university of agricultural science and veterinary medicine of Cluj-Napoca*, 61, 29-33.

Rutgers M., Mulder C., Schouten A.J., Bloem J., Bogte J.J., Brussaard L., De Goede R.G.M., Faber J.H., Jagers op Akkerhuis G.A.J.M., Keidel H., Korthals G.W., Smeding F.W., Ter Berg C., Van Eekeren N., 2008. Soil ecosystems profiling in the Netherlands with ten references for biological soil quality. RIVM Report 6076040009/2008, Bilthoven, 86 p.

Rutgers M., Schouten A.J., Bloem J., Van Eekeren N., De Goede R.G.M., Jagers op Akkerhuis G.A.J.M., Van der Wal A., Mulder C., Brussaard L., Breure A.M., 2009. Biological measurements in a nationwide soil monitoring network. *European Journal of Soil Science*, 60, 820-832.

S

Sammul M., Kull K., Tamm A., 2003. Clonal growth in a species-rich grassland: results of a 20-year fertilization experiment. *Folia Geobotanica*, 38, 1-20.

Sanderson F.J., Kloch A., Sachanowicz K., Donald P., 2009. Predicting the effects of agricultural change on farmland bird populations in Poland. *Agriculture, Ecosystems and Environment*, 129, 37-42.

Sang A., Teder T., Helm A., Pärtel M., 2010. Indirect evidence for an extinction debt of grassland butterflies half century after habitat loss. *Biological Conservation*, 143, 1405-1413

Sarzeaud P., Pfimlin A., Perrot C., Becherel F., 2008. Diversity of beef farming systems and grassland use in Europe. *Grassland Science in Europe*, 13, 693-705.

Schiltz R., Aarts F., Bussink D., Conijn J., Corré J., van Dam A., Hoving I., van der Meer H., Velthof G., 2002. Grassland renovation in the Netherlands: agronomic, environmental and economic issues. *In: Grassland reseeding and grass-arable crop rotations*, the EGF Working Group Report 1, 9-24.

Schmalzer K., Weiss K., Krause R., 2010. Suitability of perennial grasses and legume-mixtures for methane production. *Grassland Science in Europe*, 15, 283-285.

Schott C. (Dir.), Mignolet C., Benoît M., 2009. *Agriculture du bassin de la Seine : Découvrir l'agriculture du bassin de la Seine pour comprendre les enjeux de la gestion de l'eau*. Nanterre (FRA) : Agence de l'Eau Seine-Normandie. 79 p. Programme Piren - Seine, (5).

- Schupbach B., Zraggen K., Szerencsits E., 2008. Incentives for low-input land-use types and their influence on the attractiveness of landscapes. *Journal of Environmental Management*, 89, 222-233.
- Silva J.P., Toland J., Jones W., Eldridge J., Thorpe E., O'Hara E., 2008. LIFE and Europe's grasslands: Restoring a forgotten habitat. European Commission, 52 pp.
- Singh A., Korres N., Murphy J., 2010a. Grass biomethane: a sustainable alternative industry for grassland. *Grassland Science in Europe*, 15, 139-148.
- Singh A., Smyth B., Murphy J., 2010b. A biofuel strategy for Ireland with an emphasis on production of biomethane and minimization of land take. *Renewable and Sustainable reviews*, 14, 277-288.
- Skórka P., Lenda M., Tryjanowski P., 2010. Invasive alien goldenrods negatively affect grassland bird communities in Eastern Europe. *Biological Conservation*, 143, 856-861.
- Smit A., Kuikman P., 2005. Organische stof: onbeminde of onbekend? Alterra-rapport 1126. Alterra, Wageningen, 39 p.
- Smit H., Metzger M., Ewert F., 2008. Spatial distribution of grassland productivity and land use in Europe. *Agricultural systems*, 98, 208-219.
- Soegaard K., Eriksen J., Kristensen I.S., 2002. Grassland cultivation in Denmark. In: *Grassland reseed and grass-arable crop rotations*, EGF Working Group Report, 1, 33-46.
- Sölter U., Höppner F., Liesink W., Ingwersen B., Feuerstein U., Greef J., 2010. Grass and grass – legume mixtures for methane production. *Grassland Science in Europe*, 15, 295-297.
- Souchère V., King C., Dubreuil N., Lecomte-Morel V., Le Bissonais Y., Chalot M., 2003. Grassland and crop trends: role of the European Union Common Agricultural Policy and consequences for runoff and soil erosion. *Environmental Science and Policy*, 6, 7-16.
- Soussana J.-F., Loiseau P., Vuichard N., Ceschia E., Balesdent J., Chevallier T., Arrouays D., 2004a. Carbon cycling and sequestration opportunities in temperate grasslands. *Soil Use and Management*, 20, 219-230.
- Soussana J.-F., Salètes S., Smith P., Schils R., Ogle S., Allard V., Ambus P., Amézquita M.C., Arrouays D., Ball B., Boeckx P., Brüning C., Buchmann N., Buendia L., Campbell C., Cellier P., Cernusca A., Clifton-Brown J., Dämmgen U., Ewert F., Fiorelli J.-L., Flechard C., Freibauer A., Führer J., Harrison R., Hensen A., Hiederer R., Janssens I., Jayet P.-A., Jones M., Jouany J.-P., Jungkunst H., Kuikman P.J., Lagreid M., Leffelaar P.A., Leip A., Loiseau P., Martin C., Milford C., Neftel A., Oenema O., Olesen J.E., Pesmajoglou S., Petersen S.O., Pilegaard K., Raschi A., Rees R.M., Sezzi E., Skiba U., Stefani P., Sutton M.A., van Amstel A., Van Cleemput O., van Putten B., van Wesemael B., Verhagen J., Viouy N., Vuichard N., Tuba Z., Weigel H.-J., Willers H.C., 2004b. Greenhouse gas emissions from European grasslands. Discussion paper originated from a workshop in Clermont-Ferrand, France. A contribution to the project Concerted Action CarboEurope – GHG, part of the CarboEurope Cluster.
- Spörndly R., Nilsdotter-Linde N., 2011. L'ensilage des prairies temporaires en Suède: un développement réussi. *Fourrages*, 206, 107-117.
- Stapledon R.G., Davies W., 1948. *Ley farming*, Faber and Faber, London.
- Stebler F.G., 1895. *Die Grassamenmischungen*, Wyss, Bern.
- Steinfeld H., Gerber P., Wassenaar T., Castel V., Rosales M., de Haan C., 2006. Livestock's long shadow, environmental issues and options. FAO and LEAD, 390 pp.
- Stoate C., Baldi A., Beja P., Boatman N.D., Herzog I., van Doorn A., de Snoo G.R., Rakosy L., Ramwell C., 2009. Ecological impacts of early 21st century agricultural change in Europe – A review. *Journal of Environmental Management*, 91, 22-46.
- Stybnarova M., Haki J., Krhovjakova J., Pozdisek J., 2009. Botanical composition of pasture sward influenced by intensity of utilisation and mineral fertilisation. In: *Proceedings of the 15th of the European Grassland Federation Symposium*, Brno, Czech Republic.
- Stypinski P., Hejduk S., Svoboda M., Haki J., Rataj D., 2009. Development, current state and changes in grassland in the past year. *Grassland Science in Europe*, 14, 1-11.
- Suter D., Rosenberg E., Mosimann E., 2004. Standardmischungen für den Futterbau. Revision 2005-2008. *Agrarforschung*, 11(9), 1-12.

T

- Taberlet P., Coissac E., Pansu J., Pompanon F., 2011. Conservation genetics of cattle, sheep, and goats. *Comptes Rendus Biologies*, 334, 247-254.
- Tallowin J.R.B., Jefferson R.G., 1999. Hay production from lowland semi-natural grass-

lands: a review of implications for ruminant livestock systems. *Grass and Forage Science*, 54, 99-115.

Taube F., Hermann A., Pötsch E., 2007. What are the consequences of producing energy crops in the European Union for grassland renovation and new forage production systems? *Grassland Science in Europe*, 12, 463-471.

Taube F., Wachendorf M., Trott H., 2002. Future challenges in grassland cultivation in Europe. In: *Grass reseeding and grass-arable crop rotations*, EGF Working Group Report, 67-78.

Tonn B., Thumm U., Claupein W., 2010. Life cycle of heat generation using biomass from semi-natural grasslands in Central Europe. *Grassland Science in Europe*, 15, 284-296.

U

UK National Ecosystem Assessment, 2011. The UK National Ecosystem Assessment Technical Report. UNEP-WCMC, Cambridge.

V

Van den Pol-van Dasselaar A., Vellinga T.V., Johansen A., Kennedy E., 2008. To graze or not to graze, that's the question. *Grassland Science in Europe*, 13, 706-716.

Van Eekeren N., 2010. Grassland management, soil biota and ecosystem services in sandy soils. Doctoral thesis, Wageningen University, Wageningen, NL, 264p.

Van Rompaey A., Krasa J., Dostal T., 2007. Modelling the impact of land cover changes in the Czech Republic on sediment delivery. *Land Use Policy*, 24, 576-583.

Veen P., Molnár Z., Pärtel M., Nagy S., 2001. Grassland ecosystems in Central and Eastern Europe. Prepared in the framework of the High Level Conference on EU Enlargement, The relation between agriculture and nature management, 19 p.

Vidal C., 2001. Extensive areas account for at least 42% of agricultural land. EUROSTAT, Statistics in focus, 25, 8 pp.

Vickery J.A., Tallwin J.R., Feber R.E., Asteraki E.J., Atkinson P.W., Fuller R.J., Brown V.K., 2001. The management of lowland neutral grasslands in Britain: effects of agricultural practices on birds and their food resources. *Journal of Applied Ecology*, 38, 647-664.

Vignau-Loustau L., Huyghe C., 2008. *Stratégies fourragères*, Editions La France Agricole, 336 p.

Vleeshouwers L.M., Verhagen A., 2001. CESAR: a model for carbon emission and sequestration by agricultural land use. Report 36, Plant Research International, Wageningen, 27 p.

Voisin A.S., Guéguen J., Huyghe C., Jeufroy M.H., Magrini M.B., Meynard J.M., Mougel C., Pellerin S., Pelzer E., 2013. Legumes for feed, food, biomaterials and bioenergy in Europe: a review. *Agronomy for Sustainable Development*. On Line. 10.1007/s13593-013-0189-y

W

Walker K.J., Stevens P.A., Stevens D.P., Mountford J.O., Manchester S.J., Pywell R.F., 2005. The restoration and re-creation of species-rich lowland grassland on land formerly managed for intensive agriculture in the UK. *Biological Conservation*, 119, 1-18.

Weiland P., 2007. Stand und Perspektiven der Erzeugung und Nutzung in Deutschland. *Agrarspectrum*, 40, 111-122.

Whittingham M.J., Devereux C.L., 2008. Changing grass height alters foraging site selection by wintering farmland birds. *Basic and Applied Ecology*, 9, 779-788.

Wilkins R.J., Hopkins A., Hatch D.J., 2003. Grassland in Europe. *Grassland Science*, 49, 258-266.

Wittig B., Kemmermann A.R. gen., Zacharias D., 2006. An indicator species approach for result-orientated subsidies of ecological services in grasslands: a study in Northwestern Germany. *Biological Conservation*, 133, 186-197.

Woodcock B.A., Potts S.G., Pilgrim E., Ramsay A.J., Tscheulin T., Parkinson A., Smith R.E.N., Gundry A.L., Brown V.K., Tallwin J.R., 2007. The potential of grass field margin management for enhancing beetle diversity in intensive livestock farms. *Journal of Applied Ecology*, 44, 60-69.

Woodcock B.A., Potts S.G., Tscheulin T., Pilgrim E., Ramsey A.J., Harrison-Cripps J., Brown V.K., Tallwin J.R., 2009. Responses of invertebrate trophic level, feeding guild and body size to the management of improved grassland field margins. *Journal of Applied Ecology*, 46, 920-929.

Z

Zdanowicz A., Miller C., Baldock D., 2005. The Convention on Biodiversity and Its Potential Implications for the Agricultural Sector in

Europe. MEACAP project, MEACAP WP5 D2, Report Prepared for DG Research, Brussels.

Zechmeister H.G., Schmitzberger I., Steurer B., Peterseil J., Wrabka T., 2003. The influence of land-use practices and economics on plant spe-

cies richness in meadows. *Biological Conservation*, 114, 165-177.

Zohary D., 1986. The origin and early spread of agriculture in the old world. *In: The origin and domestication of cultivated plants* (Barigozzi C., ed.), Elsevier, Amsterdam.

Webography

Eurostat http://epp.Eurostat.ec.europa.eu/portal/page/portal/statistics/search_database

FAOSTAT <http://faostat.fao.org/default.aspx>

The biogeographical regions in Europe (EEA 2009) <http://www.eea.europa.eu/data-and-maps/figures/biogeographical-regions-in-europe>

Organic carbon content (%) in the surface horizon of soils in Europe http://eusoils.jrc.ec.europa.eu/esdb_archive/octop/octop_download.html

http://www.inra.fr/layout/set/print/presse/mesures_agri_environnementales_avec_engagement_de_resultat_ecologique

Annex 1

Data and data processing

The data used in this book come from several main sources: Eurostat and related publications, FAOSTAT and national data. In the Eurostat database (public website), data are not available before 1990; data for the entire 1990–2007 period are only available for a limited number of countries. The FAOSTAT database provides data from 1961, and includes data for former European communist countries. In Eurostat, these data are only available after these countries' accession to the EU. Even in the FAO database, data are lacking prior to 1992 for countries that split after political regime changes (i.e., the Czech Republic, Estonia, Latvia, Lithuania, the Russian Federation, Slovakia and the former Yugoslavian countries).

Data for Germany include those from the Federal Republic of Germany (FRG) until 1990 and those of the FRG and the former German Democratic Republic (GDR) thereafter. Any interpretation of evolution trends based on several factors must take this expansion of the German territory into account.

Data mentioned for France in this book pertain to mainland France. Eurostat lacks data for the 2005–2007 period. Data for the entire French territory were used for this period.

In FAOSTAT, data for Belgium and Luxembourg were clustered between 1961 and 1999. Since 2000, data for Luxembourg are available separately but data is incomplete for Belgium. This is why data for these two countries are not presented in this book for this database.

In the FAOSTAT database, 'permanent meadows and grasslands' refer to land used permanently (five years or more) to grow herbaceous forage crops, either cultivated or growing wild. It is synonymous with 'permanent grasslands' in this book. 'Temporary meadows and grasslands' refer to land temporarily cultivated with herbaceous forage crops for mowing or grasslands, mainly based on perennial grass and legume species; a period of less than five years is used to differentiate between temporary and permanent meadows. In this book, they are called 'temporary grasslands'. It is not always clear if 'rangelands' or 'rough grazing' are included in 'permanent meadows and grasslands'.

In the Eurostat database, 'permanent grasslands and meadows' (code F; 'permanent grasslands' or 'total permanent grasslands' in this book) include 'grasslands and meadows' (F01) and 'rough grazing' (F02). Rough grazing is defined as 'low yielding permanent grassland, usually on low quality soil, for example on hilly land and at high altitudes, usually unimproved by fertiliser, cultivation, reseeding or drainage. These areas can normally be used only for extensive grazing and are not normally

mown or are mown in an extensive manner; they cannot support a large density of animals' (Eurostat website). 'Fodder crops and grass' (D12-18-F; 'forage crops' in this book) include notably 'total forage plants' (D18). This last category is divided into 'temporary grass' (D18A; 'temporary grasslands' in this book) and 'other green fodder' (D18B). Other green fodder includes 'green maize' (D18B1; 'green maize' in this book) and 'annual legume plants' (D18B2; 'forage legumes' in this book). In this book, the total fodder area is the sum of the permanent grassland and forage crops areas.

Data on temporary grasslands are only available for some countries after 1990 in Eurostat and after 2001 in FAOSTAT.

Statistics on grasslands and fodder area as a whole must be interpreted with caution. Statistics for the same category, the same country and the same year may differ in the FAOSTAT and Eurostat databases or in national statistical systems. In some cases, not all types of grassland areas are reported and some areas reported as forage crops are not used by grazing livestock. Some common land areas might not be recorded at all. Areas of grasslands may be used mainly for other purposes (airports, military training areas, dikes). For instance in France, common lands and grasslands that are not managed by farmers were estimated at 1.5 million ha (Pointereau *et al.*, 2008), an area equivalent to almost 20% of the official permanent grassland area in 2007. Some semi-natural vegetation types such as *Calluna vulgaris* communities, wooded grasslands and rangelands or Mediterranean grazed fallow lands are not counted as grasslands although they can be grazed.

The acreages of green maize and grasslands for biogas production, which are on the rise in Germany for instance, are not separated from the forage area reported. Statistical time series on grasslands in the EU-27 are incomplete and are affected by changing survey methods, such as the minimum farm size included in the statistics (Osterburg *et al.*, 2010).

In the FAOSTAT database, data are notably available for cattle, sheep and goats. Categories are not distinguished among cattle.

In the Eurostat database, 'livestock' (J) data include data on 'granivores' (pigs and poultry) and 'grazing livestock'. Grazing livestock (J) includes 'equidae' (J01), 'cattle' (J02-08), 'sheep' (J09) and 'goats' (J10). The cattle category is divided into 'bovine < 1-year-old – total' (J02), '1 year ≤ bovine < 2 years – males' (J03), '1 year ≤ bovine < 2 years – females' (J04), 'bovine 2 years and older – males' (J05), 'heifers, 2 years and older' (J06), 'Dairy cows' (J07), 'other cows, bovine 2 years old and over' (J08). This last category includes mainly 'suckling cows'.

Data from animal performance were obtained from national databases such as 'contrôle laitier' in France.

Data for seed and seed industries were collected from the national certification offices and computed.

Data for dairy and meat industries were obtained from national statistics and were crosschecked with European data.

In this book, there are regular mentions of the EU-6, EU-9, EU-12, EU-15 and EU-27. The EU-6 includes Belgium, France, Germany, Italy, Luxembourg, the

Netherlands; the EU-9: EU-6 + Denmark, Ireland and the United Kingdom; the EU-12: EU-9 + Greece, Portugal and Spain; the EU-15: EU-12 + Austria, Finland and Sweden; the EU-27: EU-15 + Bulgaria, the Czech Republic, Cyprus, Estonia, Latvia, Lithuania, Hungary, Malta, Poland, Romania, Slovakia and Slovenia. EU-12-NMS (New Member States) is sometimes mentioned as the difference between EU-27 and EU-15; this category includes Bulgaria, the Czech Republic, Cyprus, Estonia, Latvia, Lithuania, Hungary, Malta, Poland, Romania, Slovakia and Slovenia. EU-2-NMS includes Bulgaria and Romania. EU-10-NMS is the difference between EU-12-NMS and EU-2-NMS.

Copy editor: T. Jones-Villeneuve

Formaté typographiquement par DESK (53) :
02 43 01 22 11 – desk@desk53.com.fr

The European project Multisward (http://www.multisward.eu/multisward_eng/) aims at supporting developments and innovations in grassland use and management in different European farming systems (including low-input and organic farming systems), pedoclimatic and socio-economic conditions i) to enhance the role of grasslands at farm and landscape levels to produce environmental goods and to limit the erosion of biodiversity and ii) to optimise economic, agronomic and nutritional advantages for the development of innovative and sustainable ruminant production systems.

The identification of the innovations and their implementation required an exhaustive analysis of the state of grasslands and herbivore production in Europe including how they changed over decades. The effects of public policies were investigated. The results of this analysis are published in the present book.

Christian Huyghe is a plant geneticist. Researcher at INRA in the Plant Genetics Division since 1987, he worked on a grain legume and on forage legumes and grasses (improvement of yield, forage quality and seed production, dynamics of multispecies swards). He is presently Deputy Scientific Director of Agriculture at INRA, chairs the forage and turf species section of the CTPS (French Committee for Variety Registration) and chairs the Scientific Committee of Acta, coordinating the various French agricultural technical institutes.

Alex De Vliegher is an agronomist and PhD at the Faculty of Bioscience Engineering in Ghent (Belgium). Since 1981, he is working at the Plant Sciences Unit of the Institute for Agricultural and Fisheries Research (ILVO) in Merelbeke (Belgium). He runs applied research on sustainable grassland management and forage production, with a special focus on grassland renovation, fertilization, grass/legumes and grassland use systems.

Bert Van Gils has a Master of Bioscience Engineering (Land and Forest Management). Since 2008, he has been working at the Plant Sciences Unit of the Institute for Agricultural and Fisheries Research (ILVO) in Merelbeke (Belgium). He performs applied research on functional biodiversity (natural plague control), wildlife damage in agricultural crops, agri-environmental schemes, and agroecological cropping systems.

Alain Peeters is an agronomist and agro-ecologist with theoretical and ground knowledge in general agronomy, grassland management and ecology (biodiversity). He was head of the Grassland and Field Crop Ecology Department and representative of West Europe in the World Association of Grassland scientists (IGC) (1997-2005). He is presently director of the research centre RHEA – natural resources, Human Environment and Agronomy. He is liaison officer of the FAO/CIHEAM Research and Development Network on Pastures and Fodder Crops in Europe, North Africa and Middle East (mountain and Mediterranean areas).



éditions
Quæ

Éditions Cirad, Ifremer, Inra, Irstea
www.quae.com



ISBN : 978-2-7592-2156-1



9 782759 221561

ISSN : 1777-4624