

The Phoebe A. Hearst
Expedition to
Naga ed-Deir,
Cemeteries
N 2000 and N 2500



Edited by
VANESSA DAVIES

BRILL

The Phoebe A. Hearst Expedition to Naga ed-Deir, Cemeteries N 2000
and N 2500

Harvard Egyptological Studies

Editor

Peter Der Manuelian (*Harvard University*)

Editorial Board

Thomas L. Gertzen (*Einstein Center Chronoi, Freie Universität Berlin*)

Ramadan Hussein (*Eberhard-Karls Universität Tübingen*)

Salima Ikram (*American University in Cairo*)

Peter Jánosi (*University of Vienna*)

Christian E. Loeben (*Museum August Kestner, Hannover*)

Marleen De Meyer (*KU Leuven*)

Nicholas Picardo (*The Giza Project, Harvard University*)

Harvard Egyptological Studies

This monograph series (“HES”) was established in 2015 to present scholarly publications in the field of Egyptology. It highlights, but is by no means limited to, sites and selected aspects of the Harvard University-Boston Museum of Fine Arts Expedition (1905–1947). Invited topics include recent PhD dissertations; reports from excavations; specialized studies in ancient Egyptian language, history, and culture; conference proceedings; publications of scholarly archives; and historiographical works covering the field of Egyptology. *Harvard Egyptological Studies* is published by the Department of Near Eastern Languages and Civilizations, and the Department of Anthropology, both of which are in the Faculty of Arts and Sciences at Harvard University.

VOLUME 10

The titles published in this series are listed at brill.com/hes

The Phoebe A. Hearst
Expedition to Naga ed-Deir,
Cemeteries N 2000
and N 2500

Edited by

Vanessa Davies



BRILL

LEIDEN | BOSTON



This is an open access title distributed under the terms of the CC BY-NC-ND 4.0 license, which permits any non-commercial use, distribution, and reproduction in any medium, provided no alterations are made and the original author(s) and source are credited. Further information and the complete license text can be found at <https://creativecommons.org/licenses/by-nc-nd/4.0/>

The terms of the CC license apply only to the original material. The use of material from other sources (indicated by a reference) such as diagrams, illustrations, photos and text samples may require further permission from the respective copyright holder.

Cover illustration: Cemeteries N 2000 and N 2500, Naga ed-Deir. Photo by Ayman Damarany.

Library of Congress Cataloging-in-Publication Data

Names: Davies, Vanessa (Ph.D.), editor.

Title: The Phoebe A. Hearst Expedition to Naga ed-Deir, Cemeteries N 2000 and N 2500 / edited by Vanessa Davies.

Description: Leiden ; Boston : Brill, [2021] | Series: Harvard Egyptological studies, 2352-7501 ; volume 10 | Includes bibliographical references and index.

Identifiers: LCCN 2020033264 (print) | LCCN 2020033265 (ebook) | ISBN 9789004396913 (hardback) | ISBN 9789004396906 (e-book)

Subjects: LCSH: Naga ed-Deir Site (Egypt) | Phoebe A. Hearst Expedition of the University of California (1899-1905) | Tombs—Egypt—Naga ed-Deir Site. | Cemeteries—Egypt—Naga ed-Deir Site. | Excavations (Archaeology)—Egypt. | Naga ed-Deir (Egypt)—Antiquities. | Reisner, George Andrew, 1867-1942. | Mace, A. C. (Arthur Cruttenden), 1874-1928.

Classification: LCC DT73.N2 P47 2020 (print) | LCC DT73.N2 (ebook) | DDC 962/.3—dc23

LC record available at <https://lcn.loc.gov/2020033264>

LC ebook record available at <https://lcn.loc.gov/2020033265>

Typeface for the Latin, Greek, and Cyrillic scripts: "Brill". See and download: brill.com/brill-typeface.

ISSN 2352-7501

ISBN 978-90-04-39691-3 (hardback)

ISBN 978-90-04-39690-6 (e-book)

Copyright 2021 by the authors. Published by Koninklijke Brill NV, Leiden, The Netherlands. Koninklijke Brill NV incorporates the imprints Brill, Brill Hes & De Graaf, Brill Nijhoff, Brill Rodopi, Brill Sense, Hotei Publishing, mentis Verlag, Verlag Ferdinand Schöningh and Wilhelm Fink Verlag. Koninklijke Brill NV reserves the right to protect this publication against unauthorized use.

This book is printed on acid-free paper and produced in a sustainable manner.

*For Preston, and all those who give their time preserving and recording
material in libraries, museums, and archives all over the world*



Contents

	Foreword	IX
	Acknowledgements	XIII
	Abbreviations	XV
	Map 1	XVI
	Map 2	XVII
	Introduction	1
	<i>Vanessa Davies</i>	
1	Catalogue of Tombs	29
	<i>Transcribed by Vanessa Davies</i>	
2	Ceramics	219
	<i>Gabriella diBattista and Brooke Norton</i>	
3	Four Unique Pottery Vessels from N 2000 and N 2500	294
	<i>Natasha D. Ayers</i>	
4	Scarabs, Scaraboids, Seals, Seal Impressions, and Knotted Cords	308
	<i>Emily Teeter</i>	
5	Small Stone Vessels	329
	<i>Virginia L. Emery</i>	
6	Flint Objects and Bone Object	362
	<i>Lisa Maher</i>	
7	Beads, Pendants, and the Like	370
	<i>Jocelyn Simlick, Andrea Miloslavica, and Vanessa Davies</i>	
8	Analysis of Beads and Pendants	408
	<i>Jolanda Bos and Vanessa Davies</i>	
9	Miscellaneous Objects	423
	<i>Elizabeth Minor</i>	

- 10 Late Antique Textiles 442
Amandine Mérat
- 11 Coptic Burial Wrapping 453
Jonathan P. Elias
- 12 Conclusions 483
Vanessa Davies
- Appendix 1: Arthur Mace's Draft Manuscript 487
- Appendix 2: Coptic Inscriptions 520
- Index 524

Foreword

The village of Naga ed-Deir is located on the east bank of the Nile opposite Girga in Upper Egypt and some 160 km north of Luxor. Here is located an important series of cemeteries representing a long period of time principally from the Predynastic Period to the Middle Kingdom. Sheikh Farag is located on the north and Mesheikh six kilometers to the south with Naga ed-Deir itself located about one and a half kilometers south of Sheikh Farag. Mesheikh is separated from Naga ed-Deir by the site of Mesaeed. The subdivisions of the site all form part of a single, large cemetery which served as a necropolis for the ancient town of Thinis, whether at Girga or nearby. Thinis functioned as the ancient capital of Upper Egypt nome 8, while Abydos was a secondary seat of the central government and, by the Middle Kingdom, an important religious center of the god Osiris. Reisner designated all these subdivisions as the "Cemeteries of Naga ed-Deir" or simply "Naga ed-Deir."

Reisner excavated the different subdivisions at first for the Hearst Egyptian Expedition of the University of California up to 1905, when Mrs. Phoebe Apperson Hearst, the patroness of the expedition, and mother of the newspaper publisher William Randolph Hearst, informed Reisner that owing to a fault in the gold bearing stratum of the Homestake Mine, a large part of her income had been cut off so that she could not continue her support beyond 1905. At that point, and after extended negotiations, the excavations resumed under Reisner's direction but as the Harvard-University-Boston Museum of Fine Arts Egyptian Expedition.

Reisner and his assistants published several volumes on the excavation in the Naga ed-Deir cemeteries, as follows:

- Reisner, G. A. 1908. *Early Dynastic Cemeteries of Naga-ed-Dêr, Part I*. University of California Publications, Egyptian Archaeology 2. Leipzig.
- Mace, A. C. 1909. *Early Dynastic Cemeteries of Naga-ed-Dêr, Part II*. University of California Publications, Egyptian Archaeology 3. Leipzig.
- Reisner, G. A. 1932. *A Provincial Cemetery of the Pyramid Age, Naga-ed-Dêr Part III*. University of California Publications, Egyptian Archaeology 6. Berkeley.
- Lythgoe, A. M. 1965. *The Predynastic Cemetery N 7000, Naga-ed-Dêr*. Edited by D. Dunham. University of California Publications, Egyptian Archaeology 7. Berkeley.

In addition, Henry F. Lutz published the steles from the Naga ed-Deir cemeteries in Berkeley in *Egyptian Tomb Steles and Offering Stones of the Museum of Anthropology and Ethnology of the University of California*, University of California Publications, Egyptian Archaeology 4, Leipzig, 1927. Regrettably, Lutz did not have access to Reisner's field notes and his publication is replete with errors. In 1937, Dows Dunham, then Associate Curator of Egyptian Art (later Curator of Egyptian and Ancient Near Eastern Art) published an important and substantial volume, *Naga-ed-Dêr Stelae of the First Intermediate Period*, published for the Museum of Fine Arts, Boston, by the Oxford University Press, London.

A number of Ph.D. dissertations have also been dedicated to various aspects of the Naga ed-Deir cemeteries, beginning with Caroline Nestmann Peck, "Some Decorated Tombs of the First Intermediate Period from Naga Ed-Dêr," Brown University, 1958. My own doctoral dissertation for the University of Chicago, "The Inscribed Material of the First Intermediate Period from Naga-ed-Dêr," was published by University Microfilms in 1989. An updated version has recently appeared in print, published by the Museum of Fine Arts, Boston, as *Naga ed-Dêr in the First Intermediate Period*.

The following dissertations, theses, and books also treat various aspects of the Naga ed-Deir cemeteries:

Podzorski, P. 1990. *Their Bones Shall Not Perish: An Examination of Predynastic Human Skeletal Remains from Naga ed-Der in Egypt*. PhD diss. University of California, Berkeley.

And again: 1993. "The Correlation of Skeletal Remains and Burial Goods: An Example from Naga-ed-Dêr N 7000." In *Biological Anthropology and the Study of Ancient Egypt*, edited by W. V. Davies, 119–129. London.

Harrington, L. D. 1992. *Naga ed-Der Cemetery 100: A Sample of Cranial Material and Its Context*. MA thesis. University of California, Berkeley.

Savage, S. H. 1995. *Descent, Power, and Competition in Predynastic Egypt: Mortuary Evidence from Cemetery N 7000 at Naga-ed-Der*. PhD diss. Arizona State University.

Hussein, R. B. 2004. "The Texts on the Coffin of Ppy-im': Translations and Annotations." MA thesis. Brown University.

Delrue, P. 2001. "The Predynastic Cemetery N 7000 at Naga ed-Dêr, A Re-evaluation." In *Social Aspects of Funerary Culture I: The Egyptian Old and Middle Kingdoms: Proceedings of the International Symposium Held at Leiden University, 6–7 June 1996*, edited by H. Willems, 21–66. OLA 103. Leuven.

Kroenke, K. 2010. *The Provincial Cemeteries of Naga ed-Deir: A Comprehensive Study of Tomb Models Dating from the Late Old Kingdom to the Late Middle Kingdom*. PhD diss. University of California, Berkeley.

In addition, I may mention two articles by the present writer published in the *Lexikon der Ägyptologie*, ed. W. Helck and W. Westendorf, Wiesbaden: “Naga (Nag)-ed-Dêr” and “Thinis,” *LÄ* IV, 1980, cols. 296–317, 475–486. The first of these articles provides a diachronic overview of the Naga ed-Deir cemeteries, while the second article concentrates on the capital of Upper Egypt nome 8, ancient Tjeni, Gk. Thinis, located at modern Girga or possibly el-Birba, further to the west.

All told, the following cemeteries at Naga-ed-Dêr have been published in the publications cited above: N 500–900, N 1500, N 3000, N 3500, N 7000. The cemeteries remaining to be published are the following: N 100–400 (sometimes referred to only as N 100), N 2000 and N 2500, N 9000 (near Sheikh Farag).

Referencing my article in *LÄ* IV, col. 312, it may be noted that later Egyptian, Ptolemaic, and Roman Period are little represented at Naga-ed-Deir. The largest concentration of Coptic graves was in N 2000 and 3500, but a number of disturbed burials were found distributed in N 100 and 500–900, some 221 burials all told.

Naga-ed-Deir Cemeteries 2000 and 2500 are the subject of the present volume. Vanessa Davies has assembled a catalogue of the Coptic cemeteries N 2000 and N 2500 based on the field notes of Arthur C. Mace and his unpublished manuscript. Mace was evidently planning on doing a color publication of the Coptic textiles found. Although photographs of the textiles are absent, Dr. Davies informs me that detailed drawings that Mace must have made in the field are preserved. They are quite detailed and often indicate color. Dr. Davies has also had photographs of the Coptic ceramics that are in California made and will also include drawings of the vessels made by a draftsman in the catalogue. Quite wisely, Dr. Davies has enlisted the aid of other scholars in her catalogue of the Coptic cemeteries, as may be seen in the list of Contents.

The catalogue by Dr. Davies and her colleagues will undoubtedly advance our understanding of Coptic textiles, ceramics, and other objects greatly. It is particularly gratifying to me to see another group of burials from the Naga-ed-Deir cemeteries published, thus fulfilling Reisner’s original plans for publication. The Coptic period is relatively unknown, and the research of Dr. Davies and her team will undoubtedly be greatly appreciated by scholars of Coptic decorative arts and burial customs. Fragmentary Coptic textiles from

sites such as Saqqara, Akhmim, Antinoopolis, and Hawara are largely lacking in archaeological context, so the fact that the material published by Dr. Davies and her collaborators derives from one necropolis will render the publication even more valuable.

Edward J. Brovarski

Acknowledgements

Many people contributed to the appearance of this volume. First should be recognized Mrs. Phoebe Apperson Hearst whose patronage of the young Egyptologist George Andrew Reisner enabled the excavations at this site, and many others, to occur. George Reisner and Arthur Mace, the principal excavators at Naga ed-Deir, were among the early practitioners of scientific method in the field of Egyptian archaeology. Without their meticulous labor in the field, both in terms of excavation and recording, we would not have been able to reconstruct and analyze their work in this volume. The remainder of our archaeological forebearers are the Egyptian, American, and British team members who worked these two cemeteries at Naga ed-Deir, N 2000 and N 2500. Many of their names are lost to us, but their efforts to preserve and record this material make them our partner contributors to this volume. We should also recognize those whose material this book publishes: the ancient people of Naga ed-Deir whose cultural practices have, millennia later, enriched our lives.

Among the living, this project owes its existence to Ben Porter, Director of The Phoebe A. Hearst Museum of Anthropology, who suggested that I assemble a team to publish some of the Naga ed-Deir material. Such an enormous project could not have been accomplished without the help of the wonderful staff at the Hearst Museum, including Michael Black, Katie Fleming, Leslie Freund, Natasha Johnson, Rafael Magdaleno, Adam Nilsen, Sharyn O'Keefe, Paolo Pellegatti, Martina Smith, and Linda Waterfield. Chris Hoffman of UC Berkeley organized the 3D imaging of artifacts, which can be viewed in the museum galleries. All artifacts from the Hearst Museum collection published here can also be viewed in greater detail and with color photos in the online portal (<https://portal.hearstmuseum.berkeley.edu/>). Information can also be found online on Open Context (<https://doi.org/10.6078/M75D8PZX>).

The tireless efforts of Joan Knudsen, Nancy Corbin, and Bob Bussey in reconstructing Reisner's photographic record is one of the great accomplishments of archival work. Their painstaking work matched artifacts in the Hearst Museum collection to artifacts portrayed in photographs staged by the original excavators' and taken in the field. I especially thank Joan for her incredible generosity in sharing her photographic database with me so that I could easily locate the images relevant to these cemeteries. This publication would have been far less robust without those photographs. Carol Redmount provided an enormous amount of help at a critical time in the project's trajectory. Preston Staley's work preserving Reisner's notes at the Hearst Museum was of invaluable assistance to this project. It is a shame that he was not around when this

project was in full swing at the Hearst Museum, because it would have been fun to collaborate.

At the Museum of Fine Arts, Boston, great thanks goes to Susan Allen, Larry Berman, Denise Doxey, and Rita Freed for their assistance and support in publishing the materials from Naga ed-Deir that are in that collection, as well as their help navigating the intricacies of the records stored in their archive. Also in that regard, Peter Der Manuelian and Ed Brovarski, with their vast troves of knowledge about George Reisner, his work, and the site of Naga ed-Deir, were always ready to lend an ear to my latest conundrum.

Friends old and new contributed to this book in many ways. In this project's formative days, Renee Friedman and Peter Lacovara both provided critical start-up and planning assistance. The Coptic inscription over the monastery door gave me an opportunity to enlist the help of my old friend Jennifer Westerfeld who shared her expertise by reviewing the copy of the Coptic text in Mace's unpublished manuscript. Amr Shahat helped me understand some of Mace's field Arabic. Ayman Damarany's care and effort in taking site photographs has greatly enhanced this publication. Natasha Ayers gave me critical guidance on the ceramics catalogue and looked over those drawings. I really appreciate the time she spent improving the presentation of ceramics in this volume. Without Jolanda Bos's advice and instruction, the analysis of the beads and pendants would not have been possible. I thank her for her friendship and for sharing her expansive knowledge with me. Eric Kansa and Sarah Kansa are wonderful people to work with, and I am so happy to have gotten to know them through this project. Students at UC Berkeley who contributed to this project include Lindsay Howard, Kea Johnston, Andrea Miloslavic, Brooke Norton, Alexandra Perkins, and Jocelyn Simlick. Andrea and Jocelyn worked tirelessly with me on all manner of things, including beads, wrappings, museum display cases, maps, and reams and reams of documentation: paper, photographic, and electronic. They never complained about any of the work despite the fact that the beads were always their favorites. They are both boss.

At Brill, Katie Chin, Erika Mandarino, and Carina van den Hoven are a pleasure to work with. Peter Der Manuelian's vision for an Egyptological series with a broad focus is much appreciated. Finally, I most heartily thank The Shelby White and Leon Levy Program for Archaeological Publication without whose generous support this book and the accompanying digital material would not exist. For this project, they are the omega to Mrs. Hearst's alpha, and their commitment to the publication of archaeological material is a true gift to the world.

Abbreviations

ASAE	Annales du Service des Antiquités de l'Égypte
BM	The British Museum
Cleveland	Cleveland Museum of Art
Krefeld	Deutsches Textilmuseum Krefeld
KN	Katoen Natie, Antwerp
Louvre	Musée du Louvre
Lyon MT	Musée des Tissus
Manchester	Whitworth Art Gallery
MÄS	Münchner Ägyptologische Studien
MFA	Museum of Fine Arts, Boston
Nantes	Musée Dobrée
PAHMA	The Phoebe A. Hearst Museum of Anthropology
Pushkin	The Pushkin State Museum of Fine Arts
VAM	Victoria and Albert Museum

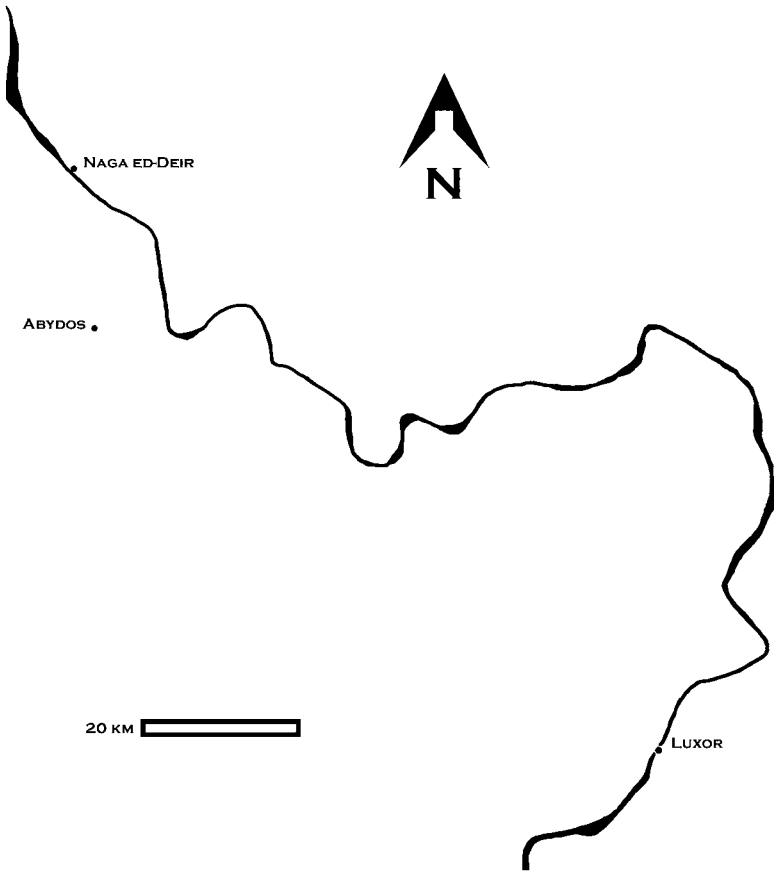

MAP 1 Location of Naga ed-Deir in Egypt

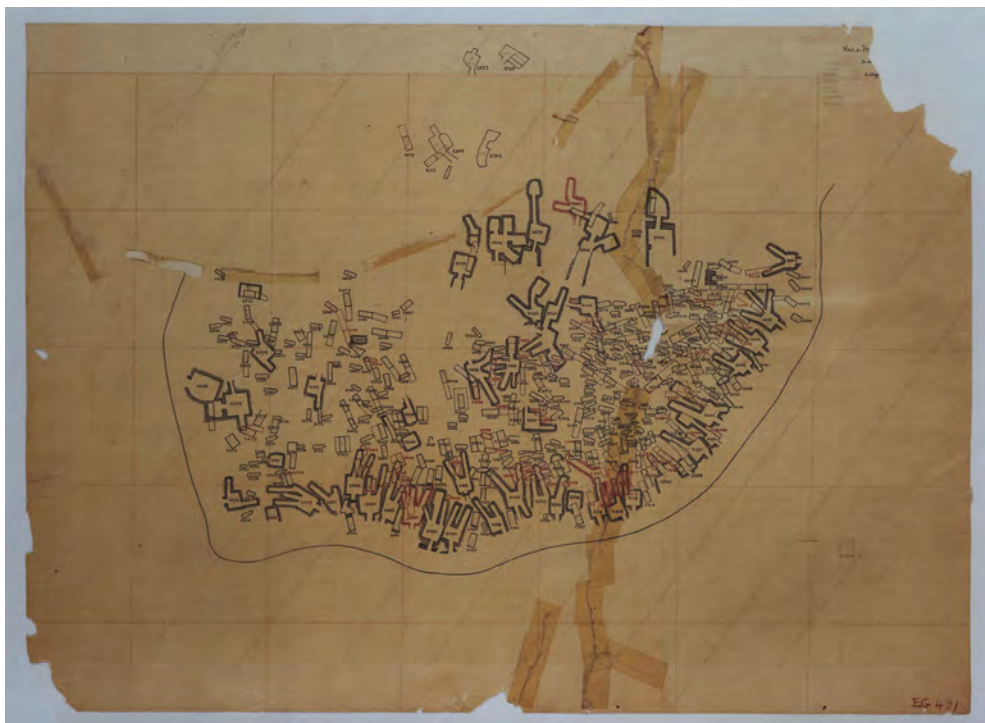

MAP 2 Map of tombs in N 2000 and N 2500, dated December 1904

Introduction

Vanessa Davies

This collected volume aids in the completion of the publication of George Reisner's excavations at Naga ed-Deir (see Map 1). This material was only partially published by Reisner during his lifetime due to both the intensity of his archaeological workload, which in the case of Naga ed-Deir resulted in a large number of excavated finds and human remains, and because of changes in his own career. From 1899–1905, Mrs. Phoebe A. Hearst supported Reisner's archaeological expedition to various sites in Egypt. Reisner directed excavations at Naga ed-Deir from February 1901 to March 1903, and Arthur C. Mace directed work at the site for Reisner from 1903 to 1905. Under Mace's direction, cemeteries N 2000 and N 2500 were excavated.

Cemeteries N 2000 and N 2500 are treated here in one publication (Figs. 0.1–0.2). The site was first visited in an official capacity by George Reisner on February 1, 1901 (Reisner vi). Reisner and his team had been working the nearby sites of el-Ahaiwah, Ballas, and Deir el-Ballas. The cemetery divisions



FIGURE 0.1 Slope of N 2000/N 2500 from the cultivation (NED-A-7672)



FIGURE 0.2 From the cliff above camp, N 2000/2500 to the north, N 3000, and N 1500 to the south (NED-B-2178)

that Reisner came up with were based on the topography of the landscape, rather than any certain chronological distinction between the burials. The core group of records from seasons 1903–1905 consist of 368 pits (either with or without burials), 240 in Cemetery N 2000 and 128 in Cemetery N 2500. Of those, in Cemetery N 2000, 105 are First Intermediate Period/Middle Kingdom, 92 are Coptic, and 43 are empty. In Cemetery N 2500, 26 are First Intermediate Period/ Middle Kingdom, 58 are Coptic, and 44 are empty. An additional 7 records are Reisner's from preliminary work he did in the cemeteries in 1901.

This publication is based on the original records of excavation work that was done at Naga ed-Deir from the 1903 through the 1905 seasons under the patronage of Phoebe A. Hearst, directed by George Reisner, and headed by Arthur C. Mace (Fig. 0.3). Other non-Egyptian team members were Albert M. Lythgoe and Frederick W. Green. In 1902, Reisner offered the anthropologist Grafton Elliot Smith some of the Coptic skeletons to study as part of his controversial theories regarding diffusion and race, theories that have been proven to be scientifically inaccurate (Challis 2013; Gange 2013). Smith's argument about diffusion rested on the premise that cultural markers, such as mummification, developed only once in human history, in this case, in Egypt, and from there were diffused throughout the world. His theory about race



FIGURE 0.3 N 7000, in the third wadi, to the south of N 2000/2500, with village in background. Note the numbered ostraca on the ground that denote the tombs. (NED-C-6745)

involved tracking skeletons' physical features, such as the shape of the head and face, to chart "racial characteristics." Scientists and Egyptologists no longer subscribe to racist theories of human development that resemble Smith's.

Most of the photographic plates taken by expedition members are today housed in the collection of the Museum of Fine Arts, Boston, although some of the images have been damaged. In the collection of The Phoebe A. Hearst Museum of Anthropology are 35 mm negatives made from fine-grain positives, which were made from the glass plate negatives in the Museum of Fine Arts, Boston. A still-ongoing project based at the Hearst Museum involves the herculean efforts of Joan Knudsen, Nancy Corbin, and Bob Bussey, who are cataloguing the original images and painstakingly identifying the objects and locations captured in the images based on Mace's notes and their own observations and knowledge of the collection. Note that in the staged shots of artifacts, some of the objects that are identified by tomb number may not have object numbers in the Hearst Museum or the Museum of Fine Arts, Boston, because not all of the artifacts found during the excavation were shipped to America. Where possible, thanks to the work of Joan, Nancy, and Bob, I have supplied an object number. In some cases, the object is only identified by tomb number.



FIGURE 0.4 Icons in the Coptic church (NED-C-8219)

Besides the photographs taken by the original expedition, a number of primary documentary sources were used in this publication, including Mace's draft of a manuscript, the tomb cards, and a map of the cemetery that someone (presumably Mace) made. The tomb cards contain the original notes and drawings made in the field. Thanks to confirmation from Peter Der Manuelian, at least two sets of handwriting, Reisner's and Mace's, have been identified on the tomb cards. Albert Lythgoe's may be represented there as well. For that reason, I have not attributed sole authorship of the tomb cards to Mace. The draft manuscript is Mace's preliminary preparation of some of the Coptic material for publication (Figs. 0.4–0.5). The original copies of the manuscript and the tomb cards are in the Museum of Fine Arts, Boston, and copies of them are in the collection of The Phoebe A. Hearst Museum of Anthropology. An unknown person or persons transcribed Mace's manuscript and some of the tomb cards. A copy of the former transcription is in the MFA and the Hearst Museum, while the latter is only at the MFA. New transcriptions were made for this publication, although those copies were consulted when questions arose due to faded pencil and scrawled handwriting. Thanks to the efforts of volunteers, such as Preston Staley, and student employees, such as Jocelyn Simlick and Andrea Miloslavich, those records have been digitized. Another digital resource was created by Alexandra Perkins and Lindsay Howard. Their digital map georeferences every tomb in this publication. To protect the integrity of the site, the map can be viewed only with login credentials in the University of California system. In the Museum of Fine Arts, Boston, there are camera-ready drawings of some of the Coptic garments, weaving techniques, and jewelry, as well as the Coptic inscription on the church. A handwritten note suggests that the artist might be L. F. Hall. Regarding the Coptic inscriptions found on ceramics in N 2016 and N 2431, there are sketches of the inscriptions on onion skin, Mace's transcription and English translations, and correspondence from Hubert Thompson to Mace regarding photographs that Mace had sent to him. Two photographs of Coptic inscriptions could not be located. The photograph 8469 that Mace references is not of Coptic inscriptions but of jewelry. The photograph 8578 must have been lost or destroyed, because it is not part of the site's photographic corpus.

Caroline Peck assembled another resource that is valuable for understanding the documentation of the work done in N 2000 and N 2500. For her Ph.D. dissertation at Brown University, Peck (1958) worked on First Intermediate Period Naga ed-Deir material. Later, as a Teaching Associate in Brown's Egyptology department and then as an independent researcher housed in Brown's classics department, she waded through the original excavation materials of Reisner's



FIGURE 0.5 Inscription over the door of the Coptic monastery (NED-C-4750)

team from Naga ed-Deir. The fruit of her work is now housed in the MFA. Binders of looseleaf pages contain her meticulous notes that organize and correlate the finds with the photographs from the original excavation.

One major difference between Mace's planned publication of cemeteries N 2000 and N 2500 and this publication of the same material concerns the images. The original documentation contains many photographs of human remains. Some of those images are of the body in situ in the tomb. Other burials were selected to be photographed in stages, as the layers of wrappings and clothing were removed from the body. None of the photographs showing human remains are used in this publication.

1 History of Work at Cemeteries N 2000 and N 2500

Mrs. Phoebe A. Hearst wanted to endow an anthropological museum on the West Coast of the U.S. with a collection as extensive as the museum that the University of Pennsylvania provided for residents of the Philadelphia area. Among those whom she commissioned to retrieve artifacts for the museum was a young archaeologist, a Harvard graduate and one-time American football coach, in 1889, at Purdue University.

Under the patronage of Mrs. Hearst, Reisner excavated a number of sites in Egypt, beginning in 1899, including at Qift, Deir el-Ballas, and el-Ahawaih. Reisner's decision to work also at Naga ed-Deir was prompted by James Quibell's report that there had been looting at the site. Reisner applied to work there, was granted a concession in October 1900, and began excavating there in February 1901 (Figs. 0.6–0.7). That first year, preliminary excavations were done in Cemeteries N 2000 “on the north side of the second ravine” and N 2500 “on the north slope of the second ravine” (Reisner 1908, 4).



FIGURE 0.6 Panoramic view of second wadi looking toward cultivation

PHOTO BY AYMAN DAMARANY



FIGURE 0.7 Panoramic view of second wadi from cultivation
PHOTO BY AYMAN DAMARANY

The departure of Frederick W. Green left a vacancy on the team. In the winter of 1901, Reisner hired Arthur C. Mace who began working with the expedition in 1902. Green's work the previous year in Cemetery N 2500 determined that there were a range of time frames, "early and late," represented in the burials there (George A. Reisner, "Introduction," in: Mace 1909, v). Coptic reuse of older burial grounds was discovered when the team was working Cemetery N 1500 and realized that the Coptic burials there were in fill, not in earth. So they excavated deeper and found tombs with superstructures dating to earlier periods of Egyptian history (Reisner 1908, 4). During the 1903 and 1904 seasons, Reisner focused his efforts at Giza, while Lythgoe, who also published N 7000, and Mace, who also published N 3500, finished "mapping, planning, photography, etc." at Naga ed-Deir (Reisner 1908, vii).

Reisner had great faith in the Egyptian staff that he employed at the site. In his introduction to the second volume of the Naga ed-Deir series, Reisner glowingly refers to the Egyptian members of his team as "the best trained and most effective gang in Egypt" (Reisner 1908, vi; more on the term "gang" below). He made special mention of Said Ahmed Said, who headed up the photographic staff, took photographs, developed negatives, and made prints. To that team, we undoubtedly owe a great debt of gratitude for the images in this volume.

The importance of scientific method to Reisner's archaeology, a relatively new development in Egyptian archaeology at that time, is evident in his introductions to the Naga ed-Deir volumes. He enumerates five general points that drove his excavation work: an organized staff trained in careful excavation and recording; excavation of a complete site, not just individual tombs; the removal and recording layers of deposition in their reverse chronological order; drawings, notes, and photographs of all stages of work; and publication of the complete record tomb by tomb (Reisner 1908, vii–viii).

Reisner's emphasis on the scientific work of archaeology is further emphasized in his statement, which accompanies point number 2, "The discovery of beautiful objects is, of course, greatly to be desired; but the search for Museum specimens is an offence against historical and archaeological research which

is utterly unworthy of any institution which pretends to be devoted to the advancement of knowledge" (Reisner 1908, viii).

Reisner's scientific method of excavating a field was somewhat thwarted due to the uneven distribution of burials. His field techniques in 1901 were to assemble the workers into eleven groups, each headed by one man—Ibrahim Omar, Sa'eed Mahfûz, Mustapha Aisa, Mahmud Khalleel, Hasan Hasib-en-Nebi, Berberi Ahmed, Mohammed Aleo, Ahmed el-Mizlif, Salman Salim, Abu-'l-Hasan Osman, and Amr Alean (Reisner 1932, 2–3). Each of the eleven groups was assigned one set of numbers ten digits apart (591, 581, 571, etc.) and set to work along the cemetery edge. As the groups' work progressed into the cemetery, they assigned each burial a number in their particular number sets, although some groups found more burials in their sections of land than did others (Reisner 1932, 3–4).

While working for Mrs. Hearst, Reisner's expedition became organized under F. W. Putnam of Harvard who was instrumental in setting up the anthropology department at the University of California, Berkeley. In 1905, Reisner's excavation work found a new home at Harvard University and the Museum of Fine Arts, Boston. For this reason, the artifacts from his excavations at Naga ed-Deir cemeteries N 2000 and N 2500 are now housed in the collections of the Phoebe A. Hearst Museum of Anthropology at the University of California, Berkeley, and the Museum of Fine Arts, Boston.

2 The Cemeteries

The zone that Reisner and his team excavated at Naga ed-Deir lies north of the modern village of Naga ed-Deir and south of the tomb of Sheikh Farag. Between these two areas are limestone cliffs that abut the cultivated plain. Three deep wadis cut into the cliffs in an east-west direction, running from the plain into the towering folds of the rock. Rock-cut tombs are found in the cliff faces, and shaft graves and the remains of mastabas are located in soil accumulations at the bases of the wadis (Figs. 0.8–0.9).

Reisner divided the excavation area of Naga ed-Deir into different cemeteries, ranging in number from N 100 to N 10000. Over time, he changed his own labeling system so that some cemeteries that he refers to in notebooks (e.g., N 4000) or in the initial publication (e.g., N 10000) are never again mentioned. The original Naga ed-Deir volumes treat cemeteries N 500–N 900, N 1500, N 3000, N 3500, and N 7000 (N 500–N 900: Reisner 1932; N 1500/N 3000: Reisner 1908; N 3500: Mace 1909; N 7000: Lythgoe 1965; Friedman 1981). The



FIGURE 0.8 Rock-cut tombs on southern slope of wadi and pit burials below
PHOTO BY AYMAN DAMARANY

unpublished cemeteries are N 100 (also referred to as N 100–N 400), N 9000, near Sheikh Farag, and N 2000 and N 2500, which this project will publish. Cemeteries N 2000 and N 2500 are located near the mouth of the second of the three wadis (Fig. 0.10). (For a complete bibliography on the site and its artifacts, see the Foreword to this volume.)

In the first volume of the Naga ed-Deir series, Reisner described Cemetery N 2000 in this way, “This cemetery of the sixth to eighth dynasties extends up the sides of the *second* ravine and over the low alluvial mound on the north side of the mouth of the ravine. The top of the alluvial mound contains pit tombs of the sixth and seventh dynasties and, mixed with these, a great number of narrow Coptic graves. The side of the mound along the ravine is lined with chambered tombs of the tenth to eleventh dynasties, cut in the hard gravel” (Reisner 1908, 1; Figs. 0.11–0.13). In his draft manuscript published here, Mace places N 2000 “on a bluff just north of the second ravine. It is bounded on the west by the road along the edge of the cultivation, on the south and southeast by the old watercourse, while to the north it merges gradually into the steep slopes of Cemetery 3500” (pages 492–493).

Reisner described the gradual erasure of the superstructures of the N 500 tombs due to four major factors: weathering by wind and rain, later Coptic



FIGURE 0.9 Pit burial below rock-cut tombs
PHOTO BY AYMAN DAMARANY



FIGURE 0.10 Southern side of northern slope of wadi with pit burials in foreground and hillside burials in background
PHOTO BY AYMAN DAMARANY



FIGURE 0.11 Southern side of northern slope of wadi with cultivation in background
PHOTO BY AYMAN DAMARANY



FIGURE 0.12 View from cultivation into the second wadi with hillside burials on left
PHOTO BY AYMAN DAMARANY



FIGURE 0.13 View from cultivation into the second wadi
PHOTO BY AYMAN DAMARANY



FIGURE 0.14 Entrance to a tomb
PHOTO BY AYMAN DAMARANY

burials intruding on earlier burials, excavation of mud brick and mud debris by modern diggers looking for the raw materials to make new bricks, and plundering of burials (Reisner 1932, 3). All of those factors also contributed to the damage done to the tombs and burials in Cemeteries N 2000 and N 2500 (Fig. 0.14).

Cemeteries N 2000–N 2500 contain burials of the First Intermediate Period/Middle Kingdom (potentially the late Old Kingdom as well) and the Coptic Period, although there are many Coptic burials at Naga ed-Deir outside of the 2000 number range. Two of those (N 3747, N 4511) are included in this publication for one reason only: both of those tombs are discussed, and factor quite prominently, in Mace’s draft of his publication. An anonymous document at the MFA in Boston named “Appendix I List of Coptic Tombs from Naga ed-Deir” also lists the following tomb numbers: 30, 73, 74, 81, 83, 89, 90, 100, 105, 181, 453b, 500, 520, 563, 587, 641, 771, 781, 1535, 1581, 1584, 1596, 1601, 1629, 3526, 3529, 3586, 3718, 3723, 3925, 4203, 4318, 4354, 4356, 4512. They are not included in this publication because they are outside of its scope.

On the N 2640 tomb card, Mace's note indicates that "in the notebook" N 2640 = N 3747, thus, associating those two tomb numbers with one another. On the map, N 3747 is located directly next to N 2640 and is surrounded by a number of tombs in the N 2000–N 2500 range that cluster around it. At more of a distance, to the north and northwest of N 3747 (so farther up the slope from the N 2000–N 2500 tombs), are tombs in a higher number range: N 3746, 3579, and others.

N 3747 is not unusual in having a number that does not correspond to its cemetery number. In the Naga ed-Deir cemeteries, tomb numbers did not necessarily indicate a location in a particular cemetery. In the first Naga ed-Deir volume, Reisner discussed N 3041, a communal grave dating to the Coptic era that enlarged and reused a Middle Kingdom grave. The Coptic burial, he wrote, belongs "undoubtedly to cemetery 2000 situated on the opposite bank of the ravine" because "cemetery 3000 contained no other Coptic burials" (Reisner 1908, 67, pl. 69d).

The situation concerning N 4511 is more complex. No case can be made for N 4511 being a part of Cemeteries N 2000 or N 2500 based on geography. The location of N 4511 is so far removed from the tombs in this publication that it is not even on Mace's map of the cemetery (Map 2). N 4511 can be found on a very large map in the collections of the Hearst Museum and the MFA labeled "Naga-éd-Dêr." Four separate maps of the site were joined to make one large map. The rightmost map has a north arrow labeled October 1902. On that map, tomb 4511 is found in the block F (horizontal), d (vertical). Mace singled out that tomb for inclusion in his publication because of one critical find that was in the tomb: a coin that he dates to the third or fourth year of Justinian (529–530 CE). (Mace provides two different dates in his publication, 529 CE and 530 CE.)

That coin was the only certain dating criterion that Mace had in all of the burials. His decision to include it in his publication reflects the importance that he attributed to it as a dating element and the concomitant uncertainty he must have felt regarding any other possible dating that might emerge from the material. Because the coin was used as a pendant ("pierced and hung round a child's neck"), it must not have had value as a coin, *per se*. Mace guesses that the coin would have been kept and used in this way for a period of time not more than 50 years after its date of manufacture. Thus, "with some confidence," Mace points to the second half of the sixth century CE as the date of "our cemetery" (by which it is unclear if he means N 2000–N 2500, of which N 4511 is not a part, or if he dates all of the Coptic burials at Naga ed-Deir to that time frame).

3 Mace's Recording Techniques

Mace intended his publication to be a scientific record of only the Coptic burials in Cemeteries N 2000 and N 2500. Some of the objects in the First Intermediate Period/Middle Kingdom tombs from those cemeteries were published by Reisner in Part III of his *Naga ed-Deir* series (Reisner 1932). An example of a difference between Reisner's publication and this one is seen in Reisner's drawing (Reisner 1932, fig. 50:13) of a scarab from N 2071b (now with the object number PAHMA 6-14374) and the drawing and image in this volume (Figs. 4.1–4.2). Furthermore, although Reisner did mention some artifacts from these burials in the third volume of his *Naga ed-Deir* series, he did not publish a complete record of the First Intermediate Period/Middle Kingdom burials, as this volume does.

Almost all of the tomb cards are written in Mace's handwriting. In the few instances where his pencil marks have faded to such an extent that his words are now illegible, I noted this in the text with either [ed.:?] or [illegible]. Some of the tomb records (N 2001, 2021, 2041, 2501, 2511, 2521, 2542) were written in 1901 (Reisner 1932, 2, fig. 1, a–b). Reisner's notes on the contents of those tombs



FIGURE 0.15 N 2511. This is the “hillside cave” that Reisner excavated as part of his preliminary work in 1901. When the cemetery was systematically excavated a few years later, another burial was also given this number. 2511 on Reisner's map (1932, Fig. 1) is the hillside cave. N 2511 on Mace's map is the Coptic burial.
PHOTO BY AYMAN DAMARANY



FIGURE 0.16 N 2511 (detail)
PHOTO BY AYMAN DAMARANY

are much more abbreviated than Mace's. The tomb numbers themselves seem to have not been reserved because N 2001, 2041, 2501, and 2511 were reused when Mace directed the excavations of the cemeteries (Figs. 0.15–0.16). For example, one card lists tombs N 2001, N 2021, and N 2041. The short notations concerning N 2001 (“Rotten wooden box empty.”) and N 2041 (“Empty pits. Rectangular cloth. Shells, etc.”) indicate that they cannot refer to the same N 2001 and N 2041 later excavated by Mace. According to Mace's numbering system, N 2001 contained an intact Coptic-era burial, and N 2041 contained nothing (“Absolutely plundered out.”). For the sake of completeness, Reisner's brief descriptions have been included in the Catalogue of Tombs.

4 The Tomb Catalogue

The Catalogue of Tombs lists all of the burials in Cemeteries N 2000 and N 2500. The list is compiled from two sources: Mace's manuscript draft and the tomb cards. Mace did not intend to include in his publication all of the tombs that are published here. From his draft manuscript, it is clear that Mace intended to publish only the two cemeteries' Coptic burials, not any earlier burials, and only those Coptic burials that had a certain level of detail. For example, tombs N 2614

and N 2648, which admittedly do not provide much information, were recorded on tomb cards, but were not included in Mace's draft of the tomb catalogue.

Because this project is as much interested in the ways that work was done—the organization of work in the field, the methods of documentation, and the excavators' approach to the material—as well as the results of the work—objects found and burials unearthed—all of the information recorded on tomb cards has been included here. The Coptic tombs, the First Intermediate Period/Middle Kingdom tombs, and the tombs of uncertain date that were found completely empty or destroyed are all documented in the Catalogue (Figs. 0.17–0.18). The descriptions and drawings, even of the tombs that yielded no finds, are historical documents in their own right.

Two photographs provide insight into work and life in the field. A photo taken looking over N 2000 in the north, to N 3000 and N 1500 in the south, shows us the excavation camp located on the slope of N 3000 (Fig. 0.2). An image taken from N 7000, located to the south of N 2000/N 2500, shows the village of Naga ed-Deir in the background (Fig. 0.3). It is included in this publication because it is a historical record of the living village and because the photo reveals Reisner's method of numbering tombs on ostraca on the ground.

The tomb data in the tomb cards is complete, but Mace's manuscript draft, which treated only the Coptic tombs, unfortunately jumps from page 3 to page 14. So the information that he recorded there for Coptic tombs N 2005 through N 2170 is now lost. Those pages may have existed as recently as the 1970s, as evidenced by a document in the MFA entitled "Appendix II Catalogue of the Burials." The author of that document, which is dated March 29, 2012, claims to have compiled the information from Mace's 33-page manuscript and the tomb cards "as transcribed by an anonymous author in the 1970s." If Mace's manuscript was indeed 33 pages long in the 1970s when the anonymous author transcribed the material, then the now-missing pages still existed at that time.

Although the missing pages of Mace's manuscript may have been a source for the material that now comprises Appendix 11, the data in the Catalogue for tombs N 2005 through N 2170 was compiled exclusively from the tomb cards. The reason for this is that the data on the tomb cards is much more detailed than what is found in the Appendix, which has shorter descriptions and no illustrations, and because the discrepancies between the Appendix and the tomb cards cannot be resolved by checking Mace's original work, which is no longer accessible.

When tombs were documented on both tomb cards and in the draft manuscript, I combined the information in both sources to form a more complete record in the tomb catalogue. The reason for this is that I noticed that certain interesting and instructive details had been omitted from Mace's draft



FIGURE 0.17 On right, southern side of northern slope of second wadi (N 2000). On left, a series of pit tombs.
PHOTO BY AYMAN DAMARANY



FIGURE 0.18 Same view higher up the slope, with city of Girga in background
PHOTO BY AYMAN DAMARANY

manuscript. For example, on the tomb cards, the level of detail about and drawings of the ornamentation on the Coptic garments is quite extensive. There is no indication that Mace planned to include those drawings in his publication. In fact, he notes plans to produce in the future a “supplementary volume” to address “the question of design” and to present the garments in color.

In a few instances, the information provided on the tomb card was altered by Mace for his manuscript. For example, in N 2004, the bracelets are described as bronze on the tomb cards and copper in the manuscript. In those cases, I included the later (i.e., manuscript) information, rather than the earlier (i.e., tomb card) information.

Mace’s choice of word was preserved whenever possible. Changes were made where necessitated by grammar (such as when “that” was substituted for “which”), the standards of American English (such as when “pit” (of a drupe) was substituted for “stone” and “motifs” for “motives”), and modern conventions (such as when “aged” was substituted for “aetat” and “approx.” for “circ.”). Other substantive changes were avoided. Thus, although today, we might more commonly refer to a particular Coptic garment as a “tunic,” I did not alter Mace’s description of the garment as a “shirt.” To aid in understanding Mace’s sometimes brief notes, punctuation, especially commas, and editorial notes, enclosed in brackets, were inserted into the text when necessary.

Mace frequently left a blank or inserted a question mark in the narrative on the tomb cards when he was unsure of a detail. For example, if an object in the tomb was unidentifiable to him (N 2005), if he was dealing with unknown substance (N 2631), or if he was unsure of the measurement of a garment (N 2009), he would simply insert a question mark, apparently intending to resolve the issue at a later date. Those question marks have been left in the narrative with editorial notes added as necessary.

Mace’s drawings of pits and burials on the tomb cards were often comprised of rough and somewhat crooked lines. He was, after all, drawing in freehand, in pencil, in the field. Comparing his drawings to the published drawings of burials in the earlier Naga ed-Deir volumes that he and Reisner wrote, it was clear that they had made certain editorial decisions regarding their drawings, such as straightening wobbly lines made by an unsteady hand. So when rendering Mace’s drawings from cemeteries N 2000 and N 2500 in digital form, we also straightened wobbly lines.

Many of the tombs include a depth measurement. Those measurements were probably based on an arbitrary datum line, as was the practice when excavating Cemeteries N 500–900 (Reisner 1932, 180).

An interesting fact emerged from comparing the records of the Coptic burials on the tomb cards with the records of those same burials as Mace compiled them in his manuscript. On the tombs cards, the layers of clothing and linen

that enveloped around bodies are described from the outside in, apparently recording each layer as the body was unwrapped, including extra paddings and items, such as palm sticks and salt, that were sprinkled over the body. In the draft of his manuscript, Mace reverses the order and describes the wrapping and other items from the inside out, as if he is reburying the person. For this reason, the garments on the bodies in tombs N 2005–N 2170 will be described in the reverse order as the rest of the burials.

Mace conceptualized the earlier and later burials of these two cemeteries as quite distinct from one another. On the tomb cards, the later burials are often, although not always, identified as “Copt.” But then in two key instances, Mace betrays his sense of a cultural break between the First Intermediate Period/Middle Kingdom and the Coptic era. On the tomb card, he notes that N 2296 is the “Upper part of an Egyptian burial,” a description that leaves one wondering what a non-Egyptian burial in the cemetery might be. The question is answered in the record for N 2514, a shallow grave of an uncertain time period that Mace describes as “Copt or possibly Egyptian.” For Mace, the Coptic culture of Naga ed-Deir is distinct from its pharaonic Egyptian culture, a view that is not shared by the authors of this volume.

On the tomb cards, Mace wrote “S.” or “See Smith” to denote Grafton Elliot Smith’s work on bodies in the Coptic-era burials. In many cases, observations are recorded on the tomb card, seemingly added by Mace at a later date, based on how the description of the person is often squeezed in between other notes. For example, the burial in N 2306 was studied by Smith, as noted by the “S” at the top of the tomb card. Mace’s description begins “Copt.” and “head W S.W.” Between those two notes is a large gap in which is written “female circ 17?” This data is also recorded in Mace’s hand, but in a slightly smaller script that floats above the line of the two flanking notes. In other cases, however, Smith’s observations are not recorded on the tomb card. For example, the tomb card for N 2307 is labeled “See Smith,” but contains no other data.

Mace had a certain abbreviated way of writing in his notes on the tomb cards. Many measurements lack a unit of measure. The tomb card for N 2243 notes that underneath the burial of a Coptic child was a second burial of a man “30 down,” which is Mace’s usual way of referring to depth. In his draft manuscript, Mace rephrased the note so that it reads, “The second burial was 30 cm below the other.” Thus, from N 2243, we learn that Mace’s unit of measuring the depth of the burials was centimeters.

The body’s “usual position,” a phrase that Mace often uses with regard to Coptic burials, is the body laying on the back, with the head to the west, and the arms by the side of the body. The “usual way” of wrapping the body in Coptic burials was with the sides of the shawl thrown over the body first and then the ends thrown over the body. Mace explains this in N 2636.

There are two crucial points that Mace did not remark on in his manuscript. Mace notes that “the [Coptic] bodies in this cemetery were not, in the strict sense of the word, mummified, though a certain amount of care was taken to preserve them” (page 496). But the Coptic burial N 2616 suggests that there was some attempt to preserve the body in a manner similar to mummification. The note on the tomb card observes, “Lower opening of the intestine was patent, and the intestine had been stuffed with preservative material.” The second point of interest involves evidence of dentistry or some type of oral surgery. Regarding N 2818, also a Coptic burial, Mace records, “Very few teeth left. On left side of lower jaw, a large hole drilled right through.”

In his notes, Mace uses a number of Arabic words and technical terms, some of which are defined in the earlier Naga ed-Deir volumes. On the tomb card for N 2300, Mace records stacks of “sont” that were found under the body. In his manuscript, he changes this to “acacia,” thus providing his own explanation of this word. Others are as follows:

<i>gebel</i>	geological stratum	<i>radim</i>	fill
<i>tufl</i>	geological clay	<i>moghar</i>	cave
<i>balat</i>	stone slab	<i>kusha</i>	temporary structure?
<i>shaum</i>	wooden staff	<i>nabut</i>	wooden staff
<i>shugf</i>	pottery sherd	<i>gotn</i>	cotton?
<i>atl</i>	tamarisk (Lane 2000, 40)	<i>sont</i>	acacia
<i>sesaban</i>	sesban (<i>Sesbania sesban</i> , i.e., Egyptian riverhemp, in the legume family)		

Other abbreviations:

A	alluvial	M	marl
---	----------	---	------

5 Mace's Map of Cemeteries N 2000 and N 2500

Although no key was included on this map (see Map 2), we can surmise the key from Mace's map in his first Naga ed-Deir publication (Mace 1909, pl. 58). His description in his draft manuscript, “the early tombs are marked in black, while those of the Coptic period are shown in red,” confirms that he followed the model of his published map for the map of these cemeteries. The tombs inked in black are earlier ones, and the tombs inked in red are the later (Coptic) ones. Diagonal lines indicate brick construction, half moons indicate stone construction, Xs indicate the outline of rock-cut chambers, and dotted lines indicate underground burial chambers.

Someone, presumably Mace, penciled in the tomb numbers on the map before inking them. Very often, the pencil marks are still clearly visible, which occasionally indicate minor errors. For example, N 2404 is written in pencil on the map, but the tomb was inked as N 2405. N 2846 was written only in pencil, not in ink.

6 Dating Burials

Although Mace intended to publish only the Coptic burials in N 2000 and N 2500, there are a number of earlier burials that he refers to in his manuscript as dating to Dynasties 6 through 9, and once he mentions that the rock-cut tombs on the site date to Dynasties 5 through 11. This corresponds generally with Reisner's earlier description of N 2000 as containing burials, including pit tombs in the alluvial soil, from Dynasties 6 through 8 and from the Coptic era, along with chambered tombs from Dynasties 10 and 11 (Reisner 1908, 1).

Reisner and Mace's dating of this early set of tombs is confirmed by the few firmly datable objects from the tombs. A few of the burials (N 2030, 2031, 2032, 2093, 2100, 2507) can be positively dated due to the distinctive First Intermediate Period stelae that were found in them (Brovarski 2018). One alabaster vase (PAHMA 6-14424) inscribed with the royal name Meryre provides a *terminus post quem* for N 2096 of Dynasty 6, after Pepy I adopted that throne name. A date to the late Old Kingdom or after is supported by the black veined vessel (PAHMA 6-14420) also found in the tomb. So although there may be a few burials that date to the late Old Kingdom, for example, possibly N 2096, the majority of the tombs seem to date to the First Intermediate Period/Middle Kingdom.

Many of the tombs of indeterminate date are described on tomb cards as "probably a pit and chamber" (N 2012) or "may have been pit and chamber" (N 2047). In those cases, Mace seems to be signaling that the tombs are datable to Dynasty 4 or later. This supposition rests on Reisner's original dating of shaft and chamber tombs at Naga ed-Deir to Dynasty 4 (Reisner 1908), although he amends that to Dynasty 5 in his later publication (Reisner 1932). This conclusion is confirmed by Mace's comment on the joint tomb card for N 2844 and 2845, where he sets up a contrast between pit and chamber architecture and Coptic burials (normally in pits), where N 2844 "had possibly been pit and chamber" and N 2845 was "probably a Copt."

There are many examples of later burials intruding on earlier ones (e.g., N 2214, 2215). One interesting example of an intrusion is found in N 2143, a chamber tomb of indeterminate date. The entrance to the chamber had been blocked with bricks and fill. An oval pottery coffin had fallen through

into the chamber from another burial. The oval pottery coffin was common at Naga ed-Deir in the Dynasty 3 tombs and perhaps Dynasty 4 tombs, as well, for example, in N 1640 and 1585 (Reisner 1908, 63–64), N 4371, 4718, 4749, 5105, 5302 (Mace 1909, 34–35, pls. 54–55), and N 544, 560, 662, 644, and 588 (Reisner 1932, 15).

In general, the Coptic burials in N 2000 and N 2500 were not found in wooden coffins unless an older coffin happened to be in a particular tomb and was reused (e.g., N 2631). Mace's association of the earlier burials with coffins and the later burials as being without coffins is clear in his observation regarding N 2305 in the Catalogue, that the tomb contained "remains of wooden coffin, so probably Dynasty 6–9" (page 107). For this reason, it has been assumed in this publication that all tombs that have evidence of a wooden coffin date to the First Intermediate Period/Middle Kingdom. Evidence of a coffin includes traces of wood or traces of paint from the coffin (e.g., 2104).

Besides not usually containing coffins, the Coptic burials are often easily identifiable due to the significant amount of linen wrappings and Coptic textiles that were preserved. Those burials typically included few, if any, manufactured artifacts, but accompanying the body were pieces of various plants, as well as salt. The First Intermediate Period/Middle Kingdom burials contained an array of ceramics, alabaster, beads, and other objects. The garments or wrappings typically did not survive, and there were no plant remains or salt associated with the body. A scarab that Mace dates to Dynasty 18 in a Coptic burial in N 2636 seems to provide evidence of antiquarianism. (For other examples, see Johnson and Whitcomb 1989; Davies 2015.) The same may be said for a scarab reading Menkheperre found under Reisner's direction during the 1901 season in N 2501.

As mentioned above, the key dating criterion for Mace was a coin from N 4511 (Fig. 9.3). Dated in his manuscript to 529 or 530 CE, the coin, in Mace's opinion, dates the Coptic burials in this cemetery "with some confidence ... to the latter half of the sixth century." He concedes, "Of course it would be possible for a coin to be kept for some time before being used in this way [i.e., being pierced and worn as a pendant], but the period would probably not exceed fifty years" (page 496). Given the evidence of the Dynasty 18 scarab found in the Coptic tomb N 2636, one wonders if fifty years is perhaps an underestimate.

7 This Publication of Cemeteries N 2000 and N 2500

This publication serves three purposes. It brings to the public for the first time archaeological material that was excavated in the early twentieth century but

was never published. It unites material from the site that is currently in the collections of two museums. Finally, the book brings together archaeological voices across time. Arthur C. Mace, the lead archaeologist at the site during the excavation of N 2000 and N 2500, left behind his field notes on individual cards and a draft of a manuscript for the publication of the Coptic tombs in this cemetery group. The data and drawings on his tomb cards have been rerecorded in the Catalogue of Tombs. His narrative, found in the Appendix, describes the site as a whole, the Coptic community as it existed in the area in his day, and his summary of the Coptic burials, the bodies, and the objects included with the burials. The authors' in this volume have added their voices to Mace's to provide a contemporary analysis of the objects.

Reisner advocated for large-scale excavation of a site rather than focusing on small areas because he required a range of materials wide enough to enable him to draw conclusions about the "development of civilization" (Reisner 1908, viii). He also stressed the importance of publishing final records of all findings in each grave rather than the "hasty publication" of annual archaeological reports with, as he saw it, their necessarily ever-changing hypotheses about the finds (Reisner 1908, viii). Our project will continue to follow Reisner's publication plan for these cemeteries with the important addition of Mace's manuscript.

The First Intermediate Period/Middle Kingdom burials contained a variety of goods. Those objects are described as follows: ceramics (Natasha Ayers, Gabriella diBattista, Brooke Norton), scarabs and seals (Emily Teeter), flints (Lisa Maher), small stone vessels (Virginia Emery), miscellaneous objects (Elizabeth Minor), and beads and pendants (Jolanda Bos, Vanessa Davies, Andrea Miloslavac, Jocelyn Simlick).

The Coptic burials often contained nothing in the way of grave goods that the excavators found. The bodies were, however, often enclosed in clothing and wraps with patterns and designs on them. Those textiles are described by Amandine Mérat. The wrapping of the bodies, which often included some sticks or other plant matter and a sprinkling of salt, are discussed by Jonathan Elias.

This volume poses two methodological questions of Reisner's work that will be answered in the documentary material. The first question is to understand the nature of the work that Reisner's team did in these two cemeteries. For example, one grave in particular (N 2446) was quite well endowed, accounting for 50% of all of the cemetery's ceramic material that is in the collection of the Hearst Museum. Does that statistic reflect the ancient material or the excavators' practices? Was the burial particularly well appointed, but ultimately an anomaly in comparison with the cemetery's other burials? Was that burial excavated more thoroughly than other burials, or were more artifacts chosen from that burial to be shipped to the U.S. for analysis?

The second question will explore why, in particular, the artifacts in the collection of the Hearst Museum were chosen by the excavators to be shipped off-site. The seemingly sporadic work in these cemeteries, which the first question will address, is reflected in the eclectic composition of the artifacts that Reisner chose to send to California. For example, the material in the Hearst Museum from cemetery N 500 includes 85 flint objects of various types, and from cemeteries N 900, N 7000, N 3500, and N 1500, there are 47, 47, 37, and 19 flint objects respectively. The collections from cemeteries N 2000 and N 2500 contain 2 flint objects each. Is this uneven distribution of material reflective of the finds in the burials, or might it relate to the excavation techniques or the particular interests of the excavation director?

This book aims to present material in the way that Reisner and Mace would have done, based on their reports of Naga ed-Deir excavations (Fig. 0.19). The organization of material here thus purposefully aligns with their publications. Modern archaeological publications present material in a different way, ask different questions of the material, and tend to be more sensitive of the power imbalance internally, between excavation directors and field laborers, and externally, between the observing culture(s) and the culture observed. Recently, archaeologists and historians have taken steps to remedy the absence of names, narratives, and images of indigenous archaeologists in most early archaeological publications (for example, Quirke 2010; Riggs 2017). This welcome trend



FIGURE 0.19 Looking south towards N 1500 with village in background
PHOTO BY AYMAN DAMARANY

acknowledges and attempts to correct the “inequalities and injustices” that “colonial-era archaeology helped create, reify, and reinforce” (Riggs 2017, 362).

Reisner was supportive of the people who worked for him in a way that was not entirely common in his day and yet was still largely constrained by the sociocultural limitations of colonial-era archaeology. In publications, Reisner often named and thanked his archaeological laborers, at least those who held leadership roles. His attitude in this regard caused him to sometimes be at odds with the culture of his contemporaries, as a tense exchange with archaeologist Clarence Fisher shows. In the exchange, Fisher disapprovingly referred to Reisner’s “inexplicable devotion” to Egyptians, particularly those who worked for him (Doyon 2018, 188). Nonetheless, whatever “devotion” Reisner may have felt for his employees was expressed within certain social, cultural, and professional strictures (Doyon 2018, 185). For example, neither Reisner nor Mace included Egyptian members of the team in the analysis or interpretation of excavated material.

Reisner organized archaeological labor according to the model that Flinders Petrie developed. It was a model that reflected the Western ideal of an orderly and methodical scientific pursuit and also was rooted in hierarchical, colonial, and industrial systems. The (Western) excavation director apportions both excavated zone and (non-Western) laborers into discrete units, setting them to their task under his (because the Director was usually a man) surveilling eye (for this, see Schlanger 2010, 164–166, Fig. 9.2). In Reisner’s case, the systems underpinning his archaeological work can be seen in his adherence to scientific method and in his description of his eleven groups of Egyptian workers at Naga ed-Deir, described above, as “gangs,” a word that homogenizes workers and their labor. This volume tries to give attention to sociocultural questions beyond the excavated material and to give appropriate recognition to the Egyptians who worked with Reisner and Mace at Naga ed-Deir by naming the Egyptian archaeologists who worked at Naga ed-Deir (those whose names were found), by not reproducing photographs of uncovered human remains, and by noting the racist work of Grafton Elliot Smith. At the same time, this volume also acknowledges its own limitations in fully addressing these concerns.

Reisner’s archaeological career spanned many historical periods at diverse sites ranging up and down the Nile River Valley. For him, one point about the site of Naga ed-Deir was that it highlighted the more important works of art, architecture, and handcrafts that were found in the vicinity of the Egyptian capital (Reisner 1932, 192). The authors in this volume present the material from Cemeteries N 2000 and N 2500 as testaments to lives lived in this region and as examples of carefully worked objects worthy of study on their own merits.

Bibliography

- Brovarski, E. 2018. *Naga-ed-Dêr in the First Intermediate Period*. Atlanta.
- Challis, D. 2013. *The Archaeology of Race: The Eugenic Ideas of Francis Galton and Flinders Petrie*. London.
- Davies, V. 2015. "Observations on Antiquities in Later Contexts." In *A Cosmopolitan City: Muslims, Christians, and Jews in Old Cairo*, edited by T. Vorderstrasse and T. Treptow, 85–92. OIMP 38. Chicago.
- Doyon, W. 2018. "The History of Archaeology through the Eyes of Egyptians." In *Unmasking Ideology in Imperial and Colonial Archaeology: Vocabulary, Symbols, and Legacy*, edited by B. Effros and G. Lai, 173–200. Ideas, Debates, and Perspectives 8. Los Angeles.
- Friedman, R. 1981. *Spatial Distribution in a Predynastic Cemetery: Naga ed-Der 7000*. MA thesis. University of California, Berkeley.
- Gange, D. 2013. *Dialogues with the Dead: Egyptology in British Culture and Religion, 1822–1922*. Oxford.
- Johnson, J. H. and D. Whitcomb. 1989. "A Royal Head from Luxor." In *Essays in Ancient Civilization Presented to Helene J. Kantor*, edited by A. Leonard, Jr., and B. Beyer Williams, 135–148. SAOC 47. Chicago.
- Lane, E. W. 2000. *Description of Egypt*. Edited and with an introduction by J. Thompson. Cairo.
- Lythgoe, A. M. 1965. *The Predynastic Cemetery N 7000, Naga ed-Der*. Edited by D. Dunham. University of California Publications, Egyptian Archaeology 7. Berkeley.
- Mace, A. C. 1909. *Early Dynastic Cemeteries of Naga-ed-Dêr, Part II*. University of California Publications, Egyptian Archaeology 3. Leipzig.
- Peck, C. N. 1958. *Some Decorated Tombs of the First Intermediate Period at Naga Ed-Der*. PhD diss. Brown University.
- Quirke, S. 2010. *Hidden Hands: Egyptian Workforces in Petrie Excavation Archives, 1880–1924*. London.
- Reisner, G. A. 1908. *Early Dynastic Cemeteries of Naga-ed-Dêr, Part I*. University of California Publications, Egyptian Archaeology 2. [Leipzig].
- Reisner, G. A. 1932. *A Provincial Cemetery of the Pyramid Age, Naga-ed-Dêr Part III*. University of California Publications, Egyptian Archaeology 6. Berkeley.
- Riggs, C. 2017. "Shouldering the Past: Photography, archaeology, and collective effort at the tomb of Tutankhamun." *History of Science* 55(3): 336–363.
- Schlanger, N. 2010. "Manual and Intellectual Labour in Archaeology: Past and Present in Human Resource Management." In *Unquiet Past: Risk Society, Lived Cultural Heritage, Re-designing Reflexivity*, edited by S. Koerner and I. Russell, 161–171. London.

Catalogue of Tombs

Transcribed by Vanessa Davies

The tomb types listed below, when supplied, are taken from Reisner (1932), where he mentions a few of the N 2000 tombs. The types are as follows:

rock-cut chamber with sloping entrance (N 2071).

vi a = Open pit with crude-brick well, roofed with stone slabs, plastered with mud (N 2096).

vi b = Open pit with rubble well, or sunk well, roofed with stone slabs (N 2103).

vi c = Open pit with burial rectangle, packed with rubble or stone slabs and covered with stones or stone slabs and mud plaster (N 2042).

vi d = Open pit with side chamber, blocked with crude-brick or rubble (N 2075).

For each tomb, there are one or two abbreviations indicating the source of that tomb data.

TC = Tomb Card (field notes in the MFA, with copies at the Hearst Museum).

MM = Mace Manuscript (manuscript draft in the MFA, with a copy at the Hearst Museum).

Where MM is crossed out (~~MM~~), it indicates that Mace had included the record in his manuscript and subsequently crossed it out.

The photograph numbers as listed below reflect the original excavator's numbering system. That system is slightly different from the current numbering systems used by the Phoebe A. Hearst Museum of Anthropology and the Museum of Fine Arts, Boston. The original glass negatives were numbered sequentially with a letter prefix (A, B, or C), which indicates the plate size. The Hearst Museum's current numbering system, which is used in this book except in the text reproduced from the original excavator's records, is NED-letter prefix-photograph number. The numbering system at The Museum of Fine Arts, Boston includes the suffix *_os* (for "Old Series") after the photograph number.

The drawings reproduced below accompanied the field notes. They do not always appear here in numerical order due to the constraints of the layout of this book.

Plates that illustrate the catalogue follow at the end. They were not inserted into the catalogue text because they are not a part of that original text.

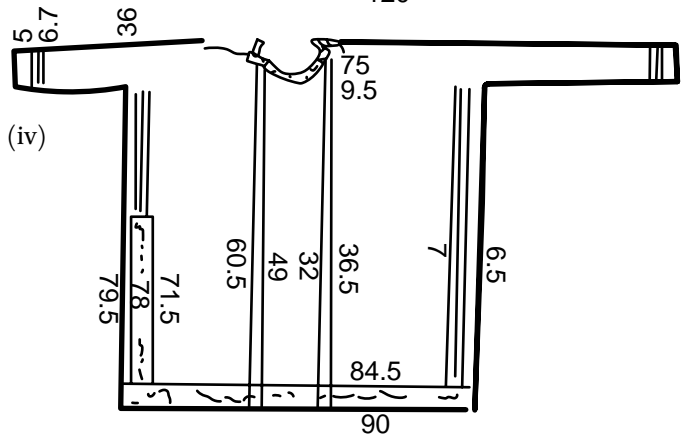
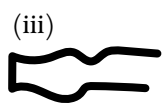
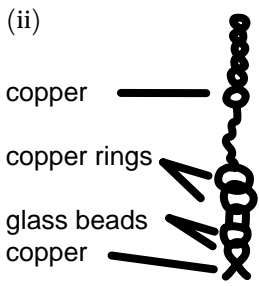
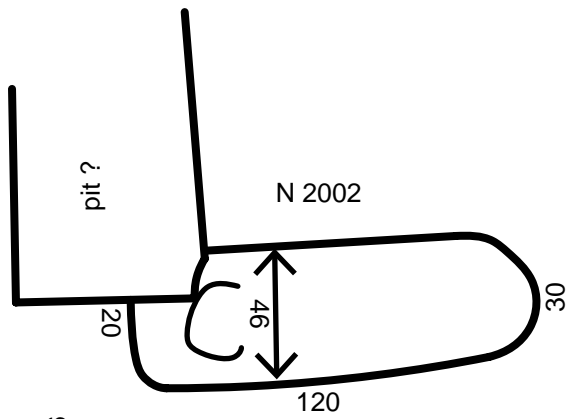
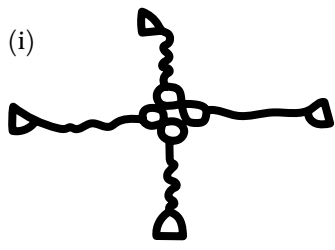
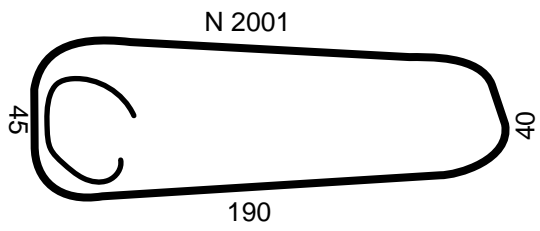
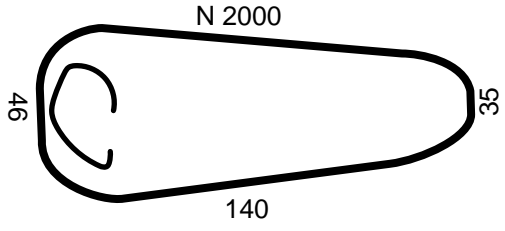

N 2000 (TC; MM) Map E3; photo C 8004

75 down. Copt. Shallow grave running east-west. Adult. Sex? On back, head west. The outside wrapping was a shawl of yellow cloth with fringed edges, and 7 lines of white thread inwoven at either end. This was laid above the body at the head end, and there was a slight excess of cloth. Here, the sides of the cloth were turned down and sewn together. At the feet end, there was a larger excess that was turned back under the feet and apparently left loose. The shawl next below showed traces of elaborate work in colored wool. This mummy was not unwrapped, but was packed and sent away whole. We have therefore no research of the inner wrappings.

N 2001 (TC) Map N/A [ed.: This record is Reisner's note of preliminary work that was done in 1901.]

Rotten wooden box empty.

[ed.: No image. This tomb card also contained brief notes about N 2021 and N 2041, referring not to Mace's tombs of those numbers, but reflecting an earlier numbering system.]

N 2001 (TC; MM) Map D3 [ed.: Map location given in excavation records; perhaps adjacent to N 2433, mostly in the tear in the map]; photo C 8194

100 down. Copt. Shallow grave running east-west. Adult male. On back, head west, arms by side. Remains of linen shirt with embroidered rosettes round sleeves, reaching apparently to halfway between knee and ankle. 3 woven ridges down each breast and over shoulder. Sides of shirt and bottom of sleeves corded. Shirt made in 1 piece. Nether arm was in sleeve. Sleeves were sewn up to above elbow at any rate. There were 2 wrapping shawls, both of sackcloth. These were folded over the body in the usual way, and ends of both were sewn together with fine cord. Between the 2 shawls, there were a few cords bound round the neck. On the outside, the bindings were of type 4 (i), but mostly gone. Quantity of salt. Under body, there were 3 palm sticks and 1 of sesaban, fastened together, and on the body there was a quantity of salt. Round the neck, there was a small shawl of coarse cloth, with lines of green and blue thread inwoven at either end. Over face, an enormous pad of cloth, consisting of an old shirt, much darned and patched.

N 2002 (TC; MM) Map D3 [ed.: according to excavation records, tomb is located in this square; N 2204 tomb card indicates that it is adjacent to N 2002, so partially in the tear in the map]; photo C 8451, C 8455

70 down. Copt. Shallow grave running east-west. Child aged approx. 8, probably a girl. On back, head west, arms by side. Traces of straight, dark hair. Round neck 2 or 3 strings of glass beads, blue, green, yellow, and red, with a few shells.

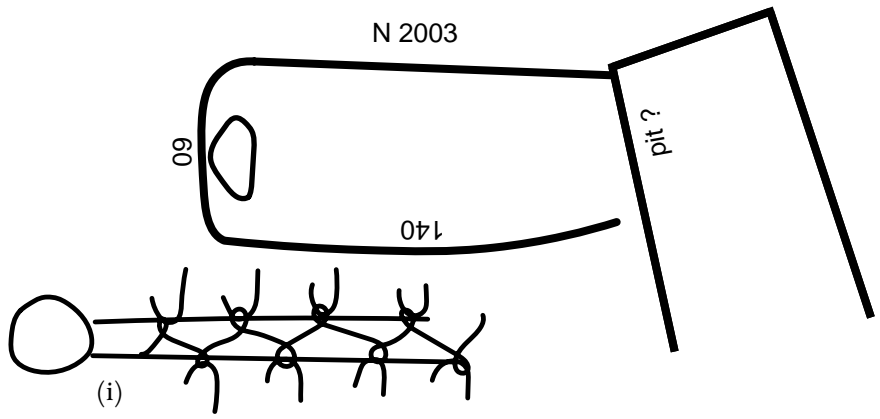
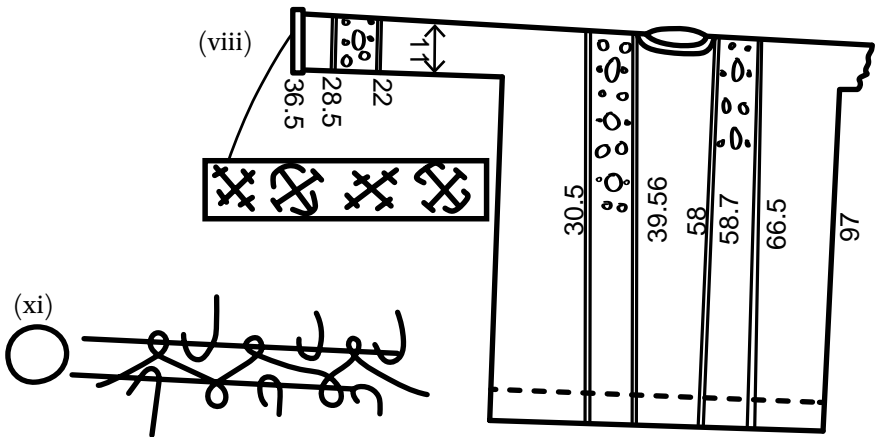
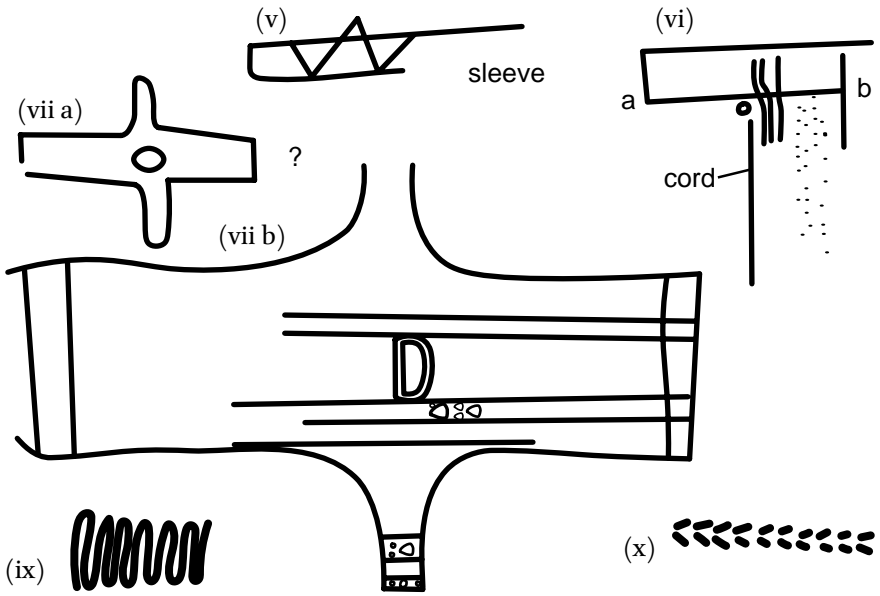

On the breast, probably attached to one of these strings, a cross composed of glass beads and copper wire. 4 beads in center, 3 red and 1 blue (i). On right ear, earring of copper with glass bead pendants (ii). On left, remains of a similar one. On the right and left wrists, a copper bracelet of type (iii), and also on the left, a broken one of bone. On a finger of the left hand, a copper ring. The body was dressed in a single linen shirt (iv) of a dark reddish color. 2 narrow lines down each breast and 3 at each side. 3 on each sleeve. Sides of shirt and ends of sleeves corded (v). Neck plain. Bottom of shirt selvage (vi) with linen ridges left in weaving (a...b). Both edges of sleeves were selvage, and thin edge [illegible] into body of shirt. Shirt cut from one piece of cloth. Sleeves originally sewn to armpit. On the head, there were remains of a net hood or cap of blue, yellow, and red thread. This was covered by a piece of cloth. Between last wrapping and shirt, under the body, a layer of salt and 2 palm sticks. These had been tied together. A few plant seeds on body. The first wrapping shawl consisted of a coarse cloth that was folded over in the usual way, but the right side was thrown over before the left. Above this, the body was wrapped in the shirt that had been unpicked at the sides and opened out to its fullest extent (vii a, vi b). Sleeves wrapped round over middle of body. Elaborate embroidery (viii): Remains of white and blue strip sewn around neck, 2 wide, and around bottom of sleeves. Around bottom of shirt, remains of a strip approx. 7 wide. On this bottom strip at any rate, white and blue were put on separately. White was sewn on so (ix), and blue thread was afterwards worked in in such a way as to leave geometrical patterns in white. From shoulder to below armpit, a line of red wool was sewn in so (x). Lines of embroidery of rosettes (flower designs) in red, yellow, blue, and green wools down front and round sleeves were enclosed by narrow lines of dark blue or heliotrope thread worked into warp. The shirt was cut from a single piece of cloth. In the weaving, there were occasional lines of thicker thread in the woof. Embroidery in blue, yellow, red, and green wool, sewn on to the warp, the woof in many cases being left underneath. The binding of horizontal 2-strand fiber cords came next above this and was of type 4 (xi).

N 2003 (TC; MM) Map D3; photo C 7979, C 7980, C 7981, C 7982, C 8003
 100 down from hard *gebel*. Copt. Shallow grave running east-west. Adult male. On back, head west, arms by side. Remains of beard, almost red in color. Pubic hair dark brown in color. Right ear still preserved. The body was clothed in 3 linen shirts, all plain except middle one, which had a decoration of 2 inwoven blue lines of thread. Under the body, there were 2 sticks, on the left, an acacia, and on the right, a palm. The first and second wrapping shawls were of coarse cloth, folded over in the usual way. Next came the binding, 2-strand fiber cords, which was of type 4 (i), and above this, there was a shawl of finer

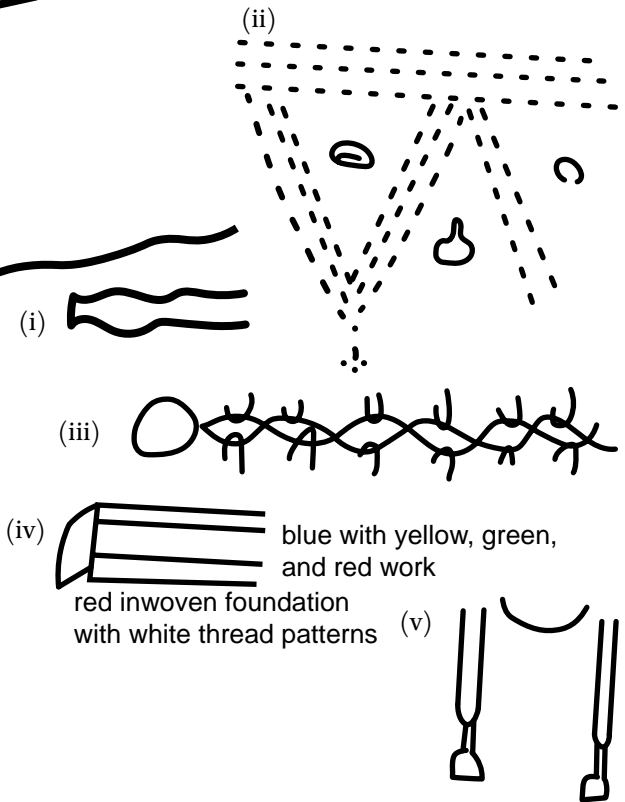
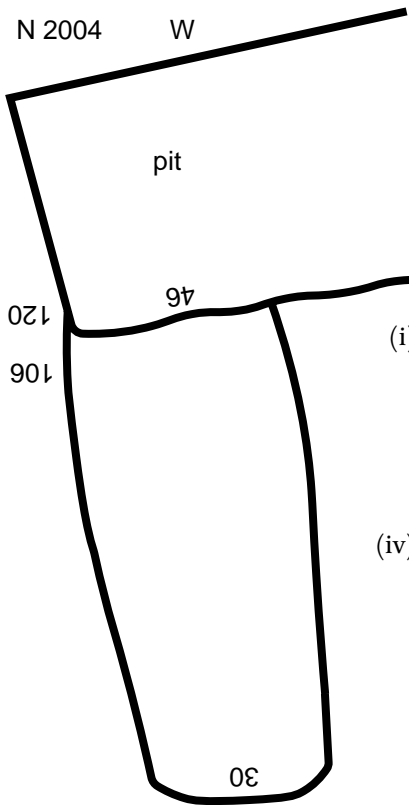
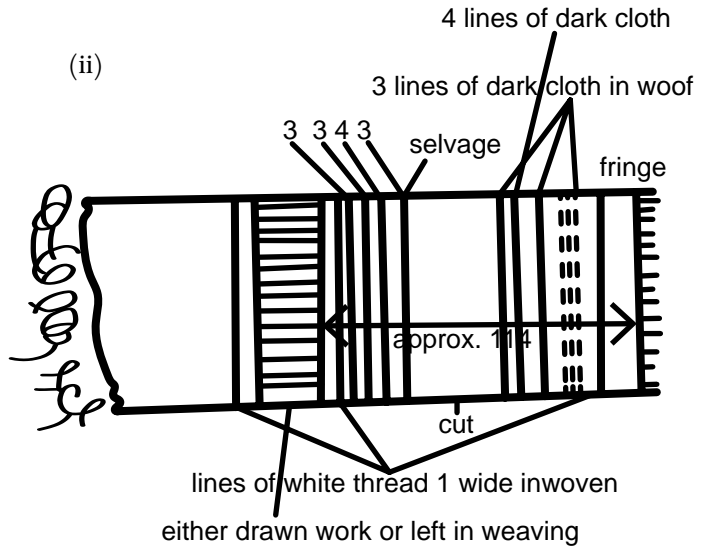

cloth, apparently laid loosely on top. This outer shawl (ii) had apparently been taken from the loom in an unfinished state, as at one end, the threads were tangled and unravelled. In the grave, under the feet at any rate, there was a layer of palm leaves.

N 2004 (TC; MM) Map D4 [ed.: Map location given in excavation records; probably adjacent to N 2838, in tear on map.]; photo C 8480

80 down. Copt. Shallow grave running east-west, west end projecting over early pit. Adult female. On back, head west, arms by side. Skull gone. Left femur broken anciently. On the right forearm, 4 iron bracelets. On the right wrist, a copper bracelet of type (i). On left wrist, copper bracelet of type (i). On the right hand, 8 rings of bone, 6 on the third finger and 2 on the little finger. On the left hand, 6 or 7 rings of bone. Wrapped on outside in a shawl of dark heliotrope color with a fringed end and white inwoven lines near end (ii). This was merely laid on top of body versus being tied round feet. Near end, there was a pattern in dark red wool. Small designs in angles in light red, blue, green, and yellow wool. Underneath, tied with 2-strand fiber cord (iii). Under this, additional horizontal bindings. Below, wrapped in 2 thicknesses of sackcloth, both with sides sewn together. Upper, left over right. In lower, right over left. Outer shirt had bands of embroidery down front and over shoulder (iv). Neither arm in sleeve. Under this, there was a shawl, which completely covered body. Below, another shirt, left arm in sleeve. First shirt: neck gone, sides corded, bottom of sleeves corded. Sleeves similar to chest bands, but double row of blue. Chest design (v) apparently not on shoulder. Sewn on to bottom, a strip of blue cloth with white thread designs, 5 wide. Similar pointed end of sleeve 1.7 wide. Second shirt: round bottom, a strip of red cloth sewn on 6 wide with designs in sewn white thread. This was apparently sewn on back and front and went a distance of 38 up sides. The cloth of shirt was brown with occasional lines of green bounded by white thread. Down the chest?, there were bands of designs in red wool. Round sleeves, a narrow band of red cloth with white thread designs. A quantity of salt and a few plant seeds were sprinkled over the body. Under body between sackcloth and shirt, 3 palm sticks. These were tied together with fiber cords at either end.

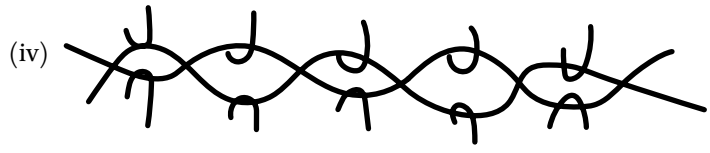
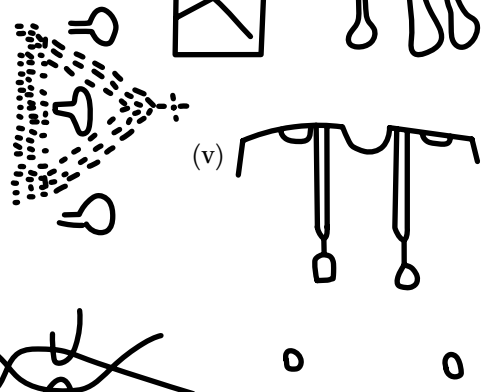
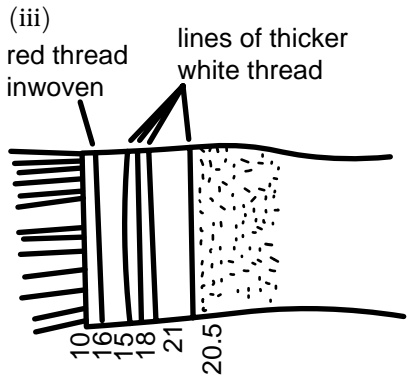
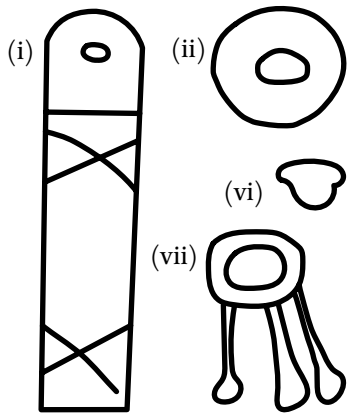
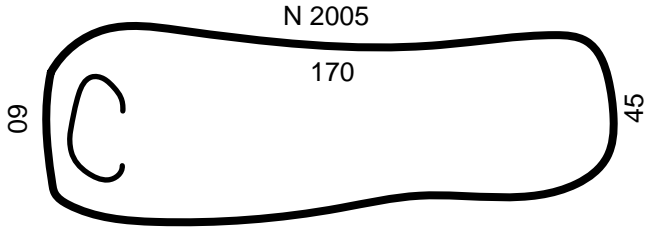

N 2006

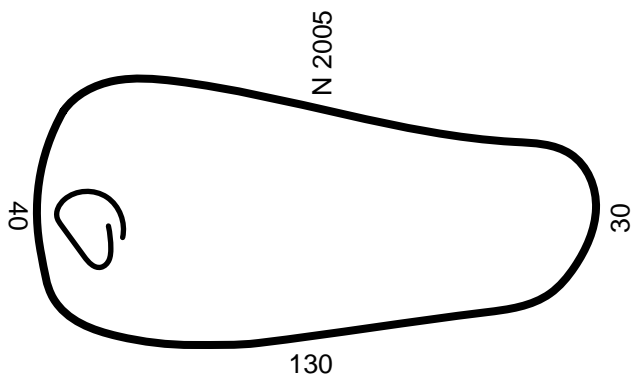

N 2106
pit

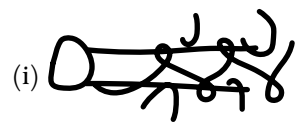

N 2005 (TC) Map D4

80 down. Copt. Male? Head west, aged 22–23. In filling, on. Also, a wooden ? pierced (i). Also, a wooden disc (ii), and a piece of fiber rope. Laid on top of body outside, not wrapped round, a shawl approx. 152 × 52 (iii). Had fringed edges. Color almost all gone. In angles, trees of green boughs with red trunks (wool). Colors all needle work. Remains of binding of 2 straw fiber cords, type (iv). Below, a single binding of sackcloth, left side over right. Below, a wrapping of cloth with 2 rows of 3 inwoven lines of green thread near each end and a wrapping of coarse cloth. These two were folded over together. Very curly dark brown hair. Shirt (v) reached almost to ankle. Bottom of shirt plain, top turned over and hemmed. Neck (vi) type. Sleeves ? Left arm at any rate not in sleeve. Right arm probably not either. Decoration of scroll flower type. Work in lines: figures? in rosettes. Background, inwoven red, green, yellow, and blue wool sewn in afterwards. A small round pad sewn on to back of neck on outside. Quantity of salt under body. Few plant ends on body. Under body, 1 “sont” [i.e., acacia] and 1 palm stick outside innermost wrappings. These had been tied together. Inside shirt by left arm, remains of an iron ? (vii).

N 2006 (TC) Map D4; photo C 8002

90 down. Coptic child. Head west, aged approx. 10. Remains of binding of type (i). On right shoulder, small ball of fiber cord and 2 or 3 skeins of fiber fastened together. Wrapped first in a cloth shawl with embroidered ends, then in a shawl of bright red. Quantity of salt on body. Over head, at any rate, under red shawl, remains of woollen wrapping with embroidery. This was almost all gone, but there remained several little bunches of wool that had been sewn on. Quantity of reddish brown short hair preserved on head. Also, on right eye, eyelashes and eyebrows preserved. Round head, a circlet of palm leaf 3 wide. This was wound inside and out with red wool that was wound round ? and into this wool were stuck bits of straw to form patterns. Remains of shirt, showing small red border sewn on round neck. On right arm, remains of an iron bracelet. Outer shawl had fringed ends (ii). Near fringe, a line of open work. All traces of color gone. Red shawl: piece of a shirt (iii). Near sides, lines of white thread (inwoven). Patterns bounded by lines of white thread. Ground of patterns blue: decoration in white thread with red and yellow wool insertion.

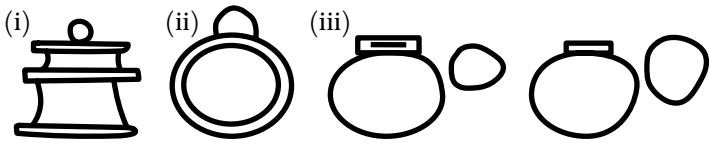
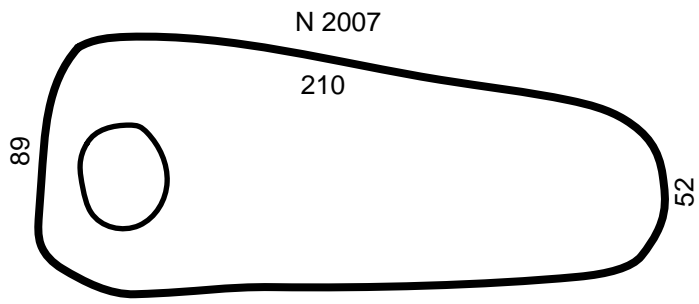
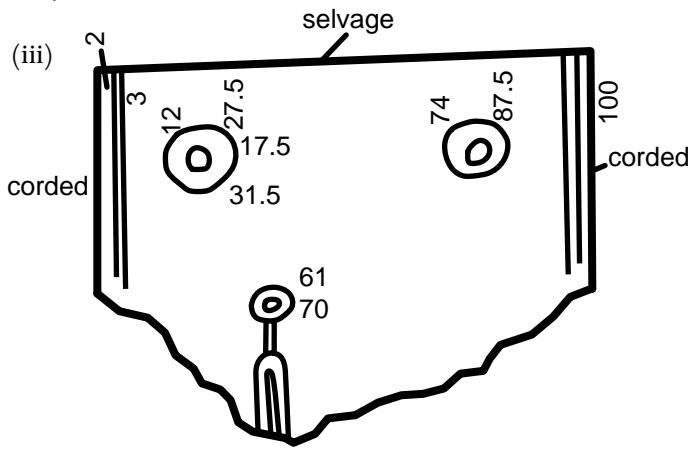
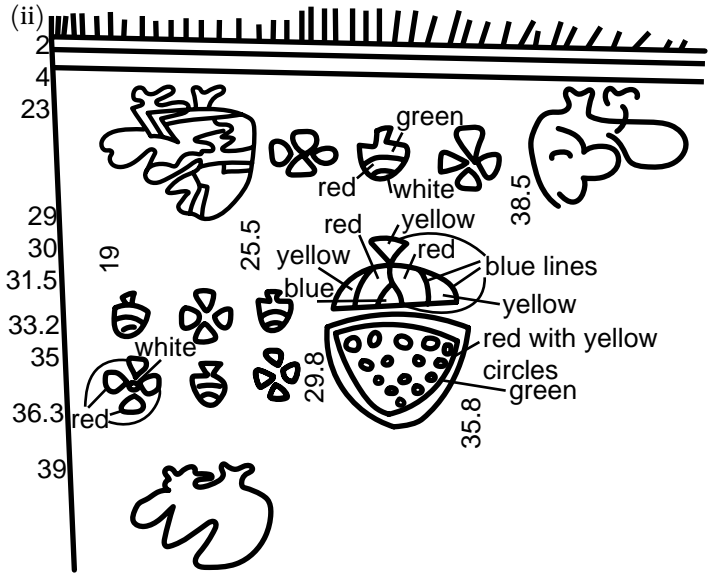

N 2007 (TC) Map D4; photo C 8463

95 down. Copt. Adult male. Head west. In filling on west side, wooden box (i). Usual position. Cloth almost all gone except from above head. On finger of left hand, silver ring (ii). On one finger of right hand, 2 copper rings (iii). These had animal figures? engraved on bezel. Skull was standing straight up so that it faced towards feet. Over skull, there was certainly 1 thickness of sackcloth, 2 of cloth. Under body, one on each side, a palm stick. By right side of body, too small for bracelet, too large for ring, a copper circlet.

N 2008 (TC) Map D4 (red)

Coptic. Burial of a small Coptic child aged 1–2 at end in filling of pit. Tied on outside with double strand fiber cord. Wrapped first in a shawl with fringed ends with, originally, lines of red, blue, and yellow wool [illegible] all over. 80 wide. Underneath, feet were wrapped in remains of a tiny plain shirt. Under body, inside wrappings, 3 palm sticks tied together at ends. Quantity of salt with body. Over head, remains of a shawl with green lines inwoven. No trace of shirt. On left arm, remains of 2 or 3 iron bracelets.

N 2009 (TC) Map E3

75 down. Copt. Head west. First tied with horizontal double strand fiber cord with style (i). Outside, a wrapping of sackcloth, ends fringed, line of open work near ends. Left side folded over right. Below, 3 wrappings of cloth, outer being of fairly rough texture, middle medium, and inner fine. They all had left side folded over right. They reached to just below feet, but there was a large excess, 40–50, beyond head. The ends of the 3 cloths were turned over head together and twisted up to form a large circular pad. The outer shawl was plain with fringed ends. Middle had tasselled ends and near ends, starting at approx. 20, a line of embroidery 45 wide, between 2 narrow lines of unwoven green thread. The embroidery consisted of geometrical patterns of yellow, green, red, and blue wool. Length approx. 230, width approx. 115. The inner shawl had plain ends turned over and hemmed, starting at 5 from end. There were 2 lines of dark red and blue cloth inwoven, 2–3 wide. Between them, there were occasional small crosses, etc., in same color (sewn in). Length 130–140, width approx. 120. This shawl was darned in several places. Between this shawl and the body, there was a quantity of salt. Over face, an extra pad of cloth. Quantity of long artificially curled hair? Remains of beard? Straight. Round neck, inside shirt, a strip of palm leaf. Body in very good condition. Most of skin left. On right leg, bottom of fibula joined both to tibia and heel bone. 3 shirts. The 2 outer ones at any rate were inside out. Remains of reddish brown pubic hair. Under body, between shirts and shawls, 2 thick “sont” sticks. These were tied together at ends. Arms were outside all sleeves. Headpad consisted of a

N 2008

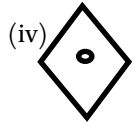
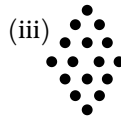
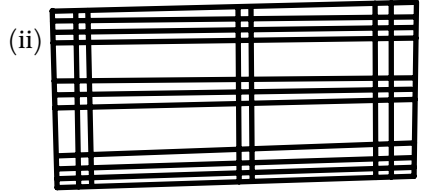
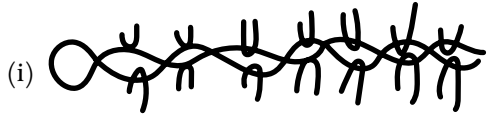
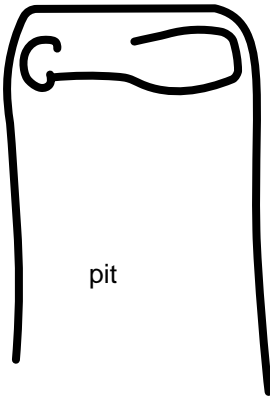

N 2009

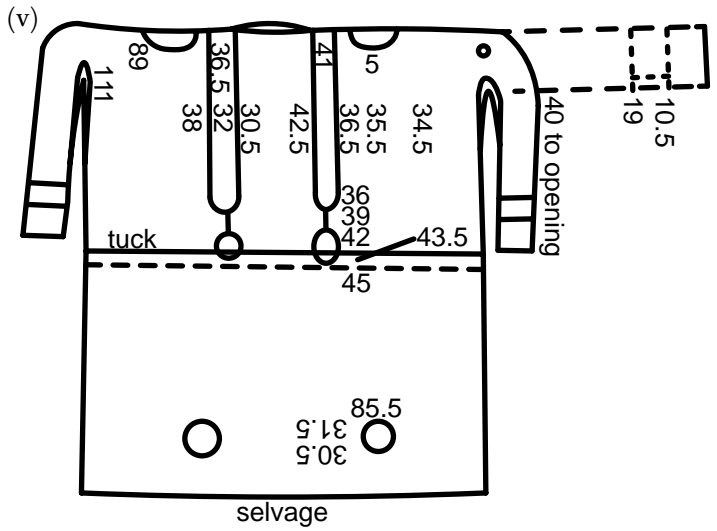
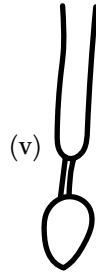
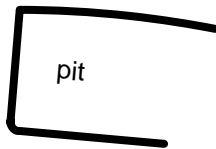
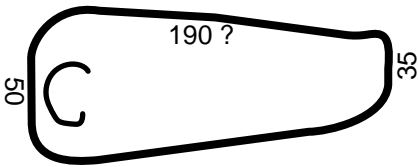
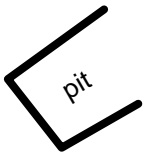

shawl 64 wide, ? long. Sides were strengthened by an ending of colored wools (ii). Lines of blue and green inwoven in cloth. Near one corner, (iii) in colored wools (needlework). Near another corner, (iv) in red wool with a green center. Put in with a needle. Probably there were 2 of each of these patterns, 1 at each of the 4 corners. Outer shirt (v): of coarse flax? Sleeve open from shoulder to neck. Made of 1 piece of cloth. Bottom of skirt plain, selvage edge of cloth ? Sides strengthened with cording, not a single cord sewn on, but a double cord worked into edge of cloth, sewn together. Bottom of sleeve similarly corded. Sleeves sewn up nearly to shoulder, left open under armpit. Sleeves were not inside out. Therefore, the arms were not in them. Tuck 3 wide, lower part of shirt gathered over upper. Sleeve panels did not go all round. There was a space 1.5 of plain cloth on each side of join. 6 lines of ribbing on each side of shirt from shoulder to end of opening. Also, 2 lines of ribbing inside breast panels. Rough tags of cloth left inside shirt at ends of ribbing and round circles of color. Second shirt: Also inside out except sleeves. Same style as outer shirt. Length 140, width ? Sleeves sewn up almost to shoulder. Neck and bottom of shirt plain. Down breast back and front, (vi) in red with decoration in original thread. Round sleeves, a panel of similar design. These were inwoven. In shoulder and near bottom of skirt, 4 medallions similar in style, but with medallion sewn on. Shirt made of 2 pieces of cloth, the join being 62 from top. Below join, a small crack. Inner shirt in very bad condition. Worn right side out. Neck finished off with sewn cording. Length 106+, width ? At 32 from top, a double tuck 10 wide, sewn at top and bottom, i.e., length of shirt was decreased by 20. (vii) down breasts back and front. Not distinct panels like second shirt, but patterns worked in red on original cloth. Similar bands round sleeves. Panels on shoulders and bottom of skirt. Those on shoulders were worked in like the panels, whereas those at the bottom were sewn on. This shirt was roughly darned in several places.

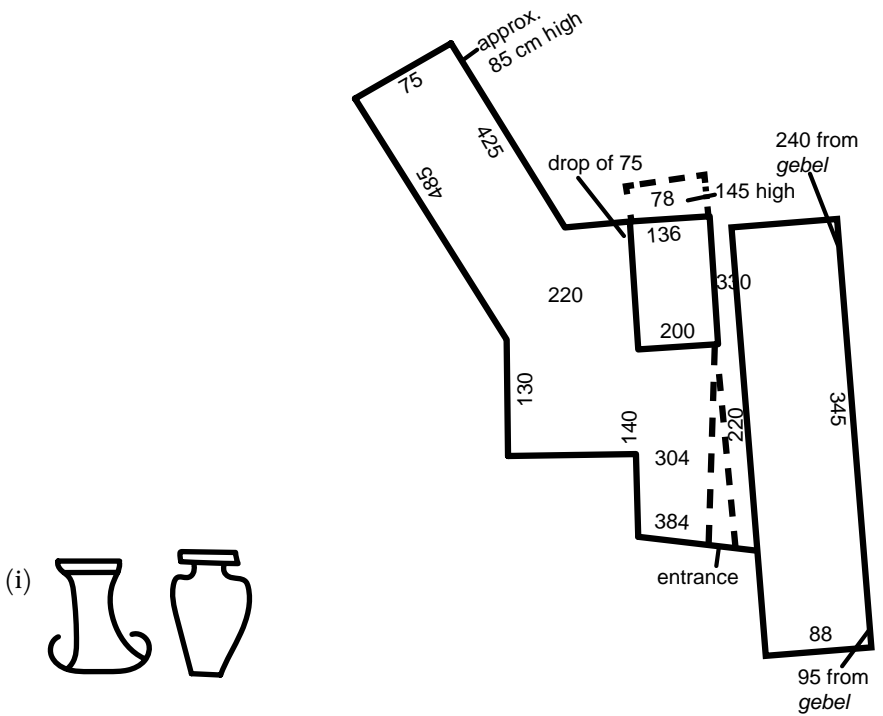
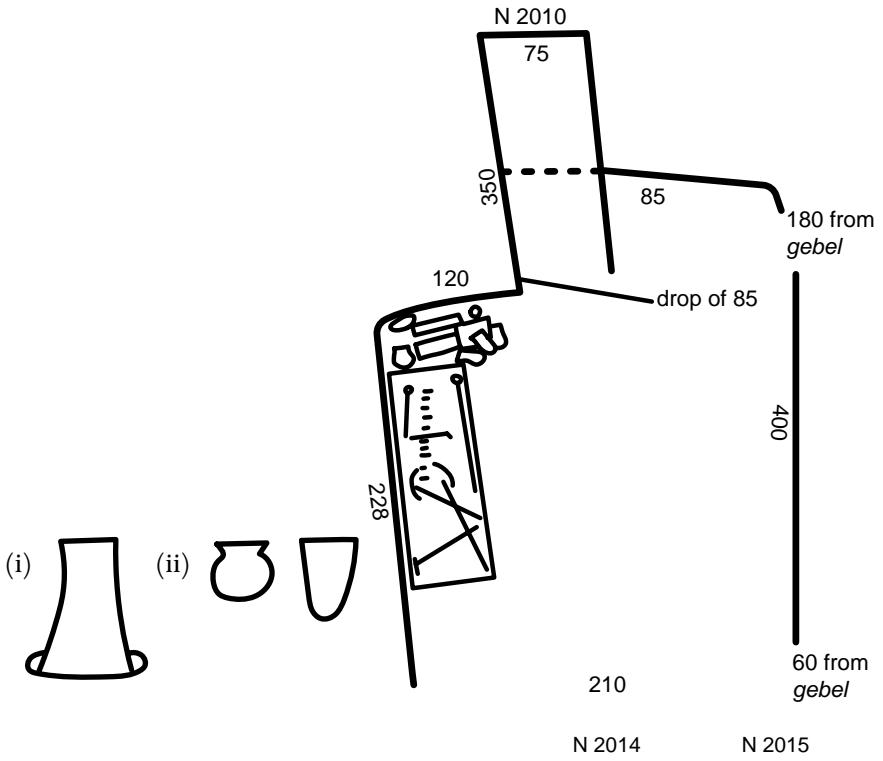

N 2010 (TC) Map D4; photo B 7129

Irregular chamber, sides broken away, *gebel* much broken away. Remains of bottom of coffin. Burial on 60 of *radim*. ? shape of tomb. Possibly two tombs. In pit, few broken bones. In large chamber, number of A pots, (i) · M, (ii). Few dark and light glass disc beads (6-14302).

N 2011 (TC) Map D4 (red)

140 to 100 from *gebel*. Contained absolutely nothing.

N 2012 (TC) Map D4

145 from *gebel* running down to nothing. Contained absolutely nothing. Was probably a pit and chamber, but roof absolutely disappeared.

N 2013 (TC) Map D5 (red)

90 from *gebel*. Contained nothing. Half tomb broken away when roof of lower *moghar* collapsed.

N 2014, N 2015 (TC) Map D4 (red), D5 (red)

2015 was chamber and pit. Portion of roof at north end shows that chamber was about 95 high. Was 60 lower than level of 2014. Chamber of 2014 had been 140 high, but almost all broken away. In large chamber, several pots (i) A, M, two skulls. In 2015, few pieces of wood showing that there had been a coffin.

N 2016 (TC) Map D4; photos A 8267, B 8251, C 8193, C 8464, C 8465

270 from *gebel*. 130 high. 80 of *radim* above. Sides and roof of chamber and pit fairly accurately cut, but floor of chamber left very rough. Larger stones from *gebel* projecting. Burial utterly plundered. Scattered three gold brooches (6-14304a-c) and stone beads, cylindrical (6-14303). In filling at top of pit, small glass bottle (MFA 47.1684?), piece of a large dish with Coptic inscription scratched on it, and broken pottery (i).

N 2017 (TC) Map D4

80 to *gebel*. Coptic burial. Male. Body originally wrapped round with rough cloth. Inside in the burial at any rate finer cloth. In front of face, circle of worked cloth. Under body, 3 palm sticks. Head raised slightly above body, resting on a small heap of sand.

N 2018 (TC) Map D4

Absolutely plundered out. Floor broken away by cutting of next tomb. Contained two or three bones and two or three fragments of Coptic? pottery.

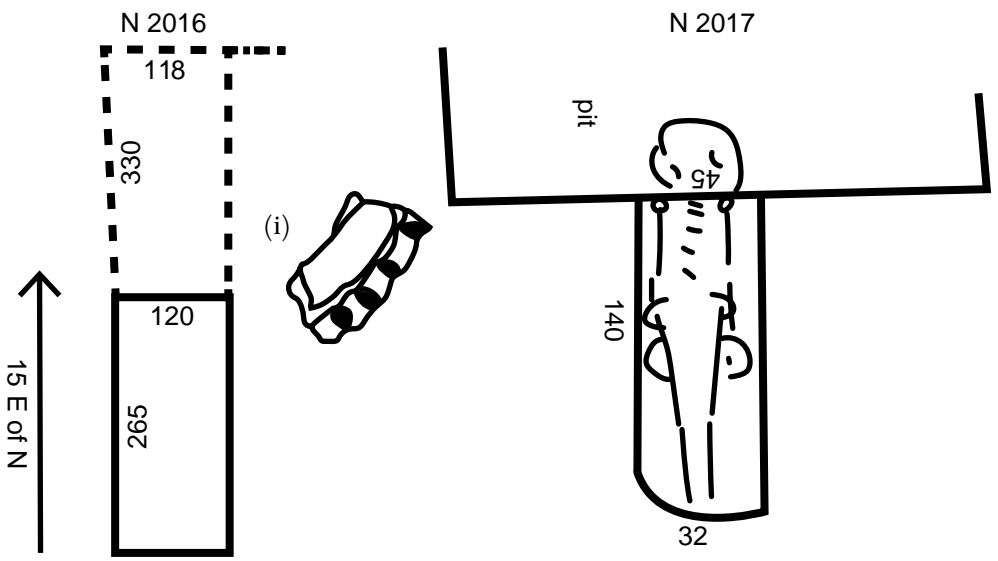
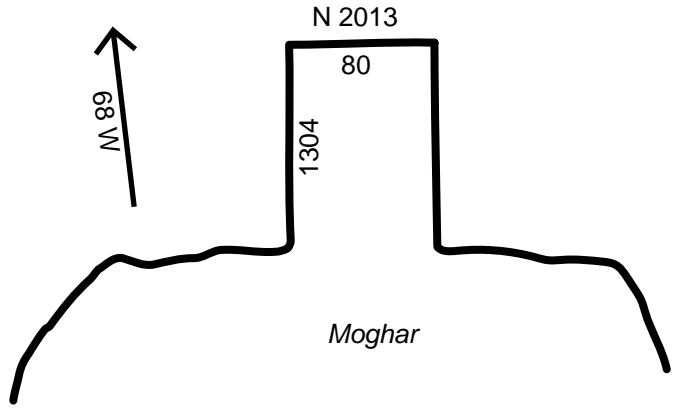
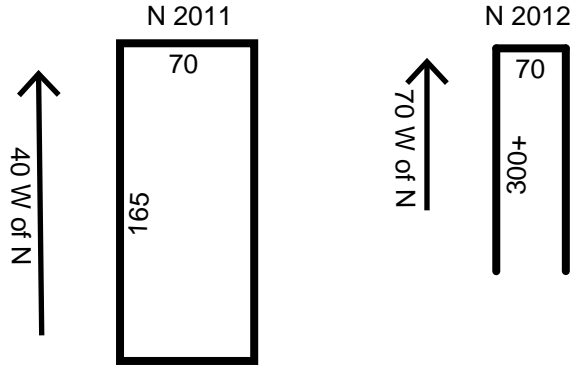

N 2019, N 2210 (TC) Map D4 (red); photo C 7074 (N 2210)
50 from *gebel*. Ends of two graves. Rest cut away. About 30 between floor of 2210 and roof of 2019.

N 2021 (TC) Map N/A [ed.: This record is Reisner's note of preliminary work that was done in 1901.]; photos A 4943, B 8247, C 9628, C 9629
Empty pits. Rectangular cloth. Shells, etc.

[ed.: No image. This tomb card also contained brief notes about N 2001 and N 2041, referring not to Mace's tombs of those numbers, but reflecting an earlier numbering system.] [ed.: According to museum records, the following objects are also from this burial: Hearst Museum: 6-14305 (metal beads), 6-14306 (carnelian amulets), 6-14307 (beads and amulets); MFA: 47.1694 (jar with pointed base), 47.1695 (tall shouldered jar with projecting rim), 47.1696 and 47.1697 (collared jars).]

N 2030 (TC) Map E4; photos B 0885, C 7001

Cut away by next tomb. Head of outside burial gone. Buried on stomach. Pottery A, M, (i). Small pottery, kohl pot. (6-14301, 6-14308, 6-14309) Stela in niche in bad condition. Name gone (ii) (6-14551). Colors in red, yellow, and black. Figures in half relief, hieroglyphs incised. In inner chamber, remains of a burial. Only one femur, a tibia, and a few small bones left.

N 2031 (TC) Map E3; photo C 0983, C 7178, C 7179

About 200 down from *gebel* level. Chamber was about 155 high, but almost all broken away. Stela face down and on top of coffin (i). Figure in sunk relief, hieroglyphs incised. Colors black, red, and yellow. Burial underneath, male. Right arm bent up. Left arm under body. Two ribs broken. Coffin had angled corner. Measurement [ed.: not given]. a. Remains of burial. Lower leg bones, broken skull, and some of vertebrae and ribs left. Had apparently been buried on back. By neck, quantity of gold foil (6-14310) had been upon something made of wood. Traces of coffin under feet, and apparently under coffin, few bones of a calf or some other small animal. Scattered about upper part of body, number of small glaze disc beads, green stone (iii) amulet, (iv) with gold lining inside, carnelian (v), white stone (vi) and (vii), green stone (viii), carnelian (viii), glaze (viii), soapstone? (ix), blue stone (x) (6-14317). Under coffin, pottery. Quantity of A, M with white inside rim (6-14313, 6-14318, 6-14321), and (ii) (6-14311, 6-14314, 6-14315, 6-14319, 6-14320). Slight groove and knife mark (6-14312). Broken clay jar stopper (xi). Also ordinary stoppers (xii).

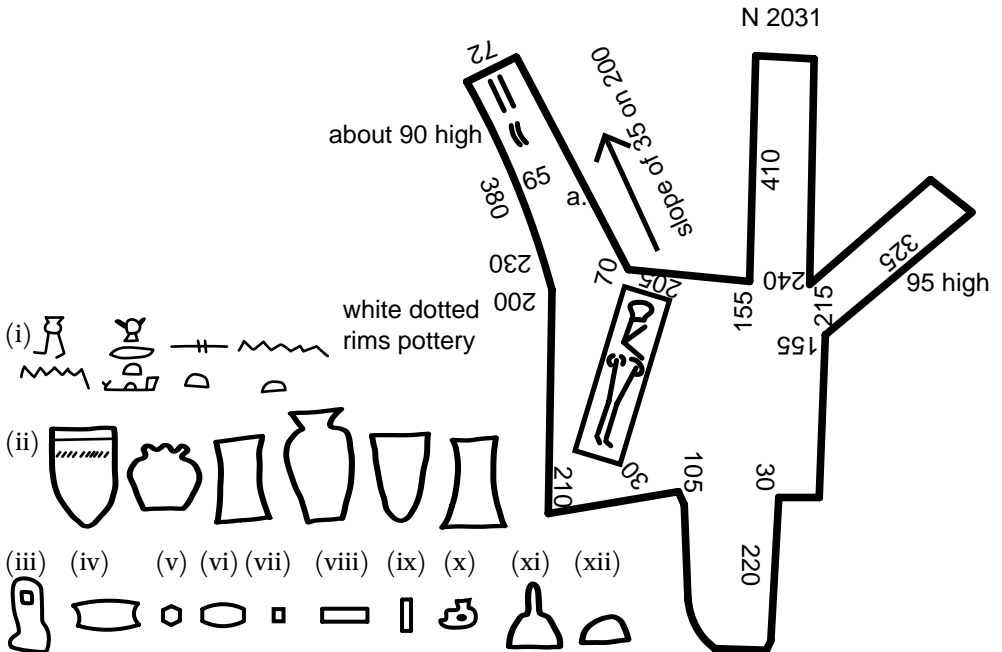
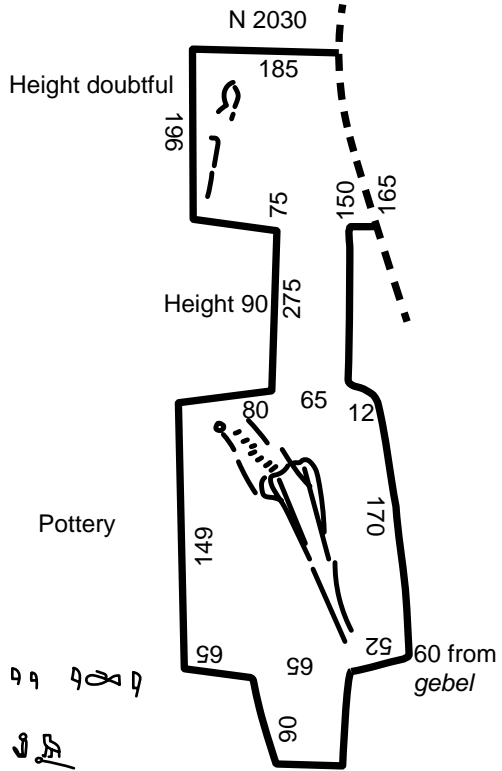
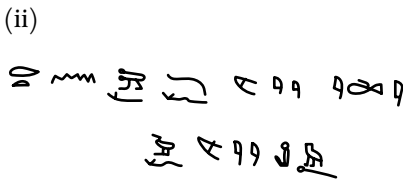
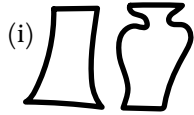

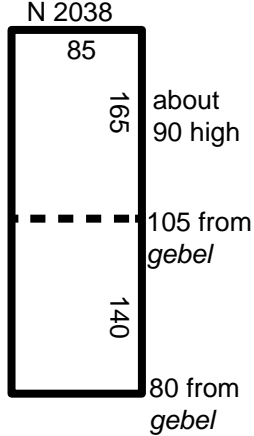
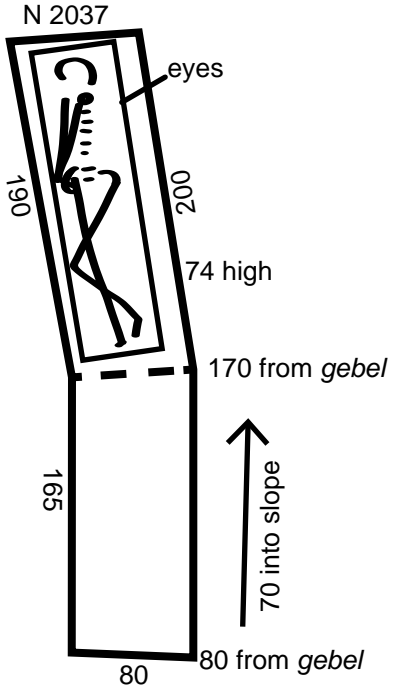
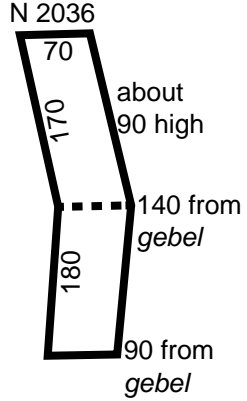
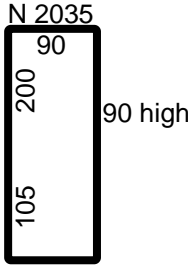
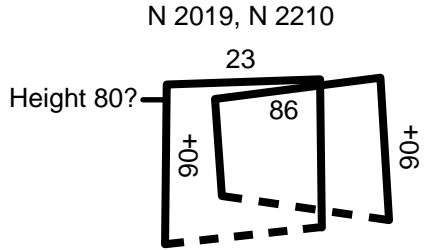
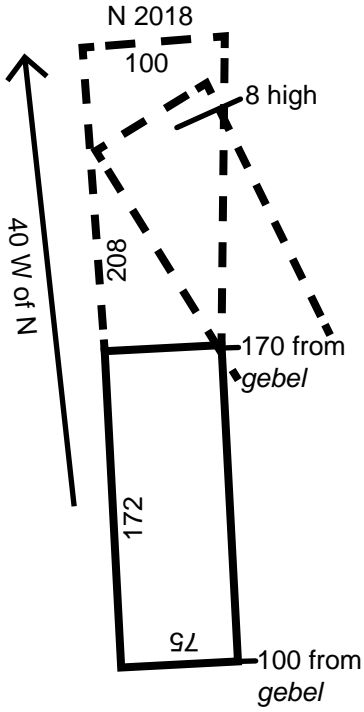

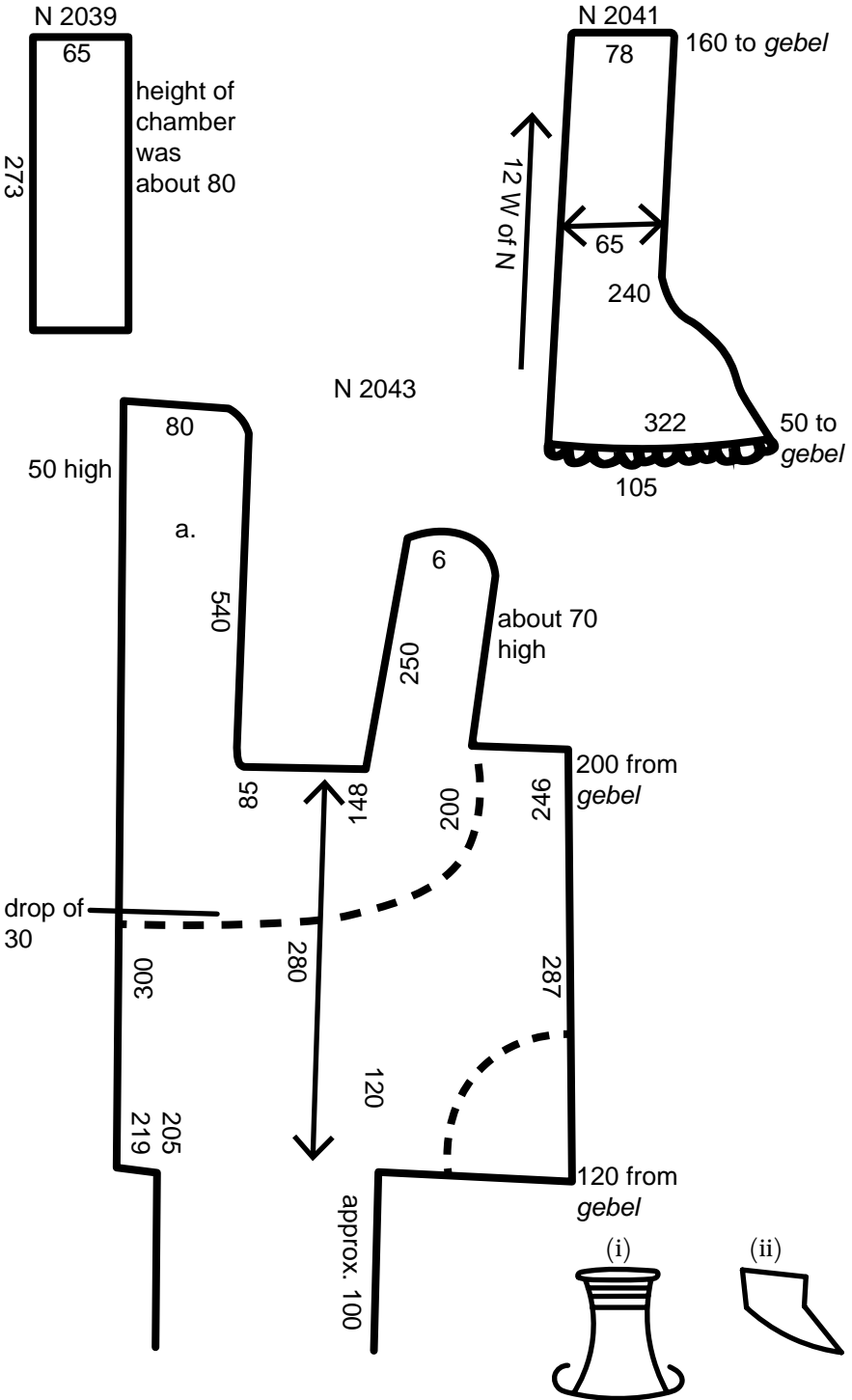

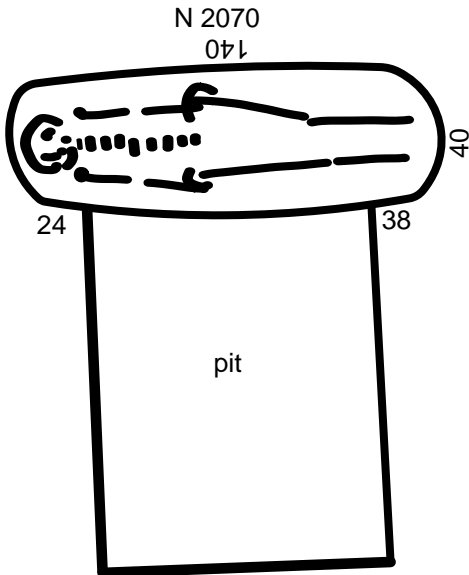
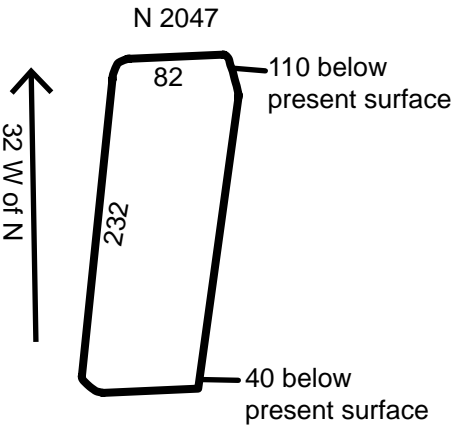
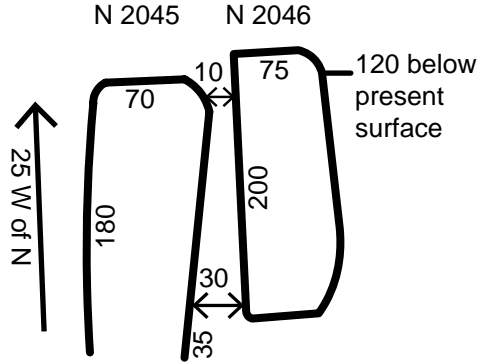
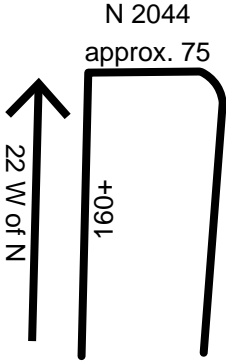

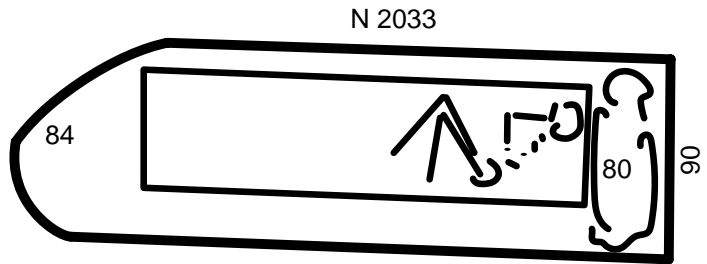
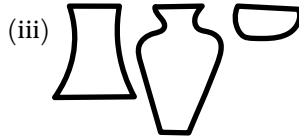
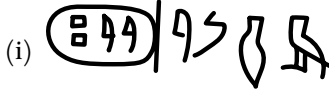
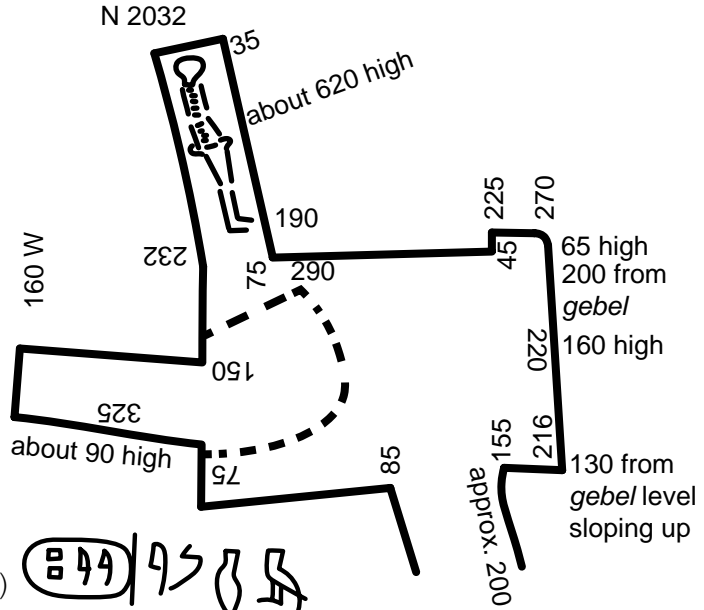

(i)

(ii)

N 2032 (TC) Map E4

200 to 130 from *gebel*, sloping up. Traces of mud show that shaft had been blocked. In dotted lines, pottery and above them, thrown down carelessly, stela of (i) (6-14552). Figure slightly cut in half relief. Colored red. Lines: two top, paint is yellow (not cut). Second two, paint is red. Hieroglyphs cut and painted green with blue. *Nabut* [i.e., staff] and (ii) yellow. Green bracelets and alternate yellow and red necklaces. Burial in small chamber in back. Remains of decayed coffin. Traces of cloth over body had been several thicknesses under body. Pottery: A, M, (iii) (6-14322, 6-14323, 6-14324, 6-14325, 6-14326, 6-14327, 6-14329, 6-14548), small white clay kohl pot, shell wand for kohl.

N 2033 (TC) Map E3 (red)

Burial of small child in long coffin. Upper bones scattered by falling apart of body. By legs, round faience rosette backed seal (i). Outside head of coffin, two small Coptic burials, one directly on top of the other. Inside measurement 185 × 31 × 40. Thickness of wood 6. Corners as usual, Round pegs. White stucco inside and out. Copts: Usual position head N. Upper A: Small child covered with four thicknesses of rough cloth, probably all one piece wrapped round. Between layers, over head, quantity of soft fiber. Over face, apparently a pad of colored cloth. Under body, inside wrappings, 4 palm sticks, bound together with fiber. Rope at either end and in middle. Few scraps of skin left, one piece showing navel. B: Usual position, head N, small child. Wrapped in 2 coarse cloth wrappings, with fringed ends with 3 narrow lines of blue approx. 10 from fringes. Body was laid on those. Sides were thrown over and corners turned back over head and feet. Tied round on outside with fiber cords. Next inside, a quantity of dried twigs and branches. Below, wrapped round body and covering face, a covering of very wide meshed cloth. Under body, inside outer wrappings, 4 palm sticks, tied together at any rate at one end. Underneath, a plain shirt, neck (ii). Underneath, rucked right up to small of back.

N 2034 (TC) Map E4; photo B 7129, C 0993, C 8285

In large chamber, small faience plaque (6-14328). In a., burial disturbed. Had been in back. Position of lower arm bones ? All upper bones disturbed. Right tibia and fibula gone. In large chamber, number of A pots, (i) M, (ii) M. Several round clay jar stoppers. Broken bronze needle. Two pieces of burnt wood. Remains of burial. Adult. Sex? On back. Arms by side? Remains of wood from coffin. [ed.: According to Hearst Museum records, 6-14316 (dish, broken) is from this burial.]

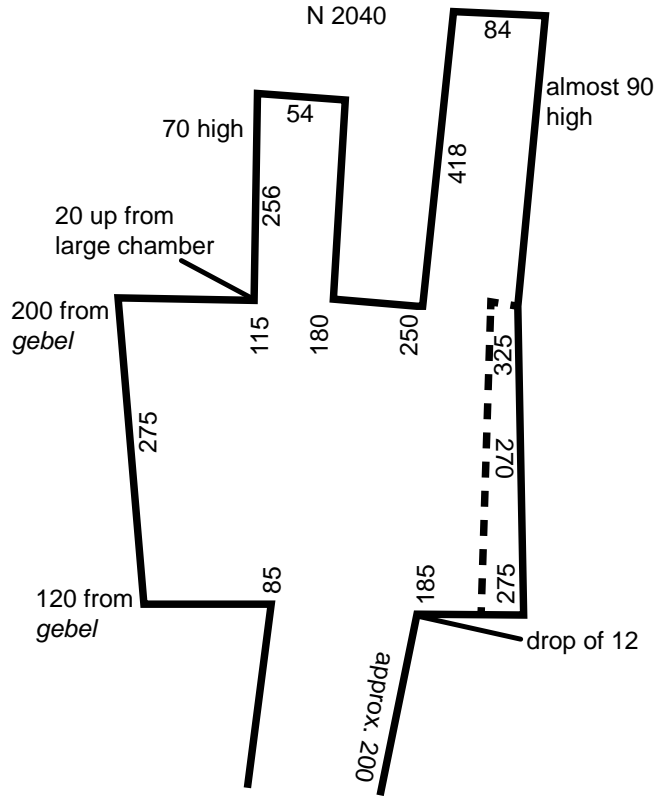
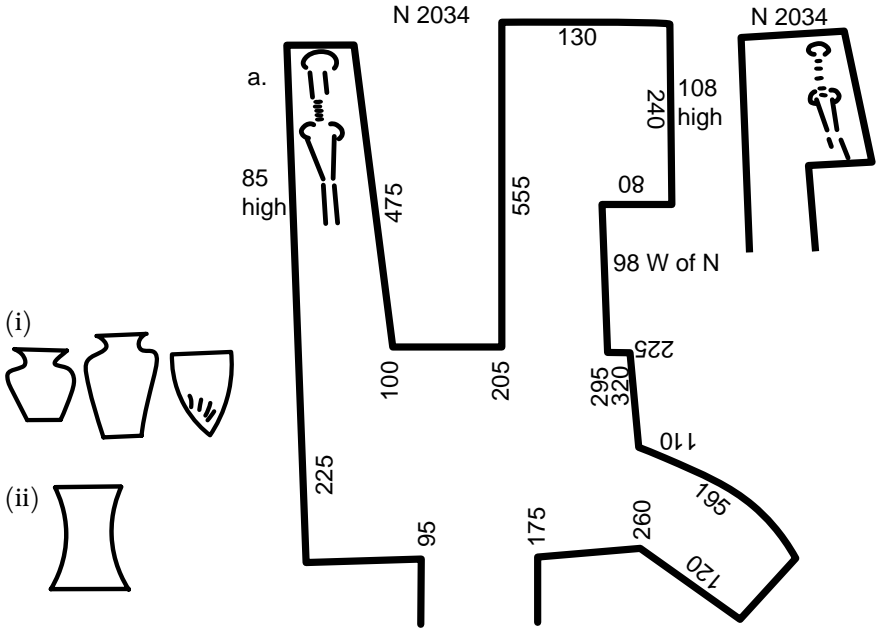

N 2035 (TC) Map E4

Contained absolutely nothing.

N 2036 (TC) Map E4

Contained only two or three broken bones and scraps of coffin.

N 2037 (TC) Map E4

Male. Body covered with much decayed cloth. On left side. Left leg straight down. Right bend under, but pelvis had probably fallen into this position. Inside measurement of coffin 178 × 42 × 42. Thickness of wood 3.5. Corners as usual. Round pegs all through coffin. Coffin white inside and out. Eyes on coffin of black, black pupils, white irises. [ed.: According to Hearst Museum records, 6-14330 (dish) is from this burial.]

N 2038 (TC) Map E4

Contained absolutely nothing.

N 2039 (TC) Map E4 (red)

100 from *gebel*. Contained nothing. Side of tomb cut away in the making of 2030.

N 2040 (TC) Map B5; photo B 8619

200 to 120 from *gebel*. Sharp slope of 32 from large chamber. Roof of large chamber completely gone. Within dotted lines, several A pots, 2 or 3 (i), 1 (ii), and 1 (iii). Also in filling, quantity of A, (iv), M. (v) with a dull yellowish unpolished surface. ? date. Also, granite (vi), (vii) worked out with a drill.

N 2041 (TC) Map N/A [ed.: This record is Reisner's note of preliminary work that was done in 1901.]

Ditto. [ed.: In reference to the N 2021 record: "Empty pits. Rectangular cloth. Shells, etc." No image. This tomb card also contained brief notes about N 2001 and N 2021, referring not to Mace's tombs of those numbers, but reflecting an earlier numbering system.]

N 2041 (TC) Map B5

Absolutely plundered out. On *gebel* at SW end, wall of stones built 30 high, 20 wide. Probably originally pit and chamber.

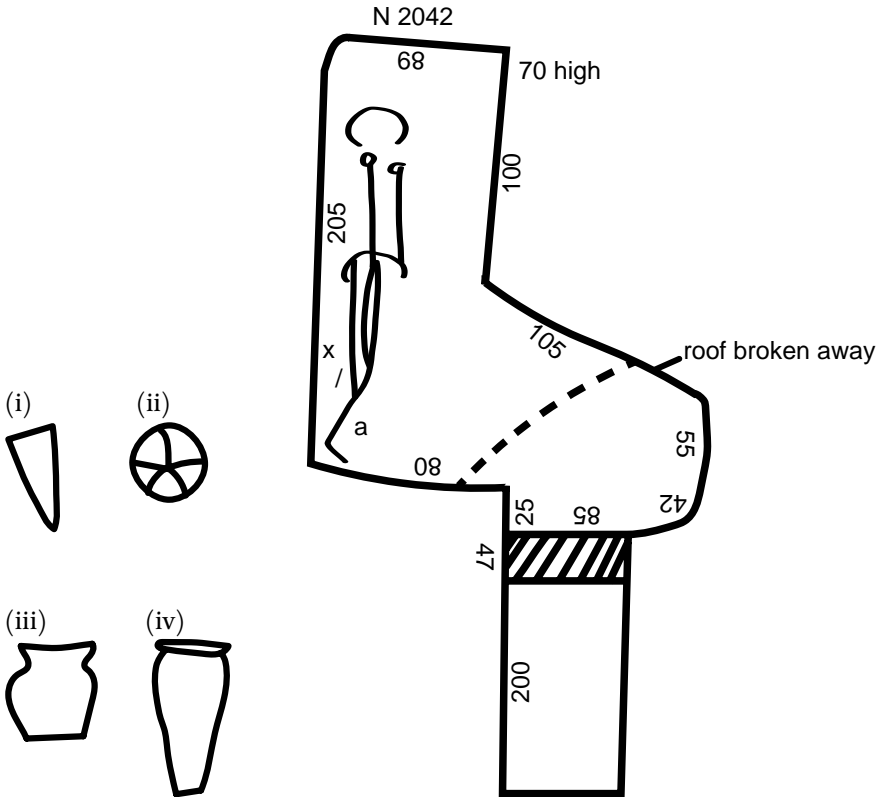
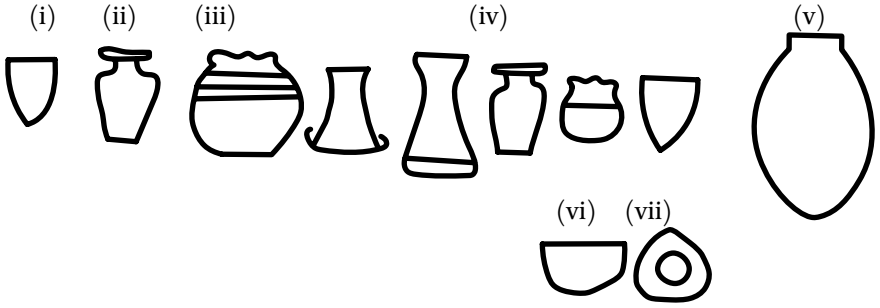

N 2042 (TC) Map B5; type vi c; photo A 8265, C 7496, C 7498, C 7499, C 7500, C 7501, C 7502, C 7503, C 7504, C 7505

Brick and a half thick. 70 high inside, i.e., full brick height. 76 high outside, i.e., half brick height. At /, 2 alabaster (i) (6-14342). At x, granite paint grinder, shell wand for kohl, and bone kohl spatula. At a, 1 alabaster kohl pot (6-14331). On left side. Pelvis out of position, but this might have come through falling apart of body. Skull broken and turned right over on upper vertebrae. Skull upwards, facing NE. Round pelvis girdle of 15 strings of shell and black and green glaze beads (6-14332, 6-14341, 6-14343). Order from below: 1. all green, 2. all white, 3. black and white, 4. black and white, 5. all white, 6. black and white, 7. black and white with few green, 8. black and white, 10. white, 11. black and white, 12. black and white. Strings were under both arms. All upper part broken owing to falling apart of pelvis. Underneath, 8 strings in position. Strings join at intervals of about an inch. Both upper and lower layers of girdle were underneath pelvis. Possibly it was a double girdle as all upper part was disturbed. There were extra strings; 1 of tiny glaze disc, and 1 of carnelian disc (6-14333, 6-14335) and tiny glaze amulets (6-14334, 6-14340). In filling, fossil (ii), bronze needle. 2 alabaster at 8194 1/4 (iii) (6-14331) and 8194 2/4 (iv) (6-14342). [ed.: According to Hearst Museum records, 6-14336 (loose beads), 6-14337 (travertine bead), 6-14338 (carnelian ball beads), 6-14339 (faience ball beads) are from this burial.]

N 2043 (TC) Map B5

Tomb fairly accurately cut. In a., 1 skull. In large chamber, several A1, broken (i), broken M, (ii) in white pottery.

N 2044 (TC) Map B5 (red)

100 below present surface, running down 17 within. Had contained a coffin. Absolutely plundered out. [ed.: According to Hearst Museum records, 6-14344 (*hes* vase) is from this burial or from N 2048.]

N 2045, N 2046 (TC) Map B4 (both red)

Neither contained anything.

N 2047 (TC) Map C4 (red)

Contained absolutely nothing. May have been pit and chamber.

N 2048 (TC) Map B3; photo C 8285

In *radim*, scarab (i) (6-14348). Also, half a wooden[ed.:?] vase, originally with lid (ii). A few bones. Cut bottom of grave. Coptic burial? [ed.: According to Hearst Museum records, 6-14344 (ceramic jar), 6-14345 (bent wire), 6-14346 (copper fragments), 6-14347 (glass fragment) are from this burial.]

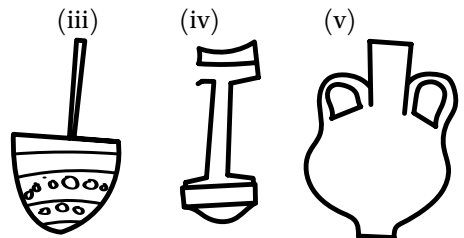
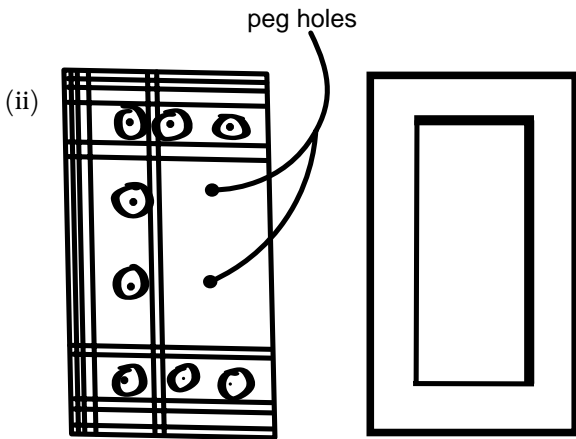
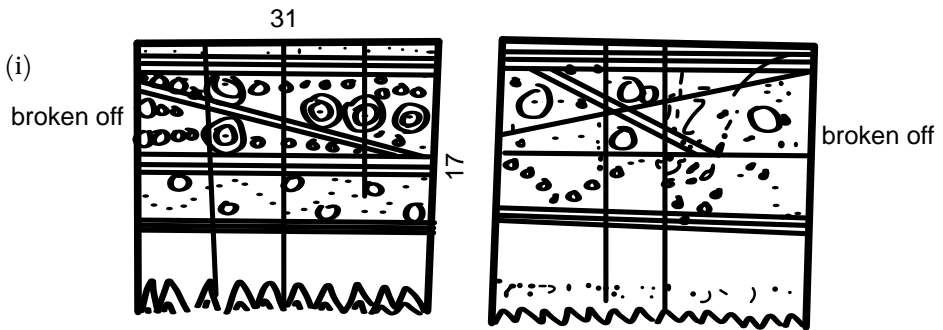
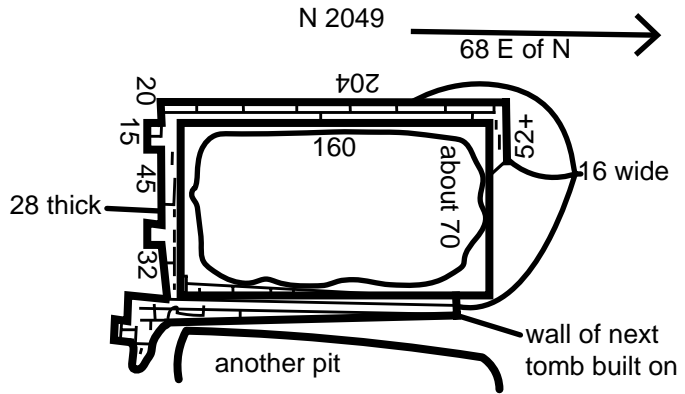

N 2049 (TC) Map B3; photos C 8460, C 8461, C 8462, C 8506

Walls built on *gebel*. 140 to bottom. Walls 25 high. At bottom, irregular hole. No chamber. No bones of any kind. Halfway down, Coptic decorated wood. Pieces pegged in 2 round pegs. Pegs ran right through (i). Pieces joined by small round pegs (ii). Whorl (iii). 14 high into stick. 8 across. And several pieces (iv) similar to (ii). Small piece of glass. Pottery (v).

N 2070 (TC) Map B4 (red)

100 from surface. Coptic burial above early burial.

N 2071 (TC) Map B4; type rock-cut chamber with sloping entrance; photos A 8267, A 8268, B 8250, C 8074, C 8194, C 8285, C 8567

Each body had originally a wooden coffin, but these had almost entirely disappeared. (a) Body of a child. Leg bones and right arm disturbed. Head broken. By pelvis, glaze (i) of striped black and white faience. Round neck, string of small brown faience disc beads (6-14372). 1 carnelian (ii) 1 (iii), 100[ed.:?] (ii), 2 carnelian (ii), and a small scaraboid (iv) (6-14372). (b) Arm bones disturbed. Round neck string of green faience disc beads (6-14365?, 6-14368?). Also, a small faience scarab (v) (6-14374). (c) Bones much disturbed and broken. Round neck strings of carnelian short cylindrical beads and tiny faience discs (6-14373?, 6-14378?, 6-14379?). Behind head number of faience amulets (6-14375). By left arm, there had been a small wooden box containing 4 faience scarabs, and a number of faience amulets, and beads (iii) and disc also scattered above body (6-14373?, 6-14378?, 6-14379?). Number of shells pierced for threading (6-14355, 6-14356). Stone pendant with black rings (6-14359). Two faience (vi) beads, white with black continuous ring decoration (6-14358). Green faience (vii) and disc beads and small amulets (6-14357?, 6-14364?, 6-14367?). 1 carnelian (viii) and 1 disc (6-14377?). Small shell disc beads (6-14362?). Pottery kohl pot. 2 pieces of an alabaster jar, one of which had been used as a scraper (6-14353, 6-14354). Pieces of 2 or 3 ivory needles. 1 mussel shell. In *radim* above, 2 pieces of a pot (ix), which had been broken and mended anciently. Below, a second layer of burials. (a) Adult male. On back. Position of arms ? (b) Sex? Aged approx. 20. On side, but exact position of legs and arms ? Head rested on a brick. (c) Remains of burial of a young child. (d+e) Remains of burials of 2 women? Bones of these 2 last considerably displaced. (e) was over on stomach. By neck of (e), a quantity of beads: blue and black glaze and light stone disc (ii, viii, iii, x) (6-14364?), 1 crumb (ii) (6-14360?, 6-14364?), 1 (i), 1 glaze scaraboid (xi) (6-14363). Door partly blocked with bricks. 40 of *radim* below, then 50 of roughly burnt brick. Alabaster at 8194: (xii) 2071a, (xiii) 2071a, (xiv) 2071: really 2093. [ed.: For the alabaster jar (xiv), see 6-14412 in N 2093. According to Hearst Museum records, 6-14351, 6-14352 (alabaster jars), and 6-14361 (bead

N 2071

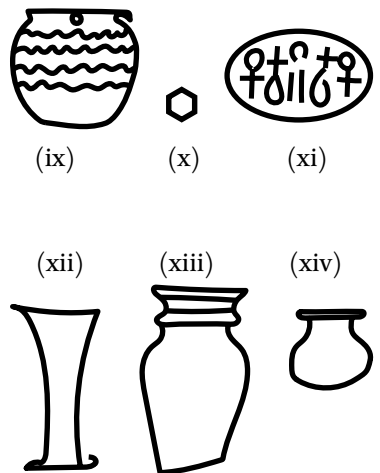
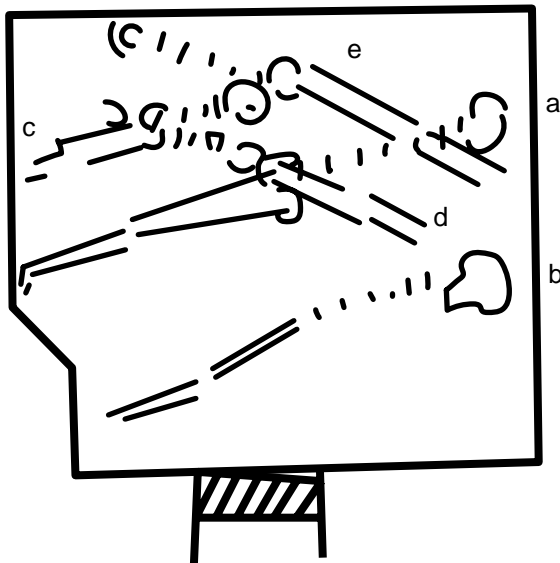
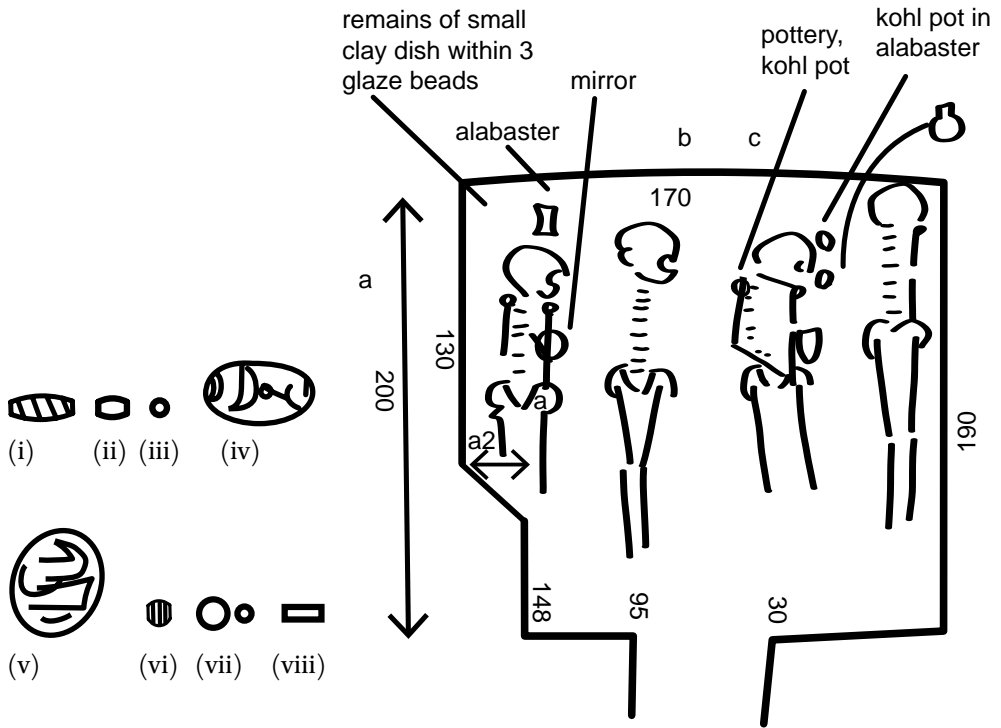

fragments and rocks) are from this burial. 6-14366 (mirror) is labeled as potentially coming from this burial. 6-14369 (alabaster jar) and 6-14370, 6-14371 (mud beads and decorations) are from N 2071a. 6-14373 (beads) are from N 2071b. 6-14376 (pendant) is from N 2071c.]

N 2072 (TC) Map A5; photo C 8235

Roof of large chamber entirely gone. Present height 120 from *gebel*. In large chamber, head and shoulders of a burial. Round neck, several strings of glaze beads sizes apparently strung separately. In front, probably on shell necklace, lion plaque in limestone (6-14381; Reisner 1932, fig. 50:19) and 1 carnelian (i) bead (6-14381). Also, string of black glaze beads. In front, apparently on black string, carnelian (ii) and (i), limestone (iii), and quartzite (i) (6-14380, 6-14381). Several broken As, 1 (iv).

N 2073 (TC) Map B4

40 from *gebel*. Coptic grave? Contained nothing.

N 2074 (TC) Map A5

35 from black clay deposit. Coptic burial. Remains of sackcloth under body.

N 2075 (TC) Map A4; type vi d; photo B 8248, C 8074, C 8194, C 8285

160 down from *gebel* level. 100 E of N. In an upper part of plundered burial. By neck, quantity of carnelian beads scattered. Barrel carnelian strung with black glaze disc between; in one place, a lazuli disc in place of glaze (6-14389a, 6-14389b, 6-14390). Small carnelian (i) strung together (6-14385). Layer of same shape either together or with black glaze between. Also, a string of tiny shell (6-14385). In large chamber, few shell disc beads. In main chamber, a few pots, mostly broken (ii). Piece of a drab (iii)? 2 alabaster C 8194 1/5 (iv) and 2/5 (v) [ed.: According to Hearst Museum records, 6-14382 (glass bead/plug), 6-14383 (scarab), 6-14384 (assorted beads, including a striped faience bead similar to the drawing in 2071), 6-14384.1 (metal beads), 6-14386 (jar fragment), 6-14387 (metal wire), 6-14388 (needle), 6-14391, 6-14392 (alabaster vessel), 6-14393, 6-14394, 6-14395 (mirrors), 6-14396 (ceramic jar) are from this burial.]

N 2076 (TC) Map A4

70 down. Coptic burial. Usual position. Head gone.

N 2077 (TC) Map A4

On black ash level. Coptic. Child. usual position. By ankles, 4 more anklets.

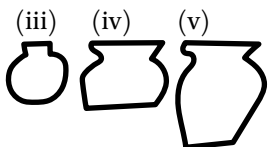
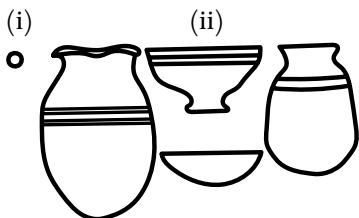
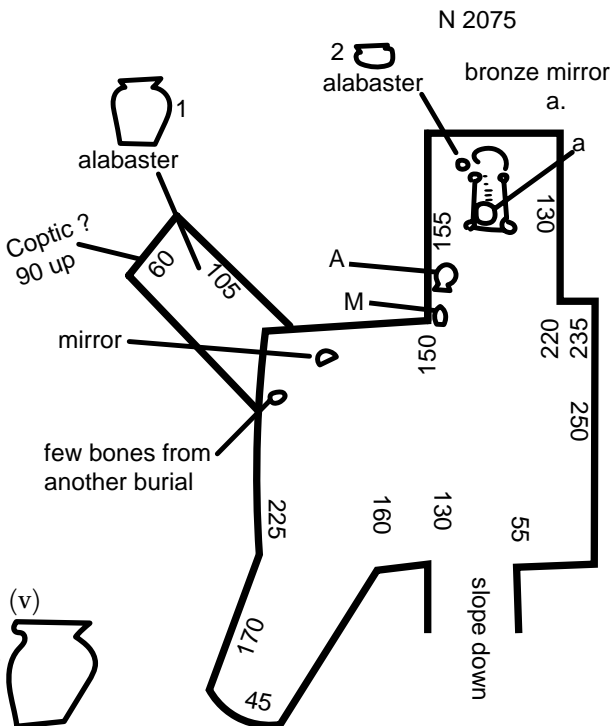
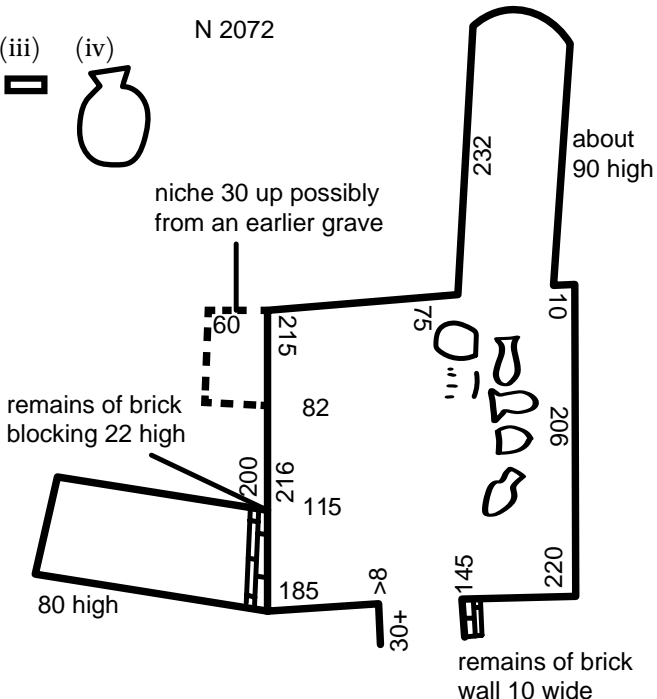
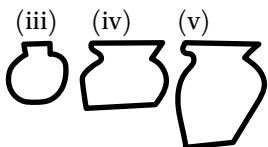
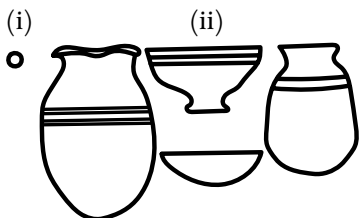
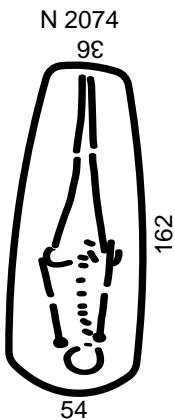
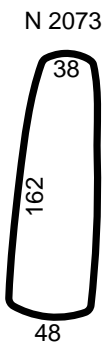
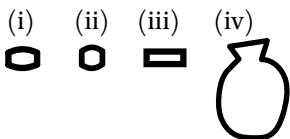

N 2078 (TC) Map A4

On black ash level. Coptic burial. Usual position.

N 2079 (TC) Map A4

20 below black level. Coptic burial. Lower leg bones gone. Had protruded over 2071.

N 2090 (TC) Map C5; photo B 7146

Few traces of decayed cord showed that there had been a coffin. Bead girdle 8 strings. Behind back, order from above was white shell (1), white and black (2), white shell (3), white shell (5), white and black (4), white and black (7), green (8), white (6). 7 and 8 did not go over left ilium. 7 came round underneath into position next to 4. 8 went over 6 and under 7 and 4 and came up between 7 and 6. Under right ilium, order from above was 1 2 3 4 5 6 7 8. All strings went over right ilium. Strings were not fastened together in any way as strings crossed especially at sides where they kept no sort of order. By right arm, few strings[ed.:?] green glaze and shell beads and 1 carnelian possibly bracelet. Round neck, string of tiny glaze disc beads. Also, a few of the beads by neck, but these may have come from girdle as beads were much scattered (6-14397, 6-14398, 6-14399, 6-14400, 6-14401, 6-14402, 6-14403, 6-14404, 6-14405, 6-14407). Remains of coffin, but measurements [ed.:?]. [ed.: According to Hearst Museum records, 6-14406 (*djed* pendant) and 6-14408 (pot stand) are from this burial.]

N 2091 (TC) Map C5 (red)

Bottom of coffin and lower leg bones gone. Curious dent on skull. Skull had been wrapped in cloth. No trace of cloth anywhere else. Coffin almost entirely destroyed by worms. [ed.: According to Hearst Museum records, 6-14409 (mirror) is from this burial.]

N 2092 (TC) Map C5; photo B 8251

90 from surface running down to nothing. Plundered body of a small child. Fragments of cloth under body. Round neck, double string of small blue faience disc beads (6-14410).

N 2093 (TC) Map C5; photo B 7129, B 7144

Slope of 50 from outside into large chamber. South side of tomb cut away where tomb 2094 was made. Sides of doorway mudded. Outside brick walls. On south side, outside, remains of a wall of stones and mud continuing out to level of outside wall of 2094: brick wall 40 high; stone wall 18 high. In b, 2 A pots. Half chamber a cut away by chamber of 2094. In large chamber, broken

N 2076



N 2077

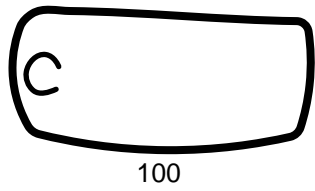

N 2078

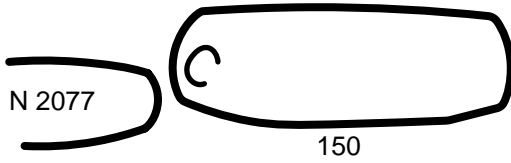

N 2079

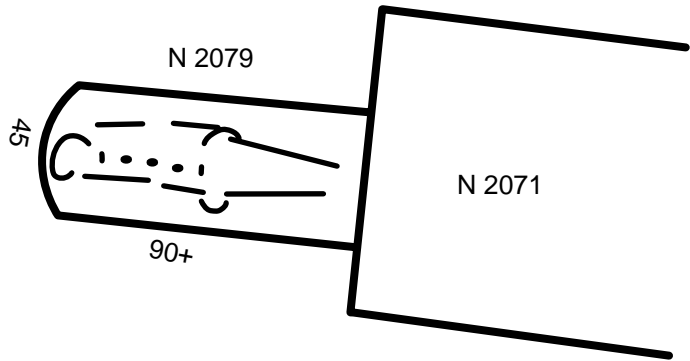

N 2090



N 2091
8E

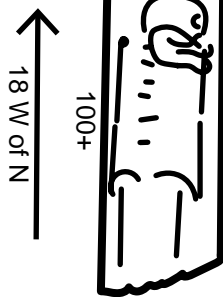

N 2092
99

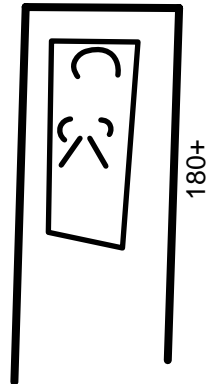

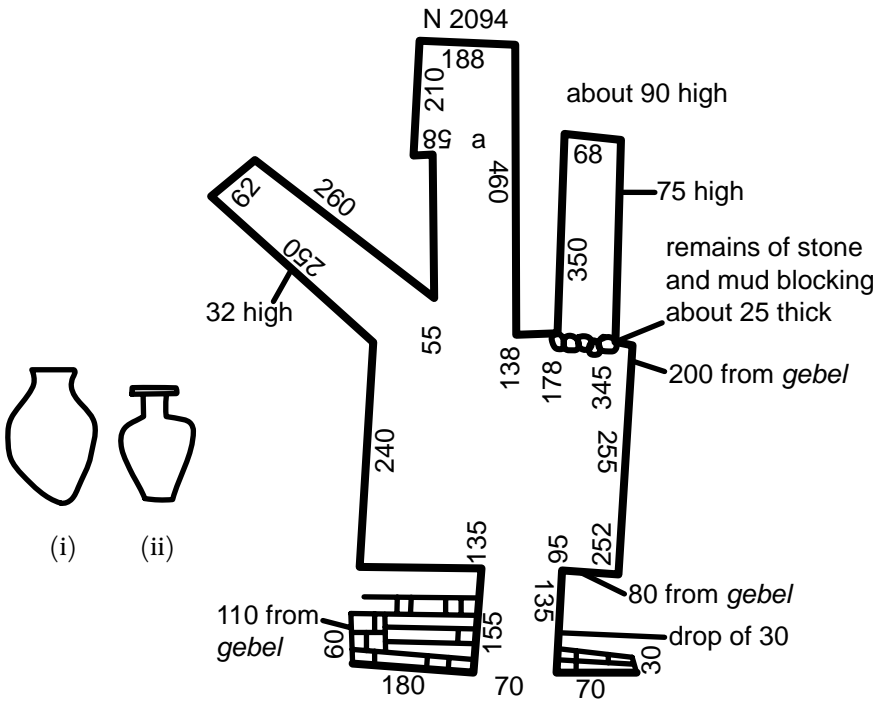
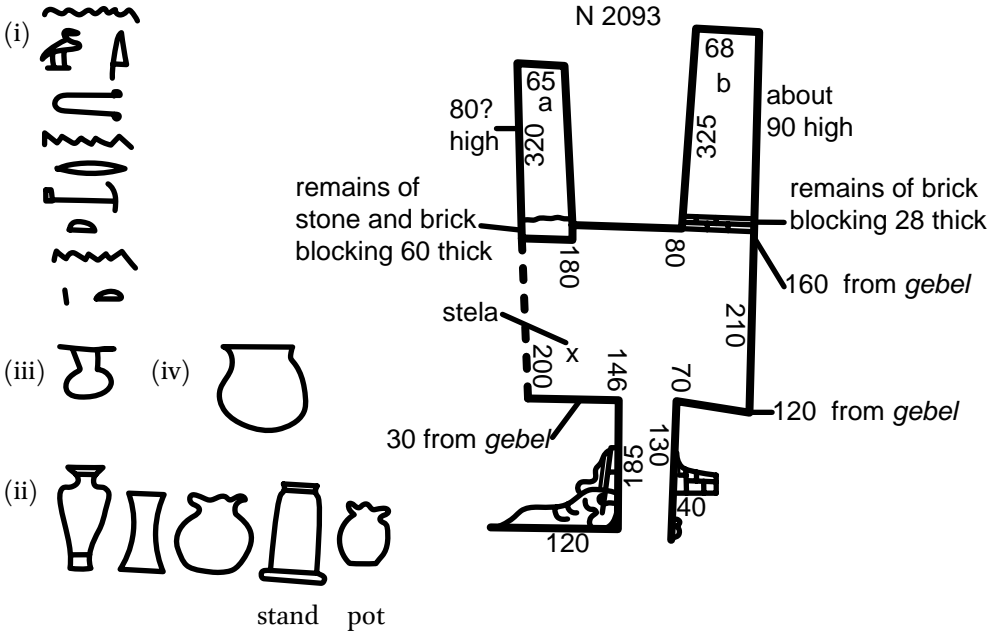

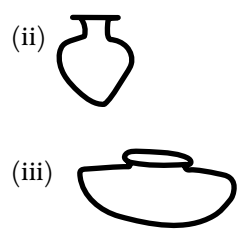
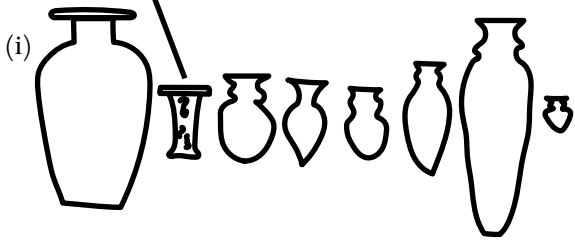
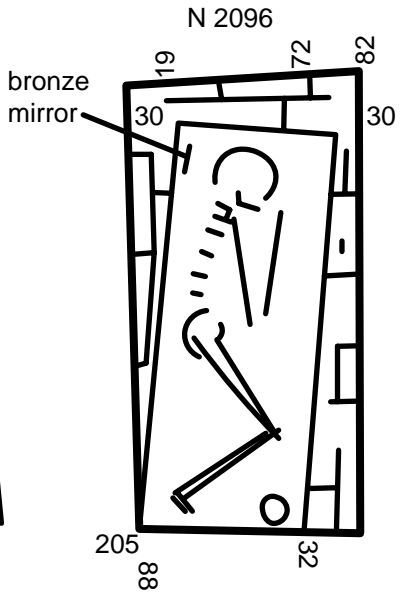
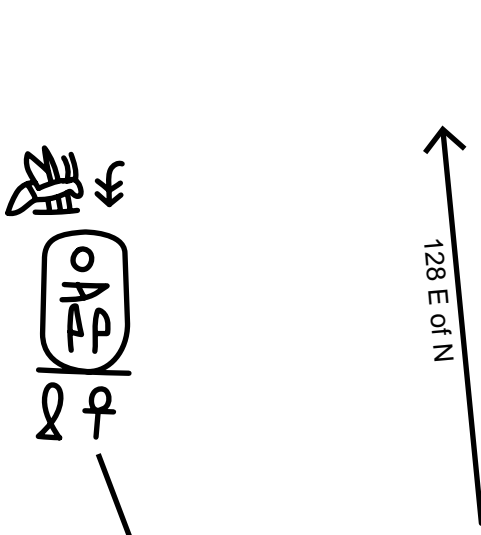
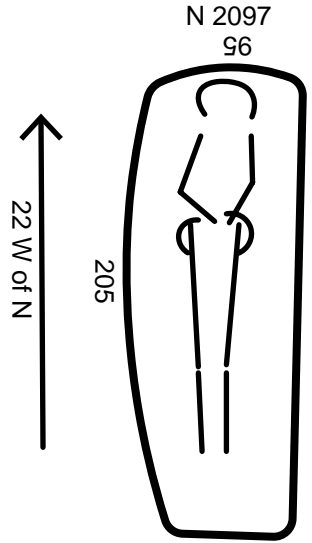
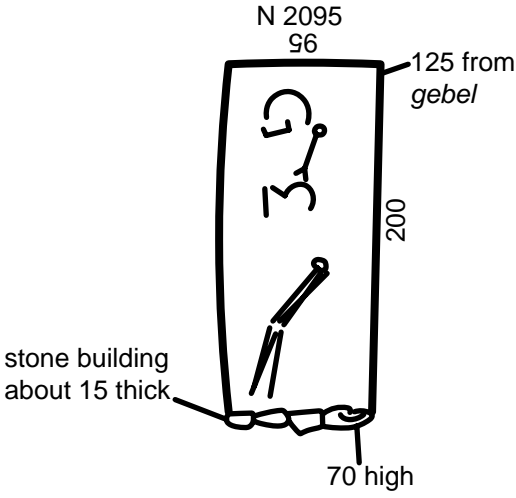

stela man and wife (i). Several As, M, (ii) (6-14411, 6-14416), small clay kohl pot (iii) (6-14418), broken stem of an alabaster vase (6-14417), shell which had been painted (6-14413). Granite paint grinder and pebble (6-14414). Small alabaster (iv) (6-14412). [ed.: For a drawing of 6-14412, see image (xiv) in N 2071. According to Hearst Museum records, 6-14415 (flint knife) is from the large chamber in this burial.]

N 2094 (TC) Map C5

a [ed.: the center shaft, labeled "a" on diagram] contained remains of 1 burial, 1 A pot, and pieces of a (i) in rough red. Large chamber contained several broken As, 2 large (ii), and 1 small M. Sides of doorway plastered. At outside, remains of brick building on top of *gebel*, which had run down almost to nothing.

N 2095 (TC) Map C5

125 from *gebel*. Plundered. Upper bones scattered and hiatus between them and leg bones, which had remained more or less in position. At end, built with stones. This may have been blocking of door with a pit outside, but the latter had disappeared altogether.

N 2096 (TC) Map C4; type vi a; photo C 2165, C 7609, C 8067, C 8068, C 8069, C 8070, C 9630

About 170 from *gebel* level. Brick 40 high. By feet, (i) in alabaster (6-14419, 6-14421, 6-14422, 6-14423, 6-14424, 6-14425, 6-14426). (ii) in limestone? (6-14427) (iii) in black veined limestone (6-14420). Traces of wooden coffin, which apparently fitted exactly inside bricking. On left side, position of left arm doubtful. Body disarrayed slightly before coffin decayed as 1 tooth and upper vertebra below pelvis. Coffin was apparently put in position.

N 2097 (TC) Map C5

65 deep. Male? Body on back. Head turned to northeast. No traces of coffin.

N 2098 (TC) Map C5

Height [of large chamber] had been about 140, but roof had practically all gone. a. Plundered bones scattered. b. Plundered from hole at side. [ed.: No "b" in drawing.] Both doors had been blocked with stones and outsides mudded. Both had been covered with rough *fantasia* scrawlings. In large chamber, number of A pots (i) (6-1298, 6-1299).

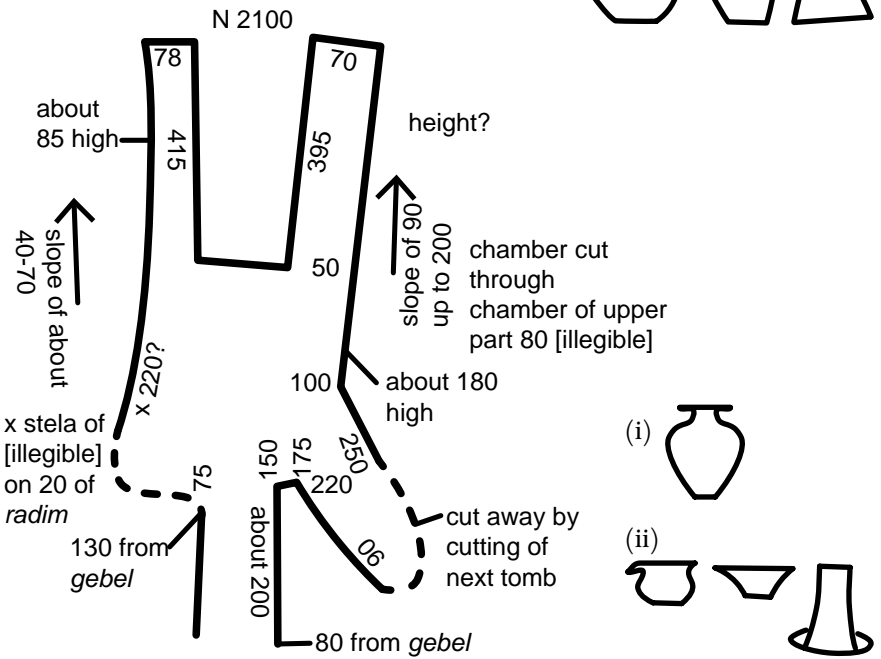
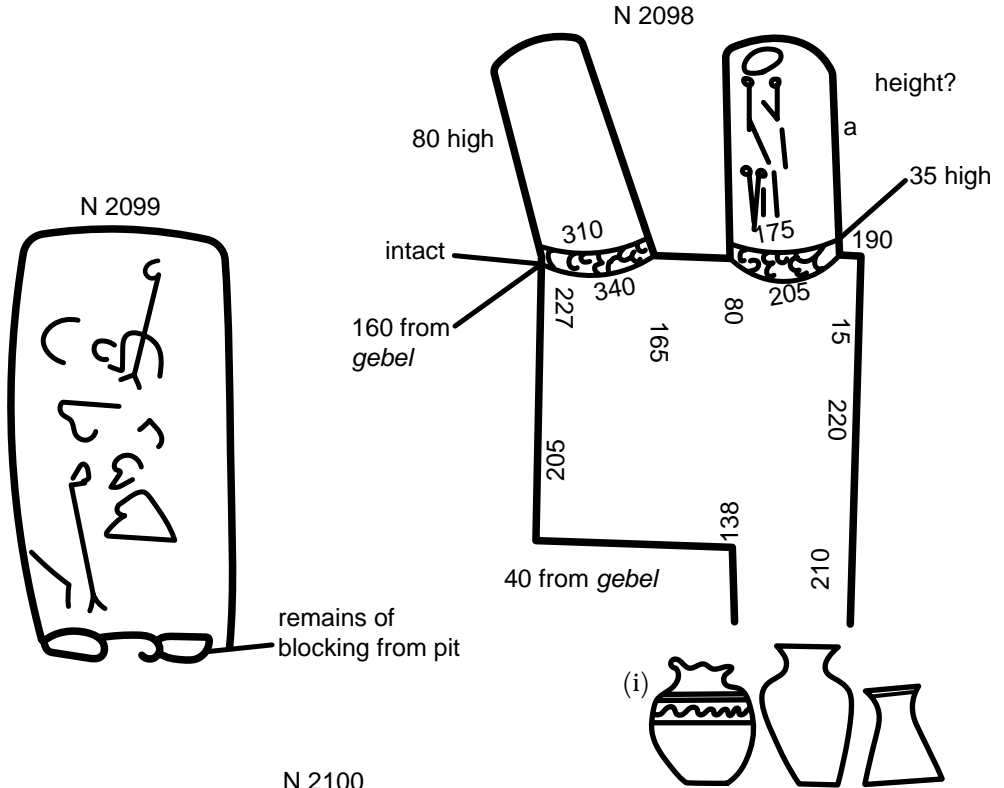

N 2099 (TC) Map C4; photo B 7471

Pottery (see photographs). Dish on ring stand (6-14428, 6-14429, 6-2799). 4 saucers, in a nest. Pieces of charcoal. Burial plundered. Bones scattered all over grave. Had been pit and chamber, but pit gone.

N 2100 (TC) Map C5

Most of roof of large chamber standing. From outside, slight slope up to door and step[ed.:?] down into chamber. In big chamber, 1 broken skull. Several A pots (i) (6-14430), M (ii). First (ii) with spout, in firm dark red pottery, slightly polished (6-14431). Stela.

N 2101 (TC) Map C4 (red)

Square hole cut to top of door, then continued down breadth of chamber only. Contained absolutely nothing.

N 2102 (TC) Map C4; photos B 8447, C 8472

70 down. Both bodies were originally wrapped in cloth. a. Female, young; bones not fully ossified. Bronze ring on third finger of left hand. Bronze bracelet just above elbow. Bracelet on right arm above wrist. Head gone. In place of it, bronze circlet. Round neck, number of strings of beads, most irregularly strung of colored glass, gilt glass, carnelian, and stone, and shells. There were traces of bronze work also. The beads probably all came from one collar that had a bronze framework. Possibly though the bronze fragments were from earrings. Under chin, small bronze cross. Also, small fragment of iron. By each ear, remains of elaborate bronze earrings with plain bead pendants. b. (i) ? Coptic cross. Both bodies had 3 palm sticks beneath them.

N 2103 (TC) Map C4; type vi b; photo C 8074, C 8194

315 down from *gebel*. Chamber 140 high. Burial on back. Skull wrought away from from upper vertebrae, but may have fallen apart so. 3 alabasters: (i) (6-14432, 6-14433, 6-14435). No trace of wooden coffin. Remains of burial from superstructure visible. No measures possible. [ed.: According to Hearst Museum records, 6-14434 (mirror) is from this burial.]

N 2104 (TC) Map D5

About 50 below *gebel* level. Burial in front of *moghar*. All trace of its pit or chamber had disappeared. Remains of stucco showed that there had been a coffin, but all wood was gone.

N 2104

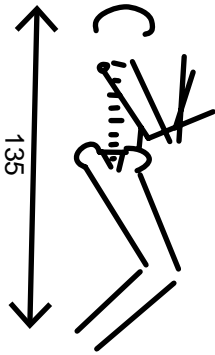

N 2101

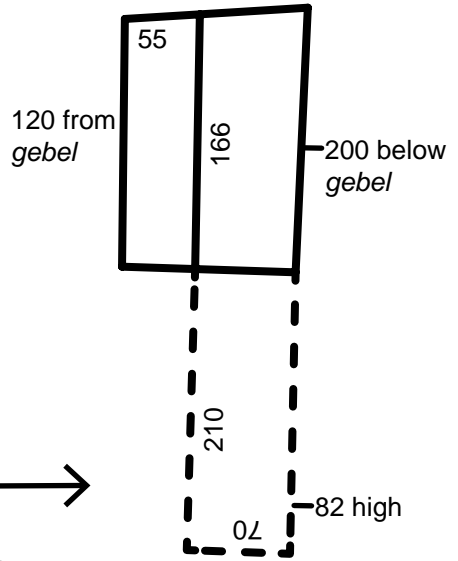

N 2102

48 E of N

open bronze circlet, ends overlapping and twisting round

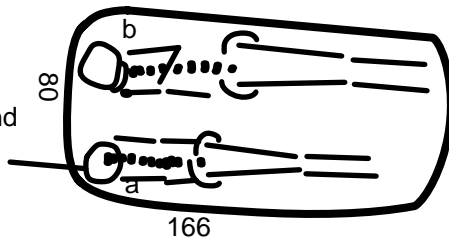

N 2103

mirror standing on edge

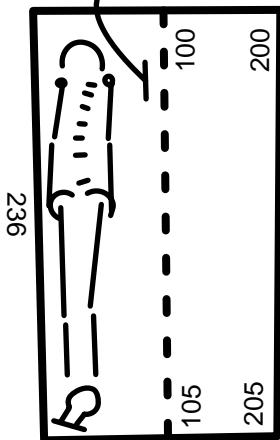

52 W of N

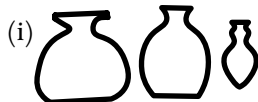

N 2105

95

fine polish

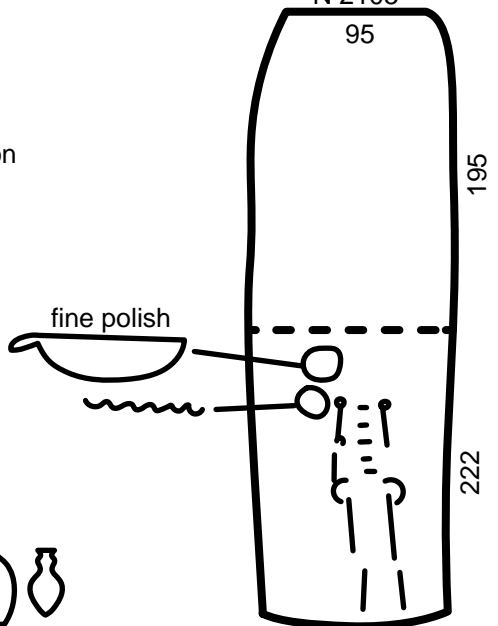

N 2105 (TC) Map D4

270 down. About 100 down. On underside of mirror, remains of cloth (6-14436). Burial plundered. Head gone. Traces of decayed coffin. Position on back. Quantity of rotten cloth by body. [ed.: According to Hearst Museum records, 6-1411 (broken ceramic dish) and 6-14437 (beads) are from this burial.]

N 2106 (TC) Map D4

70 deep. Copt. Adult. Male? Head west. Wrapped first in a fairly fine cloth and tied round. This cloth was ornamented with broad lines of blue thread at intervals. Underneath, a second covering, probably shirt, with traces of ornamentation in colored wool. Dried twigs on body. Wrappings were tied up tight in a bunch over feet: over head, a quantity of extra cloth rolled up. Under body, 2 palm sticks and 1 "sont."

N 2107 (TC) Map D4

Copt. Child of about 3. Head west. Cloth almost entirely gone. 3 palm sticks under body. [ed.: According to Hearst Museum records, 6-14438 (broken jar) is from this burial.]

N 2108 (TC) Map D4; photo C 8468

2 Coptic burials. a. Child. Female. 2 palm sticks under body. By head, roll of cloth, part of which was elaborately worked with colored wools. By right hand, small bone ring. (Rings on fingers were placed in front of pudenda. Necklace of beads and shells with copper ornaments, and a copper cross. Earrings. Brown, wavy, almost straight hair.) S. b. Adult female. Head west. Usual position. By sides of body, a palm stick and a sesban stick. Remains of 2 or 3 thicknesses of cloth, but almost all decomposed. Remains of dark, straight hair. From a?: With body (see Smith), bronze cross. Remains of twisted bronze work, 2 small bronze rings, and a quantity of coarse beads: carnelian, amethyst, beryl(?), shell, and various kinds of glass. (Large number of beads and shells with a cross.) S.

N 2109 (TC) Map C4

Copt. See Smith. Under body, 2 strong pieces of wood, sawn 5 1/2 x 8.

N 2110 (Green) (TC) Map D3

(Green) 160 deep from hard *gebel*. Contained _ pieces of veneer from coffin. Pieces of A and (i).

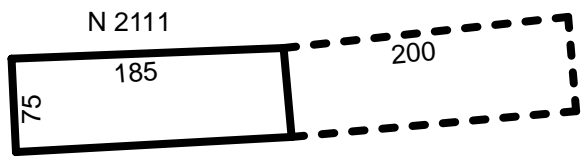
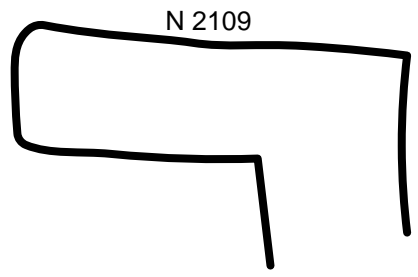
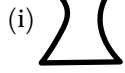
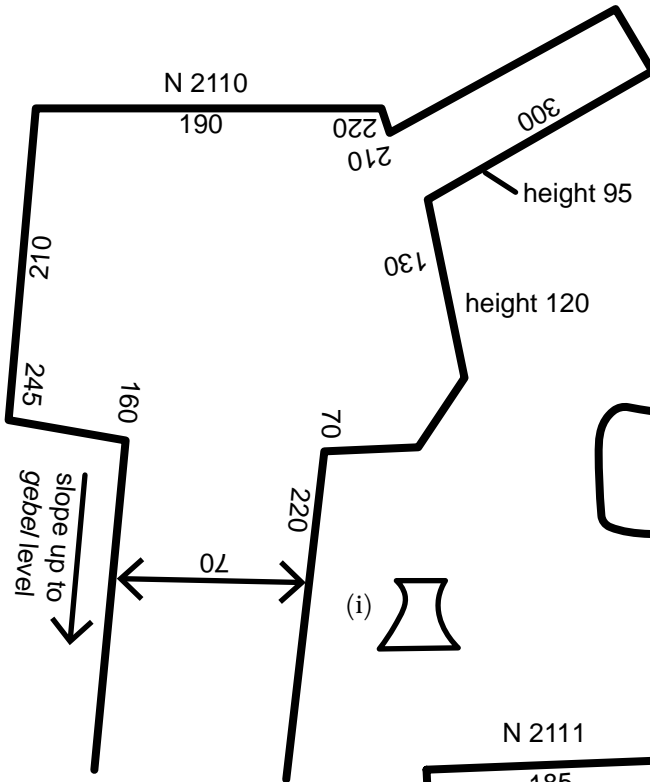
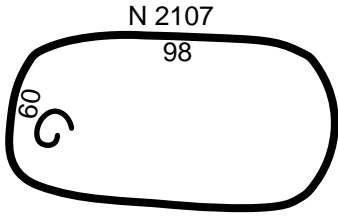
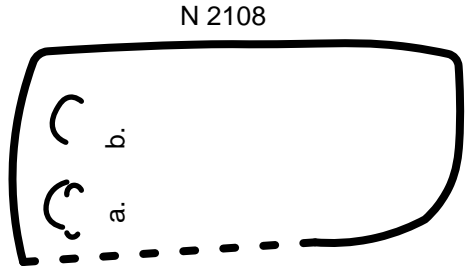
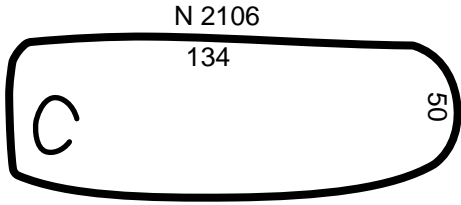

N 2111 (TC) Map D3

200 down. Contained nothing.

N 2112 (TC) Map D3

No chamber. Contained fragments of a wooden coffin. Wooden headrest (i) (6-14439). [ed.: Hearst Museum records had erroneously assigned 6-14440 (beads) to this burial, but they are from N 2212.]

N 2114 = N 2051? (TC) Map D5; photo C 8518

Height was 130. Nearly all broken away. Door blocked with rough stones faced with mud. This blocking went in 180. Adult. Sex? Burial on back. Bones in very bad condition.

N 2115 (TC) Map D5

65 high. Remains of chamber, half broken away when roof of 2114 fell in. Contained nothing.

N 2116 (TC) Map D4

185 drop from *gebel* level. 95 high. Contained nothing.

N 2117 (TC) Map D4

75 down from *gebel* level. 47 W of N. Early grave with much broken away by Copts. Remains of wooden coffin.

N 2118 (TC) Map D4 (red)

80 W. Floor of chamber broken through to chamber beneath.

N 2119 (TC) Map D5; photo C 8516, C 8538

42 W. Height of chamber? In main chamber, burial on back. Adult male. Also, several pots, A? (i) (6-14442, 6-14443, 6-14444, M (ii) (6-14441). Glazed amulet (iii). Chamber blocked with rough stones faced with mud. On mud face, a few rough scratches. This stone blocking went in a distance of 130. Burial in chamber. Male? adult. Bones in very bad condition. On right side. Position given approximate. Apparently, both hands to face. Traces of wood from coffin.

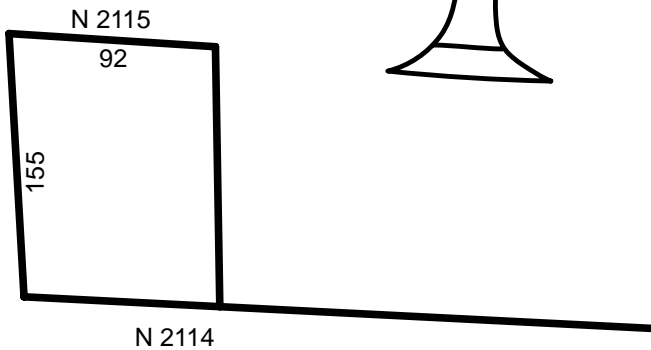
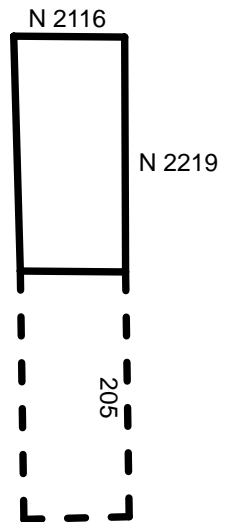
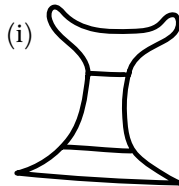
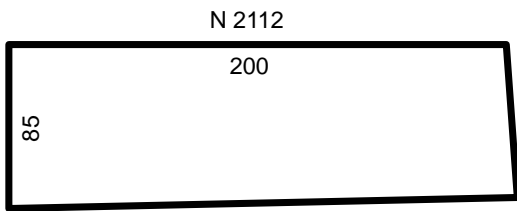
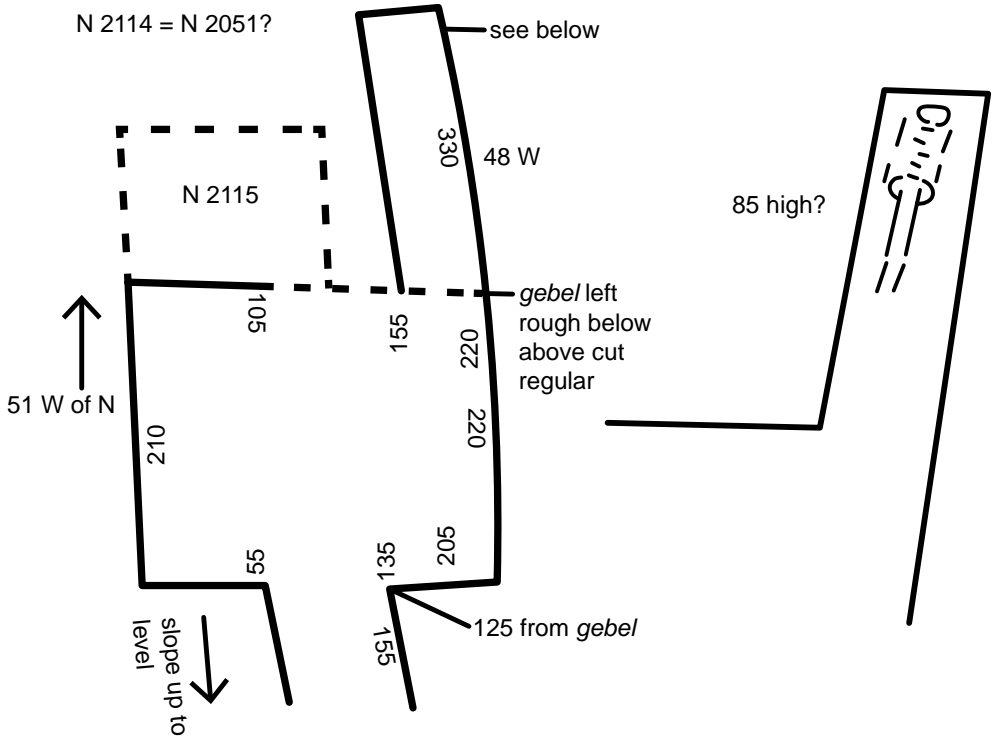

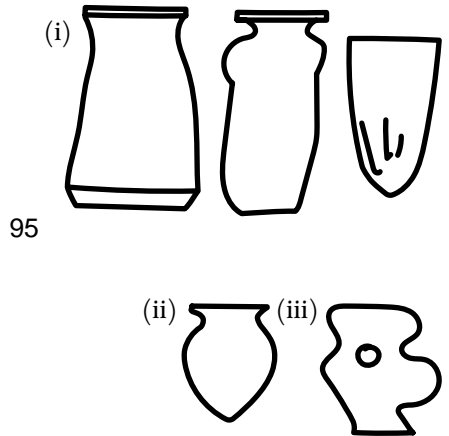
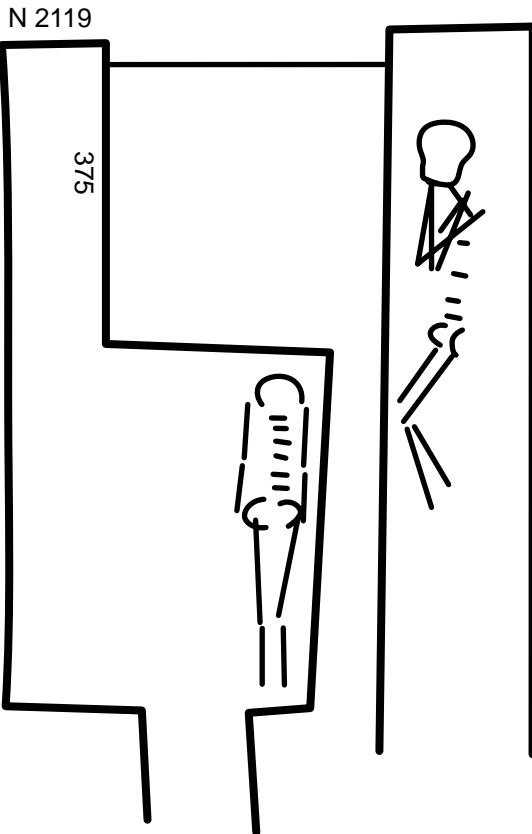
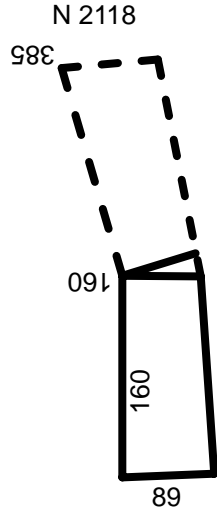
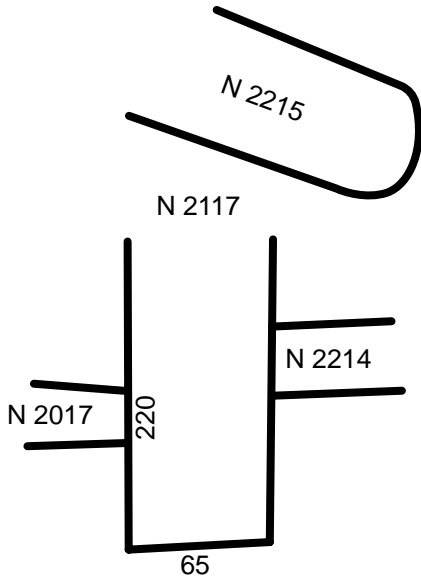

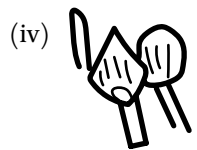
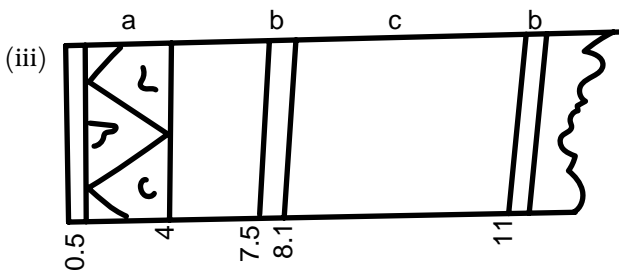
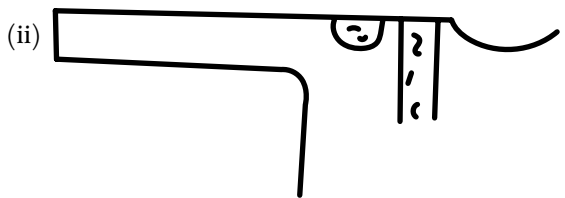
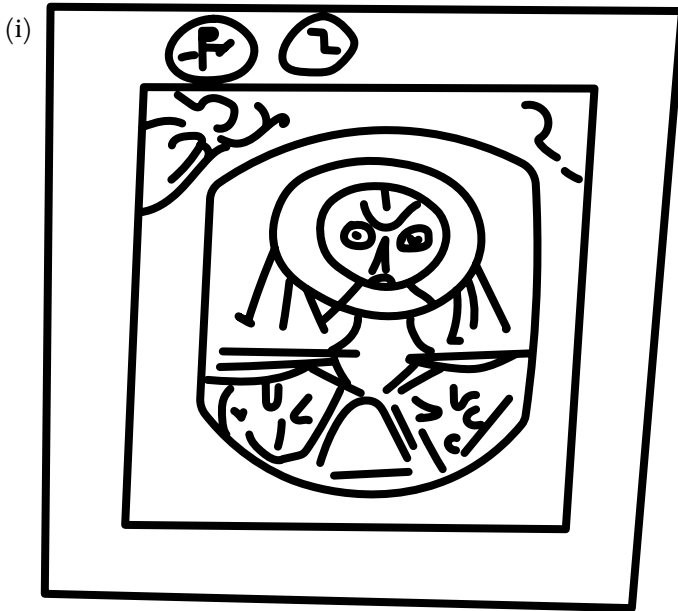
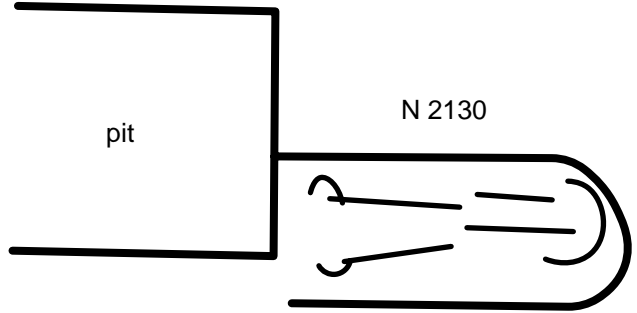

N 2130 (TC) Map E3

Male ? (S) Lower part of Coptic burial. Wrapped in coarse sackcloth. Outside this, there had been a thin wrapping of pink cloth with white bands. Inside, wrapped in 2 or 3 thicknesses of finer cloth, by feet, a square of fine drawn work. Over feet, a roll of apparently odds and ends of colored cloth, worked in various colors with wool. Just below knees, a panel of wool work in red, blue, green, and yellow. Under body, inside wrappings, remains of palm sticks. Remains of a shawl and 2 shirts. Shawl: with fringed edges. Near each corner?, a large square panel sewn on (i). This was elaborately embroidered, and was certainly all drawn and needle worked?? Pattern, a human figure?, was worked in red, blue, yellow, and green wools. Outsides of patterns were strengthened by binding thick yellow thread round and round 2 or 3 threads of the warp. First shirt: a whole sleeve remained. This shirt was worn inside out. Arm was sewn up for a distance of 37 with red wool. At the top, the edges met, but as it went lower, tuck of increasing size was left. Round the hole in the sleeve at arm pit, a cord of blue wool was sewn. On breast, there had been the usual bands and circles of embroidery in red, blue, yellow, and green ?inwoven or put in with needle (ii). Designs floral. Round cuff, an applied band of usual blue and yellow. Second shirt: Lower part of sleeve remaining (iii). a. Applied band of usual blue and yellow. b. Narrow bands of red triangles on a blue ground. c. Drawn work, filled in with needlework? of red, green, yellow, and blue. Other fragments showed remains of breast bands with floral designs of similar work. One piece with design (iv) showed very clearly that wool had been applied with the needle?

N 2131 (TC) Map E4

About 50 high. *Gebel* ran down to level at end of wall. Male? Position of arms? Remains of cloth under body. Remains of wooden coffin, too much broken to measure.

N 2132 (TC) Map E3 (red)

130 down. Broken away by falling in of roof of *moghar*. Adult male. Burial disturbed. Legs bent back sharp from the knee. Had been wrapped in cloth. Inside, traces of coffin 138 × 38 × 29. Thickness of wood 2 1/2. Corners as usual. Whitened inside and out. A part of the coffin had at some time been burnt.

N 2133 (TC) Map D4

100 down. Adult female. Lower part of Coptic burial. Head west. Upper part broken away by pit. Wrapped first with a fine cloth (very little remaining) one

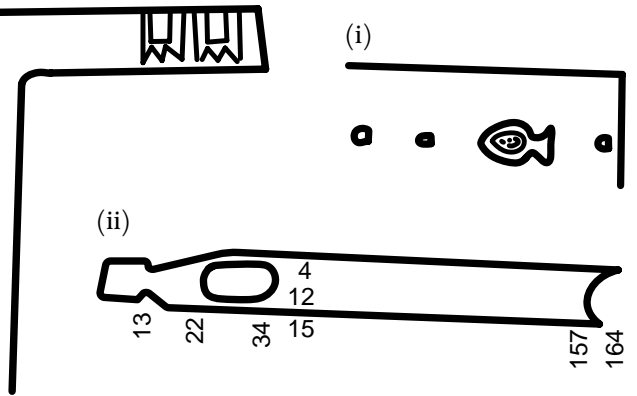
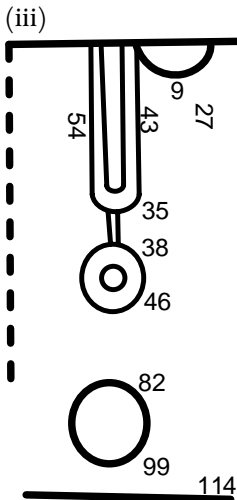
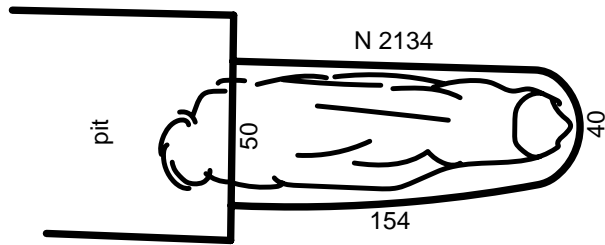
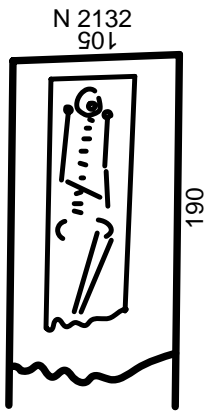
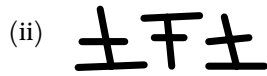
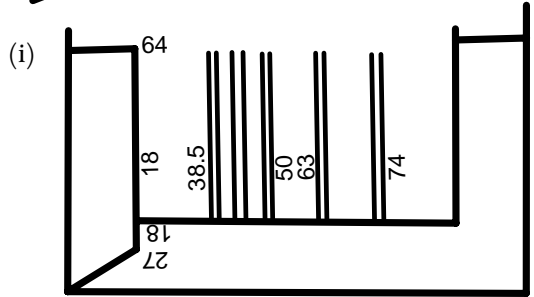
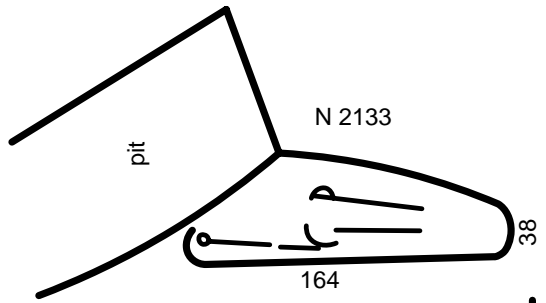
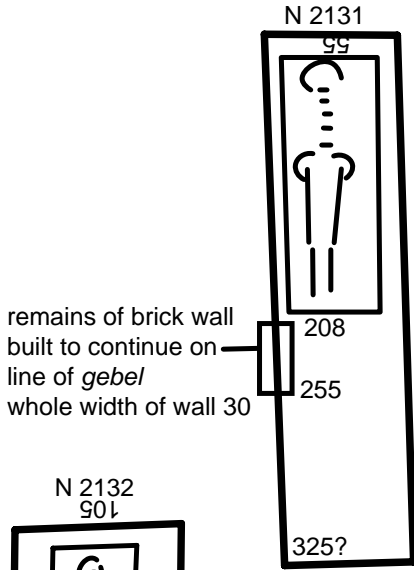

rosette remaining of red cloth (inwoven) with lines of white thread and insertion of colored wools. Under, a cloth wrapping of coarse sackcloth was thrown back over feet. Between this wrapping and the shirts, a quantity of dried leaves and a quantity of salt. Under body, between sackcloth and shirts, 2 palm sticks tied together at ends. Outer shirt of usual kind with 2 seams down each side, corded. Running up middle of front and back, 2 bands of blue and red cloth inwoven with tree and other designs in colored wools. Round bottom and down each, a wide band of blue cloth with white cord decoration was sewn on. Colored cloth in wool only. 1 sleeve remaining with broad band of drawn work, all wool gone, and narrow band of blue sewn on. From under shirt, under shirt had 2 bands of colored cloth down front and back, on woof merely. Outer shirt: width approx. 100. Same width all the way down (i). Border of blue with white decoration was sewn on. At corner, a turn of the strip was made to continue up side. This border apparently did not go up sides at back. Bands of color were continued to bottom, underneath the blue border. Panels: borders of dark blue with red (ii). Ground of main part red with floral designs in green, yellow, blue, and 2 shades of red. Of these, red ground at any rate was put in on loom. Others may have been also. Warp was crosswise to shirt. Under shirt: In very bad condition. Bottom of shirt plain. Down front and back, 2 panels 11.5 wide. Borders red with pattern in original thread. Ground of main part of panel original thread. Designs in red, green, yellow, and blue, apparently put in in the weaving. At 57 from bottom of shirt, a tuck 11 wide sewn up with yellow thread. Sides of shirt not corded, the ends of the cloth being simply folded in together and sewn with a running stitch. There were no circles at bottom of shirt. Upper part destroyed, so neck and shoulders ? Sleeves also?

N 2134 (TC) Map D4

90 down. Copt. Head west. Wrapped first in a covering of fairly fine yellow cloth. Then in sackcloth. Adult male. On outside, covered with a wrapping of cloth with patterns in red thread. This was tied round feet by the corners. This was a shawl with corded ends. Patterned ridges were left in weaving. A line of ornamentation down end in red thread inwoven (i). Underneath, remains of binding of 2-strand fiber cord, but almost all gone. Below, 2 or possibly 3 wrappings of sackcloth in very bad condition. Quantity of salt and several plant seeds on body. By head, presumably a circlet, a twist of red wool. On head, a quantity of long, dark brown, almost straight hair. On shirt, quantity of 2 shades of red cloth ornamentation (inwoven) with yellow thread decoration. Under body, outside shirt, under wrapping, roughly shaped board approx. 5 thick (ii). Left patella was broken in half. This was bound up and a piece of palm wood 18 × 4 was bound in over joint on under side. Outside this wood, an extra pad of red-brown striped cloth was placed. The bandage was bound

N 2137

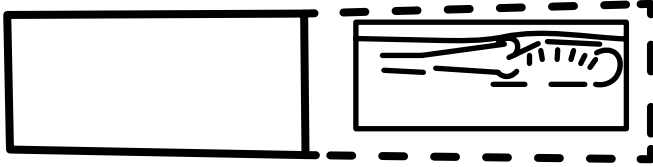

N 2140

200

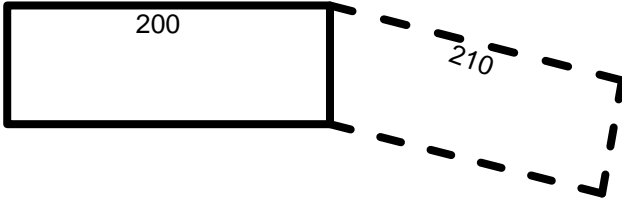

N 2142

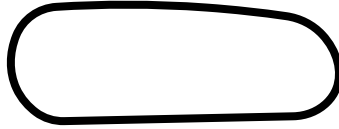

N 2143

slope down

remains of brick blocking
20 high, 33 wide

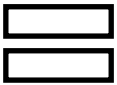
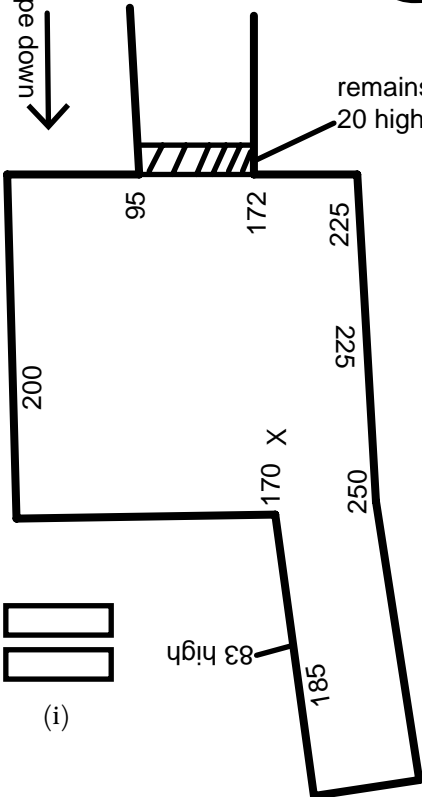

(i)

N 2138

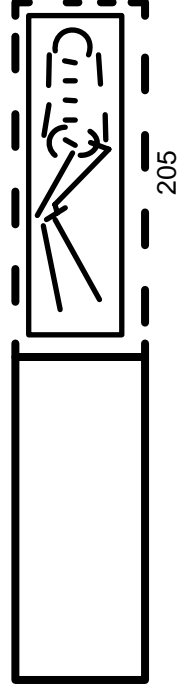

N 2139

N 2141

300

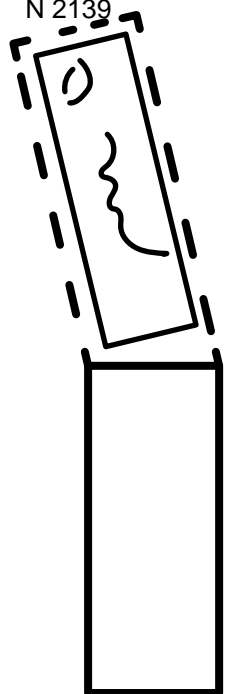
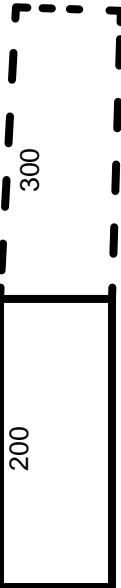

round with red wool cord. The bandage was torn from an old shirt? as there was remains of embroidery on it. Shirt in very bad condition (iii). Pattern outlined in lines of original white thread. Dumbbell outside bands in dark red and inner in light red with white thread ornamentation. Sleeves ditto. All inwoven. Shirt made from one piece. Edges corded.

N 2137 (TC) Map E3

200 down from *gebel* level. 75 high. Chamber under chamber of 2630. Adult male. Burial half over on left side, resting against side of coffin. Inside measurement of coffin 160 × 40 × 40. Thickness of wood 2. Corners as usual.

N 2138 (TC) Map E3

NE of 2232. 180 from present level. Approx. 90 high. Adult. Female? Aged approx. 30. Burial on back, but legs bent. Inside measurement 125 × 45 × 50. Thickness of wood 3.2. Corner as usual: round pegs.

N 2139 (TC) Map E4

Northeast of 2233. 185 deep from *gebel* level. 85 high? Adult male. Small dent on top of skull? from a blow. Burial plundered: position ? Head had been north. Inside measurement of coffin 176.5 × 44 × 50. Thickness of wood 3.2. Corners as usual: round pegs.

N 2140 (TC) Map B3

370 deep. Contained nothing.

N 2141 (TC) Map B3 (red)

430 deep. Contained nothing.

N 2142 (TC) Map B4

Contained nothing. ? Coptic.

N 2143 (TC) Map B4

236 deep from present level. 150 W of N. Height of chamber about 100. Nearly all broken away. In small chamber, few broken bones. Blocking of door built (i) with *radim* between the bricks. X. 140 up from floor, there had been a burial in an oval pottery coffin, most of which had fallen through into chamber.

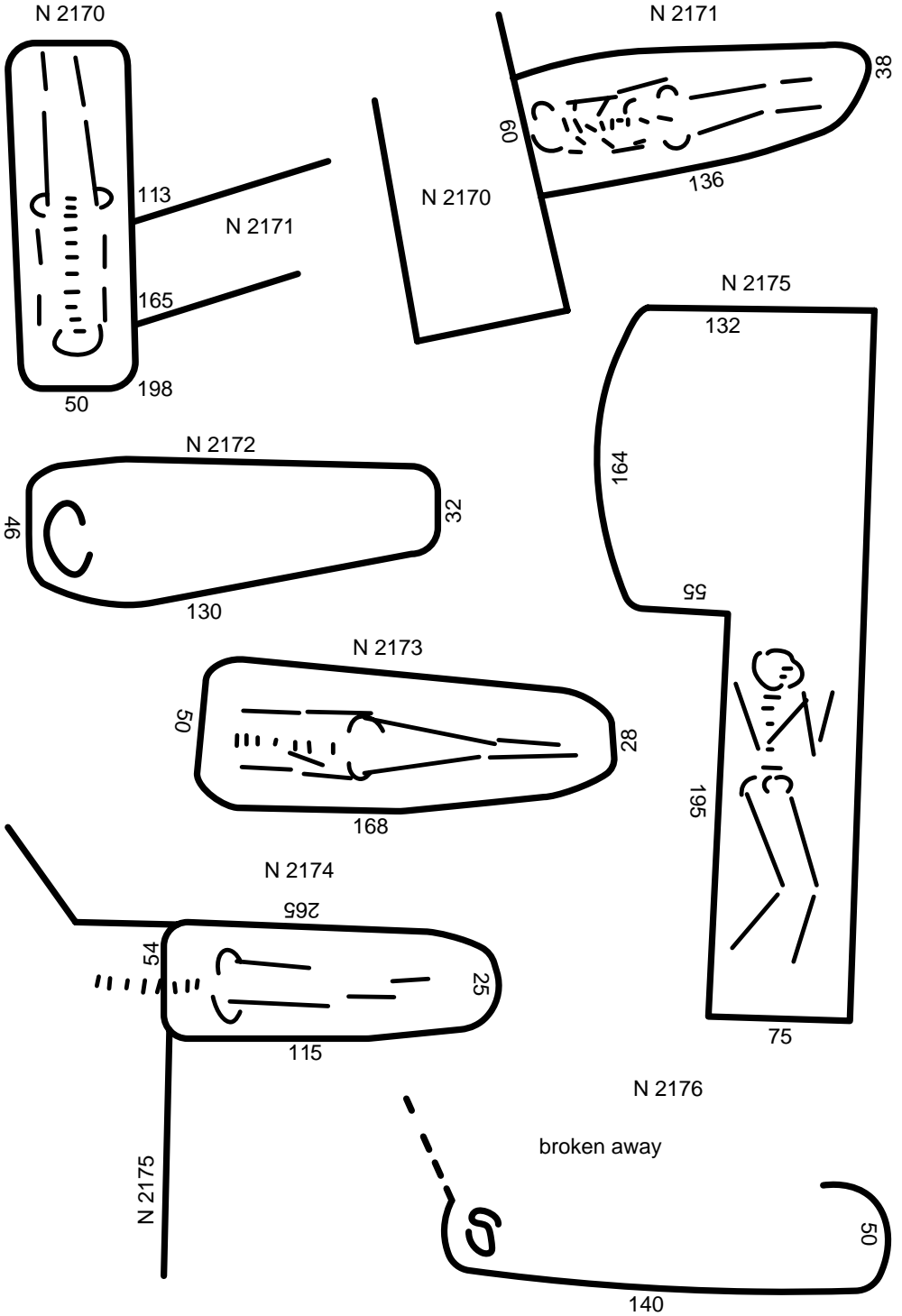

N 2170 (TC) Map B4

72 down. Coptic burial. Adult: sex? Usual position. Head south. All trace of cloth gone.

N 2171 (TC; MM) Map B4

90 down. Coptic burial. Male? On back, head west, arms by side. No cloth preserved.

N 2172 (TC; MM) Map B4

Coptic burial. Shallow grave running east-west. 85 down from *gebel*. On back, head west, arms by side. Child about 9–10. No cloth preserved. Bronze bracelets on both arms.

N 2173 (TC; MM) Map B4

Copt. Shallow grave running east-west. Approx. 80 down. Female? adult. On back, head west, arms by side. Skull gone. No cloth preserved.

N 2174 (TC; MM) Map B4

Copt. Shallow grave running east-west. West end projecting over early pit. 80 down from *gebel*. Adult female. On back, head west. Upper part of body gone. No cloth preserved.

N 2175 (TC) Map B4

Approx. 125 from *gebel*. 145 from present level. Adult female. Slightly over on left side. From way bones were spread, there could hardly have been a coffin. No discoloration of soil from one under body.

N 2176 (TC; MM) Map B4

Copt. Shallow grave running east-west. Approx. 100 down from *gebel*. Adult female. On back, head west, arms by side. No cloth preserved.

N 2200 (TC; MM) Map E3

Coptic. Shallow grave running east-west. 80 down. Head west. Adult male. On back, head west, arms by side. Skull gone. Under the body, there were 2 palm sticks, which had been fastened together. The cloth was in very bad condition, but apparently there had been one shirt and a single wrapping of sackcloth.

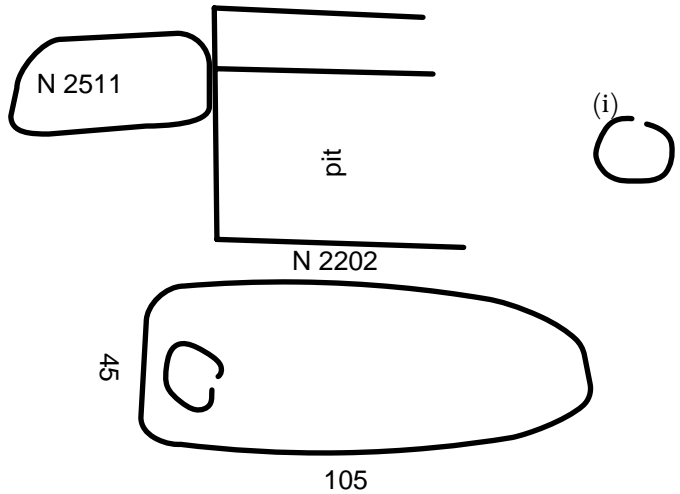
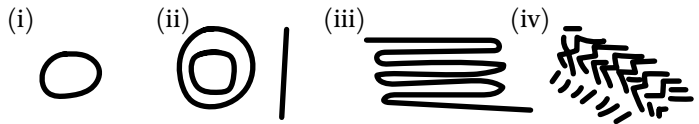
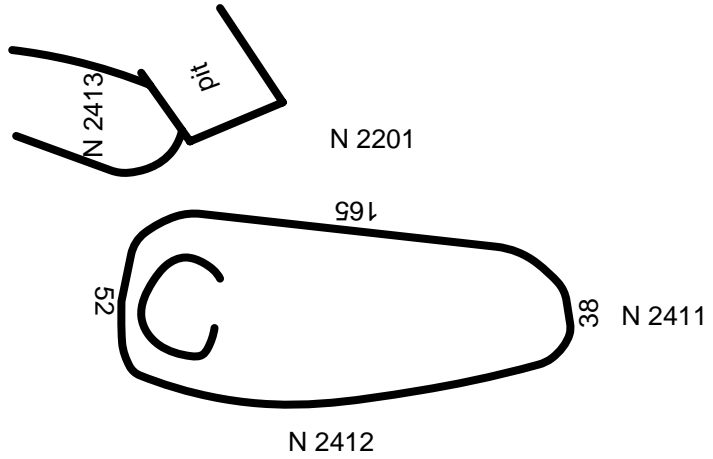
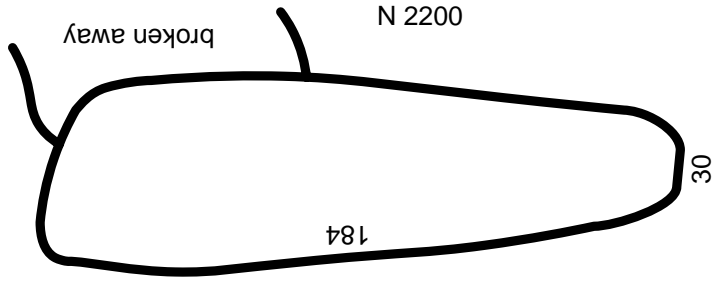

N 2201 (TC; MM) Map D4; photo C 8470

Copt. Shallow grave running east-west. 55 down. Adult female aged 22–23. On back, head west, Arms by side. Remains of dark brown curly hair. On the left forearm, an iron bracelet, and on the left wrist, iron and bronze bracelets, all (i). On one of the fingers of the left hand, a copper ring. On the right wrist, a bronze bracelet. By the left arm, but apparently not on it, a quantity of glass, shell, and carnelian beads. By head, a tiny copper ring (ii), possibly part of an earring. The body was clothed in a shirt of yellow cloth. There were no colored wool decorations, but round the bottom of the skirt and of the sleeves, the usual bands of blue with designs in yellow thread were sewn on, 4 wide on skirt, 1.8 on sleeves. At one place, near right shoulders, apparently edge of cloth was tasselled. Yellow and blue on bottom of skirt and sleeves put on as usual, i.e., yellow thread sewn on (iii), and blue thread worked into it so as to leave geometrical patterns of the yellow. On the head, there were traces of a net cap or hood. By the head, there were remains of a bag(?) of red cloth sewn (iv), containing scraps of yellow cloth and a few seeds, possibly part of a neck pad. Under the body, there were 2 palm sticks, fastened together at the feet, but widening out so that at the other end, 1 stick came under each shoulder. On the body, there was a quantity of salt, some plant seeds, and a few twigs. The body was wrapped in a single shawl of sackcloth with fringed edges, and a band of decoration [was] near the ends. The right side of this was first thrown over, and then the left and the edges were sewn together. The binding cords were in such bad condition that the type could not be determined.

N 2202 (TC; MM) Map D4

Shallow grave running east-west. Approx. 50 down. Coptic child. Aged approx. 2. On back, head west, arms by sides. Remains of a plain shirt, reaching apparently to the knees. On each ankle, a copper anklet (i). The innermost wrapping consisted of a shawl of thick yellow cloth. Outside this, there was a white shawl, with tapestry-woven designs in colored wool. All traces of cord bindings had disappeared.

N 2203 (TC; MM) Map D4; photo C 8572

Copt. 90 down. Reuse of an early grave, a Dynasty 6–9 wooden coffin being destroyed to make room for the new burial. Adult female. On back, head west, arms by side. Quantity of dark, curly hair. Lashes of left eyes also preserved. The shirt had almost entirely disappeared. On the head, there were traces of a net cap or hood. Under the body, there were 3 palm sticks. The innermost wrapping consisted of a shawl of mixed red and black cloth, decorated with elaborate tapestry-woven plant and figure designs (i). This shawl had been darned in several places, chiefly with thick black thread. Sides were corded

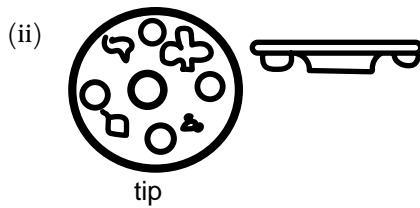
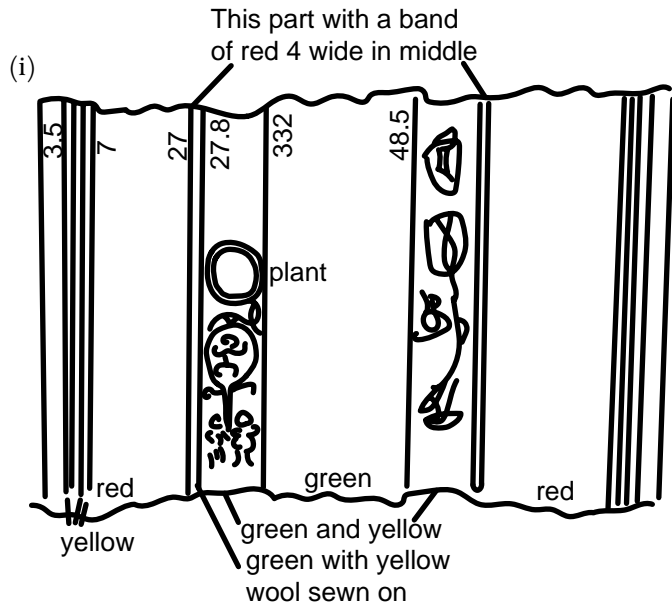
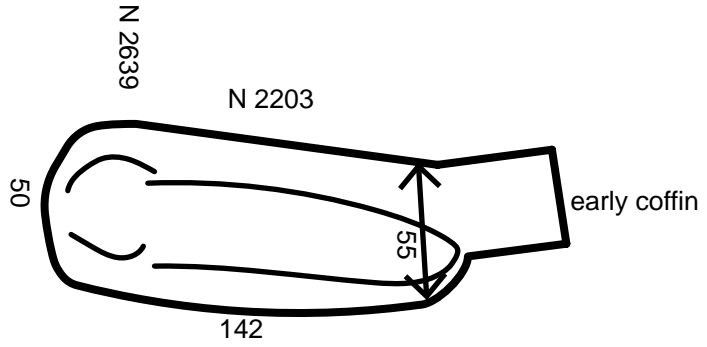

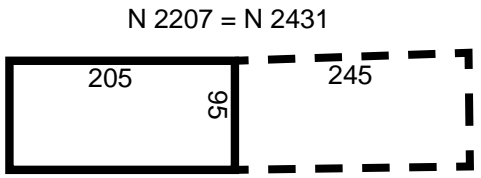
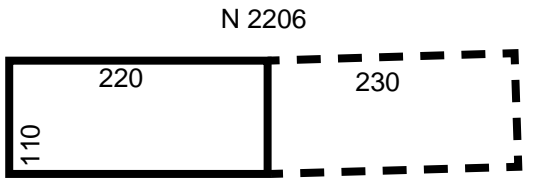
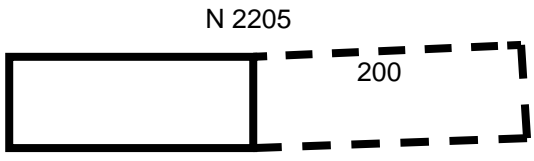
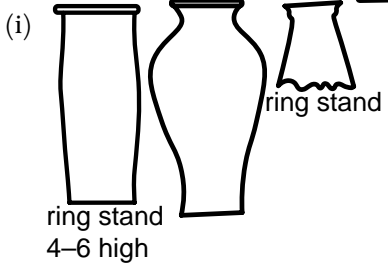
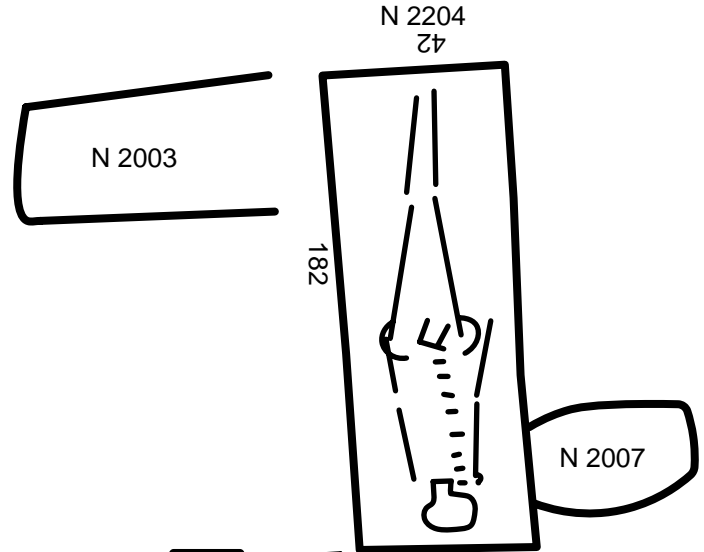

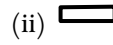
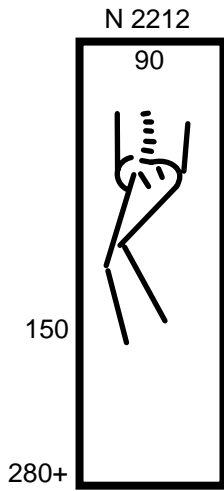
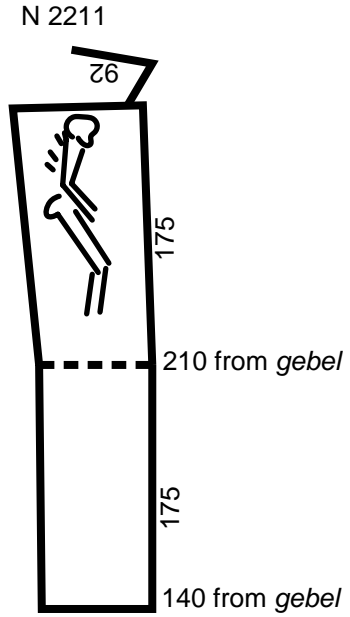
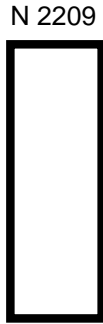
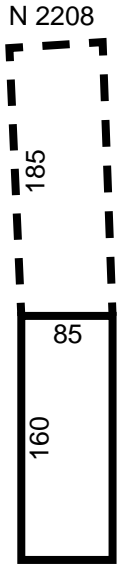

with small cords. First, inside, a thick cord was sewn in, on one side green, the other yellow. Colors were all inwoven except yellow wool in decorated panels. Near each side, 1 wide and 2 narrow lines of yellow thread, the wide in the middle. The decorated panels consisted of alternate flower and figural designs. The outer shawl was of sackcloth. The cord bindings had almost entirely disappeared. In the filling of the grave, there were pieces of a large pottery dish (ii).

N 2204 (TC) Map D3

Approx. 180 down from hard *gebel*. Regularly cut up for about 50 above irregular. Actual grave actually cut in *gebel*. Above *gebel*, contracts at both ends. Facing straight on north side, but on south, cut away irregularly. No traces of cloth. Skull may have fallen out of position. Traces of wood from coffin under body. In filling above, 3 broken pots (i).

N 2205 (TC) Map D4

Contained nothing.

N 2206 (TC) Map E3

400 deep. 130 high. Contained nothing.

N 2207 = N 2431 (TC) Map N/A [ed.: Map location not listed in excavation records; there is another tomb labeled N 2431 whose map location is also not listed in excavation records.]

335 deep from present level. 42 E of N. 115 high. Contained nothing.

N 2208 (TC) Map E4

100 down from *gebel* level. 107 W of N. Contained nothing.

N 2209 (TC) Map E3

180 deep from present level. Probably pit and chamber, but most of latter broken away. Contained nothing.

N 2210 Map D4 (red) [ed.: For drawing, see N 2019.]

N 2211 (TC) Map D4 (red)

Height? Male? 2 or 3 fragments of wood from coffin. Body on left side.

N 2212 (TC) Map D5 (red)

Remains of decayed coffin. Upper part of body gone. Head faced west. Had been probably pit and chamber. Trace of roof on west side about 75 high. By

N 2213
SL

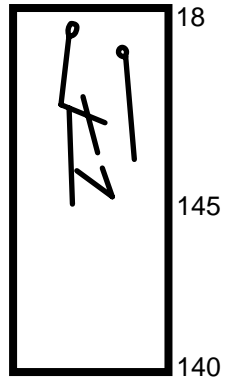

N 2214

coffin

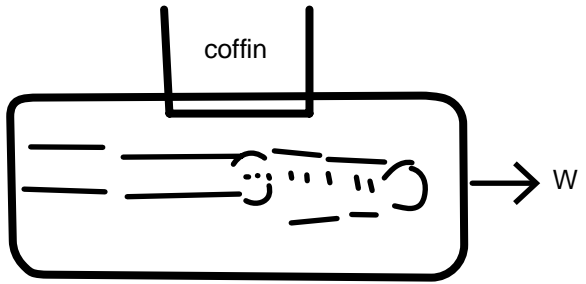

N 2215

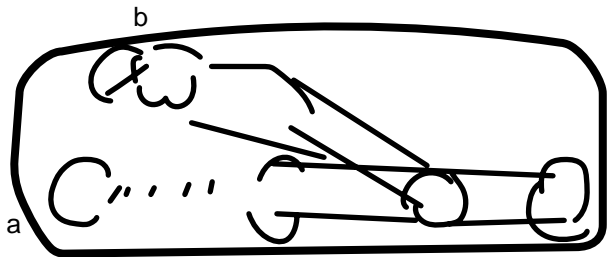

upper part, remains of necklace of, in faience, 1. "was" head amulet, 2. Bes eating snakes, 3. sphinx amulets, (i), frog, stone (ii), carnelian (ii) and disc, 3 shells (6-14440). [ed.: Note that Hearst Museum records erroneously attributed those objects to N 2112.] In filling, pieces of or saucers of M type.

N 2213 (TC) Map D4

Burial about 60 down from *gebel*. Pit going down beneath. Remains of burial in coffin. Burial had been on left side, almost over on stomach. 120 down from *gebel*. Remains of coffin and burial of small child. Also disturbed. No chamber.

N 2214 (TC; MM) Map D4

Coptic. Shallow grave running east-west, cut across an earlier grave at right angles. Adult female. On back, head west, arms by side. Only traces of sack-cloth left.

N 2215 (1) (TC; MM) Map D4

[ed.: There are two tomb cards numbered 2215. This record was also included in Mace's manuscript.]

Coptic burial. Shallow grave running east-west, cut across an earlier grave at right angles. Contained 2 burials. a. Adult. Sex? On back, head west, arms by side. Wrapped in rough cloth. Wrappings had almost entirely disappeared. Pads over head and feet. Palm sticks under body. Had been bound round with cord. b. Child aged approx. 12. On back, head west, arms by side. Skull gone. Shirt gone. Palm sticks under body. Wrapped first in sackcloth, and then in an outer shawl of fine cloth, with 3 tapestry-woven bands of colored wool at each end. (1) red, reddish brown, red, (2) yellow, blue, yellow, (3) brown, red, brown. Cord bindings too far gone for the type to be determined.

N 2215 (2) (TC) Map D4

[ed.: There are two tomb cards numbered 2215.]

(Female. Long, wavy, brown hair. Copper earring.) S. Body covered with remains of several wrappings with a variety of patterns of wool work, etc. Shawl: with fringed ends and ridged ornamentation. One panel showed (i) red ground with decoration of blue, green, and yellow wools. Red may have been unwoven. Other colors were certainly put in with the needle? Shirts: blue border with yellow thread decoration, 9 wide, sewn on, row bottom of skirt and running some distance up sides. Remains of 2 large circles near bottom of shirt with decoration in green, blue, yellow, and red.

N 2216

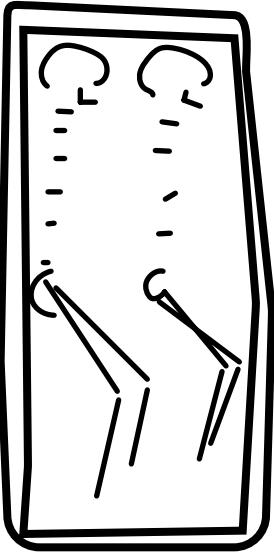

N 2217

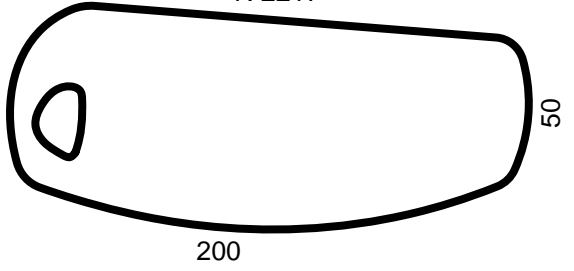

200

50

N 2218

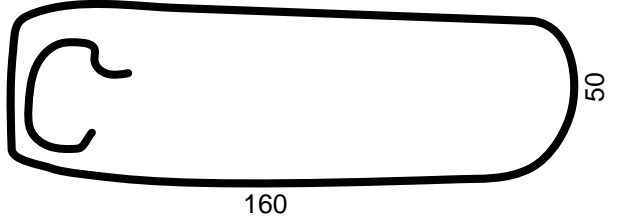

160

50

N 2219

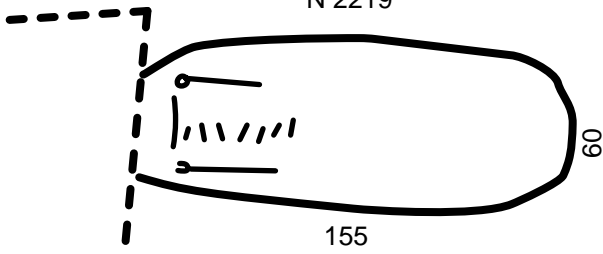

155

69

N 2230 (see N 2401)

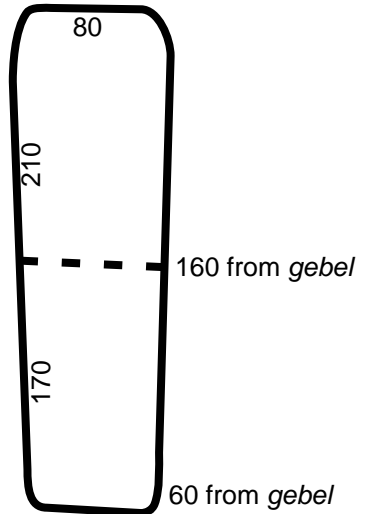

80

210

160 from *gebel*

170

60 from *gebel*

slope of about
50 to 200

(i)

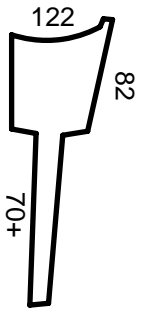

122

82

70+

(i)

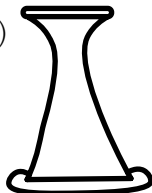

N 2216 (TC) Map D4; photo C 7064

Coffin in very bad condition. Bodies of 2 children in 1 coffin. Both on left side. Position of arms ? Traces of cloth under bodies. Inside measurement of coffin 145 × 42 × ? Thickness of wood 3. Corners as usual. White stucco inside and out.

N 2217 (TC; MM) Map D4

80 down. Coptic. Shallow grave running east-west. Adult female. On back, head west, arms by side. Remains of straight, dark brown hair. By head, remains of an earring of decomposed silver (?) with bronze pendant and 2 glass beads. The cloth had for the most part disappeared, but fragments that were left showed traces of woven designs in colored lines.

N 2218 (TC; MM) Map D4

80 from *gebel*. Coptic burial. Shallow grave running east-west. Adult female. On back, head west, arms by side. Remains of dark brown hair on skull. On lower jaw, only 3 teeth remaining. Cloth almost entirely gone. Over head, large pad consisting of a sackcloth fringed shawl rolled up.

N 2219 (TC; MM) Map D4; photo C 7709

90 down. 33 E of N. Coptic burial. Shallow grave running east-west. At west end, projecting over early pit. Adult. Sex ? On back, head west. Skull and lower part of body gone. Under the body, there was 1 palm stick and a broken wooden spade with rough curved handle, head towards feet (i).

N 2230 = N 2401 (TC) Map E4

90 high. Contained 1 piece of pottery stand (i).

N 2231 (TC) Map E4

90 from *gebel*. Entrance at *gebel* level. Upper part of burial in small chamber. Perfect, but leg bone from the thigh missing. All trace of coffin gone. In one place, 4 vertebrae joined. In another, 3. In large chamber, 8 A pots.

N 2232 (TC) Map E4; photos C 7468, C 8589, C 8590

90 from *gebel*. Male. Body was wrapped in cloth, not strips, but 1 or more large pieces folded over. Headrest (i) corners pierced with double holes and tied with cord (6-14445, 6-14446). a. Extra piece pegged on middle of inside. Rounded. 1 wide at ends, 2 at corner. Wood of main pieces 2 thick, 7 wide. 23 square. Body almost over on stomach. Right arm bent under body. Head had certainly not been placed on rest. Inside measurement of coffin 130 × 42 × 28. Thickness

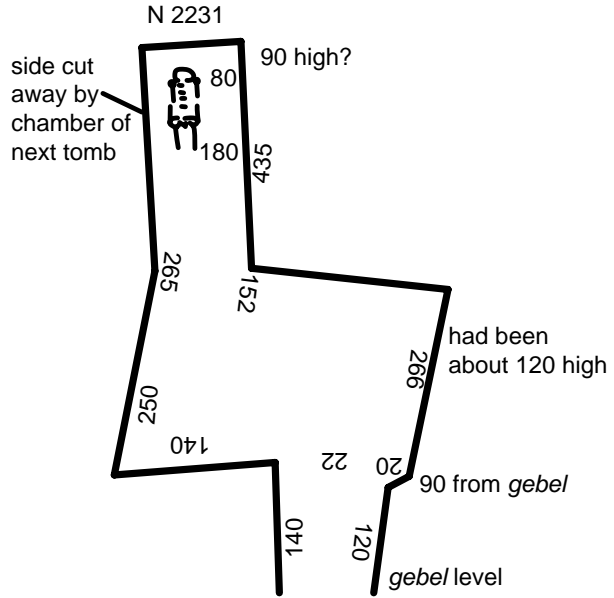

(i)

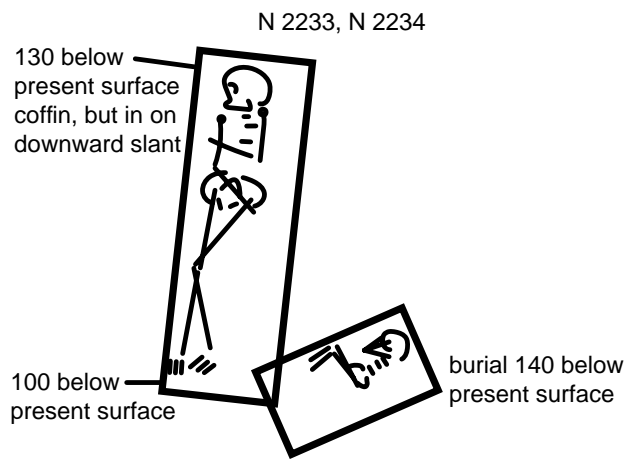
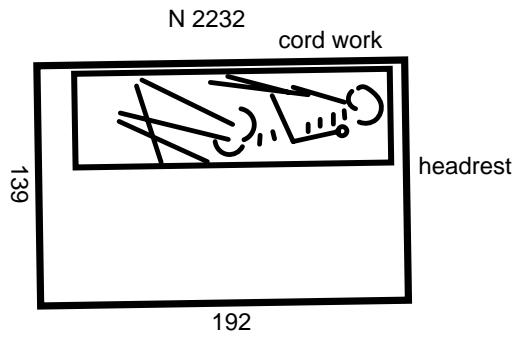
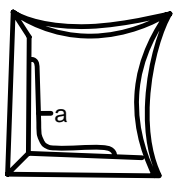

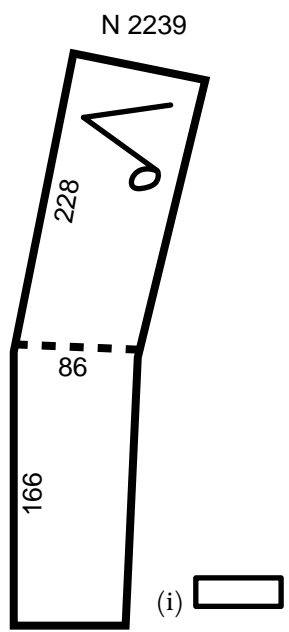
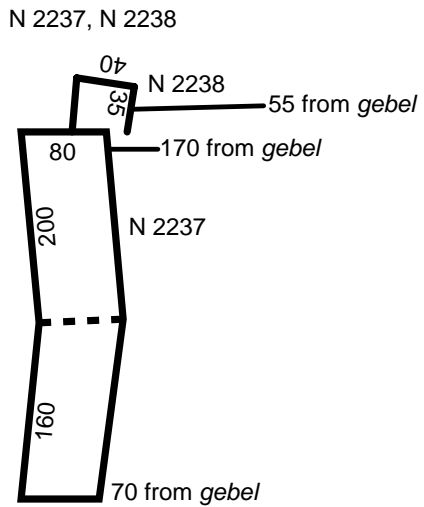
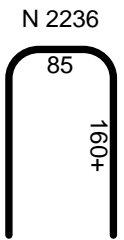
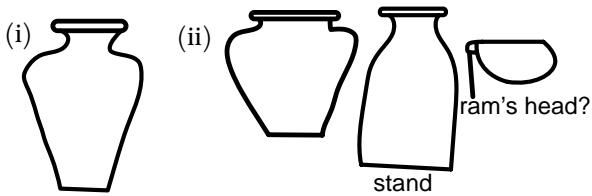
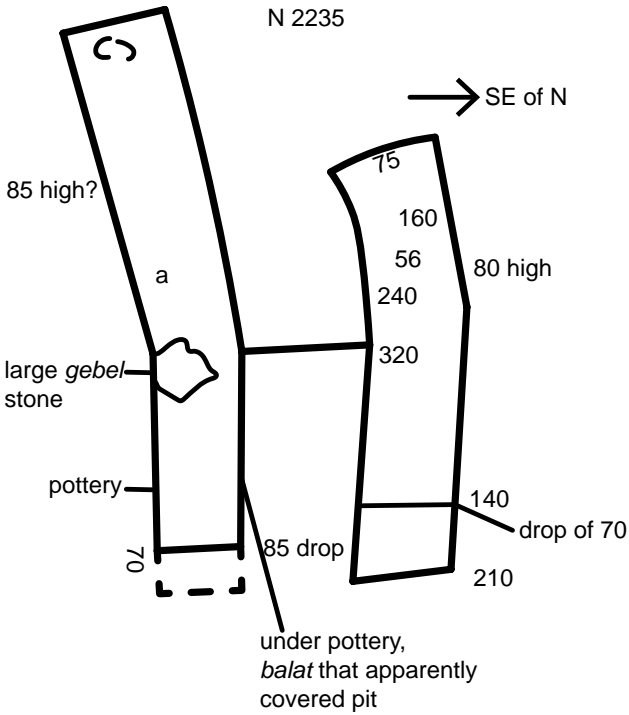

N 2240

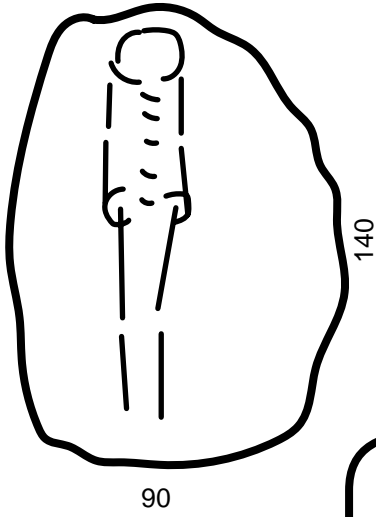

N 2241

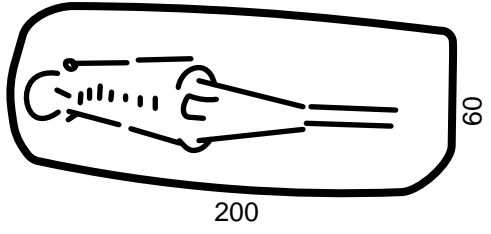

N 2242

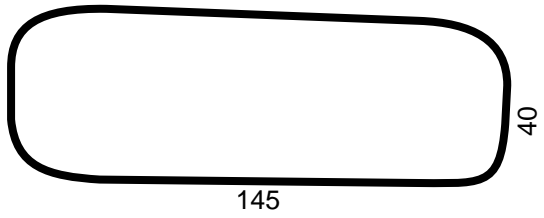

N 2243

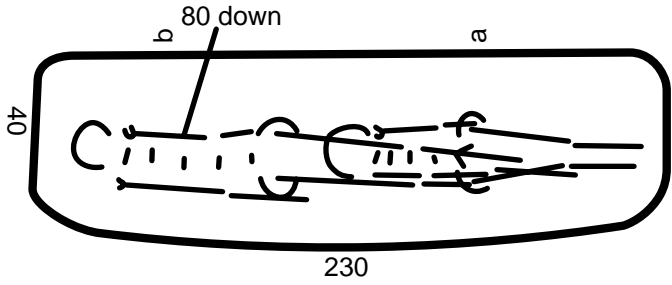

N 2244



of wood 1.5. Corners as usual. White paint outside and in. Originally probably chamber and pit, but roof had entirely gone. At side of coffin, remains of basket work with clay sealings attached (6-14447, 6-14448, 6-14449, 6-14450). May have originally enclosed coffin. Body was apparently untouched, but coffin had no lid remaining. Sealings were only at top of coffin on north side: no trace underneath. Each was marked with 2 round seals. At west end of tomb, outside coffin, traces on bronze on a stone.

N 2233 (TC) Map E4 (red)

2 pits apparently broken into 1. Burial on right side. Traces of cloth by pelvis and by head. Inside measurement 175 × 45 × 48. Thickness of wood 4. Corners as usual, round pegs throughout. White stucco inside and out.

N 2234 (TC) Map E4 (red)

2 pits apparently broken into 1. Burial of a baby. Body covered with decayed cloth. Inside measurement of coffin 57 × 34.5 × 18. Thickness of wood 1.5. Corners as usual. Round fragments everywhere. White stucco inside and out. Rim of coffin painted red and band of red of 4 on outside top and of 2 on inside top.

N 2235 (TC) Map E4; photos B 7114, B 8251, C 0996, C 8193

In large chamber, quantity of pottery, about 4 As (i) (6-14451 a–b, 6-14452, 6-14453, 6-14454, 6-14455, 6-14458), M with white rings (ii). Number of small clay discs (6-14456). Quantity of glaze disc beads (6-14457). Entrance to chamber a, blocked by large stones and smaller stones underneath. Pit filled with stones, covered over with *balat* [i.e., stone slabs]. In chamber a, remains of burial. On back? Adult. Sex? [ed.: According to Hearst Museum records, 6-14462 (assorted amulets and beads) are from this burial.]

N 2236 (TC) Map E4 (red)

105 from *gebel*. 80 high? 180 above floor level of 2231. Tomb broken away by falling in of roof of 2231. Contained nothing.

N 2237 (TC) Map D4

Contained bottom of a wooden coffin and a fragment of an A pot. Roof of chamber entirely gone.

N 2238 (TC) Map D4 (red)

End of a narrow chamber cut away by falling in of roof of 2237. 135 above level of 2237.

N 2245 (1)

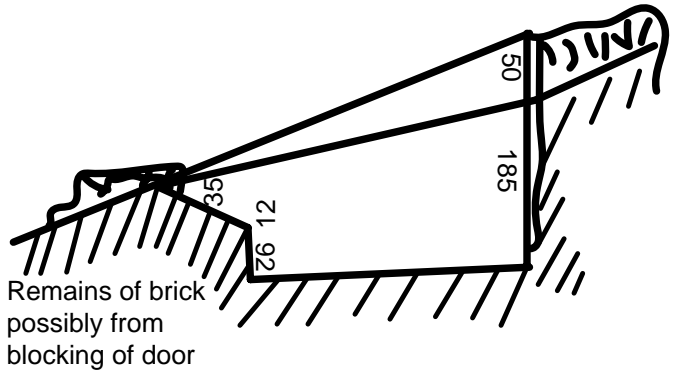
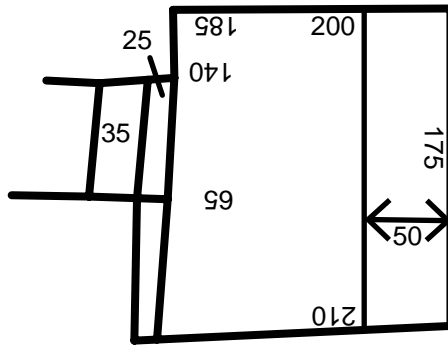

N 2245 (2)

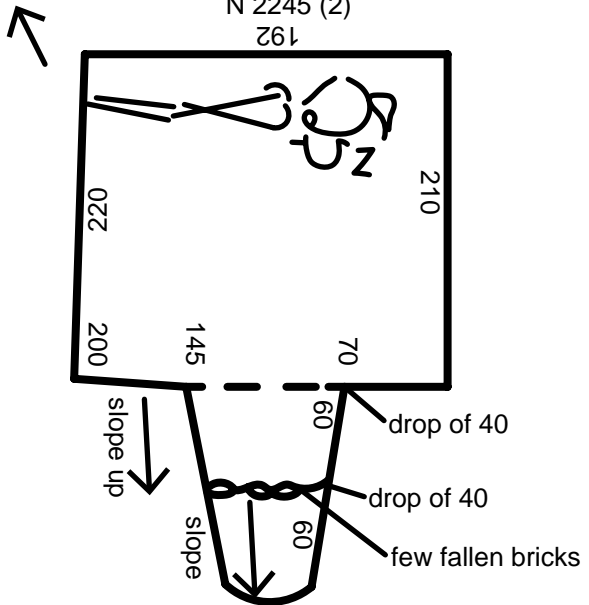

N 2239 (TC) Map D4 (red)

180 from *gebel*. 80 high. Contained broken skull and few bones. 1 femur and tibia apparently in position. Part of a decayed coffin (angled corners), which had been inscribed with black ink. Parts of wooden sandals, painted white, with remains of rush bindings. Round and square (i). Green stone beads (6-14459).

N 2240 (TC) Map B4 (red)

80 down. Irregular hole. Remains on cloth. Body of a child about 10. Under body, remains of palm sticks. On right ear, gold earring, ends twisted together.

N 2241 (TC; MM) Map B4

80 down. Coptic burial. Shallow grave, running east-west. Adult female. On back, head west, arms by side. All cloth gone. In the filling of the grave, two bronze bracelets.

N 2242 (TC; MM) Map B4

90 down. Coptic burial. Shallow grave, running east-west. Adult female. On back, head west, arms by side. On each ear, a plain bronze earring, ends twisted round each other. No traces of cloth left.

N 2243 (TC; MM) Map B4

Shallow grave, running east-west, containing two burials, one above another. a. Coptic child aged approx. 12. On back, head west, arms by side. b. Underneath, 30 down. Adult male. On back, head west, arms by side. The second burial was 30 cm below the other. The cloth wrappings in both cases had entirely disappeared.

N 2244 (TC; MM) Map B4

80 down. Copt. Shallow grave, running east-west. Adult. Sex? On back, head west, arms by side. No traces of cloth left.

N 2245 (1) Map C4

[ed.: There are two tomb cards labeled 2245.]

Traces of stucco from coffin on all 4 sides. Burial plundered. Contained nothing.

N 2245 (2) Map C4

[ed.: There are two tomb cards labeled 2245.]

180 from *gebel*. Plundered, and upper bones disturbed. Had been right over on stomach. Traces of stucco on side of tomb showed that there had been a coffin, but all wood gone.

N 2246

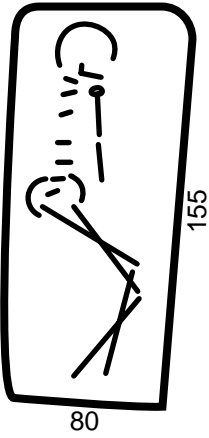

N 2247

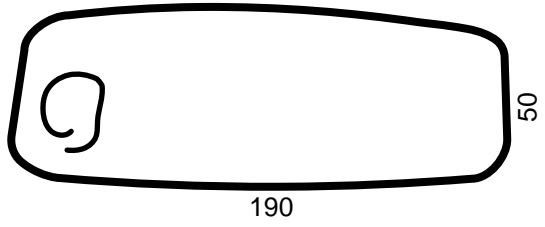

N 2248

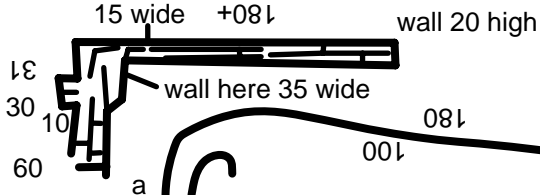

N 2249

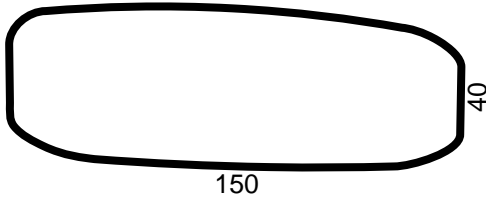

N 2248

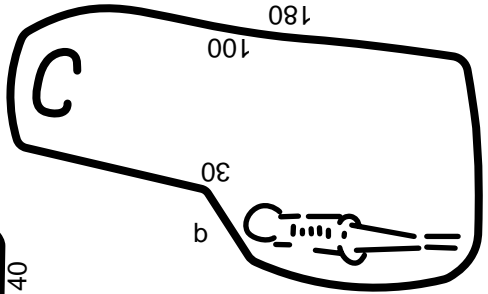

N 2270

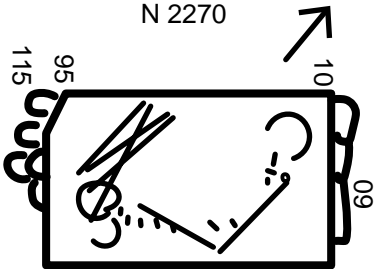

N 2272

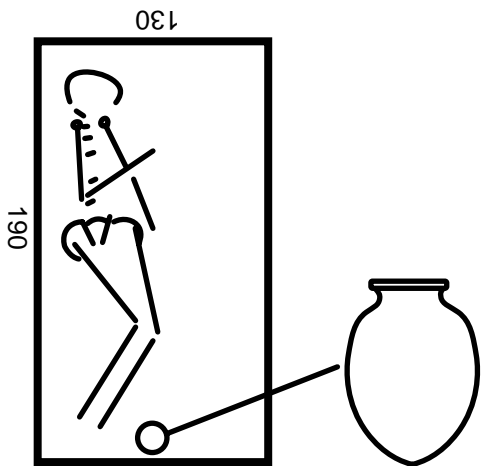

N 2271

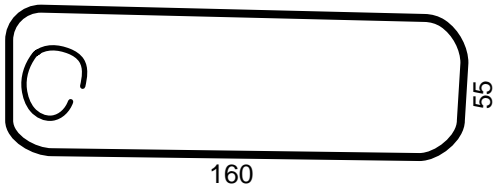

N 2246 (TC) Map B4

100 deep. On left side. *Shugf* [i.e., sherd] from a ? pot in filling. Bones in bad condition.

N 2247 (TC; MM) Map B4

120 down. Coptic burial. Shallow grave, running east-west. Adult. Sex? On back, head west, arms by side. No traces of cloth left. Bones very rotten.

N 2248 (TC; MM) Map B4

130 below level of wall. Shallow grave, running east-west, containing 2 Coptic burials. a. Adult. Sex? On back, head west, arms by side. b. Small child. On back, head west, arms by side. With neither of the bodies was there any trace of cloth. In the filling of the grave, fragments of bronze and a piece of yellow glass. Remains of brick superstructure with buttress on west end.

N 2249 (TC; MM) Map B4 (red)

100 deep. Coptic burial. Shallow grave, running east-west. Adult. Sex? On back, head west, arms by side. By elbow of each arm, fragments of broad ivory bracelets. No traces of cloth left.

N 2270 (TC) Map A4

40 below black ash level. On right side. Left arm gone, right arm under body. South side broken away. On east and west sides, remains of brick and stone enclosing walls.

N 2271 (TC; MM) Map A4

40 below black ash level. Coptic burial. Shallow grave, running east-west. Adult. Sex? On back, head west, arms by side. No traces of cloth left.

N 2272 (TC) Map A4

105 below black ash level. 170 below present level. On left side. (i) in smooth red (6-14461).

N 2273 (TC; MM) Map A4

70 below black ash level. Intrusive burial in a Dynasty 6–9 grave. a. Coptic burial. Child aged approx. 6. On back, head west, arms by side. No trace of cloth left. b. Remains of an ancient burial. c. Remains of a burial, ancient? In *radim* above, bottom of a Coptic dish with incised Maltese cross on inside bottom and a Coptic amulet. By head of b, few glaze amulets, 1 ivory amulet, and 1 rough shell bead.

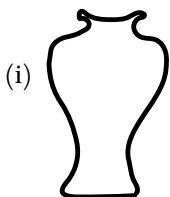
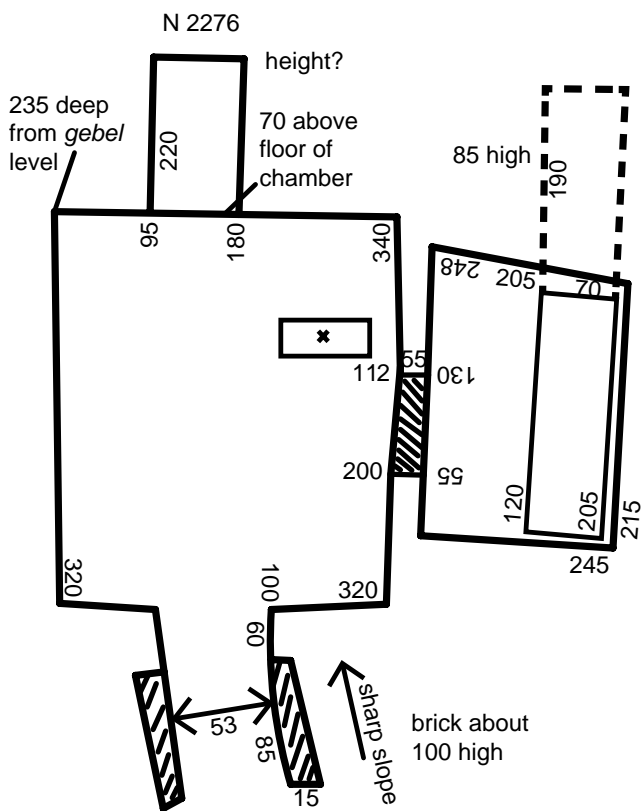
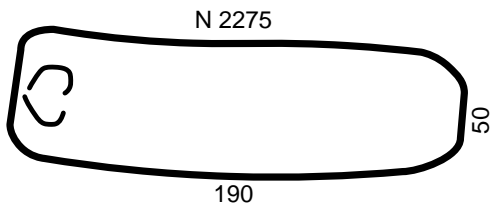
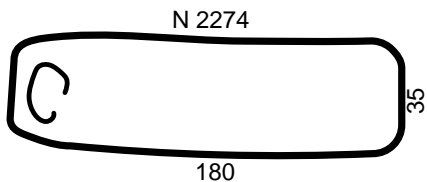
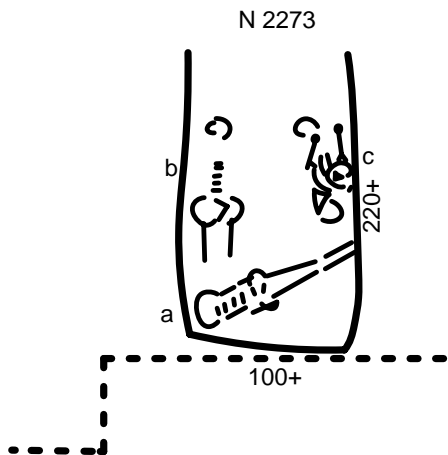

(ii)
𐤀𐤃𐤍 𐤌𐤏𐤓 𐤏𐤗𐤓𐤍 𐤏𐤗𐤓𐤍 𐤏𐤗𐤓𐤍 𐤏𐤗𐤓𐤍 𐤏𐤗𐤓𐤍 𐤏𐤗𐤓𐤍 𐤏𐤗𐤓𐤍 𐤏𐤗𐤓𐤍 𐤏𐤗𐤓𐤍

N 2274 (TC; MM) Map A4

80 below black ash level. Coptic burial. Shallow grave, running east-west. Adult. Sex? On back, head west, arms by side. No trace of cloth left.

N 2275 (TC; MM) Map A4 [ed.: Mistakenly inked on map as 2276, but labeled 2275 in pencil.]

70 from black ash level. Coptic burial. Shallow grave, running east-west. Adult. Sex? On back, head west, arms by side. No trace of cloth left.

N 2276 (TC) Map A4; photos B 8428, C 7080, C 8524, C 8525, C 8526

Chamber had been 165 high, but roof nearly all broken away. Pit 185 deep. In filling, several broken pots. A (i) round shoulder, incised inscription (ii). Ring stands, etc. × had been a wooden coffin ? Only red stucco left in position. 100 × 40 × ? Contained nothing.

N 2277 (TC) Map A3

120 down. Body on back. Bones in very bad condition. No trace of coffin.

N 2278 (TC; MM) Map A5

30 below black ash level. Coptic burial. Shallow grave, running east-west. Adult. Sex? On back, head west, arms by side. No trace of cloth left.

N 2279 (TC) Map A3

180 down. Height? Bones in very bad condition. No trace of coffin. At door, remains of stone blocking, 40 high, 45 wide.

N 2290 (TC) Map C4

Bricks built on sides. Built inside tomb to bottom. Burial on back. Traces of coffin under body. Bones in bad condition. Had been pit and chamber, but pit gone.

N 2291 (TC; MM) Map C4

70 below *gebel*. Copt. Shallow grave, running east-west. Adult. Male. On back, head west, arms by side. By head, one green glass bead (6-14550). No trace of cloth left. Under body, remains of palm sticks.

N 2292 (TC) Map C4; photo B 8251

100 below *gebel* level. Remains of burial. No skull. On north end, traces of white from coffin. Scattered several glass beads (i), and disc (6-14463, 6-14464), 1 carnelian (ii) (6-14465). Fragment of bronze from ? (6-14465).

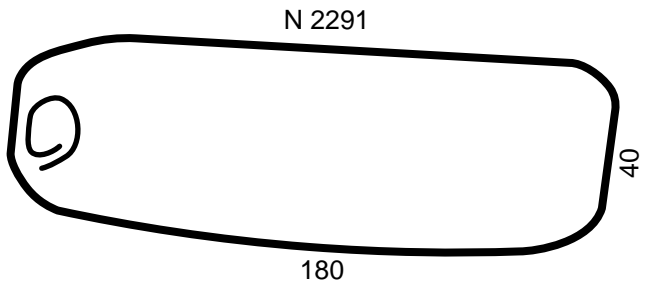
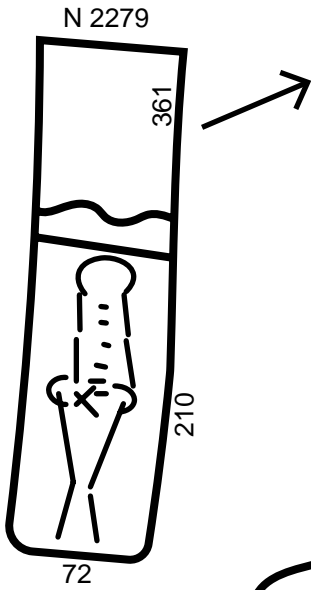
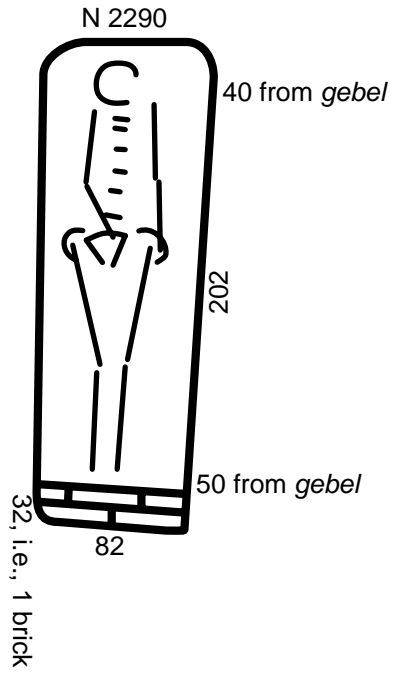
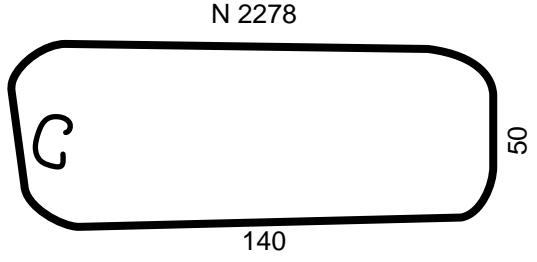
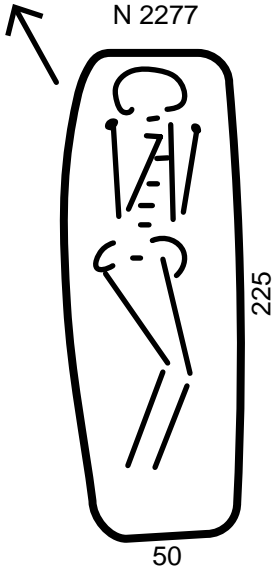

N 2292

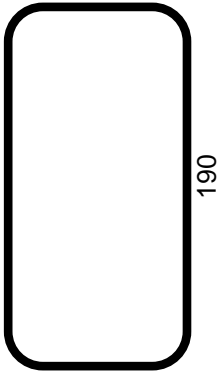

190

90

(i)



(ii)



N 2293

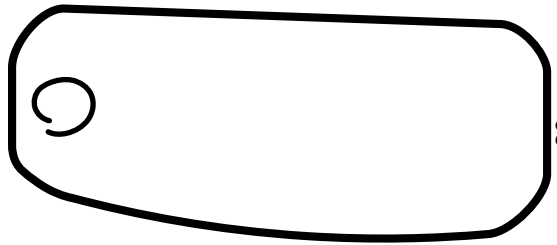

69

180

N 2294

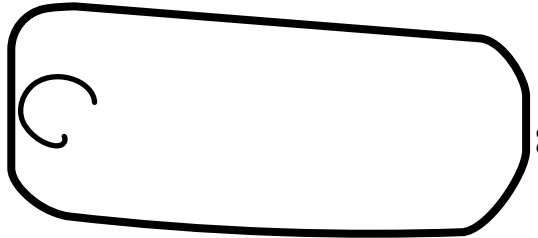

69

160

N 2295

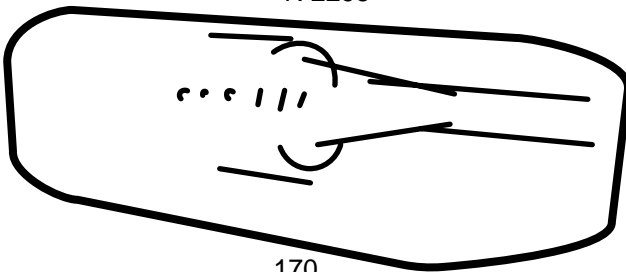

69

170

N 2297

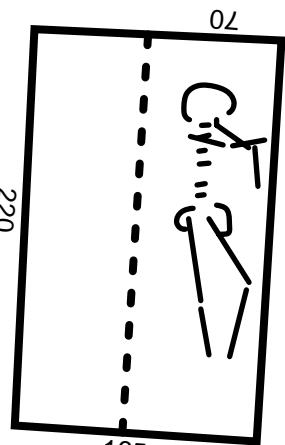

70

220

165

N 2296

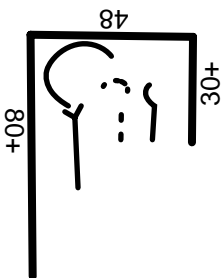

48

30+

80+

N 2298
06

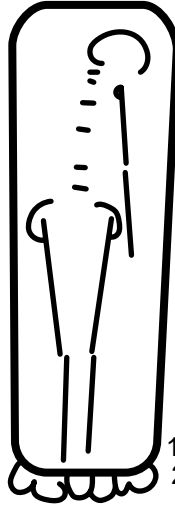

195 to end of skeleton
275

N 2299

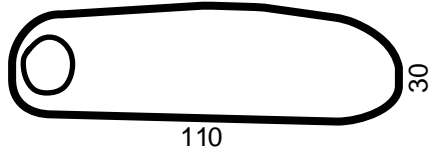

110

N 2300

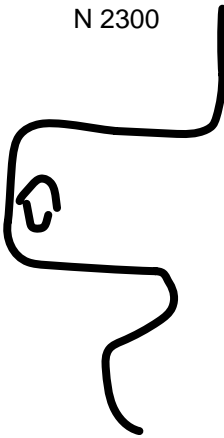

N 2304

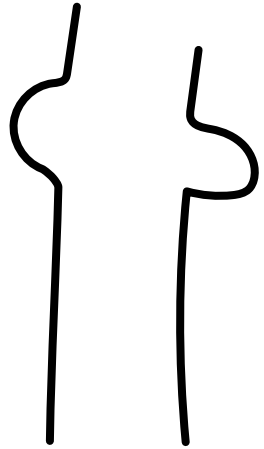

N 2293 (TC; MM) Map C4 (red)

100 below *gebel* level. Copt. Shallow grave, running east-west. Adult. Sex? On back, head west, arms by side. Traces of decayed cloth.

N 2294 (TC; MM) Map C4 (red)

100 from *gebel* level. Copt. Shallow grave, running east-west. Young adult. Joints not quite ossified. Sex? On back, head west, arms by side. No trace of cloth left.

N 2295 (TC; MM) Map C4

120 from *gebel*. Coptic burial. Shallow grave, running east-west. Adult. Sex? On back, head west, arms by side. Upper part of body gone. No trace of cloth left.

N 2296 (TC) Map C4

40 from *gebel*. Upper part of Egyptian burial. Rest of tomb broken away. Traces of wood from coffin on sides of tomb.

N 2297 (TC) Map C4

205 deep. 92 high. Burial of a small child. All traces of coffin gone.

N 2298 (TC) Map C4

115 from *gebel*. Had been buried on back. Upper part of body disturbed. Portion of right arm doubtful. Bones in bad condition. All wood of coffin gone, but traces of the plaster on north end of grave. South end of tomb blocked by stones. Type had been pit and chamber.

N 2299 (TC; MM) Map N/A [ed.: Map location not listed in excavation records; tomb seemingly not on the map.]

50 down from *gebel*. Burial at end of Dynasty 6–9 pit. Small Coptic child. On back, head west, arms by side. Remains of light brown hair. 2 palm sticks under body. The wrappings were in very bad condition, but enough remained to show that there had been at least 2 shawls, the outer being of coarse cloth, which had originally been tied round with cord, and the inner of fine, with traces of tapestry-woven designs in colored wool.

N 2300 (TC; MM) Map C4

Coptic. See Smith. Shallow grave, running east-west, east end projecting over early grave. Adult. Sex? Head west. Under body, 2 (?) sticks of acacia. Over head, a quantity of palm fiber. Remains of roll of cloth from head with worked edge and broad black? stripes (inwoven). The wrappings had almost entirely disappeared.

N 2305

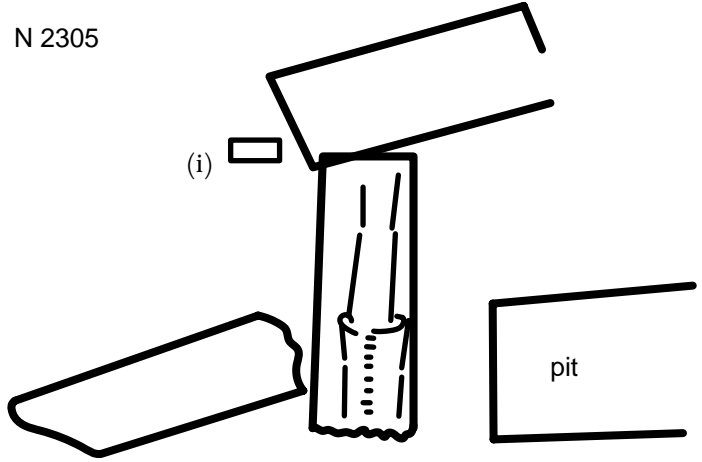

N 2306

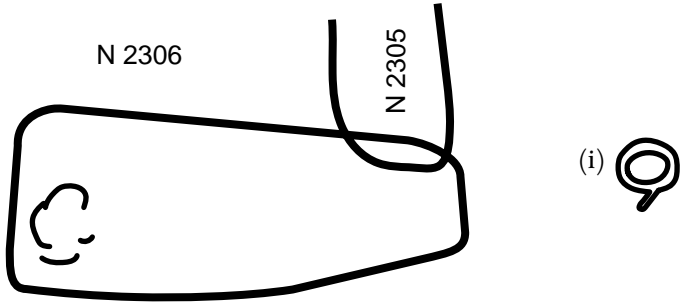

N 2309

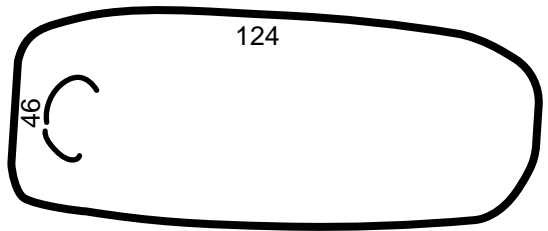

N 2310

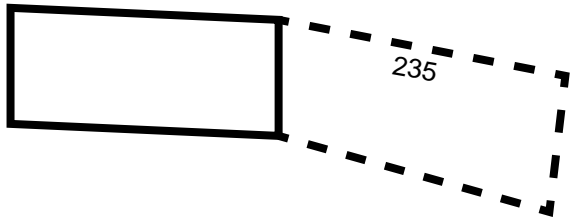

N 2301 (TC; MM) Map C4

Coptic. See Smith. [ed.: No image.]

N 2302 (TC; MM) Map C4 (red)

Coptic. See Smith. (Packed.) [ed.: No image.]

N 2303 (TC; MM) Map C4

30 below black ash level. Copt. Shallow grave. (2 bodies, both female. Northerly one had a completely ossified hyoid, showing that she had reached at least to middle age.) S. [ed.: No image.]

N 2304 (TC; MM) Map C4 (red)

Coptic burial at end of early pit. Shallow grave, running east-west, cutting across Dynasty 6–9 pit at right angles. Child about aged 15–16. Sex? Traces of sticks under body. Cloth had almost entirely disappeared.

N 2305 (TC) Map D4

Female? adult. Burial just below *gebel* level. Sides of grave broken away. Remains of wooden coffin, so probably Dynasty 6–9. Corners of coffin angled. Measurements of coffin? By head, 2 (i) stone beads, 2 carnelian disc, and 1 black glaze disc.

N 2306 (TC; MM) Map C4 (red)

Copt. S. Shallow grave, running east-west. Girl aged approx. 17. On back, head west, arms by side. With body, a plain bronze ring (i). Under body, remains of palm sticks. The wrappings had almost entirely disappeared.

N 2307 (TC; MM) Map D4

Copt. See Smith. [ed.: No image.]

N 2308 (TC; MM) Map D4

Copt. (Probably girl aged approx. 13. Extreme hydrocephalus. Head 171 mm broad.) S. [ed.: No image.]

N 2309 (TC; MM) Map D4

80 deep. Copt. Shallow grave, running east-west. Child aged approx. 8. On back, head west, arms by side. Bronze bracelet on right arm, above wrist, made of one piece bent round to meet. Also, on body, a bronze cross. The wrappings had almost entirely gone.

N 2310 (TC) Map D3

Contained nothing.

N 2311

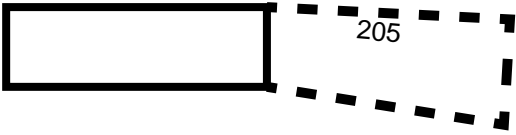

N 2313

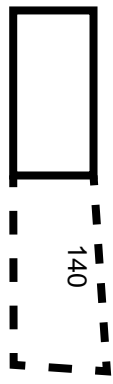

N 2314

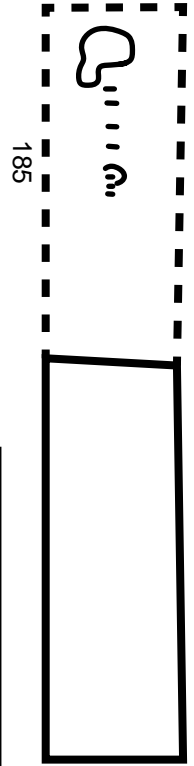

N 2312



N 2315

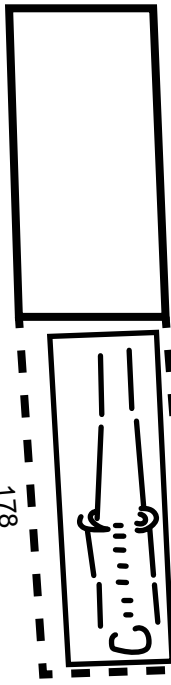

N 2316

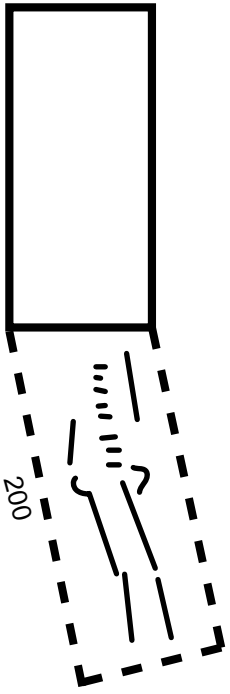

N 2318

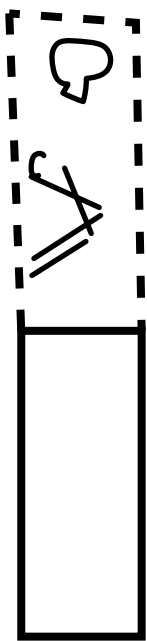

N 2319

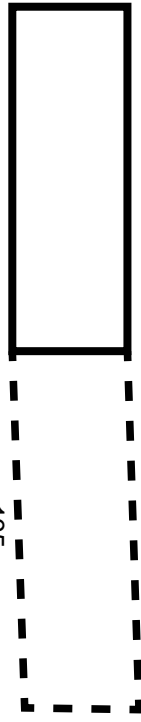

N 2317

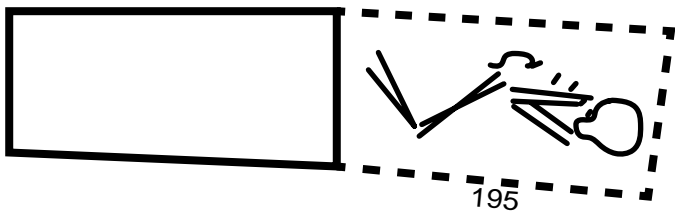

N 2311 (TC) Map D4

205 down from present level. Contained nothing.

N 2312 (TC) Map D4

Approx. 210 deep from present level. Contained nothing.

N 2313 (TC) Map D4

210 deep from present level. Approx. 90 high. Contained nothing.

N 2314 (TC) Map D4

210 deep from present level. 85 high. Adult female. Upper part of burial.

N 2315 (between 2414 and 2416) (TC) Map D3

200 deep from present level. Adult male. Burial on back. Completely covered with a loose linen wrapping, apparently a wide shawl with fringed edges. Inside measurement of coffin 168 × 40 × 41. Thickness of wood 4. Angled corners, round pegs.

N 2316 (between 2411 and 2838) (TC) Map D4

190 down from present level. Approx. 90 high. Adult. Sex? Upper part of burial disturbed. On back. Traces of wood from coffin.

N 2317 (between 2412 and 2410) (TC) Map D4

Approx. 200 deep from present level. 80 high. Adult. Sex? Leg bones somewhat scattered, but approximating position as given. Burial on left side, head south. Traces of wood from coffin.

N 2318 (by valley) (TC) Map D5

Adult. Sex? Position of arms? Remains of wooden coffin. Bones much broken.

N 2319 (TC) Map D4

240 deep. Contained nothing.

N 2330 (TC) Map E3

Contained nothing.

N 2331, N 2332, N 2333, N 2334 (TC; MM) Map E3 (2331, 2332, 2333), D4 (2334: red)
Coptic graves. Burials gone. [ed.: No image. According to Hearst Museum records, 6-14466 (jar) is from N 2332.]

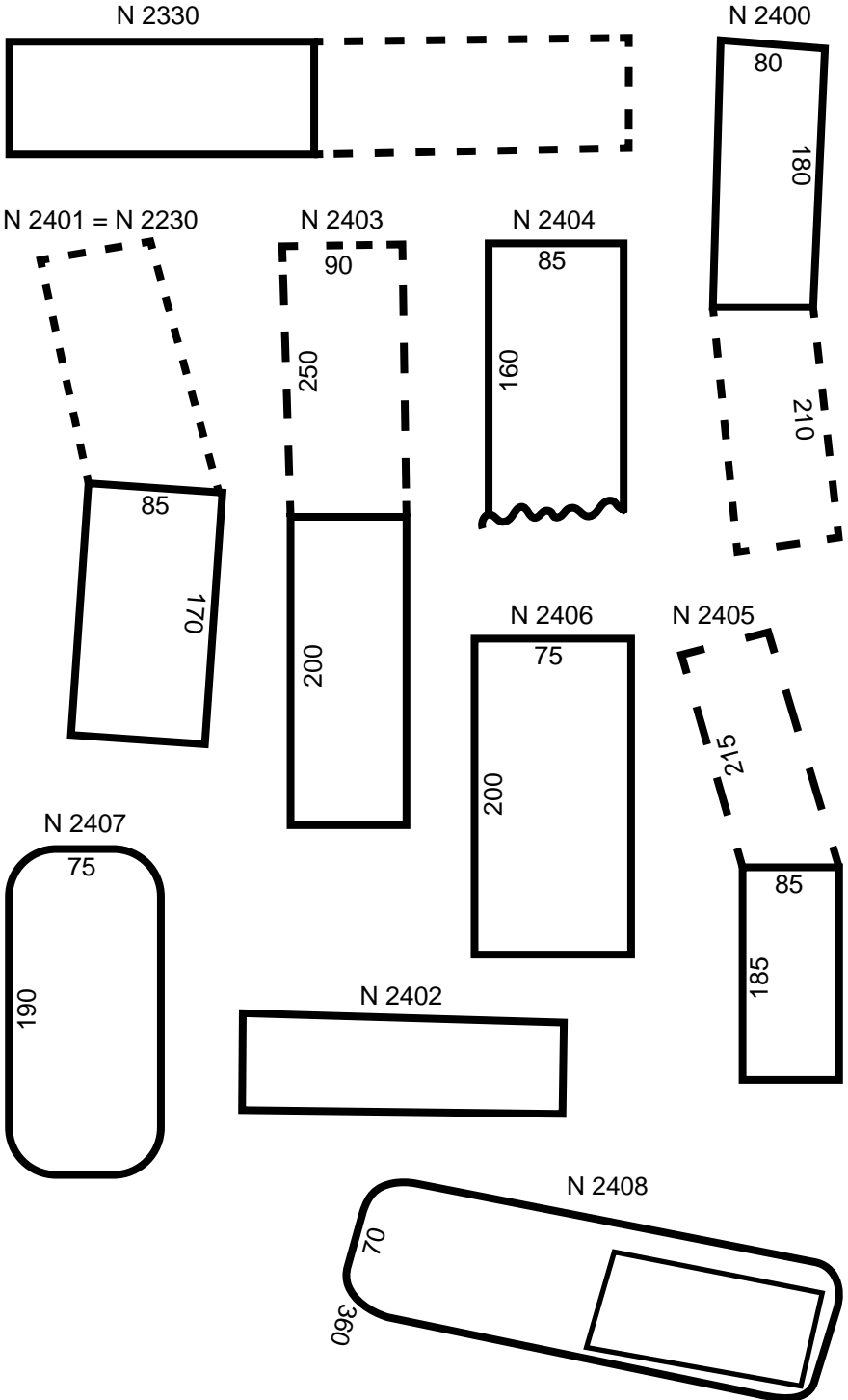

N 2400 (TC) Map E3

80 E. 200 deep from present level. 80 high. Contained only the bottom of a wooden coffin.

N 2401 = N 2230 (TC) Map E4

Plundered out.

N 2402 (TC) Map E3

May have been pit and chamber, but all trace of chamber gone. Contained nothing.

N 2403 (TC) Map E3 (red)

Had been standing open.

N 2404 (TC) Map E3 [ed.: 2405 in ink, but 2404 in pencil.]

Broken away. Contained nothing. [ed.: No image. According to Hearst Museum records, 6-14468 (broken jar) is from this burial.]

N 2405 (TC) Map E3 [ed.: 2 tombs are labeled 2405 in E3. The one more to the south and east is actually 2404. The pencilled label 2404 is visible on the map.]
97 W of N. 60 deep from *gebel*. Contained nothing.

N 2406 (TC) Map E3

85 W. 80 down from *gebel*. Contained nothing.

N 2407 (TC) Map E3

112 W of N. 100 from *gebel*. Contained nothing. Arab *kusha* [i.e., temporary structure?] built above.

N 2408 (TC) Map E3 (red)

Originally probably pit and chamber, but all trace of roof gone. At north end, remains of a wooden coffin. Inside measurements 160 × 35 × . Width of wood 3. Corners angled.

N 2410 (TC; MM) Map D4

Coptic burial. Shallow grave, running east-west. (Adult male. 1.527 high. Bad fracture of femur. Wavy black (or dark brown) hair 12 cm long.) S. On back, head west, arms by side. The body was clothed in a shirt of yellow cloth. Some of the cloth was apparently from a linen garment with corded edges or some

N 2410

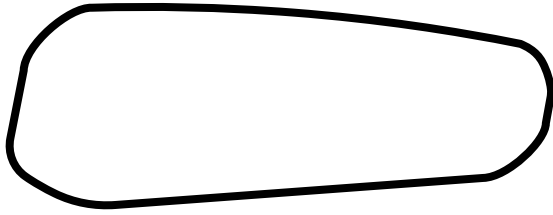

(i)



(ii) cccccc

N 2411



N 2412



N 2413

195

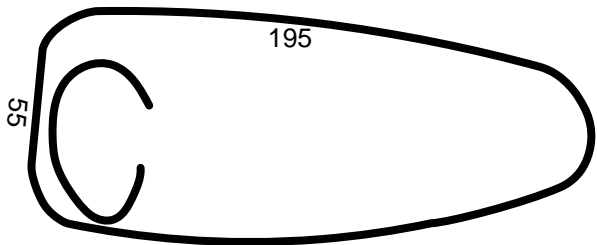

kind of cord work? This was decorated on the sleeves at any rate with bands of green, inwoven possibly from sleeves, on which animal (hares?) and other designs were left in the original yellow thread with border by each side of (i). The innermost wrapping consisted of a shawl of fine cloth with fringed ends and 11.5 from end, a band of inwoven red threads 3.2 wide (ii). Pattern was irregular, but main feature was alternation of 2 semicircles, first 2 being green ground with yellow lines and side details of yellow between 2 lines of red, second 2 being yellow ground with red lines and side details of yellow between blue. Small semicircles were always yellow and blue. The extra colors were apparently all added to the original yellow warp at the time of weaving. In every case, a thin line of original thread was left round patterns. Width of shawl was 72+. Outside this, there was a shawl of rough sackcloth.

N 2411 (TC; MM) Map D4

Coptic burial. Shallow grave, running east-west. Adult. (Sex? Height 145 cm.) S. Under body, 2 palm sticks. Remains of several wrappings, some of which showed traces of tapestry-woven designs in colored wool.

N 2412 (TC; MM) Map D4

Coptic burial. Shallow grave, running east-west. Young adult, male. Head west. The cloth was in very bad condition, but there had been 2 shawls at any rate, the outer being of sackcloth and the inner of fine cloth with tapestry-woven designs.

N 2413 (TC; MM) Map D3

100 down. Copt. Shallow grave, running east-west. Adult male. On back, head west, arms by side. Quantity of long, dark brown, curly hair. Bottom of right ulna broken, and bone worn down to a point. Growth of bone round top of right radius. Left ulna broken near middle and roughly set. The body was clothed in a plain shirt with a band of ridges made in weaving down either breast. Sides corded. Round neck turned over and hemmed. Bottom ditto. Sleeves open all the way down. The arms were not in the sleeves. On the body, there were a number of plant seeds. On the left side of the body, not underneath, there was a stick of sesban and on the right side, one of palm. Over the head, there was a pad of cloth, consisting of an old shirt. The innermost wrapping shawl was of coarse cloth. Outside this, there was a shawl of sackcloth with fringed ends and a band of open work near the ends. Next came the binding cords, but these were in too bad a condition for the type to be determined (perhaps 2-strand fiber). The final wrapping was a shawl of yellow cloth, which had apparently completely enveloped the body and was tied over the chest by the corners.

N 2414

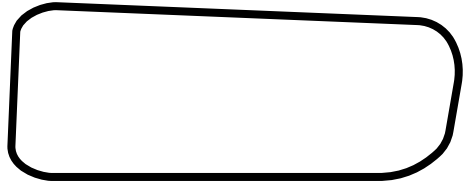

N 2415



(ii)



Sides were corded. Ends worked off in weaving. In each corner, a rosette of heliotrope (inwoven) and designs in white thread (original weave), and blue, green, yellow, and red (worked on).

N 2414 (TC; MM) Map D3; photo C 8463

Approx. 100 from true *gebel*. Coptic. Shallow grave, running east-west, containing three burials. a. (Adult. Sex? 150 cm high.) S. On back, head west. The feet were in leather sandals. The cloth was in very bad condition, but enough remains to show that there had been 2 wrapping shawls, the inner being of finer cloth and the outer of sackcloth. Over the feet, there was a quantity of frayed ends of cloth, and over the head, there was a pad, rolled up, made of an old shirt (?) much patched and darned. Remains of embroidered cloth from small burial. b. and c. (2 children of the same size, aged about 5 or 6. Full set of milk teeth. No permanent teeth.) S. These were placed one on each side of the legs of the adult burial. Both were in the usual position. The cloth was in very bad condition, but there were remains of inwoven designs. There were palm sticks under both bodies.

N 2415 (TC; MM) Map D3 (red)

S. Shallow grave, running east-west. Adult. Male? On back, head west, arms by side. Body was in good condition, most of the skin being left. Quantity of reddish-brown hair. Quantity of pubic hair. The body was clothed in 2 shirts. The outer one badly damaged with a quantity of pattern in dark blue cloth, and yellow medallions, and (i) pattern. Ornamentation in dark brown? panels, pattern in original cloth. Sleeves near end double in same ornamentation (ii). On sleeves, designs were floral. On main part of shirt, animal? Underneath, a white shirt, also much damaged. Back part was rucked up to small of the back. Shirt made of 2 pieces of cloth sewn together laterally to body, joint coming just below arm holes. Right sleeve left, sewn to about 22 above wrist, above open. Arm was not in sleeve. 4 carnelian beads scattered ? from neck. Sprinkled over the body, outside the shirts, there was a layer of salt. Under the body, there were 5 palm sticks bound together at each end with palm cord. The innermost wrapping consisted of a shawl of fairly fine cloth. Between this and the outer wrapping, which was of sackcloth and was tied round with cords, there was a lot of extra padding on the head. This consisted of a sheep-hide (?), worked, but with wool still remaining, and of a number of bundles of straw tied round with cord. [ed.: No image of burial/tomb.]

N 2416

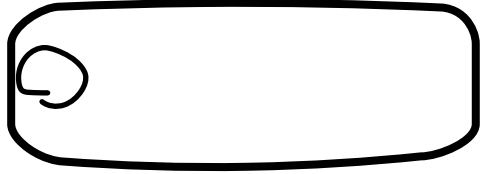

pit

N 2417

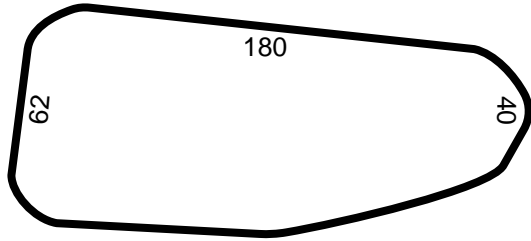

N 2418



N 2416 (TC; MM) Map D3 (red)

Coptic burial. Shallow grave, running east-west. Young adult, about 18–20. Ends of bones almost ossified. Sex? On back, head west, arms by side. Body in very good condition, a good deal of the skin being still preserved. Fingernails preserved. The body was clothed in 2 plain shirts of coarse cloth. The right arm was in the outer sleeve, but not in the inner, while the left arm was in the inner sleeve, but not in the outer. In each case, the sleeve seams were sewn together at the shoulder and the wrist, but were open between. The inner of these was a plain shirt that reached almost to the knees. The body thus attired was laid on a flat board to which it was bound by a wide strip of cloth that went round the hips. Board and body were then placed on a wide strip of cloth, spread open on the ground. A number of dried leaves were placed on the breast, and a quantity of salt was poured/sprinkled over the whole body. Over the face, a layer of very fine soft fiber was added. The left side of the shawl was turned over the body, and then the right side, the whole being bound together with fiber cords. At feet end, this cloth ended in a fringe. Above this shawl, there was a very elaborate combination of headpads. First, over the face, there was a roll of fine cloth. Next came a quantity of loose straw, embedded in which there were 5 bundles of straw, each tied up separately with cord and then all bound together. These were roughly kept in place by cords fastening round the head and were finally secured by a cloth that completely enveloped the head, with its various padding, and that was itself fastened on with cords. Next came a shawl of rough sackcloth that completely enveloped the body. The outer binding cords were of type 1.

N 2417 (TC; MM) Map D4; photo C 8472

95 deep. Coptic burial. S. Shallow grave running east-west. Adult male. On back, head west. All trace of cloth gone. Behind the head, a copper dipper (i) with handle made in 2 pieces, which were attached to one another in such a way that handle could be lengthened at will (ii). The handle was soldered to dipper. In the filling of the grave, 4 copper signet rings. [ed.: The drawings of 2 TCs numbered 2417 have been combined into 1.]

N 2418 (TC; MM) Map D4

Shallow grave running east-west. Coptic burial. Child. On back, head west, arms by side. Quantity of straight, dark brown hair. On left arm, remains of an iron bracelet, almost all decayed away. Under body, 2 palm sticks. Round head, several wrappings of finer cloth innermost one of which had patterns in colored wool. The cloth wrappings were in very bad condition. Outside this was a shawl of sackcloth.

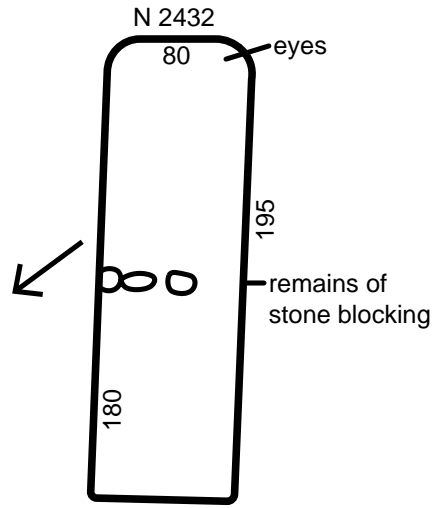
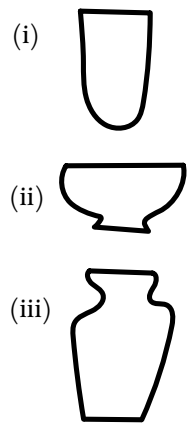
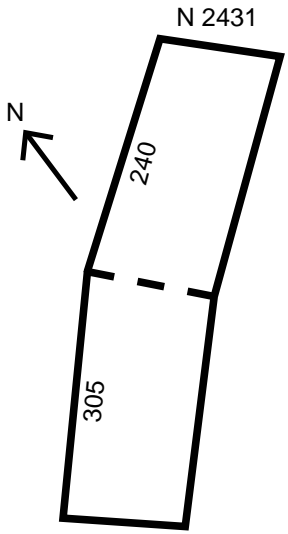
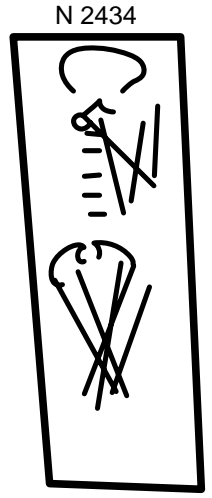
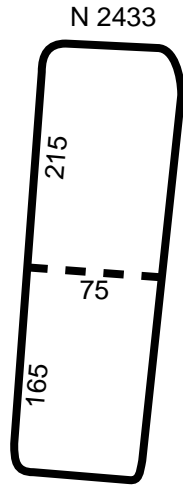
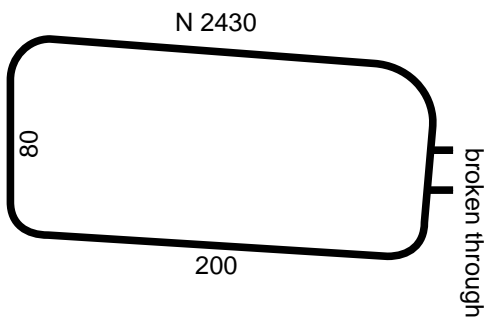

N 2419 (TC; MM) Map D4

72 down from *gebel*. Coptic burial. Shallow grave running east-west. Adult male. On back, head west, arms by side. Quantity of dark brown remaining with thin moustache of a rather lighter color. The shirt and inner wrappings had entirely disappeared. Under the body, there were 3 or 4 thin sticks of sesban. On the head, there was a pad consisting of a much patched and darned shirt with corded edges. 1 wrapping shawl of sackcloth remained, and outside this, there were traces of a very thin wrapping of red cloth.

N 2430 (TC) Map D4

100 below *gebel*? Apparently, a pit was begun, and when it broke through at bottom to next tomb, it was abandoned.

N 2431 (TC) Map D3/D4 [ed.: Map location not listed in excavation records; possibly between N 2637, N 2636, and N 2638 in tear on map. Note that there is another tomb labeled N 2431 that is associated with N 2207.]; photos C 8466, C 8467

270 down from *gebel*. 38 high? Contained 1 skull. Few fragments of coffin (angled corners). 2 rough sticks, both of which had fragments of cloth adhering to them. Piece of a pottery soul home? Several broken pots (i) A, (ii) rough outside, red polish inside (6-14470), piece of a (iii)? Fragment of rim of a slate bowl. Fragments of Coptic pottery in filling of pit with scratched inscriptions. [ed.: According to Hearst Museum records, 6-14469 (jar fragment) is from this burial.]

N 2432 (TC) Map D3; photo B 8251

200 down from *gebel* level. 94 high. In chamber, remains of coffin 174 long. Wood 3 thick. Eyes in black, white irises, red corners. Coffin yellow outside, white inside. Angled corners, round pegs throughout. Remains of inscription in dark blue paint. Piece of a *nabut* and several rough sticks. Few black and blue glaze disc beads, large size (6-14471). 1 skull.

N 2433 (TC) Map D3

200 from *gebel*. 90 high. Contained only a few fragments of coffin (angled corners).

N 2434 (TC) Map E3

Burial on *gebel* level. Lid [ed.: and(?)] tibia had been moved. On left side. Both legs had been bent sharp from knees, feet by pelvis. Coffin had been broken

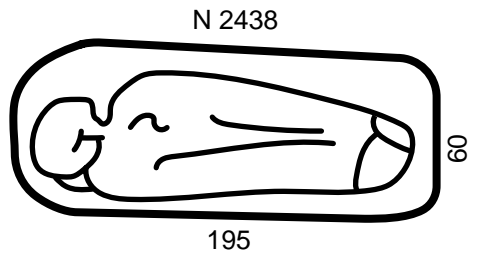
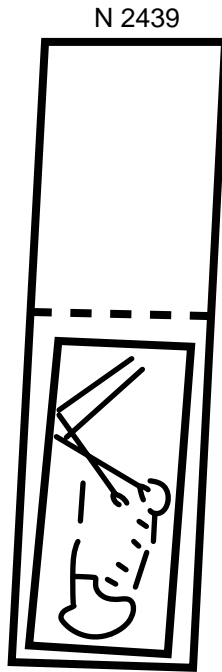
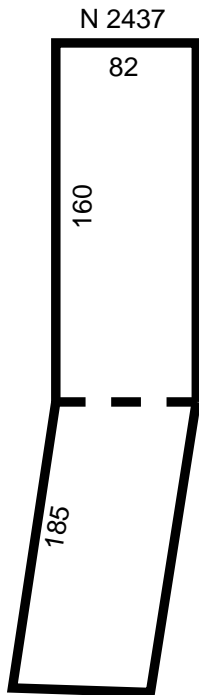
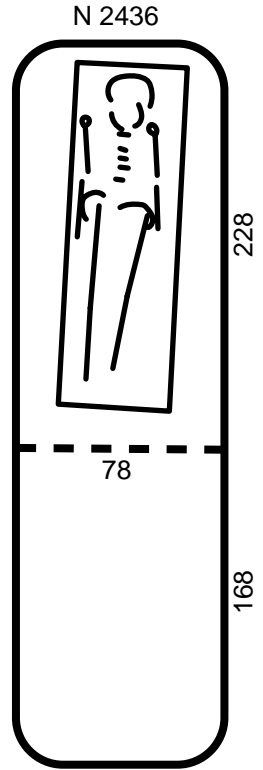
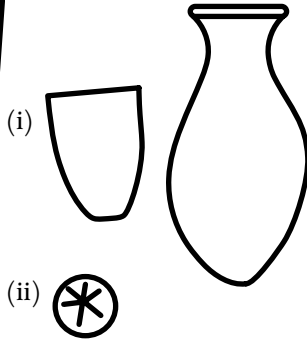
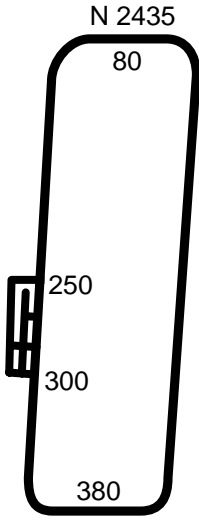

by plunderers and was scattered above. Coffin about 125 long. Few traces of cloth on body. In *radim* above, few black and blue glaze beads, 1 crumb bead (6-14472). Protuberances on left side of skull.

N 2435 (TC) Map E3

150 from *gebel*. Remains of brick building with 2 stones built above brick, 32 high. It was 20 above, 1 brick wide. Roof of chamber fallen in. Contained pieces of 2 or 3 pots (i), small fossil (ii). Part of foot, all bottom joints of toes ossified to main part of foot.

N 2436 (TC) Map E3

160 to *gebel*. 82 high. Male. Burial on back. Few traces of cloth on body, including skull. Coffin white, inside and out. Inside measurements 188 × 41 × 47. Thickness of wood 5. Corners as usual, round pegs. In filling of pit, 2 rough *nabuts* about 140 long, possibly both from one in which each pole would have been 270 long and still broken at each end. Possibly from a Coptic burial.

N 2437 (TC) Map E3

160 from *gebel*. Roof of chamber entirely gone. Contained remains of a wooden coffin. 1 skull. Contained fragments of 2 or 3 As and of a Coptic dish.

N 2438 (TC; MM) Map E4 (red)

100 down. Coptic burial. Shallow grave running east-west. Adult. Sex? Head west. The shirt had disappeared, and the inner wrappings were in a very fragmentary state. The innermost shawl seems to have been coarse cloth with a border decoration in red and yellow wool. Over feet, pad of cloth with openwork decoration. These were probably from a wrapping shawl. Above this, over the face, there was a layer of thin reeds bound to the head by a strip of cloth. Above the reeds, there were 2 pads of cloths, 1 consisting of an old shirt decorated with lines of rosettes in colored wools, blue, yellow, green, red, and black. Also, near neck, a band of openwork. Second roll consisted of a strip of ordinary coarse cloth, about 100 by 40, rolled up. The outer wrapping was of sackcloth tied round at neck and feet with cord. The binding cords had almost entirely disappeared.

N 2439 (TC; MM) Map E4; photo C 7068, C 8559

Coptic burial of a child in the chamber of a Dynasty 6–9 pit, the early coffin and burial being still in position underneath. By the head, a few twists of black, plaited hair. On right arm, by elbow, an iron bracelet. The body was clothed in a plain shirt that reached to just below the knees, sleeves down to hands. Under

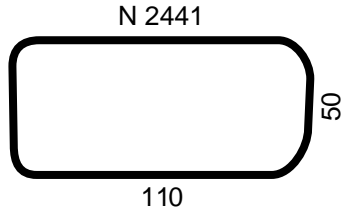
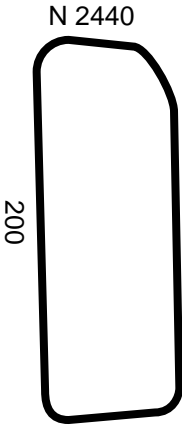

- (i)
- (ii)
- (iii)

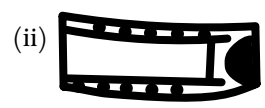
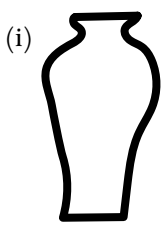
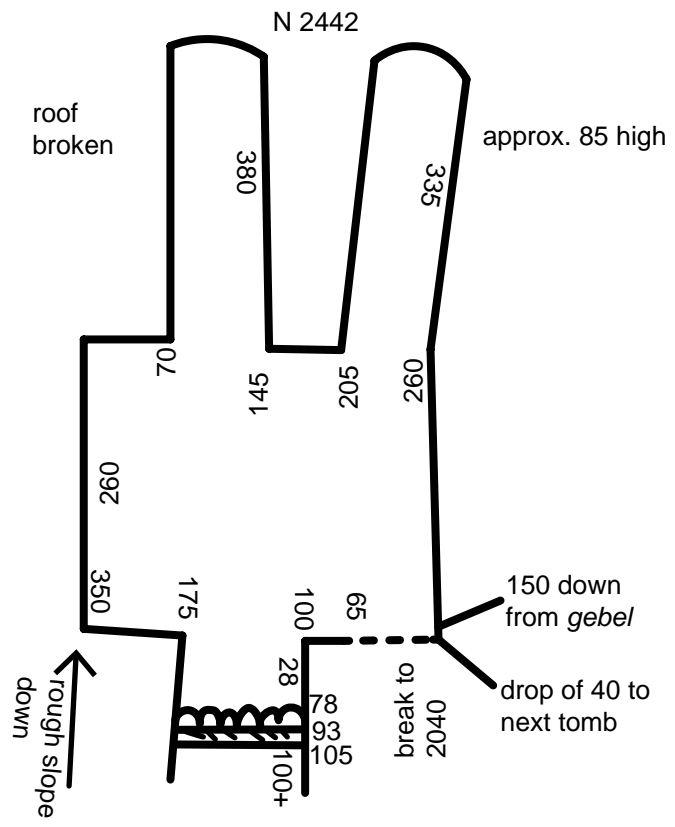

the body, there were 2 palm sticks and on the body, reaching down from the stomach to the ankles, there were a few dried branches of some aromatic herb. Thick pads over head and feet. There was apparently but 1 wrapping shawl and that of sackcloth bound round with cords that crossed in all directions.

N 2440 (TC; MM) Map B4

110 deep. Coptic burial. Shallow grave running north-south. Adult. Sex? On back, hands by side. No cloth preserved.

N 2441 (TC; MM) Map B3; photo C 8469

100 down. Coptic burial. Shallow grave running east-west. Small child. On back, head west, arms by side. By the head, there were a number of beads, blue and green glass, shell, and carnelian (i), ivory (ii), several ivory (iii) pendants threaded on bronze wire, and a small bronze cross. In the filling of the grave, there were pieces of 2 dishes and the upper part of a pottery doll. No cloth preserved.

N 2442 (TC) Map B4; photos B 8429, C 7473

Height of chamber had been approx. 130. Outside bricking of doorway, few A pots (i). In filling of chamber, few more As, M, broken pottery cone, and broken pottery ? (ii).

N 2446 = N 2522 (TC) Map E3; photos B 7142, B 7144, C 7474

Height of chamber? Chamber a: blocked with rough stones and mud. Broken away at top by plunderers. Remains of wooden coffin, rotted entirely to pieces. Adult. Sex? Head north. Bones had rotted away so completely that position of burial was indeterminable. Probably on back. Chamber b: contained nothing. In main chamber, a quantity of pottery (see photo) and a few glaze beads, disc and (i). [ed.: According to Hearst Museum records, the ceramics from this burial are 6-14473-6-14536.]

N 2447 (TC) Map B4; photo C 8542

135 down from black deposit. 175 from *gebel*. 75 high. Adult. Female? Half over on left side. Position of right arm ?, but apparently under body, both hands being together. Traces of wood from a coffin. Bronze mirror (6-14537), resting on 2 rough stones. Cloth on under side. Greater part of roof of chamber had broken away. Above tomb, (i), (ii) drab, M, (iii).

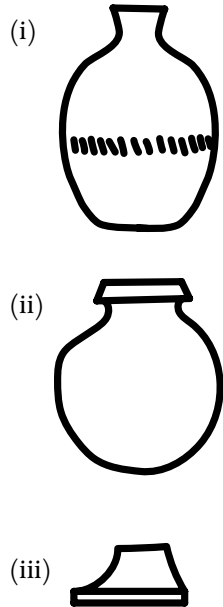
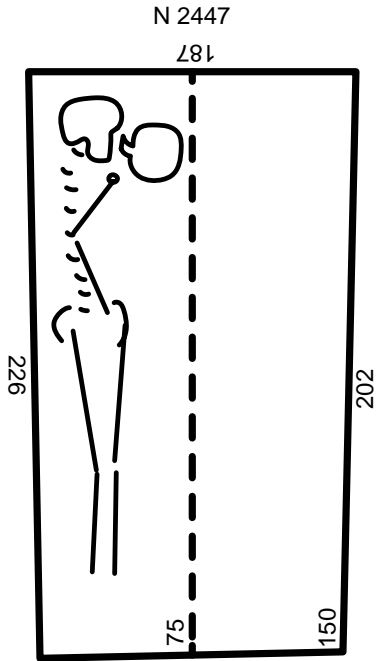
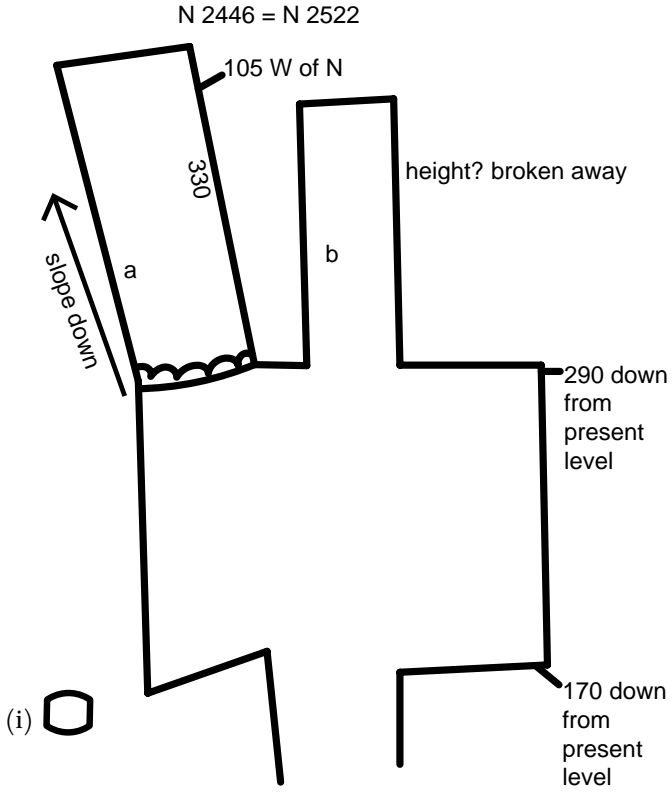

N 2448 (TC) Map B4

Approx. 50 down from *gebel*. 45 high. Wall 12 wide, i.e., half brick. Adult. Male? Traces of wood from coffin? Roof of chamber, if any, entirely gone.

N 2449 (TC) Map B4

Approx. 210 deep. 80 high. Female? From skull, pelvis too broken to determine. Burial on left side. Head north. On breast, at X, a bronze button (i) with loop back, covered with cloth on both sides (6-14539). Brick wall 16 high. Chamber was apparently originally blocked above wall by stones. 2 or 3 large stones still remaining at north end. Built in with brick wall at south end, a large pot (ii), approx. 42 × 35, in dull brown ware. In filling of pit near top (iii) with decoration in white spots. Bottom roughed and had been on a stand or dish. [ed.: According to Hearst Museum records, 6-14538 (mirror) is from this burial.]

N 2470 (TC) Map B4

Not a burial. 30 W of N. 140 deep from present level.

N 2471 (TC) Map B4

90 down. Color of soil under bodies showed that there had been a coffin. 2 bodies must have been in the same coffin. a. On left side. Adult. Female? b. Almost over on stomach. Adult. Female?

N 2472 (TC) Map B5

Brick 13 wide, about 60 high. Apparently in construction of tomb, hole was cut into next and bricked up. Just outside doorway, few A pots (i).

N 2473 (TC) Map B5; photos B 8427, C 8495

In main chamber and in door of east chamber, a quantity of pottery: table of offerings (i); A (ii) (6-14540, 6-14541); M (iii); smooth pottery, 3 black paint lines, large bowl (iv).

N 2474 (TC) Map B5

40 W of N. 185 to *gebel* level. Contained 1 broken skull.

N 2475 (TC) Map A4 (red)

68 E of N. Depth from present level 150. All roof of chamber gone.

N 2476 (TC) Map B4

52 W. 225 deep from surface. Contained nothing.

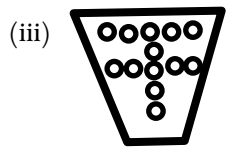
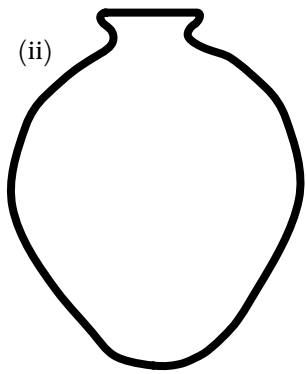
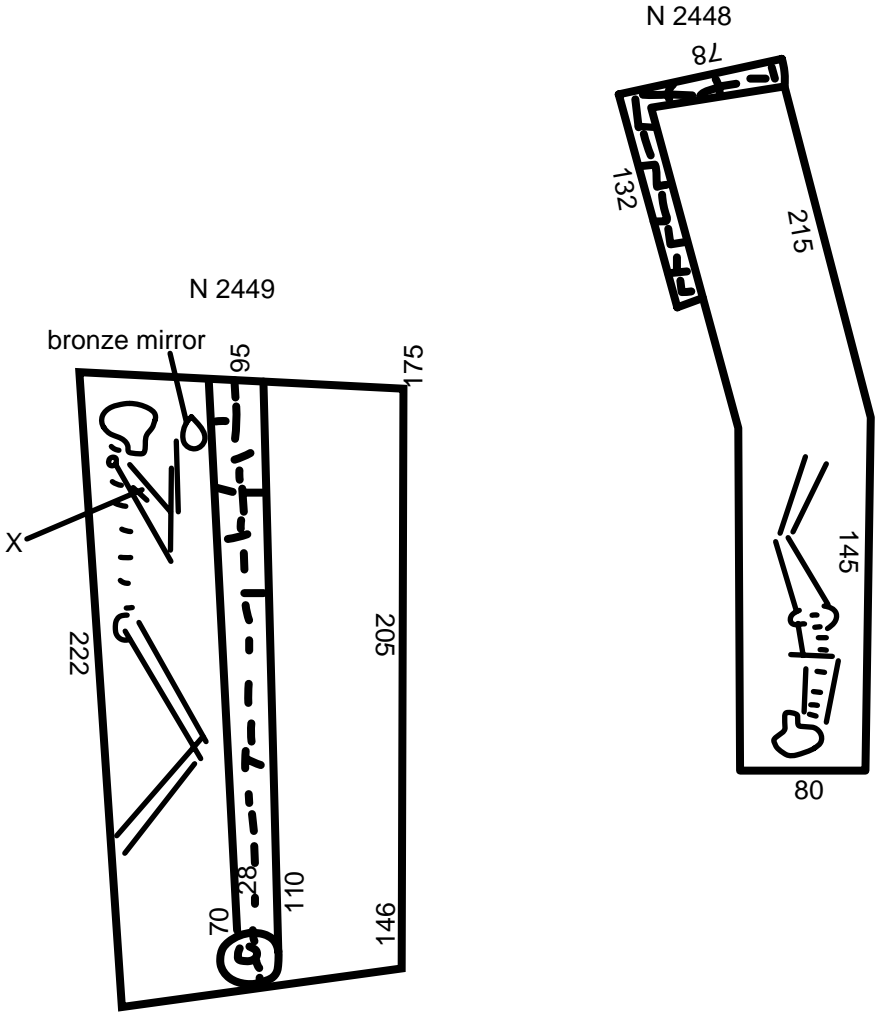

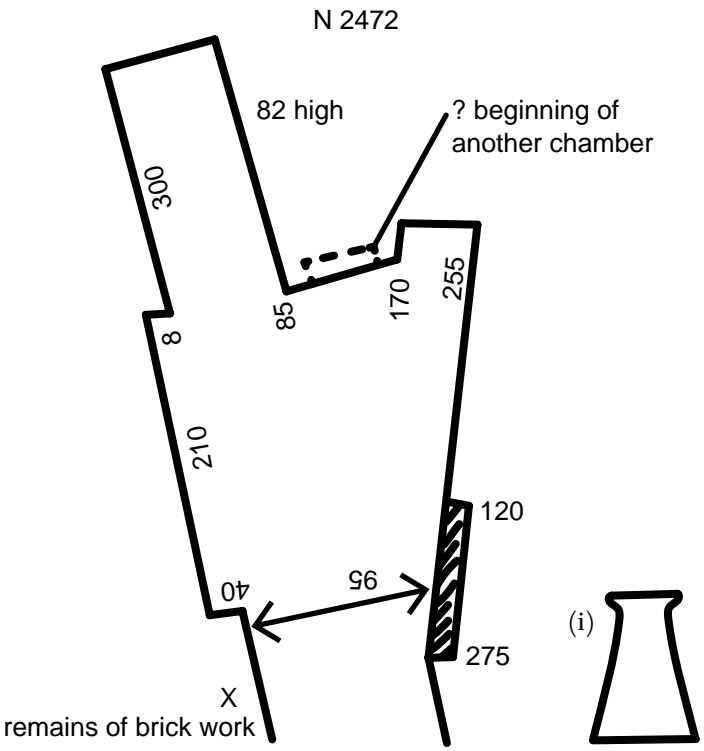
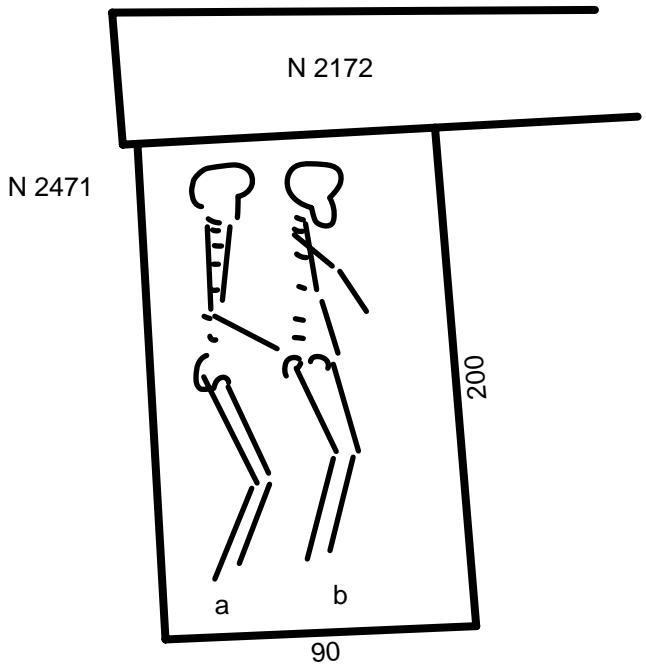
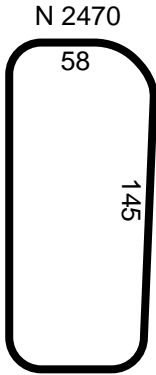

N 2473

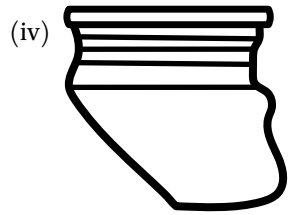
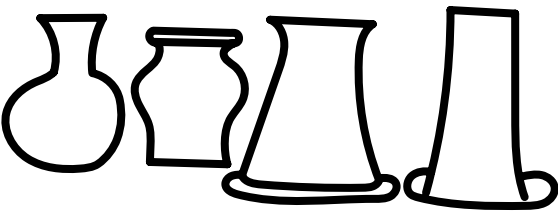
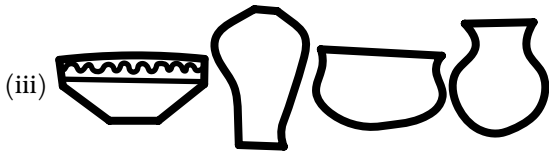
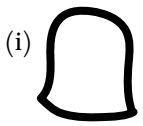
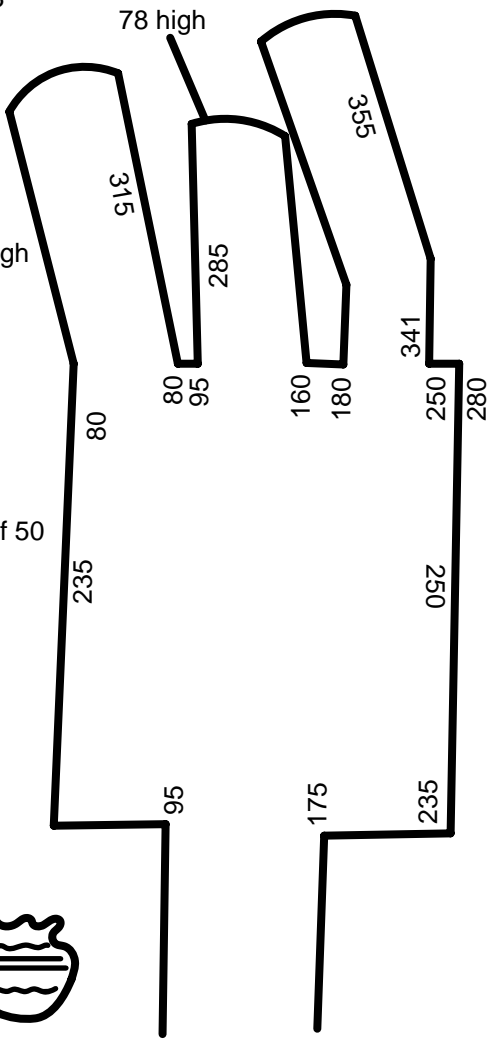

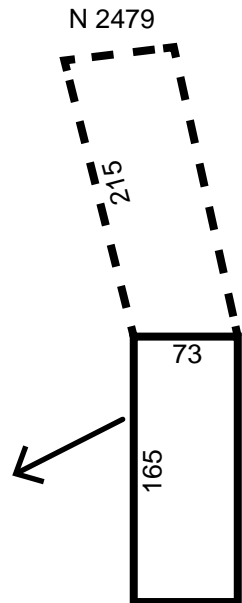
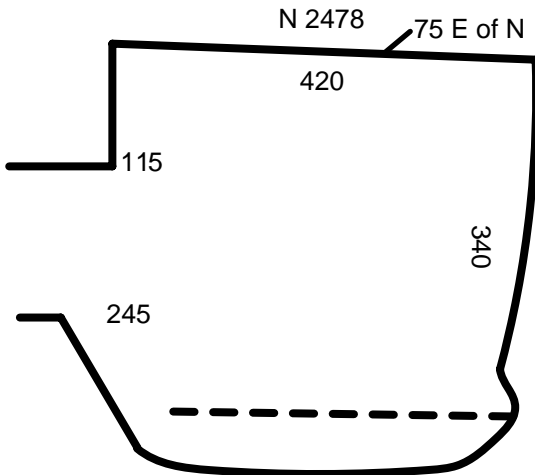
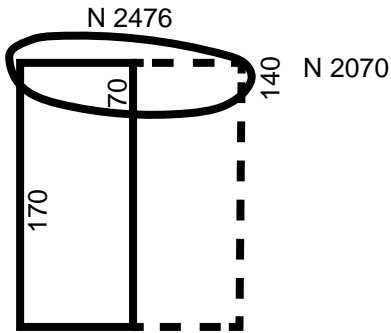
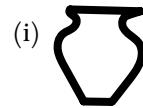
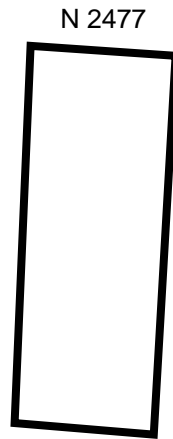
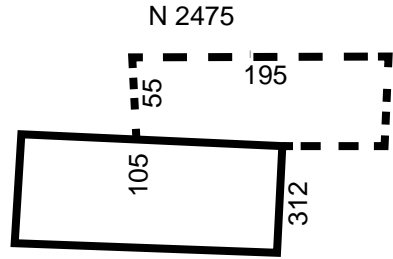
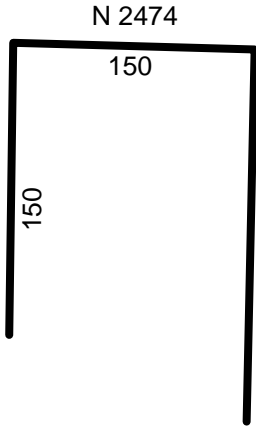

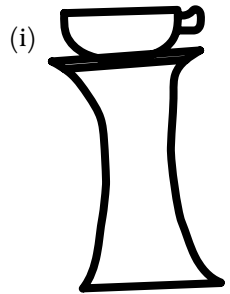
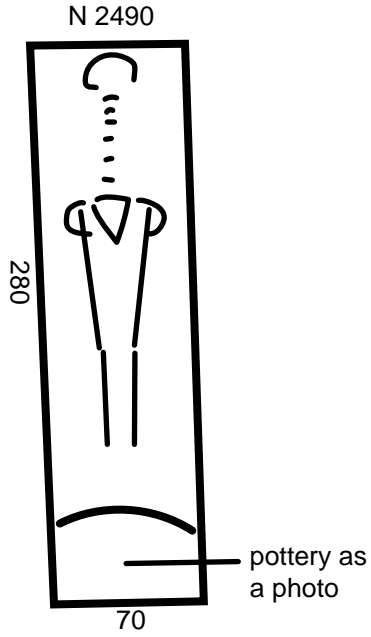

N 2491

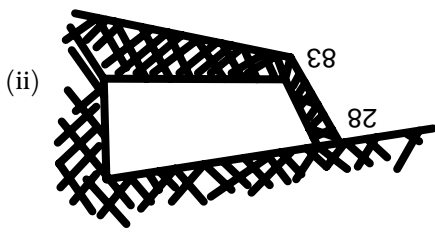
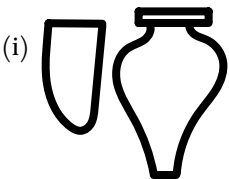
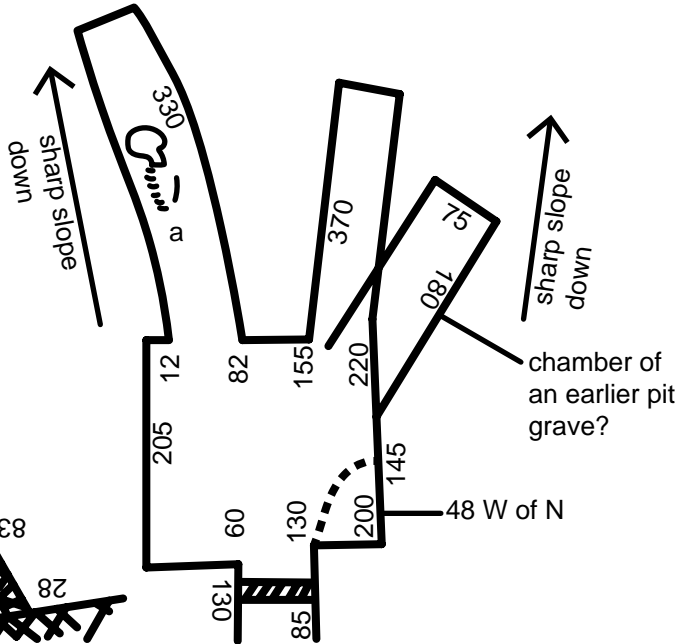

N 2477 = N 2531 of Green's (TC) Map B4

140 E. Contained a few pots only, (i) [with] spout, A.

N 2478 (TC) Map A4

Approx. 500 deep from present level. Down almost to water. Abandoned as unsafe.

N 2479 (TC) Map A4

190 deep. Contained nothing.

N 2490 (TC) Map C4 (red); photos B 7146, C 7158, C 7467

Originally probably chamber and pit, but all roof broken away. At entrance to pit, quantity of pottery (see photo), dish on stand (i) (6-14542.1, 6-14542.2).

N 2491 (TC) Map C4

75 to present level. Roof of main chamber entirely broken away. In (a), remains of burial. On left side. Adult. In dotted space, a quantity of pottery, A, M, (i). Brick blocking (ii) built on [ed.: not filled in] of *radim*. Batter 21 [i.e., receding slope of wall?]. Wall 12 thick.

N 2492 (TC) Map C4

30 W of N. 245 deep. 75 high. Lower part of burial in chamber. Head been on left side, head northwest. No trace of coffin. Pit must have been constructed before chamber of *moghar*, as roof of *moghar* chamber came above level of floor of pit chamber. [ed.: According to Hearst Museum records, 6-14549 (bone chisel) is from this burial.]

N 2493 (TC) Map C4

110 high. 360 deep from present level. Contained nothing. [ed.: According to Hearst Museum records, 6-14543 (jar), 6-14544 (broken jar), 6-14545 (broken jar) and 6-14546 (cup) are labeled as potentially from this burial.]

N 2494 (TC; ~~MM~~) Map C4

Coptic. Shallow grave running east-west. Contained only a few bones.

N 2495 (TC; ~~MM~~) Map C4

Coptic. Shallow grave running east-west. Contained nothing.

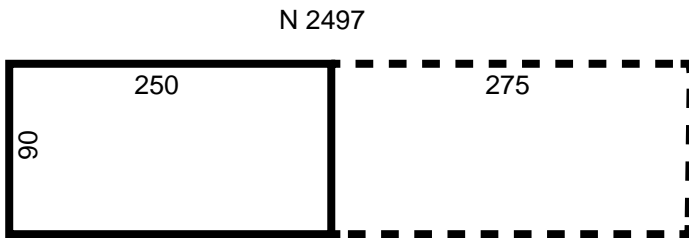
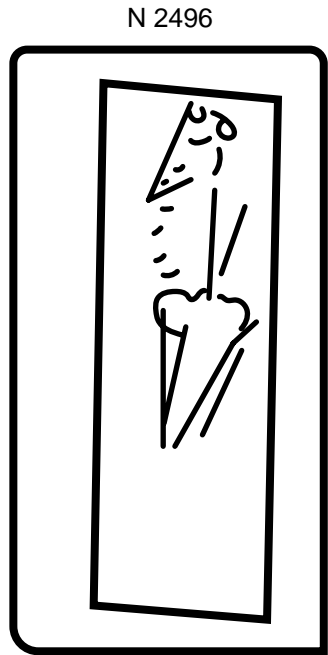
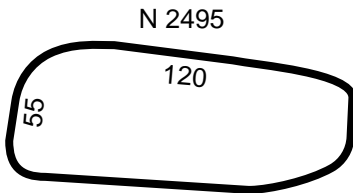
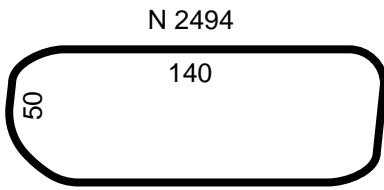
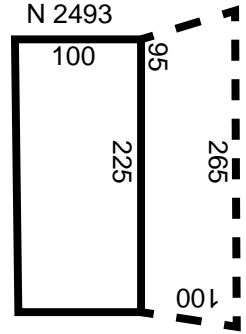
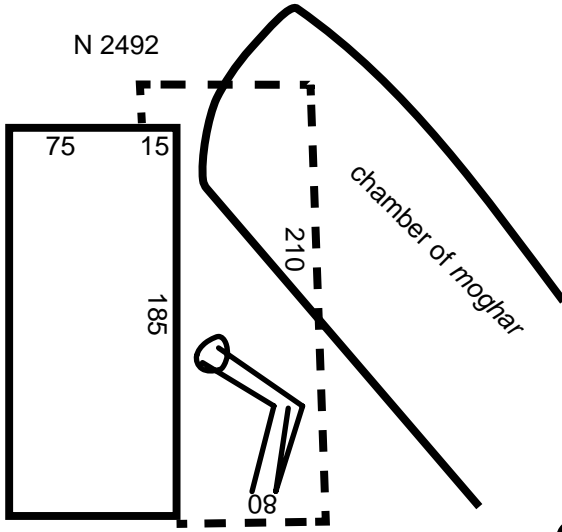

N 2496 (TC) Map C4 (red)

120 down from present level. Male adult. Knees 52 from end of coffin. Body completely wrapped up in cloth (not bandages). Bones in relative position to one another, but whole body twisted and distorted into a position impossible without dislocating joints. Right shoulder over face, humerus straight down, and lower arm bones up at right angles. Left shoulder below chin, humerus straight, ulna and radius bent straight back. Pelvis bones twisted apart. Balls of femurs still in sockets of ilia. Lower leg bones bent straight back to pelvis, but left tibia out of place. Two of the middle vertebrae forced right out of the spinal column. Lower jaw bone resting against side of face, standing upright. This was not a cut up burial, as all evidence pointed to twisting the complete body, rather than to recomposing a cut-up body. Either body was deliberately distorted before burial, or else was reburied here while bones were still more or less holding together. Inside measurement of coffin 135 × 35 × ? Thickness of wood 3. Corners as usual.

N 2497 (TC) Map C4

50 E. 450 deep. 130 high. Contained nothing. Remains of bricks above pit, probably from a superstructure, but all fallen out of position.

N 2498 (TC) Map C4; photo C 7705

General direction 55 W. All small chambers were plundered out. In main chamber and outside door, quantity of pottery A (i).

N 2499 (TC) Map C4

Coptic. Contained nothing.

N 2500 (TC; MM) Map C4

Copt. Adult. (Male. 166 cm high.) S. On back, arms by side. [ed.: No image.]

N 2501 (1) Map N/A [ed.: This record is Reisner's note of preliminary work that was done in 1901.]

Hole in hillside south, walled-up door in wall. Scarab (i), alabaster (ii) (6-12501), rubbing stone kohl bits (iii).

N 2501 (2) (TC) Map C4; photo C 8546

Burial in a plundered [state]; position of bones approximate. Adult male. All roof of main chamber gone. Door of d had been blocked with large stones. In doorway, quantity of pottery, Coptic (i). Brick at door 115 high to stone. Lintel

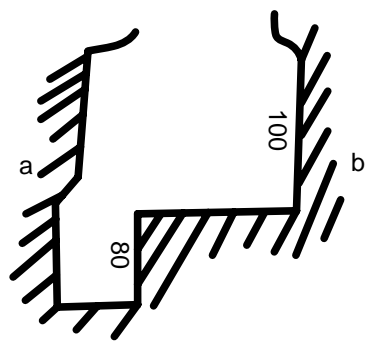
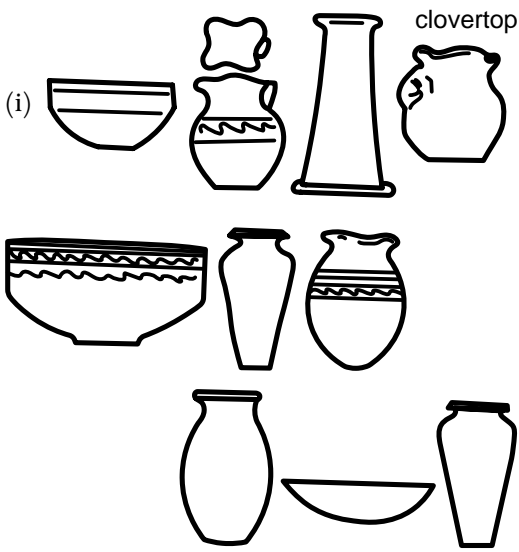
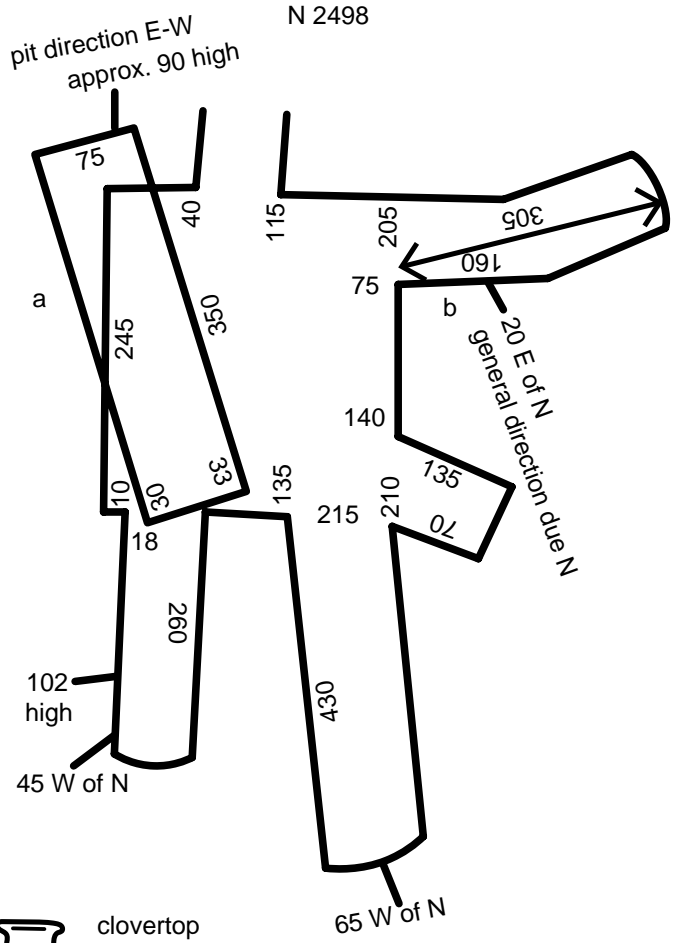

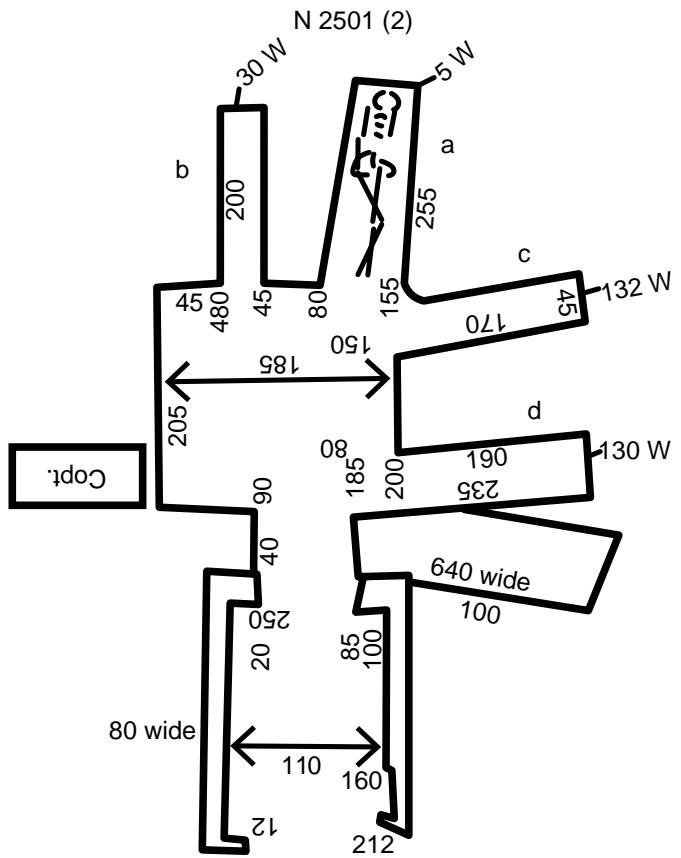
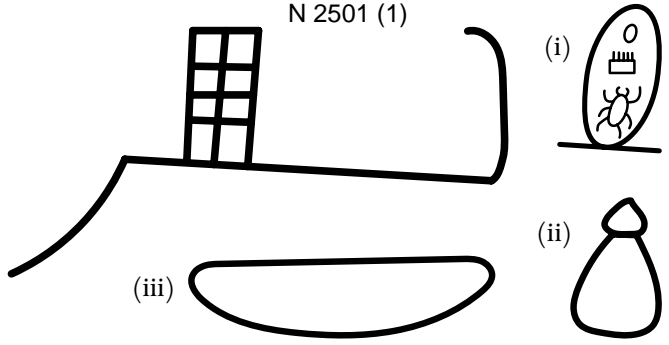
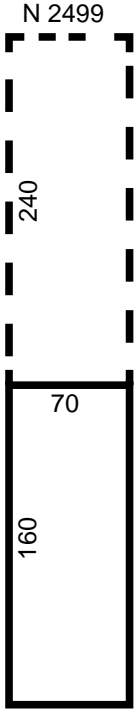

N 2503

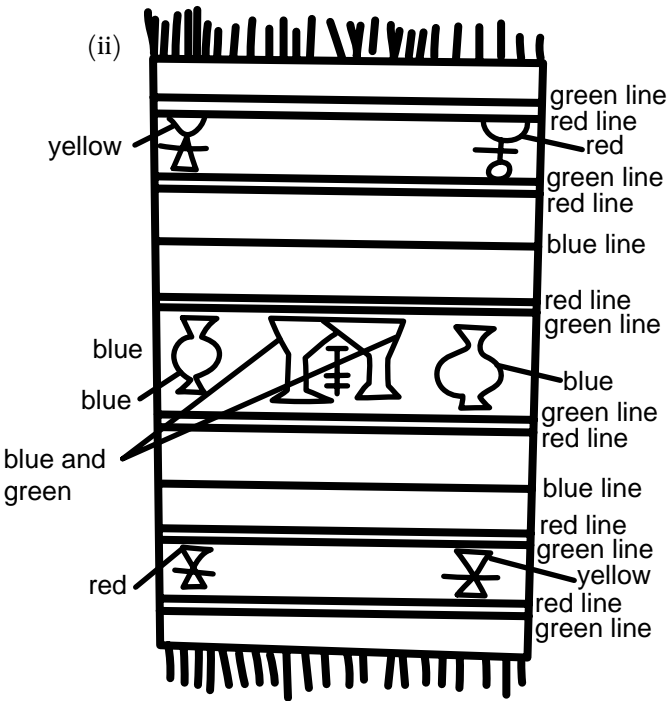
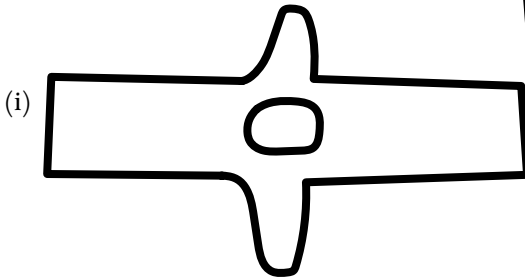

N 2504

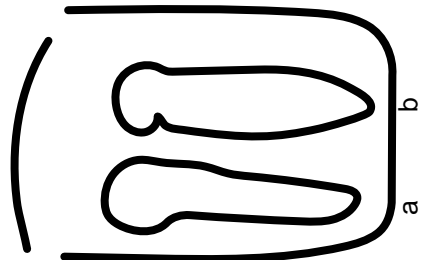

32 wide, 16 thick. This lintel was cut flat on underside in upper left rough. Side walls to top of lintel at south, 50 high from *gebel* level at north. This made the top of the wall level right along.

N 2502 (TC; MM) Map C3 (red)

Coptic burial. Double burial in the doorway of a Dynasty 6–9 tomb, At entrance to 2501. a. (Adult male. Height of man 154.5 cm.) S. On back, head west. b. (Child aged about 2. Bronze bracelet on right wrist.) S. [ed.: No image.]

N 2503 (TC; MM) Map C4

Copt. Shallow grave running east-west. Adult male. On back, head west. Quantity of long, dark brown, curly hair. (164 cm high. Hair 14 cm.) S. The body was clothed in a plain shirt of rather finer cloth [ed.: than the wrappings]. This shirt was apparently made of 2 pieces as there was a double corded border at each side that ran down sleeves (i). None of the borders were sewn together, but may have been originally and threads rotted. Under the body, there were 2 sticks, 1 of acacia, and the other of tamarisk [ed.: in TC: atl]. The innermost wrapping was a shawl of coarse cloth. Next above, there was a small shawl, 60 cm by 40, folded up and placed on the face as a protecting pad. End fringed, with ornamentation in green, red, blue, and yellow wool (ii). This ornamentation only showed on one side and was worked under and over alternate threads either of wrap or woof. Outside, there was a wrapping shawl of sackcloth.

N 2504 (TC; MM) Map D4 (red); photo C 8475

Shallow grave running east-west containing the burials of 2 Coptic children, both aged approx. 3. a. On back, head west, arms by side. Skull gone. Round neck, a string of glass beads of different various colors on linen cord. On left arm (?), a small iron bracelet. The cloth was in bad condition. There had apparently been 2 shirts, both with tapestry-woven designs in colored wool. The outer wrapping was of coarse cloth. b. On back, head west, arms by side. The body was clothed in 2 (?) shirts, decorated with tapestry-woven designs. Over the head, there was a net hood or cap covered with a piece of fine decorated cloth. This latter may have been part of an inner wrapping shawl. On the body, there was a quantity of salt, and underneath it, there were 2 palm sticks outside all wrappings. There was apparently only a single wrapping shawl of green (?) cloth with occasional inwoven bands of black and run round with cords.

(i)

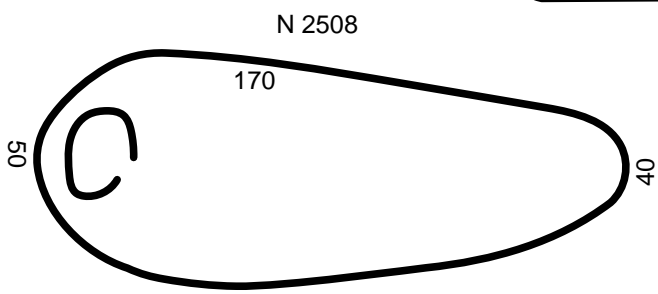
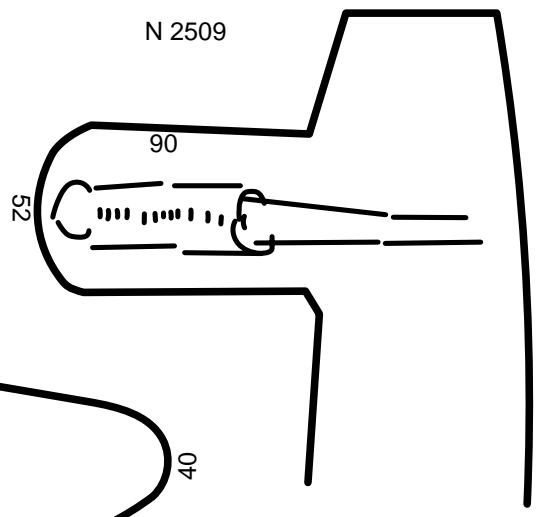
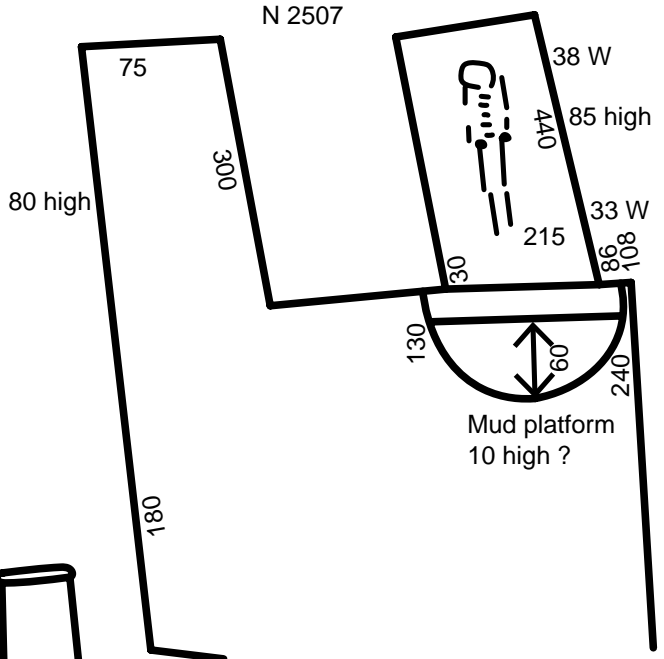

N 2505 (TC; MM) Map D4

Copt. Shallow grave running east-west. (Female aged 19–20. 153 cm in height. Iron bracelets on both arms, and by the head, much corroded bronze earrings.) S. No cloth preserved. [ed.: No image.]

N 2506 (TC; MM) Map D4; photo C 8478

(? = 2509 of Smith's) Copt. Shallow grave running east-west. Girl aged approx. 9. On back, arms by side. 2 bronze bracelets on left arm and 1 on right, each came above the elbows. Bronze rings on the right hand. Round neck, glass, shell, and amber (?) beads. Remains of bronze earrings with glass bead pendants. [ed.: No image.]

N 2507 (TC) Map C5; photos B 8076, B 8428, C 7466, C 7770, C 8522

Roof broken away. East chamber blocking a painted stela (6-14553), which projected slightly into main chamber and built in with mud and rough stones. Man red, [animal] skin yellow, inscription red (i), wife yellow, offerings red and yellow, borders alternate red, yellow, and black (?). Upper register of stela worn off. On wood at each side of stela, scratched marks: possible meant for hieroglyphs. Behind stela, blocking of rough stones and mud with a second mud facing. Behind this, blocking went in 200. Male? Burial on back. Traces of wood from coffin. Bones in very bad condition. In main chamber, quantity of pottery (ii) (6-12502).

N 2508 (TC; MM) Map D4 (red)

100 down. Copt. Shallow grave running east-west. Adult male. On back, head west, arms by side. Cloth in very bad condition, but traces of 2 shawls left, the outer being of sackcloth and the inner of finer cloth. 2 or more palm sticks under body.

N 2509 (TC; MM) Map C4

90 down. Copt. Shallow grave running east-west, east end projecting over Dynasty 6–9 grave. Adult male. On back, head west, arms by side. Lowest vertebra joined to sacrum. At either side of body, not underneath, a stick of sesban. Very little cloth remaining.

N 2510 (TC; MM) Map D4

Coptic grave. Burial gone. [ed.: No image.]

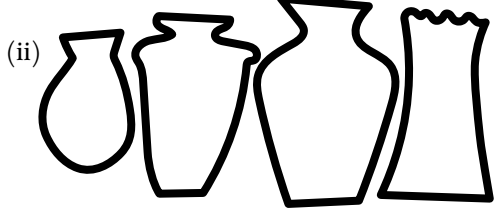
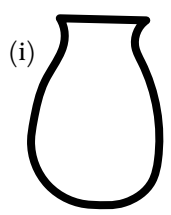
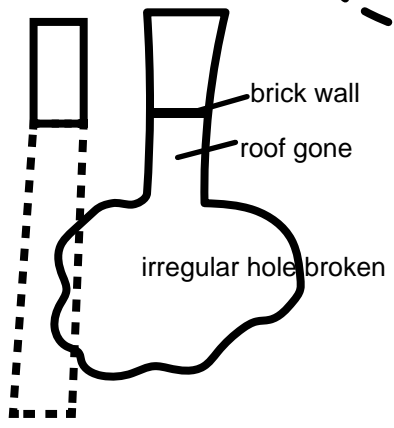
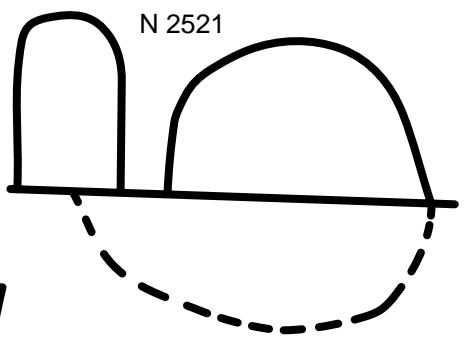
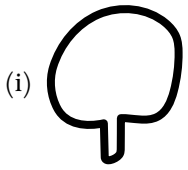
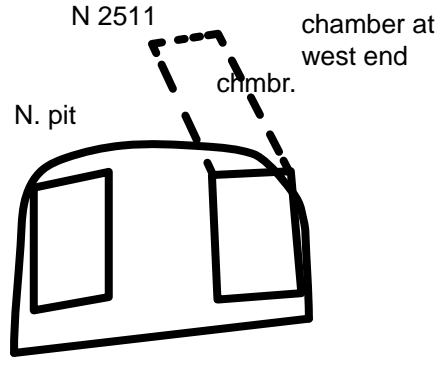
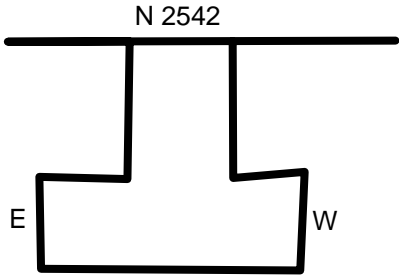

N 2511 Map N/A [ed.: This record is Reisner's note of preliminary work that was done in 1901. For this tomb on a map, see Reisner (1932, Fig. 1)]; photos C 2112, C 2113

Wednesday. Ahmed [el-]Mizlif Ismain [illegible]. Open hillside cave—two pits. Cont[ained] acct. coffin. ME [i.e., Middle Kingdom] joins. Wooden sandals on top. Photo. Flash.

N 2511 (TC; MM) Map D4

Coptic grave. No burial. [ed.: No image.]

N 2512 and N 2513 (TC; MM) Map D4

do. do. [i.e., ditto. ditto.] [ed.: No image.]

N 2514 (TC) Map D4

Shallow grave. Copt or possibly Egyptian. [ed.: No image.]

N 2521 Map N/A [ed.: This record is Reisner's note of preliminary work that was done in 1901.]

Tuesday. Hasan Hasib-en-nebi. Pots in *ghadim* of irregular hole, alabaster beads, and turtle bones. (i) thrown ware, smoothed, painted red (i), ditto (ii). Glazed stone (iii). Carnelian (iv). [ed.: According to Hearst Museum records, 6-12503 (beads) is from this burial.]

N 2522 = N 2446 (TC)

N 2531 of Green's = N 2477 (TC)

N 2542 Map N/A [ed.: This record is Reisner's note of preliminary work that was done in 1901.]

Abu'l Hasa[n] [ed.: Osman]. 2 burials. Head to north. Near head of east burial, bronze mirror (i). Also staff, red pot[tery] bowl, and rough brown ware.

N 2610 (TC; MM) Map D3

Coptic burial. Shallow grave running east-west. Adult female. (139.5 m high. Preserved with salty substance. Prognathous. Flat nose. All soft parts preserved. Eyebrows, etc. in position.) S. The body was clothed in a plain linen shirt. Outside this, there was a quantity of salt. The first wrapping shawl was of fine cloth, square with 2 sides fringed, 2 sides corded, covered with narrow inwoven lines of color, not wool. The second was of sackcloth and bound with cords.

N 2610

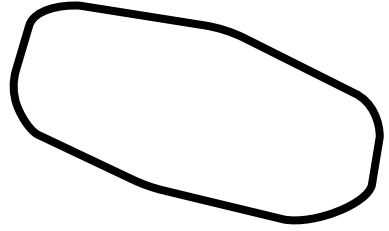

N 2611

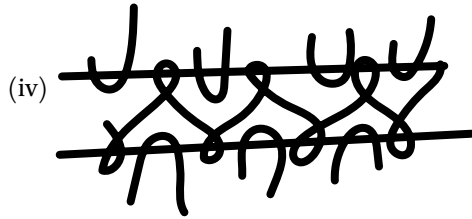
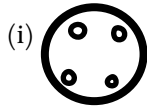
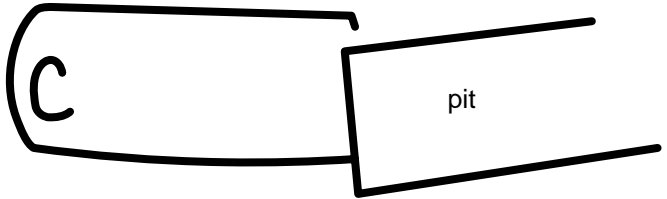

N 2612

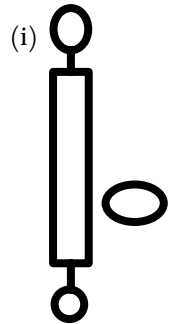
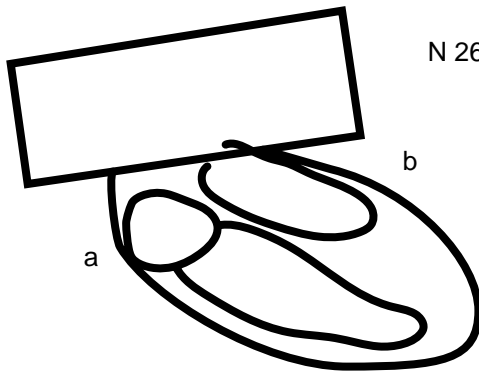

N 2611 (TC; MM) Map D3 (red); photo C 8476

Shallow grave running east-west. Coptic child aged approx. 8. On back, head west. Round neck, string of colored glass beads, dark blue, green, yellow, and resin colored. These were strung on cloth irregularly with a few plain shells being mixed with them. By left ear, bronze disc with 4 holes (i) apparently not strung with beads. On right arm, iron bracelet. On left arm above elbow, 2 bone bracelets. On left wrist, a bronze bracelet (ii). On left hand, bronze ring (iii). Over the body, there was a single shirt decorated with tapestry-woven designs in colored wool. At the bottom, there was an applied band of blue. This shirt was made up of two pieces of cloth, a straight join coming at the waist. Over the head, there was a pad of extra cloth consisting of a shawl of very fine mesh, 38 cm wide. On the left side of the body, not underneath, next to shirt, there were 3 palm sticks tied together. The first wrapping shawl was of fine cloth with occasional inwoven double lines of green thread. This entirely covered body? Went over head at any rate. Outside this, there was a shawl of sackcloth with fringed edges and bands of tapestry-woven designs of wools at either end. The binding cords were of type 4 (iv). Tied first with horizontal bindings of 2-strand cord. Then with 2 vertical bindings of 2 cords each fastened together in middle and round back.

N 2612 (TC; MM) Map D3

Coptic burials. Shallow grave running east-west, west end projecting over early pit. Contained 2 burials. a. Adult. Sex? On back, head west. Quantity of dark, curly hair. The body was clothed in a single shirt decorated with tapestry-woven designs in colored wool. The arms were not in the sleeves. Over the face, there was a quantity of extra padding. First came a square of cloth with colored wool decoration (i). Above this, there was an old decorated shirt with patterns in colored wools rolled up inside a piece of coarse cloth. By feet, cap or ? with fringed edge. Under the body, there were 2 palm sticks. The number of wrapping shawls could not be ascertained. b. Adult Sex? On back. Upper part of body had broken away and fallen into the early pit. There were 2 shirts on the body. Of the under one, remains of the bottom of the shirt reaching to knees. Round bottom, blue band similar to that on other shirt, but with a different pattern. Remains of elaborate wool ornamentation inside. The upper one was worn inside out. Width at bottom was about 90. Round bottom, an extra applied band of blue cloth with yellow patterning was sewn 4.2 wide. On each side of front and back of shirt, there was a medallion of colored wools 11 from bottom, 16 from sides. Edges of shirt were cord-bordered. On medallion, 2 dancing figures and cherubs above. All upper part of shirt was gone with exception of end of one sleeve with sewn edges. This had a narrow band

N 2613

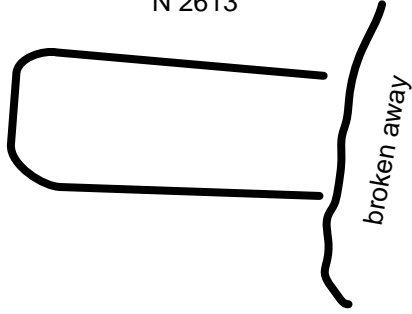

(i)

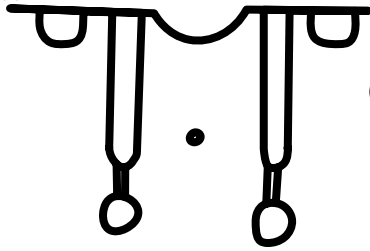

(iii)

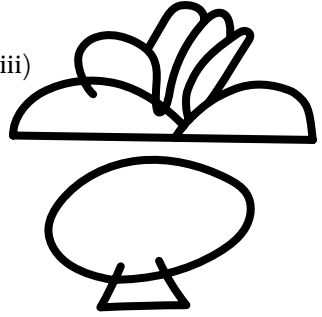

(ii)



N 2615

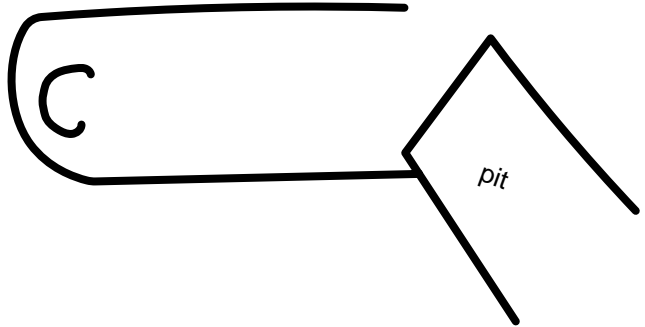

of colored cloth near bottom and a wider band higher up. This shirt reached to halfway down tibia. Beneath the body, between inner wrapping and shirt, there were 2 sticks of sesban. Outside the shirts, a cord was tied round the body at the level of the knees and knotted in front, possibly to keep the shirts from rucking up during the wrapping. The inner wrapping consisted of an old shirt of finer material with a medallion of red cloth by feet with interior medallion of colored wools. Above, there was a shawl of rough cloth, wrapped once round, ends overlapping, and tied round with cords.

N 2613 (TC; MM) Map D3; photo C 7060

Coptic burial. Shallow grave running east-west. Head west. Adult. Sex? [ed.: Tomb card reads "female."] There was 1 shirt on the body of usual pattern made from a single piece of cloth. Apparently, cut from a shawl with fringed edge, as on both sides, edges were fringed and corded as well. Round neck, there was a narrow band of applied cloth, dark blue or mauve with patterning in yellow. Similar band round skirt. Over shoulders, usual pattern of embroidery (i). Floral designs in red, yellow, green, and blue between borders of (ii). Round sleeves, double bands of similar work. Remains of outer shawl with (iii) designs at intervals in red, yellow, and shades of blue, and green, and pink wools. Occasionally, several strands of the woof were not cut away, but were left at the back. The body was wrapped in 2 or more shawls, the outer one of fine cloth, being decorated with tapestry-woven floral designs in colored wools.

N 2614 (TC) Map D4; photo C 7075

Copt. (Female. No head. Feet and hands exceptionally well preserved.) S. [ed.: No image.]

N 2615 (TC; MM) Map D3

Coptic burial. Shallow grave running east-west, east end projecting over early pit. Adult female. On back, head west. Remains of a single shirt, apparently plain. On the body, there was a quantity of salt and a few dried fruits [ed.: on TC: "a few plant seeds"], and under it, 4 palm sticks. There were 2 or possibly 3 wrapping shawls of sackcloth. Traces only of the 2-strand fiber binding cords remained and of an outer covering of fine yellow cloth. In the bottom of the grave, underneath the body, there were a number of dried palm leaves, 2 tied together at head.

N 2616

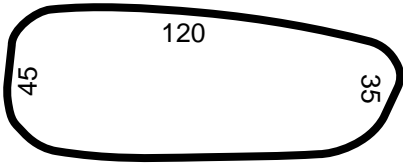

N 2617

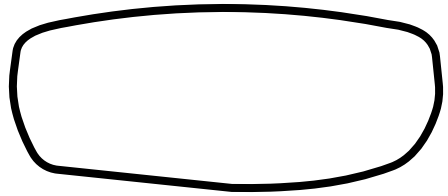

N 2630

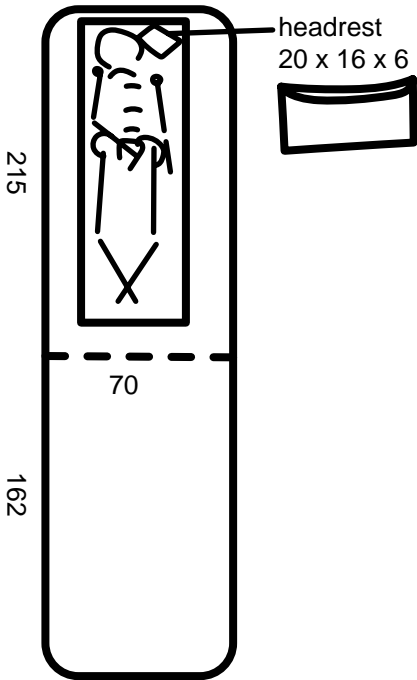

N 2619

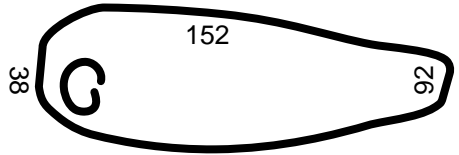

N 2618

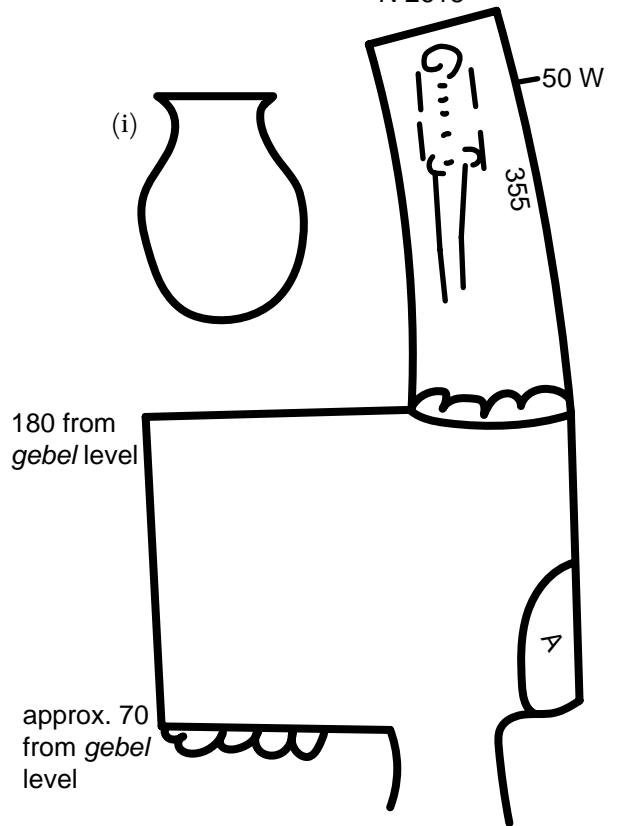

N 2616 (TC; MM) Map D3; photo C 7071

95 down. Copt. Shallow grave running east-west. (Girl aged approx. 5.) S. (Skull 12-4893 [ed.: According to Hearst Museum records, the skull belongs to a male.]) (Bronze bracelets on both wrists. Earrings [material?] still attached to ears. Lower opening of the intestine was patent, and the intestine had been stuffed with preservative material.) S. The body was clothed in a single shirt. Edge turned over at neck. On the left ulder of it, a knot of cloth was sewn as a button. Down each breast and running over shoulder and an equal distance down back (?), a band of openwork wool ornamentation almost all gone. Sleeves with bands of openwork round wrist. There were 2 wrapping shawls, 1 of ordinary cloth with fringed edges and bands of colored wool at either end, the other of sackcloth.

N 2617 (TC; MM) Map D3

Coptic grave. Shallow grave running east-west. (Female aged approx. 18. 1.47 m high. Bronze bracelet on left arm at elbow.) S.

N 2618 (TC) Map D5; photos C 8193, C 8520, C 8545, C 8594

85 high. Chamber had been approx. 120 high. Roof almost all gone. In large chamber, small gold bird amulet (6-14547). Within space A, 12 pots all of one type (i). In front of chamber, another. On south side, built up with rough stones to 70 above *gebel* level, starting on *gebel* level. Chamber blocked with rough stones, faced with mud. On facing, rough scratchings, apparently only "fantasia." This blocking went in a distance of 180. Adult. Male? Burial on back. Traces of wood from coffin. Bones in very bad condition.

N 2619 (TC; MM) Map D4

80 deep. Copt. Shallow grave running east-west. Adult. Sex? Head west. Only 2 teeth preserved in upper jaw, more in lower. Remains of short, brown hair. Cloth in very bad condition. Had been wrapped first in sackcloth with cloth underneath. Under body, 2 or more palm sticks.

N 2630 (TC) Map N/A [ed.: Tomb not on map, and map location not listed in excavation records.]

125 below *gebel*. 80 high. Female. Chamber cutting through chamber of adjoining tomb. Coffin placed on top of earlier coffin. Bones somewhat fallen apart. Left leg fallen over right. 1 rib broken and joined anciently. Inside measurement of coffin 170 × 3 × 36. Thickness of wood 3.5. Corners as usual. White paint outside and in. Red rim. Lid 5.5 thick. 2 battens under lid. 3 under coffin. Headrest 20 × 16 × 6.

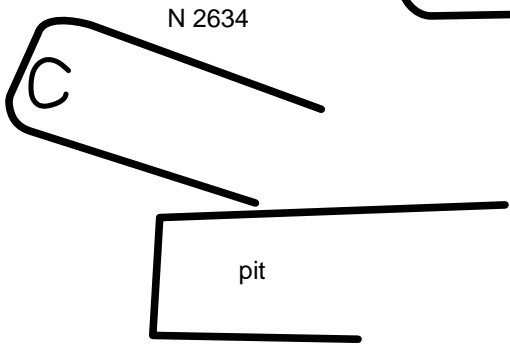
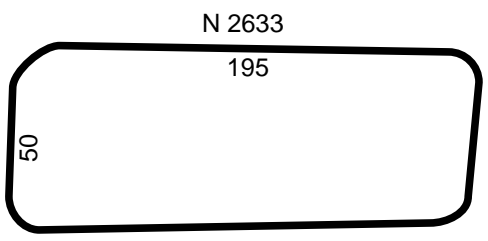
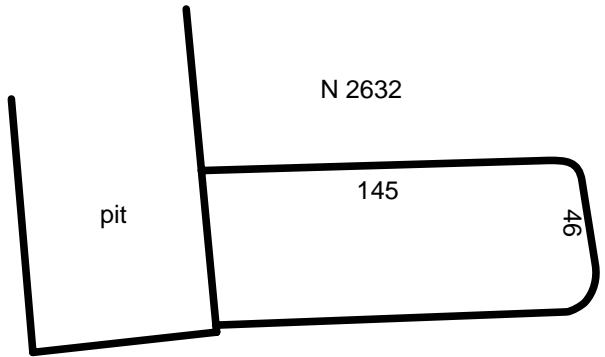
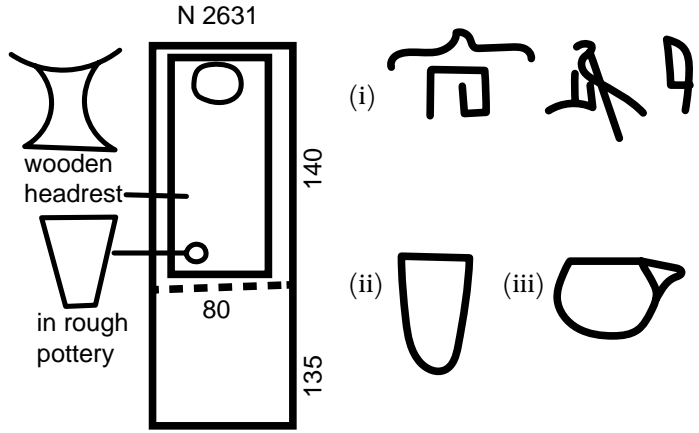

N 2631 (TC; MM) Map E4; photo C 7156

120 from *gebel*. 80 high. Reuse of an inscribed coffin. Corners as usual. White paint inside, yellow outside. Inscribed coffin of (i). 185 × 54 × 52. 4 thick. Lid broken, and Coptic burial placed inside, pieces of lid being afterwards placed carelessly on top. Original burial scattered in bottom of coffin. Adult. Sex? On back, head north. All back teeth in lower jaw gone. (Skull 12-4894 [ed.: According to Hearst Museum records, the skull belongs to a male.]) Details of the clothing could not be determined. Remains of a wrapping shawl of sackcloth pad over the face. This latter consisted of a linen cloth about 210 × 150 cm. At each corner of this cloth, there was a pattern of 5 large rosettes and 4 small ones in colored wools (green, red, blue, and yellow). Thread was first drawn in desired pattern, and then wool was worked in? Over feet, extra pad of odd pieces of cloth. Copt had been bound in sackcloth and tied round with many cross cords, but cloth had mostly decayed. Cord occasionally threaded through outer cloth. Under the body, there were 4 sticks of gotn? [ed.: i.e., cotton?]. In pit, 3 (ii) and 1 (iii). [ed.: According to Hearst Museum records, 6-12506 (headrest) is from this burial.]

N 2632 (TC; MM) Map D3

80 down. Copt. (Male.) S. Shallow grave running east-west. Adult male. On back, head west. The shirt had almost entirely disappeared. A finer cloth, over feet at any rate, apparently not a shirt. On the body, there was a quantity of salt, and underneath it, there were 4 palm sticks, originally tied together, 2 on each side, apparently inside sackcloth, but outside inner wrapping or shirt. The first wrapping shawl, or it may have been the second, was of sackcloth. Outside this, there was a second shawl of finer cloth with a tasseled edge and bands of woolwork at either end.

N 2633 (TC; MM) Map D3

About 80 down. Copt. Adult male. (161 cm high.) S. Shallow grave running east-west. Adult male. On back, head west. Remains of a plain shirt. On the body, a quantity of salt and 2 palm sticks underneath it, outside shirt and inside sackcloth. The innermost wrapping shawl was of fine cloth with corded end and a pattern of 6 stars of purple wool, apparently needleworked, at each corner. Outside this, there was a shawl of sackcloth.

N 2634 (TC; MM) Map D4

Copt. Shallow grave running east-west. (Female.) S. On back, head west. Remains of soft, dark brown hair. Remains of a shirt that was apparently unornamented. This was probably made in 1 piece. At each side, there were 2 corded edges sewn together in such a way that 1 cord was outside and the other in.

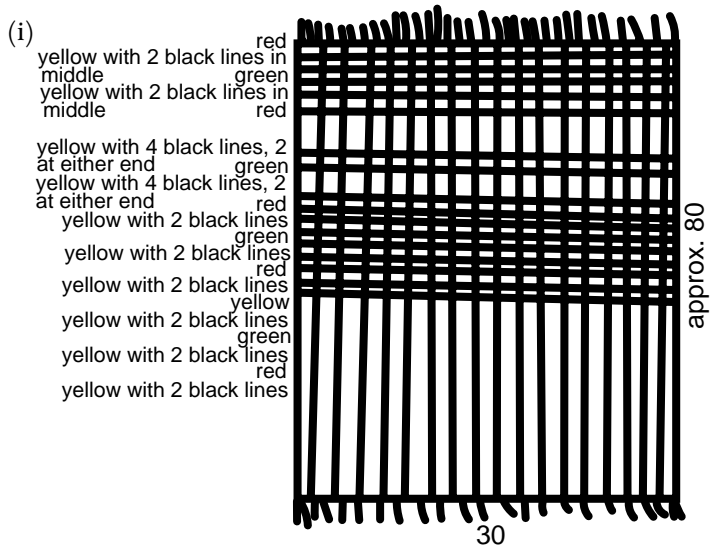
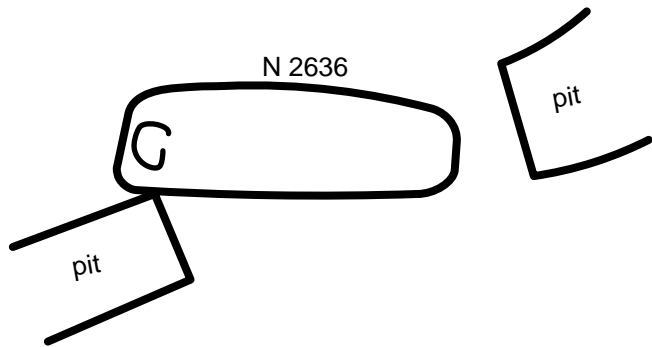
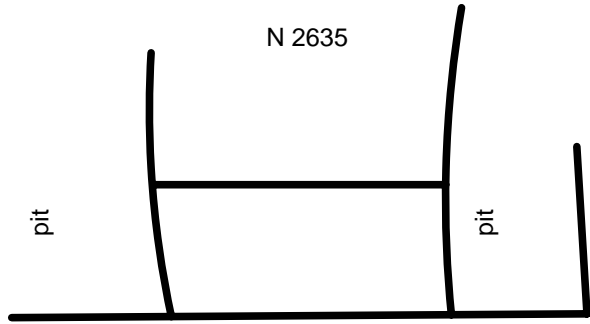

Sleeves and neck ? Over head, a mass of cloth rolled up. A quantity of salt on the body and underneath it, 2 palm sticks bound together on 1 side and 2? on the other. There were apparently 2 wrapping shawls of coarse cloth.

N 2635 (TC; MM) Map D3 [ed.: In tear on map, per pencil on map and excavation records.]; photo B 7027

Coptic burial. Shallow grave running east-west. Adult. (Male.) S. On back, head west. Remains of a shirt with corded edges. 1 sleeve remained with a pattern of black woolwork round wrist. 1 wrapping shawl of sackcloth.

N 2636 (TC; MM) Map D3; photos C 7028, C 8456, C 8457

Copt. Shallow grave running east-west. Female aged approx. 25. On back, head west, arms by side. Quantity of long, straight, dark brown hair. Round neck, a string of glass beads of different colors and shapes together with a few of green stone and a small Dyn. 18 scarab [ed.: on TC: "a small scarab of glazed pottery with a figure of Re? (Dyn. 18-19)"]. On left arm, above elbow, an iron bracelet. By right hand, a small glass bottle (MFA 47.1686). Folded into a bandage and tied tightly round the waist, next to the skin, there was a plaid shawl (i) of dark brown, yellow, red, and green, about 80 × 70 cm in size, with triple selvage, all in red. Narrow, vertical lines of black were all double, all in the warp. 1/3 from either end, a line of alternate red and yellow stitched to prevent unraveling. All the colors except the vertical black lines were in the woof. Ends left with fringe. The body was clothed in a single shirt (ii) made up of 2 pieces of cloth with a straight join at the waist. All upper part cut from 1 piece. Neck turned over and sewn. Sides and ends of sleeves corded. Bottom plain. The tapestry-woven decoration was of finer work than usual, the motifs of the designs being animal and human figures. Lines in black, background red (iii). Animals and figures in blue, green, and yellow wool. ? all inwoven. Or woof cut out, and wool sewn in. Rosettes on skirt (iv). Border of blue with plant decoration in yellow thread and green and red wool. Interior background red with yellow thread and blue and green wool decoration. Center circle blue with yellow thread decoration. Yellow thread was woof of original cloth. Other colors were worked in. Background in red thread (v). Patterns in green, blue, and yellow wool. All apparently worked on to warp. Sleeve sewn for 25 from bottom at any rate. At bottom of skirt, a strip of blue cloth with yellow thread decoration was sewn on. This was blue warp and woof. Yellow thread was added. The left arm was not in the sleeve, which was thrown back over the head. Over the face and head, there was a net veil or head shawl of mixed yellow linen and red and green wool. Covering this, there was a shawl of coarse cloth rolled up into a pad. On the body, there was a quantity of salt and mixed with the salt, there were a few

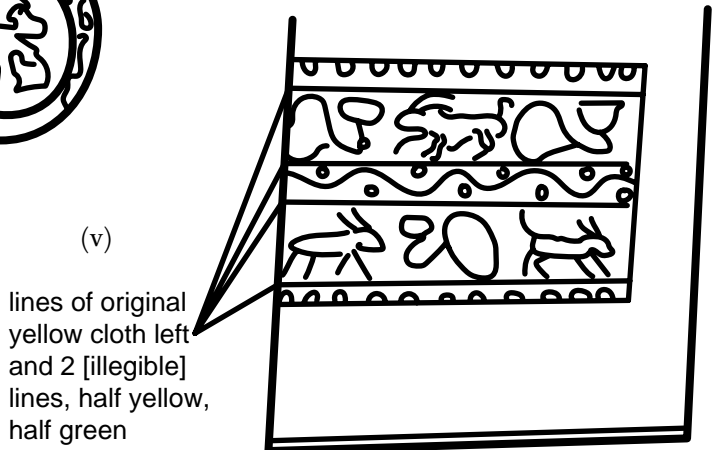
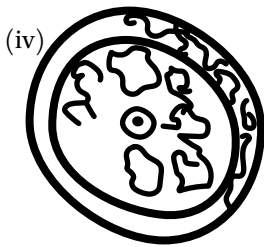
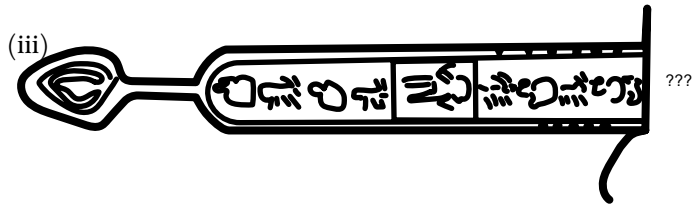
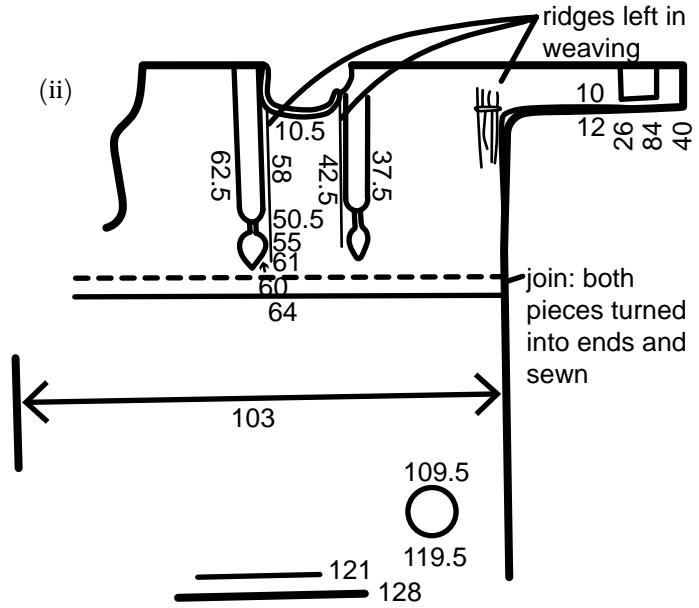

plant seeds and a date pit. Under the body, there were 2 sticks of palm and 1 of sesban. The first wrapping shawl was of yellow cloth with a narrow fringe and 6 lines of white thread insertion at head end, probably also at feet end. This was merely laid on top of the body. It completely covered body, excess at head being rolled up over face, 75 wide. Outside it, there was a shawl of very coarse cloth with fringed ends and bands of tapestry-woven woolwork at either end that was wrapped right round the body in the usual way, i.e., sides thrown over first and then ends. The type of cording could not be ascertained, but apparently tied with the usual horizontal and vertical cords. [ed.: According to Hearst Museum records, 6-12507 (headrest) is from this burial.]

N 2637 (TC; MM) Map D4 [ed.: Map location given in excavation records and in drawing; in tear on map.]

Coptic burial. Shallow grave running east-west. Adult male. On back, head west. Back teeth all gone. The body was clothed in a single shirt with corded edges and a small amount of ornamentation near neck in green cloth (inwoven) with yellow thread decoration. Over the face, there was a pad consisting of an old shirt rolled up into a ball. This had originally been very elaborately decorated with a rosette (i) with tapestry-woven designs (human figure motifs) in a mixture of red (R) and dark brown (B) thread and green (G) and yellow (Y) wool. Hands of figure and parts of beasts were outlined in dark blue. Background always red. Red and dark brown were inwoven. Other colors worked in in wool. Round head, remains of 2-strand fiber cord. Quantity of salt and a few plant seeds on body. Under the body, there was 1 palm stick and 1 of *shaum* that were tied together at the ends and had notches cut in them to hold the cords. The first wrapping shawl was of coarse cloth, possibly a shirt. Outside this, there were 2 of sackcloth. These were all folded over the body in the usual way. The cord bindings had almost entirely disappeared.

N 2638 (TC; MM) Map D4

Coptic burial. S. Shallow grave running east-west. On back, head west. Remains of a single shirt undecorated. There were 2 wrapping shawls, the inner being of coarse linen cloth with corded edge and the outer of sackcloth. Under the body, put between sackcloth and inner wrappings, 3 sticks (not palm). The method of binding was indistinguishable.

N 2639 (TC; MM) Map D3; photo C 7033

Coptic burial. Shallow grave running east-west. Adult. (Male. Long, brown, wavy hair. Abundant long, reddish, curly pubic hair. Short reddish beard.) S. On back, head west. Remains of 2 shirts with corded edges and elaborate

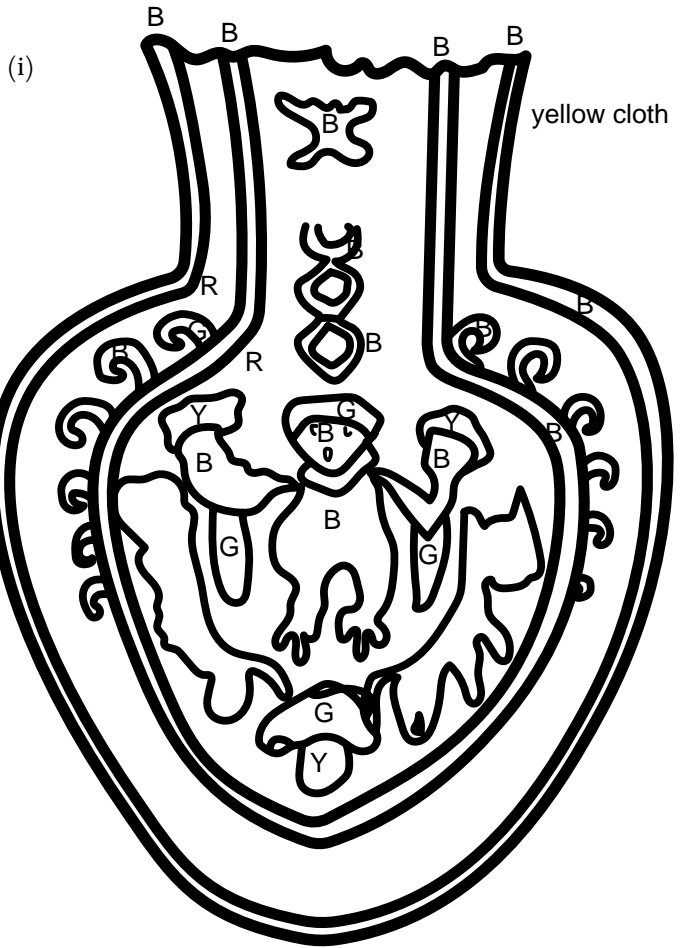
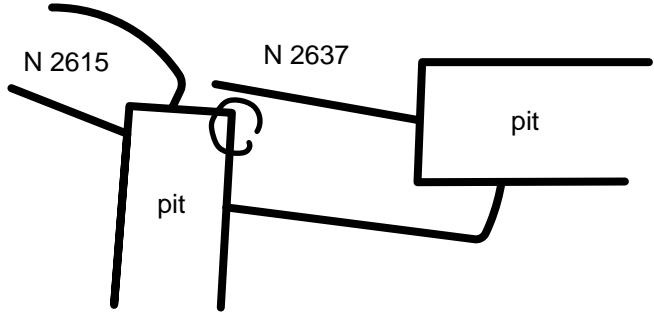

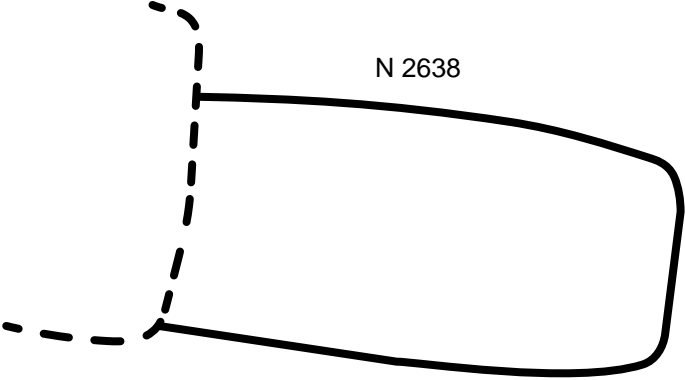

N 2638

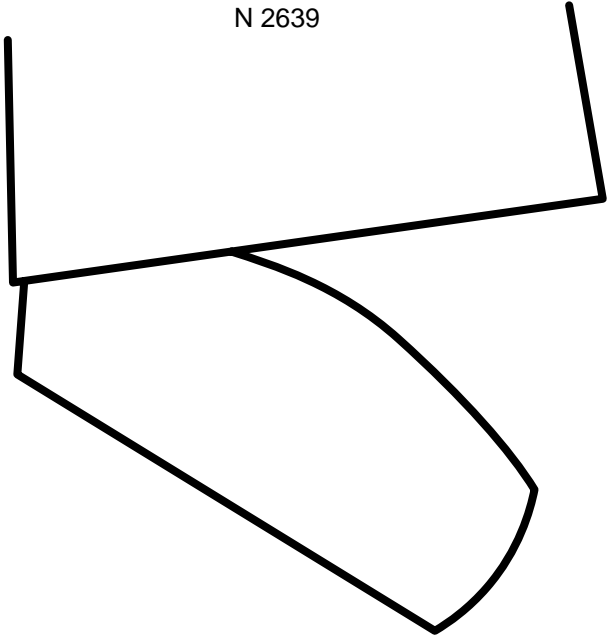

N 2639

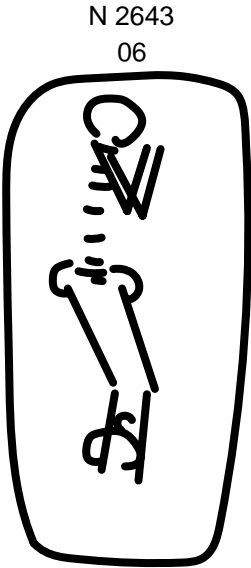

N 2643
06

295+

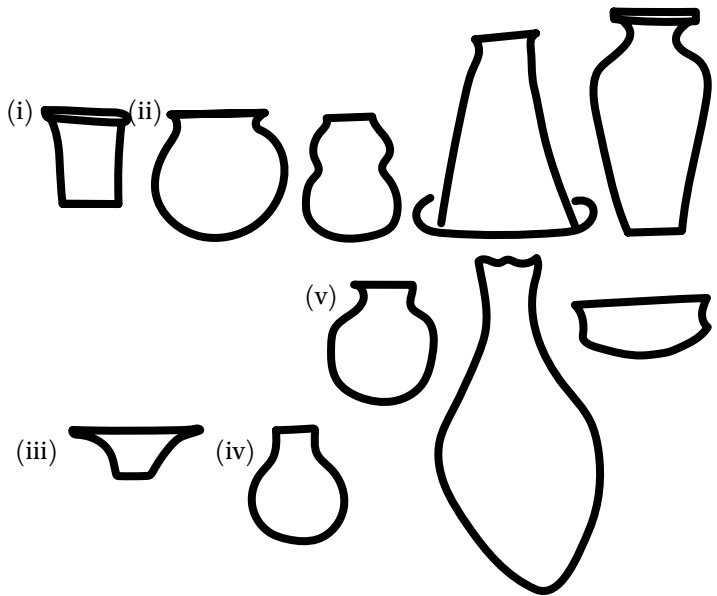
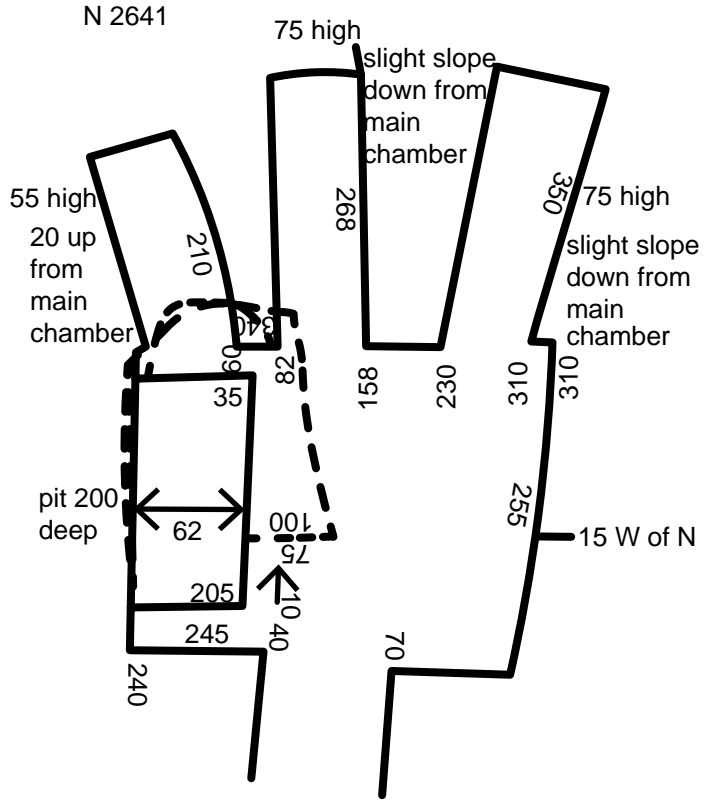

tapestry-woven decoration in colored wools. Only 1 wrapping shawl could be distinguished, a white one of fine linen with elaborate fringe. End extended considerably beyond feet and was turned back and wrapped round them. By feet, a twist of cord.

N 2640 = N 3747 in notebook (TC) Map C3 [ed.: N 3747 is in D3.]; photo C 8503 [ed.: No image.]

N 2641 (TC) Map C5 (red); photo B 8425

Pit 200 deep. Pit chamber exceedingly irregular. Had been filled with large desert boulders. In main chamber, a quantity of pottery: alabaster (i) (MFA 47.1652), different varieties of A (ii) (6-12508), M (iii). In smaller chamber, only a few broken bones. Outside doorway, several pots: drab (iv), (v).

N 2643 (TC) Map B4 (red)

100 to *gebel* level. Skull and remains of another burial over feet. On left side.

N 2644 (TC) Map B4 (red)

60 W of N. 140 deep to *gebel* level. Contained nothing.

N 2645 (TC) Map B4

Usual position. Head fallen into pit.

N 2646 (TC) Map B4

Shallow hole. Contained nothing.

N 2647 (TC) Map B4

Contained nothing.

N 2648 (TC) Map B4

47 E of N. 85 deep from present level. Coptic. Burial gone.

N 2649, N 2840 (TC) Map B4

110 E. 240 deep. 80 high. Upper part of burial in position. Head south.

N 2670 (TC) Map A3

Coptic. Contained nothing.

N 2671 (TC) Map B3

185 deep from present level. Originally pit and chamber. Contained nothing.

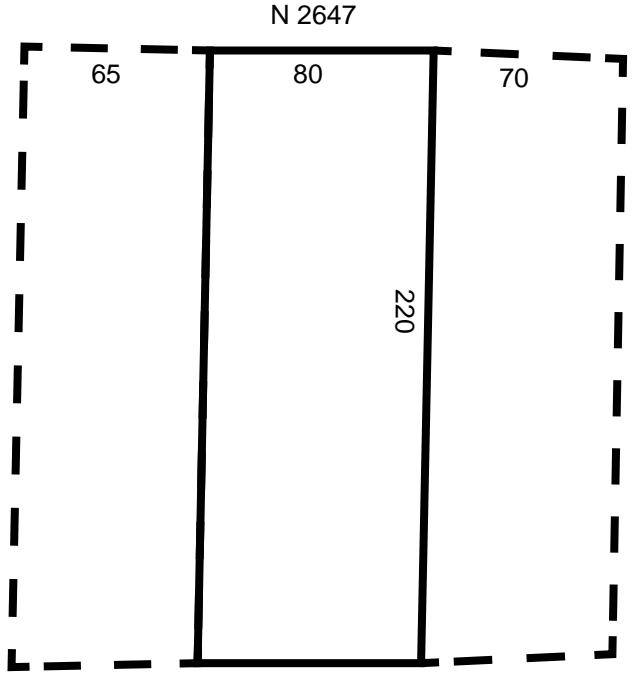
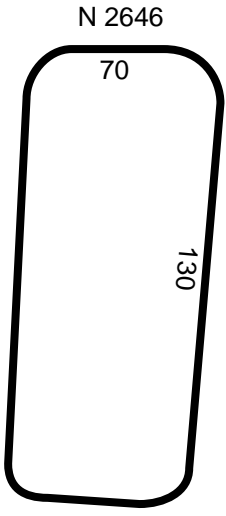
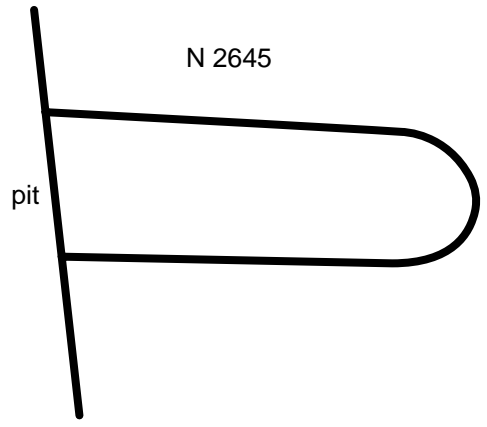
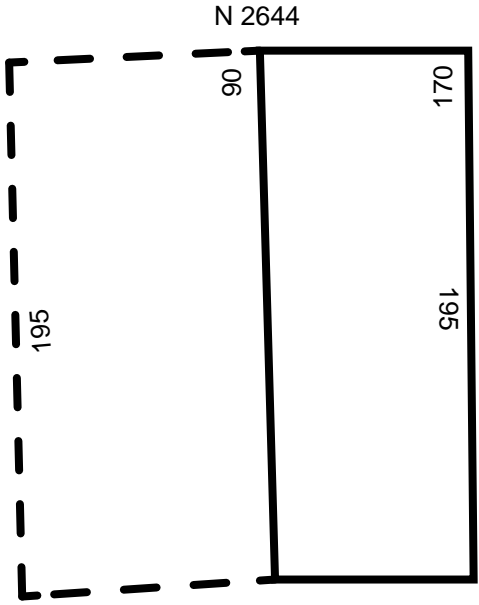

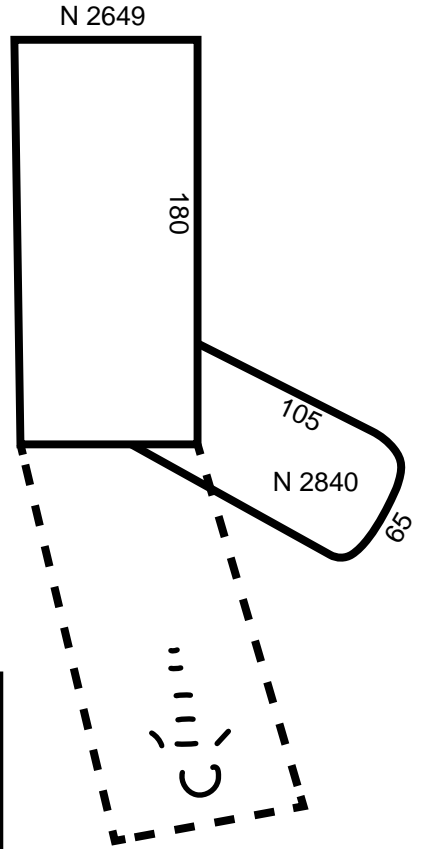
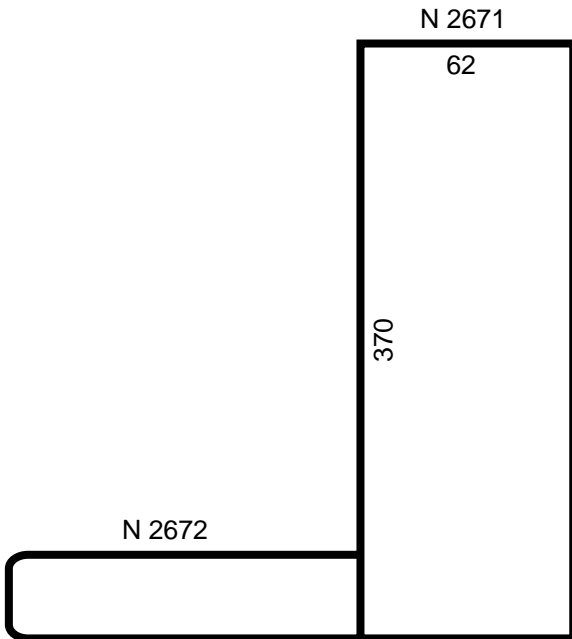
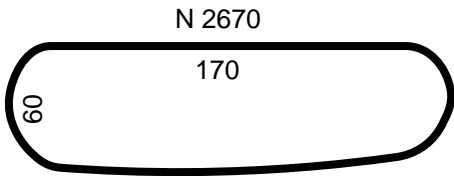

N 2673

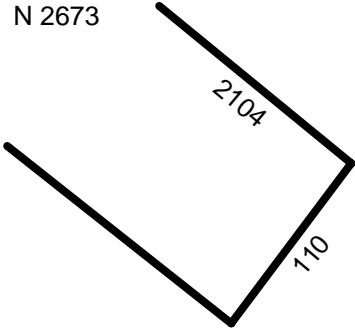

N 2674

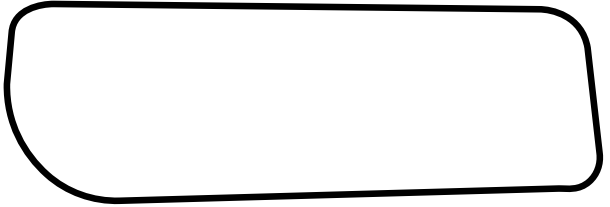

N 2678

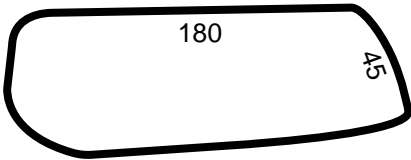

N 2675

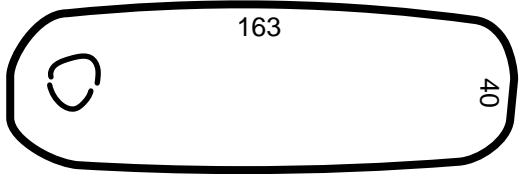

N 2676

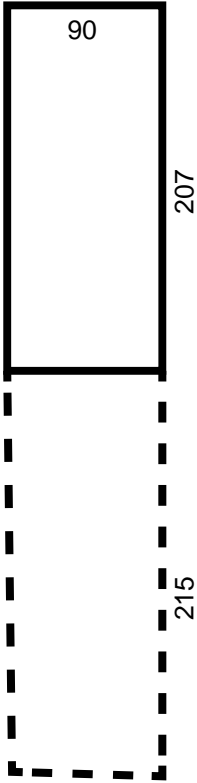

N 2677

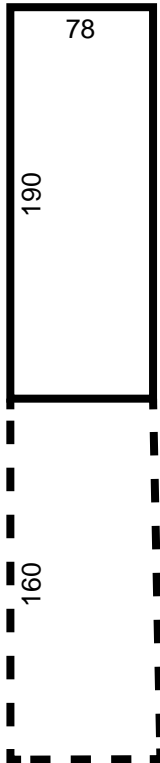

N 2679

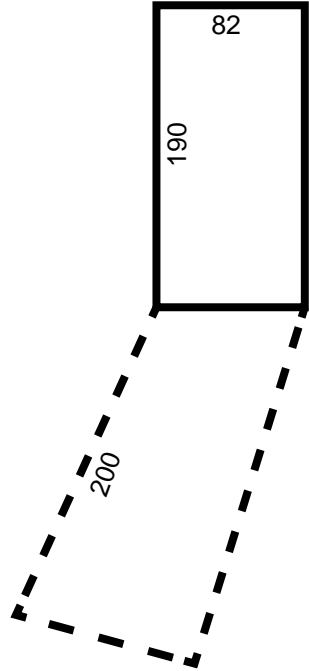

N 2672 (TC) Map B4
Copt?

N 2673 (TC) Map B3
Pit?

N 2674 (TC) Map B3
Copt? Contained nothing.

N 2675 (TC; MM) Map A3
110 W. Copt. Shallow grave running east-west. Child. Sex? On back, head west.

N 2676 (TC) Map B3
Phot. burial.

N 2677 (TC) Map B3
23 W. 340 deep. Contained nothing.

N 2678 (TC) Map B3
120 W. Copt. Contained nothing. Above, remains of an Arab "*kush*."

N 2679 (TC) Map B3
300+ deep. Contained nothing.

N 2690 (TC) Map N/A
Not a tomb. Numbered by mistake.

N 2691 (TC) Map C4
180 deep from present level. Roof almost all broken away. Contained nothing.

N 2692 (TC) Map C3
Burial of a very young child in a large coffin. On right side. Position of left arm doubtful. Remains of cloth by legs. Coffin put into grave on slant, north end being considerably lower than south. Inside measurement of coffin 175.5 × 32 × 42. Thickness of wood 5. Corners as usual. At a height of 60 in middle from top of coffin, there seems to have been a kind of arched covering of mud. The top of this in middle was 60 deep from present level. Outside bottom would have come about 80 from coffin on each side. May have no connection with coffin.

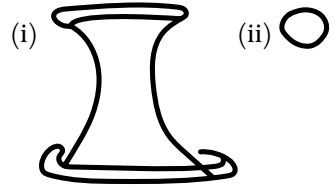
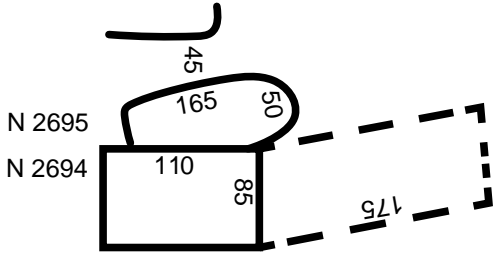
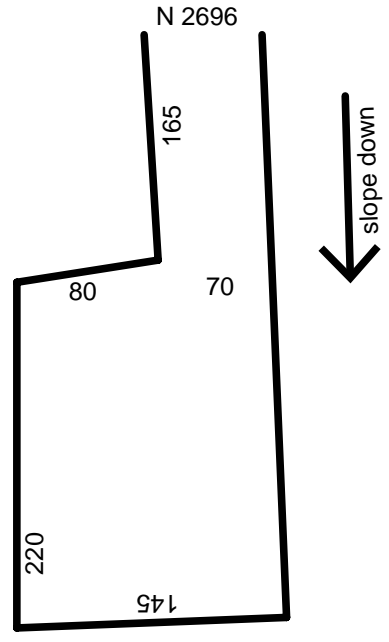
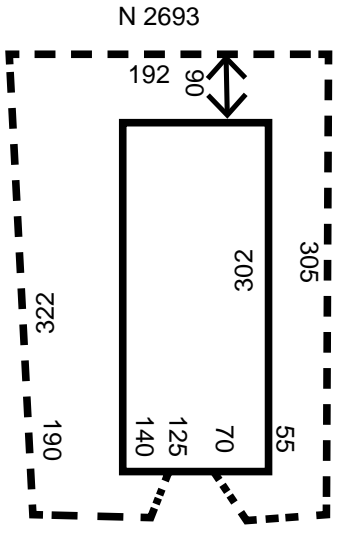
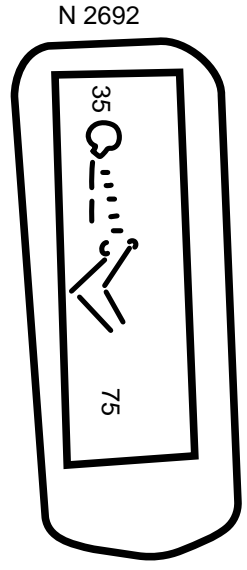
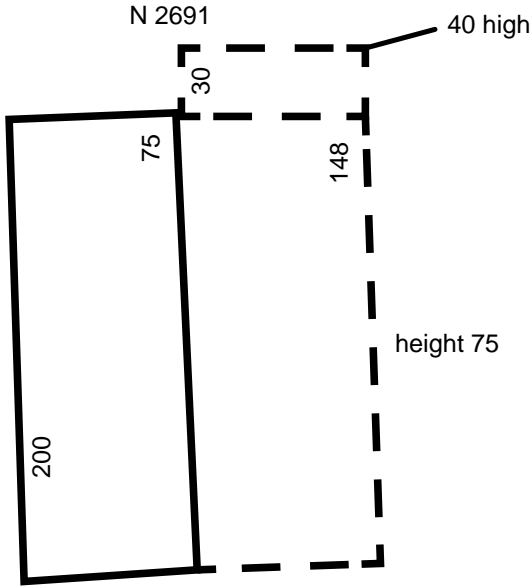

N 2693 (TC) Map C4

295 deep. Height of chamber 75? Broken away. Contained nothing.

N 2694, N 2695 (TC) Map C4, C3

72 E of N. Contained nothing. 2695 Coptic. No burial left.

N 2696 (TC) Map C4

115 high. Approx. 230 to *gebel* level. Contained fragments of pottery M, and (i), and 1 carnelian (ii) bead.

N 2697 (TC) Map B4

60 W of N. 250 deep from present level. Contained nothing.

N 2698 (TC) Map B4

Coptic. Burial gone.

N 2699 (TC) Map B4

60 deep. Remains of a wooden coffin. On east side, space between coffin and side of grave filled with thin stone slabs (not worked). Plundered out.

N 2700 (TC; MM) Map D4 (red)

80 down. Copt. Shallow grave running east-west. Adult female. On back, head west. Long, wavy hair. The body was clothed in a single shirt with tapestry-woven designs in colored wools. Round neck and sleeves, a band of blue sewn on, 4 wide, with yellow decoration (i). Round bottom of skirt, band of blue with yellow decoration, 14 wide (floral patterns). Down front and back, 2 panels. Border blue with green patterns. Main part red with figure designs in blue, green, and yellow. In one place, panel mended with red wool. Similar band round sleeves. Outside the shirt, round the waist, there was a cloth bandage folded to a width of 4.5 cm. Under the body, inside wrappings, outside shirt, there were 4 palm sticks. The body was enveloped in no fewer than 6 wrapping shawls. The innermost one was of fine, wide-meshed black cloth. Next above that came a similar shawl of yellow cloth. Next, there were 3 shawls of ordinary coarse, white cloth, and on the outside of all came a fine, wide-meshed shawl of a reddish color. Reddish cloth had a border of 10 lines of white near ends. Black cloth had similar yellow lines and a strengthening cord of threads down sides. Yellow cloth had tasselled ends and similar lines. Black cloth was 54 wide. 1 of the 2 ordinary shawls had 3 lines of inwoven red near ends with a line of green in the middle of each. All these coverings completely covered the body. The method of binding could not be distinguished.

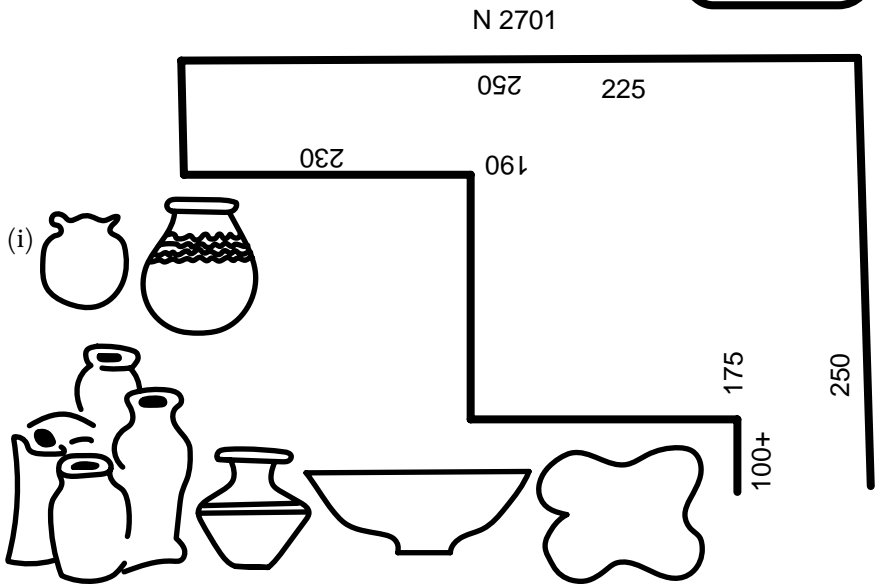
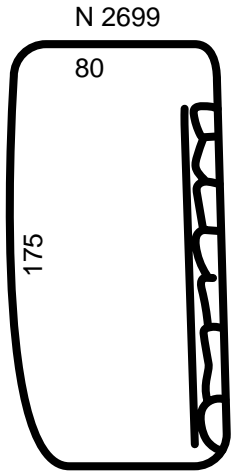
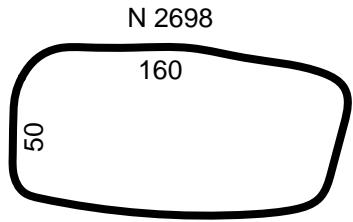
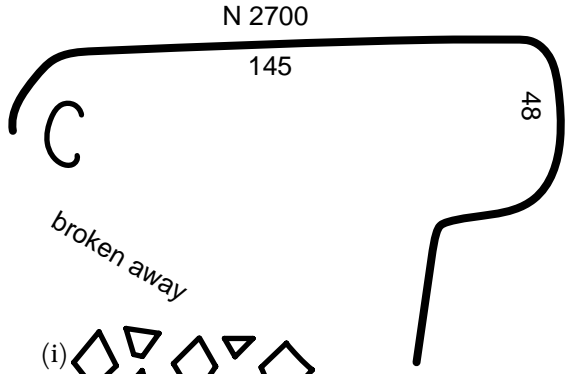
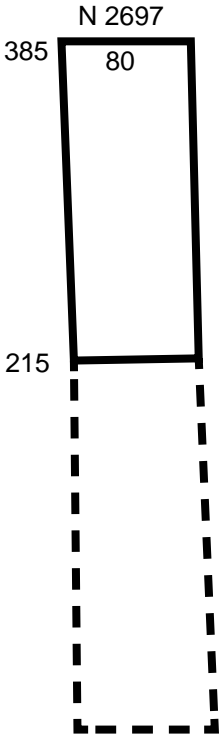

N 2701 (Green) (TC) Map C4

Height 90. Depth from *gebel* 190. Original height of chamber 90. Contained several As (i) (6-12509, 6-12510), small saucer, piece of ring stand. [ed.: According to Hearst Museum records, 6-12511 (broken flint knife), 6-12513 (flint knife) are from this burial.]

N 2702 (TC) Map C4

170 down from *gebel*. 50 of *radim* above. Contained nothing.

N 2703 (Green) (TC) Map D3

105 W of N. 220 deep. No chamber. Contained nothing.

N 2704 (Green) (TC) Map D4

Apparently an early grave, as it contained fragments of an early coffin. No burial left.

N 2705 (TC) Map D4 (red)

68 W of N. 80 down from *gebel*. Contained nothing. Not Coptic.

N 2706 (TC) Map D4

Height 70. Depth 255 from present level. Contained nothing.

N 2707 (TC) Map D5

55 W of N. 82 high. 125 down from *gebel* level. Contained only a few broken bones.

N 2708 (TC) Map D5

33 W of N. Contained nothing. Sides broken away.

N 2709 (TC) Map D5

21 W of N. 95 high. Roof fell in before measured, so measurements only approximate.

N 2800, N 2801 (TC (with 2907–2909) Map D4 (N 2800; red), C4 (N 2801)
Coptic graves. Burials gone. [ed.: No image.]

N 2802 (TC) Map D4

140 deep from present level. Contained nothing.

N 2702

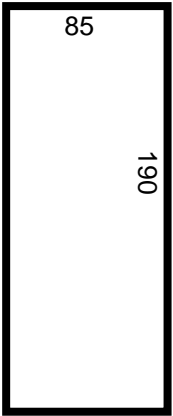

broken through to N 2702
[ed.: error for N 2701?]

N 2706

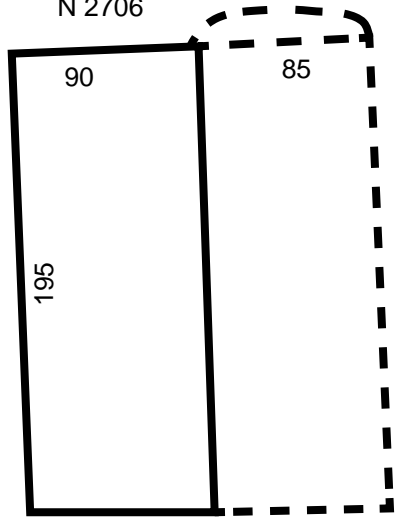

N 2703

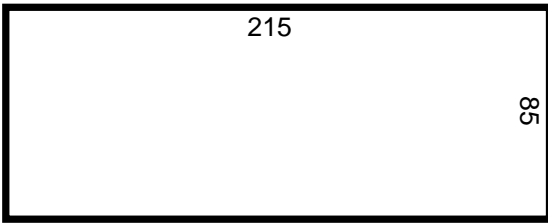

N 2705

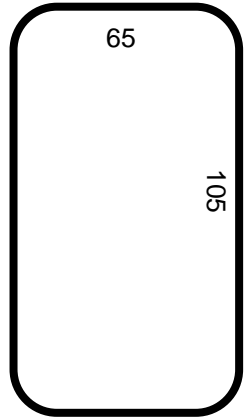

N 2704

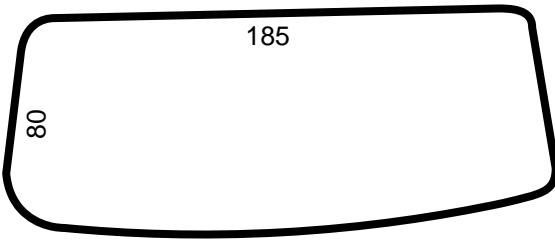

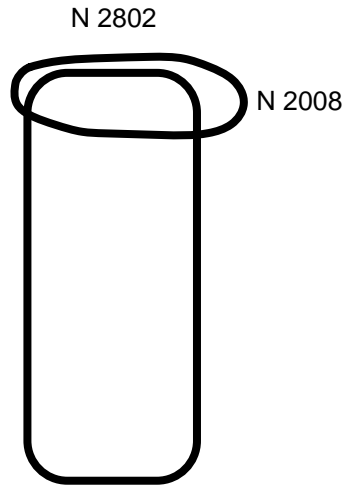
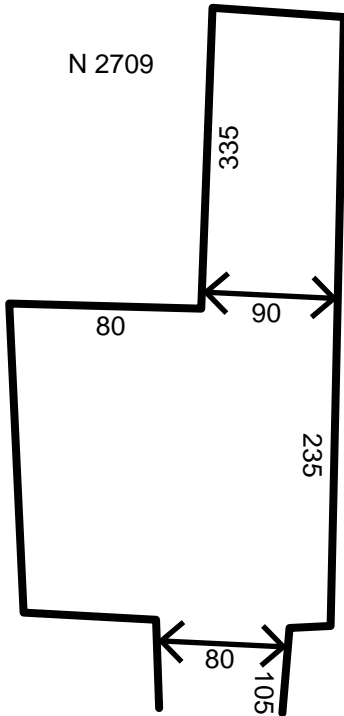
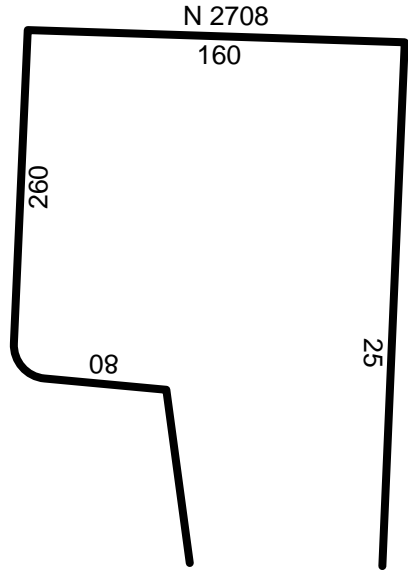
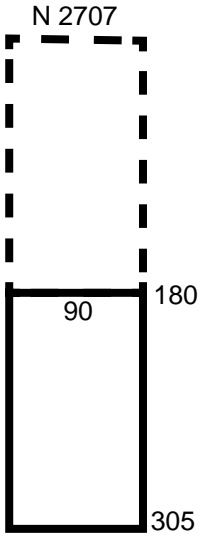

N 2803

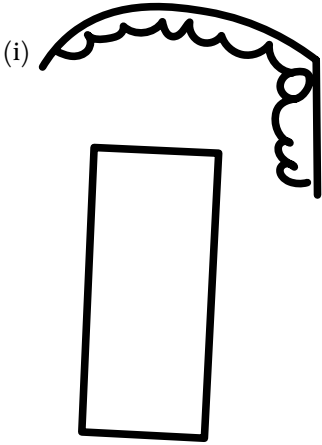

N 2805

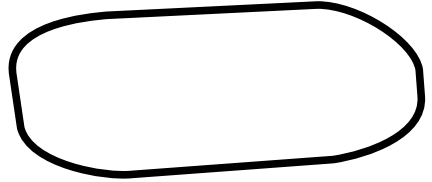

N 2810

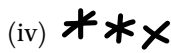
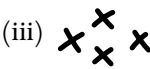
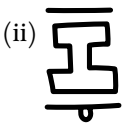
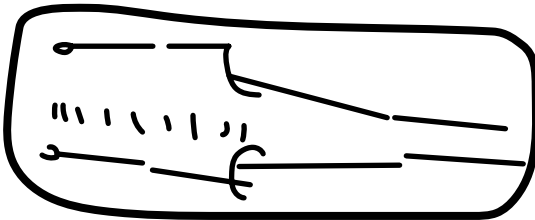

N 2806

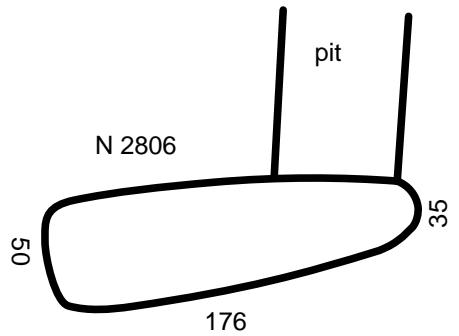

176

N 2803 (TC) Map D4

85 high? 175 deep from present level. Adult. Female? Burial on left side, portion of right leg doubtful. No trace of coffin. Remains of mud superstructure approximately 0.5 cm high (i).

N 2804 Map D4 [ed.: This burial is on the map, but there was no tomb card for it.]

N 2805 (TC) Map C4 (red)

Coptic grave. Burial gone.

N 2806 (TC; MM) Map D4

Shallow grave running east-west. Adult male. On back, head west. Remains of dark, curly hair. There was a single shirt that had narrow inwoven lines of blue thread across the shoulders, and at bottom of sleeves, 2 similar lines with a small, needleworked pattern of 4 rosettes in colored wool. Over face, an extra pad. Between this and shirt, there was a quantity of salt. Under body, next to shirt, there were 2 stout poles (not palm). The first wrapping shawl was of coarse cloth, not sackcloth, with inwoven bands of blue, 2 wide, at either end. Next came a wrapping of sackcloth outside which the mummy was corded in style 3 (i). Outside the cording, there was an upper covering of fine yellow cloth, the corners of which were tied round the neck. This had small tapestry-woven designs in one corner at any rate (ii) in dark brown wool with a border at end of alternate (iii) and (iv).

N 2810 (TC) Map D4

Coptic burial. Head gone. Position with head west. Traces of sackcloth and of finer cloth. 2 palm sticks under body.

N 2811 (TC) Map D4

45 down. Coptic burial. (Female. Height 146 cm.) S. Head west. Outside wrapping of sackcloth. Inside, 2 palm sticks. Quantity of salt with body. Next to sackcloth and outside sticks, there was a covering of elaborately worked cloth with red bands of cloth in the middle of which were wide bands of colored wools. On border, a band of blue sewn in. This was probably a shirt. Over head, extra wrappings. Outside, a wrapping of cloth with lines of drawn work and inside, a net of colored threads. By head, a ring of bronze beads of a single thread, ends being wound round after joining. Shirt had been very elaborate, designs being mixture of plant, animal, and human.

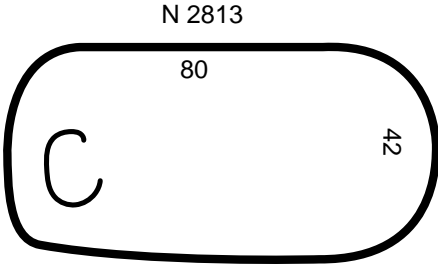
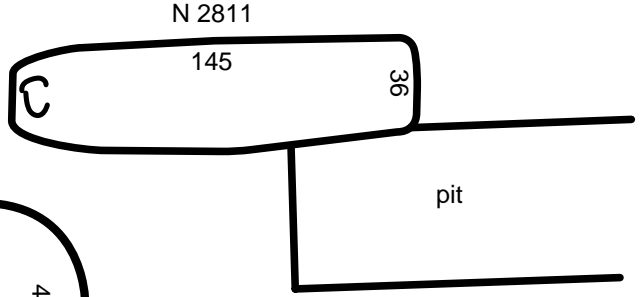

N 2812

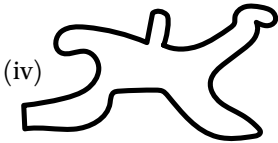
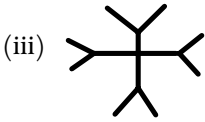
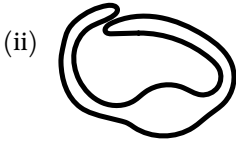
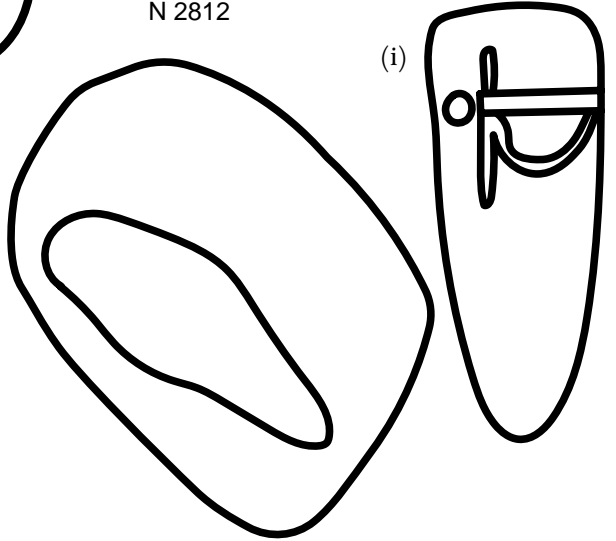

N 2814



N 2815

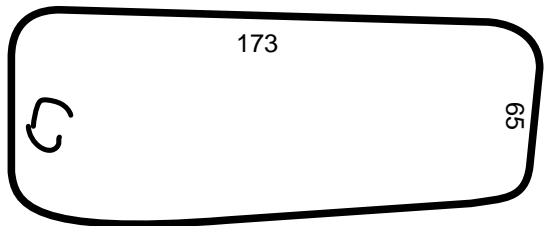

N 2812 (TC) Map D3; photo C 8451, C 8559

Coptic child. Wrapped in rough cloth, not sackcloth, and tied round with cords. Outside, a wrapping of yellow cloth with colored wool pattern round neck (i). Rosette and vertical banded black cloth with yellow and purple wool decoration (not sewn on). Horseshoe piece was a band sewn on to yellow cloth; of purple cloth with black wool decoration and a border each side of red cloth with white spots. On another part of yellow cloth, a wider band similar to horseshoe pattern (sewn on). First cloth wrapping was a shawl with fringed edge. Body was laid on it, sides were turned over. End by feet turned over. Border torn up and wound round just above feet. Under this, a quantity of dried twigs and leaves of ? 1 leather sandal by right hand. Below, a wrapping of cloth, not a shirt. Over face, 2 or 3 thicknesses with soft fiber wool between. Skull broken. By skull, 2 gold earrings (ii). Also, bronze cross and 1 green star bead. Also, remains of 2 bone bracelets. Below, 2 shirts. Under one (iii): cloth brown with blue stripes, vertical on skirt, horizontal on sleeves, irregular in number from 1-5, 2-8 between rows of stripes. Border at bottom on front turned up at right angles so shirt was probably divided for a certain distance at sides. Under part of shirt was rucked up to small of back, so exact shape could not be determined. Upper shirt (iv): worn inside out. Strip sewn on of dark blue or black cloth with yellow wool decoration (v). 2 wide. Sleeves entirely gone.

N 2813 (TC) Map D4; photo C 8459, C 8477

70 down. Coptic baby. Head west. Traces of cloth left on body with traces of wool ornamentation. On left wrist, bronze bracelet (i). On right wrist, similar bracelet (ii), but with a larger plaque and a cross ? (iii) on it. By right ear, a bronze earring ? (iv).

N 2814 (TC) Map D4

95 deep. Copt. Adult. Female? Head west. Cloth almost entirely gone. Position of body as usual. Had been a large pad of cloth over head, part of which was embroidered cloth. Under body, 2 palm sticks at least. Quantity of dark brown hair left. Round neck, a string of small shells with a few green stone beads. (5 shells were together.)

N 2815 (TC) Map D4

90 down. Copt. Head west. Usual position. Cloth almost all gone. Length of body 157, but none of joints ossified. All the parts of the sacrum unjoined. Had been wrapped first in sackcloth and then in finer cloth, part of which was dyed red. Large pad over head. Under body, 2 palm sticks.

N 2816

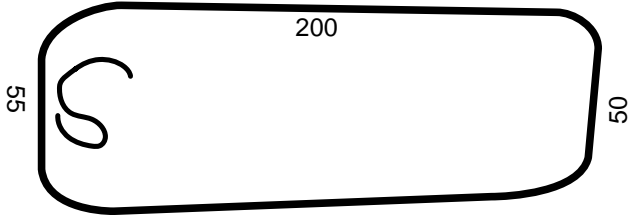

N 2817

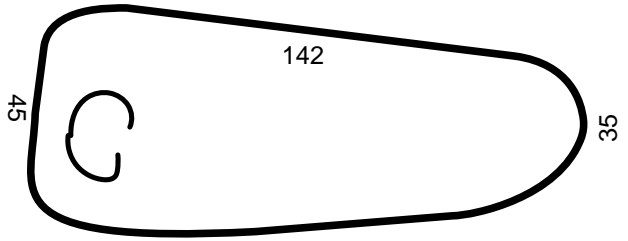

N 2818

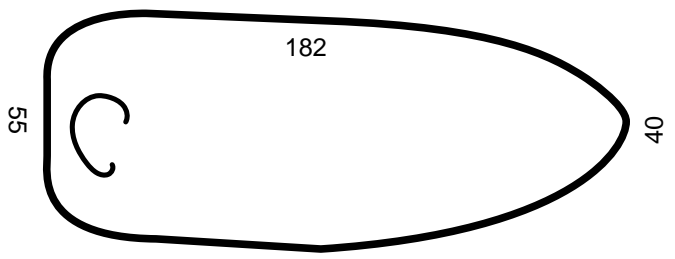

N 2410

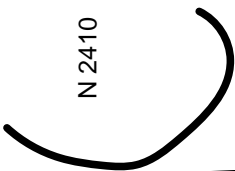

N 2819

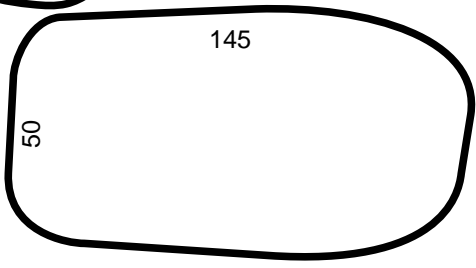

N 2830 (1)

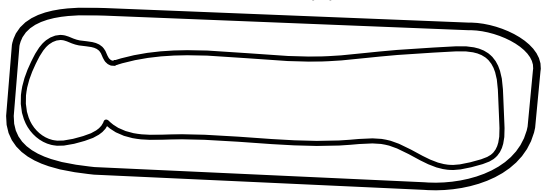

N 2816 (TC) Map D4

80 down. Copt. Adult male. Head west. Cloth nearly all gone. 6 palm sticks under body, 2 on each side and 2 in middle. Also, 6 above body inside wrappings. Over feet, there had been a quantity of fibrous material. Fibrous material over whole body inside wrappings, especially over head. Back teeth almost all gone, and bone worn away.

N 2817 (TC) Map D4

90 down. Copt. Adult female. Head west. Only 2 teeth left in upper jaw. All back ones gone in lower. Almost all traces of cloth gone. Had been wrapped in sackcloth and also in finer cloth. 2 or more palm sticks under body. Over head, remains of a cap ? of green and red cloth cord work. (Possibly they were just odd ends put in to fill up.) Head propped up, so head looked towards feet.

N 2818 (TC) Map D4

105 down. Copt. Adult male. Head west. Very few teeth left. On left side of lower jaw, a large hole drilled right through. Cloth practically all gone from body, but a large pad still remaining on head consisting of sackcloth and a finer cloth inside. Under body, on right side, 2 palm sticks. On left, 1.

N 2819 (TC) Map D4

100 down. Remains of a Coptic burial. Head southwest. Head gone, and bones considerably disturbed. Under body, 1 palm stick and 1 sesban.

N 2830 (1) (TC) Map E3; photo C 7026

Coptic burial. Body wrapped in rough sackcloth. Over this on top of body, apparently orig[inally] on top a strip of fine cloth, which went over head and was tied round the neck.

N 2830 (2) (TC) Map E3

Coptic burial. Adult male. Head west. Almost all back teeth gone. Under body, dried palm leaves. On outside, wrapped in a shawl of yellow cloth (almost all gone). Under this had been tied with fiber cords, but these had almost entirely disappeared. Wrapped outside in a shawl of sackcloth, folded over in usual way, and sewn up down front with cord. Over this, on top of body, apparently only on top, a strip of fine cloth that went over head and was tied round neck. Under excess over head, a quantity of palm fiber. Under this, a large pad of cloth. Skull had fallen out of position. The extra pad consisted of an old shirt, very much darned, rolled up into a ball. Below, completely enveloping body, a shawl of coarse cloth with a border of wool embroidery. Patterns in green, blue, and in shades of red (sewn in). Between this and shirt, a small amount of salt and

N 2830 (2)

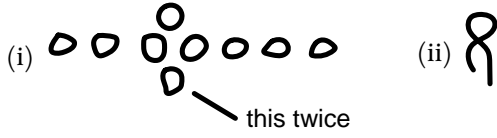
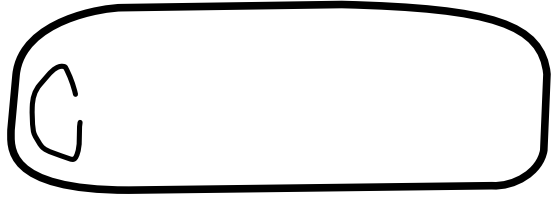

N 2831 200 from present level 145 from present level

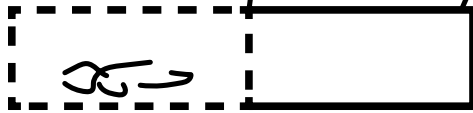

N 2832

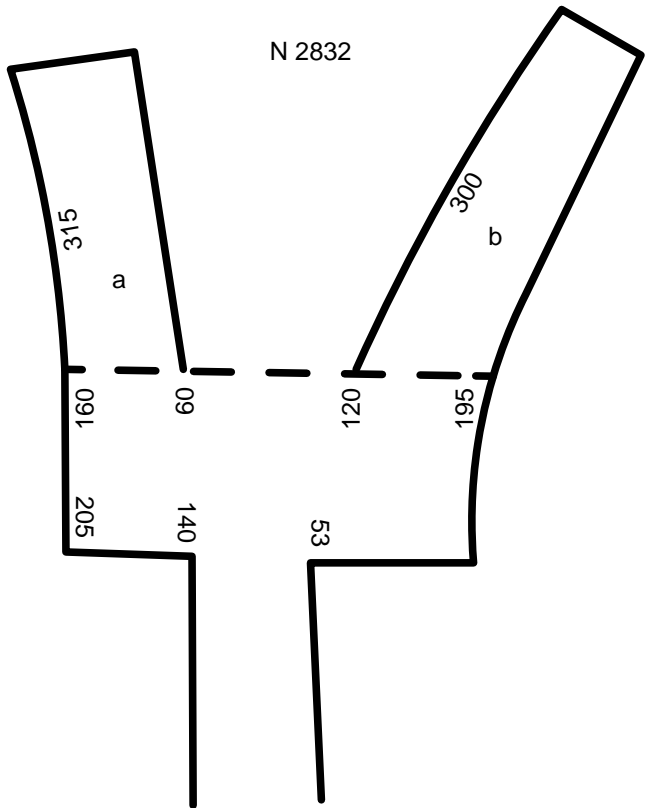

remains of a few dried plants on breast. Remains of short, straight hair, discolored. Below, 2 shirts. Outer: reached to very bottom of feet. Bottom selvage end of cloth. Neck, simple opening. Edges finished off similarly to bottom. Under body inside wrappings, 4 palm sticks and 1 acacia. These had been fastened together. Sleeves very long, coming below bottom of hand. Ends corded. Near cord, line of ridge work left in weaving. Inside this, line of tiny rosettes in dark blue and heliotrope wool (i). 2 similar rosettes on front of shirt over stomach. Both arms in sleeves. Sleeves sewn to above elbows. Under shirt: Similar, but only reaching to halfway below knees. Neither arm in sleeve. Bottom of shirt very much darned. This shirt was made of 2 pieces, join being across chest. Inside wrappings, a lock (ii) [of] artificially curled woman's hair: dark brown.

N 2831 (TC) Map E₃; photo C 7043

(Female.) S. Coptic burial in chamber of early pit on 60 of *radim*. Usual position. Head west. Remains of cloth wrappings. Palm sticks under body, also a few palm leaves.

N 2832 (TC) Map E₃

125 W of N. Remains of burial in b. Roof of main chamber and also of b completely fallen away. Contained nothing.

N 2833 (TC) Map D₃; photo C 7046

Upper part of Coptic burial. Male? Middle aged. Wrapped round with sackcloth. Outside bound round with strips of coarse white cloth with red and black ornamentation: red and black on separate strips (i). Also, bound with fiber cords. Ends of sackcloth crossed over body and fastened together on breast with a fiber knot. Body was laid on cloth, a good deal being left projecting beyond head. This projecting part was thrown back over face, sides also thrown over and then bound. Under this, a second covering of sackcloth similar to first. Between first and second wrappings, by right side of face, a ball of fine, soft cloth. Under second, a third similar sackcloth. Underneath, remains of 2 or more shirts of fine linen. Quantity of salt on body inside wrappings. The fine cloth between first and second wrappings consisted of an irregular piece of cloth with cord border. Near this border, 3 cent [ed.:imeters?] in, a pattern in purple ? 1.5 wide (ii). Further in, at intervals, (iii) in same color, 6.8 × 3. Under body, 1 stick for carrying, inside sackcloth wrappings.

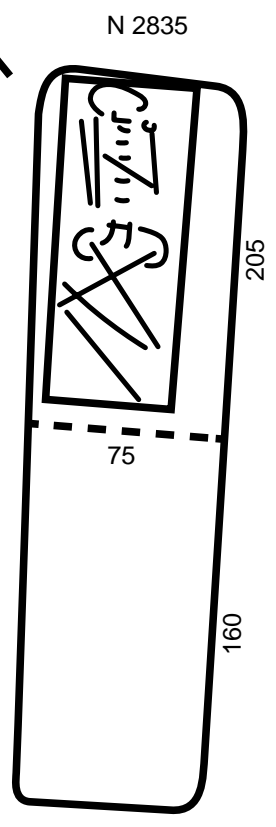
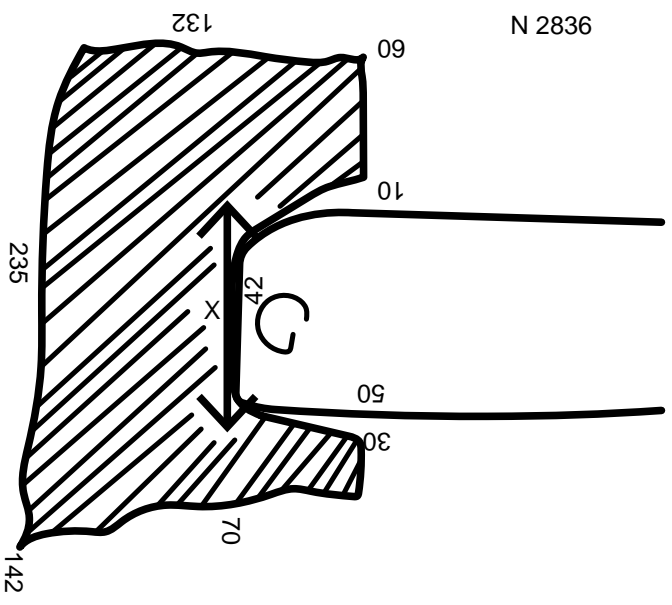
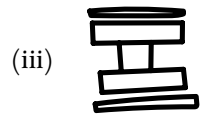
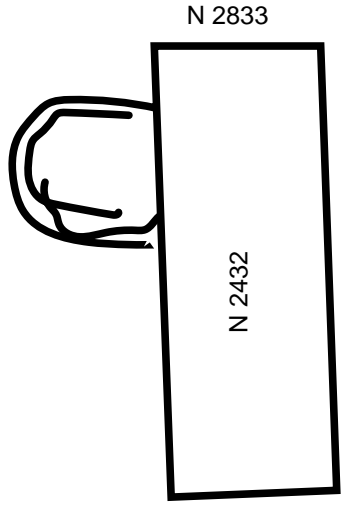
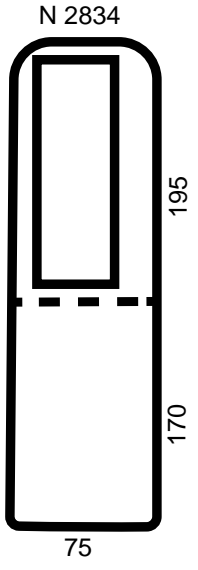

N 2834 (TC) Map D3; photo C 8193

About 80 high. Badly broken up inscribed coffin in black paint to (i). Corners as usual. Measurements doubtful. In *radim*, 2 tiny glaze amulets (6-12515).

N 2835 (TC) Map D4

180 from *gebel*. 85 high? Female. Body on back, legs crossed. Remains of several wrappings of cloth over body. Inside measurement of coffin 148, 34.5, 41.5. Thickness of wood 4.5. Corners as usual. White paint outside and in. Lid was broken and out of position.

N 2836 (TC) Map E3; photo C 7732

95 deep. Coptic. Head west. (Short, brown, wavy hair. 1.597 m high. Sex?) S. Remains of an early coffin at W end of grave, just below surface X. At W end of tomb, brick construction 10–20 thick. Over head, 2 large bunches of dried grass tied round. Under body, 3 palm sticks and 1 atl. These were all together and had been tied together. Inside sackcloth, outside shirt. Quantity of salt on body. Wrapped first in very fine cloth with corded edge and ornamentation of black cloth with yellow thread decoration. Below, 2 thicknesses of sackcloth. Below, a wrapping of yellow cloth with broad green line decoration (inwoven). Below, 2 sheets ? with varied thread patterning and elaborate decoration in green cloth with yellow thread patterns ? Also, a piece (? from shirt) with corded edge and decoration in green wool. On head, a mass of cloth, some of which at any rate was of same stuff as cloth and with similar decoration.

N 2837 (N 2634 opening from it) (TC) Map E3; photo C 7058

260 deep from present level. 80 high. Adult. Female? Suture right down forehead. Burial on back. Inside measurement of coffin 180 × 45 × 50. Thickness of wood 4.5. Corners as usual.

N 2838 (TC) Map D4

About 200 deep from *gebel*. 95 high? Adult. On left side. Position of arms doubtful. Skull badly broken: sex? Traces of decayed wood from coffin.

N 2839 (TC) Map E3 (red)

Lower part of Coptic burial. (Male.) S. Remains of several wrappings of linen, 1 or 2 pieces with elaborate decoration in colored wools. Outside these linen wrappings, there were 3 palm sticks under the body tied together at the end. Outside these 2 wrappings of cloth with twigs and dried leaves between. Fragment of a shawl (i) showed doubly corded edge into one of which cords a

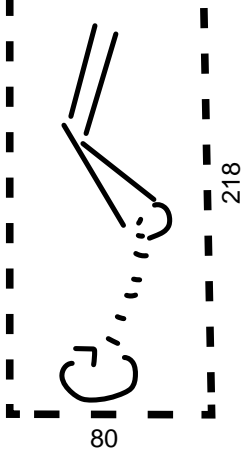
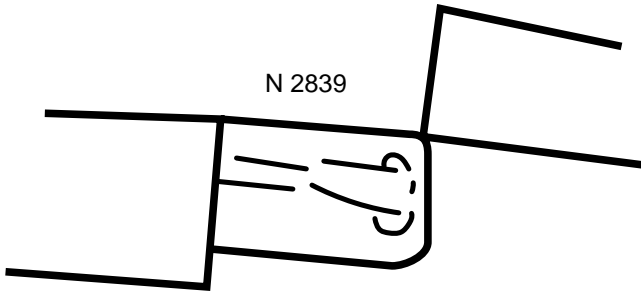
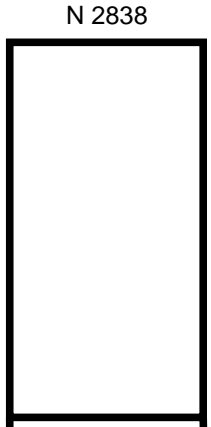
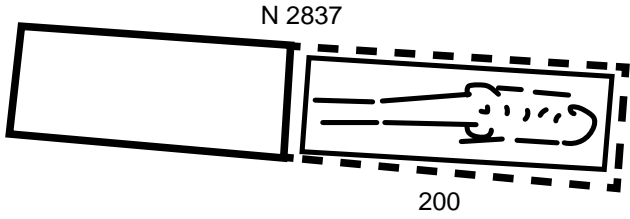

(i)

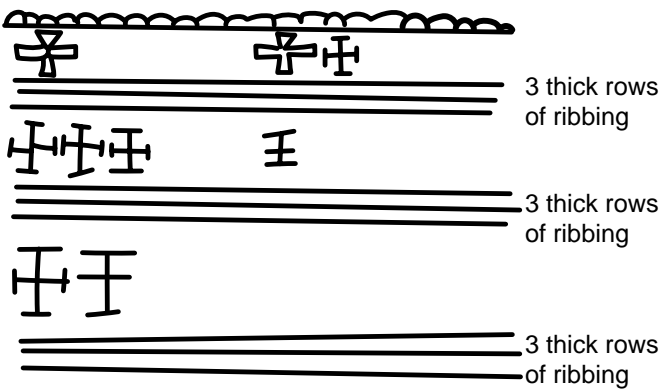

王 王 王

quantity of reddish brown wool was mixed. Crosses between lines of ribbing in the same reddish brown wool: sewn on. Also, part of shirt with lower part of usual breast ornamentation. Colors and pattern?

N 2840 Map B4 [ed.: For drawing, see N 2649.]

N 2841 (TC) Map B4
255 deep. 75 high. 115 E.

N 2842 (TC) Map B4
Depth from present level 75. 110 E of N. Contained nothing. Doubtful whether Copt or Egypt Old.

N 2843 (TC) Map B4
233 deep from present level. 88 high. Contained nothing.

N 2844, N 2845 (TC) Map B4
Both 150 deep from present level. 35 W of N. 2844 had possibly been pit and chamber. 2845 was probably a Copt. Neither contained anything.

N 2846 (TC) Map B4 [ed.: Number is in pencil only on map, not ink.]
270 deep from present level. Height? Contained nothing.

N 2847 (TC) Map B3
85 deep. Probably Coptic. Contained nothing.

N 2848 (TC) Map B3
465 deep. 95 high. Contained nothing.

N 2849 Map B3 [ed.: No tomb card for N 2849.]

N 2870 (TC) Map B3
110 W. Copt. Usual position. Head west.

N 2871 (TC) Map A3
Copt. Contained nothing.

N 2872 (TC) Map A3
Copt. Contained nothing. Burial gone.

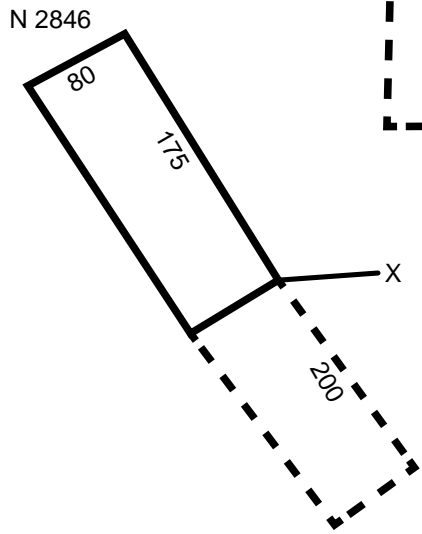
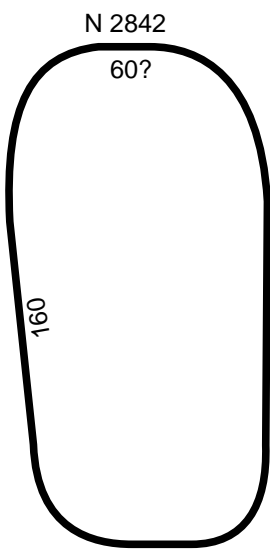
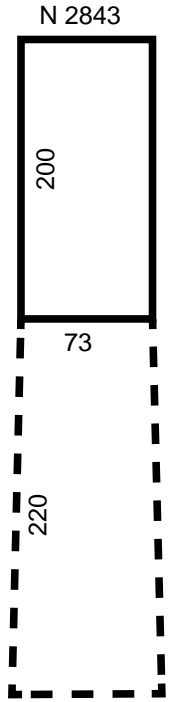
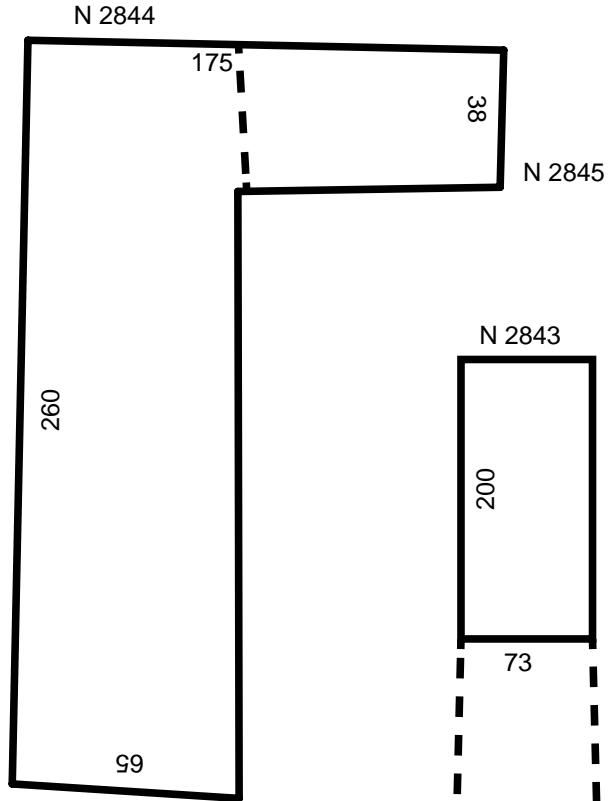
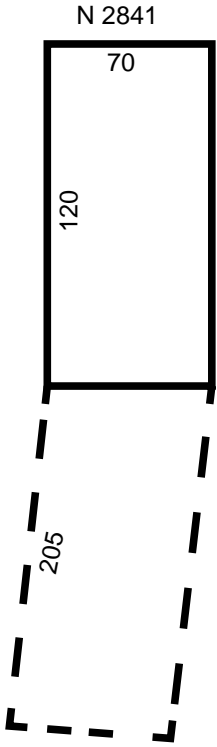

N 2847

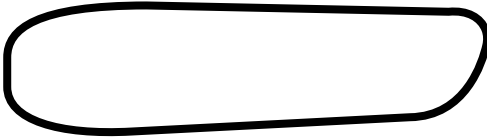

N 2848

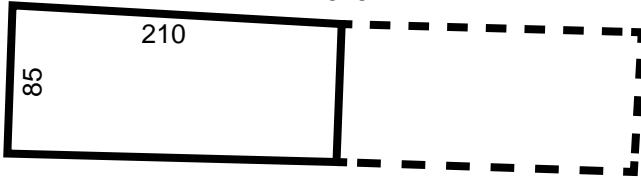

N 2870

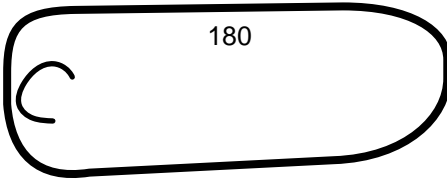

N 2871



N 2872

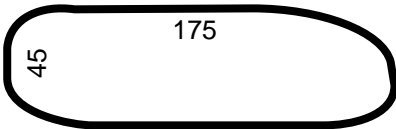

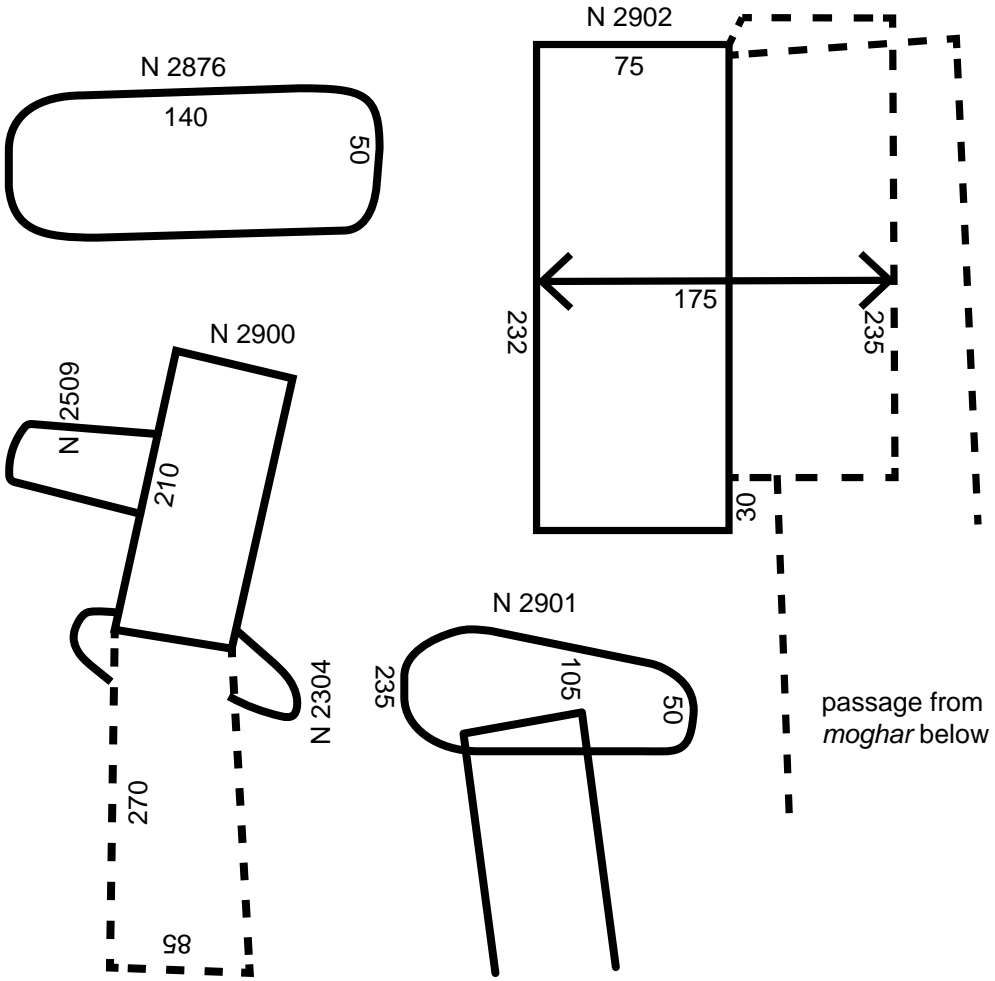
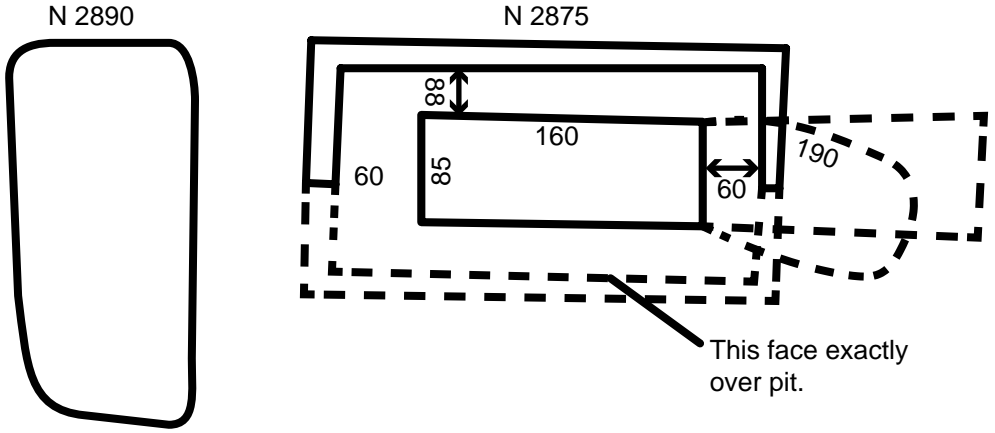

N 2873 (TC) Map A3

Copt. Burial gone. [ed.: No image.]

N 2874 (TC) Map A3

Copt. Burial gone. [ed.: No image.]

N 2875 (TC) Map A3

120 W. Contained nothing. Remains of walls to keep back *radim*. 70 high at east end, starting at 120 below present level. On north and west sides, started at same level, but only a course or two preserved. On south side, started 55 below present level. Only traces left. 1 b. wide.

N 2876 (TC) Map A3

95 W. Copt. Burial gone.

N 2877 (TC) Map B4

Copt. Burial gone. [ed.: No image.]

N 2890 (TC) Map C4

Shallow grave. Not Coptic.

N 2891 (TC) Map C4

Shallow grave: broken away by falling in of roof of 2491. [ed.: No image.]

N 2900 (TC) Map C4

Originally pit and chamber, but roof of chamber almost all gone. Contained nothing.

N 2901 (TC) Map C4

Coptic grave. Burial gone.

N 2902 (TC) Map C4 (red)

60 W of N. 280 deep from present level. Height of chamber 70. Pit must have been made before *moghar* below as floor was completely broken away by making of chamber below. Contained nothing. Pit had been filled apparently with mud and boulders.

N 2903

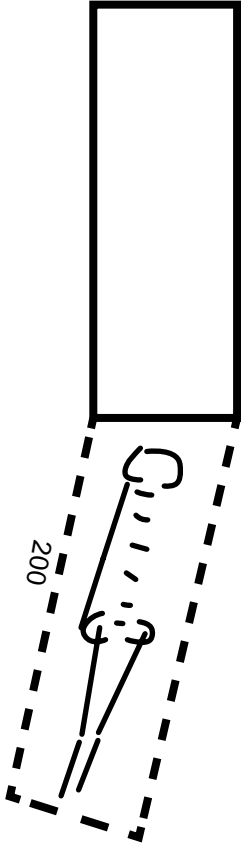

N 2904

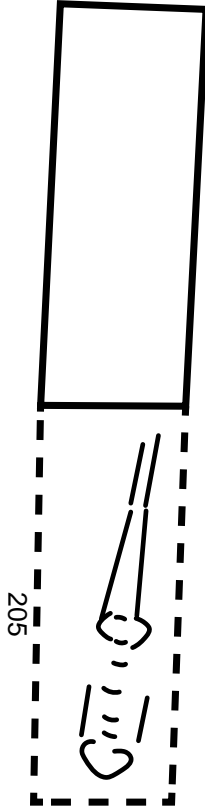

N 2906

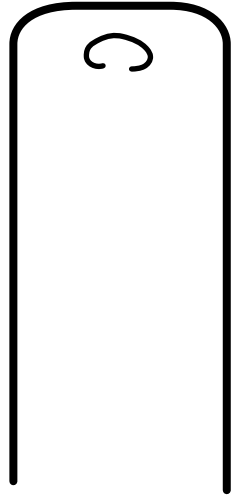

N 2905

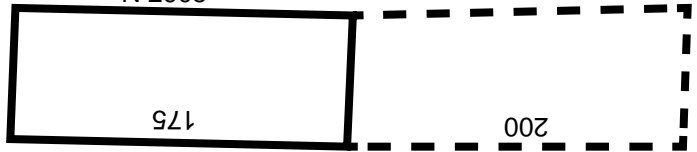

N 2903 (TC) Map C4

265 deep from present level. Height? S of Coptic. Adult. Sex? Position of left arm doubtful. Burial on back. No trace of coffin. Scraps of decayed cloth on body.

N 2904 (TC) Map C4

240 deep from present level. 80 high. S of brick tomb. Adult. Sex? Position of lower arm bones doubtful. No trace of coffin. Remains of cloth on body.

N 2905 (TC) Map D3

225 deep from present level. Height? Contained a broken (i) and M.









N 2906 (TC) Map C5

Adult. Sex? Burial head north. Position? Bones disturbed. Originally probably pit and chamber.

N 2907, N 2908, N 2909 (TC) Map C4 (N 2907, N 2908 black; N 2909 red)
3 Copts. Usual position. Head west. All adults. [ed.: No image.]

N 3747 (TC) [ed.: See also N 2640.] Map D3; photos C 0212, C 0213, C 0781, C 0814, C 7750, C 7751, C 7752, C 7753, C 7754, C 7755, C 7756, C 8503, C 8504, C 8574

Layer of stones and *radim* on floor. Above number of Copts, lying one upon another in all directions.

1. On top layer. Direction  . Head south.
2. Child in corner  . Head south.
3. Child in corner. Behind and partly under 2. Head south. Lying on stomach.
4. Top layer in middle  . Head south.
5. Across(?) tomb  . Head southwest. Under head of 1 and 4. Head broken/between of upper bones fallen through(?) on both ----. There had been 2 earrings of bronze and carnelian.
6. Top layer  . Head ---- west of 4. Lying on --- side.
7. Middle layer, in middle of tomb  . Head west.
8. Middle layer, near north end  . Head west. Laid on large stones to keep it from touching under bodies.
9. Under 7 and 8  . Head southwest.
10. Partly under 9 near door  . Head southwest.

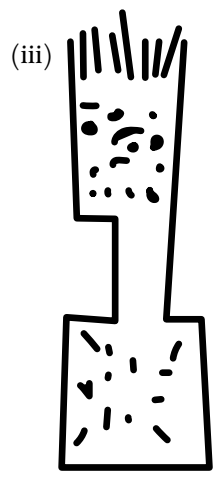
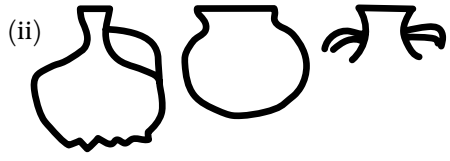
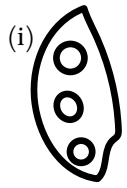
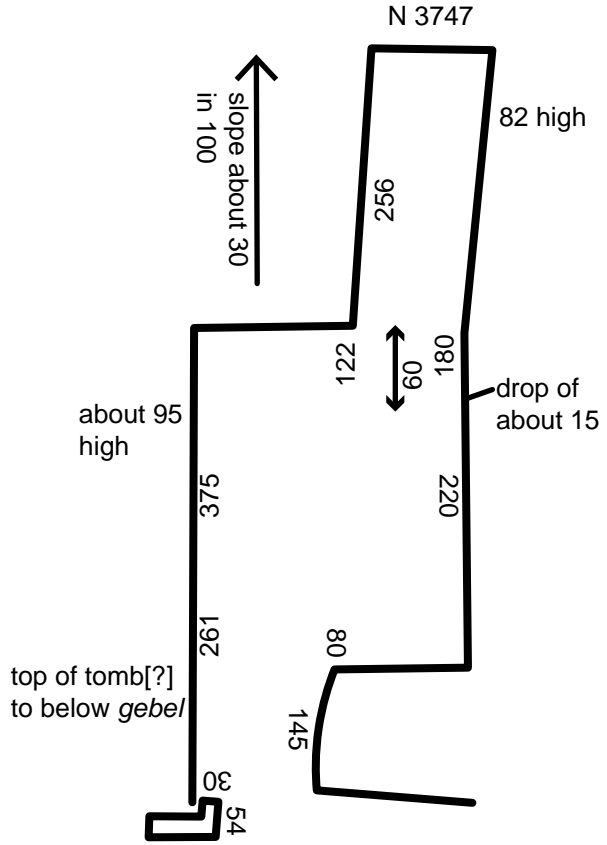

11. Partly under 10 near door ↗. Head southwest. Under bottom layer, about 20 of *radim* to floor of tomb. In northeast corner, a number of rough limestone boulders.
 12. Under 7 and 8, nearer end of tomb ↗. Head southwest.
 13. Partly under 13, near door ↗. Head southwest.
 14. Small child near northeast corner, under 8. Head southwest ↗.
 15. Small child against north wall, top →. Head west. Feet projecting ↗ beyond door of small chamber.
 16. Young child. Top layer at door of small chamber.
 17. --- 16 Sloping down into small chamber. Head just outside door. Head south.
 18. By north wall, legs across door of small chamber. Under 14 and 15. Head west.
 19. Immediately under 18. Head west.
 20. Partly under 19, nearer door →. Head west.
 21. Partly under 17. Head at door.
 22. Child, under 21. Head just outside door ↗. Head south.
 23. Under 21, sloping into small chamber. Head south. Head fallen away from body.
 24. By side of 23, skull and scattered bones of a very young child.
- In filling outside chamber, pieces of several Coptic vases. Large dish (i) with (ii) and several dishes with black paint and incised line decoration. Also pieces of ornamented wooden wool corders (?) (iii).
- 7 children.

1. Adult male. Tied round with the usual vertical and horizontal bindings of 2-fiber cord. A few additional horizontal bindings of cloth cord. Wrapped in a single covering of rough cloth (not sackcloth). This was brown in color, had fringed ends, and 3 bands of inwoven white threads near ends. This was folded over in usual way, and ends rolled up over head and feet. Underneath, remains of a second wrapping of yellow cloth with a band of inwoven red near ends? This had about entirely disappeared. Quantity of salt and a few plant seeds. Under body, inside wrappings, 2 palms sticks and 1 "sont" tied together at ends. Remains of 2 shirts. Hardly anything of woven shirt remaining. Large rosettes of dark cloth with decoration of original thread. Outer shirt (i). Width from seam to seam 72. Apparently same width all way down. Edges of neck hole turned over and down. Bottom of shirt plain. Bottom of sleeves like neck. Shirt made of 2 pieces of cloth. Straight join all round middle. Side seams overlapped and sewn together. Sleeves left open to wrist, then sewn ornamentation in red thread (inwoven) pattern being left in original thread. Band up front

N 3747 F 1

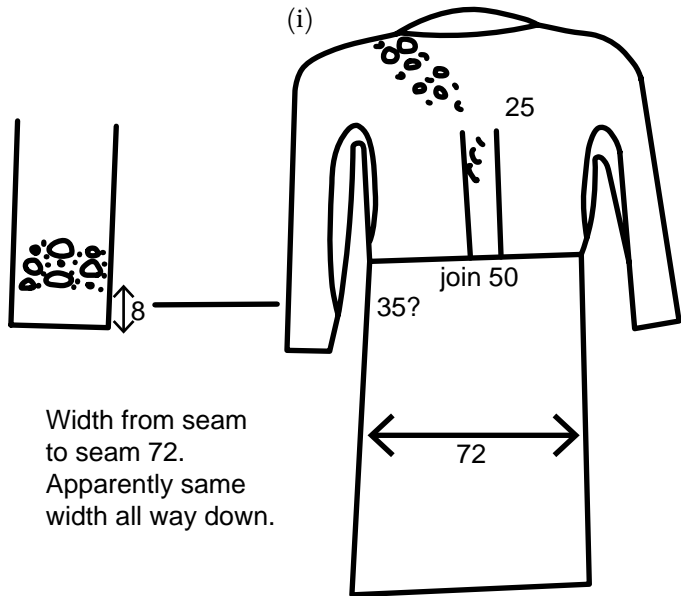

N 3747 F 2

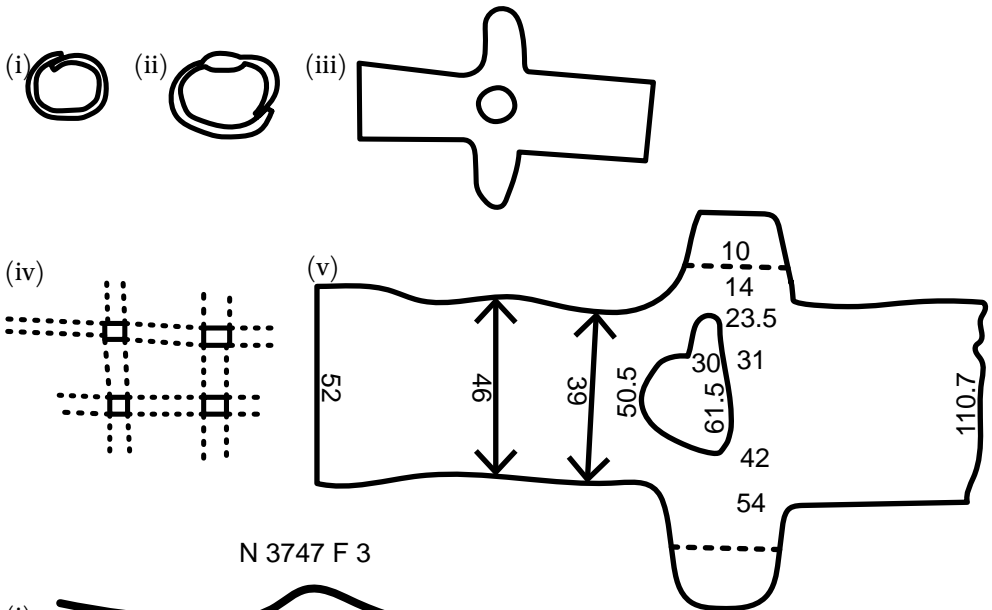

from join dividing on breast and going over shoulder and part of the way down back. Another band down center of back to join. Another band 8 from ends of sleeves.

2. Child aged approx. 7. Wrapped first in a piece of sackcloth. This was a long shawl c. 200 long and c. 100 wide with fringed ends. The large excess was left at gut, which was thrown back and reached almost to chin. Then excess at head was thrown back, sides thrown over, and the whole tied round with fiber cord. Number of [ed.: blank] seeds on body. 1 palm stick and 1 [ed.: rubbok?] under body. Inside shirt, fastened together at either end, the cord which tied end running down stick to fasten other end. Salt on body. On left arm, iron bracelet (i). On right arm, 2 iron bracelets (ii). First shirt was used as a wrapping merely and not worn. It was opened out so (iii), and body was laid upon it. This shirt was plain, save for a slight frilling to sleeve. Underneath, remains of a more elaborate shirt with a large check pattern of open work (iv) and remains of elaborate embroidery. Sleeves and bottom? had a narrow band of red cloth sewn on with embroidery of yellow thread. First shirt (v). On right shoulder, a knob of cloth with a cord loop on other side for fastening. An extra piece 10 wide sewn on to each sleeve and join being apparently hidden by a band of embroidery sewn on. From this another band probably ran from shoulder to neck, but embroidery all gone. There had also been a narrow band round bottom of sleeves and round neck. Bottom of shirt plain.

photo C 8473

3. Child aged approx. 10–12. Lying on stomach. Wrapped first in sackcloth and tied round with 2 kinds of cord, one of coarse 2-stranded fiber, the other fine of 2 strands, each of which was made by 3 strands. Under body, between sackcloth and shirt, 2 palm sticks of which the ends were tied together, a groove being cut in one to hold cord. Quantity of salt on body and several plant seeds. Bronze bracelet on right wrist, at join (i). On left, a similar bracelet, but without ornamentation. Round neck, a string of green glass beads and also a few green glaze disc beads, not on same string? Over head, remains of a net cap with tassel. Shirt had a narrow band of blue cloth with yellow thread decoration sewn on round neck and bottom of sleeves in band running over shoulders and down sleeves? Bottom of shirt had a fringed end and some distance above it, a line of drawn work with rosettes at intervals. Very little of the wool insertion left. Shirt made of 1 piece without seam.

N 3747 F 4

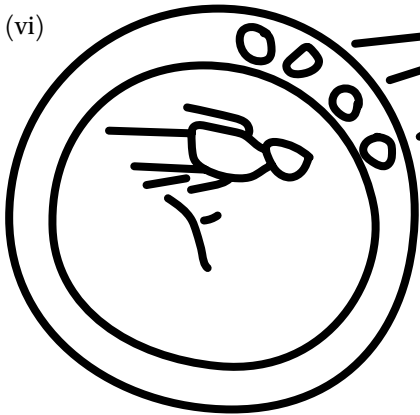
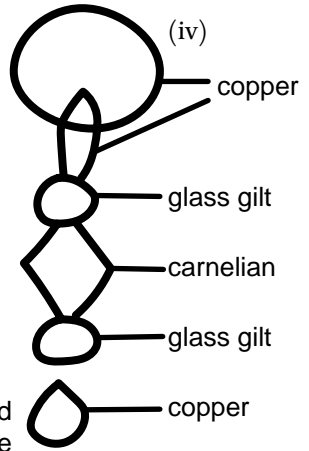
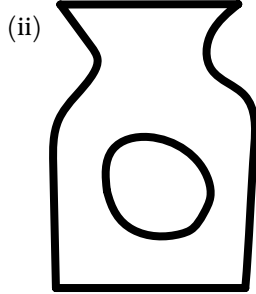
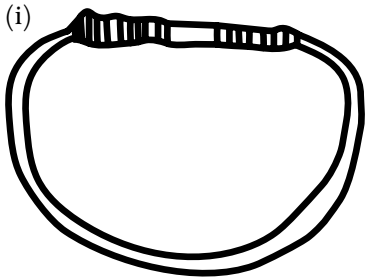

alternate
yellow, red, and
green on a blue
ground

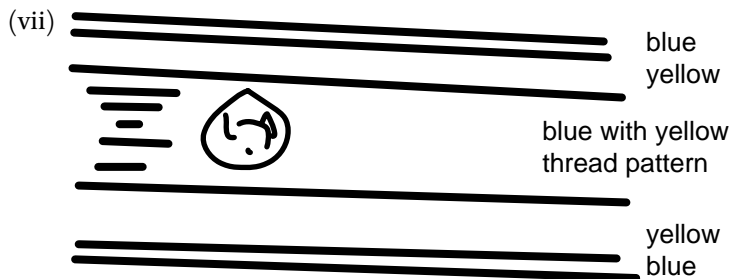
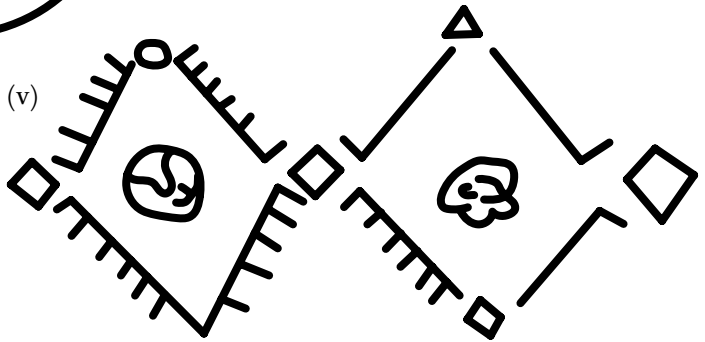

photos C 8451, C 8456, C 8457, C 8472

4. Female aged approx. 25–28: bones only recently ossified. Tied round first with a rough network of horizontal 2-strand fiber cord. Above it, 2 bindings of vertical cords, 2 in each. Also tied round feet with a number of thin strips of cloth. Wrapped in 2 shawls which completely covered body of fairly coarse cloth with fringed edges and a line of embroidery near each edge. Outer shawl: 14 from fringe, a line of wool work 4.5 wide. Various patterns worked in red, green, yellow, and blue. The wool was worked onto warp of original cloth. These patterns were bounded by lines of the cloth thread. At head, end rolled up into a tight roll to rest on top of the head. At either end, there were 3 bands of coarser wool thread. Inner shawl: Much smaller, only covered top of body and halfway underneath. Similar band of wool work, but less elaborate and apparently only yellow and blue wool used. This shawl was wrapped round feet, but only came up to neck. Head fallen out of position. By it, out of position, there was a circlet (i) made by crossing ends and then twisting round so that circlet could be enlarged and contracted. This was made of copper. Under body, 3 palm sticks between wrappings and shirt. These were tied together at either end. One had a groove cut at the end for cord. Between wrappings and shirt, there was a regular layer of salt. A few plant seeds also on body. Round neck, a string of shells and glass beads, strung apparently with a string of shells together with 3 glass at intervals. Also strung on it, a silver ? cross. Remains of dark straight brown hair. By head, inside wrappings, a small glass bottle (ii) with an indentation each side and at bottom (MFA 47.1685). By head, remains of a hood of red cloth and black net work. On left forearm, 1 copper ? bracelet with ends (iii) and 1 of twisted palm? On right forearm, a similar copper? and 2 palm? On right arm above elbow, 2 ? bracelets. On left arm above elbow, 3 ? bracelets, 1 with key attached. By head, 2 earrings (iv). By right hand, plain copper ring. By left hand, 2 rings of twisted hair. Remains of 2 shirts. Outer: Round bottom, a band of blue cloth 5 wide sewn on exactly at bottom. On the blue, a pattern in white thread (v). At sides, where seams joined, this band extended up for about 6. Seams were corded. Near bottom, 2 on front and 2 on back, 4 large rosettes (vi), on 2 sides woven in, on 2 sides sewn. Edges corded. Alternate yellow, red, and green on a blue ground. Inside red ground. On this, 2 very rough figures picked out in blue thread with green dresses. Inner shirt, which was a good deal darned, had a somewhat similar blue strip sewn on bottom, but projected considerably below bottom of cloth (vii). Seams at sides corded. Like other shirt, had apparently 4 rosettes near bottom designs ? Also, from top of shirt, there were bands of red cloth, some showing lions? in blue and green, some alternate hares and flowers. Sleeves had double rows of hares and flowers.

N 3747 F 5

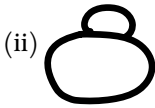
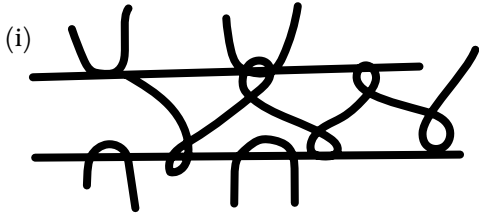

(v) dark blue with
pattern in red

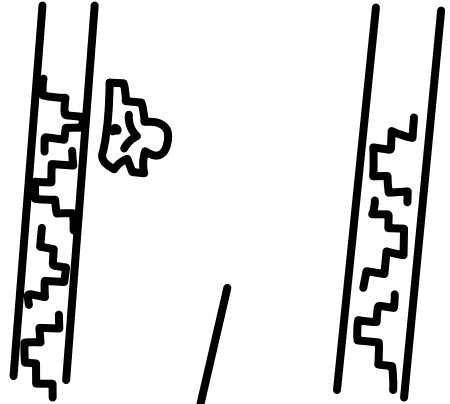

red with various
patterns in
original cloth

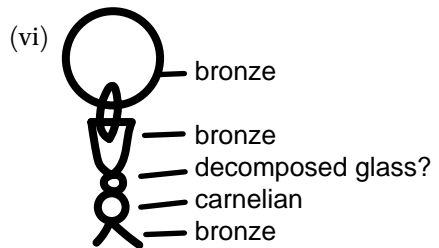
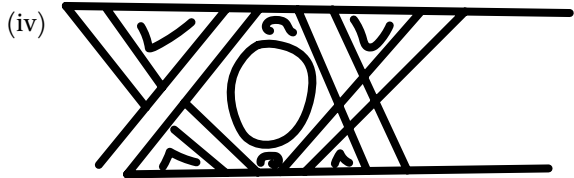
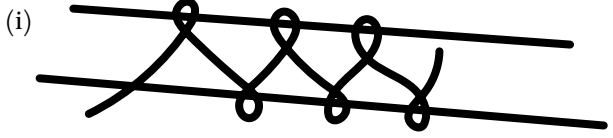

photo C 8451, C 8477

5. Female aged approx. 20–23. Most of bones just ossified. Tied first with horizontal bindings of coarse 2-strand fiber cords. Then above with 2 vertical bindings of 4 and 3 cords respectively of fine 2-strand fiber cords. These were bound as usual (i). Wrapped in a single wrapping of sackcloth folded over in usual way, flaps on body being sewn together with thin fiber cord. Quantity of salt on body. On finger of right hand, 4 rings, 2 of bone and 2 of bronze or copper, with small bezel (ii). On left wrist, bracelet of copper? Ends (iii). On left finger, bone ring. At either side of body, not underneath, a palm stick that on right side being outside and on left side inside shirt. Upper part of body disturbed and much damaged. Over skull, an additional pad of cloth. This consisted of an older shirt, which had once been embroidered. Two shirts on body. The outer one was of thin yellow cloth. Round bottom, a strip of blue cloth was sewn on, 13 wide, with decoration in white and yellow thread (iv). Down front and back, 2 broad lines of colored cloth inwoven (v). Thin lines of original cloth left between the lines. By head, 2 earrings (vi). Skeleton of fetus within. Bones fully formed. Between the shirts, round stomach, a belt of cloth 6 wide or folded up to that width. This was tied at the back. Similar band round sleeves and also a thin band of blue sewn on at cuff. Ends of sleeves corded. Inner shirt almost all destroyed. Sewn on to bottom of skirt, a band of blue 13 wide with patterns in yellow.

6. Adult male. Tied first with coarse 2-strand fiber rope. Above, bound vertically and horizontally with strong cord with additional horizontal bindings of finer cord. Wrapped on outside in a single wrapping of sackcloth folded over in usual way. Underneath, a wrapping of ordinary, rather coarse, cloth. This enveloped body completely and was tied round neck with strong cord. (After second photograph, body was turned on back.) This wrapping was turned back over body. Round feet, it was wound round and tied by ends of the fringing. On chest, the ends were sewn together with cord. Round neck, it was tied and also bound by a corner of the cloth wound round. Ends of this wrapping were fringed and starting at 19 in from fringe at either end, there were 5 lines of wool patterns sewn onto cloth. Underneath remains of an embroidered shirt, but only just enough to show that there had been one. Number of plant seeds on body and a quantity of salt. Under body, inside both wrappings, 2 palm sticks and 1 "sont." These were tied together at either end. Remains of dark brown straight hair.

N 3747 F 7



N 3747 F 8

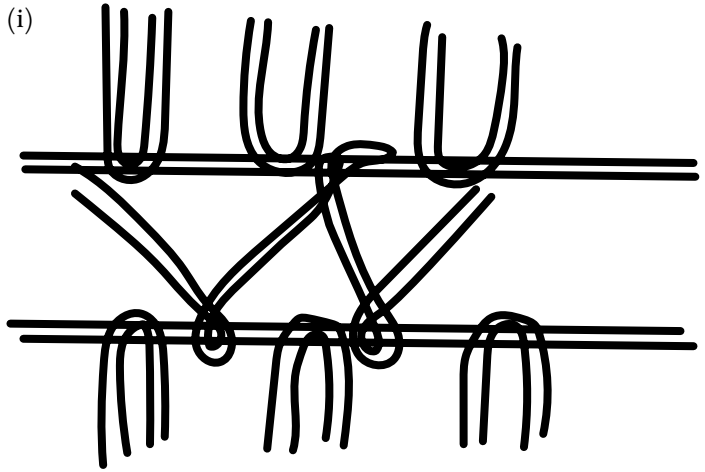

N 3747 F 9



7. Adult. Female? Tied first with a rough horizontal network of 2-strand fiber cord. Then 2 vertical bindings of 3 and 4 cords respectively. These were fastened by cords, which went under body, and by separate crossing cords between them (i). Near feet, 1 strip of palm leaf bound round. Wrapped in a single shawl of sackcloth with plain edges and a line of open work near each end. Sides and ends folded over in usual way. Inside, a wrapping of fine black cloth. Quantity of salt. Several seeds on body. On right side of body, not underneath, 3 palm sticks tied together at ends. These were inside black wrapping. Below, a wrapping of coarse cloth. Below, remains of a very thin cloth shirt with corded edges. Skin remaining on upper part of body. Hands resting in front of pelvis.

8. Wrapped round on outside with rough sackcloth with fringed edges. Body was laid on this. Sides were thrown over and join on top of body. Sewn together with thin fiber cord. Ends thrown back over head and feet. Then tied round with coarse 2-strand fiber cords horizontally in a rough network. Then tied with 2 double cords down front of body going round head and feet. To each of them were attached tape bindings, which went underneath body, a network of similar tapes joining the 2 double cords inside (i). These tapes were made of alternate coarse red and white threads on a warp of smaller double brown threads, (the latter) being 2 at a time at wide intervals. Sent away whole.

9. Adult female. No back teeth in lower jaw. Tied first with 2 vertical bindings of 2-strand fiber cord tied round head and feet. To these were attached thin cords, which went round body (i). A single wrapping of sackcloth turned over in usual way. Salt and plant seeds on body. Below remains of a cloth wrapping, which completely covered body? By head, remains of a hood or veil of black cloth. Only traces left. Below, remains of a cloth shirt apparently plain. Nose of skull extraordinarily turned up. Under body, inside wrappings, 2 palm sticks fastened together at ends. These were bent to a bow shape. Shirt reached to about halfway between knees and ankles.

10. Adult female. Bindings of 2-strand fiber cord. 3 vertical bindings first down front and round head and feet. Then horizontal bindings of 3 or 4 ends each fastened round each other and around vertical bindings in a rough network (i). Wrapped in 2 rough sackcloth shawls with fringed edges and a band of drawn work near each end. Under body, between sackcloth and shirt, 2 palm sticks. These were fastened together at either end. Quantity of salt on body. Over head and face, a covering of fine black cloth. At top, coarse net. Below, closely woven. Few plant seeds scattered on body inside wrappings. On left hand, a

N 3747 F 10

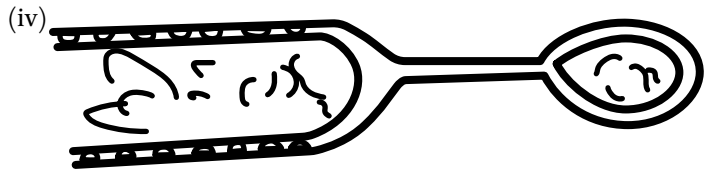
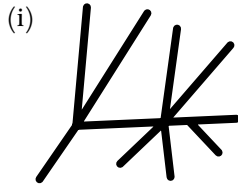

N 3747 F 12

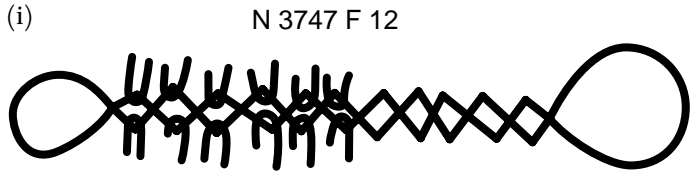

ring of [ed.: material not given here; in manuscript, it is bronze] with seal. On right wrist, bronze bracelet (ii). Right arm at any rate was not in sleeve of shirt. On left wrist, a similar bracelet. On left elbow, an iron bracelet. On right elbow, an iron bracelet, end overlapping, both ends so (iii). One pierced shell inside wrappings. Remains of shirt with 2 bands of colored cloth and embroidery down front. Edges corded (iv). Border blue with red semicircles. Inside red with patterns in original cloth. Remains of sleeves with a similar band.

11. Female? Very old. No teeth left in either jaw. Tied round with vertical and horizontal single-strand cord. Tied in with cords on top. 3 or 4 rough balls of cord. Wrapped round on outside with coarse cloth, not sackcloth, with fringed edges. Edges of cloth turned over in usual way. Below, a second similar wrapping, also tied round. Over head, a mass of dark, finer cloth. Bones were considerably disarrayed. Remains of a shirt, but almost entirely rotted away. Corded edges. 2 palm sticks under body. Right humerus had been broken. 2 parts had receded and were worn down to points. Ball of left femur also broken off and decayed. Few plant seeds scattered on body. Quantity of salt on body. By left hand, a ball of cord containing a piece of pottery. Remains of another wrapping? with a wide check pattern of dark red or black thread.

12. Female? Old. Hardly any teeth. Tied first with a few horizontal bindings, then with 2 vertical bindings of 3 cords each. These were fastened round head and feet and crossed each other in zigzag down body, being held in position by cords, which caught the loops and passed round back (i). The cords were of fiber, 2 strand. Outside cords, remains of a cloth wrapping? This may have belonged to another burial. Covered with a single wrapping of sackcloth with fringed ends and a band of open work near each end. The ends were rolled up in usual way over head and feet. Sides were turned over and fastened together with cord. Below, wrapped in a double wrapping of cloth, which reached to knees. Ends of this were folded over in such a way that they did not meet over body. Below, another wrapping, which covered whole body including feet. Below, remains of a plain shirt with corded edges. Under body, outside shirt, 2 palm sticks. These were fastened together at either end, notches being cut to keep cords in place. Quantity of salt on body and a few plant seeds. Remains of a fine cloth veil or cap by head.

13. Adult male. On outside, tied round with 2-strand fiber cords horizontally, then with a vertical tying of 8 cords running down middle of body and tying round feet and head. Wrapped outside in a covering of sackcloth with fringed

N 3747 F 14

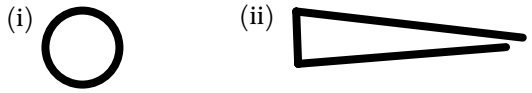

N 3747 F 15

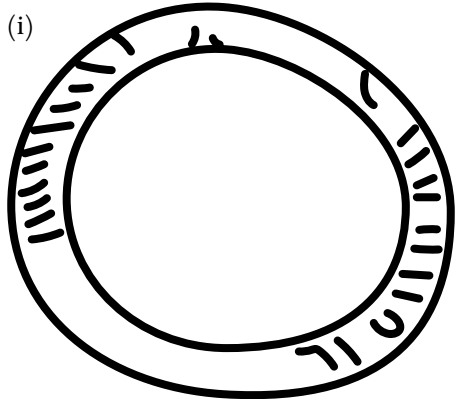

N 3747 F 16

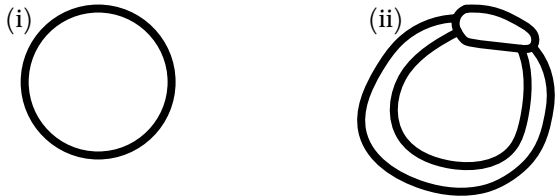

N 3747 F 17

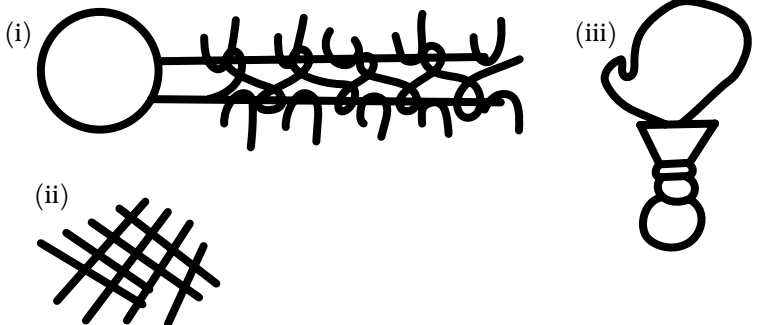

edges. Under this, body was tied round leg and by neck only. Below, more sackcloth shawl wrappings. 4 in all. Quantity of salt on body. Between sackcloth and shirt, 1 on each side of body, not below, 2 thick sticks, 1 "sont" and other sesaban? Near end of latter, head end, a pierced dom nut transfixed. Remains of 2 shirts? Outer had almost all decayed away. Had been elaborately embroidered, but only cord enclosing work left. Over head, a pad of fine cloth. This had been apparently a fringed shawl with an elaborate line of embroidery at either end, possibly only in corners. Right ulna had been broken near elbow, radius not. Upper shirt was of somewhat coarser dark cloth. Under shirt was of fine, soft, white cloth with remains of embroidery. Round sleeve from end, 2 narrow bands of red cloth with patterns in black and original cloth (all inwoven). A similar band went down front of shirt? There were also 2 rosettes of similar designs, but these were sewn onto cloth.

14. Child aged approx. 4. Wrapped first in sackcloth and tied round. Underneath, remains of a plain linen shirt. 2 palm sticks under body, inside sackcloth. On left arm, bronze bracelet of (i) type, ends widening out (ii).

15. Child aged approx. 5. Wrapped first in sackcloth and tied round with 2-strand fiber cord. This cloth was made of 2 pieces sewn together. Body was laid upon it, sides thrown over and excess at head and feet thrown over and tied round. Below, remains of a coarse linen shirt. This had been embroidered, but color almost all gone. Round neck, narrow red border with yellow thread decoration. Under body, between sackcloth and shirt, 2 palm sticks. Quantity of salt on body. On right arm, a bracelet of bronze, bound round and round with a strip of copper? wire (i). Similar bracelet on left arm.

photos C 7787, C 8475

16. Small child aged approx. 3. Wrapped first in a rough cloth and tied round with fiber cord. Under this, a second wrapping of cloth with remains of embroidery, apparently a shirt. On each arm, 2 iron bracelets (i), 2 with (ii) [ed.: i.e., bezel] (MFA Eg.Inv. 1541). On breast, a cross of lead or decomposed silver. Also, a bronze bird amulet. Body covered with salt. Inner shirt apparently of usual pattern with 2 seams at each side. 1 sleeve left. Sewn for 11 up from wrist. Above open. Round bottom, a band of red cloth sewn over, and a second similar band at top of sewn part of sleeve. Bottom of shirt plain. Top? 2 or 3 corded frames of rosettes for working left, but wool almost entirely gone.

photo C 8451

17. Adult female. Tied first with horizontal 2-strand fiber cords. Above, 2 vertical bindings of 6 cords, bound as usual (i). Round neck, an additional binding

N 3747 F 19

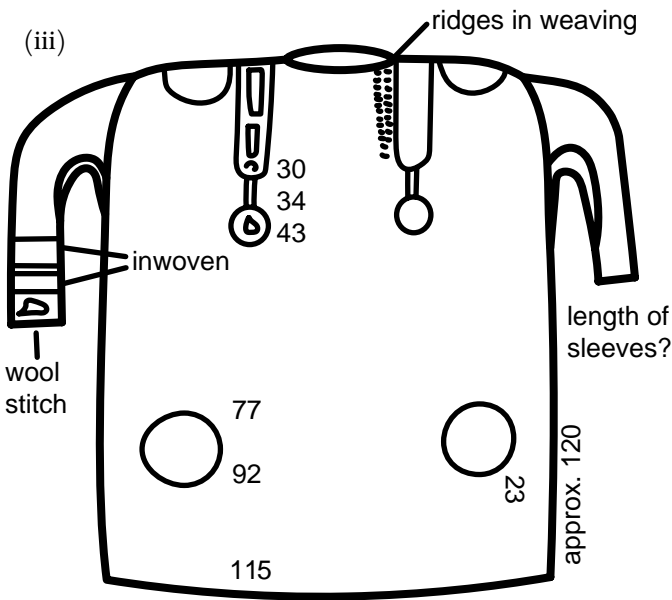
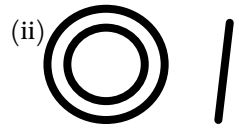
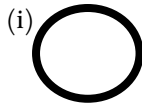

sleeve

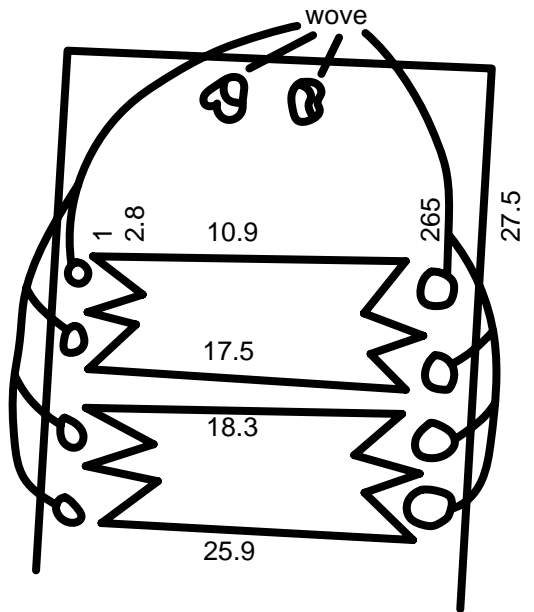

of strips of cloth. Tied in with this at neck, a quantity of loose palm fiber. Wrapped outside in a covering of sackcloth. Edges thrown over in usual way and fastened together with cord. Under this wrapping, over head, remains of black cloth. Below, wrapped in a covering of coarse cloth. This enveloped head and came down to ankles, round which it was fastened by the 2 cords. Quantity of salt between this wrapper and the shirt. Also, a few plant seeds. Skull had fallen out of position. On it, there was the remains of a net hood or veil by head, but all folded up and not in position. Also, apparently round neck, tight rolls of cloth covered with red cloth worked diagonally (ii). This was apparently attached to a thick cord. By left ear, silver? earring (iii) (MFA Eg.Inv. 1544). Right one had gone. Remains of elaborate embroidery by neck of shirt, but only outlines of patterns left. There may have been a third wrapping above shirt.

18. Outside wrapping consisted of a cloth wrapping with fringed edges. This was a shawl on which body was laid, sides and ends being thrown over. Tied round with horizontal and vertical cords (2-stranded) of fiber. Quantity of salt. Under body, between shirt and wrapping, 1 thick "shawm" and 2 "sont" sticks. By left hand, a large twist of fiber. Remains of shirt with elaborate work, which had almost all rotted away. Over head, roll of cloth with rows of white thread inwoven. This was end of outside wrapping.

photo C 8477

19. Adult male. Tied first with a network of 2-strand fiber horizontal bindings. Above, a few horizontal bindings of 4 strips of sackcloth down center of body and joining round head and feet. To these were also attached fiber cords, which went round body. Wrapped in a shawl of plain cloth (not sackcloth) with fringed edges folded over in usual way, ends tied round feet. Quantity of salt on body. Also, a few plant seeds. Under body on left side, but not by hand, 4 iron? rings with bezels and 2 of bronze?, 1 of usual pattern (i), other cut from a thin disc (ii). These were probably all tied together, as there was a wisp of thread by them. They were all surrounded by salt. Under body, between wrapping and shirt, 2 palm sticks. One of these was notched at the end for end, but they were not tied together nor was there any cord visible. Remains of an elaborate shirt of yellow cloth ornamented with green cloth (inwoven) with yellow stitched patterns. Wide band over each shoulder. Large rosette on either breast and on either side near bottom. This shirt reached to the knees (iii). Neck turned over and hemmed. Sides corded. Bottom finished off thick in weaving. Bottom of sleeves corded. Ornamentation in green cloth, worked in on warp, sides sewn. Pattern worked in in yellow thread. Shirt cut from one piece of cloth. Long, very curly hair.

N 3747 F 21

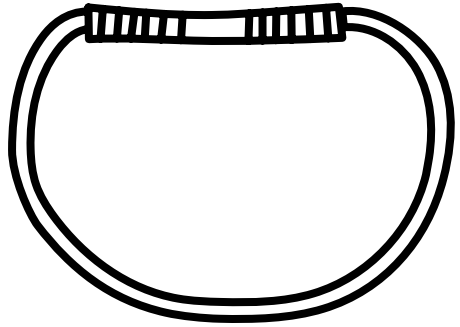

N 3747 F 22

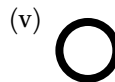
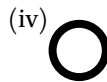
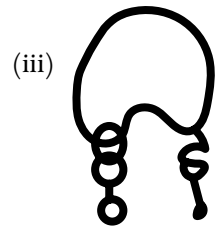
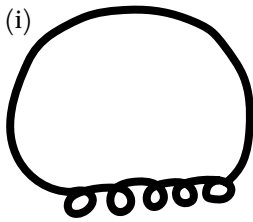

20. Adult. Male? Back teeth worn away. Outside wrapping of plain cloth (almost all gone) tied round with a few cords. Below, wrapping of sackcloth with numerous horizontal bindings of fiber cord and a vertical binding of 9 cords running down center of body and dividing to go round feet and head. Sticks at sides, not underneath, between sackcloth and shirt. At right side, 1 long palm, and 1 short palm, and short piece of "sont." On left side, a long "sont." Over head, several bunches of soft palm fiber. Quantity of salt on body. Remains of shirt with corded edges.

photo C 8472

21. Adult female. Remains of 2-strand fiber cords, 2 thickness. Type of tying? By feet, a bunch of cloth strips in very bad condition covered with a single wrapping(?) of plain cloth. Under body, apparently inside shirt, 4 palm sticks. Over head, remains of a net veil of twisted yellow and black cloth. Round neck, a circlet of bronze? of (i) type. Remains of shirt with a border of green or dark blue with yellow geometrical patterns sewn on to bottom. Also, remains of a large rosette near bottom with yellow, red, and blue wool embroidery. Outer shawl had a fringe and occasional lines of open work filled in with red thread.

photos C 8451, C 8474

22. Child aged approx. 10–12. Cloth very much decayed. Apparently, wrapped first in rough cloth with a large pad over head (see below). Underneath this, tied round in all directions most carefully with 2-strand fiber cord. Over head, a handmade network of coarse threads and dark green wool. Under this, a net cap or hood with knob top. On both ears, elaborate earrings (i) made of a single bronze wire by twisting. From loops hung bronze chains (ii), 2 links being made by twisting a simple wire. These differed in length. At end of each, a glass bead, but on left in one case instead of chain (iii). Fastened to main ring above a small ring (iv). On right forearm, a bronze bracelet (v). On left forearm, 2 iron bracelets. At left elbow, bracelet made by bending to a circle a thin strip of palm and binding it round and round with fiber? Round neck, a necklace consisting of a few shells, 3 small bronze crosses, a bone button, and 2 or 3 green glass beads threaded on cloth twist. Under body, between shirts and outer wrappings, 2 palm sticks. Quantity of salt on body. On 1 finger of left hand, 3 bronze rings and 2 bone. Remains of straight, dark brown hair. Few plant seeds on body. Underneath, apparently 2 shirts, both in very bad condition and stiff with salt. Head pad consisted of a shawl 144 × 60 with fringed edge and 2 small bands of drawn work at each end filled with green wool.

N 3747 F X

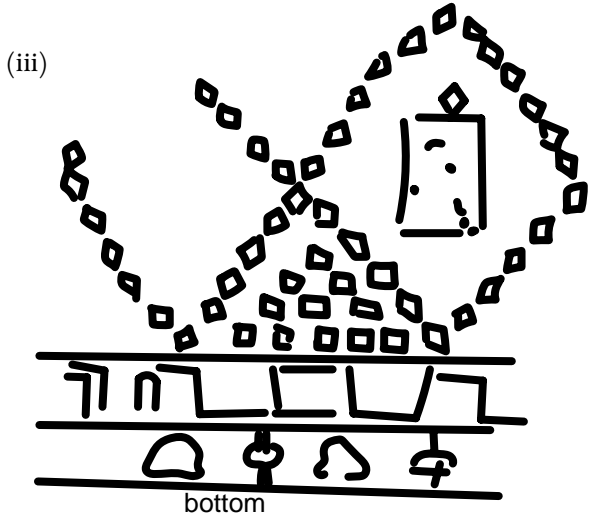
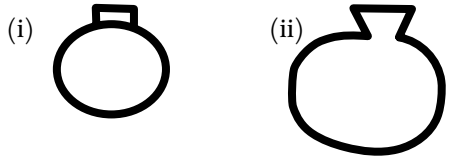

N 4511

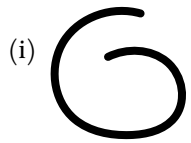
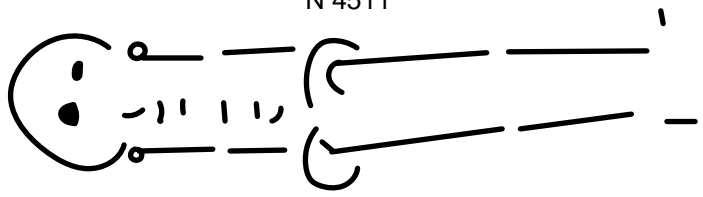

23. Adult female. Remains of 3-strand fiber cord. Not enough left to show type. Wrapped in 2 or possibly 3 shawls of cloth, the 2 outer being fine, the inner coarse. The middle one of these had fringed ends, and near ends, a band of drawn work with decoration in dark blue and red wool. Skull had fallen away out of position. Remains of an embroidered shirt, but very little left. Under body, 1 on each side, 2 palm sticks. Quantity of salt with body. Remains of an extra pad of cloth, which had gone over head. 2 small bronze rings by body ? ? earrings.

photo C 8478

? number X

[ed.: The "X" designation was apparently an official one. In the draft of his manuscript, Mace refers to this burial as 3747 F X.]

Tied first with horizontal 2-strand fiber cord bindings. Then with double vertical bindings, which were fastened together and round body. By feet, a ball of extra cord. Below, wrapped in a sackcloth, ends of which did not meet on top, but underneath. Band of open work near ends. Under this, over head, 5 rolls of halfa grass tied round separately with cord. These contained a small palm stick in center as core. These rested on a bed of loose fiber, the whole being fastened to head by bindings of cord. Below, bound with additional horizontal bindings of cord. Below, a second wrapping of sackcloth similar to first, but without line of open work. Sides of this fastened together with cord. Skull fallen out of position. Vertebrae beginning to join together. 7 lightly joined in one place. On little finger of left hand, an iron ring (i). On third finger of left hand, bronze ring (ii). Round neck, remains of a leather collar? with small pendant leather bag. Remains of 2 shirts? Upper: Practically nothing left but pieces of the embroidery. Lower: Apparently nothing but a shirt reaching to breast, but possibly upper part had disappeared. This had been covered with embroidery sewn straight on to cloth without drawn work. Pattern was something of this sort, etc. (iii)

24. Small child. Remains of a net veil over head.

[ed.: According to Hearst Museum records, 6-1712 (wooden staff) and the ceramics 6-1713-6-1722 and 6-2863 are from this burial.]

N 4511 (TC) Not on map; photos C 8479, C 8571

Copt. Small child. Covered with rough sackcloth. On both wrists, elbows, and ankles, gilt bronze rings, all of (i) pattern. Round head, circlet of palm wood, surrounded on outside with with paste and straw. Round neck, strings of shell and blue and green glass beads. The glass beads were all on left side. On other

side, only one blue bead fastened to a thick cord of leather. Above left shoulder, copper disc, possibly coin, dated 4th year of Justinian (MFA Eg.Inv. 1545). On left ear, bronze earring.

Other objects

[ed.: According to Hearst Museum records, the following objects are attributed to tombs that do not exist in the original excavators' records.]

6-12504, jar, N 2567

6-12505, hoe handle, N 2606

6-12514, incomplete jar, N 2747

6-14349, ovoid jar, N 2051 [ed.: Note that the original excavators' notes tentatively label N 2051 as N 2114, but there is no record of this object in that burial.]

6-14350, broken jar, N 2064

6-14460, jar, N 2265

6-14467, jar, N 2379

Bibliography

Reisner, G. A. 1932. *A Provincial Cemetery of the Pyramid Age, Naga-ed-Dêr Part III*. University of California Publications, Egyptian Archaeology, vol. VI. Berkeley.

Plates



FIGURE 1.1 Modern Coptic graves with plaques (NED-C-8552)



FIGURE 1.2 Superstructure of N 2049 (NED-C-8506)



FIGURE 1.3 Blocked door of N 2114 (NED-C-8518)



FIGURE 1.4 Blocked door of N 2119 (NED-C-8516)



FIGURE 1.5 Blocked door of N 2442 (NED-C-7473)



FIGURE 1.6 Blocked door of N 2507 (NED-C-8522)



FIGURE 1.7 Blocking in front of stela in N 2507 (NED-C-7466)



FIGURE 1.8 Stela in position N 2507 (NED-C-7770)



FIGURE 1.9 Coffin with sandals on top N 2511 (NED-C-2112)



FIGURE 1.10 Blocked door of N 2618 (NED-C-8520)



FIGURE 1.11 Detail of scratchings on door of N 2618 (NED-C-8594)



FIGURE 1.12 N 2640 and N 3747 with superstructure (NED-C-8503)



FIGURE 1.13 Doorway of N 3747 (NED-C-8504)



FIGURE 1.14 (Upper): 1. earring (N 3747, 4, iv), 2. earring (N 3747, 5, vi), 5. earring (N 3747, 17, iii); (middle): 1. gold earring (N 2812, ii); (bottom): 1-2. earring (N 3747, 22, i-iv), 5. copper earring with glass bead pendants (N 2002, ii) (NED-C-8451)

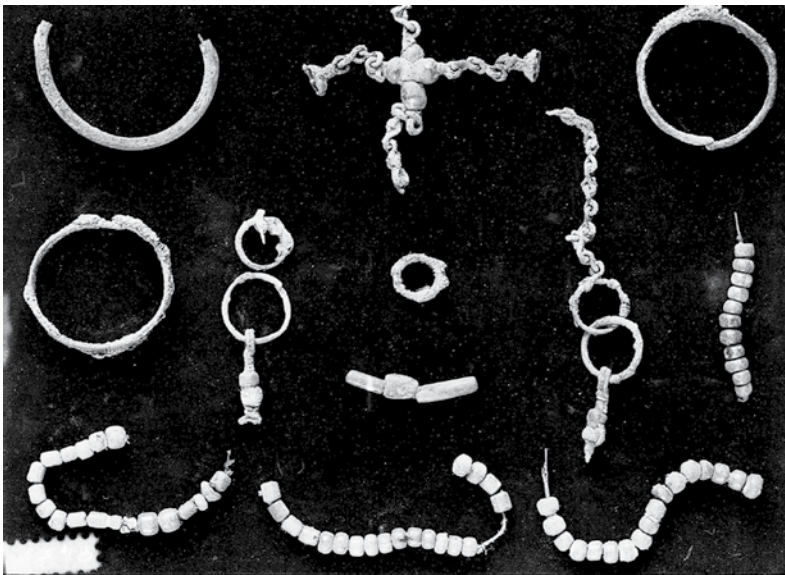

FIGURE 1.15 (Upper): 2. cross of glass beads and copper wire (N 2002, i); (middle): 5. copper earring with glass bead pendants (N 2002, ii) (NED-C-8455)



FIGURE 1.16 Wooden box found in filling on west side (N 2007) (NED-C-8463)



FIGURE 1.17 Broken wooden spade as found under the body in N 2219 (NED-C-7709)

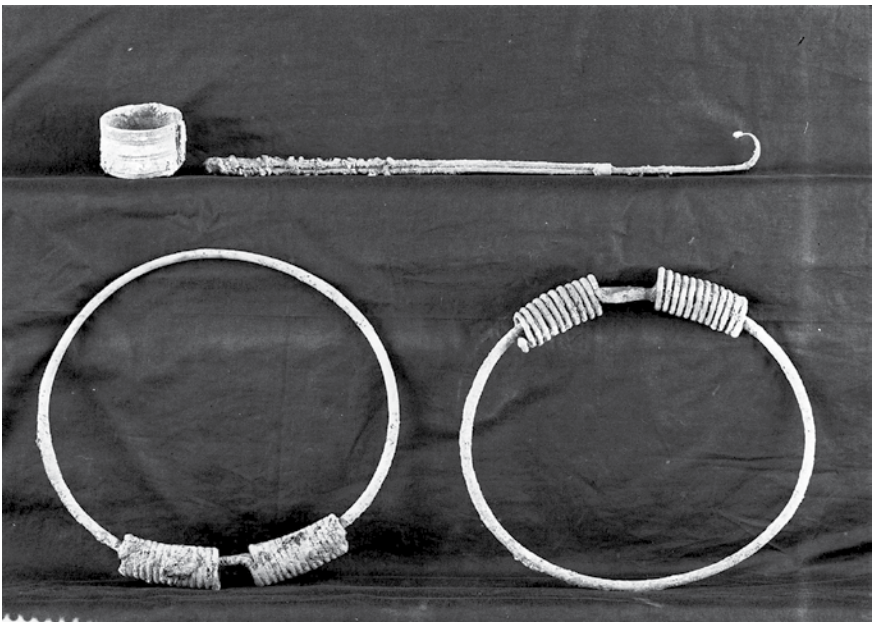

FIGURE 1.18 Copper dipper and handle (N 2417) and bracelets/circlets (as in N 2102, N 3747, 4, i, 21, i) (NED-C-8472)

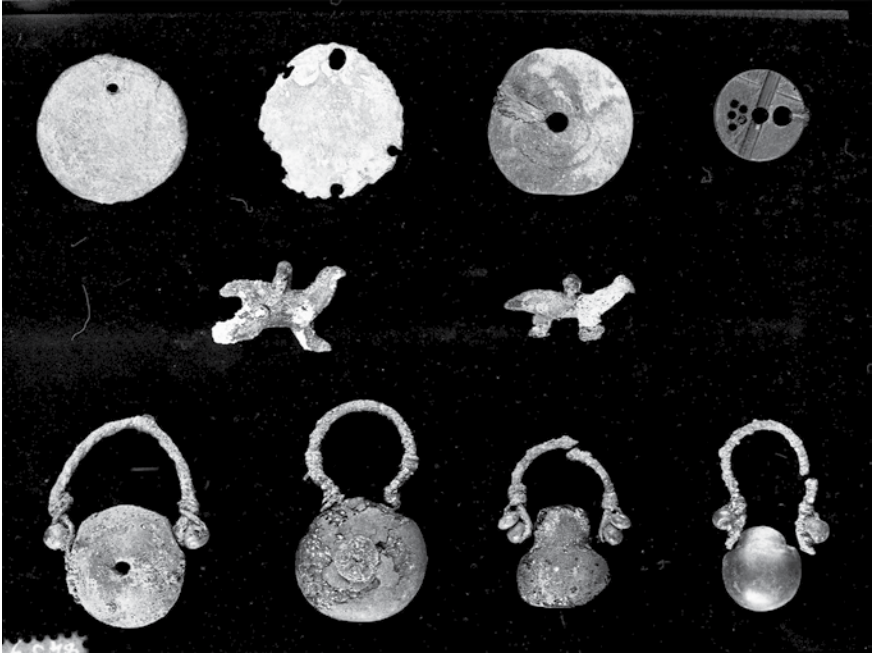

FIGURE 1.19 Jewelry from Coptic tombs. (Middle left): Tentatively identified by excavator as bronze earring (N 2813) (NED-C-8459)

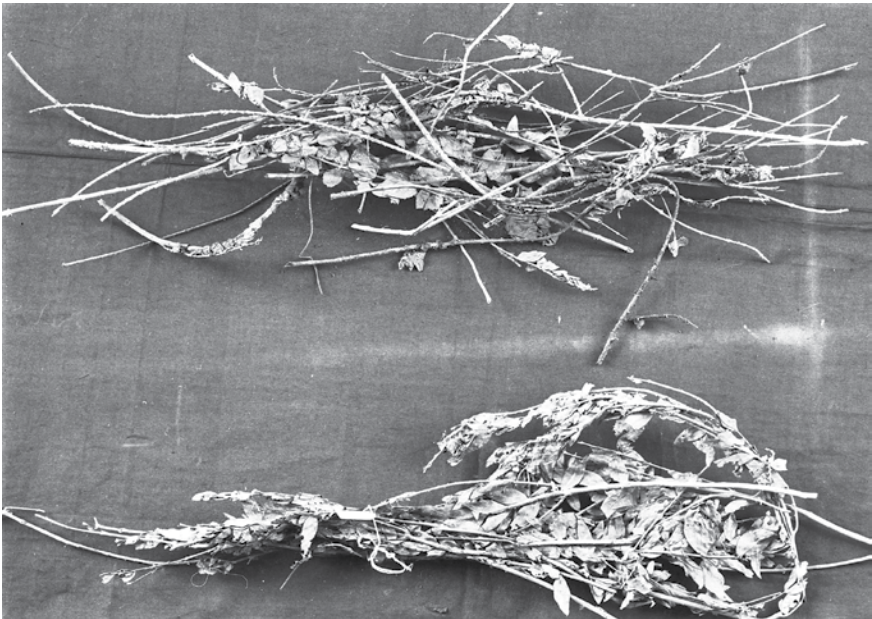

FIGURE 1.20 Dried plant bundles (N 2812, N 2439) (NED-C-8559)

Ceramics

Gabriella diBattista and Brooke Norton

The pottery corpus from N 2000/N 2500 examined for this volume is in keeping with what one expects in a cemetery dating to the First Intermediate Period and Middle Kingdom. The Coptic-era ceramics found at the site were not among the objects in the collections of the Hearst Museum and the MFA (Fig. 2.1). The range of shapes is standard, but fairly broad. Following Schiestl and Seiler (2012), the vessels have been grouped in the catalogue according to whether they are open, closed, produced for a specific use, or miniature. Four objects of particular interest are treated separately (Chapter 3).

In terms of number of vessels, the tomb that immediately stands out in this catalogue is N 2446 = N 2522. 66 ceramic objects, fragmentary and intact, attributed to this tomb are currently in the Hearst Museum collection. That number represents 50% of the entire ceramic corpus from N 2000/N 2500 in



FIGURE 2.1 Coptic ceramics showing decoration (NED-C-8573)

the Hearst Museum. As seen in the table below, according to Hearst Museum records, 77% of tombs listed as find spots for ceramics contained only 1 or 2 ceramics. With the exception of N 2446 = 2522, the greatest number of ceramics, a total of 8 or 9, derive from N 2032 and N 2031 respectively. Given this distribution pattern, one might expect that the hoard of 66 vessels in N 2446 would have been worthy of note by the excavators.

The tomb cards, however, do not indicate that N 2446 was in any way unusual in terms of its finds. Of the tomb's two chambers, one was completely empty, and the other contained a coffin and a human body, both largely destroyed by time and elements. The discovery of the ceramic vessels was noted in this way: "In main chamber, a quantity of pottery (see photo) and a few glaze beads." This comment is sufficiently understated to suggest that the quantity of vessels was unremarkable to the excavators. The photograph mentioned in the field notes has not been identified, so we cannot look at that for evidence of the number of ceramics found in the tomb. A staged photograph (Fig. 3.3) shows 23 intact and fragmentary vessels from N 2446. That number is far fewer than the total of 66 ceramics attributed to N 2446 in Hearst Museum records, but the subjects of that photograph may not represent the entire corpus found in this tomb.

TABLE 2.1 Distribution of ceramic objects in tombs

Number of ceramics attributed to tomb in Hearst Museum records	Total number of tombs
1	19 (N 2034, 2037, 2048, 2051, 2064, 2075, 2090, 2099, 2105, 2107, 2265, 2272, 2332, 2379, 2404, 2507, 2567, 2641, 2747)
2	5 (N 2100, 2431, 2473, 2490, 2701)
3	2 (N 2030, 2093)
4	2 (N 2119, 2493)
6	1 (N 2235)
8	1 (N 2032)
9	1 (N 2031)
66	1 (N 2446 = N 2522)
Total: 133 objects	Total Tombs: 31 tombs

Note: Sherd groups were counted as 1 object. The offering stand in N 2099 was given 3 object numbers in the Hearst Museum, but was counted as 1 object because it was fired together.

The quantity of ceramics found in N 2446 is not the outlier example it seems to be from the Hearst Museum records when compared with the excavators' notes about other tombs in N 2000/N 2500. The tomb cards and the photographs taken on site show that other tombs had large ceramic assemblages. The excavators' comments about other large sets of ceramics from these cemeteries are similarly minimal like the comments about N 2446 quoted earlier. N 2031 is securely dated to the First Intermediate Period because of a stela found face down on the coffin. On the tomb card, the excavator described the stela, coffin, human remains, and a large quantity of beads and also drew the positions of 2 bodies in the tomb, the hieroglyphic name on the stela, 6 ceramic objects, 8 beads, and 2 stoppers. The description of the ceramic find on the tomb card is brief and accompanied by a drawing, "Under coffin, pottery. Quantity of A [alluvial], M [marl] with white inside rim, and [drawing of 6 ceramics]. Slight groove and knife mark." Despite the attention given on the tomb card to the artifacts in N 2031, the field notes do not indicate that a particularly large group of ceramics was found there. A "quantity" is the descriptor, and the drawing is of 6 objects. Approximately 50 ceramics are visible in situ in the field photograph (NED-C-0983). The amount of ceramics pictured in the photographic record tell the story, and on the tomb card, the excavator did not comment further on the size of the assemblage.

The ceramic finds in N 2034 and N 2235 are treated similarly. The tomb card for N 2034 states, "In large chamber, number of A pots, [drawing of 3 ceramics] M, [drawing of 1 ceramic] M." The in situ photograph (NED-C-0993) shows approximately 20 ceramic objects. The N 2235 tomb card reads, "In large chamber, quantity of pottery, about 4 As [drawing of 1 object], M with white rings [drawing of 3 objects].... Entrance to chamber a, blocked by large stones and smaller stones underneath. Pit filled with stones, covered over with *balat* [i.e., stone slabs]." The drawing of the tomb further specifies, "under pottery, *balat* that apparently covered pit." The photographic record of the *balat* (NED-C-0996) shows approximately 15 pieces of pottery next to the stone with another 3 pieces of pottery under it. But the description on the tomb plan states that the *balat* was "under the pottery." Thus before this photograph was taken, the excavators must have already moved the pottery that had been on top of the *balat*. The approximately 18 objects seen in this photograph are just a portion of the full pottery corpus found in N 2235. From the photographic record, we see that N 2031 contained approximately 50 ceramics, N 2034 contained approximately 20, and N 2235 at least 18, probably many more. Currently in the collection of the Hearst Museum, there are 9 ceramic objects from N 2031, 1 from N 2034, and 6 from N 2235. The reason why more objects from the extensive corpora

TABLE 2.2 Distribution of ceramic types

Type group	Count	% of the corpus	Total number of tombs in which material appears
I. Open Vessels	20	18%	12
II. Closed Vessels	79	69%	40
III. Vessels for Production and Specific Household Use	11	10%	10
IV. Closed Miniature and Model Vessels	4	4%	3
Total objects 114			Total tombs 65

of N 2031, 2034, and 2235 were not sent to California, when a large number of objects from N 2446 were sent there, is not clear from the excavation records.

Closed vessels account for the vast majority (69%) of the Hearst Museum corpus of ceramics. Closed vessels were found in 62% of N 2000/N 2500 tombs that contained ceramic objects (partial or whole, but not sherd groups) that are now in the collection of the Hearst Museum. The next most common type is open vessels, which account for 18% of the total corpus in the Hearst Museum. Vessels for specific household use and miniature vessels accounted for 10% and 4% of the corpus respectively.

The vessel type most commonly found in the N 2000/N 2500 collection is the bag-shaped jar, which accounted for 35% of all ceramic types and 51% of all closed vessels in the Hearst Museum from those cemeteries. Most of the bag-shaped jars in this corpus have round bases (90%). The other bag-shaped jar represented here has a flat base and quatrefoil rim (10%). The majority of the bag-shaped jars in the Hearst Museum (60%) were found in N 2446, the tomb that is the find spot for 66 ceramic objects in the Hearst Museum collection. Among that 60%, only one example has the quatrefoil rim and flat base.

The most commonly represented type of open vessel is the shallow simple (30%) and deep simple (25%) bowls. Tall stands account for the majority (82%) of the vessels made for specific use, appearing in 8 tombs. Two types of miniature vessels are represented in the Hearst Museum corpus, the bag-shaped and carinated, and 1 tomb was the find spot for 3 of those vessels.

Vessels of special interest because of their unusual nature and infrequent representation in this corpus include the 4 miniature jars (PAHMA 6-14301, PAHMA 6-14308, PAHMA 6-14309, N 2030; PAHMA 6-14418, N 2093), the 3 bowls

TABLE 2.3 Distribution of ceramic types (detail)

Type	Count	% of group	Total number of tombs in which material appears
I. Open Vessels			
Hemispherical Bowl	1	5%	1 (N 2032)
Shallow Simple Bowl	6	30%	3 (N 2037, 2235, 2246)
Deep Simple Bowl	5	25%	3 (N 2031, 2034, 2235)
Carinated Bowl with Spout	1	5%	1 (N 2490)
Carinated Bowl	3	15%	2 (N 2431, 2446)
Deep Carinated Bowl	3	15%	1 (N 2446)
Restricted Bowl	1	5%	1 (N 2235)
Total objects	20		Total tombs 12
II. Closed Vessels			
Globular Jar	9	11%	3 (N 2446, 2473, 2641)
Ellipsoid Jar	3	4%	3 (N 2031, 2032, 2446)
Cylindrical Beaker	4	5%	3 (N 2032, 2446, 2701)
Ovoid Jar	9	11%	6 (N 2051, 2119, 2272, 2446, 2507, 2747)
<i>Hes</i> -Jar	1	1%	1 (N 2093)
Ovoid Jar related to <i>Hes</i> -Jar	5	6%	3 (N 2032, 2048, 2446)
Bag-Shaped Beaker	1	1%	1 (N 2119)
Bag-Shaped Jar	40	51%	12 (N 2031, 2032, 2075, 2093, 2100, 2235, 2265, 2332, 2379, 2446, 2493, 2567)
Bag-Shaped Bottle	2	3%	1 (N 2446)
Conical Beaker	1	1%	1 (N 2493)
Carinated Jar	6	8%	6 (N 2031, 2064, 2119, 2235, 2404, 2701)
Total objects	79		Total tombs 40
III. Vessels for Production and Specific Household Use			
Lamp	1	9%	1 (N 2100)
Tall Stand	9	82%	8 (N 2031, 2032, 2090, 2107, 2119, 2446, 2473, 2490)
Offering stand	1	9%	1 (N 2099)
Total objects	11		Total tombs 10
IV. Closed Miniature and Model Vessels			
Bag-Shaped Miniature Jar	3	75%	2 (N 2030, 2093)
Carinated Miniature Jar	1	25%	1 (N 2030)
Total objects	4		Total tombs 3

with ring bases (PAHMA 6-14470, N 2431; PAHMA 6-14494, PAHMA 6-14526, N 2446), the lamp (PAHMA 6-14431, N 2100), a carinated jar with a black surface (PAHMA 6-12510, N 2701), a carinated bowl with white painted decoration, (PAHMA 6-14507, N 2446), a carinated bowl with spout (PAHMA 6-14542.1, N 2490) found on a tall stand, and an offering stand with incised decoration (PAHMA 6-14428, PAHMA 6-14429, PAHMA 6-2799, N 2099). The bowl and stand were given 3 object numbers in the Hearst Museum because of the object's fragmentary condition. The largest vessel in this corpus is the ovoid jar PAHMA 6-14461, which is more than 28 cm in height.

1 Ceramics Catalogue

Explanation of the ceramics catalogue:

The finds' description of context below is taken from the Catalogue of Tombs. The photograph numbers reflect the original excavator's numbering system.

Fabric: Nile silt, Marl clay, Black clay with further classifications according to the Vienna system, as described in Nordström and Bourriau (1993) and Bourriau, Nicholson, and Rose (2006).

Shape: according to Schiestl and Seiler (2012)

Surface: comments made from first-hand analysis

Measurements: height, width, exterior rim diameter and thickness, exterior base diameter, and others as relevant, with aperture index calculated according to Schiestl and Seiler (2012). "Max height" indicates a vessel that is slightly uneven or fragmentary and so had larger pieces.

Color: according to Munsell Soil Color Chart

Note regarding objects with multiple object numbers: Some objects in this catalogue have more than one object number associated with them (e.g., PAHMA 6-14318 is a bowl comprised of five sherds. The center sherd in the base is catalogue number PAHMA 6-1470). In addition, some object numbers are associated with more than one vessel (e.g., PAHMA 6-14512 is the catalogue number of an ovoid jar, and PAHMA 6-14512 was also assigned to sherds that are part of the bag-shaped jar PAHMA 6-14510). These vessels with multiple numbers assigned to them seemingly arrived in California intact. Mrs. Phoebe A. Hearst founded what was then known as the University of California Museum of Anthropology in 1901. The museum's collections, including the material from Naga ed-Deir, were stored at that original location at Parnassus Heights in San Francisco. In April 1906, a devastating earthquake followed by days of intense

fires destroyed the majority of the city. The objects in this catalogue that have multiple object numbers assigned to them were likely intact vessels that had been broken during the earthquake. Afterwards, the vessel sherds were given separate object numbers. When the vessels were subsequently reconstructed, the resulting objects consisted of many different object numbers.

Pottery Types

1. Open Vessels

Hemispherical Bowl, Direct Rim, Round Base, Round Contour

Vessels of this type were wheel-made in a variety of materials and sizes (Schiestl and Seiler 2012, 60). This one has a round base.

N 2032 PAHMA 6-14548 (Fig. 2.2)

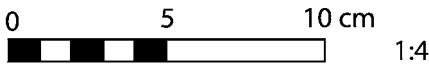
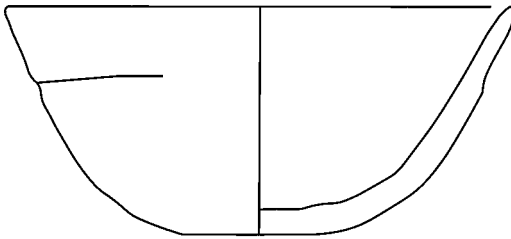

FIGURE 2.2 Hemispherical bowl 6-14548 (N 2032)

Shallow Simple Bowl, Direct Rim, Flat Base

These bowls, which were used for food and/or perhaps incense, were made like the shallow and deep inflected bowls: wheel-thrown with base cut by hand. The sole example in this corpus has a slip on the outer surface.

N 2235 PAHMA 6-14454 (Fig. 2.3)

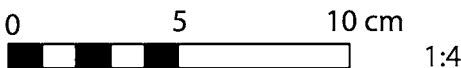
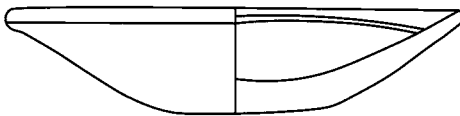

FIGURE 2.3 Shallow simple bowl 6-14454 (N 2235)

Shallow Simple Bowl, Modelled Rim

The shallow bowls in this corpus are slipped. Two of the examples here (PAHMA 6-14473, PAHMA 6-14475) have an incised line on the inner surface that delineates the rim. All of these examples have round bases except one, which has a flat base (PAHMA 6-14473).

N 2037 PAHMA 6-14330

N 2446 PAHMA 6-14473, PAHMA 6-14475, PAHMA 6-14486, PAHMA 6-14492

Deep Simple Bowl, Direct Rim, Round Base

These bowls, which are used to hold food, are wheel-thrown with their bases hand-cut into shape (Schiestl and Seiler 2012, 208). PAHMA 6-14318 and PAHMA 6-14321 both have a white band painted on the inner surface.

N 2031 PAHMA 6-14318, PAHMA 6-14321

N 2235 PAHMA 6-14453

Deep Simple Bowl, Modelled Rim, Round Base

This vessel type is found in a variety of contexts and was used for holding incense and probably food (Schiestl and Seiler 2012, 172).

N 2031 PAHMA 6-14313 (Fig. 2.4)

N 2034 PAHMA 6-14316

Naga ed-Deir
6-14313
Rim diam. 14.68 cm

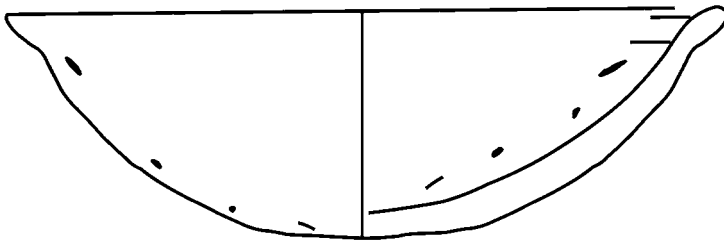

0cm

10cm

FIGURE 2.4 Deep simple bowl 6-14313 (N 2031)

Carinated Bowl with Spout, Direct Rim, Round Base

Bowls with separately attached spouts, found in settlement and funerary contexts, were used for pouring liquids (Schiestl and Seiler 2012, 342). The example in this corpus is made of Nile silt, red-slipped, carinated, and has a round base. It was found in situ on a tall stand (PAHMA 6-14542.2).

N 2490 PAHMA 6-14542.1 (Fig. 2.5)

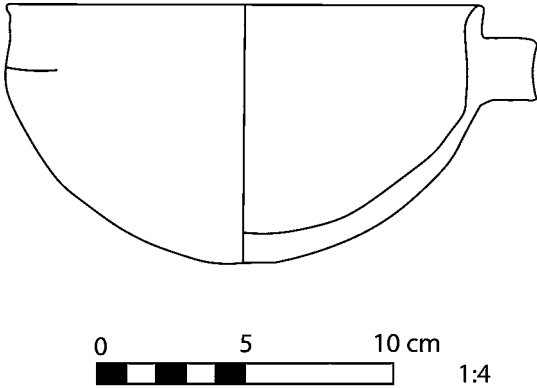

FIGURE 2.5 Carinated bowl with spout 6-14542 (N 2490)

Carinated Bowl, Direct Rim, Flat Base

Neither bowl is currently intact, and PAHMA 6-14501 is too fragmentary to know if it is deep or shallow. PAHMA 6-14501 is slipped and has two incised lines on the outer surface that delineate the rim. Unusual for this corpus is the decoration on the inner surface of PAHMA 6-14507: a white painted cross or X and white dots.

N 2446 PAHMA 6-14501, PAHMA 6-14507

Deep Carinated Bowl, Direct Rim, Flat Base

This fragmentary vessel, like others of this type, has two incised bands under the rim (Schiestl and Seiler 2012, 3230).

N 2446 PAHMA 6-14477 (Fig. 2.6)

Naga ed-Deir
6-14477
Rim diam. 13.66 cm

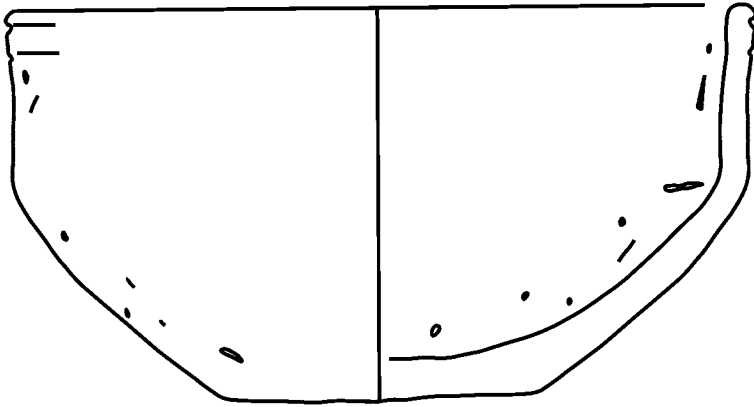

0cm

10cm

FIGURE 2.6 Deep carinated bowl 6-14477 (N 2446)

Deep Carinated Bowl, Direct Rim, Ring Base

These vessels constitute two of this corpus's three examples of applied ring bases, the other being PAHMA 6-14470. Both vessels are red slipped with three incised lines under the rim.

N 2446 PAHMA 6-14494, PAHMA 6-14526

Carinated Bowl, Short Upper Body, Direct Rim, Ring Base

This fragmentary bowl is unusual in this corpus for its applied ring base. The only other vessels in this corpus with that base are two deep hemispherical bowls with round contours (PAHMA 6-14494, PAHMA 6-14526). The inner surface of this vessel is burnished.

N 2431 PAHMA 6-14470 (Fig. 2.7)

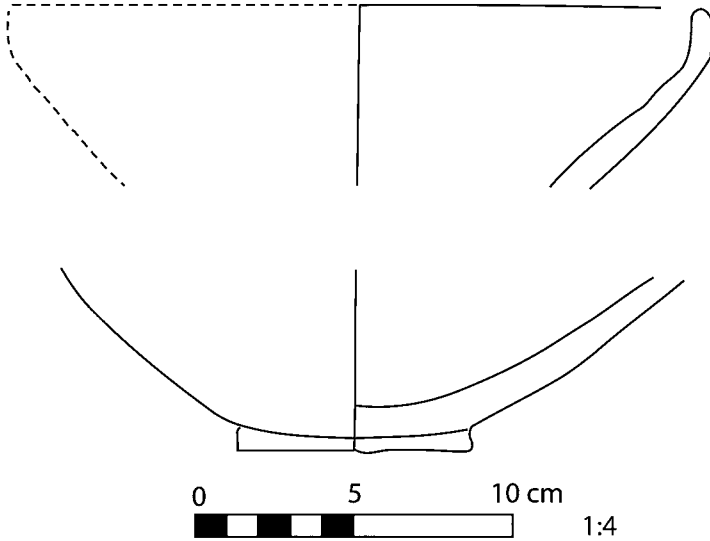

FIGURE 2.7 Carinated bowl 6-14470 (N 2431)

Restricted Bowl, Carinated Contour, Direct Rim, Round Base

The fragmentary state of this slipped bowl resulted in it being assigned two object numbers before it was realized that all the pieces belonged to one vessel. This bowl is decorated with incised lines, one at the rim and more at the shoulder.

N 2235 PAHMA 6-14451a-b (Fig. 2.8)

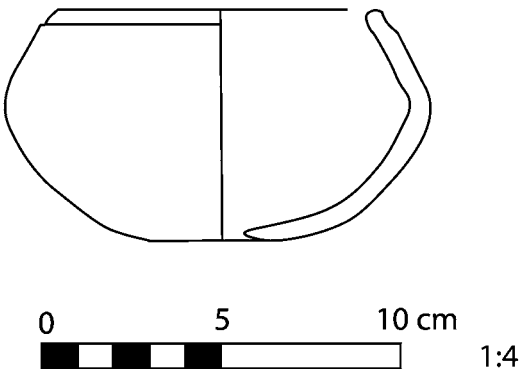

FIGURE 2.8 Restricted bowl 6-14451A (N 2235)

II. Closed Vessels

Globular Jar, Short Neck, Modelled Rim, Round Base

The rims of these vessels are flared slightly (PAHMA 6-14519) and everted (PAHMA 6-12508). PAHMA 6-14519 is also double the height of PAHMA 6-12508.

N 2446 PAHMA 6-14519

N 2641 PAHMA 6-12508

Globular Jar, Quatrefoil Modelled Rim, Flat Base

Examples of this shape are found at Middle and Upper Egyptian funerary sites, used to hold liquids. Other examples of this type of jar have embellishments, such as an incised band (Schiestl and Seiler 2012, 388). The specimens from this corpus that have similar decoration are PAHMA 6-14540 (three molded lines), PAHMA 6-14500 (two incised lines), PAHMA 6-14504 (two incised lines), PAHMA 6-14508 (uneven incised lines), and PAHMA 6-14522 (incised wavy line centered between two incised lines).

N 2446 PAHMA 6-14499, PAHMA 6-14500, PAHMA 6-14504, PAHMA 6-14508, PAHMA 6-14522, PAHMA 6-14523 (Fig. 2.9)

N 2473 PAHMA 6-14540

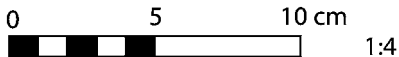
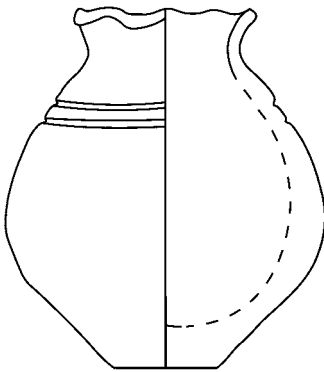

FIGURE 2.9 Globular jar 6-14504 (N 2446)

Ellipsoid Jar, No or Very Short Neck, Modelled Rim, Round Base

Jars of this type, used for storing liquids, have been found at sites along the Nile River Valley (Schiestl and Seiler 2012, 428).

N 2031 PAHMA 6-14319 (Fig. 2.10)

N 2032 PAHMA 6-14325

N 2446 PAHMA 6-14534

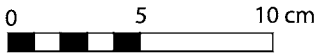
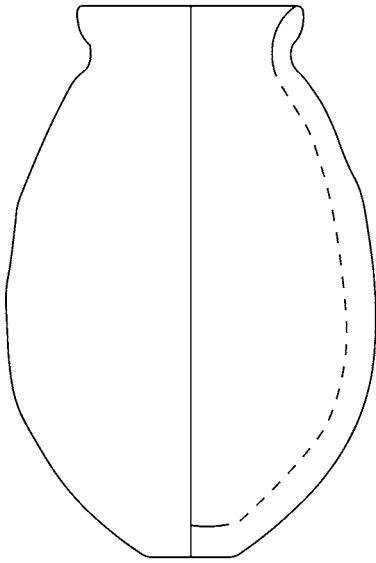

FIGURE 2.10
1:4 Ellipsoid jar 6-14319 (N 2031)

Cylindrical Beaker, Short Flaring Direct or Modelled Rim, Round Base

These beakers, with a round base, are used for storing liquids and are primarily found at Middle and Upper Egyptian funerary sites (Schiestl and Seiler 2012, 448). All of the examples in this corpus are slipped. The flat base on PAHMA 6-14327 is unusual, and there is one broken base (PAHMA 6-14482).

- N 2032 PAHMA 6-14327
 N 2446 PAHMA 6-14482, PAHMA 6-14516
 N 2701 PAHMA 6-12509 (Fig. 2.11)

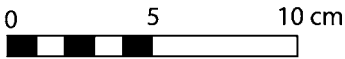
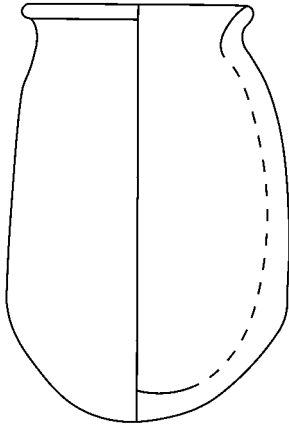

FIGURE 2.11
 1:4 Cylindrical beaker 6-12509 (N 2701)

Ovoid Jar, No or Short Neck, Direct Rolled or Modelled Rim, Flat Base

This shape group is typically made from Nile silt and many are red coated. They are related to *hes*-jars, but this particular variation, with sides that are nearly vertical or that taper to the base, is not common after early Dynasty 12. They are typically found in funerary contexts in Middle and Upper Egypt (Schiestl and Seiler 2012, 512).

- N 2051 PAHMA 6-14349
 N 2446 PAHMA 6-14503, PAHMA 6-14512, PAHMA 6-14525, PAHMA 6-14529
 N 2507 PAHMA 6-12502
 N 2747 PAHMA 6-12514

Ovoid Jar, No or Very Short Neck, Modelled Rim, Round Base

This type of ovoid jar has been separated into medium (heights of 15–18 cm) and large to very large (heights of 45–55 cm) (Schiestl and Seiler 2012, 480). The slipped vessel PAHMA 6-14461, which at a height of 28.4 cm is the largest ceramic in this corpus, falls between those two categories. Additionally, all

examples of this vessel are made of marl clays, while these example are made of Nile silt. PAHMA 6-14441 is white slipped.

N 2119 PAHMA 6-14441 (Fig. 2.12)

N 2272 PAHMA 6-14461

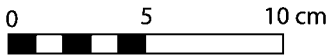
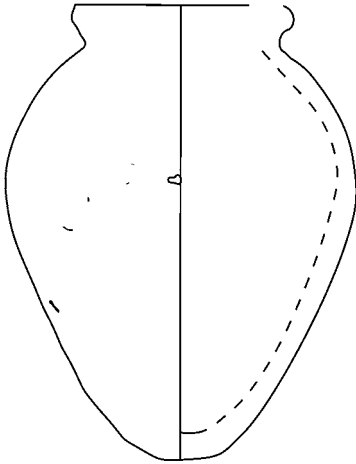

FIGURE 2.12
1:4 Ovoid jar 6-14441 (N 2119)

Hes-Jar

These jars, used for libation, were held at the narrowest point of the vessel, above the base. Nile silt versions are often red coated, and the shape, though widely distributed, is not found in the delta (Schiestl and Seiler 2012, 508).

N 2093 PAHMA 6-14411 (Fig. 2.13)

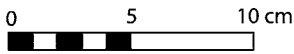
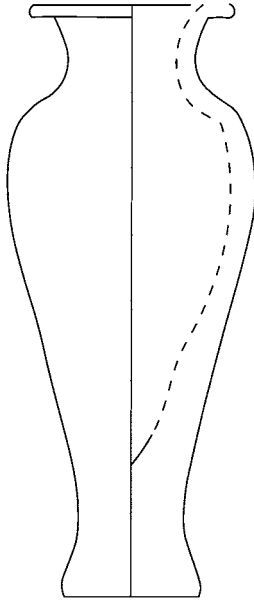

FIGURE 2.13
1:4 *Hes*-jar 6-14411 (N 2093)

Ovoid Jar, Angular Shoulders, Short to Medium Length Neck, Disc-Shaped Rim, Flat Base, Sides Tapering to Base

These jars are similar in form to *hes*-jars, often lacking the splayed base (Schiestl and Seiler 2012, 512).

N 2032 PAHMA 6-14322 (Fig. 2.14)

N 2048 PAHMA 6-14344

N 2446 PAHMA 6-14487, PAHMA 6-14488, PAHMA 6-14493

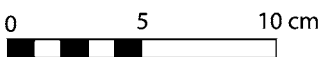
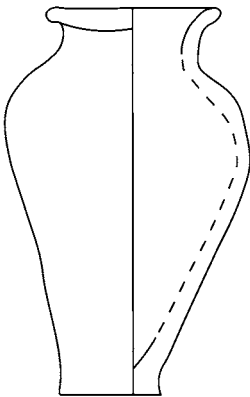

FIGURE 2.14
1:4 Ovoid jar related to *hes*-jar 6-14322 (N 2032)

Bag-Shaped Beaker, Slightly S-Curved Sides, Direct Rim, Flat Base

Vertical striations run around the top of PAHMA 6-14444.

N 2119 PAHMA 6-14444 (Fig. 2.15)

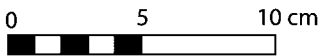
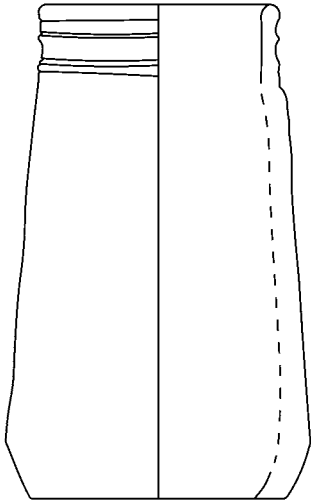

FIGURE 2.15
1:4 Bag-shaped beaker 6-14444 (N 2119)

Bag-Shaped Jar, Wide Straight Neck, Quatrefoil Modelled Rim, Flat Base

This shape is generally created from Nile B2, with the neck's surface coated in red. The documented range of this vessel is quite restricted, from Middle to Northern Upper Egypt and from mid-Dynasty 11 to early Dynasty 12. The vessel type is used for short-term storage of liquids and is often decorated on the shoulder with incised lines, three in parallel or one way between two parallels (Schiestl and Seiler 2012, 554). In this corpus, three of the four vessels are decorated on the shoulder. PAHMA 6-14396 is slipped and painted with two incised lines. PAHMA 6-14416 is slipped with 1 incised line that makes four rotations around the vessel. PAHMA 6-14528 is slipped with two incised lines. PAHMA 6-12504 is slipped with two deeply incised lines. One vessel in this corpus (PAHMA 6-14396) unusually has a round base.

N 2075 PAHMA 6-14396

N 2093 PAHMA 6-14416

N 2446 PAHMA 6-14528

N 2567 PAHMA 6-12504 (Fig. 2.16)

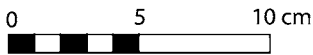
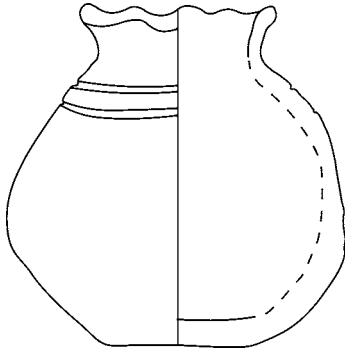

FIGURE 2.16
1:4 Bag-shaped jar 6-12504 (N 2567)

Bag-Shaped Jar, No or Very Short Neck, Everted Modelled or Rolled Rim, Round Base

This is by far the most common type among the ceramics from N 2000/N 2500 now in the collection of the Hearst Museum. According to museum records, most of the 33 specimens were found with other examples of the same type. Three samples are from N 2032, and a surprising 22 examples were in N 2446. The attributions of PAHMA 6-14460 to N 2265, PAHMA 6-14466 to N 2332, PAHMA 6-14467 to N 2379, and PAHMA 6-14543, PAHMA 6-14544, and PAHMA 6-14545 to N 2493 are uncertain due to discrepancies between the original excavators' notes and the data about these objects in the Hearst Museum.

Bag-shaped jars were commonly found in Middle and Upper Egypt and were used for short-term storage or as cooking vessels during Dynasty 11 and early Dynasty 12. Most of the vessels in this corpus do not have the angular shoulder that has been associated with late Dynasty 11 date (Schiestl and Seiler 2012, 556). PAHMA 6-14532 (N 2446) and PAHMA 6-14544 (N 2493) are two examples that do have a small shoulder, although the shoulder on the former is not consistent around the diameter of the vessel.

N 2031	PAHMA 6-14320 (Fig. 2.17)
N 2032	PAHMA 6-14323, PAHMA 6-14326, PAHMA 6-14329
N 2100	PAHMA 6-14430
N 2235	PAHMA 6-14458
N 2265	PAHMA 6-14460
N 2332	PAHMA 6-14466
N 2379	PAHMA 6-14467

N 2446 PAHMA 6-14483, PAHMA 6-14489, PAHMA 6-14490, PAHMA 6-14495, PAHMA 6-14496, PAHMA 6-14497, PAHMA 6-14498, PAHMA 6-14502, PAHMA 6-14505a, PAHMA 6-14505b, PAHMA 6-14506, PAHMA 6-14510, PAHMA 6-14511, PAHMA 6-14513, PAHMA 6-14514b, PAHMA 6-14518, PAHMA 6-14520, PAHMA 6-14521, PAHMA 6-14527, PAHMA 6-14530, PAHMA 6-14531, PAHMA 6-14532, PAHMA 6-14535, PAHMA 6-14536
 N 2493 PAHMA 6-14543, PAHMA 6-14544, PAHMA 6-14545

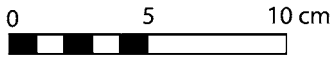
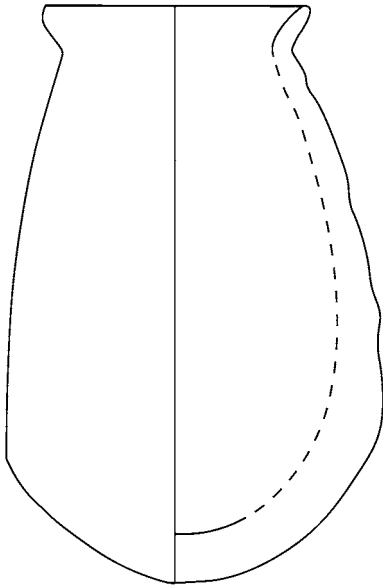

FIGURE 2.17
 1:4 Bag-shaped bottle 6-14320 (N 2446)

Conical Beaker, Direct Rim, Pointed Base

The pointed base of this coarse-ware vessel is unusual within this corpus, although it is commonly found in First Intermediate Period cemeteries and in Upper Egypt into the early Middle Kingdom (Schiestl and Seiler 2012, 132). With this base, the vessel is found exclusively in funerary and ritual contexts.

N 2493 PAHMA 6-14546 (Fig. 2.18)

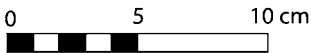
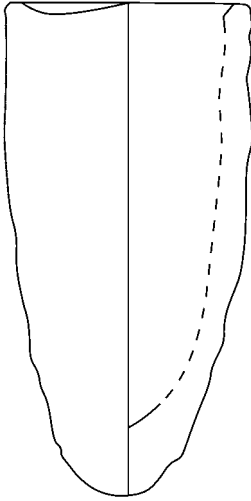

FIGURE 2.18
1:4 Conical beaker 6-14546 (N 2493)

Carinated Jar, No Neck, Modelled Rim, Flat Base

This type of jar is most frequently found in cemeteries in the region of Memphis and the Faiyum.

N 2235 PAHMA 6-14452

Carinated Jar, No Neck, Tall Everted Modelled Rim, Flat Base

This jar type has been separated into small (up to 12.6 cm in height) and medium to large (Schiestl and Seiler 2012, 636). These examples are of medium height. Vertical striations run down the length of the body of PAHMA 6-14443.

N 2031 PAHMA 6-14314 (Fig. 2.19)

N 2064 PAHMA 6-14350

N 2119 PAHMA 6-14443

N 2404 PAHMA 6-14468

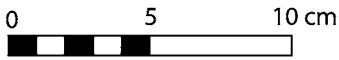
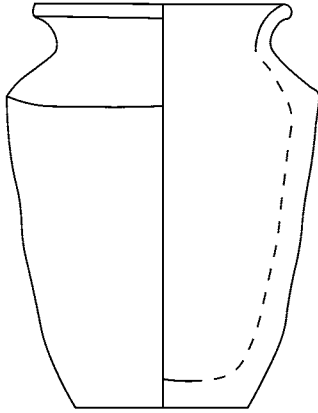

FIGURE 2.19
1:4 Carinated jar 6-14314 (N 2031)

Carinated Jar, Straight Neck, Folded Rim, Flat Base

This vessel is unique in this corpus, the only object with a black surface and the only object of this shape.

N 2701 PAHMA 6-12510

III. Vessels for Production and Specific Household Use

Lamp

Pinched lips that hold a wick in place are a hallmark of lamps, but as noted (Schiestl and Seiler 2012, 778) this vessel type could also have been used as a feeding cup.

N 2100 PAHMA 6-14431 (Fig. 2.20)

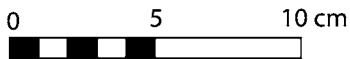
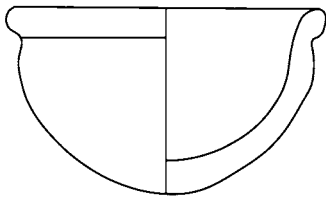

1:4

FIGURE 2.20 Lamp 6-14431 (N 2100)

Tall Stand (Reisner [1932, 94] Type XIII.b Tall Bowl-Stand with Bowl in One Piece)

Tall stands were used in ceremonial contexts to support offering bowls (Schiestl and Seiler 2012, 828). Two of the examples in this corpus have incised lines: PAHMA 6-14541 has 1 incised line, and PAHMA 6-14315 has a series of molded lines.

N 2031	PAHMA 6-14311, PAHMA 6-14315 (Fig. 2.21)
N 2032	PAHMA 6-14324
N 2090	PAHMA 6-14408
N 2107	PAHMA 6-14438
N 2119	PAHMA 6-14442
N 2446	PAHMA 6-14533
N 2473	PAHMA 6-14541
N 2490	PAHMA 6-14542.2

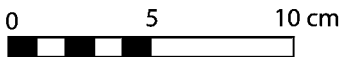
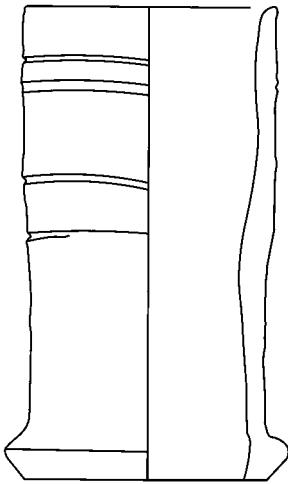

FIGURE 2.21
1:4 Tall stand 6-14315 (N 2031)

Offering Stand (Reisner [1932, 94] Type XIII.b Tall Bowl-Stand with Bowl in One Piece)

A carinated bowl (PAHMA 6-14428) was originally joined to a tall stand, now broken into two pieces (PAHMA 6-14429, PAHMA 6-2799), and the two pieces were fired together. The bowl is decorated with a slip and two incised decorative bands of wavy lines bounded by horizontal lines.

N 2099	PAHMA 6-14428 (Fig. 2.22), PAHMA 6-14429, PAHMA 6-2799
--------	--

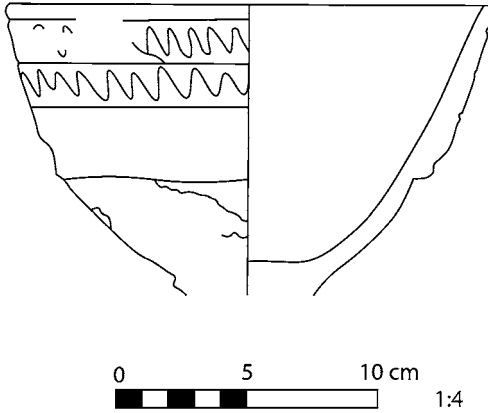

FIGURE 2.22 Offering stand 6-14428 (N 2099)

iv. Closed Miniature and Model Vessels

Bag-Shaped Miniature or Model Jar, Squat, Modelled Rim, Flat Base

Like the other miniature objects from these cemeteries, these examples are made of marl.

N 2093 PAHMA 6-14418

Bag-Shaped Miniature or Model Jar, Squat, Everted Disc-Shaped Modelled Rim, Flat Base

These two vessels, which have disc-shaped rims and are made of marl, were found with another miniature jar (PAHMA 6-14308) and an assortment of other pottery. The flat base of PAHMA 6-14301 is angled, resulting in the vessel leaning to one side. The squat (3.0–3.4 cm high) version of this carinated vessel type, which is found in pottery and stone, in cemeteries and in settlements in Upper Egypt, was used for cosmetics (Schiestl and Seiler 2012, 1042). The height of only one of these vessels (PAHMA 6-14309) falls within that range.

N 2030 PAHMA 6-14301, PAHMA 6-14309 (Fig. 2.23)

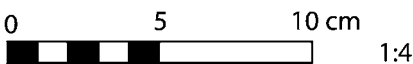
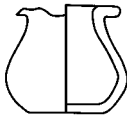

FIGURE 2.23 Ovoid miniature or model jar 6-14309 (N 2030, 2093)

Carinated Miniature or Model Jar, Squat, Everted Disc-Shaped Modelled Rim, Flat Base

This marl vessel was found with two other miniature jars (PAHMA 6-14301, PAHMA 6-14309) and an assortment of other pottery.

N 2030 PAHMA 6-14308 (Fig. 2.24)

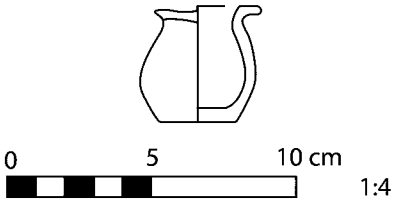

FIGURE 2.24 Carinated miniature or model jar 6-14308 (N 2030)

v. Sherds

Sherds (Beaker)

N 2446 PAHMA 6-14476

Sherds (Bowl)

N 2446 PAHMA 6-14474, PAHMA 6-14479, PAHMA 6-14480, PAHMA 6-14484, PAHMA 6-14514a, PAHMA 6-14515

Sherds (Jar)

N 2031 PAHMA 6-14312

N 2235 PAHMA 6-14455

N 2431 PAHMA 6-14469

N 2446 PAHMA 6-14491, PAHMA 6-14516, PAHMA 6-14517

Non-diagnostic sherds

N 2446 PAHMA 6-14478, PAHMA 6-14524



FIGURE 2.25 (Top row): #1=N 2030, #3=N 2034, #4=2532, #5=2746; (Second row): #3=N 2093; (Third row): #1=N 2034, #3=N 2034, #5=N 2031, #6=N 2446; (Fourth row): #1=N 2446, #2=N 2030, #4=N 2031, #5=N 2747, #6=N 2034 (NED-A-7561)

N 2030 (TC) Map E4; photos B 885, C 7001 (Figs. 2.23, 2.24, 2.25)

Pottery A, M, (i). Small pottery, kohl pot. (PAHMA 6-14301, PAHMA 6-14308, PAHMA 6-14309).

(1) PAHMA 6-14301 Miniature or Model Bag-Shaped Jar

Fabric: Marl A3

Shape: Modelled disc-shaped rim, flat base

Surface: High fired, wheel-made rim, very well-levigated, very little pitting

Height: 3.3 cm

Max Width: 3.2 cm (at rim)

Aperture Index: 43.75

Rim: Diameter: 3.2 cm outer rim, Thickness: 0.35 cm

Base Diameter: 1.0–1.5 cm (elliptical shape)

Color: Body: 10 Y 8/2 Pale Yellow, Surface Discoloration: 2.5 YR 6/4 Light Reddish Brown

The vessel leans to one side because of the angle of the base.

(2) PAHMA 6-14308 Ovoid Miniature or Model Jar

Fabric: Marl A2

Shape: Squat, modelled rim, flat base

Surface: High-fired, wheel-made, well levigated with few visible inclusions, uniform inner matrix color, body impacted on one side

Height: 4.0 cm

Max Width: 4.5 cm (at rim)

Aperture Index: 60

Rim: Diameter: 4.5 cm outer rim, Thickness: 0.30 cm

Base Diameter: 2.2–2.6 cm (elliptical shape)

Color: Body: 2.5 YR 7/6–6/6 Light Red–Red, Slip: 10 Y 8/3 Pale Yellow

(3) PAHMA 6-14309 Bag-Shaped Miniature or Model Jar

Fabric: Marl A3

Shape: Squat, disc-shaped rim, flat base

Surface: High-fired, wheel-made, well-levigated, rim broken at one side

Height: 3.5 cm

Max Width: 4.0 cm

Aperture Index: 42.5

Rim: Diameter: 3.5 cm outer rim, Thickness: 0.30 cm

Base Diameter: 2.5 cm

Color: 2.5 Y 8/2–8/3 Pale Yellow



FIGURE 2.26 Ceramics in position N 2031 (NED-C-0983)

N 2031 (TC) Map E3; photo C 983, C 7178, C 7179, C 8199 (Figs. 2.4, 2.10, 2.19, 2.21, 2.25, 2.26, 2.27, 2.28)

Under coffin, pottery. Quantity of A, M with white inside rim (PAHMA 6-14313, PAHMA 6-14318, PAHMA 6-14321), and (ii) (PAHMA 6-14311, PAHMA 6-14314, PAHMA 6-14315, PAHMA 6-14319, PAHMA 6-14320). Slight groove and knife mark (PAHMA 6-14312).

(1) PAHMA 6-14311 Tall Stand

Fabric: Nile B2

Shape: Direct rim, modelled base

Surface: Surface damage, apparently slipped, calcium carbonate and sand inclusions visible

Max Height: 17.4 cm

Max Width: 15.0 cm

Rim: Diameter: 8.5–9.0 cm (elliptical shape), Thickness: 0.50 cm

Base: Diameter: 10.5–11.0 cm (elliptical shape), Thickness: 1.0 cm

Color: Body: 7.5 YR 6/4–6/6 Light Brown–Reddish Yellow, Slip: 2.5 YR 6/6–5/6 Light Red–Red

(2) PAHMA 6-14312 Sherds (Jar)

Fabric: Nile B2

Shape: Round-Shaped Modelled Rim

Surface: Porous, thick-walled, visible red core, single incised line delineating rim/neck of the jar, outer surface slipped

Max Height: 12.4 cm

Rim: Diameter: 11.0 cm, Thickness: 1.0 cm

Location of Incised line: 2.8–3.2 cm from rim

Color: Body: 7.5 YR 5/1–5/2 Gray–Brown, Slip: 10 YR 8/1–8/2 White–Very Pale Brown, Core: 5 YR 4/6 Yellowish Red

(3) PAHMA 6-14313 Deep Simple Bowl

Fabric: Nile C

Shape: Slightly everted modelled rim, round base

Surface: Red slipped with white band (uneven) around inside of rim and traces of white paint on base; large holes for chaff inclusions

Height: 4.77 cm

Max Width: 12.9 cm

Aperture Index: 113.7

Vessel Index: 307.7

Rim: Diameter: 14.68 cm, Thickness: 0.62 cm
 Base Diameter: 4.1 cm
 Color: Body: 10R 6/6 Light Red, Slip: 2.5 YR 6/6 Light Red

(4) PAHMA 6-14314 Carinated Jar

Fabric: Nile B1

Shape: Slightly everted, modelled rim, flat base, carination at shoulder

Surface: High-fired, some surface cracks, slipped

Height: 14.1 cm

Max Width: 11.0 cm

Aperture Index: 59.1

Rim: Diameter: 8.5 cm outer rim, Thickness: 0.43 cm

Base Diameter: 6.0 cm

Color: Slip: 2.5 YR 6/6–5/6 Light Red–Red

(5) PAHMA 6-14315 Tall Stand

Fabric: Nile B2

Shape: Direct rim, modelled base

Surface: Series of molded lines, well-defined core, porous, no slip, chaff, shell, and sand visible in clay body

Max Height: 16.5 cm

Rim: Diameter: 9.0 cm, Thickness: 0.50 cm

Base: Diameter: 10.0 cm, Thickness: 1.4 cm

Color: Body: 2.5 YR 6/6–6/8 Light Red, Core: 2.5 YR 4/1–3/1 Dark Reddish Gray

This is an incomplete stand.

(6) PAHMA 6-14318 Deep Simple Bowl

Fabric: Nile B2

Shape: Direct rim, round base

Surface: Red slipped, 3.5 cm thick white painted band on inner surface, damage to round base, porous

Height: 5.3 cm

Max Width: 18.0 cm

Aperture Index: 94.4

Vessel Index: 339.6

Rim: Diameter: 18.0 cm, Thickness: 0.50 cm

Color: Clay: 7.5 YR 7/4–6/4 Pink–Light Brown, Slip: 5 YR 5/4–7/6 Reddish Brown–Reddish Yellow, Paint: 7.5 YR 8/2 Pinkish White

Object number PAHMA 6-14318 is a bowl comprised of five sherds. The center sherd in the base is catalogue number PAHMA 6-1470.

(7) PAHMA 6-14319 Ellipsoid Jar

Fabric: Nile B2

Shape: Short, slightly everted neck, modelled rim, round base

Surface: Slipped, minimal porosity, heavily abraded base, some burn marks

Height: 20.7 cm

Max Width: 14.0 cm

Aperture Index: 91.7

Rim: Diameter: 15.0 cm, Thickness: 0.58 cm

Color: Clay: 7.5 YR 6/4–6/6 Light Brown–Reddish Yellow, Slip: 5 YR 6/6 Reddish Yellow, Core: 2.5 YR 6/6–5/6 Red–Light Red

(8) PAHMA 6-14320 Bag-Shaped Jar

Fabric: Nile B2

Shape: No neck, angular-shaped modelled rim, round base (slightly flattened)

Surface: Red slipped, porous, evidence of calcium carbonate and stone inclusions, carination appears near base

Height: 20.8 cm

Max Width: 15.0 cm

Aperture Index: 57.3

Rim: Diameter: 9.5 cm, Thickness: 0.30 cm

Color: Clay: 5 YR 6/4 Light Reddish Brown, Slip: 5 YR 6/6 Reddish Yellow

(9) PAHMA 6-14321 Deep Simple Bowl

Fabric: Nile B2

Shape: Direct rim, round base

Surface: Decorative white band 3.5–4.8 cm thick around rim on the inner surface, sand and stone inclusions visible, some surface pitting visible

Height: 5.7 cm

Max Width: 18.0 cm

Aperture Index: 94.3

Vessel Index: 315.8

Rim: Diameter: 18.5 cm, Thickness: 0.51 cm

Color: Clay: 7.5 YR 6/4 Light Brown, Slip: 5 YR 5/6 Yellowish Red, Paint: 10 YR 8/1 White



FIGURE 2.27 (Second row): #5=N 2032, #8=N 2031; (Third row): #3=N 2032; (Bottom row): #1=N 2031, #4=N 2235 (NED-A-7562)

N 2032 (TC) Map E4 (Figs. 2.2, 2.14, 2.27)

In dotted lines [ed.: See Catalogue of Tombs for diagram.], pottery and above them, thrown down carelessly, stela of (i) (PAHMA 6-14552). Pottery: A, M, (iii) (PAHMA 6-14322, PAHMA 6-14323, PAHMA 6-14324, PAHMA 6-14325, PAHMA 6-14326, PAHMA 6-14327, PAHMA 6-14329, PAHMA 6-14548).

(1) PAHMA 6-14322 Ovoid Jar

Fabric: Nile B₁

Shape: Angular shoulder, everted rim with slight disc-shape, splayed foot, flat base, sides taper to base

Surface: Red-slipped, overall poorly executed, highly uneven vessel, high-fired but with obvious variation in firing condition, burnout visible in slip

Max Height: 14.3 cm

Max Width: 9.0 cm

Aperture Index: 66.9

Rim: Diameter: 6.5–7.0 cm (elliptical in shape), Thickness: 0.49 cm

Base Diameter: 4.2 cm

Color: Clay: 2.5 YR 6/4–5/4 Light Reddish Brown–Reddish Brown, Slip: 2.5 YR 7/6–6/6 Light Red

(2) PAHMA 6-14323 Bag-Shaped Jar

Fabric: Nile C

Shape: Very short neck, everted rolled rim, round base with small flattened section

Surface: Low-fired, porous, chaff visible, cracking/abrasions on the base, outer surface is variable in color

Height: 19.8 cm

Max Width: 14.0 cm

Aperture Index: 57.1

Rim: Diameter: 10.0 cm, Thickness: 1.0

Color: Surface Clay: 5 YR 6/6 Reddish Yellow; 7.5 YR 6/2–6/3 Pinkish Gray–Light Brown

(3) PAHMA 6-14324 Tall Stand

Fabric: Nile B2

Shape: Direct rim, modelled base

Surface: Heavily eroded slip, visible undulation of the outer surface, well-levigated clay with some small shell and sand, chaff visible in slip, highly uneven in shape

Max Height: 16.9 cm

Max Width: 11.6 cm

Rim: Diameter: 8.2 cm (elliptical shape), Thickness: 0.70 cm

Base: Diameter: 10.4 cm (elliptical shape), Thickness: 0.5 cm–1.0 cm

Color: Body: 7.5 YR 6/4–6/6 Light Brown–Reddish Yellow, Slip: 5 YR 5/6 Yellowish Red

(4) PAHMA 6-14325 Ellipsoid Jar

Fabric: Nile B1

Shape: Wide neck, slightly modelled rim, round base

Surface: Wheel-made, slipped, well-levigated, some erosion of surface

Height: 18.0 cm

Max Width: 14.6 cm

Aperture Index: 54.8

Rim: Diameter: 9.0 cm, Thickness: 0.50 cm

Color: Body: 5 YR 6/4–6/6 Light Reddish Brown–Reddish Yellow, Slip: 2.5 YR 7/6–6/6 Light Red

(5) PAHMA 6-14326 Bag-Shaped Jar

Fabric: Nile B2

Shape: Very short neck, everted, modelled rim, round base

Surface: Undecorated, heavily abraded, evidence of chaff, sand, calcium carbonate, and firing marks

Height: 20.2 cm

Max Width: 12.0 cm

Aperture Index: 55.8

Rim: Diameter: 8.5 cm, Thickness: 0.90 cm

Color: Core: 2.5 YR 6/6 Light Red, Outer Surface: 7.5 YR 8/1 White

(6) PAHMA 6-14327 Cylindrical Beaker

Fabric: Nile B1

Shape: Short flaring modelled rim, flat base

Surface: Red slipped, porous core with evidence of chaff and other minute inclusions

Height: 19.0 cm

Max Width: 11.0 cm

Aperture Index: 72.0

Rim: Diameter: 9.0 cm, Thickness: 0.54

Base Diameter: 8.5 cm

Color: Body: 7.5 YR 7/4-6/4 Pink-Light Brown, Slip: 2.5 YR 6/4-6/6 Light Reddish Brown-Light Red

Although many examples of cylindrical beakers feature round bases, PAHMA 6-14327 features a flat base.

(7) PAHMA 6-14329 Bag-Shaped Jar

Fabric: Nile B2

Shape: Very short neck, slightly everted, folded rim, round base

Surface: White accretion, slipped, cracked and abraded base

Height: 19.8 cm

Max Width: 12.0 cm

Aperture Index: 51.7

Rim: Diameter: 8.0 cm, Thickness: 0.90 cm

Color: Body: 7.5 YR 6/4-6/6 Light Reddish Brown-Light Red, Slip: 2.5 YR 6/6-5/6 Light Red-Red

(8) PAHMA 6-14548 Hemispherical Bowl

Fabric: Nile B2

Shape: Direct rim, round contour, round base

Surface: Red slip, wheel-made, porous, large inclusions visible, evidence of calcium carbonate and sand

Height: 7.2 cm

Max Width: 16.0 cm

Aperture Index: 95.0

Vessel Index: 222.2

Rim: Diameter: 16.0 cm, Thickness: 0.40 cm

Color: Body: 5 YR 6/4–5/4 Light Reddish Brown–Reddish Brown, Slip: 2.5 YR 5/6–5/8 Red, Core: 2.5 YR 5/3 Reddish Brown

This is a fragmentary bowl.

N 2034 (TC) Map E4; photo C 993, B 7129 (Fig. 2.25)

In large chamber, number of A pots, (i) M, (ii) M. [ed.: According to Hearst Museum records, PAHMA 6-14316 is from this burial.]

(1) PAHMA 6-14316 Deep Simple Bowl

Fabric: Nile B2

Shape: Inflected with modelled rim, round base

Surface: Undecorated, porous, some surface erosion/damage, apparent sand inclusions, visible chaff

Height: 4.2 cm

Max Width: 15.0 cm

Aperture Index: 93.3

Vessel Index: 357.1

Rim: Diameter: 15.0 cm, Thickness: 0.30 cm

Color: Body: 7.5 YR 7/4–6/4 Pink–Light Brown, Core: 5 YR 5/6 Yellowish Red

This is a fragmentary vessel. Identification has been made based on the measurements of the fragments.

N 2037 (TC) Map E4

[ed.: According to Hearst Museum records, PAHMA 6-14330 is from this burial.]

(1) PAHMA 6-14330 Shallow Simple Bowl

Fabric: Nile B2

Shape: Inflected, modelled rim, round base, significantly uneven in shape

Surface: Slipped surface, chaff visible, evidence of shell and sand included

Max Height: 3.7 cm

Max Width: 15.0 cm

Aperture Index: 84.0

Vessel Index: 378.4

Rim: Diameter: 13.0–14.0 cm, Thickness: 0.40–0.70 cm

Color: Body: 5 YR 6/4–6/6 Light Reddish Brown–Reddish Yellow, Slip: 2.5 YR 6/6 Light Red

N 2048 (TC) Map B3

Coptic burial? [ed.: According to Hearst Museum records, PAHMA 6-14344 is from this burial.]

(1) PAHMA 6-14344 Ovoid Jar

Fabric: Nile B2

Shape: Angular shoulder, everted rim with slight disc-shape, splayed foot, flat base, sides taper to base

Surface: Slipped, very worn, high number of chaffs visible, porous

Height: 16.4 cm

Max Width: 9.2 cm

Aperture Index: 72.8

Rim: Diameter: 7.9 cm, Thickness: 0.60 cm

Base Diameter: 4.3–3.2 cm (elliptical, disk shape)

Color: Body: 2.5 YR 5/6–4/6 Red, Slip: 2.5 YR 6/3–6/4 Light Reddish Brown

N 2051 [ed.: No such tomb number exists on the map or in the tomb cards, but according to Hearst Museum records, the following object was found in that tomb. Note that the original excavators' notes tentatively label N 2051 as N 2114, but there is no record of this object in that burial.]

(1) PAHMA 6-14349 Ovoid Jar

Fabric: Nile B2

Shape: Angular shoulder, short neck, slightly everted, modelled rim, flat base

Surface: Slipped, some firing marks visible, calcium carbonate and sand apparent, wear near base

Height: 23.0 cm

Max Width: 11.0 cm

Aperture Index: 65.4

Rim: Diameter: 8.1 cm, Thickness: 0.60 cm

Base Diameter: 7.5 cm

Color: Body: 2.5 YR 6/6–5/6 Light Red–Red, Slip: 2.5 YR 6/6–5/6 Light Red–Red

N 2064 [ed.: No such tomb number exists on the map or in the tomb cards, but according to Hearst Museum records, the following object was found in that tomb.]

(1) PAHMA 6-14350 Carinated Jar

Fabric: Nile B2

Shape: No neck, everted modelled rim, flat base

Surface: Slipped, some wear evident, well-levigated

Height: 14.3 cm

Max Width: 10.4 cm

Aperture Index: 77.9

Rim: Diameter: 9.2 cm, Thickness: 0.55 cm

Color: Body: 7.5 YR 6/4 Light Brown, Slip 2.5 YR 6/6 Light red

N 2075 (TC) Map A4; type vi d; photo C 8074, B 8248

[ed.: According to Hearst Museum records, PAHMA 6-14396 is from this burial.]

(1) PAHMA 6-14396 Bag-Shaped Jar

Fabric: Nile B2

Shape: Wide straight neck, quatrefoil modelled rim, round base

Surface: Slipped and painted, two incised lines decorate the shoulder of the vessel 5.8–7.2 cm from the vessel rim

Height: 21.5 cm

Max Width: 16.0 cm

Aperture Index: 53.0

Rim: Diameter: 9.0–9.5 cm, Thickness: 0.51 cm

Color: Body: 7.5 YR 7/4–6/4 Pink–Light Brown, Slip: 2.5 YR 7/8 Light Red,

Paint: 10R 6/6–5/6 Light Red–Red

Typically, this bag shape features a flat base, however, PAHMA 6-14396 features a round base.



FIGURE 2.28 (Second row): #8=N 2031 #10=N 2090; (Third row): #5=N 2100, #6=N 2235, #7=N 2031, #8=N 2090; (Fourth row): #6=N 2099, #7=N 2490 (NED-A-7560)

N 2090 (TC) Map C5; photo A 8266, B 7146 (Fig. 2.28)

[ed.: According to Hearst Museum records, PAHMA 6-14408 is from this burial.]

(1) PAHMA 6-14408 Tall Stand

Fabric: Nile C

Shape: Tapered, modelled rim and base

Surface: Handmade, slipped, not well-levigated, evidence of large shell inclusions, sand, stone, and grog, porous

Max Height: 17.8 cm

Max Width: 10.5 cm

Rim: Diameter: 10.5 cm, Thickness: 0.55 cm

Base: Diameter: 5.0 cm, Thickness: 1.0 cm

Color: Body: 2.5 YR 7/6–6/6 Light Red, Slip: 5 YR 6/4–6/6 Light Reddish Brown–Reddish Yellow

N 2093 (TC) Map C5; photo B 7129, B 7144 (Figs. 2.13, 2.23, 2.25)

In b [ed.: See Catalogue of Tombs for diagram.], 2 A pots. In large chamber, broken stela man and wife (i). Several As, M, (ii) (PAHMA 6-14411, PAHMA 6-14416), small clay kohl pot (iii) (PAHMA 6-14418).

(1) PAHMA 6-14411 *Hes-Jar*

Fabric: Nile B2

Shape: Round shoulder, everted rim with slight disc-shape, splayed foot, flat base

Surface: Slipped, high-fired, some small inclusions visible

Height: 23.8 cm

Max Width: 10.0 cm

Aperture Index: 56.0

Rim: Diameter: 8.0 cm, Thickness: 0.50 cm

Base Diameter: 5.7 cm

Color: Body: 2.5 YR 6/6 Light Red, Slip: 2.5 YR 6/6–6/4 Light Reddish Brown–Light Red

(2) PAHMA 6-14416 *Bag-Shaped Jar*

Fabric: Nile B2

Shape: Wide straight neck, quatrefoil modelled rim, flat base

Surface: Slipped (slip variable in color based on firing environment), incised continuous line forming four lines at the shoulder of the vessel, uneven height

Max Height: 14.3 cm

Max Width: 12.0 cm

Aperture Index: 50.8

Rim: Diameter: 6.5–7.5 cm, Thickness: 0.70 cm

Base Diameter: 6.0 cm

Color: Body: 2.5 YR 4/6 Red, Slip: 2.5 YR 7/6–7/8 Light Red; 5 YR 7/4–7/6 Pink–Reddish Yellow

(3) PAHMA 6-14418 *Ovoid Miniature or Model Jar*

Fabric: Marl A3

Shape: Squat, modelled rim, flat base

Surface: Some surface pitting and abrasion at the rim

Height: 3.9 cm

Max Width: 3.8 cm

Aperture Index: 46.8

Rim: Diameter: 2.2 cm, Thickness: 0.21 cm

Color: Body: 10 Y 8/3 Pale Yellow

N 2099 (TC) Map C4; photo C 7471 (Figs. 2.22, 2.28)

Pottery (see photographs). Dish on ring stand (PAHMA 6-14428, PAHMA 6-14429, PAHMA 6-2799). 4 saucers, in a nest.

(1) PAHMA 6-14428 Offering Stand (Deep Bowl)

Fabric: Nile B₁

Shape: Direct rim, carinated, breakage at base

Surface: Slipped, two decorative bands of wavy lines, evident breakage at base, some calcium carbonate and sand apparent

Height: 11.1 cm

Max Width: 18.5 cm

Aperture Index: 94.6

Vessel Index: 166.7

Rim: Diameter: 18.5 cm, Thickness: 0.50 cm

Color: Clay: 2.5 YR 6/6–5/6 Light Red–Red, Slip: 2.5 YR 6/4–6/2 Light Reddish Brown–Pale Red, Core: 10 YR 5/1–4/1 Gray–Dark Gray

PAHMA 6-14428 was previously fired together with and attached to PAHMA 6-14429.

(2) PAHMA 6-14429 Offering Stand (Tall Stand Attached to Bowl [A])

Fabric: Nile B₁

Shape: Disc-shaped base

Surface: Slipped, burn marks evident

Max Height: 17.6 cm

Max Width: 17.0 cm

Base: Diameter: 17.0 cm, Thickness: 0.60 cm

Color: Clay: 2.5 YR 6/6–5/6 Light Red–Red, Slip: 2.5 YR 6/4–6/2 Light Reddish Brown–Pale Red, Core: 10 YR 5/1–4/1 Gray–Dark Gray

PAHMA 6-14429 was previously attached to PAHMA 6-14428.

(3) PAHMA 6-2799 Offering Stand (Tall Stand Attached to Bowl [B])

Fabric: Nile B₁

Shape: Angled modelled rim

Surface: Slipped, burn marks evident

Max Height: 7.2 cm

Max Width: 15.0 cm

Rim: Diameter: 15.0 cm, Thickness: 0.90 cm

Color: Clay: 2.5 YR 6/6–5/6 Light Red–Red, Slip: 2.5 YR 6/4–6/2 Light Reddish Brown–Pale Red, Core: 10 YR 5/1–4/1 Gray–Dark Gray

PAHMA 6-2799 was originally attached to PAHMA 6-14429 as well as PAHMA 6-14428.

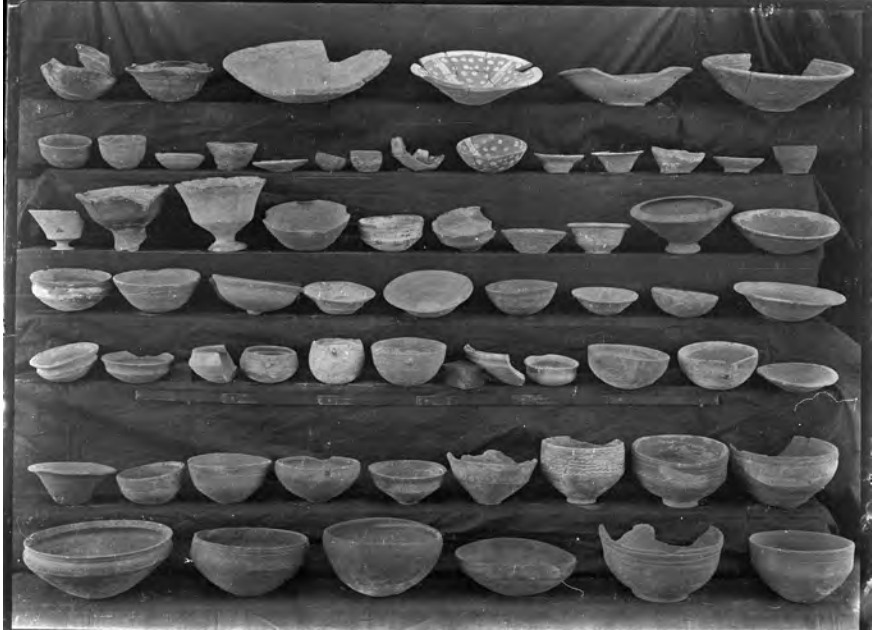

FIGURE 2.29 (Second row): #8=N 2446, #9=N 2717; (Third row): #7=N 2100; (Fifth row): #11=N 2235; (Sixth row): #1=N 2100; (Seventh row): #5=N 2445 (NED-A-7673)

N 2100 (TC) Map C₅ (Figs. 2.20, 2.28, 2.29)

In big chamber, 1 broken skull. Several A pots (i) (PAHMA 6-14430), M (ii). First (ii) with spout, in firm dark red pottery, slightly polished (PAHMA 6-14431).

(1) PAHMA 6-14430 Bag-Shaped Jar

Fabric: Nile B₂

Shape: Very short neck, everted direct rim, round base

Surface: Porous, slipped, damage to slip, visible calcium carbonate and grog included in clay matrix

Height: 20.0 cm

Max Width: 13.0 cm

Aperture Index: 65.4

Rim: Diameter: 9.5 cm, Thickness: 0.50 cm

Color: Body: 7.5 YR 6/4–6/6 Light Brown–Reddish Yellow, Slip: 5 YR 6/6 Reddish Yellow

(2) PAHMA 6-14431 Lamp

Fabric: Nile B₂

Shape: Folded rim, round base

Surface: Slipped, some erosion of slip at the rim

Height: 6.3 cm

Max Width: 11.0 cm

Aperture Index: 81.8

Vessel Index: 174.6

Rim: Diameter: 11.0 cm, Thickness: 1.0 cm

Color: Body: 7.5 YR 6/4 Light Brown, Slip: 2.5 YR 6/6 Light Red

N 2105 (TC) Map D4

[ed.: According to Hearst Museum records, PAHMA 6-1411 is from this burial.]

(1) PAHMA 6-1411 This object has not been located.

N 2107 (TC) Map D4

Copt. Child of about 3. [ed.: According to Hearst Museum records, PAHMA 6-14438 is from this burial.]

(1) PAHMA 6-14438 Tall Stand

Fabric: Nile B2

Shape: Modelled rim, direct base

Surface: Red slipped, incisions near the shoulder of the stand, evident wear, porous, sand and stone inclusions apparent

Max Height: 24.7 cm

Max Width: 10.0 cm

Rim: Diameter: 10.0 cm, Thickness: 0.55 cm

Base: Diameter: 7.0 cm, Thickness: 0.90 cm

Color: Body: 7.5 YR 6/4–6/6 Light Brown–Reddish Yellow, Slip: 2.5 YR 6/4–6/6 Light Reddish Brown–Light Red, Core: 7.5 YR 6/4–6/6 Light Brown–Reddish Yellow

N 2119 (TC) Map D5; photo C 8516, C 8538 (Figs. 2.12, 2.15)

In main chamber ... several pots, A? (i) (PAHMA 6-14442, PAHMA 6-14443, PAHMA 6-14444, M (ii) (PAHMA 6-14441).

(1) PAHMA 6-14441 Ovoid Jar

Fabric: Nile B2

Shape: Modelled rim, short, slightly everted neck, triangular shape, round base

Surface: White slipped, porous, chaff visible on outer surface

Height: 20.0 cm

Max Width: 12.8 cm

Aperture Index: 51.6

Rim: Diameter: 8.0 cm, Thickness: 0.70 cm

Color: Body: 2.5 YR 5/6–4/6 Red, Slip: 10 YR 8/1–8/2 White–Very Pale Brown, Core: 2.5 YR 6/3–5/3 Light Reddish Brown–Reddish Brown

(2) PAHMA 6-14442 Tall Stand

Fabric: Nile B2

Shape: Direct rim, modelled base

Surface: Slipped, cracking at the base, evidence of calcium carbonate, grog, and shell apparent on the surface

Height: 19.3 cm

Max Width: 11.2 cm

Rim: Diameter: 9.5 cm, Thickness: 0.90 cm

Base: Diameter: 10.5 cm, Thickness: 1.0 cm

Color: Body: 2.5 YR 7/6–7/8 Light Red, Slip: 2.5 YR 6/6–5/6 Light Red–Red

(3) PAHMA 6-14443 Carinated Jar

Fabric: Nile B2

Shape: Carinated shoulder, no neck, tall, everted modelled rim, flat base

Surface: Vertical striations on the body of the vessel, slipped, small shell inclusions in clay matrix

Height: 19.7 cm

Max Width: 10.0 cm

Aperture Index: 70.0

Rim: Diameter: 7.5–8.0 cm (elliptical shape), Thickness: 0.50 cm

Color: Body: 7.5 YR 7/4–6/4 Pink–Light Brown, Slip: 2.5 YR 6/6–5/6 Light Red–Red

(4) PAHMA 6-14444 Bag-Shaped Beaker

Fabric: Nile B2

Shape: Everted neck, direct rim, sides flare out almost into a carination, flat base

Surface: High-fired, decorative incised lines from rim, chaff, calcium carbonate, and some small shell inclusions evident, horizontal lines around top of aperture

Height: 18.1 cm

Max Width: 11.4 cm

Aperture Index: 56.4

Rim: Diameter: 9.0 cm, Thickness: 0.70 cm

Base Diameter: 9.5 cm

Color: Body: 2.5 YR 5/6–4/6 Red, Slip: 2.5 YR 6/4 Light Reddish Brown



FIGURE 2.30 Ceramics and blocked door N 2235 (NED-C-0996)

N 2235 (TC) Map E4; photos C 996, B 7114, B 8251 (Figs. 2.3, 2.8, 2.27, 2.28, 2.29, 2.30)

In large chamber, quantity of pottery, about 4 As (i) (PAHMA 6-14451 a–b, PAHMA 6-14452, PAHMA 6-14453, PAHMA 6-14454, PAHMA 6-14455, PAHMA 6-14458), M with white rings (ii).

(1a) PAHMA 6-14451a Restricted Bowl

Fabric: Nile E

Shape: Carinated contour, direct rim, round base

Surface: Slipped, very thin-walled, evidence of sand and shell inclusions, an incised line denotes the rim

Height: 4.5 cm

Max Width: 10.0 cm

Aperture Index: 76.6

Vessel Index: 222.2

Rim Diameter: 9.0 cm, Thickness: 0.67 cm

Color: Body: 5 YR 6/6–6/4 Light Reddish Brown–Reddish Yellow, Slip: 2.5 YR 5/6–4/6 Red

This object number comprises some body sherds and rim fragments.

(1b) PAHMA 6-14451b Restricted Bowl

Fabric: Nile B₁

Shape: Carinated contour, direct rim, round base

Surface: Red slipped, very thin-walled, incised lines at "shoulder" of vessel, larger incised line delineates rim

Height: 5.0 cm

Max Width: 10.0 cm

Aperture Index: 59.6

Vessel Index: 200

Rim: Diameter: 7.0 cm, Thickness: 0.52 cm

Color: Body: 5 YR 6/6–6/4 Reddish Yellow–Light Reddish Brown, Slip: 2.5 YR 6/4–5/4 Light Reddish Brown–Reddish Brown

This object number comprises a number of body sherds and a rim fragment.

(2) PAHMA 6-14452 Carinated Jar

Fabric: Nile B₂

Shape: No neck, round shoulder, modelled rim, flat splayed base

Surface: Traces of red-slip, well-levigated

Height: 7.8 cm (base sherd), 9.4 cm (rim sherd)

Max Width: 8.1 cm (base sherd), 11.5 cm (rim sherd)

Aperture Index: 64.8

Rim: Diameter: 6.1 cm, Thickness: 0.55 cm

Base: Diameter: 6.6 cm

Color: Body: 7.5 YR 6/4 Light Brown, Slip: 2.5 YR 5/6–6/6 Red–Light Red, Core: 7.5 YR 6/4 Light Brown

Unclear how the sherds join.

(3) PAHMA 6-14453 Deep Simple Bowl

Fabric: Nile B₂

Shape: Direct rim, round base

Surface: Slipped, well-levigated, white accretion on surface

Height: 4.9 cm

Max Width: 16.0 cm

Aperture Index: 96.2

Vessel Index: 326.5

Rim: Diameter: 16.0 cm, Thickness: 0.30 cm

Color: Body: 7.5 YR 6/4–6/6 Light Brown–Reddish Yellow, Slip: 2.5 YR 6/6 Light Red

(4) PAHMA 6-14454 Shallow Simple Bowl

Fabric: Nile B2

Shape: Direct rim, flat base

Surface: Outer surface slipped, low-fired, porous, evidence of calcium carbonate and sand

Height: 3.0 cm

Max Width: 13.5 cm

Aperture Index: 98.4

Vessel Index: 450.0

Rim: Diameter: 13.5 cm, Thickness: 0.22 cm

Base Diameter: 4.0 cm

Color: Body: 2.5 YR 6/8–5/8 Light Red–Red, Slip: 5 YR 5/6 Yellowish Red

(5) PAHMA 6-14455 Sherds (Jar)

Fabric: Nile B2

Shape: Direct rim

Surface: Slipped, surface pitting visible, large inclusions

Height: 11.0 cm

Rim: Diameter: 10.0 cm, Thickness: 0.80 cm

Color: Body: 7.5 YR 6/4–5/4 Light Brown–Brown, Slip: 2.5 YR 6/6 Light Red, Core: 2.5 YR 6/6 Light Red

(6) PAHMA 6-14458 Bag-Shaped Jar

Fabric: Nile B2

Shape: Slightly everted modelled rim, round base

Surface: Red slip, porous, large inclusions visible, apparent wear to surface slip

Height: Rim Sherd: 18.1 cm, Base Sherd: 7.0 cm

Max Width: 13.5 cm

Aperture Index: 62.2

Rim: Diameter: 9.5 cm, Thickness: 0.55 cm

Color: Body: 7.5 YR 6/4–6/6 Light Brown–Reddish Yellow, Slip: 5 YR 6/6 Reddish Yellow; 7.5 YR 5/1–4/1 Gray–Dark Gray; 2.5 YR 6/4–6/6 Light Reddish Brown–Light Red

PAHMA 6-14458 consists of a series of sherds that comprise the bag-shaped jar. Among these sherds is one labeled with catalogue number PAHMA 6-14455 despite belonging to the same vessel. Together, these catalogue numbers are categorized under Temp No. 2015.0100.

N 2265 [ed.: No such tomb number exists on the map or in the tomb cards, but according to Hearst Museum records, the following object was found in that tomb.]

(1) PAHMA 6-14460 Bag-Shaped Jar

Fabric: Nile C

Shape: No neck, slightly everted modelled rim, round base

Surface: Slipped (flaking), some pitting and chaff visible in surface, obvious undulation of vessel wall

Height: 18.5 cm

Max Width: 14.7 cm

Aperture Index: 54.4

Rim: Diameter: 9.0 cm, Thickness: 0.50 cm

Color: Body: 7.5 YR 7/4-6/4 Pink-Light Brown, Slip: 5 YR 7/6-6/6 Reddish Yellow

N 2272 (TC) Map A4

(i) in smooth red (PAHMA 6-14461).

(1) PAHMA 6-14461 Ovoid Jar

Fabric: Nile D

Shape: Short neck, modelled rim, round base

Surface: Slipped, well-levigated clay matrix, evidence of calcium carbonate on the slip, rim flattened to one side, burn marks in the slip

Max Height: 28.4 cm

Max Width: 20.0 cm

Aperture Index: 44.5

Rim: Diameter: 9.9-10.5 cm, Thickness: 0.80 cm

Color: Body: 2.5 YR 6/6 Light Red, Slip: 2.5 YR 5/6 Red

PAHMA 6-14461 is the largest ceramic vessel in the corpus.

N 2332 (TC; MM) Map E3

Coptic graves. Burials gone. [ed.: According to Hearst Museum records, PAHMA 6-14466 is from this tomb.]

(1) PAHMA 6-14466 Bag-Shaped Jar

Fabric: Nile B2

Shape: No neck, everted modelled rim, round base

Surface: Slipped, impacted to one side, evidence of sand included, minor pitting in the slip surface, chaff visible

Height: 19.0 cm

Max Width: 16.0 cm

Aperture Index: 47.5

Rim: Diameter: 8.8 cm, Thickness: 0.60 cm

Color: Body: 2.5 YR 6/6 Light Red, Slip: 2.5 YR 6/4 Light Reddish Brown

N 2379 [ed.: No such tomb number exists on the map or in the tomb cards, but according to Hearst Museum records, the following object was found in that tomb.]

(1) PAHMA 6-14467 Bag-Shaped Jar

Fabric: Nile B2

Shape: Short, flaring neck, modelled rim, round base

Surface: Slipped, small shell inclusions evident in clay matrix, abrasions near the vessel base

Height: 20.0 cm

Max Width: 12.0 cm

Aperture Index: 60.8

Rim: Diameter: 8.5 cm, Thickness: 0.60 cm

Color: Body: 7.5 YR 6/4-7/4 Light Reddish Brown, Slip: 2.5 YR 6/6 Light Red

This is a typical shape within the cylindrical beaker categorization.

N 2404 (TC) Map E3 [ed.: 2405 in ink, but 2404 in pencil.]

Broken away. Contained nothing. [ed.: According to Hearst Museum records, PAHMA 6-14468 is from this burial.]

(1) PAHMA 6-14468 Carinated Jar

Fabric: Nile B2

Shape: Short neck, everted modelled rim, carination at shoulder, flat base

Surface: Red-slipped, evidence of calcium carbonate, sand, and grog visible in surface

Height: 18.8 cm

Max Width: 13.0 cm

Aperture Index: 48.5

Rim: Diameter: 8.5 cm, Thickness: 0.50 cm

Base Diameter: 7.5 cm

Color: Body: 7.5 YR 6/4 Light Reddish Brown, Slip: 2.5 YR 6/6 Light Red

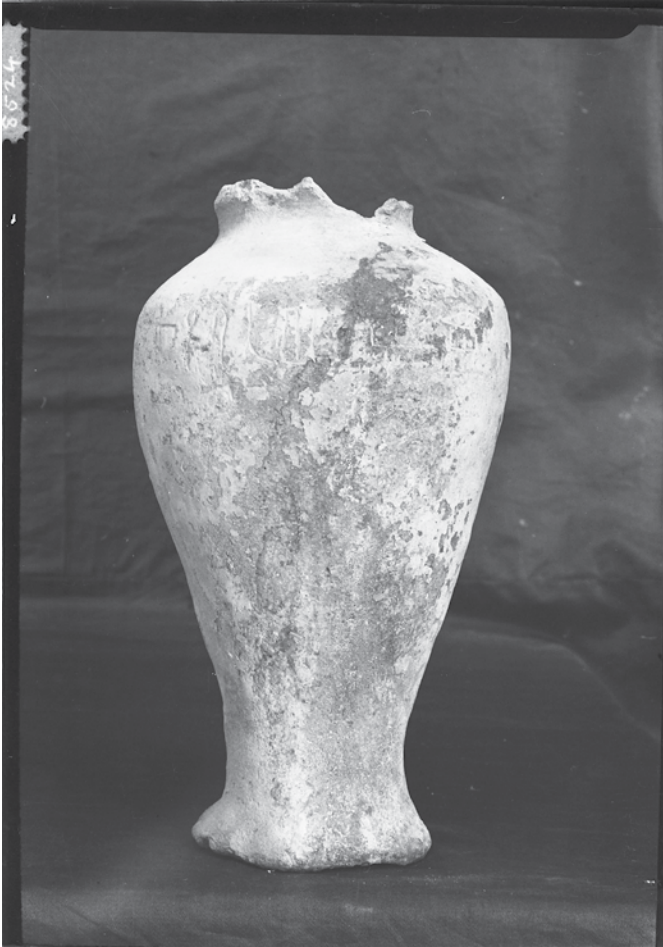

FIGURE 2.31 Inscribed ceramic vessel found in N 2276 (NED-C-8524)

N 2431 (TC) Map D3/D4 [ed.: Map location not listed in excavation records; possibly between N 2637, N 2636, and N 2638 in tear on map. Note that there is another tomb labeled N 2431 that is associated with N 2207.]; photo C 8466 (Fig. 2.7)

Several broken pots (i) A, (ii) rough outside, red polish inside (PAHMA 6-14470), piece of a (iii)? Fragment of rim of a slate bowl. Fragments of Coptic pottery in filling of pit with scratched inscriptions. [ed.: For an inscribed ceramic from N 2276, see Fig. 2.31. According to Hearst Museum records, PAHMA 6-14469 is from this burial.]

(1) PAHMA 6-14469 Sherds (Jar)

Fabric: Nile C

Shape: Round base (with flattened section)

Surface: Undecorated, very thick-walled, porous, some chaff visible along with calcium carbonate, shell, stone

Max Height: 17.2 cm

Max Width: 13.5 cm

Max Wall Thickness: 3.2 cm

Color: Body: 5 YR 6/6–5/6 Reddish Yellow–Yellowish Red, Core: 5 YR 3/1–4/1 Very Dark Gray–Dark Gray

PAHMA 6-14469 is subsumed under Temp no. 2015.0434.

(2) PAHMA 6-14470 Carinated Bowl

Fabric: Nile B2

Shape: Direct rim, carinated, ring base

Surface: Burnished inner surface, few inclusions with the exception of small shell, inner surface is striated

Max Height: Rim Sherd: 5.7 cm, Base Sherd: 6.7 cm

Max Width: 22.0 cm

Aperture Index: 95.4

Rim: Diameter: 22.0 cm, Thickness: 0.50 cm

Base Diameter: 7.0 cm

Color: Body: 7.5 YR 5/4–6/5 Brown–Light Brown, Slip: 2.5 YR 6/4–6/6 Light Reddish Brown–Light Red

This is a fragmentary bowl. The ring base seen on PAHMA 6-14470 is rare in the corpus.

N 2446 = N 2522 (TC) Map E3; photos B 7142, B 7144, C 7474 (Figs. 2.6, 2.9, 2.17, 2.25, 2.29)

In main chamber, a quantity of pottery (see photo). [ed.: According to Hearst Museum records, the ceramics from this burial are PAHMA 6-14473 through PAHMA 6-14536.]

(1) PAHMA 6-14473 Shallow Simple Bowl

Fabric: Nile B2

Shape: Inflected, modelled rim, flat base

Surface: Slipped, chaff evident, stone inclusions in clay matrix, porous, abrasions near base, incised line on inner surface delineating rim

Height: 5.5 cm

Max Width: 20.0 cm

Aperture Index: 95.0

Vessel Index: 363.6

Rim: Diameter: 20.0 cm, Thickness: 0.40 cm

Color: Body: 7.5 YR 5/4–6/4 Brown–Light Brown, Slip: 2.5 YR 5/6–6/6 Red–Light Red

This is a fragmentary bowl. PAHMA 6-14473 is attached to catalogue number PAHMA 6-16931 and is subsumed under Temp no. 2015.099. This likely fits together with catalogue number PAHMA 6-14475, which is part of this corpus and is also subsumed under Temp no. 2015.099.

(2) PAHMA 6-14474 Sherd (Bowl)

Fabric: Nile B2

Shape: Modelled rim, likely inflected body shape, no base available

Surface: Slipped, incised line delineating modelled rim, evident sand and shell inclusions as well as chaff, abrasions at base

Sherd Height: 6.3 cm

Max Width: 20.0 cm

Aperture Index: 94.3

Rim: Diameter: 20.0 cm, Thickness: 0.57 cm

Color: Body: 7.5 YR 6/4–7/4 Light Brown–Pink, Slip: 10 R 6/8 Light Red

This is a fragmentary bowl.

(3) PAHMA 6-14475 Shallow Simple Bowl

Fabric: Nile B2

Shape: Inflected, modelled rim, round base

Surface: Slipped, chaff evident, stone inclusions in clay matrix, porous, abrasions near base, incised line on inner surface delineating rim

Height: 5.5 cm

Max Width: 20.0 cm

Aperture Index: 95.0

Vessel Index: 363.6

Rim: Diameter: 20.0 cm, Thickness: 0.40 cm

Color: Body: 7.5 YR 5/4–6/4 Brown–Light Brown, Slip: 2.5 YR 5/6–6/6 Red–Light Red

This is a fragmentary bowl. Based on comparison of the clay body and decoration, PAHMA 6-14475 is likely attached to PAHMA 6-14473. Both are currently separately filed under Temp no. 2015.099.

(4) PAHMA 6-14476 Sherds (Beaker)

Fabric: Nile B2

Shape: Cylindrical, no neck, everted, modelled rim, no base available

Surface: Slipped (very worn), abrasions evident, chaff evident in surface

Max Height: 13.7 cm

Max Width: 10.4 cm

Aperture Index: 67.3

Rim: Diameter: 8.0 cm, Thickness: 0.50 cm

Color: Body: 7.5 YR 7/4 Pink, Core: 7.5 YR 5/1-5/2 Gray-Brown, Slip: 2.5 YR 6/4-6/6 Light Reddish Brown-Light Red

PAHMA 6-14476 consists of a number of sherds subsumed under Temp no. 2015.0865 and associated with catalogue number PAHMA 6-14524.

(5) PAHMA 6-14477 Deep Carinated Bowl

Fabric: Nile C

Shape: Direct rim, flat base

Surface: Red slipped and burnished; two incised lines on rim (exterior)

Height: 7.3 cm

Max Width: 13.4 cm

Aperture Index: 101.9

Vessel Index: 187.1

Rim: Diameter: 13.66 cm, Thickness: 0.59 cm

Base: Diameter: 5.1 cm

Color: Body: 7.5 YR 6/4 Light Brown, Slip: 2.5 YR 5/6-6/6 Red-Light Red, Core: 7.5 YR 6/4 Light Brown

This is a fragmentary bowl.

(6) PAHMA 6-14478 Non-diagnostic sherd (1.8 cm total diameter)

(7) PAHMA 6-14479 Sherd (Bowl)

Fabric: Nile B2

Shape: Hemispherical, direct rim, triangular contour, no base available

Surface: Slipped, decorative incision surrounding rim, porous, some stone embedded in outer surface

Sherd Height: 7.1 cm

Max Width: 18.0 cm

Aperture Index: 96.7

Rim: Diameter: 18.0 cm, Thickness: 0.30 cm

Color: Body: 5 YR 5/4-6/4 Reddish Brown-Light Reddish Brown, Core: 5 YR 6/2-6/3 Pinkish Gray-Light Reddish Brown, Slip: 2.5 YR 5/6-6/6 Red-Light Red

(8) PAHMA 6-14480 Sherd (Bowl)

Fabric: Nile C

Shape: Inflected, direct rim, round base

Surface: Fragmentary, slipped, porous, some chaff visible, included stone and shell

Max Sherd Height: 5.2 cm

Max Width: 21.0 cm

Aperture Index: 95.2

Rim: Diameter: 21.0 cm, Thickness: 0.50 cm

Color: Body: 5 YR 6/6–7/4 Reddish Yellow–Pink, Slip: 2.5 YR 6/4–6/6 Light Reddish Brown–Light Red

(9) PAHMA 6-14481 Bag-Shaped Jar

This object number refers to sherds associated with PAHMA 6-14511. See that record for other object numbers associated with PAHMA 6-14511.

(10) PAHMA 6-14482 Cylindrical Beaker

Fabric: Nile B2

Shape: Very short neck, everted modelled rim, flat base

Surface: Slipped, evidence of burnishing, porous, 3 incised lines 0.1–0.2 cm in thickness at shoulder

Height: 23.2 cm

Max Width: 11.0 cm

Aperture Index: 84.7

Rim: Diameter: 10.0 cm, Thickness: 0.34 cm

Base Diameter: 8.5 cm

Color: Clay Body: 2.5 YR 6/6–5/6 Light Red–Red, Slip: 2.5 YR 6/6–5/6 Light Red–Red

Unusual flat base.

(11) PAHMA 6-14483 Bag-Shaped Jar

Fabric: Nile B2

Shape: No neck, everted modelled rim, round base

Surface: Slipped, porous, included calcium carbonate and shell in large quantity, size of shell included is relatively large (0.90 cm in length)

Max Height: 17.0 cm

Max Width: 13.0 cm

Aperture Index: 58.5

Rim Diameter: 9.0 cm

Rim Thickness: 0.70 cm

Color: Body: 2.5 YR 5/4 Reddish Brown, Slip: 7.5 YR 8/2 Pinkish White

This is a fragmentary jar.

(12) PAHMA 6-14484 Sherds (Bowl)

Fabric: Nile B2

Shape: Hemispherical, apparent triangular contour, modelled rim, no base

Surface: Slipped, incision on inner surface 0.20–0.45 cm thick delineating rim, multiple sherds, porous, variable thickness, sand and shell evident, abrasions on the outer surface of sherds indicating possible hand-shaped base

Max Sherd Height: 5.5 cm

Max Width: 19.0 cm

Aperture Index: 94.7

Rim: Diameter: 19.0 cm, Thickness: 0.50 cm

Color: Body: 7.5 YR 6/4–7/4 Light Brown–Pink, Slip: 2.5 YR 6/4–5/4 Light Reddish Brown–Reddish Brown, Core: 7.5 YR 5/1–6/1 Gray

(13) PAHMA 6-14485 Bag-Shaped Jar

This object number refers to sherds associated with PAHMA 6-14511. See that record for other object numbers associated with PAHMA 6-14511.

(14) PAHMA 6-14486 Shallow Simple Bowl

Fabric: Nile B2

Shape: Inflected, slightly everted modelled rim, round base

Surface: Porous, slipped, evidence of chaff and calcium carbonate in clay matrix, incision 0.40–0.50 cm thick delineating rim on inner surface

Height: 4.5 cm

Max Width: 23.0 cm

Aperture Index: 93.9

Vessel Index: 511.1

Rim: Diameter: 23.0 cm, Thickness: 0.70 cm

Color: Body: 7.5 YR 6/4–6/6 Light Brown–Reddish Yellow, Slip: 5 YR 6/6–5/6 Reddish Yellow–Yellowish Red, Core: 7.5 YR 4/1 Dark Gray, 2.5 YR 6/4–4/6 Light Reddish Brown–Red

This is a fragmentary bowl.

(15) PAHMA 6-14487 Ovoid Jar

Fabric: Nile B2

Shape: Angular shoulder, everted rim with slight disc-shape, splayed foot, flat base, sides taper to base, impacted to one side at rim and neck

Surface: Red-slipped, well-levigated, low-porosity
 Max Height: 21.5 cm
 Max Width: 12.1 cm
 Aperture Index: 45.5
 Rim: Diameter: 7.5 cm, Thickness: 0.70 cm
 Base Diameter: 5.7–6.0 cm
 Color: Body: 7.5 YR 6/4 Light Brown, Slip: 2.5 YR 5/6–6/6 Red–Light Red

(16) PAHMA 6-14488 Ovoid Jar

Fabric: Nile B1
 Shape: Angular shoulder, everted disc-like rim with slight disc-shape, splayed foot, flat base, sides taper to base
 Surface: Red-slipped, well-levigated, abrasions near base, white accretion on vessel sides
 Max Height: 22.5 cm
 Max Width: 13.0 cm
 Aperture Index: 33.8
 Rim: Diameter: 6.2 cm, Thickness: 0.50 cm
 Base Diameter: 8.6 cm
 Color: Body: 2.5 YR 5/6–6/6 Red–Light Red, Slip: 2.5 YR 5/6–6/6 Red–Light Red

(17) PAHMA 6-14489 Bag-Shaped Jar

Fabric: Nile B2
 Shape: Very short neck, slightly everted rolled rim, round base
 Surface: Slipped, with cracks evident in surface, pitting and chaff apparent
 Height: 19.7 cm
 Max Width: 12.4 cm
 Aperture Index: 85.4
 Rim: Diameter: 8.0 cm, Thickness: 0.90 cm
 Color: Body: 7.5 YR 6/4 Light Brown, Slip: 2.5 YR 5/6–6/6 Red–Light Red

(18) PAHMA 6-14490 Bag-Shaped Jar

Fabric: Nile B2
 Shape: No neck, everted modelled rim, round base
 Surface: Slipped, undulating surface to one side, evidence of sand and chaff in surface, uneven
 Height: 21.0 cm
 Max Width: 15.0 cm
 Aperture Index: 56.0

Rim: Diameter: 9.8 cm, Thickness: 0.70 cm

Color: Body: 5 YR 5/6–6/6 Yellowish Red–Reddish Yellow, Slip: 5 YR 7/4–7/6 Pink–Reddish Yellow

(19) PAHMA 6-14491 Sherds (Jar)

Fabric: Nile C

Shape: Round base, no rim

Surface: Slipped but very worn, low-fired, porous, large inclusions of stone and shell visible

Max Sherd Height: 7.0 cm

Max Width: 13.0 cm

Color: Body: 5 YR 6/4–7/4 Light Reddish Brown–Pink, Slip: 2.5 YR 6/6 Light Red
Sherd data taken from the only diagnostic sherd associated with this catalogue number.

(20) PAHMA 6-14492 This object has not been located.

(21) PAHMA 6-14493 Ovoid

Fabric: Nile B2

Shape: Angular shoulder, everted rim with a slight disc shape, flat base, sides taper to base

Surface: Red-slipped, porous, evidence of calcium carbonate and sand, base is relatively thick

Max Height: Body Sherd: 16.3 cm, Rim Sherd: 4.0 cm, Base Sherd: 2.0 cm

Rim: Diameter: 6.5 cm, Thickness: 0.80 cm

Base Diameter: 5.0 cm

Color: Slip: 2.5 YR 6/4–6/6 Light Reddish Brown–Light Red

This jar is highly fragmentary, however the presence of diagnostic rim and base sherds together with a large portion of the vessel body allow us to conclude the original character of the vessel. This vessel is associated with sherds labeled with catalogue number PAHMA 6-17060.

(22) PAHMA 6-14494 Deep Carinated Bowl

Fabric: Nile B1

Shape: Direct rim, ring base

Surface: Red-slipped, 3 incised lines 0.10–0.20 cm thick starting just under rim, sand evident in clay body

Height: 9.6 cm

Max Width: 18.5 cm

Aperture Index: 90.7

Vessel Index: 192.7

Rim: Diameter: 18.5 cm, Thickness: 0.40 cm

Base: Diameter: 8.0 cm, Height: 0.20 cm

Color: Body: 2.5 YR 5/1–6/1 Reddish Gray, Slip: 2.5 YR 5/4–6/4 Reddish Brown–Light Reddish Brown, Core: 5 YR 6/4 Light Reddish Brown

This is a fragmentary bowl.

(23) PAHMA 6-14495 Bag-Shaped Jar

Fabric: Nile B2

Shape: Very short neck, rolled rim, round base

Surface: Slipped, evidence of sand and shell inclusions, porous

Height: 21.9 cm

Max Width: 12.4 cm

Aperture Index: 57.2

Rim: Diameter: 8.5 cm, Thickness: 0.70 cm

Color: Body: 2.5 YR 5/6 Red, Slip: 2.5 YR 6/6 Light Red

(24) PAHMA 6-14496 Bag-Shaped Jar

Fabric: Nile B2

Shape: No neck, everted modelled rim, round base

Surface: Slipped, very coarse clay, rim delineated with two incised lines roughly 0.1 cm thick, evidence of calcium carbonate, shell, and sand, larger inclusions visible at rim

Height: 18.5 cm

Max Width: 12.4 cm

Aperture Index: 60.4

Rim: Diameter: 8.5 cm, Thickness: 1.0 cm

Color: Body: 7.5 YR 6/4 Light Brown, Slip: 2.5 YR 6/6 Light Red

(25) PAHMA 6-14497 Bag-Shaped Jar

Fabric: Nile B2

Shape: Short neck, everted modelled rim, round base

Surface: Red-slipped, porous, well-levigated, evidence of calcium carbonate and chaff

Height: 19.8 cm

Max Width: 15.0 cm

Aperture Index: 44.7

Rim: Diameter: 8.5 cm, Thickness: 0.90 cm

Color: Body: 5 YR 6/6–7/6 Reddish Yellow, Slip: 2.5 YR 6/6–7/6 Light Red, Core: 5 YR 6/1–7/1 Gray–Light Gray

This is a fragmentary jar.

(26) PAHMA 6-14498 Bag-Shaped Jar

Fabric: Nile C

Shape: No neck, rolled rim, round base

Surface: Slipped, porous, large shell and grog inclusions evident, calcium carbonate and chaff visible, abrasions near the vessel base

Max Sherd Height: Body: 16.6 cm, Rim: 5.2 cm

Max Width: 11.0 cm

Rim: Diameter: 9.0 cm, Thickness: 1.1 cm

Color: Body: 5 YR 5/6–6/6 Yellowish Red–Reddish Yellow, Slip: 7.5 YR 6/4–7/4 Light Brown–Pink

PAHMA 6-14498 is fragmentary. Rim and base sherds, as well as a large portion of the body, account for the characterization of this jar.

(27) PAHMA 6-14499 Globular Jar

Fabric: Nile B2

Shape: No neck, flaring quatrefoil modelled rim, flat base

Surface: Apparently undecorated, although there is a small trace of either very worn slip or post-depositional accretion near the base, very rough clay matrix with shell, calcium carbonate, shell, and sand evident, heavily abraded surface area

Max Height: 12.5 cm

Max Width: 11.0 cm

Aperture Index: 56.3

Rim: Diameter: 6.0–7.0 cm, Thickness: 0.40 cm

Color: Body: 2.5 YR 4/6–5/6 Red

Aperture index calculated based off of the largest potential aperture size of the quatrefoil rim.

(28) PAHMA 6-14500 Globular Jar

Fabric: Nile B2

Shape: Very short neck, flaring quatrefoil modelled rim (although rim is largely missing aside from one small section), flat base

Surface: Red-slipped, two incised lines 0.10–0.20 cm thick at shoulder of vessel, vessel missing a section of rim, some evidence of chaff and calcium carbonate

Height: 11.2 cm

Max Width: 11.0 cm

Aperture Index: 57.2

Rim Thickness: 0.50 cm

Color: Body: 7.5 YR 6/4 Light Brown, Slip: 2.5 YR 6/4–6/6 Light Reddish Brown–Light Red

The portion of rim missing is significant enough to render the measurement of rim diameter inconclusive for this vessel.

(29) PAHMA 6-14501 Carinated Bowl

Fabric: Nile B2

Shape: Deep bowl, direct rim, flat base

Surface: Slipped, porous, evidence of stone, shell, chaff, and silicate, 2 incised lines delineating rim on outer surface 0.10–0.20 cm thick

Max Sherd Height: Rim: 7.1 cm, Base: 6.0 cm

Max Width: 15.0 cm

Aperture Index: 94.7

Rim: Diameter: 15.0 cm, Thickness: 0.40 cm

Base Diameter: 4.8–5.2 cm (elliptical shape)

Color: Body: 5 YR 6/4–7/4 Light Reddish Brown–Pink, Slip: 2.5 YR 5/6–6/6 Red–Light Red, Core: 5 YR 5/1–6/1 Gray

PAHMA 6-14501 is fragmentary but can be characterized based on the rim and base sherds available.

(30) PAHMA 6-14502 Bag-Shaped Jar

Fabric: Nile B2

Shape: No neck, everted modelled rim, round base

Surface: Slipped, evidence of chaff, sand, calcium carbonate, and grog, abrasions near base

Height: 20.6 cm

Max Width: 12.6 cm

Aperture Index: 57.1

Rim: Diameter: 9.0 cm, Thickness: 0.40 cm

Color: Body: 7.5 YR 6/4 Light Brown, Slip: 2.5 YR 6/6–6/8 Light Red

(31) PAHMA 6-14503 Ovoid Jar

Fabric: Nile B2

Shape: Short neck, slightly angular shoulder, modelled disc-shaped rim, flat base

Surface: Slipped, some large grog inclusions, evidence of chaff and shell, roughly 50% of the rim is missing

Height: 21.7 cm

Max Width: 12.4 cm
 Aperture Index: 46.8
 Rim: Diameter: 7.0 cm, Thickness: 0.40 cm
 Base Diameter: 8.0 cm
 Color: Body: 5 YR 6/6 Reddish Yellow, Slip: 10R 5/6–6/6 Red–Light Red

(32) PAHMA 6-14504 Globular Jar

Fabric: Nile B2
 Shape: Short neck, flaring quatrefoil modelled rim, flat base
 Surface: Slipped, 2 incised lines at vessel shoulder 0.1–0.15 cm in thickness, base heavily abraded
 Max Height: 12.3 cm
 Max Width: 11.0 cm
 Aperture Index: 52.4
 Rim: Diameter: 5.2–6.2 cm, Thickness: 0.32 cm
 Base Diameter: 3.0–3.5 cm
 Color: Body: 2.5 YR 4/6–5/6 Red, Slip: 2.5 YR 6/4–7/4 Light Reddish Brown

(33) PAHMA 6-14505a Bag-Shaped Jar

Fabric: Nile B2
 Shape: No neck, slightly everted modelled rim, round base
 Surface: Slipped, high-fired, well-levigated with minimal evidence of calcium carbonate, sand, and shell
 Height: 19.4 cm
 Max Width: 14.0 cm
 Aperture Index: 50.0
 Rim: Diameter: 8.0 cm, Thickness: 1.0 cm
 Color: Body: 7.5 YR 6/4 Light Brown, Slip: 2.5 YR 6/6 Light Red; 7.5 YR 8/2–8/3 Pinkish White–Pink
 There are two objects with the catalogue number PAHMA 6-14505.

(34) PAHMA 6-14505b Bag-Shaped Jar

Fabric: Nile B2
 Shape: Short neck, everted modelled rim, round base
 Surface: Slipped, porous, evidence of calcium carbonate and sand, abrasions at base
 Height: 19.5 cm
 Max Width: 13.5 cm
 Aperture Index: 53.3
 Rim: Diameter: 8.0 cm, Thickness: 0.40 cm

Color: Body: 7.5 YR 6/4–6/6 Light Brown–Reddish Yellow, Slip: 2.5 YR 6/4–6/6 Light Brown–Reddish Yellow

(35) PAHMA 6-14506 Bag-Shaped Jar

Fabric: Nile B2

Shape: No neck, slightly everted modelled rim, round base

Surface: Slipped, porous, evidence of chaff and sand in surface, features an incised line that does not extend around the entire vessel

Height: 19.5 cm

Max Width: 13.8 cm

Aperture Index: 52.2

Rim: Diameter: 8.0–9.0 cm, Thickness: 0.80 cm

Color: Body: 5 YR 6/4–6/6 Light Reddish Brown–Reddish Yellow, Slip: 2.5 YR 6/6 Light Red

(36) PAHMA 6-14507 Carinated Bowl

Fabric: Nile B2

Shape: Deep carinated bowl, carination near middle of vessel, direct rim, flat base

Surface: Painted white dots and cross on the inner surface

Height: 7.0 cm

Max Width: 11.0 cm

Aperture Index: 90.9

Vessel Index: 157.1

Rim Diameter: 11.0 cm, Thickness: 0.50 cm

Base Diameter: 4.0 cm

Color: Body: 2.5 YR 6/6 Light Red, Slip: 2.5 YR 6/6 Light Red, Paint: 7.5 YR 8/2–8/1 Pinkish White–White

This is a fragmentary bowl.

(37) PAHMA 6-14508 Globular Jar

Fabric: Nile B2

Shape: Short neck, flaring quatrefoil rim, flat base

Surface: Slipped, porous, uneven shape, uneven incised lines at the shoulder of the vessel, some damage to slipped surface, displaying chaff, sand, and shell included in the clay body

Height: 11.8 cm

Max Width: 12.0 cm

Aperture Index: 45.8

Rim: Diameter: 5.5–6.5 cm, Thickness: 0.50 cm

Base Diameter: 4.5 cm

Color: Body: 2.5 YR 5/6–6/6 Red–Light Red, Slip: 7.5 YR 8/1–8/2 White–Pinkish White

(38) PAHMA 6-14509 This object has not been located.

(39) PAHMA 6-14510 Bag-Shaped Jar

Fabric: Nile B2

Shape: No neck, slightly everted modelled rim, round base

Surface: Undecorated, heavily abraded, evidence of chaff, sand, and shell, the thickness of wall surfaces varies, porous

Height: 20.0 cm

Max Width: 12.0 cm

Aperture Index: 63.3

Rim: Diameter: 9.0 cm, Thickness: 0.70 cm

Color: Body: 5 YR 6/6 Reddish Yellow

This is a fragmentary jar. PAHMA 6-14510 is attached to catalogue numbers PAHMA 6-14511 and PAHMA 6-14512.

(40) PAHMA 6-14511 Bag-Shaped Jar

Fabric: Nile B2

Shape: Very short neck, everted modelled rim, round base

Surface: Slipped, porous, some surface pitting and large shell inclusions

Max Sherd Height: Rim: 9.2 cm, Base: 16.4 cm

Max Width: 14.0 cm

Aperture Index: 54.3

Rim: Diameter: 9.0 cm, Thickness: 0.70 cm

Color: Body: 7.5 YR 6/4–7/4 Light Brown–Pink, Slip: 2.5 YR 5/6 Red

PAHMA 6-14511 is a reconstructed vessel comprised of a number of sherds labeled under different catalogue numbers. These include PAHMA 6-14481, PAHMA 6-14485, PAHMA 6-14513, PAHMA 6-14514, and PAHMA 6-14614, and PAHMA 6-17060. PAHMA 6-14511 is also associated separately with PAHMA 6-14510 and Temp no. 2015.0103.

(41) PAHMA 6-14512 Ovoid Jar

Fabric: Nile B2

Shape: Medium-long neck, modelled disc-shaped rim, angular shoulder, flat base

Surface: Red-slipped, slip is worn, porous, large calcium carbonate, sand, shell, stone particles evident in clay body

Max Sherd Height: Rim: 8.0 cm, Base: 15.0 cm

Max Width: 10.0 cm

Rim: Diameter: 7.0 cm, Thickness: 0.55 cm

Color: Body: 5 YR 5/4–6/4 Reddish Brown–Light Reddish Brown, Slip: 2.5 YR 5/6–6/6 Red–Light Red, Core: 5 YR 4/1–5/1 Dark Gray–Gray; 4/6 Yellowish Red
PAHMA 6-14512 is separately associated with PAHMA 6-14510. This fragmentary vessel can be characterized based on the presence of both rim and base sherds.

(42) PAHMA 6-14513 Bag-Shaped Jar

Fabric: Nile B2

Shape: No neck, everted modelled rim, no base available

Surface: Slipped, minor pitting in surface, a small amount of wear at rim displays evidence of sand and shell

Height: 17.0 cm

Max Width: 13.0 cm

Aperture Index: 57.5

Rim: Diameter: 8.5 cm, Thickness: 0.51 cm

Color: Body: 7.5 YR 6/4 Light Brown, Slip: 5 YR 6/4–6/6 Light Reddish Brown–Reddish Yellow, Core: 7.5 YR 4/1–5/1 Dark Gray–Gray

For the various object numbers associated with PAHMA 6-14513, see PAHMA 6-14511.

(43) PAHMA 6-14514a Sherds (Jar)

Fabric: Nile B2

Shape: Round base

Surface: Slipped, porous, chaff evident, large holes and pitting visible in surface

Height: 8.5 cm

Max Width: 13.0 cm

Color: Clay: 5 YR 6/4–6/6 Light Reddish Brown–Reddish Yellow, Slip: 2.5 YR 6/4–6/6 Light Reddish Brown–Light Red, Core: 5 YR 4/1–5/1 Dark Gray–Gray

For the various object numbers associated with PAHMA 6-14514a, see PAHMA 6-14511. There are two objects that are labeled PAHMA 6-14514.

(44) PAHMA 6-14514b Bag-Shaped Jar

Fabric: Nile B2

Shape: Short neck, rolled rim, round base

Surface: Slipped, evident shell inclusions, porous

Max Sherd Height: Rim: 16.0 cm, Base: 8.4 cm

Max Width: 13.3 cm

Rim: Diameter: 8.0 cm, Thickness: 0.73 cm

Color: Body: 7.5 YR 6/4–7/4 Light Brown–Pink, Slip: 2.5 YR 6/6 Light Red, Core: 7.5 YR 4/1–5/1 Dark Gray–Gray

(45) PAHMA 6-14515 Sherds (Indeterminate Inflected Bowl)

Fabric: Nile B2

Shape: Inflected, slightly everted modelled rim, round base

Surface: Incised line 0.10–0.20 cm thick on inner surface delineating rim, slipped but very worn, porous, evident sand inclusions

Height: 6.3 cm

Color: Body: 7.5 YR 6/4–6/6 Light Brown–Reddish Yellow, Slip: 2.5 YR 6/4–6/6 Light Reddish Brown–Light Red, Core: 2.5 Yr 5/6–6/6 Red–Light Red

Unable to assess rim diameter because only 11.9 mm of rim section remains.

(46) PAHMA 6-14516 Sherds (Jar)

Fabric: Nile B2

Shape: Short neck, everted modelled rim, round base

Surface: Red-slipped, large holes in surface

Max Sherd Height: Rim: 8.7 cm, Base: 14.1 cm

Max Width: 15.0 cm

Aperture Index: 76.0

Rim: Diameter: 13.0 cm, Thickness: 0.80 cm

Color: Body: 7.5 YR 6/4 Light Brown, Slip: 2.5 YR 5/6–6/6 Red–Light Red, Core: 7.5 YR 4/1 Dark Gray

This is a fragmentary vessel. Although cylindrical beakers usually have a round base, many of the examples in this corpus have flat bases.

(47) PAHMA 6-14517 Sherds (Jar)

Fabric: Nile B2

Shape: Round base

Surface: Rim is heavily eroded, thus the shape is unable to be determined.

Slipped, porous, calcium carbonate and chaff evident, base heavily abraded

Base Sherd Height: 5.4 cm

Max Width: 13.0 cm

Rim: Diameter: 13.0 cm, Thickness: 0.40 cm

Color: Body: 7.5 YR 5/4–6/4 Brown–Light Brown, Slip: 2.5 YR 4/6–5/6 Red

(48) PAHMA 6-14518 Bag-Shaped Jar

Fabric: Nile B2

Shape: Very short neck, rolled rim, round base

Surface: Slipped, few inclusions visible aside from minimal evidence of calcium carbonate, base heavily abraded

Height: 21.7 cm

Max Width: 13.6 cm

Aperture Index: 50.0

Rim: Diameter: 9.0 cm, Thickness: 1.1 cm

Color: Body: 2.5 YR 5/6–6/6 Red–Light Red, Slip: 7.5 YR 8/2 Pinkish White

(49) PAHMA 6-14519 Globular Jar

Fabric: Nile B2

Shape: Short neck, slightly flared modelled rim, round base

Surface: Slipped, well-levigated

Height: 22.1 cm

Max Width: 13.2 cm

Aperture Index: 53.8

Rim: Diameter: 8.5 cm, Thickness: 0.70 cm

Color: Slip: 7.5 YR 5/1–6/1 Gray

(50) PAHMA 6-14520 Bag-Shaped Jar

Fabric: Nile B2

Shape: Short neck, rolled rim, round base

Surface: Slipped, coarse, evidence of chaff, sand, shell, and grog included in clay matrix

Height: 20.5 cm

Max Width: 13.4 cm

Aperture Index: 51.5

Rim: Diameter: 8.5 cm, Thickness: 0.80 cm

Color: Body: 7.5 YR 5/6–6/6 Strong Brown–Reddish Yellow, Slip: 2.5 YR 6/6 Light Red

(51) PAHMA 6-14521 Bag-Shaped Jar

Fabric: Nile B2

Shape: Short neck, modelled rim, round base

Surface: Undecorated, variable burn marks on the surface, porous, heavily abraded base, included shell, sand, and chaff evident

Height: 20.5 cm

Max Width: 13.0 cm

Aperture Index: 55.4

Rim: Diameter: 8.0 cm, Thickness: 0.90 cm

Color: Body: 5 YR 6/6 Reddish Yellow

(52) PAHMA 6-14522 Globular Jar

Fabric: Nile B2

Shape: Short neck, flaring quatrefoil modelled rim, flat base

Surface: Slipped, incised wavy line at shoulder centered between two incised lines that together create a band, fairly well-levigated with minor pitting in the surface slip

Height: 12.5 cm

Max Width: 10.6 cm

Aperture Index: 60.4

Rim: Diameter: 6.0–7.0 cm, Thickness: 0.30 cm

Base Diameter: 3.0 cm

Color: Body: 7.5 YR 5/4–6/4 Brown–Light Brown, Slip: 2.5 YR 5/6–6/6 Red–Light Red

(53) PAHMA 6-14523 Globular Jar

Fabric: Nile B2

Shape: Very short neck, flaring quatrefoil rim, flat base

Surface: Red-slipped, porous, evidence of calcium carbonate, chaff, and sand, base is heavily abraded, slip is heavily eroded

Max Height: 12.4 cm

Max Width: 12.0 cm

Aperture Index: 51.5

Rim: Diameter: 6.0–7.0 cm, Thickness: 0.80 cm

Base Diameter: 4.5–5.5 cm

Color: Body: 7.5 YR 6/4 Light Brown, Slip: 2.5 YR 6/4–6/6 Light Reddish Brown–Light Red

(54) PAHMA 6-14524 Non-diagnostic sherds

(55) PAHMA 6-14525 Ovoid Jar

Fabric: Nile B2

Shape: Short neck, angular shoulder, slightly flaring modelled disc-shaped rim, flat base

Surface: Slipped, porous, evidence of sand, shell, and chaff

Max Height: 20.1 cm

Max Width: 8.4 cm

Aperture Index: 83.3

Rim: Diameter: 8.0 cm, Thickness: 0.50 cm

Base Diameter: 6.5 cm

Color: Body: 7.5 YR 6/4–7/4 Light Brown–Pink, Slip: 2.5 YR 6/4–6/6 Light Reddish Brown–Light Red

(56) PAHMA 6-14526 Deep Carinated Bowl

Fabric: Nile B2

Shape: Direct rim, ring base

Surface: Slipped on inner and outer surfaces, damage to rim, 3 incised lines delineating rim on outer surface, damage to slip evident, apparent chaff and grog included

Max Sherd Height: Rim: 4.8 cm, Base: 5.7 cm

Max Width: 15.0 cm

Rim: Diameter: 15.0 cm, Thickness: 0.32 cm

Base: Diameter: 6.8 cm, Height: 1.5 cm

Color: Body: 2.5 YR 6/4–6/6 Light Reddish Brown–Light Red, Slip: 10 R 5/6–6/6 Red–Light Red, Core: 7.5 YR 4/1 Dark Gray

PAHMA 6-14526 is fragmentary, however, the shape can be characterized given the presence of both rim and base sherds.

(57) PAHMA 6-14527 Bag-shaped Jar

Fabric: Nile B2

Shape: No neck, slightly everted folded rim, round base

Surface: Slipped, pitting in vessel surface

Max Height: 20.8 cm

Max Width: 13.5 cm

Aperture Index: 40.7

Rim: Diameter: 7.5 cm, Thickness: 1.0 cm

Color: Body: 2.5 YR 5/6–6/6 Red–Light Red, Slip: 7.5 YR 8/2–8/3 Pinkish White–White; 7.5 YR 5/6–6/6 Strong Brown–Reddish Yellow

(58) PAHMA 6-14528 Bag-shaped Jar

Fabric: Nile B2

Shape: Wide straight neck, flaring quatrefoil rim, flat base

Surface: Slipped, porous, evidence of grog, chaff, sand, shell, damage at base with 2 incised lines

Max Height: 12.0 cm

Max Width: 10.0 cm

Aperture Index: 55

Rim: Diameter: 6.0–6.5 cm, Thickness: 0.50 cm

Base Diameter: 4.7 cm

Color: Body: 5 YR 5/6–6/6 Yellowish Red–Reddish Yellow, Slip: 5 YR 6/4–7/4 Light Reddish Brown–Pink

(59) PAHMA 6-14529 Ovoid Jar

Fabric: Nile B2

Shape: Angular shoulder, modelled rim, flat base

Surface: Slipped, carinated at shoulder, very thick clay matrix, porous, wear in slip at both the shoulder and the base, evidence of sand, chaff, stone, and calcium carbonate

Max Height: 16.0 cm

Max Width: 11.0 cm

Aperture Index: 52.7

Rim: Diameter: 7.0 cm, Thickness: 0.60 cm

Base Diameter: 6.5 cm

Color: Body: 7.5 YR 6/4 Light Brown, Slip: 2.5 YR 5/4–6/4 Reddish Brown–Light Reddish Brown

(60) PAHMA 6-14530 Bag-Shaped Jar

Fabric: Nile B2

Shape: No neck, everted modelled rim, round base

Surface: Slipped, porous, some chaff evident, apparent shell and sand inclusions, uneven, potentially impacted base

Max Height: 19.2 cm

Max Width: 12.2 cm

Aperture Index: 65.6

Rim: Diameter: 9.0 cm, Thickness: 0.50 cm

Color: Body: 7.5 YR 6/4–6/6 Light Brown–Reddish Yellow, Slip: 2.5 YR 7/4–7/6 Light Reddish Brown–Light Red

(61) PAHMA 6-14531 Bag-Shaped Bottle

Fabric: Nile B2

Shape: Straight neck, slightly flaring modelled rim, round base

Surface: Slipped, slightly eroded surface treatment, sand evident on vessel surface, apparent calcium carbonate and shell inclusions

Max Height: 19.8 cm

Max Width: 13.0 cm

Aperture Index: 59.2

Rim: Diameter: 8.5 cm, Thickness: 0.40 cm

Color: Body: 10 R 5/6–6/6 Red–Light Red, Slip: 2.5 YR 6/6 Light Red

(62) PAHMA 6-14532 Bag-Shaped Jar

Fabric: Nile B2

Shape: Very short neck, folded rim, round base

Surface: Slipped, wear on slip evident, vessel is impacted to one side at the rim, evidence of calcium carbonate, shell, and grog included

Max Height: 19.6 cm

Max Width: 12.7 cm

Aperture Index: 62.9

Rim: Diameter: 7.5–9.0 cm, Thickness: 1.0 cm

Base Diameter: 6.5 cm

Color: Body: 5 YR 6/4–6/6 Light Reddish Brown, Slip: 2.5 YR 5/6–6/6 Red–Light Red

(63) PAHMA 6-14533 Tall Stand

Fabric: Nile B2

Shape: Everted modelled rim, direct base

Surface: Slipped, well-levigated, small stone and shell inclusions, three incised lines 0.20 cm thick at shoulder of the vessel

Max Height: 23.0 cm

Max Width: 10.0 cm

Rim: Diameter: 10.5 cm, Thickness: 0.50 cm

Base: Diameter: 8.0 cm, Thickness: 0.88 cm

Color: Body: 2.5 YR 6/4 Light Reddish Brown, Slip: 2.5 YR 6/6 Light Red

(64) PAHMA 6-14534 Ellipsoid Jar

Fabric: Nile C

Shape: Very short neck, everted modelled rim, round base

Surface: Slipped, slip is worn especially at the base, very coarse clay matrix with large shell inclusions, porous

Max Height: 19.9 cm

Max Width: 13.0 cm

Aperture Index: 52.3

Rim: Diameter: 9.0 cm, Thickness: 1.1 cm

Color: Body: 7.5 YR 6/4–6/6 Light Brown–Reddish Yellow, Slip: 2.5 YR 8/2 Pinkish White

(65) PAHMA 6-14535 Bag-Shaped Jar

Fabric: Nile B2

Shape: Very short neck, slightly everted modelled rim, round base

Surface: Evidence of chaff and large inclusions in the vessel surface, fire marks on body of the vessel, "rope" motif pressed into the body of the vessel which does not continue around the entire vessel

Max Height: 18.2 cm

Max Width: 14.0 cm

Aperture Index: 50.0

Rim: Diameter: 9.0 cm, Thickness: 1.0 cm

Color: Body: 2.5 YR 5/6 Red

(66) PAHMA 6-14536 Bag-Shaped Bottle

Fabric: Nile B2

Shape: Straight neck, folded rim, round base

Surface: Slipped, porous, evidence of chaff, shell, grog, some erosion in slip

Max Height: 19.5 cm

Max Width: 14.4 cm

Aperture Index: 45.1

Rim: Diameter: 8.5 cm, Thickness: 1.0 cm

Color: Body: 7.5 YR 6/4-7/4 Light Brown-Pink, Slip: 2.5 YR 6/4-6/6 Light Reddish Brown-Light Red



FIGURE 2.32 Ceramics in position N 2473 (NED-C-8495)

N 2473 (TC) Map B5; photos C 8495, B 8427 (Fig. 2.32)

In main chamber and in door of east chamber, a quantity of pottery: table of offerings (i); A (ii) (PAHMA 6-14540, PAHMA 6-14541); M (iii); smooth pottery, 3 black paint lines, large bowl (iv).

(1) PAHMA 6-14540 Globular Jar

Fabric: Nile B2

Shape: No neck, flaring quatrefoil rim, flat base

Surface: Slipped, erosion of surface at base, three molded lines 0.30–0.50 cm thick at shoulder of vessel, very thin body walls

Max Height: 10.2 cm

Max Width: 10.6 cm

Aperture Index: 59.6

Rim: Diameter: 6.5–7.0 cm, Thickness: 0.34 cm

Base Diameter: 4.0 cm

Color: Slip: 5 YR 6/6 Reddish Yellow

(2) PAHMA 6-14541 Tall Stand

Fabric: Nile B2

Shape: Flaring modelled rim, slightly everted modelled base

Surface: Slipped, low porosity, uneven vessel height, 1 incised line 0.10–0.30 cm thick at the “shoulder” of the vessel, evidence of chaff, sand, and calcium carbonate in surface

Max Height: 14.5 cm

Max Width: 12.7 cm

Rim: Diameter: 10.5 cm, Thickness: 0.70 cm

Base: Diameter: 6.5 cm, Thickness: 0.50 cm

Color: Body: 2.5 YR 7/6–7/9 Light Red, Slip: 2.5 YR 6/4–7/4 Light Reddish Brown



FIGURE 2.33 Ceramics in position N 2490 (NED-C-7158)

N 2490 (TC) Map C4 (red); photos C 7158, C 7467, B 7146 (Figs. 2.5, 2.28, 2.33)
At entrance to pit, quantity of pottery (see photo), dish on stand (i)
(PAHMA 6-14542.1, PAHMA 6-14542.2).

(1) PAHMA 6-14542.1 Carinated Bowl with Spout
Fabric: Nile B2
Shape: Direct rim, round base, spout to one side
Surface: Red-slipped, porous, some evidence of chaff
Max Height: 10.2 cm
Max Width: 16.0 cm
Aperture Index: 93.8
Vessel Index: 156.9
Rim: Diameter: 16.0 cm, Thickness: 0.50 cm
Spout: Height: 2.1 cm, Length: 1.9 cm
Color: Body: 5 YR 5/6 Yellowish Red, Slip: 2.5 YR 4/6–5/6 Red

(2) PAHMA 6-14542.2 Tall Stand
Fabric: Nile B2
Shape: Slightly everted modelled rim, modelled base with internal ledge

Surface: Slipped, porous, many shell, stone, chaff, and calcium carbonate inclusions evident, 2 incised lines 0.10–0.20 cm thick close to base

Max Sherd Height: Rim: 8.0 cm, Base: 25.5 cm

Max Width: 16.0 cm

Rim: Diameter: 18.0 cm, Thickness: 1.5 cm

Base: Diameter: 16.0 cm, Thickness: 1.9 cm

Color: Body: 5 YR 5/6 Yellowish Red, Slip: 2.5 YR 5/4 Reddish Brown

Vessel is fragmentary, with a section of the body missing.

N 2493 (TC) Map C4 (Fig. 2.18)

Contained nothing. [ed.: According to Hearst Museum records, PAHMA 6-14543, PAHMA 6-14544, PAHMA 6-14545, and PAHMA 6-14546 are labeled as potentially from this burial.]

(1) PAHMA 6-14543 Bag-Shaped Jar

Fabric: Nile B2

Shape: No neck, everted modelled rim, round base

Surface: Slipped, eroded slip, large inclusions >1 cm in length, abraded base, impacted to one side near the base

Max Height: 12.9 cm

Max Width: 9.0 cm

Aperture Index: 66.7

Rim: Diameter: 7.0 cm, Thickness: 0.50 cm

Color: Body: 2.5 YR 5/6–6/6 Red–Light Red, Slip: 2.5 YR 5/4–6/4 Reddish Brown–Light Reddish Brown

(2) PAHMA 6-14544 Bag-Shaped Jar

Fabric: Nile B2

Shape: Very short neck, flaring modelled rim, round base

Surface: Undecorated, coarse ware, very porous, evidence of included chaff, shell up to 0.90 cm in length, stone, and sand

Max Height: 15.0 cm

Max Width: 10.0 cm

Aperture Index: 62.0

Rim: Diameter: 7.0 cm, Thickness: 0.40 cm

Color: Body: 2.5 YR 5/6–6/6 Red–Light Red

(3) PAHMA 6-14545 Bag-Shaped Jar

Fabric: Nile B2

Shape: Heavily modelled rim with inner ledge, round base
 Surface: Undecorated, with white post-depositional accretion, heavily abraded base, evidence of calcium carbonate, shell, and sand included
 Max Height: 18.4 cm
 Max Width: 14.0 cm
 Aperture Index: 39.3
 Rim: Diameter: 6.5 cm, Thickness: 0.50 cm
 Color: Body: 2.5 YR 6/4–6/6 Light Reddish Brown–Light Red

(4) PAHMA 6-14546 Conical Beaker

Fabric: Nile C
 Shape: Direct rim, pointed base
 Surface: Undecorated thick, coarse ware, porous, cracking in surface, evidence of chaff, grog, and stone included
 Max Height: 18.8 cm
 Max Width: 9.5 cm
 Aperture Index: 78.9
 Rim: Diameter: 8.5–9.5 cm, Thickness: 1.0 cm
 Color: Body: 2.5 YR 5/6 Red; 6/3–6/4 Light Reddish Brown
 The pointed base is unusual within this corpus.

N 2507 (TC) Map C5; photos C 7466, C 7770, C 8522, B 8076, B 8428
 In main chamber, quantity of pottery (ii) (PAHMA 6-12502).

(1) PAHMA 6-12502 Ovoid Jar

Fabric: Nile B2
 Shape: Angular shoulder, modelled flaring disc-shaped rim, flat base
 Surface: Red-slipped, well-levigated with some examples of shell included, abraded base
 Max Height: 18.6 cm
 Max Width: 13.0 cm
 Aperture Index: 61.5
 Rim: Diameter: 9.0 cm, Thickness: 0.50 cm
 Base Diameter: 8.0 cm
 Color: Body: 7.5 YR 5/4–6/4 Brown–Light Brown, Slip: 2.5 YR 5/6–6/6 Red–Light Red

N 2567 [ed.: No such tomb number exists on the map or in the tomb cards, but according to Hearst Museum records, the following object was found in that tomb.] (Fig. 2.16)

(1) PAHMA 6-12504 Bag-Shaped Jar

Fabric: Nile B2

Shape: Wide straight neck, flaring quatrefoil modelled rim, flat base

Surface: Slipped, porous, evidence of included shell and stone, pitting in surface as well as abrasions at the base of the vessel, 2 deeply incised lines at shoulder of the vessel 0.20–0.30 cm thick

Max Height: 13.0 cm

Max Width: 13.0 cm

Aperture Index: 46.8

Rim: Diameter: 7.0–7.5 cm, Thickness: 0.71 cm

Base Diameter: 4.0–4.5 cm

Color: Body: 7.5 YR 5/4–6/4 Brown–Light Brown, Slip: 2.5 YR 5/8–6/8 Red–Light Red

N 2641 (TC) Map C5 (red); photo B 8425

In main chamber, a quantity of pottery: alabaster (i) (MFA 47.1652), different varieties of A (ii) (PAHMA 6-12508), M (iii). Outside doorway, several pots: drab (iv), (v).

(1) PAHMA 6-12508 Globular Jar

Fabric: Nile B2 or C

Shape: No neck, everted modelled rim, round base

Surface: Uneven shape, very light in color, evidence of chaff and large shell inclusions, abraded surface

Max Height: 12.9 cm

Max Width: 13.0 cm

Aperture Index: 62.0

Rim: Diameter: 8.5 cm, Thickness: 0.44 cm

Color: Body: 5 YR 5/4–5/6 Reddish Brown–Yellowish Red, Slip: 2.5 YR 5/4–6/4 Reddish Brown–Light Reddish Brown

N 2701 (Green) (TC) Map C4 (Fig. 2.11)

Contained several As (i) (PAHMA 6-12509, PAHMA 6-12510), small saucer, piece of ring stand.

(1) PAHMA 6-12509 Cylindrical Beaker

Fabric: Nile B2

Shape: Short neck, everted modelled rim, round base

Surface: Slipped, uneven body shape, evidence of sand in surface

Max Height: 14.2 cm

Max Width: 9.6 cm

Aperture Index: 72.9

Rim: Diameter: 8.0 cm, Thickness: 0.50 cm

Color: Body: 5 YR 6/4–6/6 Light Reddish Brown–Reddish Yellow, Slip: 5 YR 5/6–6/6 Yellowish Red–Reddish Yellow

(2) PAHMA 6-12510 Carinated Jar

Fabric: Nile B1

Shape: Carinated shoulder, straight neck, disc-shaped rim, flat base

Surface: Burnished, slipped, well-levigated, low-porosity, few visible inclusions

Max Height: 6.6 cm

Max Width: 7.0 cm

Aperture Index: 34.3

Rim: Diameter: 4.0 cm, Thickness: 0.50 cm

Base Diameter: 2.6 cm

Color: Burnished slip: 1 Grey 3/N–2.5N Black

Very distinctive black surface. The shape is unique to the corpus.

N 2747 [ed.: No such tomb number exists on the map or in the tomb cards, but according to Hearst Museum records, the following object was found in that tomb.] (Fig. 2.25)

(1) PAHMA 6-12514 Ovoid Jar

Fabric: Nile B2

Shape: Angular shoulder, straight neck, modelled disc-shaped rim, flat base

Surface: Slipped, slip is worn and flaking, surface pitting visible, apparent stone and shell inclusions

Max Height: Rim: 2.9 cm, Base: 20.9 cm

Max Width: 11.2 cm

Aperture Index: 62.5

Rim: Diameter: 9.0 cm, Thickness: 0.80 cm

Base Diameter: 8.0 cm

Color: Body: 7.5 YR 6/4 Light Brown, Slip: 2.5 YR 6/6–6/8 Light Red

Vessel is fragmentary but can be characterized based on both rim and base sherds.

Bibliography

- Bourriau, Janine D., Paul T. Nicholson, and Pamela J. Rose. 2006. "Pottery." In: Paul T. Nicholson and Ian Shaw (eds), *Ancient Egyptian Materials and Technology*, 121–147. Fourth printing. Cambridge: Cambridge University Press.
- Brunton, Guy. 1928. *Qau and Badari II*. BSAE/ERA 45. London: British School of Archaeology, Bernard Quaritch.
- Nordström, Hans-Åke and Janine Bourriau. 1993. "Ceramic Technology: Clays and Fabrics." In: Janine D. Bourriau and Dorothea Arnold (eds), *An Introduction to Ancient Egyptian Pottery*, 145–190. Fascicle 2. DAIK S 17. Mainz: von Zabern.
- Reisner, George A. 1908. *Early Dynastic Cemeteries of Naga-ed-Dêr, Part I*. University of California Publications, Egyptian Archaeology, Volume 11. [Leipzig: J. C. Hinrichs].
- Reisner, George A. 1932. *A Provincial Cemetery of the Pyramid Age, Naga-ed-Dêr, Part III*. University of California Publications, Egyptian Archaeology, Volume VI. Berkeley, Los Angeles: University of California Press.
- Schiestl, Robert and Anne Seiler. 2012. *Handbook of the Pottery of the Egyptian Middle Kingdom, Volume I: The Corpus Volume*. DGÖAW 72. Vienna: Österreichischen Akademie der Wissenschaften.

Four Unique Pottery Vessels from N 2000 and N 2500

Natasha D. Ayers

Among the largely homogeneous pottery corpus of typical First Intermediate Period and early Middle Kingdom funerary types from cemeteries N 2000 and N 2500 are four vessels that necessitate further discussion for their singularity in The Phoebe A. Hearst Museum of Anthropology corpus and for their connection to wider trends for the period.¹ A small carinated jar with partially blackened surface, a carinated bowl with white painted decoration, an offering stand with incised decoration, and a carinated bowl with spout are discussed separately below.² Each pot receives a brief summary of the archaeological context, a description of the vessel, and a discussion with inclusion of parallel comparanda.

1 PAHMA 6-12510 Carinated Jar with Partially Blackened Surface

1.1 *Context*

This small carinated jar from burial N 2701 (Fig. 3.1) was part of an assemblage with cylindrical beakers with round bases known from mid-Dynasty 11 to early Dynasty 12,³ a small “saucer,”⁴ a piece of a ring stand, and, according to Hearst Museum records, two flint knives.⁵

1 Museum collections and excavation tomb cards from early twentieth-century excavations are rarely a complete record of every object that was excavated. A selection of pottery, usually complete vessels, was documented and retained. Sherds were usually discarded. This means the possibility of additional examples cannot be discounted, and “singularity” is used with this caveat.

2 All descriptions are based on original excavators’ notes from the field (See Chapter 12), excavation negatives in the collection of the Hearst Museum, object photographs taken recently by Hearst Museum staff (available at: <https://portal.hearstmuseum.berkeley.edu/>), and Gabriella diBattista’s drawings and descriptions of ceramics (Chapter 2) in the Hearst Museum. I did not view the pottery in the museum.

3 Cylindrical beaker PAHMA 6-12509. Schiestl and Seiler 2012, 448.

4 No further description is given for the saucer.

5 PAHMA 6-12511; PAHMA 6-12513.



FIGURE 3.1A–B Carinated jar 6-12510 (N 2701)

1.2 *Vessel Description*

Produced in Nile B1 or a fine B2 fabric,⁶ this small jar was made in three parts: 1) rim and neck, 2) upper body, and 3) lower body. The latter two are connected at the carination. It is clear from the photos that the rim, neck, and upper body were turned. Inspection of the interior would be necessary to confirm a turned or handmade manufacturing technique for the lower body. A disc-shaped rim, formed by folding the rim downward, sits atop a narrow straight neck. The point of carination is above the midpoint of the body, and the lower body tapers down to a scraped flat base. A slip was added to the exterior surface and then well burnished. Narrow, tightly spaced horizontal burnishing strokes are visible. In some areas, the slip fired a light brown to reddish-brown color, but other areas are completely black. The most visually distinctive feature of this carinated jar is the black color of the surface and areas of dark gray or blackened fabric (visible because of damaged areas). Small jars with a black surface and fabric are sometimes said to be made of “black clay” and termed “black ware” or “black pottery.”⁷ I will discuss the fabric and surface treatment separately, followed by two plausible explanations for the jar’s blackened appearance.

“Black clay” is an incorrect description, and a black slip was not applied to the vessel. Regarding the fabric, the damaged areas on the jar make it possible

6 It is also necessary to distinguish between the natural clay source and the fabric. A pottery “fabric” is “a group designation for all significant physical and chemical properties of the clay and the non-plastic inclusions in a fired ceramic material, as well as all relevant technological features of the finished product” (Nordström and Bourriau 1993, 162).

7 For “black pottery” and “black ware,” see Reisner 1932, 93. For “black ware,” Slater 1974, 105.

to see the fabric at different points on the body. A chip in the rim reveals a brown exterior zone, violet zone, and a thick black core.⁸ This is a typical Nile alluvial silt fabric. Most of the damage to the upper body, as visible in Fig. 3.1B, shows a very thin brown exterior zone and a thick black core. Areas where the slip has separated from the lower body show a mottled brown and black appearance to the fabric's exterior zone. Much of the damaged surface on the side of the jar reveals little to no brown exterior zone and a predominantly black colored fabric. The lower body shows a mottled brown and black fabric below the slip. The original color of the slip ranges from a light brown to reddish-brown and is most visible on the lower body and base. A large area of the rim, neck, and upper body (and to a lesser extent, the lower body) have a blackened surface.

I propose two plausible explanations for the black color of the surface and fabric.

- 1) The jar was fired in a reducing atmosphere. This means oxygen was not allowed to reach the pot during the firing process. The result is a black surface and fabric color. Firing pottery in a reducing atmosphere is a technique commonly found in Nubian pottery and Egyptian Predynastic black topped red ware, but it was also used for small Egyptian vessels in the late Old Kingdom through the early Middle Kingdom (see below).
- 2) The jar was burned post-firing, whether intentionally or unintentionally. The black color appears irregularly on the surface, and the amount of black color in the fabric varies at different points on the vessel. This could support burning of the vessel post-firing.

1.3 *Parallels and Discussion*

No other examples of reduced vessels from N 2000 or N 2500 are held in the Hearst collection or identifiable in the excavation negatives; however, there are additional examples from Naga ed-Deir of small carinated and bag-shaped jars fired in a reducing atmosphere. At the Hearst Museum, from Tomb 752 in Cemetery 700 is a small bag-shaped jar (PAHMA 6-10755) with uneven reduced firing that reveals glimpses of the red-brown slip color on the body.⁹ Further

8 Gray or black "reduced" cores are common in Nile clay vessels. This is carbon that did not burn out during the firing process, which typically turns the gray Nile clay into a brown or reddish-brown color. The red hue is due to the high iron content in Egyptian Nile clay. Thick black cores are more common in vessels with thick walls, low fired vessels, and reduced vessels.

9 The jar at the Hearst Museum (<https://webapps.cspace.berkeley.edu/pahma/imageserver/blobs/7cdc2085-9a35-4a00-963a/derivatives/OriginalJpeg/content>) belongs to this type (Reisner 1932, 93, fig. 43:2).

north at the cemeteries of Qau, Guy Brunton excavated similar examples of small black jars with differential reduced firing. One of these is a squat carinated jar at the Petrie Museum (UC18012). Most of the surface is black, but an area at the mid and lower body turned red and reddish-brown.¹⁰ It seems that either the firing technique(s) in the late Old Kingdom through the early Middle Kingdom could not consistently produce fully reduced vessels without oxygen reaching any part of the vessel (and thereby turning part of the slip red) or this was not deemed necessary.

Small jars fired in a reducing atmosphere have not received extensive study by modern or early scholars. Guy Brunton briefly acknowledged the peculiar pottery with black surfaces uncovered at Qau in late Old Kingdom and First Intermediate Period tombs: “Black pottery is only found in very rare cases, all being squat toilet vases. We found one in the vth, four in the vith, eight in the vii–viii, and sixteen in the ix–xth dyns. In one case there was red wash on top of the black.”¹¹ The latter is probably referring to a carinated jar (Type 82E) that was not fully reduced.¹²

Not all of these small jar types were reduced to create a black surface. The same vessel types also appear fully oxidized with the typical Egyptian red or reddish-brown slip. In fact, one of the closest parallels for the narrow neck of this jar from burial N 2701 at Naga ed-Deir is a fully oxidized jar from a First Intermediate Period cemetery at Dendera.¹³

It is difficult to be certain, but this small jar from Naga ed-Deir is a poorly executed example of an intentionally reduced vessel, or the current blackened areas are the result of a post-firing event that unevenly burned the jar.

10 This jar at the Petrie Museum (UC18012) is Brunton's type 82G (Brunton 1928, pl. 87:82G).

11 Brunton 1928, 4. Some examples of small carinated jars termed as “Black,” “Pol. Black,” or “Black Pol.” are on pl. 87:81C, 82A, pl. 91:85P, 81V, 81W.

12 Brunton 1928, pl. 91:82E (described as dark red polished on black).

13 Slater 1974, fig. 20:m1h. Additionally, the best parallel for the shape of the carinated jar from N 2701 is a good example of the pitfalls of dating ceramics based on shape alone without consideration for key features in manufacturing technology and surface treatment, especially when relying on drawings. This “best parallel” is a carinated jar from Thebes in Dynasty 18 (Bader and Seco Álvarez 2016, 258, fig. 52:d, a small jar made in Marl A2 fabric with a red slip burnished horizontally on the rim and shoulders and burnished vertically below the carination). The key difference is in the method of production and surface treatment. The Naga ed-Deir jar was carefully burnished horizontally across the entire Nile clay vessel. The Thebes jar was burnished horizontally above the carination and vertically below the carination, turned more quickly on a wheel, and made of marl clay. Using shape alone can lead to incorrect dating.



FIGURE 3.2 Carinated bowl 6-14507 (N 2446)

2 PAHMA 6-14507 Carinated Bowl with White Painted Decoration

2.1 *Context*

A carinated bowl with white decoration of dots and two crossed lines (Figs. 3.2–3.3) was found in the main chamber of N 2446 = N 2522 along with carinated bowls produced from the late First Intermediate Period up to early Dynasty 12,¹⁴ a variety of bowls with simple contour known from the First Intermediate Period to early Dynasty 12,¹⁵ small jars with quatrefoil rim from Dynasty 11,¹⁶ early/pre-*hes*-jars produced from the First Intermediate Period to early Dynasty 12,¹⁷ First Intermediate Period shouldered jars with modeled

14 Carinated bowls PAHMA 6-14477; PAHMA 6-14501. See Schiestl and Seiler 2012, 230. Carinated bowl ring base PAHMA 6-14526.

15 Bowls with simple contour, direct or modeled rims, and round bases PAHMA 6-14473-75, PAHMA 6-14479-80; PAHMA 6-14515; PAHMA 6-14517, Bowl sherds PAHMA 6-14478; PAHMA 6-14484; PAHMA 6-14486; PAHMA 6-14494. For parallels to PAHMA 6-14473-75, see Wodzińska 2010, 162, First Intermediate Period 36.

16 Small jars with quatrefoil rims and flat/nearly flat bases PAHMA 6-14499; PAHMA 6-14500; PAHMA 6-14504; PAHMA 6-14508; PAHMA 6-14523; PAHMA 6-14528 and round bases PAHMA 6-145022. See Schiestl and Seiler 2012, 388.

17 *hes*-jars PAHMA 6-14487; PAHMA 6-14512; PAHMA 6-14525; PAHMA 6-14529. See Schiestl and Seiler 2012, 508, 512. The type of pre-*hes*-jar with no splayed base disappears after early Dynasty 12 and was only used in cemeteries (Arnold 1972, Abb. 5:12).



FIGURE 3.3 Ceramics of N 2446; top row #4 is 6-14507 (NED-B-7142)

rim,¹⁸ bag-shaped jars with modeled rim found from early Dynasty 11 to early Dynasty 12,¹⁹ a tall stand,²⁰ a few “glaze” beads, and a “disc.”²¹

2.2 *Vessel Description*

The Naga ed-Deir bowl is turned with a carination near the midpoint of the body. An incised line runs below the direct rim, the upper body has straight sides, and the lower body tapers to a scraped flat base. Nile B2 fabric was used

18 Jars with modeled rim, narrow neck, prominent shoulder, and flat base PAHMA 6-14488; PAHMA 6-14503. These jars have more resemblance to the late Old Kingdom tradition than the early Middle Kingdom tradition.

19 Small to medium jars with modeled rims and round scraped bases PAHMA 6-14481; PAHMA 6-14483; PAHMA 6-14489-91; PAHMA 6-14495-98; PAHMA 6-14502; PAHMA 6-14505-06; PAHMA 6-14510-11; PAHMA 6-14513-14; PAHMA 6-14516; PAHMA 6-14518-21; PAHMA 6-14527; PAHMA 6-14530-32; PAHMA 6-14534-36, jar sherds PAHMA 6-14476; PAHMA 6-14485; PAHMA 6-14492-93; PAHMA 6-14509; PAHMA 6-14524. See Schiestl and Seiler 2012, 536; Arnold 1972, Abb. 3:7.

20 Tall stands PAHMA 6-14482; PAHMA 6-14533.

21 It is necessary to bear in mind that pottery traditions do not change according to dynastic succession. For example, late Dynasty 11 and early Dynasty 12 is the same pottery phase. Other material culture or textual evidence is needed to assign an assemblage to either late Dynasty 11 or early Dynasty 12.

to make the bowl, and a thin red slip covers the body. White paint was used to apply decoration over the red slip.²² Two white bands of irregular widths run from one side of the rim to the other, crossing each other in the center of the bowl, and dividing the interior surface into four quadrants. These quadrants are decorated with white dots applied with the fingertips. The denuded appearance of some areas of the decoration is due in part to the paint being applied post-firing and, therefore, being more fragile and easily scraped off the surface.

2.3 *Parallels and Discussion*

Concerning the shape of the carinated bowl from N 2446 = N 2522, it is a well-documented type that first appears in Upper Egypt in late Dynasty 11 and spreads across Egypt in early Dynasty 12.²³ What distinguishes this bowl from other examples of this type is the white painted decoration.

Vessels with white painted decoration of lines and/or dots first appear in the First Intermediate Period, are rarer in the Middle Kingdom, and appear with more frequency in the Second Intermediate Period and early Dynasty 18. Vessel function can be difficult to confidently pinpoint, but Schiestl and Seiler do ascribe a ritual or funerary purpose to the type.²⁴ Bowls are the most common shape with this decoration; however, the use of white painted decoration is not uniform throughout Egypt or across different periods. For example, Assiut is a site with a well-documented development of vessels with white painted decoration, with the highest frequency of examples in the First Intermediate Period.²⁵ Hemispherical bowls, carinated bowls, and small jars are found with this decoration.²⁶ Interestingly, the combination of the crossed lines and dots motif found on the Naga ed-Deir bowl is not found on the Assiut bowls in the First Intermediate Period. Fewer examples and varieties of decorated shapes are found at Middle Kingdom Assiut.²⁷ At Abydos, bowls with simple contour and flat base were decorated with white dots irregularly applied on the interior

22 The white paint could be lime based. Examples have been tested elsewhere (e.g., Thebes). See Bader and Seco Álvarez 2016, 211.

23 Schiestl and Seiler 2012, 236.

24 Schiestl and Seiler 2012, 182, 184, figs. 2–3. See the bibliography on p. 182 for further sites with examples of bowls with simple contour, flat base, and painted decoration.

25 Rzeuska 2017, 179–186.

26 Rzeuska 2017, 180, 186, Tab. 2; jars Cat. 155–167; hemispherical bowls Cat. 168–171, 174; carinated bowls Cat. 172–173.

27 Rzeuska 2017, 180, 303–307, Tab. 3, Cat. 290–306. Examples in the Second Intermediate Period are rare and restricted to one vessel type (Rzeuska 2017, 180, 421–422, Cat. 328–329).

and a white band at the rim.²⁸ Bowls with flat bases and decoration of white crossed lines and dots were excavated in a settlement context at Dendera. They are rare, and Sylvie Marchand dates these examples to the end of Dynasty 11.²⁹

Bowl PAHMA 6-14507 is not the only example of white painted decoration on pottery from the Naga ed-Deir cemeteries. Two additional bowls appear in an excavation photo (NED-A-7673, top row, third from right; NED-A-7673, second row, sixth from right = Fig. 2.29). The precise context of these bowls is not clear, and their current location is unknown. All three bowls differ from one another in shape, but the interior decoration is the same pattern of two crossed lines and dots. The largest bowl (NED-A-7673, top row, third from right = Fig. 2.29) has a direct rim, simple contour, and most probably a flat base. The rim exhibits a wide white band with two white crossed lines on the interior and irregularly spaced white dots in the space between the lines. The third bowl with white painted decoration is a hemispherical bowl with the same pattern of irregularly spaced dots and white crossed lines on the interior. There is no white rim band and, surprisingly, there are white dots irregularly spaced on the exterior of the bowl. Presently, this is the only example of a bowl with white spots on the *exterior* known to me.

Although not comprising a large percentage of any cemetery or settlement context in Egypt, bowls decorated with white lines and/or dots are known from several sites with First Intermediate Period through early Middle Kingdom contexts. The three bowls with white painted decoration from Naga ed-Deir incorporate the site into this wider phenomenon.

3 PAHMA 6-14428, PAHMA 6-14429, PAHMA 6-2799 Offering Stand with Incised Decoration

3.1 *Context*

A heavily disturbed burial, N 2099, retained an offering stand with incised decoration (Fig. 3.4; also, Fig. 2.28, bottom row, second from right, and NED-B-7146 [unpublished]), early Dynasty 11 to early Dynasty 12 bag-shaped jars,³⁰ early/pre *hes*-jars known from Dynasty 11 to early Dynasty 12,³¹ early forms of the

28 Steinman 1998, Tafel 92:5–6, Kat.-Nr. 320. In the Second Intermediate Period, jars with white rim and white dots decorating the shoulder were found at the site (Steinman 1998, Tafel 95:2, Kat.-Nr. 333).

29 Marchand 2012, 281, note 44, fig. 16, Group 8 (Phase 3b); Marchand 2004, 220, figs. 51–52 (end of Phase 3).

30 Schiestl and Seiler 2012, 536; Arnold 1972, Abb. 3:7.

31 Schiestl and Seiler 2012, 512; Arnold 1972, Abb. 5:12.



FIGURE 3.4A–C Offering stand 6-14428, 6-2799, 6-14429 (N 2099)

hes-jar with splayed base that first appears around mid-Dynasty 11,³² hemispherical bowls,³³ 4 small “saucers,”³⁴ and pieces of charcoal. The offering stand, jars, and *hes*-jars are visible *in situ* at the entrance to the tomb in a field photograph (Fig. 3.5).

3.2 *Vessel Description*

The offering stand’s unusual appearance is the result of joining a carinated bowl and a stand before they were fired. The stand has a modeled rounded rim that is not flush where it joins with the bowl. This is atypical for an offering stand. It appears that a carinated bowl was turned separately and then fitted into the top of a fully formed stand in the leather-hard stage pre-firing. This method of joining two separate pieces was not a complete success, as the bowl separated from the stand in antiquity. In the photo of the offering stand still *in situ* (Fig. 3.5), a crack is visible where the bowl and stand were joined by the potter.³⁵

Both the bowl and stand were made in Nile B1 or a fine Nile B2 fabric with a red slip on the exterior surfaces, as well as on the interior of the bowl. This carinated bowl with direct rim was turned, while the stand was formed with a combination of coiling and turning.³⁶ The body above the carination on the

32 Schiestl and Seiler 2012, 508, 512.

33 Hemispherical bowl with direct rim PAHMA 6-14428.

34 No further description given for the saucers.

35 The full shape, as well as the crack, is more visible in NED-B-7146 and NED-A-7560 (Fig. 2.28).

36 Partially smoothed coils of clay are visible on the interior surface near the top of PAHMA 6-14429.

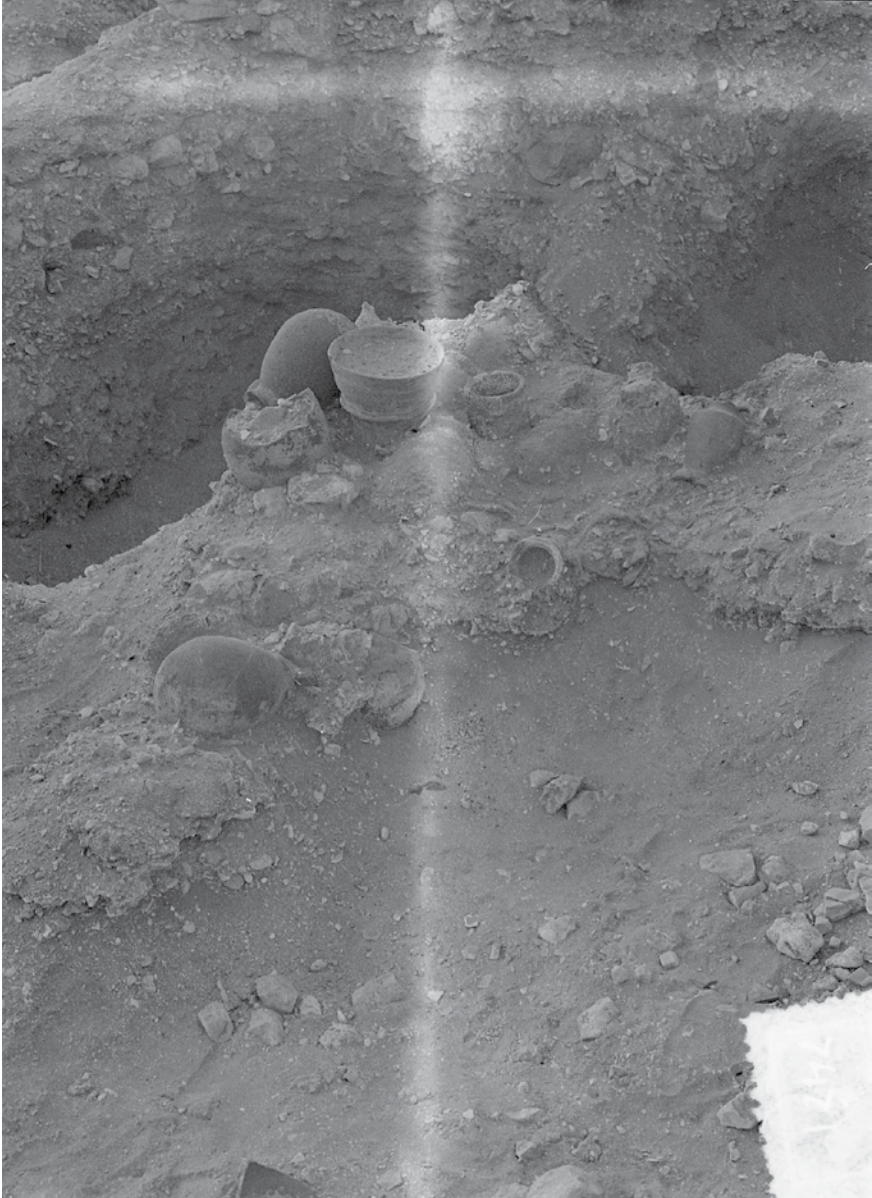

FIGURE 3.5 Ceramics in position N 2099 (NED-B-7471)

bowl shows incised decoration. Two rows of wavy lines are separated by and bounded by horizontal lines. A small area between the carination and the start of the stand was scraped horizontally. The stand column ends with a modeled everted base.

3.3 *Parallels and Discussion*

The Naga ed-Deir offering stand is unusual because the potter appears to have joined a fully formed stand to a bowl without making the join flush and also because the offering stand has incised decoration.³⁷ Since this combination is unusual and possibly unique, the best sources for comparanda are carinated bowls with direct rim, ring base, and complex incised decoration. These bowls have a long chronological span in Egyptian cemetery and settlement contexts. They first appear in Upper Egypt in late Dynasty 11 or early Dynasty 12.³⁸ In the Qau to Matmar region, carinated bowls with alternating bands of wavy and horizontal lines are found in cemetery contexts of mid to late Dynasty 11 and early Dynasty 12 (Stufe III B).³⁹ This is also the pottery phase when carinated bowls with a ring base and incised decoration are first found at Elephantine.⁴⁰ Marchand calls the carinated bowls with two rows of wavy lines, like what is found on the Naga ed-Deir offering stand, a hallmark for Phase 3 (end of First Intermediate Period–Dynasty 11) at Dendera.⁴¹ Much further to the north at Tell el-Daba, numerous carinated bowls with alternating rows of wavy and straight lines incised on the upper body have been found. The long development of the type at Tell el-Daba begins in early Dynasty 12.⁴²

Three additional large carinated bowls with incised decoration were photographed during the excavation at Naga ed-Deir. All three have ring bases and were not attached to stands. Two of the bowls exhibit two horizontal lines incised below the rim and a band of wavy lines incised on the upper body (Fig. 2.29, second row from bottom, second from right, and NED-C-8546, top row, first from right [unpublished]), while the third example is incised with

37 I am unaware of any published examples of an offering stand made with this technique and with incised decoration.

38 Schiestl and Seiler (2012, 224) place the first carinated bowls with ring bases and incised wavy lines in early Dynasty 12. Marchand dates examples at Dendera earlier (Phase 3, end of First Intermediate Period–Dynasty 11).

39 Seidlmayer 1990, 152, Abb. 59:K-A06.02.

40 Seidlmayer 1990, 434, Abb. 176.

41 Marchand 2004, 220, figs. 44–46.

42 Czerny 2015, Abb. T49–50, 294, Abb. T51 for development of the type.



FIGURE 3.6A–B Carinated bowl with spout 6-14542.1 (N 2490)

alternating rows of straight and wavy lines on the entire upper body (NED-B-7110, top row, second from left [unpublished]; N 3568).

Carinated bowls with incised decoration have a long chronological history and wide geographical spread across ancient Egypt; however, the combination of an incised carinated bowl with a fully formed stand shows a creative take on the offering stand at Naga ed-Deir.

4 PAHMA 6-14542.1 Carinated Bowl with Spout

4.1 *Context*

This spouted bowl was found *in situ* at the entrance to the pit of N 2490 still sitting on a tall stand (PAHMA 6-14542.2) with a “double base” similar to those found in the First Intermediate Period at Assiut (Figs. 2.5, 2.28, 2.33; NED-B-7467 [unpublished]).⁴³ Several bag-shaped jars with modeled rim characteristic of Dynasty 11 to early Dynasty 12 were also found in this deposit.⁴⁴

43 Double rims and double bases have a shallow incised horizontal line that gives the rim or base a double or stacked appearance. See Rzeuska 2017, 159, fig. 106, Cat. 102.

44 See image NED-C-7158 (Fig. 2.33). At least eight round base jars with modeled rim are visible and appear to be part of the same deposit. The bowl (NED-B-7146, top row, first from right) is possibly a deep inflected bowl, which is a type produced from the First Intermediate Period until the reign of Senwosret II (Schiestl and Seiler 2012, 208).

4.2 *Vessel Description*

This bowl was made in three parts: 1) rim and upper body, 2) lower body, and 3) spout. From the slightly everted rim down to the subtle carination, the bowl was turned. The exterior surface of the lower body and round base shows a rippled appearance, which could be the result of a handmade forming technique.⁴⁵ A large handmade spout was attached to one side below the rim area. The fabric employed is Nile B1, and a red slip covers all exterior and interior surfaces including inside the spout.

4.3 *Parallels and Discussion*

Spouted bowls have a long history in the Egyptian pottery corpus. Although not characteristically appearing in high numbers, spouts are found attached to bowls, jars, ewers, deep vats, and miniature vessels. Bowls with attached spouts are known from settlement and funerary contexts and were used for short-term storage and pouring liquids.⁴⁶ The Naga ed-Deir shallow spouted bowl with rounded base is not a common type in this period.⁴⁷ Spouted vats with modeled rim and flat base are more common in the First Intermediate Period up to early Dynasty 12 and mostly used for food and beer production in settlements.⁴⁸ A spouted bowl of similar shape to Naga ed-Deir PAHMA 6-14542.1 was discovered at Assiut.⁴⁹ Additional spouted bowls from Naga ed-Deir are in the photos from Reisner's excavation, but these bowls belong to the late Old Kingdom in shape and technology.⁵⁰

5 Conclusions

The majority of the pottery from Naga ed-Deir cemeteries N 2000 and N 2500 are part of a standard repertoire of types known elsewhere in Egypt from the First Intermediate Period through early Dynasty 12 and are found in multiples in these cemeteries. The four vessels briefly presented in this chapter show the

45 Without seeing the bowl in person, it is difficult to determine if the lower body and base are handmade or turned and the resulting rippled appearance is due to a smoothing technique/tool.

46 Schiestl and Seiler 2012, 342.

47 There are no parallels in Schiestl and Seiler for this period.

48 Schiestl and Seiler 2012, 730; Slater 1974, 64–65, fig. 12:C7c.

49 Rzeuska 2017, 306, fig. 247, Cat. 306. This completely turned bowl with a spout is from a Middle Kingdom context and later than the Naga ed-Deir bowl.

50 See image NED-B-7145, top row, first and second from left and Wodzińska 2010, 135, Old Kingdom 40.

addition of rare or unique elements, while still finding points of connection with wider trends outside of Naga ed-Deir.

Bibliography

- Arnold, D. 1972. "Weiteres zur Keramik von el-Târif. Saff el-Dawâba 1970/71." *MDAIK* 28: 33–46.
- Bader, B. and M. Seco Álvarez. 2016. "Results of Five Years of Pottery Analysis in the Temple of Millions of Years of Thutmosis III in Western Thebes (2011–2015)." *Ägypten und Levante* 26: 157–262.
- Brunton, G. 1928. *Qau and Badari II*. London.
- Czerny, E. 2015. *Tell el-Dab'a XII. "Der Mund der beiden Wege": Die Siedlung und der Tempelbezirk des Mittleren Reiches von Ezbet Ruschdi*, edited by M. Bietak. Vienna.
- Marchand, S. 2004. "Fouilles récentes dans la zone urbaine de Dendara: la céramique de la fin de l'Ancien Empire au début de la XII^e dynastie." *CCE* 7: 211–238.
- Marchand, S. 2012. "Dendara." In *Handbook of Pottery of the Egyptian Middle Kingdom, Volume 2: The Regional Volume*, edited by R. Schiestl and A. Seiler. Vienna.
- Nordström, H.-Å. and J. Bourriau. 1993. "Ceramic Technology: Clays and Fabrics. Fascicle 2." In *An Introduction to Ancient Egyptian Pottery*, edited by Do. Arnold and J. Bourriau, 142–190. Mainz.
- Reisner, G. A. 1932. *A Provincial Cemetery of the Pyramid Age. Naga-ed-Dêr. Part III*. University of California Publications, Egyptian Archaeology 6. Berkeley.
- Rzeuska, T. I. 2017. *Chronological Overview of Pottery from Asyut. A contribution to the history of Gebel Asyut al-gharbi*. Wiesbaden.
- Schiestl, R. and A. Seiler. 2012. *Handbook of Pottery of the Egyptian Middle Kingdom, Volume I: The Corpus Volume*. Vienna.
- Seidlmayer, S. J. 1990. *Gräberfelder aus dem Übergang vom Alten zum Mittleren Reich. Studien zur Archäologie der Ersten Zwischenzeit*. Heidelberg.
- Slater, R. A. 1974. *The Archaeology of Denderah in the First Intermediate Period*. PhD thesis. University of Pennsylvania.
- Steinman, F. 1998. *Tongefässe von der Vordynastischen Zeit bis zum Ende des Mittleren Reiches*. Mainz.
- Wodzińska, A. 2010. *A Manual of Egyptian Pottery. Volume 2: Naqada III–Middle Kingdom. Revised First Edition*. Boston.

Scarabs, Scaraboids, Seals, Seal Impressions, and Knotted Cords

Emily Teeter

1 Scarabs, Scaraboids, and Seals Catalogue

The N 2000 cemetery yielded only a few scarabs and seals: four scarabs or scaraboids, a button seal, and a hemi-cylindrical seal.¹ Most were found singly, although two were recovered from N 71–71b. The paucity of seals contrasts with sites such as Qau, Badari, and Hememieh where at least 229 button and scarabs were recovered (Brunton 1927, 58).

Explanation of the Scarabs, Scaraboids, and Seals Catalogue:

The finds' description of context below is taken from the Catalogue of Tombs. The photograph numbers reflect the original excavator's numbering system.

Museum Registration: Name and museum number of object.

Material: Copper alloy, faience, glazed material, glazed steatite, steatite, textile.

Measurements: Length, width, depth. Also, weight.

Color: Blue-green, brown, green.

Date: Dynasties 7–11.

1 Apparently, there were a few more scarabs from the 2000 cemetery, including PAHMA 6-14372 that was strung on beads from N 2071a–b and MFA 21.981, 21.982 (both from N 434B). See Reisner (1932, 115, fig. 50:19, 116, section 2v) for a “faience lion-seal” (PAHMA 6-14381) from N 2072 that is treated in the chapter Beads, Pendants, and the Like.



FIGURE 4.1 Seals and scarabs 1st row: 6-14381 (N 2072), 6-14328 (N 2034), 6-14348 (N 2048), 6-14383 (N 2075); 2nd row: 6-14374, 6-14372 (N 2071); 3rd row: 6-14367 (all 4 objects; N 2071) (NED-C-8285)

N 2034 Map E4; photo C 0993, B 7129

In large chamber, small faience plaque (PAHMA 6-14328). (See note, below.)

(1) PAHMA 6-14328 Hemi-cylinder seal (Figs. 4.1, 4.2)

Material: Steatite.

Measurements: L 0.74 × W 0.725 × D 0.40 cm.

Weight: 0.02 g.

Color: Green.

Date: First Intermediate Period, Dynasties 7–11.

Small square seal-like amulet with a hemi-cylinder-shaped back. The handle on the back bears a raised floral-like pattern. The back of the seal below the handle has a raised rim, so when the seal is seen from the top, the floral pattern appears to be enclosed in the square frame.² The hemi-cylinder is pierced.

² The pattern on the back does not look like the drawing in Reisner (1932, 114, fig. 49.5) (reproduced by Wiese 1996, pl. 60, no. 1227), where it is shown as being a crosshatched pattern, whereas the pattern looks floral.

The underside has a meandering line pattern or maze/labyrinth pattern in a square frame. The object is covered with green glaze.

Note on provenience: There is confusion in the records about the provenience of this seal. According to one set of Hearst Museum records, it is from N 2032 (tomb of Pepi-Iam, a *h3ty*-c and seal bearer of the King of Lower Egypt), while according to the older set of Hearst Museum records and the original (and more accurate) documentation, it is from N 2034.

Note on date: The date is based on the provenience, which is confirmed by the pattern that is seen on other scarabs/seals of the First Intermediate Period. Brunton (1927, 57) dates the square hemi-cylinders to Dynasties 7–8. Haynes and Markowitz (1991, no. 7) comment “these linear patterns are characteristic of First Intermediate design amulets and scarabs.”

This type of hemi-cylinder occurs in Dynasty 6 and disappears in Dynasty 11 (Newberry 1906, 57–58; Reisner 1932, 119).

This form of seal is referred to by various names, most commonly a “hemi-cylinder” (Newberry 1906, 56–61; Brunton 1927, 55–56), “halbzylinder” (Wiese 1996, 55–56, 59–61) or “cylinder + plate-seal” (Reisner 1932, 115, 118, 119). It has been associated with the earliest stamp seals, although it is unclear if the first stamp seals were in this form or buttons (Reisner 1932, 119). Reisner (1932, 119) suggested that the form evolved from earlier cylinder seals that, although retaining their domed back, were given a flat base enabling them to be used as stamps. This direct development has been rejected by Wiese (1996, 56) who noted that the type of decoration on the two types of seals is completely different, one being a continuous pattern, the other a single stamped pattern.

The design on the bottom is similar to that found on button seals from Mahasna dated to Dynasty 6 and later (Garstang 1903, 33, pl. 39), while others have commented that the meander pattern is characteristic of First Intermediate Period seals.³ Brunton (1927, 56) and Slater (1974, 251) noted that objects with the meander pattern are earlier than those with spiral/scroll patterns (for example, PAHMA 6-14374) that occur as early as Dynasty 9. Newberry (1906, 59) noted that these hemi-cylinder seals almost always have geometric patterns on their bottom.⁴

According to Newberry (1906, 61), these hemi-cylinders are always glazed in either blue or green.

3 See Haynes and Markowitz (1991, nos. 7–8), with reference to Garstang (1903, pl. 39).

4 See other examples in Wiese (1996, pls. 59–60).

This is such a small object that it appears to be an amulet or a purely decorative object, like a bead rather than being intended as a functional stamp seal.

Compare to Garstang 1903, pl. 39; Petrie 1925, pl. 4 (no. 249) from Diospolis Parva; Reisner 1932, 114 (fig. 49.3-4, 8-11), 115 (g), for examples of a series of very similar small objects with “meandering line patterns,” especially fig. 49.5 from N 2034 at Naga ed-Deir; Hayes 1953, 143 (fig. 85, lower right), on a First Intermediate Period seal; Ward 1978, 47-48; Haynes and Markowitz 1991, no. 4 with a maze/labyrinth pattern and an unusual back in the form of two scribes, seated back to back, dated to the First Intermediate Period.

Published: Reisner 1932, 114 (fig. 49.5); Wiese 1996, pl. 60 (no. 1227), although the floral-like design on the top is incorrectly shown as a crosshatched pattern. Wiese, who noted erroneously that the location of this seal is “unbekannt” and so did not have access to it, has, for an unstated reason, turned his drawing of the base 90 degrees clockwise and the top 180 degrees from Reisner’s drawing.

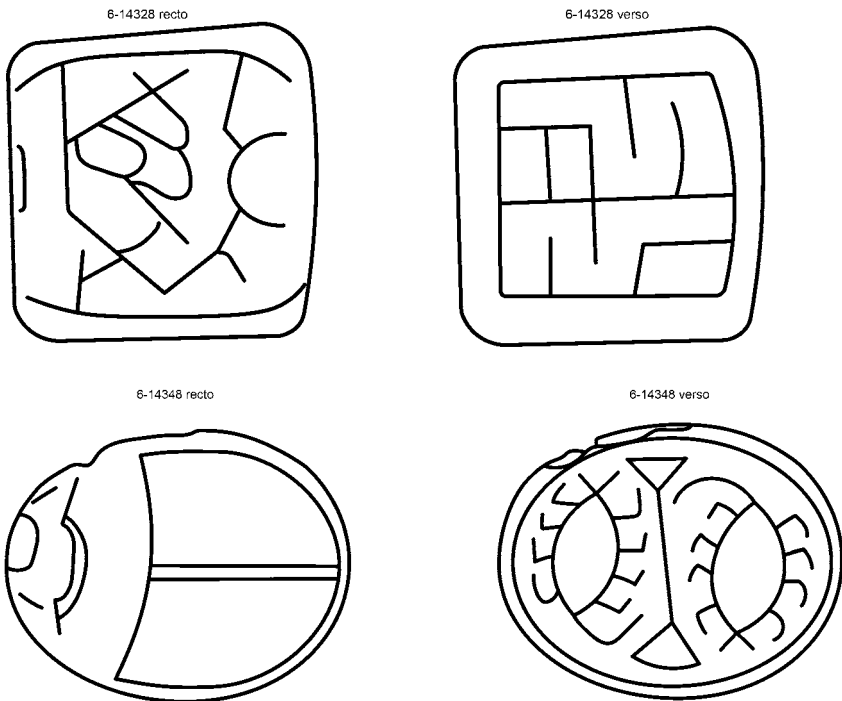
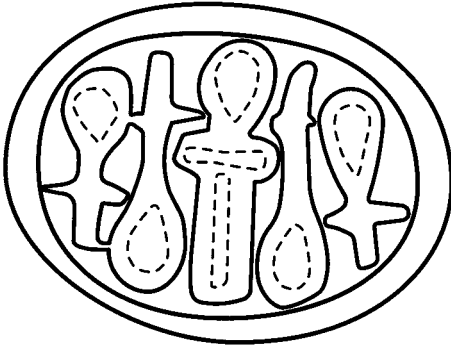
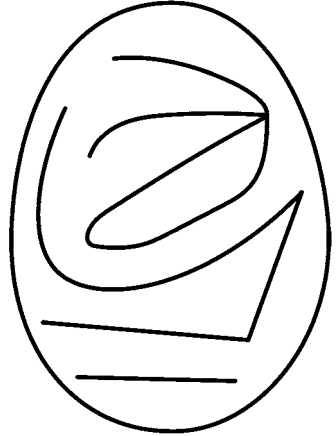

FIGURE 4.2 (1) Hemi-cylinder seal 6-14328. (2) Scarab 6-14348. (3) Scaraboid 6-14363. (4) Scarab 6-14374. (5) Scarab 6-14383. (6) Reconstruction of cylinder seal with cross-hatch pattern and plain borders. Drawn after impression on 6-14447A. (7) Round seal impression. Drawn after impression on 6-14447A. Not to scale.
DRAWINGS BY V. DAVIES

6-14363 verso



6-14374 verso



6-14383 verso

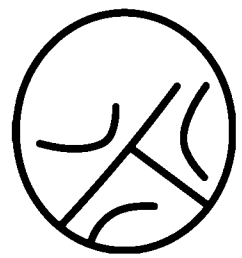
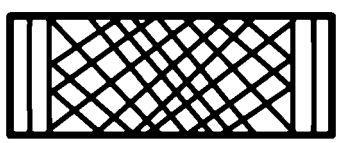
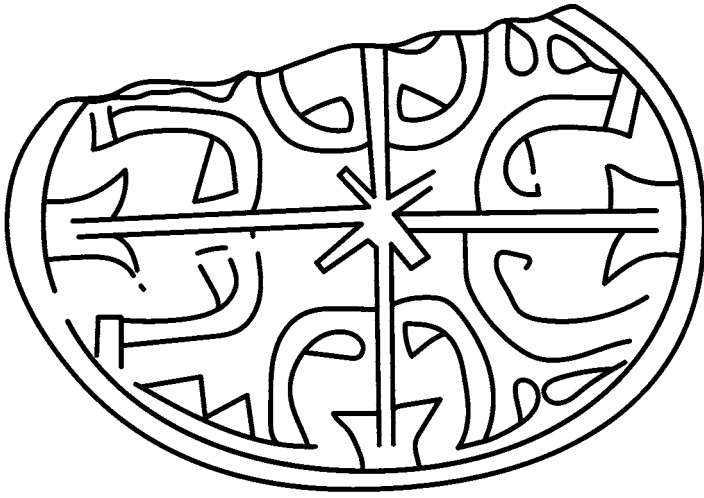

N 2048 Map B3

In *radim*, scarab (see drawing) (PAHMA 6-14348) (See note, below.)

(1) PAHMA 6-14348 Scarab (Figs. 4.1, 4.2)

Material: Faience?

Measurements: L 1.47 × W 1.11 × D 0.73 cm.

Weight: 1.0 g.

Color: Blue-green.

Date: First Intermediate Period, Dynasties 8–9.

Scarab with good detail on the back. Double lines divide the elytra and a single curved line delimits the elytra from the prothorax. The head is broad and has a ruffled clypeus. The body sits atop tall legs, and the material has been carved out between the legs. The front and middle legs meet very far forward where the prothorax meets the head. The legs are on a tall platform.

The base of the scarab has two scorpions *tête-bêche* with a flower with buds at each end separating them. The scorpions are executed in a very linear fashion that Ward (1978, 51) suggests is “characteristic of the First Intermediate Period.” The design is enclosed a single line frame. There are remains of very bright blue-green glaze on the elytra and in the incisions on the base. The piercing is very straight and regular.

Note on provenience: There is some doubt about from which tomb this was recovered. The Hearst Museum database records this from N 2051, but the original excavator’s notes assign it to the *radim* of N 2048.

The well-defined anatomy of the legs suggests that this is of a slightly later date than scarabs on a platform such as PAHMA 6-14374.

The design of animals, such as crocodiles and lizards, in a *tête-bêche* arrangement appears “with some frequency at this early date” (i.e., First Intermediate Period) (Haynes and Markowitz 1991, no. 5).

Double lines dividing the elytra and a single curved line that delimits the elytra from the prothorax are characteristic of Ward’s Type II (1978, 29). The pattern of the legs is not included in Ward’s typology (1978, 31) that shows the legs meeting where the prothorax (pronotum) and elytra join.

Compare to: Newberry 1906, pl. 42 (no. 31); Petrie 1925, pl. 14 (no. 930); Brunton 1927, pl. 33 (no. 168) also with naturalistically carved legs, dated to Dynasties 8–9; Haynes and Markowitz 1991, no. 5 for two crocodiles *tête-bêche*

on the base of a design amulet. See also Newberry 1907, 88, pl. 15 (no. 36349) with three scorpions in a much more naturalistic depiction, dated to Thutmose III. Not published.



FIGURE 4.3

Scarab 6-14363 (N 2017) (See also NED-C-8567)

N 2071 Map B4; type rock-cut chamber with sloping entrance; photos C 8074, C 8567, A 8267, A 8268, B 8250

(a) Body of a child. Round neck, a small scaraboid (iv) (PAHMA 6-14372; p. 308n1). Below, a second layer of burials. By neck of (e), 1 glaze scaraboid (xi) (PAHMA 6-14363).

(1) PAHMA 6-14363 Scaraboid (Figs. 4.2, 4.3)

Material: Glazed steatite (?).

Measurements: L 1.20 × W 0.915 × D 0.35 cm.

Weight: 0.6 g.

Color: Brown with traces of blue-green glaze.

Date: First Intermediate Period.

Oval scaraboid with a very faint line around the base (visible on one side only). Part of the back is worn away by the abrasion of the string on which it was strung. No glaze is preserved on the top, but blue green glaze remains in the hieroglyphs on the base.

The decoration on the base is enclosed in an oval frame. The design consists of a central stylized ankh flanked by what appear to be *nefer* signs. A difficulty with their interpretation is the round base of the signs may be intended to be a loop as indicated by a raised center area. If so, they were perhaps intended to be additional ankh signs.

The faint line visible on one side of the back, near the base, makes it difficult to determine if this was supposed to be a cowroid.

Note on provenience: This came from a tomb of a child with 29 other objects, including scarab PAHMA 6-14374.

Stylistically, this scarab is like a First Intermediate Period example from Matmar (Brunton 1948, pl. 33 (no. 87)), with bold signs that leave a considerable part of the background open. The vertical line that bisects the “stem” of the ankh and the broad transverse arms are known from colossal statues of Senwosret I at Karnak.⁵ See Ward (1978, 55–56) for comments about variations in the form of the ankh on pre-Dynasty 12 scarabs.

Compare to Newberry 1907, 228–229, pl. 11 (nos. 36910, 36911) for the same signs (dated to the Hyksos, and the First Intermediate Period or Hyksos, respectively), but arranged differently and with the addition of an *r* hieroglyph. See also Newberry 1907, 208, 225, 270, pl. 16 (nos. 36827, 36897, 37078), all with single ankh and *nefer*, dated to Dynasty 18.

Not published.

(2) PAHMA 6-14374 Scarab (Figs. 4.1, 4.2)

Material: Glazed material.

Measurements: L 1.10 × W 0.705 × D 0.53 cm.

Weight: 0.5 g.

Color: Brown with traces of green glaze.

Date: First Intermediate Period.

Scarab with very little detail on the back. The legs are not shown. A line divides the scarab from the base, creating a high oval plate.

The decoration on the base is difficult to make out, but Reisner (1932, 116) categorized it as a scroll pattern. Ward (1978, 102, pl. 11 (no. 40)) classified this scarab as design class 1A (maze) from his Period Two (early Dynasties 9–10 “and the first half of the contemporary local Eleventh Dynasty”).

Green glaze is preserved in spots on the back and in the incisions on the base.

Note on provenience: This came from a rich tomb of a child with 29 other objects, including scarab PAHMA 6-14363 and a string of green faience beads around the child’s neck.

⁵ Oppenheim et al. 2015, 70 (fig. 55).

Note on date: Brunton (1927, 56) and Slater (1974, 251) state that scarabs without legs (like this example) are earlier than those with more naturalistic legs. Reisner (1932, 110) dates this type of scarab that sits on a high oval plate to the early Middle Kingdom, while Ward (1978, 10), places them in the First Intermediate Period.

Compare to: Garstang 1903, pl. 39 (no. 343, top left of plate).

Published: Reisner 1932, 115, fig. 50.13, 116(i) as an “early scarab seal;” Ward 1978, 10, 102, pl. 11 (no. 40).

N 2075 Map A4; type vi d; photo C 8074, B 8248

[ed.: According to Hearst Museum records, PAHMA 6-14383 (scarab) is from this burial.]

(1) PAHMA 6-14383 Scarab (Figs. 4.1, 4.2)

Material: Steatite.

Measurements: L 2.71 × D 1.155 cm.

Weight: 7.1 g.

Color: Brown.

Date: Late First Intermediate Period?

Scarab, with part of the left side broken and lost. Additional thin pieces of the steatite have sheared off, leaving little detail on the back other than lines that represent the division of the elytra and the division of the prothorax from the elytra and the head. The legs are indicated by a double line that encircles the scarab. There is no definition of the anatomy of the legs, similar to Ward’s pattern “o” (1978, 31). The head is not well enough preserved to categorize it.

The base is decorated with a *smꜣ tꜣwy* design, the *smꜣ* sign being shown four times, its base at the outer edge of the scarab. The crossbar at the top of each sign is intertwined to make an X pattern. Floral emblems representing lily and papyrus cross the neck of the *smꜣ* signs. Small double triangles represent the marsh in which the plants grow. A single line frames the decoration.

Brown glaze remains in the hieroglyphs on the base and also in the lines that define the back. The steatite is very friable.

Note on provenience: This scarab was from a very rich tomb that contained cosmetic vessels, three mirror disks (PAHMA 6-14393, PAHMA 6-14394, PAHMA 6-14395), and many conical beads and shells.

Ward (1978, 72–73) states that on pre-Dynasty 12 scarabs, the single *smꜣ* sign appears alone, while in Dynasty 12 and afterward, the *smꜣ* is “doubled or

appears in combination with other signs." The pattern of four intertwined *smʒ* signs on this scarab suggests that Ward's comment is not accurate because this scarab surely predates Dynasty 12. So too, Ward's conclusion that the base of floral elements are pointed or curved before Dynasty 12 is not born out by this scarab, which has a thick, flat base that, according to Ward (1978, 74), is post-Dynasty 12. For scarabs with two *smʒ* signs, see Petrie (1925, pl. 10 (no. 379(?), 388)).

Comparable examples date to later periods. See Haynes and Markowitz (1991, nos. 37–38) with same *smʒ tʒwy* pattern, dated to the early Second Intermediate Period, and Newberry (1906, pl. 20 (nos. 20–24)) with bases that incorporate the *smʒ tʒwy* design, dated to "Twelfth to Eighteenth Dynasties."

Not published.

N 2449 Map B4

Approx. 210 deep. 80 high. Female? On breast, at X, a bronze button (i) with loop back, covered with cloth on both sides (PAHMA 6-14539).

(1) PAHMA 6-14539 Button Seal

Material: Copper alloy (?), textile.

Measurements: L 2.4 × W 1.2 × D 0.3 cm.

Color: Bright green corrosion, beige textile.

Date: First Intermediate Period, Dynasties 7–8.

Round seal with a thin loop handle. The face of the seal is badly corroded, and any original design (if it was even decorated) cannot not be made out. Textile adheres to part of the back and one edge of the loop handle.

Buttons of steatite, limestone, rock crystal, bone, alabaster, and pottery from this period are known (Petrie 1925, 1–2; Hayes 1953, 142), but examples in metal seem to be very rare. However, copper alloy objects (amulets, beads, a mirror disk, and vessels) were recovered from other, earlier cemeteries at Naga ed-Deir (N 500–900 in Reisner 1932, index). Brunton (1927, 57) noted that metal was only rarely used for seal amulets.

Button seals appear in Dynasty 5, becoming more common in Dynasty 6, and they continue in use through Dynasty 11.⁶ Brunton (1927, 57) noted that round buttons with a shank most commonly date to Dynasties 7–8.

⁶ Oppenheim et al. 2015, 484. Hayes (1953, 141) says buttons and stamps appear Dynasty 6, as does Newberry (1906, 57–58).

It is debated whether these were functional seals or amulets, or if they served a combination of these functions (Petrie 1925, 1).

If this tomb indeed belonged to a woman, it would reinforce the pattern seen at other contemporary sites where most seal amulets were placed in the tombs of women (summarized by Brunton 1948, 50). Slater (1974, 250) noted that seals (presumably referring to stamp seals) were generally not common at Naga ed-Deir.

Not published.

2 Seal Impressions and Knotted Cords from Tomb N 2232

2.1 *Description*

Four groups of cords knotted along their length with clay sealings attached to them were recovered from N 2232. The tomb card describes the material as “At side of coffin remains of basket work, with clay sealings attached. May have originally enclosed coffin.”⁷ However, closer examination of the material makes this interpretation unlikely. The strands of knotted cord are not attached to each other to make a network as would be expected for a basket or a sling (Figs. 4.4, 4.5).⁸ On PAHMA 6-14448B, the lengths of knotted cord appear to have been folded back and forth along their length to form a short hank and then tied with a piece of the cord and sealed with a clay *bullā*. The breakage of the strands and the sealings make it impossible to determine if the strands consisted of a few very long knotted cords that were gathered and sealed, or multiple separate pieces that were likewise folded back along their length, tied and sealed.⁹

Each group now presents itself as a dense nest of knotted cords. The material was given four different numbers (PAHMA 6-14447, PAHMA 6-14448,

7 The description continues “Sealings were only at top of coffin on N side; no trace underneath. Each was marked with 2 round seals.” Although a little vague, I take it to mean that the entire group of cords with their seals were found as a group on top of the coffin.

8 For examples of roughly contemporary rope slings from the tomb of Ipy at Thebes, see Winlock (1942, 56, pl. 18 (top)), Hayes (1953, 193, 262) (both Dynasty 12 from Lisht, the latter with reference to “knotted slings of rope” of much larger scale), and Hayes (1953, 292) for “knotted rope pot slings” from Deir el-Bahri dated to Dynasties 11–12. I thank Peter F. Dorman for the information about the jar sling from the tomb of Hatnofer (Dynasty 18).

9 However, considering the number of knots and the difficulty of making numerous small knots in a very long length of cord, shorter lengths would be more manageable, regardless of their function.

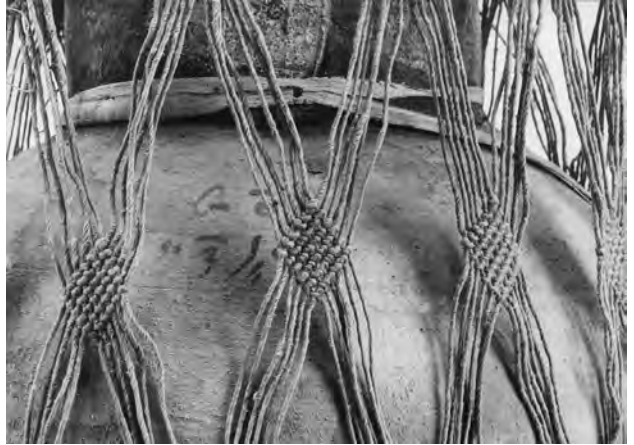

FIGURE 4.5 Detail of knots on jar sling from the tomb of Hatnofer. Photo MC16 188
COURTESY OF THE METROPOLITAN MUSEUM OF ART

FIGURE 4.4
Jar sling made of knotted fibers. Tomb of Hatnofer, Thebes, Dynasty 18 (ca. 1473–1458 BC). Photo MC16 187
COURTESY OF THE METROPOLITAN MUSEUM OF ART

PAHMA 6-14449, PAHMA 6-14450).¹⁰ PAHMA 6-14448B and perhaps PAHMA 6-14450A are separate objects (bundles of cord), but it is not clear if the rest of the material is part of those two, parts of each other, or part of other individual pieces, hence how many discreet objects are represented.¹¹

Both the diameter of the cord and the length between the knots varies slightly. All the cords seem to be made of double strands. The knots appear to be overhand knots. Willeke Wendrich identified the material as being composed of sZ2 string made of halfa grass (probably either *Desmostachya bipinnata* or *Imperata cylindrica*) with repeated S-overhand knots.¹² She commented, “Most grass string is made in the opposite direction, two z-spun yarns, that are S plied

10 Because most of the groups contained multiple sealings, I gave them (and their attached cords) alphabetic designations to differentiate the sealings within each registered group.

11 Especially looking at PAHMA 6-14448B on which the cords appear to have been folded back and forth on each other and tied to create a packet. My best guess is that there are least two discreet objects.

12 Personal communication from Willeke Wendrich.

(zS2). In this case the spin/ply direction is s-spun and Z-plyed, which is much less common.” The fiber now is a uniform dark brown color and is very brittle.

2.2 *The Sealings*

Seven clay sealing (and fragments of sealings) are preserved among the samples. All are still attached to the segments of knotted cord. When the back of a sealing is exposed, there are very clear impressions of the cords and knots.¹³

Each sealing captured multiple stands of cord. Most have areas that have been flattened or deformed by the pressure of the seal as it was applied.

The consistency of the clay used for the sealings is generally fine-textured and uniform, although some of the *bullae* (PAHMA 6-14447A, B, PAHMA 6-14448A) have pits and cracks in their surface, perhaps from air pockets in the clay. PAHMA 6-14448B in particular has numerous surface cracks, perhaps from the clay drying unevenly. All the sealings with the exception of PAHMA 6-14449 are a uniform brown color, while PAHMA 6-14449 is a lighter ashy gray tone.

2.2.1 The Seal Impressions

The sealings were covered with impressions made by two different seals. The most frequently occurring impression is a cross-hatch or basket pattern with a plain border (Fig. 4.2, 6) very much like the pattern on a cylinder seal recovered from N 505 at Naga ed-Deir.¹⁴ On impressions in PAHMA 6-14448B and PAHMA 6-14450B, it appears to be more oval but this probably due to the side of the cylinder being pressed into the clay rather than rolled over it. The clearest impressions of this seal are on PAHMA 6-14447A and PAHMA 6-14450B. On PAHMA 6-14450B, it looks like the seal was applied from two different directions. The impressions made by this seal are extremely crisp suggesting that the seal itself was made of a hard stone and was of fine quality.¹⁵ The other impression was made by a round button seal whose face has a T-like shape in the middle with indistinct patterns around it (Fig. 4.2, 7).

None of the impressions of this seal from the N 2000 cemetery are complete and totally clear, but the design strongly resembles two other button-seals

13 See especially PAHMA 6-14449.

14 Reisner 1932, 112, fig. 47.1 from N 505(1), and 111, described as a “cylinder-seal of bone.” The cross-hatch pattern (or as Reisner terms it, a “lattice”) also appears on a round button seal from N 505 (Reisner 1932, 111 (2), fig. 47.2), and he cites another (113 (1) a, fig. 48.1) in “Newberry l.c.”

15 Nadine Moeller (personal communication) noted that such fine quality seals at Edfu and Dendera are associated with higher levels of the administration and that they are often made of luxury materials like amethyst.

from Mahasna.¹⁶ The best-preserved examples of this seal impression are on PAHMA 6-14447A and PAHMA 6-14448A where it is clearly made with a round button seal. The impressions made by this seal are not as fine in detail suggesting that it was made of a material like faience rather than stone.

The cross-hatch pattern made by the cylinder is represented twice as frequently as the round T seal. Most of the seal fragments (PAHMA 6-14447A and B, PAHMA 6-14448A, PAHMA 6-14449, PAHMA 6-14450B) have two examples of the cross-hatch and a single round impression, whereas PAHMA 6-14448B appears to have perhaps 3 cross-hatches and one T circle. PAHMA 6-15550A has two cross-hatches and no circle. On PAHMA 6-14448A and B, the round impression appears on top of the cross-hatch as a counterseal.

2.2.2 Other Material

Very small shells, perhaps *Phasianella solida* (3–21 mm), or *Littoraria intermedia* (actual size 8.5–22 mm) are embedded into the strands of the fiber of PAHMA 6-14448B. Shells are also preserved in the modern storage bag registered as PAHMA 6-14448C that contains bits of cord, knots, and very small fragments of stone.

3 Sealings and Cords Catalogue

Explanation of the Sealings and Cords Catalogue:

The finds' description of context below is taken from the Catalogue of Tombs. The photograph numbers reflect the original excavator's numbering system.

Museum Registration: Name and museum number of object.

Material: Clay, cord, fiber.

Measurements: Length, width, thickness.

¹⁶ Reisner 1932, 114, fig. 48.27, 118 "3. Obscure Designs (a);" Garstang 1903, pl. 39, no. 417 (top photo, left middle of the image).

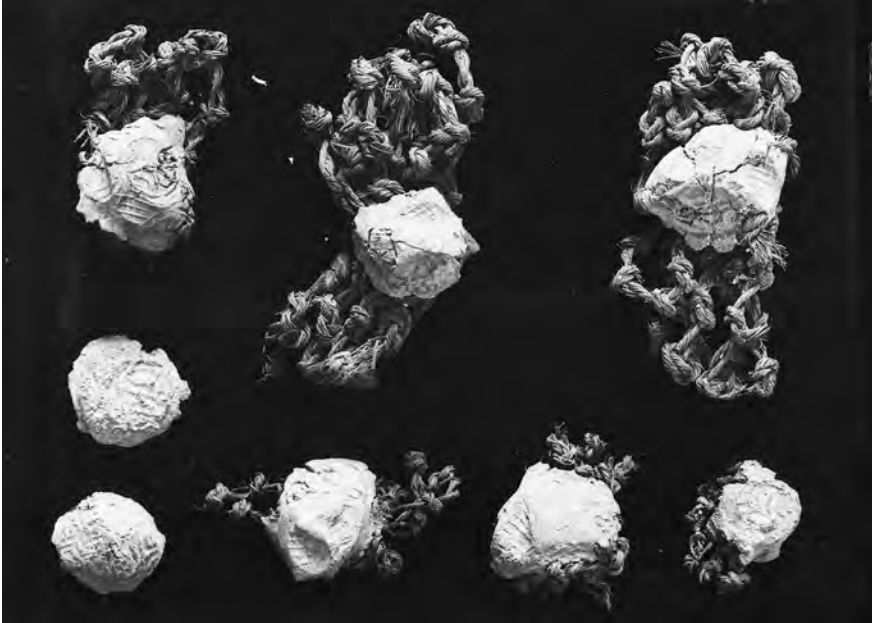

FIGURE 4.6 L-R (top): 6-14448, 6-14450, 6-14447; (middle): ?; (bottom): 6-14447?, 6-14447?, 6-14450, 6-14449? (N 2232) (NED-C-8590)

N 2232 Map E4; photos C 7468, C 8589 (Fig. 4.6)

At side of coffin, remains of basket work with clay sealings attached (PAHMA 6-14447, PAHMA 6-14448, PAHMA 6-14449, PAHMA 6-14450). May have originally enclosed coffin. Body was apparently untouched, but coffin had no lid remaining. Sealings were only at top of coffin on north side: no trace underneath. Each was marked with 2 round seals.

(1) PAHMA 6-14447A Sealing and knotted cord

Material: Clay, fiber.

Measurements of sealing: 32 × 26 mm; thickness: 21 mm.

Depending on the side viewed, the sealing can appear to be nearly round. It is of uniform brown color. The pressure of the seals has flattened the sides into different facets with ridges of clay between them. It is sealed with two very crisp cross-hatch seal impressions and one T-shaped that covers most of one side of the sealing. The latter is among the best and clearest examples of the sealing, although the clarity of the impression is obscured by pits in the surface of the clay.

The sealing is now detached from the lengths of cord, but the sealing captured several strands whose ends emerge from the clay. The cord is slightly thinner in diameter than others in the find, being more similar to PAHMA 6-14460B. The knots on one sample of this group were placed intervals of approximately 2, 4, and 11 mm.

Not published.

(2) PAHMA 6-14447B Sealing and knotted cord

Material: Clay, fiber.

Measurements of sealing: 30 × 28 mm; thickness 17 mm.

Depending on the side viewed, the bulla can appear to be nearly round, while from another angle it is a rectangle. It is of uniform brown color and is fine textured clay. It is broken into several pieces most of which still adhere to the cords.

Most of the surface is covered with seal impressions. The two cross-hatched seals are deeply impressed into the clay. The T-shape is impressed over one of the cross-hatched seals. The surface of the impression is marked by pits in the clay.

The sealing is attached to a gathering of knotted cords.

Not published.

(3) PAHMA 6-14448A Sealing and knotted cord

Material: Clay, fiber.

Measurements of sealing: 31 × 37 mm; thickness: 23 mm.

The sealing is irregular shaped, roughly a sphere and of uniform brown color. It bears two examples of the cross-hatch seal, one on a concave surface where the clay was deformed by the pressure of the seal. Unlike other impressions that seem to have been made with a cylinder seal, here it appears to be an oval, although that is probably because the seal was simply pressed against the damp clay rather than rolled. There is a very clear impression of the round T-shaped seal. The pressure of the seal made a regular flat facet in the clay. The T-seal was applied over the cross-hatch impression. It is marred by small cracks and pits probably caused by the clay drying. The sealing has many small cut-like incisions on the sides from the fiber of the cords.

The sealing is detached from lengths of cord although numerous short sections with knots are embedded in it.

Not published.

(4) PAHMA 6-14448B Sealing and knotted cord

Material: Clay, fiber.

Measurements of sealing: 37×36 mm.¹⁷

The sealing is an irregular oval shape and of uniform brown color. It is cracked into pieces, but the fragments still adhere to the knotted cords. It is medium brown in color. The *bullae* has numerous cracks that expose the sealed cord.

The sealing is impressed with three (?) of the cross-hatched impressions, each of which was applied from different angles. There is one very clear T impression that overlaps a cross-hatched impression.

The sealing is attached to a large amount of knotted cord measuring approximately 8.4×3.4 mm. The cord is knotted at close intervals that vary between 5 and 10 mm. The lengths of the knotted cord were folded back and forth against itself to make a bundle. One loop where the cord has been reversed is preserved. Other ends, which could have been places where the cord was probably turned back on itself, are now broken. The bundle is tied across its center with cord that was twisted around it three (?) times, two of the encircling cords close together, the third further away. The cord used to tie the bundle appears to be of similar construction to the bundle itself, but the two ties close together appear to be less tightly twisted. Although the tie cords have knots, on the two ties closest together, the knots are not visible on the cord to the left, although they are visible on the one to the right. The third tie, further to the right, looks similar to the cords in the bundle in texture and the frequency of knots.

Fragments of small shells are embedded in the cords.

Not published.

(5) PAHMA 6-14448C Sample of cord, shells, and fragment of stone in a plastic bag

The shells may be *Phasianella solida* (3–21 mm) or *Littoraria intermedia* (size 8.5–22 mm). The best-preserved shell is 11 mm in length. See Reisner (1932, 121ff.) for the presence of what he identified as *Nerita* shells in tombs in the N 500–900 cemeteries.

Not published.

(6) PAHMA 6-14449 Sealing and knotted cord with multiple small indistinct fragments of other sealings with seal impressions and fragments of knotted cord

¹⁷ The way that the sealing is embedded in the cord makes it impossible to measure its thickness.

Material: Clay, fiber.

Measurements of sealing: 31 × 19 mm; thickness 11 mm.

The sealing is a flattened sphere of which only half is preserved. The clay is much lighter ashy gray in color than any of the other examples in the group. It is impressed with two cross-hatched sealings and one T.

The reverse bears impressions from the cord that it originally captured. The cord is knotted at intervals ranging from 6.5–11 mm.

Not published.

(7) PAHMA 6-14550A Sealing with knotted cord

Material: Clay, fiber.

Measurements of sealing: 31 × 30 mm; thickness approximately 24 mm.

The sealing is an irregular sphere and is of uniform brown color. It has two impressions of the cross-hatched seal. One is pressed into the clay producing a concave cavity that is diagnostic of a cylinder seal being pressed (rather than rolled) in the clay. A fingerprint is preserved in the clay.

The sealing is wadded around a capture of knotted cord. From the back, it is clear that the cord has been looped back on itself and then sealed, so it is not several separate strands. It appears that there are two different types of cord, one of larger diameter, the other of smaller diameter. The knots that could be measured occur at about 7 mm intervals.

Not published.

(8) PAHMA 6-14450B Sealing with knotted cord

Material: Clay, fiber.

Measurements of sealing: 36 × 34 mm; thickness 22 mm.

From the top, it is an irregular sphere of uniform brown color. It is impressed with two cross-hatch seals that appear to be rolled from different directions. There is a single T seal. From the underside (with the knot capture) the shape of the *bulla* is an elongated oval bisected by knotted cord. One side of the bottom surface has another cross-hatch seal impression, while the surface on the other side of the cord does not have any impressions.

The *bulla* is attached to short pieces of cord that appear to be of a lighter weight and have less twist than the other examples in the overall group. The difference in the appearance of the cord on this example is quite marked from PAHMA 6-14450A.

Not published.

4 Interpretation of the Knotted Cords and Sealings

The most notable feature of this material is the value of the labor expended upon tying hundreds of small knots onto the double strands which themselves reflect considerable effort to manufacture. The resulting knotted cords were important enough that they, and perhaps more significantly their lengths, were preserved by gathering them and sealing them with clay *bullae*.

As stated, because the cords do not form a network, they appear to be individual strands of undetermined lengths that were gathered together and sealed.

Knotted cords suggest two very different purposes: magical/medical or record keeping. Several texts refer to tying knots in string or along lengths of linen to protect against sickness (Wendrich 2006, 251). Strings with lines of knots were thought to be a “barrier which evil forces cannot pass,” or the knots had the power to keep good forces from escaping (Pinch 1994, 83; Wendrich 2006, 247, 253). Linear knots could also function as a mnemonic device to record a requisite number of recitations of spells (Wendrich 2006, 253). Amulets in the form of knots are well known, such as the *tyt*, *šn*, *ts* (Wendrich 2006, 253–255; Andrews 1994, 44–45, 59, 86; 68, 76–77; 44).

The other purpose, as a recordkeeping device, seems more applicable to this material because of the presence of the sealings that suggest an administrative rather than a magical function. In this case, the knots in the strands might record specific distances and hence be related to measuring distances.¹⁸

Although no examples of knotted measuring cords are known to survive from antiquity (Clarke and Engelbach 1930, 65), they are shown on at least two New Kingdom statues, and at least eleven scenes in tombs show them in use, the knots “apparently indicating subdivisions, probably cubits” (Arnold 1991, 252).¹⁹ The measuring cords shown on statues have a “tying up cord” (Clarke and Engelbach 1930, 65; Roehrig 2005, 122–124), perhaps like the ties that secure bundle PAHMA 6-14448B.

There was a well-established tradition of placing models of tools and of entire workshops in tombs, especially in the Middle Kingdom (Winlock 1955; Freed et al. 2009). Hayes (1953, 288–289, fig. 189) noted “small carefully made models from burials of the Eleventh and Twelfth Dynasties at Thebes, Assyut, and el-Lisht,” including a small tool chest from the tomb of Ankhef at Assyut

18 I thank Willeke Wendrich for suggesting this possible interpretation. They may be likened to the *quipu* of the Inca, which record specific numbers.

19 For statues, see that of Senenmut in Roehrig (2005, 122–124), and Penanhuret in Clarke and Engelbach (1930, 65, fig. 63). For the representation of surveying ropes in tombs, see Arnold (1991, 252n8), and Clarke and Engelbach (1930, 64–65).

stocked with axes, adzes, and reamers.²⁰ Tombs of the First Intermediate Period and Middle Kingdom are well known for collections of miniaturized pottery and tools, making it tempting to interpret the knotted cords from N 2322 as miniaturized copies of surveying tools. Although speculation, perhaps the owner of the tomb (assuming it was a man) was involved with measuring fields for taxation purposes.²¹

Bibliography

- Andrews, C. 1994. *Amulets of Ancient Egypt*. London.
- Arnold, Di. 1991. *Building in Ancient Egypt*. Oxford.
- Brunton, G. 1927. *Qau and Badari I*. London.
- Brunton, G. 1948. *Matmar*. British Museum Expedition to Middle Egypt 1929–1931. London.
- Clarke, S. and R. Engelbach. 1930. *Ancient Egyptian Construction and Architecture*. Oxford.
- Freed, R. E., L. M. Berman, D. M. Doxey, and N. S. Picardo. 2009. *The Secrets of Tomb 10A: Egypt 2000 B.C.* Boston.
- Garstang, J. 1903. *Mahasna and Bet Khallaf*. Seventh Memoir. London.
- Grajetzki, W. 2014. *Tomb Treasures of the Late Middle Kingdom: The Archaeology of Female Burials*. Philadelphia.
- Hayes, W. C. 1953. *The Scepter of Egypt. A Background for the Study of the Egyptian Antiquities in the Metropolitan Museum of Art, Part 1. From the Earliest Times to the End of the Middle Kingdom*. New York.
- Haynes, J. and Y. Markowitz. 1991. *Scarabs and Design Amulets: A Glimpse of Ancient Egypt in Miniature*. nfa Classical Auctions, December 11, 1991. New York.
- Newberry, P. E. 1906. *Egyptian antiquities, scarabs; an introduction to the study of Egyptian seals and signet rings*. London.
- Newberry, P. E. 1907. *Catalogue Général des Antiquités Égyptiennes du Musée du Cairo, nos. 36001–37521: Scarab-shaped Seals*. London.
- Oppenheim, A., Do. Arnold, Di. Arnold, and K. Yamamoto, eds. 2015. *Ancient Egypt Transformed: The Middle Kingdom*. New York.
- Petrie, W. M. F. 1925. *Buttons and Design Scarabs*. London.

20 Contra Grajetzki (2014, 12), who states “Egyptian burial equipment rarely contains objects related to the profession of the deceased ... The profession of the deceased is not visible in the tomb equipment.”

21 Unfortunately, nothing is known about the owner of N 2322.

- Reisner, G. A. 1932. *A Provincial Cemetery of the Pyramid Age: Naga-ed-Dêr*, Part III. University of California Publications, Egyptian Archaeology 6. Berkeley.
- Roehrig, C. H., ed. 2005. *Hatshepsut: From Queen to Pharaoh*. New York.
- Slater, R. A. 1974. "The Archaeology of Denderah in the First Intermediate Period." PhD diss. University of Pennsylvania.
- Ward, W. A. 1978. *Studies on Scarab Seals I: Pre-12th Dynasty Scarab Amulets*. Warminster.
- Wendrich, W. 2006. "Entangled, Connected, or Protected? The Power of Knots and Knotting in Ancient Egypt." In *Through a Glass Darkly: Magic, Dreams & Prophecy in Ancient Egypt*, edited by K. Szpakowska, 243–269. Swansea.
- Wiese, A. B. 1996. *Die Anfänge des ägyptischen Stempelsiegel-Amulette*. OBO, Series Archaeologica 12. Freiburg.
- Winlock, H. E. 1942. *Excavations at Deir el Bahri: 1911–1931*. New York.
- Winlock, H. E. 1955. *Models of Daily Life in Ancient Egypt from the Tomb of Meket-Rē' at Thebes*. New York.

Small Stone Vessels

Virginia L. Emery

1 Object Types

The stone vessels recovered from Cemeteries N 2000 and N 2500 continue the chronological progression of vessels from Cemeteries N 500–900 that represents development from the Second Dynasty to the Sixth Dynasty, with a stylistic break at the beginning of the Fifth Dynasty (Reisner 1932, 36–75). For the most part, the vessels from Cemeteries N 2000 and N 2500 overlap with the Fifth Dynasty examples from the earlier cemeteries and display forms attested through the Sixth Dynasty and into the early First Intermediate Period (Reisner 1932, 56–70; Aston 1994, 84–85, 135–141). Vessel shapes and sizes otherwise unattested from Cemeteries N 500–900 were uncovered in Cemeteries N 2000 and N 2500, which necessitated the addition of subcategories to Reisner’s original typology (1932, 36–75) and suggests either that the burials from which they came were later than those in Cemeteries N 500–900, possessing more burials of the Sixth Dynasty and early First Intermediate Period, or that they are the products of different workshops with, perhaps, different styles, than the assemblages from the cemeteries published by Reisner. Given the other similarities in the vessels from the earlier cemeteries, the former is more likely than the latter. A later date is also suggested by the number of burials with stone vessels, a practice that decreased through time, as is evident in the number of vessels recovered from burials of Dynasties 2–3 compared to the number from Dynasty 4 burials (Reisner 1932, 55); for Cemeteries N 2000 and N 2500, only eight tombs contained stone vessels, seven in N 2000 and one in N 2500. The graves with stone vessels were of tomb types vi a–d, the Dynasty 5–6 types comprised of open pit tombs usually covered with stone slabs, but with various levels of wall finishing (Reisner 1932, 24–30, and Chapter 12 in this volume).

As with many durable goods, stone vessels are useful for dating, but represent a class of artifacts that could be handed down and are thus less securely diagnostic than ceramics (Slater 1974, 232–233), though, with the exception of footed cylindrical jars, their forms generally are related to those of contemporary ceramic and metal vessels (Reisner 1932, 68–70). Indeed, vessel forms across materials for the late Old Kingdom can be so similar that Reisner classified four

vessels (PAHMA 6-14301, PAHMA 6-14308, PAHMA 6-14309, PAHMA 6-14418) as limestone toilet jars (O.K.x.b, early kohl jars, Reisner 1932, 65–66), which, upon closer examination, proved to be ceramic instead and are treated in this volume with that corpus. Similarly, the collared necks of the stone jars of the Fifth and Sixth Dynasties (Reisner 1932, 63–64, O.K.iv, O.K.v) are the equivalent of the recurved rims on ceramic vessels (Wodzinska 2010, 127, O.K. 18), and the body shape of those vessels and all of the tall, slender vessels mimics that of the beer jars of the same era (Wodzinska 2010, 120–122, O.K. 1–4, 6). For the corpus of stone vessels from Cemeteries N 2000 and N 2500, many ceramic parallels date to the First Intermediate Period, suggesting a stylistic lag between popular stone and ceramic vessel shapes and would reinforce the later date of the cemeteries. The single inscribed piece (PAHMA 6-14424) bears a cartouche of Pepy I (Figure 5.6) and belongs to a class of vessels commemorating his first *sed* festival (Reisner 1932, 57, Type 1.d Example No. 2).

As with ceramics, the shapes or forms of the stone vessels presumably were related to their contents, which in turn related to the function of the vessel. Many of the stone vessels recovered from Cemeteries N 2000 and N 2500 are of types attested as hieroglyphs (Gardiner W1–2 “Sealed oil jar”=Reisner 1932, Later Group Type I; Gardiner W6 “O.K. sign for particular vessel”=Reisner 1932, Earlier Group Type I; Gardiner W14 “tall water pot”=Reisner 1932, O.K.i.a; Gardiner W22 “beer jug”=Reisner 1932, Type v; and Gardiner W24 “bowl”=related to Reisner 1932, O.K.x [early kohl jar]) and were common for the storage of valuable goods, such as perfumes, unguents, and kohl. The potential value of the contents, together with the value of the vessels’ material (stone rather than ceramic), result in valuable vessels, as evidenced by the inclusion of fragmentary vessels in several burials in Cemeteries N 2000 and N 2500, especially fragments that clearly show reuse (PAHMA 6-14353). However, the vessels included in burials need not necessarily have contained the goods for which the vessel shape was designed (Hester and Heizer 1981, 22), given that they occasionally occur with incompletely cored interiors (i.e., Reisner 1932, 39, Fig. 5, 37–39) and given the general lack of evidence for internal residue in the corpus from Cemeteries N 2000 and N 2500. Taken together, this suggests that the exterior shape alone could serve as the symbolic representation of the contents for the afterlife.

The bulk of the stone vessels from Cemeteries N 2000 and N 2500 are travertine, or Egyptian alabaster, with a preference for white or pale-yellow stone with a small crystal structure. When bands occur, the darker brown stone or clearer crystal stripes appear to have been intentionally positioned on the vessel for decorative effect, either at the neck (PAHMA 6-14351, MFA 47.1652), on the body (PAHMA 6-14421), or at the base (PAHMA 6-14421, PAHMA 6-14426). The similarity of the stone color, banding, and fine crystalline structure suggests that the raw material for most or all of the vessels was from the same

location. The most likely source is the quarries at Hatnub, as they are known to have been in operation during the Old Kingdom (Klemm and Klemm 2010, 161–163; Aston, Harrell, and Shaw 2001, 59–60; Aston 1994, 47–51). A deposit of travertine in the neighborhood of Assiut lay slightly closer to Naga ed-Deir, but appears not to have been operational until the New Kingdom (Klemm and Klemm 2010, 163–164). In addition to travertine vessels, there is a single example in veined limestone (PAHMA 6-14420) and a single example in what most likely is serpentinite (Harrell, personal communication). Limestone is widely available in Egypt, with deposits stretching from Cairo to Esna, providing a range of possible sources for the vessel (Aston 1994, 36–37; Aston, Harrell, and Shaw 2001, 40–42; Aston 1994, 35–39); known Old Kingdom limestone quarries in the area around Giza may have provided the material for the Naga ed-Deir vessel, or it may have come from a local source (Klemm and Klemm 2010, 23–139; Aston 1994, 37). Although pharaonic serpentinite quarries have proved elusive, outcrops occur in the Eastern Desert, with perhaps the most easily accessible concentrations from Naga ed-Deir being in the Wadi Hammamat (Klemm and Klemm 2010, 294–295; Aston 1994, 56–59; Aston, Harrell, and Shaw 2000, 56–57).

The vessels from Cemeteries N 2000 and N 2500 are for the most part well-executed, with polished exteriors and fully cored interiors. Exterior surface treatment ranges from highly polished with little visible indication of the polishing process, typical for the tall, slender vessels, to polished but with surviving striations on the surface of the vessel, more typical for the short, squat vessels. While the exteriors are universally polished, the interiors are not, retaining the striations and cuts resulting from the production process (Hester and Heizer 1981, 6–15). At best, the interior of the rims of tall, slender vessels are polished, a treatment especially common for the flared neck jars, and, in some cases, the finer of the internal striations were worn down, whether in the production process with the introduction of sand or emery or by additional polishing post-production, though the closed forms of most vessels suggest the former (Hester and Heizer 1981, 11–12). Although most examples have interiors with shoulders shaped to match the exterior, not all do, as a simple straight core would have simplified the production process significantly (Hester and Heizer 1981, 19–20).

1.1 *The Earlier Group of Stone Vessels, Dynasties 2–4*

Type I: Cylindrical Jars, used for containing perfumes, resins, and similar materials; shown on early reliefs with mouth covered with cloth or parchment, tied with string below rim and sealed on top (Reisner 1932, 36–37).

c. Forms without any indication of string; Dyn. 2–4

Example: MFA 47.1652 N 2641

Type v: Shoulder Jar with rim and flat base (Reisner 1932, 41)

c. (2) Wide-shouldered jars, squat form

Example: PAHMA 6-14420 N 2071

1.2 *The Later Group of Stone Vessels, Dynasties 5–6*

O.K. Vessels of Older Forms:

Type I: Cylindrical Jar, used for containing perfumes, resins, and similar materials (Reisner 1932, 56–57)

c. Without indication of string around neck

ii. Well-made forms

Examples: PAHMA 6-14386 N 2075

PAHMA 6-14417 N 2093

PAHMA 6-14424¹ N 2096

d. With exaggerated splay-foot widened into disk around base

Examples: PAHMA 6-14369 N 2071a

The New O.K. Types of Stone Vessels:

O.K.i: Jar: flaring neck with rim, round shoulder, tapering body, and practical flat base (Reisner 1932, 61–62)

a. Larger forms; height 12–16 cm

Examples: PAHMA 6-14419 N 2096

MFA 47.1695 N 2021

c. Medium forms; height 7–12 cm

Example: PAHMA 6-14392 N 2075

O.K.ii: Jar: flaring neck usually with rim, round shoulder, tapering body, and pointed base (or with small flat spot) (Reisner 1932, 62–63)

a. Larger forms; height 12–38 cm

Example: MFA 47.1694 N 2021

b. Smaller forms; height 4–9 cm

Example: PAHMA 6-14422 N 2096

O.K.iii: Jar: flaring neck with rim, ovoid body, with thickest point above middle, small flat spot as base (Reisner 1932, 63)

b. Bulging body

Example: PAHMA 6-14427 N 2096

O.K.iv: Collar jar: concave collar neck, tapering body with pointed base (Reisner 1932, 63–64).

b. Bulging forms

Example: PAHMA 6-14425 N 2096

¹ Reisner 1932, 57. Although Reisner classifies this vessel as one having a splay foot (his Type I.d), its base compares better to the vessels he classified as “well-made forms” (his Type I.c.ii).

c. Oval forms

Examples: PAHMA 6-14421 N 2096

PAHMA 6-14435 N 2103

O.K.v: Collar jar: concave collar rim, tapering body with narrow flat base (Reisner 1932, 64–65)

a. Slender forms, height 5–17 cm

Examples: MFA 47.1696 N 2021

MFA 47.1697 N 2021

PAHMA 6-14342 N 2042

PAHMA 6-14423 N 2096

b. Bulging forms, height 5–7 cm

Examples: PAHMA 6-14351 N 2071

PAHMA 6-14426 N 2103

O.K.ix: Bag-shaped jar with rim (no neck) (Reisner 1932, 65)

a. Curved outline of base

Examples: PAHMA 6-14432 N 2103

PAHMA 6-14433 N 2103

O.K.x: Small jar: short neck and rim, broad flat base; early kohl jar (Reisner 1932, 65–66)

b. Squat forms

Examples: PAHMA 6-14331 N 2041

PAHMA 6-14391 N 2075

PAHMA 6-14412 N 2093

c. Spherical jar, *nw*-jar

Example: PAHMA 6-14352 N 2071 (secondary)

Fragments:

PAHMA 6-14353 N 2071

PAHMA 6-14354 N 2071

2 Stone Vessels Catalogue

Explanation of the Stone Vessels Catalogue:

The finds' description of context below is taken from the Catalogue of Tombs. The photograph numbers reflect the original excavator's numbering system. All dimensional measurements are reported in centimeters, and all weight measurements are reported in grams.

Museum Registration: Name of object as listed on museum registration card.

Typology: Reisner 1932, Aston 1994; Wodzinska 2010, where applicable.

Material: Travertine (Egyptian alabaster), limestone, serpentinite (?).

Measurements: Height, body maximum diameter, body minimum diameter, rim diameter, rim thickness, diameter of opening, weight.

Color (with Munsell reading): White, grey, light grey, yellow, pale yellow, yellowish red, yellowish brown, brownish yellow, very pale brown, very pale light brown, pale reddish brown.

Exterior finishing: Polished or unpolished, quality of polishing (remaining tool marks), notes on surviving indications of production process.

Interior finishing: Fully or partially cored, polished or unpolished, notes on remaining indications of production process.

Internal Residue: Presence or absence, notes on contents where applicable.

All drawings of objects noted in parentheses and all diagrams of tombs can be found in the Catalogue of Tombs.

For vessels with measurements that were not applicable (N/A), entries are omitted due to space considerations.

N 2021 Map N/A [ed.: This record is Reisner's note of preliminary work that was done in 1901.]; photos C 9628, C 9629, A 4943, B 8247. (Fig. 5.1)

Context: [ed.: According to museum records, the following objects are from this burial: MFA: 47.1694, 47.1695, 47.1696, and 47.1697.].

(1) MFA 47.1694 Jar

Flaring neck usually with rim, round shoulder, tapering body, and pointed base (or with small flat spot), larger form.

Museum Registration: Slender shouldered jar with flaring rim and pointed base.

Typology: Reisner 1932, 62–63, O.K.ii.a (Dyn. 5–6); Aston 1994, 137, 127 (Dyn. 5–6); related to Wodzinska 2010, 126, OK 33 (Dyn. 6), 155 FIP 12 (FIP), and 182, MK 33 (Dyn. 11–12).

Material: Travertine (Egyptian alabaster).

Color: White (10 YR 8/1).

Height: 16.66 cm.

Diameter (max, min): 5.728 cm, 3.321 cm (at based of neck); 3.58 cm at tip of base.

Diameter (rim-external): 5.187 cm.

Thickness (rim): 0.455 cm.

Opening Diameter (boring hole): 2.917 cm.

Weight: 194 g.

Exterior finishing: Polished, vertical striations surviving on body, but much polished away and very smooth; horizontal striations on neck, especially visible under rim; rim well-rounded.

Interior finishing: 0.923 cm at rim of neck interior is polished; the rest of the interior remains unpolished, with horizontal striations of production process still visible, especially at base of vessel.

Internal residue: Two drips of something sticky on one side, with sand still slightly clinging to (possibly modern), otherwise clean.

Cream color alabaster, very fine grain for top 2/3 of vessel, larger crystals revealed at base with tapering of vessel; one opaque spot of white on neck; vessel likely suffered post-depositional damage, as evidenced by a 6.00 cm and a 2.00 cm seam or crack positioned opposite each other on the vessel; all vessels from this tomb bear similar cracks, as if something heavy fell on them when standing in a line.

(2) MFA 47.1695 Jar

Flaring neck with rim, round shoulder, tapering body, and practical flat base, larger form.

Museum Registration: Tall shouldered jar with neck and projecting rim (*hes-jar*).

Typology: Reisner 1932, 61–62, O.K.i.a (Dyn. 5–6); Aston 1994, 138, 34 (OK–MK); related to Wodzinska 2010, 156, FIP 16, FIP 17.

Material: Travertine (Egyptian alabaster).

Color: White (10 YR 8/1).

Height: 12.555 cm.

Diameter (max, min): 4.885 cm, 2.575 cm (base); 3.204 cm (base of neck).

Diameter (rim-external): 4.690 cm.

Thickness (rim): 0.494 cm.

Opening Diameter (boring hole): 2.771 cm.

Weight: 127 g.

Exterior finishing: Polished, diagonal on body (down at left, rising to right), horizontal on neck, diagonal under rim, horizontal at rim, and multi-directional across flat rim top, chevron striation at base.

Interior finishing: Unpolished, horizontal striations of production clearly visible and feelable; interior rounded at base, but close to bottom of vessel (in contrast to point of 47.1694).

Internal residue: Clean (dust only).

Broken, repaired 1950 by W. J. Young; cream-colored travertine, fine crystal, consistent across body, looks like ostrich egg shell when back lit; vessel cracked along length, almost, but not quite, in half, much like the fault line visible on

47.1694, probably post-depositional; based on the crystal structure, there is a possibility that 47.1694 and 47.1695 came from the same piece of raw material.

(3) MFA 47.1696 Collar Jar

Concave collar rim, tapering body with narrow flat base.

Museum Registration: Collared Jar.

Typology: Reisner 1932, 64, O.K.v.a (Dyn. 5–6), Aston 1994, 135–136, 123 (Dyn. 5–FIP); related to Wodzinska 2010, 128, OK 21 (Dyn. 4), 155, FIP 12.

Material: Travertine (Egyptian Alabaster).

Color: White (10 YR 8/1).

Height: 11.158 cm.

Diameter (max, min): 4.907 cm, 2.105 cm (base); 3.018 cm (base of neck).

Diameter (rim-external): 3.440 cm.

Thickness (rim): 0.443 cm.

Opening Diameter (boring hole): 2.578 cm.

Weight: 121 g.

Exterior finishing: Polished, vertical striations on body, horizontal striations on neck and on body above widest diameter; multi-directional striations across top of rim and across flat base.

Interior finishing: Polished at rim 0.36 cm into vessel, then unpolished; horizontal striations from production process visible to base; rounded base, close to flat base of exterior.

Internal residue: Small clumps of sand on one side, near widest part of vessel and again on same side near base—suggests sitting on side and filled with sand at deposition/post-deposition.

Cream-colored travertine, fine grained to within 1.17 cm of base; approximately one-quarter to one-third of the body and neck is opaque white, similar to an opaque patch on the neck of 47.1694, which may suggest that the two vessels were carved from the same raw material, as might 47.1695; like 47.1694 and 47.1695, cracks or seams run opposite each other on rim and into vessel body, probably post-depositional.

(4) MFA 47.1697 Collar Jar

Concave collar rim, tapering body with narrow flat base.

Museum Registration: Collared jar.

Typology: Reisner 1932, 64–65, O.K.v.a (Dyn. 5–6), Aston 1994, 135–136, 123 (Dyn. 5–FIP); related to Wodzinska 2010, 128, OK 21 (Dyn. 4), 155, FIP 12.

Material: Travertine (Egyptian Alabaster).

Color: Very pale brown (10 YR 8/2).

Height: 8.201 cm.

Diameter (max, min): 2.901 cm, 0.817 cm (base); 2.515 cm (base of neck).

Diameter (rim-external): 2.752 cm.

Thickness (rim): 0.305 cm.

Opening Diameter (boring hole): 2.110 cm.

Weight: 49 g.

Exterior finishing: Very polished, lower body almost perfectly smooth, horizontal striations above max diameter on body and around neck, center of flare also highly polished.

Interior finishing: Unpolished, highly striated horizontally based on production process, interior not much shaped to match exterior curvature, simply cut straight down; what little incurving there is could be accidental, based on drilling too long in one place or having trouble getting a drill bit in place.

Internal residue: Dust in deep striations of interior suggest at least filled to base of neck with dirt.

Dark cream travertine, fine laminations throughout; consistent crystal structure and color throughout body (no dark bands, no areas of larger crystals); top of body and neck may have larger crystals or may just be shape that makes the crystalline structure more pronounced.

Assemblage Comment: The four vessels from N 2021 represent one of the larger collections of stone vessels from a single tomb, with only two tombs possessing more, though they come from a tomb where the body itself was not preserved. The vessels are similar enough in material that it is possible that at least the larger three, and most likely all four, were sourced from the same piece of stone and similar enough in style and finishing to suggest that all were produced together. All four vessels possess thin vessel walls, are highly polished, and generally display an attention to high quality production. Despite the similarities, the variety of forms might indicate that each was destined to hold a different substance, though no significant residue survives in the vessel interiors to provide a clue about what they actually contained, if anything. All are tall, slender forms designed to accommodate a covering, based on the neck shapes, and all possess ceramic parallels dating to the Old Kingdom and First Intermediate Period.

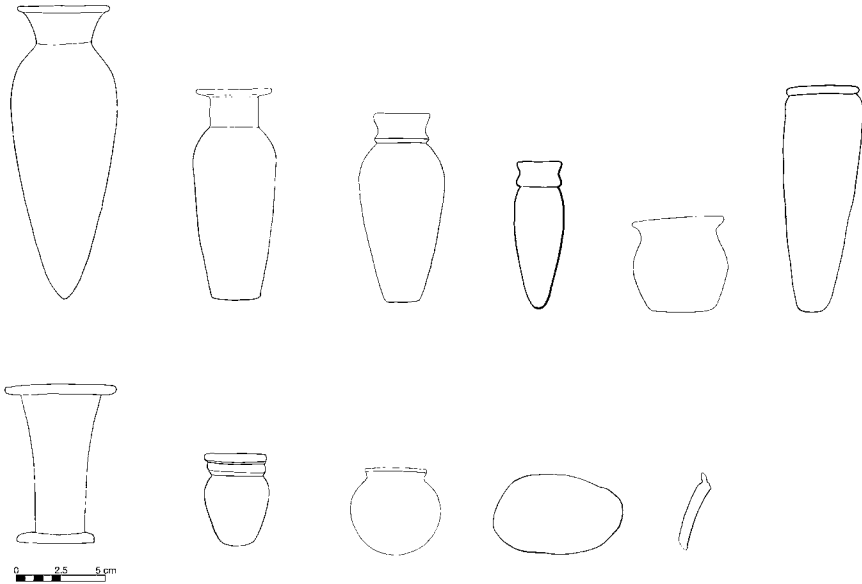

FIGURE 5.1 Stone Vessels L–R (top): Tomb N 2021: MFA 47.1694, MFA 47.1695, MFA 47.1696, and MFA 47.1697; Tomb N 2042: PAHMA 6-14331, PAHMA 6-14342; (bottom): Tomb N 2071: PAHMA 6-14369, PAHMA 6-14351, PAHMA 6-14352, PAHMA 6-14353, and PAHMA 6-14354. Drawings by author

N 2042 Map B5; type vi c; photo C 7496, C 7498, C 7499, C 7500, C 7501, C 7502, C 7503, C 7504, C 7505, A 8265. (Figs. 5.1, 5.2)

Context: At /, 2 alabaster (i) (PAHMA 6-14342). At a, 1 alabaster kohl pot (PAHMA 6-14331). 2 alabaster at 8194 1/4 (iii) (PAHMA 6-14331) and 8194 2/4 (iv) (PAHMA 6-14342).

(1) PAHMA 6-14331 Small Jar

Short neck and rim, broad flat base; early kohl jar, squat form.

Museum Registration: Alabaster toilet jar.

Typology: Reisner 1932, 66, O.K.x.b (Dyn. 5–6), Aston 1994, 140–141, 140 (FIP); related to Wodzinska 2010, 152–153, FIP 3, FIP 4.

Material: Travertine (Egyptian alabaster).

Color: White (8/1 10 YR; 8/1 2.5Y).

Height: 4.595 cm.

Diameter (max, min): 4.629 cm, 3.887 cm (neck).

Diameter (rim): 4.626 cm.

Thickness (rim): 0.496 cm.

Opening Diameter (boring hole): 3.087 cm.

Weight: 120.0 g.

Exterior finishing: Polished, horizontal and diagonal striations just under rim exterior.

Interior finishing: None; horizontal striations of drill not smoothed out; simple core removed, shoulders not widened inside.

Internal residue: Fine black residue caught in crystal structure; not powdery; heavier deposits at base, but extends up the full interior of the vessel to the rim.

Relatively unpatterned alabaster, with ~20 mm long crystals visible at rim; crystalline structure of alabaster very clear across base.

(2) PAHMA 6-14342 Collar Jar

Concave collar rim, tapering body with narrow flat base, slender form.

Museum Registration: Alabaster toilet jar, slender, tapering toward bottom.

Typology: Reisner 1932, 64, O.K.v.a (Dyn. 5–6), Aston 1994, 135–136, 123; related to Wodzinska 2010, 155, FIP 12.

Material: Travertine (Egyptian alabaster).

Color: White (8/1 2.5 Y).

Height: 12.324 cm.

Diameter (max, min): 4.165 cm, 1.881 cm (base); 3.897 cm (neck).

Diameter (rim): 4.036 cm.

Thickness (rim): 0.346 cm.

Opening Diameter (boring hole): 3.042 cm.

Weight: 182.5 g.

Exterior finishing: Polished, but crystalline structure of stone still dominates; slight chipping at base, not repolished.

Interior finishing: Not polished, horizontal striations visible; near rim and positioned at right angles, two vertical marks, one ~10 mm long, one ~30 mm long, look like tool marks of chisel or something that was the starting point for the core borer; opposite side of interior smoother and thinner, no such marks visible.

Internal residue: Sand only, bottom half (and very little).

Travertine with crystalline structure that resembles fish scales with the curving of the vessel; three bands of very fine striation, alternating with two bands of larger crystals; neck shape is unusual and may be the result of cutting down a larger collared rim that broke or cracked in order to salvage the rest of the vessel.

Assemblage Comment: The two vessels found in N 2042 are a relatively standard set for the cemetery, with one shorter, squatter vessel and one taller, more slender vessel. The vessels were found together near the knees of the tomb

owner, and the two shapes would suggest two different substances originally were contained in them. Both are made of stone displaying a marked preference for lighter travertine and are similar in their execution, lacking attention to the niceties of shape and being less polished than other stone vessels from Cemetery N 2000. This level of production and care might indicate that these vessels date closer to the First Intermediate Period than to the height of the Old Kingdom, a conclusion borne out by their ceramic parallels, which fall squarely in the First Intermediate Period. Unusually, the squat kohl retains vestiges of a fine black residue in the striations of the interior that is heaviest at the base, but extend all the way to the rim of the vessel; the other vessel contained only sand.



FIGURE 5.2 Stone vessels L–R (top): 6-14369, 6-14351, 6-14352 (N 2071), 6-14331 (N 2042), 6-14391 (N 2075); (bottom): 6-14432, 6-14433, 6-14435 (N 2103), 6-14342 (N 2042), 6-14392 (N 2075) (NED-C-8194)

N 2071 Map B4; type rock-cut chamber with sloping entrance; photos C 8074, C 8567, A 8267, A 8268, B 8250. (Figs. 5.1, 5.2, 5.3)

Context: (b) 2 pieces of an alabaster jar, one of which had been used as a scraper (PAHMA 6-14353, PAHMA 6-14354). Alabaster at 8194: (xii) 2071a, (xiii) 2071a, (xiv) 2071: really 2093. [ed.: For the alabaster jar (xiv), see PAHMA 6-14412 in N 2093. According to Hearst Museum records, PAHMA 6-14351 and PAHMA 6-14352 are from this burial. PAHMA 6-14369 is from N 2071a.].

(1) PAHMA 6-14369 Cylindrical Jar

With exaggerated splay-foot widened into disk around base.

Museum Registration: Alabaster toilet jar, flaring rim and base broken.

Typology: Reisner 1932, 57, Type I.d (Dyn. 5–6), Aston 1994, 104, 35 (Dyn. 5–11).

Material: Travertine (Egyptian alabaster).

Color: Pale yellow (8/2 2.5Y).

Height: 8.233 cm.

Diameter (max, min): 4.225 cm (neck), 2.606 cm (base).

Diameter (rim): 5.975 cm.

Thickness (rim): 0.432 cm.

Opening Diameter (boring hole): 3.586 cm.

Weight: 80.4 g.

Exterior finishing: Highly polished, no striations visible except on top of footed base, where a single groove was not polished away.

Interior finishing: Top half of vessel interior polished, bottom half retains horizontal striations with four visibly larger grooves on sides and at base.

Internal residue: Little, dark sand at bottom only.

Cream colored travertine with fine white lines on top half of vessel and very fine white lines in alabaster on bottom half of vessel, separated by a band of larger-crystaled, clearer colored stone, pretty obviously exploited as decorative, given its position on the vessel (especially visible when backlit).

(2) PAHMA 6-14351 Collar Jar

Concave collar rim, tapering body with narrow flat base, bulging form.

Museum Registration: Alabaster toilet jar, bulging at shoulder, rim chipped.

Typology: Reisner 1932, 65, O.K.v.b (Dyn. 5–6), Aston 1994, 135–136, 125 (Dyn. 5–FIP); related to Wodzinska 2010, 156, FIP 16–17.

Material: Travertine (Egyptian Alabaster).

Color: White (8/1 10 YR).

Height: 5.452 cm.

Diameter (max, min): 3.938 cm, 3.528 cm (neck).

Diameter (rim): 4.018 cm.

Thickness (rim): 0.463 cm.

Opening Diameter (boring hole): 2.514 cm.

Weight: 81.2 g.

Exterior finishing: Polished, scattered islands of diagonal striations still visible, along with horizontal striations around the indentations of the neck; flaw in stone at base of vessel created fine line, not smoothed down or polished off.

Interior finishing: Simple core, no shoulders added to follow external profile of vessel; horizontal striations, most visible in bottom half of vessel, top half of vessel has been smoothed.

Internal residue: Very little sand in bottom third.

Neck of vessel more angular than other examples of collared jars; fine striations visible in the alabaster; three bands of clearer crystals in top half of vessel have been exploited to coincide with the concave part of the neck and the transition at the base of the neck for decorative purposes (most visible when backlit).

(3) PAHMA 6-14352 Spherical Jar, *nw*-jar

Museum Registration: Alabaster jar, globose, rim chipped.

Typology: unattested Reisner 1932, extend typology to include O.K.x.c., Aston 1994, 137, 131 (Dyn. 5–8) and 141, 142 (MK); related to Wodzinska 2010, 160, FIP 31.

Material: Travertine (Egyptian alabaster).

Color: Very pale brown (8/2 2.5Y).

Height: 4.405 cm.

Diameter (max, min): 4.815 cm, 3.161 cm.

Diameter (rim): 3.222 cm.

Thickness (rim): 0.392 cm.

Opening Diameter (boring hole): 2.676 cm.

Weight: 100.2 g.

Exterior finishing: Polished, base more polished than top half of exterior, and top of vessel more polished than equator; rim slightly chipped and not re-polished.

Interior finishing: Simple core, shoulders not cut to match exterior profile of vessel; horizontal striations visible from base to rim, four deep grooves irregularly spaced in very base of interior.

Internal residue: Very clean, only some sand in grooves at base.

The spherical form of this vessel is otherwise unattested at Naga ed-Deir and suggests a later date for its production because the best parallels date to the First Intermediate Period and Middle Kingdom; uniform cream color alabaster with two white patches; very fine internal lines from crystalline structure.

(4) PAHMA 6-14353 Fragment, Jar

Museum Registration: Alabaster jar fragment.

Material: Travertine (Egyptian alabaster).

Color: White (8/1 2.5 YR).

Diameter (max, min): 7.453 cm (length), 4.669 cm (width).

Thickness (body): 0.347 cm.

Weight: 28.5 g.

Exterior finishing: Polished—originally well-polished; broken fragment appears to have been reused, ~80% of edge re-sanded (no crystalline structure visible), external surface scratched, in opposing diagonals, three patches of original surface survive, two positioned such that it may have been used as a scoop with two fingers protecting the original polish and one placed on the inside as a balance; opposing diagonals run with angle of curve, meeting at break point.

Interior finishing: Horizontal striations, two especially deep grooves probably indicate original base (transition of angle from body to base); re-polished edges particularly noticeable, with one section of edge polished at a double angle.

Internal residue: None.

Edges of fragment worn or repolished, suggesting reuse of broken vessel; curve of surviving fragment suggests original diameter of approximately 10 cm, which would indicate either a bowl, which is a form otherwise unattested for stone vessels in Cemetery N 2000 and therefore very unlikely, or a large, squat jar of a size attested only for Dynasties 3 and 4 at Naga ed-Deir (Reisner 1932, 41–42, Earlier Group Type v.c.(2) [Dyn. 2–4]), which would explain the apparent repurposing; cream color travertine, very consistent, no crystal structure visible (therefore fine crystalline structure).

(5) PAHMA 6-14354 Fragment, Jar

Museum Registration: Alabaster jar fragment.

Typology: N/A.

Material: Travertine (Egyptian alabaster).

Color: Pale yellow (8/2 2.5 Y).

Diameter: 59.18 cm (length).

Thickness (body; max, min): 0.455 cm; 0.178 cm.

Weight: 16.7 g.

Exterior finishing: Polished, horizontal striations at string line.

Interior finishing: Polished, vessel thins from string line (max thickness) down body (min thickness), which may have led to break along natural fault in stone.

Internal residue: None.

Cream color, fine crystalline structure; white stripes at body curve transition (diagonal to string line); breaks all fresh, not repolished, which indicates that the fragment was not actively reused, leaving open the reason(s) behind its inclusion in the burial; curve of surviving piece suggests an approximately 6 cm vessel diameter, but not reconstructed from a rim or a base, so tentative.

Assemblage Comments: This tomb with its multiple burials includes five stone vessels or fragments of vessels, more than all but one other tomb in Cemeteries N 2000 and N 2500, but, in most cases, it remains unclear which vessel(s) belong to which burial. Where the position of the vessels in the tomb were noted, they lay near the heads of those buried in the tomb. All vessels display the preference for light colored travertine, but apparently from different sources or deposits, given the banding on some pieces and the consistency of fabric on others. As is the case for other tombs, the mix of forms—cylindrical, bulging collared jar, and spherical jar—suggests a range of contents included in the burials, though no residue to indicate contents survives. The cylindrical jar and the collared jar both display bands of clear crystal positioned decoratively on the vessel, demonstrating attention to aesthetic considerations and possibly suggesting that the two were produced together. Unlike other tombs, this assemblage includes two jar fragments, an indication of the potential prestige value of stone vessels, even when incomplete; it is likely that both fragments came from jars dating to the early Old Kingdom.



FIGURE 5.3 Stone vessels L–R (top): 6-14433 (N 2103), 6-14391 (N 2075) 6-14351, 6-14352 (N 2071); (bottom): 6-14432, 6-14435 (N 2103), 6-14392 (N 2075), 6-14369 (N 2071) (NED-C-8074)

N 2075 Map A4; type vi d; photo C 8074, C 8194, B 8248. (Figs. 5.2, 5.3, 5.4)
 Context: In main chamber, 2 alabaster C 8194 1/5 (iv) and 2/5 (v) [ed.: According to Hearst Museum records, PAHMA 6-14386, PAHMA 6-14391, and PAHMA 6-14392 are from this burial.].

(1) PAHMA 6-14386 Fragment, Cylindrical Jar Fragment
 Without indication of string around neck, well-made forms.
 Museum Registration: Alabaster toilet jar rim fragment.
 Typology: Reisner 1932, 56–57, Type I.c.ii (Dyn. 5–6), Aston 1994, 104, 35 (Dyn. 5–11).
 Material: Travertine (Egyptian Alabaster).
 Color: White (10 YR 8/1).
 Height: 1.690 cm.
 Diameter: 1.581 cm (width of fragment taken at the neck).
 Thickness (rim): 0.300 cm.
 Weight: 1.7 g.
 Exterior finishing: Polished, looks like final, finishing polish was vertical.
 Interior finishing: Rim very polished, but rest of interior striated, horizontal to vessel.
 Internal residue: Well encrusted with sand, both sides, hence post-depositional.

Very small fragment of very small vessel; very fine white lines of crystal formation on surviving portion.

(2) PAHMA 6-14391 Small Jar
 Short neck and rim, broad flat base; early kohl jar, squat form.
 Museum Registration: Alabaster Toilet Jar, squat.
 Typology: Reisner 1932, 66, O.K.x.b (Dyn. 5–6), Aston 1994, 140, 140 (Dyn. 7–12); related to Wodzinska 2010, 152–153, FIP 3, FIP 4.
 Material: Travertine (Egyptian Alabaster).
 Color: White (8/1 10 YR) body with bands at neck and base in pink (7/3 7.5 YR).
 Height: 2.840 cm.
 Diameter (max, min): 4.286 cm, 3.912 cm (neck).
 Diameter (rim-external): 4.326 cm.
 Thickness (rim; max, min): 0.960 cm, 0.528 cm.
 Opening Diameter (boring hole): 2.655 cm.
 Weight: 70.6 g.
 Exterior finishing: Polished, natural irregularities near base of vessel not polished away; shape of vessel irregular (lopsided), but smooth throughout.

Interior finishing: Simple core, but not that much space left for shoulder shaping inside; horizontal bands still visible, with two deeper grooves, one halfway up and one at transition from body to base.

Internal residue: Sand, light, looser, larger grained.

Vessel overall not well formed or finished; cream alabaster with very fine white lines for most of body; rim and base darker, pinker material; clearer section approximately 0.7 cm wide under rim on about half of vessel.

(3) PAHMA 6-14392 Jar

Flaring neck with rim, round shoulder, tapering body, and practical flat base, medium height.

Museum Registration: Alabaster jar; bulging, flat rim broken.

Typology: Reisner 1932, 61–62, O.K.i.c (Dyn. 5–6), Aston 1994, 138–139, 134–135 (Dyn. 1–12); related to Wodzinska 2010, 156, FIP 16–17.

Material: Travertine (Egyptian alabaster).

Color: White (8/1 10 YR).

Height: 9.230 cm.

Diameter (max, min): 7.212 cm, 5.727 cm (neck).

Diameter (rim): 7.464 cm.

Thickness (rim): 0.722 cm.

Opening Diameter (boring hole): 4.275 cm.

Weight: 547.1 g.

Exterior finishing: Polished, but with diagonal striations from polishing process around neck and very visible under rim; under rim area clearly polished in sections by something that left straight lines, with striations overlapping where turned and polished more; irregular striations also on shoulder as by-product of neck polishing; natural irregularities in the stone at base not polished down fully.

Interior finishing: Simple core, shoulders not extended to match external profile; horizontal striations with narrowing just below halfway point, then widening again about 2 cm up from base, likely from drill instability.

Internal residue: A lot of light, large grained, very compact sand.

Central portion of body in white alabaster with very fine lines; two darker bands positioned horizontally on body, one-third and two-thirds of the way down the body of the vessel, seemingly with decorative intent.

Assemblage Comments: The two complete vessels in this tomb are a standard set of one short and one tall, with the addition of a cylindrical jar rim that shows no reworking. The early kohl jar form was found near the head of the

tomb owner, and the tall, slender jar was found in a separate part of the tomb; no note was made of the original location of the jar fragment. The banding of the raw material was used to decorative effect at transitional points for the two complete vessels, which were made of similar stone and with similar production style, both being slightly irregularly shaped and neither being highly polished. The fragment of cylindrical jar was more highly polished and more finely worked than the two complete vessels, suggesting it was the product of a different hand. None of the three preserved internal residue to indicate original contents.



FIGURE 5.4 Stone Vessels L–R (top): Tomb N 2075: PAHMA 6-14386, PAHMA 6-14391, PAHMA 6-14392; Tomb N 2093: PAHMA 6-14412, PAHMA 6-14417; (bottom) Tomb N 2103: PAHMA 6-14432, PAHMA 6-14433, PAHMA 6-14435; Tomb N 2641: MFA 47.1652. Drawings by author.

N 2093 Map C5; photo B 7129. (Fig. 5.4)

Context: In large chamber, broken stem of an alabaster vase (PAHMA 6-14417). Small alabaster (iv) (PAHMA 6-14412). [ed.: For a drawing of PAHMA 6-14412, see image (xiv) in N 2071.].

(1) PAHMA 6-14412 Small Jar

Short neck and rim, broad flat base; early kohl jar, squat form.

Museum Registration: Alabaster toilet jar, squat, flat rim.

Typology: Reisner 1932, 66, O.K.x.b (Dyn. 5–6), Aston 1994, 140, 140 (Dyn. 7–12); related to Wodzinska 2010, 152–152, FIP 3, 4, and 160, FIP 30, 31.

Material: Travertine (Egyptian Alabaster).

Color: Very pale brown (8/2 10 YR) body, with patch of light reddish brown (6/4 10 YR) at rim.

Height: 4.503 cm.

Diameter (max, min): 5.487 cm, 4.586 cm.

Diameter (rim): 5.304 cm.

Thickness (rim; max, min): 1.035 cm, 0.905 cm.

Opening Diameter (boring hole): 3.583 cm.

Weight: 163.9 g.

Exterior finishing: Polished, body smooth, horizontal rubbing marks around neck (top and bottom); some degradation of stone at base, hard to tell if original or post-deposition.

Interior finishing: Simple core, shoulders not shaped to follow external profile; narrows to rounded base inside; horizontal striations visible, some signs of polishing away finer striations, but deeper grooves still remain.

Internal residue: Sand, light, larger grain, mostly at base; not much on sides because a bit more polished.

Cream color alabaster with little variation; flaws in bottom of vessel and irregularity of darker color (not banded) suggest stone not the best quality; vessel generally irregular (rim, interior) and not highly finished; similar in style of craftsmanship to PAHMA 6-14391.

(2) PAHMA 6-14417 Cylindrical Jar

Without indication of string around neck, well-made forms.

Museum Registration: Alabaster jar fragment.

Typology: Reisner 1932, 56–57, Type I.c.ii (Dyn. 5–6), Aston 1994, 104, 34 (slender, Dyn. 5–6).

Material: Travertine (Egyptian alabaster).

Color: Very pale light brown (8/2 10 YR).

Height (surviving): 3.755 cm.

Diameter (max, min): 3.140 cm (top); 4.390 cm (foot), 2.891 cm (above base).

Thickness (body; max, min): 0.598 cm, 0.293 cm.

Weight: 55.0 g.

Exterior finishing: Polished, fine striation from polishing at foot on one side; rim of foot chipped, top break slightly rubbed down, but not fully repolished; one flatter side of foot may have been repolished.

Interior finishing: Narrows to base, horizontal striations, with several deep grooves still visible, though it appears some care has been taken to polish away shallower striations; details rather obscured by amount of sand still encrusted on interior.

Internal residue: Light, larger grained sand, somewhat loosely packed into base.

Cream color alabaster with very fine white lines; surviving portion of vessel too thick to be very transparent.

Assemblage Comments: The two vessels from this tomb represent the standard combination of one squat and one tall, but the tall vessel is unusual for being a fragment and for being a cylindrical jar, instead of a flare or collared neck jar. Both vessels were produced from slightly cloudy stone with more crystal structure visible than other tomb assemblages. Neither is highly polished, though the early kohl jar is a more shapely and better polished version of the form than is otherwise attested in the cemetery. Both were clean inside, with loose remnants of sand the only contents.

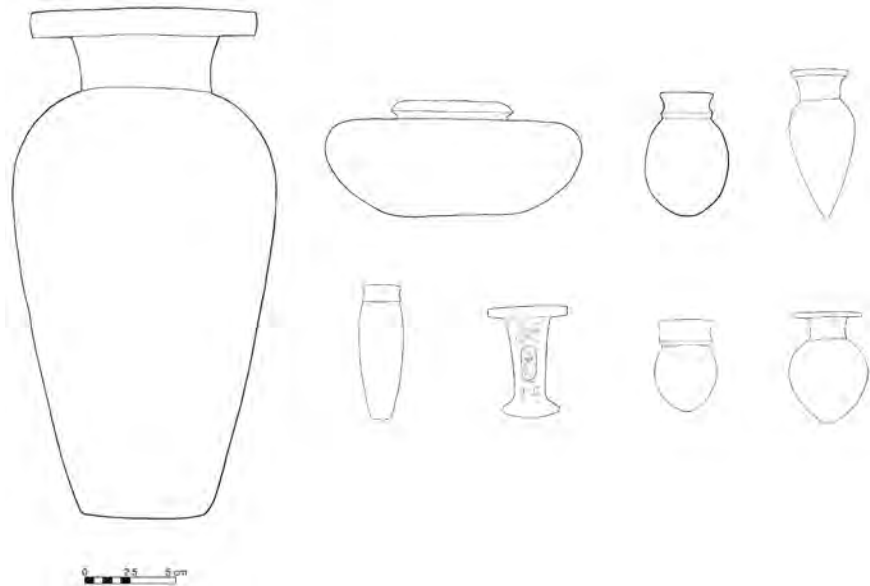

FIGURE 5.5 Stone Vessels L–R: Tomb N 2096: PAHMA 6-14419, (top): PAHMA 6-14420, PAHMA 6-14421, PAHMA 6-14422 (bottom): PAHMA 6-14423, PAHMA 6-14424, PAHMA 6-14426, PAHMA 6-14427. Drawings by author.

N 2096 Map C4; type vi a; photo C 2165, C 7609, C 8067, C 8068, C 8069, C 8070, C 9630. (Figs. 5.5, 5.6, 5.7)

Context: By feet, (i) in alabaster (PAHMA 6-14419, PAHMA 6-14421, PAHMA 6-14422, PAHMA 6-14423, PAHMA 6-14424, PAHMA 6-14425, PAHMA 6-14426). (ii) in limestone? (PAHMA 6-14427) (iii) in black veined limestone (PAHMA 6-14420).

(1) PAHMA 6-14419 Jar

Flaring neck with rim, round shoulder, tapering body, and practical flat base, larger forms.

Museum Registration: Alabaster jar; bulging flat rim.

Typology: Reisner 1932, 61–62, O.K.i.a (Dyn. 5–6), Aston 1994, 138–139, 134 (Dyn. 5–6); related to Wodzinska 2010, 156, FIP 17.

Material: Travertine (Egyptian alabaster).

Color: White (8/1 10 YR).

Height: 23.750 cm.

Diameter (max, min): 12.200 cm, 6.226 cm (neck).

Diameter (rim): 11.084 cm.

Thickness (rim): 0.810 cm.

Opening Diameter (boring hole): 5.733 cm.

Weight: Could not be determined (too heavy for scale).

Exterior finishing: Polished, vertical rubbing of final polish evident; some chipping at base not fully polished away, but horizontal and diagonal striations surrounding it suggest that it was original to the vessel and not post-depositional; equally, wavy lines across body, especially shoulders and on base, seem to be from flaws running through stone, not fully polished away.

Interior finishing: Shoulders shaped inside; vessel thickness apparently consistent throughout, except for one band roughly one third of the way down the body, where it appears the stone was harder; some polishing of fine grooves at very top of neck, but deeper horizontal grooves remain visible in rest of vessel.

Internal residue: Reddish brown color patch on one-third of interior, base to neck, with some darker brown on shoulder only, and a clump of sand at very base; probably found tipped over on its side with sand blown in.

The finished product in the whole group of vessels that represents the finest craftsmanship as reflected in scale and finishing, including the level of polishing; largest of all vessels from Cemeteries N 2000 and N 2500; white alabaster with larger crystals, but with two distinct bands of very fine white lines that make a decorative element one-third and two-thirds of the way down the body.

(2) PAHMA 6-14420 Shoulder Jar

With rim and flat base, wide-shouldered jars, squat form.

Museum Registration: Limestone jar; squat marbled.

Typology: Reisner 1932, 41–42, Earlier Group Type v.c (2) (Dyn. 1–4), Aston 1994, 130, 107 (Dyn. 3–6).

Material: Limestone (veined).

Color: White (8/1 2.5 Y) and grey (5/1 2.5 Y).

Height: 5.462 cm.

Diameter (max, min): 12.173 cm, 5.413 cm.

Diameter (rim): 5.711 cm.

Thickness (rim): 1.214 cm.

Opening Diameter (boring hole): 3.311 cm.

Weight: 563.5 g.

Exterior finishing: Well-polished, even under rim; some straight striations on the flat of the shoulders, clearly accommodating the neck and rim of the vessel, with the occasional finishing marks on the body; patina of darker color (10 YR 7.3 very pale brown) at base, typical of weathered limestone.

Interior finishing: Shoulders shaped to follow external profile; interior polished, though transition to base still visible.

Internal residue: Sand, light, larger grained stuff; slightly loose, not cemented.

White field with grey marbling; one side of vessel has a vein of clearer crystals running through it.

(3) PAHMA 6-14421 Collar Jar

Concave collar neck, tapering body with pointed base, oval form.

Museum Registration: Alabaster toilet jar.

Typology: unattested Reisner 1932, extend typology to include O.K.iv.c (Dyn. 5–6), Aston 1994, 135–136, 124–125 (Dyn. 5–8); related to Wodzinska 2010, 155, FIP 13, 14.

Material: Travertine (Egyptian alabaster).

Color: White (10 YR 8/1) and yellowish red (5 YR 5/6).

Height: 7.050 cm.

Diameter (max, min): 4.973 cm, 2.793 cm.

Diameter (rim): 2.998 cm.

Thickness (rim; max, min): 0.364 cm, 0.232 cm.

Opening Diameter (boring hole): 2.353 cm.

Weight: 75.8 g.

Exterior finishing: Well-polished, with some visible striations around neck and in collar, horizontal to indentation; multi-directional striations (including verticals) visible on body in intermittent patches.

Interior finishing: Not polished; horizontal striations remain from rim to base.
Internal residue: None.

Striped alabaster, cream field with medium crystal structure visible, interrupted by two bands of darker, reddish material across shoulder, at base, and one tiny spot on rim, positioned for decorative effect.

(4) PAHMA 6-14422 Jar

Flaring neck usually with rim, round shoulder, tapering body, and pointed base (or with small flat spot), smaller form.

Museum Registration: Alabaster toilet jar, pointed bottom, flared mouth.

Typology: Reisner 1932, 63, O.K.ii.b (Dyn. 5–6), Aston 1994, 137, 127 (Dyn. 5–6); related to Wodzinska 2010, 126, Old Kingdom 16.

Material: Travertine (Egyptian alabaster).

Color: Yellow (2.5 Y 8/2).

Height: 7.961 cm.

Diameter (max, min): 3.615 cm, 2.216 cm.

Diameter (rim): 3.080 cm.

Thickness (rim): 0.330 cm.

Opening Diameter (boring hole): 2.699 cm.

Weight: 44.0 g.

Exterior finishing: Highly polished, vertical and horizontal striations of final, finishing polish only visible on close examination; fully pointed base, no lingering flatness; light wavy lines from flaws in stone visible near base.

Interior finishing: Rim of neck polished but interior otherwise unpolished, with horizontal striations visible; shoulders shaped to match external profile, vessel appears to have same thickness throughout.

Internal residue: Little light sand, mostly clean (tag in vessel blocking part of view).

Very consistent cream-colored alabaster with very fine white lines; only one surviving oval of a whiter line to interrupt the uniformity of the stone.

(5) PAHMA 6-14423 Collar Jar

Concave collar rim, tapering body with narrow flat base, slender forms.

Museum Registration: Alabaster toilet jar.

Typology: Reisner 1932, 64, O.K.v.a (Dyn. 5–6). Aston 1994, 135–136, 123 (Dyn. 5–8); related to Wodzinska 2010, 155, FIP 12.

Material: Travertine (Egyptian Alabaster).

Color: Pale Yellow (2.5 Y 8/2).

Height: 7.551 cm.

Diameter (max, min): 2.632 cm, 1.240 cm.

Diameter (rim): 2.235 cm.

Thickness (rim): 0.257 cm.

Opening Diameter (boring hole): 1.836 cm.

Weight: 40.9 g.

Exterior finishing: Well-polished, no striations on body or even around neck.

Interior finishing: Simple core with no shaping to match external vessel shape; horizontal striations from base to just shy of rim still visible; rim area polished approximately 2 mm into vessel.

Internal residue: Light sand, otherwise very clean.

Cream colored alabaster with very fine white lines, very consistent piece of stone; fine work.



FIGURE 5.6 Inscription on 6-14424 (N 2096)

(6) PAHMA 6-14424 Cylindrical Jar (Fig. 4)

With exaggerated splay-foot widened into disk around base.

Museum Registration: Alabaster jar, slender flat rim, cartouche on side, spreading base.

Typology: Reisner 1932, 56–57, Type I.c.ii (Dyn. 5–6), Aston 1994, 104, 35 (Dyn. 5–11).

Material: Travertine (Egyptian alabaster).

Color: Pale yellow (2.5 Y 8/2).

Height: 6.034 cm.

Diameter (max, min): 3.306 cm (foot), 1.854 cm (base above foot).

Diameter (rim): 4.596 cm.

Thickness (rim): 0.446 cm.

Opening Diameter (boring hole): 2.661 cm.

Weight: 58.0 g.

Exterior finishing: Well-polished body, no striations visible; visible striations around underside of rim, straight in overlapping patches to accommodate round shape of vessel; even bottom is well polished.

Interior finishing: Simple core, conical shape, matches shape of body, narrows to base; horizontal striations from base to rim, no part of rim interior polished.

Internal residue: None.

Cream colored alabaster with very fine white lines; very consistent throughout vessel; lines lie horizontal to vessel body. Although Reisner classified this vessel as having a splayed foot (Reisner 1932, 57), its profile better matches the examples of his Type I.c.ii with a more gently sloping foot, as it has been categorized here and as the bulk of the other vessels in the N 2000 and N 2500 cemeteries are. This vessel is the only one with an inscription: the carefully etched pre-nomen cartouche of Pepy I (Beckerath 1999, 62–63, Dyn. 6; Reisner 1932, 57, Type I.d, Example 2), like a number of other stone vessels recovered throughout the Nile River Valley that commemorate his first *sed* festival (c.f. Berlin 7715E, Louvre 527, 644, E. 3165, and E. 5356, MMA 23.10.11 and 27.2.2, OI Reg. E 10748) (Hornung and Staehelin 1974, 23–24; Strudwick 2005, 130–131).

(7) PAHMA 6-14425 Collar Jar

Concave collar neck, tapering body with pointed base, bulging form.

Museum Registration: Alabaster toilet jar, pointed bottom.

Typology: Reisner 1932, extend typology to include O.K.iv.b (Dyn. 5–6), Aston 1994, 135–136, 124 (Dyn. 5–8); related to Wodzinska 2010, 155, FIP 14.

Material: Travertine (Egyptian alabaster).

Color: White (2.5 Y 8/1).

Height: 3.147 cm.

Diameter (max, min): 1.911 cm, 1.582 cm (neck).

Diameter (rim): 1.802 cm.

Thickness (rim): 0.238 cm.

Opening Diameter (boring hole): 1.327 cm.

Weight: 10.3 g.

Exterior finishing: Polished, horizontal striations around neck, inside collar and at top of shoulders; diagonal striations on bottom half of body, clearly having to do with finishing pointed base.

Interior finishing: Simple core, interior not shaped to match exterior, perhaps due to the size of the vessel; horizontal striations from base to rim visible; no polishing around rim, which is surprisingly square in transition from interior to flat top of rim.

Internal residue: Sand, light, larger grained.

Smallest vessel of all those from Cemeteries N 2000 and N 2500, cream colored alabaster with very fine white lines; only one patch defined by white lines (as with PAHMA 6-14422); small size of vessel means stone is very consistent.

(8) PAHMA 6-14426 Collar Jar

Concave collar rim, tapering body with narrow flat base, bulging form.

Museum Registration: Alabaster toilet jar, heavy rim, pointed bottom.

Typology: Reisner 1932, 65, O.K.v.b (Dyn. 5–6), Aston 1994, 135–136, 124 (Dyn. 5–8); related to Wodzinska 2010, 155, FIP 13, 14.

Material: Travertine (Egyptian alabaster).

Color: Very pale brown (10 YR 8/2) banded with reddish yellow (5 YR 6/6).

Height: 5.264 cm.

Diameter (max, min): 3.664 cm, 2.769 cm (neck).

Diameter (rim): 3.177 cm.

Thickness (rim): 0.367 cm.

Opening Diameter (boring hole): 2.452 cm.

Weight: 56.3 g.

Exterior finishing: Polished, horizontal striations around neck and on inside of collar; multi-directional striations on bottom half of vessel, created as pointed base was shaped.

Interior finishing: Simple core, not shaped to match exterior; horizontal striations from base to rim, with a collection of deeper grooves at very bottom; appears to be some attempt at polishing top 0.2 cm at transition from interior to rim, which is less square than the rim of PAHMA 6-14425.

Internal residue: Clean, faint sand in deeper grooves at base.

Cream color alabaster with medium size crystals; band of darker, redder stone at base (for decorative effect), well defined by dark line with lighter but still redder matrix at base.

(9) PAHMA 6-14427 Jar

Flaring neck with rim, ovoid body, with thickest point above middle, small flat spot as base, bulging body.

Museum Registration: Alabaster toilet jar, globose, flat rim broken.

Typology: Reisner 1932, 63, O.K.iii.b (Dyn. 5-6), Aston 1994, 137-138, 130 (Dyn. 5-8).

Material: Serpentinite(?).

Color: Brownish yellow (10 YR 6/6) and yellowish brown (10 YR 5/4).

Height: 5.665 cm.

Diameter (max, min): 4.121 cm, 1.863 cm.

Diameter (rim): 3.582 cm.

Thickness (rim): 0.207 cm.

Opening Diameter (boring hole): 1.764 cm.

Weight: 34.4 g.

Exterior finishing: Well-polished, high shine; horizontal striations visible from neck to shoulder curve; horizontal, vertical, and diagonal striations visible from shoulder curve to base; overlapping crossed striations on underside of rim.

Interior finishing: Shoulders shaped to follow external profile; horizontal and vertical striations visible in neck, interior less visible; very fine horizontal striations on visible portions of interior, without deep grooves of the travertine vessels.

Internal residue: None.

Stone is unusual for corpus, with a very fine structure based on the clean break at the rim. Shape is also unusual for corpus.

Assemblage Comments: With nine vessels, this tomb with a single individual contained the most stone vessels of any tomb in Cemetery N 2000 or N 2500, and the vessels from this tomb represent the finest examples as well, with the greatest range of shapes and materials. As noted when excavated, the vessels were positioned near the feet of the tomb owner in the burial. Seven of the nine are made of travertine, with four being consistently colored and three being banded; where banded, the form is only ovoid collared jars, and the darker bands in the stone have been decoratively positioned to fall at transition points on the bodies of the vessels. The two different types of travertine indicate different sources for the raw material and perhaps also different

workshops producing the vessels, though all are high quality work. The cylindrical jar is the only inscribed vessel recovered from the cemetery. The material of the veined limestone squat jar is explained by its earlier date, belonging to the earlier part of the Old Kingdom when a greater variety of stone was used to make vessels. Though the shape of the serpentinite(?) vessel is consistent with those produced in the Fifth and Sixth Dynasties, the material is unusual, both for this tomb assemblage, as well as for the cemetery assemblage, the site assemblage, and, indeed, assemblages throughout the Nile River Valley. Although no early kohl jars were included in the tomb, it does possess a balanced mix of shorter, rounder vessels and taller, slender vessels, matching the general distribution of types in tombs with only two or three vessels. Despite the number of vessels in the tomb, none have anything but sand in them to indicate original contents.



FIGURE 5.7 Stone vessels L–R 6-14419; (top): 6-14420, 6-14427, 6-14425, 6-14424; (bottom): 6-14421, 6-14426, 6-14422, 6-14423 (N 2096) (NED-C-8067)

N 2103 Map C4; type vi b; photo C 8074. (Figs. 5.2, 5.3, 5.4)

Context: 3 alabasters: (i) (PAHMA 6-14432, PAHMA 6-14433, PAHMA 6-14435).

(1) PAHMA 6-14432 Bag-shaped Jar
With rim (no neck), curved outline of base.

Museum Registration: Alabaster jar, broadest at base, hole in side.

Typology: Reisner 1932, 65, O.K.ix.a (Dyn. 5–6), Aston 1994, 137, 128 (Dyn. 5–6); related to Wodzinska 2010, 157, FIP 20, and 158, FIP 22.

Material: Travertine (Egyptian alabaster).

Color: White (10 YR 8/1).

Height: 9.897 cm.

Diameter (max, min): 6.689 cm, 3.073 cm.

Diameter (rim): 4.116 cm.

Thickness (rim): 0.283 cm.

Opening Diameter (boring hole): 2.474 cm.

Weight: 174.4 g.

Exterior finishing: Polished, horizontal and diagonal striations visible across body and base; horizontal only on neck; rim slightly chipped, not re-polished; thickness of rim consistent.

Interior finishing: Shoulders shaped to match external profile; unpolished, even at rim; fine horizontal striations visible from base to rim, with one deep groove visible approximately 0.4 cm below rim on half of vessel neck, but no other deep grooves.

Internal residue: None.

Cream colored alabaster with very fine white lines consistently throughout; very fine stone specimen, very nicely worked and finished; same stone (and finishing) as PAHMA 6-14435; hole in vessel slightly oval, measuring 1.3 cm from top to bottom and 2.2 cm from side to side at the widest point, and positioned along the line of a natural flaw in stone that goes all the way around the vessel, which might explain the presence of the hole; some chipping around its edges, especially top left corner (exterior) and bottom edge (interior), but otherwise the edges of hole have been polished and smoothed (horizontal to the vessel body), suggesting some deliberateness in the hole or at least its repair.

(2) PAHMA 6-14433 Bag-shaped Jar

With rim (no neck), curved outline of base.

Museum Registration: Alabaster jar; broadest at base, rim chipped.

Typology: Reisner 1932, 65, O.K.ix.a (Dyn. 5–6), Aston 1994, 137, 128 (Dyn. 5–6); related to Wodzinska 2010, 157, FIP 20 and 158, FIP 22.

Material: Travertine (Egyptian alabaster).

Missing from Hearst Museum Collection, but represented in photo negative NED-C-8194 with the rest of the tomb assemblage. It has been typed and drawn based on that photo.

(3) PAHMA 6-14435 Collar Jar

Concave collar neck, tapering body with pointed base, oval form.

Museum Registration: Alabaster jar, elliptical, pointed bottom.

Typology: unattested in Reisner 1932, extend typology to include O.K.iv.c (Dyn. 5–6), Aston 1994, 135–136, 125 (Dyn. 5–8); related to Wodzinska 2010, 155, FIP 13, 14.

Material: Travertine (Egyptian alabaster).

Color: White (10 YR 8/1).

Height: 9.559 cm.

Diameter (max, min): 5.403 cm, 2.632 cm.

Diameter (rim): 3.216 cm.

Thickness (rim): 0.503 cm.

Opening Diameter (boring hole): 2.113 cm.

Weight: 116.9 g.

Exterior finishing: Polished, vertical and diagonal striations from base to neck, horizontal and diagonal striations visible at neck, inside collar and up to rim; one chip to rim, not repolished.

Interior finishing: Shaped to match exterior of vessel; horizontal striations from neck to base, no deeper grooves visible; top 0.4 cm of neck interior polished and angled to flare out.

Internal residue: None.

White alabaster with very fine white lines throughout, evenly distributed from rim to base; consistent color and pattern across vessel; looks like ostrich egg shell (including texture); similar stone and manufacture as PAHMA 6-14432 (and possibly the missing PAHMA 6-14433).

Assemblage Comments: The three vessels from this tomb represent a usual number of vessels, but an unusual group of shapes, with two bag-like forms that are unique in the cemetery. All were positioned at the feet of the tomb owner (photo C 0886), and all were produced of similar material in a similar style, suggesting they were produced as a set. In addition to the unusual bag-shaped vessels, the collared jar demonstrates individuality, with a more exaggerated curve to the rim than is found on other vessels of the same form. All three vessels are tall, closed forms, and thus more like the assemblage from N 2021 than the standard mix of a balance of squat forms and tall, slender forms. All the vessels are clean inside, with no indication of original contents.

N 2641 Map C5 (red); photo B 8425. (Fig. 5.4)

Context: In main chamber, alabaster (i) (MFA 47.1652).

(1) MFA 47.1652 Cylindrical Jar

Museum Registration: Cylindrical beaker.

Typology: Reisner 1932, 36–37, Early Group Type 1.c (Dyn. 2–4), Aston 1994, 102, 31 (Dyn. 1–4); related to Wodzinska 2010, 97–99, Archaic 38, 42.

Material: Travertine (Egyptian alabaster).

Color: Munsell: White (10 YR 8/1) with light grey (10 YR 7/2) band under rim.

Height: 8.467 cm.

Diameter (max, min): 7.433 cm, 5.518 cm.

Diameter (rim-external): 7.407–7.433 cm (ovoid).

Thickness (rim): 0.445 cm.

Opening Diameter (boring hole): 5.866 cm.

Weight: 232.0 g.

Exterior finishing: Polished, horizontal and diagonal striations on body, horizontal striations around base of neck and bottom of rim, diagonal striations on edge of rim, diagonal and radiant striations on top of rim; bottom of vessel, multi-directional striations.

Interior finishing: Walls of vessel relatively smooth, but not polished; 1.515 cm of deep horizontal striations at opening, and again approximately 0.5 cm from interior base of vessel, and again about halfway down sides; off-center divot in bottom of vessel where drill bit or cording of drill bit rubbed; base shows circles from production process.

Internal residue: Dust on 20% of base diameter, otherwise clean.

Cream colored alabaster with band of darker stone just under rim, with maximum thickness of 1.736 cm; travertine with fine crystalline structure, small white lines very close together on body below darker band, on base, and on rim.

Assemblage Comments: This tomb is unique for possessing a single vessel, and a vessel whose form dates from the earlier part of the Old Kingdom at that; either the vessel was an heirloom included in a late Old Kingdom burial, or this tomb was one of the earliest in the cemetery. The cylindrical vessel is made of banded travertine, with a darker band positioned just under the rim, and was clean inside.

Bibliography

Aston, B. 1994. *Ancient Egyptian Stone Vessels: Materials and Forms*. Heidelberg.

Aston, B., J. Harrell, and I. Shaw. 2001. "Stone." In *Ancient Egyptian Materials and Technology*, edited by P. Nicholson and I. Shaw, 5–77. Cambridge.

- Beckerath, J. von. 1999. *Handbuch der Ägyptischen Königsnamen*. Mainz.
- Hester, T. R. and R. F. Heizer. 1981. *Making Stone Vases: Ethnoarchaeological Studies at an Alabaster Workshop in Upper Egypt*. Malibu.
- Hornung, E. and E. Staehelin. 1974. *Studien zum Sedfestival*. Geneva.
- Klemm, R. and D. D. Klemm. 2010. *Stones and Quarries in Ancient Egypt*. London.
- Reisner, G. A. 1932. *A Provincial Cemetery of the Pyramid Age, Naga-ed-Dêr Part III*. University of California Publications, Egyptian Archaeology 6. Berkeley.
- Slater, R. A. 1974. *The Archaeology of Denderah in the First Intermediate Period*. PhD diss. The University of Pennsylvania.
- Strudwick, N. 2005. *Texts of the Pyramid Age*. Brill.
- Wodzinska, A. 2010. *A Manual of Egyptian Pottery, Volume 2: Nagada III–Middle Kingdom*. Boston.

Flint Objects and Bone Object

Lisa Maher

According to Hearst Museum records, the following objects were found in tombs from cemeteries N 2000 and N 2500. Mace's original excavation notes, however, do not reference finding knives, chisels, or any flint objects at all in the tombs in these cemeteries. It is possible that these objects actually derive from other cemeteries at Naga ed-Deir, ones where such objects were found, such as N 100, 500, 1500, and 3500.

1 Flint Catalogue

Explanation of the Flint Catalogue:

The finds' description of context below is taken from the Catalogue of Tombs. The photograph numbers reflect the original excavator's numbering system.

Material: Flint, bone.

Measurements: Length, width, thickness.

N 2093 (TC) Map C5; photo B 7129, B 7144

[ed.: According to Hearst Museum records, PAHMA 6-14415 is from the large chamber in this burial.]

(1) PAHMA 6-144153 Knife

Unfortunately, this piece could not be located by the Collections Manager in the museum collections for analysis.



FIGURE 6.1 Bone chisel (6-14549) with tool parts discussed in text labelled (exterior surface, interior surface, beveled end, broken/unmodified end)

N 2492 (TC) Map C4

[ed.: According to Hearst Museum records, PAHMA 6-14549 is from this burial.]
(Fig. 6.1)

(1) PAHMA 6-14549 Chisel

Material: Bone.

Measurements: 7.5 cm length, 1 cm width, 0.5 cm thickness (max).

This piece is a bone chisel (not ivory as also listed in the museum collections). It is a split long bone fragment (medium mammal, unknown taxa or element), with one end beveled flat (Figure 6.1). It is highly polished on both surfaces and along its margins, but the polish is best developed predominantly at the tip of the chisel (with the other end broken and showing very light polish; this break is fresh and post-excavation). The outer/exterior surface of the bone has flaked off in some areas due to post-excavated drying and treatment, especially on the outer surface, which also exhibits small black marks across its surface (mold?). One end is beveled flat (the “chisel” portion). Both sides, but especially the exposed interior of the bone fragment, show traces of manufacturing under the polish in the form of striations from abrasion. The striations run oblique/diagonal on the interior surface of the bone; polish and beveling is much more extensive here too. The marrow cavity of the bone is visible on this surface, and there is evidence of gouging to remove bone here to shape this surface. The exterior surface of the bone shows only some oblique striations at the tip of the piece and, in fact, it is unclear whether these striations here result

from manufacturing or use. The margins are highly polished, with one edge rounded and the other comparatively pointed. The rounded edge also shows more extensive polishing and edge fracturing towards the pointed end than the pointed edge shows, suggesting that the rounded edge was more extensively used. The tip remains quite sharp. There is a small piece of bone removed from the interior side of the tip and another along one margin of the chisel near the tip that may represent gouges from use. The tip of the bone is a darker brown to reddish on both surfaces and margin, suggestive of heat treatment and extensive use (given the extent of polish development here). There are recent pencil marks on both surfaces of the tool and an accession number written in marker on the interior surface.

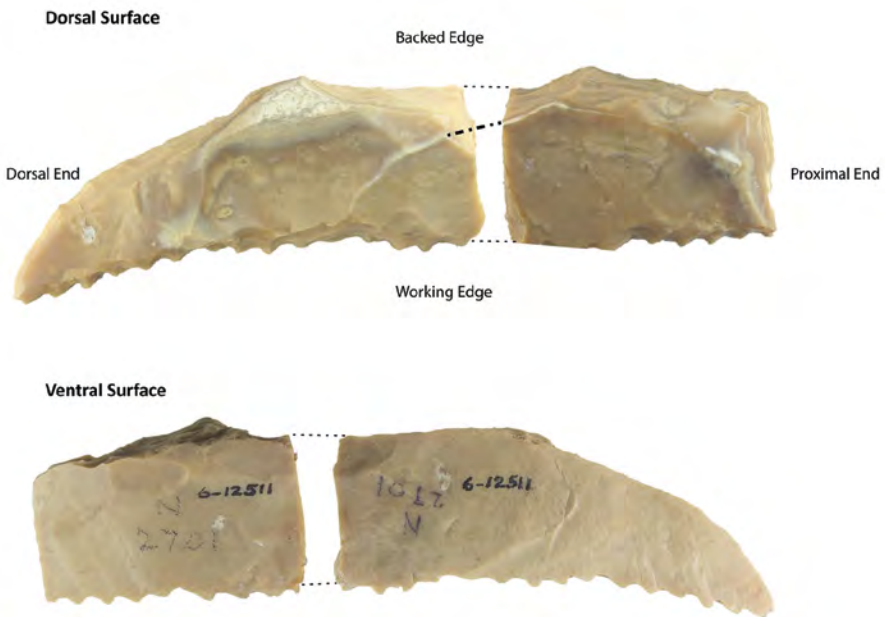

FIGURE 6.2 Reconstructed joining of two knife fragments (6-12511) with tool parts discussed in text labelled (backed edge, working edge, tip or distal end, base or proximal end)

N 2701 (Green) (TC) Map C4

[ed.: According to Hearst Museum records, PAHMA 6-12511, PAHMA 6-12513 are from this burial.] (Fig. 6.2)

(1) PAHMA 6-12511 Broken knife

Material: Flint.

Measurements: 12 cm length, 3 cm width, 1.5 cm thickness (max).

This object is actually two conjoining pieces of banded flint that were broken after excavation and collection. The break is fresh, and there is glue residue in the break indicative of an attempt to refit and conjoin the two pieces in the past. There is also a small chip/fragment of the edge of one piece missing from the break, further suggesting that the attempt to reattach the two pieces results from an accidental break occurring after excavation. This piece was likely collected intact, and the break did not happen in antiquity—thus, disposal of the piece in antiquity was not a result of the structural failure of the tool (Figure 6.2). Since there is no doubt about these two fragments belonging to the same original single knife, further reference to “the piece” refers to both fragments together.

This piece is manufactured on a medium-grained, slightly brown-banded, tan-colored flint, with traces of a white chalk or marly limestone cortex on both the dorsal and ventral surfaces of both pieces. The largest exposure of visible cortex (dorsal surface of larger, pointed fragment) shows a visibly pitted surface characteristic of extensive wind abrasion. Rare concentric, crystalline inclusions are visible on the dorsal surface of the pieces; the inclusions may have hindered the workability of the flint, particularly in attempts to thin the blade (see below).

The “knife” is manufactured from a blade blank; however, perpendicular flake scars on the dorsal surface suggest that this blade blank could have been removed from either a primarily flake-based or blade-based core reduction technology, with recent flake removals during core maintenance. The proximal and distal ends of the piece have been extensively modified by retouch. However, the natural tapering and thinning of the pointed end of the tool (seen also in the direction of blade scars) and thicker butt end of the tool, provide clear indications of the pieces’ orientation, with the dorsal end terminating in a point and the blunted butt end of the piece being the proximal end. It would have measured approximately 9–10 cm in total length (reconstructed from conjoining the two pieces) and averaged no more than 5 cm in width. The tool varies considerably from the proximal to distal ends, with the proximal end measuring 9 mm in thickness, the middle of the piece measuring 12 mm in thickness, and the distal (pointed) end of the piece measuring 4 mm in thickness.

The piece evidences traces of several failed attempts to thin the blade, resulting in many hinged and stepped fractures along the backed edge. After extensively hinging the dorsal surface of the piece, the knapper abandoned further attempts to thin the piece and modified the tool’s edges as is. The piece, thus, has a steep, triangular cross-section, especially towards its proximal end. This failure of the knapper to adequately thin the blade (evidenced by hinged

terminations in the absence of raw material inclusions or other flaws) suggests some degree of inexperience in knapping skill.

The backed edge of the piece shows an abrupt, curved profile as a result of shaping by steep, large, abrupt retouch scars that run discontinuously along this edge. There is one small area along the backed edge of the larger, pointed distal fragment of the knife that is left unretouched. The entire edge of the smaller fragment is extensively backed, with the backing overprinting larger hinged flake scars from failed attempts to thin the piece (especially at its midpoint). The larger, pointed fragment shows similar overprinting at its midpoint, while the distal end is tapered to a point as a result of the backing. The distal end of the piece is thus pointed; the proximal end is retouched with a straight truncation.

The working edge of the piece has been heavily denticulated, where the knapper manufactured several large notches or serrations along the entire edge of the piece. This serrated working edge also exhibits a slightly concave profile from proximal to distal ends, notable since the cross-section profile of the piece is largely straight (although the piece bulges slightly in thickness at midpoint). Notably, the working edge shows clear evidence of polish. Although use-wear analysis was not performed on this piece, the polish is similar to sickle polish documented elsewhere (Macdonald 2014; Richter 2007; Unger-Hamilton 1988) that results from contact with silica-rich grasses. This polish is only documented on the highest ridges of the serrations along the worked edge and was not noted in the “grooves” of the notch flake scars (Figure 6.3).



FIGURE 6.3 Close-up of the dorsal surface of the working edge of 6-12511, with arrows showing the locations of visible polish

All of the retouch (the backing along the backed edge and the notches produced to denticulate the working edge) is unilateral and visible only on the dorsal surface of the knife. The ventral surface is highly fractured, showing a coarseness to the raw material.

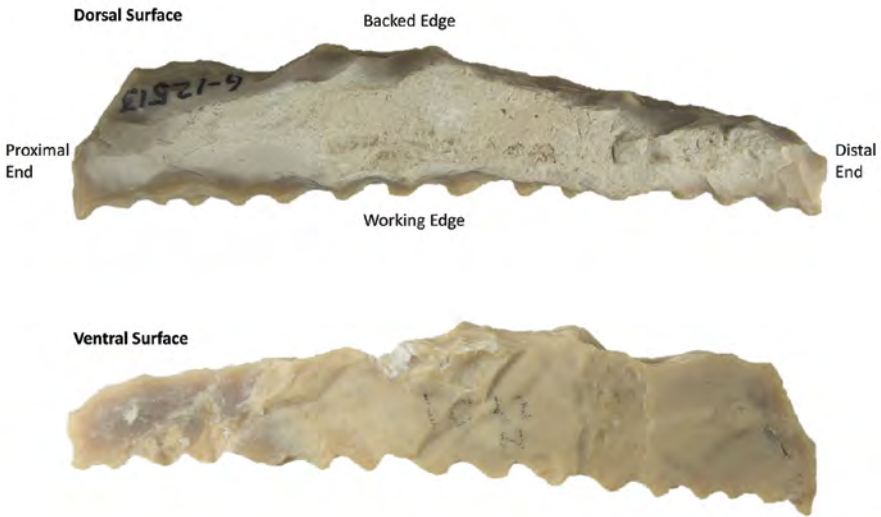

FIGURE 6.4 Schematic of the almost complete knife (6-12513) with tool parts discussed in text labelled (backed edge, working edge, tip or distal end, base or proximal end, ventral surface, dorsal surface)

(2) PAHMA 6-12513 Knife

Material: Flint.

Measurements: 8.5 cm length, 1.4 cm width, 0.8 cm thickness (max).

This object is reported as a complete knife manufactured from a similar raw material to PAHMA 6-12511 (the above-mentioned broken knife) (Figure 6.4). It is a banded light brown flint of a similar medium-to-coarse quality as PAHMA 6-12511. The bands are a darker brown, and there are rare concentric crystalline inclusions throughout the piece. The piece also exhibits some traces of the rock's original cortex (weathered outer surface); it is a white chalk or marly limestone. The abundance of crystalline inclusions and very rough, uneven, and fractured ventral surface suggests a relatively poor quality flint, and this would have impacted its ability to be easily knapped. Indeed, a cross-section view of the piece indicates that the flint easily fractures in a laminar manner that follows some of the visible banding and inclusions, and this may account for the extensiveness of stepped fractures produced during edge

retouching. Thus, the success in making the knife suggests its manufacturer was not a novice (although the abundance of hinged and stepped terminations along the backed edge suggest the knapper experienced challenges in thinning this piece too). Although petrographic or geochemical examination of the raw material was not performed, macroscopic visual comparison strongly suggests that these two pieces (PAHMA 6-12511 and PAHMA 6-12513) were manufactured on flint from the same geological outcrop (even though this knife was made on a coarser variant of this flint).

One end of the small elongated piece has been retouched to create an end that curves towards the backed edge, while the other end, which tapers considerably, is broken. The tapering evident towards this end suggests that it may have been pointed, as with PAHMA 6-12511, and just the tip is missing. This break is not as evidently recent as PAHMA 6-12511 (and there are no traces of attempted repair), and so the piece may have been excavated as is, with the tip broken in antiquity.

The “knife” is manufactured from a blade blank. The extensiveness of cortex on the dorsal surface of the piece indicates that it was produced on either a primary piece with extensive edge modification or, more likely, a secondary blade with cortex remaining in the center of the dorsal surface. Given the coarseness of the raw material and its propensity to laminar fracturing, the knapper did not invest much effort in thinning the piece, resulting in an overall thick, triangular profile and a dorsal surface covered in cortex.

It is less clear which “end” of the knife represents the proximal or distal ends of the blade blank, as there are no clear ripple marks on the ventral surface or traces of a bulb of percussion, platform, point of impact, or *erillure* scars. One end is extensively retouched to produce a curved profile, curved towards the backed edge. The other end is broken. As the retouched end is wider and thicker and the broken end tapers towards a (broken) point, it is likely that the retouched end is the proximal end and the broken tip is the distal end of the blade. The knife is 80 mm in maximum length.

The backed edge of the piece shows an abrupt, curved profile as a result of shaping by steep, large, abrupt retouch scars that run continuously along this edge. This edge is notably thicker than the working edge and covered in scars with stepped and hinged terminations that represent a combination of attempts to thin the blade and retouch scars from backing.

Like PAHMA 6-12511, the working edge of the piece has been heavily denticulated, where the knapper manufactured several large notches or serrations along the entire edge of the piece. This serrated working edge has a straight profile from proximal to distal ends. The working edge shows no clear evidence of polish or any other forms of use. All of the retouch (the backing along the

backed edge and the notches produced to denticulate the working edge) is unilateral and visible only on the dorsal surface of the knife. The ventral surface is highly fractured, showing a coarseness to the raw material.

Bibliography

- Macdonald, D. A. 2014. "The Application of Focus Variation Microscopy for Lithic Use-Wear Quantification." *Journal of Archaeological Science* 48:26–33.
- Richter, T. 2007. "A Comparative Use-Wear Analysis of Late Epipalaeolithic (Natufian) Chipped Stone Artefacts from the Southern Levant." *Levant* 39:97–122.
- Unger-Hamilton, R. 1988. *Method in Microwear Analysis: Prehistoric Sickles and Other Stone Tools from Arjoune, Syria*. BAR International Series 435. Oxford.

Beads, Pendants, and the Like

Jocelyn Simlick, Andrea Miloslavic, and Vanessa Davies

Explanation of the bead and pendant catalog:

The finds' description of context below is taken from the Catalogue of Tombs. The photograph numbers reflect the original excavator's numbering system.

Description of objects and count of objects (exact or approximate).

Typology: Made according to descriptions in Beck (2006, Part 11), and Harrell (2017, Table 2), as well as numbers from Xia Nai's (2014) bead corpus. Following Reisner (1932, 149), the distinction between ring and disk beads is that rings are 2–4 mm in diameter, and disks are 4–10 mm in diameter.

Material: Agate, amethyst, carnelian, coral, Egyptian blue, faience, feldspar, glass, gold, metal, mud, onyx, ostrich eggshell, quartz, seed, shell, steatite, travertine.

Color: Red, orange, yellow, gold (yellow, rose, brown), green, blue, purple, brown, black, white. Measurements: Length, diameter, weight, and others as relevant. Aperture measurements were collected only for unstrung objects.

Production: Determined according to Xia (2014). For the abbreviations OMM A/B (Ordinary Modeling Method A/B) and SMM C/D (Special Modeling Method C/D), see Xia (2014, 38). Production method was not noted if the stone was simply carved.

Edge/no edge: According to Beck (2006, 3). Aperture: Apex/end, according to Beck (2006, 2).

Perforation: According to Beck (2006, Part 111) and Harrell (2017, Table 2). Recorded only for hard and soft stones and shells. Not relevant to faience, glass, paste, and metal objects.

Striations: Longitudinal/rotary/random, according to Xia (2014, Section 7.1). Relevant only for hard stone. Decoration: According to descriptions in Beck (2006, Part VI) and Xia (2014).

Glaze: Mostly worn/mostly not worn. Polish: High/moderate/dull/rough.

N 2010 Map D4; photo B 7129

In large chamber, with a number of A and M pots, a few dark and light glass disc beads (PAHMA 6-14302).

(1) PAHMA 6-14302 Loose beads

Exactly 41 beads.

Typology: Disc, barrel—PN2g (40); spacer—PD18e (shell, 1). Material: Faience. Color: Green (19); black (22).

Length: 0.75–2.75 mm. Diameter: 3.65–6.85 mm. Aperture: 0.85–1.37 mm. Weight: 1.2 g.

Production: OMMA (faience). No edge.

Aperture: End.

Glaze: Mostly not worn.

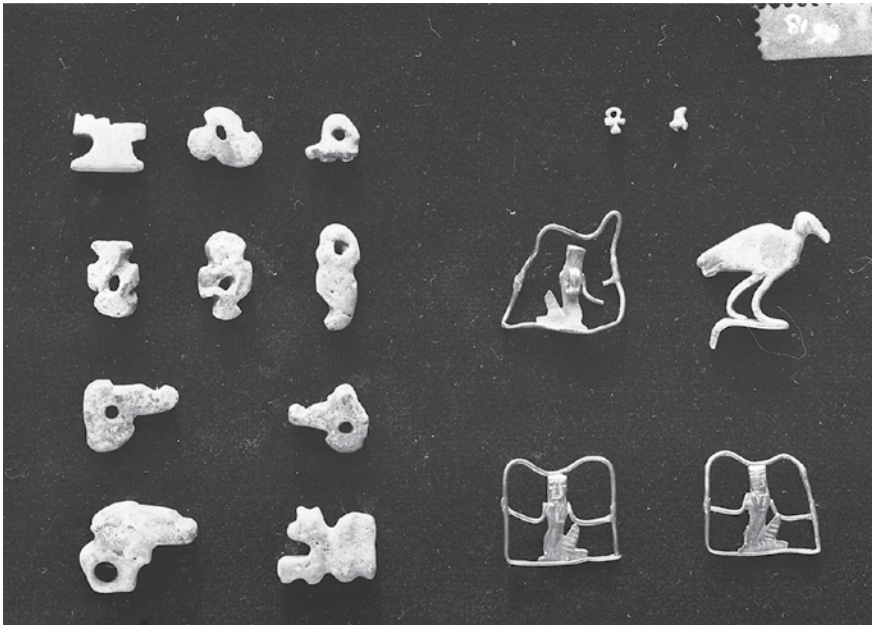

FIGURE 7.1 (Left): 6-14462 (N 2235); (Right): 6-12515 (N 2834), 6-14304a–c (N 2016), 6-14547 (N 2618) (NED-C-8193)

N 2016 Map D4; photos A 8267, B 8251, C 8193, C 8464 (Figs. 7.1, 7.3)

Burial utterly plundered. Scattered three gold brooches (PAHMA 6-14304a–c) and stone beads, cylindrical (PAHMA 6-14303). In filling at top of pit, small glass bottle, piece of a large dish with Coptic inscription scratched on it, and broken pottery.

(1) PAHMA 6-14303 Loose beads and pendant

Exactly 13 objects (12 beads and 1 pendant).

Typology: Cylindrical, long—L16q (glazed steatite, 4); barrel, short—PN17h (faience, 2); barrel, short—H15m (carnelian, 1); figural—2 lions, 1 double lion head, 1 Tawaret, 1 paddle (?), 1 pendant (Ihy? Khonsu? Shed?) (faience, 6).

Material: Carnelian (1), steatite (4), faience (8).

Color: Orange (carnelian); green (faience); light brown (faience); brown (faience, glazed steatite). Length of objects: 1.84–28.88 mm.

Diameter of objects: 3.63–6.84 mm. Aperture of objects: 0.14–2.37 mm.

Weight: 0.2–2.3 g.

Production: OMMB (faience). No edge.

Aperture: End.

Perforation: Double cone (carnelian); plain (steatite). Striations: Random (carnelian); longitudinal (steatite). Glaze: Mostly not worn (steatite); mostly worn (faience). Polish: Moderate (carnelian).

For parallels, see the following: Lion: Brooklyn Museum 16.366; Petrie 1914, pl. 38:219; Reisner 1923, 128, pl. 44,2,20–21; Brunton 1948, pl. 31:26. Double lion head: Brunton 1928, pl. 95:17D6. Tawaret: PAHMA 6-14306 (N 2021); Petrie 1914, pl. 40:236; Brunton 1948, pl. 31:37. Child amulet, Petrie 1914, pl. 26:145.

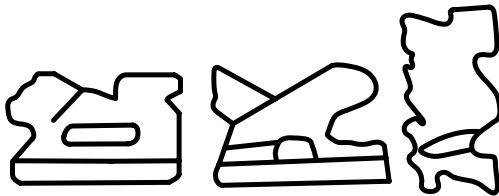

FIGURE 7.2
Lions and Tawaret

(2) PAHMA 6-14304a–c Loose pendants

Exactly 3 pendants.

Typology: Figural (*heh* hieroglyphs). Material: Gold.

Color: Yellow gold. Length: 1.60–1.85 mm. Diameter: 3.35–3.60 mm.

Aperture: 1.60–1.82 mm.

Head to feet: 14.40 mm (a), 14.10 mm (b), 15.75 mm (c). Arm to arm: 15.25 mm (a), 15.13 mm (b), 16.25 mm (c). Weight: 2.5 g.

Production: Molding (metal body); soldering (arms and reeds: wire soldered together and soldered to body). Aperture: End.

Perforation: Single plain.

Decoration: Metal has carved details (face and garment).

For parallels, see Brooklyn Museum 13.1035, 13.1036, 13.1037; MFA 13.3772; MMA 04.16.6, 04.16.10, 04.16.11, 04.16.13, 04.16.14, 11.215.206; BM EA 65331, 66662;

UC 18025; EG5072; Petrie 1914, pls. 4:59a–d, 46:59e; Andrews 1997, fig. 4e; Brunton 1948, pl. 32:81.

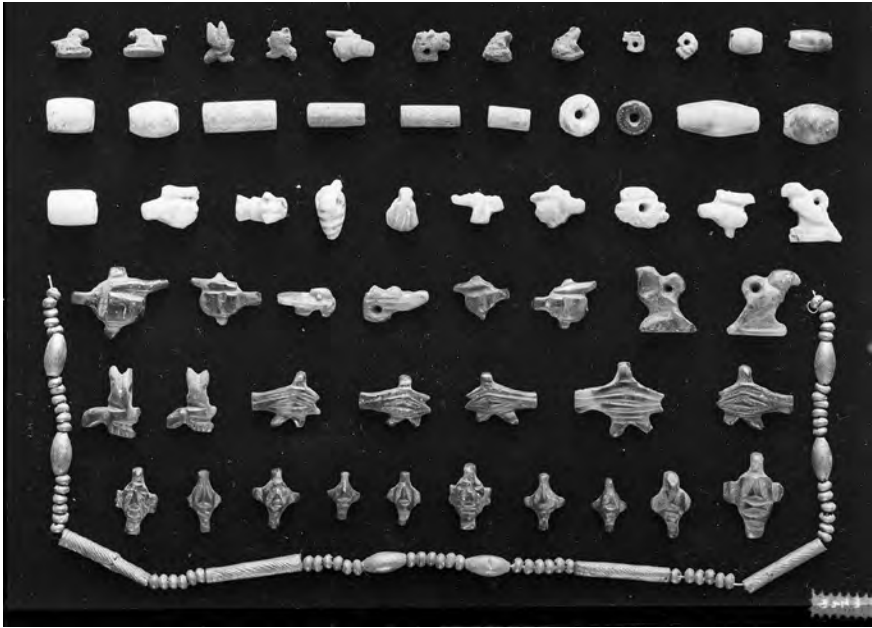

FIGURE 7.3 (Rows 1–3): 6-14307; (Rows 4–6): 6-14306; (bottom): 6-14305 (N 2021) (NED-B-8247)

N 2021 Map N/A [ed.: This record is Reisner's note of preliminary work that was done in 1901. But according to Hearst Museum records, the objects below were found in N 2021.] photos A 4943, B 8247, C 9628, C 9629 (Fig. 7.3)
Empty pits. Rectangular cloth. Shells, etc.

(1) PAHMA 6-14305 Bracelet

Exactly 74 beads.

Typology: Barrel, short—M9f (6); cylindrical, short—M12p (4); ring, biconical—M2c (64). Material: Faience covered in gold.

Color: Brown gold.

Length of strand: 13.1 mm. Diameter of strand: 8.5 mm. Length of beads: 1.34–19.93 mm. Diameter of beads: 2.75–4.16 mm. Weight: 2.2 g.

Production: Could not determine (faience); plating on core (metal, with faience as the core). Edge (ring beads), no edge (cylindrical and barrel beads).

Aperture: End.

Decoration: Metal cylindrical beads decorated by the burnished on core method with 2 lines on either end of the bead that run perpendicular to the length of the bead (the type of decoration that Beck (p. 66) refers to as a “zone bead”) and a spiral design in the center of the bead.

Polish: Moderate.

(2) PAHMA 6-14306 Bracelet

Exactly 25 pendants.

Typology: Figural—10 face (full-frontal); 4 fist (2 left, 2 right); 5 eye of Horus; 1 Tawaret; 1 lion head; 2 bee; 2 falcon.

Material: Carnelian. Color: Red, orange.

Length of pendants: 1.90–4.77 mm. Diameter of pendants: 3.50–5.58 mm.

Weight: 14.0 g.

No edge. Aperture: End. Perforation: Double cone. Striations: Random. Decoration: Carved. Polish: High.

For parallels, see the following: Head: Petrie 1914, pl. 1:2a–f; BM EA 30416; Brunton 1948, pl. 31:12–13; fist: Petrie 1914, pl. 1:12a–c; eye of Horus: Petrie 1914, pl. 12:94. Tawaret: PAHMA 6-14303 (N 2016); Petrie 1914, pl. 40:236; Brunton 1948, pl. 31:37. Lion head: UC 18117; BM EA 57774i (Andrews 1997, fig. 5e); UC 38551; Petrie 1914, pl. 2:22f; Brunton 1928, pl. 95:16, 1948, pl. 31:33–34; PAHMA 6-10067 from N 570. Bee: Petrie 1914, pl. 4:47; MMA 59.103.18, 59.103.19, 59.103.21. Falcon: Petrie 1914, pl. 41:245af; Reisner 1907, pl. 25:12516, 12517, 12526; MMA 26.7.895; BM EA 58319.

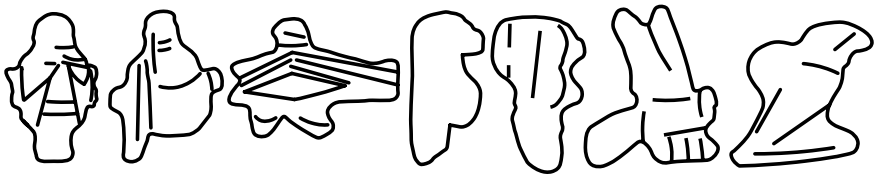

FIGURE 7.4 Face (frontal), fist, eye of Horus, Tawaret, lion head, bee, falcon

(3) PAHMA 6-14307 Bracelet, loose beads, and pendants

Exactly 31 objects (20 beads and 11 pendants).

Typology: Barrel, long—PN18h (faience, 1); barrel, short—H15r (carnelian, agate, 7); cylindrical, long—PN22r (faience, 1); cylindrical, long—S18i (glazed steatite, 4); disc, cylindrical—H2n (carnelian, 1); disc, biconical—H51 (green feldspar, 1); cylindrical, short—H22b (green feldspar, 2); figural—2 lions, 3 lion heads, 1 broken unknown (faience, 5); 2 shells, 1 falcon, 1 fish, 2 fists, 2 broken unknown (green feldspar, 9).

Material: Faience (7), carnelian (2), steatite (6), green feldspar (12), agate (4).

Color: Blue, brown (faience); orange, white (carnelian, agate); green (feldspar); light brown (glazed steatite). Length of objects: 1.68–16.52 mm.

Diameter of objects: 4.09–8.13 mm. Weight: 13.1 g.

Production: OMMA (1 faience), OMMB (1 faience); molded (figured faience); carved (figured hard stone).

Edge (some); no edge (some). Aperture: End.

Perforation type (unstrung beads only): Biconical (agate); single plain (feldspar).

Striations: Rotary (barrel, biconic disc: feldspar, carnelian, agate); longitudinal (cylindrical: feldspar, steatite); random: (cylindrical: carnelian disc). 1 green feldspar has a “basket”-patterned striae.

Glaze: 1 not worn, remainder mostly worn (faience); mostly worn (steatite).

Polish: High (agate); moderate (carnelian); dull to moderate (feldspar).

For parallels, see the following: Lion: Brooklyn Museum 16.366; Petrie 1914, pl. 38:219; Reisner 1923, 128, pl. 44,2,20–21. Shells: Petrie 1914, pl. 14:109,111; MMA 10.130.2436; BM EA 58574. Falcon: Petrie 1914, pl. 41:245af; Reisner 1907, pl. 25:12516, 12517, 12526; MMA 26.7.895; BM EA 58319. Lion head: UC 18117; BM EA 57774i (Andrews 1997, fig. 5e); UC 38551; Petrie 1914, pl. 2:22f; Brunton 1928, pl. 95:16, 1948, pl. 31:33–34; PAHMA 6-10067 from N 570. Fist: Petrie 1914, pl. 1:12; BM EA 57832.



FIGURE 7.5 Lion, lion head, shells, falcon, fish, fist

N 2031 Map E3; photo C 983, C 7178, C 7179, C 8199

These objects also found with a stela face down and on top of coffin. Coffin had angled corner. By neck, quantity of gold foil (PAHMA 6-14310) had been upon something made of wood. Traces of coffin under feet, and apparently under coffin, few bones of a calf or some other small animal. Scattered about upper part of body, number of small glaze disc beads, green stone amulet, with gold lining inside, carnelian, white stone, green stone, carnelian, glaze, soapstone?, blue stone (PAHMA 6-14317). Under coffin, pottery. Quantity of A, M with white inside rim (PAHMA 6-14313, PAHMA 6-14318, PAHMA 6-14321), and (PAHMA 6-14311, PAHMA 6-14314, PAHMA 6-14315, PAHMA 6-14319, PAHMA 6-14320). Slight groove and knife mark (PAHMA 6-14312). Broken clay jar stopper. Also ordinary stoppers.

(1) PAHMA 6-14310 Flakes of gold foil

Color: Yellow and red.

Too fragile to be measured.

(2) PAHMA 6-14317 Length of necklace (not a loop) and loose beads

Approximately 1065 beads (1035 strung and 30 loose).

Typology: Barrel, short—H15n (carnelian, 1); barrel, long—L12k (steatite, 1); cylindrical, short—PN22c (faience, 3), H21h (carnelian, 1); cylindrical, long—PN22r (faience, 1), H15i (onyx, 1); disc, barrel—H5j (carnelian, 2); ring, barrel—PN2 (faience, approx. 1035 in necklace, 15 loose); ring, cylindrical—H6f (feldspar, 1), M3b (metal, 2); 2 figural—*tilapia Nilotica* fish (blue, 1), 1 hippopotamus(?) head (in profile; made to hang upside down; unknown material, 1). Material: Faience (approx. 1035 in necklace and 20 loose beads), carnelian (4), steatite (1), green feldspar (1), onyx (1), metal (2), Egyptian blue (1), unknown (1). Color: Orange (carnelian); green (feldspar, faience, unknown); blue (Egyptian blue); brown (metal, steatite, onyx).

Length of strand: 69 cm.

Length of beads: 0.61–7.56 mm. Diameter of beads: 1.69–4.85 mm. Aperture of loose beads: 0.53–1.60 mm. Weight: 6.8 g.

Production: RSMB (joined) (metal).

Edge (2 carnelian disc beads); no edge (all the rest). Aperture: End.

Perforation: Double cone (2 carnelian barrel disc, 1 carnelian barrel short); single plain (steatite, onyx, feldspar, carnelian cylinder).

Striations: Longitudinal (steatite).

Glaze: Mostly not worn (faience, steatite).

Polish: High (carnelian, onyx); moderate (carnelian, green feldspar).

For parallels, see the following: carnelian disc bead with edge, Reisner 1908, 85, 118. Fish: Petrie 1914, pl. 43:257a, 50:257; MMA 22.1.1944y, 22.1.1944z; Germond 2005, fig. 28.

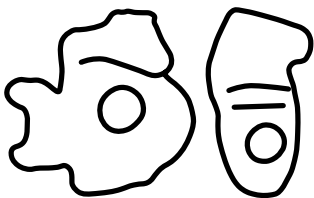

FIGURE 7.6
Fish, hippopotamus(?) head

N 2042 Map B5; type vi c; photo C 7496, C 7498, C 7499, C 7500, C 7501, C 7502, C 7503, C 7504, C 7505, A 8265

Round pelvis girdle of 15 strings of shell and black and green glaze beads (PAHMA 6-14332, PAHMA 6-14341, PAHMA 6-14343). Order from below: 1. all green, 2. all white, 3. black and white, 4. black and white, 5. all white, 6. black and white, 7. black and white with few green, 8. black and white, 10. white, 11. black and white, 12. black and white. Strings were under both arms. All upper part broken owing to falling apart of pelvis. Underneath, 8 strings in position. Strings join at intervals of about an inch. Both upper and lower layers of girdle were underneath pelvis. Possibly it was a double girdle as all upper part was disturbed. There were extra strings; 1 of tiny glaze disc, and 1 of carnelian disc (PAHMA 6-14333, PAHMA 6-14335) and tiny glaze amulets (PAHMA 6-14334, PAHMA 6-14340).

These objects were found with 2 alabaster objects (PAHMA 6-14342), granite paint grinder, shell wand for kohl, bone kohl spatula, and alabaster kohl pot (PAHMA 6-14331). In filling, fossil, bronze needle. 2 alabaster at 8194 1/4 (PAHMA 6-14331) and 8194 2/4 (PAHMA 6-14342). [ed.: According to Hearst Museum records, PAHMA 6-14336 (loose beads), PAHMA 6-14337 (travertine bead), PAHMA 6-14338 (carnelian ball beads), PAHMA 6-14339 (faience ball beads) are from this tomb.]

(1) PAHMA 6-14332 Loose beads

Approximately 200 beads.

Typology: Disc, barrel—PN2g (faience, approx. 112); ring, barrel—H2e (carnelian, 1), R52f (ostrich eggshell, approx. 67); ring, cylindrical—PN2b (faience, approx. 20).

Material: Faience (approx. 132), carnelian (1), ostrich eggshell (approx. 67).

Color: Red (carnelian); black (faience); white (ostrich eggshell).

Length: 0.90–1.53 mm. Diameter: 2.36–4.39 mm. Aperture: 0.50–1.50 mm.

Weight: 9.0 g.

Production: OMMA (faience). No edge.

Aperture: End.

Perforation: Double cone, single plain (ostrich eggshell). Striations: Rotary.

Glaze: Mostly worn (faience).

These beads probably originally were part of the girdle (PAHMA 6-14343).

(2) PAHMA 6-14333 Length of necklace (not a loop)

Exactly 387 beads.

Typology: Ring, barrel—H6e (faience); ring, cylindrical—PN2c (carnelian).

Material: Faience (222); carnelian (165).

Color: Red, orange (carnelian); black (faience). Length of strand: 35 cm.

Length of beads: 0.70–0.95 mm. Diameter of beads: 2.35–2.60 mm. Weight: 2.3 g.
Production: OMMA (faience). No edge.

Aperture: End.

Perforation: Single plain (carnelian). Striations: Random.

Glaze: Mostly worn (faience). Polish: Moderate (carnelian).

(3) PAHMA 6-14334 Pendant

Exactly 1 pendant now in 4 pieces.

Typology: Figural—human figure (no head) with false beard.

Material: Faience. Color: Brown. Length: 3.46 mm. Diameter: 5.84 mm.

Weight: Did not register. No edge.

Aperture: Unknown because pendant is broken. Production: Molding.

Glaze: Mostly worn.

(4) PAHMA 6-14335 Loose beads and pendants

Exactly 15 objects (12 beads and 3 pendants).

Typology: Barrel, long—PN18l (faience, 1); cylindrical, long—PD63f (faience, 2); ring, barrel—H2e (carnelian, 8); ring, cylindrical—R52f (shell, 1); figural—double humped (*sema tawy?*), human(?) figure, broken (faience, 3).

Material: Faience (6), carnelian (8), shell (1).

Color: Red (carnelian), orange (carnelian), brown (faience), white (shell).

Length: 0.80–21.03 mm.

Diameter: 2.32–7.90 mm. Aperture: 0.55–1.93 mm. Weight: 1.3 g.

Production: OMMA, molding (faience). No edge.

Aperture: End.

Perforation: Double cone (carnelian), single plain (shell). Striations: Objects too small to determine (carnelian). Decoration: Faience is incised (2 cylindrical, long). Glaze: Mostly worn (faience).

Polish: Moderate (carnelian).

The human(?) figure has hair down to (beyond?) the shoulder, is seated with knees up, with head turned behind him, one hand resting on his knees and one hand on the ground next to him.

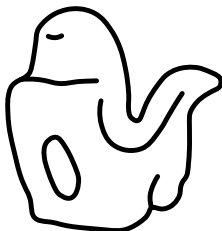

FIGURE 7.7
Human(?) figure

(5) PAHMA 6-14336 Loose beads, some with original string inside
Exactly 36 beads.

Typology: Barrel, short—H15q (amethyst, 1 quartz, 1), H15h (carnelian, 2), PN17f (mud, 1); cylindrical, short—PN22k (faience, 2); cylindrical, long—PN22t (faience, 15); drop—PN22d (faience, 1); ring, cylindrical—PN2c (faience, 5); ball—PN9e (faience, 1), H8f (amethyst, 2), H8d (amethyst, 5). Material: Faience (24); amethyst (8); carnelian (2); quartz (1); mud (1).

Color: Orange (carnelian); green, blue (faience); purple (amethyst); brown (mud); white (quartz). Length: 0.87–17.69 mm.

Diameter: 2.44–7.78 mm. Aperture: 0.36–1.56 mm. Weight: 4.6 g.

Production: OMMA and blue pigment was incorporated in the manufacturing process (faience). No edge.

Aperture: Apex; end.

Perforation: Single plain (2 amethyst); others unknown due to ancient string.

Striations: Rotary.

Glaze: Mostly worn (7 faience); mostly not worn (17 faience). Polish: Moderate (1 amethyst), dull (amethyst, carnelian, quartz).

For the blue frit used in making some beads being the same as Egyptian blue, see Xia 2014, 40.

(6) PAHMA 6-14337 Loose bead
Exactly 1 bead.

Typology: Figurel—cowrie shell. Material: Travertine.

Color: White. Length: 16.23 mm. Diameter: 13.53 mm. Aperture: 1.80 mm.

Weight: 1.9 g.

No edge. Aperture: Apex.

Perforation: Not determined because the hole is blocked with string. Striations: Longitudinal.

Decoration: Stone was carved with a groove down the center.

For parallels to the cowrie shell, see Petrie 1914, pl. 14:107 [not numbered on plate]; BM EA 3077; MMA 09.180.1200, 22.1.1279.

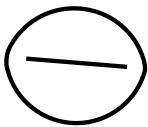

FIGURE 7.8
Cowrie

(7) PAHMA 6-14338 Loose beads

Exactly 14 beads.

Typology: Disc, barrel—H2k (2); ball—H9g (12). Material: Carnelian.

Color: Orange, white. Length: 4.83–6.91 mm. Diameter: 5.19–7.34 mm.

Aperture: 1.18–2.75 mm. Weight: 4.9 g.

No edge. Aperture: End.

Perforation: Double cone (2 barrel discs); single plain (12 ball beads). Striations: Random.

Polish: Ranges from moderate to high. Original string is still present in 5 ball beads.

(8) PAHMA 6-14339 Loose beads

Exactly 11 beads. Typology: Ball—PN8d. Material: Faience.

Color: Black.

Length: 5.72–6.85 mm. Diameter: 5.80–7.53 mm.

Aperture: Could not be measured (too small). Weight: 3.2 g.

Production: SMMD. No edge.

Aperture: End. Glaze: Mostly worn.

(9) PAHMA 6-14340 Loose pendants and a loose bead

Exactly 4 objects (3 pendants and 1 bead).

Typology: Figural—lion (faience, 2); pear-shaped pendants—H73r (but larger and with glaze, green feldspar, 1), H37r (amethyst, 1).

Material: Faience (2), amethyst (1), green feldspar (1). Color: Green (feldspar); blue (faience); purple (amethyst). Length of objects: 1.55–8.55 mm.

Diameter of objects: 2.71–14.04 mm. Aperture of objects: 0.70–1.20 mm.

Weight: 3.1 g.

Production: Molding (faience). No edge.

Aperture: End.

Perforation: Single plain (feldspar, amethyst). Striations: Longitudinal (amethyst); random (feldspar).

Decoration: Imprinted design of the outline of 6 circles arranged in the shape of a cross: 4 circles in a vertical line, and 1 circle on either side of the second vertical circle (feldspar).

Glaze: Mostly worn (feldspar); mostly not worn (faience). Polish: Moderate (amethyst).

For parallels, see the following: Lion: Brunton 1948, pl. 31:25 (15D), 31 (15Z). Feldspar pendant: UC 52186 (shell forehead pendant with 5 rows of circles (not

just outlines) drilled into it; 3 to 4 circles per row), UC 52187 (shell forehead pendant with ringed circles incised on the surface, seemingly in the shape of a capital letter I); Petrie 1914, pl. 16:13ok.

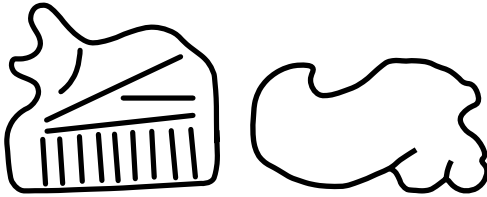

FIGURE 7.9
Lions

(10) PAHMA 6-14341 Loose beads

Approximately 200 beads.

Typology: Disc, cylindrical—PN2j (faience), R52f (ostrich eggshell). Material: Faience (1), ostrich eggshell (approx. 199).

Color: White.

Length: 1.39–1.57 mm. Diameter: 4.10–5.51 mm. Aperture: 1.40–1.81 mm.

Weight: 14.8 g.

Production: OMMB (faience).

No edge. Aperture: End.

Perforation: Double cone (ostrich eggshell). Glaze: Mostly worn (faience).

(11) PAHMA 6-14343 Strung girdle

Typology: Disc, barrel—PN2g (only black faience, approx. 720); ring, barrel—PN2f (various faience, approx. 1440); disc, cylindrical—R51g (ostrich eggshell, approx. 1080). Material: Faience (approx. 2160), ostrich eggshell (approx. 1080). Color: Light green, light brown, black (faience); white (ostrich eggshell). Length of girdle: 56 cm.

Length of beads: 0.68–2.02 mm. Diameter of beads: 3.32–7.01 mm. Production: OMMB (faience).

No edge. Aperture: End.

Perforation: Single plain (ostrich eggshell). Glaze: Mostly worn (faience).



FIGURE 7.10 Beads and pendants from N 2016 and N 2071 (NED-A-8267)

N 2071 Map B4; type rock-cut chamber with sloping entrance; photos C 8074, C 8194, C 8285, C 8567, A 8267, A 8268, B 8250. (Figs. 4.1, 7.10).

This grave had 2 layers of burials, the upper with 4 burials and the lower with 5 burials.

Upper: (a) By pelvis, glaze [barrel] of striped black and white faience. Round neck, string of small brown faience disc beads (PAHMA 6-14372). 1 carnelian [short barrel] 1 [disc], 100[ed.:?] [short barrel], 2 carnelian [short barrel], and a small scaraboid (PAHMA 6-14372). (b) Round neck string of green faience disc beads (PAHMA 6-14365? PAHMA 6-14368?). Also, a small faience scarab (PAHMA 6-14374). (c) Round neck strings of carnelian short cylindrical beads and tiny faience discs (PAHMA 6-14373? PAHMA 6-14378? PAHMA 6-14379?). Behind head number of faience amulets (PAHMA 6-14375?). By left arm, there had been a small wooden box containing 4 faience scarabs, and a number of faience amulets, and beads [ring] and disc also scattered above body (PAHMA 6-14373?, PAHMA 6-14378?, PAHMA 6-14379?). Number of shells pierced for threading (PAHMA 6-14355, PAHMA 6-14356). Stone pendant with black rings (PAHMA 6-14359). Two faience beads, white with black continuous ring decoration (PAHMA 6-14358). Green faience [ring] and disc beads

and small amulets (PAHMA 6-14357?, PAHMA 6-14364?, PAHMA 6-14367?). 1 carnelian [cylindrical] and 1 disc (PAHMA 6-14377?). Small shell disc beads (PAHMA 6-14362?). These objects were found with a pottery kohl pot, 2 pieces of an alabaster jar, one of which had been used as a scraper (PAHMA 6-14353, PAHMA 6-14354), pieces of 2 or 3 ivory needles, and 1 mussel shell. In *radim* above, 2 pieces of a pot, which had been broken and mended anciently.

Lower: By neck of (e), a quantity of beads: blue and black glaze and light stone disc (PAHMA 6-14364?), 1 crumb (PAHMA 6-14360?, PAHMA 6-14364?), 1 [barrel], 1 glaze scaraboid (PAHMA 6-14363).

[ed.: According to Hearst Museum records, PAHMA 6-14350 (ceramic jar), PAHMA 6-14351, PAHMA 6-14352 (alabaster jar), PAHMA 6-14360 (assorted beads and organic material), PAHMA 6-14361 (bead fragments and rocks), PAHMA 6-14366 (mirror), PAHMA 6-14369 (alabaster jar), PAHMA 6-14370, PAHMA 6-14371 (mud beads and decorations), PAHMA 6-14376 (pendant) are from this tomb.]

(1) PAHMA 6-14355 Loose shells

Exactly 4 shells (3 with perforation bored as a pendant and 1 without perforation). Material: Mollusk shell (family: *Cardiidae*).

Color: Light brown. Length: 4.38–5.68 mm. Diameter: 15.70–19.19 mm. Aperture: 1.50–2.38 mm. Weight 3.0 g.

Perforation: Single plain.

For parallels, see Petrie 1914, pl. 14:111a.

(2) PAHMA 6-14356 Loose beads

Exactly 17 beads.

Typology: Barrel, long (faience, 2; steatite, 4)—PN17h, L12g; ball (faience)—PN8d (small, 7), PN8h (big, 2). Material: Faience (11), steatite (4), mollusk shell (family: *Neritidae*, 2).

Color: Green (faience); brown (faience, steatite); white (steatite, shell). Length: 4.57–11.60 mm.

Diameter: 4.20–12.70 mm. Aperture: 1.27–4.60 mm. Weight: 6.3 g.

Production: OMMA (faience). No edge.

Aperture: End.

Perforation: Single plain (steatite); other (top of shell was cut off to enable shell to be strung as a bead). Striations: Random.

Glaze: Mostly worn (faience, steatite).

For parallels to the shells, see PAHMA 6-1076 from N 3018 (Reisner 1908, 85, 118).

(3) PAHMA 6-14357 Loose beads

Exactly 23 beads.

Typology: Figural—PD10m (faience spiral, 1); shell? (faience, 1); rosette L66b, L66b', L66d, L66d' (glazed steatite spacers, 11); broken (faience, 10). Material: Faience (10), steatite (13).

Color: Blue (faience); brown (faience, steatite). Length: 1.92–14.66 mm.

Diameter: 4.38–8.45 mm. Aperture: 1.03–1.65 mm. Weight: 2.7 g.

Production: SMMD (faience). No edge.

Aperture: End.

Perforation: Single plain (steatite). Glaze: Mostly worn (faience, steatite).

(4) PAHMA 6-14358 Loose beads (now strung together with wire) Exactly 2 beads.

Typology: Ball—PD3. Material: Faience.

Color: White with black spiral decoration. Length of beads: 9.56–9.79 mm.

Diameter of beads: 11.73–12.55 mm. Weight: 2.6 g.

Production: OMMA (faience). No edge.

Aperture: Apex. Decoration: Painted. Glaze: Mostly worn.

(5) PAHMA 6-14359 Pendant

Exactly 1 pendant.

Typology: Other (oval drop)—A172.

Material: Quartz, perhaps with ferruginous bands.

Color: Brown, white. Length: 4.61 cm. Diameter: 19.78 mm. Major radius: 17.48 mm.

Width (around thickest point): 8.94 mm. Aperture: 1.56 mm.

No edge. Aperture: End. Perforation: Double cone. Striations: Longitudinal.

Polish: Moderate.

(6) PAHMA 6-14360 Loose pendants and loose beads

Exactly 6 objects (1 broken pendant, 1 intact pendant, 1 broken bead, 3 intact beads).

Typology: Barrel, short—R59 (seed, 1); cylindrical, short—PD50d (faience, 1), L16n (glazed steatite, 1); pendant, lenticular—R46d (mud, 1); broken bead (seed, 1); broken pendant (carnelian, 1).

Material: Faience (1), carnelian (1), steatite (1), mud (1), seed (2). Color: Red (carnelian); brown (faience, glazed steatite, mud, seed). Length of objects: 2.60–12.46 mm.

Diameter of objects: 4.65–7.29 mm. Aperture of objects: 1.03–1.52 mm.
Weight: 2.2 g.

Production: OMMA (faience). No edge.

Aperture: End.

Perforation: Single plain (steatite). Striations: Longitudinal (carnelian, steatite). Decoration: Crumb decoration (1 faience). Glaze: Mostly worn (faience, steatite). Polish: Moderate (carnelian).

(7) PAHMA 6-14361 Loose bead and rocks

Exactly 4 objects (1 bead fragment and 3 rocks).

Typology: Barrel, short (1; no Xia Nai number because broken). Material: Faience (1).

Color: Brown.

Length of bead: 10.41 mm. Diameter of bead: 6.86 mm. Aperture: N/A (broken).

Weight: 0 g (did not register). No edge.

Aperture: End. Glaze: Mostly worn.

(8) PAHMA 6-14362 Loose beads

Approximately 100 beads.

Typology: Disc, barrel—PN6g (faience, approx. 40), R52f (ostrich eggshell, 5); ring, cylindrical—PN6d (faience, approx. 47), H6c (carnelian, 2); spacers—L66b, L66d' (steatite, 4), A16 (faience, 1), A207 (carnelian, 1). Material: Faience (approx. 88), carnelian (3), steatite (4), ostrich eggshell (5).

Color: Red (carnelian); green (faience); brown (steatite, faience, unknown); black (faience); white (ostrich eggshell).

Length: 0.75–3.25 mm. Diameter: 1.98–6.24 mm. Aperture: 0.64–1.95 mm.

Weight: 3.9 g.

Production: OMMA (faience). No edge.

Aperture: End.

Perforation: Double cone (carnelian, ostrich eggshell); single plain (steatite, carnelian spacer). Striations: Longitudinal (carnelian); random (steatite).

Glaze: Mostly worn (faience). Polish: Moderate, dull (carnelian).

(9) PAHMA 6-14364 Loose beads

Exactly 48 beads.

Typology: Barrel, short—PN17f (faience, 19), PD48d (faience with crumb decoration, 8), S14k (steatite, 5); conical, long—Gd7 (glass, 1); cylindrical, long—S18s (steatite, 8); ring, barrel—L5b (faience, 1); ball—PN8d (faience, 4); shell (1); broken (faience, 1).

Material: Faience (33), steatite (13), glass (1), shell (1).

Color: Green (faience); brown (faience, steatite); black (faience); white (steatite). Length: 1.14–14.9 mm.

Diameter: 2.72–6.19 mm. Aperture: 1.00–1.91 mm. Weight: 5.3 g.

Production: OMMA (faience); SMMD (ball bead). No edge.

Aperture: End.

Perforation: Single plain (steatite). Striations: Longitudinal (steatite).

Decoration: Crumb decoration (1 faience). Glaze: Mostly worn (faience, steatite).

For a parallel to the crumb bead, see PAHMA 6-14472 (N 2434), UC 51425.

(10) PAHMA 6-14365 Loose beads and 1 unperforated shell

Approximately 800 beads.

Typology: Barrel, short—PN17c, PN17f (faience, approx. 5); biconical, short—PN20p (faience, approx. 20); ring, barrel—PN1c (faience, approx. 515), H2a (carnelian, 1); ring, cylindrical—PN2c (faience, approx. 257), R52e (ostrich eggshell, 1); other: unseparated groups of ring, cylindrical—PN62a, PN62a', PN62b (approx. 12 groups).

Material: Faience (approx. 797), carnelian (1), mollusk shell (1 without perforation), ostrich eggshell (1). Color: Orange, green, brown, black, white.

Length of beads: 0.91–6.03 mm. Diameter of beads: 2.57–4.11 mm. Aperture of beads 0.41–0.70 mm.

Weight: 6.7 g.

Production: OMMA (faience). Edge and no edge.

Aperture: Apex and end.

Perforation: Double cone (carnelian, ostrich eggshell). Striations: Longitudinal.

Glaze: Mostly worn (faience). Polish: Moderate (carnelian).

(11) PAHMA 6-14367 4-strand necklace

Approximately 260 beads.

Typology: Ball—PN8d, PN8f (faience, approx. 232); figural—door/ladder (4, 1 broken), scarabs (4), paddle (1), unknown (ox head?) (1); spacer—PD18d' (but not decorated, 1); cylindrical, short—PN22t (faience, 4); spacer—L66b, L66b', L66d' (steatite, 23); cylindrical, short—L17c (steatite, 1); cylindrical, long—L17e (steatite, 2); barrel, short—L12l (steatite, 2); barrel, long—L11l (steatite, 1); shell—*conus* shell? perhaps *Mitra maculosa* shell? (2).

Materials: Faience (approx. 248), steatite (approx. 29), shell (2).

Color: Blue, green (faience); white (faience, steatite, shell); brown (faience, steatite). Length of strand: 38 cm.

Diameter of strand: 28.2 cm.

Length of beads: 1.48 mm–16.74 mm. Diameter of beads: 4.80–10.41 mm.

Weight: 51.2 g.

Production: OMMA, molding (faience). No edge.

Aperture: Apex, end (faience); end (steatite). Perforation: Single plain (steatite).

Striations: Longitudinal (steatite).

Glaze: Mostly worn, mostly not worn (faience); mostly worn (steatite).

For parallels, see the following: Shell: EA 63299; Petrie 1914, pl. 14:109–110. Ox head: Petrie 1914, pl. 5:62; Brunton 1948, pl. 31:41. For a similar looking bull head, MMA 10.130.2050, 10.130.1338. For a design similar to the one reproduced below but on a First Intermediate Period scarab from Matmar, see Brunton 1948, pl. 33:85.

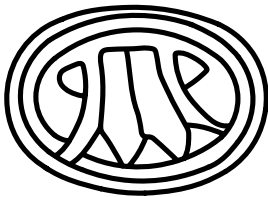

FIGURE 7.11
Scarab

(12) PAHMA 6-14368 Length of necklace (not a loop) Approximately 200 beads.

Typology: Disc, cylindrical—R52f (ostrich eggshell, approx. 42); ring, barrel—PN2c (faience, approx. 100); ring, cylindrical—PN6d (faience, approx. 50), R52c (ostrich eggshell, approx. 8); other—PN2d (double ring; faience, 2).

Material: Faience (approx. 150), ostrich eggshell (approx. 50). Color: Green, brown (faience); white (ostrich eggshell). Length of strand: 52 cm.

Length of beads: 0.71–2.46 mm. Diameter of beads: 2.77–5.76 mm. Weight: 6.5 g.

Production: OMMA (faience). No edge.

Aperture: End.

Perforation: Double cone (ostrich eggshell).

Glaze: Mostly worn (faience); mostly not worn (faience).

(13) PAHMA 6-14370 (from N 2071a) Loose beads and conical decoration (without perforation) Approximately 300 objects.

Typology: Barrel, short—PN17h (approx. 200); cylindrical, short—PN6q (approx. 10); conical decoration—PN19g (approx. 90). The mud is a fine, compact mud.

Material: Mud. Color: Brown.

Length of objects: 5.32–20.50 mm. Diameter of objects: 2.65–5.98 mm.

Aperture of objects: Too small to be measured, if present at all. Weight: 57.0 g.

Production: Rolled. No edge.

Aperture: Apex, end, and irregular (some have 1 end side and 1 apex side).

(14) PAHMA 6-14371 (from N 2071a) Loose beads, conical decorations (no perforation), faience ball (no perforation), and chips of shell

Approximately 300 objects.

Typology: Barrel, short—R57d (mud, approx. 170); cylindrical, short—R58e (mud, approx. 30); ring, cylindrical—PN2a, PN2b (faience, 3); ball—PN9e (faience, 3); other: sharp, conical decoration—R58i (mud, approx. 100). The mud is a fine, compact mud.

Material: Faience (ring bead (3), ball bead (3)); mud (approx. 294).

Color: Brown.

Length of objects: 0.77–16.78 mm. Diameter of objects: 2.52–5.81 mm.

Aperture of objects: Too small to be measured, if present at all. Weight: 57.7 g.

Production: Rolled. No edge.

Aperture: Apex, end, and irregular (some have 1 end side and 1 apex side).

(15) PAHMA 6-14372 Length of string (bracelet?) (not a loop), broken fragments of beads, and a loose scarab

Exactly 200 objects (199 intact beads and 1 scarab).

Typology: Disc, barrel—PN2g (faience, 189); disc, cylindrical—PN6g (faience, 10); figural—scarab (steatite, 1).

Materials: Faience (199), steatite (1). Color: Brown.

Length of strand: 21 cm.

Length of beads: 0.79–1.52 mm. Length of scarab: 8.63 mm. Diameter of beads: 2.28–3.68 mm. Diameter of scarab: 3.54 mm. Weight: 1.5 g.

Production: OMMA (faience). No edge.

Aperture: End.

Perforation: Single plain (scarab). Striations: Random.

Decoration: Etched (scarab).

Glaze: Mostly worn (faience, glazed steatite).

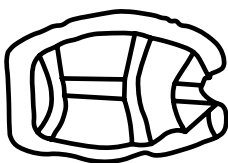

FIGURE 7.12
Scarab

(16) PAHMA 6-14373 (from N 2071b) Length of necklace (not a loop) with a pendant

Exactly 337 beads and 1 pendant.

Typology: Ring, barrel—PN2g (337); pendant, lenticular (1). Material: Faience. Color: Brown.

Length of strand: 40 cm.

Length of beads: 0.70–1.70 mm. Diameter of beads: 2.87–3.40 mm. Weight: 3.2 g.

Production: OMMB (faience). No edge.

Aperture: End.

Perforation: Single plain.

Glaze: Mostly worn.

(17) PAHMA 6-14375 (from N 2071c) Loose beads and pendant

Exactly 22 objects (21 beads and 1 pendant).

Typology: Barrel, short (blobbed)—PN17h (faience, 1); lenticular—PN32f (faience, 1); spacers (steatite)—L66b (1), Lbb6' (2), L66d (1), L66d' (2); figural (faience)—ram/ichneumon (1), winged scarab (2), door/ladder (1), lion (1), double lion head (1), double lion (1), with horizontal lines (4), broken (2); six-holed pendant (1). Material: Faience (16), steatite (6).

Color: Blue (faience); brown (faience, steatite). Length of objects: 1.97–18.95 mm.

Diameter of objects: 4.07–10.14 mm. Aperture of objects: 0.94–1.57 mm.

Weight: 5.3 g.

Production: OMMA (faience: barrel, short), OMMB (faience: lenticular), molding (faience: figurals).

No edge. Aperture: End. Perforation: Single plain.

Striations: Longitudinal (1 spacer), indeterminate (5 spacers).

Glaze: Mostly worn (faience, steatite).

The blobs on the faience bead PN17h are regular and irregular. Glaze clearly overlays the blobs, so the blobs appear to have been formed during the firing process. For parallels, see the following: Ram/Ichneumon: Reisner 1907, pl. 21:12337 (listed as a ram); Brunton 1948, pl. 31:45–46 (listed as an ichneumon). Winged scarab: Petrie 1914, pl. 11:93d–e; UC43123. Door/ladder: MMA 22.1.1944j; Reisner 1923, 123, pl. 43.2. Lion: Brunton 1928, pl. 95:15D3, 15D6. Double lion head: Brunton 1928, pl. 95:17D6; Petrie 1914, pl. 10:91c (although it is gold); Reisner 1907, pl. 18:12225 (frit). Double lion: Brunton 1928, pl. 95:17D6. Six-holed pendant: Petrie 1914, pl. 33:188z; Brunton 1948, pl. 32:82–84, 105.

(18) PAHMA 6-14376 (from N 2071C) Loose pendant

Exactly 1 pendant.

Typology: Pendant, lenticular—H74j. Material: Agate.

Color: Red, orange, white. Length: 3.35 mm. Diameter: 6.12 mm.

Top to bottom: 15.10 mm. Aperture: 1.03 mm. Weight: 0.7 g.

No edge. Aperture: End. Perforation: Double cone. Striations: Random. Polish: Moderate.

(19) PAHMA 6-14377 (from N 2071C) Loose beads and one shell without a perforation

Exactly 78 objects.

Typology: Barrel, long—PN17l (faience, 8); cylindrical, short—L16j (steatite, 3); cylindrical, long—L16q (steatite, 2); disc, cylindrical—R52f (ostrich eggshell, 25); ring, barrel—PN2g (faience, 20), H2f (carnelian, 7); ball—PN8d (faience, 6); other: broken faience (1); double elliptical with teardrop-shaped perforation—PN14c (faience, 1); spacer bead—PD17e (faience, 1); 2 shells, family: *Neritidae*; 1 shell, family: *Conidae*; 1 shell, type undetermined (top had been cut off in order to string it).

Material: Faience (37), carnelian (7), steatite (5), mollusk shell (4), ostrich eggshell (25). Color: Orange, green, brown, white.

Length of objects: 1.13–19.32 mm. Diameter of objects: 2.00–10.40 mm. Aperture of objects: 0.80–3.32 mm. Weight: 7.3 g.

Production: OMMA (faience). No edge.

Aperture: End.

Perforation: Double cone (carnelian, ostrich eggshell); single plain (glazed steatite, mollusk shells). Striations are random.

Glaze: Mostly worn (faience, steatite). Polish: Moderate (carnelian).

(20) PAHMA 6-14378 (from N 2071C) Length of bracelet (not a loop) Exactly 69 beads.

Typology: Disc, barrel—H2e (37); disc, biconical—H5d (6); disc, cylindrical—H6e (24); ring, cylindrical—H6c (2).

Material: Carnelian. Color: Red, orange.

Length of strand: 12.5 cm. Length of beads: 0.92–2.31 mm. Diameter of beads: 2.58–4.59 mm. Weight: 2.7 g.

Edge (disc, biconical); no edge (the remainder of the beads). Aperture: End.

Perforation: Double cone. Striations: Rotary.

Polish: High.

(21) PAHMA 6-14379 (from N 2071C) Length of necklace (not a loop) Exactly 283 beads.

Typology: Disc, cylindrical—PN6g (faience, approx. 50); ring, barrel—PN2c (faience, approx. 231); ring, biconical—H5e (carnelian, 1); figural—ring bead with knob (faience, 1).

Material: Faience (282), carnelian (1).

Color: Red (carnelian); blue, brown, black (faience). Length of strand: 29 cm.

Length of beads: 0.52–1.96 mm. Diameter of beads: 2.14–3.32 mm. Weight: 1.8 g.

Production: OMMA (faience). No edge.

Aperture: End.

Perforation: Double cone (carnelian). Glaze: Mostly worn (faience).

Polish: Moderate (carnelian).

N 2072 Map A5; photo C 8235

Round neck, several strings of glaze beads sizes apparently strung separately. In front, probably on shell necklace, lion plaque in limestone and 1 carnelian [long barrel] bead (PAHMA 6-14381; for the lion plaque, see also Reisner 1932, fig. 50:19). Also, string of black glaze beads. In front, apparently on black string, carnelian [short barrel] and [long barrel], limestone [cylindrical], and quartzite [long barrel] (PAHMA 6-14380, PAHMA 6-14381). With these finds were several broken As and 1 jar.

(1) PAHMA 6-14380 Loose beads

Approximately 175 beads.

Typology: Conical, short—PN21e (faience, 1); disc, cylindrical—PN6d, PN6g (faience, approx. 139), H6e (carnelian, 9), R52e (ostrich eggshell, approx. 25); figural—lion (faience, 1).

Material: Faience (approx. 141), carnelian (9), ostrich eggshell (approx. 25).

Color: Red, orange (carnelian); green, brown, black (faience); white (faience, ostrich eggshell). Length: 0.48–7.67 mm.

Diameter: 2.18–6.15 mm. Aperture: 1.10–2.03 mm. Weight: 4.1 g.

Production: OMMA, molding (faience). No edge.

Aperture: End.

Perforation: Double cone (carnelian); single plain (ostrich eggshell). Striations: Random.

Glaze: Mostly worn (faience). Polish: Moderate, dull (carnelian).

For a parallel to the lion, see Brunton 1928, pl. 95:15D6.

(2) PAHMA 6-14381 Length of necklace (not a loop)

Approximately 370 beads.

Typology: Barrel, short—H15n (carnelian, 1); conical, short—PN19d (faience, 4); cylindrical, short—S18i (steatite, 1); disc, barrel—H2k (quartz, 1); disc, biconical—H5j, H5m (carnelian, 2); disc, cylindrical—R52f (ostrich eggshell, approx. 270); ring, cylindrical—R52c (ostrich eggshell, approx. 89); figural—lion; broken (faience, 2). Material: Faience (6), carnelian (3), quartz (1), steatite (1), ostrich eggshell (approx. 359).

Color: Red (carnelian); brown (faience); white (quartz, steatite, ostrich eggshell). Length of strand: 47.5 cm.

Length of beads: 0.67–6.88 mm. Diameter of beads: 3.86–9.28 mm. Weight: 17.3 g. Production: OMMA (faience), molding (lion) Edge (carnelian); no edge (the remainder). Aperture: End.

Perforation: Double cone (quartz, carnelian); single plain (steatite, ostrich eggshell). Striations: Longitudinal (steatite); rotary (carnelian); random (quartz). Glaze: Mostly worn (faience, steatite). Polish: Dull (carnelian), rough (quartz).

For parallels to the lion, see Brooklyn Museum 16.366; Petrie 1914, pl. 38:219; Reisner 1923, 128, pl. 44,2,20–21.

N 2075 Map A4; type vi d; photo C 8074, C 8194, B 8248

By neck, quantity of carnelian beads scattered. Barrel carnelian strung with black glaze disc between; in one place, a lazuli disc in place of glaze (PAHMA 6-14389a, PAHMA 6-14389b, PAHMA 6-14390). Small carnelian [ring bead] strung together (PAHMA 6-14385). Layer of same shape either together or with black glaze between. Also, a string of tiny shell (PAHMA 6-14385). In large chamber, few shell disc beads.

These items were found with, in main chamber, a few pots, mostly broken. Piece of a drab [bowl]? 2 alabaster C 8194 1/5 [squat jar] and 2/5 [jar]. [ed.: According to Hearst Museum records, PAHMA 6-14382 (glass bead/plug), PAHMA 6-14383 (scarab), PAHMA 6-14384 (assorted beads, including a striped faience bead similar to the drawing in 2071), PAHMA 6-14384.1 (metal beads), PAHMA 6-14386 (jar fragment), PAHMA 6-14387 (metal wire), PAHMA 6-14388 (needle), PAHMA 6-14391, PAHMA 6-14392 (alabaster vessels), PAHMA 6-14393, PAHMA 6-14394, PAHMA 6-14395 (mirrors), PAHMA 6-14396 (ceramic jar) are from this tomb.]

(1) PAHMA 6-14382 Loose bead

Exactly 1 bead.

Typology: "Ear stud," but pierced from flat end to tip so as to be strung. Material: Glass.

Color: Yellow, blue, white. Length: 36 mm.

Diameter at center: 7.15 mm. Diameter at flat end: 16.11 mm. Diameter at tip: 8.36 mm. Weight: 4.5 g.

Production: Modeling (glass). No edge.

Aperture: End. Perforation: Single plain.

Decoration: By simple elements without a separate matrix; left spiral white on blue with yellow on base and tip.

For parallels, see BM EA 68532, 68535; MMA 21.9.321; SI F1909.446; Brooklyn Museum 48.66.30, 48.66.31, 37.1438Ea-b; Andrews 1997, p. 117, fig. 96g; Petrie 1914, p. 12–13, pl. 4:20; Reisner 1907, p. 125:12141, 12143, pl. 10:12141.

(2) PAHMA 6-14384, PAHMA 6-14384.1 Loose beads and a seed

Exactly 15 objects.

Typology: Barrel, short—H15m (carnelian, 1; glazed steatite, 2), M7d (gold, 1); barrel, long—PD1e (faience, 1); cylindrical, long—PD62b (faience, 1), PN22t (faience, 1); disc, cylindrical—H6e (carnelian, 1); ball—PN8d (faience, 1), PN8h (faience, 2); figural—(faience) fly(?) (1); other: lenticular—PN33d (1); N/A (broken steatite, 1; seed, 1).

Material: Faience (8), carnelian (2), steatite (3), gold (1), seed (1).

Color: Orange (carnelian), green (faience), brown (faience, steatite), black (faience stripe), rose gold (gold). Length of beads: 1.53–18.75 mm.

Diameter of beads: 4.20–10.10 mm. Aperture of beads: 1.10–1.90 mm. Weight: 3.7 g.

Production: OMMA (faience), molding (ribbed cylindrical, long and figural (fly?)); joined-halves (metal).

No edge. Aperture: End.

Perforation: Double cone (carnelian barrel); single plain (carnelian disc, all steatite, gold). Striations: Random.

Decoration: Painted (1 with black spiral) (faience). Glaze: Mostly worn (faience, glazed steatite). Polish: Moderate (carnelian).

For parallels to the fly, see Petrie 1914, pl. 2:19j; Reisner 1923, 131. Object PAHMA 6-14384.1 (metal bead) is strung on modern string and stored with PAHMA 6-11575, fragments of a gold ring from Tomb 3576 (Cemetery N 3500).

(3) PAHMA 6-14385 Some loose beads and a length of bracelet (not a loop) Approximately 150 beads.

Typology: Ring, barrel—H1e (carnelian, 6), PN1c (faience, approx. 100); cylindrical, long—S18s (steatite, 1), PN22t (faience, 1); disc, barrel—PN2j (faience, approx. 50).

Material: Faience (approx. 143), steatite (1), carnelian (6).

Color: Orange (carnelian); brown (faience); black (faience); white (steatite).

Length of beads: 0.88–15.74 mm.

Diameter of beads: 2.27–4.88 mm. Aperture of beads: 0.53–1.95 mm.

Weight: 3.4 g.

Production: OMMB (faience). No edge.

Aperture: End.

Perforation: Double cone (carnelian); single plain (steatite). Striations: Longitudinal (steatite).

Polish: Moderate (carnelian). Glaze: Mostly worn (faience).

(4) PAHMA 6-14389a Necklace (not as originally strung; see PAHMA 6-14389b) Exactly 22 beads.

Typology: Barrel, short—H15p, H15q (carnelian and agate, 13); barrel, long H16e (carnelian, 1); biconical, short—H19h (carnelian and agate, 6); biconical, long—H19n (agate, 1); drop—H20p (agate, 1).

Material: Carnelian (17), agate (5).

Color: Red, orange (carnelian, agate); white (agate). Length of strand: 16.4 cm.

Diameter of strand: 11.9 cm. Length of beads: 9.15–20.16 mm. Diameter of beads: 6.75–12.48 mm. Weight: 34.4 g.

Edge and no edge (random; does not correlate with material or shape).

Aperture: End.

Perforation: Double cone (carnelian, agate); single cone (drop agate); single plain (carnelian). Striations: Rotary (carnelian, agate).

Polish: High (agate); moderate, dull, rough (carnelian).

For parallels, see PAHMA 6-1050 from N 3061 (Reisner 1908, 85–86); PAHMA 6-10465 from N 503.

(5) PAHMA 6-14389b Necklace (not as originally strung; these beads were found with PAHMA 6-14389a and with them, may have comprised 1 necklace) Exactly 273 beads.

Typology: Cylindrical, long (carnelian, 1)—H21q; disc, biconical (carnelian, approx. 118)—H2f, H5e (small), H2i, H5i (medium), H2k, H5m (large); ring, barrel (carnelian, approx. 155; agate, 3; faience, 4; Egyptian blue, 1)—PN2g.

Material: Faience (4), carnelian (264), agate (3), Egyptian blue (1).

Color: Red, orange (carnelian); blue (Egyptian blue); black (faience); white (agate). Length of strand: 73.0 cm.

Diameter of strand: 26.0 cm. Length of beads: 1.68–4.38 mm. Diameter of beads: 3.98–7.09 mm. Weight: 29.2 g.

Production: OMMB (faience).

Edge (carnelian disc and barrel beads); no edge (carnelian cylinder, faience, agate, Egyptian blue). Aperture: End.

Perforation: Double cone (carnelian, agate); single plain (carnelian cylinder).

Striations: Rotary (agate); random (carnelian).

Glaze: Mostly worn (faience).

Polish: High, moderate (carnelian, agate).

(6) PAHMA 6-14390 Loose beads and broken faience ring and disc beads

Exactly 12 intact beads and many broken faience beads.

Typology: Barrel, short—H2r (carnelian, 5), H9g (carnelian, 2); barrel, long—H15p (carnelian, 3; quartz, 1)—H15p; disc, cylindrical—H2i (carnelian, 1); broken ring and disc beads (faience).

Material: Faience (no count because broken), quartz (1), carnelian (11). Color: Red, orange (carnelian); black (faience); white (quartz).

Length of beads: 2.58–8.43 mm. Diameter of beads: 5.74–10.50 mm. Aperture of beads: 1.25–2.66 mm. Weight: 8.7 g.

No edge. Aperture: end.

Perforation: Double cone (carnelian, quartz).

Striations: Rotary (carnelian), random (carnelian; quartz). Glaze: Mostly worn (faience).

Polish: High (1 carnelian); moderate (10 carnelian, 1 quartz).

N 2090 Map C5; photo A 8266, B 7146

Bead girdle 8 strings. Behind back, order from above was white shell (1), white and black (2), white shell (3), white shell (5), white and black (4), white and black (7), green (8), white (6). 7 and 8 did not go over left ilium. 7 came round underneath into position next to 4. 8 went over 6 and under 7 and 4 and came up between 7 and 6. Under right ilium, order from above was 1 2 3 4 5 6 7 8. All strings went over right ilium. Strings were not fastened together in any way as strings crossed especially at sides where they kept no sort of order. By right arm, few strings[?] green glaze and shell beads and 1 carnelian possibly bracelet. Round neck, string of tiny glaze disc beads. Also, a few of the beads by neck, but these may have come from girdle as beads were much scattered (PAHMA 6-14397, PAHMA 6-14398, PAHMA 6-14399, PAHMA 6-14400, PAHMA 6-14401, PAHMA 6-14402, PAHMA 6-14403, PAHMA 6-14404, PAHMA 6-14405, PAHMA 6-14407). [ed.: According to Hearst Museum records, PAHMA 6-14406 (carnelian *djed*-pillar pendant) and PAHMA 6-14408 (pot stand) are from this tomb.]

(1) PAHMA 6-14397 Necklace Approximately 270 beads. Typology: Disc, cylindrical—R52f. Material: Ostrich eggshell.

Color: White.

Length of strand: 36 cm. Diameter of strand: 25.5 cm. Length of beads: 1.33–1.92 mm. Diameter of beads: 5.04–7.01 mm. Weight: 37.3 g.

No edge. Aperture: End. Perforation: Double cone.

(2) PAHMA 6-14398 Necklace

Exactly 494 beads.

Typology: Disc, barrel—PN2g (faience); disc, cylindrical—R52m (ostrich eggshell). Material: Faience (429), ostrich eggshell (65).

Color: Black (faience); white (ostrich eggshell). Length of strand: 68 cm.

Length of beads: 0.90–2.05 mm. Diameter of beads: 4.04–5.65 mm. Weight: 18.5 g.

Production: OMMA (faience). No edge.

Aperture: End. Glaze: Mostly worn.

(3) PAHMA 6-14399 Necklace Approximately 342 beads.

Typology: Disc, cylindrical—R52f. Material: Ostrich eggshell.

Color: White.

Length of strand: 31.4 cm. Diameter of strand: 21.4 cm. Length of beads: 1.58–2.19 mm. Diameter of beads: 6.46–8.27 mm.

Weight: Approximately 22 g (strung too tightly to measure completely on scale).

No edge. Aperture: End. Perforation: Single plain.

(4) PAHMA 6-14400 Length of necklace (not a loop) Exactly 491 beads.

Typology: Disc, barrel (faience, approx. 30)—PN6k; disc, cylindrical (ostrich eggshell, 151)—R52f; ring, barrel (faience, approx. 310)—PN2j.

Material: Faience (340), ostrich eggshell (151). Color: Black (faience), white (eggshell).

Length of strand: 71 cm.

Length of beads: 0.97–1.87 mm. Diameter of beads: 3.34–5.70 mm. Weight: 17.6 g.

Production: OMMA (faience). No edge.

Aperture: End.

Perforation: Single plain (eggshell). Glaze: Mostly worn (faience).

(5) PAHMA 6-14401 Necklace Approximately 308 beads.

Typology: Disc, cylindrical—R52f. Material: Ostrich eggshell.

Color: White.

Length of strand: 29.1 cm. Diameter of strand: 18.7 cm. Length of beads: 0.49–2.25 mm. Diameter of beads: 4.58–6.97 mm.

Weight: approx. 15.9 g (strand too large for accurate reading on scale). No edge.

Aperture: End. Perforation: Single plain.

(6) PAHMA 6-14402 Length of necklace (not a loop) Exactly 304 beads.

Typology: Disc, cylindrical—R52f. Material: Ostrich eggshell.

Color: White.

Length of strand: 59.0 cm. Length of beads: 0.78–1.94 mm. Diameter of beads: 6.22–7.56 mm. Weight: 33.4 g.

No edge. Aperture: End. Perforation: Single plain.

(7) PAHMA 6-14403 Length of necklace (not a loop) Exactly 563 beads.

Typology: Disc, barrel—PN2f (faience, approx. 60); disc, cylindrical—PN6k (faience, 121), R52f (ostrich eggshell, 127); ring, barrel—PN2b (faience, approx. 255). Material: Faience (436); ostrich eggshell (127).

Color: Black (faience); white (ostrich eggshell). Length of strand: 78 cm.

Length of beads: 0.82–1.81 mm. Diameter of beads: 4.61–5.60 mm. Weight: 22.1 g.

Production: OMMA (faience). No edge.

Aperture: End.

Perforation: Single plain (ostrich eggshell). Glaze: Mostly worn (faience).

(8) PAHMA 6-14404 Length of necklace (not a loop), with some loose beads Exactly 366 beads (360 strung and 6 loose).

Typology: Disc, barrel—PN2k (approx. 272); disc, cylindrical—PN6h (3); ring, barrel—PN2g (approx. 91). Material: Faience.

Color: Green, brown. Length of strand: 58 cm.

Length of beads: 1.15–2.45 mm. Diameter of beads: 4.01–4.69 mm. Weight: 10.9 g.

Production: OMMA (faience). No edge.

Aperture: End. Glaze: Mostly worn.

(9) PAHMA 6-14405 Some loose beads and length of bracelet (not a loop) Exactly 200 beads (180 strung and 20 loose).

Typology: Disc, cylindrical—R52e (ostrich eggshell, 124); ring, barrel—PN2g (faience, 74); ring, biconical—H5j (carnelian, 1).

Material: Faience (74); carnelian (1); ostrich eggshell (124).

Color: Orange (carnelian); green (faience); brown (faience); white (ostrich eggshell). Length of strand: 21 cm.

Length of beads: 0.89–2.03 mm. Diameter of beads: 2.64–4.02 mm. Aperture of beads: 0.70–1.67 mm. Weight: 3.4 g.

Production: OMMA (faience).

Edge (carnelian); no edge (all the rest). Aperture: End.

Perforation: Double cone (carnelian); single plain (ostrich eggshell). Striations: Random.

Glaze: Mostly worn (faience); mostly not worn (a few green faience). Polish: Dull (carnelian).

(10) PAHMA 6-14406 Loose pendant

Exactly 1 pendant.

Typology: Figural—*djed* pillar. Material: Carnelian.

Color: Orange. Length: 10.75 mm. Width: 21.63 mm.

Length of aperture (outside): 2.76 mm. Width of aperture (outside): 2.92 mm.

Aperture (inside): 1.82 mm.

Weight: 2.5 g. No edge. Aperture: End.

Perforation: Double cone. Striations: Longitudinal. Decoration: Carved. Polish: Moderate.

For parallels, see Petrie 1914, pl. 3:35a; Reisner 1923, 123, pl. 43,2.



FIGURE 7.13
Djed pillar

(11) PAHMA 6-14407 Length of necklace (not a loop) Approximately 734 beads.

Typology: Ring, cylindrical—PN2c. Material: Faience.

Color: Blue, brown. Length of strand: 36.7 cm. Length of beads: 1.07–1.31 mm.

Diameter of beads: 2.91–3.14 mm. Weight: 3.0 g.

Production: OMMB (faience). No edge.

Aperture: End. Glaze: Mostly worn.

N 2092 Map: C5

Round neck, double string of small blue faience disc beads (PAHMA 6-14410).

(1) PAHMA 6-14410 Length of necklace (not a loop) Approximately 1,076 beads.

Typology: Ring, barrel—PN1b, PN2b, PN2c (faience, approx. 1,074); ring, cylindrical—PN62a (2 bright blue faience that are stuck together).

Material: Faience.

Color: Green, blue, brown, white. Length of strand: 83 cm.

Length of beads: 0.52–1.27 mm. Diameter of beads: 2.67–3.62 mm. Weight: 8.8 g.

Production: OMMA (faience). No edge.

Aperture: End.

Glaze: Mostly not worn (2 bright blue faience beads that are stuck together); mostly worn (all of the other beads).

N 2093 Map C5; photo B 7129

In large chamber, shell which had been painted (PAHMA 6-14413). This object was found with a broken stela, several As, M, [jars] (PAHMA 6-14411, PAHMA 6-14416), small clay kohl pot (PAHMA 6-14418?), broken stem of an alabaster vase (PAHMA 6-14417), granite paint grinder and pebble (PAHMA 6-14414), and small alabaster [jar] (PAHMA 6-14412). In chamber b, 2 A pots. [ed.: According to Hearst Museum records, PAHMA 6-14415 (flint knife) is from this tomb.]

(1) PAHMA 6-14413 Loose shell without perforation

Exactly 1 object.

Material: Mollusk shell (family: *Cardiidae*). Color: Light brown.

Length: 13.80 mm. Diameter: 33.33 mm. Weight 13.5 g. Perforation: None.

Shell length and diameter measured as if the shell had a perforation in the same way as did 3 of the shells of object number PAHMA 6-14355. For a parallel, see Petrie 1914, pl. 14:111a.

N 2105 Map D4

This object not mentioned in the excavation record of N 2105. In that tomb, a mirror (PAHMA 6-14436) was found. [ed.: According to Hearst Museum records, PAHMA 6-1411 (broken ceramic dish) is also from this tomb.]

(1) PAHMA 6-14437 Loose beads

Exactly 3 beads.

Typology: Barrel, short—H15m (carnelian, 2); cylindrical, long—PN22t (faience, 1). Material: Faience (1), carnelian (2).

Color: Orange (carnelian); brown (faience). Length: 5.50–12.43 mm.

Diameter: 3.84–6.11 mm. Aperture: 1.72–2.52 mm. Weight: 0.7 g.

Production: OMMA (faience). No edge.

Aperture: End.

Perforation: Double cone (carnelian). Striations: Rotary (carnelian).

Glaze: Mostly worn (faience). Polish: Moderate (carnelian).

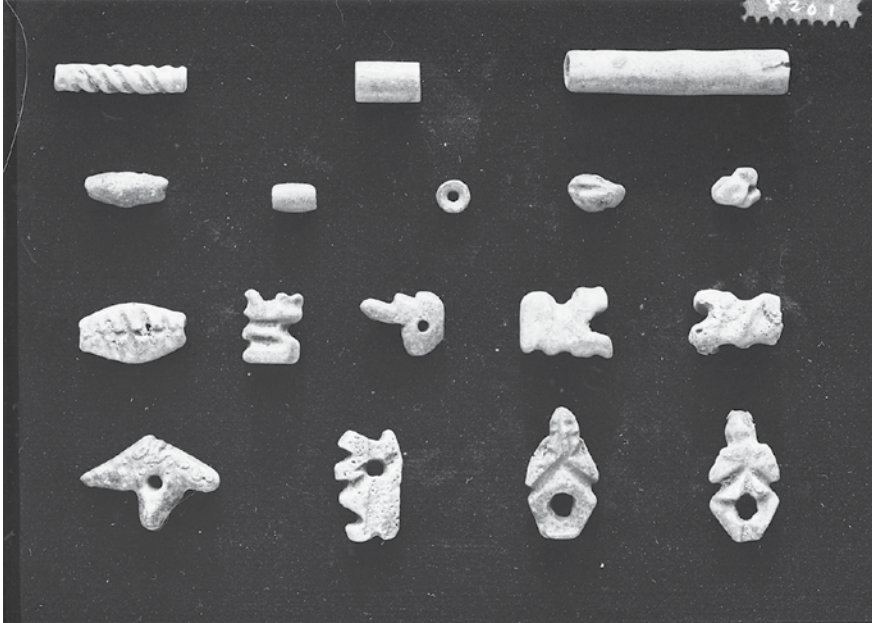

FIGURE 7.14 Beads and pendants from N 2212 (NED-C-8201)

N 2212 Map D5 (red); photo C 8201 (Fig. 7.14)

By upper part [ed.: Of coffin? Because upper part of body gone.], remains of necklace of, in faience, 1. “was” head amulet, 2. Bes eating snakes, 3. sphinx amulets, frog, stone [cylindrical], carnelian [cylindrical] and disc, 3 shells. In filling, pieces of or saucers of M type. [ed.: Note that Hearst Museum records erroneously attributed these objects to N 2112.]

(1) PAHMA 6-14440 Loose pendants and beads

Exactly 15 beads and 6 pendants.

Typology: Barrel, short—H15m (carnelian, 1); cylindrical, short—L17c (steatite, 1); cylindrical, long—PN22v, PD10p (faience, 2); figural (faience)—2 Bes (?), 2 lions, 1 paddle, 1 frog, 1 was-scepter head, 1 Tawaret (?), 1 unknown (faience); (steatite)—1 lion head; other (shells, 3; broken faience pieces, 4).

Material: Faience (15), steatite (2), carnelian (1), shell (3).

Color: Red (carnelian); blue (faience); brown (steatite); white (shell). Length of objects: 4.93–29.46 mm.

Diameter of objects: 3.81–14.00 mm. Aperture of objects: 1.21–4.81 mm.

Weight: 8.5 g.

Production: OMMA (faience), molding (faience). No edge.

Aperture: End.

Perforation: Single plain (steatite, carnelian). Striations: Longitudinal (steatite); random (carnelian). Decoration: Incised (1 faience cylinder); carved (steatite). Glaze: Mostly not worn (faience, steatite).

Polish: Dull (carnelian).

For parallels, see the following: Bes: MMA 11.215.178; Petrie 1914, pl. 33:188; Brunton 1948, pl. 31:9. Lion head: UC 18117; BM EA 57774i (Andrews 1997, fig. 5e); UC 38551; Petrie 1914, pl. 2:22f; Brunton 1928, pl. 95:16N9, 1948, pl. 31:33–34; PAHMA 6-10067 from N 570. Lion: Brooklyn Museum 16.366; Brunton 1948, pl. 31:24–25; Petrie 1914, pl. 38:219; Reisner 1923, 128, pl. 44,2,20–21.

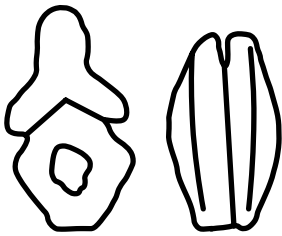

FIGURE 7.15
Bes and paddle

N 2235 Map E4; photos C 8193, C 996, B 7114, B 8251 (Fig. 7.1)

In large chamber, a number of small clay discs (PAHMA 6-14456) and a quantity of glaze disc beads (PAHMA 6-14457). [ed.: According to Hearst Museum records, PAHMA 6-14462 (assorted amulets and beads) are from this tomb.] These objects were found with a quantity of pottery, about 4 As [jars] (PAHMA 6-14451 a–b, PAHMA 6-14452, PAHMA 6-14453, PAHMA 6-14454, PAHMA 6-14455, PAHMA 6-14458), M with white rings [jars].

(1) PAHMA 6-14456 Loose sequins

Exactly 325 objects.

Typology: PN8d, except without perforation. The mud is a fine, compact mud.

Material: Mud; a few rocks, most of which are small. Color: Brown; white (a few rocks).

Weight: 64.9 g.

Production: Sequins are flat on the bottom and rounder on top, seemingly not formed by pressing down on the top with a finger.

This object is accompanied by a small bag of fine mud crumbles.

(2) PAHMA 6-14457 Length of necklace (not a loop) Approximately 1,140 beads.

Typology: Ring, cylindrical and barrel—PN2c.

Material: Faience. Color: Black.

Length of strand: 60 cm. Length of beads: 0.67–3.39 mm. Diameter of beads: 2.66–4.36 mm.

Weight: 4.7 g.

Production: OMMB (faience). No edge.

Aperture: End. Glaze: Mostly worn.

(3) PAHMA 6-14462 Length of bracelet (not a loop) Exactly 9 beads.

Typology: Spacer—PD18d' (although undecorated; faience, 1); figural (faience)—lion heads (4), *tjt* amulet (1), lion (1); figural (coral?)—lion (1).

Material: Faience (7), coral(?) (1), shell (1).

Color: Green, brown (faience); white (coral, shell). Length of beads: 3.06–12.57 mm.

Diameter of beads: 7.26–13.24 mm. Weight: 3.1 g.

Production: Molding (faience). No edge.

Aperture: End.

Perforation: Single plain (coral). Striations: Random.

Glaze: Mostly worn (faience).

For parallels, see the following: *tjt* amulet, Petrie 1914, pl. 7:88. Lion: Brooklyn Museum 16.366; Petrie 1914, pl. 38:219; Reisner 1923, 128, pl. 44,2,20–21. Lion head: UC 18117; BM EA 57774i (Andrews 1997, fig. 5e); UC 38551; Petrie 1914, pl. 2:22f; Brunton 1928, pl. 95:16, 1948, pl. 31:33–34; PAHMA 6-10067 from N 570.

N 2239 Map D4 (red)

Green stone beads (PAHMA 6-14459). This object found with parts of wooden sandals, painted white, with remains of rush bindings. Round and square [cylindrical beads].

(1) PAHMA 6-14459 Loose beads

Exactly 2 beads.

Typology: Cylindrical, short—L16n; square—L17c. Material: Steatite.

Color: Green, brown, white. Length: 10.34–13.76 mm. Diameter: 5.27–5.43 mm.

Aperture: 2.09–2.45 mm. Weight: 1.2 g.

No edge (cylindrical bead); edge (square bead). Aperture: End.

Perforation: Single plain.

Striations: Longitudinal (cylindrical); diagonal (square). Glaze: Mostly worn.

N 2291 Map C4

Coptic grave. By head, one green glass bead (PAHMA 6-14550).

(1) PAHMA 6-14550 Loose bead

Exactly 1 bead.

Typology: Cylindrical, short—H6f. Material: Green feldspar.

Color: Green. Length: 3.53 mm. Diameter: 4.27 mm. Aperture: 1.25 mm.

Weight: N/A (does not register). No edge.

Aperture: End. Perforation: Single plain. Striations: Rotary.

Polish: High.

N 2292 Map C4; photo B 8251

Scattered several glass beads [cylindrical and conical beads], and disc (PAHMA 6-14463, PAHMA 6-14464), 1 carnelian [biconical?] (PAHMA 6-14465). These objects were found with a bronze fragment (PAHMA 6-14465).

(1) PAHMA 6-14463 Length of necklace (not a loop) Approximately 180 beads.

Typology: Disc, cylindrical—R52f (ostrich eggshell); ring, barrel—PN2c (faience). Material: Faience (approx. 178); ostrich eggshell (2).

Color: Blue, brown (faience); white (faience, ostrich eggshell). Length of strand: 24 cm.

Length of beads: 0.64–2.62 mm. Diameter of beads: 2.72–4.57 mm. Weight: 2.6 g.

Production: OMMA (faience). No edge.

Aperture: End.

Perforation: Single plain (ostrich eggshell). Glaze: Mostly worn (faience).

(2) PAHMA 6-14464 Length of necklace (not a loop) Exactly 28 beads.

Typology: Conical, short—PN24d (27); cylindrical, short—PD9l (1). Material: Faience.

Color: Blue, brown. Length of strand: 22.2 cm.

Length of beads: 6.40–11.06 mm. Diameter of beads: 3.58–5.17 mm. Weight: 3.8 g.

Production: OMMA (faience). No edge.

Aperture: End.

Decoration: Gadrooned (some conical beads); molded spiral decoration (cylindrical bead). Glaze: Mostly worn.

(3) PAHMA 6-14465 Loose beads, a broken pendant, and some fragments of metal (bronze?)

Exactly 8 objects (7 beads and 1 pendant).

Typology: Barrel, short—PN16c (faience, 3); cylindrical, short—PN22e (faience, 1), L16l (glazed steatite, 2); a disc, biconical—H5l (carnelian, 1). Could not be determined: broken pendant (1). Material: Faience (4 beads, 1 pendant); carnelian (1); steatite (2).

Color: Red (carnelian), green (faience), white (faience and steatite). Length of objects: 2.07–5.64 mm.

Diameter of objects: 2.00–8.46 mm. Aperture of objects: 0.96–2.35 mm.

Weight: 0.7 g.

Production: OMMA (faience); could not be determined (faience pendant).

Edge (carnelian); no edge (the remainder).

Aperture: End.

Perforation: Double cone (carnelian), single plain (glazed steatite). Striations: Longitudinal (glazed steatite), random (carnelian).

Glaze: Mostly worn (faience, glazed steatite), mostly not worn (1 green faience, broken pendant). Polish: Dull (carnelian).

N 2432 Map D3; photo B 8251

Few black and blue glaze disc beads, large size (PAHMA 6-14471). These objects were found with the remains of a coffin, a piece of a *nabut*, and several rough sticks.

(1) PAHMA 6-14471 Loose beads

Exactly 36 beads.

Typology: Disc, barrel—PN2g, PN2j, PN2k. Material: Faience.

Color: Green, blue, black. Length: 1.28–2.77 mm. Diameter: 4.36–5.70 mm.

Aperture: 1.03–1.95 mm. Weight: 2.4 g.

Production: OMMA (faience). No edge.

Aperture: End.

Glaze: Mostly not worn.

N 2434 Map E3

In *radim* above remains of burial, few black and blue glaze beads, 1 crumb bead (PAHMA 6-14472).

(1) PAHMA 6-14472 Loose beads

Exactly 60 beads.

Typology: Barrel, long—PD48d (faience with crumb decoration, 1); disc, barrel—PN2k (19); ring, barrel—PN2g (40).

Material: Faience.

Color: Green, blue, black. Length: 1.15–7.73 mm. Diameter: 3.82–6.30 mm.

Aperture: 0.90–1.87 mm. Weight: 2.7 g.

Production: OMMA (faience). No edge.

Aperture: End.

Decoration: 1 faience has crumb decoration. Glaze: Mostly not worn.

The barrel bead has large chunks of glaze adhering to the surface. For a parallel, see PAHMA 6-14364 (N 2071), UC 51425.

N 2521 Map N/A [ed.: This record is Reisner's note of preliminary work that was done in 1901.]

Alabaster beads in *ghadim* of irregular hole. Also, glazed stone and carnelian [ring/disc, barrel, and cylindrical beads] (PAHMA 6-12503). Also in *ghadim* were found turtle bones and pots: [jars] thrown ware, smoothed, painted red. [ed.: According to Hearst Museum records, PAHMA 6-12503 (beads) is from this tomb.]

(1) PAHMA 6-12503 Necklace

Approximately 426 beads.

Typology: Disc, barrel—PN2f (faience, approx. 413); disc, biconical—H5i (carnelian, 3); disc, cylindrical—H6r (carnelian, 9); teardrop—L15c (glazed steatite, 1).

Material: Faience (approx. 413), carnelian (12), steatite (1).

Color: Red, orange (carnelian); green, blue (faience); light brown (glazed steatite). Length of strand: 30.4 cm.

Diameter of strand: 19.7 cm. Length of beads: 0.61–7.17 mm. Diameter of beads: 4.16–6.94 mm. Weight: 10.7 g.

Production: OMMB (faience).

Edge: 1 (glazed steatite), 3 (carnelian). Aperture: End.

Perforation type: Double cone (carnelian); plain (glazed steatite). Striations: Random (carnelian); longitudinal (steatite).

Polish: Moderate (carnelian).

Glaze: Mostly worn (faience, steatite).

N 2618 Map D5; photos C 8193, C 8520, C 8545, C 8594 (Fig. 7.1)

In large chamber, small gold bird amulet (PAHMA 6-14547). This object found with 12 pots all of one type in space A and another in front of chamber.

(1) PAHMA 6-14547 Loose pendant

Exactly 1 pendant.

Typology: Figural—ibis on standard. Material: Gold.

Color: Silver, gold.

Length of pendant (chest to back): 13.80 mm. Diameter of pendant (head to standard): 22.13 mm. Aperture: 1.22 mm.

Weight: 2.0 g.

Production: Casting (metal).

For parallels, see Petrie 1914, pl. 42:247, BM EA 62460.

N 2834 Map D3; photo C 8193 (Fig. 7.1)

In *radim*, 2 tiny glaze amulets (PAHMA 6-12515). In burial, badly broken up inscribed coffin in black paint.

(1) PAHMA 6-12515 Loose pendants

Exactly 2 pendants.

Typology: Figural—ankh sign (1), lion (1) Material: Faience.

Color: Blue.

Length: 1.48–2.65 mm. Diameter: 3.00–3.61 mm.

Aperture: N/A (too small to measure). Weight: N/A (did not register).

Production: Molding (faience). Aperture: End.

Glaze: Mostly not worn.

For parallels to the lion, see Brunton 1928, pl. 95:15F6, 15F9.

Bibliography

Andrews, C. 1997. *Ancient Egyptian Jewelry*. New York.

Beck, H. C. 2006. "Classification and Nomenclature of Beads and Pendants." *BEADS: Journal of the Society of Bead Researchers* 18:1–76. Available at: <http://surface.syr.edu/beads/vol18/iss1/4>.

Brunton, G. 1948. *Matmar*. British Museum Expedition to Middle Egypt 1929–1931. London.

Germond, P. 2005. *The Symbolic World of Egyptian Amulets, from the Jacques-Édouard Berger Collection*. Milan.

Harrell, J. A. 2017. "A Preliminary Overview of Ancient Egyptian Stone Beads." *Palarch's Journal of Archaeology of Egypt/Egyptology* 14(2) (tEBP Series): 1–16.

Petrie, W. M. F. 1914. *Amulets. Illustrated by the Egyptian Collection in University College, London*. London.

Reisner, G. A. 1907. *Amulets*. CGC [35]. Cairo.

Reisner, G. A. 1908. *Early Dynastic Cemeteries of Naga-ed-Dêr, Part I*. University of California Publications, Egyptian Archaeology, Volume 2. [Leipzig].

- Reisner, G. A. 1923. *Excavations at Kerma, Parts IV–V*. Harvard African Studies 6. Cambridge, MA.
- Reisner, G. A. 1932. *A Provincial Cemetery of the Pyramid Age, Naga-ed-Dér Part III*. University of California Publications, Egyptian Archaeology 6. Berkeley.
- Xia, N. 2014. *Ancient Egyptian Beads*. Beijing. DOI: 10.1007/978-3-642-54868-0.

Analysis of Beads and Pendants

Jolanda Bos and Vanessa Davies

1 Introduction

The beads and pendants from the excavations that Arthur Mace conducted under George Reisner in the Naga ed-Deir cemeteries N 2000 and N 2500 were one of the object categories that were abundantly present in the tombs. The beads and pendants were made from a variety of materials, including Egyptian faience, ostrich shell, stone, and metal. On first glance, the bead repertoire is typical for the periods they represent (Old Kingdom/First Intermediate Period). This chapter summarizes the evidence from cemeteries N 2000 and N 2500 and complements the catalogue of the beads and pendants. Due to the restrictions in the documentation of Mace, certain spatial statistical evaluation of the beads and pendants may no longer be possible.

2 Research Method

The most complete Naga ed-Deir typology is that of the Dynasty 3 through 6 beads and pendants from cemeteries N 500–900.¹ Some of the material here was also presented in that volume of Reisner's. Much of this current analysis was done by Andrea Miloslavic and Jocelyn Simlick, with Vanessa Davies. They catalogued the beads according to shape, color, material, dimensions, and surface treatment. In total, approximately 17,000 objects were examined, made from 18 different kinds of materials.

For this analysis, the Xia publication on ancient Egyptian beads was used to understand the Naga ed-Deir bead repertoire. The percentages of different materials and shapes were used to date the burials, which correspond to burial dates derived from the material described in the tomb catalogue. A difficulty that should be taken into account, however, when drawing conclusions from analyzing the materials of a bead corpus is that Harrell pointed out that the analysis of different materials in the archaeological stone bead repertoire has

1 Reisner 1932, 105–153.

TABLE 8.1 Distribution of materials

Materials	Number	% of the repertoire	Total number of tombs in which material appears
Faience	11,530	68%	18 (N 2010, 2016, 2021, 2031, 2042, 2071, 2072, 2075, 2090, 2092, 2105, 2212, 2235, 2292, 2432, 2434, 2521, 2834)
Ostrich eggshell	3,504	21%	5 (N 2042, 2071, 2072, 2090, 2292)
Mud	927	0.06%	3 (N 2042, 2071, 2235)
Carnelian	634	0.04%	12 (N 2016, 2021, 2031, 2042, 2071, 2072, 2075, 2090, 2105, 2212, 2292, 2521)
Steatite	99	0.006%	10 (N 2016, 2021, 2031, 2071, 2072, 2075, 2212, 2239, 2292, 2521)
Faience covered in gold	74	0.004%	1 (N 2021)
Shell	20	0.001%	5 (N 2042, 2071, 2093, 2212, 2235)
Green feldspar	15	>0.001%	4 (N 2021, 2031, 2042, 2291)
Agate	13	>0.001%	3 (N 2021, 2071, 2075)
Amethyst	9	>0.001%	1 (N 2042)
Gold	5	>0.001%	3 (N 2016, 2075, 2618)
Quartz	4	>0.001%	4 (N 2042, 2071, 2072, 2075)
Seed	3	>0.001%	2 (N 2071, 2075)
Egyptian blue, glass, metal	2 each	>0.001%	Blue (N 2031, 2075); glass (N 2071, 2075); metal (N 2031, 2075)
Coral(?), onyx, travertine, unknown	1 each	>0.001%	Coral (N 2235); onyx, unknown (N 2031); travertine (N 2042)
Total	16,847		

often been incorrectly determined.² Although we acknowledge the fact that it is difficult to analyze the different stone types, a rough distinction between the materials is nonetheless given here. The attribution of material type was consequently done on the basis of visual inspection, and no invasive tests were done on this material. Color divisions were also done based on visual inspection. Classification of the beads was done using the publications of Xia,

² Harrell 2017, 2.

Beck, and Harrell. Objects were described using the terminology of Beck and Harrell and when possible were given a typological classification according to Xia's typology.³

The most common bead groupings buried with the individuals was faience (68%) and ostrich eggshell (21%). Xia Nai analyzed the variation of different materials used in the First Intermediate Period, finding a relatively low amount of carnelian when compared to the Old Kingdom and a relatively high amount of ostrich eggshell and faience.⁴ His analysis is in line with our findings, although the percentages of materials from the Naga ed-Deir bead corpus deviates from the percentages of Xia's bead corpus Xia. Xia also mentioned a decrease in glazed steatite and metal beads in the First Intermediate Period, although we do find metal (gold, 5 beads) and glazed steatite (98 beads in total).⁵ According to Xia, no amethyst was used in bead fabrication in the Old Kingdom repertoire in Reisner's earlier excavations at Naga ed-Deir, but this corpus contains several amethyst beads (9 in total).⁶

3 Spatial Distribution

In total, approximately 16,847 beads, pendants, and the like were uncovered from a total of 22 burials. Of those 22 burials, 19 are from the Dynastic era, 1 is Coptic, and 2 are undetermined, but probably also from the Dynastic era. The two undetermined burials are described only by Reisner's terse notes when he made a preliminary survey of N 2000 and N 2500 in 1901. Beads were found in only 15% of excavated tombs from the Dynastic era. The total number of tombs from that time period in these cemeteries is 138. Neither beads nor pendants were found in 117 tombs from the Dynastic era. Therefore, the main body of beads came from the 21 Dynastic-era tombs and 1 Coptic-era burial (N 2291). The amount of beads that were interred with the buried individuals varies between 1 (N 2291) and 4,072 (N 2090). The amount of pendants varies between 1 (N 2618) and 36 (N 2021).

A clear connection between the graves containing beads and the sex of the individuals buried in those graves was not fully possible to determine due to the deterioration and disturbance of many of the human remains in the

³ Beck 2006, Part II; Harrell 2017, Table 2.

⁴ Xia 2014, 97.

⁵ Xia 2014, 97.

⁶ Xia 2014, 89.

Dynastic era burials. The following statements can be made. Beads were found in conjunction with the burials of two children (N 2071, 2092). The only Coptic burial that contained beads was of an adult male (N 2291). A bird amulet was found in the main chamber of a tomb that contained a burial in the side chamber that Mace questioningly identified as a male (N 2618).

The date for most of these graves remains inconclusive although the majority of the tombs yielding the beads described here can be attributed to the (end of the) Old Kingdom or the First Intermediate Period. The distribution of burials containing beads and pendants across the cemetery is fairly even. Two tombs in column A on Mace's map contained these objects (A4: N 2075; A5: 2072), two tombs in column B (B4: N 2071; B5: 2042), five tombs in column C (C4: N 2291, 2292; C5: N 2090, 2092, 2093), eight tombs in column D (D3: N 2432, 2834; D4: N 2010, 2016, 2105, 2239; D5: N 2212, 2618), and three tombs in column E (E3: N 2031, 2434; E4: N 2235). The greater number of tombs containing beads and pendants in columns C and D corresponds to the higher concentration of burials in general in those two areas. The two tombs excavated by Reisner in 1901 (N 2021, 2521) are not on Mace's map, which is dated December 1904.

Among the tombs with the greatest variety of beads, pendants and the like are N 2042, 2071, and 2090. Correspondingly, these tombs have among the largest number of those objects (N 2042 with 4,109 objects; N 2071 with 3,053 objects; N 2090 with 4,073 objects). The burial in N 2031 is notable because it contained fewer objects (1,065), but those were made from a wide variety of materials, including steatite, green feldspar, onyx, metal, Egyptian blue, and an undetermined green opaque material, in addition to faience and carnelian, which were more commonly found in these cemeteries. A quantity of flakes of yellow gold was also found in N 2031. Two burials are significant because of the large number of amuletic/figural pendants found in them. N 2021 contained 25 carnelian, 12 green feldspar, and 5 faience amuletic pendants, as well as a number of more commonly found beads and 74 faience beads covered in gold, the only ones to be found in these cemeteries. N 2016 contained 6 amuletic pendants made of faience and 3 in gold. Judging from the notes Mace made on these cemeteries, beads and pendants seem to be one of the most generally used prestige objects in the tombs.

4 General Character of the Beads and Pendants

Forms and dimensions of the beads are of course closely linked to the technology of bead manufacturing, the constraints of the material, and the consequential

TABLE 8.2 Distribution of beads

Tomb number	Number of beads	Number of pendants	Other
N 2010	41		
N 2016	12	4	
N 2021	94	36	
N 2031	1,065		
N 2042	4,102	7	
N 2071	2,876	9	3 unperforated shells, 190 conical decorations
N 2072	545		
N 2075	471		1 seed
N 2090	4,071	1	
N 2092	1,076		
N 2093			1 unperforated shell
N 2105	3		
N 2212	15	6	
N 2235	1,149		325 sequins
N 2239	2		
N 2291	1		
N 2292	215	1	
N 2432	36		
N 2434	60		
N 2521	426		
N 2618		1	
N 2834		2	
Subtotal	16,260	67	520
Total	16,847		

use of the objects.⁷ Many of the beads from this assemblage were made of faience or glazed material, ostrich shell, or stone. In the Naga ed-Deir cemeteries, ring beads were the most common type. Subtypes include barrel, biconical, and cylindrical. The second largest group consists of disc beads, also of barrel, biconical, and cylindrical subtypes. Another common bead type is barrel beads of short and long varieties. Xia mentions an increase in the appearance

⁷ Bar-Yosef 2013.

TABLE 8.3 Distribution of shapes

Shape	Number	% of the repertoire	Total number of tombs in which the shape appears
Ring	8,890	53%	11 (N 2021, 2031, 2042, 2071, 2072, 2075, 2090, 2092, 2235, 2292, 2434)
Disc	6,291	37%	12 (N 2010, 2021, 2031, 2042, 2071, 2072, 2075, 2090, 2292, 2432, 2434, 2521)
Barrel	490	0.03%	11 (N 2016, 2021, 2031, 2042, 2071, 2072, 2075, 2105, 2212, 2292, 2434)

of ring beads and a notable decrease in long beads in the First Intermediate Period, with an increase in spheroid beads at the expense of ring beads as the Middle Kingdom approaches.⁸ 90% of this corpus consists of ring beads and disc beads. The next most common shape, although not nearly as numerous as the ring and disc beads, are barrel beads. Other shapes found in N 2000/N 2500 are ball beads, figural objects, cylindrical beads, spacers, conical and biconical beads, and others, including non-bead items, such as mud sequins and mud conical decorations. According to Xia Nai and our understanding of the bead repertoire based on the spread of the bead types and materials, this Naga ed-Deir assemblage likely belongs to the First Intermediate Period. This is also obvious from the lack of a certain complexity in materials and shapes, which is often present in the Old and Middle Kingdom bead repertoires.

Two burials contained girdles that were wrapped around the body of the deceased (N 2042, 2090). These girdles were mostly intact in situ when excavated and consisted of green, black, and white disc and ring beads made of faience and ostrich eggshell. The following objects contain a large number of beads, and their presence in their respective tombs cause the amount of beads in those burials to increase considerably (N 2031: necklace PAHMA 6-14317; N 2042: girdle PAHMA 6-14332, PAHMA 6-14341, PAHMA 6-14343; N 2090: girdle PAHMA 6-14397, PAHMA 6-14398, PAHMA 6-14399, PAHMA 6-14400, PAHMA 6-14401, PAHMA 6-14402, PAHMA 6-14403, PAHMA 6-14404, PAHMA 6-14405, PAHMA 6-14407; N 2092: necklace PAHMA 6-14410).

⁸ Xia 2014, 98.

5 Some Notes on Beads and Pendants

Some noteworthy pendants reinforce the general dates of burials. Three *heh* amulets executed in gold (PAHMA 6-14304a–c) were found in N 2016. These amulets are typical for the Old Kingdom, from Dynasty 6 onwards. The pendants are schematically executed and stylized, although the face, hair, and kilt are easily visible. The god Heh depicted there is shown holding a palm rib in each hand representing the hieroglyph for “years.” In the First Intermediate Period and Middle Kingdom, these amulets appear more frequently, often executed in gold, copper, or faience, although the latter material goes hand in hand with less detailed examples.⁹ Five amulets in the Ashmolean Museum were found in the Hammamia tomb of a woman, arranged on her skull.¹⁰ Similar amulets were found at Abydos and date to the Middle Kingdom (MMA 04.16.6, 04.16.10, 04.16.11, 04.16.13, 04.16.14). Those amulets were excavated by the Egypt Exploration Fund in 1904 in Cemetery V, Tomb V21, although little information is known about the original arrangement of the jewelry items.¹¹ The gold *heh* pendant in the Oriental Museum, University of Durham (EG 5072) shows a relatively well-executed figure in gold depicted with a long curved beard and tripartite wig and a disc on his head. That object dates to Dynasty 6, and the museum also has a mold in which objects like this could be produced. Three similar amulets (Brooklyn 13.1037, 13.1035, 13.1036) are possibly made of electrum and date to Dynasties 12 and 13. These stylized versions were excavated at Abydos from tomb D 303. A silver version of the pendant (MFA 13.3772), fairly large for this pendant type (2.1 cm) dates to the Middle Kingdom and was found close to Naga ed-Deir, at Sheikh Farag, in tomb SF 170. All other known samples are approximately 1 cm in size. The general interpretation of these types of pendants is that the deceased buried with them will enjoy millions of years in the afterlife due to the association with the god Heh. Based on the similar finds from other cemeteries, the most likely date for the Naga ed-Deir burial containing the *heh* amulets is the First Intermediate Period or Middle Kingdom, although an Old Kingdom date cannot be ruled out.

A pendant in the shape of an ibis (PAHMA 6-14547) was discovered in N 2618. A parallel in the British Museum (EA 62460) dates to Dynasties 8 or 9 and was excavated at Mostagedda, grave 542. In the collection of the Hearst Museum, another similar pendant (PAHMA 6-22885) was also excavated at Naga ed-Deir,

⁹ O'Neill, O'Neill, and Allen 1999, 488.

¹⁰ O'Neill, O'Neill, and Allen 1999, 488.

¹¹ Hayes 1953, 236.

from cemetery N 3500, tomb N 3526, dating to the end of the Old Kingdom.¹² This type of pendant becomes more numerous at the beginning of the First Intermediate Period, thus providing a strong date for the burial in N 2618 as well. Most similar pendants are made of gold, electrum, or copper. Both examples in the collection of the Hearst Museum exhibit a poorly rendered bird beak. Additional indications that these two pendants date to the same time frame are the striking similarity in the manner in which the legs of both bird amulets are attached to the body and the attachment of the suspension ring.¹³

The dataset contained one mushroom-shaped glass pendant (PAHMA 6-14382) perforated along the long axis of the object. This type of pendant has been frequently identified as an ear-plug or ear-stud. In a forthcoming publication, however, Anna Hodgkinson reinterprets them and cautions not to take the interpretation as ear-plug for granted. These pendants could also have been worn as parts of larger jewelry pieces or may have been ornaments worn in the hair or wig since quite a large number of them had been pierced.¹⁴ The object dates to the New Kingdom, and the specific color scheme of this pendant suggests that the object dates to the Amarna period or slightly earlier or later.¹⁵ The fact that this object is part of this data set is remarkable, however, since the beads and pendants are mostly dated to the Dynastic era, mostly to the First Intermediate Period and Middle Kingdom.

Some other objects that are noteworthy are the ball beads with spiral black and white decoration (PAHMA 6-14358; PD3 according to the typology of Xia Nai). These balls most likely date to the Old Kingdom. However, the two glazed pendants shaped like an ankh sign and possibly an animal head (PAHMA 6-12515), both of which are very small (1.48–2.65 mm), suggest a New Kingdom date, likely similar to the mushroom-shaped pendant (PAHMA 6-14382).

6 Beading Technology

Most of the beads found in the cemeteries are small and were, most likely, produced to be threaded into necklaces or other jewelry items. This can be determined from the general shapes that make the beads fit for simple threading. Very few objects contain the original thread. Evidence of thread can be

¹² Andrews 1994, Fig. 62.

¹³ O'Neill, O'Neill, and Allen 1999, 486.

¹⁴ Hodgkinson, forthcoming.

¹⁵ Personal communication with Dr. Anna Kathrin Hodgkinson.



FIGURE 8.1 A portion of the girdle (6-14343) as found in situ (NED-C-7502)

found inside the amethyst and faience beads of PAHMA 6-14336, the carnelian of PAHMA 6-14338, and some of the faience beads of PAHMA 6-14365.

Despite the fact that no single complete object exists as it would have in antiquity, one of the more remarkable objects, the so-called girdle (PAHMA 6-14332, PAHMA 6-14341, PAHMA 6-14343), can be reconstructed. The girdle, found in N 2042, consisted of fifteen strings of white, green, and black beads that were threaded together in different interlacing chains. The beads have been re-threaded in modern times. Some beads that were once part of the girdle are now separated from it, so the pattern as preserved today does not entirely adhere to the original design. The excavation photographs provide our best evidence of the girdle's original patterning. What was used as the basis for the modern interpretation of the original pattern is unclear. Currently, the girdle is a net-like structure, 56 centimeters in length that seems to mimic the original shape of the object based on the photographs of the object in situ (Fig. 8.1).

The other complex beaded object from the cemetery, the girdle found in N 2090, has been restrung in modern times as several separate objects. Based on the burial goods, such as the kohl wand, found with the girdle in N 2042, it may be that N 2042 is a Middle Kingdom burial. Kohl sticks (if this is the excavator indicated by the word "wand") are said to appear after Dynasty 11, although no detailed analysis of this object type is available. A correlating fact is

that beaded girdles are more often found in the Middle Kingdom. At Diospolis Parva, Petrie excavated a girdle of beadwork dating to Dynasties 6–8 that was “strung together irregularly,” similar to the Naga ed-Deir girdle. The Diospolis Parva girdle is 10 inches long with rows of blue, black glaze, and shell beads sewn onto a material, possibly leather, which had deteriorated.¹⁶ The predominant beading technology in ancient Egypt is threading, and a netted beading technique would have been necessary for the production of the Naga ed-Deir girdle if the girdle was made without textile or leather support.

Other notable beads include the rolled faience (PAHMA 6-14303, N 2016), the faience beads covered in gold (PAHMA 6-14305, N 2021), the striped faience (PAHMA 6-14364, N 2071), the bubbly bead (PAHMA 6-14375, N 2071), and the scarab where the hole was not drilled uniformly through the center of the object (PAHMA 6-14372, N 2017).

7 Amulets

A large variety of amulet types were found in cemeteries N 2000 and N 2500. The following table summarizes those finds.

TABLE 8.4 Distribution of figural types

Figural type	Number	% of the repertoire	Total number of tombs in which the figural type appears
Lion	12	12%	8 (N 2016, 2021, 2042, 2071, 2072, 2212, 2235, 2834)
Full frontal face	10	10%	1 (N 2021)
Lion (crocodile/jackal?) head	9	9%	3 (N 2021, 2212, 2235)
Fist	6	6%	1 (N 2021)
Door/ladder	5	5%	1 (N 2071)
Eye of Horus	5	5%	1 (N 2021)
Scarab	5	5%	1 (N 2071)
Shell	5	5%	3 (N 2021, 2042, 2071)
Lenticular (bead/pendant)	4	4%	2 (N 2071, 2075)
Double lion head	3	3%	2 (N 2016, 2071)
Falcon	3	3%	1 (N 2021)
<i>heh</i> hieroglyph	3	3%	1 (N 2016)

¹⁶ Petrie and Mace 1901, 41; Xai 2014, 93.

TABLE 8.4 Distribution of figural types (*cont.*)

Figural type	Number	% of the repertoire	Total number of tombs in which the figural type appears
Paddle	3	3%	3 (N 2016, 2071, 2212)
Tawaret	3	3%	3 (N 2016, 2021, 2212)
Bee	2	2%	1 (N 2021)
Bes (?)	2	2%	1 (N 2212)
Fish	2	2%	2 (N 2021, 2031)
Scarab, winged	2	2%	1 (N 2071)
ankh	1	1%	1 (N 2834)
Double humped (<i>sema tawy?</i>)	1	1%	1 (N 2042)
<i>djed</i> pillar	1	1%	1 (N 2090)
Fly	1	1%	1 (N 2075)
Frog	1	1%	1 (N 2212)
Hippopotamus (?) head	1	1%	1 (N 2031)
Human (?)	1	1%	1 (N 2042)
Human with false beard	1	1%	1 (N 2042)
Ibis	1	1%	1 (N 2618)
Ihy/Khonsu/Shed (?)	1	1%	1 (N 2016)
Ox head (?)	1	1%	1 (N 2071)
Ram/ichneumon	1	1%	1 (N 2071)
Six-holed pendant	1	1%	1 (N 2071)
<i>tj.t</i>	1	1%	1 (N 2235)
<i>was</i> -scepter head	1	1%	1 (N 2212)
Unidentified	1	1%	1 (N 2212)
Total	100		

By far the most common figure represented in this corpus, accounting for 24% of the total number of figural items, was the lion, whether complete, the head, or a double lion. The shape referred to as a lion head was identified by Brunton as lion/dog head and by Petrie as a jackal head.¹⁷ Regarding UC 38551, The Petrie Museum's online catalogue identifies the shape as a "jackal (or crocodile?) head." Because of the large number of lions in N 2000 and N 2500, we have chosen to follow the identification of the head as a lion. According

¹⁷ Brunton 1928, pl. 95:16; Petrie 1914, 13.

to Brunton, these forms are found from Dynasties 4 through 11, placing them squarely in the date range typical for earlier burials in N 2000 and N 2500.

8 Results

The bead and pendant assemblages from the N 2000 and N 2500 cemeteries of Naga ed-Deir were common and most likely date to the late Old Kingdom/First Intermediate Period and possibly the Early Middle Kingdom with the exception of the few New Kingdom outliers mentioned above. The majority of the beads were made of faience and were probably all made to be threaded into simple, one strand beadwork and/or necklaces, although more complex bead structures, such as the girdle, were excavated. When discussing the character of this period's beadwork, Xia described necklaces in which the spacing of larger beads was done by groups of ring beads, strings of ring beads with cylindrical beads, and amulets or scarab pendants as a centerpiece.¹⁸ These kinds of strands are also found in the N 2000 and N 2500 cemeteries (restrung) beadwork.

It should be noted that some of the objects described in the Seals and Sealings chapter might have been included here among the corpus of beads. The distinction between a seal and a bead was made largely on whether or not the object was strung since it was thought that the strung assemblages, although strung in modern times, reflected what the excavators thought the object's purpose was. For example, some strung necklaces included in this corpus contain scarabs (PAHMA 6-14367, PAHMA 6-14372) that, had they not been strung, would likely have been included in the other corpus. Likewise, the scarabs treated in Emily Teeter's chapter (PAHMA 6-14348, PAHMA 6-14363, PAHMA 6-14374, PAHMA 6-14383) would have been included here had they formed part of a necklace. The same is true of the small green faience square (PAHMA 6-14328) bored through the center to be strung.

The majority of the beads were most likely manufactured in workshops, where the stone beads were fabricated and glazed. Xia commented on the limited variety of materials used in bead production, and that limited variety is evident in cemeteries N 2000 and N 2500, although his stated reason, the social disorder at that time, is not necessarily, in the view of these authors, the cause.¹⁹

18 Xia 2014, 101.

19 Xia 2014, 97.



FIGURE 8.2
The divot in the aperture of a faience bead
(part of the 6-14377 object number)
PHOTO BY ANDREA MILOSLAVIC

In an earlier Naga ed-Deir publication, Reisner noted that the edges of the faience and most of the carnelian ring and disc beads were rounded.²⁰ This brings us to a lacuna in the bead analysis from ancient Egypt: use-wear analysis. Use-wear analysis has, for instance, been done by Annelou van Gijn.²¹ It would be interesting for future research to study both the typical wear marks revealing more information on the use of these beads as well as explain the typical edges of the beads.

In this corpus, wear patterns can be seen on a number of objects. In the aperture of one of the faience beads in the grouping PAHMA 6-14377, a sharp divot suggests that the bead repeatedly rubbed on a string (Fig. 8.2). A number of the carnelian beads in PAHMA 6-14378 have small chips on their exterior edges and rounded surfaces. These could have occurred because the beads banged up against hard objects, perhaps other stone beads, while being worn, or they could have occurred in modern times. A more likely sign of ancient wear is a carnelian bead in PAHMA 6-14390. The very small chips all along the

20 Reisner 1932, 149.

21 See, for example, Van Gijn 2014.

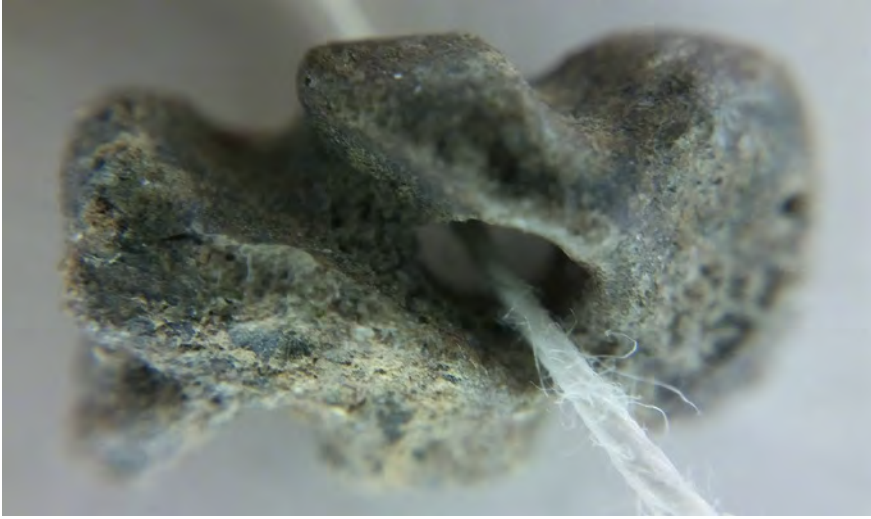

FIGURE 8.3 A deep groove on a *tjt* amulet (6-14462) suggests repeated rubbing against a string.
PHOTO BY JOCELYN SIMLICK

outer aperture of that bead are indicative of the bead edge repeatedly knocking against another hard bead. The edges of the cylindrical and square beads of PAHMA 6-14459 show evidence of damage from wear, where small chips have been removed from the surface edge of the beads. Finally, a spacer and a *tjt* amulet in PAHMA 6-14462 contain deep grooves on their outer surfaces where those surfaces have repeatedly rubbed up against a string (Fig. 8.3). For more detailed analysis of the wear pattern, however, the material should be compared microscopically to similar materials and wear marks on other beads.

Bibliography

- Andrews, C. 1994. *Amulets of Ancient Egypt*. Austin.
- Bar-Yosef, M. 2013. "Towards a Typology of Stone Beads in the Neolithic Levant." *Journal of Field Archaeology* 38(2): 129–142.
- Beck, H. C. 2006. "Classification and Nomenclature of Beads and Pendant." *BEADS: Journal of the Society of Bead Researchers* 18: 1–76. Available at: <http://surface.syr.edu/beads/vol18/iss1/4>.
- Brunton, G. 1928. *Qau and Badari II*. London.
- Falci, Catarina Guzzo, Annelou Van Gijn, M. Magdalena Antczak, Andrzej T. Antczak, and Corinne L. Hofman. 2016. "Challenges for microwear analysis of figurative shell ornaments from pre-Colonial Venezuela." *Journal of Archaeological Science: Reports* 11 (2017): 115–130.

- Harrell, J. A. 2017. "A Preliminary Overview of Ancient Egyptian Stone Beads." *PalArch's Journal of Archaeology of Egypt/Egyptology* 14(2) (tEBP Series): 1–16.
- Hayes, W. C. 1953. *Scepter of Egypt I: A Background for the Study of the Egyptian Antiquities in The Metropolitan Museum of Art: From the Earliest Times to the End of the Middle Kingdom*. Cambridge, MA.
- Hodgkinson, A. K. Forthcoming. "Ear-plugs, Ear-studs or Beads? Reinterpreting a Group of New Kingdom Glass Objects in the British Museum." *British Museum Studies in Ancient Egypt and Sudan*.
- O'Neill, A., J. P. O'Neill, J. Allen. 1999. *Egyptian Art in the Age of the Pyramids*. New York.
- Petrie, W. M. F. 1914. *Amulets, illustrated by the Egyptian Collection in the University College, London*. London.
- Petrie, W. M. F. and A. C. Mace. 1901. *Diospolis Parva, The Cemeteries of Abadiyeh and Hu, 1898–9*. London.
- Reisner, G. A. 1932. *A Provincial Cemetery of the Pyramid Age, Naga-ed-Dêr Part III*. University of California Publications, Egyptian Archaeology 6. Berkeley.
- Van Gijn, A. L. 2014. "Science and Interpretation in Microwear Studies." *Journal of Archaeological Science* 48: 166–169.
- Xia, N. 2014. *Ancient Egyptian Beads*. Beijing. DOI: 10.1007/978-3-642-54868-0.

Miscellaneous Objects

Elizabeth Minor

1 Object Types

The miscellaneous objects from Naga ed-Deir cemeteries N 2000 and N 2500 help shed light on daily life and personal adornment. Cosmetic equipment, such as mirrors, were used in the afterlife to continue to ensure the beauty of the deceased. Headrests were set in the grave to add comfort to their final resting place. Other items—especially tools like a balance scale, grinding stone, hoe, and needle—offer small glimpses of quotidian activities. A small corpus of Coptic objects demonstrates the reuse of ancient graves over time.

Balance scale, copper

N 2048 PAHMA 6-14345, PAHMA 6-14346

First catalogued as a fragmented copper vessel and bent wire, this balance scale has one almost complete basket and a second basket that is about one-quarter preserved. One thick gauge copper wire fragment is bent over itself and has trace impressions of thread or twine wrapped around one end of it. One basket is almost complete, although broken and reconstructed after excavation. The shallow concave circle has two piercings still visible at about a quarter turn from each other. The other two piercings are hidden under thick corrosion products. The other basket is about one-quarter preserved, with another small fragment of rim. The larger fragment also has a piercing at the rim still visible. These scale baskets are from the same tomb as the bent wire (PAHMA 6-14345), which means that wire is likely its balance beam. There are also faint traces of fiber preserved in one area of rim of the more complete basket, perhaps the remnants of the stringing.

Balance scales are known in Egypt as early as the Predynastic Period (Petrucci 1981, 44) and played a key role in economic administration (Petrie 1926). As grave N 2048 had both First Intermediate to Middle Kingdom material and Coptic material, the balance scale could originate in either of those periods.

Bottles, glass (Fig. 9.1)

N 2016? MFA 47.1684

N 2636 MFA 47.1686

N 3747, F4 MFA 47.1685

The three glass bottles from Naga ed-Deir cemeteries N 2000 and N 2500 are of general types known from late Roman and early Byzantine times. Square bottles without indentations and with handles were more common in western regions of the Roman Empire, and were most prevalent in first century and continued through late second century (Whitehouse 2004, 163–164; Cool and



FIGURE 9.1A–D Glass bottles MFA 47.1684 (N 2016), MFA 47.1685 (N 3747, F4), MFA 47.1686 (N 2636). Game piece 6-12501 (N 2501)

Price 1995, 179–185) The pinched square profile found in these Naga ed-Deir examples is more similar to an example from an otherwise unknown Egyptian context (Whitehouse 1997, 182, no. 321, 356, no. 321). Museum records do not list a findspot at Naga ed-Deir for object MFA 47.1684. It may have been the glass bottle found in N 2016.

Fragments, glass

N 2048 PAHMA 6-14347

A dark brown curved fragment of glass could be part of another bottle, but is too fragmentary for reconstruction. Due to the presence of Coptic blown-glass vessels, this is most likely from the same period of use of the cemeteries and intrusive into the grave.

Game piece (Fig. 9.1)

N 2501 PAHMA 6-12501

This single draughtsman once belonged to a set of *senet* game pieces and is a relatively squat, large, and heavy example. Before the New Kingdom, *senet* games were included in tombs in physical form and depicted in wall paintings as part of daily life scenes of enjoyment in the afterlife (Piccione 1980, 57; Kendall 1982, 263–264). No fragments of the rest of the set nor of the game board were noted by the excavators.

Gold flakes

N 2031 PAHMA 6-14310

This thin gold foil has a reddish tinge over 60% of surface. The fragments are too small and deformed to identify the original form. The excavators noted decayed wood and suggested this gold foil is the remains of a gilded object. Found near the neck of the deceased, this could have been a jewelry element, amulet, or displaced furniture/box element.

Grinding stone

N 2093 PAHMA 6-14414

The roughly shield-shaped groundstone has a flat side with a deep central well, although that side has broken off into three small flakes. The other side is more rounded, worked into a pillowed shape, with a flattened middle section. The groundstone is sized and shaped to be held comfortably in the hand. Due to the fragmented grinding side, no residue remains to help identify what substance was processed with this implement. This utilitarian palette is of a type found in Middle Kingdom tombs (Stevenson 2009, 6).

Handle, hoe

N 2606 PAHMA 6-12505

A well-worn wooden agricultural hoe was originally complete with a blade and connecting rope, which have been missing since 1983. The remaining handle is smoothed from frequent use, with a hole for attaching the blade, and a tang midway along the shaft for holding the tension-bearing rope in place. This hoe was used in life and was possibly included in the tomb to promote agricultural fertility in the afterlife rather than relying on a magical substitution such as a tomb model or shabti.

Headrests (Fig. 9.2)

N 2112 PAHMA 6-14439

N 2232 PAHMA 6-14445, PAHMA 6-14446

N 2631 PAHMA 6-12506

N 2636 PAHMA 6-12507

Elements of five wooden headrests were recovered from four tombs in cemeteries N 2000 and N 2500 at Naga ed-Deir. An important object for ensuring comfort during life and for eternity, several of the headrests have wear patterns showing that they had seen regular use before interment. Two headrests are of the typical form with a flat base, stem, and curved platform to support the

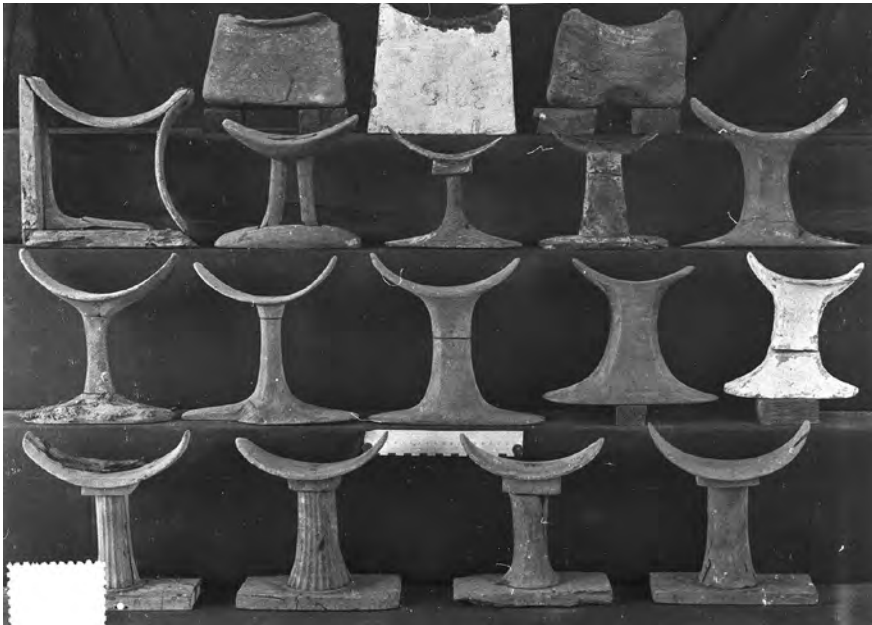

FIGURE 9.2 Headrest (2nd row): #1=6-14446 (N 2232) (NED-B-7148)

head (PAHMA 6-14439, PAHMA 6-12506). One block headrest is more utilitarian than decorative (PAHMA 6-12507). One fragmentary headrest takes an unusual form (PAHMA 6-14445, PAHMA 6-14446), with one braced L-shape component, with a second L-shaped element made of two curved platforms attached to it. This unique piece of woodworking could offer a choice of two different platforms on which to lay one's head, but is not a double headrest meant for use by a couple as is found in West and South African ethnographic examples (Nettleton 2007, figs. 154, 167, 412, 413).

Due to the vagaries of organic preservation at Naga ed-Deir, these fragmentary headrests are likely only a small selection of what may have originally been contained in the graves of cemeteries N 2000 and N 2500. As a standard element of funerary equipment, headrests were meant to magically protect the head of the deceased (Fischer 1979, 688–689). In order to perform this protection, headrests were listed in Coffin Texts spells (Fischer 1979, 688–689), depicted on painted coffins (Freed 2009, 143), and set within the grave. The two stemmed headrests have octagonal stems, which is slightly more common in the New Kingdom than Middle Kingdom, but have roughly equal lengths for the base and top platform which fits with the Middle Kingdom corpus (Fischer 1979, 687–689).

Jewelry (Fig. 9.3)

Bracelets

N 3747, F16 MFA Eg.Inv.1541

Earrings

N 3747, F17 MFA Eg.Inv.1544

Earrings (Coins)

Not given MFA Eg.Inv.1542

Not given MFA Eg.Inv.1545

Two sets of heavy metal bracelets were made for a child. One set has a bezel with dots in the shape of the cross, and the other set has geometric decoration incised into the metal. One earring is made from pressed bronze sheeting, with a lobed rosette suspending a ball. Three earrings were made from pierced Byzantine copper coins. The corrosion has obscured most of the coin imprints. The most visible marking on the coins is the large M on the reverse, denoting the 40 nummi follis coin first minted by Anastasius I in 498 CE and retired by Theophilus by 829 CE (Grierson 1999, 17–20).

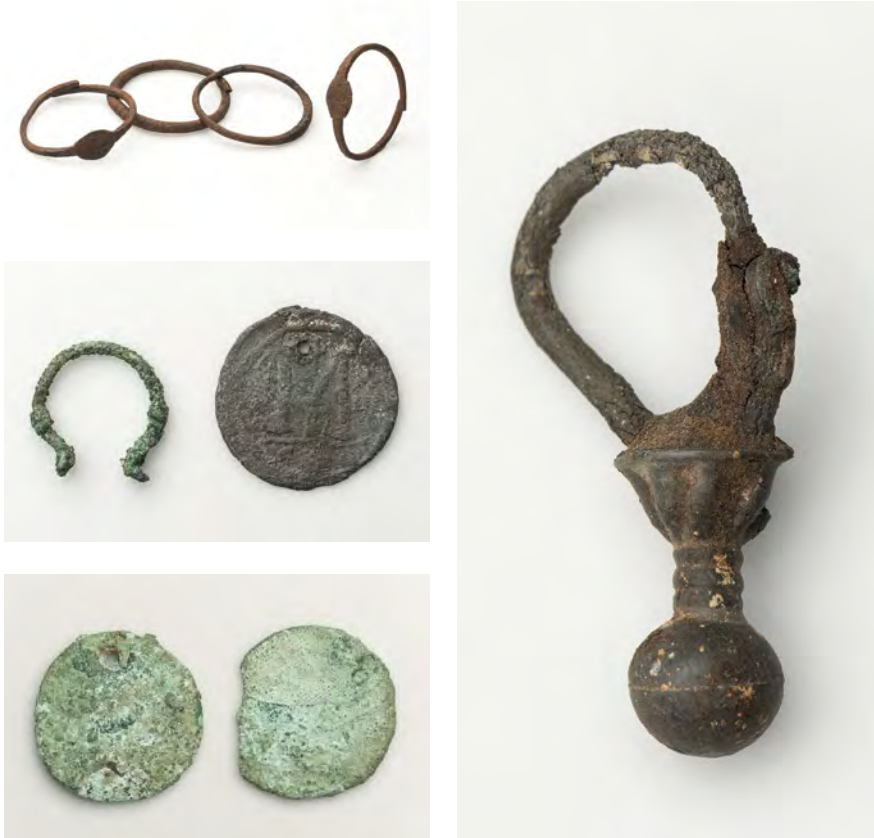

FIGURE 9.3A–D Jewelry/coins MFA Eg.Inv.1541 (N 3747, F16), MFA Eg.Inv.1542, MFA Eg.Inv.1544 (N 3747, F17), MFA Eg.Inv.1545

Mirrors (Fig. 9.4)

- N 2071 PAHMA 6-14366
 N 2075 PAHMA 6-14393, PAHMA 6-14394, PAHMA 6-14395
 N 2091 PAHMA 6-14409
 N 2103 PAHMA 6-14434
 N 2105 PAHMA 6-14436
 N 2447 PAHMA 6-14537
 N 2449 PAHMA 6-14538

The mirrors from Naga ed-Deir N 2000 and N 2500 have a consistent form of a disc that is slightly wider in proportion and has a long tang for attachment to the handle. No handles are preserved, which may suggest that they all were

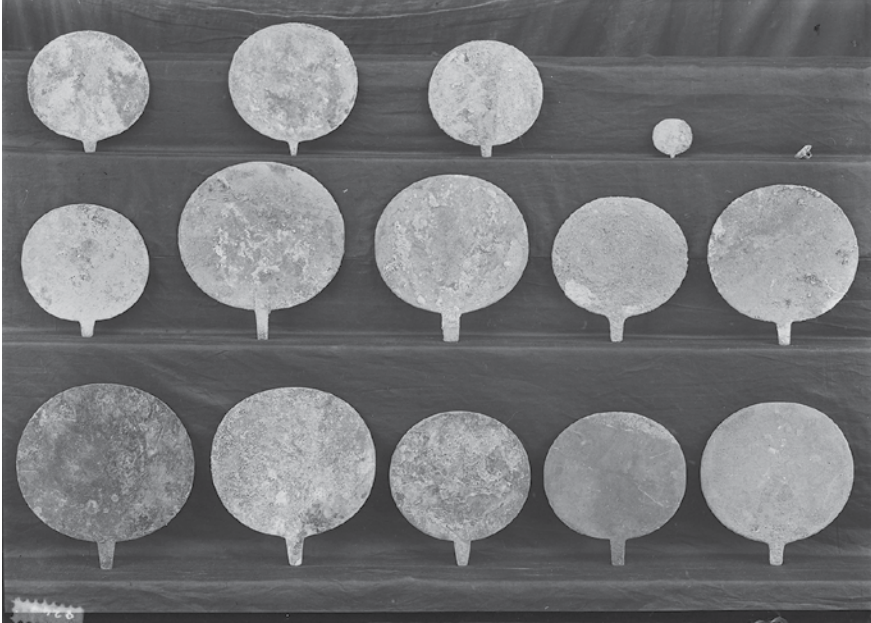

FIGURE 9.4 Mirrors (Top row): #1=6-14395 [?] (N 2075), #2=6-14393 [?] (N 2075), #3=6-14394 [?] (N 2075), #4=6-14366 (N 2071); (2nd row): #2=6-14436 (N 2105), #3=6-14434 (N 2103), #4=6-14537 (N 2447), #5=6-14538 (N 2449) (NED-B-8244)

made of wood rather than ivory or another material that would have better preservation. Unfortunately, without the handle it is difficult to put the mirrors within a decorative typology (Lilyquist 1979, 1982, 2007). One mirror has a slightly unusual tang that is attached by rivets, which may be a manufacturing technique local to Naga ed-Deir as a comparable example was found in the Middle Kingdom tomb 435B (MFA 21.10559).

Needle

N 2075 PAHMA 6-14388

This ubiquitous piece of sewing implement has been found in a long range of ancient Egyptian contexts (Vogelsang-Eastwood 1999, 282), and therefore could be from First Intermediate Period to Middle Kingdom deposits or from Coptic ones as well. This needle has a bend about $\frac{1}{3}$ of length from tip. The shaft of the needle is round in cross section. The eye of the needle is a precise tiny circle on one side, and is broken or corroded into a larger slit on the other side. The point of the needle is well formed and sharp.

Wire, rectangle

N 2075 PAHMA 6-14387

This copper alloy object is a rectangle, possibly made by casting, with four sets of incised double lines and one deeper groove in the middle of one side. This may be a product of more recent manufacture, such as a buckle.

2 Miscellaneous Objects Catalogue

Explanation of the Catalogue of Miscellaneous Objects:

The finds' description of context below is taken from the Catalogue of Tombs. The photograph numbers reflect the original excavator's numbering system.

Material: Glass, copper alloy, iron(?), gold, sandstone(?), travertine, wood, linen.

Measurements: Diameter, height, height with tang, length, thickness, width.

Color: Reddish-purple, reddish-brown, yellow, blue, blue-green, green, copper, bronze, gold, off-white, grey, brown, black, clear.

N 2016 (TC) Map D4; photos A 8267, B 8251, C 8193, C 8464, C 8465 (Fig. 9.1)

In filling at top of pit, small glass bottle (MFA 47.1684?), piece of a large dish with Coptic inscription scratched on it, and broken pottery.

(1) MFA 47.1684 Glass bottle

Material: Glass.

Measurements: H 5.3 cm × W 3.9 cm.

Color: Clear and red.

Glass bottle, round cross-section with a deep concave bottom and flared rim. Bluish-clear glass body with dark opaque reddish-black applied spiral decoration on the rim and broken remnant of a handle on the shoulder.

N 2031 (TC) Map E3; photo C 0983, C 7178, C 7179

a. By neck, quantity of gold foil (PAHMA 6-14310) had been upon something made of wood.

(1) PAHMA 6-14310 Gold, fragments

Material: Gold.

Measurements: Largest fragment: 5.5 cm × 4.0 cm; Thickness: 0.02 cm.

Color: Reddish tinged gold.

N 2048 (TC) Map B3; photo C 8285

[ed.: According to Hearst Museum records, PAHMA 6-14345, PAHMA 6-14346, PAHMA 6-14347 are from this burial.]

(1) PAHMA 6-14345 Wire, bent (Part of Balance scale)

Material: Copper alloy.

Measurements: L 0.5 cm (bent), 9.2 cm (total) × T 0.2 cm.

Color: Corrosion products are green, blue, and yellow.

Thick gauge copper or copper alloy wire that is bent over on itself. One end of the wire has marks as if thread or twine were wrapped around it and have been preserved in corrosion products.

(2) PAHMA 6-14346 Balance Scale

Material: Copper alloy.

Measurements: Complete basket: D 4.0 cm × T 0.1 cm.

Fragment 1: 3.3 cm × 2.4 cm; Fragment 2: 2.8 cm × 1.1 cm.

Color: Corrosion products are green, blue, and yellow.

These scale baskets are from the same tomb as the bent wire (PAHMA 6-14345), which means that wire is likely its balance beam.

(3) PAHMA 6-14347 Glass fragment

Material: Glass.

Measurements: L 2.8 cm × W 3.6 cm × T 0.3 cm.

Color: Dark brown.

Triangular fragment of dark brown glass. Inner surface is matte from weathering, breaks are fresh looking. The color is concentrated and dark. Without light coming through it, the glass looks black. Some small bubbles inside the glass show the direction of the turning/blowing of the vessel. One stripe of abrasions on the outside show where the glass was held during working and blowing the glass. Another stripe of rippled/bubbles are above. The color, translucence, and manner of blowing the glass make it unlikely that this is from earlier than the Roman or Coptic period.

N 2071 (TC) Map B4; type rock-cut chamber with sloping entrance; photos A 8267, A 8268, B 8250, C 8074, C 8194, C 8285, C 8567 (Fig. 9.4)

[ed.: According to Hearst Museum records, PAHMA 6-14366 (mirror) is labeled as potentially coming from this burial.]

(1) PAHMA 6-14366 Mirror

Material: Copper alloy.

Measurements: H 4.3 cm × W 4.7 cm × T 0.1 cm; Height with tang: 4.7 cm.

Color: Corrosion products are blue-green, green, and yellow.

Ovoid mirror, copper alloy, with significant corrosion products. Very short tang, possibly broken off in antiquity (has corrosion on end of it).

N 2075 (TC) Map A4; type vi d; photo B 8248, C 8074, C 8194, C 8285 (Fig. 9.4)
[ed.: According to Hearst Museum records, PAHMA 6-14387, PAHMA 6-14388, PAHMA 6-14393, PAHMA 6-14394, and PAHMA 6-14395 are from this burial.]

(1) PAHMA 6-14387 Wire, rectangle

Material: Copper alloy.

Measurements: L 3.1 cm × W 2.0 cm × H 0.3 cm.

Color: Corrosion products are light green, yellow, black, and deep blue-green.

Rectangle made of cast metal, one long side of the rectangle is thicker and has four sets of incised double lines, with one deeper groove in the middle. The deeper groove in the middle is likely where the tang of a buckle would sit, although that piece is now missing. The metal is likely copper alloy and is in a solid state of preservation. Seems more likely to be of more recent manufacture, perhaps a belt buckle from modern use.

(2) PAHMA 6-14388 Needle, bent

Material: Copper alloy.

Measurements: L 8.1 cm × T 0.1–0.2 cm.

Color: Brown.

Bent about one third of length from tip of needle.

(3) PAHMA 6-14393 Mirror

Material: Copper alloy, linen.

Measurements: H 14.5 cm × W 15.3 cm × T 0.2 cm; Height with tang: 15.7 cm.

Color: Corrosion products are blue-green, green, and yellow.

Ovoid mirror, copper alloy, corrosion product covers 100% of surface, mostly thin powdery blue green color, medium thick yellow, and front side has significant remains of linen textile preserved in blue-green corrosion product (10% of surface of the disc). Pattern of textile in corrosion product over about

25% of front of disc and 25% of back of disc. Preserved textile is S-twist, relatively coarse weave. About 18 threads per centimeter. Tang is trapezoidal and complete.

(4) PAHMA 6-14394 Mirror

Material: Copper alloy.

Measurements: H 12.8 cm × W 14.0 cm × T 0.1 cm; Height with tang: 14.3 cm.

Color: Corrosion products are blue-green, gold, and brown.

Ovoid mirror, copper alloy with deep reddish brown base color. Significant corrosion on 10% of upper surface, less on lower surface. Corrosion is thick and crystalline, gold and brown in color with ring of blue-green powdery corrosion. Tang is short and looks like it was broken in antiquity.

(5) PAHMA 6-14395 Mirror

Material: Copper alloy.

Measurements: H 17.8 cm × W 19.4 cm × T 0.1–0.2 cm; Height with tang: 21.4 cm.

Color: Copper

Copper alloy ovoid mirror, no corrosion products left after cleaning. Possible pattern of textile that could have been adhered with corrosion, but could also be bubbles or impurities in copper alloy.

N 2091 (TC) Map C5 (red)

[ed.: According to Hearst Museum records, PAHMA 6-14409 is from this burial.]

(1) PAHMA 6-14409 Mirror

Material: Copper alloy.

Measurements: H 12.3 cm × W 13.3 cm × T 0.1 cm; Height with tang: 12 cm.

Color: Corrosion products are blue-green, black, and yellow.

Ovoid mirror, copper alloy with corrosion products over 100% of surface on front and back, light colored in general, yellow, powdery blue-green, and some black. Impression of textile on one side. Tang looks complete.

N 2093 (TC) Map C5; photo B 7129, B 7144

In large chamber, granite paint grinder and pebble (PAHMA 6-14414).

(1) PAHMA 6-14414 Grindstone/Metate/Quern

Material: Sandstone (?).

Measurements: H 1.7 cm × L 11.9 cm × W 8.1 cm.

Color: Dark grey.

Pebble noted in excavation records is no longer present. The dark gray stone has a homogenous granular texture/sandy grain, fine crystals, and no inclusions. It is probably dark sandstone, and definitely not slate or schist. The tomb number (N 2093) is written on it twice in blue pencil. A possible parallel to this object is BM EA 5547.

N 2103 (TC) Map C4; type vi b; photo C 8074, C 8194 (Fig. 9.4)

[ed.: According to Hearst Museum records, PAHMA 6-14434 is from this burial.]

(1) PAHMA 6-14434 Mirror

Material: Copper alloy.

Measurements: H 16.6 cm × W 18.3 cm × T 0.3–0.5 cm; Height with tang: 20.2 cm.

Color: Corrosion products are green.

Ovoid mirror, copper alloy, corrosion product covers 100% of surface. Very thick dark green corrosion product, in about 1% of disc linen textile is visible, immersed in corrosion. One exposed thread is well preserved, S-twist. More textile may be preserved under the surface of the very thick corrosion product. Two small flakes on the other side expose shiny copper alloy. Thicker disc and larger shape makes this much heavier than previous examples. The tang is wide, thick, and elongated. A small ridge runs around the middle, perhaps from attachment to handle. On the back side, a horizontal texture may be wood grain or even perhaps wrapped string.

N 2105 (TC) Map D4 (Fig. 9.4)

On underside of mirror, remains of cloth (PAHMA 6-14436).

(1) PAHMA 6-14436 Mirror

Material: Copper alloy.

Measurements: H 17.5 cm × W 19.7 cm × T 0.1–0.2 cm; Height with tang: 21.2 cm.

Tang: L 5.7 cm × W 1.4 cm × T 0.6 cm; Diameter, rivets: 0.4 cm.

Color: Corrosion products are blue-green, mostly copper.

Ovoid copper alloy mirror, very little corrosion except near tang, powdered blue-green corrosion product. Likely that it was cleaned with electrolysis. Textile pattern present on top third of one side of disc, but remnants were removed through electrolysis. The tang has unusual attachment. Two rectangular

strips of copper alloy were sandwiched around the disc and hammered together below the disc. Two rivets run through the tang sections and disc to hold it together. For a comparable example, see MFA 21.10559 (www.mfa.org/collections/object/mirror-144674)

N 2112 (TC) Map D3

Wooden headrest (i) (PAHMA 6-14439).

(1) PAHMA 6-14439 Headrest

Material: Wood, linen.

Measurements: Top section: H 7.4 cm × L 20.3 cm × W 6.0 cm.

Base section: H 14.1 cm × L 22.1 cm × W 7.6 cm.

Cross-section of stem: L 7.6 cm × W 4.4 cm.

Color: Brown.

Complete headrest in three pieces, two of which are still attached by pegs. The top section is carved to make a strong lunate curve, with a small lip overhang on the long sides. The top section pinches down into the stem, which is octagonal but is an elongated rectangle with trimmed edges (very similar to the cross-section of PAHMA 6-12506). The grain of the wood runs in the lengthwise direction of the headrest. Two roughly square holes are cut into the base of the top section. A small piece of linen (c. 3 mm square) is adhered inside one hole.

The stem of the headset is the second piece. The grain runs vertically and the cross-section matches the octagon of the top piece. The two pegs that were carved into the top of the second section are rectangular in cross-section (matching the holes in the bottom of the top section). Linen remnants are adhered on all four sides of one peg and one side of the other peg. The linen may have been used to keep the peg in place during use. The section section is still connected to the base section. The two long, flat rectangular pegs that come down from the middle section can be seen in the holes that go through the base section. No linen remnants are visible in this connection.

The base section follows the octagonal cross-section, then flares out into an elongated oval base. The wood grain once again runs in the lengthwise direction of the base.

N 2232 (TC) Map E4; photos C 7468, C 8589, C 8590 (Fig. 9.2)

Male. Headrest (i) corners pierced with double holes and tied with cord (PAHMA 6-14445, PAHMA 6-14446). a. Extra piece pegged on middle of inside. Rounded. 1 wide at ends, 2 at corner. Wood of main pieces 2 thick, 7 wide, 23 square.

(1) PAHMA 6-14445 Headrest fragment

Material: Wood.

Measurements: H 0.9 cm (max) × L 21.5 cm × W 8.4 cm.

Color: Brown.

Piece of wood that is shaped and carved as if a headrest top, but has two pairs of two holes on edges for attachment to another element(s). Remains of peg in one hole. When set on flattened edge of tip of wooden piece, makes a 90-degree surface on the back of the other tip.

(2) PAHMA 6-14446 Headrest and/or box fragments

Material: Wood.

Measurements: L 12 cm × W 6.7 cm.

Color: Brown.

Multiple wooden fragments. One L-shaped brace and two rectangular segments with two peg holes on each end are part of a headrest. The two rectangular segments were held in alignment by the angled brace. The other half of the headrest was observed to be made of PAHMA 6-14445 and a matching curved piece, now lost.

N 2447 (TC) Map B4; photo C 8542 (Fig. 9.4)

Adult. Female? Bronze mirror (PAHMA 6-14537), resting on 2 rough stones. Cloth on under side.

(1) PAHMA 6-14537 (1) Mirror

Material: Copper alloy.

Measurements: H 14.5 cm × W 15.9 cm × T 0.1–0.4 cm; Height with tang: 17.5 cm.

Color: Corrosion products are blue-green.

Ovoid copper alloy mirror, corrosion product over 80% on back (powdery blue-green), on 15% of front (powdery blue-green), and with textile preserved in corrosion product. Textile pattern extends into top of tang as well.

There are two copper alloy mirrors assigned the Object Number PAHMA 6-14537 in the Phoebe A. Hearst Museum of Anthropology collection. The excavation records only list one mirror from this tomb, leaving the cause of this duplication error unknown.

(2) PAHMA 6-14537 (2) Mirror

Material: Copper alloy.

Measurements: H 15.6 cm × W 17.5 cm × T 0.1–0.2 cm; Height with tang: 17.4 cm.
Color: Corrosion products are blue-green.

Ovoid copper alloy mirror, corrosion product over 2% of disc (flaking blue-green powdery), flaking edges, one side is shiny from cleaning by electrolysis. This one matches the tomb card description better because it has textile imprints on one side.

N 2449 (TC) Map B4 (Fig. 9.4)

[ed.: According to Hearst Museum records, PAHMA 6-14538 is from this burial.]

(1) PAHMA 6-14538 Mirror

Material: Copper alloy.

Measurements: H 16.3 cm × W 17.7 cm × T 0.2 cm; Height with tang: 19.1 cm.

Color: Copper.

Ovoid copper alloy mirror, has been cleaned in the past (electrolysis?), 100% no corrosion deposits on surface. No traces of textile pattern on surface.

N 2501 (1) Map N/A [ed.: This record is Reisner's note of preliminary work that was done in 1901.] (Fig. 9.1)

Alabaster (ii) (PAHMA 6-12501).

(1) PAHMA 6-12501 Game piece/draughtsman

Material: Travertine.

Measurements: H 3.5 cm × W 2.8 cm (base), 1.4 cm (knob).

Color: Off-white.

Squat example of a senet conical game piece. Travertine is consistent in light cream color and flat crystals. The ball top is also more squat than typical form, with sharper edge along bottom by neck to conical base. Tomb number (2501) is written on it twice in pencil. Relatively large and heavy for a game piece.

N 2606 [ed.: No such tomb number exists on the map or in the tomb cards, but according to Hearst Museum records, the following object was found in that tomb.]

(1) PAHMA 6-12505 Hoe handle

Material: Wood.

Measurements: H 4.1 cm (max) × L 48 cm × W 4.1 cm (max).

Color: Light brown.

Hoe handle, long curved section. Rope missing since 2/83. Shape identical to most agricultural tools of this type. Midway along the shaft the point of connection for the rope is a tang that is a seven-sided tear-drop in cross section. The end of the handle is worn from use with a sheen on the wood.

N 2631 (TC; MM) Map E4; photo C 7156

From scattered original contents of burial inside coffin. [ed.: According to Hearst Museum records, PAHMA 6-12506 is from this burial.]

(1) PAHMA 6-12506 Incomplete headrest

Material: Close-grained wood, acacia (?).

Measurements: H 9.7 cm × L 21.2 cm × W 8.0 cm (max), 6.9 cm (stem).

Color: Brown.

Octagonal cross section, rectangular with trimmed edges. Elongated oval flared base. Most likely acacia, with strong grain. Broken close to the stem for top half. Stable condition.

N 2636 (TC; MM) Map D3; photo C 7028, C 8456, C 8457 (Fig. 9.1)

Copt. Female aged approx. 25. By right hand, a small glass bottle (MFA 47.1686). [ed.: According to Hearst Museum records, PAHMA 6-12507 is from this burial.]

(1) MFA 47.1686 Glass bottle

Material: Glass.

Measurements: H 6.7 cm × W 4.8 cm × T 4.0 cm.

Color: Reddish-purple with blue-green applied decoration.

Rectangular body with large bubble inclusions. Reddish-purple glass with spiraled blue-green glass decoration at rim. Convex bottom. Reddish-brown residue inside.

(2) PAHMA 6-12507 Block headrest

Material: Wood.

Measurements: H 16.4 cm × L 20.7 cm × W 7.2 cm.

Color: Brown.

This block headrest has roughly shaped sides with adze marks visible on the thin vertical sides and many overlapping parallel scratches on one wide side

(the one that the top slopes down to). The wood looks like acacia. The wood grain runs in the lengthwise direction of the headrest. The center of the tree rings can be seen on the thin vertical section, and the cracks run radially out from the center of the tree rings. The top of the headrest is shaved down and worn from use (with a slight sheen from wear on the edge that the top slopes down to). The curve exposes the tree rings but on the horizontal plane instead of cross-cutting them. The very top of the curve and part of the bottom edge seem slightly separated, have a thicker, spongy texture, and may be close to the bark section of the tree. The tomb number N 2636 is written on the headrest on two different sides.

N 3747 (TC) [ed.: See also N 2640.] Map D3; photos C 0212, C 0213, C 0781, C 0814, C 7750, C 7751, C 7752, C 7753, C 7754, C 7755, C 7756, C 8503, C 8504, C 8574 (Figs. 9.1, 9.3)

N 3747, F4 photos C 8451, C 8456, C 8457, C 8472

4. Female aged approx. 25–28. By head, inside wrappings, a small glass bottle (ii) with an indentation each side and at bottom (MFA 47.1685).

(1) MFA 47.1685 Glass bottle

Material: Glass.

Measurements: H 5.6 cm × W 3.7 cm.

Color: Clear.

Clear glass with blue tinge, no applied decoration. Four dimples on each side, not precisely aligned, so the bottle is a pentagon in cross-section. Concave bottom and flared rim. Minimal bubbles in glass and no residue.

N 3747, F16 photos C 7787, C 8475

Small child aged approx. 3. On each arm, 2 iron bracelets (i), 2 with (ii) [ed.: i.e., bezel] (MFA Eg.Inv.1541).

(1) MFA Eg.Inv.1541 Bracelets

Material: Iron(?).

Measurements: D 4.1 cm × T 1.0 cm.

Color: Reddish-brown.

Heavy metal with reddish-brown corrosion. Two pairs of bracelets. One pair has incised herringbone decoration on overlapping points and seven sets of double lines along the rest of the loop. The other pair has a flattened middle area with six dots arranged to make a cross.

N 3747, F17 photo C 8451

Adult female. By left ear, silver? [bronze] earring (iii) (MFA Eg.Inv.1544). Right one had gone.

(1) MFA Eg.Inv.1544 Earring

Material: Bronze or other copper alloy.

Measurements: L 4.1 cm × D 1.9 cm (of loop).

Color: Brown.

Drop earring with rosette and ball. Light and hollow bronze sheeting.

N 4511 (TC) Not on map; photos C 8479, C 8571 (Fig. 9.3)

Copt. Small child. Above left shoulder, copper disc, possibly coin, dated 4th year of Justinian (perhaps MFA Eg.Inv.1542 or MFA Eg.Inv.1545?).

(1) or MFA Eg.Inv.1542 Coin earring(?)

Material: Bronze or copper alloy.

Measurements: D 3.9 cm × T 0.2 cm.

Color: Green and bronze.

Pierced copper coin with curved C-shaped wire. Coin is complete and corroded, only reverse imprint legible is an M with a cross over it and illegible letters on either side and below (40 *nummi* Byzantine *folles*). Obverse has male face with an illegible inscription arched above it.

(2) MFA Eg.Inv.1545 Coin earrings(?)

Material: Bronze or copper alloy.

Measurements: D 4.0 cm × T 0.2 cm.

Color: Green and bronze.

Two pierced copper coins. One coin is very corroded, has the imprint of fabric, and is not legible. The other coin is complete and corroded. The only imprint legible is an M with a cross over it (40 *nummi* Byzantine *folles*).

Bibliography

Cool, H. and J. Price. 1995. *Roman Vessel Glass from Excavations in Colchester, 1971–1985*. Colchester.

Fischer, H. G. 1979. "Kopfstütze." In *Lexikon der Ägyptologie* 3, edited by W. Helck and E. Otto, cols. 686–693. Wiesbaden.

- Freed, R. E. 2009. *The Secrets of Tomb 10A: Egypt 2000 BC*. Boston.
- Grierson, P. 1999. *Byzantine Coinage*. Dumbarton Oaks Byzantine Collection Publications. Washington [DC].
- Kendall, T. 1982. "Games." In *Egypt's Golden Age: The Art of Living in the New Kingdom 1558–1085 B.C.*, by R. Freed, 263–272. Boston.
- Lilyquist, C. 1979. *Ancient Egyptian Mirrors from the Earliest Times through the Middle Kingdom*. MÄS 27. Munich.
- Lilyquist, C. 1982. "Mirrors." In *Egypt's Golden Age: The Art of Living in the New Kingdom 1558–1085 B.C.*, by R. Freed, 184–188. Boston.
- Lilyquist, C. 2007. "Reflections on Mirrors." *The Archaeology and Art of Ancient Egypt: Essays in Honor of David B. O'Connor*, Vol. 2, edited by Z. A. Hawass and J. Richards, 95–109. ASAE 36. Cairo.
- Nettleton, A. 2007. *African Dream Machines: Style, Identity and Meaning of African Headrests*. Johannesburg.
- Petrie, W. M. F. 1926. *Ancient Weights and Measures*. London.
- Petruso, K. 1981. "Early Weights and Weighing in Egypt and the Indus Valley." *Bulletin of the Museum of Fine Arts, Boston* 79:44–51.
- Piccione, P. A. 1980. "In Search of the Meaning of Senet." *Archaeology* 33,4: 55–58. <http://www.jstor.org/stable/41726340>.
- Stevenson, A. 2009. "Palettes." In *UCLA Encyclopedia of Egyptology*, edited by W. Wendrich. Los Angeles. <https://escholarship.org/uc/item/7dhox2no>.
- Vogelsang-Eastwood, G. 1999. "Textiles." In *Ancient Egyptian Materials and Technology*, edited by P. T. Nicholson and I. Shaw, 268–298. Cambridge.
- Whitehouse, D. 1997. *Roman Glass in the Corning Museum of Glass, Volume One*. Corning, NY.
- Whitehouse, D. 2004. *Roman Glass in the Corning Museum of Glass. Volume Three*. Corning, NY.

Late Antique Textiles

Amandine Mérat

Excavations led between 1903 and 1905 by Arthur C. Mace in cemeteries N 2000 and N 2500 at Naga ed-Deir resulted in the discovery of thousands of burials, divided in Mace's notes into two groups based on their dates. Amongst the so-called Coptic tombs—in opposition to the Egyptian (or Dynastic) tombs—approximately forty-four graves provided textiles, either garments, sackcloth or furnishing items, used or reused in the preparation of the dead for the afterlife.¹ Although many of the artifacts from these cemeteries were shipped to the University of California, Berkeley, there is no indication that the Coptic textiles were sent there. They are only known today thanks to Mace's manuscript, excavation notebooks, and a few pictures and drawings made at the time of discovery. Based on the sources listed above, this chapter aims to give an overview of the textiles discovered at Naga ed-Deir, their context of production, use and reuse, and excavation, as well as, where possible, an attempted identification of the items described by Mace and his team.

1 The Collection: Discovery and Sources

Excavation directed by Mace at Naga ed-Deir between 1903 and 1905 resulted in the discovery of hundreds of textiles. Those included in this study come from approximately forty-four tombs, recorded in excavation notebooks and Mace's manuscript as “Copts,” in opposition to the dynastic burials identified as “Egyptians.”²

Approximately forty-nine individuals were found in these graves, mainly simple pits and a few reused Fifth–Twelfth Dynasty rock-cut tombs. The deceased were mostly buried on their own, except for three tombs where an adult was buried with one or two children and, in another tomb, where two children

1 Called *mummies* by Mace, even if he himself added a note in his manuscript to mention that “The term ‘mummy’ is misleading, but there is no other word available for a wrapped-up burial.” The words *dead*, *deceased*, or *bodies* will be used in this publication instead of *mummies*.

2 The tombs studied here are N 2000–2009, 2130, 2133–2134, 2201, 2203, 2215, 2410, 2413–2416, 2438, 2503–2504, 2611–2613, 2616, 2631–2637, 2700, 2806, 2810–2813, 2830, 2833, 2836, 2839.

were buried together.³ Eighteen individuals could be identified as adult males, ten as adult females, ten as adult of undetermined gender, and eleven as children (babies and children up to ten years old).

Thanks to the exceptional discovery in a child's grave of cemetery N 2000 of a coin minted in year three of the reign of Justinian (529 CE), the graves—and therefore, the textiles found in them—can be contextually dated to the mid-fifth to the sixth century CE. At the time, a period most commonly known today as Late Antiquity, Egypt had been a province of the Roman Empire since the defeat of Cleopatra VII against Octavius in 31 BCE, and was ruled from Constantinople since its scission in 395 CE.⁴

Amongst the Roman traditions adopted by Egyptians from the second century onwards, two can explain the increase in number and diversity of textiles found in burial contexts after that date. Indeed, while they progressively abandoned mummification to bury their dead in their daily clothes, head- and footwear, and wrapped into utilitarian or furnishing textiles reused as shrouds, Egyptians also adopted Roman fashion and its most common item of clothing for men, women, and children alike, the tunic.⁵

Mace's description of the textiles discovered in the Late Antique burials varies from a simple listing to an intensive description supported by drawings and, in a few cases, pictures. He himself divided the finds into two main categories: the wrapping textiles and the shirts (or tunics), while he also recorded any headwear—such as hairnets or circlets—and textile accessories—such as a bag and a bandage—found on or near the deceased. Descriptions of the textiles were made by Mace and his team as the bodies were discovered and/or unwrapped.⁶ Therefore, they mostly follow the same model, starting with the outside layer of cloth used to wrap the dead to finishing with the inner one, in direct contact with the body.

Thanks to such consistency, and despite the textiles' absence today and a slight difference between Mace's and contemporary textile terminology, it was possible to identify most of the items Mace was looking at, but also to translate his words into today's most commonly used terms, in order to get a

3 For the adult buried with children, see N 2215, N 2612, and N 2414. For two children buried together, see N 2504.

4 For more information regarding the origin and meaning of the word "Copt," see Rutschowskaya and Bénazeth (2000, 28).

5 For more information on clothing and furnishing textiles in the first millennium CE, see Mérat (2015).

6 If unwrapping mummies was a rule in the nineteenth-early twentieth centuries, this practice has been abandoned and is even forbidden in most countries where studies are being held and bodies preserved. For more information on the topic, see Taylor and Antoine (2014, 11–21).

better understanding and overview of the Late Antique textiles discovered in Cemeteries N 2000 and N 2500 at Naga ed-Deir in 1903–05.

2 Overview and Attempted Identification of the Textiles Excavated at Naga ed-Deir

Amongst the forty-four burials excavated by Mace and his team that preserved textiles, six were excluded from this study as cloths found in them were in too poor of a condition to be identified or studied, both in 1903–1905 and in 2019.⁷ The remaining thirty-eight tombs provided a total of more than sixty-five shirts, a hundred and ten wrapping cloths and nine remains of headgear, an attempted overview of which will be given here.⁸

Although not included in the following study, the discovery of these items also bear mention: a textile bag of red cloth, a bandage made from an old shirt, a textile folded into a bandage and tied around the waist of a small glass bottle, and also a few weaving tools (carding comb and spinning wheels) (Fig. 10.1).⁹

3 Garments

Bodies excavated by Mace were commonly buried with one to three tunics (called “shirts” by Mace), either worn by the deceased or covering the body. Sixty-five were identifiable in Mace’s notes and recorded in this study, presenting different techniques of production, weaving, and elements of decoration.

The deceased were most of the time buried with one, sometimes two, plain tunics in undyed linen and/or colored wool, and one or more decorated and more elaborated tunic.¹⁰ The latter category consists of T-shaped tunics in linen and/or wool, woven in plain weave and/or tapestry, in one or three pieces depending on their desired length.¹¹ Neck-openings, when preserved,

7 N 2007, N 2414, N 2631, N 2632, N 2810, and N 2813.

8 Almost all of the burials also contained padding cloths. As they were most of the time only briefly mentioned by Mace, they could not be counted nor recorded with certainty here and were therefore left out of this study. They mostly consisted of old, plain shirts reused to cover the head or fill in areas such as the neck before the wrapping.

9 For the textile bag, see N 2201; bandage: N 2134 (especially drawing (ii)); textile wrapping a bottle: N 2636; weaving tools: N 2049. For the weaving tools, see also NED-C-8460, 8461.

10 See, for example, the yellow shirt found in N 2201. For a possible comparison, see Manchester T.1994-135 (Pritchard 2006, 10; Hubert 2019, 86, fig. 2).

11 For an example of a tunic woven in one piece, see N 2001, drawing (iv), and Mace’s description: “Remains of linen shirt with embroidered rosettes round sleeves, reaching

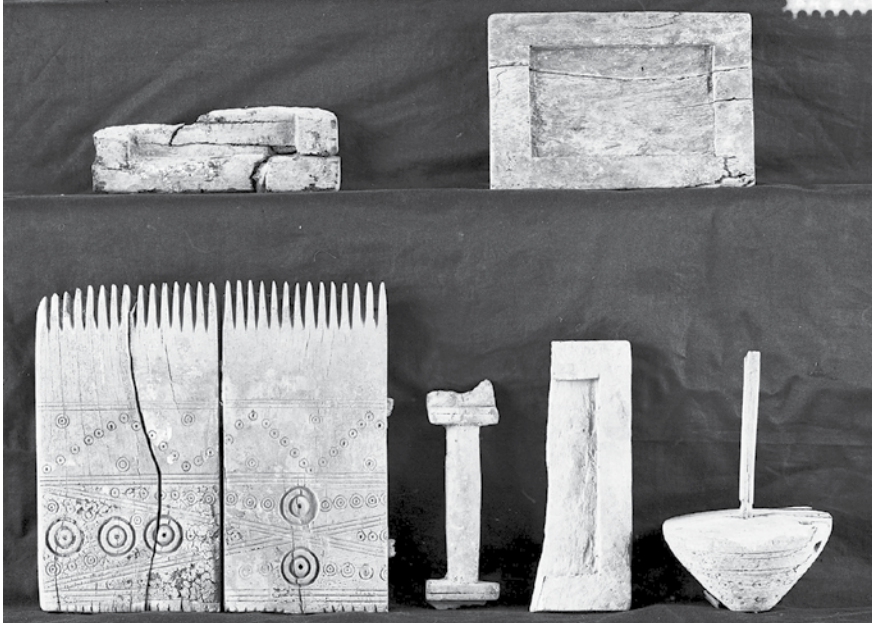

FIGURE 10.1 Weaving tools from N 2049 (NED-C-8462; see drawings in Tomb Catalogue N 2049 (i)–(v))

were mostly cut in a round shape on one or both sides.¹² A child's tunic also preserved a knot of cloth sewn as a button, probably to adjust the garment once put on, while the neck-opening of another child's tunic was framed on each side by two small sort-of-braids in red wool, made by two lines of chain stitches embroidered at an angle.¹³

apparently to halfway between knee and ankle. 3 woven ridges down each breast and over shoulder [shoulder bands in tapestry, or *clavi*]. Sides of shirt and bottom of sleeves corded [possibly corded ending and starting borders of shirt]. Shirt made in 1 piece [T-shaped tunic woven in one piece, starting with one sleeve, then the body, and finishing with the second sleeve, before the shirt is folded and sewn on the sides, under the arms] [...] Sleeves were sewn up to above elbow." For an example of a tunic made of three pieces (i.e., two square pieces sewn at front and back to the upper T-shape part of the garment, thus creating a tuck there), see N 2009 (v) and N 2636 (ii). For the record, Mace mistakenly identified similar tunics as "made up of two pieces of cloth, a straight join coming at the waist" in N 2611 and N 2636. For more information on T-shape tunics, see Kwaspen (2019, 228–231), Kwaspen (2014), and Verhecken-Lammens (1992, 29–36).

12 See, for example, N 2002 (vi), N 2005 (vi), N 2503 (i), N 2613 (i), and N 2812 (iii) and (iv). For a possible comparison, see Manchester T.8360, T.8361 (Pritchard 2006, 88–90).

13 For the tunic with knot of cloth, see N 2616. For a possible comparison with a later child's tunic, see Manchester T.9885 (Pritchard 2006, 20–22). For the tunic framed by "braids"

The tunics mostly have long sleeves, either woven at the same time as the body or sewn to it later.¹⁴ They were decorated with varied inwoven or applied ornaments located on the shoulders, wrists, knees, and bottom of the garment.¹⁵ Decoration usually consisted of tapestry and also white, blue, and/or red brocaded ribbons (identified by Mace as strips with geometrical patterns embroidered or sewn), separately woven and sewn around the opening, the wrists, and/or the bottom of the garment.¹⁶ Self-banding in the weft direction (called ridges or lines of thicker thread in the woof (weft) by Mace) and flying thread brocading (identified by Mace as needlework or embroidery sewn on or worked into the warp) were also found.¹⁷

Ornaments consist of shoulder bands (*clavi*) of different lengths (breast to ankle length) and shapes (simple straight bands, bands ending with medallions or leaf-shaped motifs, or bands made of several isolated motifs called drawn work by Mace).¹⁸ Most elaborated tunics also bear *orbiculi* (circular

of red wool, see N 2002 (ix). For possible comparisons, see Coll. Fondation Roi Baudouin FT 3 (Mérat and Quertinmont 2019, 92–93, cat. 72) and Manchester T.8374 (Pritchard 2006, 98–99).

- 14 For the former, see N 2009 (v) and N 2636 (ii). For the latter, see N 2002 (v).
- 15 See, for example, N 2002 (iv) and (vi): tunic with applied and sewn bands on the shoulders and at the bottom and sides. For more information on tunic and shawl ornaments, their shapes and distribution, see Rutschowskaya (1990, 151). For possible comparisons, see Coll. Fondation Roi Baudouin FT 74 (Mérat and Quertinmont 2019, 248–249, cat. 225), Pushkin KT 572 (Lechitskaya 2010, 125), and Coll. Fondation Roi Baudouin FT 132 (Mérat and Quertinmont 2019, 250–251, cat. 227).
- 16 See, for example, N 2002: “Above this, the body was wrapped in [a] shirt [with] elaborate embroidery (vii): Remains of white and blue strip sewn around neck, 2 wide, and around bottom of sleeves. Around bottom of shirt, remains of a strip approx. 7 wide. On this bottom strip at any rate, white and blue were put on separately. White was sewn on so (viii), and blue thread was afterwards worked in such a way as to leave geometrical patterns in white.” See also N 2133 (i) and N 2812 (iii). For possible comparisons, see Lyon MT 2013.0.57 (Calament and Durand 2013, cat. 128) and Coll. Fondation Roi Baudouin FT 136 (Mérat and Quertinmont 2019, 252–253, cat. 231).
- 17 For self-banding, see N 2002 (viii); N 2636 and description as follows in N 2003: “[...] The body was clothed in 3 linen shirts, all plain except middle one, which had a decoration of 2 inwoven blue lines of thread.” For a possible comparison, see Manchester T.1994-132 (Pritchard 2006, 72, fig. 4.20(b)). For flying thread brocading, see N 2002 (vii) and N 2130 (ii)–(iv). For examples of flying thread brocading on furnishing textiles, see Krefeld 11768 (Paetz gen. Schieck 2003, 45) and Louvre AF5884 (Rutschowskaya 1990, 24).
- 18 For *clavi*, see N 2002 (iv) and (vi); N 2004 (iv); N 2005 (v); and N 2637 (i). For possible comparisons, see BM EA 72491 (Moor 2010, 35, 38, fig. 5) and BM EA 18198. For bands ending in medallions or leaf-shaped motifs, see N 2004 (v); N 2005 (v); N 2009 (vi) and (vii); N 2134 (iii); N 2613 (i); N 2636 (ii) and (iii); and N 2637 (i). For possible comparisons, see KN DM 121 (Moore 1993, 230) and Coll. Fondation Roi Baudouin FT 121 (Mérat and Quertinmont 2019, 128–129, cat.120). For bands made of isolated motifs, see N 2130

ornaments called medallions or rosettes by Mace), and/or single, double, or triple wrists bands.¹⁹ Iconography on them is representative of the period's taste and consists of geometric (lines, bands, waving motifs, etc.), floral and vegetal (rosettes, vegetal interlacing called scroll flower type by Mace, etc.), animal (quadrupeds and birds) and figural (dancing figures and *putti*) motifs.²⁰

4 Wrapping Cloths

According to Mace's notes, over one hundred wrapping cloths were identified and recorded. The deceased were wrapped in up to six layers of textiles, separated by Mace into two categories: sackcloths and shawls (possibly utilitarian and furnishing items, respectively, reused as shrouds in funerary context).²¹

Textiles called sackcloths by Mace are simple, plain coarse textiles (possibly reused utilitarian textiles, such as ship sails, for example), sometimes fringed and decorated with bands of openwork near the ends.²²

Items described by Mace as shawls are more varied and can be divided into three categories according to his descriptions. The first category comprises

-
- (ii)–(iv); N 2812 (iii); and N 2830 (i). For possible comparisons, see Lyon MT 24400.512 (Calament and Durand 2013, 156–157) and Coll. Fondation Roi Baudouin FT 167, FT 168, and FT 170 (Mérat and Quertinmont 2019, 136–137, cat. 132).
- 19 For *orbiculi*, see N 2005 (v); N 2009 (v); N 2134 (iii); N 2613 (i); and N 2636 (ii) and (iv). For wrist bands, see N 2009 (v); N 2134 (iii); N 2415 (ii); and N 2636 (ii) and (v). For possible comparisons, see VAM T.49-1917, Cleveland 1914.527, and Coll. Fondation Roi Baudouin FT 181 (Mérat and Quertinmont 2019, 100–101, cat. 84).
- 20 For geometric motifs, see N 2700 (i). For a possible comparison, see n. 24, BM EA 72491. For floral and vegetal motifs, see N 2130 (ii)–(iv); N 2133 (i); and N 2830 (i). For the so-called scroll flowers, see a possible comparison in Rassart-Bebergh (1976, 24–25), n° 7; Coll. Fondation Roi Baudouin FT 30 (Mérat and Quertinmont 2019, 104–105, cat. 90), and for an iconographic parallel, see Brussels, Musée Royaux d'Art et d'Histoire E.8066 (Mérat and Quertinmont 2019, 52–53, cat. 44). For animal motifs, see N 2410 (i) and N 2636 (iii) and (v). For a possible comparison, see Coll. Fondation Roi Baudouin FT 66 (Mérat and Quertinmont 2019, 280–281, cat. 264). For figural motifs, see N 2637 (i) and description as follows in N 2612: “on each side of front and back of shirt, there was a medallion of coloured wool [...]. On medallion, two dancing figures and cherubs [*putti*] above.” For possible comparisons with dancing figures, see Coll. Fondation Roi Baudouin FT 80 (Mérat and Quertinmont 2019, 42–43, cat. 28) and VAM T.141-1922. For possible comparisons with *putti* figures, see Krefeld 12471 (Paetz gen. Schieck 2003, 72) and Pushkin КТ 561 (Lechitskaya 2010, 238).
- 21 See, for example, N 2700 and N 2836.
- 22 N 2009, N 2201, N 2413, N 2416, N 2438, N 2812, and N 2830. For an image of the textile in N 2416, see NED-B-7102. For possible comparison, see Coll. Fondation Roi Baudouin FT 191-1 (Mérat and Quertinmont 2019, 170–171, cat. 140).

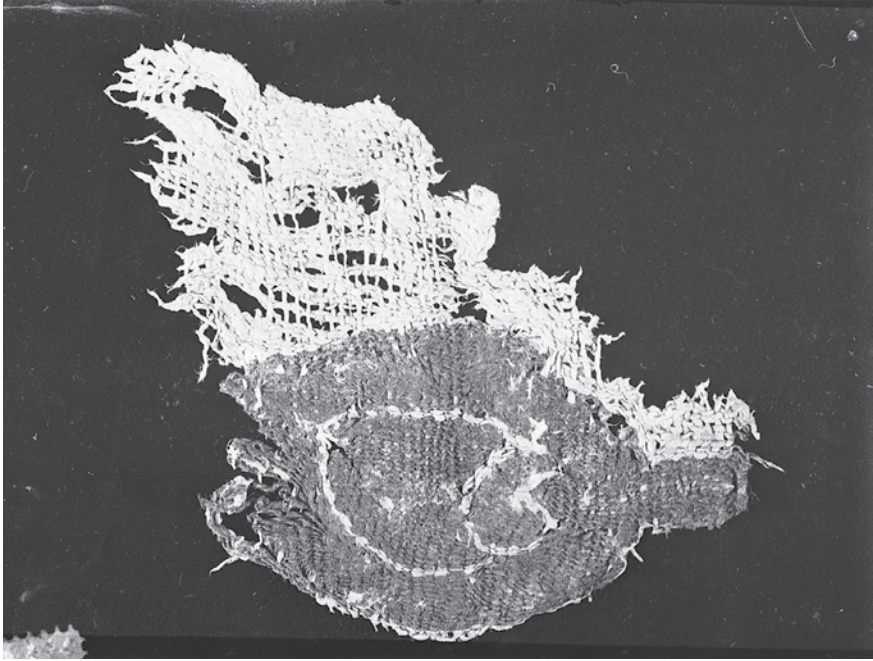

FIGURE 10.2 Rosette from N 2003 (NED-C-7979)

cloths, sometimes fringed or tasseled, of varying workmanship, woven in colored wool (yellow, red, green, etc.). Their decoration, located near the ends and at the corners of the cloths, consists of multicolor geometric patterns (lines, triangles, stars, etc., in white, black, red, etc.) made in brocade (or supplementary brocaded wefts, called embroidery, needlework, or sewn-in patterns by Mace).²³

The second category comprises a group of cloths, often fringed, woven in plain weave or tapestry, and bearing a geometric decoration covering either the whole surface of the fabric or near its ends only, and made of inwoven lines in either or both directions.²⁴

Finally, the third category is made of large pieces of textiles, also fringed in some cases, possibly woven in linen plain weave and/or woolen tapestry, with

23 N 2001 (ii); N 2004 (iii); N 2005, cloths 2), 3), head pad, and drawings (ii)–(iv); N 2009, N 2130, N 2133, N 2413, N 2504, N 2616, N 2633, N 2636, N 2700, N 2830, and N 2836. For a possible comparison, see Coll. Fondation Roi Baudouin FT 156 (Mérat and Quertinmont 2019, 170–171, cat.141).

24 For decoration covering the entire fabric, see N 2003 (unfinished textile), N 2130, N 2611, N 2636 (plaid shawl), N 2833, and N 2836. For decoration only near the ends, see N 2005, N 2215, N 2438, and N 2806.

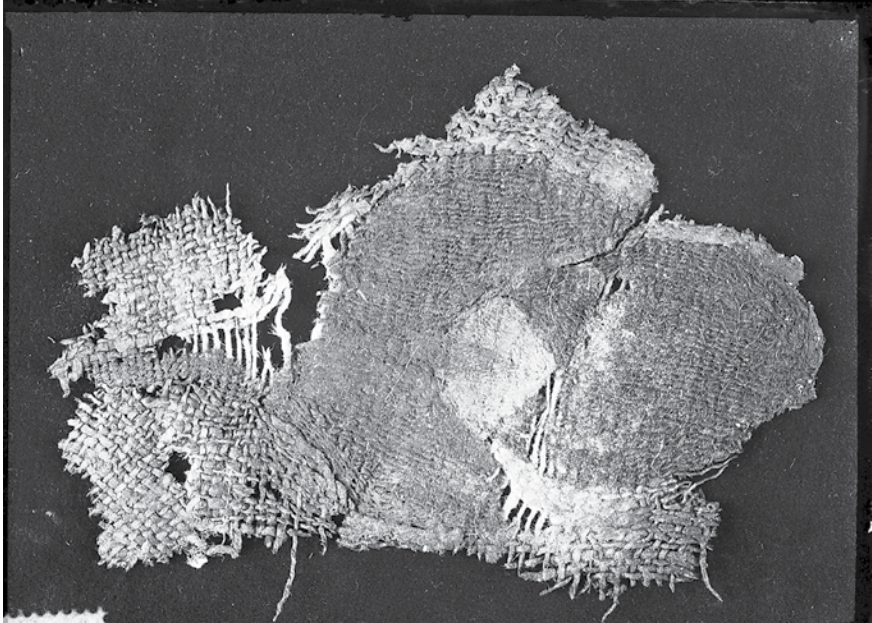

FIGURE 10.3 Rosette from N 2003 (NED-C-7981)

a decoration made of geometric, floral and vegetal (trees, flowers baskets, four-petaled flowers called rosette by Mace, heart-shaped flowers, leaf-shaped motifs), animal (quadrupeds or birds), and figural motifs, located at the corners and/or covering the whole surface of the fabric (Figures 10.2–3).²⁵

25 For geometric motifs, see N 2413 (ii); N 2503 (ii); N 2612 (i); N 2806 (i)–(iv); N 2812 (i); N 2839 (i). For floral and vegetal motifs, see N 2203 (i); N 2613 (iii); N 2812 (i). For trees, see N 2005. For possible comparisons, see Private Collection (Mérat and Quertinmont 2019, 48–49) and VAM 2162-1900. For flower baskets, see N 2006 (ii). For a possible comparison, BM EA 29771 (Mérat 2015, 106, cat. 104), VAM 373-1895, and Coll. Fondation Roi Baudouin FT 146 (Mérat and Quertinmont 2019, 46–47, cat. 35). For rosettes, see N 2003 (ii), N 2006, and N 2413. For N 2003, see also NED-C-7980, 7982. For possible comparisons, BM EA 29771 (Mérat 2015, 106, cat. 114) and Coll. Fondation Roi Baudouin FT 197 and FT 198 (Mérat and Quertinmont 2019, 144–145, cat. 139). For heart-shaped flowers, see N 2006 (ii). For possible comparisons, BM EA 29771 (Mérat 2015, 106, cat. 114). For leaf-shaped motifs, N 2134 (i) and N 2215 (unnumbered drawing). For possible comparisons, Lyon MT 49189, MT 51398.28, and MT 2013.0.19 (Calament and Durand 2013, 162–163), Chemnitz Ko 169 (Mössinger and Metz 2018), and Manchester T.8564 (Pritchard 2006, 124). For birds, see N 2006 (ii). For possible comparisons, see Louvre E 28307, E 28314, E 28723, and E 29302 (Rutschowskaya 1990, 94–95) and BM EA 29771 (Mérat 2015, 106, cat. 114). For figural motifs, see N 2203 (i). See especially N 2130 (i). Based on Mace's drawing, the human figure in the centre of the *tabula* (square ornament) could be identified as an allegory of the personification of Earth, Gaia, or one of the Four Seasons. For more information on Allegories

Drawings made by Mace allow one to identify these textiles as possible furnishing textiles (such as covers or hangings), reused as shrouds in a funerary context.

5 Headgear

Very few headgear, eight in total, were found on or close to the deceased in the tombs studied here. Amongst these, six were hairnets (called net cap or hood by Mace) in colored wool.²⁶ Two were found in children's burials and four in women's graves.²⁷ Two circlets were also excavated, one in a child's burial, the other in a man's grave.²⁸ Both were made of palm tree leaves wound by red wool threads or fabrics.

Although the Coptic garments went missing during the twentieth century, Mace's rigor in precisely and carefully recording any textile item discovered in N 2000 and N 2500, at a time where most archaeologists, in search of the most beautiful dynastic artifacts, were sending to Europe only the most colorful, cut-out elements of textiles with no or limited archaeological context, represents a precious and rare resource permitting one nonetheless to identify the finds excavated in 1903–05.

Dated to the mid-fifth to the sixth century, thanks to the exceptional discovery in the cemetery of a coin from year three of the reign of Justinian, the Naga ed-Deir textiles are representative of the textile production, fashion, and taste in Late Antique Egypt. Indeed, mostly woven in linen and wool plain weave, tapestry, or brocade, they consist of tunics, headgear, shawls, and furnishing items reused in a funerary context, richly decorated with bands, medallions, and varied patterns bearing geometric, vegetal, floral, animal, and figural motifs mostly inherited from classical imagery.

of the Earth and the Four Seasons, see Mérat (2010). For possible thematic comparisons, see Louvre AF 5982 (Rutschowskaya and Bénazeth 2000, cat. 57) or Manchester T.1968.252 and T.1968.253 (Pritchard 2006, 30–31).

26 For possible comparisons, see KN KTN 816-03 (Moor and Fluck 2011, 84) and Nantes D 2001.2.3 (Durand and Saragoza 2002, 126).

27 For the former, see N 2002 and N 2504. For the latter, see N 2201, N 2203, N 2636, and N 2811.

28 For the former, see N 2006. For the latter, see N 2134.

Bibliography

- Calament, F. and M. Durand, eds. 2013. *Antinoé, à la vie, à la mode: visions d'élégance dans les solitudes*. Lyon.
- Durand, M. and F. Saragoza, eds. 2002. *Égypte, la trame de l'Histoire: textiles pharaoniques, coptes et islamiques*. Rouen.
- Hubert, B. 2019. "Textiles de Kellis, un village de la période romaine dans l'Oasis de Dakhla." In *De Lin et de laine. Textiles égyptiens du 1^{er} millénaire*, edited by A. Mérat and A. Quertinmont, 76–83. Brussels.
- Kwaspen, A. 2014. "L'importance de l'analyse des techniques et de la connaissance des objets pour la conservation des textiles archéologiques." In *KBR-APROA Bulletin* 1/201:24–32.
- Kwaspen, A. 2019. "Quelques fragments de tuniques de la collection Fill-Trevisiol." In *De Lin et de laine. Textiles égyptiens du 1^{er} millénaire*, edited by A. Mérat and A. Quertinmont, 228–233. Brussels.
- Letchitskaya, O. 2010. *Coptic Textiles. The Pushkin State Museum of Fine Art*. Moscow.
- Martiniani-Reber, M. 1991. *Tissus coptes: Musée d'Art et d'Histoire de Genève*. 2 vols. Geneva.
- Mérat, A. 2010. *Les Allégories de la Terre et des Saisons: des sources littéraires et iconographiques gréco-romaines aux textiles égyptiens d'époque byzantine*. Mémoire de Recherche en Histoire de l'Art et Archéologie, Ecole du Louvre. Unpublished, available upon request at l'Ecole du Louvre, Palais du Louvre.
- Mérat, A. 2015. "Clothing and Soft Furnishings." In *Egypt: Faith after the Pharaohs*, edited by C. Fluck, G. Helmecke, and E. R. O'Connell, 214–221. London.
- Mérat, A. and A. Quertinmont, eds. 2019. *De Lin et de laine. Textiles égyptiens du 1^{er} millénaire*. Brussels.
- Moor, A. De. 1993. *Koptisch textiel uit Vlaamse privé-verzamelingen*. Zottegem.
- Moor, A. De. 2010. "Radiocarbon Dating and Dye Analysis of Roman Linen Tunics and Dalmatics with Purple Coloured Design." *Archaeological Textiles Newsletter* 51:34–47.
- Moor, A. De and C. Fluck, eds. 2011. *Dress Accessories of the 1st Millennium AD from Egypt*. Tielt.
- Mössinger, I. and K. Metz, eds. 2018. *Ägyptische Textilien aus spätantiker und frühislamischer Zeit im Bestand der Kunstsammlungen Chemnitz*. Bielefeld.
- Paetz gen. Schieck, A. 2003. *Aus Gräbern geborgen, Koptische Textilien aus eigener Sammlung*. Krefeld.
- Pritchard, F. 2006. *Clothing Culture: Dress in Egypt in the First Millennium AD. Clothing from Egypt in the Collection of the Whitworth Art Gallery*. Manchester.
- Rassart-Debergh, M. 1997. *Textiles d'Antinoé (Égypte) en Haute Alsace. Donation E. Guimet*. Colmar.

Rutschowskaya, M.-H. 1990. *Coptic Fabrics*. Paris.

Rutschowskaya, M.-H. and D. Bénazeth, eds. 2000. *L'art copte en Égypte: 2000 ans de christianisme*. Paris.

Taylor, J. and D. Antoine, eds. 2014. *Ancient Lives, New Discoveries: Eight Mummies, Eight Stories*. London.

Verhecken-Lammens, C. 1992. "Opzetboorden bij Koptische Weefsels." *Vlaamse Vereniging voor Oud en Hedendaags Textiel VVOHT Bulletin*, 29–36.

Coptic Burial Wrapping

Jonathan P. Elias

“Bandages of fine linen cloth, smeared over with gum”—how frequent is the refrain and how quintessentially Egyptian. However, the Herodotean account of Egyptian embalming (*The Persian Wars* Book II, 86) is quoted so often as to almost disguise its own significance. Of the three embalming standards Herodotus addresses, only his “most perfect” one includes wrapping as part of the service. Furthermore, Herodotus leaves us with the distinct impression that wrapping is as basic as evisceration and embalming to really approaching the “manner” of Osiris and that only by providing a decent wrapping job will one have a shot at practical preservation and ritual conquest of oblivion.¹ To the extent that this properly represents an ongoing ancient Egyptian tradition and not just one current around 440 BCE, what effect would such ideas have on funerary wrapping in the Christian era and at Naga ed-Deir in particular?²

In speaking about Christian funerary behavior, there is a tendency to refer to earlier traditions as “pagan” as if there had been a clean break with all ancient rites once monotheism was adopted. The notion of a “clean break” associated with new religious sensibilities is misleading and in view of the difficulty in recognizing the practices of “Early Christianity” archaeologically inside Egypt, it will be preferable to discuss wrapping methods at Naga ed-Deir in a stylistic or methodological way, and simply say “Coptic Egyptian” when referring to wrapped bodies prepared under the Byzantine hegemony.³ In view of the complex array of wrapping methods, there is clearly a need to understand

1 Herodotus in the original passage respects Osiris by not naming him.

2 In the Byzantine period, Naga ed-Deir developed as a village and cemetery area immediately northwest of the Coptic monastery known as Deir el-Malak (Deir el-Melac in older sources). A large wadi, the southernmost of three cutting through the ancient cemeteries (Wadi 3) limited village expansion to the north, while the area south of the village, Reisner noted, served the Coptic community of Girga as burial ground (Reisner 1908, 2). The city of Girga, of course, lies immediately southwest of Naga ed-Deir and on the opposite (west) side of the Nile. Cemetery N 2000/N 2500 is well north of the village astride the mouth of the middle wadi (Wadi 2). The Coptic interments occur amidst those of far earlier times. A long historical association of Naga ed-Deir and Girga is likely.

3 On the difficulty of discerning “Early Christianity” in the archaeological record in Egypt, see Bagnall (1988; 1993, 279). Regarding the stylistic or methodical approach of this chapter, compare the division of Roman Period mummies into ten types, presented by Petrie (1911, 3).

Coptic Egyptian wrapping as distinct from other modes associated with late antiquity, such as “red shroud” compositions, produced before CE 180 when the Roman Empire was at its most affluent, and rhombic (diagonal lozenge) “builds” largely datable to before CE 230, after which time the Empire’s fiscal and administrative problems mounted.⁴

Under a wealthy and cosmopolitan Empire eager for novelty, experimentation in funerary expression took off. Egypt was by this time part of the broader Mediterranean world and was subject to artistic influences from a wide area; Hellenism and the realistic aesthetic of the Faiyum mummy portrait had grown to be popular in the northern part of the country.⁵ Egyptian abhorrence of foreign practices, referred to by Herodotus (*The Persian Wars* Book II, 91) had relaxed enormously. Thick mud-plaster “cartonnage” mummy cases expressing Hellenistic tunics and togas sculpturally came into production alongside the more traditional masks and flat plaque ensembles of plastered linen. The art of the painted linen shroud became similarly subdivided; those showing the deceased clothed elegantly in fine linen mantles holding the requisite cup

As an aside, similar caution is suggested in using the term “Greco-Roman” to describe mummies. Greco-Roman is a loose time period, not a style of mummification. Nor should the term be used to insinuate that the culture was being watered down, as much as it was simply beginning to change in different parts of Egypt. For instance, mummification in the way it was practiced in the Ptolemaic period was widely disparaged by Smith and Dawson (1924), as being a pale reflection of earlier methodologies. This is really not very accurate, as the Ptolemaic Period saw rather careful adherence in certain communities to the methods of so-called “classic mummification,” close to what Herodotus described as “the most expensive method” in his day (440 BCE).

4 The red shroud mummy of Artemidorus (British Museum EA 21810) is dated by the hair styling of his portrait to 100–120 CE, the time of Trajan (Taylor 2001, 89, fig. 52).

Rhombic bandaging is Petrie’s term for the crisscrossing of bandages into lozenge-shaped coffers, often embellished with a gilt stud. Other terms suggested for this form of bandaging include “coffered” or “diagonal lozenge webbing.” It is itself “traditional” insofar as the lozenge pattern is not a Hellenistic innovation, but occurred in various types of bead net shrouds manufactured from the Third Intermediate Period to Ptolemaic times. We note at least some of the portraits associated with lozenge-webbed mummies have been attributed to the aesthetic of the Empire under Caracalla (198–217 CE), like Mummy Berlin SMPK Ägyptisches Museum 11673 (Willeitner 1998, 320, fig. 61).

5 The naturalistic portrait panels (encaustic paintings on wooden board) are positioned upon the face of mummies of both the red shroud and rhombic bandage types. Many of the panels were long ago separated from the bodies they adorned, so we do not often know which wrapping pattern they accompanied, but panel-painting is believed to continue into the second half of the fourth century (Parlasca, 1997, 129). Opinion remains divided as to whether the painting was done on these panels specifically for a funerary purpose (Parlasca 1997, 127). Portraits were surely done also upon shrouds, and some of these are used by persons devoted to the cult of Serapis (Riggs 2005, 231).

and garland of rosebuds and myrtle, are so-designed as to reduce the image of Osiris to a mere doll, while protective deities and *ba*-birds are pushed to the sides; on others, Osiris or Hathor are still the main event.⁶ The red shroud mummies combine two different systems: the face is a naturalistic Faiyemic portrait, while from the shoulders down, traditional symbols and motifs are arranged in ways reminding us of anthropoid coffins of 675 BCE.⁷ Under the tolerance of cosmopolitan Hellenism, traditions that varied from each other in specific ways merged with each other and were folded in again with Egyptian ones in syncretism.⁸ Process-wise, the era is extremely interesting and still not fully understood. What can be said is that under an economically stressed, significantly weakened Empire ruled from Byzantium, there was a receding of sumptuous funerary expression.

1 Interplay of Traditions

In Egypt, there was considerable variation in thoroughness of mummification long before Christianity had become something tolerated under Constantine (313 CE) and had been elevated to the state religion under emperor Theodosius (346–395 CE).⁹ Mummification persisted during this era, but the degree of adherence to so-called “classic” mummification, with its emphasis on evisceration, natron-desiccation, aromatic spicing, and elaborate wrapping, may be presumed to have varied widely within and between communities.¹⁰ By

6 Bresciani 1996.

7 See, for example, Cairo CG 33219, of 100–125 CE. The paintings on this red shroud mummy are organized into traditional horizontal registers like those found on earlier coffins. It is described by Corcoran (1997, 47) and shown in her plate 5. Similar organization and motifs are seen in the red shroud mummy of Artemidorus, dated to the same period (note 4).

8 Mention should be made of Terenuthis (the western Delta site of Kom Abu Billo) where the funerary stelae associated with Christians often include images of a dog (Anubis) and a bird (Horus) as companions to the deceased lying supine on a bed. See Willeitner (1998, 317, fig. 56). Palmyrene embalming may have had an effect on Egypt, particularly during the period of administrative joining in the era of Odenathus and Zenobia at the end of the third century. Palmyra emerged as a silk-using and even a silk-producing locus, and mummies of Palmyrene origin (rarities, as only four are known) show use of silk in the wrapping (Gk. *όλοσηρικός*) to a larger extent than Egyptian mummies (Girotti et al. 2005, 263).

9 For example, a sizeable proportion of the so-called golden mummies of Bahariya (c. end of the first century BCE) are generally laid to rest without sufficient desiccation. Resin is liberally used but to little effect as a body preservative (Ikram 2015, 20).

10 The consensus view is that some “form of mummification” survived until the sixth century (Heikkinen 2012, 107).

392 CE, such practices were under enormous pressure.¹¹ We can assume that the people of Naga ed-Deir, located not so far south of the White Monastery (Deir el-Abyad, north of Sohag), would have been particularly hard-pressed to reject the “errors” of traditional mummification as admonished by its abbot Shenoute (fl. 430–460 CE) who regularly assailed whatever non-Christian monuments still stood in the region of Akhmim, in Panopolis proper, and at Atripe (Athribis) on the west bank, opposite.¹²

Budge commented on the essential difference between pre-Christian Egyptian and Christian Egyptian attitudes regarding the necessity of mummifying dead bodies: “The Egyptian embalmed his dead because he believed that the perfect soul would return to the body after death and would inhabit it once more; he therefore took pains to preserve it from all destroying influences. The Christian believed that Christ would give him back his body changed and incorruptible, and that it was therefore unnecessary for him to preserve it with spices and drugs.”¹³ In a toned-down way, this remark conveys the feelings of St. Augustine (354–430 CE) who pointed out that body preservation has nothing to do with Christian goals, for these have at their heart the immortality of the soul.¹⁴ At the same time, Christians held the Old Testament figures in high esteem, and the tradition surrounding the burial of patriarchs Jacob and Joseph treated embalming, and specifically that done in the Egyptian manner, as a keen demonstration of respect.¹⁵ Similarly, and in reference to such Old Testament archetypes, the infant Jesus receives frankincense and myrrh from the Magi, as a sign of burial. He appears tightly swaddled and mummy-like on the day of his birth as a sign to the shepherds of his future, in which he transacts death and achieves life eternal. Regarding a demonstrably late Roman mummy in Montreal, whose preparation (dated through radiocarbon) occurred within the period 200 to 400 CE, the body was eviscerated and

11 392 CE is the moment of sea change. The placement of mummies within domestic structures was outlawed by Theodosius in that year (Willeitner 1998, 320). Lösch, Hower-Tillman, and Zink (2013, 36), accounting for the discovery of bituminous matter in some bodies buried at the Coptic era site of Deir el-Bachit, point out that mummification itself was not specifically banned in Theodosian decrees.

12 Schulz 1998, 491. Shenoute is given an unconfirmed lifespan of 118 years (348–466 CE). He attended the Council of Ephesus (Ad. 431). He established the monastery around 440 CE and was present at the Council of Chalcedon (451 CE).

13 Budge 1894, 188.

14 Leca [1976] 1981, 251.

15 Genesis 50:3, where Joseph prepared Jacob's body for burial, contains the tradition of the forty days allotted for embalming; three score and ten days total for mourning.

received incision plates clearly intended to align with older ideas.¹⁶ The application of linen cloth around this mummy is voluminous, with use of outer investing layers tied down by ribbon-width bandages crisscrossing the body. The modality aligns with far older methods, showing that classic mummification was obtainable in a period when Christian communities were expanding throughout Egypt.¹⁷

Mummification of the “classic” type falls away after the late fourth century, but salt is a frequent addition to burials in Coptic Egypt, and its use was intended to help preserve non-eviscerated bodies for a time after burial while they underwent decomposition. Along with sand and hot sun, such deliberate buffering may allow Coptic bodies to reach preservation states describable as “assisted natural mummification.”¹⁸ A good example of such a mummy is the so-called “Embroiderer,” a Coptic woman found at el-Sheikh Ibada (Antinoë), excavated by Albert Gayet (1895–1910).¹⁹ The fact is that “mummies” of this type show the ways in which Coptic funerary preparation differs considerably from that of pharaonic times. The woman is not “wrapped” in bandages; rather, she was “clothed” in three dresses and a cap. With regard to the use of other embalming substances by the Copts, new studies are surprising. A “black mummy”, having skin treated externally with resin (bitumen), has been confirmed recently as being Coptic in date, and while somewhat unusual, it is not an isolated case.²⁰

As far as fabric usage in the Coptic Egyptian burials at Naga ed-Deir is concerned, bodies are initially dressed or have draped around them normal articles of clothing. In what were early medieval survivals of traditional processing, they are sometimes provided with supportive backboards of wood or

16 Redpath Museum (RM2717): its linen is radiocarbon dated to the interval 230–380 CE (Wade et al. 2014, 106).

17 At Akhmim, for example, just north of Naga ed-Deir, the Christian population was substantial already in the late third century (McNally and Dvoržak Schrunck 1993, 5).

18 This specifically Coptic variant of mummification is seen in many burials at Naga ed-Deir, but is found in many other sites as well, for example, at el-Hibeh, farther north in Middle Egypt (Heikkinen 2012, 107–116).

19 Brussels RMAH Inv. Nr 1045 (Pommerening 2010, 88, fig. 14).

20 This “black mummy” is the so-called “Mummy of a woman with a baby” (Museum of Confluences, Lyon Inv. 9002977 A). The hair of this person (sample Lyon6) is dated to 1270 +/- 30 yr. and 1275 +/- 30 yr. BP, putting her into the seventh century CE (Richardin et al. 2013, 349).

A “bitumen-like substance” has also been identified in the lung tissue, intervertebral spaces, and abdomen of damaged mummies discovered in the necropolis associated with the Coptic monastery at Deir el-Bachit, at Dra Abu el-Naga, Thebes (Lösch, Hower-Tillman, and Zink 2013, 31).

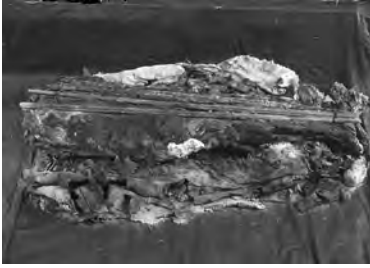

FIGURE 11.1A
Body from N 2004 turned over showing supporting struts (a “litter”) and caked salt (NED-B-7888)

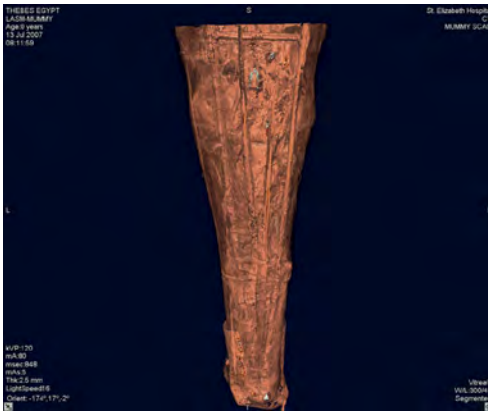

FIGURE 11.1B
A mummy with supportive struts, Late Ptolemaic Period, probably from Thebes LASM Inv. MG 64.1.1a. Baton Rouge, Louisiana

travois-like litters of sticks (of species: “sunt”, *Acacia nilotica*, palm, *Phoenix dactylifera* L., Sesaban, *Sesbania aegyptiaca*) often tied together, intended to keep limbs and trunk articulated during transport.²¹ This core is then enveloped protectively by so-called “wrapping shawls” of linen varying in fineness, and frequently (but not always) with shawls of “sackcloth” used on the outside. (See Fig. 11.1a and historical precedent, Fig. 11.1b.)

2 Visual Representations and Expectations

The expectation that a dead body should be embalmed and wrapped has influenced scriptural tradition and has even wormed its way into iconography to influence and sometimes confuse our impressions of how Christian

21 The term “litter” is used by Yohe, Gardner and Heikkinen (2005) to describe these constructions. They are not new to the Coptic period and are noted in burials of the Late Ptolemaic and Early Roman eras. One of these litter-constructions was found intact in a mummy of Late Ptolemaic date in Baton Rouge, Louisiana, scanned by the Akhmim Mummy Studies Consortium and Louisiana State Art Museum in 2007 (LASM Inv. MG 64.1.1.a; Elias 2007, 11, fig. 22).

bodies looked when fully prepared for burial.²² Engraved renderings of those mummies entering early European cabinets of curiosity (*wunderkammern*) emphasized their often elaborate bandaging and have taught us to expect all mummies to be more or less systematically wrapped in narrow gauge strips. Although much of this content pertained to Dynastic mummies, some mummies of the later periods were also illustrated. A good example is the famous figure of a Roman Period mummy drawn by G. B. Balatri in 1647 to illustrate Giovanni Nardi's commentary to Book 6 of Lucretius's *De Rerum Natura*.²³ Its limbs are entwined within a tight herringbone pattern of the kind created by repeated figure-of-eight bandaging turns (Fig. 11.2, upper). This wrapped figure with its bizarre encaged head was so impressive that it was carried over into many later publications. These included Willem Goeree's *Jewish Antiquities* (1690) and the early eighteenth century treatise on embalming, Thomas Greenhill's *Nekpokēdeia* (1705).²⁴ It even appears in Jacob Scheuchzer's series on Biblically relevant plant species (1731), where it accompanies a fanciful scene showing the embalming of Jacob.²⁵ It has become iconic. Similarly, a late child mummy shown in van den Aveele's plate from Goeree's publication (Fig. 11.2, lower) is depicted with wide spiral bandages that want to suggest a swaddled baby Jesus. Spiral work is also the choice of the Mennonite mystic and artist Jan Luyken who shows in his illustration of Lazarus newly raised from death (Fig. 11.3a) tightly wound by ribbon-width bandages, which Christ's voice is coaxing to unwind.²⁶

-
- 22 An interesting example is found on a gold relief in the Louvre. It contains a depiction of Jesus's sudarium floating above a diagonally crisscrossing assemblage of struts or bandages. It dates to the tenth century (Reber, 1893, 113, fig. 65).
- 23 Giovanni Nardi (1580–1655), a Florentine physician, collected Egyptian antiquities. Artist Giovan Batista Balatri was engaged by Nardi to draw elements of his collection to illustrate his commentary on *De rerum Natura*, by the Roman atomist philosopher Lucretius (Nardius 1647). The mummies appeared in plate 4 of that work. See the illuminating article by Śliwa (2006, 256). The illustration was also reproduced in Pollès (2001, 49).
- 24 Willem Goeree of Amsterdam, publisher of Biblical treatises (1635–1711). *Joodsche Oudheden, ofte voor-bereidselen tot de bybelsche wysheid* (*Jewish Antiquities, or Introduction into Biblical Wisdom*) is the alternative title of the Goeree's *Voor-bereidselen tot de Bybelsche wysheid, en gebruik der heilige en kerklijke historien*, (*Introduction into Biblical Wisdom and the Use of the Holy and Ecclesiastical Histories*) published in Amsterdam in 1690. Balatri's original plate was redrawn and engraved by the Dutch artist Jan van den Aveele (1655–1722).
- 25 J. Scheuchzer, *Physica Sacra*, 1731, Tab. 119, entitled: Iacobus aromate conditus, an illustration of the text of Genesis chapter 50, 2–3, which is set in a European anatomical theatre, shows Nardi's mummy hanging next to the frame of the print.
- 26 The relevant passage is John 11:44. Even images of Jewish bodies appearing in illustrations of the Enlightenment period emphasize spiral bandaging, for example, those in Calmet ([1722] 1732, 660).



FIGURE 11.2
Mummies by van den Aveele (original Figs. 1A, 1F)

The net effect of this type of imagery is to further complicate our ideas regarding how Christian funerary behavior emerged as something distinct from overlapping Hellenistic traditions. We are reminded that the Coptic wrapping modes actually encountered in late cemeteries like Naga ed-Deir N 2000/N 2500 are rather distinct, as well they should be, since they represent strategies used five hundred years after many of those associated with late antiquity.²⁷ One of the few wrapped bodies in an early collection whose treatment is remotely suggestive of Coptic methods is the “mummy on the plinth” (Fig. 11.3b) in the

27 Within the context of Byzantine culture, Copts were monophysite Christians (Eutychians or Jacobites) believing that Christ had one nature, divine. This faith was rejected by mainstream Orthodoxy at the Council of Chalcedon in favor of the doctrine that Christ has two natures, human and divine. Coptic beliefs are to be distinguished from those of Melkites, “royalists” loyal to the Emperor Marcian, who upheld the strictures of the Council of Chalcedon. The seventh century CE saw both persecution of the Copts and attempts by the emperor to heal the schism through compromises. These were unsuccessful, and the Coptic Church maintained an adversarial position with regard to Orthodoxy and enmity toward the policies of Constantinople. The Arab conquest of Egypt was simplified as a result (Bell [1948] 1980, 116).



FIGURE 11.3A
Jan Luyken, Lazarus raised from the dead,
a work of 1690

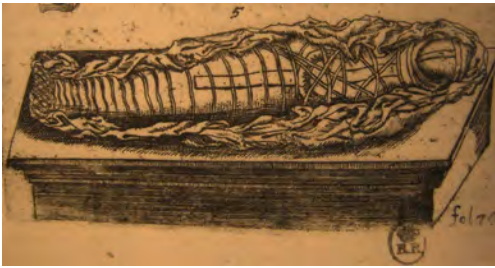

FIGURE 11.3B
Mummy owned by Duke
Friedrich III of Holstein-Gottorp
shown in Olearius's *Gottorffische
Kunstkammer* (1674)

collection of Duke Friedrich III of Holstein-Gottorp in Schleswig shown in Olearius's *Gottorffische Kunstkammer*.²⁸

3 Wrapping Methods of Earlier Times

Pre-Coptic mummy wrapping approaches varied greatly, but generally utilized linen bandages in such a way as to form complex overlapped winding layers of narrow bandages that tend to be overrun by larger textile pieces investing the windings, topped by some type of shroud. Winding methods of various sorts are discernible in ancient Egyptian mummies, but too seldom described. Nevertheless, the principles basic to the work are part of all bandaging, not just that which is ancient Egyptian.²⁹ Essentially, a starter point at the tip of the initial bandage is held down, presumably by fingers of the left hand, while

28 Olearius 1674, Tab. 36, no. 5, shown in Germer (1997, 104). It is also reproduced in Pollès (2001, 52).

29 An established terminology can be found in Bureau of Medicine and Surgery, *Handbook of the Hospital Corps United States Navy 1939*, Washington DC, Govt. Printing Office, 1939 (revised from 1930).

the right hand holds the active bandage (known as a roller) and circles the circumference of the body part with sustained tension so as to be superimposed on the preceding layer. So-called “initial turns” are crucial to protect against slippage. In “good bandaging,” the exposed part of each underlying bandage should be kept equal. This is done by laying the lower edge of the active roller over an imaginary center line in the bandage previously laid down.

Conservator Mimi Leveque has done some interesting research on wrapping as part of her various conservation projects on Egyptian mummies. For example, in research performed on a Twenty-first Dynasty mummy, Leveque found “six principle layers” consisting of fabrics of different grades varying in fineness of weave used at differing elevations in the mummy bundle.³⁰ The innermost wrapping layer (A) was not very easily understood, but included bandages varying from 10.0 to 15.5 cm in width. The head was involved in this early stage. In the next stage (B), the bandages covering it were secured by thin “straps” (12–13 mm wide) that essentially crisscrossed the zone above the shoulders, while wadded scraps of linen (crudely folded) were positioned lower down to fill voids between limbs. This wadding was particularly concentrated on the abdomen to help support overlying layers describable as spiral (or “diagonal”) windings (layers C and D). The bandages in the more inward of these windings (C) were finely woven stuff, approx. 27.0 to 28.0 cm (11 inches) wide. At one point, retaining straps had been arranged vertically as a tie-down to keep the spirally wound bandages in place, and also kept a fringed bundle in place on the mummy’s abdomen. In layer D, bandages of coarsely woven linen were applied spirally. Layer E consisted of a “very large” piece of “loosely woven fabric” 152.5 cm across, which had been so-folded as to produce a four-layer pad that was also wound around the body spirally. G. Elliot Smith describes the folding of a large sheet to produce a multi-layer covering by the Twenty-first Dynasty priests who restored the mummy of Siptah.³¹

4 Christian Innovations in Body Preservation and Wrapping Methodology

An examination of over ninety burials from the Coptic cemetery Naga ed-Deir N 2000/N 2500 shows throughout that dead bodies supported by struts of palm,

30 Leveque 2001. This mummy is called “the Scribe” from the old Niagara Falls Museum collection (NFM-M4), later transferred to Emory University, Atlanta, Michael C. Carlos Museum (Inv. 1999.1.11) and now in a private collection. It is contained in a yellow coffin of Twenty-first Dynasty type.

31 The item is called in this case a “large investing sheet” (Smith [1912] 2000, 70).

acacia (Ar. *sunt*), and sesaban wood are dressed in clothing and then enfolded in wrapping shawls functioning to hold the physical remains together in a bound bundle.³² Salt has been systematically added into the resulting bundles but claims about Christian mummification such as are referred to by Budge must be toned down.³³ Natural mummification (linked to the spontaneous effects of climate and soil alkalinity) is demonstrable in many cases, just as it is in earlier Egyptian mummies. If embalming is done, it is not generally being done to perfection. The old ideal of at least attempting a general drying of the body prior to burial is not adhered to as regularly as it had in pre-Christian times. Therefore, we find many examples where a salt substance (ostensibly natron but untested) has been placed into burials or packed within the wrappings to promote desiccative processes following interment.³⁴ This contrasts with classic mummification, which always attempts to desiccate the body before deposition. That being said, Coptic “salting” of undesiccated bodies is not something unprecedented. It represents a continuation of less-stringent practices already being seen in the Roman, Ptolemaic, and indeed even in the Third Intermediate Period and earlier periods. Salting would have reduced putrefactive odors sensible to the living, and for this purpose it is sprinkled “in quantity” at a level interior to the investment shawls so that it lies on the clothing in which the corpse is dressed; sometimes it is accompanied by botanical material as well (N 2830). To a lesser extent, salt is positioned in a layer underneath the body. In burials found at other sites, embalming spices have been reported, and even significant use of juniper berries, but at Naga ed-Deir, it is only infrequently that preservative material (other than natron) is found in connection with the bodies, such as in tomb N 2616, where intestinal stuffing was noted or in N 2439 where two palm sticks were placed under the body along with aromatic herbal branches.³⁵ Other layered matter found in the burials is possibly ritual in nature, palm leaves, for example, being laced under the feet of one body (N 2003). Examination of Tables 11.1 through 11.5 will give the reader an idea of the range of Coptic burial modes and their regularities.

32 *Sesbania aegyptiaca*, “Egyptian riverhemp”, is a flowering shrub of the family Leguminosae or Fabaceae, colloquially, Egyptian pea. Sesban is the Arabic name. It is called throughout the notes “sesaban”, and that usage is retained here. On the medicinal properties of this plant known as Jayanti in Hindi, see Goswami et al. (2016).

33 Budge 1894, 188.

34 Large amounts of salt (20 kg) used within the wrappings of a mummy discovered at el-Hibeh (NGLP-7) and systematically unwrapped in modern times is shown in Yohe, Gardner, and Heikkinen (2005, 9, fig. 10). See also Heikkinen (2012, 108).

35 For embalming spices at el-Hibeh, see Yohe, Gardner, and Heikkinen (2005). For juniper berries noted at Deir el-Bachit, see Lösch, Hower-Tillman, and Zink (2013). The intestine in the body of the young girl in tomb N 2616 had “been stuffed with preservative material.” What it was exactly is not described.

TABLE 11.1 Wrapping features Naga ed-Deir N 2000 (Tombs N 2000 to N 2033)

Tomb number	Wrapping shawls	Treatment of the head	Directly on the body apparel worn	Underbody supports
N 2000 Adult	Shawl outer, yellow, fringed Shawl inner, elaborate colored wool Not unwrapped in 1905	Unwrapped, therefore undetermined	Unwrapped, therefore undetermined	Unwrapped, therefore undetermined
N 2001 Adult M	2 shawls of sackcloth Quantity of salt noted, possibly between the shawls	Face padded by an old shirt Small shawl around neck	Shirt of linen, neither arm in sleeve	3 palm sticks and 1 of sesaban Salt around body
N 2002 Child F	Shawl of coarse cloth An opened-up shirt	Hat on head	Shirt of linen Layer of salt under it	2 palm sticks
N 2003 Adult M	2 shawls, coarse cloth bound in 2-strand fiber cords	Nothing recorded	3 shirts, linen, outer and inner plain; middle with blue interwoven design	2 acacia and 1 palm stick layer of palm leaves
N 2004 Adult F	Shawl, heliotrope fringed, 2-strand fiber cord 2 thicknesses of sackcloth sewn up sides	Nothing recorded	Outer shirt, neither arm in sleeve 2nd shirt Salt and plant seeds sprinkled on body	3 palm sticks tied with fiber cords at either end Salt over body
N 2005 Adult M?	Shawl, 152 × 52, fringed, bound with 2-fiber cords Sackcloth over cloth	Nothing recorded	Shirt, left arm not in sleeve; probably not right arm either Quantity of salt under body	Slat under body Litter of acacia stick and palm stick tied together
N 2006 Child	Shawl, embroidered Shawl, red Salt noted	Woolen wrapping over head Cirlet of palm leaves	Shirt	Nothing recorded

TABLE 11.1 Wrapping features Naga ed-Deir N 2000 (Tombs N 2000 to N 2033) (*cont.*)

Tomb number	Wrapping shawls	Treatment of the head	Directly on the body apparel worn	Underbody supports
N 2007 Adult M	No cloth preserved	Thickness of sackcloth and 2 thicknesses of cloth over skull	No cloth preserved	Palm stick under each side of body
N 2008 Child	Shawl, fringed	Nothing recorded	Shirt, plain Quantity of salt with body	3 palm sticks
N 2009 Adult	Sackcloth, fringed 3 cloth wrappings, outer rough; middle, medium texture; inner, fine Shawl, inner, then a quantity of salt	Ends of 3 cloth wrappings twisted together over face like a pad	2 shirts, arms not in sleeves	2 thick acacia sticks
N 2017 Adult M	Poorly preserved rough cloth overlying wrapping of finer cloth	Head raised by small heap of sand	Nothing recorded	3 palm sticks
N 2033 Child A	In coffin 4 thicknesses rough cloth from 1 piece wrapped around (4 times)	Pad of cloth over face	Nothing recorded	4 palm sticks bound in 3 places
N 2033 Child B	2 coarse cloth wrappings, fringed Body laid on top and wrapping folded over Dried twigs and branches within	Meshed cloth covering face	Shirt, plain	4 palm sticks

TABLE 11.2 Wrapping features Naga ed-Deir N 2000 (Tombs N 2102 to N 2300)

Tomb number	Wrapping shawls	Treatment of the head	Directly on the body apparel worn	Underbody supports
N 2102 2 Bodies	Cloth wrappings not preserved	Nothing recorded	Nothing recorded	Each body equipped 3 palm sticks
N 2106 Adult M	Fine cloth wrapping 2nd covering (a shirt)	Extra quantity of cloth rolled up over the head	Uncertain if 2nd covering was actually worn	2 palm sticks and 1 acacia stick
N 2107 Child	Cloth wrappings not preserved	Nothing recorded	Nothing recorded	3 palm sticks under the body
N 2108a Child	Nothing recorded	Roll of cloth by head	Nothing recorded	2 palm sticks
N 2108b Adult F	2 or 3 thicknesses of cloth	Nothing recorded	Nothing recorded	Palm stick and sesaban stick at sides
N 2109 Adult?	Possibly recorded in "Smith's Notes"	??	??	2 pieces of sawn wood
N 2130 Adult	Fine pink cloth over coarse sackcloth	Nothing recorded	2 or 3 thicknesses of finer cloth	Litter of palm sticks under body but inside wrappings
N 2133 Adult F	Fine cloth over sackcloth	Nothing recorded	2 shirts Quantity of salt and leaves on outer shirt	2 palm sticks between shirts and sackcloth
N 2134 Adult M	Shawl with patterns in red thread 2 or 3 wrappings of sackcloth	Cirlet of red wool	Fine yellow cloth with sackcloth overlying Shirt, salt, and seeds on body	Roughly shaped board
N 2200 Adult M	Sackcloth poorly preserved	Nothing recorded	Shirt poorly preserved	2 palm sticks fastened together
N 2201 Adult F	Shawl of sackcloth, fringed, formerly cord bound	Net cap or hood on head; possible neck pad	Shirt with right shoulder tassels	2 palm sticks fastened, widening to shoulders

TABLE 11.2 Wrapping features Naga ed-Deir N 2000 (Tombs N 2102 to N 2300) (*cont.*)

Tomb number	Wrapping shawls	Treatment of the head	Directly on the body apparel worn	Underbody supports
N 2202 Child	White shawl formerly cord bound	Nothing recorded	Shirt (plain)	
N 2203 Adult F	Shawl of sackcloth	Hat or net cap	Shawl decorated with panels (flowers and figures)	Litter of 3 palm sticks
N 2215a Adult	Wrapped in rough cloth, poorly preserved	Pads over head (and feet)	Shirts	Palm sticks
N 2215b Child F	Fine cloth shawl	Traces of shirt are implied	Shirts	Palm sticks
N 2218 Adult F	Shawl of sackcloth	Rolled-up, fringed sackcloth	Nothing recorded	Nothing recorded
	Cloth poorly preserved	Shawl over head		
N 2219 Adult	Poorly preserved	Nothing recorded	Nothing recorded	1 palm stick and 1 spade-handle of wood
N 2241 Adult F	Poorly preserved	Nothing recorded	Nothing recorded	Nothing recorded
N 2243 Child	Poorly preserved	Nothing recorded	Nothing recorded	Nothing recorded
N 2243 Adult M	Poorly preserved	Nothing recorded	Nothing recorded	Nothing recorded
N 2273 Child	Poorly preserved	Nothing recorded	Nothing recorded	Nothing recorded
N 2300 Adult	Poorly preserved	Palm fiber over head	Nothing recorded	Litter of 2 sticks of acacia

TABLE 11.3 Wrapping features Naga ed-Deir N 2000/N 2500 (Tombs N 2410 to N 2509)

Tomb number	Wrapping shawls	Treatment of the head	Directly on the body apparel worn	Underbody supports
N 2410 Adult M	Shawl of sackcloth Shawl	Nothing recorded	Shirt, yellow	Nothing recorded
N 2411 Adult	Several wrappings, woven tapestry (remains only)	Nothing recorded	Nothing recorded	2 palm sticks
N 2412 Adult M	Shawl of sackcloth Shawl of fine cloth with woven tapestry designs, poorly preserved	Nothing recorded	Nothing recorded	Nothing recorded
N 2413 Adult M	Shawl of yellow cloth Shawl of sackcloth, fringed with open work ends Shawl of coarse cloth	Pad of cloth over head made from an old shirt	Shirt, arms not in sleeves Plant seeds on body	Sticks of sesaban/ palm on left/right sides of body
N 2414 Adult	Shawl of sackcloth Shawl of finer cloth	Pad of cloth over head made from old shirt	Nothing recorded	Nothing recorded
N 2414 Child	Poorly preserved	Nothing recorded	Nothing recorded	Palm sticks
N 2414 Child	Poorly preserved	Nothing recorded	Nothing recorded	Palm sticks
N 2415 Adult M	Shawl of sackcloth Shawl of finer cloth	Sheep-hide with wool and bundles of straw corded- up padding the head	2 shirts Salt layer overlying	5 palm sticks bound together

TABLE 11.3 Wrapping features Naga ed-Deir N 2000/N 2500 (Tombs N 2410 to N 2509) (*cont.*)

Tomb number	Wrapping shawls	Treatment of the head	Directly on the body apparel worn	Underbody supports
N 2416 Adult	Shawl of rough sackcloth	Elaborate pads: a roll of fine cloth, loose straw with 5 separately corded straw bundles, then secured by cloth	2 plain shirts of coarse cloth, right arm in outer sleeve but not in inner; left arm in inner sleeve but not in outer	Body tied onto flat board
N 2417 Adult M	Poorly preserved	Nothing recorded	Nothing recorded	Nothing recorded
N 2418 Child	Poorly preserved	Nothing recorded	Nothing recorded	Nothing recorded
N 2419 Adult M	Red cloth Shawl of sackcloth	Pad consisting of a shirt on head	Shirt	3 or 4 sticks of sesaban
N 2438 Adult	Shawl of sackcloth	Layer of reeds tied to face 2 cloth pads consisting of old shirt	Fragmentary shawl of coarse cloth over a shirt, poorly preserved	
N 2439 Child	Shawl of sackcloth bound with cords crossing in "all directions"	Thick pad on head (and on feet)	Shirt (plain) Branches of aromatic herb on body	2 palm sticks
N 2441 Child	No cloth preserved	No cloth recorded	No cloth recorded	Nothing recorded
N 2503 Adult M	Outer shawl of sackcloth Inner shawl of coarse cloth	Small shawl folded as pad on face	Shirt (plain)	1 stick acacia, 1 stick tamarisk
N 2504 Child a.	Poorly preserved Outer wrapping of coarse cloth	Nothing recorded	2 shirts, tapestry-woven	Nothing recorded

TABLE 11.3 Wrapping features Naga ed-Deir N 2000/N 2500 (Tombs N 2410 to N 2509) (*cont.*)

Tomb number	Wrapping shawls	Treatment of the head	Directly on the body apparel worn	Underbody supports
N 2504 Child b.	Outer shawl, green cloth bound by cords Inner shawl	Net hood or hat on head	2 shirts, tapestry woven	2 palm sticks
N 2505 Adult F	Poorly preserved	Nothing recorded	No cloth recorded	Nothing recorded
N 2506 Child F	No cloth recorded	Nothing recorded	No cloth recorded	Nothing recorded
N 2508 Adult M	Poorly preserved Outer shawl of sackcloth Inner shawl of finer cloth	Nothing recorded	No cloth recorded	2 palm sticks or more
N 2509 Adult M	Poorly preserved Little cloth remaining	Nothing recorded	No cloth recorded	Stick of sesaban on either side of body

TABLE 11.4 Wrapping features Naga ed-Deir N 2500 (Tombs N 2610 to N 2700)

Tomb number	Wrapping shawls	Treatment of the head	Directly on the body apparel worn	Underbody supports
N 2610 Adult F	Body well preserved; salty substance noted Outer shawl of sackcloth Inner shawl of fine cloth, fringed	Nothing recorded	Shirt (plain)	
N 2611 Child	Outer shawl of sackcloth-bound with 2-strand fiber cords Inner shawl of fine cloth	Pad of extra cloth over head (a mesh shawl)	Shirt of fine cloth	3 palm sticks next to body

TABLE 11.4 Wrapping features Naga ed-Deir N 2500 (Tombs N 2610 to N 2700) (*cont.*)

Tomb number	Wrapping shawls	Treatment of the head	Directly on the body apparel worn	Underbody supports
N 2612 Adult a.	Wrapping shawls	Extra padding over face; cloth square and old shirt rolled inside coarse cloth	Shirt, arms not in sleeves	2 palm sticks
N 2612 Adult b.	Shawl of rough cloth Shirt (old) of finer material	Nothing recorded	2 shirts	2 sticks of sesaban
N 2613 Adult F	Outer shawl with designs in colored wool Inner shawl of fine cloth with tapestry-woven designs Inner shawl (coarse cloth implied in notes)	Nothing recorded	Shirt	Nothing recorded
N 2615 Adult F	2 or 3 wrapping shawls of sackcloth Traces of 2-strand fiber cords	Nothing recorded	Shirt (plain) Salt in quantity on body with dried fruit and seeds	4 palm sticks Below body, dried palm leaves, 2 tied together
N 2616 Child F	Shawl of ordinary cloth, fringed Shawl of sackcloth	Nothing recorded	Shirt	Nothing recorded
N 2619 Adult	Poorly preserved Outer wrapping cloth Inner wrapping sackcloth	Nothing recorded	No cloth recorded	2 palm sticks
N 2632 Adult M	Outer shawl of finer cloth, tassled Inner shawl of sackcloth	Nothing recorded	Shirt poorly preserved; salt on the body	4 palm sticks, tied together 2 per side in sackcloth
N 2633 Adult M	Outer shawl of sackcloth Inner shawl of fine cloth	Nothing recorded	Shirt (plain)	2 palm sticks in sackcloth

TABLE 11.4 Wrapping features Naga ed-Deir N 2500 (Tombs N 2610 to N 2700) (*cont.*)

Tomb number	Wrapping shawls	Treatment of the head	Directly on the body apparel worn	Underbody supports
N 2634 Adult F	2 wrapping shawls of coarse cloth	Nothing recorded	Shirt (plain) Salt on body	2 palm sticks bound together Salt under body
N 2635 Adult M	Shawl of sackcloth	Nothing recorded	Shirt with corded edges	Nothing recorded
N 2636 Adult F	Outer shawl of coarse cloth, fringed with tapestry-woven wool, bound in cordage Inner shawl of yellow cloth laid on body	Net veil or head shawl of yellow linen and wool, covered by shawl rolled into a pad	Shirt Plaid shawl next to skin Quantity of salt on body	2 palm sticks and 1 sesaban stick
N 2637 Adult M	Outer shawl of sackcloth Middle shawl of sackcloth Inner shawl of coarse cloth	Pad made of old shirt rolled into a ball, tapestry-woven 2-strand cord tied on head	Shirt Quantity of salt and seeds	Litter of 1 palm stick and 1 of <i>shaum</i>
N 2638	Shawl of sackcloth Coarse linen	Nothing recorded	Single shirt undecorated	3 sticks wrapped in coarse linen (2)
N 2639 Adult M	Wrapping shawl of fine linen, fringed	Nothing recorded	2 shirts, corded edges, tapestry-woven decoration	Nothing recorded
N 2700 Adult F	Outer shawl, fine wide-meshed red cloth Shawl of white cloth Shawl of white cloth Shawl of white cloth Shawl of yellow cloth Inner shawl, fine wide-meshed black cloth	Nothing recorded	Shirt with tapestry-woven designs	4 palm sticks

TABLE 11.5 Wrapping features Naga ed-Deir N 2500 (Tombs N 2806 to N 2839)

Tomb number	Wrapping shawls	Treatment of the head	Directly on the body apparel worn	Underbody supports
N 2806 Adult M	Outer covering of fine cloth, yellow Middle shawl of sackcloth Inner shawl of coarse cloth	Extra pad over face Salt	Shirt	2 stout poles
N 2810 Adult	Poorly preserved Sackcloth traces Finer cloth traces	Head missing	No cloth recorded	2 palm sticks
N 2811 Adult F	Sackcloth	Extra wrappings over head	Shirt, poorly preserved but had been elaborate	2 palm sticks Salt with body
N 2812 Child	Outer wrapping of yellow cloth Rough cloth (not sackcloth) bound with cords	2 or 3 thicknesses of soft wool fiber	2 shirts (upper shirt inside out)	Twigs and leaves
N 2813 Infant	Poorly preserved Traces of cloth	Nothing recorded	No cloth recorded	Nothing recorded
N 2814 Adult	Poorly preserved	Large pad over head, some embroidery	No cloth recorded	2 palm sticks
N 2815 Adult	Outer wrapping of finer cloth Inner wrapping of sackcloth	Large pad over head	No cloth recorded	2 palm sticks
N 2816 Adult M	Poorly preserved	Nothing recorded	No cloth recorded	6 palm sticks: 2 on each side, 2 in the middle
N 2817 Adult F	Poorly preserved Wrappings of sackcloth and finer cloth (order not described)	Nothing recorded	No cloth recorded	2 palm sticks

TABLE 11.5 Wrapping features Naga ed-Deir N 2500 (Tombs N 2806 to N 2839) (*cont.*)

Tomb number	Wrapping shawls	Treatment of the head	Directly on the body apparel worn	Underbody supports
N 2818 Adult M	Poorly preserved	Large pad consisting of finer cloth inside of sackcloth	Nothing recorded	2 palm sticks on right 1 palm stick on left
N 2819 Adult	Poorly preserved	Head missing	No cloth described	1 palm stick 1 sesaban stick
N 2830 (1) Adult	Rough sackcloth	Nothing reported	Nothing reported	Nothing reported
N 2830 (2) Adult M	Shawl of yellow cloth tied with fiber cords Shawl of sackcloth sewn up with cord Inner shawl of coarse cloth with wool border	Quantity of palm fiber over the head Pad of cloth on head (consisting of old shirt rolled into a ball) positioned over inner shawl	Shirt covered with small amount of salt and dried plants on breast 2 more shirts, body's arms in-the-sleeves of outer shirt; arms not-in-the-sleeves of inner shirt Lock of female hair (curled) in the wrappings	4 palm sticks and 1 acacia stick fastened together Dried palm leaves
N 2831 Adult F	Poorly preserved cloth wrappings	Nothing reported	Nothing reported	Palm sticks under body and a few palm leaves
N 2833 Adult M	Outer wrapping of sackcloth bound with strips of coarse white cloth, with red and black ornamentation, and fiber cords Middle wrapping of sackcloth Inner wrapping of sackcloth	Ball of fine, soft cloth with pattern in purple, placed by right side of face, over middle wrapping	2 shirts of fine linen positioned under inner wrapping	1 stick for carrying inside sackcloth wrappings

TABLE 11.5 Wrapping features Naga ed-Deir N 2500 (Tombs N 2806 to N 2839) (*cont.*)

Tomb number	Wrapping shawls	Treatment of the head	Directly on the body apparel worn	Underbody supports
N 2836 Adult	Wrapping of yellow cloth with green motif Thickness of sackcloth Thickness of sackcloth Wrapping of fine cloth (Sequence may be reversed)	2 large bunches of grass, tied round over head Mass of cloth on head	Shirt Quantity of salt on body	3 palm sticks and 1 atl. (?) tied together in sackcloth
N 2839 Adult M	Poorly preserved Remains of several linen wrappings with decoration in colored wools	Nothing recorded	Shirt with breast ornamentation	3 palm sticks tied together, above 2 wrappings Twigs and dried leaves between

5 Discussion

The emphasis on putting the body into daily dress is a very different approach to burial when contrasted to earlier periods during which bodies are undressed when invested in bandaging. Coptic bodies at Naga ed-Deir N 2000/N 2500 tend to be buried at shallow levels along an east-west orientation.³⁶ A body is typically placed on its back with its head to the west as in other Coptic cemeteries.³⁷ The arms frequently lie at the sides of the bodies (N 2001, N 2002).

A class of textile, the so-called “wrapping shawl”, is referred to throughout the notes. They often have fringed edges. Many are made of a coarse-weave fabric or an even cruder weave described in the notes as “sackcloth”.³⁸ Because of their context of discovery, the “wrapping shawls” might be interpreted as

36 Shallow burial is by no means a Christian innovation; it is seen widely in the Late Period at sites such as Saqqara and Abusir. However, the consistent East-West orientation of the bodies at Naga ed-Deir N 2000/N 2500 is noteworthy and is found in Coptic burials at other sites, for example, at el-Hibeh.

37 Heikkinen (2012, 114) notes head-west burials at Fag el-Gamous. At this site, the loci “regularly have at least two bodies interred together, and in some cases as many as nine....”

38 A fabric with thick ridges of tightly coiled fabric strands. The material of the base thread appears fibrous but is not identified.

specifically created for funerary purposes. However, at least some of them were articles of clothing worn in life, similar to the *hulaleeyah* described by Edward William Lane interestingly enough, specifically in connection with habits of dress found “above Akhmim”.³⁹ The shawls are used somewhat like the folded investment sheets of the earlier era (e.g., the type seen in Siptah’s burial), covering the bodies and turned “back” (folded upon themselves) usually with left side flap coming in first with the right side overlapping it.⁴⁰ Some of these are turned up at the ends or partly sewn up to hold and cushion the body within (N 2000), or folded above the body and secured by outer “bindings” (N 2001). They may be used singly (N 2200), but often occur in pairs or even in threes (N 2003), although investment in four shawls (N 2009) or even six shawls is also seen (N 2700).⁴¹

Use of 2-strand fiber cordage to bind bodies is much more widespread than in pharaonic times. This “tying up” is particularly noticeable in the exterior layers of investment where it is used to secure the wrapping shawls around the bodies. Outer binding can sometimes be exceedingly complex, if not elaborate or decorative. Cordage can form intersections that are artfully knotted to form taut lozenge-shaped lashings running along the body’s central axis (N 2004, N 2005, N 2009; Fig. 11.4a).⁴² A related approach to lashing found at Naga ed-Deir N 2000/N 2500 may be called axial truss-pattern (Fig. 11.4b).⁴³ It is sometimes found used to bind the inner wrapping shawl (N 2003). In other inner bindings, the approach is even simpler: ten or twelve transverse cords are sometimes passed around the body within its shawl, and these are often connected by just a few dispersed diagonal cords (N 2416).

Clothing items (referred to as “shirts” within the notes) are the primary apparel worn, and in the vast majority of cases, the investment sheets (“wrapping

39 Lane [1860] 1908, 52–53. The *hulaleeyah* is described as woolen. It is a shawl wrapped around the shoulders.

40 A sheet of this type was also noted surrounding the bandaged mummy of Irethorrou (c. 500 BCE) from Akhmim (Fine Arts Museums of San Francisco 42895). Irethorrou was laid upon the sheet, a tough linen fabric of thick strands, and its sides were pulled up around the body (Dreyfus and Elias, 2014, fig. 6). I suspect that this form of investment sheet was rather more common than is reflected in the literature.

The Naga ed-Deir notes concerning the wrapping shawls refer repeatedly to folding over “in the usual way”; a shawl in burial N 2002 was done differently, the right side described as having been “thrown over before the left”.

41 In N 2003, the third wrapping shawl is described as unfinished, as if removed from the loom to be added to this burial.

42 See NED-B-7868 from N 2009. A similar lashing pattern is used to secure a Coptic body found at Deir el-Bachit (western Thebes), but in it (SKB 5), decorative woven ribbons are used to do the tying (Lösch, Hower-Tillman, and Zink 2013, 34, fig. 5).

43 See NED-B-7904 from N 2003. The pattern resembles the structural truss used in iron bridge construction.



FIGURE 11.4A
Body from N 2009 (as discovered) with axial lozenge-pattern lashing on the exterior (NED-B-7868)

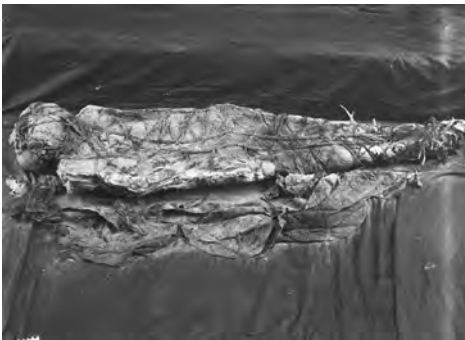

FIGURE 11.4B
Body from N 2003 showing axial truss-pattern lashing under an external un-lashed sheet that has been removed (NED-B-7904)

shawls” in the notes) are drawn up around them. It is not uncommon for a body to wear two or three shirts.

The way in which the bodies wear the shirts is extremely interesting, for arms being left out-of-the-sleeves is noted again and again. One case is the body in N 2001, where a “shirt with embroidered rosettes round (the) sleeves” was placed on the mummy but without the arms being put into the sleeves themselves.⁴⁴ The significance of this practice is unknown, but leaving arms out-of-sleeve, so to speak, may be a deliberately non-quotidian gesture or sign of devotion akin to a priestly scapular. As far as the “old shirts” mentioned in the notes are concerned, many see service “opened-up” like sheets in which to enfold the body or, more often, rolled up as protection over the head, sometimes forming “an enormous pad of cloth” over the face.⁴⁵ In N 2008, a small shirt was used to wrap an infant child’s feet.

Padding of the head and face is a vital distinguishing characteristic of Coptic funerary preparation. This is not confined to Naga ed-Deir, but has been seen at

44 Keeping the arms out-of-the-sleeves is not unusual at N 2000/N 2500 and should be noted in any future excavations at Coptic sites.

45 N 2000, N 2001.



FIGURE 11.5A
Body from N 2416 before unwrapping
(State 1) (NED-B-7089)



FIGURE 11.5B
Body from N 2416, head bundle revealed
(State 2) (NED-B-7090)



FIGURE 11.5C
Body from N 2416, outer wrapping shawl
pulled open (State 3) (NED-B-7091)



FIGURE 11.5D
Body from N 2416, head cloth pulled
back, stuffing inside revealed (State 4)
(NED-B-7092)



FIGURE 11.5E
Body from N 2416, showing rolled fiber
bundles on the head portion of the inner
wrapping shawl (State 5) (NED-B-7093)

el-Hibeh and elsewhere. A large number of bodies show carefully rolled up cylinders made of grass or other vegetal fibers, secondarily wrapped in cloth and tied off (N 2416). Body N 2416 is a good example of just how much attention might be lavished on the head for protective or ritual purposes, as is shown in an unwrapping sequence captured in the original Naga ed-Deir season photos

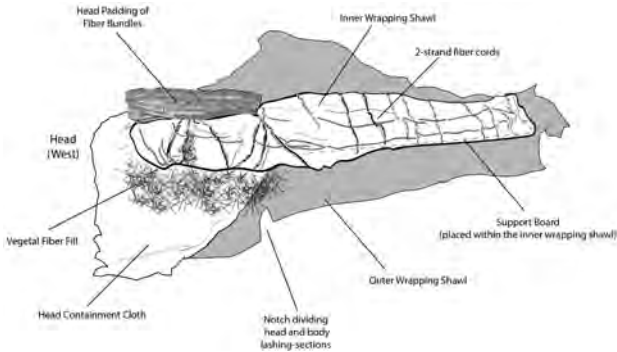

FIGURE 11.6 Diagram of the body in N 2416 showing its main wrapping features
DRAWN BY J. ELIAS

(Figs. 11.5a–e).⁴⁶ A system of five cylindrical bundles of tied grass is used. The bundles are grouped, then cushioned with loose fiber, and the whole mass is unified inside a fine cloth head shawl. The outer “wrapping shawl” is given a special notch to create a flap that allows it to more effectively cover the voluminously covered head. The major features are shown and labeled in Fig. 11.6.

Considering the age of the Naga ed-Deir burials, skeletal articulation is fairly high, and this shows that the approaches to wrapping found at this Christian site were sufficient to maintain bodily integrity for centuries after death. This effectively is a coincidental benefit of the community’s adherence to a traditional and very ancient Egyptian respect toward physical remains. It shows a very understandable need to care for bodies through multitiered protective wrapping strategies and is far from the departure from body-centrism that St. Augustine would have preferred. The use of salt is important, but it is difficult to determine how much of it had been used as a chemical immersive as opposed to being added into the wrappings at time of burial. In many cases, seeds are found in connection with the salt, and it would be interesting to know if the excavators viewed the seeds as a symbol of fertility or as a practical additive.⁴⁷ Although the excavation notes from N 2000/N 2500 do not mention fragrance impact in connection with any of the tombs, we must conclude that aromatic herbs were deliberately used or indirectly introduced in vegetal materials, like acacia, placed next to the bodies for other purposes.⁴⁸ Nevertheless the saturation levels in the bodies are not very high.

46 The complete series is NED-B-7089-7093.

47 The particular species are not identified.

48 Acacia has resinous qualities.

The limited scope of such applications seems to say something about Coptic “mummification” in the Naga ed-Deir/Deir el-Malak community and likely at Girga as well.⁴⁹ It cannot be concluded on the basis of the available notes that N 2000/N 2500 was a cemetery filled of impoverished souls. However, the effectiveness of soft tissue preservation afforded by the desiccation substances placed within the wrapping layers of the Naga ed-Deir bodies was not particularly high when compared with earlier methods or with some of the more elaborate strategies identified at other Coptic sites. N 2000/N 2500 appears as a more conservative cemetery in this regard.

Bibliography

- Bagnall, R. S. 1988. “An Early Christian Burial at Tell el-Maskhuta.” *ZPE* 74:291–292.
- Bagnall, R. S. 1993. *Egypt in Late Antiquity*. Princeton.
- Bell, H. I. [1948] 1980. *Egypt: From Alexander to the Arab Conquest, A Study in the Diffusion and Deca of Hellenism*. Reprint. Chicago.
- Bresciani, E. 1996. *Il volto di Osiri. Tele funerary dipinte nell’Egitto romano (The Face of Osiris. Painted Funerary Shrouds in Roman Egypt)*. Translated by H. Adkins. Lucca.
- Budge, E. A. W. 1894. *The Mummy, Chapters on Egyptian Funereal Archaeology*. 2nd ed. Cambridge.
- Calmet, A. [1722] 1732. *Dictionnaire historique, critique, chronologique, géographique et littéral de la Bible*, vol. 2. Translated by S. D’Oyley and J. Colson. London.
- Corcoran, L. 1997. “Mysticism and the Mummy Portraits.” In *Portraits and Masks: Burial Customs in Roman Egypt*, edited by M. L. Bierbrier, 45–53. London.
- Dreyfus, R. and J. Elias. Forthcoming. “Mummy by the Bay: Irethorrou, An Egyptian Priest of the Early Persian Period.” In *Gedenkschrift for Candy Keller*. Also: www.academia.edu/38354340/Dreyfus_R._and_Elias_J._2014._Mummy_by_the_Bay_Irethorrou_An_Egyptian_Priest_of_the_Early_Persian_Period._Draft_of_an_article_accepted_for_publication_but_delayed and www.famsf.org/blog/mummy-bay-irethorrou-egyptian-priest-early-persian-period.

49 The community referred to had strong connections with Girga into recent times. Frederick Ludwig Norden’s map of the stretch of the river taking in Akhmim and Naga ed-Deir (drawn 1738, published 1755) is labeled as follows: Deier Melac Chretiens de Tschirsch. (Girga). Although on the same side of the river as Akhmim, Naga ed-Deir was not under the jurisdiction of the Prince of Akhmim in Norden’s day.

- Elias, J. 2007. "Preliminary CT Scan Analysis of an Egyptian Mummy in the Louisiana Art and Science Museum, Baton Rouge." *AMSC Research Report, AMSC-16, Study 1*. Carlisle.
- Germer, R. 1997. *Mummies: Life after Death in Ancient Egypt*. Munich.
- Girotti, M., K. Al-Hariri, S. Al-Khayem, R. Boano, S. Harter-Lailheugue, C. El-Bcheraoui, D. Chevé, E. Fulcheri, E. Massa, and G. Boëtsch. 2005. "The Mummies of the Archaeology Museum of Palmyra." *Proceedings of the V World Congress on Mummy Studies, Journal of Biological Research* 80: 262–267.
- Goswami, S., K. Mishra, R. Singh, P. Singh, and P. Singh. 2016. "Sebania sesban, A Plant with Diverse Therapeutic Benefits: An Overview." *SGVU Journal of Pharmaceutical Research & Education* 1:111–121.
- Greenhill, T. 1705. *Nekpokēdeia, or, The Art of Embalming*. London.
- Heikkinen, D. 2012. "The Influence of Christianity on Burial Practices in Middle Egypt from the Fourth to the Sixth Centuries." In *Current Research in Egyptology 2011*, edited by H. Abd El Gawad, N. Andrews, M. Correas-Amador, V. Tamorri, J. Taylor, 107–116. Oxford.
- Ikram, S. 2015. "Bahariya Oasis: Valley of the Golden Mummies." In *Mummies around the World: An Encyclopedia of Mummies in History, Religion, and Popular Culture*, edited by M. Cardin, 19–21. Santa Barbara.
- Lane, E. W. [1860] 1908. *The Manners and Customs of the Modern Egyptians*. London.
- Leca, A.-P. [1976] 1981. *The Egyptian Way of Death: Mummies and the Cult of the Immortal*. Translated by L. Asmal. Garden City.
- Leveque, M. 2001. "Conservation Study of Mummy 1999.1.11." Report on file in the Michael C. Carlos Museum, Emory University, Atlanta.
- Lösch, S., E. Hower-Tillman, and A. Zink. 2013. "Mummies and Skeletons from the Coptic Monastery Complex Deir-el-Bachit in Thebes-West, Egypt." *Anthropologischer Anzeiger* 70/1: 27–41.
- McNally, S. and I. Dvůřák Schränk. 1993. *Excavations in Akhmim Egypt: Continuity and Change in City Life from Late Antiquity to the Present*. Oxford.
- Nardius, I. 1647. *Titi Lucretii Cari De Rerum Natura Libri Sex. Una cum Paraphrastica Explanazione & Animadversionibus*. Florence.
- Norden, F. L. 1757. *Travels in Egypt and Nubia*. Translated by Peter Templeman. London.
- Olearius, A. 1674. *Gottorffische Kunst-Kammer, Worinnen Allerhand ungemene Sachen, so theils die Natur, theils künstliche Hände hervor gebracht und bereitet*. Schleswig.
- Parlasca, K. 1997. "Mummy Portraits: Old and New Problems." In *Portraits and Masks: Burial Customs in Roman Egypt*, edited by M. L. Bierbrier, 127–130. London.
- Petrie, W. M. F. 1911. *Roman Portraits and Memphis (IV)*. London.
- Pollès, R. 2001. *La Momie de Khéops à Hollywood*. Paris.

- Pommerening, T. 2010. "Mummies, Mummification Techniques and the Cult of the Dead in Ancient Egypt—A Chronological Overview." In *Mummies of the World*, edited by A. Wiczorek and W. Rosendahl, 74–91. Munich.
- Reisner, G. A. 1908. *The Early Dynastic Cemeteries of Naga-ed-Dêr, Part I*. Leipzig.
- Richardin, P., M. Coudert, N. Gandolfo, and J. Vincent. 2013. "Radiocarbon Dating of Mummified Human Remains: Application to a Series of Coptic Mummies from the Louvre Museum." *Proceedings of the 21st International Radiocarbon Conference, Radiocarbon* 55: 345–352.
- Riggs, C. 2005. *The Beautiful Burial in Roman Egypt: Art, Identity, and Funerary Religion*. Oxford.
- Schulz, R. 1998. "Travelers, Correspondents, and Scholars: Images of Egypt through the Millennia." In *Egypt The World of the Pharaohs*, edited by R. Schulz and M. Seidel, 491–497. Cologne.
- Śliwa, J. 2006. "Andreas Gryphius und Giovanni Nardi." In *Aegyptus et Pannonia III*, edited by H. Gyory, 247–259. Budapest.
- Smith, G. E. [1912] 2000. *The Royal Mummies*. London.
- Smith, G. E. and W. R. Dawson. 1924. *Egyptian Mummies*. London.
- Taylor, J. H. 2001. *Death and the Afterlife in Ancient Egypt*. Chicago.
- Wade, A. D., B. Lawson, D. Tampieri, and A. J. Nelson. 2014. "Hybrid Ritual: Abdominal Incision Plate Use in a Case of Transperineal Evisceration." *Yearbook of Mummy Studies* 2:103–108.
- Willeitner, J. 1998. "Tomb and Burial Customs after Alexander the Great." In *Egypt: The World of the Pharaohs*, edited by R. Schulz and M. Seidel, 313–321. Cologne.
- Yohe, R. M., J. Gardner, and D. Heikkinen. 2005. "A Preliminary Analysis of Mummies NGLP-7 and NGLP-8 from the North Gate Looter Pit, Tell El-Hibeh, Middle Egypt 2005 Field Season." Report on File at the Archaeological Research Center, Cairo.

Conclusions

Vanessa Davies

At the outset of this project, we posed two fundamental questions about the Naga ed-Deir material. Both questions relate to the number of artifacts currently in the collection of the Hearst Museum. According to museum records, some tombs have many more artifacts attributed to them than others. Why is that? Were some burials simply outfitted with more objects than other burials? Was it a question of preservation, or excavation techniques, or other decisions made by the excavators? These questions were answered by comparing the archaeological material in the Hearst Museum of Anthropology and the Museum of Fine Arts, Boston, with the excavators' field notes (tomb cards), photographs taken in the field and staged photographs, and Mace's draft publication of the Coptic tombs.

Tomb N 2446 = N 2522 is a good starting point to discuss the relative number of objects found in tombs. According to the Hearst Museum records, N 2446 was a particularly well-appointed tomb, accounting for 50% of all of the museum's ceramic materials from N 2000/N 2500. But N 2446 is not as unusual an example as it appears from the Hearst Museum records. By consulting the excavator's notes, it is readily apparent that the statistical analyses made from artifacts in the Hearst Museum do not necessarily translate to the original corpus of objects found in the cemeteries. Other tombs, such as N 2031, N 2034, and N 2235, also had large ceramic assemblages. For reasons unknown at this late date, the assemblage removed from N 2446 was shipped to California, while the other corpora were split between Egypt and California with the majority of the objects remaining in Egypt.

Many flint objects from other Naga ed-Deir cemeteries, such as N 500, N 900, and N 7000, were shipped to the Hearst Museum. Only four flint objects from N 2000 and N 2500 are currently in that collection. We wanted to find out why there was an uneven distribution of material. Was that uneven distribution reflected in the finds? Did it relate to the excavation techniques or the particular interests of the excavator?

In the case of the flint, the low number of finds from cemeteries N 2000 and N 2500 seem to be a simple error in recording. There is no indication that the original four objects (of which only three are currently available for study) actually derived from those cemeteries. The excavators' notes on tomb cards

contain no reference to finding flint objects. Given the large quantity of flint found in other Naga ed-Deir cemeteries, it seems likely that the four objects listed in the museum as deriving from N 2000/N 2500 actually came from a different Naga ed-Deir cemetery.

An obvious reason for the disparity in the number of objects found in tombs in N 2000 and N 2500 is one of time. The First Intermediate Period/Middle Kingdom tombs contained more ceramic and stone vessels, beads, and other objects, as well as occasionally wood remains from coffins or other items, than do the Coptic tombs. The Coptic tombs contained preserved clothing, wrappings, and botanical materials, all of which had previously decayed in the earlier tombs if they were ever present at all. But in comparison with the First Intermediate Period/Middle Kingdom tombs, the Coptic tombs contained little in the way of inorganic remains like ceramic and stone vessels. As might be expected, group burials, such as N 2071 of the First Intermediate Period/Middle Kingdom and N 3747 of the Coptic period, contained many more objects and a wider variety of objects than did single burials.

Although some tombs resulted in more object finds than others, the representation of this discrepancy as presented in museum records was inaccurate. For example, N 2002, a burial of a young female dated to the Coptic period, was a particularly rich source of information and provides one of only a few examples of beads from this era. Mace made 12 drawings of jewelry and garments from this tomb, but no objects from this tomb exist in the records of the Hearst Museum. Conversely, some tombs have objects attributed to them in the records of the Hearst Museum that are not mentioned in the original excavation notes. N 2075 is described by the excavators as containing beads and ceramics. Records in the Hearst Museum attribute to that tomb a metal wire, a needle, stone vessels, and mirrors. Perhaps those objects were assigned to N 2075 in error.

The original tomb cards containing the excavators' site notes preserve valuable information, especially about some of the Coptic-era artifacts that are now stored in an uncertain location. The decorated wood and whorl from N 2049 were carefully drawn on tomb cards and photographed by the excavators. Since the artifacts are delicate and prone to decay, the early twentieth-century drawings and photographs are important records of Coptic handiwork. The tomb cards meticulously record Coptic-era garments, such as the tunic from N 2002, the shawls from N 2006, N 2130, and N 2503, the rosette from N 2637, and the many wrappings from N 2009, N 2636, and N 2812. Those notes and drawings survive only in the tomb cards. Mace's unfinished manuscript, finally published in this volume (see Appendix 2), excludes the garments entirely because he had planned a later publication devoted solely to them.

Certain tombs in N 2000 and N 2500 are significant because of the large quantity of a particular object type in them or because of the unusual nature of the objects in them. A number of tombs contained a large quantity of ceramics (N 2040, 2473, 2501, 2641), stone vessels (N 2096, 2641), or beads (N 2042, 2071, 2075, 2090). N 2042, 2071, and 2075 contained many beads and also a wide range of other objects, including amulets and scarabs, stone vessels, ceramics, and various other objects. N 2031, 2032, 2093, 2100, and 2507 contained stelae that name and depict the tomb owners. Other goods were found in those tombs, including a wooden object covered in gold foil (N 2031), beads, ceramics, stone vessels, and other assorted objects, suggesting perhaps that the tomb owners were afforded a certain amount of prestige in life. N 2332 contained the unusual square headrest and the intriguing and well-preserved rope with sealings that were found on top of a coffin. Other unusual finds include 3 rings worn by the tomb owner and a wooden box in N 2007, the whorl and decorated wood pieces joined by pegs, which were mentioned earlier, in N 2049, 4 rings and a copper dipper with an adjustable handle in N 2417, and the jewelry in N 2813.

In his 1932 publication of *Naga ed-Deir*, Reisner characterized the community he was excavating at Giza as far more impressive than the “provincial” (as he put it in the book title) community at *Naga ed-Deir*. In that third volume of the *Naga ed-Deir* series, Reisner concludes the main part of the text with this observation on the two sites: “Memphis appears as one of the most brilliant of the courts of history, the product of the greatest of the ancient civilizations of the world. Of all this glory practically nothing was reflected in the daily life of our obscure agricultural community at *Naga-d-Dêr* ... the products of the great arts and crafts [of Memphis] were not for the people of our village” (Reisner 1932, 192).

Reisner’s comments here are at odds with the pattern of work over his career, which focused on both monumental art and architecture and the finds of “daily life” that were typically less desirable to collectors. Letters he wrote to Mrs. Phoebe A. Hearst discuss objects like ceramic and flint, as well as trips to dealers to purchase statuary, stelae, and an offering table (Reisner 190–, 25, 29, 30, 33). At a time when scientific method in the archaeology of the Nile River Valley was not yet the norm, Reisner’s fieldwork and publications treat all archaeological material.

The group of scholars who have contributed to this volume have arrived at a conclusion somewhat different from Reisner’s quoted earlier. Given the range of finds and the evidence of craftsmanship analyzed and published in this volume, we feel that the attention given to Coptic textiles, to finely crafted beads and amulets, to scarabs, stone and ceramic vessels, painted stelae, and a variety

of other objects indicates that the populations who lived at Naga ed-Deir, although perhaps lacking the large stone statuary and largescale stone architecture that Reisner saw at Memphis, nonetheless enjoyed a range of carefully made goods. Reisner saw “glory” only in the products produced for the ancient Egyptian capital. The authors in this volume see that glory reflected in the careful and detailed work the residents of Naga ed-Deir valued enough to include in their tombs.

Bibliography

- Reisner, G. A. 190-. *Letters of G. A. Reisner [to Mrs. Hearst]*. From Phoebe Apperson Hearst Papers. Bancroft Library. University of California, Berkeley. No location.
- Reisner, G. A. 1932. *A Provincial Cemetery of the Pyramid Age, Naga-ed-Dêr Part III*. University of California Publications, Egyptian Archaeology 6. Berkeley.

Arthur Mace's Draft Manuscript

[ed.: Mace's British spellings have been changed to standard American English spellings, such as "shewn", changed to "shown"; "natrun", to "natron"; "colour", to "color", etc. In order to exactly reflect Mace's thoughts, changes have not been made to either his punctuation or his outdated, classist, and colonialist ethnographic descriptions, such as "peasant", "Mohammedans", and comments about the "mental untidiness" and "barbarity" of the Coptic Christians, stereotypes that are also found in eugenic thought. Mace's footnotes were numbered, but there was not always a corresponding numbered cross-reference in the text. When the cross-reference was absent, one was inserted into the text in the place thought most appropriate for it. When Mace referenced figures and plates, he did not insert the number for the figure or plate, but left a blank space. Those omissions have been noted in the text by "-". Plates that the editor believe reflect what Mace intended to illustrate in his plates follow this transcription. They were not inserted into his text because they are not a part of his original text.]

I The Site

Naga-ed-Dêr (the village of the monastery) is not, as its name would seem to imply, a Coptic village. It derives its name from its proximity to the Dêr, but the village itself is essentially Mohammedan, and at present has but one Coptic inhabitant. It is indeed very doubtful whether there ever was a Coptic community of any size on the east bank of the river. From the earliest times, as has been pointed out in the former volumes, the eastern desert has been used as a burial ground by the inhabitants of the Thinite nome capital on the west bank, and it is still so used by the Copts of Girga, a modern town which so far as we can judge occupies a site close to the ancient one of This. The Dêr was probably built long before the village came into being, and, as the distinctive landmark of the neighborhood, gave its name to the new *Naga*.

The exact date at which the site first came into Coptic use is doubtful. The earlier civilization gave us an unwritten series of graves, ranging from early prehistoric to the Twelfth Dynasty, but at this latter date, or shortly after, the site seems to have been abandoned, and later Egyptian, Ptolemaic, and Roman periods are not represented at all. The next graves that we find are Coptic and Coptic of a comparatively late date. There are three distinct cemeteries, those marked 500, 1500, and 2000 in the general plan (Pl. -). One of the burials in Cemetery 2000 contained a coin dated to the third year of Justinian (529 AD), and we may therefore, with a fair amount of probability,

date the material contained in this cemetery to the latter half of the sixth century. The burials in the other two cemeteries appear from this style to belong to about the same period, but our present knowledge of the dating and range of Coptic material does not justify us in making too sure of the point. In any case the beginning of the sixth century would probably be the earliest limit to which one could assign the beginning of Coptic activity in the district.

The three cemeteries all mark sites which had been made use of many centuries before by the dynastic Egyptians; for the casual Copt, as everywhere else in Egypt, seems to have preferred an easily constructed grave in the soft ground of an old cemetery to a decently excavated one in the clean desert. All three were carpeted with Coptic burials, scattered in most promiscuous fashion, and tucked into all sorts of unrespected corners, the superstructures of the old graves being frequently cut to pieces to make room for them. Indeed it is probably to this destruction of the early dynastic superstructures by the Copts that we owe the material published in Volume II of this series. Modern plunderers had started operations on the cemeteries, but had abandoned them, thinking that the remains were all Coptic. For our present purpose there was not much of interest in Cemeteries 500 and 1500, as the graves lay close to the inundation limit, and the burials were consequently in bad condition, the wrappings having in most cases disappeared. Part of Cemetery 2000, however, lay on higher ground, and here the wrappings in many cases were almost perfectly preserved. It is with this cemetery that the present volume is chiefly concerned.

Other evidences of the activity of the Copt at this early period are to be found in plenty in the V–XII dyn. rock-cut tombs. The site is an ideal one for hermit life, for the high desert cliffs come close down to the river and the recluse could pick and choose his place of retreat with the certainty of an abundant water supply. Nor did he have far to seek for a shelter, for the cliffs were honeycombed in all directions with the old rock-tombs. Many of the tombs had of course been covered over and concealed before Coptic times, but a number stood open, and these seem in every case to have been taken into use, and in the usual Coptic fashion sadly disfigured, walls being cut about to suit the convenience of the new occupant and rough graffiti scrawled in all directions.

A *Sixth Century*

The period between the sixth century and the building of the Dêr is a blank, nor is there any evidence as to when the modern Coptic cemetery came into use. The town of Girga which it serves is one of the most important Coptic cemeteries in Upper Egypt, and judging from the size of one cemetery it has evidently been so for a considerable time. It is curious, however, though Girga has commonly been held to derive its name from the Coptic Saint Girgis, there is yet no mention of the town or of a monastery in

its immediate neighborhood in either Abû Salih (XIIIth century) or Maqrizi (XIV century). Leo Africanus on the other hand, writing in the XVI century, describes a convent of Mâri Girgis, usually supposed to have been situated at Girga, as being one of the largest and richest in Upper Egypt. "This," he says, "was in times past a famous monastery of Christians, called after the name of S. George, and being six miles distant from Menshieh [ed.: al-Minshah]. It was inhabited by more than two hundred monks, who, enjoying large territories, possessions and revenues, showed themselves courteous and beneficial unto strangers; and the overplus of their yearly revenues was sent unto the patriarch of Cairo, who caused the same to be distributed amongst poor Christians: but about an hundred years ago, all the monks of this monastery died of a pestilence which spread itself over all the land of Egypt. Whereupon the prince of Menshieh compassed the said monastery with a wall, and erected divers houses for artificers and merchants to dwell in and being allured by the pleasant gardens situate amidst the beautiful hills, he himself with thither to inhabit: but the patriarch of the Jacobites making his moan unto the Sultan, the Sultan caused another monastery to be built in the same place, where in times past the old city stood; and assigned so much allowance thereunto, as might maintain thirty monks."¹

There are some curious discrepancies in this account. If a monastery of the size given by Africanus existed at Girga it must surely have found a place in the lists of Abu Salih and Maqrizi, and must moreover have left some trace of its presence today.

B *? Present Coptic Church in Girga*

Further Girga can hardly be described as a town "situate amidst the beautiful hills." On its west side there are about eight miles of flat cultivated land, and on the east it is washed by the river. The only way to make the place suit the description would be to suppose that the river originally ran to the west of the town, and for that we have no evidence whatever. On the whole it seems probable that the monastery² described by Africanus was not situated at Girga, and that we must look both for a new site for the monastery and for a new derivation of the name of the town.

Before going on to deal with Cemetery 2000 we propose in the next chapter to describe the Dêr and modern Coptic cemetery. It will also be of interest to give, for comparative purposes, a short account of the burial customs of the modern Copt.

1 John Pory's translation. Vol. II p. 902.

2 Possible one of the numerous monasteries in the neighborhood of Ekhmim [ed.: Akhmim] could be identified from the description. That of Deir el Hadid for instance, on the east bank, south of Ekhmim, is almost exactly six miles from Menshieh.

II The Dêr and Modern Cemetery

A *The Dêr*

The Dêr—dedicated to the Archangel Michael—consists of a complex of mudbrick buildings, the actual church, as usually in Coptic Monasteries, being surrounded and almost entirely concealed by later haphazard additions. The whole is enclosed by a wall of considerable height (see Pl. –) [ed.: see Appendix 1, Fig. 1]. At one time there was probably a community living within its precincts, but the buildings are now only used for special occasions, and are looked after by one of the villagers.

The church itself is somewhat unusual in shape, in that its greatest length is from north to south. It consists of sanctuaries, choir and narthex, and in general arrangement is very similar to the church of El Shiukh³ at Dêr abu Makar n the Wadi Natrun, though its system of roofing is different. The sanctuaries are apsidal, and are separated from the choir by a heavy wooden screen, a separate door giving entrance into each sanctuary (see Pl. – a) [ed.: see Appendix 1, Fig. 2]. The narthex is divided off from the choir by three columns, the space between the columns being filled in with a wooden screen. From these columns arches spring in all four directions to carry domes (Pl. – a and b) [ed.: see Appendix 1, Fig. 3]. At the north and south there are side aisles, the northern being open, while the southern is separated from the main body of the church by means of a screen. This probably served as the women's place of worship. The door was, as usual, on the west side, and gave entrance into an additional domed chamber, screened off from the church, which may have served as the baptistery. There are several pictures on the sanctuary screen, but none are of any importance. One is shown on Pl. –. In the middle of the choir there hangs a glass chandelier, and before the sanctuary screen there are small hanging lamps and a number of ostrich eggs. This custom of hanging ostrich eggs in churches is common to Copt, Greek and Muslim alike, and has been variously explained. Some, more particularly the Copts, believe that the eggs are hung in the church as an aid to devotion, serving to remind the worshipper that as the ostrich mother-bird never (according to tradition) removes her eyes from the nest, so he should keep his thoughts fixed steadfastly on spiritual things.⁴ A simpler theory, and probably the correct one, is that the eggs were first introduced as emblems of the resurrection. As a matter of fact the veneration of ostrich eggs goes much further back than either Copt, Greek or Muslim, and has probably come down to all three from a common source. In predynastic Egyptian graves ostrich eggs are not infrequent, and in the later graves they are also occasionally found. The egg, moreover, plays a considerable part in the old Egyptian symbolism—so much so that in the later writing the word “son” is generally written with a single hieroglyphic sign, that of the

³ Butler, *Ancient Coptic Churches I*, p. 298.

⁴ Butler, *Ancient Coptic Churches II*, p. 79.

egg—and it would be quite natural for the early Egyptian Christians, desiring a symbol for the resurrection, to take for the purpose an object which under the old religion had a significance that was almost exactly the same.

Structurally, the most interesting feature in the church is its system of stalactite vaulting, the pendentives here being carried out in brick instead of the usual stone. Its use, moreover, gives us an early limit of date, for stalactite vaulting was not introduced into Egypt until the 13th century (Tomb of El Shâfe'i). Very possibly the church in its present form was built in the 14th century. It does not appear in Maqrizi's list of churches (compiled in that century), but the fact does not necessarily preclude its existence, for the list, though comprehensive, is not exhaustive. It is more than likely, indeed, that there was a church of some kind on the site for several centuries before this. Built in over the doorway at the main entrance to the Dêr (Pl. –) [ed.: see Appendix 1, Fig. 4] there is a tombstone, dedicated to a certain Apa Enoch, which can hardly be later than 8th century, and it was probably in honor of this saint, and on the site of his tomb, that the original Dêr was built. The inscription is given in Fig. 1. For the following translation and notes I am indebted to Sir Herbert Thompson.

	<table border="1"> <tr><td>†ΙΧΧΟΥΖΑΓΙΟ[Δ]</td></tr> <tr><td>ΠΑΜΙΧΑΗΛΟΥΖΑΓΙΟ</td></tr> <tr><td>ΑΠΑΓΙΡΑΤΕΛ ΝΑΝΤΕΛ</td></tr> <tr><td>ΟΣΤΗΡΟΥ ΜΠΕΧΣΕΤΗ</td></tr> <tr><td>ΑΣΑΠΠΕΧΣΕΧΝΤΕΨΗ</td></tr> <tr><td>ΧΗ ΝΤΑΣ</td></tr> <tr><td>ΜΤΟ Ν</td></tr> <tr><td>ΜΜΟΣ ΝΟΥΩΜΝΤ ΝΗ</td></tr> <tr><td>ΩΠ ΕΤΕΑΡΑ Ε</td></tr> <tr><td>ΝΩΧ ΠΕ ΠΕΡΕΣΒΕΤΕΡΟΣ</td></tr> </table>	†ΙΧΧΟΥΖΑΓΙΟ[Δ]	ΠΑΜΙΧΑΗΛΟΥΖΑΓΙΟ	ΑΠΑΓΙΡΑΤΕΛ ΝΑΝΤΕΛ	ΟΣΤΗΡΟΥ ΜΠΕΧΣΕΤΗ	ΑΣΑΠΠΕΧΣΕΧΝΤΕΨΗ	ΧΗ ΝΤΑΣ	ΜΤΟ Ν	ΜΜΟΣ ΝΟΥΩΜΝΤ ΝΗ	ΩΠ ΕΤΕΑΡΑ Ε	ΝΩΧ ΠΕ ΠΕΡΕΣΒΕΤΕΡΟΣ
†ΙΧΧΟΥΖΑΓΙΟ[Δ]											
ΠΑΜΙΧΑΗΛΟΥΖΑΓΙΟ											
ΑΠΑΓΙΡΑΤΕΛ ΝΑΝΤΕΛ											
ΟΣΤΗΡΟΥ ΜΠΕΧΣΕΤΗ											
ΑΣΑΠΠΕΧΣΕΧΝΤΕΨΗ											
ΧΗ ΝΤΑΣ											
ΜΤΟ Ν											
ΜΜΟΣ ΝΟΥΩΜΝΤ ΝΗ											
ΩΠ ΕΤΕΑΡΑ Ε											
ΝΩΧ ΠΕ ΠΕΡΕΣΒΕΤΕΡΟΣ											

Jesus Christ: O holy father Michael, O holy father Girael (sic),⁵ all ye angels of Christ, pray⁶ ye⁷ to Christ for the soul which went to its rest on the 8th day of Mechir, which was Apa Enoch [the]⁸ priest.

5 For Gabriel, of course.

6 ααπ must be a mistake of the stone cutter for ααπ̄ = απ̄, strictly απ̄.

7 ετνα, as it stands, should be translated "who will pray:" but I have no practical doubt that it is dialectic for ετετνε—Fut. III with hortative meaning. For the dialect cf. απ̄ for απ̄. Where is the Dêr? In the Fayûm?

8 The correct phrase would be ετεαπα ενωχ πε πεπερεσβ. The mason has left out one πε, either the copula or the article.

In a large domed hall north of the church there is a well and a square Epiphany tank, and in another part of the enclosure there is a second quite modern church. No Sunday services are now held on this side of the river,⁹ and the Dêr is only visited on the occasion of a funeral, and at the three great yearly festivals—Christmas, Epiphany and Easter.

B *The Modern Cemetery*

The modern Coptic cemetery (see Pls. –), situated on the low desert just behind the Dêr, and divided into two parts by a foothill, covers a considerable extent of ground. It is much more pretentious than such cemeteries usually are, and its graves show an unusual amount of elaboration. The superstructures (see Pls. –) are all very similar in character: they consist of a long barrel-vault which covers the whole length of the grave, the arch either rising straight from the ground, or from a low platform. They are constructed of crude or baked brick. In the former case a coating of white plaster is added, covered in most instances with an elaborate painted decoration. With baked bricks plaster is as a rule considered superfluous, but a very effective design is sometimes produced by building the bricks on a zig-zag, and picking out the alternate courses with white. The graves in every case run east-west. On many of these superstructures we get an interesting survival of the old “false door” and place of offerings in the shape of a panel of inscription—sometimes a tablet in a regular recess—which records the name of the deceased and the date of his death, and concludes in most cases with a pious admonition to the passerby. These are almost always at the west end of the southern side. Some of the graves have one or more additional recesses, but the tablets in these—usually of wood—seem to be more in the nature of ornament. The inscriptions are almost always in Arabic. Three are given on Pl. – [ed.: NED-C-8552?], and read as follows:—

- a. “(The tomb is a door through which all must pass. Death is a) cup which his drained by all. This world should be a world of worship ... Remember, O Lord, thy servant Gergis Yusef, son of ..., in the bosom of our blessed Fathers Abraham, Isaac and Jacob, in the chorus of the living, in the Paradise of Bliss, Amen. In the year 1586 Coptic.”

If we take the usual Coptic dating—i.e. from the beginning of the reign of Diocletian—this gives us AD 1870 for the date of the grave.

9 In the eighteenth century, according to Pococke, the church seems to have been used regularly by the Girga Copts. In his “Travels in Egypt” he states—“We came to the poor little convent of Girge, on the east side, under the rocks. To this place the Copts of Girge come to church, not being allowed a church in the city.” [ed.: Pococke, Richard, *A Description of the East, and Some Other Countries. Volume the First. Observations on Egypt*, London, 1743, p. 82.]

- b. "O thou who passest by my tomb, be not amazed at my condition. Yesterday I was even like unto thee, and in time thou shalt be like me. Remember, O Lord, thy servant Gergis Simon in the bosom of thy Saints. In the year 1309(?) Arabic."

It is very unusual for Copts to date from Hegira. If our date is right this tomb was made in 1891.

It is impossible to say when this cemetery first came into use. Graves such as these very quickly fall into decay and leave no trace behind them, and it is probable that few, if any of the superstructures now standing go back more than a hundred years. It is only reasonable, however, to assume that the cemetery is at least as old as the Dêr, and may very likely be older.

C *Modern Coptic Burial Customs*

The burial customs of modern Copts are in many ways very similar to those of his ancestor of the sixth century, and this fact gives us an excuse, if excuse be needed, for a short account of what might otherwise seem somewhat outside the scope of the present volume. It will be interesting to note the changes which thirteen hundred years have produced, and to see whether the change is greater or less than that of any similar period in Egyptian history. Naturally customs vary a little in different part of the country, and the following account of practices used now in Girga will be of most interest in this connection.

The burial pits are about a meter and a half deep, with a chamber on one side, or sometimes on each side, just high enough to take the burial.¹⁰ These chambers are subsequently bricked up, the pit is filled, and the superstructure built directly over it. Like the early burials the pits run E-W. The bodies are prepared for burial almost immediately after death, and are almost always buried on the day of death. They are clothed in a shirt and drawers of white cloth, made specially for the occasion. They are then placed on a wide shawl which is folded over them. Ordinarily a single cotton shawl is considered sufficient, but richer people sometimes have two or more shawls, the inner one being of silk. The shawls are tied with strips of cotton round the feet, never with rope. The body thus prepared is carried to the grave on a wooden bier,¹¹ covered with a pall, black for a woman or priest, white for a man.¹² The funeral is attended by the men friends and relations: women never go to funerals, and only visit the cemetery three times in the year, at the great festivals. No chant of any kind is sung during the funeral procession. Arrived at the grave the body is placed in the chamber in a recumbent

¹⁰ Similar chambers are used by the Mohammedans.

¹¹ In some districts of Upper Egypt wooden coffins are used. These are placed in an open pit, and not in a bricked off chamber.

¹² This usage is very similar to that of the Mohammedans, who use red for women and white for men.

position, legs and arms straight, head west, turned slightly over on the side to face north.¹³ Wooden headrests are sometimes used, and occasionally a piece of money is placed in the right hand, but otherwise there are no burial deposits of any kind.

On the three yearly festivals—Christmas, Epiphany and Easter—all the Copts, men, women and children, who can possibly arrange to do so spend the night and greater part of the day on the cemetery, the only exceptions being those in whose families there has been a recent death. Provisions are brought which are distributed to all who may need them.

Burial customs in Cairo differ considerably from those of the upper country, as may be seen from the following notes, furnished by a Coptic student at the Kasr el-Aini School of Medicine.

The grave consists of a subterranean chamber, reached by a flight of three or four steps. In this the coffins are placed side by side. Superstructures above these graves sometimes assume considerable proportions, and even include rooms in which the relatives may lodge.

After the death the body is washed with soap and *lifā* fiber, first in hot water and then in cold, men being washed by men and women by women. It is then clothed in a complete suit of ordinary clothes. Only jewels or personal ornaments are placed with the body, or in the case of a priest a crucifix. The wrapping consists of a single large shawl of cotton or silk. This is folded in two and the sides sewn together. Into the open bag thus formed the body is introduced the ends are folded over head and feet, and a bandage is tied round the waist to keep the whole in position. The body is then placed in a coffin—usually of wood, though stone is occasionally used—together with some flowers and powdered leaves of perfume. Before the coffin is closed for the last time water and dust are sprinkled over the body by the priest. The color of the coffin varies according to the age of the deceased, white being used for young people and black for old. They are frequently decorated with crosses. Until recent years women used to follow the funeral, but now the funeral processions are composed entirely of men.

The position of the body in the grave is always the same, flat on the back, with the face turned to the east, i.e. towards Jerusalem.

III Cemetery 2000

Cemetery 2000 is situated on a bluff just north of the second ravine. It is bounded on the west by the road along the edge of the cultivation, on the south and southeast by

13 Local north that is to say, according to the direction of the river: strictly it is north-east, i.e. Jerusalem-wards. The Mohammedan position is very similar, but the right hand is placed under the head, and the face is turned to the east, towards Mecca.

the old watercourse, while to the north it merges gradually into the steep slopes of Cemetery 3500. In Pl. –, taken from the top of the slope, Cemetery 2000 is shown in the foreground; beyond are Cemeteries 3000 and 1500, and on the extreme left, in the distance, the village and Dêr.

The surface of the bluff was already, before Coptic times, well pitted with VI–IX dyn. Graves, while the slopes below and above were honeycombed with rock-cut tombs of the same date. These will be described with the other tombs of Cemetery 3500 in a later volume.¹⁴ In the general plan (Pl. –) the early tombs are marked in black, while those of the Coptic period are shown in red. The Coptic graves were constructed above and around the older ones in most haphazard fashion; though haphazard is perhaps hardly the right term to apply to the work of a man who deliberately chooses the softest ground to dig in. Unfortunately the direction of the old pits did not, as a rule, conform to that which custom demanded the new should take, so that the Copt could not make the fullest use, as he doubtless would otherwise have done, of the work of his predecessors. Most of the VI–IX dyn. pits have Coptic graves running across them, and as the pits seem in most cases to have been plundered after the Coptic period it is a common sight to see a Coptic burial cut off sharp in the middle, or left partially overhanging (see Pl. –).

Occasionally the Copts went still further, and actually made use of the original old grave, in some cases appropriating the coffin itself. Instances of this are shown in Pl. –: –

- a. represents a VI–IX dyn. pit with an inscribed wooden coffin in the chamber. The burial had been disturbed, either in pre-Coptic times or by the Copts themselves, and the lid of the coffin had fallen in. Inside this coffin, supported by the remains of the former burial and the ruins of the lid, there was a Coptic burial [ed.: N 2631].
- b. shows a Coptic burial placed in the innermost chamber of a rock-cut tomb [ed.: N 2439].
- c. gives us an excellent example of the careless and irreverent manner in which the Copts disposed of their dead. The excavation of the grave brought to light a wooden coffin of the small square type so common in the VI dynasty. The coffin, constructed as it was for a contracted burial, was useless for their purposes, and the most natural course for them to pursue would have been either to move the coffin out of the way, or to shift the position of the new burial a little to one side. They did neither. The lid was removed, one of the sides was broken down, the original occupant of the coffin was unceremoniously pushed out of the way, and the new burial was deposited, body inside and legs projecting. Then, that no touch of the grotesque might be wanting, the lid of the coffin was replaced.

14 See Vol. II in this series, page –.

In the photograph, the skull and small pot seen on the further side of the coffin belong to the early burial.

- d. is a still more glaring instance of Coptic barbarity. The original grave contained a VI dyn. basket burial,¹⁵ and this the Copts deliberately broke up and destroyed, a rough wooden headrest and a few reeds from the basket alone remaining to show that the grave was a reused one.

In e. we have another case of wanton destruction, an early burial being almost entirely broken up to make room for the new one. In the photograph, part of the original coffin, with the skull and a few bones, can be seen, still in position, to the left of the feet of the Coptic burial [ed.: N 2203?].

In f. we have a Coptic burial introduced into the chamber of an early pit. In this case the early coffin and burial were not disturbed [ed.: N 2630?].

We have seen the absolute want of respect that the Copts showed towards the dead of their ancestors: for their credit—or further discredit from another point of view—we must add that they showed an almost equal want of respect towards their own. A good instance of this is shown in the next plate (—). 3747 F was a large VI–IX dyn. rock-cut tomb chamber. In this, heedless of propriety or possible contamination, some twenty-five bodies had been piled; not regularly arranged with a due regard to the proper direction, but indiscriminately thrown one upon another, filling the chamber from floor to roof, the final burial blocking the doorway, half in, half out. The plate shows a series of photographs taken in the course of the clearing, and gives a better idea than words can of the manner in which the bodies must have been pitchforked—there is no other word to describe it—into the chamber. Of the bodies 6 were men, 10 were women, and the rest were children. It is impossible to say why this method of internment was adopted. The burials were not appreciably poorer than the others, so that we cannot explain it on grounds of economy. They may possibly have all belonged to one family, or have been the victims of some sudden epidemic.

Apart from this group the bodies were usually buried singly, though a few instances of multiple burials were found. Examples of this are shown in Pl. —. In a. we have a group of 5(?) burials, jumbled together in much the same fashion as those in the rock-cut tomb.

In b. the juxtaposition of the bodies was probably accidental: indeed the burial on the right may be old Egyptian.

In c. we have two children, buried one above another at the end of an old grave.

15 These were contracted burials in oval reed baskets.

In d. we have (in the foreground) two burials side by side, one a woman and the other a child. Beyond there is another Coptic burial; beneath the three there is an old Egyptian coffin, while to the left there is another old coffin.

In e. and f. there are two examples of double burials, in the one case a woman and child, and in the other a man(?) and child.

Types of the ordinary class of single burials are shown in Pl. – (wrappings preserved) and (wrappings gone). The graves are roughly cut, and are just large enough to contain the body, the head end being wider than the feet. They vary in depth from 50–150 cm.

Of surface construction there is hardly a trace remaining in the whole cemetery, but we must by no means take it for granted that there never were any superstructures. We have seen in the case of the modern cemetery that it is possible for a superstructure to be effaced completely in a comparatively short space of time, and it is at least extremely probably that the graves were covered by some sort of rude memorial. Gayet states that at Antinoe the tombs of the “second period”—AD 320 to 620—were covered by rectangular enclosures of brick,¹⁶ and from the evidence of two tombs in this cemetery (Nos. – and –) it would appear that a somewhat similar superstructure prevailed here. Round the tops of the graves (Pl. –) there were the remains of rectangular brick retaining-walls, half brick thick, with a present height of – cm. That belonging to No. – was fairly complete, but of only the north side and part of the west side remained. On their western aces there were two projecting buttresses, which were apparently rounded. These were probably intended merely for ornament, but it is tempting to connect them with the “false doors” in the west faces of the early mastabas.¹⁷ As to the height of these structures and method of roofing—if roofed they were—we have no direct evidence. There is one fact, however, which has a considerable bearing on the question, and that is the extraordinary similarity that exists between the modern Coptic tomb and the XXVI–XXX dynasty wooden sarcophagus. A good illustration of this is afforded by the room of late sarcophagi in the Cairo Museum, which presents a strikingly similar appearance to that of our modern Coptic cemetery. Having then a coffin of a distinctive shape in the 8th–4th centuries BC, and a superstructure of practically the same shape so many centuries later, and knowing that the later Copts at any rate did not use coffins, it is reasonable to suppose that the Coptic superstructures which intervened between the two periods should be of the same type. The transference of the shape from the coffin to the superstructure presents no difficulties, though

16 Gayet, *Le Costume en Égypte du III^e au XIII^e Siècle*, p. 13.

17 The places of offerings in the early graves on this site were always on the west (i.e. the river) side.

unfortunately we know so little of the archaeology of the first few centuries of the Christian era that we have practically no evidence on which to base any theory. It is possible that the shape was common to both coffin and superstructure in the early period; or again it may be that at the time when coffins were abandoned, the shape of the coffin was transferred to the superstructure. Probably, then, the old Coptic superstructure was in general appearance very similar to the modern one, and the brick rectangles which we have here, and which Gayet refers to, may have been the bases for rough barrel-shaped vaults.

In Pl. – we have the remains of superstructure of a different type. This was situated just west of the entrance to the crowded rock-tomb referred to above, and consisted of a circular wall, one brick thick and about – cm high, with a diameter of – cm. In the photograph the entrance to the chamber is on the right. This structure may have supported a dome; it probably had some connection with the burials in the tomb.

So little is known of the old Coptic period that it is impossible to date material with any degree of accuracy. Fortunately in this cemetery we have dating evidence of some value in the shape of a coin (Pl. –) which was pierced and hung round a child's neck as a pendant. It is dated to the third year of Justinian, that is to say AD 530. Of course it would be possible for a coin to be kept for some time before being used in this way, but the period would probably not exceed fifty years, and we may with some confidence assign our cemetery to the latter half of the sixth century.

IV The Burials

A *General Details*

The bodies in this cemetery were not, in the strict sense of the word, mummified, though a certain amount of care was taken to preserve them, and the bodies were so elaborately wrapped that they present on the outside all the appearance of mummies.¹⁸ The preservative used was common rock-salt, such as occurs in plenty in the desert round, and even in the cemetery itself. This was not applied in solution, but was used in its crude state, being bound in with the wrappings. With it there were in most cases a number of small globular fruits.¹⁹ The system was crude, and by no means to be

18 The bodies which belong to the earlier centuries of the Christian era were very completely mummified, and it would be interesting to know when and why the practice of mummification was abandoned. In the present state of our knowledge, however, such speculation is valueless, and we must hope that in the near future this dark period in the archaeological history of the country may be satisfactorily filled up.

19 A sample of the preservative material was sent to M. Lucas, of the Egyptian Government Survey Department. We are indebted to him for the following note—"The sample consists

commended from an excavator's point of view, for in certain cases it had preserved the bodies just long enough to make them unpleasant to deal with. The salt, moreover, had penetrated right through the various layers of shirts and wrappings, rendering the cloth stiff and brittle, and very difficult to handle. The condition of the burials varied considerably. On the western side of the cemetery, that adjoining the cultivation, there was never anything left but the bare skeleton, but on the upper side, where the ground was drier, the wrappings were as a rule well preserved, and the bodies themselves were in some cases almost perfect (see Pl. -). The hair was frequently in a perfect state of preservation (see Pl. -), and occasionally eyebrows and lashes, remains of beard, or even in one case of moustache, were still in position. The color of the hair was very constant, a dark brown, inclining in some cases to auburn. Both men and women seem to have worn the hair long, but a curious and somewhat unexpected distinction can be marked between that of the two sexes. With women it was either straight (Pl. -) or wavy (Pl. -), showing no marked tendency to curl; whereas with men it was frequently very curly (Pl. -), so elaborately curly in fact that we are almost forced to the conclusion that the effect was produced by artificial means. Beards seem to have been worn quite short, and our single specimen of moustache (Pl. -) was thin, with upturned points. Children also seem to have worn the hair long, though we have one case at least—that of a boy—where the hair was cropped quite close (Pl. -).

The position of the body in the grave was constant—on the back, straight out—the only variation being that the arms were occasionally crossed over the body instead of being straight at the side. The grave, as we have stated, was with rare exceptions oriented east-west, and in it the body was always laid head west. On the few occasions in which the body for some reason or other, such as the reuse of an old grave, was placed in a north-south position, the head was always to the north. Unlike the modern burial, in which the face is inclined to one side, the skulls were always face upwards. In many cases the neck was bent forwards, so that the chin rested on the breast, but it is possible that this was not intentional, but was the result of the wrapping and strenuous tying up which the body had to undergo in the course of its preparation for the tomb.

Many of the bodies were in too fragmentary a state for the sex to be identified. Of the examples which could be sexed 43 were adult males, 38 were adult females, while

essentially of two entirely separate and distinct substances, one of which is common salt (sodium chloride) containing small amounts of the usual impurities such as iron, lime and magnesia compounds, together with a little sulphate. This salt however does not contain any sodium carbonate and hence is free from natron. The other portion of the sample consists of small globular fruits much crushed and broken and each containing apparently three seeds. The exact number of seeds in the fruit however cannot be stated with certainty owing to its broken condition. This fruit has not been identified."

40 were immature, many of them being quite small children. In one case (No. 3747 F 5) a woman had died only about a month before she would have given birth to a child.

Broken bones were comparatively rare. In 3747 F 11 (female) the right humerus had been broken, and the broken ends had receded and worn down to points. The ball of the left femur had also broken off, and was much decayed.

In 3747 F 13 (male) the right ulna had been broken near the elbow. The radius was not affected.

In 2004 (female) the left femur had been broken.

2134 (male) provides us with one of the most interesting examples of ancient surgery that has yet been found (see Pl. –), namely splinting for a broken patella. The left patella had been snapped in half. The joint was tightly bound round, and a splint of palm-wood, 18 cm long by 4 cm wide, inserted in the bandages below the knee. Outside the splint there was a large pad of red and brown striped cloth, apparently torn from an old shirt. The whole was tied round with red woolen cords. In the plate (a) shows the bandaging over the upper part of the joint; (b) shows the bandaging over the lower side, with the splint; (c) shows the lower side after the removal of the bandages, while (d) shows the upper side and the actual break. It is doubtful whether gangrene intervened, or whether the patient had received other injuries which caused death, but in any case the patient died soon after the operation, and was buried with the bandages and splint still in position. Two other instances of splinting have been found in Egyptian graves, both cases occurring, curiously enough, in cemetery 3500, within a hundred yards of the site of the present grave. In the one case it was the femur that was broken, and in the other the radius and ulna. Both belonged to the VI–IX dyn. period.²⁰

In 2410 (male) there was a bad fracture of the femur.

In 2413 the bottom of the right ulna had been broken, and had worn down to a sharp point. The left ulna had also been broken near the middle, and the two ends, without being properly reset, had grown together.

The Copts of this cemetery were not swathed in bandages, but were buried in their ordinary everyday clothes. Nor were these burial clothes of a special type, or even bought new for the occasion, as is evident from the fact that many of the garments used show distinct signs of wear, and in some cases had even been carefully patched and darned. The outfit was not elaborate, that of the woman differing in but few essentials from that of the man. Both were clothed in shirts²¹ of the same type, one, two, or even three being used, and, in the case of the men at any rate, this was all they wore. A few of the shirts were plain, but as a rule—with men women and children alike—they were more or less elaborately decorated. In a few examples the shirts were worn inside

20 See paper by Dr. Elliott-Smith in .

21 For a detailed description of the shirts and other garments see Chapter v.

out, and occasionally the arms were not inserted in the sleeves. Three of the women (3747 F 5, 2636 and 2700) had belts of cloth round the lower part of the body. With the first, the case mentioned on page—the belt was between the inner and the outer shirt, and consisted of a narrow strip, folded to a width of about 6 cm, which went once round and was fastened at the back. That belonging to 2636 was next to the skin. It consisted of a small plaid shawl with fringed ends, about 80 cm long by 70 cm wide when open, and like the other was tied at the back. In 2700 the belt consisted of a piece of ordinary cloth, folded to a width of 4.5 cm, and was worn outside the shirt.

The men wore nothing in the shape of a headdress, but the women frequently had net caps or hoods, or both—they were so crushed and stiff with salt that it was difficult to make any distinction (Pl. –). The copper circlets, of which three were found, were all with women. None were in place on the head, and, were it not for the fact that circlets of other materials were found actually in position, it would seem more natural to suppose that they were worn round the neck. One of them, in fact, was actually found in this position (Pl. –), but it might easily have fallen so subsequently. Of the remaining two, one was found by the side of the head, while the other was lying in the position of the head, though the skull itself was missing (Pl. –). Burials 4511 and 2006 wore circlets composed of cloth and palm-leaf (Pls. – and – a–d). Both were children, the former probably a girl and the latter a boy. With burial 2134, a man, there was a circlet of twisted red wool. This again was not actually in position, but it was lying close to the head. The purpose served by the circlet was presumably to keep the head-shawl in position. The tightly wound turban had not yet been introduced. In the present day indeed the Bedouin Arab and the Syrian peasant both wear a loose head-shawl and a stiff camels-hair binding that is to all intents and purposes a circlet. The cloth and palm type a circlet seems somewhat inadequate for everyday use, but the owners may have kept them for show occasions.

Sandals were very rare. They occurred in three instances, and in only one of the three (No. 2414) were they actually worn (see photograph on Pl. – f, with the foot still in position). The body was that of an adult whose sex was not determined. In Grave 2812, that of a child, a single sandal was found close to the right hand of the mummy, bound in with the wrappings. The third example was from a child's grave on another part of the site (Pl. – d). In all three cases the sandals were of leather.

With the exception of signet rings, the use of jewelry and personal ornaments was entirely confined to the women and children. Even signet rings were uncommon in men's graves, only occurring in four examples. In the graves of the women and children, however, rings were found in considerable numbers, the materials being bronze, iron, silver, bone and twisted hair (Pl. –). They were worn on either hand, but, as far as our evidence went, on the third and little fingers only. The subjoined table gives all the evidence of position that we were able to recover:—

Grave No.	Material	Position
2002	1 bronze	L hand
2004	14 bone	R 3rd finger 6, little finger 2 (see Pl. – a) L hand 6
2007	2 bronze	R hand
	1 silver	L hand
2102 A	1 bronze	L 3rd finger
2201	1 bronze	L hand
2506	2 bronze	R hand
2611	1 bronze	L hand
3747 F	1 bronze	L 3rd finger
	1 iron	L little finger
3747 F 4	1 bronze	R hand
	1 twisted hair	L hand
3747 F 5	2 bronze	R hand
	3 bone	R hand 2, L hand 1
3747 F 10	1 bronze	L hand
3747 F 22	3 bronze	L hand
	1 bone	L hand [ed.: in TC, 2 bone rings]

In Grave 3747 F 19 four iron and two bronze rings were found on the left side of the body, but some distance away from the hand. They were probably all tied together, for there was a wisp of thread by them.

Beads (Pl. –), curiously enough, were comparatively rare, only occurring in 15 burials (colored glass and rough stone).

Bracelets (Pl. –) were fairly common. They were usually made of bronze, but iron, bone, ivory and twisted palm-fiber were also found. They were worn on either arm, and frequently on both, and on any part of the arm, from the wrist to above the elbow.

Anklets were only found in two graves. In both instances the burials were of children, and it is noteworthy that in neither case were there necklaces, earrings, finger-rings or bracelets. Four examples, of which the exact position was doubtful, were found in the one case (Grave 2077), and two in the other (Grave 2202), one on either ankle. All six were of bronze.

Earrings (Pl. –) occur 14 times, the material being gold (one example), silver and bronze, the last mentioned usually having bead pendants.

Crosses (Pl. –) were found in 8 cases. They seem usually to have been attached to the necklace, as many as three being found with one burial. Most of the crosses were

of bronze, but two were of silver, and one was an elaborate combination of bronze chain-work and beads.

In Pls. – the personal ornaments from the more elaborate burials are shown in groups. In some cases the outfit is very complete. Burial No. 3747 F 4 for example had:—

a bronze circlet
 earrings of bronze, with gilt glass and carnelian beads,
 a necklace of glass beads and small shells with a pendant silver cross,
 on the right wrist one bracelet of bronze and two of twisted palm,
 above the right elbow two bronze bracelets,
 on the left wrist one bracelet of bronze and one of twisted palm,
 above the left elbow three bronze bracelets, one with a key attached to it,
 on the right one bronze ring,
 on the left hand two rings of twisted hair,
 by the head a small glass bottle.

Small glass bottles (Pl. –) were found in position in two burial, both women. In each case the bottle was wrapped up with the body, one (3747 F 4) being by the head, and the other (2636) by the right hand. Pottery seems never to have been placed in the grave with the body. The few pieces found (Pl. –), and they were mostly broken, were always in the filling near the surface. The only other objects found in position with the burials were a bronze dipper (Pl. –), which lay close by the head of 2417 (male) and a small leather bag (Pl. –), which was attached to a leather cord and hung round the neck of 3747 F X (male).

B *Preparation of the Body for Burial*

So far we have confined ourselves to the body and to the personal possessions that were buried with it. There remain the wrappings, which were elaborate and complicated; and of these we shall probably be able to give a more intelligible account if we reverse our field notes, and describe the actual process of preparation for burial. In Plates – there are a number of series of photographs taken during the unwrapping of the various bodies to show the successive stages of the wrapping process. For our present purposes we must read these series of photographs backwards, starting with the skeleton, and working gradually up to the completed mummy.²² There are of course many peculiarities and minor points of difference in the wrappings of various mummies, but the general idea is the same in all. Such minor details may be left to the

²² The term "mummy" is misleading, but there is no other word available for a wrapped-up burial.

catalogue of burials in Chapter VI, and it will be sufficient here to give a broad outline of the method employed.

In the first place, and we must notice this before going any further, there were no coffins; nor, apparently were biers used to convey the body to the cemetery. Instead, the body was rendered stiff for carrying by the insertion of two or more long sticks or poles *inside* the wrappings. Palm wood was naturally in commonest use, but branches of acacia, tamarisk, and other trees were also found. The sticks were usually placed underneath the body, but occasionally two were deposited on either side of it, and in one case no less than six were used, three above the body, and three below it. The adjacent ends of the sticks were fastened together, notches being cut in the wood to keep the cord in position. In default of sticks a flat board was sometimes employed; in fact anything was used that happened to lie handy, in one instance an old spade even being requisitioned (Pl. –).

The bodies were not swathed in bandages like the early mummies, but were simply wrapped up in a series of shawls, each one being applied separately. The shawls were of varying quality of cloth, ranging from coarse sackcloth to the finest linen. As a rule they were a good deal longer than the body, and of sufficient width to envelope it completely, though for certain purposes smaller finer shawls were used, which did not wrap round, but were placed loosely on top. The number of shawls used varied considerably: in some cases a single wrapping was considered sufficient, while in others there were four, five, or even six. As a general rule the finer shawls were used nearer the body, and the coarser ones outside; though the finest one of all was usually kept for the last, to cover up the binding cords and to act as a kind of pall. The method of wrapping was as follows—

The innermost shawl was laid flat on the ground, and the palm or other sticks placed lengthwise upon it. The body, dressed in its one, two or three shirts, as the case might be, was then lifted, and deposited on or between the sticks, care being taken to leave an excess of shawl at both head and feet. The head usually rested directly on the shawl, but in one example (3747 F 17) there was a neck-pad, composed of folded cloth covered with red net (Pl. –). From the appearance of the bodies this part of the ceremony was not too carefully and reverently performed, as the shirts, in the majority of cases, were rucked up to the small of the back. The body in position, a quantity of salt was sprinkled upon it, mixed with crushed fruits and, occasionally, sprigs of some aromatic herb (Pl. –). The sides of the shawl were then thrown back over the body, the right side first as a rule, and then the left, and were sewn together or tied round with cord. Next, the excess of cloth at the ends was folded in over the head and feet, the extra fullness at the head end being utilized to form a kind of pad over the face; and, finally, a cord or strip of cloth was tied round either end to keep everything in place. The second shawl was then laid out and the process was repeated, and so with the third and fourth until the required number had been used. Special attention was paid in the wrapping to the protection of the face. As stated above, the excess ends of the

shawl wrappings were utilized as pads for this purpose, and, in addition, extra padding of various kinds was introduced between the successive layers of cloth. This in some cases assumed absurd proportions, and gave a somewhat grotesque appearance to the mummy (see for example Pl. –). The padding usually consisted of waste cloth—old shirts, torn shawls, and scraps of all kinds—but in 11 instances grass, palm fiber, or chopped straw, was used instead, either loose (Pl. –) or tied up into small bundles (Pl. – and –). In 2416 the padding was very elaborate and merits special description. Placed immediately on the face itself there was a quantity of very fine soft fiber (Pl. –). Above it there was a shawl which enveloped the whole body, and above this again there was, first a quantity of chopped straw, and then five small bundles or faggots of straw (Pl. –), each bound separately, and then all five bound together. These were kept in position by a cloth wrapping, which went right [over] the head and was fastened with cords (Pl. –). Over this there came the outer shawl of sackcloth, which was corded round in the usual way, but had in addition a number of extra bindings round the head, composed of thin strips of sacking, to ensure that the padding should not slip out of place (Pl. –).

The outermost of the wrapping shawls in almost every instance consisted of rough sackcloth. This in place, the mummy was subjected to a very elaborate system of cording. Five slightly different methods of binding could be distinguished, though all based on much the same principle. In each case a double series of cords was involved, a longitudinal series, looping round the head and feet, and a transverse series, encircling the body. These five methods are shown in diagram in Figs. –.

1. Fig. – shows the simplest method of binding. The transverse cords were fastened first, either straight round the body (Pl. –), or crossing each other to form a kind of network (Pl. –). The longitudinal bindings were then added. They consisted of a varying number of cords, which were looped round the head and feet, and then fastened together to run straight down the center of the body. Occasionally a few extra transverse cords were added to keep the longitudinal ones in place. Five examples of this type of cording were found.
2. In Fig. – we get a slight variation. In this case the longitudinal cords, instead of uniting and running down the center of the body in one group, were fastened in such a fashion that they formed two parallel groups (Pl. –). Only two examples of this were found (see Mace-Fig5).
3. The method of binding in Fig. – was considerably more elaborate. Here the longitudinal cords were the first to be applied. They were not fastened together in any way, and therefore ran in parallel lines down the front of the body. A succession of transverse bindings were then added. These passed round the body and coming up on either side looped over the two longitudinal cords, first one, and then the other; in other words, coming from under, they caught into the near and far cords alternately (1). Thus, when the transverse bindings were drawn tight, the longitudinal cords crossed each other between each binding, assuming the arrangement shown in (2). Six examples of this were found (see Pl. –; Mace-Fig6).

4. Here we meet with a new element (Fig. –). A few preliminary transverse bindings were first applied. Next the longitudinal “head and feet” bindings were added, and, to keep them in position, an additional cord was introduced, which ran between them, and lopped over either side in turn. To these succeeded the regular series of transverse bindings, looping into the longitudinal cords and passing underneath; and finally there were in some cases a number of additional cords, which completely encircled the body (Pl. –). Nine examples were found which could be assigned definitely to this group (see Mace-Fig7).
5. This was an elaboration of the last method. The longitudinal bindings were divided into three, and therefore a double set of inner looping cords were required to keep them in position (Fig. –). Above there was a network of transverse bindings, which covered the whole body, fastening round each other, and looping into the longitudinal cords (Pl. –). Only one example of this was found (see Mace-Fig7).

The 23 burials quoted above were the only ones which were sufficiently well preserved for the method of binding to be noted accurately. There may have been a number of other variations. The binding cords consisted of palm fiber, and usually consisted of two strands twisted together. There were, however, occasional instances of a finer variety of cord, made by the twisting of two strands, each of which was composed of three minute strands. Strips of coarse cloth were occasionally used in place of cord. These were not haphazard lengths cut from a shawl, but regularly woven tapes, a decorative effect being produced by alternating different colored threads.

Baled and corded till it had lost all semblance of human form, the mummy was now ready for transport to the cemetery. In some cases however—possibly in all, for the outside wrapping would be the first to disappear—there was yet another covering to be added. This consisted of a shawl of a finer quality of cloth than that of any of the inner wrappings, either colored throughout, or decorated with elaborate inwoven designs in colored wool. Its object was doubtless to conceal all defects in the inner wrapping, and to give a more dignified appearance to the mummy. It covered the top only, and was fastened by tying or sewing the corners together round head and feet.

V Notes on the Objects Found

A *Clothing and Wrappings*

The garments of the sixth century Copt were, from a dressmaking point of view, of an engaging simplicity. Cutting out there was none; and all problems of piecing and fitting were obviated by making each garment complete in a single piece in the loom itself.²³ Fig. – illustrates the method by which this was accomplished. Beginning at

23 This must surely have been the type of garment referred to in St. John's Gospel, Chap. 19, v. 23.

the end of one sleeve, and allowing for double width, a band was woven for the estimated sleeve length. The weave then widened on either side to form the back and front of the skirt, and finally narrowed down again to the original size for the other sleeve. Removed from the loom the cloth was folded double; the edges c ... e and l ... i respectively were sewn together to form the sleeves, and b ... f and m ... h respectively to form the sides; a hole was cut for the head; and the shirt was made. It is difficult to see why this method of beginning with the sleeve, necessitating as it did a very wide loom, was adopted, when it would certainly seem more natural to begin with the bottom of the skirt. It may have been found to be more convenient in dealing with the shirt decoration, which, as we shall see later, was added while the cloth was still in the loom. Whatever the reason there was evidence that this was the method that was most usually employed, a,c,e,g,i and l being almost invariably selvage edges, while b,d,f,h,k and m were warp ends, generally twisted up to form a cord border.

A shirt of this description must have been extremely awkward and uncomfortable to wear, the sleeves in particular presenting difficulties owing to the excess of material at the shoulders. To obviate this the majority of the shirts were not sewn all the way up at the seams, the sleeves from the wrist or elbow to the shoulder, and the sides for a considerable distance down, being left open. The wearer could thus, if he were engaged in manual labor, or wanted for any other reason to have free play for his arms, slip them out of the sleeves altogether, and either tie the sleeves round his neck, or leave them to hang loose. In the climate of Upper Egypt this method of dispensing with the sleeves on occasion would have distinct advantages. The neck opening was usually a straight slit (Fig. 1) but sometimes an extra cut was added at the bottom (2), and occasionally, either on the right shoulder or the left, there was an extension of the cut (3). In this case a toggle of cloth was sewn on at the side of the neck on one side, and a loop to button it to on the other. The cut neck-edges were oversewn, or hemmed.

In six instances, due probably to repair rather than to original design, the shirts were made of two pieces of cloth joined together, the join being a straight one across chest of waist. Three instances were found of tucks on the body of the shirt, two being simple narrow ones, while the third was a large double tuck that reduced the length of the skirt by 20 cm. In one instance there was a narrow tuck on a sleeve. Darns were not infrequent.

Exact measurements as to the size of the garments were extremely difficult to come by, even in graves in which the cloth was comparatively well preserved. Owing to the rigorous constriction that the bodies had undergone in preparation for burial the shirts, ill-fitting and baggy as they must have been at the best of times, were gathered into innumerable folds and pleats. There were, moreover, thoroughly impregnated with salt, and therefore stiff and intractable. Immersion in a bath with several changes of water, followed by careful ironing, was necessary before they could be considered safe to handle. In some cases the cloth had hardened to such an extent that it was necessary, in order to separate the shirts from the bones, to put the whole body into

the river to soak. The few measurements that could be secured are given in the following table:

Tomb No.	Length	Width	Sleeve length	Sleeve width
2002	90 cm	79.5 cm	36 cm	?
	95	97	36.5	11 cm
2006	?	100	?	?
2009	117	111	45	?
	140	?	?	?
2133	?	110	?	?
2134	114	?	?	?
2611	88	84.5	?	?
2636	128	103	42	12
2812	63.5	?	?	?
3747 F 1	127	72	?	?
3747 F 19	115	c. 120	?	13.5

A few of the shirts were plain, but the majority were ornamented with more or less elaborate designs in colored linen or wool. As is usual in Coptic textiles these designs were in almost every case loom-worked and not embroidered: they form that is to say a part of the original fabric, instead of being worked on to the finished cloth after it had been taken from the loom. Tapestry-weaving is the term that has usually been applied to these textiles, but, strictly speaking, it is an incorrect term to use, since the patterns were probably worked on to the warp threads by means of needles, rather than actually shuttle-woven. "Weft-mosaic" has been suggested as an alternative that more accurately described the method of working.²⁴ True embroidery does of course occur. A few examples were found in the cloths under discussion, the needle being used to outline certain parts of the pattern, or for small independent designs, but, as a general rule, the complete design was filled in before the cloth was taken from the loom.²⁵ In few instances, the weft threads were of red throughout.

Fig. — shows the commonest type of shirt decoration at this period, with bands crossing the shoulders and running down back and front, medallions on the shoulders

²⁴ Laure E. Start, *Coptic Cloths*, p. 15 (Bankfield Museum Notes, Second Series, No. 4).

²⁵ The possibility of drawn work was not lost sight of. There *may* have been instances of this, but there was no direct evidence for, and in the majority of cases very definite evidence against, such a possibility.

and at either side of the bottom of the skirt, back and front, and bands round the cuffs. There were of course minor variations in this pattern of shirt. The terminals of the shoulder-bands, for instance, were sometimes round instead of spade-shaped, and the cuff-bands were occasionally doubled, and in some bases had broken edge (Fig. —), There were instances too in which the skirt-medallions were cut from another cloth and applied, instead of being inwoven in the cloth of the shirt itself. This style of shirt seems to have been worn by men and women alike, with the difference that in the shirts intended for women brighter colors seem to have been used, the patterns being worked in wools in preference to colored linen thread. In addition, women's and children's shirts had frequently another distinguishing mark in the shape of an extra colored band, sewn on at the bottom and part of the way up the side of the skirt, round the edge of the sleeve, and occasionally round the neck also. These bands were usually of blue cloth, with a geometrical or other design in white or yellow thread. In five cases the bands were red instead of blue. Another fairly common scheme of decoration consisted of wide panels across the shoulders and down back and front to the bottom of the skirt. In the example given (Fig. —) blue, yellow, red and green wool were used, the panels being enclosed by narrow lines of dark blue or heliotrope linen thread. This skirt also had the additional applied bands of blue and white round the bottom of the skirt, the neck, and the cuffs. A third scheme—noted in one instance only—consisted of a vertical panel up the front and back, dividing into two at the chest and shoulder-blades to pass over each shoulder, with a similar band round the cuffs of the sleeves. This shirt (Fig. —) was made of two pieces of cloth, with a straight join at the waist. The ornamentation was in red linen thread. Fig. — shows a plainer type of shirt, the decoration consisting of inwoven narrow lines of darker thread—two down each breast, three at the sides of the skirt, and three on each cuff. Blue bands with designs in white thread were added, after its removal from the loom, to the bottom of the skirt, halfway up the sides, and round the neck-opening.

It is proposed to issue a supplementary volume, illustrated with colored plates, in which the question of design will be taken up in detail. For the purposes of the present volume it will be sufficient to state that in the patterns floral and geometrical motives predominated, and that occasional examples of animal, or more rarely of human, figures occurred.

Sixteen of the burials—women and children—showed remains of head-coverings, but there were so badly crushed and in such fragile condition that it was impossible, in the majority of cases, to do more than note the fact that they had existed. Some of them may have been caps, but of this there was no definite evidence. Most of them seem to have been more in the nature of head-shawls, made either of net, or of a combination of net and closely woven cloth. The position in which they were found was not necessarily an indication of the manner in which they were meant to be worn. In some cases, for example, the net was drawn tight down over the face, and that it

here served merely the purpose of a burial covering is clear from the fact that in other instances its place was taken by a plain square of cloth. In other cases it was merely folded or crushed together and laid on or by the head. The best-preserved examples are shown on Pl. -. The first two photographs (Grave 2636) show the shawl completely covering the face: the lower part was of plain linen thread, whereas above it was made of wool, red, yellow, and green. In c and d (Grave 3747 F 22) we have a double face-covering—above a diagonally woven cloth of coarse linen and dark green wool, and below a net cap or hood (?), with a kind of knob top. In e (Grave 3747 F 10) the covering was a combination of net and closely woven cloth. The net in f (Grave 2203) covers the back of the head and not the face, and was probably placed as it had been worn during life. g (Grave 2002) shows the remains of an elaborate net covering of blue, yellow, and red linen thread. Yellow and black, and green and red, were combinations of color that occurred in other graves. Pl. - c and d (Grave 3747 F 17) shows clearly that in this case the net covering was carelessly crushed together and placed as a pad on top of the head. By the neck of this same mummy there were bundles of cloth, tightly rolled up into cushions, and covered with a diagonally woven cloth of bright red.

The position and use of the circlets have been discussed in the preceding chapter. Three of them (Graves 2102 A, 3747 F 4 and 3747 F 21) were of bronze (see Pls. - and -).²⁶ These were fastened, not by soldering, but by crossing the ends and twisting them round the wire in a series of close rings to form a kind of spring (Fig. -). The circlet would thus be expanded to the extent of the interval between the two sets of rings, and sprang back to its original size when the tension was released. Photographs a, b, c and d on Pl. - show an elaborate circlet found in position on the head (Grave 2006). The basis of it was a piece of palm leaf 3 cm wide. This was covered inside and out with red wool, which was apparently wound round it in narrow strips, and to the wool were fastened small bits of straw in various patterns. In Pl. - e and f two views are shown of a circlet consisting of a twist of red wool. This was not actually found in position on the head, but was lying beside it.

Only three instances of sandals were found. Two were of plain, undecorated leather, but the third (Pl. -) was of somewhat elaborate workmanship. Decorative patterns were stamped on the sandal proper; a ring for the big toe was fastened to the sole,

26 Samples of metals found in these graves were submitted to Mr. Lucas of the Egyptian Survey Department, and he reports on them as follows:

Circlet No. 2102,	These three have all approximately the same composition,
Bracelet No. 2747 F 3	and consist of an alloy of copper containing
Bracelet No. 2309	zinc and tin, together with traces of lead and iron.
Ring No. 2005	Consists of iron, but contains a trace of tin.
Finger ring No. 2002	Consists of an alloy of copper containing zinc and tin, together with a trace of lead.
Finger ring	Consists of silver which has been largely converted into silver chloride, but it also contains traces of copper and iron.

and attached to this ring and to the sides there were four thongs of plaited leather to carry over the instep. In addition, there seems to have been a fifth strip to go round the heel.

The shawls were of all varieties of cloth, from coarse sackcloth to the most finely woven linen, and of considerable range in size, from the winding sheet that completely enveloped the body to the small cloth that was folded up and laid over the face, and which may originally have served as a head shawl. Measurements were even harder to obtain than they were in the case of the shirts, for in many cases the original size of the shawl was reduced by cutting. The few that could be noted are given below.

	Length	Width
2003	?	90
2005	152	52
2008	?	80
2009	230	115
2009	140	120
2009	?	64
2503	60	40
2611	?	38
2636	80	70
2636	?	75
2700	?	54
3747 F 2	200	100
3747 F 22	144	60

As a general rule, the sides were selvage and the ends tasseled or corded, but in two or three cases the ends were selvage and the sides were cord edged. The decoration naturally varied with the fineness of the cloth. The thick sackcloth outer wrappings were, in the majority of cases, plain, but a few had narrow bands of inwoven colored wove at either end. The inner wrappings of ordinary cloth were much more commonly decorated, the decoration, like that of the sackcloth shawls, consisting usually of bands of color near the ends, either of wool (combinations of red, yellow, blue and green), or of linen (green, blue, red, white or black). Occasionally narrow lines of colored linen thread were employed to enclose the bands of wool. In one case (Grave 2130) the original shawl was plain, but at each corner there had been applied a large square panel, cut from another cloth, containing a human figure in red, blue, yellow, and green wool. Real embroidery was sometimes employed on these shawls. In one case, for instance (Grave 2009) there were lines of inwoven dark red and blue linen thread, and between

the lines courses in colored wool that were evidently needle-woven on the finished cloth. The outermost wrapping of all—the pall—usually consisted of colored cloth—yellow commonly, though red, pink, and a dark heliotrope also occurred. These again were usually decorated with inwoven bands of colored linen or wool. One (Grave 2413) had in each corner an inwoven medallion of heliotrope and white linen thread, combined with blue, green, yellow and red wool. The head-shawls were more elaborate. One (Grave 2009) had a design of vertical and horizontal lines of inwoven blue and green linen. It had also a diamond of real embroidery in each corner and a cording of colored wool along the sides. In another (Grave 2503), narrow lines of green, red and blue were combined with bands of decoration in colored wools (Fig. –). A third (Grave 2636), probably a head-shawl originally, though when found it was wrapped tightly round the stomach, was a regular plaid. At regular intervals in the warp threads double black lines were inserted, while the weft consisted of alternating bands of yellow, red and green, with occasional lines of black thread, similar to those used in the warp. This was of linen throughout.

B *Ornaments*

A number of necklaces, with beads strung as nearly as possible in original order, are shown in Pl. –. Others are included in the tomb groups on Pls. –, –, and –. See also Pls. – C and G, where the beads are shown in position on the body. In the original stringing no sort of order or method was followed, the beads being apparently taken haphazard from a miscellaneous stock, and the result is thoroughly typical of the mental untidiness that characterized the Copt.

Of the materials used, glass was by far the commonest, the beads being made in a variety of shapes and in numerous colored—red, blue, green, yellow, or gilt. Shells were also of frequent occurrence, and there were occasional instances of faience, beryl, carnelian, and amethyst. To the necklaces were attached pendants of various kinds.

Crosses seem to have been commonly worn in this way, for the y were always found on the breast and generally in combination with bead necklaces. In cases where there was no necklace they were probably strung round the neck on a plain cord. The crosses (see Pl. – B) were usually of plain bronze, but there were two cases of silver and one that was a combination of bronze chain work and glass beads. Usually a single cross was worn, but in one grave (3747 F 22) the necklace was composed of three bronze crosses, a few shells, two green glass beads and a bone button (Pl. – E).

Other examples of pendants are shown on Pl. – C. The first on the top row is a bronze coin, dated in the third year of Justinian (see also Pl. –). The second may also have been a coin, but there was no inscription visible: possibly it was used as an earring. The third and fourth are bone discs. The two copper binds in the middle row may also have been pendants of earrings. The dour at the bottom consist of bronze rings with glass beads attached, to which are suspended discs of bone (left), paste (middle),

and glass (left). A necklace in Grave 2636 provided an excellent example of Coptic catholicity of taste, in the shape of a faience scarab of the Eighteenth Dynasty.

The earrings are of considerable variety. A number of them are shown on Pl. – B: see also Tomb groups on Plates – and –, and, for a photograph of one in position, Pl. –. Some were of plain metal, silver (Pl. – B, top row 5), bronze (top row 6), gold (middle row 1), and lead (middle row 2): others consisted of bronze rings, from which drops or pendants were suspended: others again found elaborate combinations of rings, chains and pendants. Three distinct methods were used for fastening the suspension rings (see Fig. –). In (1), the ends were simply overlapped and left; in (2) the ends were bent into loops and one hooked through the other; in (3)—originally used in cases in which thin wire was employed—the ends, after overlapping, were twisted round the ring in a series of loops. The pendants were either plain drops of glass, or a combination of glass and carnelian beads: in both cases they were strung on bronze wire, one end of which looped round the ring while the other formed a second loop, plain or fish-tailed, at the bottom of the pendant. A restoration of an elaborate type of earring, of which two more or less complete pairs and pairs of several other were found, is given in Fig. –. With the exception of a single glass bead at the bottom of each pendant, it is of bronze throughout. Another combination of rings and chains is shown in Pl. – B, bottom row 4. The top of the earring is missing, but it probably consisted of a small ring. Next comes a considerable length of chain; then two more rings, the upper of Type 3 in Fig. – and the lower of Type 1; and finally a pendant of true glass beads. In this earring, as in all other cases in which chain work finds a place, the links of the chain were made by bending both ends of a length of wire into loops, in such fashion that the plane of the one loop was at right angles to the plane of the other (see Fig. –). In Pl. – C two other types of pendants are shown, which were found close to the side of the beads, and which may, or may not, have been earrings—namely the bronze disc (top row 2), and the two bronze binds (middle row).

The rings (see Pl. – A) were of various materials—bronze, iron, silver, bone, and twisted hair. Those of metal were in some cases case, but more often they consisted of a strand of wire loosely bent round to the required size. A few widened out into bezels, on which rough designs, usually animal motifs, were cut.

The bracelets were of bronze, iron, bone, ivory, and twisted palm. The metal ones were as a rule simply bent to the required dimension, and not fastened in any way, the ends in some cases overlapping considerably. In one instance, however (Pl. – A, top row, 5) the bracelet was bound throughout its entire circumference with bronze wire. Usually they were plain rings, without any attempt at ornamentation of any kind, but in some cases the ends were either thickened or worked as in Fig. –, and there were two instances of wide bezels (Fig. –). One bracelet had a bronze key attached to it. Those of palm were made by bending to a circle a thin strip of palm leaf, and binding it round and round with fiber.

Anklets were very rare. The few examples that were found were all of bronze, exactly similar in type to the simple form of bracelet.

C *Miscellaneous*

The pottery (see Pl. –) was scarce and fragmentary; and in no single instance was there a piece found in position with a burial. The fragments in photograph A were found scattered outside the entrance to the burial vault 3747 F, and the remainder in the upper filling of the graves or in the surface sand above them. Food offerings were clearly not a part of the mummy's equipment, and it is to post-funereal visits to the grave, probably at the time of the three yearly festivals, that we owe the pottery here represented. Most of it was rough and crude, but there were a few pieces of a fine red highly polished ware (see for example the two handled vases and the half dish in e). This particular ware was generally decorated with incised patterns. The coarser variations were frequently ornamented with bands and splashes of white, and there were a few examples of plant motifs in black paint.

The ostraca on Pl. – a–e were also found in the upper filling of the graves. In each there is a date—presumably the date of burial. Mr. H. S. Evelyn-White translates them as follows:

[ed.: No translation included here in the original manuscript.]

In (a) and (b) of Pl. – are shown a group of decorated wooden objects, and found in the filling of a plundered grave (2049), consisting of a carding comb, a spinning wheel, and parts of a box (?) (sic). In (c) there are a number of similar fragments from various graves, including also a broken hair-comb. The only other wooden object that remained was the round box in Pl. – f.

Three perfect glass bottles were found, and pieces of two or three others (pl. – d). The bottles were molded (?) (sic): two of them were decorated with glass thread wound round the neck.

The bronze dipper in Pl. – f was found behind the head of the mummy in Grave 2417. The arm of the dipper was made of two lengths of wire, joined by twisting an end of each in a series of rings round the other. The wires were thus left free to slide, and the arm could be lengthened or shortened at will. The upper of the two wires were soldered to the bowl, and the lower ended in a hook handle.

VI Catalogue of Burials

[ed.: This is where Mace's manuscript ends.]

Plates



FIGURE A1.1 Coptic monastery and cemetery (NED-B-8610)



FIGURE A1.2 Interior of Coptic church (NED-B-8242)



FIGURE A1.3 Interior of Coptic church (NED-B-8241)



FIGURE A1.4 Inscription above entrance to Coptic monastery (NED-C-8218)

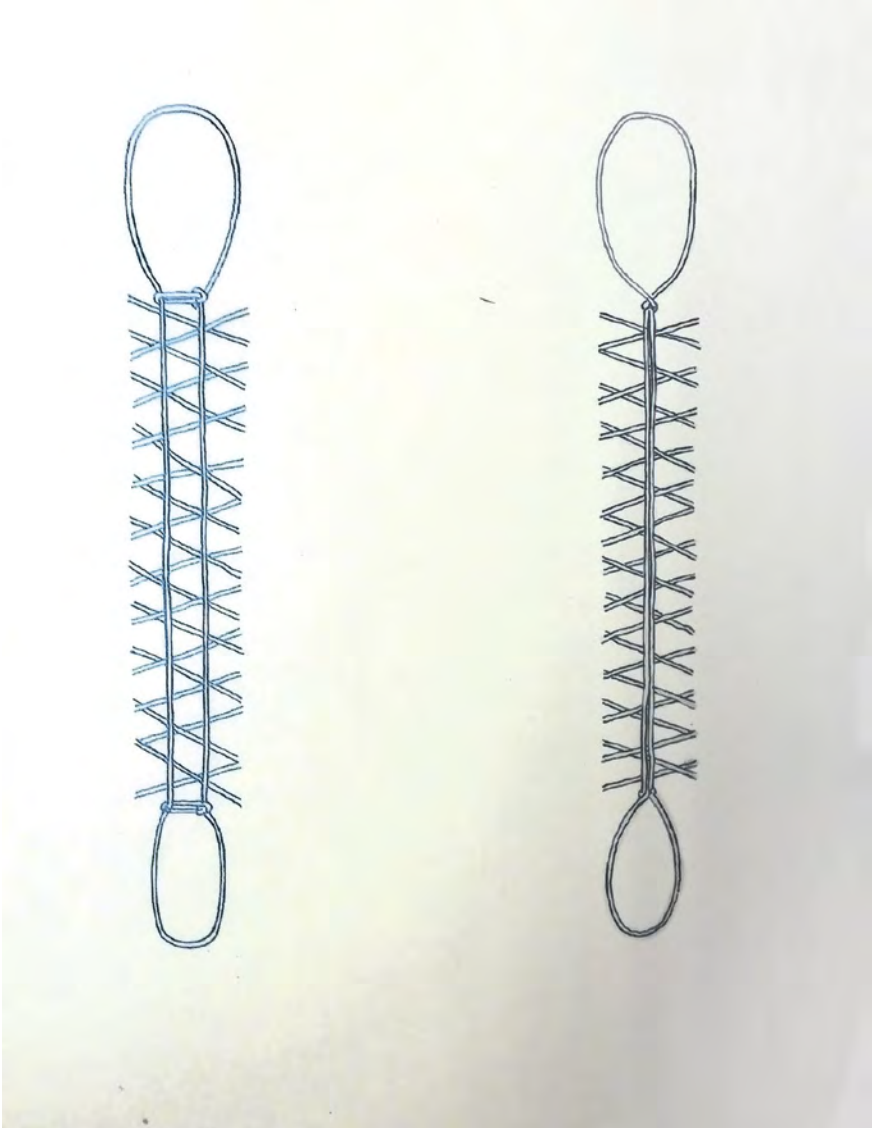

FIGURE A1.5 Bindings 1 and 2
DRAWING ATTRIBUTED TO LINDSLEY FOOTE HALL

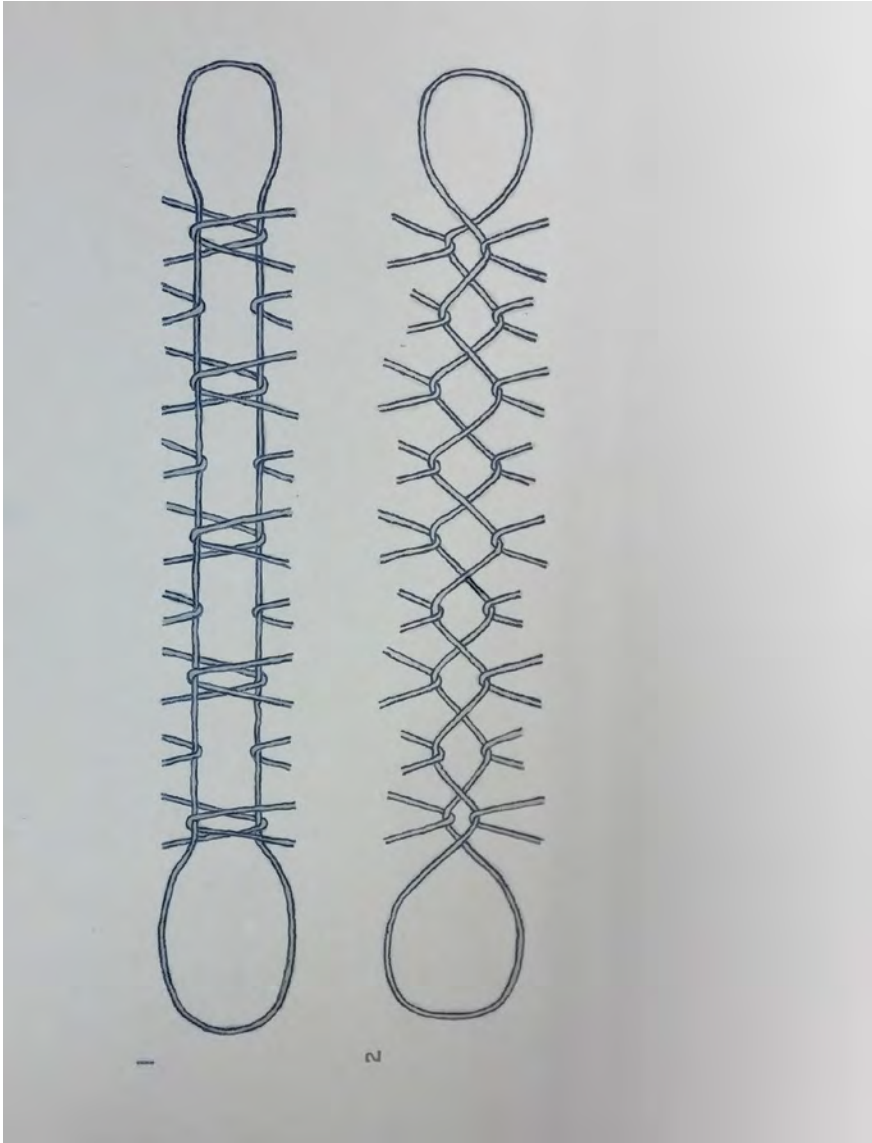

FIGURE A1.6 Binding 3, types 1 and 2
DRAWING ATTRIBUTED TO LINDSLEY FOOTE HALL

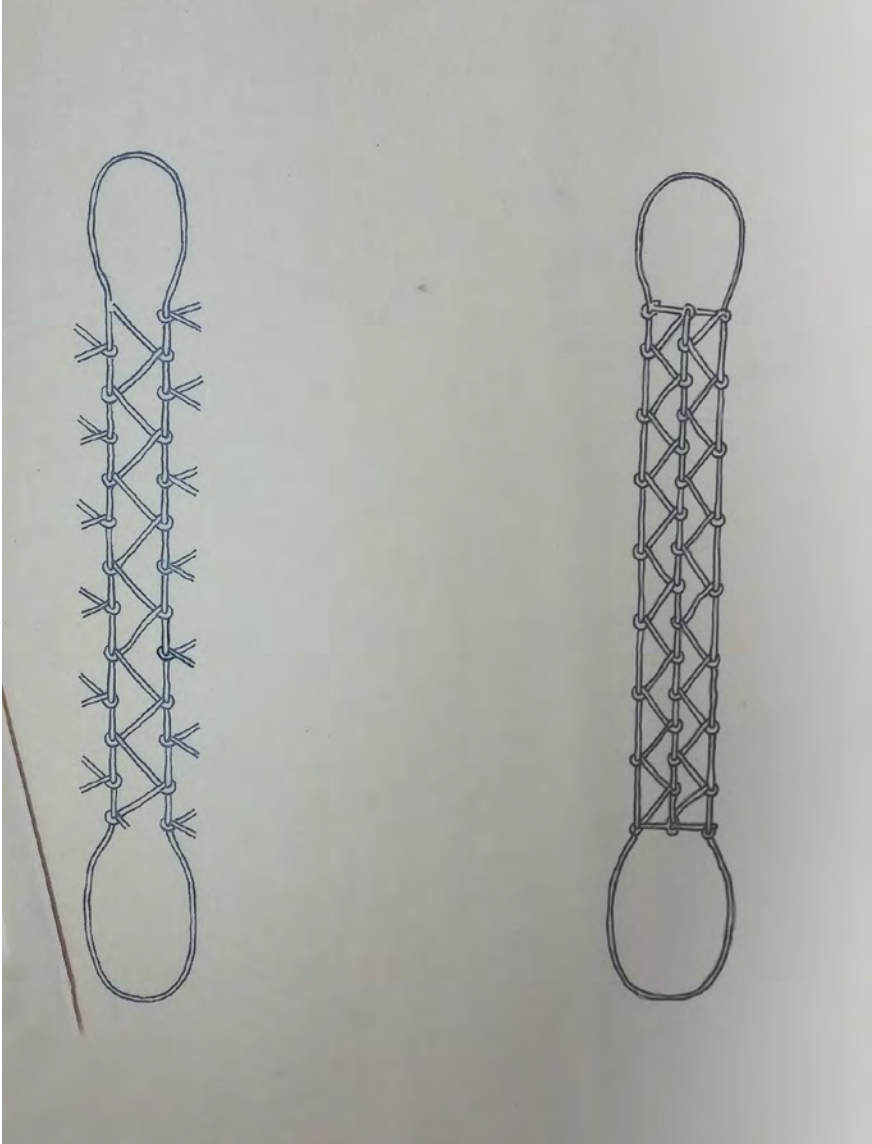

FIGURE A1.7 Bindings 4 and 5
DRAWING ATTRIBUTED TO LINDSLEY FOOTE HALL

Coptic Inscriptions

[ed.: These undated translations were found on note cards with transcriptions of the Coptic texts. The tomb numbers, photograph numbers, and NB are part of the original text.]

1. 2016 (Photo 846g)

]Υ ΠΙΝΟΥΤΕ ΔΡΙΟΥΝΔΑΜ ΝΤΕΨΥΧΗ

ΝΤΕΚΖΗΖΑΛ

ΤΑΛΟΥΛΕ

ΤΩΒΕ ΚΕ *ΔΗΔΔΡ *ΤΕΤΑΛΤΥΣ

ΤΗΘ

... God, have mercy (?) on the soul of thy handmaid Taloule (?) Tōbe 26th of the 4th (Indiction?)

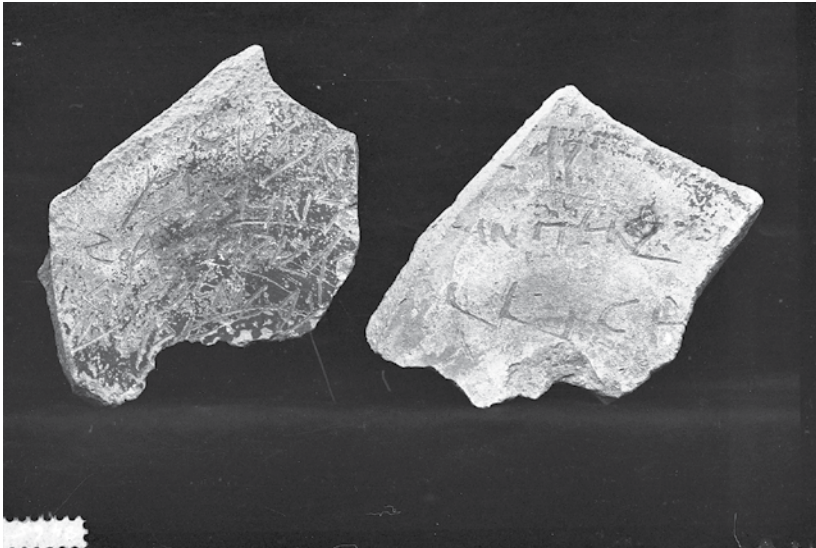

FIGURE A2.1 Inscriptions numbers 2 and 3, N 2431 (NED-C-8465)

2. No number (Photo 8465a; Fig. Appendix 2.1)

Κ_ΔΡ<1>ΟΥΝ[ΔΜ? ΝΤΕ

ΨΥΧΗ ΝΤ[ΕΚ ΖΗ

ΖΑΛ ΗΑΡΙΑ [ΕΤΑΧΗΤΟΝ

ΜΜΟC ΝCΟΥ[

ΝΚΙΑΞΚ[

[God], have mercy (?) on the soul of thy handmaid Maria who fell asleep on the [...] day of Khoiak.

3. No number (Photo 8465b; Fig. Appendix 2.1)

ΞΡΙ

ΟΥΝΑ.]Μ ΝΠΕΚΞΜ [sic]

Ξ]ΑΛ ΙCΕ[

... Have mercy (?) upon thy servant Ise ...

4. 2431 (Photo 8578a)

]Ν[

]ΝCΟΥ Δ[

]ΝCΩΙΡ* [= ΜCΩΙΡ

... on the 4th day of Machir

5. 2431 (Photo 8578b)

ΞΡΙΟΥΝ]ΔΜ ΝΤΕΚΞ[ΜΞΔΛ

ΝCΟΥ] Ι ΝΤ[Ω]ΒΕ

[God], have mercy on thy handmaid ... on the 10th [day] of Tôbe.



FIGURE A2.2 Inscriptions numbers 6 through 9, N 2431 (NED-C-8466)

6. 2431 (Photo 8466a; Fig. Appendix 2.2)

Μ]ΩΡ ΠΩΜ[

... Mechir ...

7. 2431 (Photo 8466b; Fig. Appendix 2.2)

]ΒΙΚΤ[ΩΡ?

]ΓΛΗΛ[

... Victor ...

... Paul ...

8. 2431 (Photo 8466c; Fig. Appendix 2.2)

ΜΗΝΟΣ [ΦΑΜΕΝ?

ΩΘ* ΙΕΤ *Bohairic

ΦΔ ΜΑΡ[ΤΥΡΟΣ

... on the 16th of the month Pham-Enoth, [Year??] 501 of the Martyrs ...

[NB. This is *very uncertain*. I think line 3 begins with a Φ, but is it necessarily a cipher?

And ΜΑΡ [need not necessarily be ΜΑΡ[ΤΥΡΟΣ. *If* the numeral is real date = 785 AD.]

9. 2431 (Photo 8466d; Fig. Appendix 2.2)

ΠΝΟΥ]ΤΕ ΕΚΑΡ<Ι>ΟΥ

ΝΑ]Μ ΝΤΕΥ[Υ]ΧΗ

ΝΤΕΚ]ΣΜΖΑΛ

God, have mercy (?) on the soul of thy handmaid ...



FIGURE A2.3 Inscription number 10, N 2431 (NED-C-8467)

10. No number (Photo 8467b; Fig. Appendix 2.3)

ΜΗΗ]ΟC ΤΥΒΥ ΚΒ ΝΤΙ[

Μ]ΤΟΝ ΝΜΟϞ [sic] ΠΝΟΥΤΕ Ε[

]ΝΤΕ[κ

On the 22nd of the month of Tyby ... fall asleep ... God, [have mercy on the soul] of thy [servant].

Index

- Abu al-Makarim [Abu Salih] 489
Acacia 22, 438, 439, 458, 463, 464–9, 474, 479, 479n48, 504
Akhmim (Panopolis) 456, 457n17, 476, 476n40, 480n49, 489n2
Ankh sign 314, 315, 406, 415, 418, Fig. 4.3
Antinoë (Sheikh Ibada) 457, 497
Antiquarianism 24
Atripe (Athribis) 456
Axial truss pattern 476, Fig. 11.4B
- Balance scale 423, 431
Box, wooden 485, 514, Fig. 1.16
- Cartonnage 454
Cemeteries N 500–900
 Beads from 408
 Erasure of superstructures in 10
 Measurement of depth of tombs 20
 Stone vessels from 329–330
Chisel 363–4, Fig. 6.1
Christianity (“Early”) 453
Coin 15, 24, 427–8, 440, 443, 450, 487, 498, 512, Fig. 9.3
Coptic
 Burial practices, modern 493–4
 Cemetery, modern 492–3
 Graves and Arabic texts on 492–3, Fig. 1.1
 Graves and survival of pharaonic false door 492, 497
 Inscription 491, 520–3, Fig. 0.5, Fig. A1.4, Figs. A2.1–3
 Monastery and church 487–92, Figs. 0.4–0.5, Figs. A1.1–4
- Dating burials, Mace’s 23–4
Deir el-Malak 453n2, 480
Dentistry 22
Diagonal lozenge 454n4, Fig. 11.4A
Dipper, copper Fig. 1.18
Documentation, original
 Abbreviated way of writing, Mace’s 21
 Arabic words in Mace’s Catalogue of Tombs 22
 Changes made to Mace’s notes 20
 Distinction between “Coptic” and “Egyptian,” Mace’s 21
 Explanation of Mace’s Catalogue of Tombs 17–22
 Missing page’s from Mace’s draft manuscript 18
 Technical terms in Mace’s Catalogue of Tombs 22
 Tomb cards, Mace’s, and Mace’s draft manuscript 5, 16, 18, 20, 25
 Tomb cards, Reisner’s 16–17
 Tomb numbering 18, Fig. 0.3
 Tomb numbering, confusion between Reisner and Mace 16–17
 Two points missing from Mace’s manuscript 22
- Egyptian team heads named 9
 Said, Said Ahmed, head of photographic staff 8
El-Hibeh 457n18, 463nn34–35, 475n36, 478
- Gayet, Albert 457, 495, 496
Girga 453n2, 480n49, 487–9, 493, Fig. 0.18
Grinding stone 425, 433–434
- Hall, L. F. 5
Headrest 426–7, 435–436, 438, 485, 494, 496, Fig. 9.2
Herodotus 453, 454
Hieroglyphs on stone vessel 330, Fig. 5.6
Hoe 426, 437–8
- Investment sheets 463, 476
- Knife 362, 364–9, Figs. 6.2, 6.4
Knotted cord 318–27
- Leo Africanus 489
Lythgoe, Albert 2, 5, 8
- Mace, Arthur C. 1–2, 8, 25
Map
 Explanation of 5, 22–23
 N 4511 not placed on 15
Maqrizi, al- 489

- Mirror 428–9, 431–7, 484, Fig. 9.4
- Mummification 2, 22, 443, 498
 (Classic) 454–7, 463
 Golden mummies 455n9
 Natural 463
- Naga ed-Deir, village of 9, 18, 453n2, 487,
 Figs. 0.3, 0.19
- Nardi, Giovanni 459
- Nefer* sign 314, 315
- Needle 429, 432, 484, 508
- Ostrich eggs, hung in church 490–1
- “Pagan” traditions 453
- Palm sticks (struts) 458, 462–75, 504,
 Figs. 11.1A–11.1B
- Peck, Caroline 5
- Pepi-Iam 310
- Pepy I 23, 330, 354, Fig. 5.6
- Photograph numbering system
 Cross-referenced by Knudsen, Joan,
 Nancy Corbin, and Bob Bussey 3
 Museum of Fine Arts, Boston 29
 Phoebe A. Hearst Museum of
 Anthropology 29
- Photographic plates, Museum of Fine Arts,
 Boston 3
- Quibell, James 7
- Red shroud 454–455
- Rhombic bandage 454
- Salting 21, 24–5, 457, 463, 479, 498–9,
 Fig. 11.1A
- Sandals 501, 510, Fig. 1.9
- Shawl 21, 447–50, 458, 463–79, 493–4,
 504–6, 510–2, Figs. 10.2–10.3, 11.5, 11.6
- Shells 321, 324, 409–10, 412, 417, 512
- Shenoute 456
- Silk 455n8, 493, 494
- Smith, Grafton Elliot 2–3, 21, 27, 462
- Soft tissue preservation 480
- Spade, wooden 467, 504, Fig. 1.17
- Splint 500
- Stela 23, 221, 455n8, 485, Figs. 1.7–1.8
- Stone vessels, relationship to ceramics
 329–330
- Terenuthis (Kom Abu Billo) 455n8
- Tomb types, Reisner’s 29
- Tools, model 326–7
- Vessels
 Closed 222–3, 230–9
 For specific household use 239–41
 Miniature 241–2
 Open 222–3, 225–9
- Weaving tools 444, 514, Fig. 10.1
- Winding methods 461–2
- Wunderkammern* 459