

# We are IntechOpen, the world's leading publisher of Open Access books Built by scientists, for scientists

5,300

Open access books available

130,000

International authors and editors

155M

Downloads

Our authors are among the

154

Countries delivered to

TOP 1%

most cited scientists

12.2%

Contributors from top 500 universities



WEB OF SCIENCE™

Selection of our books indexed in the Book Citation Index  
in Web of Science™ Core Collection (BKCI)

Interested in publishing with us?  
Contact [book.department@intechopen.com](mailto:book.department@intechopen.com)

Numbers displayed above are based on latest data collected.  
For more information visit [www.intechopen.com](http://www.intechopen.com)



# Issues Associated with Genetic Diversity Studies of the Liver Fluke, *Fasciola hepatica* (Platyhelminthes, Digenea, Fasciolidae)

Denitsa Teofanova, Peter Hristov,  
Aneliya Yoveva and Georgi Radoslavov  
*Institute of Biodiversity and Ecosystem Research,  
Bulgarian Academy of Sciences,  
Bulgaria*

## 1. Introduction

Parasitic diseases are huge problem for human and veterinary medicine and for economy, agriculture and wildlife management. One of these diseases is fasciolosis, which is caused by two trematode species, *Fasciola hepatica* (liver fluke) and *Fasciola gigantica*. Only *F. hepatica* is a concern in Europe and Americas but the distribution of both species overlaps in many areas of Africa and Asia (Mas-Coma et al., 2005). *F. hepatica* occurs mostly in cattle, sheep and wild ruminants. Recently, worldwide losses in animal productivity due to fasciolosis were estimated at over US\$ 3.2 billion per annum (Spithill et al., 1999). The infection of humans has been regarded as accidental for many years. However, fasciolosis is now recognized as an emerging human disease: the World Health Organization (WHO, 2006) has estimated that 2.4 million people are infected with *F. hepatica* and a further 180 million are at risk of infection (Mas-Coma et al., 1999).

Considering all these facts, the increasing of the knowledge of population structure and genetic diversity of liver fluke is necessary. The most often used methods for taxonomical and population studies have been morphological but nowadays they are incomplete and imperfect. Various molecular and genetic techniques are recently utilized, in addition to the classical methods (Ai et al., 2011). Part of the genetic methods is based on molecular markers for identification of genotype variability or genetic differentiation of geographic isolates.

A variety of molecular methods have been applied for genetic structuring of parasitic populations and in particular of the liver fluke. Examples of such methods are: PCR-RFLP of multiple genes (ribosomal, mitochondrial, etc.), RAPD variability, usage of microsatellite markers, etc. Most of these methods are time- and/or labour-consuming, expensive, hard for interpretations and sometimes repetitively impossible. To avoid these negative features, recent developments include single nucleotide polymorphism (SNP) assays after direct sequencing, which has been proved to be the most reliable method used in genetic diversity studies of *F. hepatica*. The information about those variations could increase the knowledge of species belonging, differentiation and diversity of closely related species and intraspecific relationships.

## 2. PCR based molecular approaches for genetic detection, identification and characterisation – Pros and cons

Most of the molecular techniques utilized for taxonomic, phylogenetic and evolutionary investigation of *Fasciola* species are based on conventional polymerase chain reaction (PCR) method. PCR is widely used in genomic analysis. One of its main applications is in the DNA markers determination and gene mapping, which is useful in breeding, taxonomy and evolution. Several PCR based methods are available varying in complexity, reliability and information generating capacity. These include random amplified polymorphic DNA (RAPD), simple sequence repeat polymorphism (SSR), restriction fragment length polymorphism (RFLP), the novel sequence-related amplified polymorphism (SRAP) method, etc. Each system has its own advantages and disadvantages.

### 2.1 RAPD (Random Amplified Polymorphic DNA)

RAPD markers are DNA fragments from PCR amplification of random segments of genomic DNA with single primer of arbitrary nucleotide sequence. Unlike traditional PCR analysis, RAPD does not require any specific knowledge of the DNA sequence of the target organism. Different primer sequences will produce different band patterns and possibly will allow a more specific recognition of individual strains. RAPD is a simple method to fingerprint genomic DNA, but poor consistency and low multiplexing output limit its use. That technique is often utilized for genetic variation level establishment among the populations and for species phylogeny determination. RAPD has its limitations as a method. For example nearly all RAPD markers are dominant, i.e. it is not possible to distinguish whether a DNA segment is amplified from a locus that is heterozygous (1 copy) or homozygous (2 copies). Co-dominant RAPD markers, observed as different-sized DNA segments amplified from the same locus, are detected only rarely. PCR is an enzymatic reaction, therefore the quality and concentration of template DNA, concentrations of PCR components, and the PCR cycling conditions may greatly influence the outcome. Thus, the RAPD technique is notoriously laboratory dependent and needs carefully developed laboratory protocols to be reproducible. Mismatches between the primer and the template may result in the total absence of PCR product as well as in a merely decreased amount of the product. Thus, the RAPD results can be difficult for interpretation.

RAPD is a technique for the identification and differentiation of *F. hepatica* and *F. gigantica*. Using that method, only a low level of genetic variation have been detected among *F. gigantica* populations from different hosts (cattle, buffalo, and goat) (Gunasekar et al., 2008). RAPD variability and genetic diversity for *F. hepatica* in particular have been examined from Semyanova et al. (2003) in cattle populations of liver fluke from Ukraine and Armenia. Established results for genotypic diversity have showed higher variability within than between examined populations. Obtained data suggested multiple genetically different parasites but did not provide adequate information about genetic diversity, distribution and population structure of studied liver fluke isolates. Specific RAPD assay have been developed for differentiation of fasciolid species in UK, Peru, Ghana and Sudan (McGarry et al., 2007). That technique enabled distinguishment of *F. hepatica* and *F. gigantica* from cattle and sheep hosts from countries mentioned above. All liver flukes have been correctly identified to species level. In general all these investigations do not give detailed and complete information for genetic structure and diversity of liver fluke intrapopulations and do not established intra- and interpopulation relationships in different geographic regions.

## 2.2 SRAP (Sequence-Related Amplified Polymorphism)

SRAP is a simple marker technique aimed for the amplification of open reading frames (ORFs) of genomes from related organisms and it is based on two-primer amplification (Li & Quiros, 2001). SRAP technique has been found to be useful for revealing genetic variability within and between *F. hepatica*, *F. gigantica* and evidential for the existence of the “intermediate *Fasciola*” from different host species and geographical locations in mainland China (Li et al., 2009). The same technique has been utilized for evaluation of genetic diversity of *F. hepatica* populations from different host species and 16 geographical locations in Spain (Alasaad et al., 2008). SRAP polymorphic banding patterns have indicated presence of genetic variability in the coding regions of the genomes within the examined *F. hepatica* representatives even in low degree. The authors have defined four clusters that were not related to particular host species and/or geographical origins of the samples. As RAPD technique the SRAP method also do not provide explanation of obtained genetic structure of Spanish liver fluke populations and what it is due to.

## 2.3 SSR (Simple Sequence Repeat polymorphism or microsatellite markers)

Microsatellites (sometimes referred to as simple sequence repeats) are short segments of DNA that have a repeated sequence (e.g. CA<sub>n</sub>) and they tend to occur in non-coding DNA. In some microsatellites, the repeated unit may occur two to four times, in others it may be seven or thirty. In diploid organisms there will be two copies of any particular microsatellite segment. In comparison with other DNA regions microsatellites have high level of mutations which could be caused by many events (e.g. recombination, “proofreading” mistakes, etc.). Microsatellite markers have many different applications as in forensics, disease diagnostics and identification, conservation biology and population studies. By looking at the variation of microsatellites in populations, inferences can be made about population structure and diversity, genetic drift and even for last common ancestor of the examined population. Microsatellites can be used also to detect sudden changes in population, effects of population fragmentation and interaction of different populations. Microsatellites are useful in identification of new and incipient populations. That method has been used for human population identification studies as well (Pemberton et al., 2009) but recently it is considered that it has a lot of disadvantages. For example it is necessary to have previous information about studied organism genomes so microsatellite analysis could be performed only for well known species. That assay requires huge upfront work and there are a lot of problems associated with PCR of microsatellites. With regards to liver fluke there are only a few investigations reported. Isolation and characterization of microsatellite markers in *F. hepatica* have been performed from Hurtrez-Bousses et al. (2004). In total six microsatellite markers have been isolated from *F. hepatica* and for representatives from Bolivian Altiplano only five were polymorphic. The demonstrated genetic variability does not provide precise information applicable for adequate conclusions about genetic structure of *F. hepatica* population.

## 2.4 PCR-RFLP (Restriction Fragment Length Polymorphism)

PCR-RFLP method is based on amplification of particular DNA region that contains polymorphic site and subsequent restriction enzyme digestion of target amplicon. The mentioned polymorphism creates or removes specific restriction site for the used

endonuclease and different bands could be observed. RFLP detection relies on the possibility of comparing band profiles generated after restriction enzyme digestion of target DNA. There are multiple applications of that technique concerning genetic diversity, genetic relationships between species, origin and evolution of species, genetic drift and selection, whole genome and comparative mapping, etc. PCR-RFLP assay has its advantages as a highly robust methodology with good transferability between laboratories. Its simplicity gives the availability the technique to be readily applied to any organism and through the codominant inheritance heterozygosity can be estimated. To utilize that analysis sequence information is not mandatory required but because it is based on sequence homology PCR-RFLP is recommended for phylogenetic analysis between related species. It also has a discriminatory power and can be applied at the species and/or population levels or individual level. Nevertheless PCR-RFLP has also disadvantages. For example usually large amount of amplified DNA is required and automation is not possible. That technique is not applicable when in some species there is no or very low level of polymorphism and only a few loci can be detected per assay. It is also time consuming comparatively expensive and hard for interpretation method and sometimes different enzyme combinations may be needed as well. With respect to *F. hepatica* researches PCR-RFLP has been often utilized in different cases and for various genes. Marcilla et al. (2002) have developed that assay targeting 28S ribosomal DNA (rDNA) region for *F. hepatica* and *F. gigantica* distinction in Spain. Similar analysis has been used for differentiation between *F. hepatica*, *F. gigantica* and the "intermediate Fasciola" or identification of *Fasciola* spp. targeting the ITS 2 (internal transcribed spacer 2) of rDNA (Huang et al., 2003), ITS 1 (internal transcribed spacer 1) of rDNA (Ichikawa & Itagaki, 2010) or *cox1* (cytochrome c oxidase I) mitochondrial gene (Hashimoto et al., 1997) as genetic markers. Through PCR-RFLP analysis Walker et al. (2007) have defined for *F. hepatica* three mitochondrial DNA (mtDNA) regions with highest polymorphism frequency. Authors also through PCR-RFLP established 52 different complex haplotypes specific for particular geographic isolates and/or hosts. In total PCR-RFLP method is simple and easy to perform but for more detailed and complete interpretation of the results consequent sequence analysis of target DNA is recommended.

## 2.5 PCR-SSCP (Single-Strand Conformation Polymorphism)

SSCP is the electrophoretic separation of single-stranded nucleic acids often based on single nucleotide variations, which result in a different secondary structure and a measurable difference in mobility through a gel. It offers an inexpensive, convenient, and sensitive method for determining genetic variations (Sunnucks et al., 2000). Like RFLPs, SSCPs are allelic variants of inherited, genetic traits that can be used as genetic markers. However SSCP analysis can detect multiple DNA polymorphisms and larger mutations in DNA (Orita et al., 1989). Nevertheless as a mutation scanning technique, it is often used to analyze the polymorphisms at single loci (Sunnucks et al., 2000). Most experiments involving SSCP are designed to evaluate polymorphisms at single loci and compare the results from different individuals. Recently, more convenient molecular techniques have been developed, although it is a simple method to amplify the double strand and then denature it into single strands instead of searching suitable primers if the targeted sequence is unknown. That is because of some disadvantages and limitations of PCR-SSCP procedures. For example the single-stranded DNA (ssDNA) mobility is temperature dependent and for best results, gel electrophoresis must be run in a constant temperature. Sensitivity of SSCP is



also affected by pH. Double-stranded DNA fragments are usually denatured by exposure to basic conditions and lowering of the electrophoresis buffer pH is necessary for increasing the sensitivity and clearer data. Fragment length also influences SSCP analysis. For optimal results, DNA fragment size should fall within the range of 150 to 300 bp (Wagner, 2003).

Specific PCR-SSCP assays have been developed for the accurate identification of *Fasciola* spp. (Alasaad et al., 2011). That study has established a fluorescence-based PCR-linked SSCP (F-PCR-SSCP) assay for the identification of *Fasciola* spp. based on the sequences of ITS 2 of the rDNA and with specific primers labelled by fluorescence dyes. That method has displayed three different SSCP profiles that allowed the identification of *F. hepatica*, *F. gigantica* and the "intermediate" *Fasciola* from China, Spain, Nigeria, and Egypt. Under optimal conditions, approximately 80 to 90% of the potential base exchanges are detectable by SSCP (Wagner, 2003). If the specific nucleotide responsible for the mobility difference is needed, a technique of SNP may be applied.

## 2.6 LAMP (Loop-Mediated Isothermal Amplification)

Loop-mediated isothermal amplification (LAMP) is a novel technique for the amplification of DNA which uses single temperature incubation and two or three sets of primers (Notomi et al., 2000). It allows amplification of target nucleic acids under isothermal conditions with high rapidity and precision and has applications for pathogens detection. Detection of the product can be only by photometry. LAMP could be used as a simple, low cost screening method for infectious disease and different pathogens diagnosis. LAMP can also be quantitative. Ai et al. (2010) developed a LAMP assay for the sensitive and rapid detection and discrimination of *F. hepatica* and *F. gigantica* using intergenic spacer (IGS) region of rDNA as a target for PCR amplification.

As it concerns *Fasciola* spp. many other examples for molecular approaches based on PCR technique for species differentiation and genetic characterisation could be presented. Conventional PCR and its modifications like multiplex PCR (Magalhaes et al., 2008) and TaqMan real-time PCR (Alasaad et al., 2011) have been used for amplification of different target DNA regions. The most often utilized are mitochondrial polymorphic genes like *nad1* (NADH dehydrogenase 1) and *cox1* or ribosomal variable regions like ITS 1 and ITS 2, aiming detailed studies of genetic diversity and/or the origin, evolutionary relationships of fasciolides etc. Although many researches includes above mentioned techniques they are often combined with sequencing and followed by SNP assay. That is because of already pointed disadvantages of these methods and SNP analysis' higher informativeness, precision, detailness and easier results interpretation.

## 3. Single Nucleotide Polymorphism (SNP) assay

SNP assay is based on analysis of single base pair variations at a specific locus inside and/or outside the coding DNA regions. Single polymorphisms have two alleles per marker; they are very common in the genome (1 per 1000 bp); the necessary PCR product could be either very small (markers will work even with degraded DNA samples) or if needed, larger. Other advantages are associated with complete automation of sample processing and possibility of multiplex SNP assay on chips. Because SNPs are conserved during evolution, they have been used as markers for quantitative trait loci analysis and in other studies in

place of mentioned in Section 2 methods. SNPs can also provide a fingerprint for use of species identification, population genetic structuring, molecular taxonomy, phylogeny, evolution and genetic diversity investigations. There are multiple methods for SNP genotyping: hybridization-based methods, enzyme-based methods and other post-amplification methods based on physical properties of DNA. Examples of such methods are: Reverse Dot Blots (based on position of spots blotted with specific allele probes);

HPLC Genotyping (HPLC technique of separating components based on time of moving through the column and resulting on three profiles - two for homozygous and one for heterozygous forms);

TaqMan Assay (uses fluorescent allele specific probes);

Fluorescence Polarization (differentiation of amplicons through four different coloured ddNTPs);

Microchips (uses silicon chips with attached allele specific oligonucleotide probes and binding of fluorescent labelled PCR products);

Pyrosequencing (the way of DNA sequencing detected through releasing of pyrophosphate and light during the dNTPs incorporation);

SNaPshot (e.g. mini-sequencing, uses extension primers up to SNP and again adds ddNTPs labelled with different coloured dye, assay can be multiplexed);

Direct Sequencing, etc.

### 3.1 SNP genotyping through direct sequencing

The most often utilized and the simplest method for search of unknown SNP is by direct sequencing (Figure 1). It is based on sequencing the region of interest using Sanger dideoxy method. The fragment with the suspected SNP is compared to a known wild type fragment or to another sequenced one. A SNP may or may not be present in the fragment to compare. Correct reading of the gene region sequence is of a high importance for interpretation of obtained data. Many software products facilitate the processing and comparing multiple sequences.

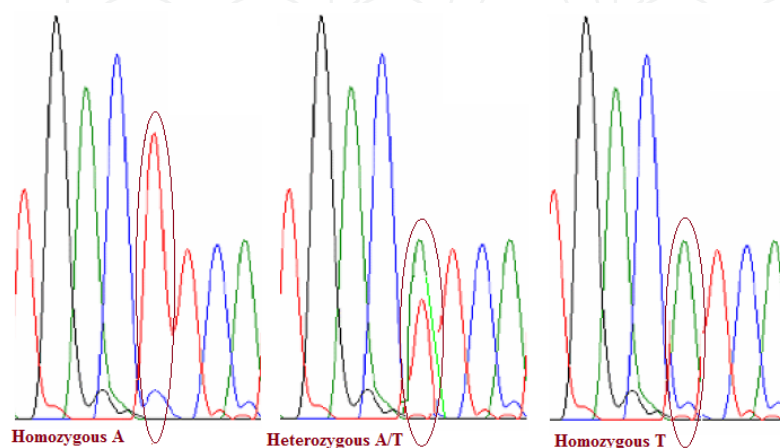

Fig. 1. Example of SNP assay after direct sequencing.

That way of DNA sequences microanalysis allows the detection of polymorphic sites through which it is possible to make inter- and intraspecific differentiation. As these single variations are conservative in particular population and from an evolutionary point of view, they are a reliable marker for genotype mapping. SNP assay after a direct sequencing has been proved to be the most reliable method used in genetic diversity studies of *F. hepatica*. As genetic markers for SNP analyses, multiple genes have been used: ribosomal, mitochondrial and protein coding (somatic). These genes are predominantly highly conservative, with a small number of nucleotide variations. The information about those polymorphisms could increase the knowledge of species identification, differentiation and diversity of closely related species as well as of interspecific relationships.

### 3.1.1 Ribosomal DNA regions used for SNP assay

Ribosomal DNA (rDNA) has been widely used for taxonomy status establishment and/or inter- and intraspecific differences. It consists of alternating conservative and variable regions (Figure 2).

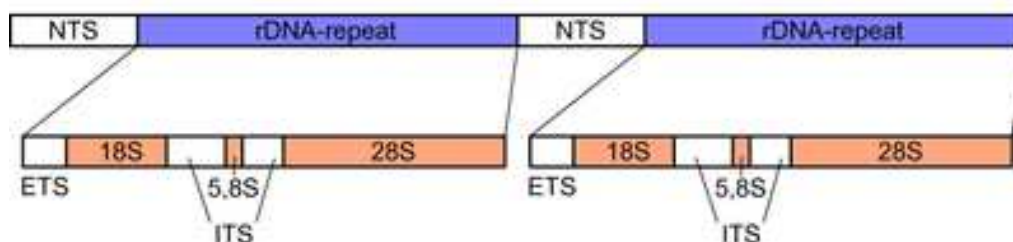

Fig. 2. Structure of eukaryote rDNA genes (18S, 5,8S, 28S) in tandem clusters with internal (ITS 1 and ITS2) and external (ETS) transcribed spacers and nontranscribed spacers (NTS). ([http://www.absoluteastronomy.com/topics/Ribosomal\\_DNA](http://www.absoluteastronomy.com/topics/Ribosomal_DNA)).

Coding rDNA regions provide information for systematics and phylogeny of the species (Hillis & Dixon, 1991). Conservative genes (18S, 28S) are used for revealing the relationships between different or closely related species. For clarifying intraspecific genetic structure of populations only a variable ribosomal regions could be reliable for analysing. Most commonly utilized variable regions are ITS 1, ITS 2 and D-domains (divergent regions in 28S and 18S genes). As it concerns *F. hepatica* many research teams have applied above mentioned rDNA genes in multiple investigations (Lee et al., 2007; Olson et al., 2003; Lotfy et al., 2008; Vara-Del Río et al., 2007; Marcilla et al., 2002, etc.). D1-region from 28S rDNA has been used for genetic structuring of the populations of species from phylum Platyhelminthes (Lee et al., 2007). Differences in nucleotide sequences have been observed even in the same class but nevertheless high phylogenetic similarity has been found in classes and orders. Similar investigations have been obtained with 18S rDNA and D1-D3 regions of 28S rDNA for class Trematoda (Olson et al., 2003). The results from that investigation have enabled clarifying of taxonomy, phylogeny and evolutionary relationships in the class. As it concerns the evolution and origin of fasciolid species and liver fluke in particular, Lotfy et al. (2008) utilized 28S rDNA, ITS 1 and ITS 2 spacers to establish monophyleticity of that group. Using the nucleotide sequences and phylogenetic relationships of mentioned ribosomal regions the authors described evolutionary processes that occurred with fasciolid species and defined their origin. A fragment from 28S rDNA has been used to demonstrate



the genetic heterogeneity of *F. hepatica* isolates in Spain (Vara-Del Río et al., 2007). SNP assay of that fragment sequence revealed intraspecific genetic variability. Sequence analysis again of 28S rDNA region in combination with PCR-RFLP assay also allowed differentiation between *F. hepatica* and *F. gigantica* (Marcilla et al., 2002). Although intraspecific polymorphisms have not been proved and only a few interspecific variation have been found. With the same fragment genetic diversity studies have been performed (Teofanova et al., 2011). 28S rDNA has not been proved as proper molecule marker for that kind of population research but better for species identification. Usually for *Fasciola* spp. identification the researches have been performed with ITS 1 and ITS 2 spacers because of their higher variability (Semyenova et al., 2005; Erensoy et al., 2009; Morgan & Blair, 1995; Prasad et al., 2008; Huang et al., 2004; Amer et al., 2010). That type of investigations have been conducted for different geographic locations – Russia, Ukraine, Armenia, etc. (Semyenova et al., 2005), Turkey (Erensoy et al., 2009), China (Huang et al., 2004) and other countries. These spacers have been commonly used for population structuring and genetic diversity explanations.

### 3.1.2 Mitochondrial DNA regions used for SNP assay

Mitochondrial DNA (mtDNA) is also frequently used in molecular taxonomy and genetic diversity investigations. That is due to its specific characteristics. For example maternal inheritance gives the opportunity to trace out the genealogy that defines population relationships and origin (Le et al., 2000a, 2001, 2002). Also its evolution, faster than nuclear DNA evolution, assumes more frequent mutation events and often gene variations or rearrangements are specific for particular taxa. Mitochondrial haplotype defining enables the genetic diversity determination among and within the populations (including liver fluke populations). mtDNA genes sequence analysis assists sometimes extremely hard differentiation of two species and/or subspecies closely related in accordance with their morphological and physiological characteristics. There is a detailed mtDNA data for a number of organisms and in particular full nucleotide sequence of *F. hepatica* mitochondrion have been described from Le et al., (2001). As a conservative molecule not all of the gene regions of liver fluke mtDNA are “plastic” and therefore informative enough for population structuring, phylogenetic and genetic diversity studies. Three areas of it have been defined as potentially most polymorphic (FhmtDNACOX3/ND4, FhmtDNAATP6/ND1 и FhmtDNACOX1/1-rRNA) (Figure 3) (Walker et al., 2007).

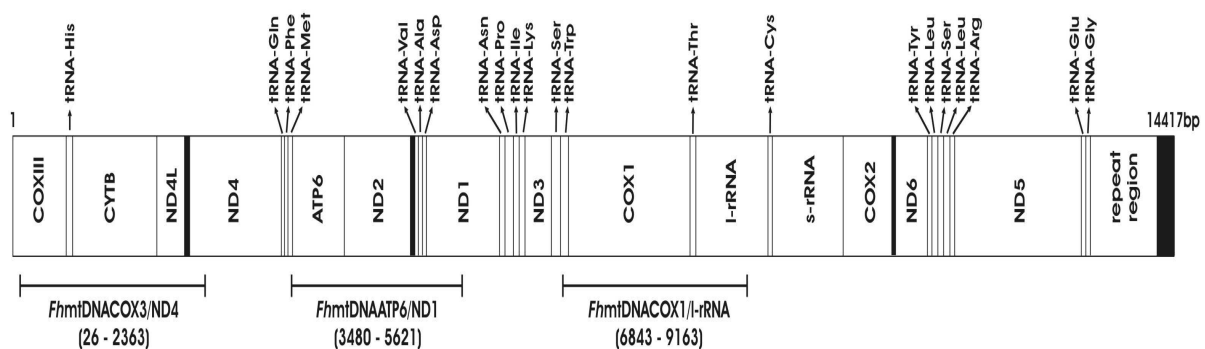

Fig. 3. Localization of the three most polymorphic regions in mtDNA of *F.hepatica* (Walker et al., 2007).

Most often used is variation analysis of the *nad1* and *cox1* genes (Hashimoto et al., 1997; Semyenova et al., 2006; Lee et al., 2007; Amer et al., 2010). The comprehensive information about them helps definition of polymorphic sites as molecule markers for explanation of liver fluke populations' genetic diversity. Sequence analysis of *cox1* gene has been performed for establishment of taxonomical belonging of Japanese *Fasciola* sp. (Hashimoto et al., 1997). *F. hepatica* differs with 25-28 nucleotides from Japanese *Fasciola* sp. but *F. gigantica* differs only with 4-5 nucleotides. Respectively amino acid variations are 4 for *F. hepatica* and only one for *F. gigantica*. This data in combination with PCR-RFLP profiles of full mtDNA enables the confirmation by the authors of taxonomical identity of Japanese fasciolides and *F. gigantica*. *cox1* gene has been also used for revealing the phylogenetic relationships of the species from Phylum Platyhelminthes (Lee et al., 2007). It has been shown that even in one and the same class there are differences not only in PCR products length and GC content but also in nucleotide sequence and the presence of gaps which are 9 and 5 for trematodes and cestodes respectively. *nad1* и *cox1* gene sequences have been analysed also for differentiation between Eastern European and Western Asian liver fluke populations (Semyenova et al., 2006). 13 *nad1* and 10 *cox1* haplotypes have been identified in that research. They have been dispersed within two main lineages (I and II) with 1.07% nucleotide difference and unequal distribution in studied geographic areas. Obtained data has been interpreted by the authors as different maternal origin from two genetically different ancestral populations. It has been hypothesized that lineage I has Asian origin but both of them present in European population of *F. hepatica*. Nucleotide sequence of *nad1* gene has been used also aiming the search of evolutionary history and origin of fasciolide species by Lotfy et al. (2008). Noncoding regions of mtDNA (long (LNR) and short (SNR)) have been studied (Korchagina et al., 2009) and it has been assumed that the polymorphisms and structural differences among them are associated with different haplotype groups of *F. hepatica*. In comparison with all other researchers, Teofanova et al. (2011), Walker et al. (2011) and Kantzoura et al.(2011), performed the investigations not with commonly used *nad1* and *cox1* genes from respectively second and third "plastic" regions of mtDNA (Figure 3) but with part from the first one which found to be most variable. Teofanova et al. (2011) have defined the population structure of liver fluke in Eastern Europe and Walker et al. (2011) have studied population dynamics of *F. hepatica* and genetic diversity of its populations in the Netherlands. Kantzoura et al. (2011) have established the correlation between defined South-Eastern European genetic variants and physicogeographic characteristics of those regions and prognosticated these haplogroups distribution through mathematical modelling.

### 3.1.3 Protein coding genes used for SNP assay

Population genetics researches could apply sequence analysis of protein coding genes as well. For that purpose it is important the selection of highly conservative genes. With regard to parasitic helminths commonly used are genes encoding target proteins for variety potential antihelmintic drugs. Different proteins and protein coding genes have been studied for genetic structuring of populations. These proteins are for example cathepsin L-like enzymes, cathepsin L protease family,  $\beta$ -tubulin 3, etc. (Robinson et al., 2001, 2002; Irving et al., 2003; Ryan et al., 2008). For fasciolides exhaustive sequence and evolutionary analysis of 18 different cathepsin L-like enzymes have been obtained (Irving et al., 2003). Respectively amino acid assay have been performed by the authors aiming the definition of

specific sites in polypeptide chain which are presumable targets of positive adaptive evolution. The built phylogenetic structure of these fasciolide enzymes have been used for divergence timing between closely related species *F. hepatica* and *F. gigantica*.

Target proteins for antihelmintic drugs as  $\beta$ -tubulin 3 are not well studied. It has been established that *F. hepatica* express different isotypes of tubulin proteins and many of them are associated with antihelmintic resistance and because of that they are subject of recent investigations (Robinson et al., 2001, 2002; Ryan et al., 2008). The  $\beta$ -tubulin 3 gene have been utilized for genetic diversity research of liver fluke populations but it has been found to be not suitable as a molecule marker because of the multiple polymorphism without structuring properties (Teofanova et al., 2011).

#### **4. Issues associated with genetic diversity studies of Fasciola hepatica**

Despite of the high quality of SNP analyses, data and results interpretations bring up many questions. They concern the presence of heteroplasmy within the mitochondrial haplotypes, the presence of recombination events in ribosomal genes and/or protein coding genes and their indicative value for the presence of cross-fertilization in populations of liver flukes. A substantial problem is also to find the correct correlation between SNP analyses data and the species origin and genetic diversity of geographic isolates. Despite the fact that *F. hepatica* has been an object for many years of research, its origin, biogeography, evolution and genetic diversity are still very intensive and not entirely complete which is also a problem to resolve.

##### **4.1 Choosing a gene of an interest to study**

The choice of gene regions to study is determined by the search and identification of the most proper molecule marker for population and genetic diversity studies. These regions could be with different type of inheritance and genetic status (e.g. organelle or nuclear localisation). Detailed analysis of chosen gene sequence would provide information about genetic drift, phylogeny of the species, evolution, genetic diversity and its relation to geographic localization and/or a host. Data comparison of variety of investigation would contribute to obtain complete view of genetic structure of *F. hepatica* populations. Nevertheless more of them do not point out any particular gene to be the most suitable marker and what are the advantages or disadvantages of that gene region usage. Comparative analyse of three gene fragments with different types of inheritance has been performed only in the research of Teofanova et al. (2011). It has been established that with respect to population structuring, phylogenetic and genetic diversity studies mtDNA genes are most adequate molecule markers. rDNA only allows clarification of taxonomic belonging of the organism and only a partial explanation of genetic diversity and evolution. Somatic protein coding gene used in that investigation, regardless its insignificant role for establishment of inter- and intrapopulational relationships, have been proved to be important for confirmation of cross-fertilization between liver flukes.

##### **4.1.1 28S rDNA gene regions analysis**

SNP assay of 28S rDNA gene region has been used for taxonomic belonging confirmation to *F. hepatica* species (Teofanova et al., 2011) which is not surprising taking the fact that in

Europe it is the only representative of *Fasciola* spp. (Mas-Coma et al., 1999; WHO, 2006). Investigations for species differentiation (Marcilla et al., 2002) and genetic heterogeneity (Vara-Del Rio et al., 2007) also have been performed (Section 3.1.1) but only the study of Teofanova et al. (2011) gives the opportunity for lineage definition (e.g. b105A, b105G and b105C/T) aiming determination of genetic diversity of liver fluke populations. It also has contributed to establishment of relations between the lineages and geographic location and for the first time the reason of such distribution of these lineages has been shown (e.g. polymorphism at 105 bp) (Figure 4). Some of the lineages have been found specific for the country of origin (e.g. b105C/T for Poland). The interpretation of that small group is dabatable considering the low frequency of presence. Although the study of Vara-Del Rio et al. (2007) shows variation at the same nucleotide position it has not been concretely defined and only commented as associated with sensitive and/or resistant to antihelminthic drugs liver fluke isolates in Spain but not in a view of population structuring.

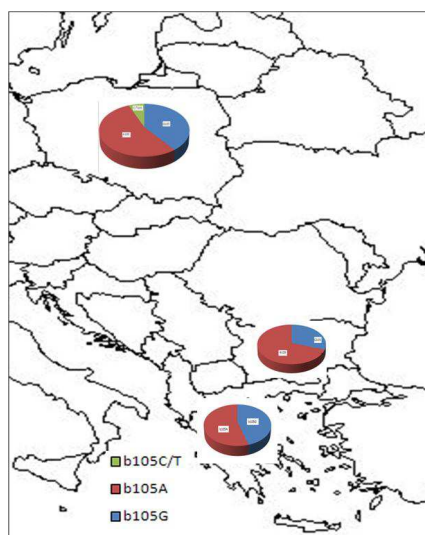

Fig. 4. Geographic distribution of 28s rDNA lineages for *F. hepatica* populations (Teofanova et al., 2011).

In total all the investigations on 28S rDNA are related to a single geographic isolates of *F. hepatica* but not at the populational level which is one of the main issues using such a conservative genes. It is a common casus finding of additional and not depended on the distribution of the basic lineages genotype groups (e.g. S28f and S28e; Teofanova et al., 2011) which can not be previously predicted and more hardly to explain with a higher level of speculation.

#### 4.1.2 mtDNA gene regions analysis

mtDNA is the most common used for interpopulational structuring, intra- and interspecific definition studies. That is due to its characteristics such as high conservativeness, specific inheritance (maternal and very rarely parental) and absence of recombinant events (haploid genome). The most valuable and most common mitochondrial genes were presented in Section 3.1.2. Only three studies (Teofanova et al., 2011; Walker et al., 2011; Kantzoura et al., 2011) concerned different but found to be most polymorphic fragments from mtDNA of *F. hepatica* (consisted from partial *cox3* (cytochrome c oxidase 3) gene, *tRNA-His*, partial *cob*



(cytochrome B) gene). Again predominance of the researches refers to single geographic isolates of *F. hepatica* but not forming a worldwide picture of populational groups' distribution. Only in some cases analysis of nucleotide variations of mitochondrion genes was performed for species identification (Section 3.1.2). Choosing "plastic" fragments of liver fluke mitochondrion means choosing the most informative and adequate markers for obtaining a complete view on genetic diversity of *F. hepatica* in the world. Nevertheless only three available in bibliographic data bases studies could give such a picture (Semyenova et al., 2006; Teofanova et al., 2011; Walker et al., 2011). One of them is genetic diversity investigation of liver fluke populations from Eastern Europe (Teofanova et al., 2011). Obtained data appears to be very informative and allows defining of genetic intrapopulational structure, evolution history and migration processes of *F. hepatica*. It also enables the differentiation of two main lineages (CtCmt1 and CtCmt2) and divergent CtCmt2 myotypes from first and second level, which are specific for Southerneastern or Northernestern Europe populations (Figure 5). These lineages and haplogroups are well described according to the corresponding single nucleotide polymorphisms and their presence frequency. That frequency gives the opportunity for phylogenetic ageing of each group having in mind that higher frequency correlates to evolutionaty earliar origin.

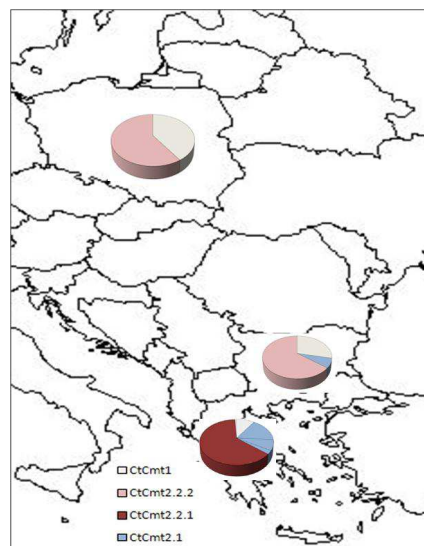

Fig. 5. Geographic distribution of mtDNA lineages for *F. hepatica* populations (Teofanova et al., 2011).

It is also possible that revealed after a detailed aminoacid sequence analysis substitutions in the studied mitochondrial proteins to be with physiological influence with direct adaptive evolutionary role for liver fluke individuals. This data could be compared only with mentioned above two other studies – about the genetic differentiation in Eastern European and Western Asian populations of *F. hepatica* (Semyenova et al., 2006) and about population dynamics of *F. hepatica* and genetic diversity of its populations in the Netherlands (Walker et al., 2011). Although the investigation of Semyenova et al. (2006) has been performed using nad1 and cox 1 gene both lineage I and II were described through the characteristic nucleotide variations as well as in investigation of Teofanova et al. (2011) (Figure 6). Mediated by the full mitochondrion sequence of *F. hepatica* (AF216697; Le et al., 2000b) it is possible to claim the identity of lineage I and CtCmt1. By analogy to lineage I the origin of



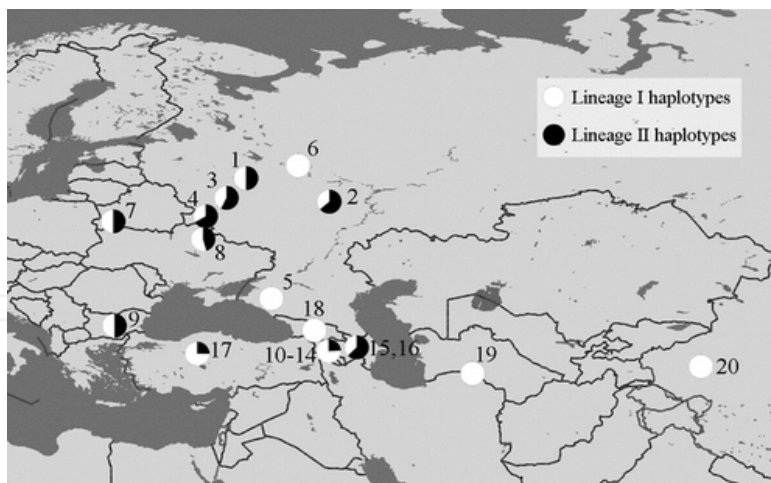

Fig. 6. Geographic distribution of two mitochondrial lineages for *F. hepatica* populations (Semyenova et al., 2006).

CtCmt1 was assumed to be Asian. That is also due to the fact that unlike CtCmt2 lineage CtCmt1 does not divergate to additional haplogroups and it is almost equally distributed in Eastern Europe. Probably there is also a correlation between lineage II and CtCmt2 but there are no direct evidences about that. Some of the mentioned above explanations are an example of solving the problem of finding the correct correlation between SNP assay data and the species origin and genetic diversity of variety of geographic isolates. It also reveals the properties of well described and interpreted nucleotide variations data for polymorphic mtDNA gene regions. Unfortunately such analysis is rarely observed in published researches and that decrease the opportunity for establishment of whole and complete picture of worldwide liver fluke genetic diversity. Another debatable case could be found after elaboration of Walker et al. (2011) investigation about the Dutch population of *F. hepatica* and after a search for correlation between available in GenBank™ sequences from the Netherlands and those typical for CtCmt1/CtCmt2 lineages and the divergent mytotypes. Dutch liver fluke representatives have been differentiated in three detached clades but the belonging of GenBank™ sequences to them has not been described by the authors. Sequence comparative assay enables their assignation to CtCmt1, CtCmt2.1.3 and CtCmt2.2.2 haplogroups from the study of Teofanova et al. (2011). That confirms that CtCmt2.2.2 is characteristic mytotype for Northern populations and gives the opportunity to presume that CtCmt2.1.3 haplotype is typical for Western European populations but not for Greek ones as it has been mentioned by Teofanova et al. (2011). That once again shows that a correct and complete genetic diversity analysis is very difficult and associated with multiple issues but realizable as it concerns mtDNA genes as molecule markers for SNP assay.

#### 4.1.3 $\beta$ -tubulin 3 (somatic) gene analysis

It is not so common to use somatic genes for phylogenetic and populational genetics analysis. The reason is the higher variability and the presence of heterozygosity in consequence of recombination events. They are also different than genes described in Sections 4.1.1. and 4.1.2 with respect to the inheritance type.  $\beta$ -tubulin 3 in particular has never been used for populational research except for study of Teofanova et al. (2011). Even in that investigation that gene analysis has not been proved to be adequate for definition of

explicit lineages because of the multiple polymorphism, heterozygosity and recombination. That problem has been resolved by its directing to independent frequency evaluation of polymorphisms in sequences with different country of origin (Figure 7). There has been observed a tendency of decreasing polymorphisms frequency in liver fluke populations in a South/North direction in Eastern Europe.

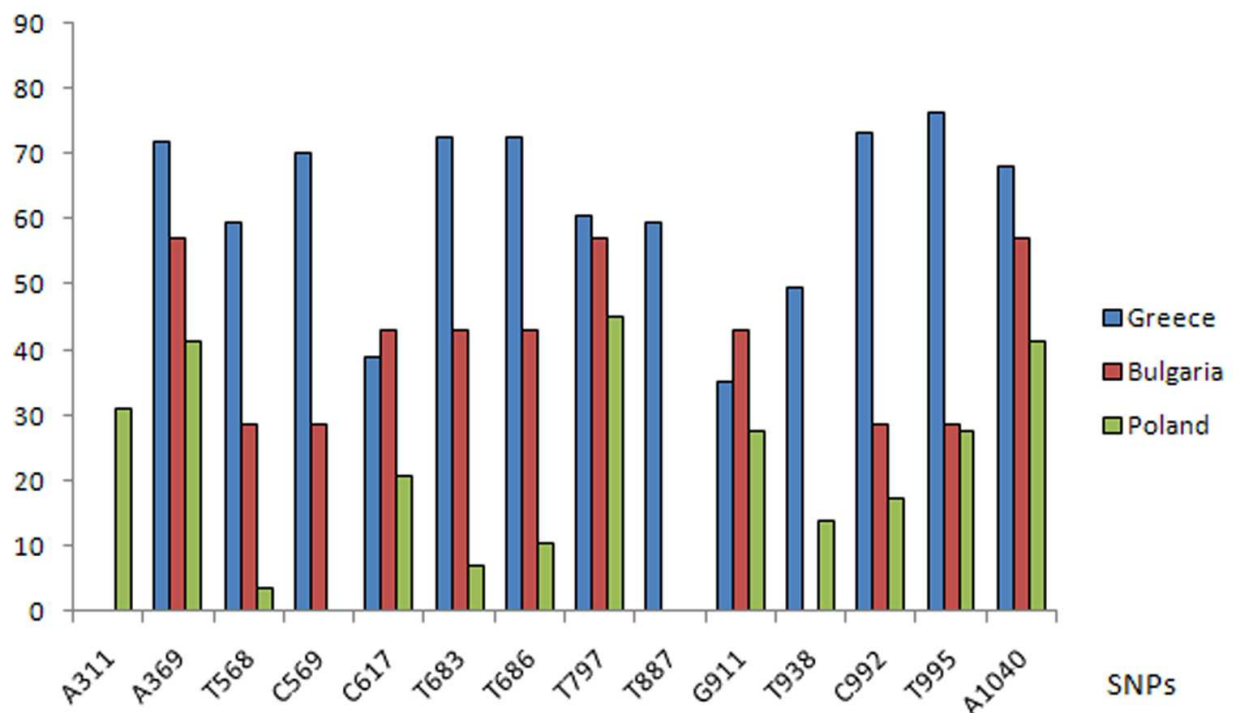

Fig. 7. Geographic distribution of  $\beta$ -tubulin 3 gene polymorphisms for *F. hepatica* populations (Teofanova et al., 2011).

Although that somatic gene has not been found suitable as a molecule marker for populational structuring and phylogenetic studies, it supports the analysis data for ribosomal and mitochondrial gene regions in that particular study for discrimination of Southern and Northern *F. hepatica* populations from Eastern Europe.

#### 4.2 Heterozygosity and heteroplasmy

A diploid organism is heterozygous at a gene locus when its cells contain two different alleles of a gene.

Heteroplasmy could be explained by the inheritance of mixed organelle populations (e.g. mitochondrial) (Doublet et al., 2008; Reiner et al., 2010) and is found only for haploid genomes.

As it concerns somatic genes, the heterozygosity in them is a commonly observed as a multiple alleles resulting from high level of recombination events which are usual for outbreeding systems. In the case of  $\beta$ -tubulin 3 gene (Section 4.1.3) the heterozygosity could be used as an evidence for cross-fertilization processes together with hermaphroditic sexual reproduction which was considered to be the only way of reproduction of *F. hepatica* in past.

Now some investigations are attempting to prove the presence of mating between different liver fluke individuals as well (Hurtrez-Bousses et al., 2001; Fletcher et al., 2004; Amer et al., 2010; Teofanova et al., 2011).

More strange and unusual is observed heterozygosity in rDNA (Teofanova et al., 2011) which could be defined as a phenomenon and is not well studied. The heterozygosity in 105th nucleotide could have different explanations. One of them is the possibility that is highly mutable position. On the other side it could be due to recombination events by analogy with somatic genes. There are no much published data about this event and more of it concerns yeasts (Petes, 1980) so the first presumption seems more likely. Heterozygosity has been found also in additional S28f and S28e genotype groups of rDNA (Teofanova et al., 2011). In that case heterozygosity has been with high rate and could be an attestation for their evolutionary history defining them as evolutionary young groups. Analogically the presence of only one polymorphic nucleotide site (105 bp) with low level of heterozygosity would be determinative for evolutionary old mutation which is proved by almost equal distribution of basic lineages (b105A and b105G). Of course all of that is quite speculative and could not be used as a definitive evidence for the reason of observed heterozygosity. Only in one other case was mentioned about the heterozygosity in 28S rDNA and that is in single Spanish isolate (Vara-Del Río et al., 2007) but with no reasoning explanation.

It is possible to say that heteroplasmy is “heterozygosity of haploid organisms” and represents a mixture of more than one type of an organellar genome (mitochondrial DNA or plastid DNA) within a cell or individual. The presence of heteroplasmic individuals is probably due to recent evolutionary processes. It is quite uncommon commenting that effect of SNP assay of mitochondrial sequences. Only a few authors mention its observation but more information about it could give the opportunity for correct and complete data interpretation (Semyenova et al., 2006; Korchagina et al., 2009; Teofanova et al., 2011). In the investigation of Semyenova et al. (2006) for population structure of liver flukes with respect to *nad1* and *cox1* mtDNA genes heteroplasmy has been defined as a source of the population haplotype diversity. Korchagina et al. (2009) discuss more widely the heteroplasmy in noncoding mtDNA regions from *F. hepatica* but pointed that the right mechanism that cause and sustain heteroplasmy is unknown. Changed copies are thought to result from polymerase slippage during DNA replication (Levinson & Gutman, 1987), mispairing (Buroker et al., 1990), and, in some cases, DNA recombination (Lunt & Hyman, 1997). In the investigation of Teofanova et al. (2011) heteroplasmy has been observed with high frequency in small haplogroups (C3mt(193-206) and CBmt(710/711)) and it could be presumably suggested that it is due to a recent evolutionary processes and these groups are young and still forming their appearance. It is obvious that if the heteroplasmy presence problem would be resolved the obtained data could be more detailed and precise.

#### 4.3 Cladogram visualisation issues

When working with sequence analysis a variety of software products could facilitate the processing (e.g. ChromasPro 1.5 (Copyright © 2003-2009 Technelysium Pty Ltd), ClustalW2 (Larkin et al., 2007), BLAST (Basic Local Alignment Search Tool), MEGA 4.0 (Kumar et al., 2008)). That always means that many mistakes are possible for example due to statistical problems or not taking into account the scientific background. For example only single

nucleotide variations or polymorphisms with very low and insignificant frequencies must not be considered and are detected as sequencing mistakes. Nevertheless some programs do include such variations when processing the analysis. Moreover most of the programs do not evaluate mutation occurrence frequencies of any studied SNPs and could not detect their phylogenetic and evolutionary significance. Another problem concerns cladogram visualisation. Sometimes it shows hard for interpretation and contradictory data and in that case it is not suitable for SNP assays. For example some programs when building Neighbor Joining Trees could put the heterozygous or heteroplasmic representatives in a separate group which is not correct. Also two different programs could build two different cladograms independently of used tool for that. The process was checked with sequences from investigation of Teofanova et al. (2011) which are available in GenBank™ as populational sets and with BLAST tool (at <http://www.ncbi.nlm.nih.gov>), with ClustalW2 and MEGA 4.0 programs and built cladograms appeared to be different between each other and not coinciding with data obtained from polymorphisms description.

#### 4.4 Evolutionary and phylogenetic reasoning for genetic diversity

Data for the origin, biogeography, evolution and their association with genetic diversity of *F. hepatica* is not entirely complete. It is a problem that not many investigations discuss and usually there are a lot of speculations and presumptions with only an indirect evidencing. Still there are some researchers trying to solve these issues (Irving et al., 2003; Semyenova et al., 2006; Lotfy et al., 2008; Teofanova et al., 2011). All these studies performed their hypothesis based on obtained results. Modern theories for the evolution and origin of fasciolid species are connected to the coevolution of definitive (mammals) and intermediate (freshwater snails) hosts during the Neozoan age. It has been assumed that fasciolides' originated in Africa about 50 MYA (million years ago) during the Eocene Epoch followed by their dispersion in Eurasia (Lotfy et al., 2008). Authors have accepted the hypothesis of coevolution between fasciolides and their hosts and because of that they have suggested that definitive hosts of the ancient fasciolid species were predecessors of the elephants. As it concerns intermediate hosts according to Lotfy et al. (2008) that are freshwater planorbid (Planorbidae) and/or lymnaeid (Lymnaeidae) snails. It has been presumed that the switch between planorbids (specific for ancient fasciolides from Africa) to lymnaeids had happened in Eurasia which favoured emergence of Fasciolinae. Because of that it has been hypothesized that *F. hepatica* has Eurasian origin and colonization of Africa occurred secondary. The evidence for that is parasite preference to the lymnaeid snail *Galba truncatula*. Subsequently according to Irving et al. (2003) the divergence between *F. hepatica* and the closely related to it *F. gigantica* has occurred about 28 - 16 MYA during the Miocene Epoch. Hypotheses about the following evolution of the liver flukes are connected with the evolution of cloven-footed animals (mainly sheep, goats, and cows). Because of that there are many searches for correlation between particular definitive hosts and specific genetic lineages or clades of *F. hepatica* (Hiendleder et al., 2002; Semyenova et al., 2006) but there are no direct evidences for that. As it was mentioned in Section 4.1.2 there is a lineage with Asian origin (Semyenova et al., 2006) subsequently spread in Europe. Geological timing of that recolonization has not been defined but it is very probably to be associated with the end of the last ice age and/or with human migration from Asia to Europe at the end of Pleistocene Epoch. These evolutionary and phylogenetic hypotheses are combined and visualised on Figure 8.



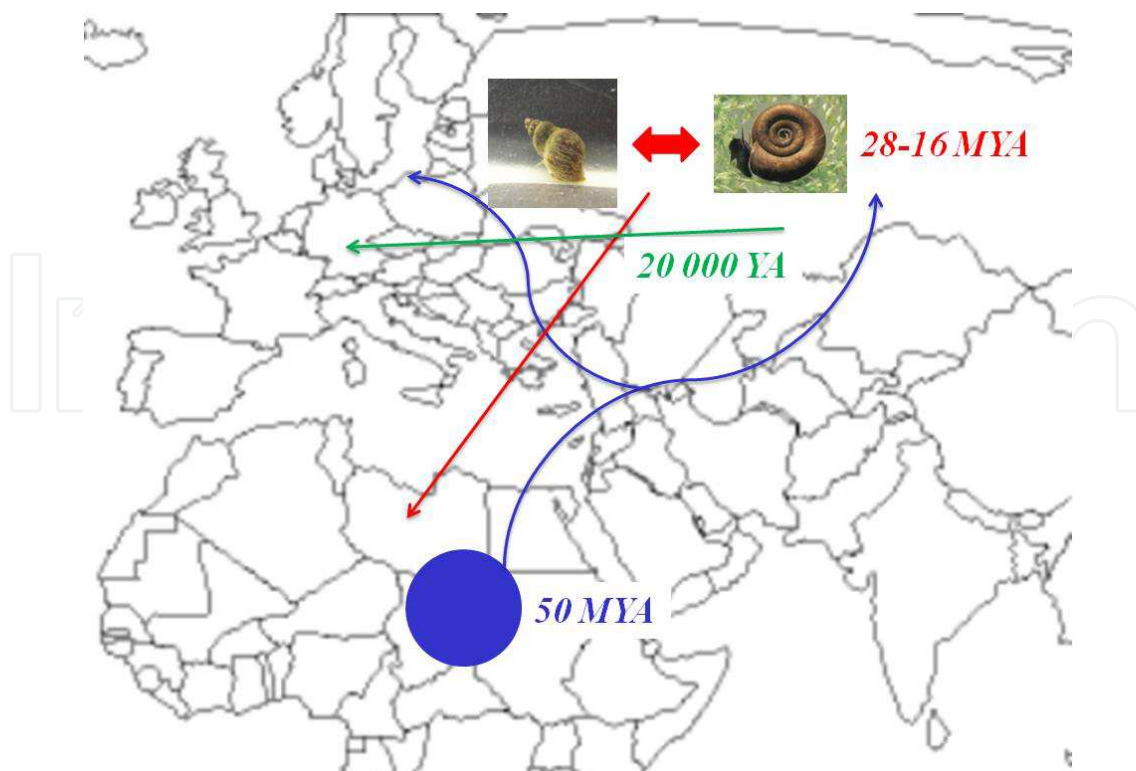

Fig. 8. Evolutionary and phylogenetic hypotheses for *F. hepatica*. Blue arrows – African origin of fasciolid species and distribution in Eurasia (Lotfy et al., 2008); Red arrows – Eurasian origin of *F. hepatica* as a result of switch between planorbids and lymnaeids and recolonization of Africa (Irving et al., 2003); Green arrow – Mitochondrial lineage with Asian origin and colonization of Europe (Semyenova et al., 2006).

The investigation of Teofanova et al. (2011) proposed some more additional hypotheses. First one has resulted from determination of haplogroup belonging of Australian (AF216697), (Le et al., 2000b) and Tanzanian sequence (EU282862), (Walker et al., 2008) to CtCmt1 and CtCmt2.2.2 respectively. Because mentioned haplogroups have been defined as specific for Northern European liver fluke populations the presence of *F. hepatica* in Australia and Tanzania has been assumed to be result of those geographic areas colonization from Northern European liver fluke populations (mainly from UK). Second theory in that study has been based on territorial and populational isolation of chosen geographic areas in past due to the continental drift. During the Miocene about 19 MYA Africa collided with Eurasia (Seyfert & Sirkin, 1979). During that period present-days' part of Italia and Greece (part of Western Balkans) have not been connected to Eurasian continent. Although it is quite speculative, that could be an explanation of observed differences between the liver fluke populations in Central Europe (Poland) and Southern Eastern Europe (Greece) regions. It is possible either Eurasian liver fluke populations or populations from newly joined to Eurasia Greek areas to perform divergation and colonization.

Third hypothesis from the investigation of Teofanova et al. (2011) has been associated with *F. hepatica* rerecolonization after last ice age during the Pleistocene Epoch about 20 000 years (Figure 9).



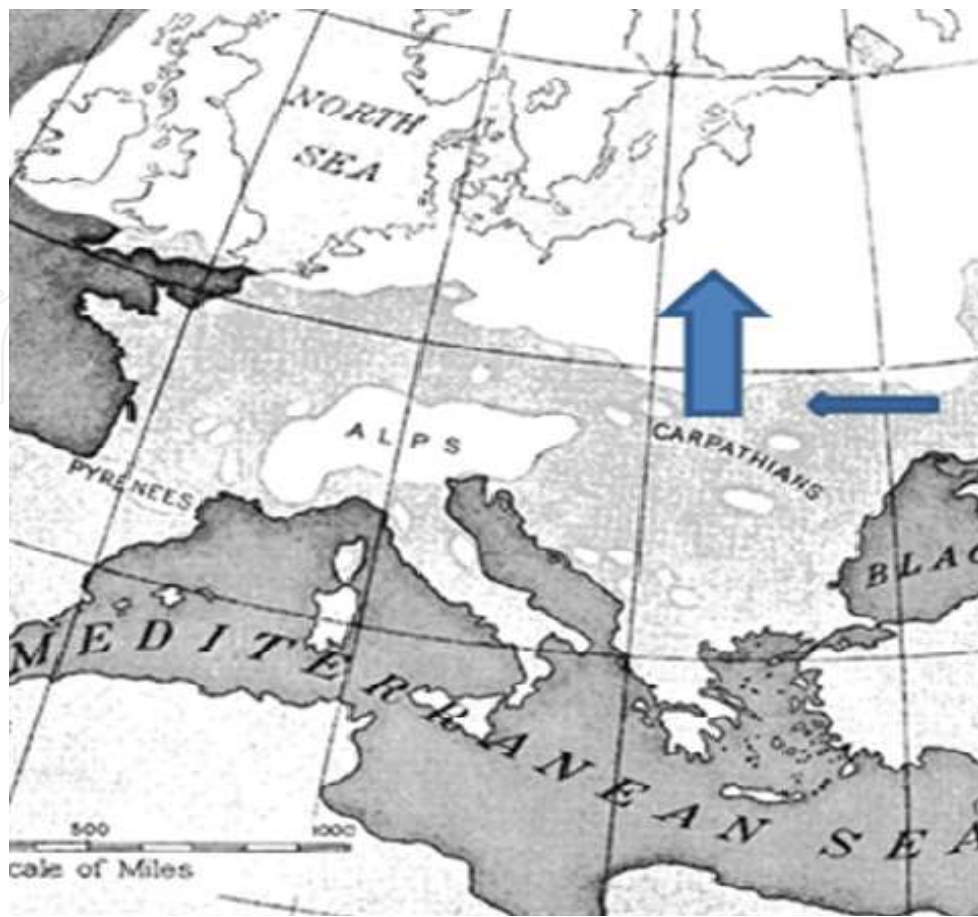

Fig. 9. Spreading of glacial sheets during the last ice age during Pleistocene Epoch and colonization possibilities of newly released geographic regions (Blue arrows).

During the last ice age glacial sheets did not cover the territories of Bulgaria and Greece and reach only Northern Carpathian Mountains (Seyfert & Sirkin, 1979). According to the study of Teofanova et al. (2011), re-colonization of Northern areas after ice age originated not from far South (Greece) but from boundary regions of the glacial sheets. This hypothesis is confirmed by the presented data for the b-tubulin 3 gene and mitochondrial profile of Bulgarian population. The parallel genetic drift could be also realized from East to West (from Asia to Europe). That could be also related to human migration and the transfer of domestic animals. The evidence was found in the mitochondrial lineage I with Asian origin from the investigation of Semyanova et al. (2006) and identical to CtCmt1 lineage (Teofanova et al., 2011).

In total it is obvious that the results of any population structuring or genetic diversity investigation are associated with variety of issues and problems but their resolution is not impossible and could contribute to a better understanding of the genetic structure and heterogeneity of liver fluke intrapopulations worldwide.

## 5. Conclusion

The increasing of the knowledge of population structure and genetic diversity of liver fluke is necessary. A variety of molecular methods have been applied for genetic structuring of

parasitic populations and in particular of the liver fluke. Each one of them has its advantages and disadvantages. To avoid their negative features, recent developments include single nucleotide polymorphism assays after direct sequencing, which has been proved to be the most reliable method used in genetic diversity studies of *Fasciola hepatica*. Despite of the high quality of that assay it is pursued of a lot of issues and problems to resolve (heteroplasmy within the mitochondrial genes, recombination events in ribosomal genes and/or somatic genes, etc.). Their proper and complete analysis and evaluation in combination with correct data interpretation could solve a substantial problem to find the correlation between nucleotide variations and the species origin and genetic diversity of geographic isolates. In view of using data of genetic polymorphism for solving practical issues (studying differences in the pathogenic effects of various haplotypes, infectivity monitoring of pastures and wetlands, etc.), it is of a significant importance to clarify the unresolved issues.

## 6. Acknowledgment

This study was supported by the grant WETLANET funded by FP7 EC (FP7 CSA – SUPPORT ACTION, GA 229802) and by the European Union funded DELIVER Project (Contract No.: FOOD-CT-2004-023025).

## 7. References

- Ai, L., Chen, M.-X., Alasaad, S., Elsheikha, H.M., Li, J., Li, H.-L., Lin, R.-Q., Zou, F.-C., Zhu, X.-Q. & Chen, J.-X. (2011). Genetic characterization, species differentiation and detection of *Fasciola* spp. by molecular approaches, *Parasites & Vectors*, Vol.4, No.101, pp. 1-6, ISSN 1756-3305
- Ai, L., Li, C., Elsheikha, H.M., Hong, S.J., Chen, J.X., Chen, S.H., Li, X., Cai, X.Q., Chen, M.X. & Zhu, X.Q. (2010). Rapid identification and differentiation of *Fasciola hepatica* and *Fasciola gigantica* by a loop-mediated isothermal amplification (LAMP) assay, *Veterinary parasitology*, Vol.174, No.3-4, pp. 228–233, ISSN 0304-4017
- Alasaad, S., Li, Q.Y., Lin, R.Q., Martín-Atance, P., Granados, J.E., Díez-Baños, P., Pérez, J.M. & Zhu, X.Q. (2008). Genetic variability among *Fasciola hepatica* samples from different host species and geographical localities in Spain revealed by the novel SRAP marker, *Parasitology research*, Vol.103, No.1, pp. 181–186, ISSN 0932-0113
- Alasaad, S., Soriguer, R.C., Abu-Madi, M., El Behairy, A., Baños, P.D., Píriz, A., Fickel, J. & Zhu, X.Q. (2011). A fluorescence-based polymerase chain reaction-linked singlestrandconformation polymorphism (F-PCR-SSCP) assay for the identification of *Fasciola* spp., *Parasitology research*, Vol.108, No.6, pp. 1513–1517, ISSN 0932-0113
- Alasaad, S., Soriguer, R.C., Abu-Madi, M., El Behairy, A., Baños, P.D., Píriz, A., Fickel, J. & Zhu, X.Q. (2011). A TaqMan real-time PCR-based assay for the identification of *Fasciola* spp., *Veterinary parasitology*, Vol.179, No.1-3, pp. 266–271, ISSN 0304-4017
- Amer, S., Dar, Y., Ichikawa, M., Fukuda, Y., Tada, C., Itagaki, T. & Nakai, Y. (2010). Identification of *Fasciola* species isolated from Egypt based on sequence analysis of genomic (ITS1 and ITS2) and mitochondrial (NDI and COI) gene markers, *Parasitology International*, Vol.60, No.1, pp. 5-12, ISSN 1383-5769

- Buroker, N.E., Brown, J.R., Gilbert, T.A., O'Hara, P.J., Beckenbach, A.T., Thomas, W.K. & Smith, M.J. (1990). Length heteroplasmy of sturgeon mitochondrial DNA: An illegitimate elongation model, *Genetics*, Vol.124, No.1, pp. 157-163, ISSN 0016-6731
- Doublet, V., Souty-Grosset, C., Bouchon, D., Cordaux, R. & Marcade, I. (2008). A Thirty Million Year-Old Inherited Heteroplasmy, *PLoS ONE*, Vol.3, No.8, e2938, ISSN 1932-6203
- Erensoy, A., Kuk, S. & Ozden, M. (2009). Genetic identification of *Fasciola hepatica* by ITS-2 sequence of nuclear ribosomal DNA in Turkey, *Parasitology Research*, Vol.105, No.2, pp. 407-412, ISSN 0932-0113
- Fletcher, H.L., Hoey, E.M., Orr, N., Trudgett, A., Fairweather, I. & Robinson, M.W. (2004). The occurrence and significance of triploidy in the liver fluke, *Fasciola hepatica*, *Parasitology*, Vol.128, No.1, pp. 69-72, ISSN 0031-1820
- Gunasekar, K.R., Tewari, A.K., Sreekumar, C., Gupta, S.C. & Rao, J.R. (2008) Elucidation of genetic variability among different isolates of *Fasciola gigantica* (giant liverfluke) using random-amplified polymorphic DNA polymerase chain reaction, *Parasitology research*, Vol.103, No.5, pp. 1075-1081, ISSN 0932-0113
- Hashimoto, K., Watanobe, T., Liu, C.X., Init, I., Blair, D., Ohnishi, S. & Agatsuma, T. (1997). Mitochondrial DNA and nuclear DNA indicate that the Japanese *Fasciola* species is *F. gigantica*, *Parasitology research*, Vol.83, No.3, pp. 220-225, ISSN 0932-0113
- Hiendleder, S., Kaupe, B., Wassmuth, R. & Janke, A. (2002). Molecular analysis of wild and domestic sheep questions current nomenclature and provides evidence for domestication from two different subspecies, *Proceedings of the Royal Society of London. Series B. Biological Science*, Vol.269, No.1494, pp. 893-904, ISBN 3-900051-07-0
- Hillis, D.M. & Dixon, M.T. (1991). Ribosomal DNA: molecular evolution and phylogenetic inference, *The Quarterly review of biology*, Vol.66, No.4, pp. 411-453, ISSN 0033-5770
- Huang, W.Y., He, B., Wang, C.R. & Zhu, X.Q. (2004). Characterisation of *Fasciola* species from mainland China by ITS-2 ribosomal DNA sequence, *Veterinary parasitology*, Vol.120, No.1-2, pp. 75-83, ISSN 0304-4017
- Hurtrez-Bousses, S., Durand, P., Jabbour-Zahab, R., Guegan, J.-F., Meunier, C., Bargues, M.-D., Mas-Coma, S., & Renaud, F. (2004). Isolation and characterization of microsatellite markers in the liver fluke (*Fasciola hepatica*), *Molecular Ecology Notes*, Vol.4, No.4, pp. 689-690, ISSN 1471-8278
- Hurtrez-Bousses, S., Meunier, C., Durand, P. & Renaud, F. (2001). Dynamics of host-parasite interactions: the example of population biology of the liver fluke (*Fasciola hepatica*), *Microbes and Infection*, Vol.3, No.10, pp. 841-849, ISSN 1286-4579
- Ichikawa, M. & Itagaki, T. (2010). Discrimination of the ITS1 types of *Fasciola spp.* based on a PCR-RFLP method, *Parasitology research*, Vol.106, No.3, pp. 757-761, ISSN: 0932-0113
- Irving, J.A., Spithill, T.W., Pike, R.N., Whisstock, J.C. & Smooker, P.M. (2003). The Evolution of Enzyme Specificity in *Fasciola spp.*, *Journal of Molecular Evolution*, Vol.57, No.1, pp. 1-15, ISSN 0022-2844
- Kantzoura, V., Kouam, M.K., Feidas, H., Teofanova, D. & Theodoropoulos, G. (2011). Geographic distribution modelling for ruminant liver flukes (*Fasciola hepatica*) in South-eastern Europe, *International Journal for Parasitology*, Vol.41, No.7, pp. 747-753, ISSN 0020-7519

- Kumar, S., Dudley, J., Nei, M. & Tamura, K. (2008). MEGA: A biologist-centric software for evolutionary analysis of DNA and protein sequences, *Briefings in Bioinformatics*, Vol.9, No.4, pp. 299-306, ISSN 1467-5463
- Larkin, M.A., Blackshields, G., Brown, N.P., Chenna, R., McGettigan, P.A., McWilliam, H., Valentin, F., Wallace, I.M., Wilm, A., Lopez, R., Thompson, J.D., Gibson, T.J. & Higgins, D.G. (2007). ClustalW and ClustalX version 2, *Bioinformatics*, Vol.23, No.21, pp. 2947-2948, ISSN 1367-4803
- Le, T.H., Blair, D. & McManus, D.P. (2000a). Mitochondrial genomes of human helminths and their use as markers in population genetics and phylogeny, *Acta Tropica*, Vol.77, No.3, pp. 243-256, ISSN 0001-706X
- Le, T.H., Blair, D., Agatsuma, T., Humair, P.F., Campbell, N.J., Iwagami, M., Littlewood, D.T., Peacock, B., Johnston, D.A., Bartley, J., Rollinson, D., Herniou, E.A., Zarlenga, D.S. & McManus, D.P. (2000b). Phylogenies inferred from mitochondrial gene orders—a cautionary tale from the parasitic flatworms, *Molecular Biology and Evolution*, Vol.17, No.7, pp. 1123-1125, ISSN 0737-4038
- Le, T.H., Blair, D. & McManus, D.P. (2001). Complete DNA sequence and gene organization of the mitochondrial genome of the liver fluke, *Fasciola hepatica* L. (Platyhelminthes; Trematoda), *Parasitology*, Vol.123, No.6, pp. 609-621, ISSN 0031-1820
- Le, T.H., Blair, D. & McManus, D.P. (2002). Mitochondrial genomes of parasitic flatworms, *Trends in Parasitology*, Vol.18, No.5, pp. 206-213, ISSN 1471-4922
- Lee, S.-U., Chun, H.-C. & Huh, S. (2007). Molecular phylogeny of parasitic Platyhelminthes based on sequences of partial 28S rDNA D1 and mitochondrial cytochrome c oxidase subunit I, *The Korean Journal of Parasitology*, Vol.45, No.3, pp. 181-189, ISSN 0023-4001
- Levinson, G. & Gutman, G.A. (1987). Slipped-strand mispairing: A major mechanism for DNA sequence evolution, *Molecular Biology and Evolution*, Vol.4, No.3, pp. 203-221, ISSN 0737-4038
- Li, G. & Quiros, C.F. (2001). Sequence-related amplified polymorphism (SRAP), a new marker system based on a simple PCR reaction: its application to mapping and gene tagging in Brassica, *Theoretical and applied genetics*, Vol.103, No.2-3, pp. 455-461, ISSN 0040-5752
- Li, Q.Y., Dong, S.J., Zhang, W.Y., Lin, R.Q., Wang, C.R., Qian, D.X., Lun, Z.R., Song, H.Q. & Zhu, X.Q. (2009). Sequence-related amplified polymorphism, an effective molecular approach for studying genetic variation in *Fasciola spp.* of human and animal health significance, *Electrophoresis*, Vol.30, No.2, pp. 403-409, ISSN 0173-0835
- Lotfy, W.M., Brant, S.V., DeJong, R.J., Le, T.H., Demiaszkiewicz, A., Jayanthe, R.R.P.V., Perera, V.B.V.P., Laursen, J.R. & Loker, E.S. (2008). Evolutionary Origins, Diversification and Biogeography of Liver Flukes (Digenea, Fasciolidae), *The American Journal of Tropical Medicine and Hygiene*, Vol.79, No.2, pp. 248-255, ISSN 0002-9637
- Lunt, D.H. & Hyman, B.C. (1997). Animal mitochondrial DNA recombination, *Nature*, Vol.387, No.6630, pp. 247, ISSN 0028-0836
- Magalhaes, K.G., Jannotti-Passos, L.K., Caldeira, R.L., Berne, M.E., Muller, G., Carvalho, O.S. & Lenzi, H.L. (2008). Isolation and detection of *Fasciola hepatica* DNA in *Lymnaea*



- viatrix* from formalin-fixed and paraffin-embedded tissues through multiplex-PCR, *Veterinary parasitology*, Vol.152, No.3-4, pp. 333-338, ISSN 0304-4017
- Marcilla, A., Bargues, M.D. & Mas-Coma, S. (2002). A PCR-RFLP assay for the distinction between *Fasciola hepatica* and *Fasciola gigantica*, *Molecular and Cellular Probes*, Vol.16, No.5, pp.327-333, ISSN 0890-8508
- Mas-Coma, S., Esteban, J.G. & Bargues M.D. (1999). Epidemiology of human fascioliasis: a review and proposed new classification, *Bulletin of the World Health Organization*, Vol.77, No.4, pp. 340-346, ISSN 0042-9686
- Mas-Coma, S., Bargues, M.D. & Valero, M.A. (2005). Fascioliasis and other plant-borne trematode zoonoses. *International Journal for Parasitology*, Vol.35, No.11-12, pp. 1255-1278, ISSN 0020-7519
- McGarry, J.W., Ortiz, P.L., Hodgkinson, J.E., Goreish, I. & Williams D.J.L. (2007). PCR-based differentiation of *Fasciola* species (Trematoda: Fasciolidae), using primers based on RAPD-derived sequences, *Annals of Tropical Medicine and Parasitology*, Vol.101, No.5, pp. 415-421, ISSN 0003-4983
- Morgan, J.A.T. & Blair, D. (1995). Nuclear rDNA ITS sequence variation in the trematode genus *Echinostoma*: an aid to establishing relationships within the 37-collar spine group, *Parasitology*, Vol.111, No.5, pp.609-615, ISSN 0031-1820
- Notomi, T., Okayama, H., Masubuchi, H., Yonekawa, T., Watanabe, K., Amino, N. & Hase, T. (2000). Loop-mediated isothermal amplification of DNA, *Nucleic Acids Research*, Vol.28, No.12, e63, ISSN 0305-1048
- Olson, P.D., Cribb, T.H., Tkach, V.V., Bray, R.A. & Littlewood, D.T.J. (2003). Phylogeny and classification of the Digenea (Platyhelminthes: Trematoda), *International Journal for Parasitology*, Vol.33, No.7, pp. 733-755, ISSN 0020-7519
- Orita, M., Iwahana, H., Kanazawa, H., Hayashi, K. & Sekiya, T. (1989). Detection of polymorphisms of human DNA by gel electrophoresis as single-strand conformation polymorphisms (mobility shift of separated strands/point mutation/riction fragment length polymorphism), *Proceedings of the National Academy of Sciences of the United States of America, Genetics*, Vol.86, No.8, pp. 2766-2770, ISSN 0027-8424
- Pemberton, T.J., Sandefur, C.I., Jakobsson, M. & Rosenberg, N.A. (2009). Sequence determinants of human microsatellite variability, *BMC Genomics*, Vol.10, No.1, pp. 612-631, ISSN 1471-2164
- Petes, T.D. (1980). Unequal meiotic recombination within tandem arrays of yeast ribosomal DNA genes, *Cell*, Vol.19, No.3, pp. 765-774, ISSN 0092-8674
- Prasad, P.K., Tandon, V., Biswal, D.K., Goswami, L.M. & Chatterjee, A. (2008). Molecular identification of the Indian liver fluke, *Fasciola* (Trematoda: Fasciolidae) based on the ribosomal internal transcribed spacer regions, *Parasitology Research*, Vol.103, No.6, pp. 1247-1255, ISSN 0932-0113
- Reiner, J.E., Kishore, R.B., Levin, B.C., Albanetti, T. & Boire, N. (2010). Detection of Heteroplasmic Mitochondrial DNA in Single Mitochondria, *PLoS ONE*, Vol.5, No.12, e14359, ISSN 1932-6203
- Robinson, M.W., Hoey, E.M., Fairweather, I., Dalton, J.P., McGonigle, S. & Trudgett, A. (2001). Characterization of a  $\beta$ -tubulin gene from the liver fluke, *Fasciola hepatica*, *International Journal for Parasitology* Vol.31, No.11, pp. 1264-1268, ISSN 0020-7519



- Robinson, M.W., Trudgett, A., Hoey, E.M. & Fairweather, I. (2002). Triclabendazole-resistant *Fasciola hepatica*:  $\beta$ -tubulin and response to in vitro treatment with triclabendazole, *Parasitology*, Vol.124, No.3, pp. 325-338, ISSN 0031-1820
- Rokas, A., Ladoukakis, E. & Zouros, E. (2003). Animal mitochondrial DNA recombination revisited, *Trends in Ecology and Evolution*, Vol.18, No.8, pp. 411-417, ISSN 0169-5347
- Ryan, L.A., Hoey, E., Trudgett, A., Fairweather, I., Fuchs, M., Robinson, M.W., Chambers, E., Timson, D.J., Ryana, E., Feltwell, T., Ivens, A., Bentley, G. & Johnston, D. (2008). *Fasciola hepatica* expresses multiple  $\alpha$ - and  $\beta$ -tubulin isotypes, *Molecular and Biochemical Parasitology*, Vol.159, No.1, pp. 73-78, ISSN 0166-6851
- Semyenova, S.K., Morozova, E.V., Chrisanfova, G.G., Asatrian, A.M., Movsessian, S.O. & Ryskov, A.P. (2003). RAPD variability and genetic diversity in two populations of liver fluke, *Fasciola hepatica*, *Acta Parasitologica*, Vol.48, No.2, pp. 1230-2821, ISSN 1230-2821
- Semyenova, S.K., Morozova, E.V., Vasilyev, V.A., Gorokhov, V.V., Moskvin, S., Movsessyan, S.O. & Ryskov, A.P. (2005). Polymorphism of internal transcribed spacer 2 (ITS-2) sequences and genetic relationships between *Fasciola hepatica* and *Fasciola gigantica*, *Acta Parasitologica*, Vol.50, No.3, pp. 240-243, ISSN 1230-2821
- Semyenova, S.K., Morozova, E.V., Chrisanfova, G.G., Gorokhov, V.V., Arkhipov, I.A., Moskvin, A.S., Movsessyan, S.O. & Ryskov, A.P. (2006). Genetic differentiation in Eastern European and Western Asian populations of the liver fluke, *Fasciola hepatica*, as revealed by mitochondrial *nad1* and *cox1* genes, *The Journal of Parasitology*, Vol.92, No.3, pp. 525-530, ISSN 0022-3395
- Seyfert, C.K. & Sirkin, L.D. (1979). *Earth history and Plate Tectonics*, Harper and Row Publishers, pp. 600, ISBN 0060459190, New York
- Spithill, T.W., Smooker, P.M. & Copeman, D.B. (1999). *Fasciola gigantica*: epidemiology, control, immunology and molecular biology, In: *Fasciolosis*, J.P. Dalton, (Ed.), pp. 465-525, ISBN 0-85199-260-9, Wallingford, Oxon, UK: CABI Pub.
- Sunnucks, P., Wilson, A.C., Beheregaray, L.B., Zenger, K., French, J. & Taylor, A.C. (2000). SSCP is not so difficult: the application and utility of single-stranded conformation polymorphism in evolutionary biology and molecular ecology, *Molecular Ecology*, Vol.9, No.11, pp. 1699-1710, ISSN 0962-1083
- Teofanova, D., Kantzoura, V., Walker, S., Radoslavov, G., Hristov, P., Theodoropoulos, G., Bankov, I. & Trudgett, A. (2011). Genetic diversity of liver flukes (*Fasciola hepatica*) from Eastern Europe, *Infection, Genetics and Evolution*, Vol.11, No.1, pp. 109-115, ISSN 1567-1348
- Vara-Del Río, M.P., Villa, H., Martinez-Valladares, M. & Rojo-Vázquez, F.A. (2007). Genetic heterogeneity of *Fasciola hepatica* isolates in the Northwest of Spain, *Parasitology Research*, Vol.101, No.4, pp. 1003-1006, ISSN 0932-0113
- Wagner, J. (February 2003). Screening Methods for Detection of Unknown Point Mutations, Available from [http://www.users.med.cornell.edu/~jawagne/screening\\_for\\_mutations.html#Single-Strand.Conformational.Polymorphism](http://www.users.med.cornell.edu/~jawagne/screening_for_mutations.html#Single-Strand.Conformational.Polymorphism)
- Walker, S.M., Prodöhl, P.A., Fletcher, H.L., Hanna, R.E.B., Kantzoura, V., Hoey, E.M. & Trudgett, A. (2007). Evidence for multiple mitochondrial lineages of *Fasciola hepatica* (liver fluke) within infrapopulations from cattle and sheep, *Parasitology Research*, Vol.101, No.1, pp. 117-125, ISSN 0932-0113

- Walker, S.M., Johnston, C., Hoey, E.M., Fairweather, I., Borgsteede, F., Gaasenbeek, C., Prodöhl, P.A. & Trudgett, A. (2011). Population dynamics of the liver fluke, *Fasciola hepatica*: the effect of time and spatial separation on the genetic diversity of fluke populations in the Netherlands, *Parasitology*, Vol.138, No.2, pp. 215-223, ISSN 0031-1820
- World Health Organization Headquarters. (2006). Report of the WHO Informal Meeting on use of triclabendazole in fascioliasis control, ISBN 978-92-4-1564090, Geneva, Switzerland

IntechOpen

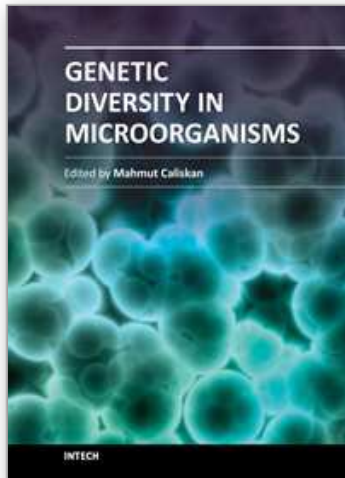

## **Genetic Diversity in Microorganisms**

Edited by Prof. Mahmut Caliskan

ISBN 978-953-51-0064-5

Hard cover, 382 pages

**Publisher** InTech

**Published online** 24, February, 2012

**Published in print edition** February, 2012

Genetic Diversity in Microorganisms presents chapters revealing the magnitude of genetic diversity of microorganisms living in different environmental conditions. The complexity and diversity of microbial populations is by far the highest among all living organisms. The diversity of microbial communities and their ecologic roles are being explored in soil, water, on plants and in animals, and in extreme environments such as the arctic deep-sea vents or high saline lakes. The increasing availability of PCR-based molecular markers allows the detailed analyses and evaluation of genetic diversity in microorganisms. The purpose of the book is to provide a glimpse into the dynamic process of genetic diversity of microorganisms by presenting the thoughts of scientists who are engaged in the generation of new ideas and techniques employed for the assessment of genetic diversity, often from very different perspectives. The book should prove useful to students, researchers, and experts in the area of microbial phylogeny, genetic diversity, and molecular biology.

### **How to reference**

In order to correctly reference this scholarly work, feel free to copy and paste the following:

Denitsa Teofanova, Peter Hristov, Aneliya Yoveva and Georgi Radoslavov (2012). Issues Associated with Genetic Diversity Studies of the Liver Fluke, Fasciola Hepatica (Platyhelminthes, Digenea, Fasciolidae), Genetic Diversity in Microorganisms, Prof. Mahmut Caliskan (Ed.), ISBN: 978-953-51-0064-5, InTech, Available from: <http://www.intechopen.com/books/genetic-diversity-in-microorganisms/issues-associated-with-genetic-diversity-studies-of-the-liver-fluke-fasciola-heptica-platyhelminthes>

**INTECH**  
open science | open minds

### **InTech Europe**

University Campus STeP Ri  
Slavka Krautzeka 83/A  
51000 Rijeka, Croatia  
Phone: +385 (51) 770 447  
Fax: +385 (51) 686 166  
[www.intechopen.com](http://www.intechopen.com)

### **InTech China**

Unit 405, Office Block, Hotel Equatorial Shanghai  
No.65, Yan An Road (West), Shanghai, 200040, China  
中国上海市延安西路65号上海国际贵都大饭店办公楼405单元  
Phone: +86-21-62489820  
Fax: +86-21-62489821

© 2012 The Author(s). Licensee IntechOpen. This is an open access article distributed under the terms of the [Creative Commons Attribution 3.0 License](#), which permits unrestricted use, distribution, and reproduction in any medium, provided the original work is properly cited.

IntechOpen

IntechOpen