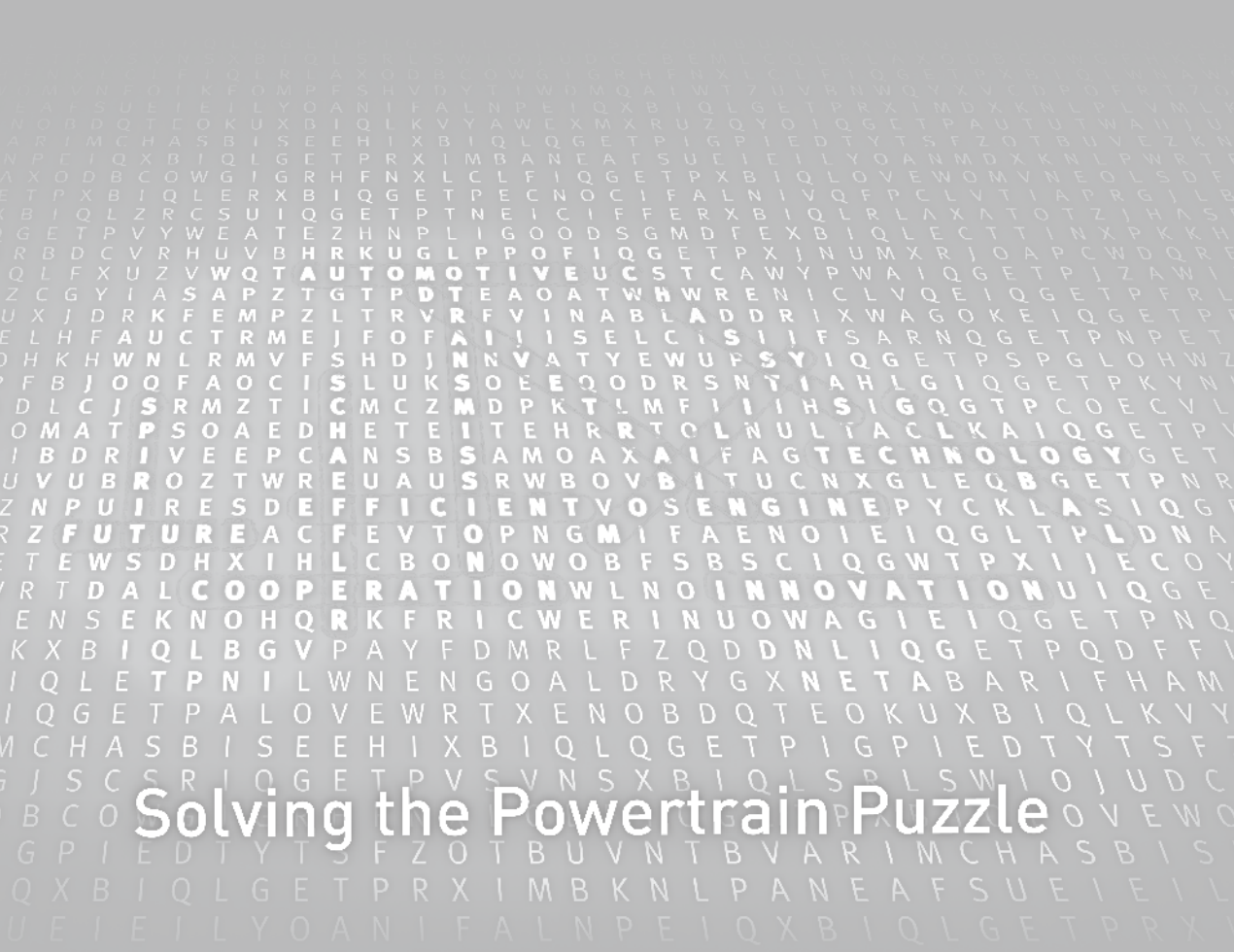


Schaeffler Technologies GmbH & Co.KG *Hrsg.*

# Solving the Powertrain Puzzle

10th Schaeffler Symposium  
April 3/4, 2014

OPEN



# Solving the Powertrain Puzzle

## 10<sup>th</sup> Schaeffler Symposium

Welcome



**SCHAEFFLER**

Schaeffler Technologies GmbH & Co. KG  
Herzogenaurach  
Germany

© The Editor(s) (if applicable) and the Author(s) 2014. The book is published with open access at SpringerLink.com

**Open Access.** This book is distributed under the terms of the Creative Commons Attribution Noncommercial License which permits any noncommercial use, distribution, and reproduction in any medium, provided the original author(s) and source are credited.

All commercial rights are reserved by the Publisher, whether the whole or part of the material is concerned, specifically the rights of translation, reprinting, re-use of illustrations, recitation, broadcasting, reproduction on microfilms or in any other way, and storage in data banks. Duplication of this publication or parts thereof is permitted only under the provisions of the Copyright Law of the Publisher's location, in its current version, and permission for commercial use must always be obtained from Springer. Permissions for commercial use may be obtained through Rights Link at the Copyright Clearance Center. Violations are liable to prosecution under the respective Copyright Law.

The use of general descriptive names, registered names, trademarks, etc. in this publication does not imply, even in the absence of a specific statement, that such names are exempt from the relevant protective laws and regulations and therefore free for general use.

DOI 10.1007/978-3-658-06430-3  
Library of Congress Control Number 2014946900

**SCHAEFFLER**



Publisher:  
Schaeffler Technologies GmbH & Co. KG  
Industriestrasse 1 – 3  
91074 Herzogenaurach · Germany  
Telephone +49 9132 82-0  
Telefax +49 9132 4950  
www.schaeffler.com

Editor: Dr. Wolfgang Reik;  
Redaktionsbüro delta eta, Frankfurt, Germany  
Layout: Nicole Daniel; Alexander Brand  
Copy editor: Heike Pinther; Jutta Dietz  
Printed by: Wünsch Druck GmbH, Neumarkt, Germany

The technical papers found in this issue are available  
in electronic format in the library  
on our homepage (search criterion: Symposium).

Reproduction in whole or part  
without our authorization is prohibited.

# Contents

Foreword	4
Overview of Technical Papers	6
Concept Vehicles	512



D L  
 WED W  
 JKJZMH  
 DLAGQSWIE  
 UBFIMBCHSEHE  
 EWCECBSTPOIODCVFEW  
 CXVNHHDG S C B M W R Z I P S F H K T V N  
 ZVTFLET C B C Y N V X A D G J L K H E S Y S C B  
 XDBPORWH T W H N E D K U N W P O N C A L V I K Z T W  
 DCSKUTE A M B C Y N V X A D G J L K H E S Y S C B M B C Y N  
 EWCBPWR E Z T W H N E D K U N W P O N C A L V I K Z T W H N E D  
 WDXSKTPI O D C V F E W C V T E B N M Z G O H A O I U Z T R E W Q  
 LZUCESG F V N P I Z R W Q S C G Z N J I M N S T R V A P I Z R W Q S E W  
 RUCXA S O L V I N G J T H E U P O W E R T R A I N B P U Z Z L E L N C W Q S C  
 QATUKQGE D N V U S G R V L G R V K G E C E Z E M D B V U G R V L L N C X W  
 CLOCZZI R E X O M N Y A Z T E W N F X J L R N I E Z E M D K V U S G R V L G R V  
 FAMTSCV C Y L J N E W C L V V F H N V R D J K U R N I F E X O M N Y U S G R V L  
 KMNOMY Q Y O B R E I N T E R N G M D S A F H B Q F J K U V Y I J N E W M N Y A Z T  
 LIEMUJNJOI P M F D B Q F G O N R E L N N E W C L Y  
 BSANSAUAH K Z M F D R O A D F N G E L N F X T  
 PIEEPDBD E F B A F V N K F N G U K Z M F D R O Q H I O G D N F N G K L D F  
 RUCATAU J G D N O I E R N G M D S A F W S P D F R B E F G D N O I E R  
 BSAEPO V U S G R V L G R V K G E C L K N I E A D G J L B E F B A F V V  
 DGVCZ L R B E F B A F V N K F N K R E W E M D G V U S G G J L E S E R K  
 YLMAT L K J H G F D S A M M B V C X Y M L M S P D L R B E F U S G R V L G F  
 CXVVT W P H C E Q A Y W S X E E C R F V E G B C E Q A Y W S B E F B A F V V  
 ZVTMF M B C Y N V X A D G J L K H E S Y S C B M Y N V X A D G Y W S X E E N C  
 XDBP T E T M B C Y N V X A D G J L K H E S Y S Y N B C Y N V X A D G J L E S N  
 DCBK WRWZ T W H N E D K U N W P O N C A L V ? T W H N E D K U N W P F H K  
 NVXD R U T E T M B C Y N V X A D G J L K H E S : B M B C Y N V X A D G J L K  
 I P O W R W Z T W H N E D K U N W P O N C A K Z T W H N E D K U N W P  
 F L K J K O I U Z T R E W Q Y X C V B N M  
 H A S E S V N P I Z R W Q S C G Z N J I M  
 G I K C K P M N E S W L N C X W Z Y K F F  
 A S U S V N P I Z R W Q S C G Z N J I  
 I K C K P M N E S W L N C X W Z Y K F  
 O X O D N V U S G R V L G R V K G  
 I N E X O M N Y A Z T E W N F  
 C Y L J N E W C L V V F H  
 N V U S G R V L G

## Foreword



There are plenty of technical ideas for the drive systems to power future generations of vehicles. But which of these is the right solution for which application? How will the markets change in the future? What basic innovations can we use to make engines and transmissions even more efficient?

At the 10th Schaeffler Symposium, 2014, we will venture a glimpse into the distant future – beyond 2020, when the most world's most stringent fuel consumption standards come into force in Europe. In the tradition of the Symposium, we will, on the one hand, be presenting our evolutionary technologies, which can make a significant contribution to optimizing the drive system. On the other hand, we will be discussing our radical innovations: Hybrid concepts

for 48-volt on-board electric systems or a transmission concept with electric power splitting as well as electric wheel hub drives for passenger cars.

We are convinced that the challenges of the future can only be overcome if permanent further development of conventional powertrains based on internal combustion engines, and the courage to realize new ideas for electrification go hand in hand. As a supplier, we focus more than ever on people's changing behavior with regard to mobility, because public acceptance will ultimately decide if and which technologies become established on the market.

In this spirit, we hope you will have exciting discussions about an exciting topic: The automotive drive systems of the future!

Norbert Indlekofer

Member of the Executive Board  
CEO Automotive

Prof. Dr. Peter Pleus

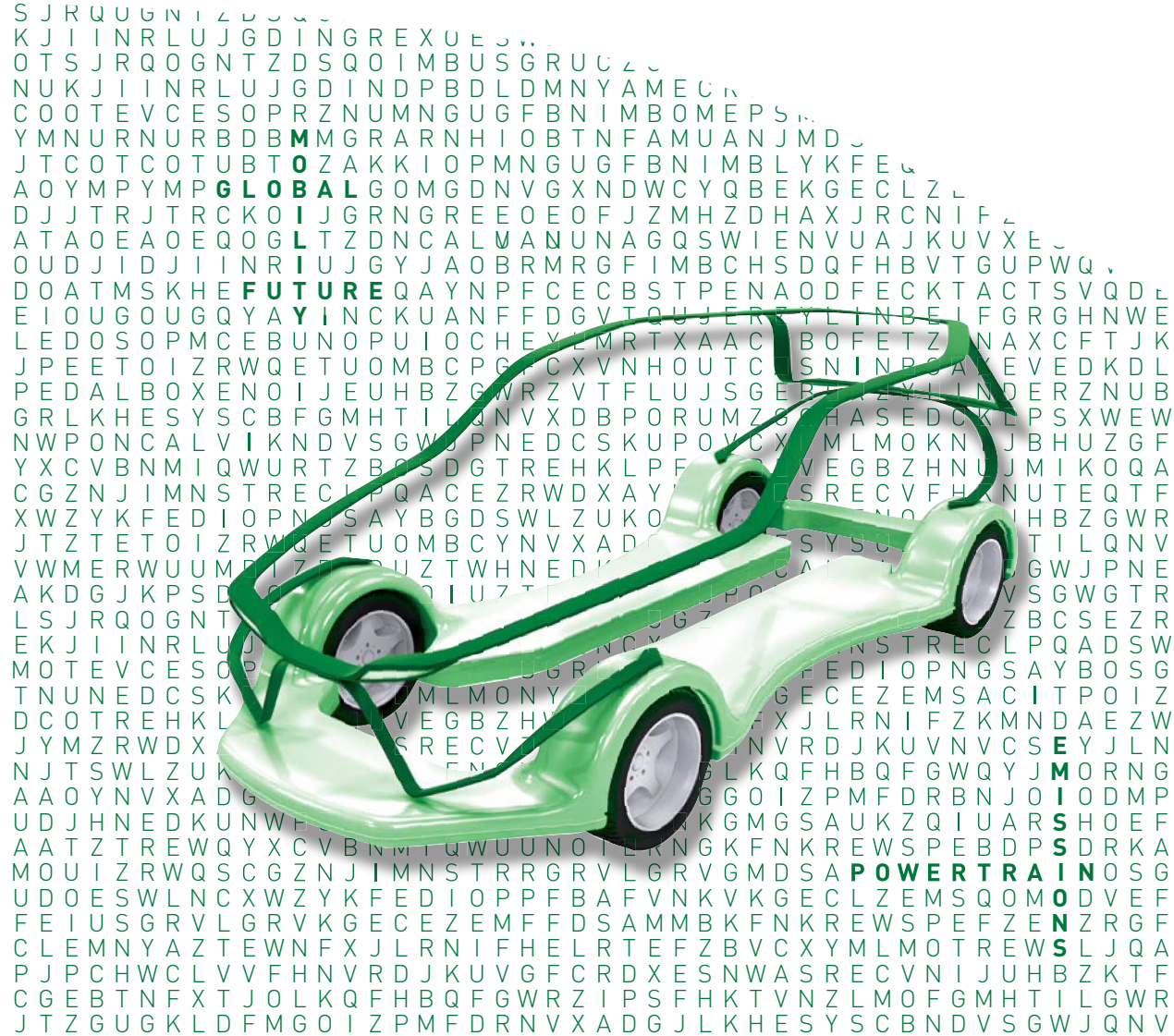
Member of the Executive Board  
CEO Automotive

V Q D L  
H N W E D W C  
F T J K J Z M H Z L  
D K D L A G Q S W I E R  
Z N U B I N G R E E O M N Y A Z I L  
X W E W V C S E - L I N E W C L V V H N V C  
U Z C X Q Y J A M B R N L N F X T J G L D Q F F E C N  
K O Z V O P L M O A Y C B E F V B N C T E N A L O P N G H C  
E Q X D G B E Q B M N E S W L N C A P Z Y K F F E T Z H N A X C  
Z G D C B N H Z I X O P L K U H G F T S A C V I N R O A X E V E D K L  
L Q E W T R E W L H G F D L G E N D R R T C A R Z Y L I N D E R Z N U W C  
J P W D H E S C I U P S K U P P L U Y G S G E A S E D C K L P S X W E Q S E W  
D G L Z I O T Y T R A N S M I S S I O N M Z G L M O K N I J B H U E C N C W Q S C  
C E R U R E W Q Y K J H G F D S A M O B V C X G B Z H N U J M I K N Z V L L N C X W  
G D Q A Y W A T O H C E Q A Y W S X Z E C R F E C V F H K N U T E G X S G R V L G R V  
M O C L I J U H B Z G V T F C R D X V S N W A R T O T J C H A S S I S N Y U S G R V L  
B O F A D G J L Y C B M W P Z I T I O N M I Q S C B F G M H T I L N E E W M N Y A Z T  
R E K M E T U O M B C I V I K N D V S G W J E W L N N E W C L  
E G L I R W O U Z - I J R T Z B C S D Z L N G E L N F X I  
P I D S A Y V N W Q S C G Z N J I M I E C L P Q A C A R D N F N G K L D I  
R U C K I O P W L N C X W Z Y K F E D I G S A Y B G D Q E F G D N O I E R  
B S Q O M G F J S G R V L G R V K G E C E Z E C I T P M O C J L B E F B A F V V  
D G I N G F M N Y A Z T E W N F X J L R N I F N D A B O F S G G J L E S E R K  
Y L V C S J N E W C L V V F H N V R D J K U V X Y M N R E K E F U S G R V L G F  
C X Q Y J R E L N F X T J O L K Q F H B Q F G U V Z E G L W S B E F B A F V V  
Z V N J C I D F N G K L D F M G O I Z P M F D R N C Y R X W B D G Y W S X E E N C  
X D U A I I O G D N O I E R N G M G S A U K Z Q I N S L T O P V X A D G J L E S N  
D C B D L R B E F B A F V N K F N K R E W S P L O Q G M F R E D K U N W P F H K  
N V U A I I O G D N O I E R N G M D S A G K Z Q I N S L W I B Y N V X A D G J L K  
I N V U S G R V L G R V K G E C L Z E M S A P M O D H N E D K U N W P  
L R B E F B A F V N K F N K R E W S P L O  
K J H G F D S A M M B V C X Y M L M O K N  
V D X A Y H B M W R Z I R F V E G B Z H I  
G V T F C R D X E S N W A S R E C V F  
I K C K P M N E S W L N C X W Z Y K F  
O X O D N V U S G R V L G R V K G  
I N E X O M N Y A Z T E W N F  
C Y L J N E W C L V V F H  
N V U S G R V L G  
G D N O I

# Technical Papers

1	Mobility of the Future	8
2	Powertrain Systems	24
3	Developing Combustion Engines	42
4	Manual Gearbox	56
5	Centrifugal Pendulum-type Absorber	78
6	Clutch Release Systems	94
7	Clutch Systems	112
8	Synchronisation Systems	126
9	Simulation Engine Systems	140
10	Camshaft Phasing Systems	156
11	Valvetrain Systems	172
12	Variable Valvetrain	188
13	Rolling Bearings for Turbochargers	202
14	48-volt Electric Axle	212
15	Double Clutch Systems	224
16	Dry Double Clutch	230
17	Wet Double Clutch	244
18	Planetary Transmission 1	256
19	Planetary Transmission 2	270
20	Torque Converter	280
21	Thermal Management	302
22	Timing Drive Systems	318
23	Customized Friction	330
24	Start-Stop	346
25	Transmission Actuators	360
26	Differential Systems	378
27	Chassis	392
28	Range-Extender	412
29	Hybrid Modules	426
30	Wheel Hub Drives	440
31	What Powertrains Could Learn from Each Other	452
32	CAFE Demonstrator	468
33	Belt Drive Systems	480
34	CVT	498





# Individuality and Variety

## Paradigms of future mobility

Prof. Dr. Peter Gutzmer

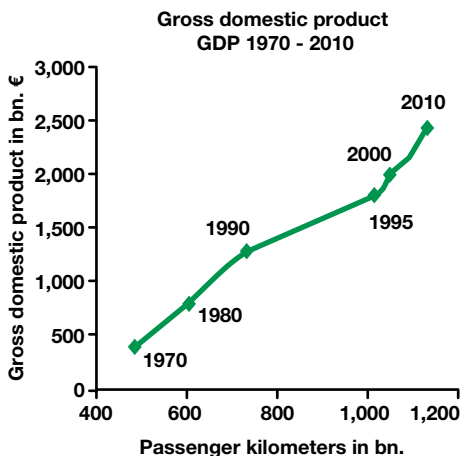


## Requirements for future mobility

### Mobility and climate protection

Mobility is not only a basic human need, it also correlates closely with economic growth. This is not only true for passenger traffic (Figure 1) but also for commercial transport, particularly on the road. Experts assume that there is a self-reinforcing effect between traffic and economic performance [1].

In contrast with total primary energy consumption, it has not been possible to disconnect traffic growth from economic growth. In spite of considerable savings in fuel consumption that have been achieved as a result of technical progress over the past few decades, the overall emissions of



Source: Federal Office of Statistics and VDA

**Figure 1** Development of Germany's gross domestic product and the number of passenger kilometers traveled annually for several years in the period from 1970 to 2010

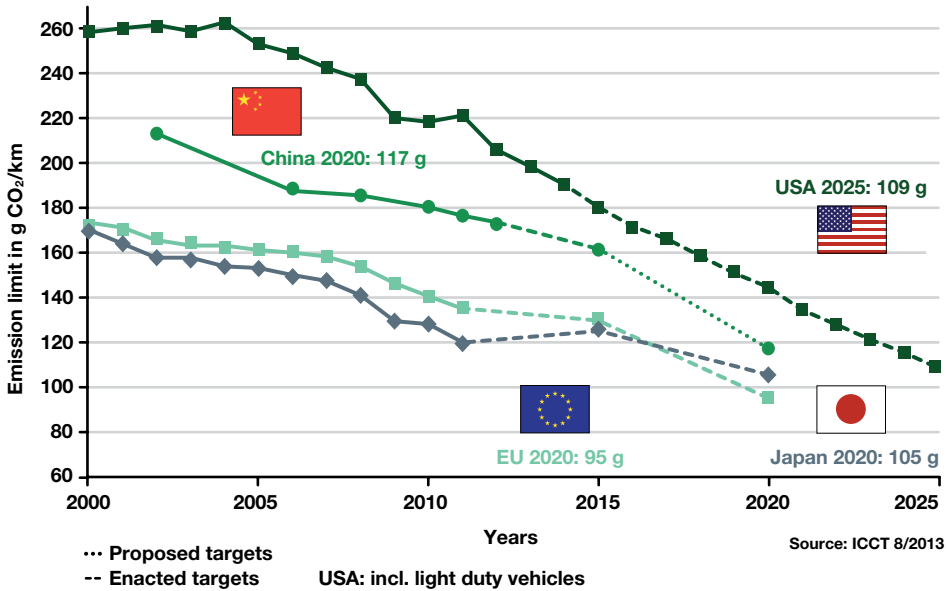
carbon dioxide related to traffic have continued to increase. The political system reacts to this by issuing ever stricter limits. This is a worldwide phenomenon in which limits converge, although with a time lag (Figure 2).

In late 2013, the European Union made a commitment to the most stringent CO<sub>2</sub> limit values worldwide [2]. According to this, a fleet limit value of 95 g/km will apply from 2020. This fleet limit value must be met initially by 95 % of the fleet and by 100 % from January 1, 2021. Vehicles emitting less than 50 g/km may be counted multiple times for three years (2020-2022). The total effect from these so-called "super credits" is limited to 7.5 g/km for each fleet.

This basically describes the primary task for future technical developments in motor vehicles. The challenge is to cover rising mobility requirements with fewer energy resources, and particularly lower CO<sub>2</sub> emissions. However, one consequence of the correlation between economic growth and mobility is that the greatest increase in the number of vehicles will be in the emerging regions outside of the "old" industrial nations of the triad (EU, USA, Japan). The question here is whether technical solutions from Europe – the Schaeffler Group's home region – can be applied without any changes.

### What do customers want? – The Schaeffler mobility study

The question of whether technologies can be transferred to another region is often reduced to the issue of costs. This is a one-sided view that bears the risk of losing sight of the customer and the customer's needs. For this reason, Schaeffler has decided to use a comprehensive approach for working out the development of future market scenarios. A recently completed



**Figure 2** CO<sub>2</sub> limits for major passenger car markets

mobility study was based on a three-step method:

1. Prepare mobility patterns for 12 selected world regions
2. Cluster the patterns in a matrix
3. Work out four in-depth scenarios for future mobility.

### Step 1: Mobility patterns

The first step involved the preparation of twelve detailed mobility patterns for selected world regions during several workshops. These patterns not only serve to analyze the current situation, they also extrapolate into 2025. Professional input was provided by in-house experts and from sources outside the company. Excerpts from four of these analyses are presented below as examples:

With an average household income of 52,900 euros (2011), there is no doubt that the borough of Manhattan in New York

can be called affluent. Its high traffic density results in permanently congested roads, particularly during the day. Inhabitants are very willing to use public transportation because their priority is to minimize travel time. However, the capacity of public transportation is also limited. At the same time, the city needs to reduce its noise and pollutant emissions. Approaches to solving these problems not only include the expansion of public transportation and increased use of bicycles, but also the introduction of small, agile electric vehicles to maximize traffic area utilization. As part of its “PlaNYC” sustainability initiative, the city plans to set up a dense network of charging stations for electric vehicles. The plan also includes the addition of electric vehicles to the municipal vehicle fleets.

The German state of Mecklenburg-Vorpommern is quite the opposite. The state’s population of 1.6 million is similar to that of Manhattan but it is 260 times larger. Not

only is population density much lower, but also the average income of 22,884 euros per capita (2011). Outside the towns, public transportation is scarce due to low demand. As a result, the majority of passenger traffic consists of – for the most part used – cars. Since the population is also getting older, a further increase in mobile services is to be expected. A mobile medical service is already being tested in **Mecklenburg-Vorpommern**.

Things are very different in the sprawling city of **Medellín** in Colombia, which has a population of 2.7 million. With more than 7,000 inhabitants per square kilometer, population density is very high, and a large number of the poorest live in unofficial shanty towns (Favela) on the outskirts of the city. Most people use “paratransit” to get downtown. This means privately operated vans or large taxis without fixed routes or stops. Expanding public transportation and implementing stricter emissions standards for vehicles could provide relief for the smog-filled downtown area. In addition, a very unusual idea has been put into practice. Medellín has integrated two cable car tracks into its regular public transportation system that serve the shanty towns on the hills surrounding the city and can transport 3,000 people per hour.

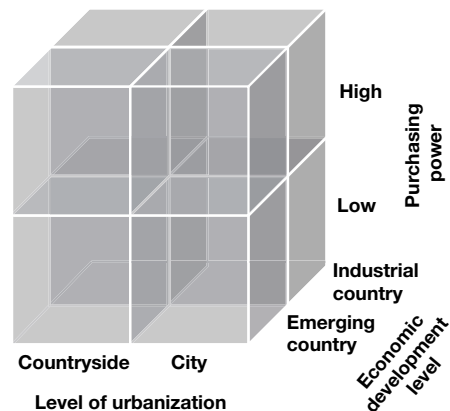
**Bangkok** has been pursuing yet another approach. This metropolitan area, which has a population of more than 12 million, has achieved a level of wealth that is considerable for a developing country. Annual household income is around 9,600 euros (2007), more than twice that of Medellín. Streets are gridlocked, and Bangkok’s inhabitants are very willing to use public transportation to get to work. However, the widely used buses sit in traffic along with the passenger cars. Expanding rail traffic would be time-consuming and expensive, which is why Bangkok has been depending on a “bus rapid transport” sys-

tem. This is made up of urban bus lines that use their own tracks separate from all other traffic and metro-like stops. At 18,000 people per day on the system’s first line that covers 16.5 km, transport capacity is very high, and costs are twenty times lower than those of an elevated train.

These mobility patterns primarily prove one thing: There is no single answer to the question of how to manage ever-increasing traffic volumes. Instead, there is a variety of answers that give consideration to issues ranging from local conditions to topography. It can also be seen that, at least in urban areas, local authorities are keen on finding solutions and have identified mobility as a factor in the international competition over geographic locations.

## Step 2: Clustering

In the second step, we looked for a master pattern behind the various patterns. Regional mobility patterns were assigned



**Figure 3** Matrix for the categorization of mobility patterns

to a three-dimensional matrix that included the dimensions of level of urbanization, purchasing power of users, and economic development level of each region (Figure 3).

It can be seen that all of the analyzed brands can be clearly assigned to one of the cubes in the 3-dimensional matrix. Manhattan meets the criteria for “City – Industrial Country – High Purchasing Power,” while Mecklenburg-Vorpommern can be categorized as “Countryside – Industrial Country – Low Purchasing Power.” This clustering is important for the transferability of solutions from one region to another.

### Step 3: In-depth scenarios

In the third and final step, we worked out four in-depth scenarios that Schaeffler believes will determine future mobility. These are:

#### **Consideration of the entire energy chain**

Future mobility solutions will no longer consist of isolated measures but incorporate the CO<sub>2</sub> footprint of the entire energy chain. Here, special consideration must be given to the generation of electricity for electric cars and to the generation of hydrogen for fuel cell vehicles. In addition, storage also plays an important role in an energy supply that is primarily based on fluctuating renewable energies. Regardless of whether it is the methanation of hydrogen or electric cars as part of a smart grid – mobility will be increasingly regarded as part of an energy system.

#### **New mobility schemes for cities**

Intermodal traffic with seamless switching from one form of transportation to another will be a matter of course in the

cities of the future. For the continued development of motor vehicles, this means that it must fit seamlessly into the urban traffic network. In addition, the majority of the population in many fast-growing cities outside of the established industrial countries will develop a pragmatic attitude towards their own mobility and choose the most time-saving and cost-efficient option.

#### **Resource-efficient inter-urban mobility**

For a growing portion of the world's population, it is becoming important to move between urban economic centers in a time-saving manner. Resource efficiency will increasingly become an essential characteristic for all carriers, regardless of whether they are airplanes, high-speed trains, or cars. At the same time, the automation of inter-urban traffic continues, which also applies to automobiles (autonomous, automated, or piloted driving), not forgetting the integration into communication networks.

#### **Environmentally friendly drives**

Vehicles' drives are one of the major factors that determine the energy efficiency and environmental compatibility of mobility. That is why the development of energy-efficient drives will continue to take top priority. This includes the optimization of existing drives as well as the introduction of entirely new systems. The goal of reducing CO<sub>2</sub> and pollutant emissions - or of someday eliminating them entirely - not only extends to the use of a vehicle but to its entire lifecycle, particularly its production.

## Energy efficiency as a driving force behind drive development

Most experts would agree that so-called “conventional” powertrains – consisting of an internal combustion engine and a transmission with a high ratio spread – will dominate most of the world’s private transport. The market shares that electric drives and hybrid drives may be able to gain over the next few years vary by region and political provisions. Figure 4 shows a forecast by IHS, a renowned market research company.

The market data show that an effective strategy for the reduction of CO<sub>2</sub> emissions from private transportation must prioritize increased efficiency in conventional pow-

ertrains based on internal combustion engines. Since diesel engines as efficiency drives will only gain large market shares in certain regions such as Europe, India, and South Korea, the optimization of the gasoline engine (which was first produced in 1877) remains the most important task in engine development.

### Muda! – minimizing power loss

The starting point for the optimization of every process is an evaluation of the losses incurred – that is, an increase in efficiency. In production circles, this approach is known as the Muda principle, going back to an engineer named Taiichi Ōno who is considered to be the inventor of the Toyota production system. “Muda” simply means “avoid waste.”

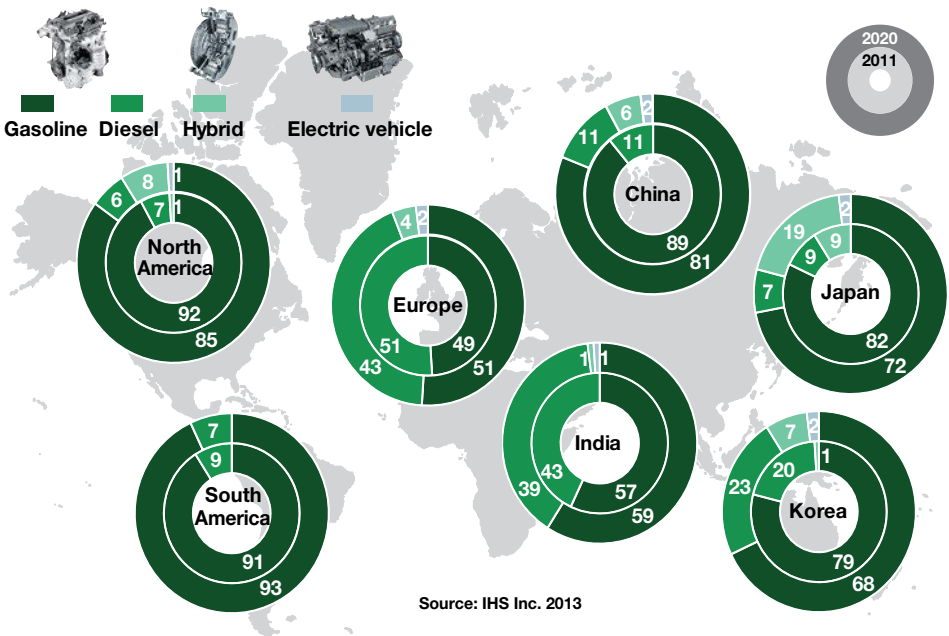
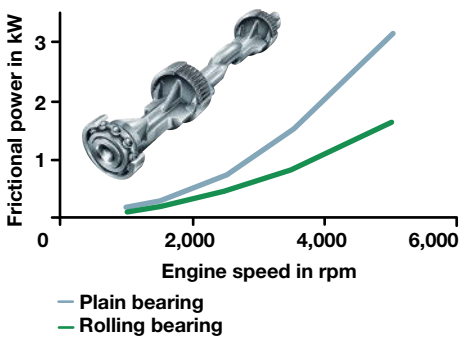


Figure 4 Market shares of various drive systems in regions of the world for 2011, 2016 and 2020 in %

When applied to vehicle drives, power losses that distinguish real engines from a thermodynamically optimum process must be analyzed consistently and technical countermeasures must be taken. A good example here is the reduction of frictional power loss in the powertrain which, according to [3], can lower the fuel consumption of a mid-size vehicle with a gasoline engine by at least 3 %.

One example of applied frictional power loss reduction is lightweight balancer shafts with rolling bearing supports. As part of the reduction of displacement and the number of cylinders, balancer shafts are increasingly used because they allow the quiet operation of small engines with a high specific performance that customers demand. The problem: Balancer shafts “eat up” part of the energy saved, both because of the necessary acceleration of their mass and the frictional power loss in their bearing supports. Schaeffler has found a solution by creating a new balancer shaft with rolling bearing supports. The balancer shafts are optimized geometrically so that a mass reduction of up to one kilogram can be achieved for a four-cylinder engine. In addition, the rolling bearing supports of the shaft(s) have helped achieve a friction reduction of up to 50 % (Figure 5).



**Figure 5** Minimization of frictional power loss through balancer shafts with rolling bearing supports



**Figure 6** Axial needle roller bearing supports of planet carriers

Efficiency, which is already high, can also be increased in the transmission that is characterized by numerous rotary, load-transmitting parts. Substituting the plain bearing supports with planetary gears for planet pinions with thrust needle roller bearings is one example here (Figure 6). In third gear, for instance, maximum frictional power loss is reduced from 470 W to just 50 W. For a transmission with four planetary gear sets, this means a frictional power loss reduced by 420 W in third gear, and thus a 90 % reduction. Based on the simulation, consumption can be expected to be reduced by around 0.5 % when substituting the thrust washers with thrust needle roller bearings in the NEDC.

It is very obvious that the analysis of power losses can not be restricted to the engine and transmission unit. It is necessary to look at the entire powertrain, including the wheels. This will help identify other sources of loss, such as the differential and the wheel bearings. Over the past few years, significant progress has been achieved here, such as by replacing tapered roller bearings with tandem angular contact ball bearings in the rear axle differential.



### Added value through increased variability

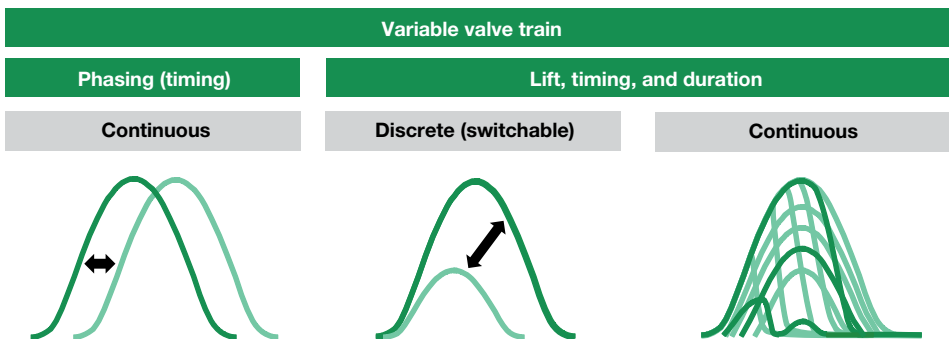
As important as the reduction of mechanical transmission losses in the powertrain may be, this in itself will not result in a thermodynamic optimum. The losses that occur in an engine are also influenced significantly by the throttle losses that depend on the operating point. This is even more true for modern internal combustion engines as the valve opening times cannot be controlled on the basis of the maximum power output alone. Instead, the raw emissions that depend on the combustion process have become an important design criterion. In terms of thermodynamics, it would be ideal to have an entirely free control of the gas exchange that is adjusted to the relevant operating point. This ideal situation could only be achieved by using electromechanical valves that are completely decoupled from the crankshaft. However, there are numerous arguments against this solution – such as the fact that a software error might lead to the immediate destruction of the engine.

Systems for camshaft phasing adjustment permit an initial approach towards

this solution. They allow the valve lift curve to be “moved,” i.e. the valves can be opened or closed earlier or later. The lift curve as such remains unchanged. The timing velocity is an essential quality criterion that is usually expressed as degrees of crank angle per second ( $^{\circ}\text{CA/s}$ ). The highest adjustment speeds, as well as complete freedom for the valve opening times when the engine starts, are provided by electromechanical phasing units. Schaeffler will launch the volume production of this type of system for the first time in 2015. However, because electromechanical solutions will have an impact on costs, Schaeffler continues to develop its hydraulic phasing units.

Valve lift can be varied – usually between two predefined points – by means of various technical solutions, such as switchable tappets. This creates the prerequisite for limiting throttle losses in low-load ranges.

It is Schaeffler’s electrohydraulic UniAir valve train system, launched around four years ago and since produced for approximately 400,000 engines, that provides near-complete variability. It permits nearly arbitrary formation of the lift curve within a predefined maximum valve lift (Figure 7).



**Figure 7** Variable lift curves through camshaft phasing units (left), switchable valve actuation (center) and the electrohydraulic UniAir valve train system (right)

The UniAir system's current applications are limited to the intake side, and the two intake valves are controlled simultaneously via a hydraulic bridge. Even this solution permits fuel consumption to be reduced by up to 15 %, compared to a naturally aspirated engine as the starting point. During the 2014 Schaeffler Symposium, a variety of new functions will be shown that can be achieved with a refined UniAir. Examples include a system for varying the valve overlap by means of a two-stage actuating cam. If such functions are utilized consistently, additional CO<sub>2</sub> savings potential can be developed – incidentally, not only for gasoline engines but also for diesel engines and even for ship propulsion.

More variability for lower CO<sub>2</sub> emissions is not just an issue for engines but also for transmissions and chassis. Here are some examples:

- For transmissions, there is a definite trend towards higher ratio spreads and thus a higher number of gears. These transmissions permit the engine to be operated at operating points with low specific consumption as often as possible. This development has consequences for conventional Schaeffler products such as clutches since the number of gearshifts increases along with the number of gears.
- More variability can thus lead to less friction. What is new here is a switchable wheel bearing for vehicles with high wheel and axle loads. It is a four-row angular contact ball bearing. When the car is driven in a straight line, load is applied only to the center rows of balls, and no load is applied to the external rows. When driven around curves, the external rows are engaged to support driving behavior in curves with the required high rigidity. Initial test results have shown an additional friction reduction of more than 25 %.

## Intelligent electrification

---

The stricter CO<sub>2</sub> regulations become (and the smaller the market share of diesel engines), the sooner automobile manufacturers reach a point when the electrification of the drive becomes relevant. The degree to which emissions are reduced is highly dependent on the level of electrification that can essentially be described by the output of the electric motor and the energy content of the battery. These parameters determine the functions that can be used to avoid the consumption of carbon fuel:

- Turning off the engine when stopping (start/stop) or in coasting mode at higher speeds
- Moving the engine load point to point to mapping areas with low specific consumption (“boosting”)
- Recuperating braking energy
- Electric driving in low-load ranges in which an internal combustion engine is operated with a highly unfavorable efficiency factor
- Using renewable energy for the drive provided that the battery can be charged externally

Unfortunately, the necessary engineering and expense increase along with increasing electric power. This is particularly true for, but not limited to, the battery. It is thus a good idea to use a step-by-step procedure for electrification to keep mobility affordable (Figure 8). Schaeffler development activities for all stages of electrification have been concentrated in its eMobility Systems Division since 2012.







	12 V	48 V	HV	Micro hybrid	Mild hybrid	Full hybrid	Plug-in hybrid	Electric car
<b>Functionality</b>				Start-stop	Boosting, recuperation	E-creeping, stop-and-go, e-sailing	Electric driving	Electric driving in all operating conditions
<b>Charging</b>							yes	yes
<b>Elec. motor power</b>		0.5 ... 8 kW		8 ... 20 kW	10 ... 50 kW	30 ... 125 kW	30 ... 125 kW	30 ... 125 kW
<b>Voltage</b>	12 ... 48 V	48 ... 280 V		48 ... 280 V	48 ... 400 V	200 ... 400 V	200 ... 400 V	200 ... 400 V
<b>Electrical range</b>						0.1 ... 5 km	10 ... 50 km	> 75 km
<b>CO<sub>2</sub> saving</b>		4 ... 6 %		12 ... 16 %	15 ... 25 %	> 50 %	> 50 %	up to 100 %
<b>E-Wheel Drive</b>								
<b>Electric axle</b>								
<b>Hybrid module</b>								
<b>Start-stop</b>								

Figure 8 Stages of electrification

### Affordable and efficient: The 48-volt on-board electric system as an opportunity

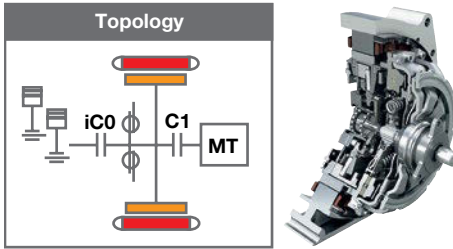
Until recently, the hybridization of a vehicle meant adding a high-voltage level to the conventional 12-volt on-board electric system. In today's volume-produced hybrid vehicles, voltages of up to 300 or 400 volts are generated and in some prototypes up to 700 volts have been implemented in order to make the construction of the electric units as compact as possible.

Driven by active chassis with their typically brief power peaks, a few automobile manufacturers introduce a 48-volt on-board electric subsystem. This is a great opportunity for the drive, as electric traction motors with an output of up to 15 kW can be produced at this voltage level with moderate system costs. These reduced costs can be attributed in part to much lower safety requirements. No separate contact protection is required for the com-

ponents of a 48-volt on-board electric system. In combination with a small lithium-ion battery (approx. 125 Wh), short distances can be driven at low speed using electric power only, such as when parking or in stop-and-go traffic. Functions such as boosting or recuperating with a much improved energy intake are also possible.

Schaeffler has been working on two solutions for the technical implementation of the 48-volt hybrid drive that will be presented in detail during the 2014 Symposium: A 48-volt variation of the hybrid module integrated into the drive and an electric axle.

Integrating the electric motor into an automatic transmission in place of the torque converter has proven to be a good solution in previous hybrid vehicles since no additional design space must be provided this way. The same can be achieved with a 48-volt hybrid module. However, an additional challenge lies in the fact that, at least in Europe, the transmission's level of



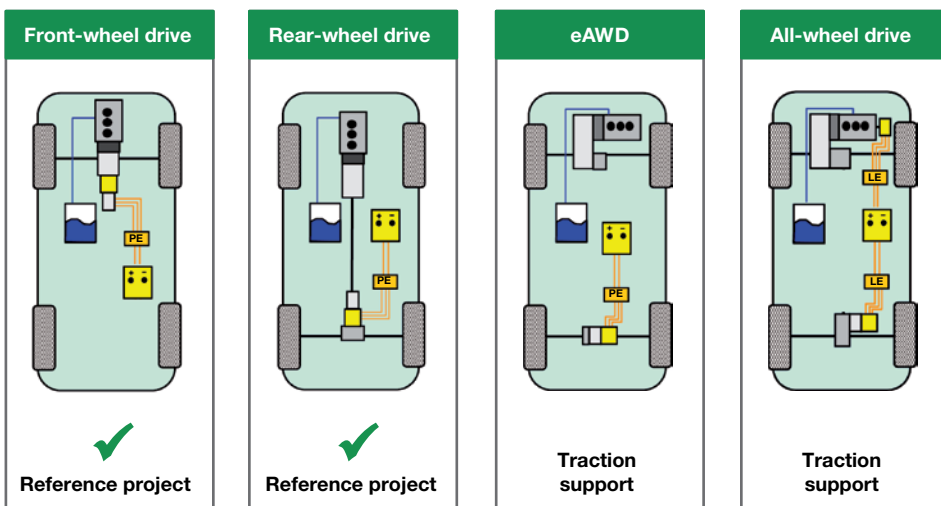
**Figure 9** Impulse clutch with an integrated electric motor for combination with a manual transmission

automation is low specifically in vehicle categories for which hybridization with a relatively inexpensive 48-volt approach would be attractive. That is why Schaeffler has developed several solutions for combining the hybrid module with a manual transmission that will be presented during the 2014 Symposium. The use of an impulse clutch appears to be particularly attractive (Figure 9).

Here, the starter is eliminated, and the internal combustion engine is brought up

to speed exclusively by closing the clutch, or it is started by the electric motor of the hybrid module. It is a transmission that can be shifted very quickly and must be able to transmit very high alternating torques of up to 1,500 Nm. In this case, the entire hybrid module, including the electric motor, is installed on the crankshaft side.

An attractive alternative for automobile manufacturers is the use of an electric axle on a 48-volt basis because here, the conventional part of the powertrain can remain completely “untouched” with the exception of the engine control system. A 48-volt axle can be integrated into the powertrain using various configurations (Figure 10). The drive axle can be assisted in both front-wheel and rear-wheel drive vehicles. In addition, an electric drive for the rear axle can be installed in a front-wheel drive vehicle, a configuration sometimes described as an “electric four-wheel drive.” The electric drive force can also be distributed between the front and rear axle, although this means that two electric



**Figure 10** Vehicle topographies with electric axle drive

motors and two power electronics units are required.

The 48-volt hybrid with an electric axle will be presented in detail during the 2014 Symposium.

### **Sporty and dynamic: High-voltage hybrid technology**

In future, large vehicles and sports cars will increasingly be designed as plug-in hybrids to achieve particularly favorable standard fuel economy. This trend towards plug-in vehicles has resulted in a significant increase in the electric power required. Hybrid vehicles will be designed to complete the entire test cycle on electric power. Consequently, one of the primary development goals for the next generation of the Schaeffler hybrid module has been to increase the power and torque density while also reducing the required design space. At the same time, the torques of the internal combustion engines used in hybrid vehicles also increase. The second generation of Schaeffler's hybrid module takes this market trend into account. The transfer of extremely high torques of up to 800 Nm is made possible by a patented system for splitting the power flow. The torque of the internal combustion engine is transferred to the transmission by both the closed disconnect clutch and simultaneously via a one-way clutch.

Some essential features of the high-voltage variation of the electric axle have also been developed further over the past four years. The third generation, currently being tested, has been adjusted to the topology of a plug-in hybrid vehicle with a front-mounted engine and front-wheel drive. The drive unit continues to be designed for coaxial installation in the rear axle. Water-cooled, hybrid-design electric motors (permanent-mag-

net synchronous motors with a high level of reluctance) are used. These automobile-specific requirements are in contrast to the industrial motors used in the first generation.

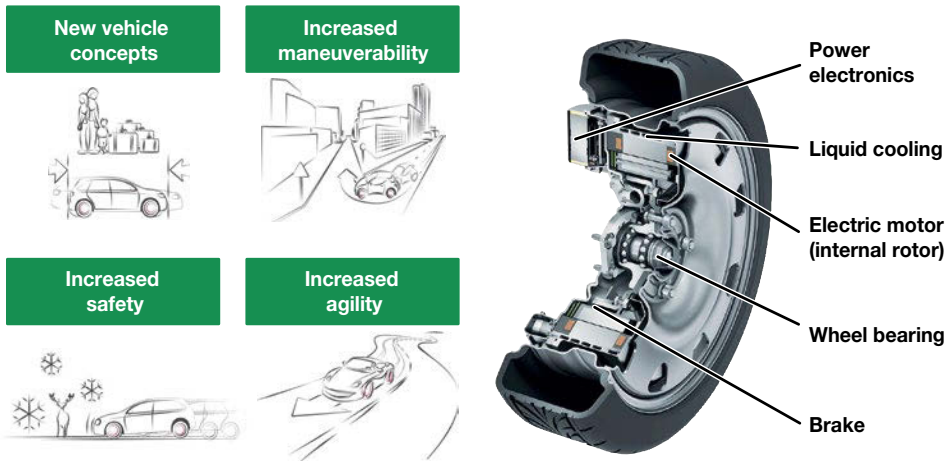
The transmission still has a planetary design but now has two transmission levels. With an increased power density, the transmission has a modular design that permits the traction and active torque distribution (torque vectoring) to be offered as separate functions.

### **Urban and flexible: Drives for electric vehicles**

As described in the first section, large cities with a high population density and great affluence will increasingly see electric vehicles as part of an intermodal traffic mix. Most of those vehicles will initially be model variations of series in which conventional powertrains are dominant. Therefore, most electric vehicles are currently equipped with a center drive.

As market penetration increases, a larger number of battery-electric vehicles will become available that have been developed specifically for the requirements of urban traffic. Schaeffler believes that a wheel hub drive is the best solution for these vehicles. Since there is no "engine compartment", this permits the design of completely new body types that offer very good utilization of the available space – an important requirement for traffic in urban areas that are congested anyway. In addition, drive shafts are no longer required, which permits the wheel angle to be increased. From the customer's point of view, this results in much better maneuverability.

For customers, this makes cars more fun to drive as well as making them safer, since the control quality of the drive is above that of center drives due to its di-



**Figure 11** Wheel hub drive with integrated electronic system – current development status

rect transmission – without a transmission and side shafts. These conventional goals of automobile development will decide customer acceptance of small city automobiles. Reason alone – such as a small traffic area and a good carbon footprint – will not make electric vehicles marketable.

Based on this motivation, Schaeffler has been developing wheel hub drives since 2007. In cooperation with the Ford research center in Aachen, the current development status (Figure 11) has been installed in a Ford Fiesta that serves as a test vehicle. The total vehicle weight has not increased when compared to an identical type of vehicle with a diesel engine (1,290 kg when empty). This includes a lithium-ion battery with a nominal capacity of 16.2 kWh.

This test vehicle has been used for various driving dynamics tests on the test site. These tests have shown that, up to speeds of 130 km per hour, the prototype is at least equivalent to a volume produced vehicle that was also driven. Maneuvers that utilized the potential of torque vectoring even yielded some significant

performance increases. During a standardized swerving-stability test with the traffic cones spaced 18 meters apart, the speed was increased by around 10 km per hour.

Schaeffler has already been working on the next generation of wheel hub drives with Ford and Continental as well as with RWTH Aachen and the Regensburg polytechnic in the MEHREN research project (MEHREN stands for multiple-motor electric vehicle with the highest possible space and energy efficiency and uncompromising driving safety). The focus of the project is on implementing a new software architecture specifically designed for wheel hub drives. In addition, the MEHREN project is intended to show for the first time what kind of potential there is for new vehicle architectures if wheel hub drives are used as a standard drive to begin with. Completion of a virtual prototype is expected for 2015.

## Summary and outlook

---

Mobility solutions for the future will be customized for specific applications more than ever before. As a consequence, the development of vehicle drives is an essential factor for energy efficiency in every mobility chain. Refined, highly efficient internal combustion engines and transmissions work hand in hand with electric drives that are adjusted to the vehicle configuration but rely on a modular design system for core components.

To be able to identify the right solution out of a wide variety of possible solutions, Schaeffler not only looks at technical potential but also at fundamental changes in markets and customer requirements. These requirements are transformed into ideas for solutions and finally technical innovations by means of a well-structured process. This approach is true to the motto of Thomas Edison, whose “Menlo Park” laboratory was the first innovation factory: “I find out what the world needs. Then I go ahead and try to invent it.”

## Literature

---

- [1] Eichhorn, U.: Zukunft der Mobilität – grün, sauber und vernetzt. cti Getriebesymposium, 2013
- [2] Council of the European Union (eds.): Informal agreement on car CO<sub>2</sub> emissions reduction. press release, 2013
- [3] Ernst, C.; Eckstein, L.; Olchewski, I.: CO<sub>2</sub>-Reduzierungspotenziale bei Pkw bis 2020. Studie, Aachen, 2013





# Powertrain Systems of the Future

Engine, transmission and damper systems for downspeeding, downsizing, and cylinder deactivation

Dr.-Ing. Hartmut Faust

# 2



## Introduction

Besides hybridizing the powertrain, which is especially advantageous in city traffic, efforts must be made to improve the efficiency of conventional powertrains in order to reduce traffic-based CO<sub>2</sub> emissions.

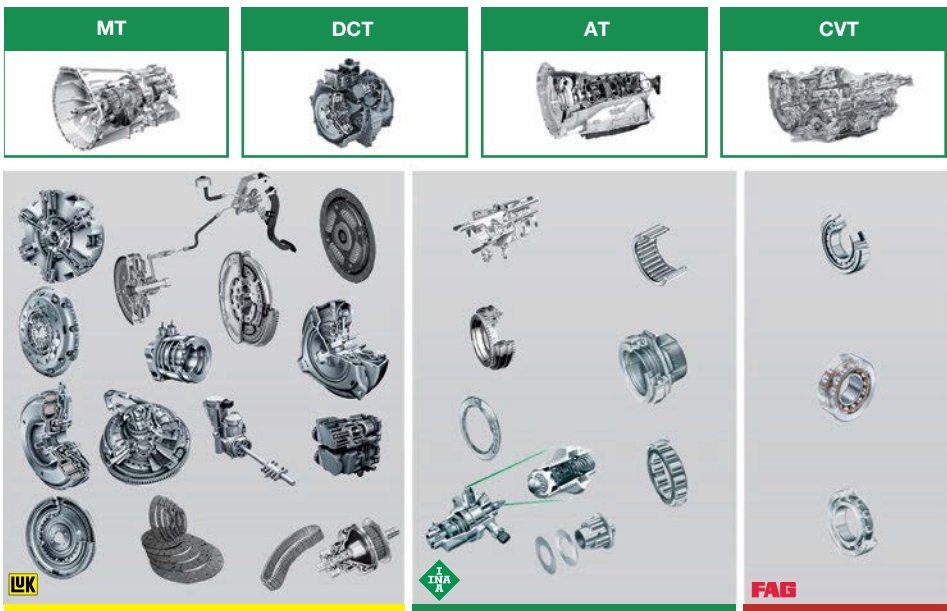
This will first require measures to directly reduce friction losses in internal combustion engines, transmissions, and chassis systems, such as the use of friction-optimized bearing supports and seals as well as coatings to lower the friction coefficient.

Furthermore, slippage losses in startup elements need to be reduced. Hydrodynamic torque converters with lock-up clutches are a notable example of this, as they can be engaged even at very low engine speeds by means of optimized damper

systems. Double clutch systems with reduced passive clutch drag torque losses of wet or – even better – dry running design are important contributions as well.

The aim of this paper is also to report on improvements to the system as a whole, in which changes on the transmission side lead to an efficiency increase in the internal combustion engine. Examples of this include transmissions with an increased spread of gear ratios, resulting in lower engine speeds even at higher travel speeds [1]. Optimized damper systems serve to further reduce and/or insulate torsional vibration excitation introduced into the entire powertrain by cyclical combustion in the engine and facilitate downspeeding of drive systems in order to reduce fuel consumption.

At the same time, advanced damper systems permit the design of downsizing systems that reduce engine friction with a



**Figure 1** Samples from the product portfolio of the Schaeffler Group's Transmission Systems Business Division designed to reduce losses and optimize comfort as well as NVH behavior

lower number of cylinders and substantially increased torsional vibration excitation without having strong NVH issues in the entire powertrain. Finally, a rolling cylinder deactivation system is introduced that enables engines with three cylinders to run effectively on 1.5 cylinders ("RCD 1.5"). The measures taken on the engine and transmission system side to prevent excessive torsional vibrations along the entire powertrain are described in detail.

## Reducing consumption by means inside the transmission

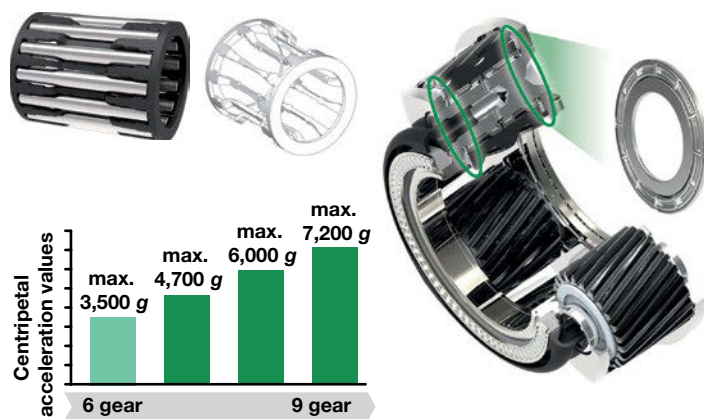
An analysis of energy losses in the chain from well to wheel shows that the greatest percentage of energy losses occurs when the chemical energy bound up in fuel is converted to mechanical power at the crankshaft. This is due to the high thermodynamic and friction losses in the internal combustion engine.

In contrast, the power transmission efficiency is up to more than 90 %, depending on the transmission system and operating conditions. Nevertheless, efforts to reduce this rather low proportion of the losses are valuable as well, since such optimizing measures usually generate minimal

additional costs relative to the increase in efficiency. Due to legislative regulations that – starting in 2020/2021 – will bring penalties of up to 95 euros per g/km in excess of a CO<sub>2</sub> emission limit of 95 g/km in the EU, clear target values can now be derived with regard to the additional expenditure that is acceptable in order to increase efficiency.

In presentations at the 10<sup>th</sup> Schaeffler Symposium in 2014, many solutions for reducing CO<sub>2</sub> emissions will be introduced in detail. Figure 1 provides an overview of the product portfolio.

In planetary automatic transmissions, plain bearing supports are being increasingly replaced by rolling bearing supports. Needle roller bearings are very frequently used for this application and in the case of planet gear bearing supports are subjected to centripetal acceleration. In the most recent nine-speed automatic transmissions, both for inline and FWD arrangements, values up to 7,200 g must be taken into consideration and made sustainable by means of a suitable design (Figure 2).



**Figure 2** Centripetal acceleration values in the planet gear bearing supports of automatic transmissions and a newly developed axial needle roller bearing support for planet gears with a high relative speed

For the CVT, the advantages of the LuK chain with low-friction rocker joints compared to other CVT linking elements [2, 3] are being increasingly implemented on the market with an improved fuel consumption of up to 4 %. Starting with applications that have a high torque of 400 Nm, chains with smaller pitch lengths are now being used as well. Besides the volume-produced 08 and 07 chain types, the smaller 06 and 05 types are being developed in order to make use of the robustness and efficiency advantages in the lower torque and vehicle class range also.

## Startup elements

A broad portfolio of startup elements is produced under the Schaeffler LuK brand – from a dry clutch for manual transmissions and torque converters to double clutch systems with a wet or dry design.

## Hydrodynamic torque converters

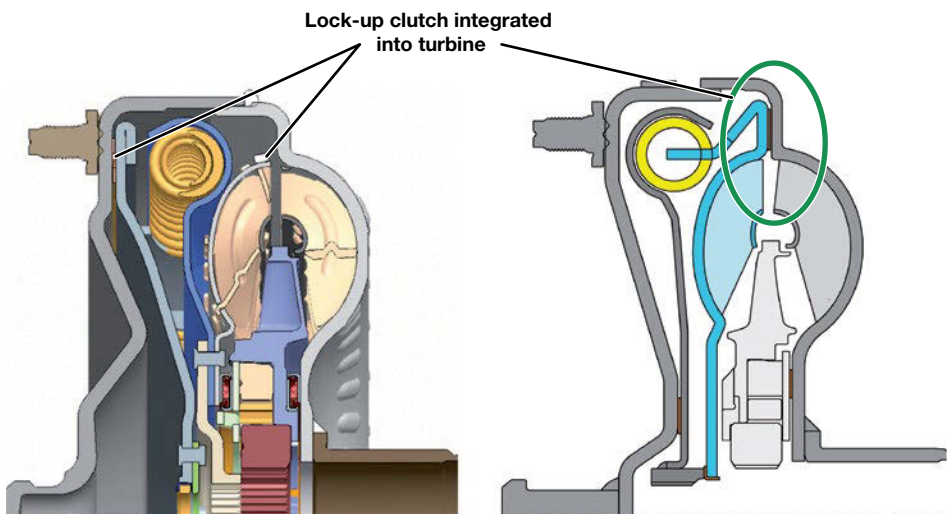
Along with optimizing the hydrodynamic circuit in order to keep losses to a minimum even in open converter operation, the hydrodynamic torque converters provided for automatic transmissions take the following key developmental aspects into account:

- High-capacity torsional dampers, including centrifugal pendulum-type absorbers running in oil that facilitate early lock-up even at very low engine speeds and
- Reduction of the rotating masses being accelerated.

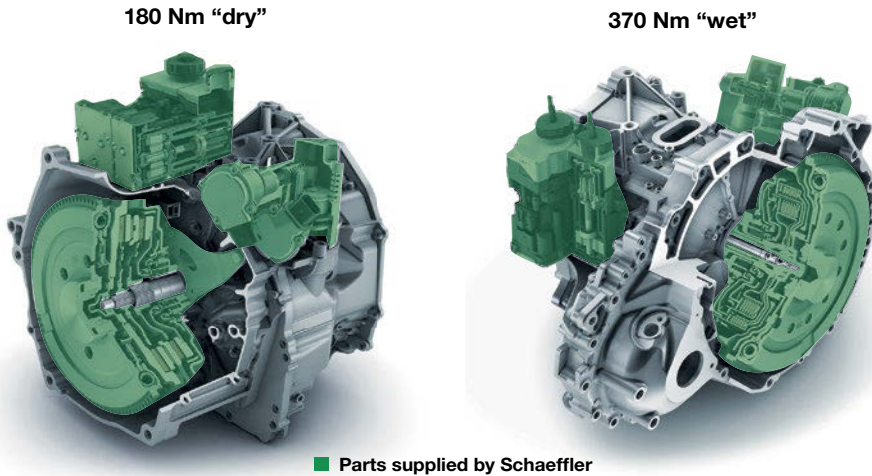
Great progress is being made with the new development referred to as iTC with its innovative integration of the lock-up clutch into the turbine wheel [4] (Figure 3).

## Double clutch systems and their actuators

For double clutch system solutions [5, 6], which are gaining an ever greater share



**Figure 3** Innovative iTC with lock-up clutch integrated into the turbine wheel



**Figure 4** Dry and wet running double clutch systems, including electrically power on demand operated clutch and transmission actuators from Schaeffler for hybrid transmissions

of the market, Schaeffler's LuK brand has been offering dry double clutch systems since the end of 2007. In contrast to wet double clutches, they have the advantage of not causing fluid-induced drag losses in the passive clutch, which account for approx. 2 % fuel consumption and CO<sub>2</sub> emission advantages in the NEDC. In the meantime, volume-produced dry double clutches have been delivered to five international OEMs and transmission manufacturers, even for hybridized versions (Figure 4).

The range of applications of dry double clutch systems currently includes engine torques of up to 250 Nm. The main objective of current development work is to continue optimizing comfort features in order to meet increasing demands and the wide range of usage profiles – including for hybridized powertrains.

After Schaeffler had already been involved in the initial basic development of wet multi-disk clutches in the 300 Nm range, volume production of the first wet double clutches from Schaeffler's LuK brand started in 2013 (Figure 4 right).

In many applications, LuK not only offers double clutches, but also the clutch actuation system with optimized auxiliary energy consumption. For example, the lever actuator made it possible to pursue the power-on-demand principle so that the clutch can be actuated with small electric BLCD motors and the electrical power consumption is under 20 W during practical driving operation including electromechanical gear actuation [7].

Moreover, volume production has begun for a new electrically operated hydrostatic clutch actuator (HCA). The HCA was developed in a modular design approach so that it could be used for actuating both dry and wet double clutches in conjunction with engagement bearings.

At the same time, volume production of a new kind of gearshift actuator was launched, which uses the active interlock concept to actuate all of the gears of the hybridized double clutch transmission with the help of two electric motors. This actuator was also developed with a modular design so that it can be used in both dry and wet double clutch transmissions (Figure 4 left and right).

## Damper systems for torsional vibration isolation

Trends in engine development place high requirements on damper systems:

- Downsizing to reduce internal engine losses resulting in higher torsional vibration excitation due to lower numbers of cylinders coupled with lower excitation frequencies
- Higher turbocharging pressures with a corresponding torque increase and higher peak pressures, leading to increased excitation amplitudes
- Downspeeding with high torques even at very low engine speeds thanks to optimized turbocharging concepts, which leads to even lower excitation frequencies coupled with very high amplitudes.

The developmental history of damper systems extends from the transition from

torsionally damped clutch disks to the dual mass flywheel with an extremely low first natural frequency and corresponding isolation of all higher excitation frequencies to the introduction of the centrifugal pendulum-type absorber (Figure 5).

The centrifugal pendulum-type absorber is a kind of vibration absorber, whose frequency is inherently regulated by the engine speed frequency due to the centrifugal effect so that the damping effect can be utilized for all speeds according to the main engine vibration order. Due to the positioning of the centrifugal pendulum-type absorber (CPA) on the secondary side of the dual mass flywheel (DMF), it was possible with a small mass to achieve a significant additional reduction of the engine excitation on the transmission input shaft, which was already insulated by the DMF. This is used for both manual transmissions (MT) and double clutch transmissions (DCT). It has not been needed in previous applications of dry double clutch transmissions, since the required thermal masses of

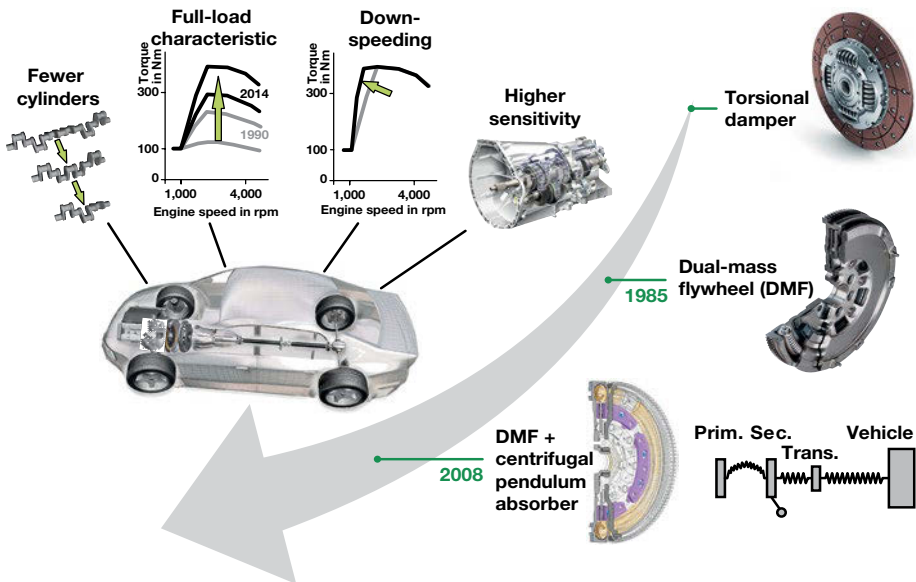


Figure 5 History of damping system development

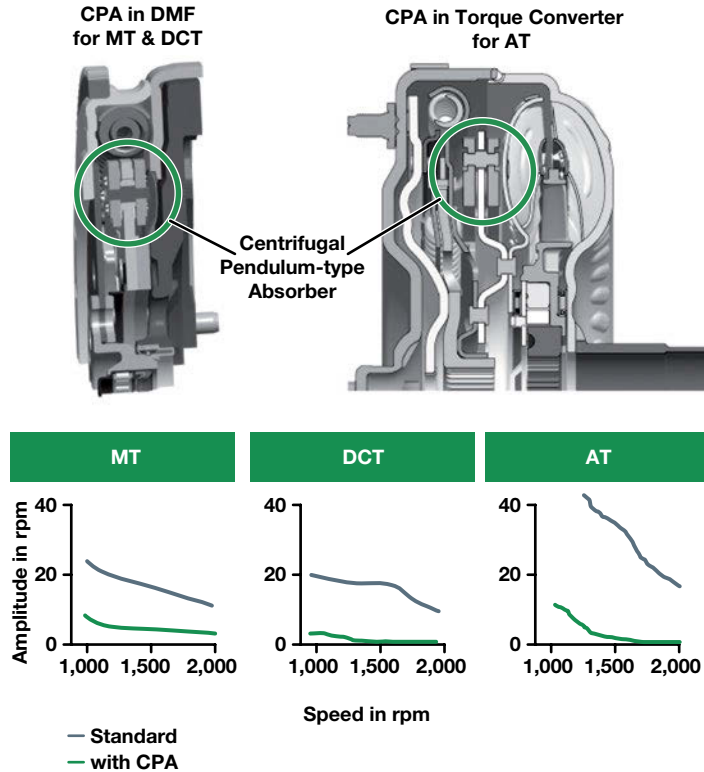
the pressure plates already provide sufficient isolation for torsional vibrations with conventional dual mass flywheels. It has been possible to use the centrifugal pendulum-type absorber even in torque converter dampers (Figure 6).

When used in torque converters, it is important to consider here that the centrifugal pendulum-type absorber is immersed in oil, meaning that corresponding adjustments of the characteristic curve must be calculated by means of simulations and measurements on the component test stand and in the vehicle in order to arrive at optimum operational results. By using the centrifugal pendulum-type absorber, it is possible to close the lock-up clutch sooner, for one thing – at speeds even below 1,000 rpm – and, for another, to avoid loss-inducing acoustic micro-slip. Besides saving on consumption, this also achieves a stronger connection in the entire powertrain with a better dynamic sensation.

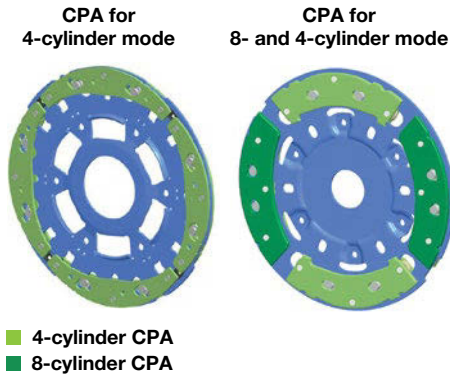
### Damper systems for cylinder deactivation

The deactivation of cylinders in internal combustion engines running under partial

load is increasingly being introduced for reducing fuel consumption and CO<sub>2</sub> emissions. This leads to the requirement for the damper system to ensure good NVH quality when the engine is operating both on all cylinders and a partial number of cylinders. The easiest solution is still to manage a V8 engine running on four-cylinders. Depending on the application, a conventional damper can be designed for when the engine is operating on all cylinders and the additional centrifugal pendulum-type absorber designed for cylinder deactivation operation only so that good torsional vibration behavior can be ensured in both cases. In a four-cylinder engine with the



**Figure 6** Use and effect of the centrifugal pendulum-type absorber in dual mass flywheels for manual and double clutch transmissions as well as in torque converters



**Figure 7** Centrifugal pendulum-type absorber combination matched for operation of the engine on all cylinders and with cylinder deactivation

two center cylinders deactivated, it has been sufficient to implement an adequate damper solution by optimizing a two-stage curve for the dual mass flywheel due to the limited torque range in two-cylinder operation.

However, new applications with very high nominal torques, both in V8 and four-

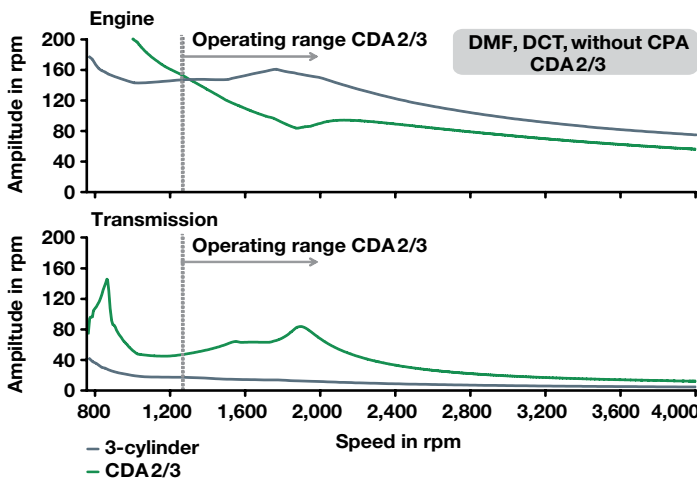
cylinder engines are resulting in increased requirements, both when operating the engine on all cylinders and a partial number of cylinders. Solutions are being developed that actually incorporate two different centrifugal pendulum-type absorber systems in order to optimize both operating modes independently of each other (Figure 7). To do so, one pair of pendulum-type absorbers is calibrated for operation of the engine on all cylinders and the other for operation on a partial number of cylinders with half of the primary order of excitation.

## New kinds of rolling cylinder deactivation for the “1.5-cylinder engine”

If additional CO<sub>2</sub> reduction must be achieved by means of cylinder deactivation for three-cylinder engines as well, this

raises the question as to whether this can be attained through simple static cylinder deactivation. Torsional vibration simulations indicate large excitation amplitudes, however (Figure 8).

What is more, the order analysis shows that excitation is mainly characterized by a very low 0.5<sup>th</sup> fundamental order (Figure 9). This can hardly be brought



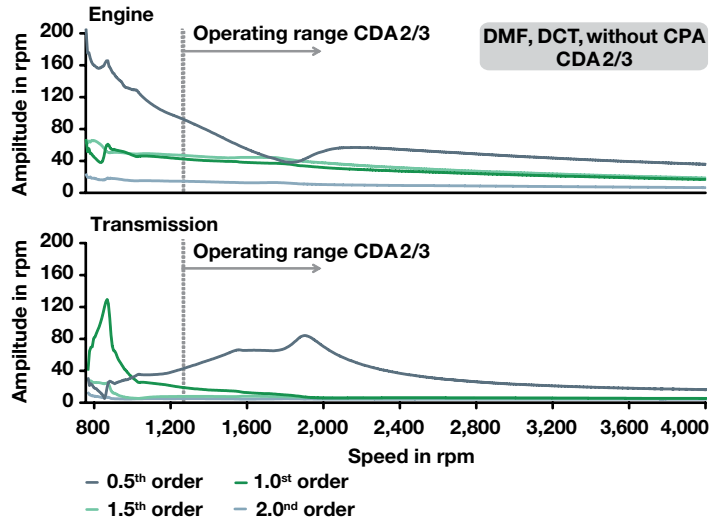
**Figure 8** Torsional vibration excitation for conventional static cylinder deactivation with two of the three cylinders active (CDA 2/3)



to a torsional vibration level that is acceptable for the powertrain with the damper designs of today.

Further reflections on the physical and mathematical background of the origin of excitation orders have led to the suggestion of designing rolling cylinder deactivation in three-cylinder engines, ultimately leading to “1.5-cylinder operation” (Figure 10).

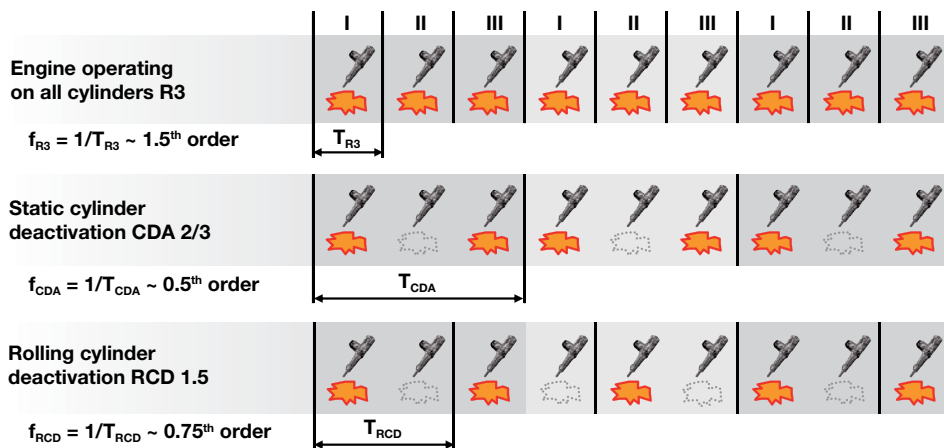
The basic idea is that the time signal of excitation recurs already after two cylinder operating cycles have elapsed if there is alternation between the active and inactive cylinder. The frequency spectrum of excitation is therefore determined by a fundamental frequency resulting from the inverse of the duration of only two consecutive cylinder



**Figure 9** Order analysis with conventional static cylinder deactivation CDA 2/3

operating cycles, and their higher harmonics. The periodic recurrence comes after just 2/3 of a camshaft revolution and not only after a complete revolution, as would be the case with static deactivation of a fixed cylinder.

The fundamental frequency of the excitation function is 3/2, or 1.5 times the cam-



**Figure 10** Principle of rolling cylinder deactivation “RCD 1.5” with 1.5 of the three cylinders active

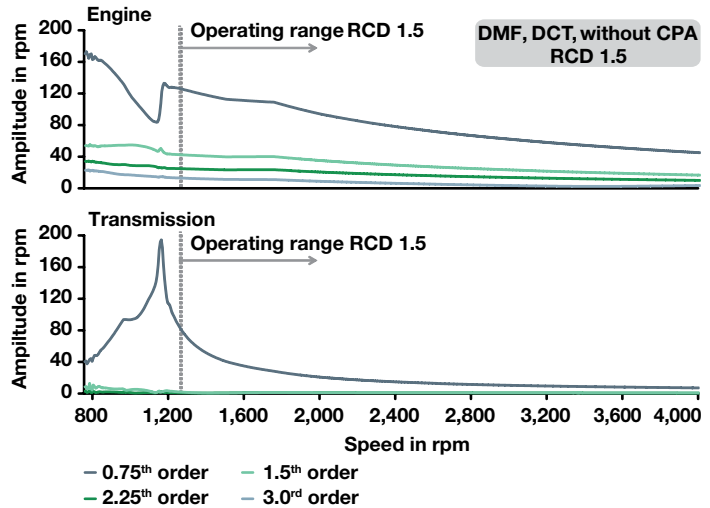
shaft speed and thus the 0.75<sup>th</sup> order of the crankshaft frequency (Figure 11). It is plausible that the alternating operation of active and inactive cylinders in three-cylinder engines results in 1.5-cylinder operation, generating a 0.75<sup>th</sup> fundamental order for the four-stroke cycle principle.

The rolling cylinder deactivation “RCD 1.5” suggested here with 1.5 rolling active cylinders out of three cylinders therefore offers the following basic advantages over static cylinder deactivation with two fixed active cylinders out of three cylinders (CDA 2/3):

- Fundamental excitation frequency of the 0.75<sup>th</sup> order instead of the practically uncontrollable low-frequency 0.5<sup>th</sup> order, with all excitation frequencies 50 % higher – the main objective of this development;
- Even higher reduction in fuel consumption due to only 1.5 instead of two active cylinders.

As a result of further tests, it is possible to provide the following advantages over static cylinder deactivation as well:

- No oil suction due to a vacuum, since each deactivated cylinder is actively fired during the next camshaft revolution, and thus there are no prolonged vacuum phases in the cylinder.
- This also prevents the deactivated cylinder from cooling down, thereby reducing heat-related cylinder distortion during deactivation operation.



**Figure 11** Order analysis for RCD 1.5 operation with a 0.75<sup>th</sup> fundamental order without centrifugal pendulum-type absorbers

- Since no cylinders are deactivated for prolonged periods with the RCD 1.5 concept, fewer warmup measures are needed than for the static cylinder deactivation concept. For this reason, it is possible to drive in RCD 1.5 mode even directly after a cold start, which leads to another improvement in fuel consumption compared to static cylinder deactivation.

### Optimizing cylinder charging in deactivation operation

At this point, one might ask how and with what charges the deactivated cylinders should be operated. With current cylinder deactivation systems, fresh air is generally locked into the deactivated cylinder, where it is compressed and passively expanded without combustion. In principle, the options of “exhaust gas in the cylinder” or “nearly no gas in the cylinder” are also open for discussion. A de-

activated cylinder compresses and expands twice without ignition and combustion during one revolution of the camshaft, while an active cylinder in four-stroke operation only compresses and expands once, using the second half of the camshaft's revolution to exchange the gas. Excitation therefore originates from a deactivated cylinder twice per camshaft revolution and only once from an active cylinder.

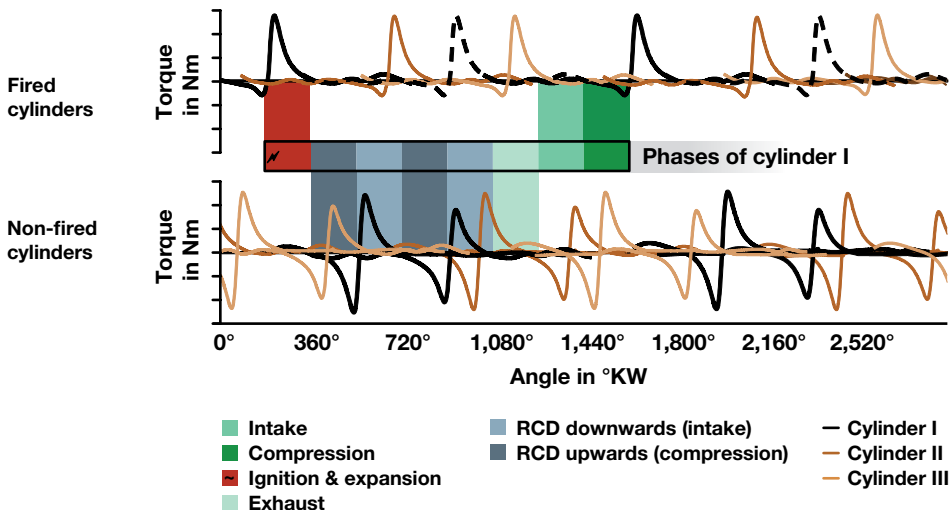
Consideration of the three options for potential cylinder charging leads to the following results for RCD 1.5:

- Variant 1, leaving the exhaust in the cylinder:

Here, relatively high working pressures occur analogous to the pressure of the residual gas, which is unfavorable with respect to thermodynamic process and friction losses. Moreover, the torsional vibration excitation in the 0.75<sup>th</sup> order is unacceptable due to the high exciting cylinder pressures.

- Variant 2, fresh air in the cylinder:  
The disadvantage here are the losses due to working pressures. In addition, excitation still partly produces the 0.75<sup>th</sup> fundamental order here due to the additional second "dummy" compression in asynchronous phasing relative to the omitted ignition.
- Variant 3, almost no gas in the cylinder:  
After expelling the last combustion gas from the previous stroke, the intake and exhaust valves remain closed so that the piston completes two intake strokes against a vacuum, after which compression occurs with a large portion of the compression energy being recuperated. The second time that the piston returns to TDC, the intake valves are then reopened so that the normal intake, compression, ignition, and exhaust operation is restored.

Simulations of torsional vibration excitation based on the cylinder pressure curves do not indicate the presence of any dis-



**Figure 12** Formation of alternating torques of cylinder deactivation operation in three-cylinder engines in the variant with relatively high exhaust gas pressure in the cylinder

turbing low-frequency 0.5<sup>th</sup> order; instead, the lowest occurring order is the 0.75<sup>th</sup>, as expected. The excitation amplitude is smaller than with the first two cylinder charge options and basically stems from the lack of ignition and to a lesser degree from the dummy intake strokes completed against a vacuum with subsequent re-compression. Advantageous here is the fact that relatively low pressures are involved, so that the friction losses in the deactivated cylinders are small, thereby achieving a considerable reduction in fuel consumption. Since the deactivated cylinder is fired normally on the next camshaft revolution, no oil is sucked in despite the short vacuum phase.

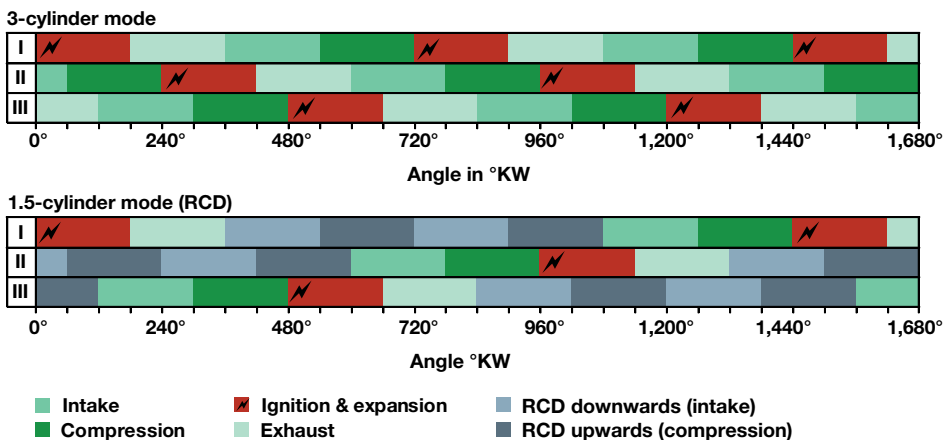
### Implementing the RCD concept with various numbers of cylinders

The outcome that must be kept firmly in mind is that the RCD 1.5 concept in conjunction with nearly no cylinder charge attained the best results with respect to both a reduction in fuel consumption as

well as torsional vibration excitation. In essence, 1.5-cylinder operation was realized with a three-cylinder engine. The cycles of the individual strokes and the RCD strokes contained in them are portrayed in Figure 13.

Using the same principles, a five-cylinder engine can effectively be operated as a 2.5-cylinder engine with RCD 2.5 in cylinder deactivation operation. Fundamental excitation then occurs in a 1.25<sup>th</sup> order, which can be controlled by means of relevant damper systems.

Rolling cylinder deactivation can also be implemented in engines with an even number of cylinders. For example, depending on the power required, a four-cylinder engine can either run as RCD 1.33 or as RCD 2.66 along with normal static deactivation CDA 2/4. A 0.66<sup>th</sup> fundamental order is produced, however, in the first two cases that is hard to control due to the fundamental period duration according to the sequence of three of the four cylinders up to the periodic recurrence of the sequence.



**Figure 13** Comparison of the stroke cycles in a three-cylinder engine operating on all cylinders and in RCD 1.5 operation

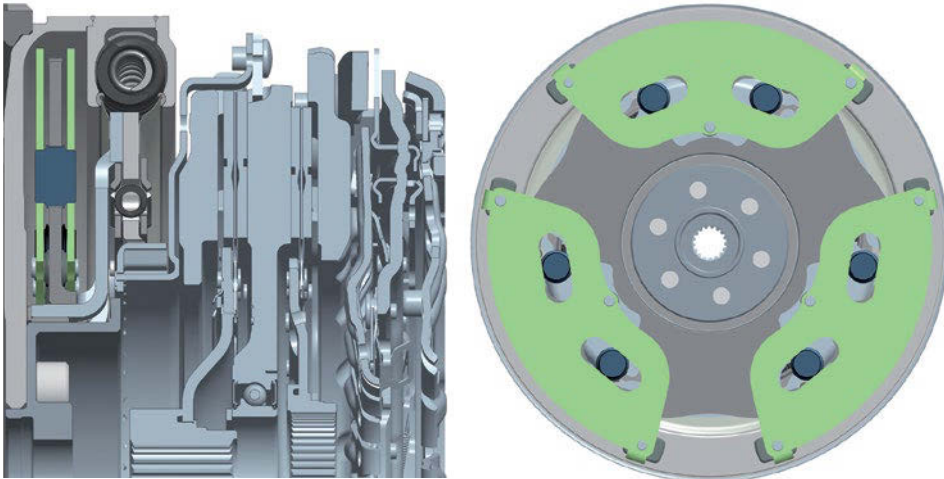
The valve control required for RCD operation, i.e. the deactivation of intake and exhaust valves of each cylinder being deactivated during a camshaft revolution, can be implemented so as to be completely variable with the Schaeffler UniAir system for electro-hydraulic valve actuation [8].

As a rule, the intake and exhaust valves can be deactivated by means of switching mechanisms as well [9]. Options include switchable tappets, finger followers, pivot elements, and – with certain limitations – even the principle of cam shifting. These types of components are currently used for valve switching, and are capable of switching within parts of a camshaft revolution. In order to be used with RCD 1.5 and the considerably greater number of switching cycles involved, further development would be required, since switching would have to occur after each camshaft revolution.

## Torsional vibration damper development for RCD 1.5

---

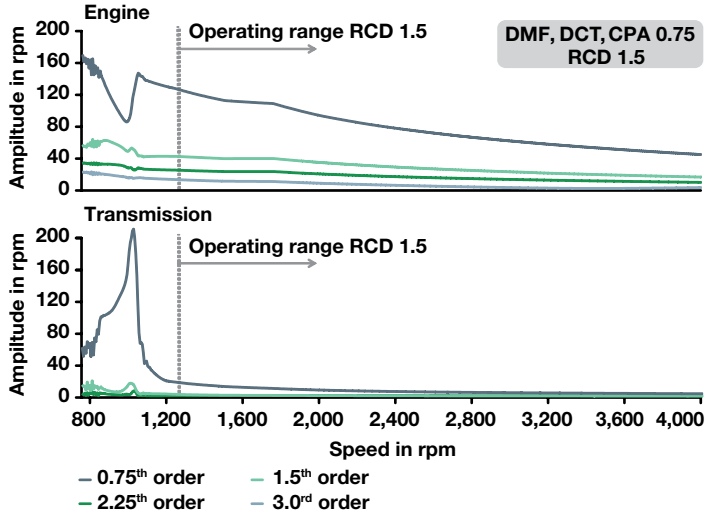
The 0.75<sup>th</sup> fundamental order occurring in RCD 1.5 operation places heavy demands on the torsional damper system. Figure 14 shows a design solution in connection with dry double clutches – the result of DMF optimizations and a centrifugal pendulum-type absorber designed for the 0.75<sup>th</sup> order. Due to the advantage of the overall length of three-cylinder engines as compared to four-cylinder engines in identical vehicles, it was possible here to choose a design for which the arc spring damper and the centrifugal pendulum-type absorber masses are both arranged axially one behind the other on large effective radii.



**Figure 14** DMF design with a centrifugal pendulum-type absorber for the 0.75<sup>th</sup> order for RCD 1.5 rolling cylinder deactivation in three-cylinder engines

The resulting order analysis of the simulations shows how the excited 0.75<sup>th</sup> order is reduced by the matched centrifugal pendulum-type absorber to the very low amplitudes on the transmission input (Figure 15).

Figure 16 depicts the behavioral comparison of a three-cylinder engine running operating on all cylinders and under full load as well as in cylinder deactivation operation according to the RCD 1.5 principle at its highest operating load, which is set at 70 % of the theoretically highest producible half-engine torque. It is evident that practically the same

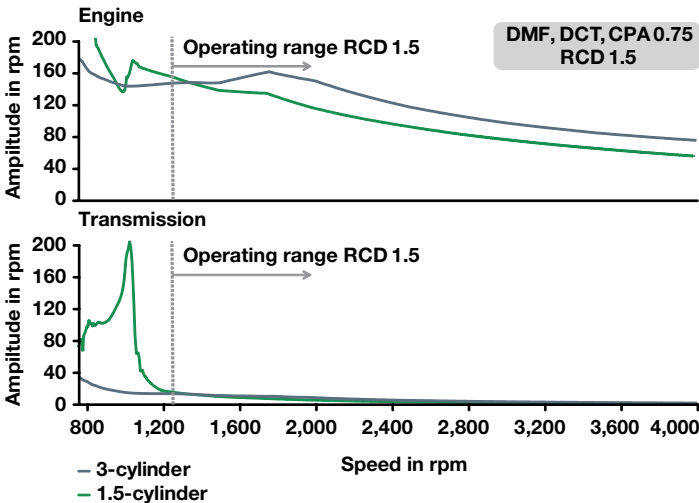


**Figure 15** Order analysis of RCD 1.5 operation with a centrifugal pendulum-type absorber

speed amplitude occurs under such conditions at the transmission input in RCD 1.5 operation as when the engine is operating on all cylinders.

The means for this is the centrifugal pendulum-type absorber with a total mass of approx. 1 kg that has been optimally matched for the occurring 0.75<sup>th</sup> order.

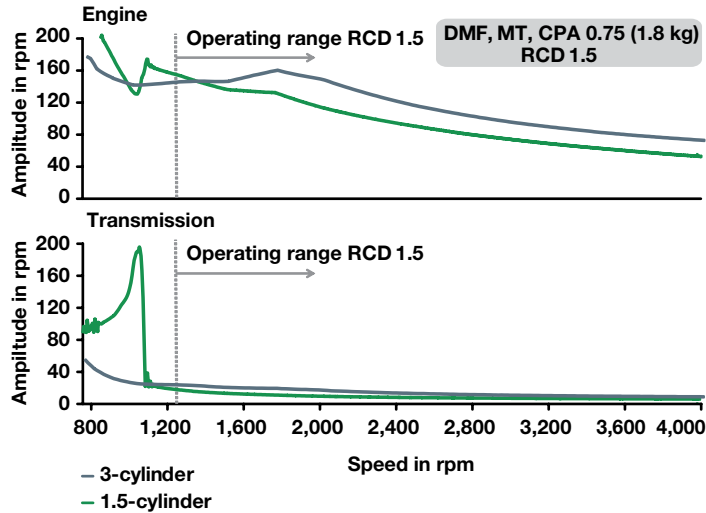
In addition, a centrifugal pendulum-type absorber approx. 800 g larger was designed for manual transmissions for which the secondary moment of inertia of the mass is less than with the dry double clutch, which has a thermal mass that is practi-



**Figure 16** Comparison of torsional vibrations in the powertrain in a three-cylinder engine operating on all cylinders and for rolling cylinder deactivation in RCD 1.5 operation with a dry double clutch

cally used twice (Figure 17).

In this way, the goal of implementing cylinder deactivation operation in three-cylinder engines with acceptable torsional vibration behavior in the powertrain was achieved, both with a dry double clutch and for manual transmissions. In RCD 1.5 operation, this can in effect be managed with only 1.5 active cylinders to reduce fuel consumption and CO<sub>2</sub> emissions.



**Figure 17** Comparison of torsional vibrations in the powertrain in a three-cylinder engine operating on all cylinders and for rolling cylinder deactivation in RCD 1.5 operation with a single clutch for manual transmissions with a larger centrifugal pendulum-type absorber

## Summary

This article describes measures for reducing fuel consumption and CO<sub>2</sub> emissions in motor vehicles to the extent that they are primarily influenced by transmission systems:

- Direct friction reduction in the transmission through optimized bearing supports
- Wet and dry double clutches with reduced drag torque
- Transmission designs with a large spread of gear ratios
- Optimized damper technology for achieving downsizing and high turbocharging pressures, along with downspeeding for reducing losses in combustion engines.

Such drive trends are related to an increase in torsional vibration excitation from the internal combustion engine into the pow-

ertrain. Finally, a new approach is introduced for implementing RCD 1.5 rolling cylinder deactivation for three-cylinder engines to attain 1.5-cylinder operation. The basic characteristics are:

- Sophisticated rolling cylinder deactivation in order to increase the fundamental frequency of the excitation spectrum from the 0.5<sup>th</sup> order with static cylinder deactivation to the much more controllable 0.75<sup>th</sup> order with rolling cylinder deactivation
- Optimized cylinder charge setting to reduce the excitation amplitude.

The resulting torsional vibration excitation is controlled by the innovative damper technology developed by Schaeffler, which entails a dual mass flywheel with an optimized curve, the use of centrifugal pendulum-type absorbers on the secondary DMF mass that are matched to the occurring 0.75<sup>th</sup> main excitation order, and an additional damped clutch disk if needed. Similarly, it is possible

to implement RCD 2.5 operation, which is advantageous for five-cylinder engines.

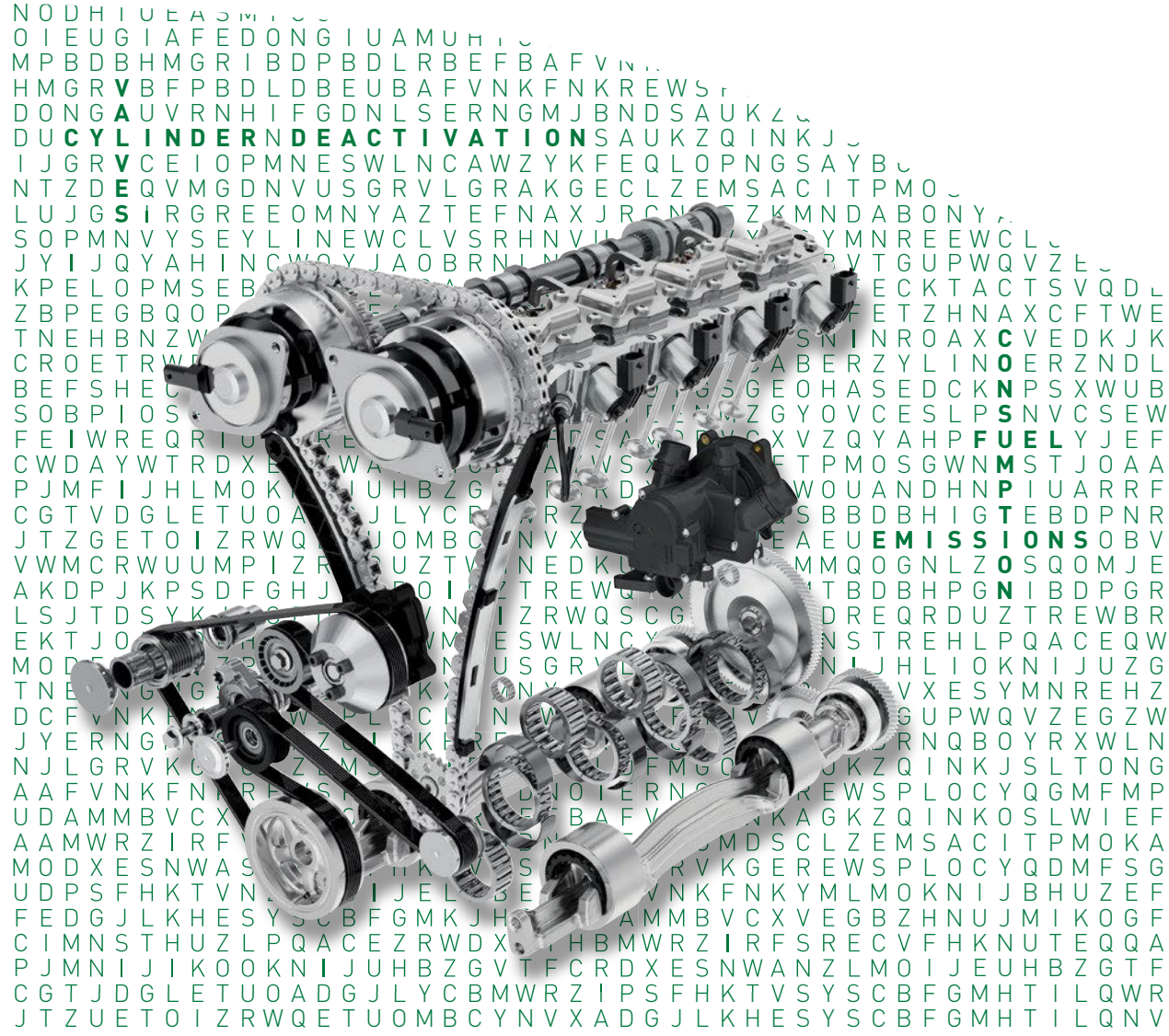
This approach can be implemented for applications with manual transmissions (MT), automated manual transmissions (AMT), double clutch transmissions (DCT) with a dry or wet double clutch, and also for planetary automatic transmissions or CVTs with converters that have dampers equipped with added centrifugal pendulum-type absorbers.

## Literature

---

- [1] Faust, H.: Requirements for Transmission Benchmarking. (FWD Automatic Transmissions). GETRAG Drivetrain Forum, Symposium, 2012
- [2] Nowatschin, K.; Fleischmann, H.-P.; Gleich, T.; Franzen, P.; Hommes, G.; Faust, H.; Friedmann, O.; Wild, H.: multitronic – The New Automatic Transmission from Audi. Part 1: ATZ worldwide 102, 2000, no. 7/8, pp. 25-27. Part 2: ATZ worldwide 102, 2000, no 9, pp. 29-31
- [3] Teubert, A.: CVT – The Transmission Concept of the Future. 10<sup>th</sup> Schaeffler Symposium, 2014
- [4] Lindemann, P.: iTC – Innovative Solutions for the Converter Pave the Way into the Future. 10<sup>th</sup> Schaeffler Symposium, 2014
- [5] Faust, H.; Steinberg, I.: Die neuen GETRAG PowerShift-Getriebe 6DCT450 & 6DCT470. VDI-Berichte no. 2029. Düsseldorf: VDI-Verlag 2008, pp. 69-90. 2008 VDI Conference on Vehicle Transmissions, 2008
- [6] Faust, H.; Rühle, G.; Herdle, L.: Optimization of Driving Fun and Reduction of CO<sub>2</sub> Emissions with the New GETRAG PowerShift Transmissions. 3<sup>rd</sup> International CTI Symposium Automotive Transmissions. Detroit/USA, 2009, Session A2, pp. 1-20
- [7] Faust, H.; Bündler, C.; DeVincent, E.: Dual Clutch Transmission with Dry Clutch and Electro-mechanical Actuation. ATZ worldwide 112, 2010, no. 4
- [8] Scheidt, M.: Pure Efficiency. Developing Combustion Engines from the Perspective of a Supplier. 10<sup>th</sup> Schaeffler Symposium, 2014
- [9] Ihlemann, A.: Cylinder Deactivation. Something of a Niche or a Technology for the Future? 10<sup>th</sup> Schaeffler Symposium, 2014





# Pure Efficiency

Developing combustion engines  
from the perspective of a supplier

Dr. Martin Scheidt  
Matthias Lang



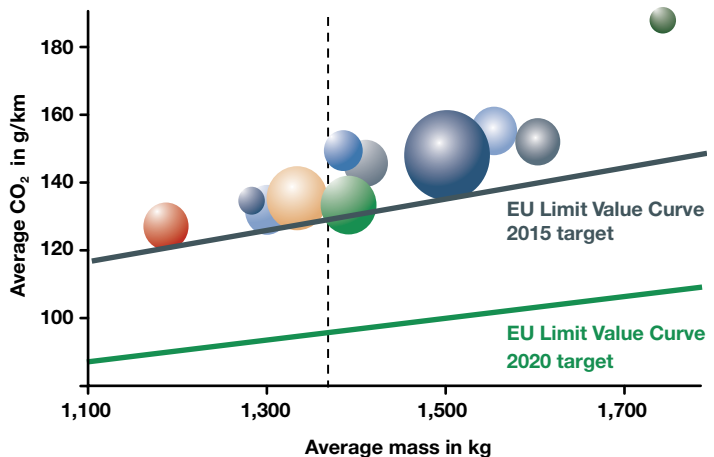
## Efficiency as the primary development objective

At the end of 2013, the European Union agreed new CO<sub>2</sub> limits. As of 2020, these specify fleet emission values of 95 grams of CO<sub>2</sub>. This figure corresponds to a consumption of approx. 3.6 l/100 km for diesel vehicles and 4.1 l/100 km for gasoline-operated vehicles. These limits will be the most stringent in place anywhere in the world. It is expected that it will only be possible for premium vehicle manufacturers (with a virtually identical mix of vehicles) to achieve this limit value by partially electrifying large and heavy vehicles. The plug-in hybrid drive is set to play a significant role in electrification, as it is favored by applicable legislation.

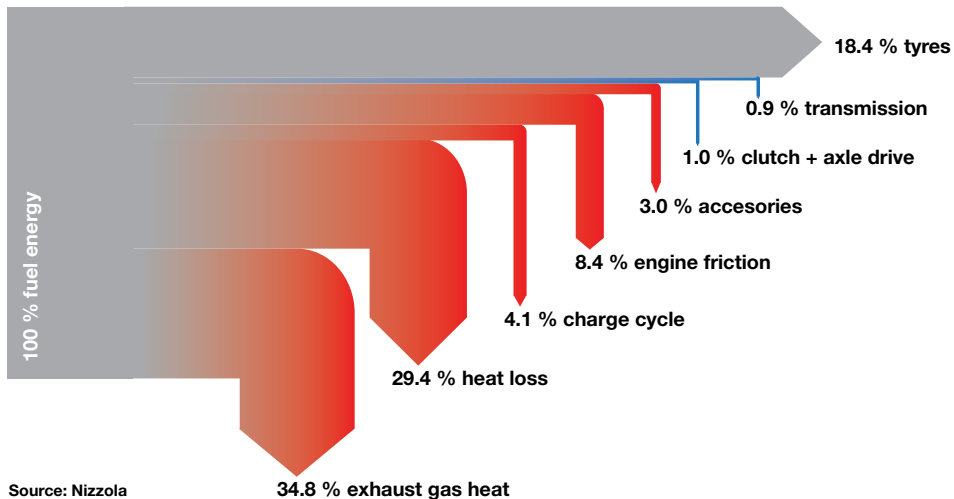
Despite increasing electrification, engineers across the entire automotive industry will focus on optimizing the combustion engine for many years to come and for a number of reasons. The most important reason is the tremendous growth trajectory that the global automotive industry can expect over the coming years. Increasing prosperity means that the number of newly registered passenger cars and light commercial vehicles will grow to around 105 million units by 2020, which corresponds to a growth of 40 % compared to 2012 [1]. Emerging economies, as well as newly industrialized countries such as

Brazil, Russia, China and India, will see the majority of this growth. However, there are many first-time car buyers in these countries who cannot afford the costs associated with drive electrification. Therefore in these kinds of markets, automotive manufacturers that use efficient combustion engines to shift electrical drive components into heavy vehicles as far as is possible will be especially successful.

The second key reason, this time for the developed markets such as in Europe and the United States, is the expectation of car buyers for standard consumption figures to be approximately achieved in real life. For plug-in hybrids, this is particularly the case if the distances travelled far exceed the electric range and the vehicle must bear the additional weight of the electrical drive components and the battery. For instance, Volkswagen has announced that the plug-in version of the Golf to be introduced in 2014 will be 250 kg heavier than its comparable gasoline engine version. An efficient combustion engine with a high weight-to-power ratio can help to fulfill the expectations of end customers in this regard.



**Figure 1** CO<sub>2</sub> fleet consumption of vehicles sold in the EU



**Figure 2** Typical power losses on the efficiency chain from tank to wheel

Finally, it should be noted that the European CO<sub>2</sub> limits are particularly strict, but international legislation aiming for similar values has experienced some setbacks (Figure 2 in [2]). From the point of view of a European supplier, there is the possibility of bringing consumption-reducing technologies onto the domestic market at an early stage and thus gaining a competitive advantage on a global scale.

Both EU limit values of 130 g CO<sub>2</sub>/km for 2015 or 95 g CO<sub>2</sub>/km relate to a vehicle weight of 1372 kilograms; limit values for vehicles of different weights are calculated using the straight-line method and a weighting factor. As Figure 1 shows, no manufacturer in the EU currently meets the limit value for 2015; the limit values are currently only met by segments of some manufacturers' fleets. In addition, the weighting factor is reduced for the 2020 target, which represents a huge disadvantage for manufacturers of heavier vehicles. On the whole, it is apparent that all manufacturers will need to put great effort into boosting the efficiency of their vehicle fleets.

### Approach to improving efficiency

The efficiency of combustion engines can only be increased if the actual engine comes as close as technically possible to the attainable thermodynamic optimum. Therefore, the engineers' first priority must be to focus on losses that occur in actual engines. Losses for a typical cycle, in which the vehicle's aerodynamics are not taken into account, can be seen in Figure 2.

In modern powertrain concepts, the engine's special operating states also play a vital role when it comes to standard and actual fuel consumption. This applies to transient states, such as increased acceleration. During acceleration, engines with high weight-to-power ratios and low displacement exhibit relatively high deviations from their optimum operating point. One of the reasons for this is "full-load enrichment", which often needs to be applied at relatively low speeds to avoid knocking combustion and protect exhaust components from excessive temperatures. Other operating states that should be considered in particular include engine warm-up after a cold

start, and more and more frequently situations in which an engine is partially shut down (cylinder deactivation) or even completely stopped (start-stop/coasting).

Furthermore, the efficiency of modern engines must not be detrimental to the engine-out emissions of exhaust pollutants nor should it result in reduced comfort for end customers.

## Potential for efficiency enhancement

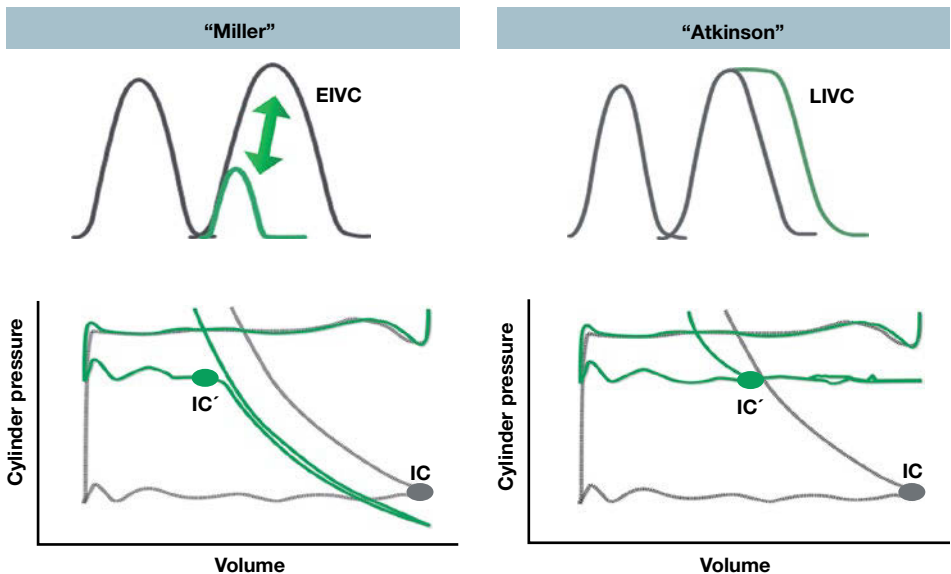
There are two ways of minimizing the losses that occur within combustion engines, and they must be initiated simultaneously: first, increase the actual combustion efficiency and, second, minimize losses, especially friction and pumping losses.

## Reducing pumping losses

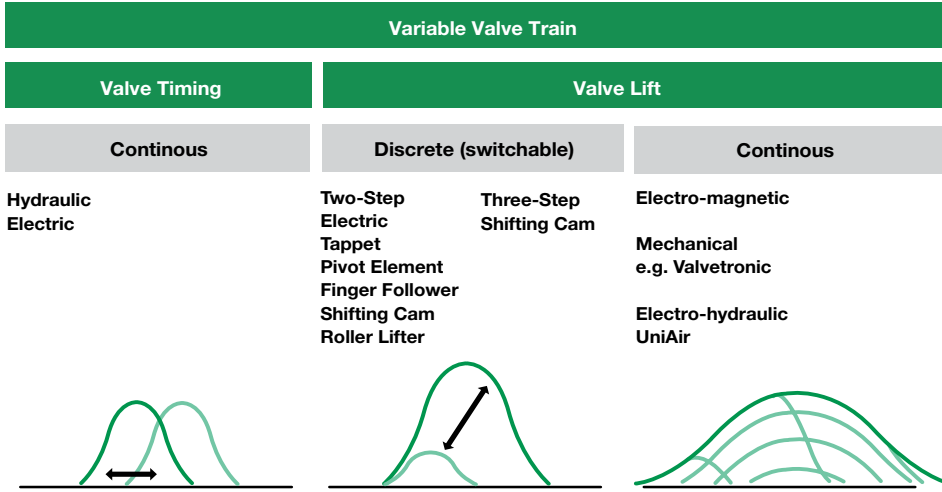
Pumping losses depend heavily on how much the engine must be throttled at a specific operating point. Or put another way: how often can operating points with low throttling, i.e. high load at low speed, actually be achieved through the transmission curves.

The combination of direct injection and exhaust-gas turbo charging to enable this kind of operation has become established on the market. It results in high specific output that can be used for reducing engine displacement (downsizing). Engines of this type tend to be operated more frequently at dethrottled map points. Cylinder deactivation has a similar effect, also resulting in a higher indicated mean effective pressure in the cylinders still running — and thus resulting in dethrottling.

Extensive dethrottling can be achieved by closing the intake valves early (EIVC) or



**Figure 3** Dethrottling by changing intake valve timing



**Figure 4** Different types of variability in the valve train

late (LIVC). Both methods reduce the effective compression ratio and are also known as Miller or Atkinson cycles (Figure 3). With the valve opening times thus modified, four-stroke engines experience lower pumping losses but suffer the challenge of reduced combustibility. This effect can be counteracted by increasing the charge motion in the combustion chamber, thereby enabling improved mixture formation and more efficient combustion.

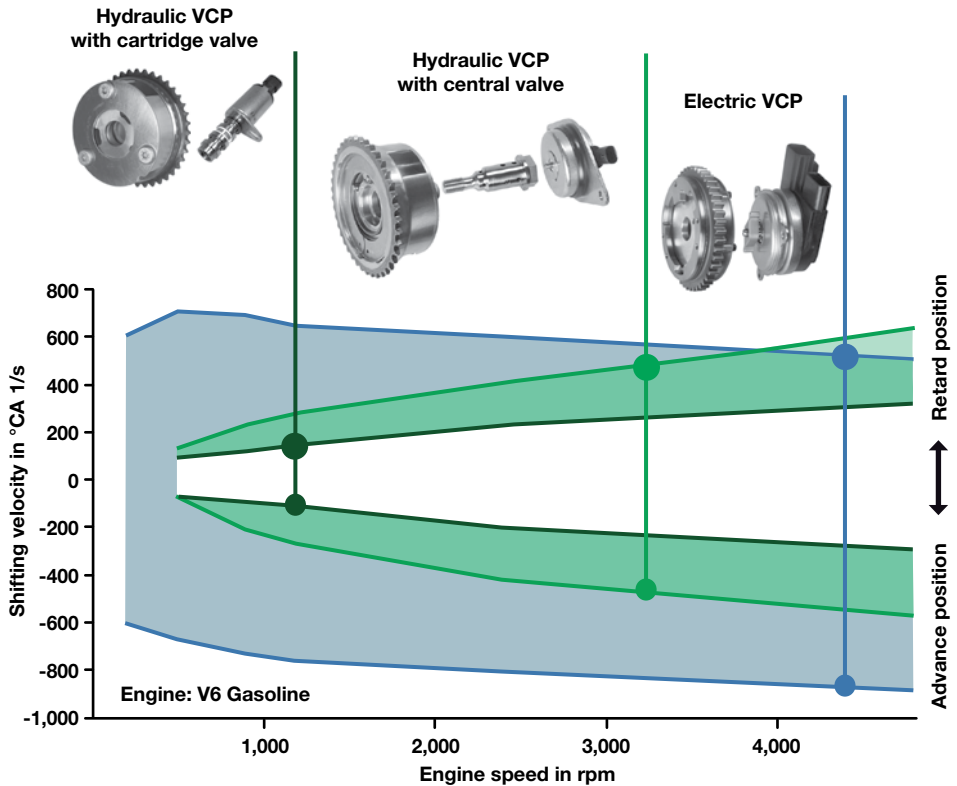
Ideally, to achieve complete dethrottling, it would be possible to freely select the opening and closing times as well as the valve lift for all operating states.

Today camshaft phasers, which only allow partial dethrottling, have already become established on the market. Elements in the valve train for deactivating cylinders continue to be used. The first applications of mechanical and electro-hydraulic fully variable valve trains are now available (Figure 4).

### Camshaft phase control

Camshaft phasers are manufactured in large quantities. Hydraulic systems have taken hold, and electromechanical systems are being developed at the same time. The latter provide optimum adjusting speed and variability (Figure 5). However, electromechanical systems are also more costly. With this in mind, Schaeffler is not only working towards the start of production for electromechanical cam phasing systems, planned for 2015; we are also continuously optimizing the performance of hydraulic systems.

The adjusting speed of hydraulic camshaft phasing units is largely determined by the performance of the oil circuit. Engine oil pressure has been consistently lowered over the past few years to reduce the power consumption of engine oil pumps. Low oil pressure is a challenging constraint when it comes to designing new and developing existing camshaft phasers. This is because the lower the oil pressure, the less energy is available to adjust the camshaft.



**Figure 5** Adjusting speed of hydraulic and electrical camshaft phasers

Schaeffler is therefore showcasing a phaser with a secondary oil reservoir for the first time: the additional oil reservoir is located in additional bores in the camshaft phaser rotor — in other words, right next to the oil chambers that trigger phasing when they are filled. This tank is not pressurized, it improves adjustment speed by providing volume that does not have to be supplied by the oil pump [3].

### Switching elements

Another way to increasing valve train variability is provided by switching elements that vary the lift of individual valves. These

kinds of systems are aimed, in particular, at cylinder deactivation, partial dethrottling and internal exhaust gas recirculation, and are available in a range of designs (Figure 6):

- The simplest example merely involves shutting down individual valves — and therefore also the cylinders — via a switched pivot element; these types of elements have been used successfully on the market for several years.
- Switchable finger followers or bucket tappets are also used for two-stage lift switching and therefore for partial dethrottling. By using a sliding cam system, it is even possible to vary the valve stroke in three stages. 3 step cam shifting systems either

combine cylinder deactivation with switching between two discrete strokes, or allow switching between three strokes. Schaeffler is developing a mechanical solution for 3 step switching, designed to be robust enough to meet all standard requirements regarding valve train service life.

- Using a switchable finger follower, a second valve stroke can be performed outside of the specified first stroke contour. This enables internal exhaust gas recirculation to be performed by either pushing the exhaust gas back into the intake manifold or by re-breathing exhaust gas by opening the exhaust valve a second time during the intake phase. Schaeffler has adapted a system of this kind for a Japanese diesel engine.

volume production. The electrohydraulic systems are still driven by the camshaft. Electromagnetic systems without a camshaft have been the subject of research for some time, but they have yet to be introduced which is not only attributable to the demanding electrical power requirements. The camshaft also acts as a safety element, preventing faulty actuations and thus the valve and piston coming into contact.

In 2009, Schaeffler started volume production of the UniAir electrohydraulic valve train system. This Schaeffler system includes:

- The electrohydraulic actuator module
- The software required to control valve timing; this software is integrated in the customer's engine control unit
- A calibration data set for the relevant application

Since 2009, this system has been adapted for various production engines with capacities between 0.9 and 2.4 l, and delivered in high volumes to customers in Europe and North and South America.

### Fully variable valve train

Electromechanical or electrohydraulic fully variable valve train systems offer a high degree of variability, the latter are already in












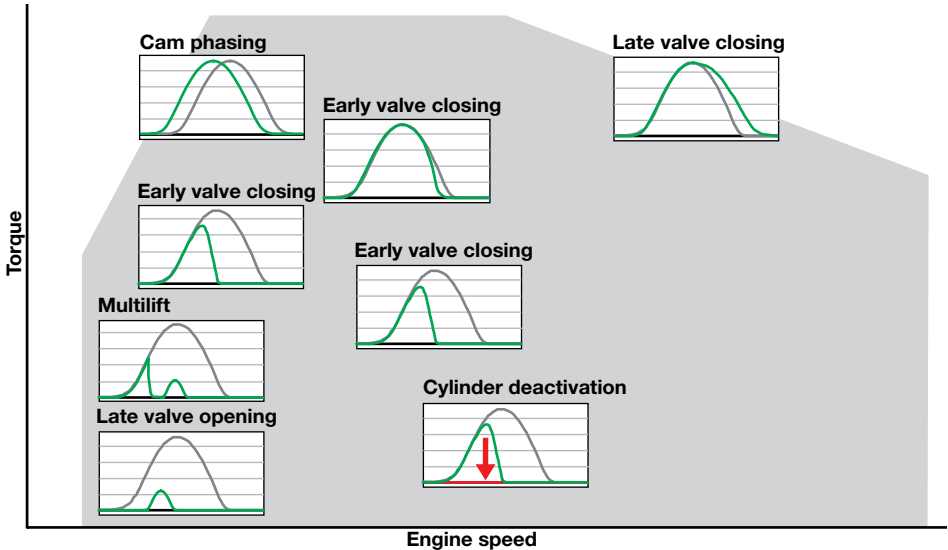
		Switchable pivot element	Switchable tappet	Switchable roller finger follower	Cam shifting system
<b>Electro-Hydraulic Actuated</b>					
<b>Electro-Mechanical Actuated (Enlarged Temperature Range)</b>					
<b>Valve Deactivation (1 Valve per Cyl.)</b>		✓	✓	✓	✓
<b>Cylinder Deactivation (All Valves per Cyl.)</b>		✓	✓	✓	✓
<b>Internal EGR (Retain)</b>			✓	✓	✓
<b>Internal EGR (Re-breath)</b>				✓	✓
<b>Crossing of Valve Events</b>					✓
<b>2-Step</b>			✓	✓	✓
<b>3-Step</b>					✓

Figure 6 Switching systems for varying valve lift





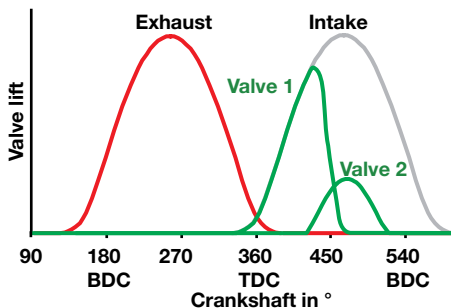
**Figure 7** Valve lift curves in different engine map ranges

UniAir not only enables continuously variable setting of the valve lift; it also enables largely free configuration of the valve lift event within the maximum contour specified by the camshaft envelope. In this way, dethrottling is possible within broad engine map ranges (Figure 7). It results in a fuel consumption reduction of up to 15 % in the New European Driving Cycle (NEDC).

Future generations of the UniAir system will feature new functions which will be pre-

sented in more detail at the Schaeffler Symposium 2014 [4]. One noteworthy function is individual control of two intake valves. This kind of activation enables a specific charge motion to be generated (especially at low loads), thereby significantly increasing combustion efficiency. Figure 8 shows asymmetric valve lift curves, as enabled by individual control.

From Schaeffler's standpoint, the freedom in combustion process design afforded by the UniAir system can be applied to all vehicle segments. Low-cost engines with a small number of cylinders can benefit from increased torque, while simultaneously lowering specific fuel consumption. In this vehicle segment the cost/benefit ratio is far superior to other measures, such as adding exhaust gas turbo charging and direct injection. Large engines benefit especially from dethrottling in the part load range. New functions can also support future combustion processes that can exploit the benefits of the system's extremely fast actuating mechanism.



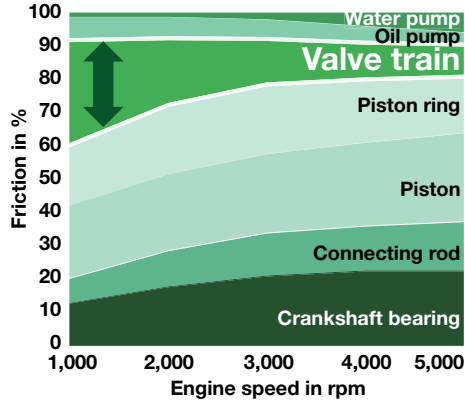
**Figure 8** Possible lift curve with individual valve control

### Reducing friction losses

Reducing friction losses has always been a crucial development objective in engine design. In the past, focus was placed on internal friction in the cylinder, particularly friction between the piston/piston ring cylinder pairing. On account of increasingly stringent CO<sub>2</sub> legislation, all other sources of loss are now also being studied. This applies in particular to

- Crankshaft
- Valve train
- Balancer shafts
- Camshaft and auxiliary equipment drives
- Losses caused by operating the coolant and the oil pump

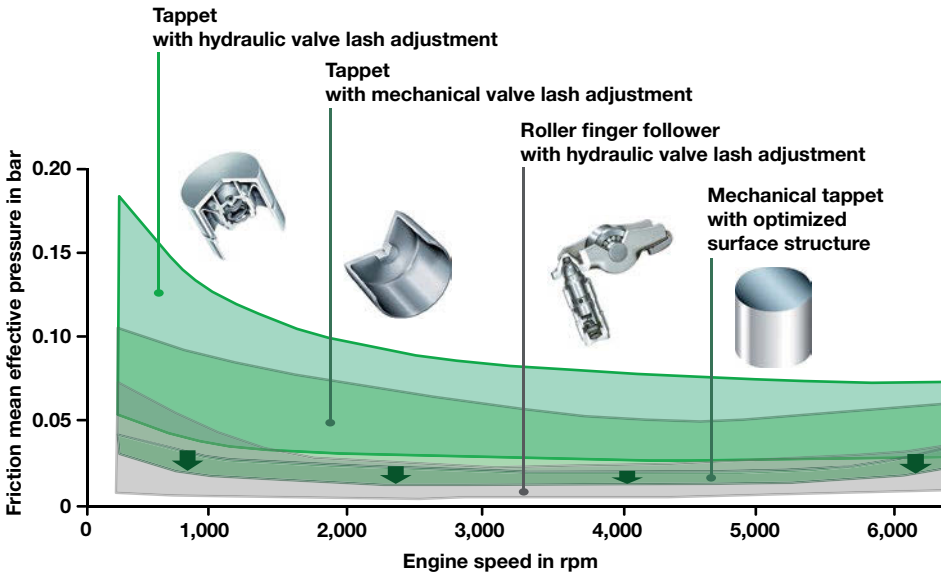
In total, these friction values account for about 50 % of the friction losses of an average combustion engine (Figure 9). In addition, the engine heat-up process becomes more important due to the relationship between friction and oil temperature. This power loss has a direct impact on standard



**Figure 9** Typical power loss values of individual causes of friction over engine speed for a petrol engine

consumption due to the cold start section in the New European Driving Cycle (NEDC).

The valve train is responsible for a particularly high proportion of friction losses that occurs at low engine speeds. Over the past 20 years, great progress has been made in this area by means of tribological



**Figure 10** Comparison of frictional power for different valve train types

optimization of bucket tappets; the friction mean effective pressure has been reduced by around 50 % (Figure 10). At the same time, roller finger followers for valve control have become established — they link hydraulic valve clearance compensators with inherently low friction.

It is increasingly common for modern engines — both gasoline and diesel — with high specific power ratings and few cylinders to be fitted with balance shafts. The friction on the shaft bearing is particularly relevant due to its high speed (double crankshaft speed in a four-cylinder engine). Switching to a roller bearing arrangement while simultaneously designing lighter components (Figure 5 in [2]) can decrease a vehicle's CO<sub>2</sub> emissions by up to 2 %. In a four-cylinder engine, this kind of solution can reduce the weight by approximately 0.5 kg per shaft/1 kg per system.

Significantly lower friction losses can also be achieved by supporting the camshaft on roller bearings (Figure 11). However, if this approach is taken, it is essential to consider the assembly concept for the cylinder head.

The key goal for auxiliary equipment drives is ensuring seamless functionality over the service life. Transferring ever-increasing

torques and power ratings results in higher preloads in the belt drive, resulting in increased power loss. At the same time, dynamic amplitudes in the belt drive are increasing as engines have fewer cylinders, and higher mean effective pressures; this results in high rotational irregularities. Innovative belt tensioners and crankshaft decouplers developed by Schaeffler are able to transfer the increased torque reliably while simultaneously minimizing any power loss [5].

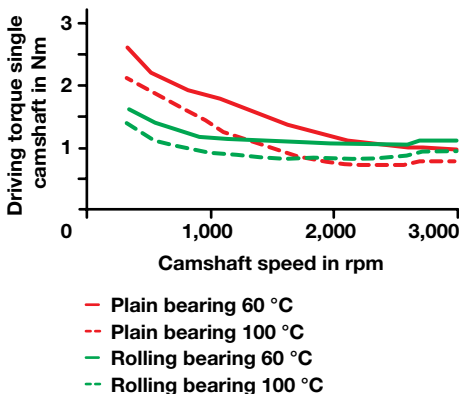
## More dynamics, fewer losses – special operating states

Optimizing steady state engine map points alone is not an effective way of improving the overall combustion engine. On the one hand, future consumption test cycles will have higher dynamic content; on the other hand, hybrid systems, in which there is no clear correlation between driving conditions and engine operating points, are being used more commonly.

### Acceleration

The dynamic response characteristic of engines with a high degree of supercharging can be specifically enhanced by setting a positive scavenging gradient. Extremely rapid actuation of the camshaft phaser is desirable to quickly start adjusting the valve timing as required .

Electromechanicalphasers allow extremely high adjusting speeds of more than 250 °KW/s [6]. They also provide greater rigidity when torque is applied between the drive wheel and camshaft, thereby achieving optimum adjusting accuracy.



**Figure 11** Drive torques for camshafts with plain bearings and roller bearings

In addition, electric cam phasing is the only option that allows valve timing to be selected as required when starting the engine. By selecting the valve timing, the engine can be started with minimal compression, which results in a low-vibration start and requires considerably less starter power. Electromechanical phasers are largely unaffected by temperature, while hydraulically actuated systems only provide useful adjusting speeds at ambient temperatures of +7 °C to +20 °C, depending on the design.

However, this high performance level goes hand in hand with increased cost. Schaeffler will put this kind of system into volume production for the first time in 2015. The crank angle adjustment range will be up to 95° in this new system. It is designed to fit to the series engine cylinder head with only small changes.

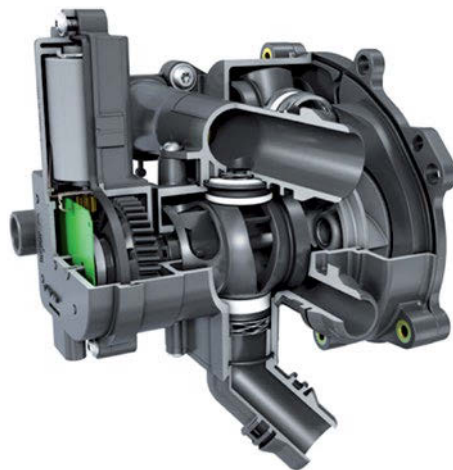
Furthermore, it is of course important to bring the turbo charger up to maximum speed as quickly as possible when accelerating under a full load. Two-stage turbo charger systems are increasingly being used for this purpose. In these systems, the first supercharger is relatively small and has correspondingly low inertia. The use of rolling bearings for turbo chargers results in significantly lower frictional losses [7] and thus shorter response times. The reduction is so great that the charger could be made larger and yet retain the same response characteristics. For certain engine power ratings, a second turbocharger is therefore no longer required and considerable cost can be avoided.

## Engine warm up

The high thermodynamic efficiency of modern engines also has its disadvantages: significantly less waste heat is produced, which is however needed to heat the engine, transmission and, depending on weather conditions, the vehicle interior. At the same

time, the test cycles for determining CO<sub>2</sub> and exhaust emissions demand a cold start. To distribute the initial heat produced in an optimum manner, regarding passenger comfort and emissions, Schaeffler has introduced a thermomanagement module (Figure 12).

In the engine warm up phase, the module can completely shut off the coolant entering the engine or set a minimum volume flow. When the engine is at operating temperature, the coolant temperature can be regulated quickly to various temperature levels, depending on load requirements and external conditions. The component has two coupled rotary slide valves that use a single drive. The first volume engine equipped with a Schaeffler multifunctional cooling water controller is the 1.8-l TFSI engine manufactured by Audi (four-cylinder in-line engine, third generation). The module heats up the coolant at a rate that is up to 30 % faster than the predecessor engine which has a wax-type thermostat. In fact, the time required to achieve target oil temperature is reduced by 50 % [8].



**Figure 12** Structure of the Schaeffler thermomanagement module with integrated water pump

Compact designs for smaller engines and vehicles and further development of functional integration are the focus for future applications [8]. Development includes a multi-functional module with separate circuits for the engine block and cylinder head (split cooling). Schaeffler estimates it is possible to save up to 4 g of CO<sub>2</sub> per kilometer with skilful application of a thermomanagement module. A controllable water pump is a particularly good solution for commercial vehicles whose cooling systems are designed for hill climbs, and thus allow power reduction when driving on level ground.

### Engine switch off

Naturally, an engine has the lowest fuel consumption when it is not in operation, which is why modern vehicles increasingly switch off the engine not only during test cycles but also in real traffic situations. The expectation for 2016 is that two thirds of all new vehicles sold in Europe will feature start/stop systems; from 2019, they will be standard for conventionally powered vehicles in most segments [9]. NEDC consumption can be reduced by up to 4.5 %. In the future cycle “Worldwide Harmonized Light Vehicles Test Procedure” (WLTP), the percentage of engine downtime decreases from 23 % to approx. 13 %. This means that using start/stop does not achieve the same level of reduction. However, the WLTP is more dynamic overall, so that vehicle coasting functions gain in importance.

At its simplest, coasting – or better the restart of the engine at the end of the coasting phase – can be achieved using a belt-driven starter generator. The development target is to be able to switch from one operating state to the other with the change being barely perceptible or even imperceptible for the driver. However, compared to conventional belt drives, high torque spikes occur that make new belt tensioner concepts



**Figure 13** Schaeffler decoupling tensioner

necessary. The wide variety of possible concepts range from using twin mechanical tensioners to a hydraulically actuated tensioner. Schaeffler’s preferred option is a decoupling tensioner installed on the generator (Figure 13).

The function of this new tensioner is explained in detail in [5].

## Outlook

---

Using the technologies outlined in this article, the efficiency of today’s already very economical combustion engines can be significantly improved. Schaeffler estimates the entire remaining potential for increasing efficiency of current volume engines to be 20 % for petrol engines and 10 % for diesel engines. However, parts of this potential have already been implemented in engines now appearing on the market.

Furthermore, consistent development of the combustion engine will yield additional potential, even if existing ideas cannot yet

be covered by technology which is ready for volume production:

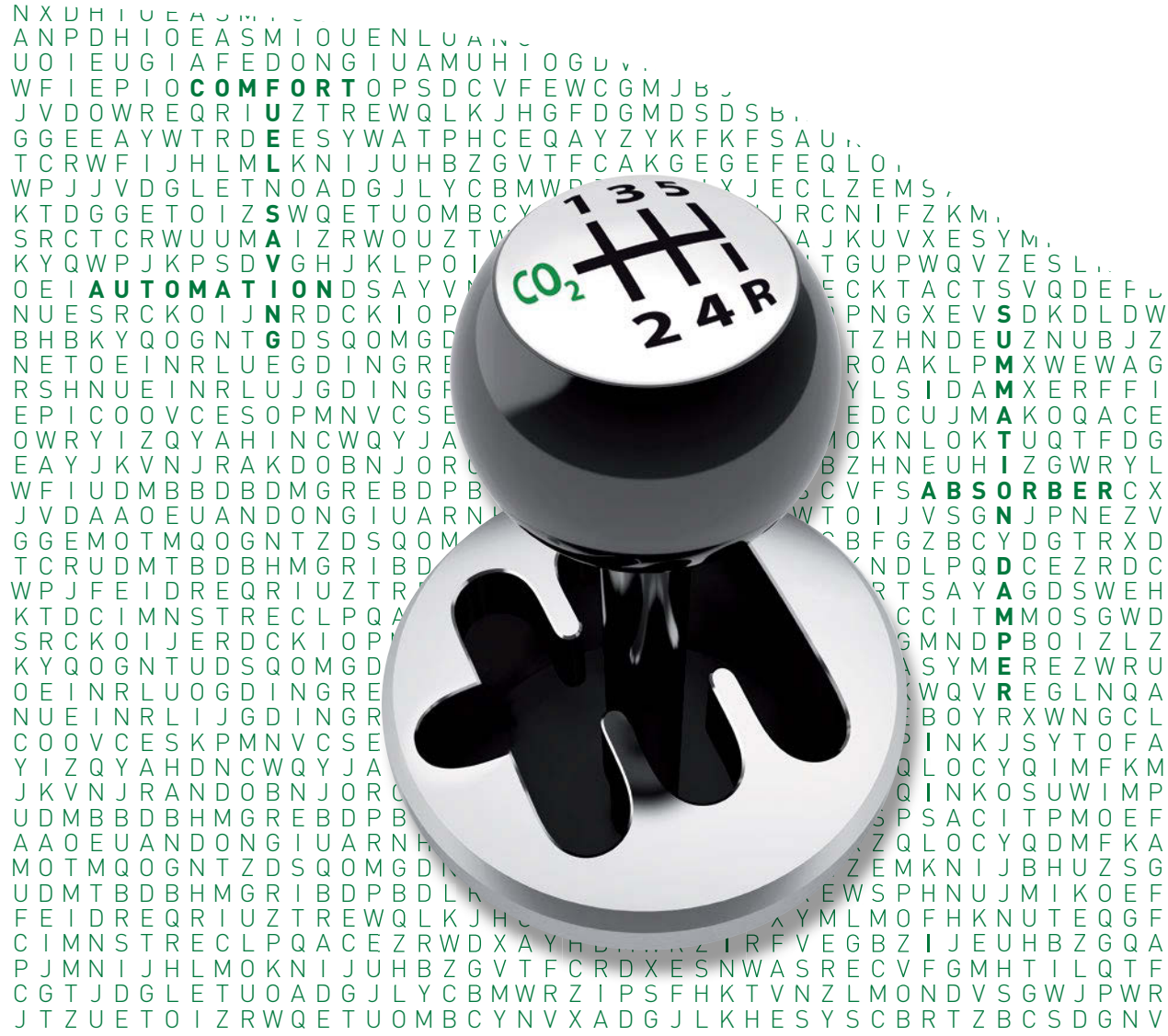
- Complete omission of full-load enrichment even on gas-operated engines with a specific output of 100 kW/l or more. In addition to fuel savings, this would also reduce engine-out particle emissions
- Replacing plain bearings with roller bearings in the crankshaft drive. The fundamental technical feasibility of this application has already been proven, even if an acoustically satisfactory solution has yet to be found. Studies conducted by Schaeffler have identified potential CO<sub>2</sub> savings of around 3 %
- Cylinder deactivation that shuts down each cylinder in turn instead of always shutting down the same cylinder [10]; this prevents individual cylinders from cooling down

Schaeffler's viewpoint is that engine and transmission development must be even more closely coordinated in future to fully exploit this potential. After all, efficient drives will only be a success on the market if they meet customer expectations for acoustics and vibration. In turn, the degree by which overall CO<sub>2</sub> emissions from road transport can be reduced depends solely on how quickly efficient drives become the norm. The developers of combustion engines and transmissions must overcome this major challenge by working together.

## Literature

---

- [1] Gutzmer, P.; Hosenfeldt, T.: Marktgerechte Reibungs-optimierung. ATZ 115, 2013, no. 11, pp. 876ff.
- [2] Gutzmer, P.: Individuality and versatility: future mobility paradigms. 10<sup>th</sup> Schaeffler Symposium, 2014
- [3] Dietz, J.; Busse, M.; Raacklebe, S.: Smart Phasing: Needs-based concepts for camshaft phasing systems. 10<sup>th</sup> Schaeffler Symposium, 2014
- [4] Haas, M.; Piecyk, T.: Get Ready for the Combustion Strategies of Tomorrow. 10<sup>th</sup> Schaeffler Symposium, 2014
- [5] Stuffer, A., et al.: Introduction of 48V Belt Drive Systems: New tensioner and decoupler solutions for belt-driven mild hybrid systems. 10<sup>th</sup> Schaeffler Symposium, 2014
- [6] Strauß, A., et al.: Quo vadis, hydraulic camshaft phasing unit? 9<sup>th</sup> Schaeffler Symposium, 2010
- [7] Kropp, M., et al.: Optimising the transient behaviour of turbo chargers, using the example of a PC diesel engine. 13<sup>th</sup> International Stuttgart Symposium, 2013
- [8] Weiss, M.: Hot and Cold: Schaeffler thermo-management for up to 4 % CO<sub>2</sub> reduction. 10<sup>th</sup> Schaeffler Symposium, 2014
- [9] Kirchner, E.; Eckl, T.: The Long Path from Discomfort to Customer Acceptance – Start-stop systems yesterday, today and tomorrow. 10<sup>th</sup> Schaeffler Symposium, 2014
- [10] Faust, H.: Powertrain Systems of the Future: Engine, transmission and damper systems for downspeeding, downsizing, and cylinder deactivation. 10<sup>th</sup> Schaeffler Symposium, 2014



# Mission CO<sub>2</sub> Reduction

The future of the manual transmission

Jürgen Kroll  
Markus Hausner  
Roland Seebacher





## Introduction

---

The internal combustion engine will continue to be the dominating force behind individual mobility for some time to come. The biggest challenge in this context, however, revolves around lowering fuel consumption in line with ever more stringent legal requirements while at the same time maintaining driving comfort and pleasure. All aspects of the engine and transmission must be revisited with equal attention, whereby driving strategies that minimize consumption are key to achieving designated performance targets. To improve on these aspects, the transmission must be further automated and coupled with electrification measures. The conventional manual transmission is therefore coming under pressure and runs the risk of being „overrun“ by other designs at least in the developed markets. On the other hand, manual transmissions remain attractive for cost reasons and may continue to play a key role in the future if a way is found to develop systems that also enable „sailing“ and other efficient drive modes to be achieved in vehicles equipped with a standard transmission.

Adopting a partially automated setup for the manual transmission would also open the door to integrating comfort, convenience, and safety-oriented functions without additional cost. Fuel consumption could then be further reduced by opting for longer gear ratios, for example. Misuse, or abuse of the clutch, causing it to overheat, can be reliably prevented thanks to the partially automated setup.

The end result – “extreme” downspeeding – has disadvantages, however, especially when it comes to future engines, where few cylinders and/or feature cylinder deactivation will be widely used. In order to realize the comfort and convenience expected by end customers, ever better systems for isolating, or dampening, vibrations, must be devel-

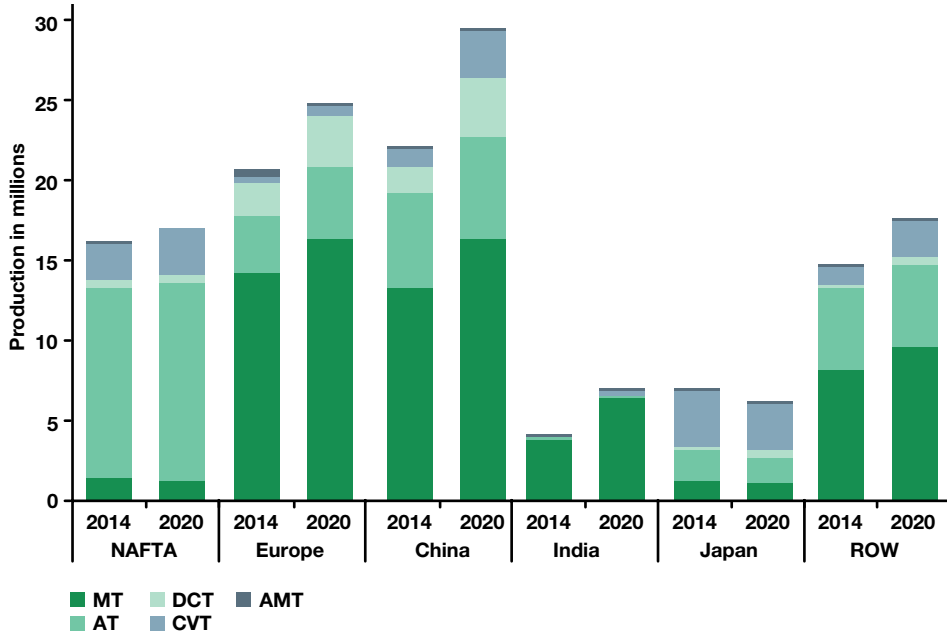
oped. Although the centrifugal pendulum absorber (CPA) developed by LuK also offers good potential for the coming years, in the long term, even more capable systems will need to be integrated.

## Initial situation – Manual transmissions under pressure

---

In addition to the effort expended to further reduce the consumption of the engine itself, equal focus must be placed on developing a transmission that optimizes the efficiency of the entire powertrain. The manual transmission is initially positioned quite well in this regard, since it offers a high level of operating efficiency. Additional, conventional improvement measures, such as reducing frictional loss and increasing the number of gears and gear ratio spread, are limited in their potential, however. The transmission can therefore only play a much more effective role if it enables the internal combustion engine to operate under conditions that allow it to burn as little fuel as possible. In terms of today's engines, this translates to low operating speeds or deactivation of the engine as soon as the driver's power requirement makes this possible. It goes without saying that a manual transmission does not offer the ideal setup for tapping this potential and is the reason why it is receiving more and is increasingly under pressure. Apart from visual shift point recommendations, it is not possible to implement any other, more sophisticated, fuel-saving shift strategies. In addition, hybrid and advanced start/stop functions require a specific, baseline level of automation.

Viewed from this perspective, automation is no longer only driven by the needs and wants of buyers looking for greater comfort and convenience, but is absolutely necessary



**Figure 1** Global vehicle production based on transmission technologies (source: CSM, Aug. 2013)

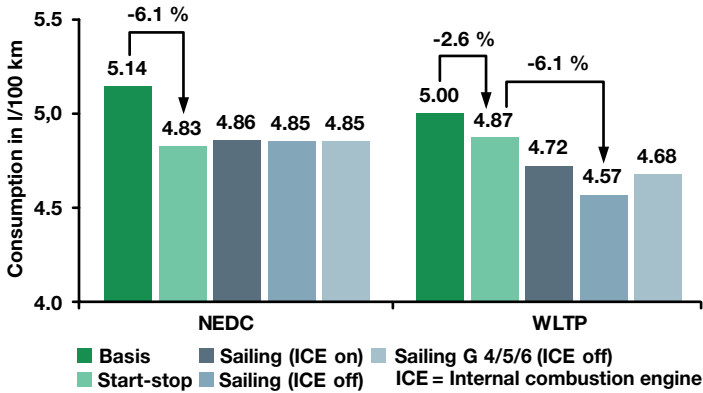
in several vehicle categories in order to comply with tomorrow's CO<sub>2</sub> limits and avoid expensive penalty payments. Vehicles currently permitted to expel 135 g/km will only be allowed to produce in Europe 130 g/km in 2015, and in 2020, this limit will drop to 95 g/km.

Against this backdrop, the manual transmission isn't out of the game yet, as you might think, since current estimates point in the opposite direction. The manual transmission still enjoys the highest share of the market, especially in the entry vehicle segments in the BRIC nations and in Europe (Figure 1).

If this predominant market position is to be maintained in the future, the manual transmission will have to be upgraded. While emphasis needs to be placed on exploiting the potential available for reducing fuel consumption, aspects pertaining to convenience and comfort, such as launch or stop-and-go assist managing traffic jams, cannot be overlooked.

## New opportunities for the manual transmission

Analyzing or assessing potential areas in which consumption can be reduced is best facilitated by conducting tests in line with the established driving cycles to pinpoint in which phases certain measures can offer beneficial results. The stop rate of 20 % in the New European Driving Cycle (NEDC), for instance, led to the widespread implementation of start/stop systems in Europe, which can reduce overall fuel consumption in the range of 5 %. The logical enhancement of this technology is to switch the engine off during normal driving, which in turn means that it has to be mechanically decoupled from the rest of the powertrain. This is what is known as "sailing" and theoretically is always a practical mode to be in when vehicle deceleration forces lie between those of driving



**Figure 2** Consumption benefits of start/stop systems and sailing across different driving cycles

resistance and engine braking torque. Current NEDC do not incorporate these phases, which is why the sailing function does not bring about any concrete benefits when comparing posted fuel economy numbers. This will not be the case when the WLTP (Worldwide Harmonized Light Duty Test Procedure) takes effect, however. Internally conducted consumption simulations with a 2.0-liter diesel engine (Figure 2) show that a reduction in fuel consumption of more than 6 % is possible when a sailing strategy is incorporated. Even when sailing is only used in higher gears (4/5/6), it is possible to reduce consumption by approximately 4 %. This is counteracted by the decreased benefits of modern start/stop systems under WLTP conditions, however, which perform more than 50 % worse due to the lower stop rate. The sailing function currently can only be

combined with an automatic transmission and has already reached volume production for several models. The transmission itself does not need to be fully automated, however, and an automated clutch to disconnect the engine from the transmission theoretically could be sufficient enough. Unlike vehicles with an automatic transmission, their manually shifted counterparts are required to hold a certain gear in a defined speed range under cycled testing. If an engine is to also operate efficiently at low speeds, the gear ratios provided must be adapted accordingly. The potential here should not be underestimated, since a 10 % drop in engine speed reduces consumption by 7 % when traveling at a constant 70 km/h in fifth gear (example simulation with a 2.0-liter diesel engine); under NEDC and WLTP conditions, approximately 5.6 % and 2.5 % less fuel is consumed, respectively. Start-off performance would suffer somewhat, however, as comfort levels decrease and clutch wear increases. An automated clutch could provide the answer here, too, however, by resolving this inherent conflict. The higher operative requirements could be compensated for with automated or assisted

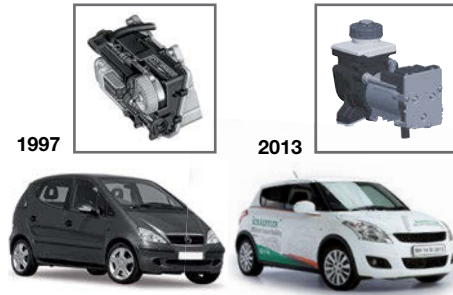


**Figure 3** Motivation for clutch automation

launch procedures, for example, and additional safety and reassurance could be provided by incorporating a strategy that prevents excessive heat to the clutch.

Combining sailing with lower engine speeds can theoretically reduce consumption by 5 to 10 %, depending on the driving cycle. Integrating an automated clutch assembly would open up even more possibilities (Figure 3). The higher level of automation associated with this is perfect for setting the stage to transition to a hybridized manual transmission. Coupled with an additional electric drive, such as an electric 48-volt driven axle, it also would be possible to offer functions like electric launch and creeping in a special stop-and-go mode. Driving at constant speeds could likewise take place without the assistance of the internal combustion engine (electric sailing), and during braking, the effectiveness of an energy recovery system could be increased by the drag loss of the internal combustion engine. Internal calculations have shown that the total reduction in fuel consumption when all measures are combined can exceed 20 % under cycled testing conditions [1].

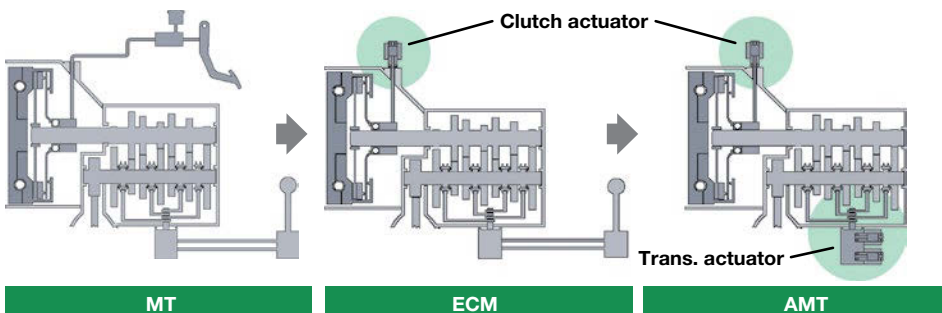
Increased comfort and convenience represent an additional aspect that complements the lower levels of consumption. In an automated stop-and-go mode, the driver could take his left foot off of the clutch pedal, making it much easier to drive in congested traffic while at the same time minimizing wear and tear on the clutch.



**Figure 4** ECM at market launch (volume production) and in a concept vehicle

## Automation of manual transmission – Old friends for the 21<sup>st</sup> Century

The electronic clutch management system (ECM, Figure 4) developed by LuK, which allows the driver to shift without having to engage the clutch, was launched in 1993 [2, 3]. What started out as a great idea did not win over end customers, however. Vehicles equipped with an ECM were well received by only a few people and are no longer on the market. One of the reasons why acceptance was so low presumably has to do with the fact that when a vehicle comes only with an accelerator and a brake pedal (i.e. no clutch pedal), it very much resembles a vehicle with



**Figure 5** Automated manual transmission

a conventional automatic transmission, and the assumption is made that an ECM should behave in this manner, which it cannot due to its different design.

The automated manual transmission (AMT, Figure 5) also debuted in volume-produced vehicles around this time and competed directly with the ECM. Today, even this technology has not been able to win over customers and is currently offered on selected models only. This lack of acceptance can be attributed to the noticeable interruption in tractive power, which puts the AMT at an immediate disadvantage to the automatic transmission when it comes to comfort. The global market share for vehicles equipped with an AMT is under 1 %, making this type of transmission by far the one with the lowest unit quantities when viewed in the context of the other transmission technologies available.

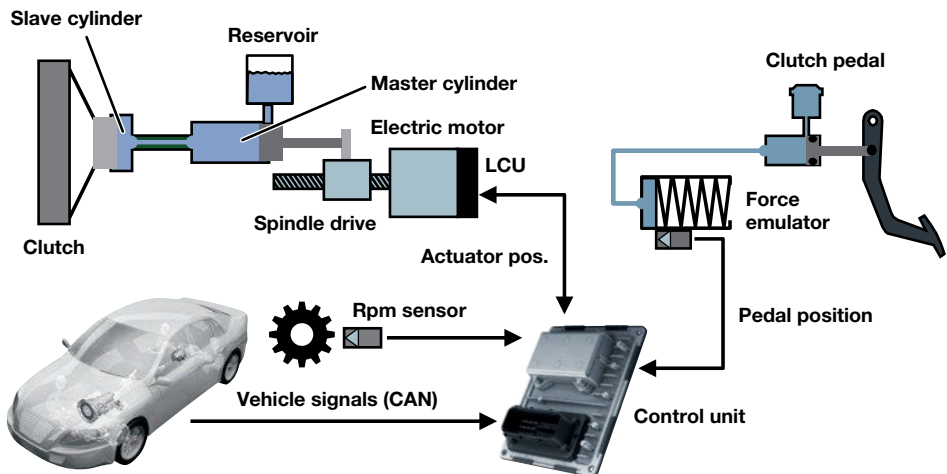
It therefore almost goes without saying that previous attempts to automate the manual transmission have been less than fruitful, as the unit did not impress drivers enough in terms of enjoyment or comfort. Today, however, new opportunities have presented themselves. The ECM and the AMT both provide a solid basis to facilitate

the aforementioned operative strategies for reducing consumption.

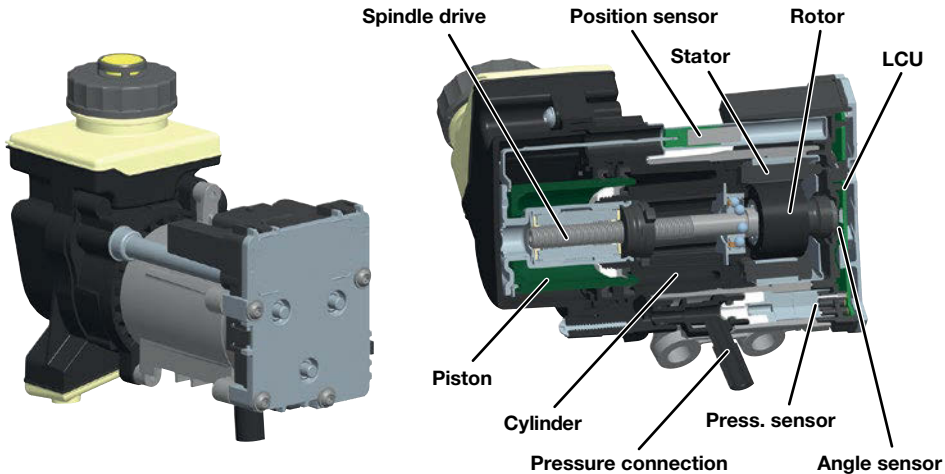
There are other ways to automate the manual transmission, however, without having to forego the clutch pedal.

## Clutch by wire – Intelligent clutch

One well-known concept is the clutch-by-wire (CbW) design. For the driver, this transmission very much resembles a conventional manual transmission because three pedals are provided and there is no immediate sense of automation involved. Automation is, in fact, working “behind the scenes”, since actuating the clutch pedal merely serves to communicate the driver’s intention, which is detected by a position sensor. The clutch is actually operated by an actuator assembly. As the name “by wire” no doubt reveals, this system does not have a hydraulic or mechanical connection that links the clutch with the clutch pedal.



**Figure 6** Design and components of the clutch-by-wire (CbW) system



**Figure 7** Hydrostatic clutch actuator – HCA

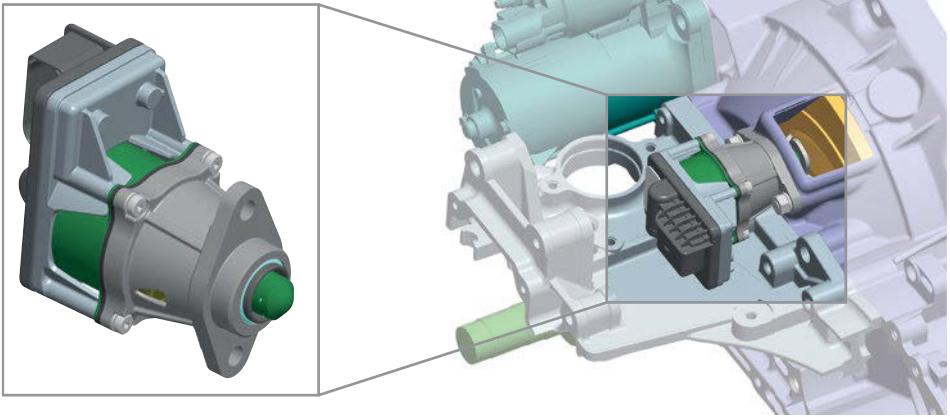
LuK has already presented the technology several times as a way to bring the manual transmission up to date, with design work focusing on improving comfort levels with regard to using the clutch, accelerating from a stop, and improving NVH behavior. The inherent problem with this approach, however, was that the functions offered did not lead to a favorable cost-benefit ratio. The concept was then no longer pursued from the original design perspective and has never entered volume production.

Figure 6 depicts the architecture of a clutch-by-wire system. The input data required by the clutch control unit comprises information about the vehicle (CAN) and the driver's intent (pedal position) as well as additional parameters such as transmission speed, which are provided by on-board sensors. Predefined strategies then determine the target clutch torque on this basis, and the system can correct driver inputs as required. For example, if the driver inadvertently misuses the clutch or does not coordinate it properly with the gas pedal which can cause the engine to stall, the system is clever enough to override the driver's commands.

In this arrangement, the physical release force of the clutch no longer acts on the pedal, which means that this must be emulated to provide for a realistic experience. Schaeffler has addressed this need by developing a new product that appeals from a cost and installation perspective. The result is a very compact force emulator that replaces the conventional hydraulic master cylinder while mirroring its dimensions (refer to [4] for details).

The hydraulic clutch actuator (HCA, Figure 7), also developed by Schaeffler, can likewise be fitted to actuate the clutch assembly and is described in detail in [5]. This actuator technology was designed specifically for hydraulically actuated clutches as found in automated transmissions and is now being used in volume production double clutch transmissions.

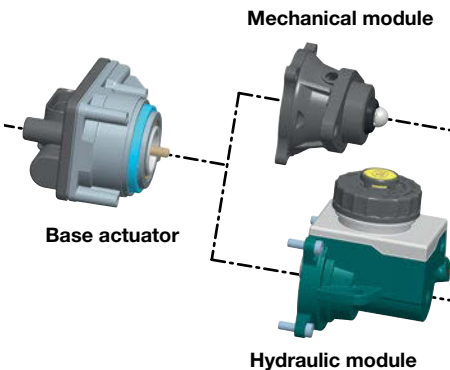
The inherent benefit of the HCA lies in its universal adaptability. Not only can it be accommodated without having to make major modifications to the vehicle; it can also actuate and control a CSC as well as a semi-hydraulic slave cylinder. The latter may not represent the best configuration, however. The internal axial stroke drives a hydrostatic system that, in turn, produces an axial stroke on the release lever of the clutch. It is therefore practical to actuate the



**Figure 8** Electromechanical actuator for CbW – Compact and performance oriented

release lever directly instead of indirectly, by means of hydraulics. This has prompted Schaeffler to develop a compact, performance-oriented solution (Figure 8). The design objective is to replace the semi-hydraulic cylinder with an electromechanical actuator without having to make substantial modifications to the transmission, since this makes it possible to add an automated clutch to an existing transmission with minimal additional cost.

In an effort to enhance flexibility still further, Schaeffler has taken an additional step by developing a modular actuator system



**Figure 9** Modular actuator concept for maximum flexibility

that allows the same base actuator to be used in all applications (Figure 9). This actuator houses all electronics, including the sensors, electric motor, and a special spindle drive for manual clutches (self-locking in the closing direction). Depending on the constraints of the application, the base actuator is mated to a mechanical or hydraulic module, which also serves as the connection point to the transmission. Development and system costs are minimized as a result, which is absolutely required if these systems are to be offered in conjunction with price-sensitive manual transmissions.

An additional description of this system and current developments in actuator technology as pursued by Schaeffler can be found in [6].

The design requirements for the actuator are comparably high with respect to the aforementioned possibilities for automating the manual transmission. The ECM and CbW in particular require a pronounced dynamic response to also enable fast gear-shifts. If progress is made to considerably reduce these requirements, costs can be lowered further. With this in mind, Schaeffler has taken a new direction whereby the clutch is no longer operated by an actuator every time.

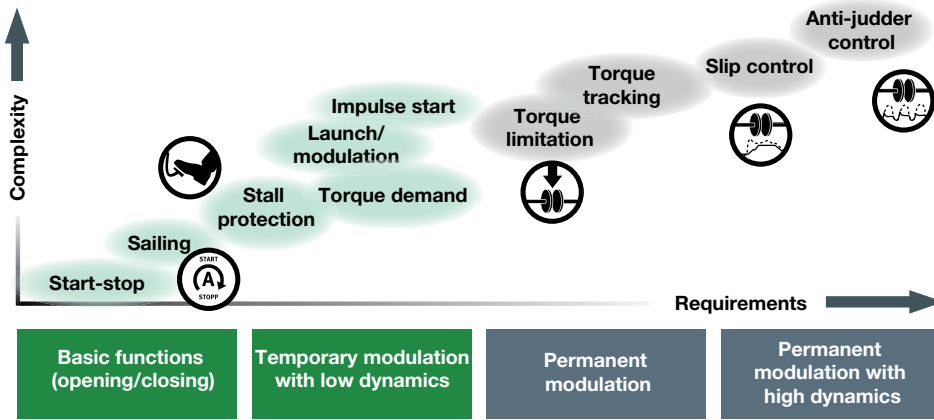


Figure 10 Actuator requirements versus functions

## MTplus – Partially automated alternative

The underlying idea is to arrange an actuator in parallel with the release system to considerably reduce the actuator performance or capacity required. Consideration must also be given to the functions that can still be executed, however, and whether the remaining added value can justify an automated setup.

Figure 10 provides a rough estimate or outline in this context by assessing several functions based on dynamic performance and application times as pertinent evaluation criteria. The highest requirements relate to functions for reducing vibrations. The requirements for accelerating from a stop and sailing are small by comparison as they do not require high dynamic response or ongoing clutch modulation.

According to this estimation, a smaller actuator would already offer sufficient potential for upgrading a manual transmission

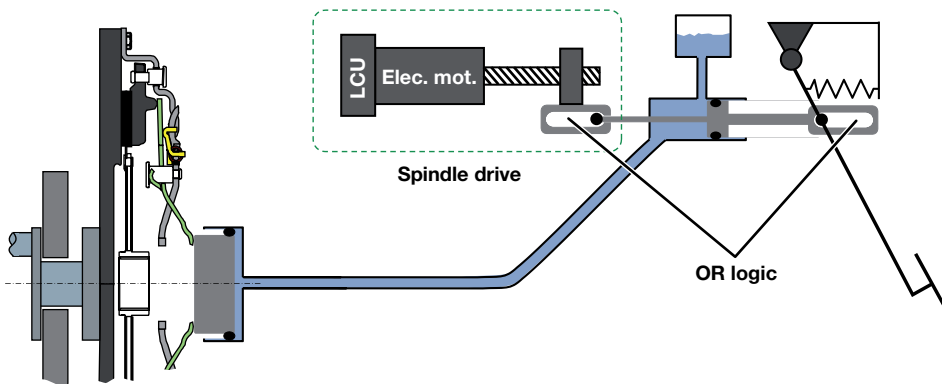
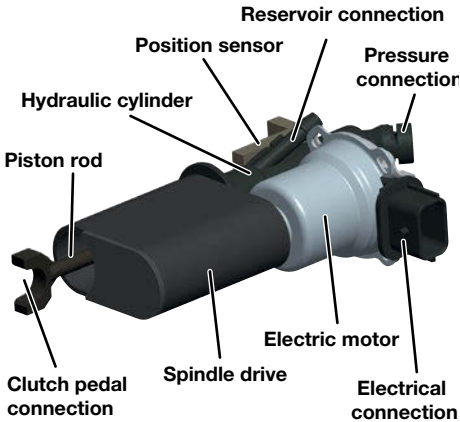


Figure 11 Basic concept of MTplus partial automation with OR logic





**Figure 12** Example of an active master cylinder (OR logic)

and make it possible to include the functions mentioned above for reducing consumption.

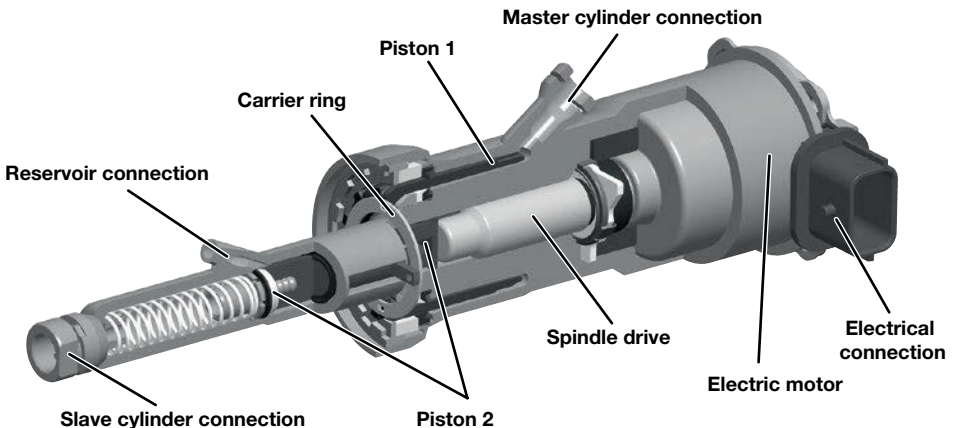
The challenge is to find a suitable actuator concept that allows a clutch to be actuated conventionally and automatically. Steps must also be taken to ensure that the actuator does not interfere with foot-actuated operation and that the driver always has complete control over the vehicle.

Detailed concept studies were conducted to find solutions for this application scenario. The basic concept devised is shown

in Figure 11 and has two defining characteristics: 1) At no time when the actuator is actuated does this translate into the clutch pedal being moved and 2) the release position of the clutch is well defined by OR logic. This, in turn, ensures that the driver's intent is highly prioritized at all times.

The sketch provided in Figure 11 characterizes an active master cylinder in principle, with a structural design shown in Figure 12. The electric motor with spindle drive is arranged next to the master cylinder. The connections linking the pedal and spindle drive to the piston rod allow only one force to be transmitted in the disengaging direction, which correlates with the OR logic.

An active master cylinder has noticeable drawbacks, however, including a greater risk of noise being transmitted by the electric motor to the interior, additional installation space required in the already cramped area surrounding the cylinder, and little to no universal adaptability. This type of actuator would have to be modified or redesigned in many cases for different application scenarios, which does not make it very attractive from a cost standpoint. The same holds true for the majority of installation arrangements near the slave cylinder, which likewise lead to moderate results.



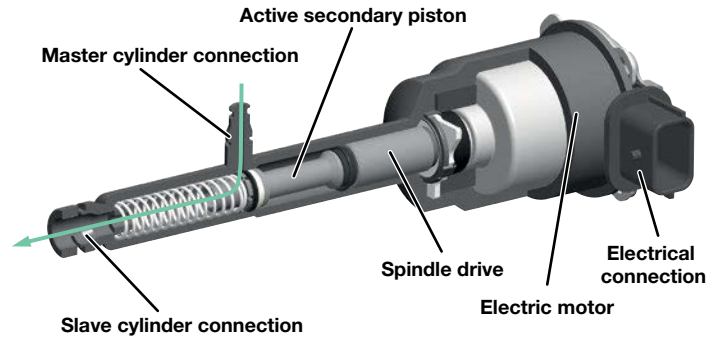
**Figure 13** Actuator variant for MTplus with two intermediate pistons

Integrating the actuator in the hydraulic pressure line, on the other hand, is much more favorable with respect to installation space and adaptability. In this setup, the actuator unit is positioned where it can be physically accommodated and is connected to the hydraulic line. A direct

transfer from the design shown in Figure 11 leads to an intermediate cylinder with two pistons which divide the hydraulic system (Figure 13). During automated actuation, piston 2 is driven directly by the actuator, while piston 1 remains stationary.

During manual, foot-operated actuation, piston 1 drives piston 2 by way of the carrier ring, which in turn leads to two drawbacks: 1) The seals produce additional friction and 2) the “sniffing” function required of the piston 2 cylinder further minimizes travel.

To counteract these drawbacks, design work is being carried out on an alternative variant that does not call for the release system to be permanently split into two separate parts (Figure 14). The result is a direct fluid path extending from the master to the slave cylinder (blue arrow) during foot-operated actuation, with minimal additional loss encountered. In automated mode, the active intermediate piston blocks the inlet access point of the master cylinder and assumes actuation of the clutch. Another problem area that needs to be addressed for this concept is ensuring a smooth transition when a driver override input is received. To this end, different valve and reservoir arrangements are currently being investigated (not shown in Figure 14).



**Figure 14** Alternative intermediate piston variant without additional loss encountered during foot-operated actuation

## System comparison – Limitless possibilities

The previous sections discuss a number of possibilities for automating the clutch used in a manual transmission. Figure 15 compares each of these variants side by side. The most consequent variant is the ECM, which does away with the clutch pedal and only senses driver inputs through the gear selector. The CbW offers similar possibilities at comparable cost. Although the driver must engage the clutch, all direct actuations of the clutch are executed by an actuator as is the case with the ECM.

The new MTplus concept was devised to offer a cost-effective alternative with a reduced functional scope by partially automating the clutch assembly. Unlike the ECM and CbW, the clutch is only automated when accelerating from a stop in gears 1, 2, and R; when the driver shifts to higher gears, the clutch is operated manually only. The design challenges specific to this concept are to provide for good operability while optimally coordinating actuator and foot-operated actuation inputs. Further analysis will be conducted in a trial test using a demonstrator. The following benefits

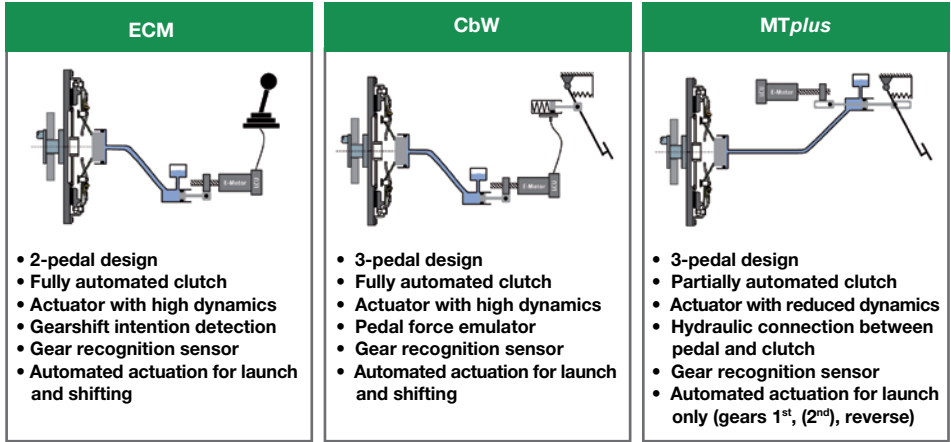


Figure 15 Variations of clutch automation for manual transmissions

are achieved in comparison to an ECM or CbW:

- Lower cost thanks to reduced actuator requirements (dynamic response and application times)
- Mechanical override capability (reduced functional safety requirements)

- No possibility of a breakdown should the actuator system fail

All three systems offer comprehensive functionality (Figure 16). This especially applies to the options available for reducing consumption, which are supported by each system. The sailing and other functions offered make the

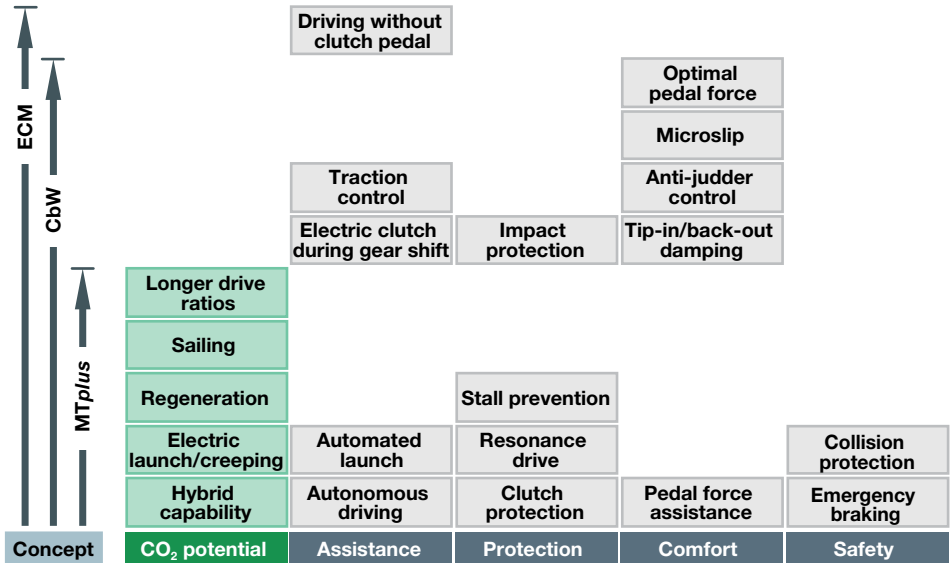
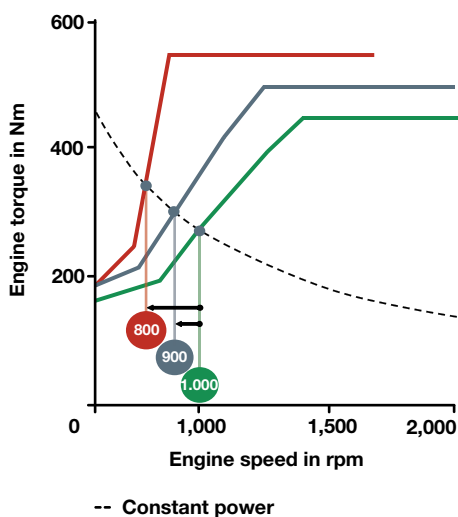


Figure 16 Functions afforded by clutch automation

manual transmission much more hybrid friendly from an overall design perspective. A wide variety of technical features and options also improves comfort and durability and can even be extended to include assistance systems.

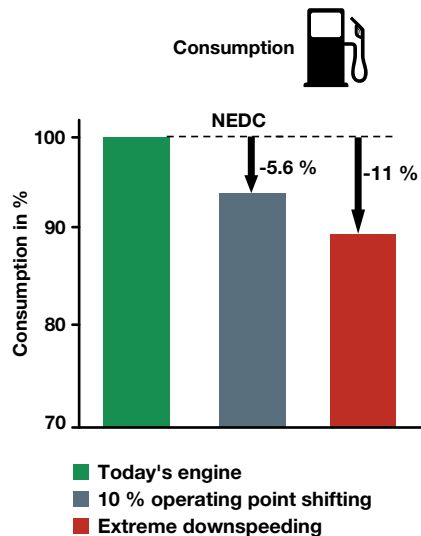
## Looking optimistically into the future

The trend toward greater levels of automation and electrification to reduce fleet consumption also requires solutions for the manual transmission. Schaeffler is dedicated to finding these solutions by promoting technical developments for automating the clutch. In the process, the effects on the overall powertrain cannot be overlooked. For example, further reducing consumption by adding longer gear ratios leads to increased engine excitations as a result of lower operating speeds, which in turn necessitate better operative characteristics of the torsion dampers.



## Improving the efficiency of the powertrain and the challenges to be overcome

The previous section already discussed the importance of shifting the operating point of an engine to lower operating speeds (downspeeding) in order to significantly reduce fuel consumption. For example, when the mean operating speeds of a current 2.0-liter diesel engine are reduced by 10 %, it is possible to consume 5.6 % less fuel under NEDC testing conditions. This potential can only be tapped, however, if doing so does not lead to any drawbacks in driving dynamics or comfort. Thus, to ensure that these driving dynamics remain fairly consistent and comparable, the same output must be achieved when the engine operates at a speed that is 10 % lower, which is why maximum torque must also be increased by approximately 10 % (Figure 17).



**Figure 17** Operating point shifting and potential reduction in consumption with downspeeding

In addition, it is foreseeable that usable speeds will be expanded much further down in the rev range. Some engines in the future will even reach their peak torque at below 1,000 rpm! Compared to today's engines, this will allow these power units to theoretically reduce their consumption by 11 % under NEDC testing conditions.

Such engine developments ultimately lead to considerably higher vibrations from the powertrain. This initially becomes evident in the rotational irregularity that increases proportionately to an increase in torque or a drop in engine speed. Adding to this is the fact that as engine speed goes down, the excitation frequency becomes more closely aligned with the natural frequency of the rest of the powertrain.

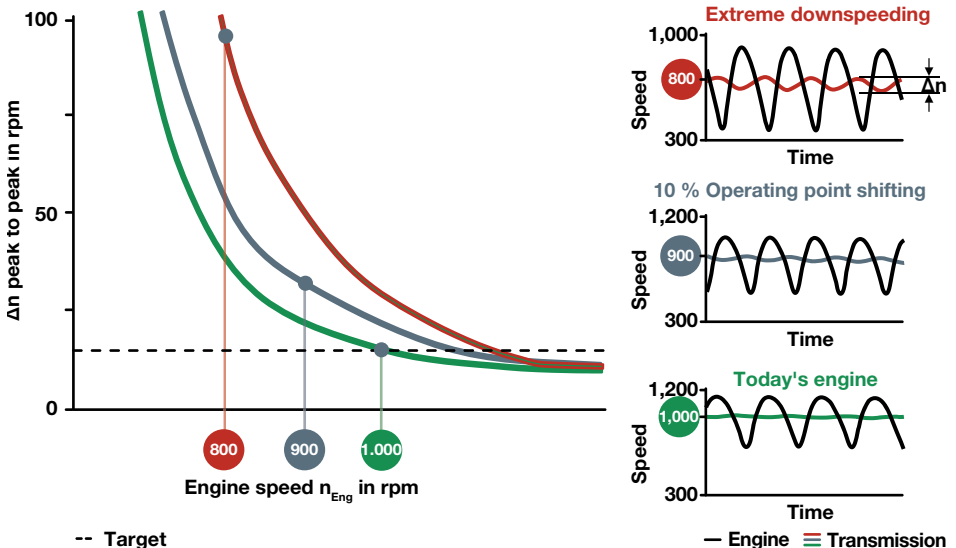
Figure 18 summarizes the effects on the rotational irregularity in the powertrain. Relative to a current engine (green line), the oscillation range at the transmission input doubles for the same damper technology when engine speed is reduced by 10 % (blue line). This marks the starting point at which target comfort levels can no longer be attained. Some drivers would

even intentionally avoid low engine speeds for this reason and thereby not profit from the lower fuel consumption otherwise possible.

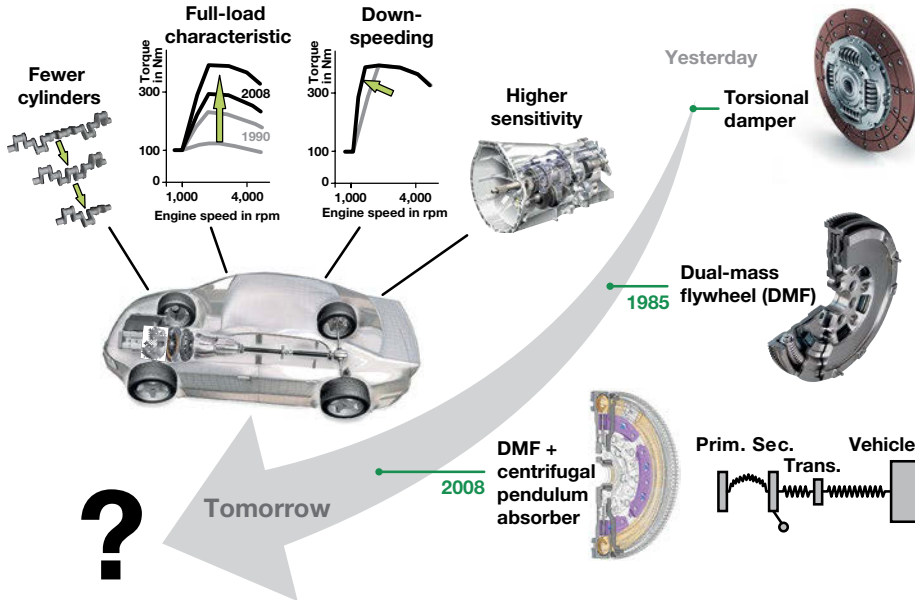
Further downspeeding amplifies the situation disproportionately (red line). When maximum torque is available below 1,000 rpm, the comfort target at this speed is undershot by more than 600 %. In order to achieve an acceptable comfort level with these engines, performance-oriented damper systems must be fitted and are critical to ensuring that the consumption benefits afforded by downspeeding can, in fact, be realized.

## Vibration isolation – State of the art

Some 20 years ago, the requirements placed on damper technology dramatically rose as a result of the direct-injected diesel engines then offered for passenger cars (Figure 19).



**Figure 18** Rotational irregularity at the engine and transmission input for current and future engines



**Figure 19** Dramatic increase in performance requirements for vibration-dampening systems

This shift in engine technology presented the developers of these systems with entirely new challenges. The resulting rotational irregularity could not be sufficiently counteracted using the available torsion-damped clutch disks. Although the principle of the low-pass filter was known, it was not regarded as being technically feasible until the dual-mass flywheel (DMS) was introduced in passenger-car applications. By leveraging its comprehensive knowledge of the operating principles of passive damping systems, LuK systematically started investigating the underlying correlations early on and was consequently able to offer a compatible solution that met the emerging challenges in good time. Many years of know-how in metalworking then finally led to a robust product.

In the years that have passed, specific torque outputs have more than doubled in comparison to the first turbocharged, direct-injection diesel engines. The resulting effect is that even today, some engines

experience torsional vibrations that cannot be counteracted with a DMS alone. The answer to these increased requirements is the centrifugal pendulum absorber (CPA), which is a damper assembly that introduces additional mass external to the power flow. The dual-mass flywheel and centrifugal pendulum absorber have been continually refined and advanced and will meet the requirements associated with the upcoming evolutionary stages set for the current generation of engines [7].

The next engine generation, however, which is currently under development, will call for vibration isolation measures that are even more capable, which is why Schaeffler is not only investigating the possibilities and constraints of today's technology, but is also looking at alternative solutions.

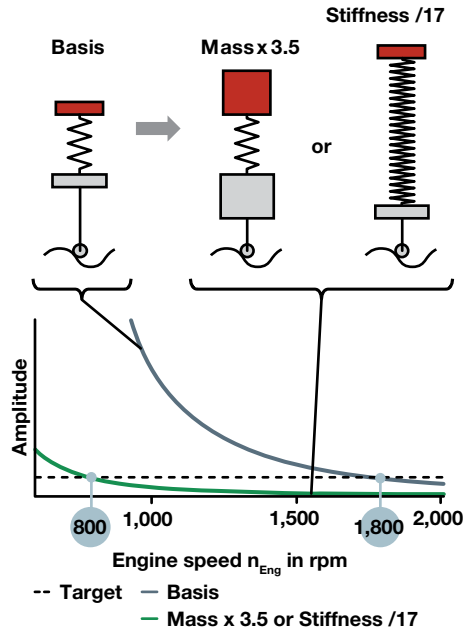
## Alternative solutions – Options and the operating principles that define them

Before implementation concepts are considered at product level, the operating principles that govern them must be thoroughly evaluated with respect to future requirements. It is in this context that the method that uses simple, linearized models to investigate the relative operating principles has proven successful. Not only the technical potential of the different approaches must be factored into the overall assessment, however, but also their cost-benefit ratio, whereby the objective must always be to find approaches that offer equal, uniform performance across an engine's entire operating speed range. Improvements made at very low engine speeds are not optimal if they compromise the progress already achieved in the mid and high-speed ranges. In addition, only those solutions that comply with the restrictions for installation space and weight and are just as robust as current systems when it comes to friction, wear, and manufacturing tolerances are promising candidates.

The following systems will be investigated to determine whether (and under which conditions) their physical potential is capable of isolating the torsional vibrations of a motor that utilizes an extreme downspeeding concept so that comfortable driving is possible from 800 rpm.

### Spring-mass system – Principle of the dual-mass flywheel

The basic operating principle of this arrangement is that two masses connected to each other by a spring-damping system oscillate against one another. In terms of the operating range used today and the excita-



**Figure 20** Isolation capacity and limitations of the spring-mass system

tions that are encountered as a result, dampers demonstrate overcritical performance, and provide better isolation as frequency increases. When frequency drops, the resonance frequency is more closely aligned with these excitations and torsional vibrations become more prevalent.

Theoretically, it is also possible to use a spring-mass system to reach the required target even in extreme downspeeding scenarios. This, however, would require the mass to be increased by a factor of 3.5 or the spring rate to be reduced by a factor of 17 compared to the base construction. Neither is realistic. Arguments not in favor of increasing mass are the increased installation space required, added weight, and worse driving dynamics. Reducing the spring rate by an extreme amount is also not possible as a result of the installation space problem and the compromised driving experience that would result.

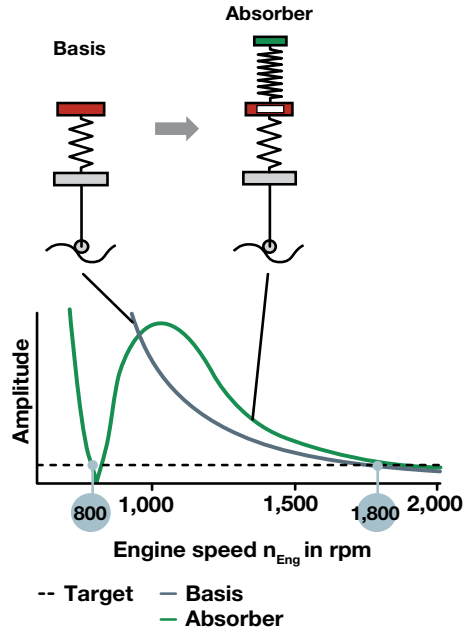
### Anti-resonance – Principle of interference

The following describes two concepts for generating anti-resonance: The spring-mass absorber and the summation damper. Although both concepts use a different operating principle, they produce similar results under the same conditions.

#### The spring-mass absorber

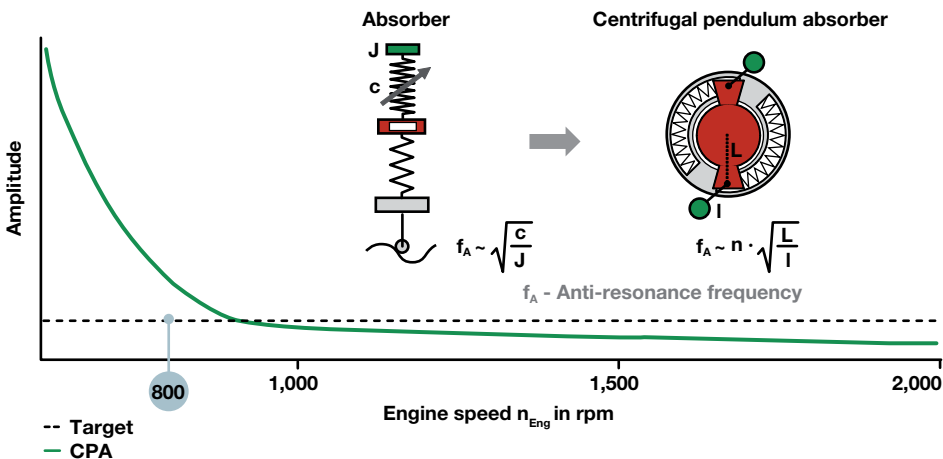
The spring-mass absorber is based on a second spring-mass system. When this system is excited at its resonance frequency, an opposing oscillation is generated that ideally completely cancels out the original excitation. With a conventional absorber connected via a spring, this effect occurs at exactly one frequency – the resonance frequency of the absorber. The drawback is an additional resonance point above the absorber resonance frequency.

A conventional absorber is therefore not a suitable means of reducing torsional vibrations in the powertrain. What is required is a absorber whose dampening frequency of the engine at all times. This property is fulfilled by the centrifugal pendulum absorber (Fig-



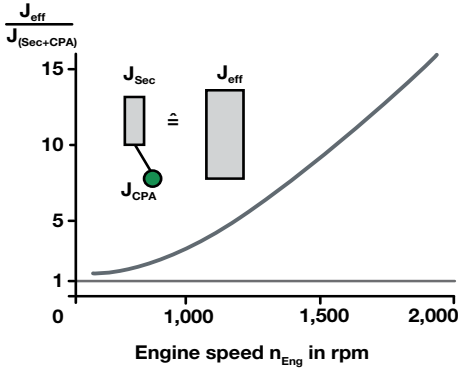
**Figure 21** Principle and isolation effect of a conventional absorber

ure 22), which restoring force is dominated by the centrifugal force of the absorber mass. Since the centrifugal force changes quadratically in relation to the engine speed,



**Figure 22** Centrifugal pendulum absorber (CPA) as a speed-dependent absorber





**Figure 23** Equivalent effective mass inertia of a centrifugal pendulum absorber

the centrifugal pendulum absorber has a absorber frequency that is proportionate to this speed. This is the ideal property or attribute for reducing torsional vibrations in the powertrain, since a fixed excitation order can be dampened.

Figure 23 shows how effective the mass of a centrifugal pendulum absorber is. The graph depicts, in relation to the engine speed, by what factor the secondary mass would have to be increased for similar performance – e.g. by a factor of 3 at a speed of 1,000 rpm or a factor of 9 at 1,500 rpm.

With a CPA, a vibration isolation figure of 100 % could theoretically be achieved up on a defined frequency. In demonstrator vehicles, a decoupling performance rating of up to 99 % was already demonstrated in conjunction with a DMF. This, in turn, makes it easy to meet the requirements of today's engines and their upcoming evolution stages. Current systems are even capable of fulfilling the requirements of two-cylinder engines. The potential offered by the CPA is described in an additional article in this book [7].

When engine speed drops, the centrifugal pendulum absorber must absorb more energy. The ability of this pendulum to respond depends on the mass involved and the vibration angle, whereby the latter is in-

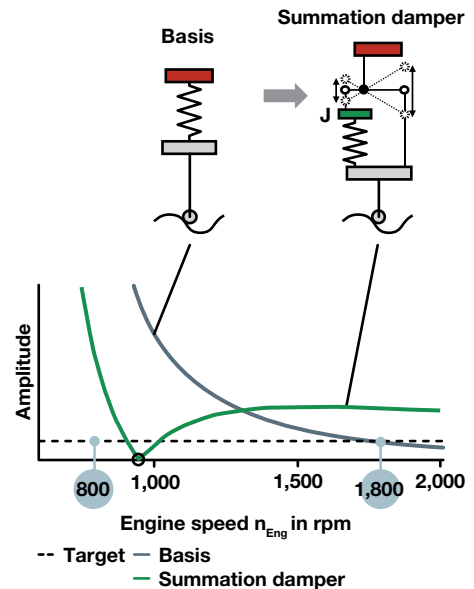
trinsic. The mass of the pendulum can also only be increased to a certain extent due to the installation space available.

Whether the CPA can produce a vibration isolation that is also compatible with the excitations of the next generation of engines is not entirely clear at present. Recent improvements made to the system support this working hypothesis, however.

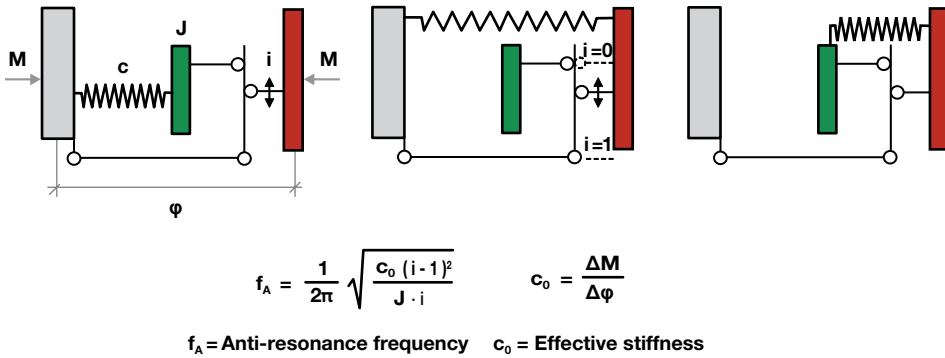
Nevertheless, Schaeffler also continues to search for alternative approaches. Using mass intelligently is the key to implementing future solutions.

### The summation damper

Another way of dampening vibrations with anti-resonance is to add two vibration paths together. Figure 24 charts this principle. Vibrations are transferred via a spring-mass system along the one path and directly to a lever on the other. The pivot point of the lever (summation unit) is void of force and motion from a dynamic vibration perspective.



**Figure 24** Principle and isolation effect of a summation damper



**Figure 25** Variations in spring arrangement for the summation damper

As in the case with a conventional absorber, a summation damper can also decouple 100 % of vibrations but only for a single frequency. The summation damper therefore has an advantage over the absorber in that no additional natural frequency is generated. Unwanted vibrations above and below the anti-resonance frequency remain present, however.

The frequency to be isolated, or targeted, can theoretically be selected as required. When coordinating the system, the summation damper provides one additional parameter not available with the conventional absorber – the lever ratio in addition to the spring rate and the rotary mass (J). Another benefit is that the system can also be configured so that a dampening effect is achieved on the primary side (engine side).

Further arrangements are possible in addition to the summation damper characterized in Figure 24. For example, the spring can be positioned at any point required (Figure 25). Comprehensive testing has revealed that the same basic laws and principles apply irrespective of the positional arrangement of the spring. The anti-resonance frequency can even be calculated for all concepts using a single formula. Assuming that the lever ratio, spring capacity, and mass J do not change, not only is the same anti-resonance frequency yielded for all of

the concepts, but also an identical transfer response.

When the transfer response for design concepts with different anti-resonance points is considered, the typical properties of a summation damper become apparent. Anti-resonance frequencies can theoretically be shifted to any low engine speed. Doing this, however, not only reduces the absorption width, but also the isolating properties above the anti-resonance frequency (Figure 26). This, in turn, means that a summation damper configured for very low anti-resonance responds sensitively to fluctuating parameters. A satisfactory solution can only be achieved if at least one of the three relevant parameters is variable with respect to engine speed.

In a direct comparison, the summation damper has a slightly higher theoretical potential for dampening vibrations than the conventional damper (Figure 27). Having said this, the advent of the centrifugal pendulum absorber has already provided a solution for realizing a variable-speed damper and is currently being used in volume production applications. Variable-speed summation dampers, on the other hand, have yet to be integrated.

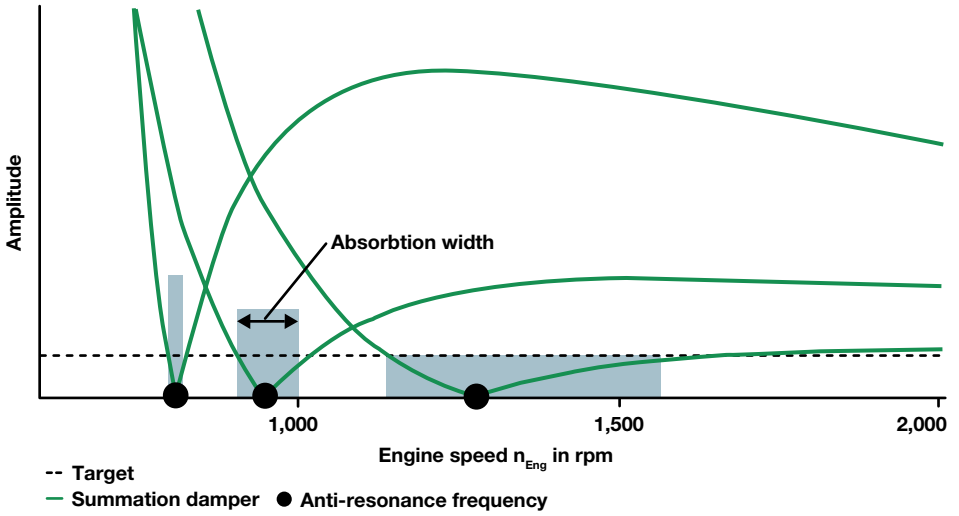


Figure 26 Influence of the anti-resonance frequency on the absorption width

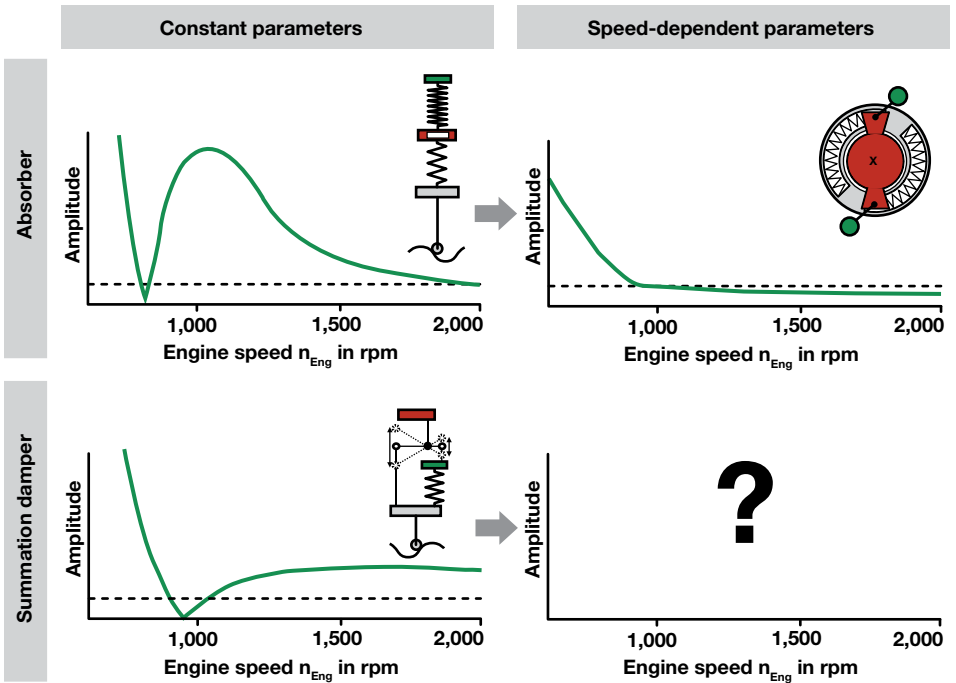


Figure 27 Evolution of the absorber and summation damper

## Summary

---

In the race to achieve global CO<sub>2</sub> targets, automatic transmissions have clearly taken an early lead as they allow engineers to develop fuel-saving strategies by decoupling the engine from the transmission. The manual transmission also offers certain benefits, however, including reliability, durability, and a low price, the latter of which continues to appeal to buyers of small vehicles in particular. The logical next step of advancing the technology of the proven manual transmission must therefore focus on automating the clutch so that the driving strategies explored here can also be implemented in vehicles with manual transmissions. In addition to offering technical solutions that have already been developed (ECM, CbW), Schaeffler is working on systems that, when scaled down in scope, largely maintain the price advantage that a manual transmission has over its automatic counterpart.

Automated clutches are not only capable of decoupling the engine from the rest of the powertrain, but also actively support and facilitate many other comfort and protective functions. Automating acceleration from a stop, for example, can prevent the clutch from being overloaded or misused, which in turn allows the powertrain to be configured differently so that longer gear ratios can be implemented to further reduce fuel consumption.

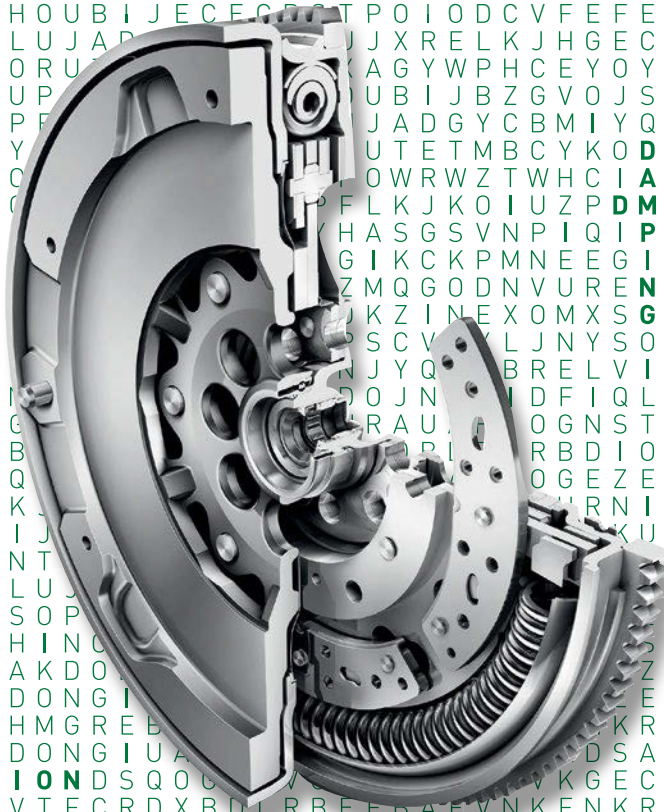
The operating point of the internal combustion engine then shifts to lower speeds and specific torque is increased. Both measures lead to more pronounced rotational irregularity, however. The resulting higher design requirements for mechanisms that isolate frequencies will nevertheless be reliably met by current technology as it is incorporated into today's engines and those targeted for the next evolution stage. The problem revolves around the next generation of engines, which will require even more capable systems. Although the technology offered by the dual-

mass flywheel in conjunction with a centrifugal pendulum absorber is a prime candidate, the summation damper is also worth considering if a way can be found to extend its high potential at low operating speeds to mid-range and higher speeds. Schaeffler continues to investigate both concepts with a great deal of interest. The key to developing a more responsive summation damper lies in the ability to vary one relevant parameter with respect to engine speed. A solution that is robust, affordable, and can be deployed on a large scale has not yet crystallized, however.

## Literature

---

- [1] Gutzmer, P.: Individuality and Variety. 10<sup>th</sup> Schaeffler Symposium, 2014
- [2] Kremmling, B.; Fischer, R.: The Automated Clutch. 5<sup>th</sup> LuK Symposium, 1994
- [3] Fischer, R.; Berger, R.: Automation of Manual Transmissions. 6<sup>th</sup> LuK Symposium, 1998
- [4] Welter, R.; Herrmann, T.; Honselmann, S.; Keller, J.: Clutch Release Systems for the Future. 10<sup>th</sup> Schaeffler Symposium, 2014
- [5] Müller, M.; Kneissler, M.; Gramann, M.; Esly, N.; Daikeler, R.; Agner, I.: Components for Double Clutch Transmissions. 9<sup>th</sup> Schaeffler Symposium, 2010
- [6] Müller, B.; Rathke, G.; Grethel, M.; Man, L.: Transmission Actuators. 10<sup>th</sup> Schaeffler Symposium, 2014
- [7] Kooy, A.: The Evolution of the Centrifugal Pendulum Absorber. 10<sup>th</sup> Schaeffler Symposium, 2014
- [8] Fidlin, A.; Seebacher, R.: DMF Simulation Techniques. 8<sup>th</sup> LuK Symposium, 2006
- [9] Kroll, J.; Kooy, A.; Seebacher, R.: Torsional Vibration Damping for Future Engines. 9<sup>th</sup> Schaeffler Symposium, 2010
- [10] Reik, W.; Fidlin, A.; Seebacher, R.: Gute Schwingungen – böse Schwingungen. VDI-Fachtagung Schwingungen in Antrieben, 2009



F B A D H I U E A S M . . . S  
N L I B F I M B C H S E H E B P S K R B E F B A F . . .  
P O I F E G V T Q U J X R E L J H G G E U N L I E R N G M J B . . .  
J Z R A N L M R T X A G Y W U F I M B C H S E H E B U P S K S A U . . .  
A G Y F T X V N H O U B I J E C E C R T P O I O D C V F E F E Q L O . . .  
U B I R R V T F L U J A D . . . J X R E L K J H G E C L Z E M S . . .  
J A D V I D B P O R U . . . A G Y W P H C E Y O Y R X W N G K M . . .  
O W T R E E F U H K L P . . . U B I J B Z G V O J S L T O M P L I E C L . . .  
L K J R G D X A Y . . . U T E T M B C Y K O D L W I K A P I E K M L A G . . .  
A S G W A Z U K O . . . O W R W Z T W H C I A P M O S G R U C L I B F I M . . .  
I K C G L U C Z . . . F L K J K O I U Z P D M F Y Q G M F E F B S W C E C V . . .  
M Q G Z D A T S . . . H A S G S V N P I Q I P K O S L W I K A P I F D G V . . .  
K Z I W P L O M . . . G I K C K P M N E E G I S O L A T I O N Q A Y L M . . .  
S C V N E A M U . . . Z M Q G O D N V U R E S N V O Y R M W N G K M N Q A . . .  
J Y Q N G M N S . . . J K Z I N E X O M X S G C O J S L P O M P L I E C L . . .  
O J N P D I E P . . . S C V N J N Y S O B I Y Q G A F E F B S A F A . . .  
R A U F U S A T . . . N J Y Q . . . B R E L V I K K O S L C I K A P I E K M . . .  
P D B A L U I E P I . . . O J N . . . I D F I Q L U C I T P T O S G R U C L I . . .  
R A U G U U C Z G . . . R A U . . . I O G N S T R P L O C Y Q G M F E F B S . . .  
M O Q F M S A T B . . . P L O G N S T R P L O C Y Q G M F E F B S . . .  
P D B F - G V T Q . . . R B D I O P Q I N K O S L W I K A P I . . .  
O T R J T D S Y K . . . O G E Z E M S D T I T P M O S G R U C . . .  
Y A Z J Y C K O I J . . . R N I F Z U M N D A B O I Z W C L O . . .  
W C L T P Q O G N T . . . K U V X K W Y M N R E Z W C L O . . .  
N F X U E I N R L U . . . G U U M Q V Z E G L N F A M . . .  
G K L O Z V C E S O P . . . R N M Y O Y R X W N G K M N . . .  
N O I I A Q Y A H I N C . . . Q I Z O J S L T O M P L I E . . .  
F B A K B S N U R A K D O . . . S P L T I Y Q G M F E F B S A . . .  
N O I O S K M S D O N G I . . . Z E M S P C I T P M O S G R U C . . .  
G R V M O B H B H M G R E B . . . K R E W E P L O C Y Q G M F E F . . .  
F B A O R U G N D O N G I U A . . . D S A G K Z Q I N K O S L W I K A . . .  
F D V I B R A T I O N D S Q O C . . . V K G E C L Z A M S A C I T P M O S G . . .  
E L E M E B Z G V T F C R D X B D L R B E F B A F V N K F N K R E W B P L O C Y Q D M F E F . . .  
F C R I R Y C B M W R Z I P S Q L K J H G F D S A M M B V C X Y M L S O K N I J B H U Z G F . . .  
R Z I E U M B X N V X A D G W I V B A U E L E M E N T E R F V E G S O Z H N U J M I K O Q A . . .  
V X A M K I J H L M O K N I J H B Z G V T F C R D X E S N W A S R E R V F H K N U T E Q T F . . .  
E D K T J D G L E T U O A D G L Y C B M W R Z I P S F H K T V N Z L B O I J E U H B Z G W R . . .  
R E W Z U E T O I Z R W Q E T O M B C Y N V X A D G J L K H E S Y S E B F G M H T I L Q N V . . .

# Isolation is the Key

The evolution of the centrifugal pendulum-type absorber not only for DMF

Dr. Ad Kooy

# 5



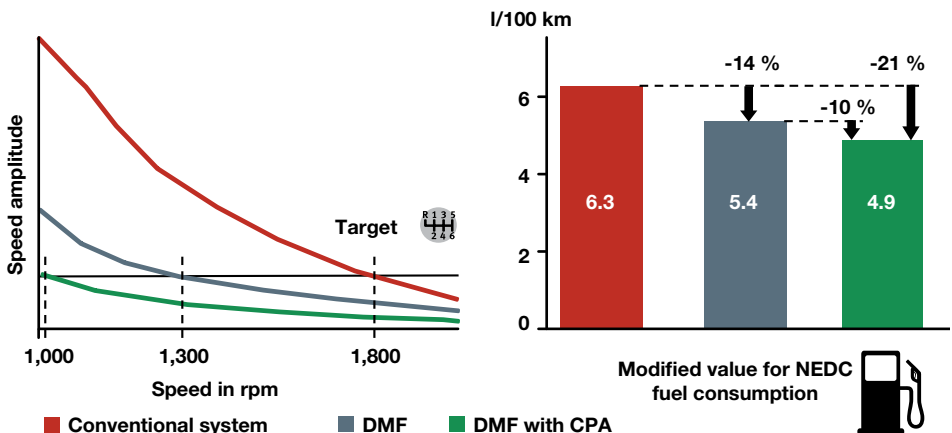
## Introduction

A key task that has concerned the automotive industry in recent years has been to reduce consumption. One effective measure for achieving this goal is to exploit even lower engine speeds for driving. Torque is increased to achieve this without losing power. Doing so allows the engine to run only very slightly above idle speed and therefore in an extremely consumption-efficient range. One challenge is to achieve adequate powertrain isolation even for these low engine speeds and thus provide drivers with their usual level of comfort.

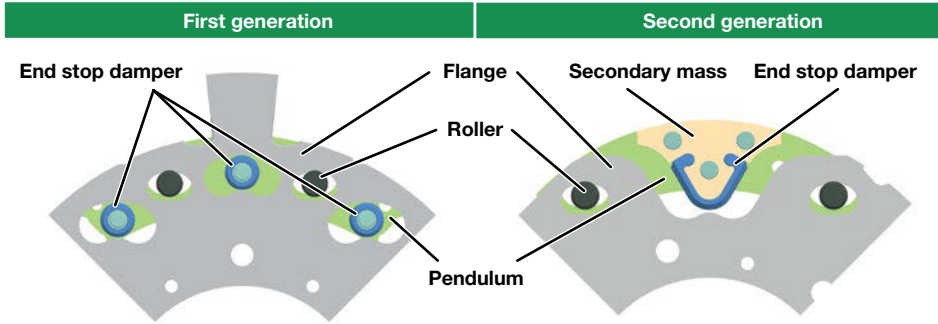
Figure 1 [1] shows that the dual mass flywheel (DMF) is a factor in achieving this goal, particularly in connection with the centrifugal pendulum-type absorber. While twin-cylinder engines have yet been unable to reach the projected fuel savings for day-to-day use, the increasing numbers of three-cylinder engines have achieved lower consumption figures. However, lower consumption places stricter demands on vibration isolation. The secondary-side centrifugal pendulum-type absorber (CPA)

was introduced as a concept in conjunction with the DMF as early as 2002 [2], and successfully went into series production a few years later. The simple physical principle, modular design and extremely good isolation have led to increasing acceptance and proliferation not only in the DMF, but also in other damping concepts such as torque converters and clutch discs. There have also been huge improvements in how the centrifugal pendulum-type absorber works thanks to far-reaching understanding of the centrifugal pendulum-type absorber; more detailed information is provided about this below.

As the DMF must also be optimised for other operating points, such as startup, or optimised for so called impacts – very high torque peaks when bottoming out the arc springs – compromises must be made. These compromises also have an indirect influence on isolation in drive mode. We will be using examples of impacts that affect DMFs when stalling the vehicle and demonstrating methods of preventing stress of this kind and making DMFs more robust. These result in greater freedom for optimising torsion isolation and so improving driving comfort.



**Figure 1** Fuel economy potential with DMF and DMF with CPA



**Figure 2** Layout of end stop dampers on first and second-generation CPAs

## Development of DMF centrifugal pendulum-type absorbers

To date, one million centrifugal pendulum-type absorbers have been produced for six-cylinder, four-cylinder and three-cylinder engines, and the concept has been continually developed. Prototypes show that the technology could also be employed in twin-cylinder engines.

The secondary-side arrangement of the centrifugal pendulum-type absorber makes the arc spring damper, which provides pre-isolation, especially important. Taking engine torque development into consideration largely automated simulation programs run through hundreds of variations evaluating start and drive to find the optimum combination of arc spring and CPA for a vehicle application. Of course, this requires vehicle parameters of adequate quality which are not always available during the early stages of development in which design takes place. This is where LuK's wealth of experience really comes into its own, as it allows us to complete missing data in a meaningful manner. However, should corrections be required subsequently during to vehicle test-

ing, simulations of this kind can quickly be repeated. Interaction with other critical operating points can also be integrated, such as stalling the engine along the critical details of engine timing management.

It is easy to calculate the natural frequency of a thread pendulum, in other words a point mass moving on a circular path, if the angle is small. However, this approach is inadequate for centrifugal pendulum-type absorbers. The path curvature must be more pronounced to maintain a constant order (natural frequency to speed frequency ratio) independently of the magnitude of the angle. This approach is the only way to achieve optimum isolation over the whole engine speed for partial throttle as well as for wide-open throttle. Special attention must be given to the rpm range slightly above idle speed. On account of the low centrifugal forces in this range, the CPA needs as large a vibration angle as possible to store sufficient vibration energy. High engine torques exacerbate the situation. Therefore, the goal is to maximise this angle along with the pendulum inertia. For this reason, the three circular end stop dampers previously present on first-generation centrifugal pendulum-type absorbers have been combined into a V-shaped end stop damper on an additional intermediate mass in second-generation absorbers (Figure 2).

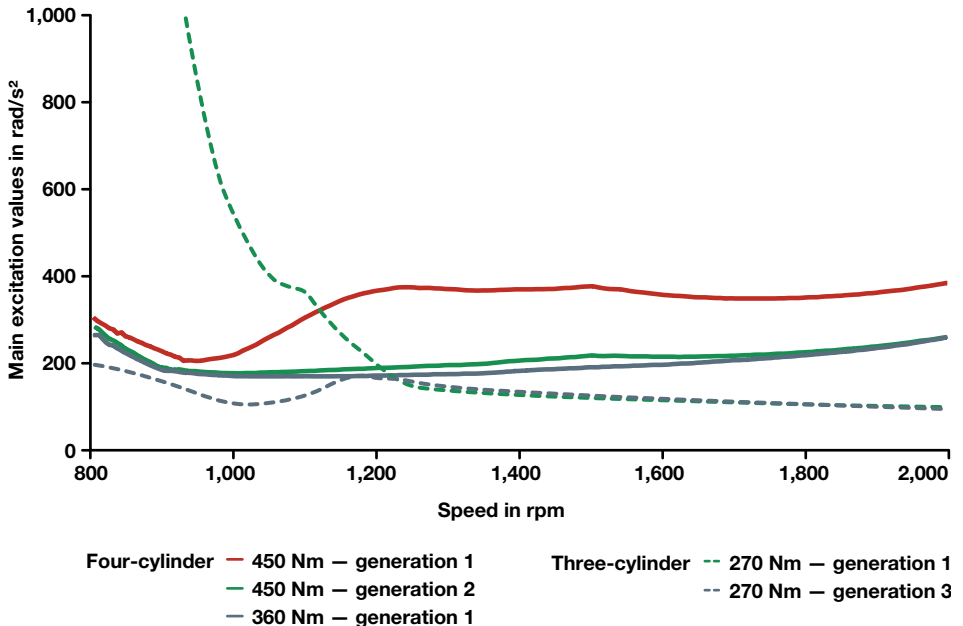


This eliminates the need for the bean-shaped holes in the flange required for the circular end stop dampers and creates additional space for greater vibration angles or heavier pendulums. The added intermediate mass lies relatively far towards the outer edge in radial terms, thereby improving isolation in the low speed range through increased inertia. A number of other optimisations, such as optimising the arc spring damper with the centrifugal pendulum-type absorber as a system, smoother pitch surfaces and optimised paths, have together resulted in a significant performance boost, especially at low engine speeds (Figure 3).

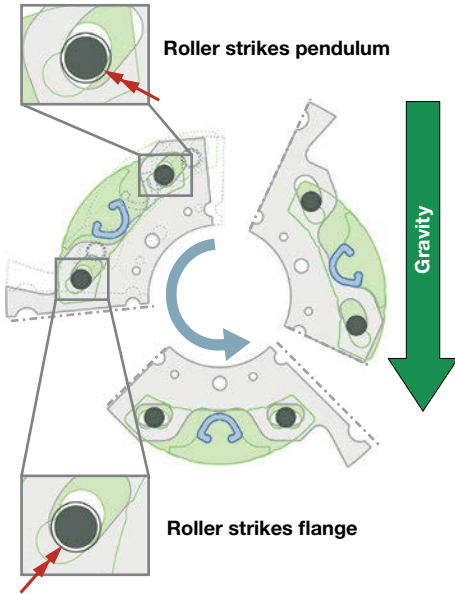
The example of a four-cylinder diesel engine shows that when using the first generation absorber an increasing of the engine torque from 360 to 450 Nm leads to a clear deterioration in isolation. In contrast, when the second generation is used, a torque in-

crease can be handled without loss of comfort. For three-cylinder engines acceptable values of 500 rad/s<sup>2</sup> from about 1,000 rpm are already achieved (in this example, a diesel engine with 270 Nm). However, these values can still be significantly reduced: If the entire clutch system — i.e. DMF with centrifugal pendulum-type absorber and clutch — is designed according to an entirely new layout, (third generation), it is possible to achieve angular acceleration amplitudes of below 200 rad/s<sup>2</sup> from 800 rpm upwards and without requiring any further space. The rigidity of drive shafts, in particular, must be incorporated into this concept. If rigidity changes, it results in a completely new design. It makes close coordination with the vehicle manufacturer's development process essential.

The considerations mentioned above relate to a centrifugal pendulum-type absorber integrated below the arc spring



**Figure 3** Comparing DMF isolation with various CPA generations in three-cylinder and four-cylinder engines



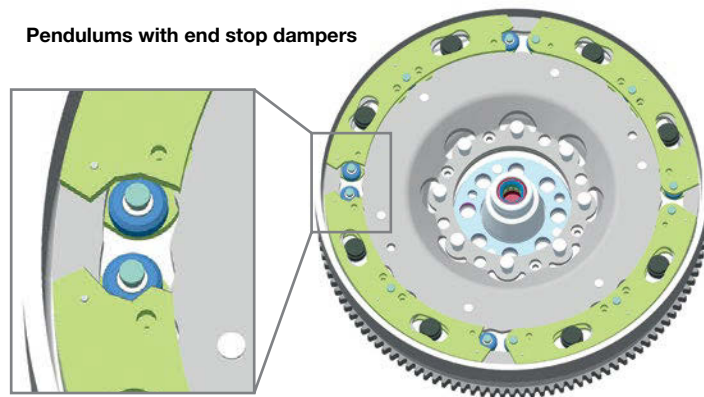
**Figure 4** Kinematic simulation of pendulum motion at 150 rpm

damper. As already shown in [1], a centrifugal pendulum-type absorber can also be arranged next to the arc spring, i.e. radially further towards the edge, if sufficient space is available; this improves isolation even further, where necessary. For engines without cylinder deactivation, as commonly used in series production, it is therefore possible to achieve adequate isolation using a centrifugal pendulum-type absorber. Should a CPA of this kind provide isolation better than that required, costs can be reduced by omitting two of the four pendulum masses.

Path wear is not expected due to the fact that the pendulum only has a rolling motion. However rattling noises may occur when switching the engine off: As soon as the engine speed drops below approx. 200 rpm, the pendulum's centrifugal force drops below the force of gravity. It falls a few millimetres within the designed degree of freedom until it strikes the bolts on the flange. In order to better understand this process, kinematic simulations have been carried out and compared using high-speed recordings (Figure 4).

The simulation demonstrates how the two rollers strike differently; the precise arrangement of the damper and rollers and the clearance between the roller components have an effect on these striking patterns. These parameters must be precisely analysed and optimised. In addition to these kinds of optimisations, ways of preventing stopping noises have also been investigated. One option is to arrange circular end stop dampers at the end of the pendulum (Figure 5).

This causes the pendulums to strike each other after a short fall, and a part of the kinetic impact energy stored in the pendulum system is neutralised without any noise occurring. The rollers striking on the



**Figure 5** CPA on outer edge with end stop dampers between the pendulums

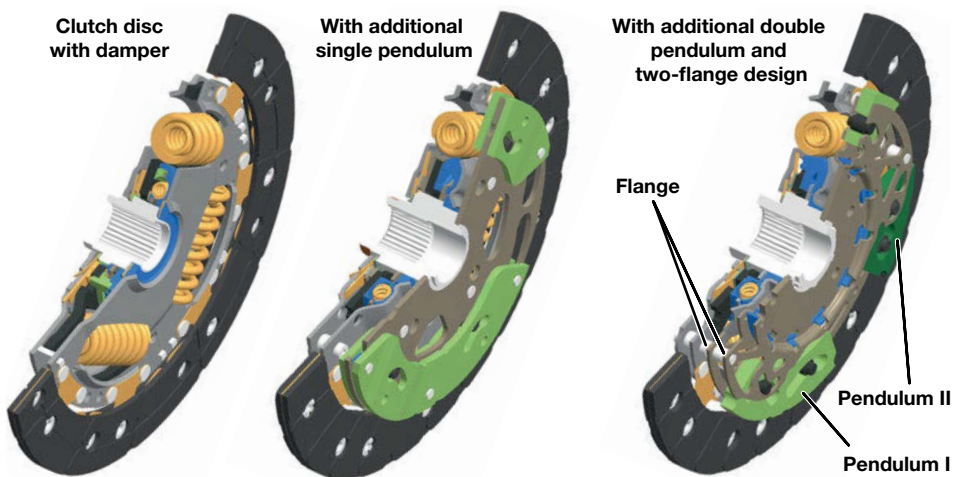
flange only cause slight noise. This concept works well with a closed throttle valve, as pure torsional acceleration is low in this state. However, much higher torsional acceleration occurs when stopping if the throttle valve is to remain open, for instance to enable cylinders to charge correctly to enable quick automatic start-up. The result is that all pendulums have a virtually synchronised torsional motion, thereby rendering the rubber stops on the end of the pendulum ineffective; their job is then assumed by the central V-shaped end stop damper.

## Centrifugal pendulum-type absorber mounted on the clutch disc

The success of the DMF is due to the fact that hypercritical operation is largely possible, compared to torsion-damped clutch discs. The result is an enormous increase

in isolation, as already shown in an example in [3]. Also discussed in [3] was the option of arranging a centrifugal pendulum-type absorber on the clutch disc – positioned on the gearbox input shaft for simulation purposes. Based on the knowledge of pendulum path design, permissible mass moments of inertia and tolerances permitted in series production available at that time, a viable solution was not within reach. Today, our in-depth expertise concerning the design of centrifugal pendulum-type absorbers coupled with new ideas on the reduction of clutch disc mass inertia means this approach can be implemented (Figure 6).

For clutch discs with a single pendulum system, it comprises of two or three pendulums and is calibrated to the main excitation, i.e. order 1.5 for a three-cylinder engine. Clutch discs with double pendulum systems have two additional auxiliary pendulums, calibrated to double the main excitation frequency. In both designs, the pendulums are arranged next to the damper. During development, a particular aim was to keep the extra clutch disc inertia caused by



**Figure 6** Clutch discs without a pendulum, with a single pendulum and with a double pendulum system

the pendulums to a minimum, so that gear synchronisation was not overloaded. Therefore, the pendulums needed to be particularly effective despite their low mass. As the effect of a pendulum is mainly determined by the product of mass and vibration angle, the vibration angles consequently had to be hugely enlarged.

Initial designs for the first generation used three pendulums. In the optimised, second-generation version, two pendulums with secondary spring masses were used for clutch discs with a single pendulum system (Figure 7).

The additional intermediate mass was introduced along the same lines as the DMF (Figure 2): Therefore, more mass can be arranged on the outer edge in radial terms. But the most important innovation concerns the two roller paths of each pendulum. The paths are now no longer identical and are

now skewed relative to one another instead of merely displaced. This is reflected in the skewed arrangement of the bean-shaped holes for the rollers in the pendulums, as a comparison of the first and second generations shows. This arrangement causes the pendulum to execute a rotation in addition to oscillation. The sketch in Figure 7 illustrates this principle: During movement, the end of the pendulum is guided radially inwards while the other end simultaneously moves radially outwards. This arrangement has become known as a trapezoidal pendulum, while the first generation is called a parallel pendulum.

Thanks to their trapezoidal oscillation, the pendulums need less space meaning that considerably larger pendulum vibration angles can be achieved. Additional rotational energy is also stored when turning, so better use is made of the pendulum mass.

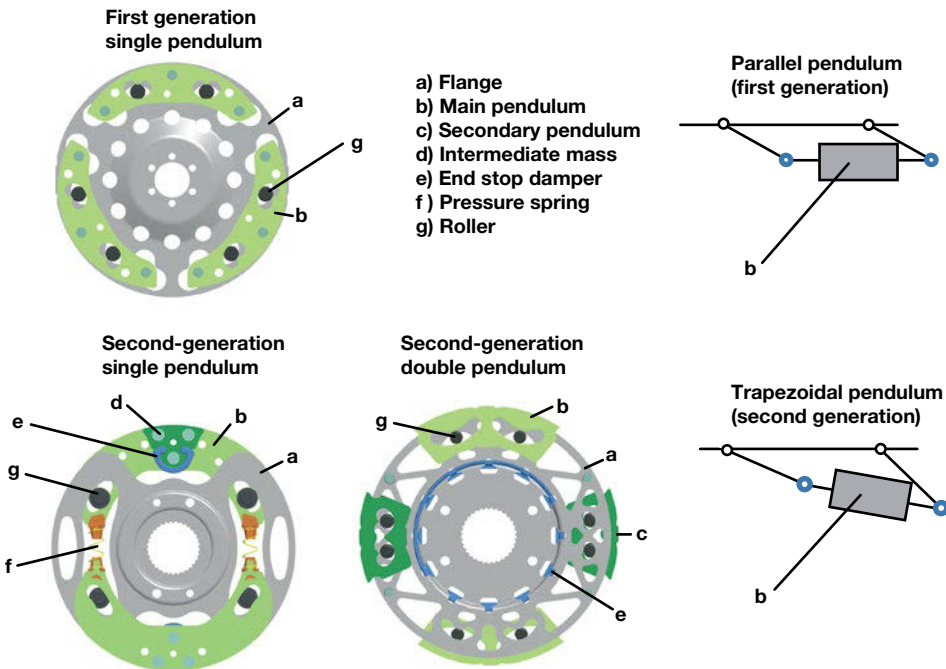


Figure 7 CPA for clutch discs

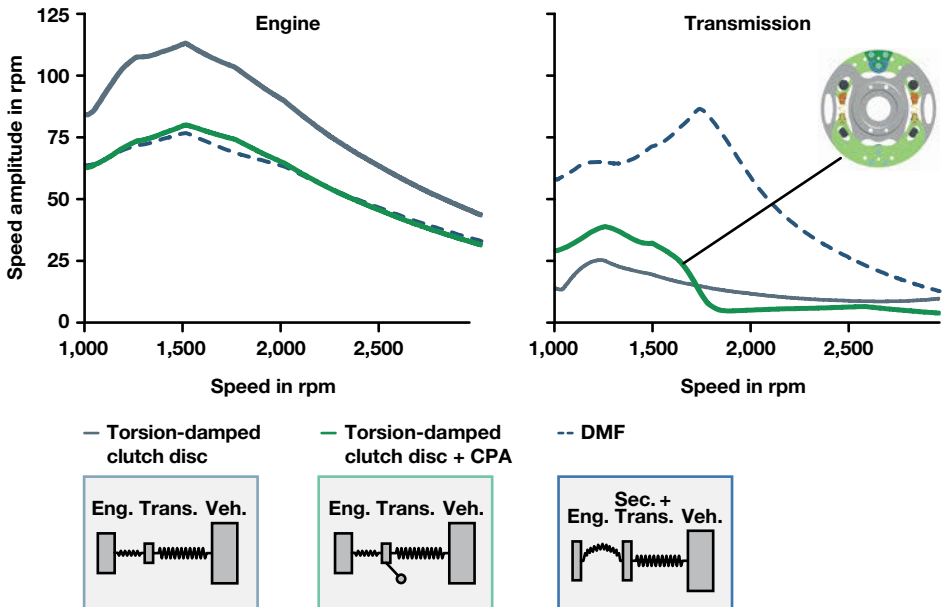
This effect can also be utilised on the DMF, but it is not so effective there due to the mounting space available.

Although the pendulum masses are lower than those of the DMF, undesirable knocking noises may occur when stopping if the bell housings are sensitive or open. The spring bracing of second-generation pendulum masses (Figure 7) also helps combat this problem. The preloaded springs can be designed to be especially soft thanks to the reduced pendulum masses. This is important because the spring forces are not speed-dependent and do not follow the principle of the centrifugal pendulum-type absorber. An angular correction of path geometry minimises this effect.

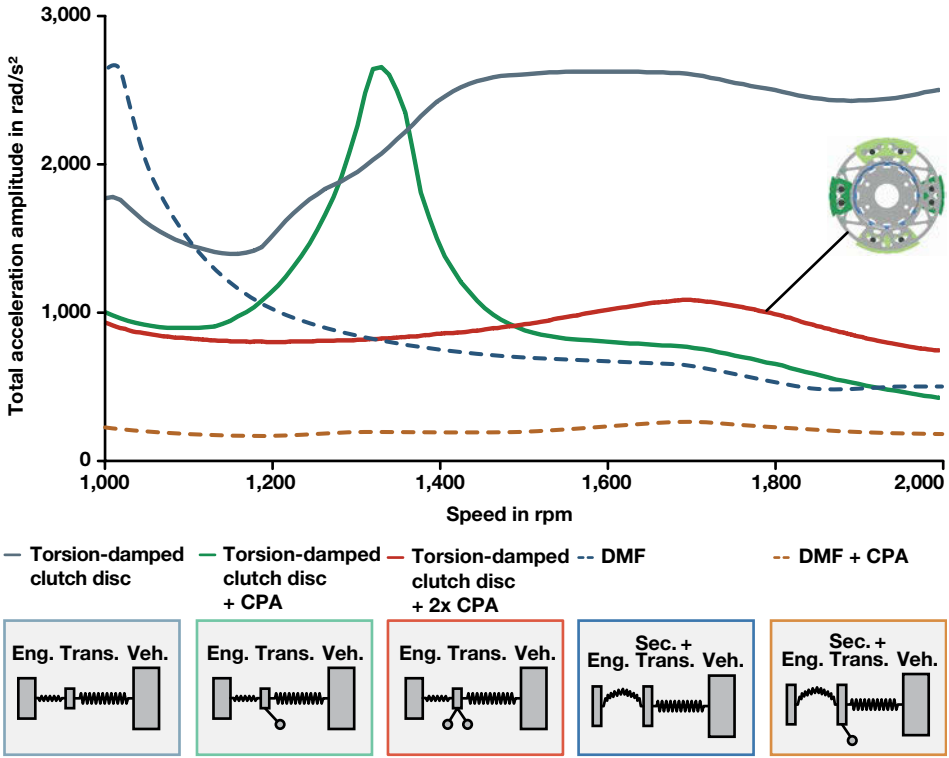
Figure 8 shows a comparison of a DMF with a single mass flywheel with CPA on the clutch disc and a torsion-dampened clutch disc using the example of a four-cylinder engine. The single mass flywheel with a CPA on the torsion-dampened clutch disc takes

the middle position with regard to isolation of the torsional vibrations from the gearbox. On the engine side it even leads to smaller irregularities than a DMF, resulting in a lower load on the belt drive. This configuration proves its worth for three-cylinder engines in conjunction with soft drive shafts. However, when combined with rigid shafts, we have the problem that the third order comes through very dominantly in the overall amplitude of gearbox acceleration (Figure 9). The figure shows the total amplitude in which both orders arrive.

To dampen the third order, an additional pendulum system calibrated to this order has to be added; in other words, a double pendulum system is required. Figure 6 and 7 show the layout of both pendulums on the clutch disc. It goes without saying that only smaller pendulum masses are possible due to space constraints, but this is compensated in part by a dual-flange design. In this design, the pendulum is situated between



**Figure 8** Comparing three damping concepts based on isolation of a four-cylinder engine in 6<sup>th</sup> gear



**Figure 9** Comparing five damper concepts based on isolation of a three-cylinder engine with rigid side shafts in 6<sup>th</sup> gear

two flanges. In the contrary, on a DMF it is usual practice for two pendulums to be arranged around a central flange (Figure 2). This new design principle omits the connection elements of the sub-pendulums, which weaken the flange. As a result, larger pendulum vibration angles can be integrated. The achievable isolation reveals astonishing results: in 6<sup>th</sup> gear, isolation below 1,300 rpm is even better than with a DMF. However, if the DMF is combined with a centrifugal pendulum-type absorber, it is once again clearly the superior combination.

In order not to place additional stress on gear synchronisation, the entire mass inertia must not be significantly greater than for a

normal torsion-dampened clutch disc, despite the CPA. This is achieved by reducing the mass of all individual parts affected. Detailed comments about mass reduction of this kind can be found in another article [4]. In conjunction with a CPA, the actual torsional damper in the clutch disc is dampened to a lesser extent which benefits isolation at higher engine speeds. Another significant benefit is that the centrifugal pendulum-type absorber aids isolation in the creeping range, i.e. the low torque range. This allows the creeping stage to be designed for steeper rates and higher torques. In this way, creeping rattle can be largely prevented.

The introduction of clutch discs with centrifugal pendulum-type absorbers pro-

vides additional damping solutions, depending on vehicle configuration and the required isolation level. Simulations help when it comes to selecting the optimum damping parameters whilst taking complex boundary conditions into account. They can be used to implement a solution halfway between a DMF and a torsion-damped clutch disc both in terms of isolation and costs and long-awaited by the automotive industry.

### Centrifugal pendulum-type absorbers for trucks

In comparison to passenger cars, significant damping of a truck gearbox requires considerably higher inertia of the centrifugal pendulum-type absorber on the clutch disc. However, this higher inertia leads to an unacceptable reduction of synchronisation service life, which at 1,000,000 km is well above the requirements for passenger cars. For this reason, other ways of improving isolation have been explored: The CPA was arranged on the single mass flywheel (Figure 10). It can be detached for easy maintenance.

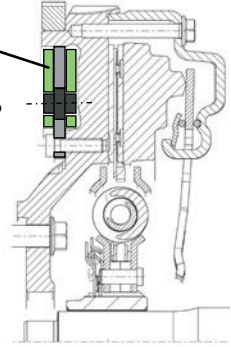
**CPA of 6 kg reduces vibrations:**

**Engine side by 30 %**

**Transmission side 46 %**



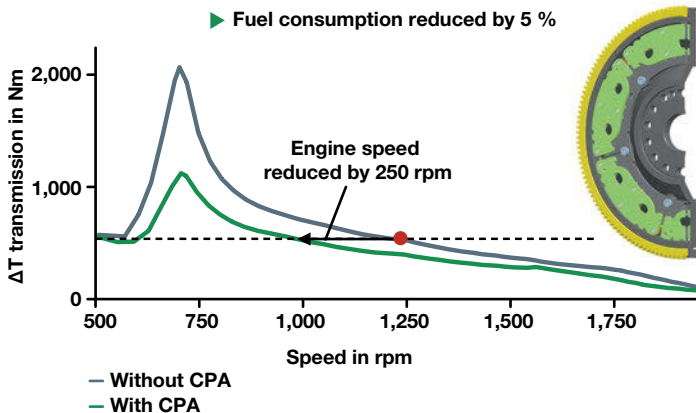
**Engine: 2,400 Nm**  
**Transm.: 12 gears**  
**Weight: 40 t**



**Figure 10** CPA on a truck single mass flywheel

The solid pendulums, which weigh around 6 kg, reduce engine vibrations by 30 % for a typical six-cylinder engine at 2,400 Nm, and reduce gear vibrations by 46 %. The latter directly improves the gearbox service life, as it is restricted if the vehicle is often driven at low engine speeds. In contrast, using a single mass flywheel with CPA can reduce engine speed without compromising service life when only low to medium engine torques are used, as is often the case (Figure 11). Fuel consumption is reduced by 5 %,

which represents a competitive edge for end customers that should not be underestimated. The service life of the belt drive also benefits from reduced engine vibrations, thereby allowing this drive to be more simply constructed or service intervals to be extended.



**Figure 11** Fuel consumption savings in a truck thanks to a single mass flywheel with CPA

Points of operation	Impact level	Frequency of occurrence	Meaning
Stalling when moving off	High	Medium	
Misshift 2 <sup>nd</sup> to 5 <sup>th</sup>	High	Rare	
Fast clutch engagement	Medium	Rare	
Back shifting in while using throttle	Medium	Infrequent	
Engine start	Medium	Infrequent	
Emergency braking	Medium	Rare	
Jackrabbit start	Low	Rare	

Figure 12 Classifying impacts

## Reducing impacts

The principle of a DMF (without centrifugal pendulum-type absorber) is ultimately based on shifting the resonance speed of the powertrain from the driveable range into ranges well below idle speed. By shifting this speed, hypercritical driving is possible throughout the entire speed range with the resulting excellent isolation. Even in the early days of DMF development, it became clear that driving situations below idle speed, such as that occur when stalling a vehicle, lead to large vibration angles and the DMF can strike the end stops (impact). The energetic transition of high kinetic energy in the relatively rigid end stop results in torques that can be up to 40 times the engine torque. Impacts can also occur at other operating points, however not usually at this level or with this regularity (Figure 12).

Many ideas for reducing impacts have already been developed and implemented. The majority of them actually contradict the primary task of the damper system, i.e. isolation, by requiring additional mounting space (such as a slipping clutch in the flange) or using thicker (more robust) spring wires (damping arc springs). The following describes one approach using software and one using hardware; these approaches dramatically cut the severity and regularity of these kinds of impacts.

### Influence of the engine control unit when stalling

Figure 13 shows a typical stalling measurement of a three-cylinder diesel engine plotted in an engine speed/time diagram. It can be seen that powerful impacts are caused by the extreme difference in speed between the primary and secondary side. To aid understanding, this diagram is converted into speed squared ( $n^2$ ) over crankshaft angle; this is because combustion causes an injection quantity to be turned into kinetic energy, which, in turn, is proportional to  $n^2$ . Thus, cyclic engine irregularities for the same injection quantity are shown as the same amplitudes regardless of engine speed. It is appropriate to use the crankshaft angle, as the ignitions occur at equidistant intervals in the diagram. Very high impacts occur when the engine stops at TDC or when the engine does not reach TDC at all due to the retroactive effect of the secondary flywheel. In the latter case, reverse combustions are produced with extreme impacts. The aim must be to anticipate this situation and disable the injection process in time. Until now, fixed speed limits have been implemented in the control system to disable the process, but Figure 13 shows that it is advisable to use an additional gradient-based limit. If a straight line is drawn in this diagram through the two



previous ignition or injection points just before TDC, as shown in Figure 13, it is immediately apparent that the engine will stop at approx. 0 rpm when it reaches the next TDC. This causes the high impacts afterwards.

The last ignition or injection were therefore not only useless – the engine was at a standstill afterwards – they also damaged the DMF and it would have been better for them to have been disabled by the engine control unit. These types of problems can now be identified early on in the project using simulations. By them, it is apparent that even a small difference of 10 ms in the engagement time can cause a

tremendous difference in the impact level (Figure 14).

This finding also matches the large variations observed time and again in road tests. Statistical analysis is therefore essential, and can be conducted by means of simulations using a well-calibrated model (Figure 15).

These simulations then form the basis for estimating field quality. During this process, the behaviour of multiple drivers is calculated using Monte Carlo methods (rolling the dice for impact levels) in conjunction with the S/N curves of the arc spring and the regularity of occurrence. It is possible to evaluate the software using the simulation

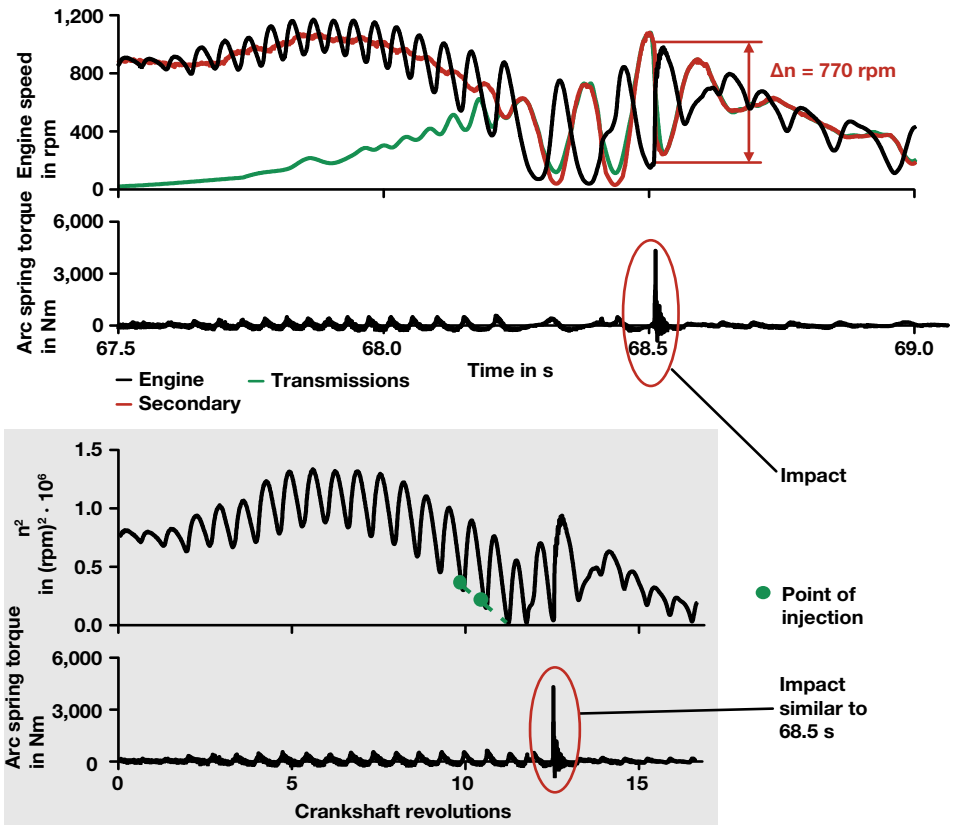
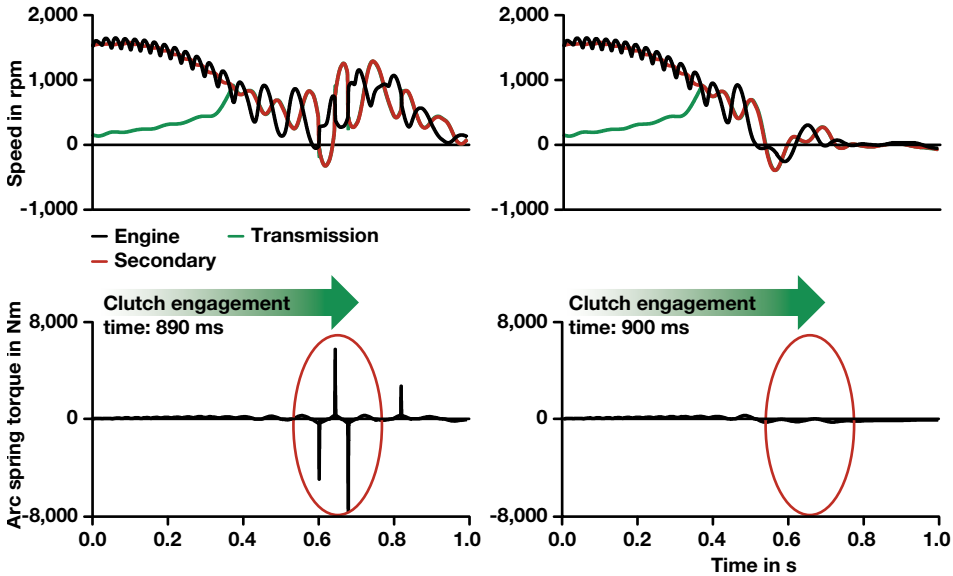


Figure 13 Impact when stalling



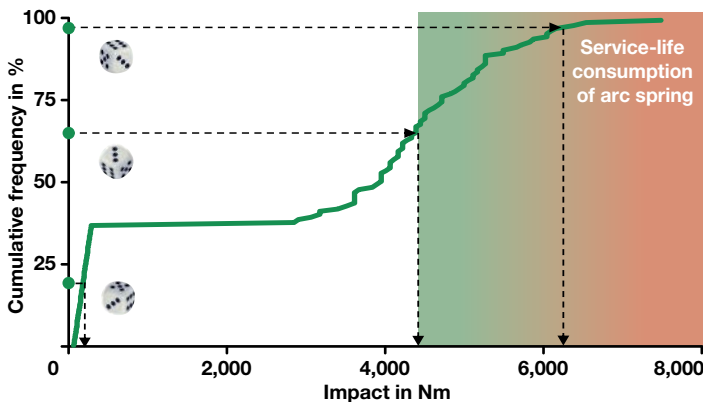
**Figure 14** Influence of clutch engagement time on the impact level in stalling simulations

by integrating the software parameters. It is important to trigger necessary software adjustments early on in the project, preferably at the start of the project, as testing of software changes is extremely time-consuming. The engine control unit should also prevent the engine being restarted by the continuing motion of the vehicle after stall-

ing as this causes speed ratios and impacts that are difficult to control.

### The High Capacity spring

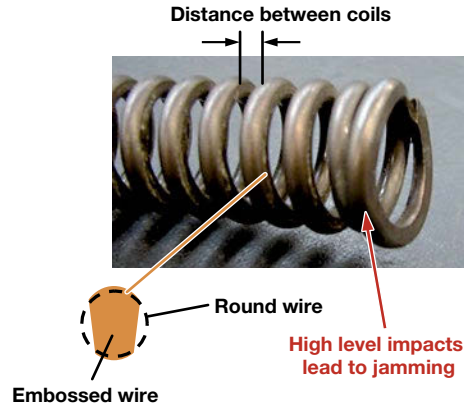
It is difficult to develop an active engine control unit strategy that can prevent impacts entirely for all operating conditions and combinations of parameters. Therefore, the remaining impacts must be intercepted by an increased robustness of the DMF. This is where the High Capacity spring (HC spring) can play a vital role (Figure 16).



**Figure 15** Cumulative frequency of impacts during stalling and illustration of the Monte Carlo method

**High capacity arc spring:**

- Increased distance between coils
- Can store up to 50 % more energy
- Helps to prevent deformations
- Similar wire thickness
- Same tension when engine torque applied
- Same level of insulation
- Spring rate only slightly higher
- No significant load losses due to setting under approx. 8,000 Nm



**Figure 16** High capacity spring (HC spring)

The basic idea is to considerably increase the torque capacity of the arc spring and therefore absorb approx. 30 % to 50 % more energy in the characteristic curve, without hitting the end stop. Figure 17 shows the end of a start-up procedure, in which high clutch torque results in the damper striking the end stop.

The higher torque capacity of the HC spring is achieved by an increased distance between the coils and largely absorbs the high clutch torque. Wire thickness is kept approximately the same, so that the stress exerted on the springs by engine torque, and thus the service life, remains unchanged. As the distance between the coils increases as a consequence of the concept, fewer coils can be accommodated in the same space. The nominal spring rate therefore increases slightly. This affects starting behaviour to a small extent, but not drive characteristics. This is because the rear coils are disabled in drive mode as a result of the friction caused by centrifugal force. The shortened spring consequently has absolutely no effect on reducing the number of active coils.

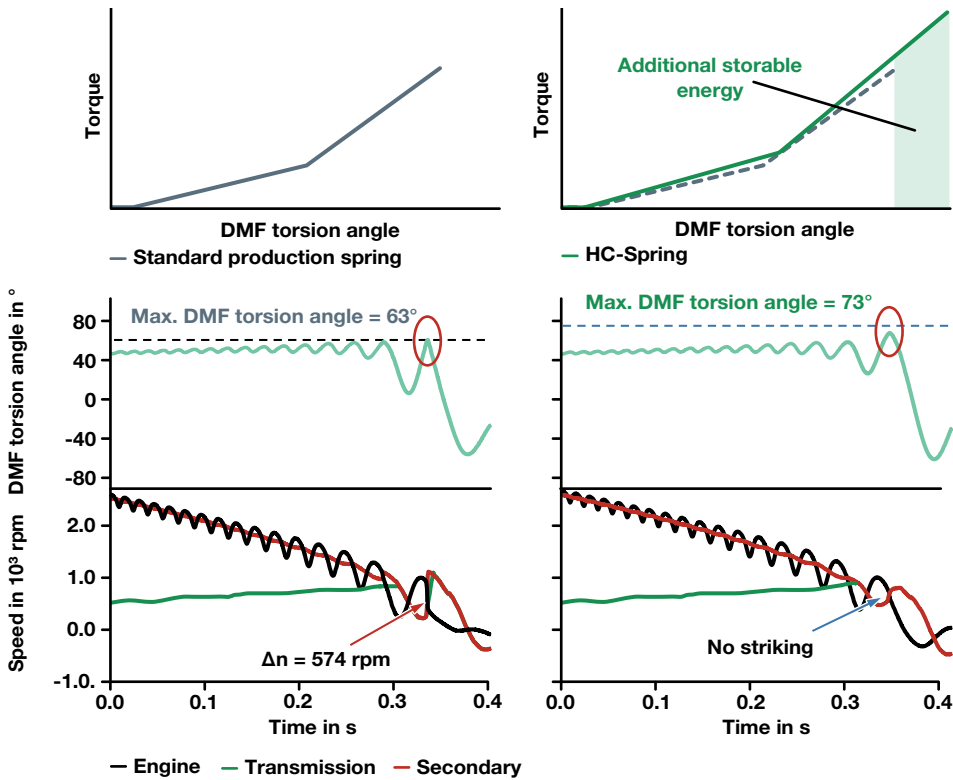
Fatigue strength is not an issue for small impacts as impacts are relatively rare — typically fewer than 1,000 load cycles over the vehicle's service life. The determined

service life for small impacts is more than an order of magnitude greater. However, if higher impacts do happen to act on the HC spring despite its capability of absorbing energy, flattened coils can absorb the difference without serious crushing. LuK has used flattened coils successfully on standard springs for quite some time now. As HC springs have a significantly higher torque capacity than standard springs, set HC springs can still safely absorb the engine torque. Overall, HC springs yield huge benefits for the DMF in terms of robustness without compromising torsion isolation.

## Summary

---

The evolution of the centrifugal pendulum-type absorber in conjunction with overall damper tuning improved the isolation achieved by DMFs to such an extent that it can also cope with higher engine torques and cover today's three-cylinder and even twin-cylinder engines. Furthermore, they still have further potential, as regard to isolation, for dealing with the expected further



**Figure 17** Influence of the HC spring when driving off

increase of engine torque from idle speed upwards. However, close interaction between powertrain design and damper concept is absolutely essential if this potential is to be achieved.

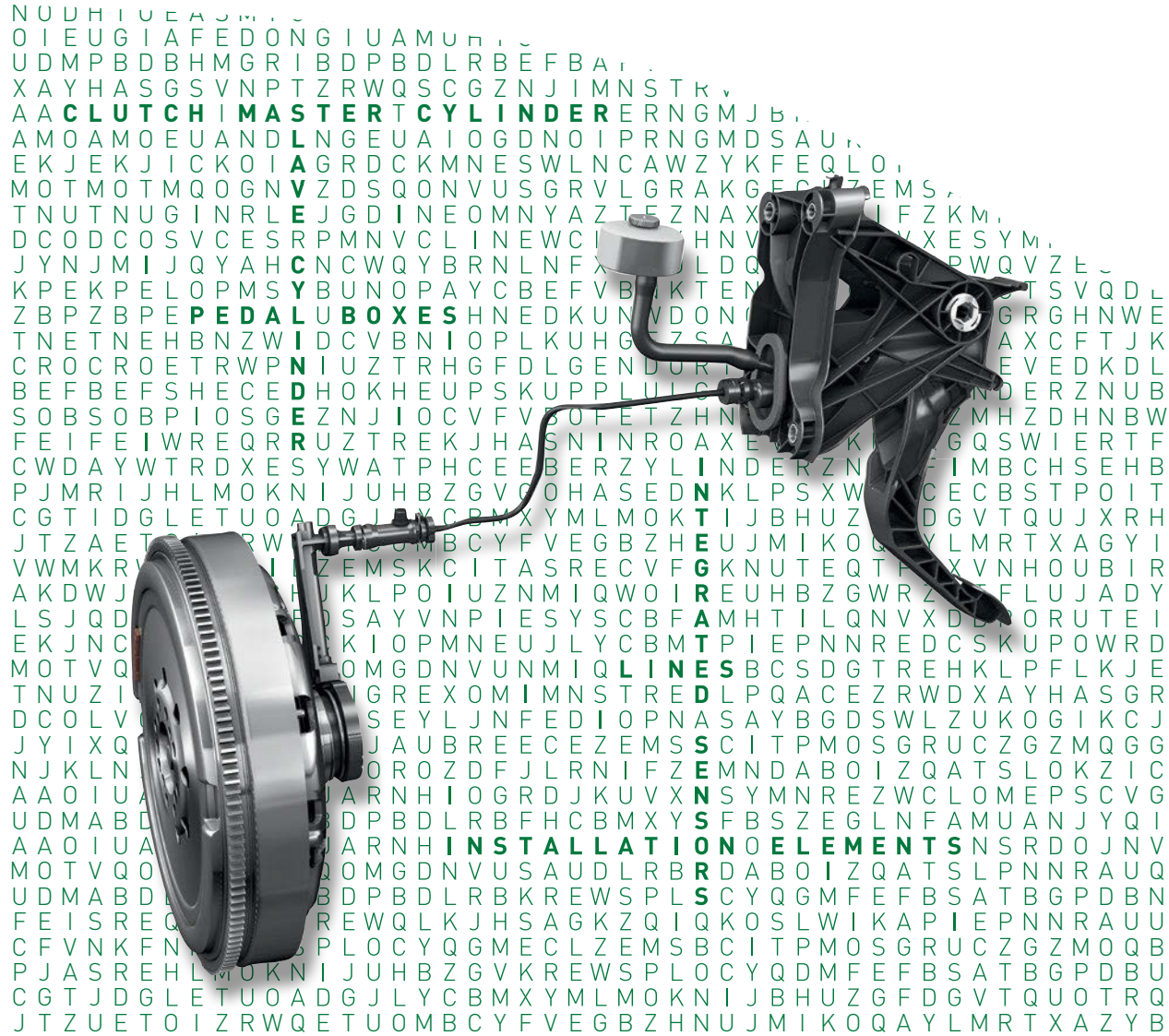
Locating the centrifugal pendulum-type absorber on the clutch disc succeeded in providing a long-awaited solution halfway between a simply damped clutch disc and a DMF. For trucks, arranging the CPA on the single mass flywheel also leads to reduced strain on the gearbox and the belt drive. Impact situations can be managed through early optimisation of the engine control unit and the use of High Capacity springs. No additional protective measures must then be implemented in the DMF; the system comprising DMF and centrifugal pendulum-

type absorber can be designed specifically for maximum isolation.

## Literature

- [1] Kroll, J.; Kooy, A.; Seebacher, R.: Land in sight? 9<sup>th</sup> Schaeffler Symposium, 2010,
- [2] Kooy, A.; Gillmann, A.; Jaeckel, J.; Bosse, M.: DMF – Nothing new? 7<sup>th</sup> LuK Symposium, 2002
- [3] Reik, W.: Torsional vibration isolation in the powertrain. 4<sup>th</sup> LuK Symposium, 1990
- [4] Schneider, M. et al.: The Clutch Comfort Portfolio: From a supplier's product to an equipment criterion. 10<sup>th</sup> Schaeffler Symposium, 2014

**Open Access.** This chapter is distributed under the terms of the Creative Commons Attribution Noncommercial License, which permits any noncommercial use, distribution, and reproduction in any medium, provided the original author(s) and source are credited.



# Clutch Release Systems

From system know-how to a successful volume produced product

Roland Welter  
Tim Herrmann  
Sebastian Honselmann  
Jeremy Keller



Dw  
J Z M H  
AG Q S W I E R  
F I M B C H S E H E B  
C E C B S T P O I O D C V F E W  
D G V T Q U J X R E L K J H G F D S A M M L  
N B M R T X A G Y W P H C E Q A Y W S X E E C R F  
R T V N H O U B I J B Z G V T F C R D X E S N W A S R E L  
E H T F L U J A D G Y C B M W R Z I P S F H K T V N Z L M O I  
O I B P O R U T E T M B C Y N V X A D G J L K H E S Y S C B M B C  
X R S K U P O W R W Z T W H N E D K U N W P O N C A L V I K Z T W H N  
G Y K L P F L K J K O I U Z T R E W Q Y X C V B N M I Q W U O I U Z T R E  
B I X A Y H A S G S V N P I Z R W Q S C G Z N J I M N S T R V N P I Z R W Q S  
A D U K O G I K C K P M N E S W L N C X W Z Y K F E D I O P P M N E S W L N C X  
T E C Z G Z M Q G O D N V U S G R V L G R V K G E C E Z E M D N V U S G R V L G R  
W R T S L O K Z I N E X O M N Y A Z T E W N F X J L R N I F E X O M N Y A Z T E W  
K J O M E P S C V C Y I  
S G M U A N J Y  
K C N S R D O  
Q G E P N N  
Z I A T B  
C V E P  
Y Q C Z  
J N A  
A U V  
D B M  
A U  
O Q  
D B  
D D L R B E F B A F V N K  
U A H I O G D N O I E R N G M  
O Q O D N V U S G R V L G R V K G  
P D B D D L R B E F B A F V N K F N K  
O T R E L K J H G F D S A M M B V C X  
X A Z Y W P H C E Q A Y W S X E E C R F V  
O U B I J B Z G V T F C R D X E S N W A S  
U J R D G Y C B M W R Z I P S F H K T V N  
R U T E T M B C Y N V X A D G J L K H E S  
P O W R W Z T W H N E D K U N W P O N C A  
F L K J K O I U Z T R E W Q Y X C V B N M  
H A S E S V N P I Z R W Q S C G Z N J I M  
I K C K P M N E S W L N C X W Z Y K F F  
A S U S V N P I Z R W Q S C G Z N J I  
I K C K P M N E S W L N C X W Z Y K F  
O X O D N V U S G R V L G R V K G  
I N E X O M N Y A Z T E W N F  
C Y L J N E W C L V V F H  
N V U S G R V L G R

## Introduction

More than 100 years after the invention of the automobile, it seems as if the technology of clutch release systems, is a mature one, without the necessity of changes. However, even in this seemingly evolved family of products, the innovation dynamic remains high. Current developments aim to further increase robustness, replace existing materials with polymer materials, and integrate sensors in the master cylinder.

Master cylinders with integrated sensors have only been used in a few cases in the past. The proliferation of systems such as start/stop or the electronic parking brake is now leading some car manufacturers to consider such sensors in the master cylinder as obligatory. The sensors make it possible to measure the travel on the clutch pedal and thus determine the driver's intent.

Materials too are evolving. While for decades cast iron or aluminum alloys were dominant, in new applications, master cylinders, pipes and slave cylinders are almost always made of plastic. Initial problems with the use of polymer materials, such as master cylinder squeaking, high adhesive friction and volume expansion, have since been resolved. The technologies necessary for the use of plastics have been constantly refined and are now solid and economical. Even in double clutch systems, which have higher, continuous loads, plastic cylinders are gradually becoming established. Current developments are focused on using plastic in the pedal box.

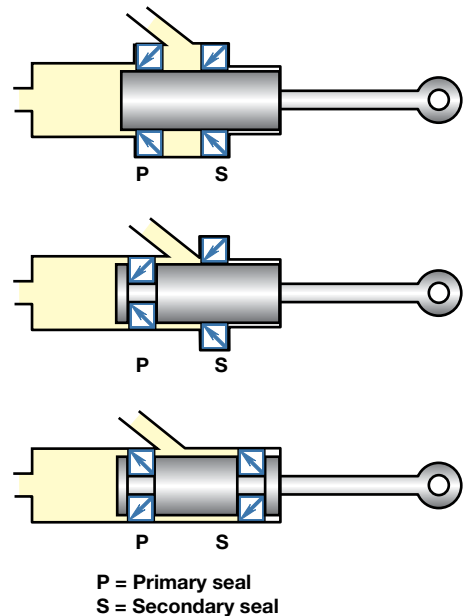
Ultimately, the robustness requirements for the components used in clutch operation have risen significantly. Even just a few years ago, one million cycles

was the going operating load specification for release systems. Now, it is not unusual to require two to three million cycles – accompanied by increased requirements regarding the ambient conditions of temperature, water and contaminant exposure.

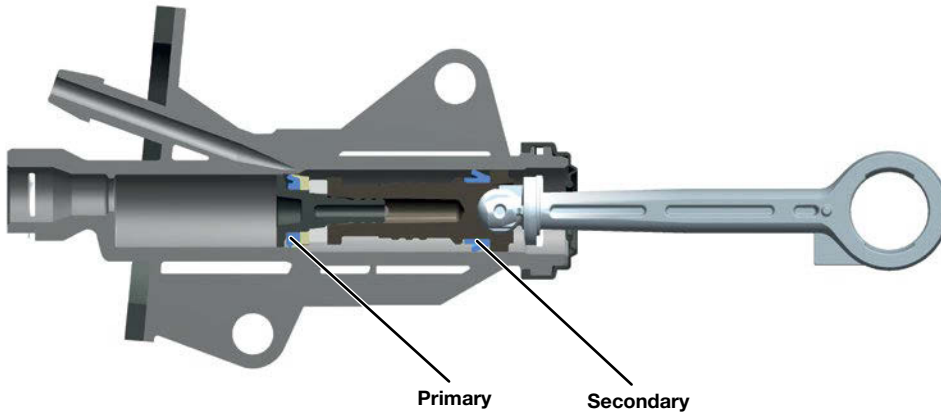
## Clutch master cylinder

Schaeffler's LuK brand currently has three different types of plastic clutch master cylinders in the product line. The difference in the designs is in the seal configuration used.

The clutch master cylinder that is used the most in volume production has a mov-



**Figure 1** Types of clutch master cylinders



**Figure 2** New clutch master cylinder with a one-piece housing and seals mounted to the pistons

ing piston and two stationary seals (Figure 1, top). This configuration allows the primary seal to build up pressure toward the slave cylinder while the secondary seal retains the fluid without pressure in the reservoir. The advantages of this design include the fact that the pistons can be manufactured using a duroplastic material. With this material, the squeaking encountered with the usual seals made of synthetic ethylene propylene diene monomer (EPDM) rubber is effectively suppressed. The disadvantage to this design is that for installation reasons of the seals the housing must be made in two pieces and thus is comparatively more costly to set up. In addition, the entire pressure chamber expands radially during operation, which results in a relatively high volume expansion.

The second design (Figure 1, center) uses a primary seal that moves with the piston and a stationary secondary seal in the housing. The volume expansion during operation is lower due to the smaller pressure space when the piston is pushed in. The disadvantages of this design include the fact that the noise problem has not thus far been satisfac-

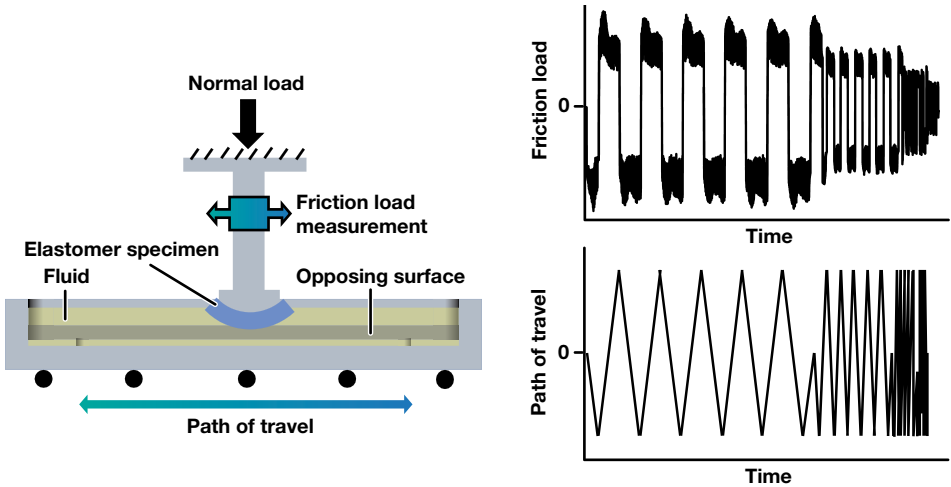
torily resolved, and that, in addition to the installation of the secondary seal, a costly, two-piece housing is necessary here as well.

In new applications, LuK is therefore focusing on a third variation (Figure 1, below), which has a one-piece housing made of thermoplastic and uses seals that are mounted to the piston. Figure 2 shows an example of the technical design of one such clutch master cylinder.

Seals made of EPDM are generally used, with the primary seal being protected on the outer diameter against the cylinder raceway by a shield made of unreinforced polyamide in order to improve friction and wear. This type of measure is not needed for the secondary seal, which is not under pressure during operation. To prevent squeaking noises with critical brake fluids, seals made of special materials can be used with this master cylinder design.

A well-thought-out test stand system is helpful in researching suitable seal and raceway material combinations for the specific brake fluid. In addition to standardized noise measurements with complete master cylinders, there is a tribologi-





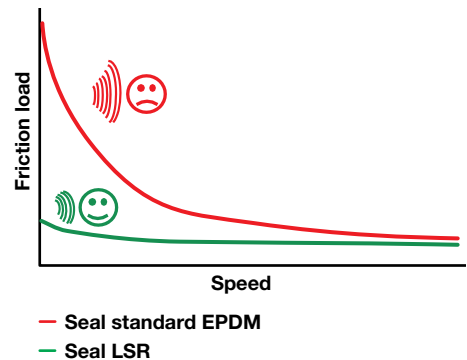
**Figure 3** Tribological test stand for basic trials on seal friction and noise excitation

cal test stand available for basic trials that was developed specifically for this purpose (Figure 3).

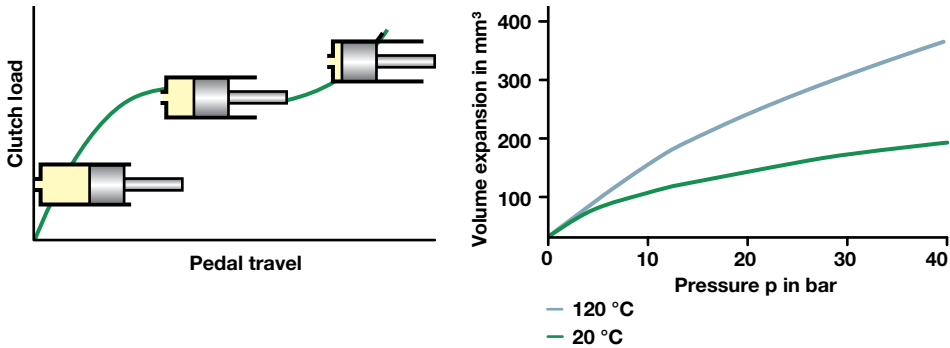
Current trials on this Tribometer involve mounting and loading a flat specimen made of the raceway material with a seal material specimen, which is pushed along the flat specimen. In the process, the contact points can be flooded with brake fluid and maintained at a constant temperature. Measuring devices allow the friction load and frictional vibrations to be recorded. Suitable material combinations show two clear effects: The gradient of the friction coefficient over the piston speed is small and there is no detectable frictional vibration. Figure 4 shows an example of the contact of polyamide with standard ethylene propylene diene monomer rubber (EPDM) and liquid silicon rubber (LSR).

In all of the trials conducted thus far, LSR has proven itself superior with regard to friction gradient, friction level and friction vibration behavior. There are, however, a few brake fluids on the market, particularly in Asia, that are not compatible with LSR. The goal for future development is to avoid this limitation.

Advantages of the new cylinder design with moving seals include its low volume expansion. This is due to the design, since the highest pressure occurs with the piston nearly pushed in, when the “breathing” cylinder surface is comparatively small. Due to the one-piece housing, static burst pressures of more than 200 bar were achieved with the new cylinder design.



**Figure 4** Friction load gradient for an EPDM and an LSR specimen against a raceway made of polyamide PA 66 with fiberglass fill



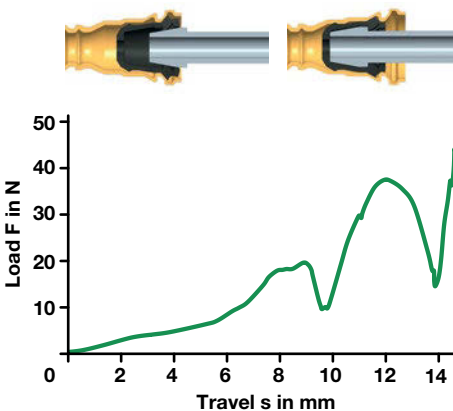
**Figure 5** Volume expansion of the new master cylinder

The cylinder can be equipped with additional attachments if desired, such as a premounted bleeding pipe, which is most cost-effective designed as a plastic convoluted tube. In contrast to the seal customarily used thus far for this type of convoluted tube, which has to be greased to attain acceptable mounting forces, a new type of self-locking seal is used. The seals have locking hooks on the adjacent side, which engage into a groove of the convoluted tube during mounting (Figure 6). Additional lubrication is not required. The associated problem of contamina-

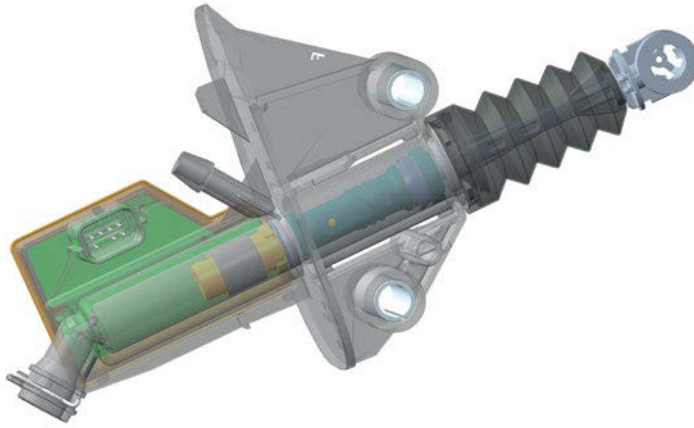
tion is thus eliminated. The mounting forces are 40 N, maximum. The haptic indication of a successful mounting is a noticeable drop in the sliding force. Normal fill pressures during vehicle assembly of up to 10 bar are endured without issue.

## Integrated sensor system

There is currently an increased demand for master cylinders with travel and/or position sensor systems. The travel sensors continuously measure the piston travel and thus replace the potentiometer on the pedal axle, whereas the position sensors generate a digital signal when passing through defined piston positions and thus take over the pedal switch function. Both measuring tasks can take place in one space-saving sensor on the clutch master cylinder. In addition, travel measurement on the clutch master cylinder is less dependent on tolerances and thus more accurate. The sensors used in the clutch master cylinder work exclusively without contact and thus cause no noise or wear. In the meantime, in addition to the familiar Hall sensors, magnet-free inductive sen-



**Figure 6** Ergonomically configured connection between bleeding hose and fir tree connection



**Figure 7** Master cylinder with integrated inductive travel and position sensor

sors integrated into the housing are now also available in volume production, as the example in Figure 7 shows.

The reason for the increased demand for sensor information from the clutch pedal is the need to make travel and position information available to the engine controller or the control units for start/stop or the electronic parking brake, which allow conclusions to be drawn regarding the engagement status of the clutch as well as the driver's intention. Common functions today are shown in Figure 8.






Additional signal utilization is conceivable, but are is not yet used on a large scale. Examples include detecting operating errors such as insufficient load release of the pedal when driving, too frequent slipping of the clutch or resetting a calculation model for wear predictions.

Hall switches, integrated Hall ICs for travel measurement as well as magnet-free inductive sensors are used in volume production. The use of intelligent sensors makes it possible to compensate for the tolerances related to production and mounting with a calibration after mounting on the clutch master cylinder. They also

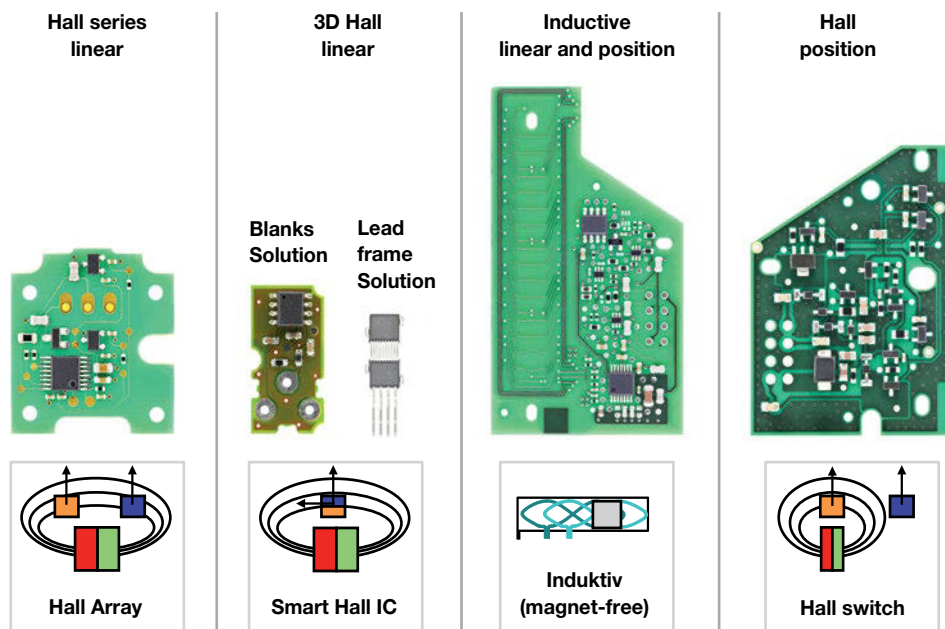
have a certain diagnostic capability. Cable breaks, short circuits and internal sensor errors can be detected in this way and communicated to the controller.

The requirements for the functional safety of electronic components in vehicles according to ISO 26262 are met with design up to level "ASIL C". This is dependent,

however, on the specific safety goals of the sensor-related vehicle functions, which must be specified by the automobile manufacturer. Usually multiple pieces of avail-

-  **Early detection of driver intention when disengaging at engine start**
-  **Preventing engine start for unseparated clutch**
-  **Automatic release of the electronic parking brake**
-  **Controlled start up on hill**
-  **Turn-off of speed controller for clutch operation**
-  **Comfort increase from engine engagement (speed increase)**

**Figure 8** Use of the sensor signal on the clutch master cylinder in the vehicle



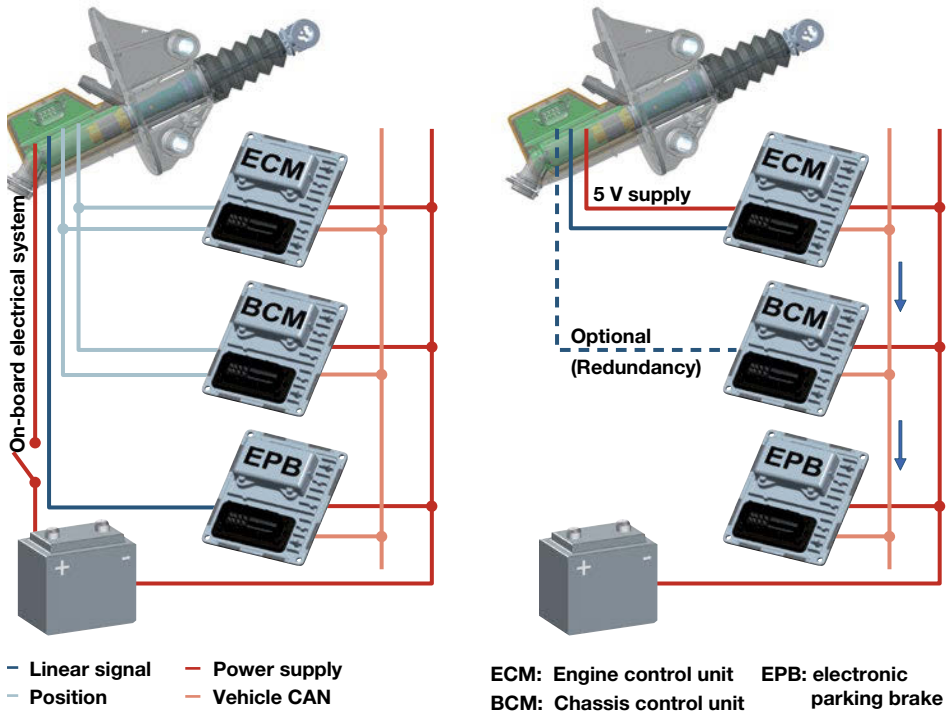
**Figure 9** Sensors used in the clutch master cylinder

able sensor information are accessed in order to reach the safety goals at a vehicle level. This reduces the requirements on individual sensors.

One important advantage of the Hall sensors is their short axial installation length, which can be further reduced in the future. Thus, Hall array sensors use two Hall cells connected one behind the other and signal processing via a micro-controller. Highly integrated chips use multiple Hall elements, which make it possible to measure the magnetic field in multiple dimensions and derive travel information. In miniaturized form, these sensors no longer have boards, but rather are all mounted directly on the lead frame together with the necessary circuit. The price of the advantage of a small installation space is that additional circuits or custom solutions are not possible.

Development goals include reducing the mass of the magnets and minimizing the proportion of rare earths. While cylindrical magnets were used originally, LuK is increasingly switching to segment magnets and using an anti-rotation device for the pistons. In the Hall switch-point sensor, the magnet has now been reduced to a small cube.

Despite these advances, efforts are being made in newer solutions to completely eliminate the use of magnets in order to circumvent the price volatility for rare earths. One initial result of these efforts is a contact-free inductive travel sensor that uses a small aluminum ring as the measuring element. Higher precision can be achieved with this type of system than with a Hall sensor, and additional switch points can be derived from the signal of the integrated controller or from an additional switch as needed.



**Figure 10** Master cylinder signal processing in the vehicle; left: commonly used today; right: future concept

The only disadvantage to the inductive solution is the comparatively large installation length. The length of the coil system, depending on the design, can be up to 135% of the measured travel. This poses no problem for most applications. Nevertheless, LuK is working on shorter installation solutions, but they are not yet production-ready.

Highly integrated sensors emit a travel signal as well as position signals and provide this information to different controllers. Since the signal interfaces and the expected voltage levels are not uniform, and the on-board electrical system is the only available power supply, the full potential of an intelligent sensor solution cannot be completely realized at this time.

Since, in contrast to the linear travel signals, the position signals are not available from active diagnostic functions, safety goals according to ISO 26262 are often not completely met at vehicle levels with position points derived from the linear travel signal. For applications with high safety requirements, LuK therefore recommends using a travel sensor with two independent travel signals, which are processed by the respective controllers and which can be compared as needed for increased safety. A stabilized 5 V power supply is provided in this case by a controller and the sensor signals are preferably provided as pulse-width modulation (PWM) or as digital signals (for example SENT). One advantage of this solution is that the information needed for different

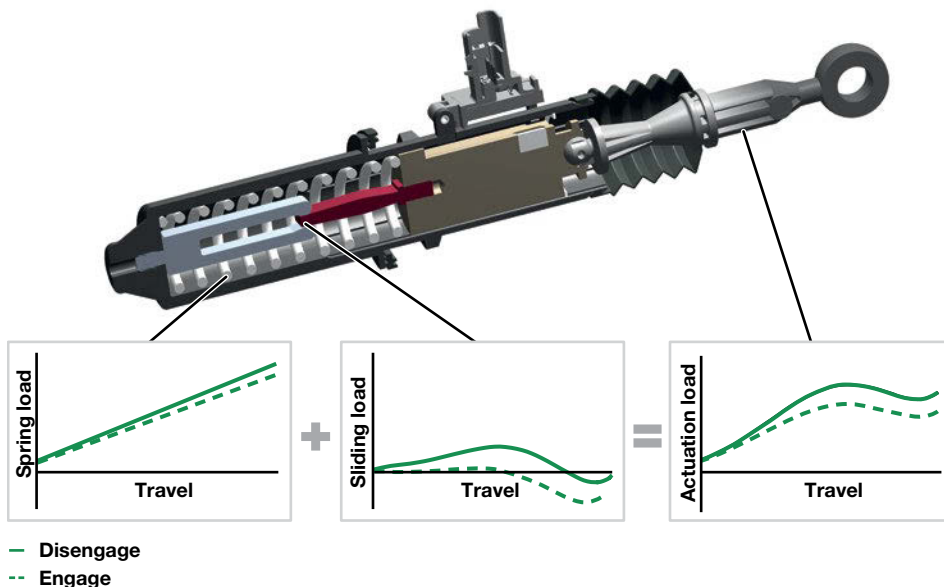
vehicle functions is derived directly from the linear signal and can be transmitted via CAN bus to the respective controllers. The first manufacturers are already planning to use this concept.

The travel measurement via integrated sensor system can also be used for clutch-by-wire applications. To this end, a broad spectrum of more or less complex solution suggestions are being discussed. LuK favors a solution in which only the conventional master cylinder in the pedal box is replaced by an element with similar installation space. This could consist of a housing with a piston rod and interior spring assembly. A spring with a linear characteristic curve is eclipsed by the spring and hysteresis effect of a clamping element and ensures the usual plateau of the clutch operation. The sensor is on the outside of the housing in this design, the same as with the conventional master cylinder.

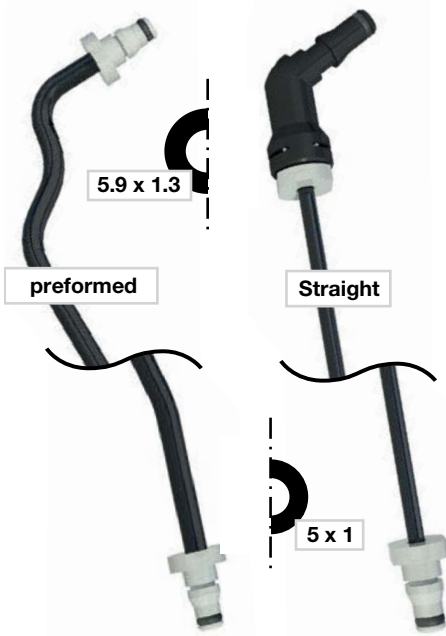
## Clutch pipes and installation elements

Pipes have the task of transferring the hydraulic pressure safely and with as little friction and volume loss as possible. In addition, pipes are supposed to prevent engine vibrations propagating as far as the pedal box. Installation elements such as dampers and anti-vibration units are used for this.

Pipes are currently made of steel/rubber or polyamide (PA 12 and PA 612) materials. Currently, pipes made of plastic are becoming increasingly common because of their low costs [1]. LuK now uses PA 610 for almost all pipes. This plastic is more than 60 % based on plant raw materials. The global availability of prematerials is better than for PA 12 and PA 612. The



**Figure 11** Compact pedal load emulator with sensor for clutch-by-wire systems

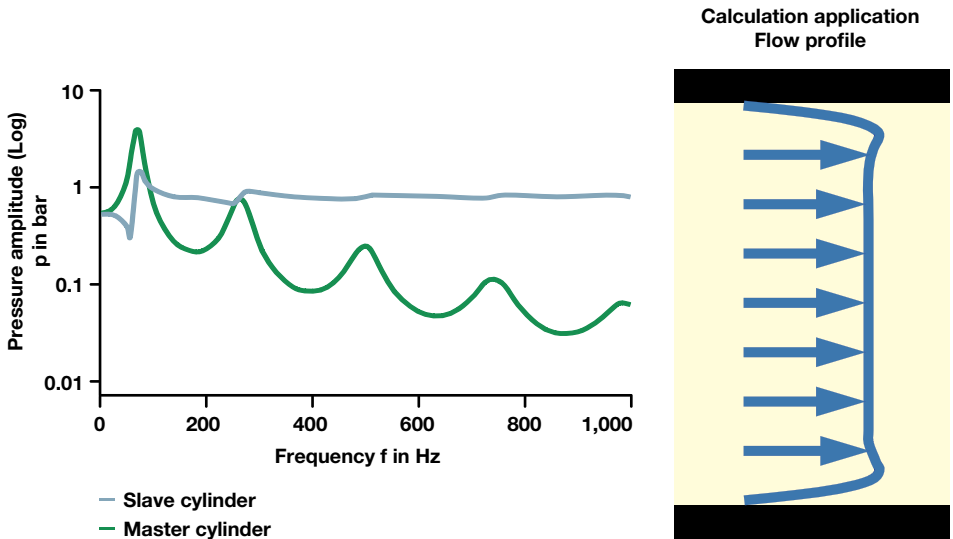


**Figure 12** High Pressure Pipes made of PA 610 for clutch operation

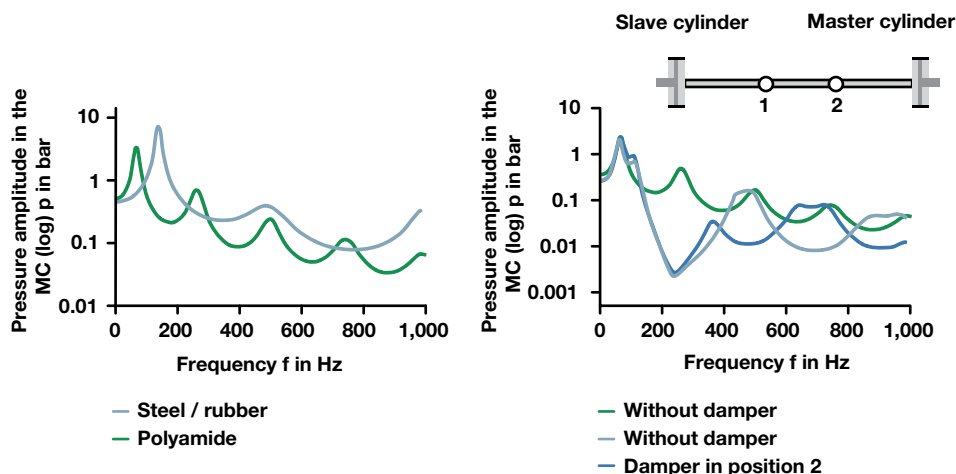
mechanical properties are almost the same as for PA 612 and the chemical compatibility is better.

Plastic pipes in vibration-critical applications (diesel engines and engines with few cylinders) mostly require the use of a filter to counter pedal vibration and interior noises. This filter traditionally operates like a soft added volume in the pipe. However, this regularly caused a conflict between good filter effect and low-loss direct operation.

Due to the complexity of this conflict of interest, an optimal solution was very hard to come by in testing. Therefore, specialized simulation tools had to be used. In general, it is sufficient to calculate the transmission behavior of the pipe within the frequency range. For this purpose, LuK has the PipeSim program, which calculates the flow and vibration behavior in the pipe based on the numerical solution of the Navier-Stokes equations.



**Figure 13** Simulation of the transmission behavior of clutch pipes and built-in vibration dampers



**Figure 14** Example of a variation calculation using PipeSim

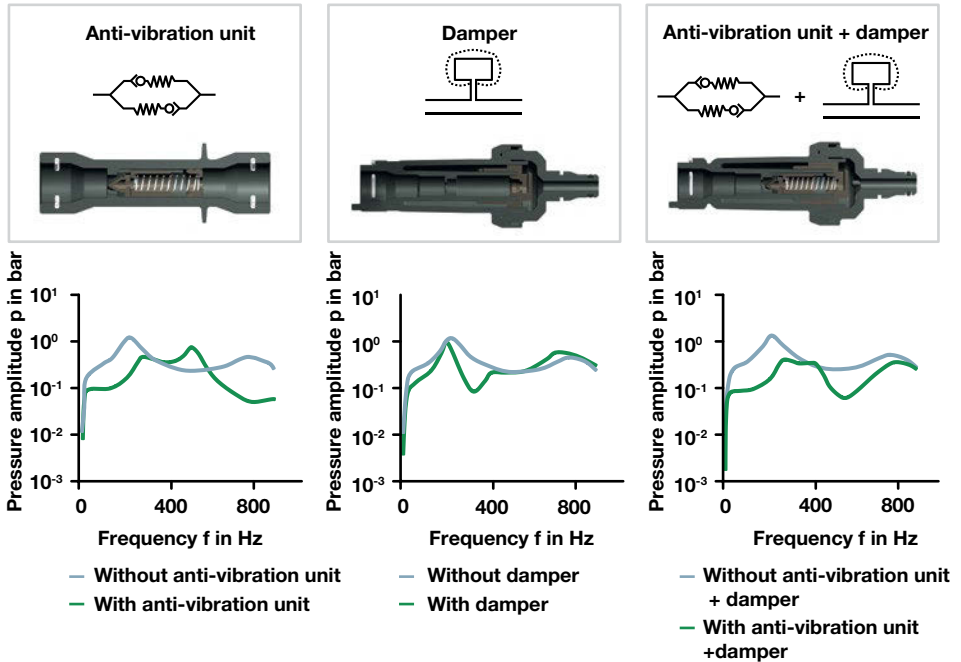
PipeSim helped in carefully studying the vibration transmission up to the master cylinder and identifying the best corrective measures. This generally involves a vibration damper with appropriate tuning, an anti-vibration unit or a combination of the two at an optimal point along the pipe. The simulation also allows for early determination of the pipe routing, which is available even before test vehicles.

The following example shows the procedure and the advantages of the simulation: The pipe is first divided into multiple segments based on its mechanical design. An excitation is then specified as a frequency curve via the slave cylinder. Based on the transmission behavior of the line, this generates a corresponding pressure vibration in the master cylinder. The diagram of the results is shown in Figure 14 on the left; the black line shows the curve for a steel/rubber pipe and the red line shows a typical PA pipe: The steel/rubber variant exhibits a resonance of the incoming vibrations at approx. 150 Hz. Problems with pedal vibration can be expected there. The pressure curve over the frequency for the plastic pipe is largely

lower, but there are also several potential resonances. In the example shown, only the resonances at approx. 250 Hz showed as unpleasant in the vehicle. This can be countered by installing a vibration damper, whose optimal placement can be calculated using PipeSim.

The technology for the damper and anti-vibration unit could be improved considerably, to a certain extent as a side effect of the simulation technology: These elements can be adjusted perfectly and individually to the respective application. They only show a minimal volume expansion which does not disrupt the pedal characteristic curve and are available as modules. The anti-vibration unit (AVU) in Figure 15 left is, from a hydraulic perspective, a type of mutual automatic shut-off valve when the pedal is depressed, or a restrictor in case of light flow. It is used to counter low-frequency pedal vibrations up to approx. 150 Hz, which can be felt by the foot as vibration. The vibration damper in Figure 15, center, was based on a Helmholtz damper in the gas dynamic. This involves a resilient capacity with a defined restriction as a cross connection to the

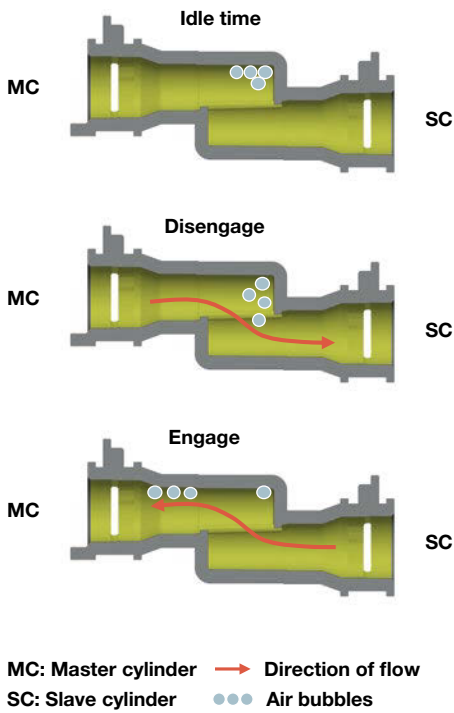




**Figure 15** Anti-vibration unit and modular system of vibration dampers

pressure pipe. The effect is used more in the high frequency range and serves to counter interior noises. The volume expansion of the connected capacity as well as the length and the diameter of the restrictor determine the damper frequency and the bandwidth. The goal is to keep the volume expansion as low as possible in order to minimize release travel losses. Thus the damper is adjusted specifically for each application. A combination of anti-vibration unit and damper is shown in Figure 15, right. There, the damper is tuned so that the resonance, at approx. 550 Hz from Figure 15, left, is corrected. Thus far, this approach has been successful in practically all cases, even difficult problems, by using a combination of plastic pipe and corresponding filter. This is an argument for further substitution of steel/rubber pipe with cost effective plastic solutions.

In addition to the vibration dampers, the installation of other elements is possible in the pipes. Examples include ventilation aids for long and non-continuously sloped pipe such as are needed for rear-wheel drives. For these types of installation situations, a double pipe and two supply reservoirs have often been used thus far. Ventilation assistance makes this double design superfluous. The small hydraulic stage allows air bubbles to move only toward the master cylinder even if the line is partially tilted away from it. The air thus collects at the highest point of the ventilation aid, is mostly transported toward the master cylinder during engagement and can be discharged via ventilation holes.



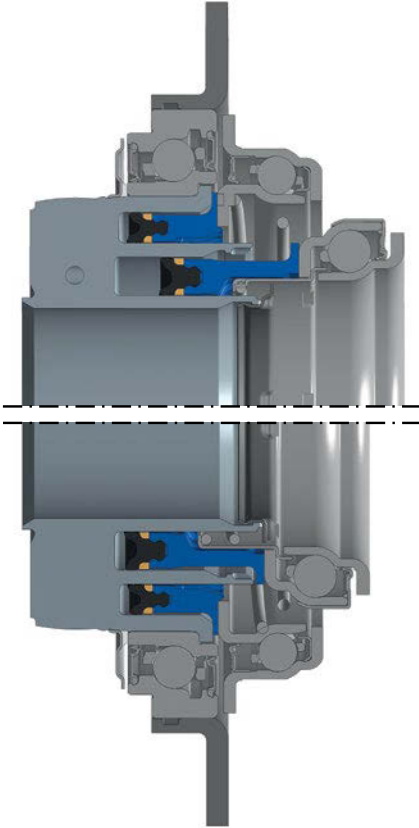
**Figure 16** Ventilation aid for clutch that slope downward to the master cylinder

## Slave cylinder – plastic prevails

Prior years show a clear trend worldwide toward concentric slave cylinders (CSC) and toward housings made of temperature-resistant plastic for practically all passenger cars and light utility vehicles. The advantages of CSCs include its compact design, uniform bearing load and reasonable price in comparison to all of the other systems. Technical further developments allow for a continuous increase in reliability. Core topics in the development are protection of the hydraulic system and the bearing from contamination, extended service life of the central seal up to three million cycles and constantly low friction. Almost 100 % of all new CSCs for manual transmissions are now built with plastic housings. A detailed technical description is provided in [3].



**Figure 17** Travel adjusted clutch (TAC) and cover-mounted release system (CMR) with smaller cover bearing on the end of the guide sleeve [2]



**Figure 18** Cover-mounted release system for double clutch

The cover-mounted release system (CMR) presented earlier is now running in initial applications including in volume production and presents comfortable driving behavior with regard to pedal vibrations, slip and judder. Further developments of the CMR focus on reducing the size of the cover bearing and a combination with the new clutch with travel-controlled wear adjustment (Travel Adjusted Clutch, TAC). The smaller cover bearing should save money and space. The CMR with TAC is configured such that a conventional release cylinder or a CMR can be used with the same cover tool. This provides the customer maximum flexibility for volume production.

The proven technology for the manual transmission is, to some extent, now being transferred to the double clutch transmission with hydraulic actuation and expanded upon. Thus, CSCs for double clutch transmissions now use the reinforced seal, permanent lubrication to reduce friction and the CMR technology. Additional enhancements include:

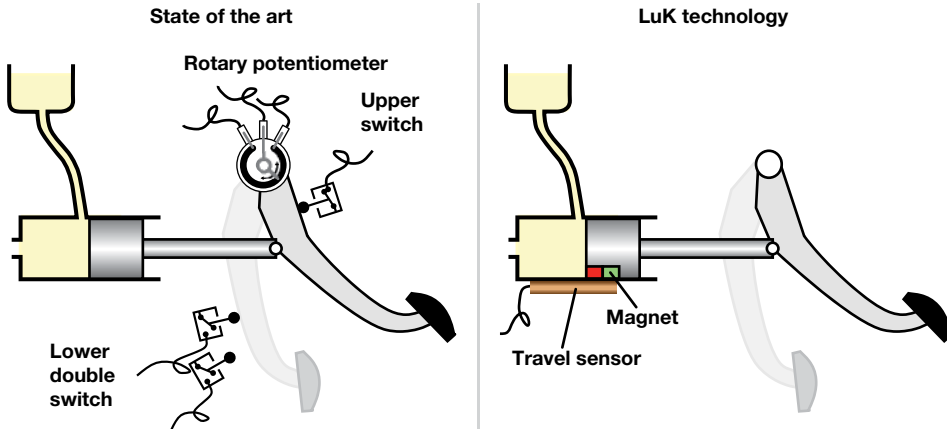
- Piston with universal joint for parallel lift-off of the clutch,
- Drag torque secured to the housing via springs instead of a pre-load spring
- Dimensioning of the engagement bearing for constant high loads.

## Pedal boxes – wallflowers with great potential

---

Pedal boxes for the clutch operation are increasingly being used separately from the brake and driving pedal. This topic would therefore also be of interest to a clutch system manufacturer. Current activities at LuK involving pedal boxes include a design simplified by integrating the sensor system, lightweight construction by a direct use of plastic with an integrated master cylinder and, last but not least, the most ergonomic pedal characteristic curve possible.

The pedal box structure is simplified considerably by the possibility of integrating the sensor system in the master cylinder. Thus far, three switches and a potentiometer with corresponding retainer, stops and cables have been used in an extreme case. When using a sensor in the master cylinder, these components can be completely omitted except for one cable. The measurement precision of the system is increased at the same time.



**Figure 19** Simplified design of the pedal box by integrating the sensor system in the master cylinder

From a material technology perspective, it is conceivable to manufacture the above new type of master cylinder as one part with the pedal box housing using plastic injection molding. This reduces the assembly ex-

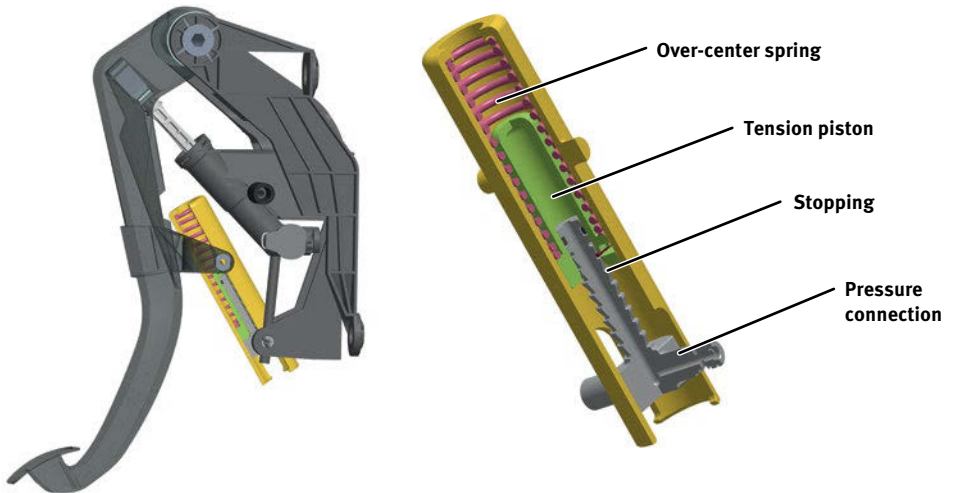
pense and increases the stiffness by eliminating the joints. Even the pedal would be manufactured from plastic for this type of solution. In the example shown, there are two possible joint points between the pedal

and pedal box. As a result, two different ratios can be used in the same structure. The spring is configured as a cylindrical coil spring and mounted in the middle, covered by the housing. The sensor is mounted on the side of the master cylinder or integrated in the structure.

An ergonomically perfect design of the load-travel characteristic curve on the pedal is indispensable [4]. Various automotive manufacturers are pursuing



**Figure 20** Pedal box for clutch operation made of plastic with integrated master cylinder and sensor



**Figure 21** Pedal box with self-adjusting OCS for pedal effort limitation

the goal of reducing tolerance-based load fluctuations in conventional systems in new condition. The idea behind this is to create a brand-specific pedal feeling. Since this is not sufficiently feasible due to tolerance limitations, LuK is posed with the task of studying an adjustment mechanism in the pedal box. Two adjustment mechanisms were considered for this: An adjustment of the pedal ratio as well as a preload of the over-center spring (OCS).

Finally, the idea to make changes to the pedal transmission was proposed because this also changes the travels on the pedal or on the release bearing. The adjustment of the preload of the OCS offers an elegant option for influencing the load level. This makes a manual or automatic adjustment equally conceivable. The manual adjustment could, for example, be made by a simple setting screw on the pedal and a measurement of the pedal effort in the vehicle could be taken. Since this type of step is not provided for in the vehicle assembly lines, LuK is focusing on

the automatic setting. For this, the base point of the OCS is acted upon via a small hydraulic cylinder with the pressure from the release system. In new condition, the OCS is unloaded, and thus compensates very little. With maximum pedal effort or increasing pressure in the system, the spring is preloaded further until a balance is reached between spring load and pressure. A mechanism for engaging prevents the tension piston from resetting.

In this way, the complete form of the characteristic curve is not adjusted to a set curve, although the height of the maximum load is. The form of the automatic adjustment shown has the side effect that force increases in the operation can be prevented in part. In this way, wear adjustment is also achieved within a certain range. If a clutch repair is needed, the stop mechanism is triggered and the automatic adjustment starts over. Details on this mechanism are currently being developed; the target application is in vehicles with conventional clutches.

## Summary

---

There are numerous starting points for innovation in what appears to be the mature field of release systems. New sensors and pedal boxes with integrated master cylinder made of plastic promise numerous advantages for future volume-produced vehicles. In addition to an increase in functionality for customers, there is also a benefit from the lightweight design and savings in fuel consumption.

## Literature

---

- [1] Welter, R.; Wolf, B.; Ineichen, L.: Leitungssysteme für die Kupplungsbetätigung. VDI Reports no. 2139, 2011, pp. 231-240
- [2] Welter, R.; Wittmann, C.; Hausner, M.; Kern, A.; Ortman, S.: Deckelfester Zentralausrücker für Kupplungen. VDI Reports No. 2206, 2013, pp. 67-79
- [3] Welter, R.; Lang, V.; Wolf, B.: Clutch Operation; 9<sup>th</sup> Schaeffler Symposium, 2010, pp. 61-74
- [4] Zink, M.; Hausner, M.; Welter, R.; Shead, R.: Clutch and Release System; 8<sup>th</sup> LuK Symposium, 2006, pp. 27-45



# The Clutch Comfort Portfolio

From supplier's product  
to equipment criterion

Juergen Freitag  
Dr. Martin Haessler  
Steffen Lehmann  
Christoph Raber  
Michael Schneider  
Christoph Wittmann



DWU  
JZMHZL  
AGQSWIER  
FIMBCHSEHEBU  
CECBSTPOIODCVFfwU  
DGVTTQUJXRELKJHGFD SAMML  
YLMRTXAGYWP HCEQAYWSXEECRF  
CXVNHOUBIJBZGVTFCRDXESNWASREU  
ZVTFLUJADGYCBMWRZIPS SFHKTVNZLMOY  
XDBPORUTETMBCYNVXADGJLK HESYSCBMBU  
DCSKUPOWRWZTWHNEDKUNWPONCALVIKZTWHNL  
EHKLPFLKJKOIUZTREWQYXC VBNMIQWUOIUZTRE  
WDXAYHASGSVNPIZRWQSCGZ NJIMNSTRVNPIZRWQS  
LZUKOGIKCKPMNESWLNCXWZYKFEDIOPPMNESWLNCX  
RUCZGZMQGODNVUSGRV LGRVKGECEZEMDNVUSGRV LGR  
QATSLOKZINEXOMNYAZTEW NFXJLRNIFEXOMNYAZTEW  
CLOMEPSCVCY  
FAMUANJY  
KMNSRD  
LIEPN  
BSATB  
PIEP  
RUCZ  
BSA  
DGV  
YLM  
CX  
ZV  
XD  
HIOGDNOIERN  
DDLRBEFBAFVNK  
UAHIOGDNOIERNGM  
OQODNVUSGRV LGRVKG  
PDBDDL RBEFBAFVNKFNK  
JOTRELKJHGFD SAMMBVCX  
XAZYWP HCEQAYWSXEECRFV  
OUBIJBZGVTFCRDXESNWAS  
UJRDGYCBMWRZIPS SFHKTVN  
RUTETMBCYNVXADGJLK HES  
IPOWRWZTWHNEDKUNWPONCA  
FLKJKOIUZTREWQYXC VBNM  
HASESVNPIZRWQSCGZ NJIM  
GIKCKPMNESWLNCXWZYKF  
ASUSVNPIZRWQSCGZ NJI  
IKCKPMNESWLNCXWZYKF  
OXODNVUSGRV LGRVKG  
INEXOMNYAZTEW NFX  
CYLJNEWCLVVF  
DNVUSGRV LGR

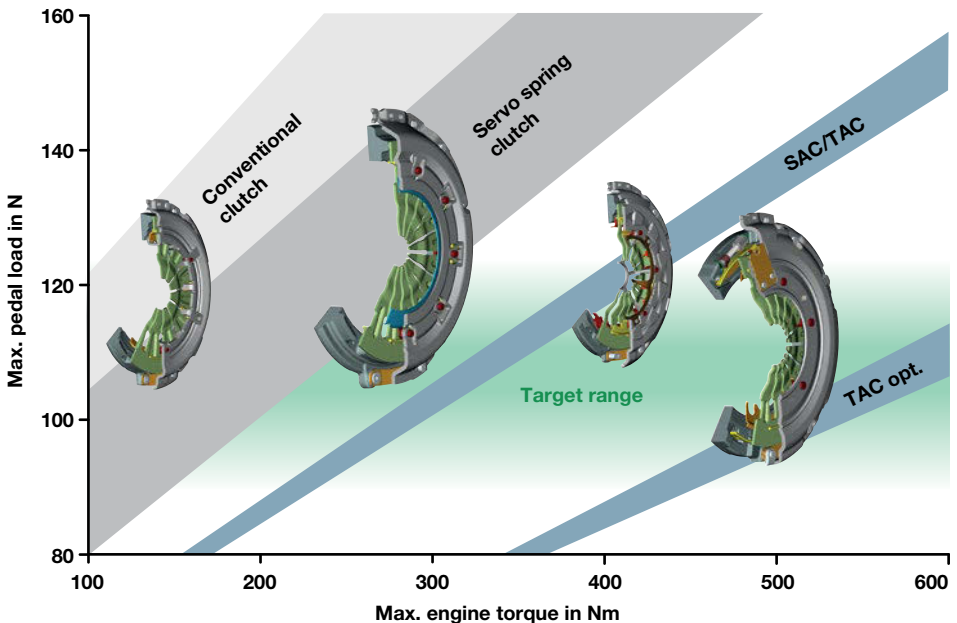


## Introduction

Buying a new automobile ranks as one of the most expensive single expenditures for private households. It therefore goes without saying that the emotions and expectations associated with such a purchase are quite high. These expectations are never fixed and rigid, however, but are constantly changing and evolving. Just take a look at history. At first, consumers were more than satisfied with such vehicles as the Messerschmitt Kabinenroller, Opel Laubfrosch, and Goggomobil because they enabled personal mobility. As the years went by and this newfound feeling of excitement wore off, different consumer priorities emerged in the form of reliability, power and performance, and comfort. Once these requirements were met, people became more and more interested in safety, low fuel consumption, and equally low emissions while

also expecting new developments and features in other areas.

As technical developments frequently have a mutual influence on each other, innovations realized for one component more often than not necessitate adaptations to other systems. The same applies to automotive clutch systems, which greatly facilitate driving comfort and convenience. Increased torque or ignition pressure in the engine, for example, leads to more pronounced axial vibrations along the crankshaft. To ensure that this inherent tendency does not compromise the driving experience by inducing strong pedal vibrations, high pedal forces, or creating disturbing noise levels, the clutch systems installed must be adapted accordingly. Figure 1 shows a graph of the targeted areas, or sweet spots, targeted for achieving comfortable pedal forces and depicts a selection of different clutch designs that can be incorporated to approach these areas, depending on the amount of engine torque available.



**Figure 1** Excerpt from the product portfolio of clutch pressure plates

## Comfort

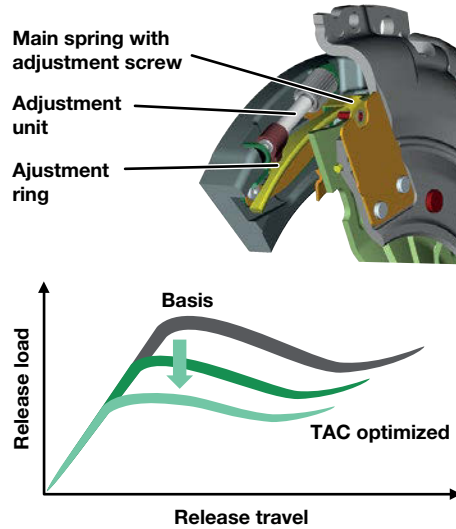
A clutch pedal should not only be comfortable and convenient to operate, but also fulfill other design criteria such as complying with defined levels of vibration and manual shifting force when a gear is engaged as well as reliably withstanding extreme loads. Another requirement that is equally as important is environmental compatibility. More recent developments to this end include start-stop systems and clutches for hybrid and fully electric powertrains. Extending beyond the range of traditional performance applications, Schaeffler now also offers innovative designs for clutch assemblies used in motorcycles.

### Comfort of actuation

The current drive of automakers to leverage the concepts of downsizing, downspeeding, increased boost pressures, and transmissions designed to reduce internal friction in an effort to minimize CO<sub>2</sub> emissions necessitate a clutch system that is even more robust and resistant to axial vibrations experienced along the crankshaft. In addition to realizing the stability required to harmonize the characteristic curve for pedal application forces, topics such as pedal vibration, gear rattle, and judder are becoming increasingly important.

By developing a clutch that utilizes travel-controlled wear adjustment (travel-adjusted clutch, or TAC) [1] as an alternative to the classic, proven clutch design integrating a force-controlled wear adjustment mechanism (self-adjusting clutch, or SAC), it is possible to reduce pedal application forces despite higher engine torque outputs while at the same time catering to changed vehicle constraints.

The TAC also facilitates a more flexible selection of plotted performance curve



**Figure 2** Clutch with travel-controlled wear adjustment and its optimization potential

characteristics as well as lends itself to a high level of operational stability. Adding to this is the fact that the robust nature of TAC assemblies when it comes to resisting axial-based vibrations makes it possible to reduce the torque transfer capabilities of the clutch to enable lower contact pressures and, in so doing, lower the release and pedal pressures required for identical maximum torque ratings.

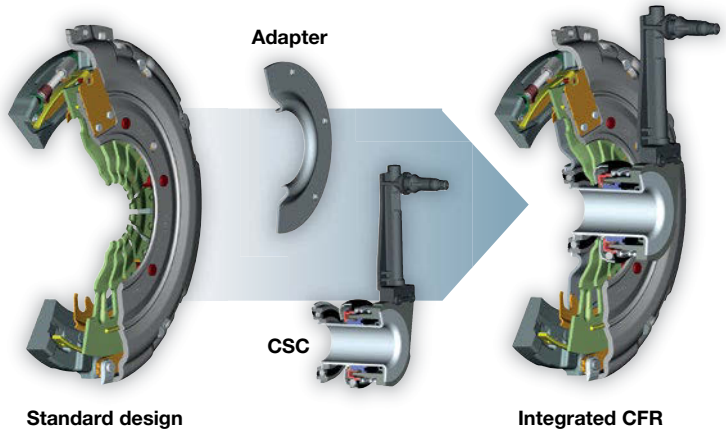
Due to the pronounced active adjustment characteristics of the TAC, engineers can also enhance performance curves in relation to the overall system as it interacts with the pedal system or implement additional componentry to further reduce pedal forces by up to 40 percent (Figure 2).

As a result of the adjustment system used, the tongue height and operating range of the clutch remain constant. This, in turn, makes the TAC an ideal partner to combine with a cover fixed release system, or CFR [2]. Coordinating and harmonizing these two

components allows NVH performance to be noticeably improved. To this end, the CFR eliminates pedal vibration and judder, since the clutch and clutch release bearing are no longer braced by the transmission and can instead freely oscillate in the transmission bell housing to prevent the axial vibrations of the engine and integrated clutch system from transitioning to clutch modulation.

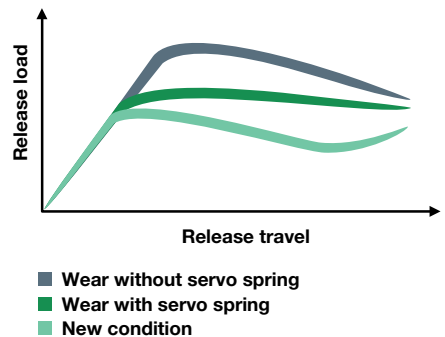
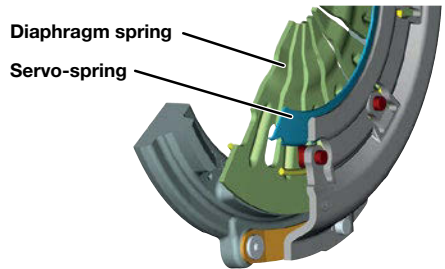
The design configuration of the CFR as an easily adaptable ancillary component even makes it possible to use the TAC in conjunction with a conventional release system early in the development phase. Should it then be determined later on, right before the start of production (SOP), that undesirable noises will have to be eliminated (as is often the case), minor adjustments can be made to the TAC to align it with the CFR. This introduces a whole new dimension of flexibility, which is further enhanced by the fact that the CFR is designed in modular design. As such, the CFR can also be used for different sizes of the TAC assembly (Figure 3).

A servo-spring clutch can also be fitted as an alternative option for improving comfort levels. This development closes the gap between conventional and self-adjusting systems. Normally, the release force of a conventional clutch increases as the lining continues to degrade over time due to the characteristics of the diaphragm spring. This effect is counteracted by the servo spring clutch as a result of an additional servo spring that overlays



**Figure 3** Clutch with travel-controlled wear adjustment and cover fixed release system

the characteristic curve of the diaphragm spring in such a way that a less pronounced difference in force is encountered between the as-new and worn states.



**Figure 4** Clutch with servo spring support

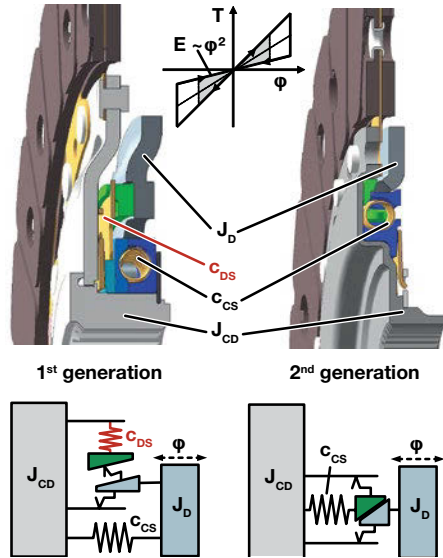
This, in turn, reduces the maximum level of release force as compared to a conventional system that does not have an additional spring and minimizes the maximum pedal application force required by up to 20 percent across the entire service life of the assembly (Figure 4). Servo spring clutches are particularly well suited to applications in which a conventional clutch can no longer meet the target comfort requirements that a self-adjusting clutch system can more than fulfill.

### Comfort of launch

In an effort to improve launch comfort, several passenger car powertrains have been realized with a judder damper integrated in the clutch disk since 2011. Characteristic for this product is not only the correct adjustment to the natural frequency, but also a friction level between the damper mass and the mass to be damped that is directly proportionate to the twist angle. The result is that the oscillatory energy that increases as a square of the fluctuations observed in transmission speed is optimally damped [3].

In today's series production versions, compression springs that target tangential forces coincide with the torsional rigidity of the judder damper. A ramping mechanism between the damper mass and a friction element generates the friction proportionate with the twist angle, while the force of a separate diaphragm spring as it contacts the ramps and axial support of the damper mass produces the corresponding frictional torque.

An alternative setup to this design would be to utilize the available tangential compression springs to produce this torque directly. In one such judder damper that has already entered its second generation, the diaphragm spring is then no longer needed. As a result, fewer compo-



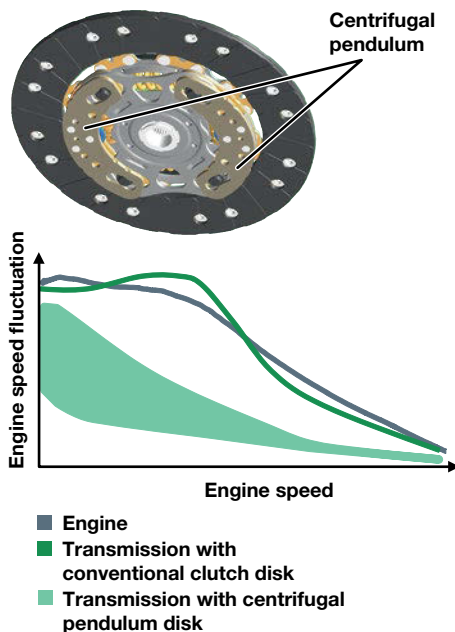
**Figure 5** First-generation (left) and second-generation (right) judder damper

nents and less installation space are required to provide the same level of functionality. In order for this to be possible, the ramping mechanism previously arranged in parallel with the compression springs has been redesigned to connect them in series. When the damper mass is deflected against the clutch disk – with corresponding deflection of the compression springs acting in the circumferential direction – the force associated with it produces an axial force by way of a wedge-shaped contact whose intensity is defined by the wedge angle. This axial force generates a frictional torque at the contacts of the axial support points that is proportionate to the torsional moment and either increases or decreases it, depending on the direction of motion. Figure 5 compares a first and second-generation judder damper.

## Vibration isolation

Disturbing noises are among the most frequent complaints made with respect to new vehicles. It is often difficult to localize these noises because they can have many culprits. In the case of the powertrain, for example, speed irregularities of the combustion engine can excite torsional vibrations. Resonance frequencies and low engine operating speeds in particular cause vibrational output to be perceived as bothersome.

Torsional dampers in clutch disks connected to a rigid flywheel minimize the resonance of vibration amplitudes as a result of their friction-damping characteristics but at the same time can only isolate the vibrations experienced in different speed ranges to a limited extent.



**Figure 6** Clutch disk with centrifugal pendulum

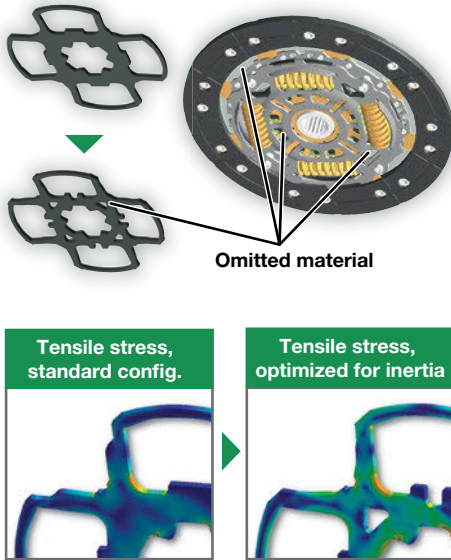
A new design approach involves modernizing the principle of the centrifugal pendulum for application on the torsion-damped clutch disk (Figure 6). Simulation exercises and vehicle trial testing reveal that vibrations can be isolated across a wide range of engine speeds when such a setup is used. Instead of generating heat by dampening friction levels, the centrifugal pendulum uses in-phase inertia forces to reduce fluctuating engine speeds more effectively and efficiently.

Further details about this innovation are explained in [4].

## Shifting comfort

The ease with which gears are shifted is a telltale sign of the quality of modern manual transmissions. Achieving this effect frequently poses an inherent conflict to designers, however, who must balance the integration of additional components such as the centrifugal pendulum and judder damper, which improve NVH comfort levels but also increase the mass moment of inertia to be synchronized. This increased inertia not only leads to higher transmission synchronizing loads, but also requires more effort and time on the part of the driver to shift gears. The answer therefore lies in systematically optimizing all components of the clutch disk with the end goal of minimizing the mass moment of inertia as far as possible.

Optimization measures at the design level serve as the perfect starting point. Up to now, the sheet metal parts of clutch disks have primarily been designed with functional performance aspects in mind. As such, areas that make poor use of material and thus offer the potential to reduce mass can be found with relative ease. By leveraging FE analytical techniques, these components can be optimized to such an extent from a bionic per-



**Figure 7** Clutch disk with reduced mass moment of inertia

spective that areas that do not contribute to operative functionality or that are subjected to only minimal loads are removed (Figure 7).

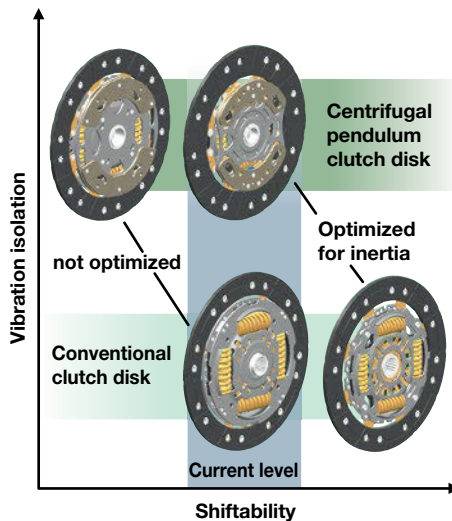
Further reducing the mass moment of inertia allows a cushion deflection system to be constructed out of single segments of thin spring steel. The resulting thinner lining structures can then be further optimized with respect to the wear reserves or strength required in the target application. Design measures can also be implemented for the centrifugal pendulum or judder damper themselves.

The combined effect of these measures in turn make it possible to maintain the mass moment of inertia of a clutch disk with centrifugal pendulum or judder damper at the level of current clutch disks. Without these additional damping elements in place, it would even be conceivable to undershoot this level (Figure 8).

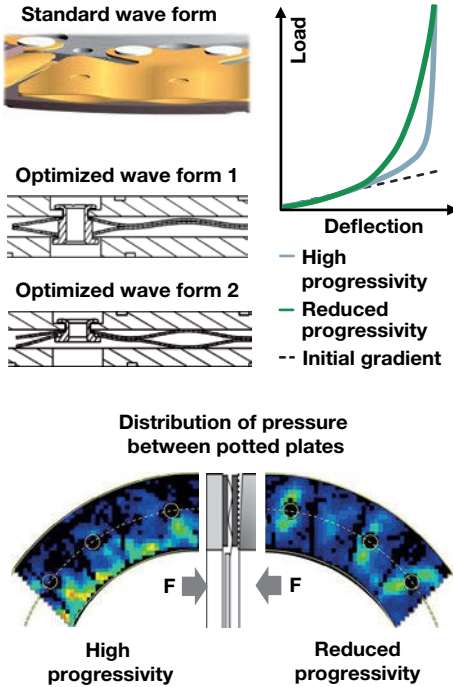
## Comfort at high stress

When a vehicle is driven along mountain passes, it is much more likely for the clutch assembly to overheat, especially under extreme circumstances such as repeated hill starts while towing a trailer or due to clutch misuse. In some cases, the toll this takes can even be smelled! From a technical standpoint, the thermal deformations that occur on the flywheel and the pressure plate at this time reduce the effective friction radius and induce localized temperature peaks.

It goes without saying that the clutch should offer sufficient performance in extreme situations such as those mentioned a certain number of times before friction levels drop so far (fading) that the friction lining starts to slip and deteriorate. Better thermal resistance can be achieved with systems that maintain the target friction radius and friction coefficient constant for as long as possible under a wide variety of operating conditions. This is why cushion deflections systems that have a high compensatory capacity were developed.



**Figure 8** Potential for reducing the mass of clutch disks



**Figure 9** Cushion springs with high compensatory capacity

The increasing sensitivity of vehicles when it comes to dealing with fluctuations in torque resulting from the slipping clutch (judder effect) necessitates a cushion deflection characteristic that has a small initial gradient. For this purpose, spring elements made from thin steel are typically used. Already when subjected to forces below the maximum clamp-load the elements are pressed completely flat and show a high level of progressivity in this range with almost zero spring travel. The problem with this design is that these elements are relatively incapable of counteracting thermal deformation of the flywheel and pressure plate. Pressure distribution measurements taken under high-load conditions with a deformed pressure plate confirm this.

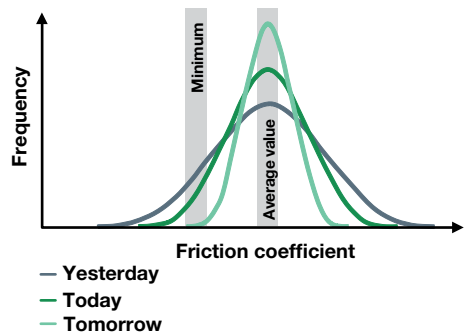
Developing specific wave forms for the thin cushion spring elements resolves the conflict of realizing the small initial gradient

required while providing for high compensatory capacity. The wave forms are designed in such a way that when a defined spring travel position is reached, additional waves that summon much more energy are activated, for a combined effect. This, in turn, leads to a performance curve with substantially less progressivity and a higher compensatory capacity as maximum clamp-load is reached. Pressure distribution measurements taken under a load in the presence of a deformed pressure plate attest to this improved design response, since the friction radius is held largely consistent. The results of hill-start tests conducted in real-world conditions underscore the potential of this concept.

Without requiring any additional space or increasing the mass moment of inertia, the high-capacity cushion deflection elements enhance the thermal durability and power transfer capabilities of the clutch (Figure 9).

To improve load capabilities and launch comfort in the aforementioned situations, Schaeffler is also currently developing new organically-bound friction materials for strip-wound linings. The target objective for these constant- $\mu$  linings is not so much to achieve as high a friction coefficient as possible, but to realize one that is largely consistent (Figure 10).

The thinking behind this strategy is that by minimizing changes in the friction coefficient of the lining across a wide range of operating con-



**Figure 10** Constant- $\mu$  lining

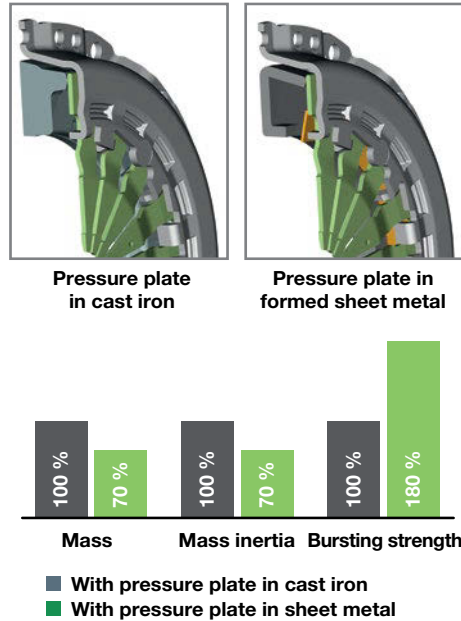
ditions and parameters while sustaining an unwavering average performance value, a higher minimum friction coefficient can be attained. This not only improves power transfer reliability, but also facilitates lower clamp-loads, which in turn lead to lower release forces for a given clutch with specific rated dimensions and identical power transfer capabilities. An alternative approach is to fit a smaller clutch assembly, whose reduced maximum friction coefficient limits the amount of torque that can be transferred and, in so doing, softens peak loads in the powertrain under dynamic load conditions. Automated clutch systems also profit from the design, as a constant friction coefficient makes it easier to actively regulate the build-up of torque along the engagement and release travel respectively.

## Environmental compatibility

Automakers are presently looking for any and all ways to reduce the CO<sub>2</sub> emissions of the models they produce. An optimized clutch can help in this regard, since reducing the mass and mass moment of inertia of the assembly further improves the efficiency of the overall vehicle.

To this end, applications could be conceived that involve reducing the mass of the pressure plate. The limiting factor here is the cast materials that are currently in use, however. In order to safeguard compliance with defined criteria such as burst strength, thermal durability, and feasibility from a manufacturing perspective, the mass of the pressure plate frequently cannot be reduced to the theoretical minimum.

Addressing the issue can take the form of higher-grade cast materials to allow these performance limitations to be marginally shifted. Manufacturing pressure plates from rolled steel offers greater potential, however, since a steel plate design gives rise to new design configurations that leverage closer tolerances, thinner cross sections, and increased durabil-



**Figure 11** Pressure plate made from rolled sheet steel in comparison to a cast variant

ity to make better use of available installation space while reducing mass and the mass moment of inertia (Figure 11).

## Comfort at engine startup

With the advent of an ever larger number of new vehicles equipped with start-stop systems comes the requirement to find solutions that allow the engine to restart with little to no delay. In response to this development, the last Schaeffler Symposium was used as a venue to present a new sprag clutch design for a permanently engaged starter assembly, or PES [5]. The benefit of this concept is that the starter drive pinion no longer has to be engaged. As a result, combustion engines can be started and stopped faster, quieter, and with less wear from a standstill as well as when coasting to a stop. The concept-bound lifting motion of the sprags after



startup, which is controlled using centrifugal force, is completely void of friction throughout the entire operating range, thus allowing the potential of a start-stop system to reduce CO<sub>2</sub> exhaust emissions to be maximized.

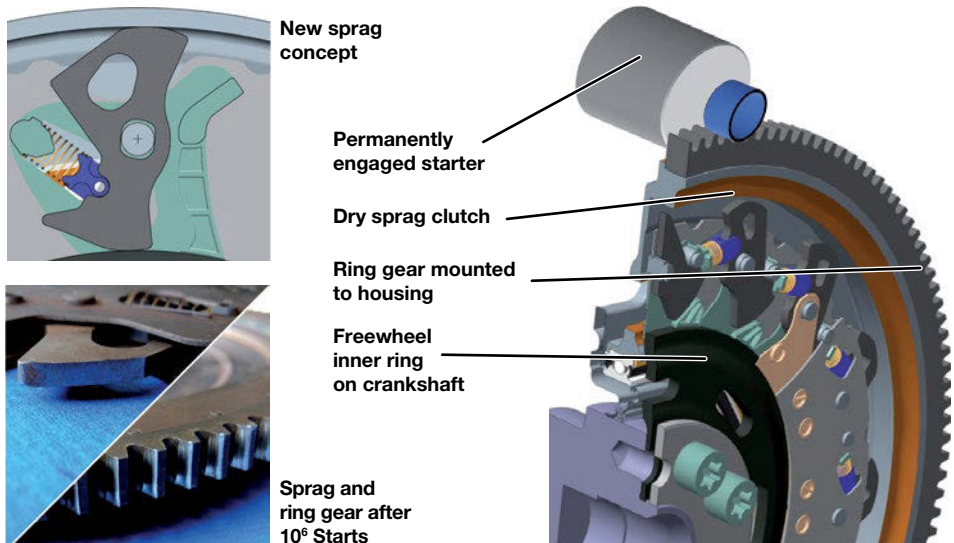
Since the Symposium, the design effect has been investigated using vehicle demonstrators and the system further enhanced. By improving the operating direction of the spring used to generate the lift movement, it was possible to reduce the contact force present throughout the sliding process during freewheel overrun. The usable wear volume of the sprags was also increased and the wear properties of the friction partners optimized. The combined effect of these measures is good for around one million starts, a performance benchmark that was verified on an actual combustion engine (2.0-liter diesel). The positive impact of the concept on the wear exhibited by the starter ring gear was confirmed as well. If manufacturers experience a heightened need for this configuration, the PES could be used not only in the start-stop systems of combustion engines, but also in the repeat-start systems designed for hybrid applications (Figure 12).

## Electrification

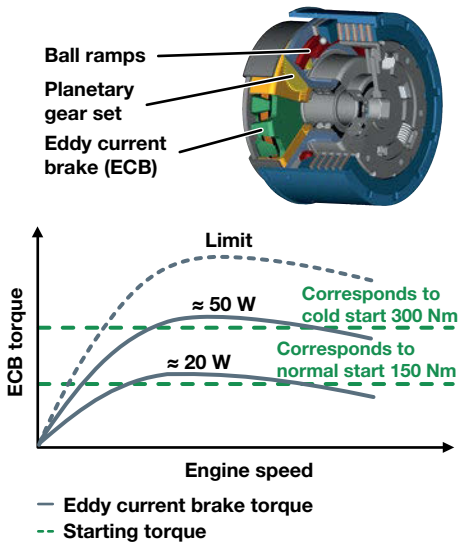
As the powertrains in modern automobiles become increasingly electrified, Schaeffler is currently in the process of developing an electrically operated clutch. One of the design objectives of this project is to keep the actuation energy as low as possible. The underlying operation of the electrical integrated actuator clutch (eIAC) is based on the booster principle [1] and encompasses a pre-control and a main clutch unit (Figure 13).

Booster clutches generate contact pressure by producing a minimal pre-control torque that is converted into an axial force by a ball ramp system. With this design, the pre-control element can be realized by a small conventional clutch or an electrically operated variant. Options here include a magnetic or solenoid clutch and an eddy current brake. The energy required to close the clutch assembly can be taken from the powertrain itself.

Future applications for the eIAC involve hybridized platforms whereby the clutch, which is fitted inside a ring-shaped electric motor, is



**Figure 12** Freewheel for permanently meshed starter assembly (PMSA)



**Figure 13** Drive clutch with electrical actuation

called on to mechanically link the combustion engine with the powertrain as required.

When the vehicle is operated in electric mode only, the eIAC is actuated to disengage the engine from the rest of the powertrain as efficiently as possible. To this end, the system is designed with a “normally open” configuration.

As the combustion engine is started via the electric motor, the eIAC can be actively closed very quickly using an eddy current brake. Since this brake is wear-free by design, the torque transferred can be regulated with exacting precision across the entire service life of the clutch.

To facilitate a smooth transfer of torque to the powertrain while the engine is running, a freewheel is used as a pre-control element. Part of the torque generated by the engine is siphoned off over the one-way clutch to close the clutch.

One of the benefits of the electrical integrated actuator clutch is the accurate control of overrun torque with minimum response time as afforded by the eddy current brake. This performance can be maintained throughout the

entire service life of the unit, since the brake is a wear-free assembly. In addition, no energy is required to actuate the clutch when the vehicle is driven in electric mode or together with the combustion engine, thereby realizing the operative conditions of a “normally stay” clutch.

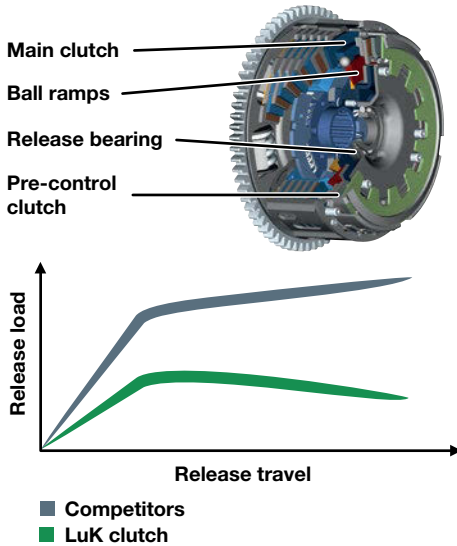
When suitable pre-control elements are chosen, the eIAC can also be used in other applications to:

- Activate an alternative drive system
- Couple an additional driven axle
- Distribute drive force, or driving power (torque vectoring)
- Connect/disconnect other assemblies

## Motorcycle clutches

Almost four million motorcycles are registered in Germany alone, with low six-digit registration numbers of new models each year testifying to the ongoing attraction of this form of personal transportation. This also applies to many other regional markets, although there are pronounced differences in what people expect of such machines.

In Germany, for example, customers want a motorcycle that provides a level of comfort similar to that of a passenger car. Trends in technology are also very apparent in motorcycle applications as is the case with automobiles. Continually increased power densities, the never-ending pursuit to minimize mass, and efforts to reduce the somewhat excessively high actuation forces of certain clutch assemblies are just a few examples of improvements being sought out in this field. The situation in the south-east Asian markets could not be more different. There, a motorcycle is simply viewed as another form of transportation that should offer high everyday practicality more than anything else. In this context, the development activities that surround motorcycle clutches are almost as multifaceted as those observed in passenger car applications. When appropriate solutions are de-



**Figure 14** Motorcycle clutch for improving actuation comfort

vised, however, it is possible to transition to an entirely new level of technology.

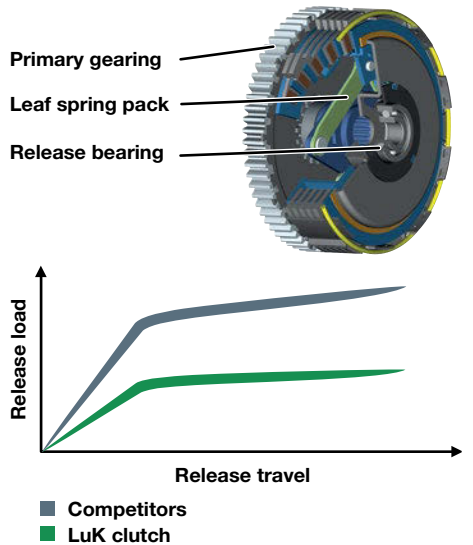
For example, the actuation forces required to operate a motorcycle clutch can be significantly reduced by applying the design principles of the electrically actuated drive clutch to a multi-disk clutch assembly. By realizing a modular construction in the sense of an interconnected system of building blocks, engineers can quickly adapt the mechanicals as required for different engine variants (Figure 14).

The modular concept of the clutch assembly also lends itself to integrating a function that limits the engine braking torque generated in overrun mode as it is transferred to the rear wheel. This “anti-hopping” function considerably improves driving safety, since it prevents the motorcycle’s rear wheel from losing some or all of its traction. A critical aspect in this regard is that the braking effect generated by the engine, which can cause wheel blockage when the vehicle experiences a dynamic shift in weight toward the front wheel as the rear wheel becomes

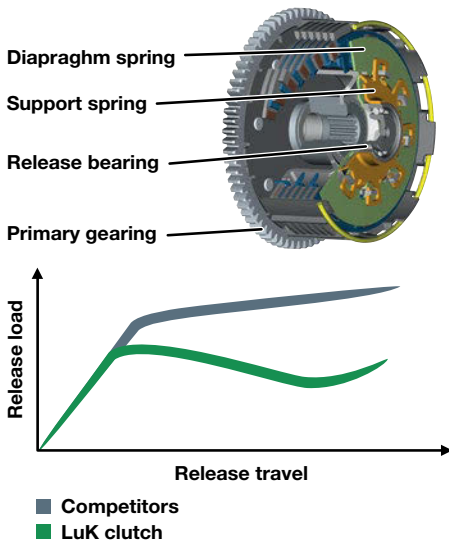
severely unweighted during periods of heavy braking combined with quick downshifts, must be limited to maintain safe handling characteristics.

Another development angle is to simplify the amplification function of a multi-disk clutch assembly to greatly reduce the forces required to actuate it. Although the market currently offers clutches that realize this type of amplification using slide ramps, the problem with their design construction is that the changes in the coefficient of friction (static, dynamic friction) can lead to fluctuations in torque delivery when combined with these ramps.

An innovative new development from Schaeffler circumvents these friction-based effects by allowing the torque yielded by the contact pressure in the inner cage to be transferred via leaf springs to the inner hub. Since these springs have a tilting angle, a force amplification or reduction function is realized with practically no friction, similar to an articulated lever, depending on the angle of attack. The leaf



**Figure 15** Reducing actuation forces with an amplification function



**Figure 16** Concept of a motorcycle clutch for the Asia-Pacific region

springs also center the inner cage and apply the contact pressure.

This concept, which was purposely devised with simplicity in mind, requires comparably little installation space, and can be quickly adapted for different engine variants thanks to its modular construction. An “anti-hopping” function can likewise be integrated if needed (Figure 15).

The development activities being pursued for a motorcycle clutch targeted for the Asia-Pacific region take a completely different direction, whereby the key objectives are to optimize operative functionality while reducing costs by leveraging Schaeffler’s manufacturing expertise in the areas of stamping, punching, and metal forming. To this end, a diaphragm spring is integrated in place of compression springs as an energy-storage mechanism to lower release and holding load when the assembly is new. At the same time, this setup also increases stability with respect to centrifugal force.

An additional compulsory disengagement facility is fitted between the clutch disks as a

further design measure and ensures that the disks are ventilated in a uniform, consistent manner to minimize drag torque. The modular construction of this component also makes the clutch a universally compatible assembly. Adding to this are the benefits of low weight and compact dimensions (Figure 16).

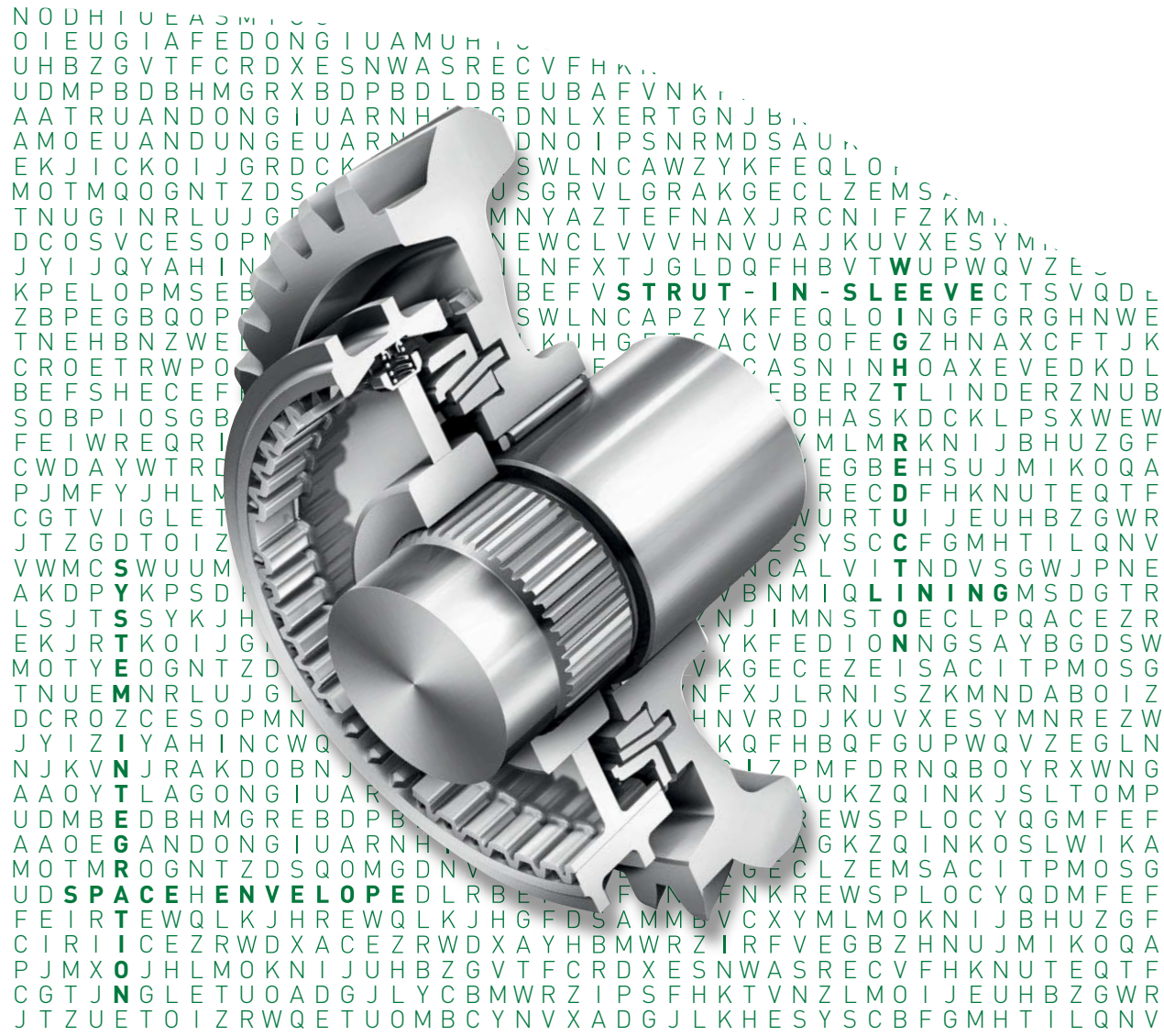
## Outlook

Although the clutch has over 100 years of development behind it, it still offers considerable potential to be optimized further. The broad and diversified portfolio Schaeffler has assembled for clutch-based technologies can be leveraged to realize solutions for many different applications in the automotive and motorcycle industries as future innovations target new design criteria established to achieve higher levels of comfort and efficiency while reducing CO<sub>2</sub> emissions.

## Literature

- [1] Freitag, J.; Gerhardt, F.; Hausner, M.; Wittmann, C.: The clutch system of the future. 9<sup>th</sup> Schaeffler Symposium, 2010
- [2] Welter, R.; Wittmann, Ch.; Hausner, M.; Kern, A.; Ortman, S.: Deckelfester Zentralausrücker für Kupplungen. VDI report, 2013, no. 2206, pp. 67-79
- [3] Hausner, M.; Häbfler, M.: Kupplungsscheibe mit Frequenztilger gegen Rupfschwingungen. ATZ 114, 2012, no. 1, pp. 64 - 69
- [4] Kooy, A.: Isolation in the drive train. 10<sup>th</sup> Schaeffler Symposium, 2014
- [5] Zink, M.; Hausner, M.: LuK clutch systems and torsional dampers. 9<sup>th</sup> Schaeffler Symposium, 2010

**Open Access.** This chapter is distributed under the terms of the Creative Commons Attribution Noncommercial License, which permits any noncommercial use, distribution, and reproduction in any medium, provided the original author(s) and source are credited.



# Holistic Development of Synchronizing Systems

Short, light and convincing

Gunter Hirt  
Pascal Kohtes  
Constanze Franke



DWU  
JZMHZL  
AGQSWIER  
FIMBCHSEHEBC  
CECBSTPOIODCVFELWU  
DGVTTQUJXRELKJHGFDSAMML  
YLMRTXAGYWPHCEQAYWSXEECRF  
CXVNHOUBIJBZGVTFCRDXESNWASREU  
ZVTFLUJADGYCBMWRZIPSFHKTVNZLMOY  
XDBPORUTETMBCYNVXADGJLKHESYSCBMBU  
DCSKUPOWRWZTWHNEDKUNWPONCALVIKZTWHNL  
EHKLPFLKJKOIUZTREWQYXCVBNM IQWUO IUZTRF  
WDXAYHASGSVNPIZRWQSCGZNIJMNSTRVNP IZRWQS  
LZUKOGIKCKPMNESWLNCXWZYKFEDIOPPMNESWLNCX  
RUCZGZMQGODNVUSGRV LGRVKGECEZEMDNVUSGRV LGR  
QATSLOKZINEXOMNYAZTEWNF XJLRNIFEXOMNYAZTEW  
CLOMEPSCVCY  
FAMUANJY  
KMNSRDO  
LIEPNN  
BSATB  
PIEP  
RUCZ  
BSA  
DGV  
YLM  
CX  
ZV  
XD  
HIOGDNOIERN  
DDLRBEFBFAFVNK  
UAHIOGDNOIERNGM  
OQODNVUSGRV LGRVKG  
PDBDDL RBEFBFAFVNKFNK  
JOTRELKJHGFDSAMMBVCX  
XAZYWPHCEQAYWSXEECRFV  
OUBIJBZGVTFCRDXESNWAS  
UJRDGYCBMWRZIPSFHKTVN  
RUTETMBCYNVXADGJLKHES  
POWRWZTWHNEDKUNWPONCA  
FLKJKO IUZTREWQYXCVBNM  
HASESVNPIZRWQSCGZNIJ  
G I K C K P M N E S W L N C X W Z Y K F F  
ASUSVNPIZRWQSCGZNI  
IKCKPMNESWLNCXWZYKF  
OXODNVUSGRV LGRVKG  
INEXOMNYAZTEWNF  
CYLJNEWCLVVFH  
DNVUSGRV LGR

## Introduction

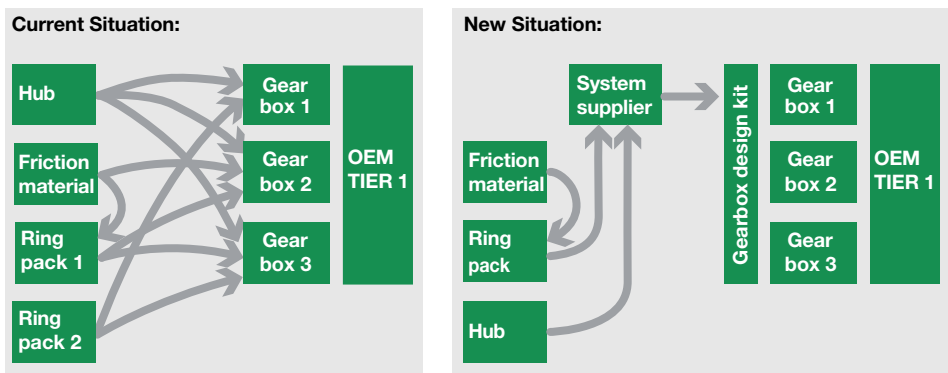
Currently, the value added chain of manual transmissions is characterized by the fact that major automobile manufacturers in the triad (EU, USA, Japan) buy their individual synchronization system components from different suppliers (Figure 1). However in new markets, manufacturers have for some time preferred to work with suppliers who design and develop the entire synchronization system and deliver it ready to install. It is becoming apparent that the value chain will be reorganized along these lines in Western industrialized countries too. A key driver of this development is the need for lightweight designs, which are now increasingly finding their way into the powertrain. If transmissions are to become lighter and more compact, then the subsystems such as the synchronization must become more efficient. The solution to this lies in the need for components to require less installation space and material and be even better matched to each other at the same time.

Schaeffler is prepared for this new situation. The final module required at the component level is the development of efficient

friction linings for synchronization systems and this has already been completed. Typically, synchronizer manufacturers need to limit the size of their systems to the space available between the gears to be shifted. Schaeffler has additional expertise in the design of the connecting components – such as the bearings supporting the shafts and speed gears – as well as gear teeth in general. In addition, there is comprehensive power transmission expertise available throughout the Group. Thus, from the clutch to the transmission output, the power transmission system can be tuned so that from a systemic point of view an optimum is reached in terms of cost, space, weight and gearshift comfort.

## Development and manufacture from a single source

Practice has shown that system expertise will lead to the best solutions if it is accompanied by corresponding expertise at the component level. Schaeffler therefore de-



**Figure 1** New requirements in the value added chain of manual transmissions



**Figure 2** Schaeffler develops and manufactures the complete synchronization system in-house

velops and manufactures all synchronization system components exclusively in-house. These include (Figure 2):

- Selector sleeve
- Presynchronization detents
- Selector hub
- Clutch body
- Ring package incl.
- Carbon-based friction linings

With the development of friction linings, Schaeffler has completed its product portfolio and is now able to offer a complete synchronization system from a single source. This vertical integration is unique worldwide. When it comes to friction linings, it ranges from the selection of raw materials to the development and manufacture of the friction material and its attachment to the carrier.

However, the aggregation of optimized components often does not result in an optimum overall system. The development history of the selector hub is one such example: By reducing the size of the detent, the component can in principle become more robust and in a further step narrower. Converting the manufacturing process from sintering to metal forming allows another reduction in size and weight. However, if it weren't for the development of the

strut-in-sleeve design described in greater detail below, this step would lead down a dead end. A number of lightweight effects would remain out of reach since the correct function could no longer be guaranteed.

Other potential benefits can be tapped if the system expertise extends beyond the synchronization unit. The advantages of such an approach have already been demonstrated in specific customer orders.

### Opportunities resulting from the systems approach

#### A practical example

Economic considerations prompted the customer to use a clutch disk with a centrifugal pendulum-type absorber from LuK. However, this would have led to a level of gearshift comfort that would have been classified as not in line with market expectations (Figure 3). The reason for this was a 45 % increase in mass inertia at the transmission input, which would have led to increased gearshift forces if not countered. The default parameters of driver behavior, gearshift system, trans-

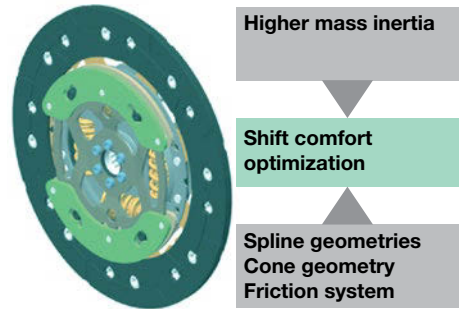


mission temperature level and the type of transmission oil to be used had to be taken into account.

Therefore, the development work focused on two main approaches:

- New tooth geometry of the selector sleeve and clutching teeth
- Verification of the friction lining and modification of the cone geometry and friction system

The measures taken regarding the first field of work were so effective that the existing friction lining was retained and a satisfactory overall result achieved. The testing and evaluation of the modified transmission took place both at Schaeffler and at the customer's premises. In particular, the operating life and the gearshift behavior were investigated and evaluated in detail. The simulation had already indicated that the new gearshift curve would be much more harmonious and this result was confirmed during the test stand trial (Figure 4). The comparison of the opti-

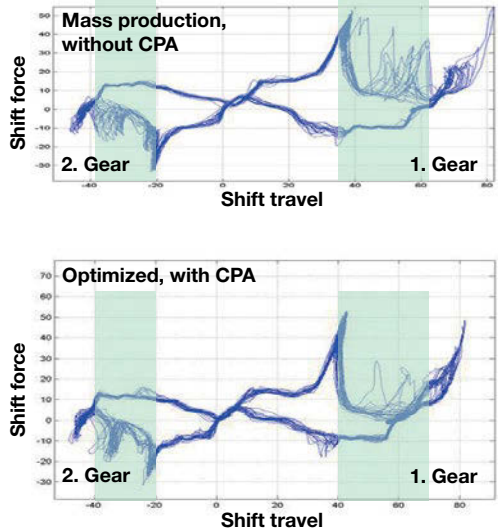


**Figure 3** Optimization of gearshift comfort, matched to a clutch disk with centrifugal pendulum-type absorber

mized transmission with the standard transmission in the vehicle finally corroborated that the optimization makes itself felt not only on the data sheets: The perceived gearshift comfort achieved a better value on the ATZ rating scale than the target specified by the customer.

	Customer target
Mass production (5.6 g m <sup>2</sup> )	7.25
Mass prod. w. CPA (8.1 g m <sup>2</sup> )	6.5
Optimized with CPA (8.1 g m <sup>2</sup> )	7.75

Perceived gearshift comfort (ATZ scale)



**Figure 4** Measurement of the gearshift gearshift curve before (above) and after. The perceived gearshift comfort was improved despite higher mass inertia.

## Carbon-based friction linings developed and manufactured by Schaeffler

Requirements to minimize the transmission design envelope and weight, and to offer increased gearshift comfort and higher power density require comprehensive, optimized synchronization systems.

In double clutch transmissions, the high performance requirement results from the skipping of gears: The synchronization system must compensate for a speed difference that normally does not occur in manual transmissions – and all this within a very short time. Drivers expect much quicker gearshifts with automated transmissions than they themselves could manage. Such operating conditions require high-quality synchronization systems which usually feature carbon-based friction linings. Schaeffler has already presented such a material with its “Friction Pad System”. After further developments, the new STC 300 friction lining is now available. The acronym STC stands for “Schaeffler Technologies Carbon” and refers to the base material.

The second new friction lining, STC 600, is based on this material too, however, it is a completely new development designed to meet the most exacting requirements.

### STC 300 – Carbon-based composite friction material

STC 300 is manufactured according to the method of molded friction material – a manufacturing technology in which Schaeffler Friction Products has been proficient for many years now. The friction lining is made of a composite of carbon and other materi-



**Figure 5** STC 300: Friction lining made of carbon-based composite material

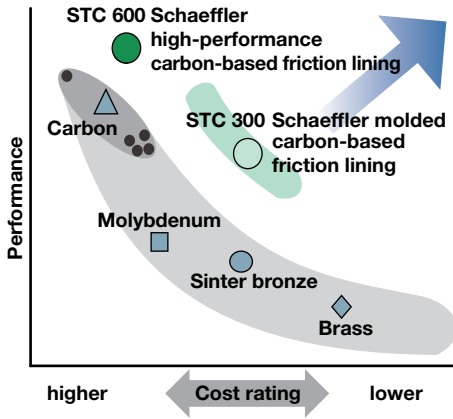
als, which are bound by resin (Figure 5). Schaeffler has developed and industrialized the production process. STC 300 offers significantly enhanced friction coefficient stability and wear characteristics compared with brass and bronze-sintered products, whilst having a similar cost level.

### STC 600 – Carbon fiber friction material

STC 600 is a carbon-based friction lining of the highest performance class. The lining is manufactured using a process derived from paper production (Figure 6). This manufacturing process, which was also developed by Schaeffler, offers significant cost benefits compared with woven material and provides equal and in some cases even better



**Figure 6** STC 600: Premium class carbon-based friction lining



**Figure 7** Performance of different types of friction lining in relation to costs

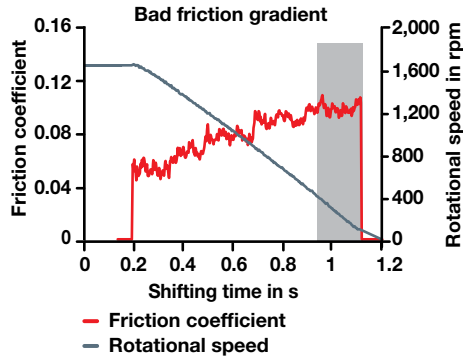
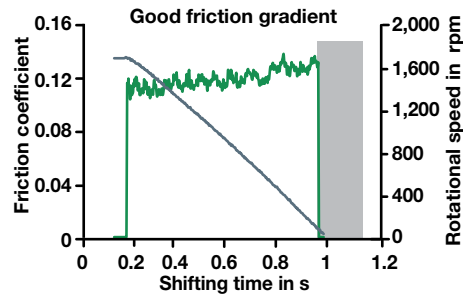
results compared with products of the same performance class (Figure 7).

**Performance**

STC 600 friction lining achieves excellent results in all relevant fields, such as consistent friction coefficient characteristics throughout the period of use, friction coefficient gradient and friction level within one gearshift operation as well as wear resistance. STC 600 is highly robust and can permanently sustain a high level of friction energy. This is demonstrated by the measurement and test results in absolute terms and in comparison with products that are currently leading in the market. These are presented in more detail below.

**Dynamic friction coefficient**

The speed at which the friction lining in contact with the synchro ring builds up the friction coefficient, as well as the friction coefficient curve during the gearshift operation both have a substantial effect on how the gearshift comfort is perceived by the driver. Ideally, the friction coefficient rises sharply to its maximum level and remains constant until the transmission shaft and the gear are synchronous. In practice, the maximum friction

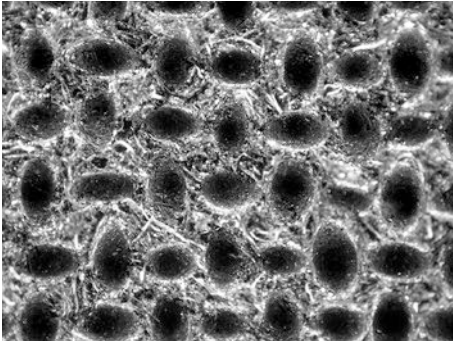


**Figure 8** Comparison of unfavorable (below) and good friction coefficient curves (above)

coefficient is reached only gradually, and after the displacement of the oil in the contact gap. The lower graph in Figure 8 shows an undesirable example: Such a friction coefficient curve either can no longer ensure the proper function or it negatively affects the gearshift comfort. The measurements show that the actual friction coefficient curve of STC 600 differs only slightly from the ideal curve (Figure 8 above). Among other factors, this result is due to the excellent drainage capacity of STC 600 (Figure 9).

**Friction coefficient level**

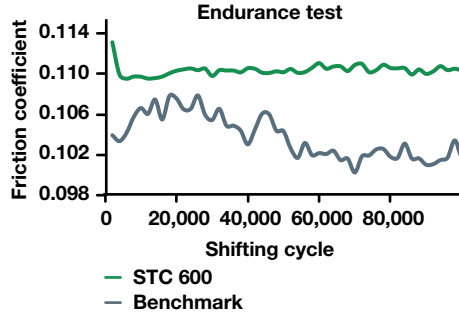
The coefficient of friction is decisive for the maximum achievable friction performance. The increased friction coefficient leads to higher friction performance, which means



**Figure 9** Surface structure of STC 600 friction lining

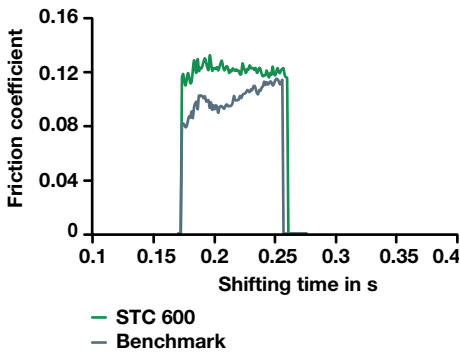
that the synchronization can occur within a shorter time. Values of 0.11 and above indicate that the STC 600 friction lining is a high-end product (Figure 10). Thus the friction material contributes to an increase in power density. Thanks to its high load capacity – both in absolute terms and relative to the benchmark – it is possible to reduce the necessary contact area and thus shorten the entire synchronization system. The gain in design envelope is added across all gear combinations and leads to a more compact and simpler transmission design.

Another indicator for quality is friction coefficient stability. This has practical relevance in that the gearshift feel remains the same over time. With STC 600, the start level remains practically unchanged over the entire operating life (Figure 11). The curve can be interpreted as a successful development outcome because a high friction coefficient and high friction stability are achieved at the same time. Technologically comparable materials statistically show a friction coefficient level of low uniformity over their operating life. In comparison with the materials commonly used on the market it is clear that the STC 600 friction lining is superior to those in particular in terms of friction coefficient gradients and curves (Figure 12).

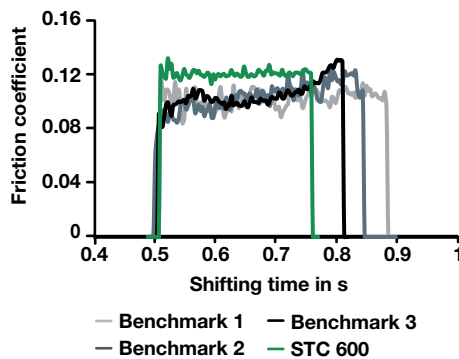


**Figure 11** Low spread of coefficient of friction during the operating life

STC 600 shows a convincing coefficient of friction in comparison with the benchmark (Figure 10). The graph shows that STC 600 maintains a higher and more stable friction coefficient during the shifting process compared to the benchmark. The STC 600 curve shows a sharp rise to a peak of approximately 0.13 at a shifting time of about 0.18 seconds, followed by a slight dip and then a steady decline. The benchmark curve shows a lower peak of approximately 0.11 at a shifting time of about 0.22 seconds, followed by a more pronounced dip and then a steady decline. This indicates that STC 600 provides a more consistent and higher friction coefficient during the shifting process.



**Figure 10** Convincing coefficient of friction in comparison with the benchmark



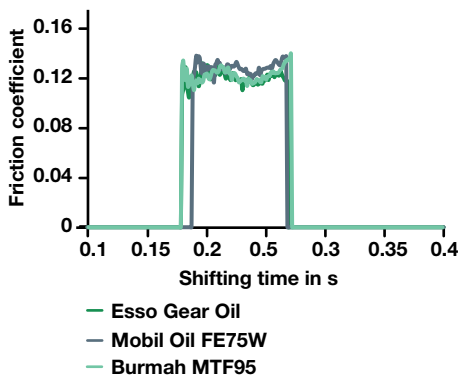
**Figure 12** Friction coefficient gradient of various materials in comparison

### Oil sensitivity and wear

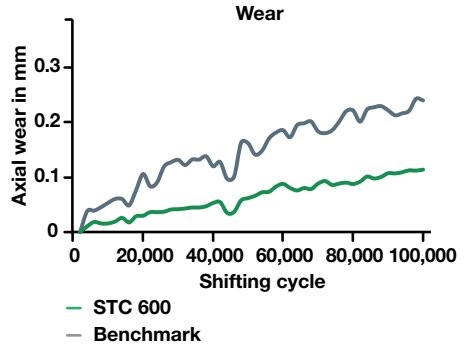
Depending on the oil, a friction material shows different behavior, in particular with respect to friction coefficient level and wear. A friction material is ideal from a customer's perspective, if it is equally efficient in all criteria in conjunction with any oil. In practice, this has not yet been achieved. When selecting the transmission oil, the primary focus is not usually on optimizing the gearshift comfort, but on protecting the gear teeth against wear and minimizing drag losses.

STC 600 friction lining shows relatively low sensitivity to the oils tested to date (Figure 13). The next development stage involves the extension of potential applications, for example, to a preferred type of transmission oil in a specific application. Schaeffler prefers to take this step hand in hand with the customer to ensure the best possible result.

When it comes to wear, STC 600 friction lining performs significantly better than the benchmark: Under the given experimental conditions and depending on the oil used, the necessary wear reserve for STC 600 needs to be only half as large, so that less installation space is required (Figure 14).



**Figure 13** Low oil sensitivity of STC 600

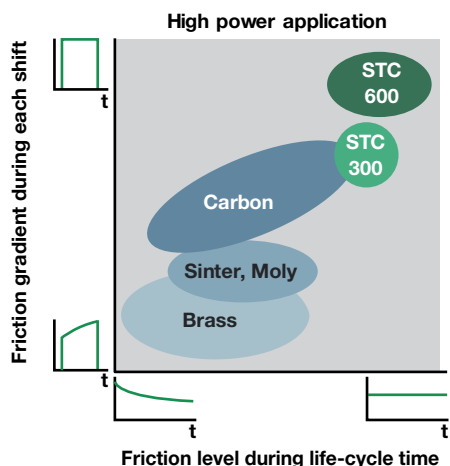


**Figure 14** Low wear over the operating life

### Results in overview

STC 300 and STC 600 have been designed for two different product categories. Both were developed by Schaeffler, starting with the selection of raw materials through to the finished product including the manufacturing processes, and they are manufactured using the company's own machines exclusively. The linings are positioned in different performance classes, but they all share the same carbon-based friction material. STC 300 offers higher performance in relation to friction coefficient stability and wear performance compared to brass and bronze-sintered products, but it comes at similar cost.

STC 600 achieves better results with regard to the essential criteria of dynamic friction coefficient, friction coefficient level and stability than the best products currently available on the market. In the combined analysis of friction coefficient stability over the operating life and the margin with which the different friction coefficients deviate from each other during the individual gearshifts, STC 600 is close to the optimum (Figure 15). Its sensitivity to the transmission oils tested so far is low. STC 600 also compares



**Figure 15** Overview of performance characteristics of STC 300 and STC 600

favorably to benchmark in terms of wear resistance.

## Innovative components with system impact

### Smaller design envelope and lower weight

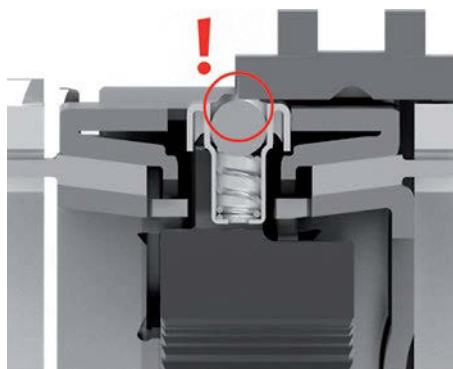
The goal of designing systems and components that are as light as possible while maintaining the cost targets also applies to the transmission and its subsystems. In addition, the minimization of the required design envelope is gaining more and more importance. The “strut-in-sleeve” concept is a big step forward in this regard. The name refers to the consistent further development of the selector sleeve, detent and selector hub and the optimized harmonization of these components. If all options are used, then the mass of each synchronizer can be

reduced by about 90 g. With a six-speed transmission this comes to about 350 g – secondary effects at transmission level not included.

### Operating principle

In the conventional design, the rib of the selector hub houses the pressure springs of the presynchronization detent. This installation space requires a specific mechanical strength which is achieved by appropriate material thickness. The further development of this basic design is a version using flat struts. These reduce the required depth of recess in the rib of the selector hub, which also reduces the stress peaks in the critical cross-section. In this way, higher torques can be transmitted with unchanged geometry. And vice versa: For an equally high transmission torque a narrower rib will suffice.

In principle, this approach would allow a narrower design for the entire selector hub and thus for the selector sleeve too. But since the shift path is a given, this op-

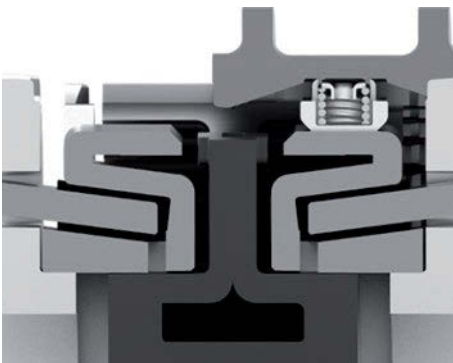


**Figure 16** With conventionally assembled detents, the scope for producing a narrower selector hub design is limited

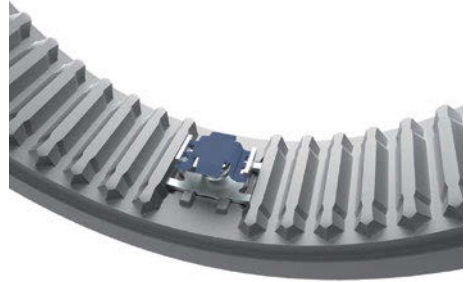
tion is limited. This is because when the gear is engaged, there is a risk of the detent balls getting stuck since the selector sleeve no longer covers them completely (Figure 16).

The strut-in-sleeve concept path paves the way towards a narrower selector hub. In this case, the strut is not mounted in or on the selector hub, but in a recess in the internal teeth of the selector sleeve. So during the gearshift operation, it is now guided by the selector sleeve (Figure 17).

With this innovation, the selector hub is no longer impaired in any way so that there are no longer any critical cross-sections. Now the width of the selector sleeve can be chosen freely and the opportunity of choosing a narrower rib can be fully exploited. This results in a far-reaching benefit: Every single synchronization system is about 2 mm shorter. Consequently the gears move closer to each other. This, in turn, allows the use of shorter shafts and ultimately a shorter transmission housing.



**Figure 17** With a strut-in-sleeve selector sleeve, the strut is guided in the direction of the gearshift



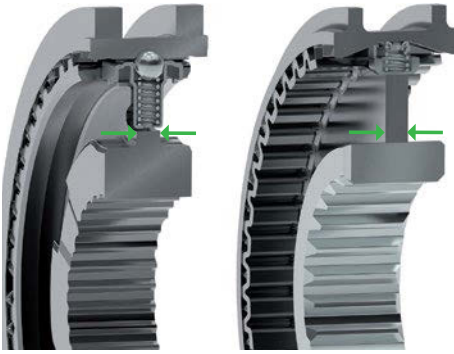
**Figure 18** Selector sleeve with integrated detent (strut-in-sleeve)

### System requirements

The strut-in-sleeve concept can be implemented at no additional cost. The basis for this is the selector sleeve manufactured by Schaeffler in volume production using forming methods. In contrast to components that are manufactured in a metal-cutting process from forged blanks, the integration of the usual three recesses for locating the struts does not require an additional operation. The recesses are designed so that the struts only have to be pushed in (Figure 18).

Selector hubs for car transmissions are now manufactured almost exclusively from sintered metal. Since the selector sleeve introduces the torque into the selector hub off-center, it is subject to high torsional and bending loads. Therefore the selector hub has a solid design and weighs several hundred grams. New product concepts based on sheet steel designs focus on two courses of development: One on weight optimization and the other on strength optimization.

At the current state of development, the strength of the weight-optimized design (Figure 17) is still in the same range as that of a powder metal sintered component. In the case of a six-speed manual transmission in the 350 Nm torque class, the weight advantage is about 350 g, which is equivalent to 25 % with regard to the synchronization units.



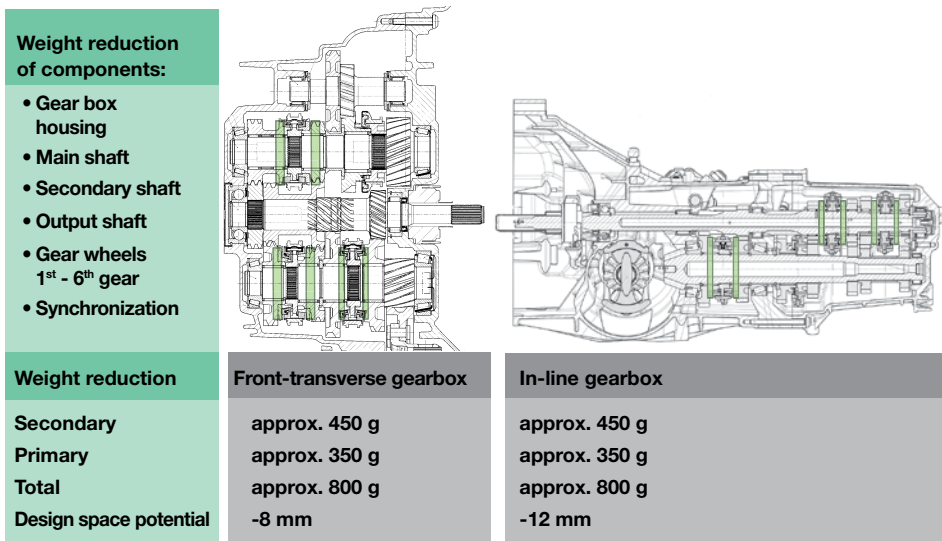
**Figure 19** Selector hub of steel (right) compared to one made of sintered metal (left)

The strength potential of sheet steel designs can be used to reduce the design envelope. As a result, the rib width as well as the width of the internal teeth of the sheet steel selector hub can be reduced so that the slightly higher density of steel is over-compensated (Figure 19).

## Transmission savings

Schaeffler has evaluated the possible secondary effects of a transmission optimized with strut-in-sleeve and improved synchro ring packages (Figure 20). For front transverse installations, the transmission housing is about 8 mm shorter due to shorter shafts. Depending on the conditions in the vehicle, this gain in design envelope can make a difference in compensating for the necessary enlargement of other components in the engine compartment. The weight savings from secondary effects alone add up to approximately 450 g. Primary and secondary effects reduce the weight by about 800 g.

In a longitudinally mounted transmission, the overall length is reduced by about 12 mm. The secondary effect in terms of weight and material cost is roughly equivalent to that of a front transverse transmission.



**Figure 20** Saving potential regarding weight and design envelope

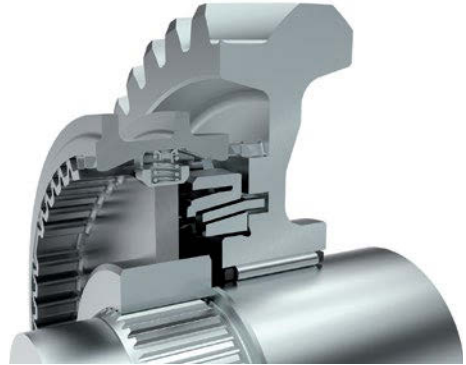


## Summary and outlook

Customers in growth markets and increasingly in industrialized countries are looking for suppliers who offer not only individual components but rather complete synchronization systems for their transmissions. Schaeffler has thus decided to become a system supplier and has complemented its product portfolio with the development of carbon-based friction linings. It now consists of a sheet steel selector hub, selector sleeve, presynchronization detent, ring package and gear cone body. Schaeffler has developed all these components and manufacturing methods and manufactures them in-house worldwide.

In the course of this product range extension, the company has continuously developed the expertise necessary to design synchronization systems using an integrated approach. This involves not only the validation of the specific component characteristics, but also the functional optimization of power transmissions from the clutch to the speed gear including vibration isolation, in vehicle tests if necessary. Schaeffler has already demonstrated its expertise in this area in related projects.

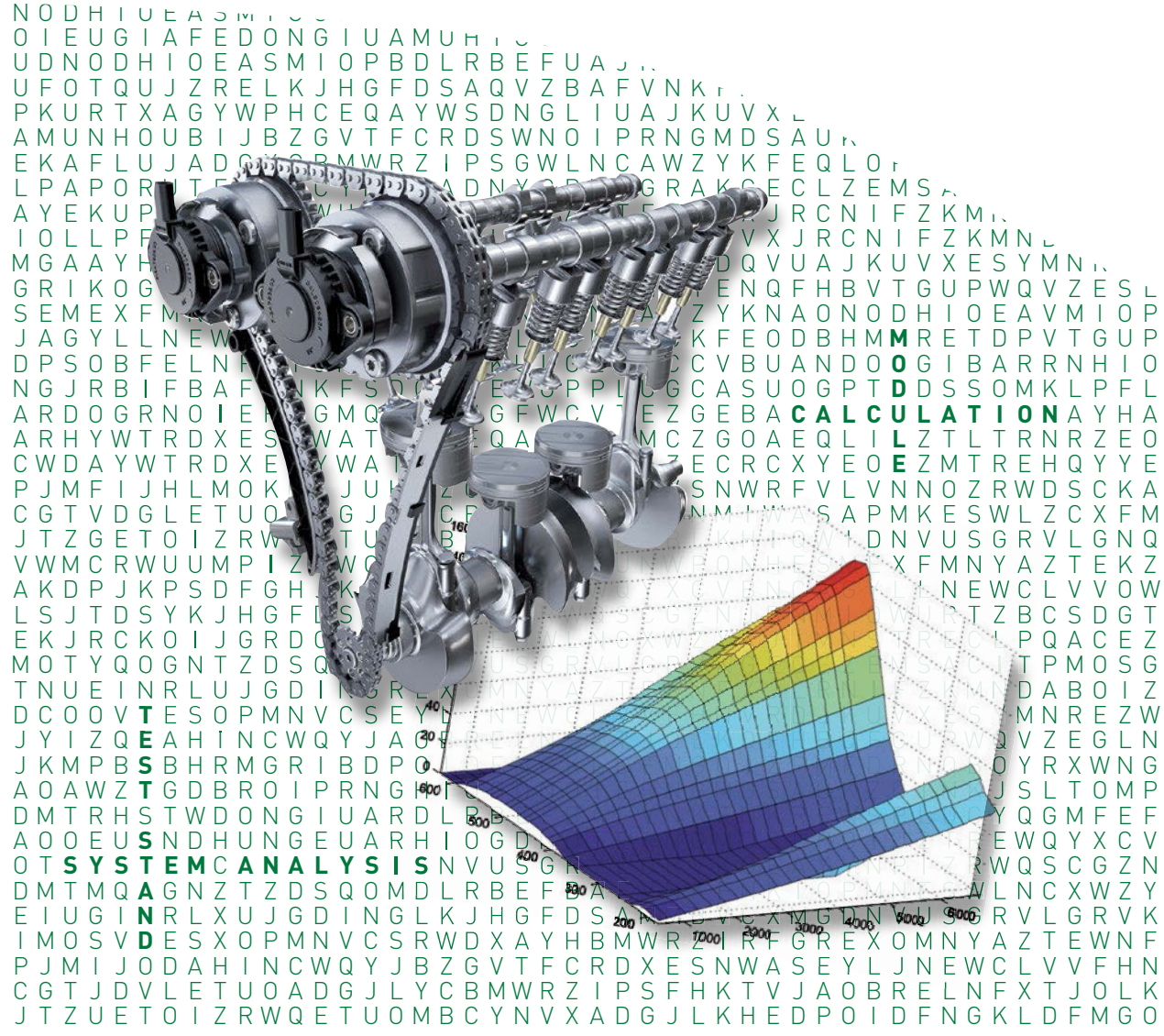
In system optimization Schaeffler can draw on its long-standing expertise in component development. Thanks to the high degree of vertical integration, the components can be precisely matched to each other so that an optimum result is achieved at the system level. Concepts such as strut-in-sleeve combined with a selector hub



**Figure 21** Further potential for reducing the design envelope can be tapped by including the freewheel and bearing support in the optimization of the synchronization system.

made from sheet steel illustrate the potential: The secondary effects of a shorter synchronization system result in a more compact and lightweight transmission.

The aim of a smaller design envelope will be given even more attention in the future. A development approach that extends beyond system boundaries opens up the opportunity of achieving even better results than the ones described above – for example, if the speed gear is included in the optimization of the synchronization system (Figure 21). However, designs that extend far beyond those currently encountered on the market require new solutions for the bearings and gears. Therefore, the company's combined expertise in the area of tooth systems and bearings is gaining increasing importance in the further development of synchronization systems.



# Holistic Simulation

The future approach for calculating engine systems?

Dr. Christoph Brands



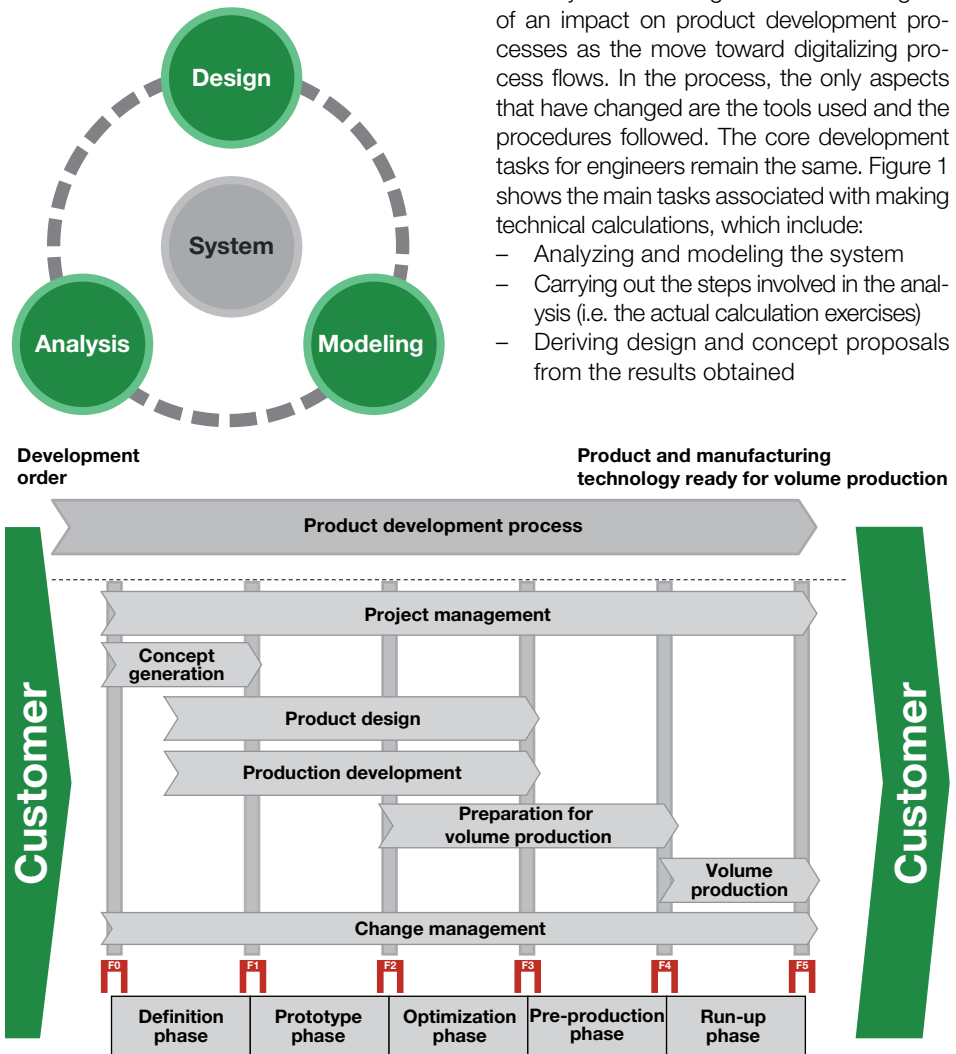
## Introduction

Ever shorter development times, an increased range as well as continually more complexity and diversity of engine systems, are the megatrends driving the value-added chains in the au-

tomotive and supplier industry. To relieve some of the pressure exerted by these processes, virtual product development has become an essential component of design and engineering work. When incorporated in time, technical calculations can facilitate quick response in many different areas and thereby effectively shorten development cycles and times.

Very few technologies have made as great of an impact on product development processes as the move toward digitalizing process flows. In the process, the only aspects that have changed are the tools used and the procedures followed. The core development tasks for engineers remain the same. Figure 1 shows the main tasks associated with making technical calculations, which include:

- Analyzing and modeling the system
- Carrying out the steps involved in the analysis (i.e. the actual calculation exercises)
- Deriving design and concept proposals from the results obtained



**Figure 1** Tasks associated with carrying out technical calculations during the product development phase

## System Analysis and Modeling

---

Modeling always revolves around simplifying the properties and characteristics of the real, physical system. A simulation only provides results that relate to the model at hand and its performance limitations. Therefore, in order to ensure that the work carried out at this time can be transferred as required, steps must be taken to verify that the model (depending on the level of detail it incorporates) exhibits the right tendencies and leads to the correct quantitative results when used under defined system limits as performance parameters are varied in real time. This validation is typically realized by drawing comparisons with trial testing data. Different models with varying levels of detail can be created depending on the knowledge acquired about the real system. If the physical correlations of the real system are not known, a mathematical model can at least be made that provides corresponding results for changes to input parameters. In the most basic scenario, this takes the form of a regression of existing trial testing data (data-based modeling).

If the physical correlations are known, however, and sufficient, reliable input data is available, analytical approaches or complex physical models can be devised and solved numerically.

Unlike the realm of natural science, engineering involves simplifying matters and concepts on a daily basis. This abstraction or simplification is a key tool used to systematically approach complex systems. A good example of this is the pendulum as considered in the context of a point mass with respect to a thread that has no mass. When small angles are observed,  $\sin(\Phi(t)) = \Phi(t)$  is then used by way of the Taylor approximation. Modelling

also involves accepting the risk of incompleteness. To this end, when system analyses are carried out, all required effects must be identified and factored into the model so that technical and design-related questions can be answered. In order to safeguard reasonable calculation times with respect to numerical computability (stability), the model must also not be overloaded with performance data. After all, the right model must be processed using the right tool, depending on the question to explore.

One of the main tasks involved in technical calculation exercises is therefore to conduct an initial system analysis and create a model to establish a baseline. The next step is to check the plausibility of the external and internal input data available and to provide this data in a suitable format for the simulation as required. This includes geometric data from CAD systems as well as functional data such as plotted rigidity curves. Checking and verifying the input data is critical, since every result obtained directly correlates with the quality of the data itself. All process steps must be accompanied by a defined change management policy such that when geometric or other relevant data is changed, this is communicated appropriately.

### External Influential Factors

As an integral part of the product development process, the technical calculation department must deal with and account for external influential factors as is required of all other participating departments. These factors can encompass the needs and preferences of specific markets and economic requirements as well as key technical aspects (Figure 2). The automotive industry is currently being pressed to design and build vehicles that offer ever better levels of efficiency.



**Figure 2** Trends in the automotive industry

Expressed in specific terms, this translates to such developments as:

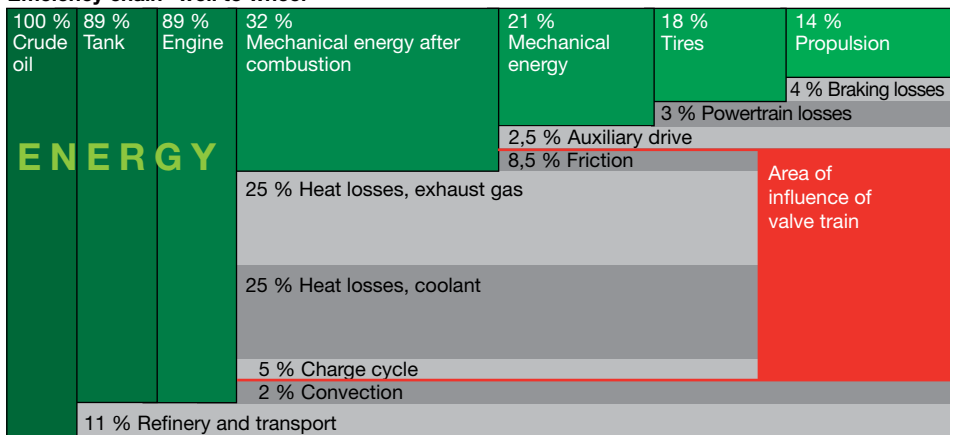
- Optimizing engine output by making the air path variable in design (VT, VCT, ECP)
- Reducing mechanical loss by enhancing tribological systems
- Integrating lightweight materials
- Electrifying the powertrain

In addition to satisfying customers by offering more fuel-efficient passenger cars and meeting self-imposed obligations, complying with ever stricter CO<sub>2</sub> emission regulations further motivates the entire industry to design and

engineer engines and vehicles that consume less fuel than their predecessor models.

It goes without saying technical calculation experts need to address these constraints by amassing new knowledge and devising methods that cater to this trend. Correctly evaluating internal engine measures requires a great deal of knowledge about thermodynamics, for example, and the increasing complexity of modern systems designed to enhance variable response characteristics need to be thoroughly understood to accurately integrate them in a simulation model. The same ap-

**Efficiency chain “well to wheel”**



**Figure 3** Energy lost from mining crude oil to operating a vehicle (“well to wheel”)

plies to components and systems used to electrify or hybridize powertrains. In addition, methods must be devised to reliably predict the outcome of friction-reducing design measures. Figure 3 provides a starting point for achieving higher levels of efficiency. As various sources indicate that by 2020, up to 1.5 billion vehicles will be in use around the world, of which well over 90 percent will have an internal combustion engine, it pays to further optimize the internal combustion engine.

Not only have these trends in technology made a significant impact on the development work and technical calculations carried out by the automotive industry, but also the recent move toward globalization. In the process, basic engines (world engines) are now being assembled in large numbers and subsequently adapted to different vehicle classes by varying the levels of performance and equipment accordingly. This, in turn, necessitates highly robust methods when it comes to technical calculation, since any inherent design flaw has the potential to affect that many more units. The models used must also accurately represent each individual variant.

Globalization has likewise led to a change in production locations, which are now spread across multiple geographical regions that are served by a separate group of suppliers offering different material mixes. This brings with it the consequence that the development teams themselves are also distributed around the globe and must collaborate to resolve the intercultural, regional, and method-based problems that arise in this context.

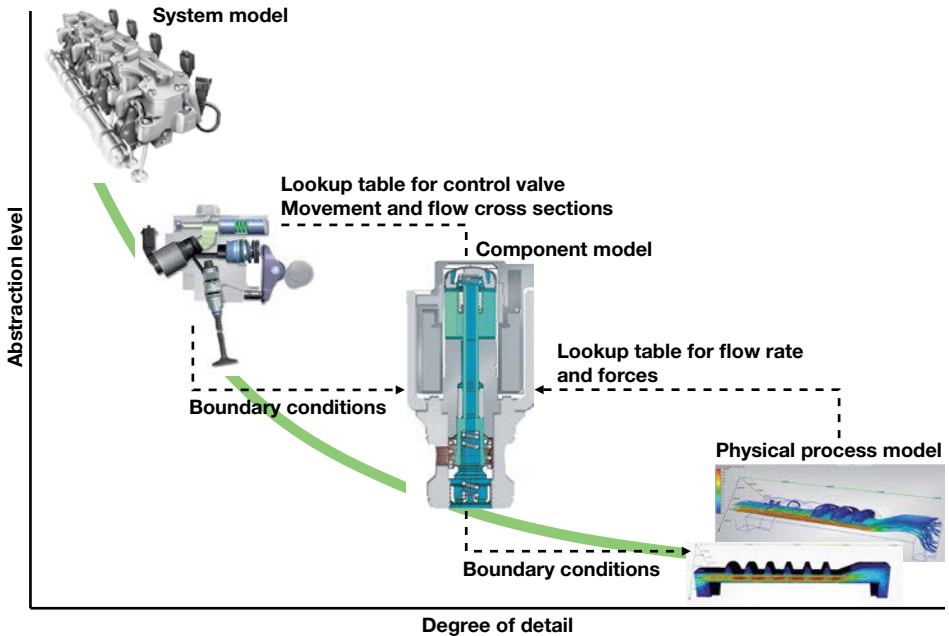
If the full potential that technical calculation has to offer is to be leveraged, the practices that it entails must be integrated in the overall design process as early as possible, and all departments need to collaborate effectively on a daily basis. This applies to new developments and products in particular. Established components and systems require less commitment, since specifications and

standard performance criteria are already in place and used around the world.

When new, highly sophisticated systems and hardware are designed, rapidly constructing simulation models around defined performance criteria is not an option, since this approach does not guarantee reliable, accurate results confirming that the function required operates within the target parameters assigned to it. Complex systems can sometimes take years to establish the right development environment including models and processes. The benefit, however, is that validated models and procedural approaches are created that are robust and can provide qualified answers to a wide range of questions in minimal time, including to ones that are asked on short notice. This, in turn, reduces outlay and underscores the true value of technical calculation.

### Internal Influential Factors

The individual phases of the product development process (PDP) correlate with different technical questions and issues that pertain to aspects of manufacturing and product development and also have a noticeable effect on modeling. This effect becomes apparent as soon as a project is started, when reliable input data is frequently not available. At the same time, the manufacturer and suppliers are busy making a great deal of changes such that the initial priority is to limit efforts to investigating the primary effects that will point to the best possible concept to be adopted (design definition and finalization). When familiar components or systems are integrated, a lack of data can be temporarily substituted with values from existing databases. The results provided by the simulation must then be taken into account with this constraint in mind and replaced with qualified, realistic values later on. In addition to this time-



**Figure 4** Modeling and system analysis

based component in the product development process, technical calculation work is also characterized by the experience that has already been gained with the system being developed.

For existing products, all recurring processes have usually been automated or at least defined in a specification (Figure 4). This is absolutely essential, especially in the case of global projects. After tools have been automated in line with technical calculation data, they can be handed over to the project engineers, who then make smaller calculations on their own and profit from expedited response times. When a finger follower is designed, for example, the question of rigidity becomes relevant. Schaeffler has fully automated this calculation and integrated it in its CAD system. Ninety-nine percent of the time, the system e-mails an automatically generated report to the project engineer at the click of a mouse just a few minutes after the start of the calculation.

The situation is different when new applications are developed, however, which are characterized by different levels of modeling detail as a result of the individual phases of the product development process and various questions fielded by specialists. Production planning personnel, for example, do not ask the same questions as the software department tasked with programming the functions for the engine control unit. Constructing a complete model that can answer all of these questions is usually too complex, requires too much calculation time, and is sometimes not even possible. Models are therefore constructed to target a specific question pertaining to a certain technical aspect and do not map an overall scenario.

One example of a scenario in which many different questions are asked throughout the product development process involves the multiphysics simulation model for the quick-acting valve used in the fully variable UniAir valve train (Figure 5).



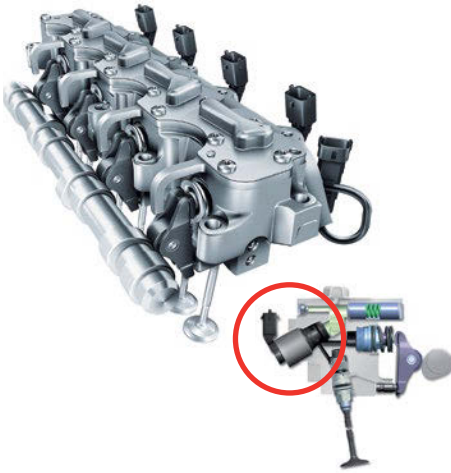


Figure 5 UniAir system

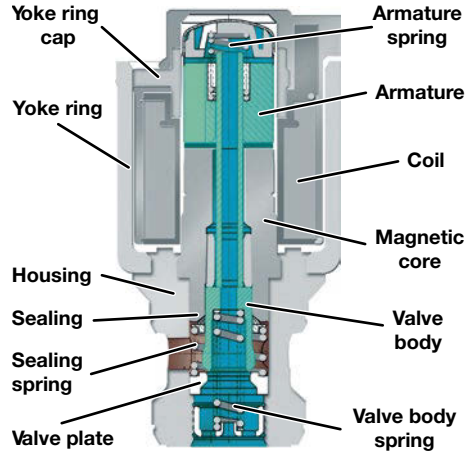


Figure 6 Quick-acting switching valve

The UniAir system comprises a camshaft-controlled actuator with an integrated, quick-acting hydraulic valve and corresponding valve timing software [1]. The switching valve is a de-energized, open 2/2-way switching valve by design that displaces a valve body relative to the valve seat to

open and close the connection linking the high and intermediate pressure chambers.

To bring the quick-acting valve into the development environment (Figure 6), a multiphysics simulation model was created that maps and correlates all mechanical, hydraulic, magnetic, and electrical design as-

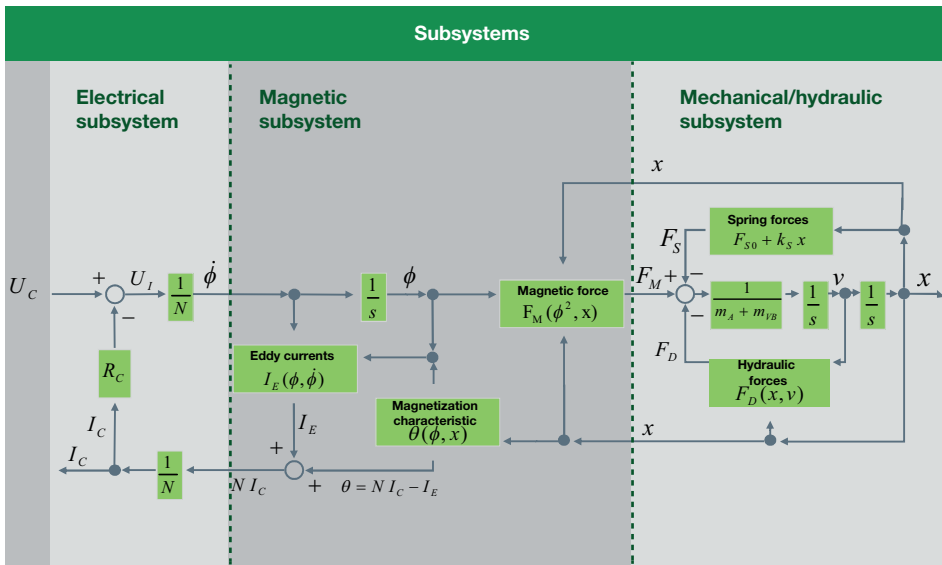
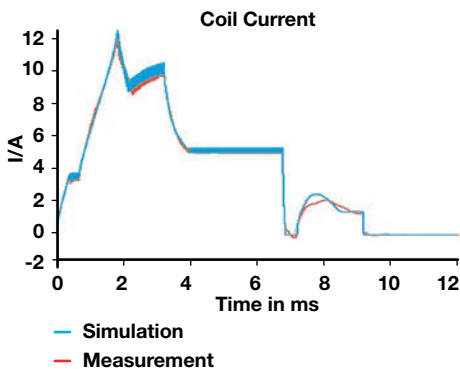


Figure 7 Physical interactions with the quick-acting switching valve

pects. Figure 7 shows the coil current. After an initial current is introduced, the maximum rated voltage is applied to produce a magnetic flux while generating the coil current and magnetic force required to close the valve. When the maximum current is reached, the closing time is characterized by a bend in the current signal (“V shape”) as a result of an actuation triggered in the presence of a constant pulse width modulation (PWM) of between 0 and 12 V. During the hold phase, an electrical current lower than the one observed in the peak phase ensures that the closed position of the valve is reliably held. Although the energy consumed at this time continues to be high, it is in line with operating requirements [2].

The valve is opened when the coil is reverse connected to the Z diode, which causes the magnetic force to quickly deplete and triggers a fast opening movement. The opening time is detected by short-circuiting the magnetic coil so that the remaining magnetism produces a current coincidental with the motion pattern of the current signal via the magnetic-mechanical coupling. Raising and overshooting the anchor as a magnetically active component, however, means that the exact opening time can only be determined using higher outlay than that for the closing time.



**Figure 8** Comparison of measurement and simulation results

When all required correlations are taken into account, a high level of conformity between the results of the measurement and the simulation is achieved (Figure 8). This, in turn, makes it possible to use the model to quantify the influence of a leakage gap variation on the operative function, for example. Questions of this nature are typically fielded by production planning experts, since the size of the gap can lead to varying costs.

The model does not lend itself to answering questions fielded by the software developers responsible for realizing the functions for the control unit. Instead, a model with real-time capability is required whose simulation time corresponds with the time spent in the real world, much as is the case in a flight simulator.

## Analysis

After system analysis and modeling have been carried out, the actual analysis work takes place. In the most basic of scenarios, calculations are run using an appropriate software application. This step can also involve model verification or a sensitivity analysis, however, which can retroactively affect the initial modeling. The objective of this verification of unknown or new models is to identify sensitive parameters to keep the number of parameters targeted for investigation as low as possible, thereby minimizing calculation times. When a finite element calculation is made, for example, the influence of temperature on the steel components in the cylinder head is not varied, since the elasticity module that relates to the temperatures prevailing in this area exhibits almost no change as the dominating influential parameter.

Model verification answers the question of which and how many parameters should be varied. Once this list has been defined, optimization algorithms such as DoE (Design of Experiments) allow the input parameters to be varied during the analysis until the de-

sired characteristic statements are quantified. These methods can also be applied to leverage the calculation work so that recommendations for reference samples can be made to the testing department. Numerous additional methods are likewise available for optimizing earlier development stages.

## Support for Design Drafting

Deriving draft or concept-based proposals is included among the core tasks assigned to the technical calculation department. The following example shows a holistic simulation for optimizing a timing drive to minimize friction.

In dynamic systems, friction provides for the necessary level of damping while at the same time exerting a negative effect on operating efficiency. To answer the question of the extent to which reducing the friction experienced in the timing drive can reduce fuel consumption, calibrated engine models must be created using corresponding data about the vehicle. In so doing, the same methods and models that were constructed to assess the potential improvements afforded by complex valve train strategies can be applied here as well.

The first step is to realistically map the effects on the internal combustion process in the model. Due to the many combinations of input data possible, the pronounced efficiency for projecting the rates at which heat is released makes quasi-dimensional internal combustion models the ideal choice in this regard. Altered operating conditions such as engine speed, load, residual gas content, air/fuel ratio, and changes in charge movement can then be evaluated. To analyze changes in knocking tendency and the resulting main combustion point, Schaeffler adopts an Arrhenius approach, while a physical-based method according to Fischer is used to account for mechanical losses. The parameters for realizing the best fuel consumption are determined at stationary mapping points that result from the frequency distribution for the combined engine and vehicle investigated in the respective driving cycle. In order to improve the design draft parameters for a large number of possible variants in the relevant section of the data map, stochastic optimization methods are leveraged. Final evaluation of the varying design draft strategies for the combined engine and vehicle is made in different driving cycles in conjunction with the overall vehicle simulation (Figure 9).

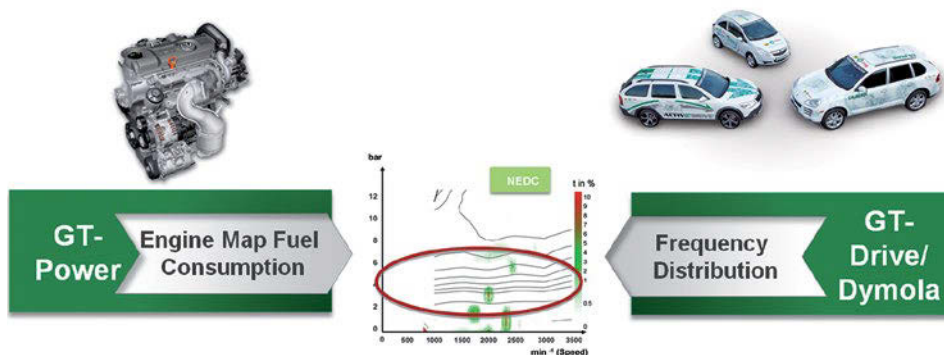
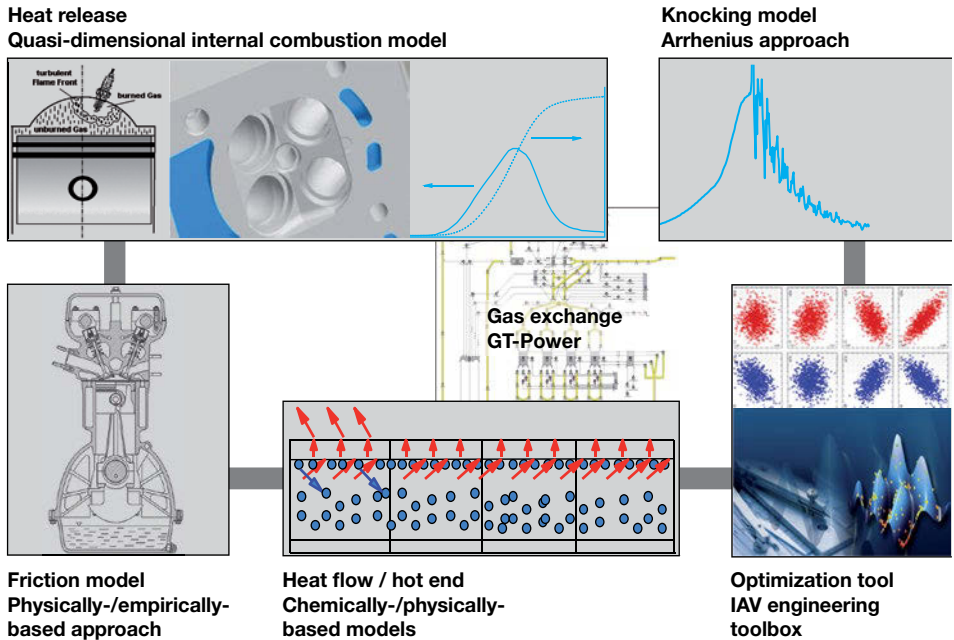


Figure 9 GT-Power modeling



**Figure 10** Calculating fuel consumption with GT-Power

The optimization models and tools shown in Figure 10 are leveraged to project combined fuel consumption [3].

To enter the corresponding data in the GT-Power model, the reduction in friction in the timing drive that is responsible for 0.5 to 2 percent of the overall loss in efficiency [4] must be examined in greater detail.

Friction can never be eliminated altogether. At the same time, however, losses must be minimized and the influential factors and interactions within the systems must be understood. By utilizing friction in a targeted manner to optimize the chain drive, the damping properties it affords can make a significant impact on limiting peak points in dynamic force. The majority of tribological systems in an internal combustion engine as it is operated or being started encounter the different types of friction (static, boundary, and hydrodynamic friction) at different frequencies.

After specialists have identified the friction phenomena that occur at specific times and in specific areas while taking the interactions in the relevant systems into account, suitable measures can be selected and combined to optimize efficiency as far as possible.

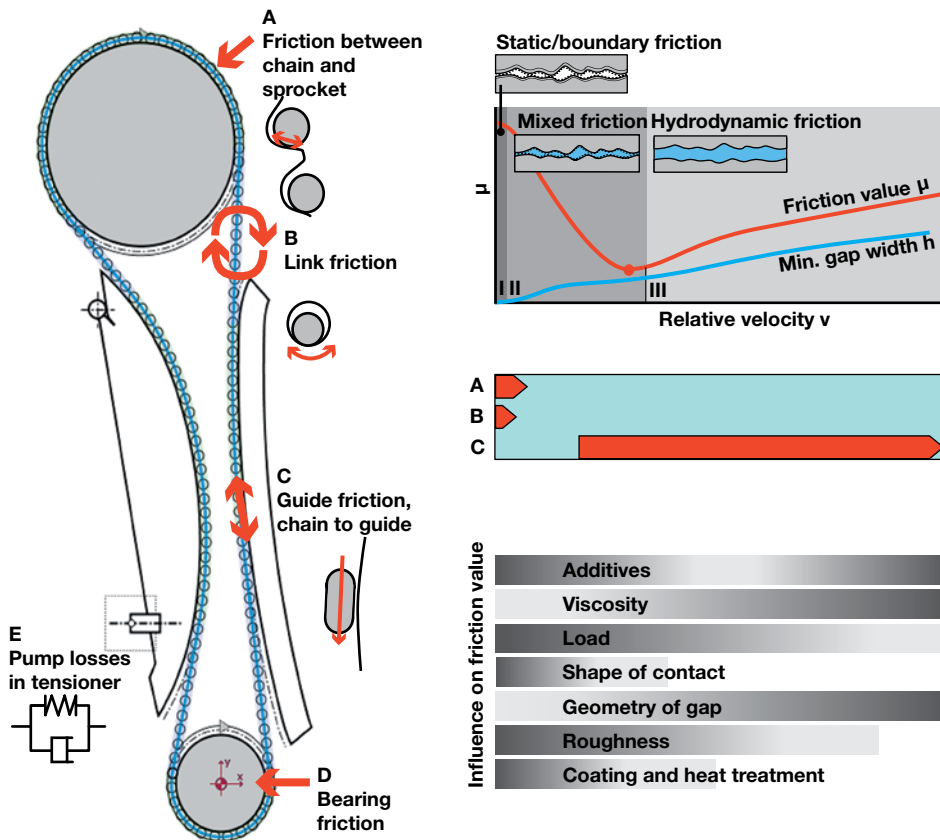
Figure 11 shows the friction types present in the chain-driven timing drive. This friction encompasses the mesh points of the chain (A), the friction in the chain link joint (B), and the friction between the chain and guides (C). Adding to this is the friction observed on the bearings of the crankshaft and camshaft as well as any auxiliary drives (D), and the losses within the tensioning elements (E).

Two problem areas arise when modeling friction in multi-body systems. The first involves correctly describing the configurations associated with static and sliding friction by making differential

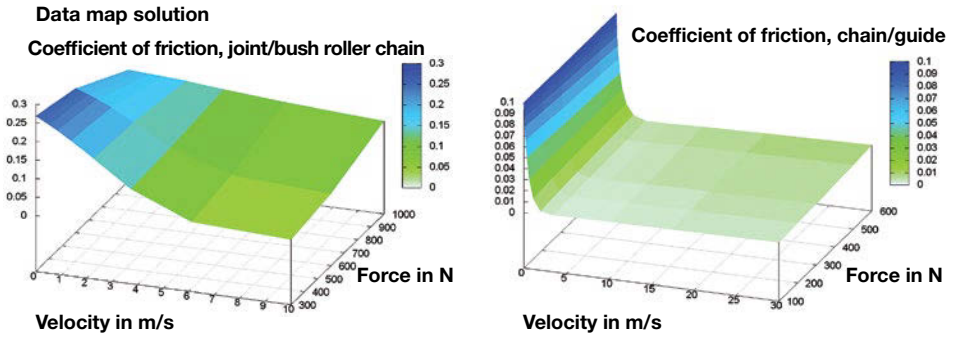
equations and numerically resolving them for a transient simulation. Frequently, the possibilities for physically describing static and sliding friction are defined by the solution algorithms available. With respect to the dissipation of energy and the pronounced dynamic characteristics of the timing drive and chain drive system, the variability of the coefficient of friction under static conditions is of minimal significance such that a breakaway torque can be specified. The second problem is determining the coefficient of friction under sliding conditions, or characterizing the kinematic variables and

physical parameters that influence this friction.

The transition from static to sliding friction is described by a new model that is being used in a simulation program at Schaeffler for the very first time. To this end, the static potential of a contact that is momentarily stationary is balanced against a virtual displacement. This potential is calculated using the parameters that describe the contact and include the coefficient of static friction, speed, and normal force. When the static potential of a contact is exceeded, sliding friction occurs.



**Figure 11** Friction points in the timing drive



**Figure 12** Data maps for the coefficient of friction and mixed-friction state

As soon as the system starts to move, the coefficient of sliding friction must be determined to quantify the friction at the contact. A single variable factor that changes depending on the type and state of the tribological system enters the equation at this point, which is why describing the coefficient of friction during the sliding phase is pertinent to observing the system from an energy perspective. When the system experiences

sliding friction, the coefficient of friction is described by data maps using state variables such as speed and load.

The left side of Figure 12 shows, by example, the coefficient of friction determined for the contact point of the chain link joint in a bush roller chain during model testing with respect to the data map. This map was plotted in relation to the sliding speed and normal force. The coefficient of static fric-



**Specification for the highly dynamic chain test stand**

- Hydrostatically supported shafts
- Drive motor with rotational irregularities similar to a crankshaft
- Brake torques similar to a camshaft
- Constant brake torques possible
- Direct chain guide friction measurement
- Conditioning of oil temperature and oil quantity

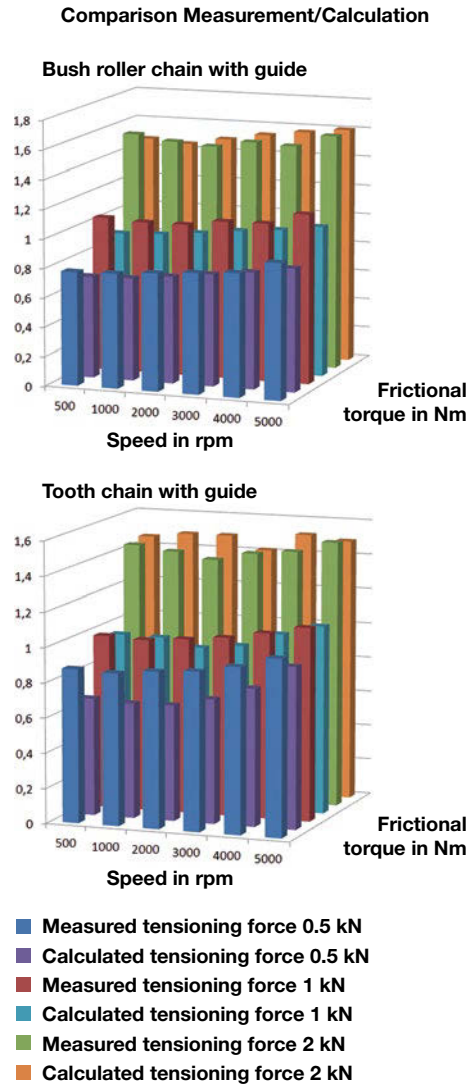
**Figure 13** Highly dynamic chain test stand

tion is approximately 0.25. When local sliding speeds increase, the coefficient drops to around 0.01. Higher normal forces cause the friction level to rise as a result of the increased proportion of solid content. The diagram on the right side (Figure 12) shows the friction value map for the contact point between the chain and guide in identical fashion. These data maps are determined for every frictional contact point (A, B, and C) in the timing drive of each chain type taking into account all additional, relevant parameters such as oil quantity and quality, the material mix, and roughness. The maps are then made available to mark the boundary conditions for the simulation and allow friction losses to be quantified.

To validate the model and define parameters for friction modeling, Schaeffler and IFT designed and constructed a highly dynamic chain test stand that comprises a separate electric motor to produce driving and braking forces. This makes it possible to simulate not only the dynamic rotational imbalance near the crankshaft, but also the braking torque of a crankshaft assembly to reproduce realistic performance constraints. Figure 13 provides a schematic representation of the design configuration.

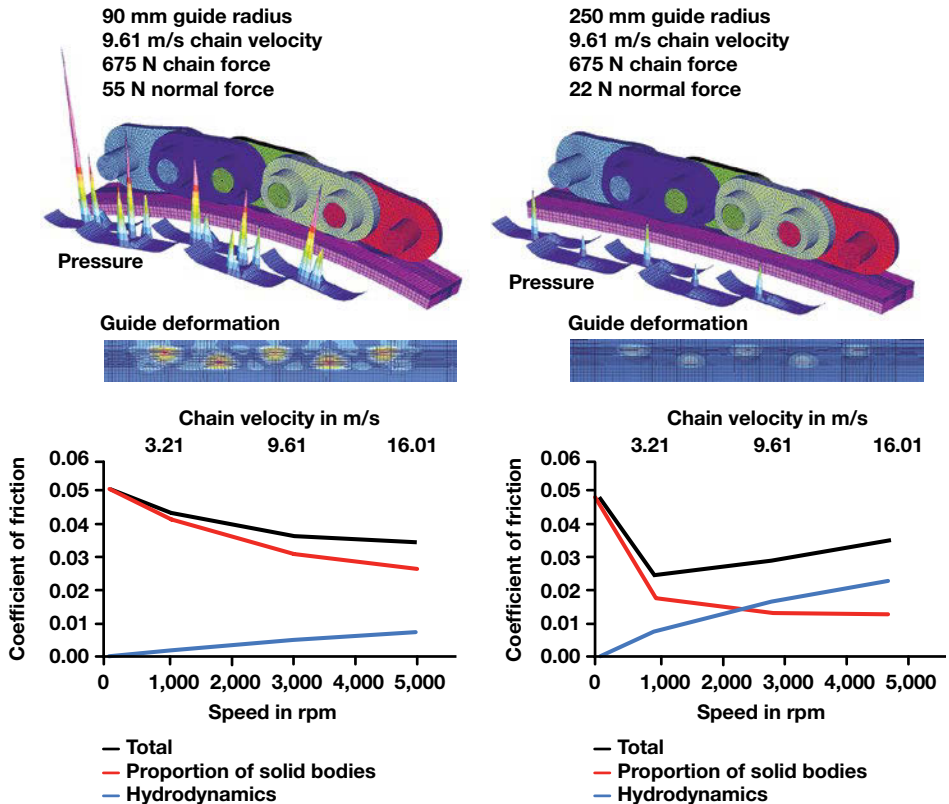
The supply unit for lubricating the chain is realized by an external oil assembly that is positioned in the immediate vicinity of the test stand. Heating and cooling systems allow the oil quantity and quality to be conditioned, and the friction observed between the chain and guide can be determined. Figure 14 shows the high level of conformity of the measurement data and simulation results. The method can therefore be used as a predictive tool for product development.

A high-resolution elastohydrodynamic simulation technique (EHD) is also employed to determine the dependencies surrounding the different frictional states. This technique accounts for the elastic characteristics of the contacting partners in conjunction with geometry, contact curvature,



**Figure 14** Comparison of measurement data and simulation results

roughness, oil properties, and the variables of load and speed that change with respect to time and location. Figure 15 shows the models used to determine the tribological system attributes of the contact point between the chain back and the guide.



**Figure 15** Influence of the guide radius on the friction between the chain and guide

The EHD simulation technique is capable of determining the proportional relationship of hydrodynamic response and solid body contact, which in turn makes it possible to systematically optimize the contact point between the chain and guide. Figure 15, for example, shows that with a guide radius of 90 mm, the proportion of the solid-body friction encountered dominates. The mixed-friction range is also constantly present, even when the system is operating at high speeds. When larger guide radii are introduced, however, the hydrodynamic proportion increases much more quickly as operating speed builds, while the overall friction value is much less pronounced.

## Outlook

Digital tools have greatly accelerated the planning and development processes carried out at Schaeffler, and the transition from the pilot stage to commonly used practices has largely been finalized. Now is the time to firmly establish the tools in the organizational structures and further optimize the ratio of outlay to usable gain by leveraging the variety of digital methods available. Starting points include standardized processes, methods, and IT solutions as well as improved integration of production data in the product development process.

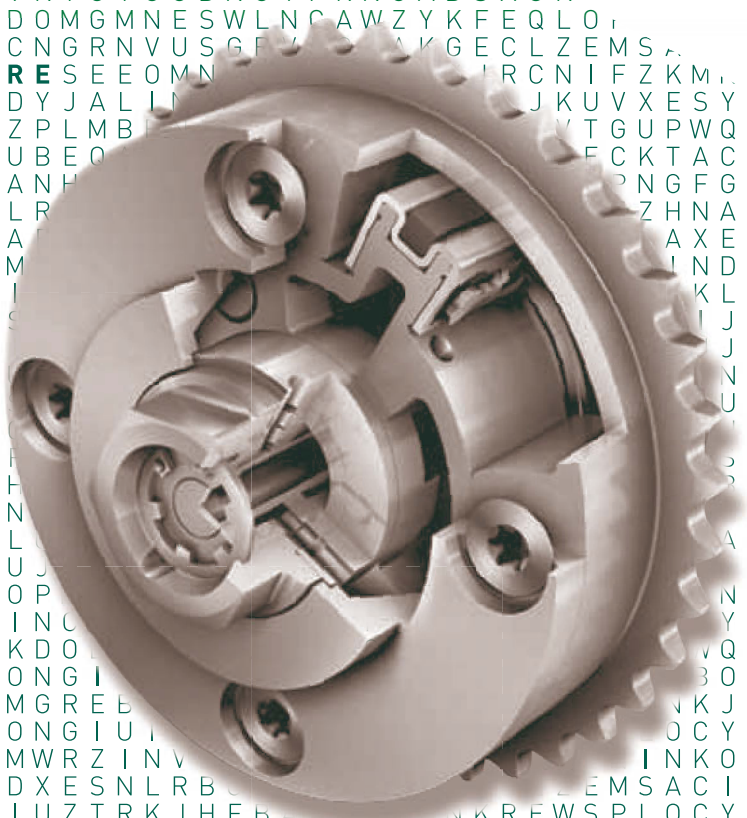


## Literature

---

- [1] Haas, M.: Just Air? UniAir – The first fully-variable, electro-hydraulic valve control system. 9<sup>th</sup> Schaeffler Symposium 2010, pp. 250-263
- [2] Mayer, A. et al.: Multiphysikalische Simulation eines schnellen Schaltventils für einen elektrohydraulisch vollvariablen Ventiltrieb. 13<sup>th</sup> MTZ symposium, "Virtual Powertrain Creation", 2011
- [3] Kirsten, K.; Brands, C.; Kratzsch, M.; Günther, M.: Selektive Umschaltung des Ventilhubes beim Ottomotor. MTZ 11/2012, pp. 834 - 839
- [4] Schlerege, F.; et al.: Optimierung von Steuertriebketten durch erweiterte Reibmodellierung. 5<sup>th</sup> VDI symposium on cylinder heads and friction, 2011

N O D H I U E A S M I S U I U A M U H I C  
O I E U G I A F E D O N G I U A M U H I C  
U U D M P O D T H M G R X B D P B L R U Z T R E W  
U A O B N I M I K O Q A Y L A R N L D B E U B A F V N K  
A A M O A L T E R N A T I N G R T O R Q U E L S E R N G M J B  
A E K J I C H B Z G W R Z V K I O I O G D N O I P R N G M D S A U  
E M O T M V T I L Q N V X D O M G M N E S W L N C A W Z Y K F E Q L O  
M T N U G O G W J P N E D C N G R N V U S G F Y A K G E C L Z E M S  
T D C O I L C P R E S S U R E S E E O M N I R C N I F Z K M  
D J Y I J U Q A C E Z R W D Y J A L I N I J K U V X E S Y M  
J K P E L M Y B G D S W L Z P L M B I Y T G U P W Q V Z E  
K Z B P E E T P M O S G R U B E O I F E C K T A C T S V Q Q D L  
Z T N E H B D A B O I Z Q A N H I P N G F G R G H N W E  
T C R O E A M N R E Z W C L R I A X E V E D K D L  
C B E F S C V Z E G L N F A I N D E R Z N U B  
B S O B P C V R X W N G K M I K L P S X W E W  
S F E I W U S L T O M P L I J M I K O Q A  
F C W D A M Q G M F E B S N U T E Q T F  
C P J M F U S L W I K A P U H B Z G W R  
P C G T V L T P M O S G R U H T I L Q N V  
C J T Z G A Q D M F E F B S G W J P N E  
J V W M C T B H U Z G F D C S D G T R  
V A K D P O M S E A J H G F H A Y B G D S W  
A L S J A R S K O T J Q O G N L T P M O S G  
L E K J L E K O T J Q O G N L T P M O S G  
E G L N E M O N U J U I N R L U J U I N R L  
X W N G M O M P E S N R L U J U I N R L  
T O M P T F E F O T C E S O P E N D A B O I Z  
M F E F D I K A Z M Y A H I N C Y M N R E Z W  
W I K A J O S G V E J R A K D O I V Q V Z E G L N  
M O S G N F E F O N A N D O N G I U I N R L  
M F E F A Z G F B T D B H M G R E E B O Y R X W N G  
U Z G F U O Q A E T A N D O N G I U I N R L  
A A O E A Q T F F S Y H B M W R Z I N V O C Y Q G M F E F  
M O T F M O T B Z P F C R D X E S N L R B C I N K O S L W I K A  
U D B Z U D B I D E E Q R I U Z T R K J H F B A N K R E W S P L O C Y Q D M F E F  
F E I D F E I M N E D R E C L P Q A W D X F D S A M M B V C X Y M L M O K N I J B H U Z G F  
C I M N C I M H Y D R A U L I C S I Z G V Y H B M W R Z I R F V E G B Z H N U J M I K O Q A  
P S F H P J F L E T U O A D G J L Y C B M F C R D X E S N W A S R E C V F H K N U T E Q T F  
C G T J D G L O I Z R W Q E T U O M B C Y R Z I P S F H K T V N Z L M O I J E U H B Z G W R  
J T Z U E T O I Z R W Q E T U O M B C Y N V X A D G J L K H E S Y S C B F G M H T I L Q N V



# Smart Phasing

## Needs-based concepts for camshaft phasing systems

Joachim Dietz  
Michael Busse  
Steffen Räcklebe

# 10



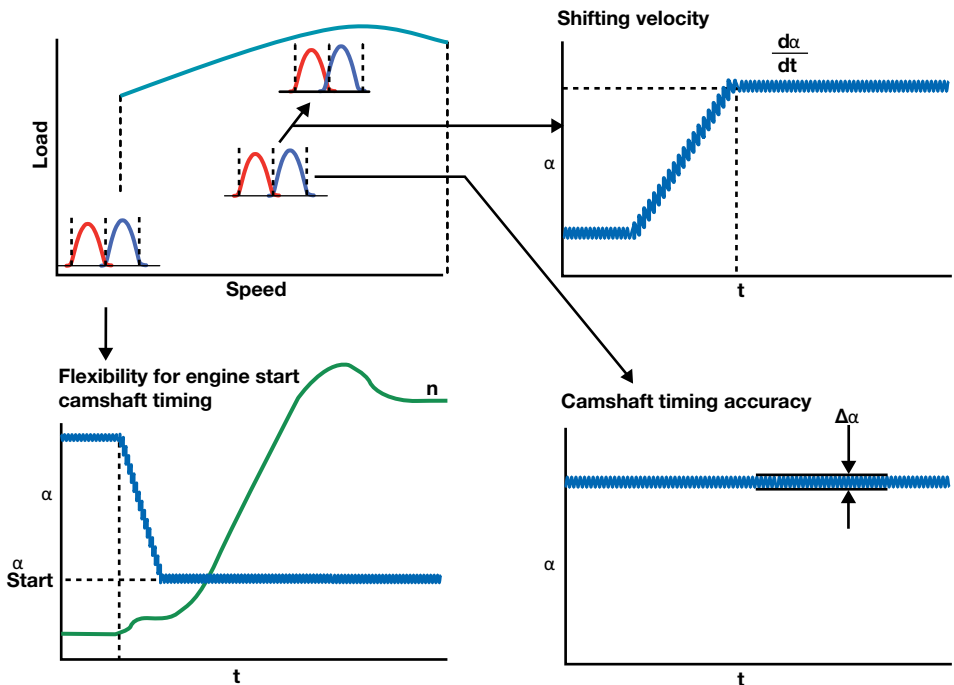
## Introduction

Increasing numbers of gasoline engines have a camshaft phasing system – either on the intake side only or on the intake and exhaust side. A volume-produced diesel engine with a phasing system on the intake camshaft recently went into production for the first time. Systems with hydraulically-actuated swivel motors have become established [1]. The trend towards downsizing and downspeeding will increase the rate with which these systems are fitted because power and torque can be increased and raw emissions reduced by changing the relative angle between the camshaft and the crankshaft. Electric phasing units would be the optimum solution from a technical perspec-

tive. They are superior to hydraulically-activated variants but are associated with higher costs. This is why it is advisable to further optimize the systems currently used. Further development of these systems must focus on meeting increasing requirements at comparatively low oil pressures.

## Requirements

The most important requirements for camshaft phasing systems are illustrated by the load-speed data map of the internal combustion engine; the engine oil temperature is also a decisive factor for optimum timing. The maximum torque can be increased by



**Figure 1** Functional requirements for camshaft phasing systems

changing the timing on the intake side through appropriate design of the cam contour. This is in line with the trend towards downspeeding. The phasing system must be able to change the timing as quickly as possible during transient operation, i.e. the timing must be changed as quickly as possible during the transition to another operating point in the data map (Figure 1).

Current adjustment speed requirements are up to 500 degrees of crankshaft angle per second. If the adjustment speed is insufficient, this can be compensated by the ignition and injection system; this usually results in disadvantages with regard to fuel consumption.

Opportunities open up for controlling the internal exhaust gas recirculation if the exhaust valves are actuated by their own adjustable camshaft. This allows to reduce the raw emissions. A prerequisite is that the phasing unit can adjust the timing of both camshafts, represented by the adjustment angle  $\alpha$ , as precisely as possible at a constant operating point. The aim is a deviation of  $1^\circ$  crankshaft angle from the set point stored in the data map. Future combustion methods, such as homogeneous charge compression ignition (HCCI), place even higher requirements in this respect than current gasoline engines with direct injection.

Another important parameter is to what extent the timing can be freely selected when starting the engine. The timing set during continuous operation is sometimes not suitable for starting the engine. The phasing unit is locked after switching off the engine because the build-up of oil pressure during starting is too low to actuate it. This is why only predefined timing is currently available during starting. In the future, variable timing could be desirable for different starting conditions (for example, hot or cold start).

## Systems and function

---

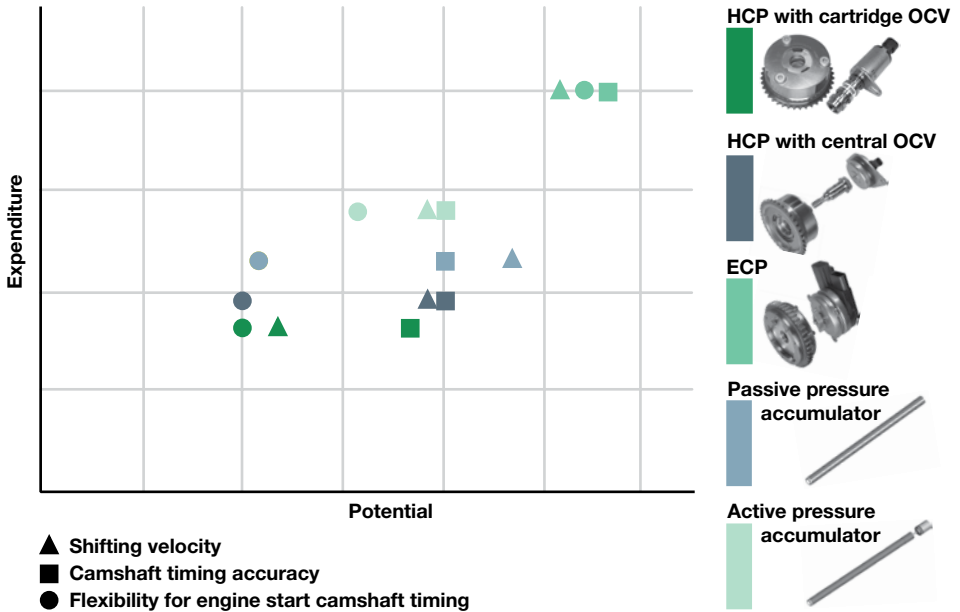
### Electric system

The electric phasing system comprises an electric motor and a three-shaft adjustment gearbox, which is mounted on the camshaft in the same way as a hydraulic phasing unit (Figure 2). The output shaft is permanently connected to the camshaft. The adjustment shaft of the three-shaft gearbox is connected with the electric motor, which adjusts the phase angle between the crankshaft and camshaft. The third shaft of the adjustment gearbox forms the gearbox housing, which is coupled with the belt pulley or sprocket of the timing drive.

If the phase angle is to be changed, the speed difference between the output shaft of the electric motor and the gearbox housing is increased. The shaft rotates faster to make an adjustment in the direction “advanced” and more slowly to make an adjustment in the direction “retarded”. The adjustment angle is held



**Figure 2** Electric camshaft phasing unit

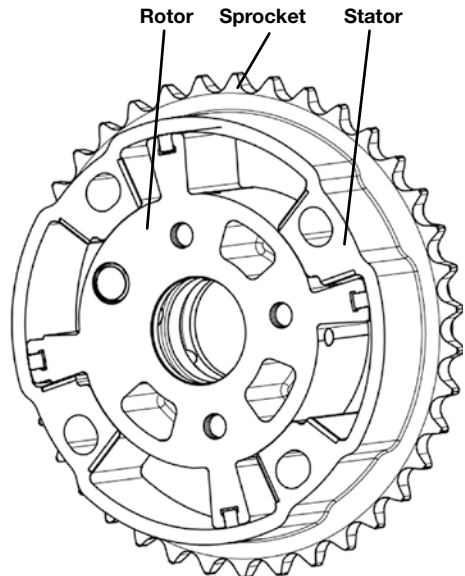


**Figure 3** Comparison of the cost and performance of different phasing systems

constant when the output shaft of the electric motor rotates at the same speed as the camshaft or gearbox housing. Typical gearbox ratios are in the range of 40:1 to 100:1.

This electric system allows the greatest degree of freedom when selecting the timing for starting. It offers higher rigidity if torque is applied to the camshaft via the crankshaft and therefore achieves the highest adjustment accuracy. The adjustment speed is also higher compared with the best hydraulic systems (Figure 3).

The electric system is also the only system to offer the option of free selection of the timing when the engine is started [2]. This high performance is also associated with a higher technical effort. Such a system will go into volume production for the first time at Schaeffler in 2015. It is designed so that no modifications to the cylinder head are required.



**Figure 4** Design principle of a hydraulic camshaft phasing unit

## Hydraulic system

### Design and function

The internal part of the camshaft phasing unit comprises a vane-type rotor, which is firmly attached to the camshaft. The external part (stator) is driven by the crankshaft via a chain or belt (Figure 4).

The range of motion of the rotor in the stator defines the maximum adjustment angle; currently, a crankshaft angle of approximately  $30^\circ$  in the directions “advanced” and “retarded” is standard on the intake side. In the neutral position, the rotor vanes are in the advanced or retarded position and are locked in this position when the engine is switched off. The chambers are filled with oil, which means the stator’s torque is transmitted to the rotor. The angular position of the camshaft relative to the crankshaft is changed depending on the change of oil pressure on both sides of the rotor. A 4/3 proportional valve connected to the oil circuit controls the relevant oil inlet and outlet. This valve is controlled by the engine control unit and operated magnetically (Figure 5). Optimum timing data for every load and speed case is stored in the engine control unit. The engine control system detects any deviations between the angular position

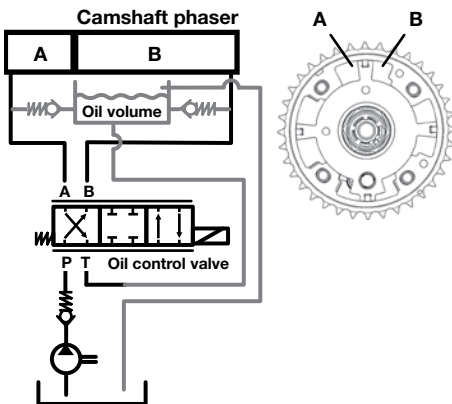


Figure 5 Function of the proportional valve

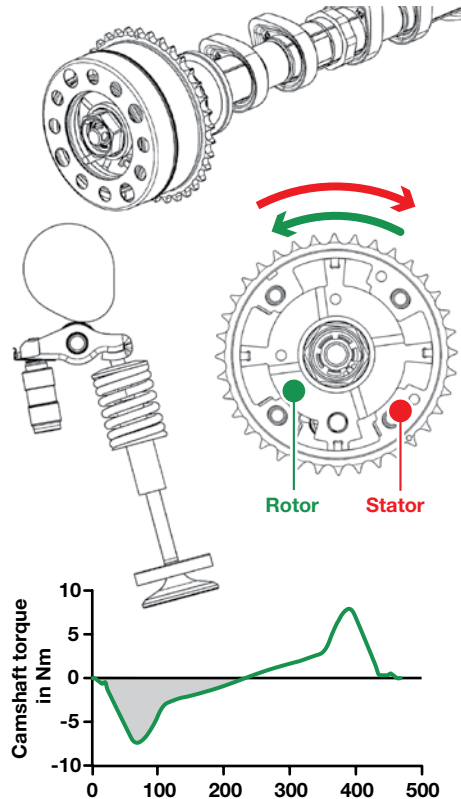


Figure 6 Effect of alternating torque on the camshaft during valve actuation

of the camshaft and the nominal value from the signals sent by the camshaft and crankshaft sensors and carries out continuous readjustment.

For the sake of simplicity, the adjustment of the timing is usually characterized as a linear process but adjustment is actually an iterative process. The motion of the cam acting on the valve actuation system slows this process during the adjustment from “retarded” to “advanced”. In contrast, this alternating torque accelerates the phasing operation when the timing is adjusted from “advanced” to “retarded” (Figure 6). The frequency with which an impulse occurs in a process depends on the adjustment distance and the

engine speed. The magnitude of the alternating torque depends on the engine speed and the valve train.

The accuracy, with which the timing can be adjusted is essentially determined by the compressibility of the oil and the leakage system. Systems equipped with a solenoid located centrally in the phasing unit therefore have an advantage compared to units fitted with a decentralized arrangement because the leakage-prone transfer of oil between the camshaft and the cylinder head via control ducts is eliminated. The speed, with which adjustment can be carried out, depends on the available power and thus the oil pressure and the alternating camshaft torque.

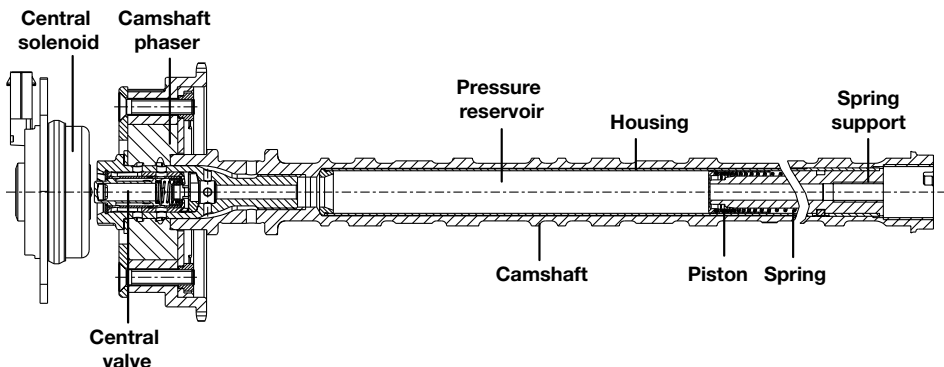
The camshaft phasing unit is locked in the “advanced” or “retarded” position after switching off the engine because the oil pressure during engine starts is insufficient to set the timing. The solenoid valve is not supplied with current. The phasing unit can be moved to the “advanced” base position using the assistance of a spring designed specifically for the application. Different timing settings are only possible if the oil pump supplies the full oil pressure.

### Pressure accumulator

Schaeffler makes a distinction between active and passive pressure accumulators. The latter increases the adjustment speed

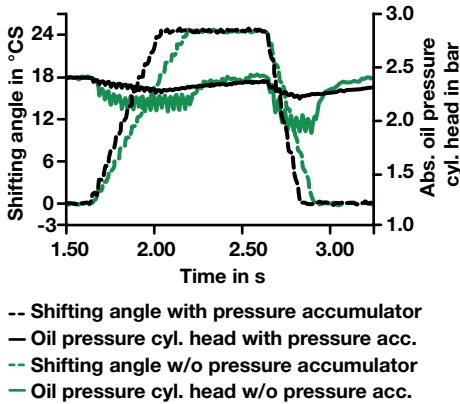
of the hydraulic camshaft phasing system so that it can be classified between a phasing unit without a pressure accumulator and an electric phasing system. In simple terms, this pressure accumulator can be described as a spring mass system, which is pressurized with oil. The system is in equilibrium if the force of the oil pressure is equal to the spring force. The compression spring forces are characterized by the preload force in the base position and the spring rate that defines the increase in force via the travel of the piston up to the end position. If the accumulator is pressurized, the piston converts the oil pressure provided by the oil pump into potential energy that is stored in the compression spring. The spring unwinds during the next phasing operation and provides additional assistance to the oil pressure during movement of the vanes. The pressure accumulator is arranged in front of the hydraulic solenoid and connected with the oil supply. It comprises a cup-shaped piston, compression spring, guidance element and a thin-walled housing with a closing plug mounted on the end face (Figure 7).

The piston is guided inside the housing and its movement is limited by two stops. In the released base position, the piston is in contact with the inside of the closing plug and in the end position, it contacts the guid-



**Figure 7** Passive oil pressure accumulator





**Figure 8** Test results for a passive accumulator during idling, at 90 °C and under zero load

ance element. A check valve located between the accumulator and the solenoid prevents a return flow of engine oil from the phasing system to the engine or oil sump. This means the phasing system remains adjustable at all the operating points. A comparison of a system with and without a pressure accumulator shows (Figure 8) that the system with a passive pressure accumulator (black curve) reaches the end stop in the stator more quickly than the system without a pressure accumulator (green curve).

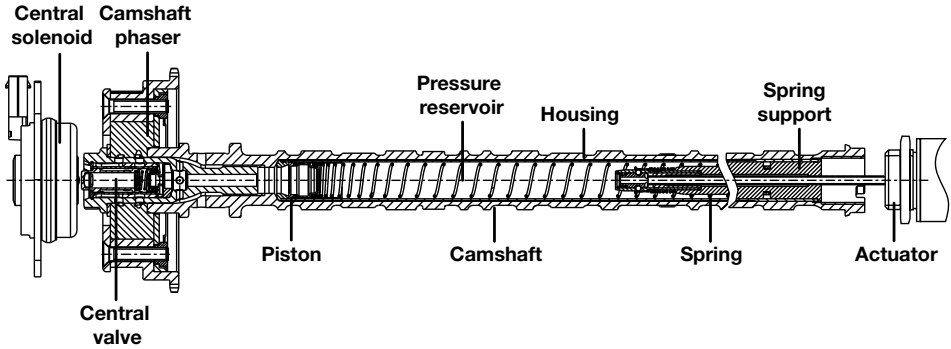
In the case of the system with the pressure accumulator, the oil pressure decreases more slowly during adjustment than in the system without a pressure accumulator. This is due to the fact that the majority of the required oil volume is provided by the pressure accumulator and therefore more energy is made available to the phasing system for the phasing operation. The reduction in oil that occurs here is primarily determined by the design of the compression spring. The greater the oil volume that can be forced out of the accumulator during a difference in pressure, the lower the decrease in oil pressure in the oil circuit. This advantage in terms of the adjustment speed does

not depend on whether adjustment is carried out away from the base position or towards the base position. The frictional torque on the camshaft alone causes the adjustment to be unsymmetrical in both directions. If the engine is switched off, the oil immediately flows back into the oil sump via the leakage points. A system with a passive pressure accumulator is therefore unable to change or set the timing during starting and must also be locked.

The active pressure accumulator can store the oil reservoir for a limited amount of time. This is sufficient to supplement a start-stop system so that the optimum timing can be set when restarting the engine. If the engine is switched off, unpressurized engine oil remains in the reservoir for some minutes and is not immediately forced out after the engine is switched off. If the engine is started, the accumulator spring is activated and pressurized oil is supplied to the phasing system so that the oil pressure in the camshaft phasing unit immediately increases. This is why adjustment from the base position starts earlier than it would without a pressure accumulator. The pressure reservoir only empties after long stationary periods, for example, if the vehicle is parked over night. This is due to leakage via the circumferential groove and radial bores in the first camshaft bearing.

The active pressure accumulator can be characterized as a switchable coupling mechanism that creates a detachable lock for the piston when the reservoir is full. The relevant actuator is located on the rear end of the accumulator (Figure 9).

The locked condition of the piston is considered for the description of the functions. If the piston is to be unlocked, an electromagnetic actuator located on the cylinder head pushes a rod against a switching pin with a circumferential groove. As soon as the balls can move in the groove, they are pushed inwards by means of the compression spring force. This releases the piston. If the accu-



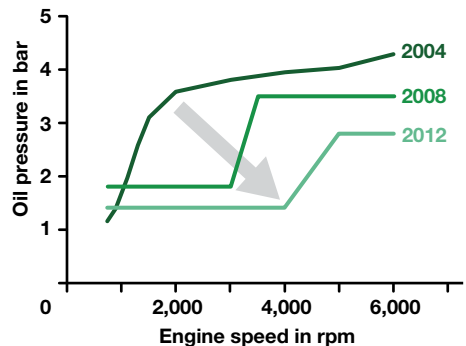
**Figure 9** Design of the active pressure accumulator

mulator is full, the piston automatically engages in the coupling mechanism. During this process, the piston locking unit pushes the sliding plate back against the sliding plate spring until the base of the piston mates to the coupling mechanism. In this position, the switching pin is moved in an axial direction via the return spring and the balls are pushed outwards from the groove in a radial direction, i.e. the piston is secured. During this process, the rod and the actuator are moved back to their original position. The piston can be unlocked again by feeding the actuator with current. The relevant signal comes from the engine control unit if it initiates an engine start. The discharge process when the engine is started is decisive for the dimensioning of the working pressure. The required working pressure level is higher than the optimum pressure level of the passive pressure accumulator that would be necessary to improve the adjustment speed during hot idling.

## Challenge posed by oil pressure

One of the most important boundary conditions for hydraulically actuated

camshaft phasing units is the pressure in the oil circuit. Only mechanically driven oil pumps were used in the past. They are designed for the worst case, i.e. a high oil temperature, low speeds and long service life. However, the oil consumption of the engine at increasing speeds does not increase as rapidly as the delivery rate of the oil pump, which increases in approximate terms proportionally to the speed in unregulated designs [3]. This is why part of the delivery is fed directly to the intake side of the pump again at medium and high speeds. The pump therefore has a low efficiency in this operating range.



**Figure 10** Development of engine oil pressure 2004 to 2012

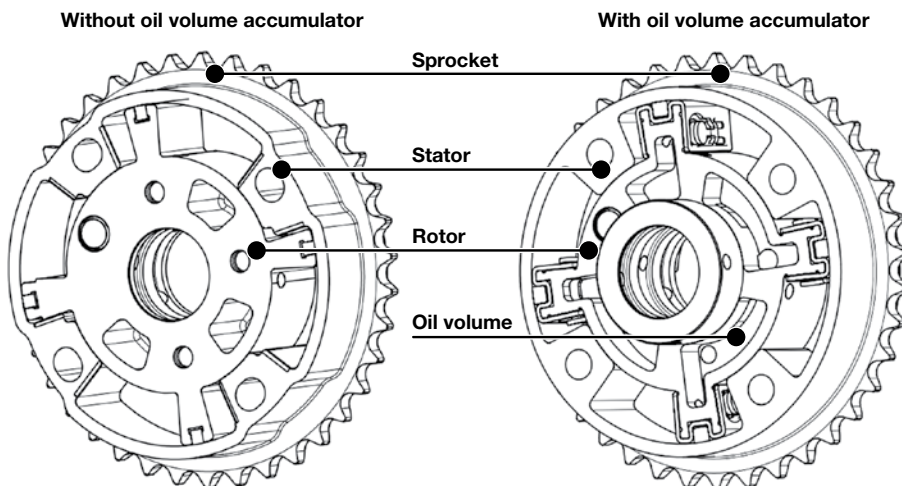
Regulated oil pumps are increasingly replacing unregulated oil pumps as part of measures to increase the efficiency of engines. The designs are becoming smaller at the same time. The aim is to reduce the amount of ineffective work to an absolute minimum. A look back at the last eight years shows that the maximum power of regulated pumps now only reaches a value that is less than the base power of unregulated pumps at the start of the comparative period (Figure 10).

There has been a very significant reduction in the overall pressure level because low-friction bearings are now used in the entire engine and leakage has been greatly reduced. It can be assumed that this trend has now reached its lower limit. However, low oil pressure is a challenging boundary condition for new and further developments of camshaft phasing systems. The lower the oil pressure, the lower the amount of energy available for phasing of the camshaft.

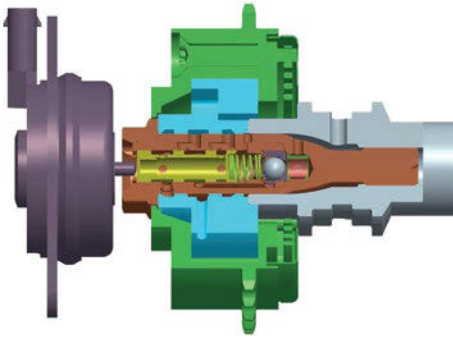
## Pressure-free oil volume accumulator

### Design and function

The adjustment speed of hydraulic camshaft phasing units is mainly determined by the performance of the oil circuit. Until now, only a system with a passive pressure accumulator could achieve a higher adjustment speed than a conventional system with a central valve. This also results in increased system costs. Schaeffler has therefore developed another option: This option is based on an oil volume accumulator located within the phaser itself. The concept is positioned between the above mentioned systems both with regard to costs and performance. The oil volume accumulator is arranged in additional bores in the rotor of the camshaft phasing unit – directly next to the oil chambers. The adjustment process is triggered when these chambers are filled (Figure 11). This oil volume accumulator is



**Figure 11** Mounting position of the oil volume accumulator



**Figure 12** Connection of the oil volume accumulator (cross-section of a phasing system)

not pressurized, but improves the adjustment speed by accelerating the flow of oil into and out of the adjustment chambers.

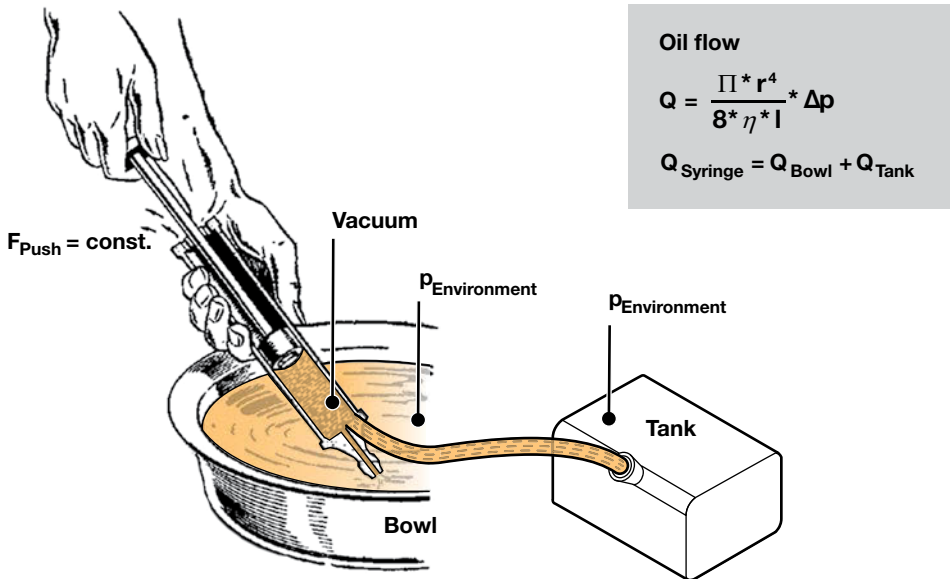
The oil volume accumulator is fed from the oil that is forced out of the chamber, in whose direction the adjustment is carried out (Figure 12). Oil is not discharged into the oil sump until the accumulator is filled.

The reservoir is immediately available again for the phasing system via only a short bore so that it is mainly used. The solenoid valve remains connected to the oil circuit, which means a second oil feed is always available.

The effect on the oil pressure supply to the adjustment chambers is comparable with the aspiration of a syringe: The faster the oil can be replenished, the faster the piston can be withdrawn (Figure 13). The oil volume accumulator results in a number of advantages, as explained in the test and simulation results presented below.

### Simulation and test results

Simulations and tests are being carried out to investigate the influence of the oil volume accumulator upon the adjustment speed and the required oil flow from the oil circuit while taking different cam contours into consider-

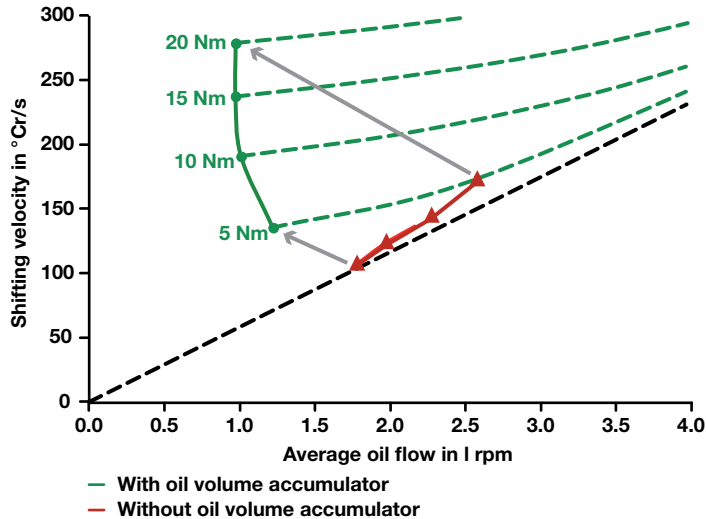


**Figure 13** The possible suction volume determines the speed with which the piston can be withdrawn

ation (Figure 14). The simulation of an adjustment at 0.5 bar oil pressure leads to the conclusion that the adjustment speed increases and the oil flow decreases significantly with all the cam contours considered here (Figure 15).

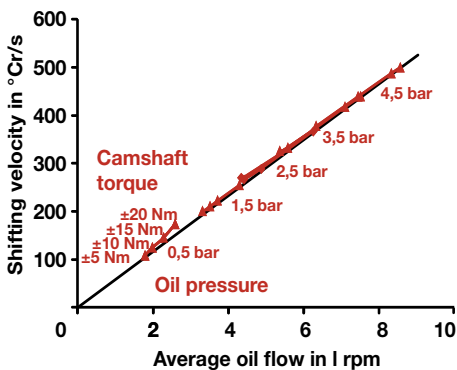
It can be expected that the oil requirement is at least halved above an alternating torque on the camshaft of 10 Nm. At the same time, the adjustment speed increases, for exam-

ple, from 175° to 280° crankshaft angle per second at 20 Nm alternating torque. Measurements carried out on a test engine confirm this simulation: Across the entire speed range, the system carries out adjustments faster in both directions with the oil volume accumulator than without the oil volume accumulator (Figure 16).

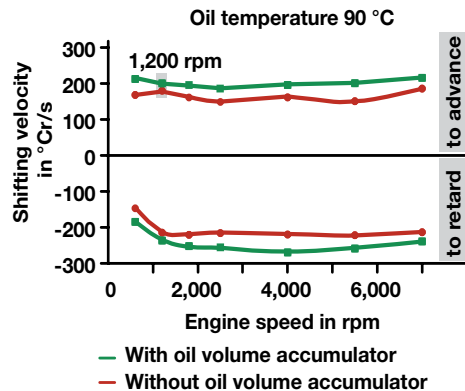


**Figure 15** Simulation of a phasing operation with a phasing system fitted with an oil volume accumulator

The test results prove that the oil volume accumulator also has a positive effect on the critical variable oil pressure. The measuring duration investigated in detail here comprises the time from when the cam starts to move the valve actuation system until when the process is completed during the phasing

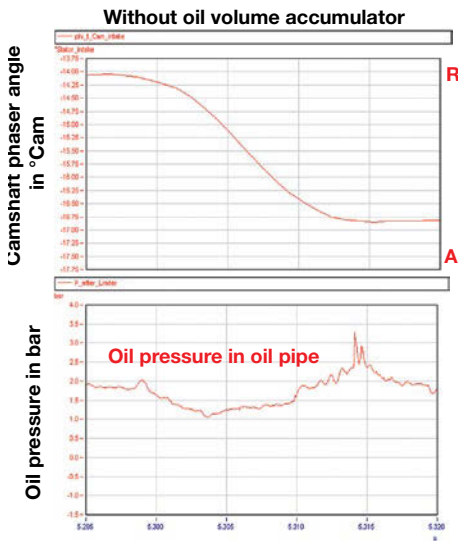
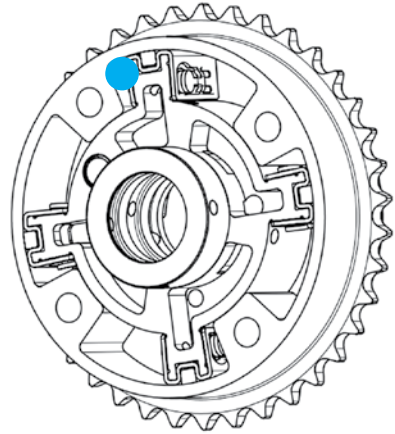
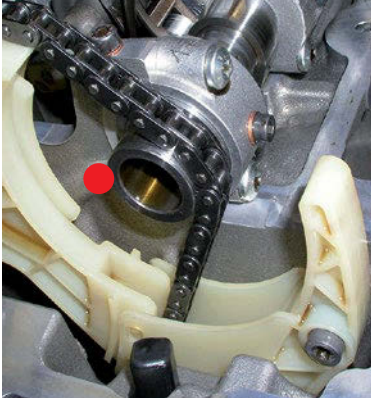


**Figure 14** Simulation of a phasing operation with a conventional phasing unit



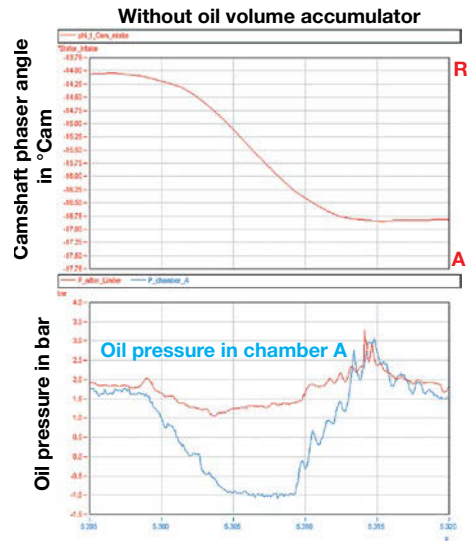
**Figure 16** Comparison of the adjustment speed across the speed range with and without an oil volume accumulator

Cylinder Head / Camshaft



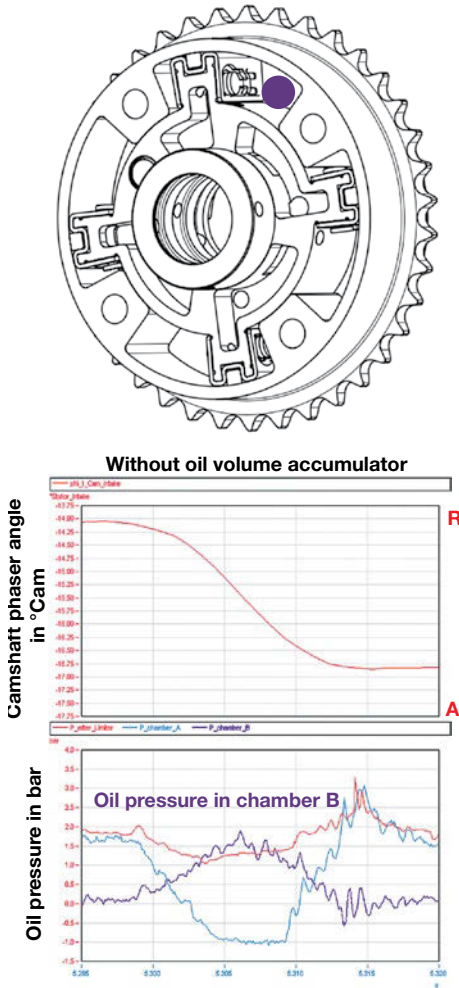
**Figure 17** Effect of an alternating torque impulse on the camshaft and development of the oil pressure

operation at a crankshaft angle of 31° from the neutral position in the direction “advanced”. The engine rotates at 1,200 rpm and the oil temperature is 90 °C. The measurement is carried out in the pressure line and in the oil chambers A and B of the camshaft phasing unit (Figures 17-20).



**Figure 18** Oil pressure curve in chamber A during alternating torque

The comparison of a system with an oil volume accumulator (Figure 20 right) and without an oil volume accumulator (Figure 20 left) shows that the oil pressure of chamber A decreases significantly less during filling in the system, if an oil volume accumulator is used. This means that the formation of a temporary vacuum is largely prevented. In



**Figure 19** Oil pressure curve in chamber B during alternating torque

contrast, a temporary vacuum of up to 1 bar is formed in the system without an oil volume accumulator. At the same time, a slightly lower pressure builds up in the chamber to be emptied B so that the oil flows away more slowly there.

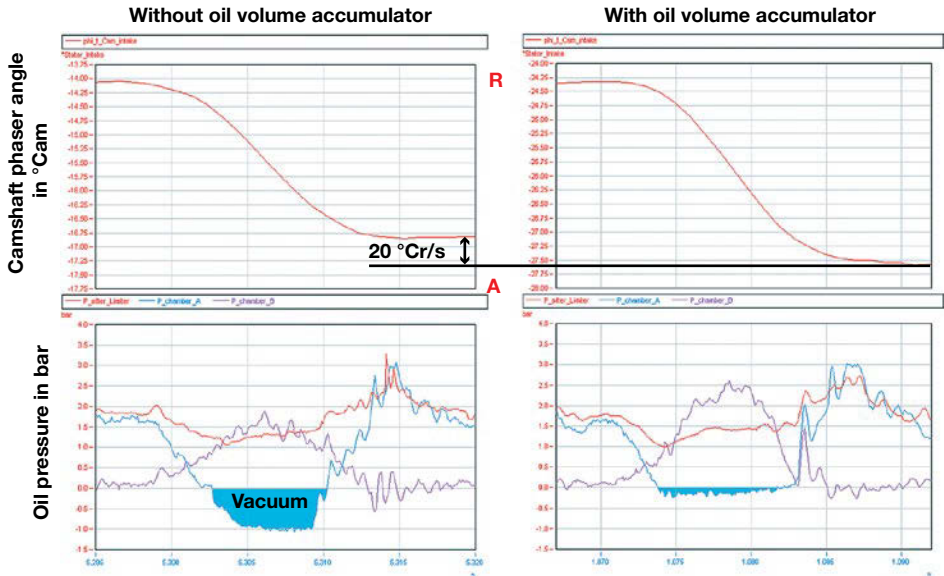
It is important to prevent the formation of a vacuum in the controlled chamber for a

number of reasons. First and foremost, it impairs the adjustment speed: The system with an oil volume accumulator is capable of carrying out an adjustment with  $20^\circ$  more crankshaft angle than a system without an oil volume accumulator in the same time. The vacuum also causes the entire system to oscillate and operate less precisely.

The oil volume accumulator is an effective approach for increasing the adjustment speed of hydraulic camshaft phasing units. It does not achieve the same degree of improvement as a passive pressure accumulator, but also does not have its level of complexity. The pressure-free oil volume accumulator also reduces the conflict of objectives between the advantage of a higher adjustment speed through the use of a passive pressure accumulator and the improvement that would arise from the use of an active pressure accumulator in combination with a start-stop system. The oil volume accumulator can also be combined with an active accumulator.

## Summary

With increasingly stringent emission regulations, it is now becoming an essential requirement to also use camshaft phasing systems in diesel engines. Hydraulic systems have now largely replaced phasing units with helical gear teeth and axial pistons. They do not achieve the same performance as electric phasing units but are more attractive when cost aspects are taken into consideration. The oil pressure is a boundary condition critical for the success of hydraulic systems. Comparisons show that both the base and the peak power of oil pumps has been significantly reduced in recent years. Accordingly, less power is available for the phasing system. One approach



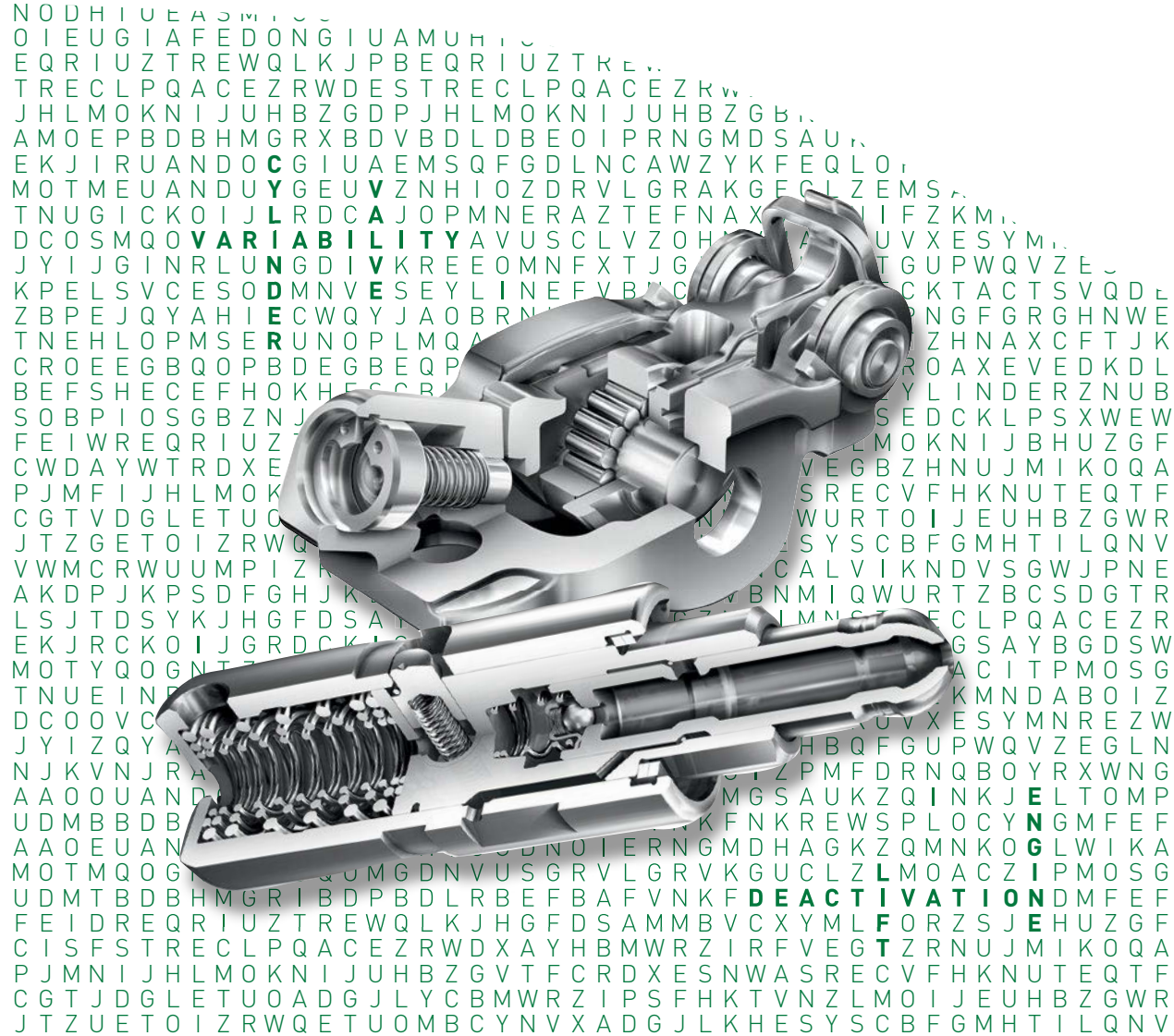
**Figure 20** Comparison of the vacuum in chamber A and the adjustment distance

is to use a passive pressure accumulator. This significantly increases the adjustment speed. The costs are moderate but an even more cost-effective system may be required in cost-conscious markets. Schaeffler has developed a pressure-free oil volume accumulator for such application. The additional oil volume reduces the requirements placed on the oil circuit and prevents the risk of a vacuum forming during rapid and extensive phasing operations. The adjustment speed is also increased across the entire speed range with this concept. The oil volume accumulator can be combined with an active pressure accumulator. The latter stores oil under pressure for several minutes, for example, if the start-stop system has switched off the engine. Sufficient energy is available during a restart to change the timing during starting.

## Literature

- [1] van Basshuysen, R.; Schäfer, F. (Hrsg.): Handbuch Verbrennungsmotor: Grundlagen, Komponenten, Systeme, Perspektiven. 5. Auflage. Vieweg+Teubner, Wiesbaden, 2010, p. 483
- [2] Schäfer, J; Balko, J.: High Performance Electric Phasing System, SAE paper 2007-01-1294
- [3] Strauß, A.; Schaefer J.; Dietz J.; Busse M.; Boeggershhausen M.: Quo vadis hydraulic variable camshaft phasing unit? 9<sup>th</sup> Schaeffler Symposium, 2010





# Cylinder Deactivation

A technology with a future  
or a niche application?

Arndt Ihlemann  
Norbert Nitz



## Introduction

One of the ways manufacturers can minimize fuel consumption is to downsize the engines they offer. A cylinder's volume can only be restricted to a certain extent, however, if the thermodynamically ideal volumetric capacity of 400 to 500 cm<sup>3</sup> per cylinder is to be retained. In practice, downsizing therefore frequently leads to a reduction in the number of cylinders.

"Temporary downsizing" in the form of cylinder deactivation offers an attractive compromise, since this allows an engine to shift its operating mode to achieve the specific consumption figures it is rated for, especially when low loads and operating speeds are encountered. At the same time, the driver still has a sufficiently powerful engine at his or her disposal that ensures the same level of

driving pleasure and comfort with regard to acoustics and vibration characteristics.

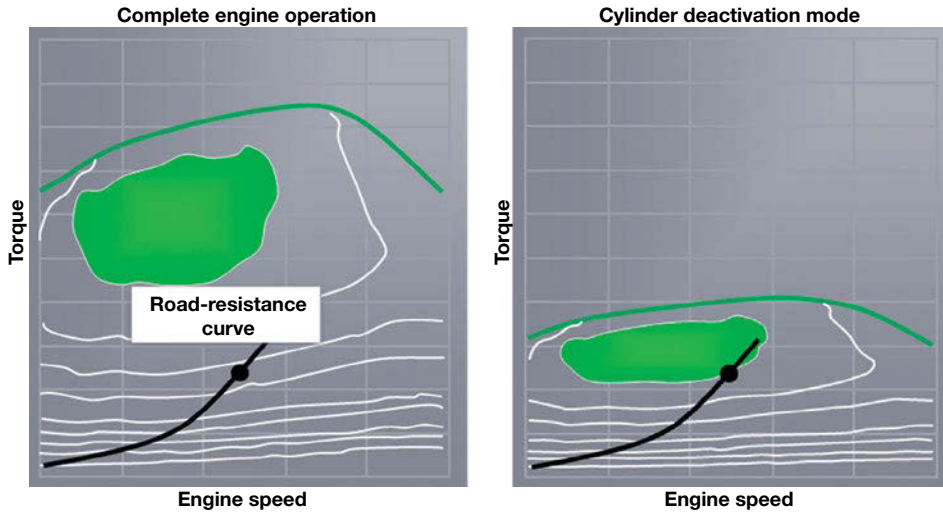
An additional key success factor that can help this technology to be deployed in a more mainstream fashion is that it can be integrated into existing engine concepts at acceptable costs.

## Designs

The most consistent form of cylinder deactivation is to not only to cut injection and ignition for the respective cylinders, but also to stop all moving parts (including the pistons). This, in turn, utilizes the entire thermodynamic potential available and considerably reduces the friction that occurs inside the engine. It goes without saying that com-

Manufacturer	Type of engine	Valve concept	Status
<b>GM</b>	6.0-liter V8-6-4 engine	Pushrod actuation, switchable rocker arm pivot point	SOP/EOP 1980
	3.9-liter V6 engine	Switchable roller tappet	EOP 2008
	5.3-liter V8 engine	Switchable roller tappet	Volume production
	4.3-liter V6 engine	Switchable roller tappet	Volume production
	6.0-liter V8 engine	Switchable roller tappet	Volume production
<b>Daimler</b>	5.0-liter V8 engine	Switchable rocker arm; MB	EOP 2005
	5.8-liter V12 engine	Switchable rocker arm; MB	EOP 2002
<b>Chrysler</b>	5.7-liter V8 engine	Switchable roller tappet	Volume production
	6.4-liter V8 engine	Switchable roller tappet	Volume production
<b>Honda</b>	3.5-liter V6 engine	Switchable rocker arm	Volume production
<b>AMG</b>	5.5-liter V8 engine	Switchable pivot element	Volume production
<b>VW Group</b>	1.4-liter inline 4-cylinder engine	Cam shifting system, VW/Audi	Volume production
	4.0-liter V8 engine	Cam shifting system, Audi	Volume production
	6 3/4-liter V8 engine	Switchable roller tappet	Volume production
	6 3/4-liter V8 engine	Switchable roller tappet	Volume production
	6.5-liter V12 engine	Only the fuel injection supply is cut	Volume production

**Figure 1** Examples of engine concepts featuring cylinder deactivation



**Figure 2** Operating data map and driving resistance curve: The operating ranges associated with the lowest specific fuel consumption are approached in cylinder deactivation mode (graphic on the right) and not when all cylinders are operating

promises must be made when it comes to the ignition sequence and dynamic balancing. What is much more significant, however, is the outlay required to separate the engine into an area that continues to run while the other area is activated and deactivated as required. Even the coupling mechanisms on the crankshaft and camshaft cannot be justified by a cost-benefit analysis, which is why implementation of the system looks somewhat bleak at present.

Almost all cylinder deactivation systems currently used interrupt the injection and ignition as well as valve actuation sequences for the cylinders to be deactivated (Figure 1). Today's applications range from engines with 4 to 12 cylinders. Analyses conducted by Schaeffler, however, reveal that temporarily deactivating one of the cylinders in a three-cylinder engine can also further reduce consumption.

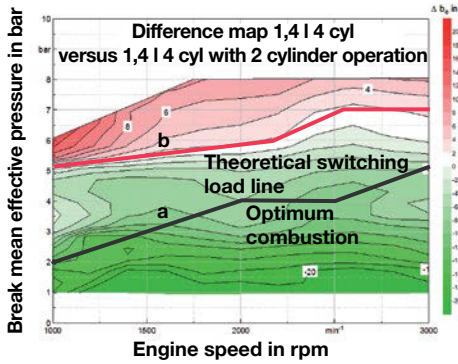
To ensure that the engine continues to run smoothly enough, only certain cylinders are deactivated in accordance with the ignition sequence.

## Effect and potential

When there is a specific performance requirement, the cylinders that are still being operated following cylinder deactivation must generate a higher mean pressure. This load-point shifting leads to a reduction in the throttle losses of the engine and ultimately helps to conserve fuel (Figure 2). Deactivating the valves also reduces friction loss in the cylinder head, which further minimizes consumption.

The potential for reducing consumption when an engine is operated on two as opposed to four cylinders can be illustrated in a simulation exercise carried out on a 1.4-liter four-cylinder engine. Line "a" plots the mean pressures at which the engine operating in two-cylinder mode can achieve its optimum combustion point (8 crankshaft degrees after TDC) (Figure 3).

When higher mean pressures are introduced in two-cylinder mode, the ignition se-



**Figure 3** Reduction in fuel consumption as a result of cylinder deactivation (simulation result)

quence must be retarded to avoid knocking. The resulting effect is that combustion no longer achieves its peak efficiency, and additional fuel is consumed. Opening the throttle valve further counteracts this and has a positive impact on consumption in cylinders running higher mean pressures. Line “b” represents the theoretical switchover or transition line, as

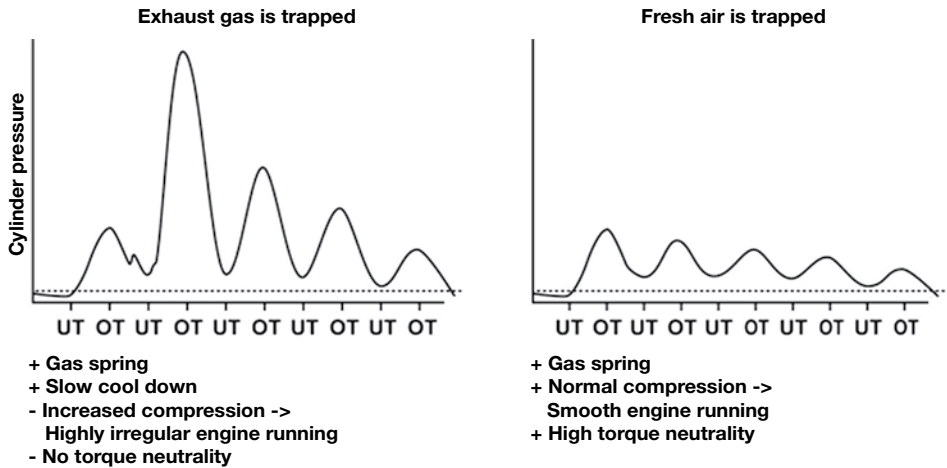
operating the engine above these plotted points in two-cylinder mode leads to additional fuel consumption. This line can also drop considerably below line “b”, depending on the application and customer requirements.

## Technical implementation

### Deactivation mode

When an engine switches to cylinder deactivation mode, there are two basic strategies that can be implemented for introducing a charge in the cylinders (refer to Figure 4):

- Confine the exhaust gas in the combustion chamber after the combustion process has been completed
  - Introduce fresh air
- Both variants allow the gas confined to act as a pressure or thrust spring.



Source: MTZ "The New AMG 5.5-liter V8 Naturally Aspirated Engine with Cylinder Shut off"

**Direct injection allows the realization „Fresh air trapped“**

**Figure 4** Possible options for introducing a cylinder charge and their effects in cylinder deactivation mode

The heat generated by the confined exhaust gas not only makes the cylinder cool down more slowly; the larger quantity of gas also produces very different pressures inside the cylinder and thus to greater irregularities on the crankshaft. The gas pressures that form during initial compression when the exhaust valves are closed can even be higher than those experienced during combustion. The support forces not only place substantial loads on the piston and cylinder, but also lead to considerable frictional losses. The deactivation phase must then be maintained for a longer period of time to ensure that a positive overall effect is achieved.

As Figure 4 shows, peak pressures drop when the residual gas cools down as well as when gas diffuses from the combustion chamber into the crank assembly (blow by). Simulation calculations reveal that after an engine has gone through approximately ten revolutions, the pressure in the cylinder reaches the level that was present when fresh air was confined.

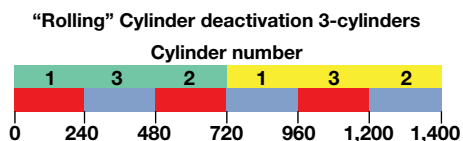
The latter is only possible with a direct-injection engine. The differences in compression between the cylinders are less pronounced in this application, and the switchover phase can be better coordinated as a result. This variant also requires compromises to be made, however, since the air in the combustion chamber loses all tumble or swirling motion produced at the intake point after just a few cycles. Depending on the geometry of the combustion chamber, it may still be possible to re-fire the engine in this operating state. The ignition timing will have to be adjusted, though, whereby the efficiency of the combustion process suffers by a corresponding amount. Care must also be taken to ensure that no suction or vacuum effect is produced in the combustion chamber, since this would lead to engine oil being drawn in.

## Alternating cylinder deactivation

Current technology dictates that specific cylinders in an engine be targeted for deactivation. Schaeffler is currently researching a concept for four-cycle engines that will allow all cylinders to be deactivated after every ignition cycle and reactivated during the next. Cylinder deactivation thus alternates within a single deactivation phase and not each time a new deactivation mode is introduced (Figure 5). The benefit is a more well-balanced temperature level inside the combustion chambers and consistent firing intervals for three-cylinder engines operating in deactivation mode.

Especially when such a design setup is used, the losses encountered when transitioning from operating mode to deactivation mode must be kept as low as possible. This is why residual gas is not confined, as the above illustration depicts. Filling the cylinders with fresh air also brings with it drawbacks due to the lower level of charge movement.

One variant appears to be particularly favorable in this context because it allows a small, precisely measured quantity of residual gas to be confined in the combustion chamber. The suction or induction effect that results from the expansion does not last long enough to lead to a noticeable loss in engine oil. The inherent benefit is that when the working cycle starts again, the required quantity of fresh air can be introduced without any restrictions in flow. The first and following combustion strokes then take place



**Figure 5** Pattern of alternating cylinder deactivation (the red phase designates the active operating mode)

without a decrease in efficiency. To ensure that the quantity of residual gas and the vacuum pressure assume optimum levels, the exhaust valves must be controlled very precisely as is the case with the fully variable UniAir system developed by Schaeffler. This system realizes any required stroke in the cycle and can completely close the valves when needed. At least one two-stage switch must be fitted to deactivate the valves on the intake side. Simulations carried out on a three-cylinder engine point to lower overall fuel consumption figures being achieved when such a refined alternating cylinder deactivation concept is used in place of a conventional setup (Figure 6).

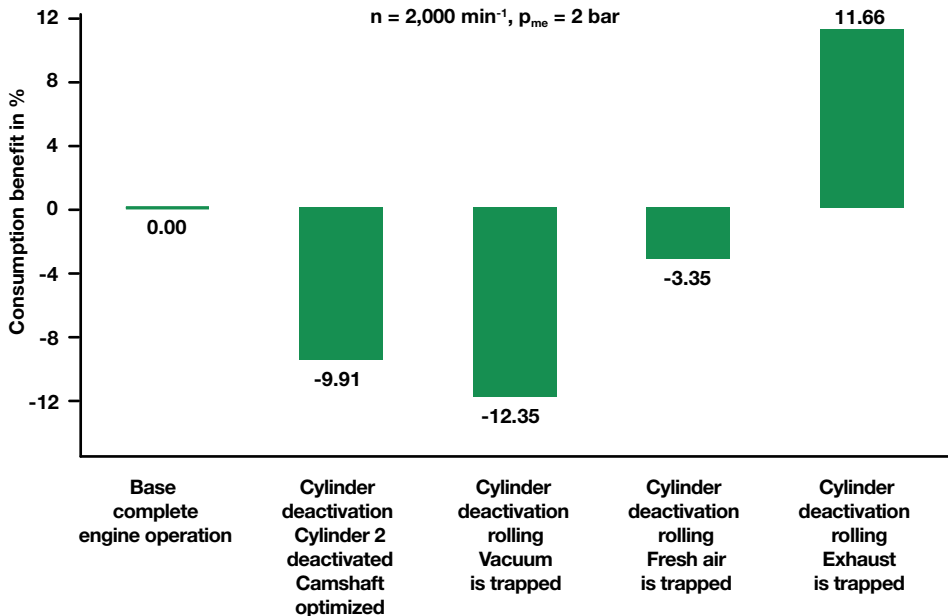
Alternating cylinder deactivation could also prove interesting when it comes to counteracting engine-induced vibration, especially in the case of three-cylinder engines.

All deactivation systems introduced in the section following the next are considered for a basic cylinder deactivation concept.

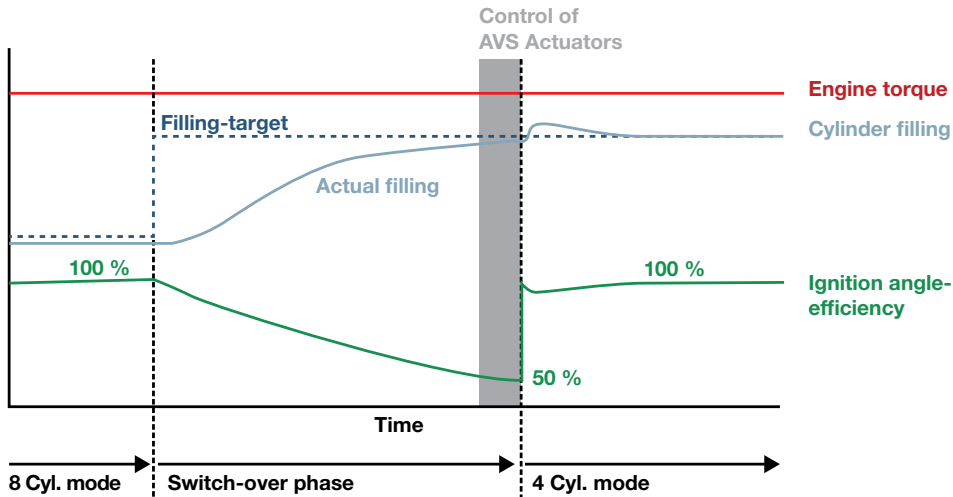
## Switchover mode

One of the logical requirements of this mode is that the driver should not be made aware of it when the switch is made. In other words, the switchover must take place in a torque-balanced manner. The transition between both modes must also occur very quickly so that the engine can provide good response at all times.

When the switch is made from operation on all cylinders to operation on half of the cylinders, the position of the throttle valve (cylinder charge), ignition timing, and fuel supply are adapted accordingly to prevent a drop in torque (refer to Figure 7). To this end, the charge is first increased and the ignition timing is delayed. When the target charge is reached, the valve train is switched over and the ignition timing for the cylinders activated is realigned with the optimum performance setting. As soon as the injection and timing sequence for the cylinders to be shut down is deactivated, the switchover is complete.



**Figure 6** Different configurations for alternating cylinder deactivation in a fuel consumption comparison



**Figure 7** Active regulation at the switchover point

Since retarding the ignition timing momentarily consumes more fuel, the deactivation mode must remain engaged long enough for an overall fuel economy benefit to be achieved. It goes without saying that the longer the engine stays in this mode, the more fuel is saved. Such is the case when traveling at constant speeds on the highway.

The following requirements are placed on the switchover mechanisms:

- The switchover process for all cylinders must take place in exactly the cycle that the control unit stipulates.
- The aforementioned design measures for compensating torque must be optimally coordinated and harmonized.
- The switchover point must occur during the ignition sequence.
- Both operating states must be stable and reliable so that no inadvertent switchovers are made.
- Since faulty switchovers and missed switchovers are relevant from an exhaust-gas perspective, a monitoring function must be implemented.

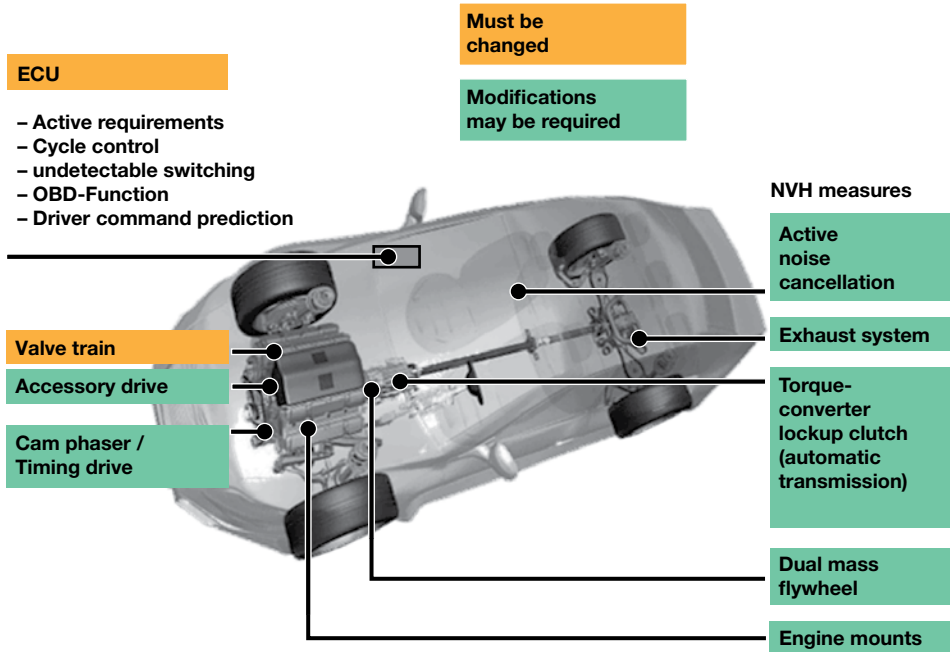
## Requirements in a system environment context

Even if the switch from one operating state to another is made successfully, in a torque-balanced fashion, the vibration characteristics of the engine and acoustic output still change. This may, in turn, necessitate modifications to the following components (refer to Figure 8):

- Phasing unit
- Timing drive
- Auxiliary drive assembly
- Clutch and dual-mass flywheel
- Exhaust system (sound engineering)
- Engine mounts

Depending on the application scenario and the requirements it entails, it is typically a good idea to integrate an active noise compensation facility for the passenger compartment. Nonetheless, it is generally necessary to operate the engine on all cylinders until the engine speed





**Figure 8** Overview of the measures accompanying cylinder deactivation

reaches approximately 1,500 rpm, depending on the engine concept, as this will ensure the desired level of comfort for passengers. In addition, cylinder deactivation cannot be engaged if the engine oil has not reached operating temperature, or engaging the mode would cause the catalytic converter to drop below its light-off temperature.

## Valve stroke deactivation

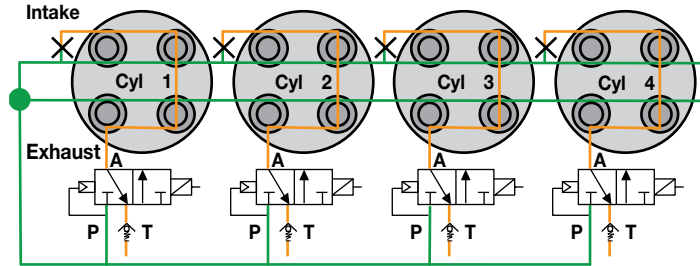
As already mentioned, it is not practical to also disengage the moving parts of the crank drive during cylinder deactivation. Deactivating the valve stroke sequence, on the other hand, can be realized with compara-

bly moderate outlay. The following options are available for this purpose:

- Switchable bucket tappets
- Switchable finger followers
- Switchable pivot elements
- Cam shifting systems
- Fully variable mechanical valve train systems based on detent cam gears
- Fully variable electrohydraulic valve train systems such as the UniAir system from Schaeffler

Most of the switchable elements are actuated using oil pressure, which is controlled and regulated by an upstream switching valve. The concept requires an additional switching or shifting oil circuit to be implemented, whereby special attention must be paid to ensuring the correct positional arrangement and geometry of the oil channels in order to create a

hydraulically robust system and avoid air pockets as well as throttling or restriction points. Figure 9 shows a basic sketch of a system that has one switching valve per cylinder.

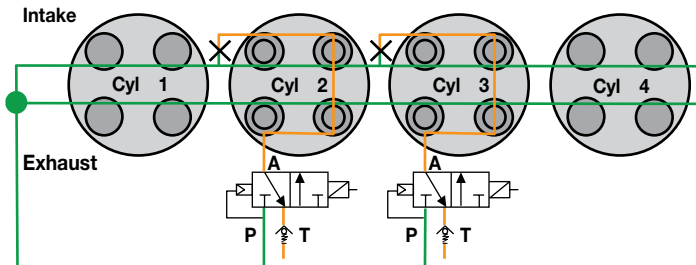


**Figure 9** Basic illustration of a valve stroke deactivation system featuring one switching valve per cylinder

### Design configuration of the shifting oil circuit

Several solutions are conceivable for controlling hydraulically actuated, two-stage valve train components and arranging the switching valves in the cylinder head. The positional arrangement of the switching valves and the design configuration of the oil channels produce different switch time intervals and system-related constraints. The following depicts two different options for deactivating cylinders 2 and 3 in a four-cylinder engine with an ignition timing sequence of 1-3-4-2 and describes the inherent benefits and drawbacks in detail.

Figure 10 shows the variant with one switching valve per cylinder, which means that one switching valve at each cylinder controls the respective intake and exhaust valves.



**Figure 10** Oil circuit with one switching valve per cylinder

The benefit of this design lies in the short oil channels and small oil volume. Any oil foaming that could occur would therefore be minimal, which is why the system is highly insensitive to fluctuations in the shifting or switching times. This concept enables a switching time interval of approximately 250 camshaft degrees, which equates to a theoretical switching time of 28 ms at 3,000 rpm. On engines with camshaft phasing units, the influence of the adjustment range must also be factored into determining the interval. By design, this variant can be enhanced or extended in such a way that all cylinders can be actively switch-controlled, which in turn means that in a four-cylinder engine application, the engine management system can deactivate one, two, or three of the four cylinders. One drawback, however, is the comparably expensive design configuration associated with the oil channel between the intake and exhaust sides.

between the intake and exhaust sides.

An alternative arrangement is also possible by controlling the oil circuit using one switching valve on the intake and exhaust sides (Figure 11). The intake and exhaust valves are then actuated by two sep-

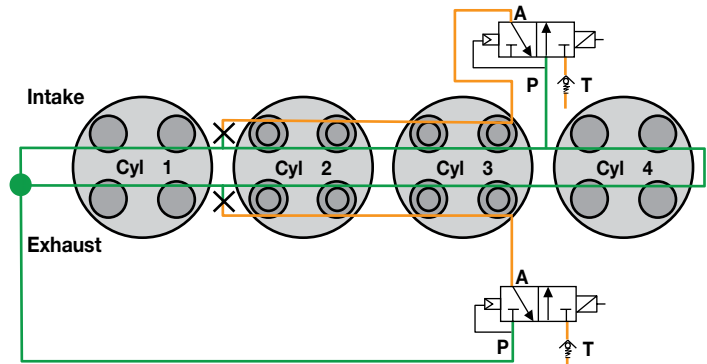
arate switching valves. The benefit of this arrangement is that the switching time interval can be governed independently of the adjustment range of the camshaft phasing unit. In addition, the oil channels can be designed in a more simplistic manner, and the switching valves can be inte-

grated more easily. This design facilitates a switching time interval of approximately 180 camshaft degrees, which corresponds to a theoretical switching time of 20 ms at 3,000 rpm. The longer oil channels do pose a limitation, however, as they require a higher oil volume, which in turn makes the system more susceptible to fluctuations in the shifting or switching times as a result of the greater potential for oil foaming to occur.

The shifting oil circuit and switching valve linkage can also be implemented in ways other than the ones described here. Critical design aspects that apply in this context are the ignition timing sequence and configura-



**Figure 12** Switchable finger follower



**Figure 11** Oil circuit with one switching valve per side

tion of the cylinder head and oil channels of the target engine, whereby the main focus of the design work should be on maximizing the switching time interval as far as possible using justifiable levels of outlay.

## Deactivation via switchable elements

### Finger followers

Since the design configurations for the switchable finger follower can also be applied to the switchable bucket tappet, we will not explore this topic any further.

The solutions that are based on finger followers or hinged-lever designs that can be coupled with one another and have a locking mechanism at the pivot point are numerous. All systems that rely on oil pressure require spring-actuated elements to return the deactivated components to their starting position after cam elevation (Figure 12). The shift mechanism must be designed in such a way that the entire valve stroke is traveled when no oil pressure is present (zero-pressure lock), since this safeguards operation in limp-home mode and is required for cold-starting the engine.

Although cylinder deactivation brings with it many benefits, the concept also has several drawbacks. The additional contact points and increased number of compo-

nents, for example, reduce rigidity as compared to a standard finger follower and negatively affect the vibration of the valve train. The added components also increase the mass moment of inertia of the follower, which in turn means that stronger valve springs need to be fitted, and the valve train assembly encounters higher levels of friction as a result. Potential space restrictions necessitate narrower rollers, a design that inherently increases the surface contact pressures between the roller and camshaft.

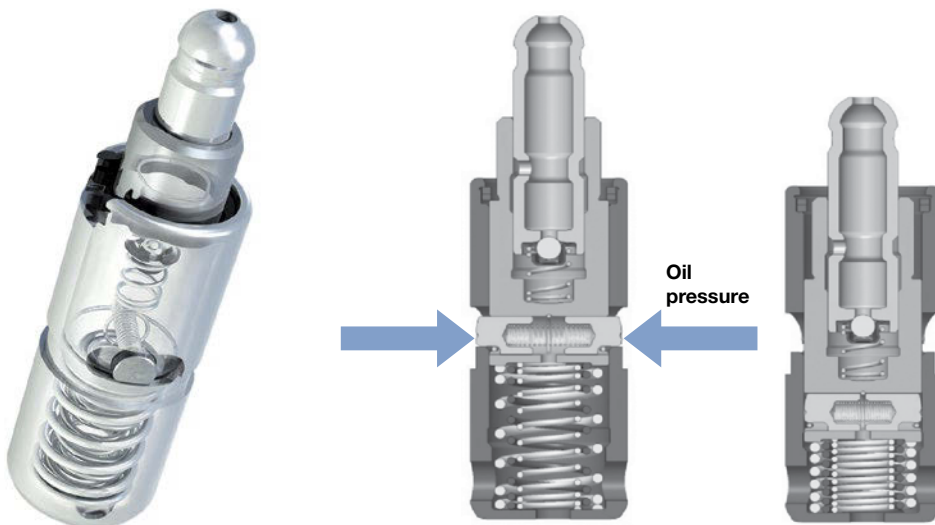
Switchable finger followers that brace themselves against a zero-stroke cam in deactivation mode create a more stable system than the variant that does not provide for this effect. The only drawback is that the camshaft then requires two different profiles per valve. If a zero-stroke cam is not provided, the acting forces must be precisely coordinated with each other; in the decoupled state, the lost-motion spring needs to be strong enough to prevent “inflation” or “pump-up” (undesired elongation) of the support element. On the other hand, the spring must not be so rigid that the motor

valve inadvertently opens in the direction opposing the valve spring pressure.

### Support element

The switchable pivot element also lends itself to being deactivated. Similar to the switchable roller tappet, the inner part of the element can be telescopically extended into the outer part (Figure 13). Here too, a spring or spring assembly is required to return the moving part to its starting position. The oil pressure, which is controlled by an upstream switching valve, is also used to actuate the coupling mechanism. The distance traveled by the oil to this mechanism is shorter, however. The same restrictions that apply to the switchable finger follower with regard to the oil pressure also hold true for this application.

The rigidity of the valve train is only reduced by the structural integrity of the coupling point in the switchable pivot element. The geometry (with the exception of the valve contact surface) and mass moment of inertia of the finger follower are unaffected. As a result, the valve spring pretension force



**Figure 13** Switchable pivot element

does not have to be changed in comparison to that of the conventional valve train assembly, which means that the surface contact pressures between the roller and camshaft remain at low levels.

### Deactivation via a cam sliding system

The cam shifting system allows the valve stroke to be switched in up to three stages. The switchover process occurs when a cam piece positioned in an axially movable arrangement on a splined shaft is displaced. This sliding cam piece comprises several cams sectioned into two groups, which are arranged in relation to the two valves on each side of a cylinder (Figure 14).

A control groove is integrated into the sliding cam piece. When the cam lift is to be adjusted, an electromagnetically actuated pin extends into this groove to force the entire unit to change its respective groove



**Figure 14** Two-stage cam shifting system



**Figure 15** Three-stage cam shifting system

contour position. A second cam profile (or a third one in the case of three-stage systems) thus acts on the finger follower to transfer the new cam lift (which can also be a zero-stroke) to the valve so that each valve pair can be actuated individually. The inherent benefits of this system are that the cylinders and camshaft can be switched selectively and the sequence of the elements to be switched is variable.

After the actuation sequence has taken place, a relay signal generated by the actuator pin as a result of a voltage shift in the electric coil is sent to the actuator. Although this signal provides clear indication of a shift occurring and the direction that was taken, it is not sufficient for determining positional arrangements as operation continues (OBD requirement). The cam shifting system offers a benefit here that initially appears to be the exact opposite: Both valves are forced to switch at the same time. This, in turn, makes it considerably easier to detect correct position during active operation by way of sensors (pressure or oxygen sensors) on the intake and exhaust side or by evaluating torque imbalance than when systems with individual switch logic are used.

When viewed from the perspective of a cost-benefit analysis, it is important to note that the cam shifting system requires more

outlay than switchable elements, since in four-cylinder engine applications, both camshafts must be equipped with a deactivation function – a design aspect that also affects positional elements that are not switchable. Consequently, the cam shifting system is a commercially viable option for cylinder deactivation if an existing two-stage system for varying the valve stroke is enhanced to include a third stage dedicated to the cylinder deactivation process (refer to Figure 15).

Theory-based investigations conducted by Schaeffler indicate that a three-stage system can offer further significant potential compared to a two-stage solution in consumption testing cycles carried out under higher load conditions. When the cam shifting system is designed so that all intake and exhaust valves can be deactivated, it is possible to deactivate any desired number of

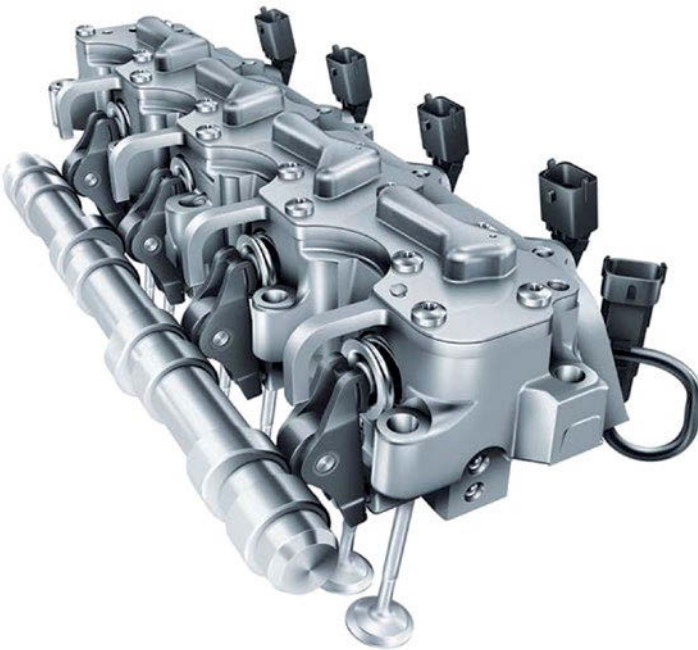
cylinders. This setup also facilitates the integration of an alternating cylinder deactivation pattern [3].

### Cylinder deactivation via UniAir

UniAir not only controls and regulates valve stroke travel in a fully variable fashion, but can also completely deactivate any cylinder (Figure 16). This deactivation is achieved by actuating the system's integrated switching valves as required. In its current version, UniAir actuates both valves in a uniform manner. As a result, both intake valves are always closed in deactivation mode. The operating state of the valve train can thus be easily determined with the UniAir system as well. When UniAir is only used on the intake side, switchable support elements can be fitted in the relevant positions on the exhaust side (as is the case with the

fully-variable mechanical system).

Schaeffler is currently working on additional valve stroke configurations that approach the potential afforded by cylinder deactivation while making it possible to forego valve deactivation on the exhaust side. The genuine appeal of this type of configuration is that it allows any number of cylinders to be deactivated without having to implement further design measures. Detailed information is provided in an additional article [4] in this book.



**Figure 16** Electrohydraulic, fully-variable UniAir valve train system

## Summary and outlook

---

Temporarily deactivating cylinders offers an attractive compromise between downsizing an engine to reduce fuel consumption and retaining high levels of comfort and driving pleasure. Even three-cylinder engines can profit from the economical benefits of cylinder deactivation. Simulations point to the potential that an alternating cylinder deactivation system has for maintaining a balanced temperature level in the engine and reducing vibrations, particularly in three-cylinder engine applications.

Several options are available for temporarily deactivating valves, especially in the context of finger follower regulation systems. When cylinder deactivation is the only variable aspect required, switchable pivot elements offer a very cost-effective solution without noticeably compromising the basic functions of the valve train assembly. In the case of multi-stage systems or entire engine families, cam shifting systems are more favorable because they can be easily adapted. Fully-variable valve train systems go hand in hand with cylinder deactivation in the presence of discretely switchable elements as a minimum expenditure item. Depending on the size of the engine and the

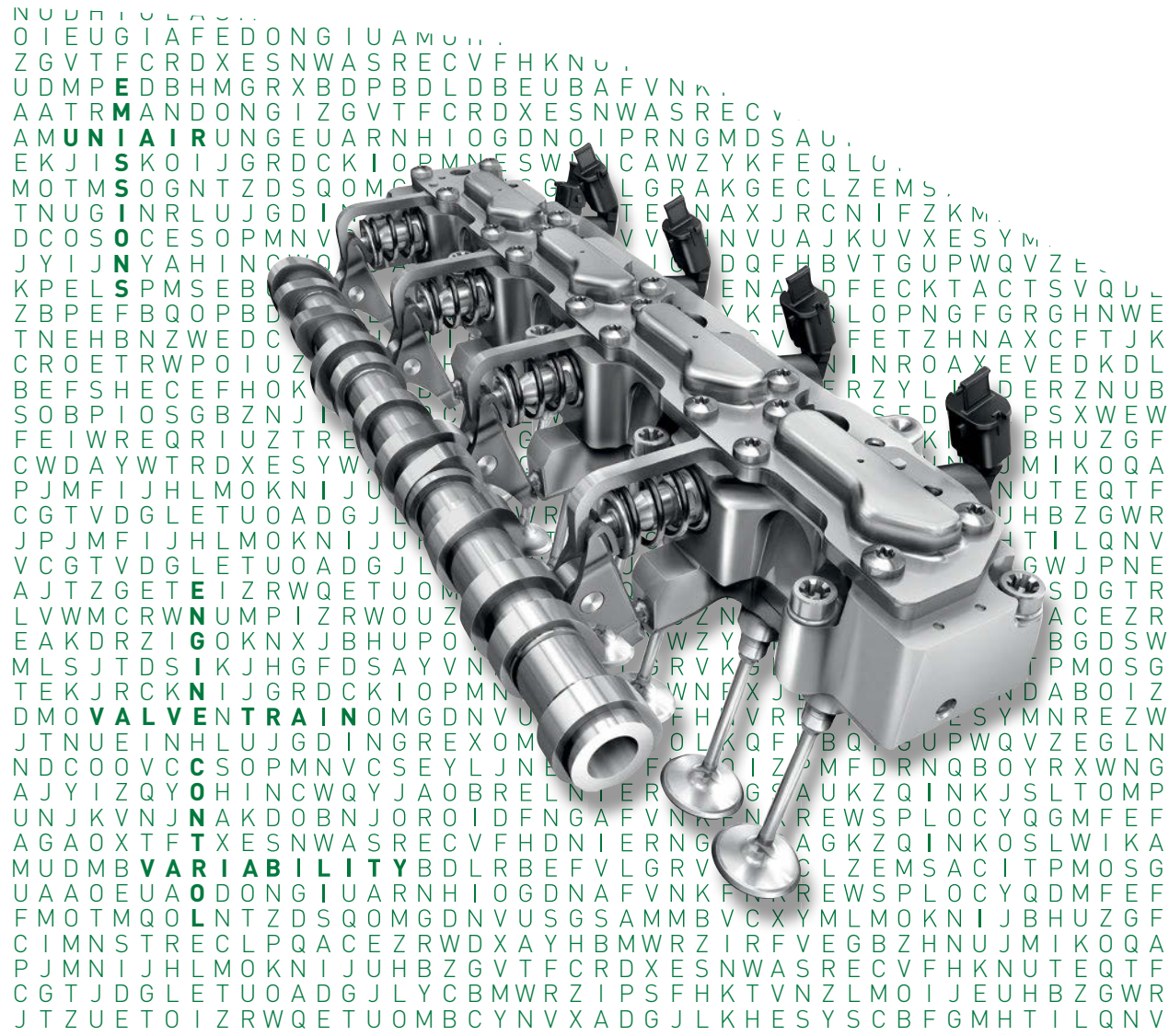
expectations customers have regarding comfort levels, additional design measures may be required for the engine and overall vehicle that conflict with the potential for reducing fuel consumption, which can be especially prominent in lightweight vehicles equipped with powerful engines.

In the future, it is highly probable that cylinder deactivation will play an ever increasing role in optimizing powertrains that use engines with three or more cylinders.

## Literature

---

- [1] Middendorf, H.; Theobald, J.; Lang, L.; Hartel, K.: Der 1,4-l-TSI-Ottomotor mit Zylinderabschaltung. MTZ, 3/2012, pp. 186-193
- [2] Kirsten, K.; Brands, C.; Kratzsch, M.; Günther, M.: Selektive Umschaltung des Ventilhubes beim Ottomotor. MTZ, 11/2012, pp. 834-839
- [3] Faust, H.: Powertrain Systems of the Future: Engine, transmission and damper systems for downspeeding, downsizing, and cylinder deactivation. 10<sup>th</sup> Schaeffler Symposium, 2014
- [4] Haas, M.; Piecyk, T.: Get ready for the combustion Strategies of tomorrow. 10<sup>th</sup> Schaeffler Symposium, 2014





# Get Ready for the Combustion Strategies of Tomorrow

Michael Haas  
Thomas Piecyk

# 12



## The variable valve train – a tool for greater efficiency

---

In the future, internal combustion engines will have to fulfill increasingly stringent requirements with regard to carbon dioxide emissions and exhaust pollutants, and this means a decisive role for the valve train: On the one hand, it should be designed in such a way that the losses occurring during the charge cycle are low, and on the other hand it creates the prerequisite for the best possible mixture preparation in the cylinder and thus a combustion process that provides optimum efficiency and low emissions. In addition, the valve timing directly influences the combustion process by way of the compression, which is adjustable within limits, and the residual gas in the cylinder.

The variability of valve trains has therefore increased dramatically in the last few years. Two basic approaches for a higher degree of variability must be observed in this context:

1. The temporal shifting of the valve lift curve using camshaft phasing units
2. The variation of the valve lift curve in terms of the lift height and the opening and closing point, and thus of the resulting opening period.

### Camshaft phase adjustment

Ever-increasing numbers of gasoline engines have a camshaft phasing system – either on the intake side only or on the intake and exhaust side – and a volume-produced diesel engine recently went into production with a phasing system on one camshaft for the first time. Systems with hydraulically-actuated swivel motors have become es-

ablished. The trend towards downsizing and downspeeding will increase the rate with which these systems are fitted because power and torque can be increased and raw emissions reduced by changing the relative angle between the camshaft and the crankshaft.

Electric phasing units are the optimum solution from a technical perspective. An electric system allows the greatest degree of freedom when selecting the timing for starting. It offers higher rigidity when torque is applied to the camshaft via the crankshaft and therefore achieves the highest adjustment accuracy. The adjustment speed is also higher compared with the best hydraulic systems. The electric system is also the only system to offer the option of free selection of the timing when the engine is started. Such a system will go into volume production for the first time at Schaeffler in 2015. It is designed so that no modifications to the cylinder head are required.

The high performance of electric phasing units is also associated with a higher outlay, however. This is why it is advisable to further optimize the systems currently used. Further development of these systems must be focused on meeting increasing requirements at comparatively low oil pressures. How this can be done is described in a separate article [1].

### Variable valve lift curves

In gasoline engines, incrementally variable valve trains on the intake and exhaust side have been known for many years, and a diesel engine with cam profile shifting implemented on the exhaust side went into volume production a few months ago.

When an incrementally variable valve train system is designed to act on the cam, this is referred to as a “shifting cam”. In this type of system, an electromagnetically op-

erated actuator axially shifts a cam assembly that is mounted on the camshaft. An advantage here is the independence from the engine's hydraulic circuit with its dependency on temperature and viscosity.

There are many known variants of valve lift curve shifting on the cam contact partner or the hydraulic pivot element, in which the task of switching between the valve lift curves is performed by a hydraulically-actuated locking piston.

Partially-variable valve trains allow both valve lift curve shifting and valve/cylinder deactivation to be implemented. These systems are attractive in that they offer significant benefits in terms of fuel consumption with only a moderate cost outlay.

Engine designers have been looking for a way to regulate the lift of both intake and exhaust valves for a long time. The ideal situation would be to have a valve lift curve that is adjusted to suit the engine's current operating point and condition and can be defined as desired, which would make it possible to set the timing in such a way that it is not a compromise between the diverse requirements of individual sub-targets.

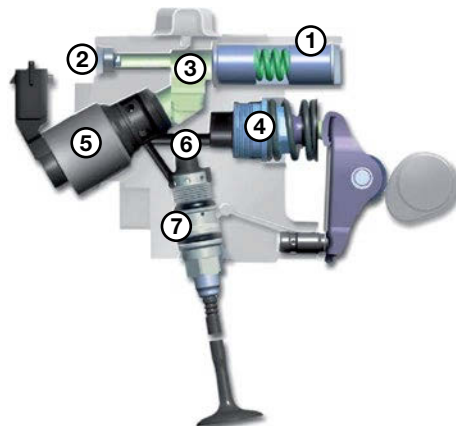
In 2009, Schaeffler and Fiat collaborated to put the UniAir electrohydraulic valve train system, the design and function of which has been described multiple times [2-4] into volume production. The scope of delivery from Schaeffler comprises the following:

- The electrohydraulic actuator module
- The software required for controlling the valve control system, which is integrated into the customer's engine control system
- A calibration data set for the relevant application

This system has since been adapted for a range of volume-production engines with capacities ranging from 0.9 to 2.4 liters and more than 500,000 units have been delivered to customers in Europe and in North and South America.

## Development level of UniAir

The basic function of the UniAir valve train has not changed since its market launch. Figure 1 shows a typical assembly. The camshaft acts on a finger follower, which drives the pump (4) that fills a high-pressure chamber (6). Depending on the position of the solenoid valve (5), the oil pressure acts on the engine valve via a piston or is reduced via outflow into the medium-pressure chamber (3) and pressure accumulator (1). By adjusting the solenoid valve – temporarily decoupled from the camshaft position – various pressure levels in the high pressure chamber and thus variable engine valve lifts can be achieved. In today's applications, the maximum pressure in the high-pressure chamber is approx. 150 bar in continuous



**Figure 1** Typical setup of a UniAir actuator with the components:

- 1 – Pressure accumulator
- 2 – Oil supply
- 3 – Medium-pressure chamber
- 4 – Oil pump
- 5 – Solenoid valve
- 6 – High-pressure chamber
- 7 – Valve brake

operation. The peak pressures that are acceptable for short periods are as high as 200 bar. For energy reasons, a portion of the oil flows from the medium-pressure chamber into a pressure accumulator (1). The oil supply (2) is provided by the engine oil circuit.

After the pressure in the high-pressure chamber drops, the engine valve is closed by the valve spring. The guide for the piston that is responsible for opening the valve has small bores that allow the oil to flow out in a controlled manner and thereby act as a brake (7).

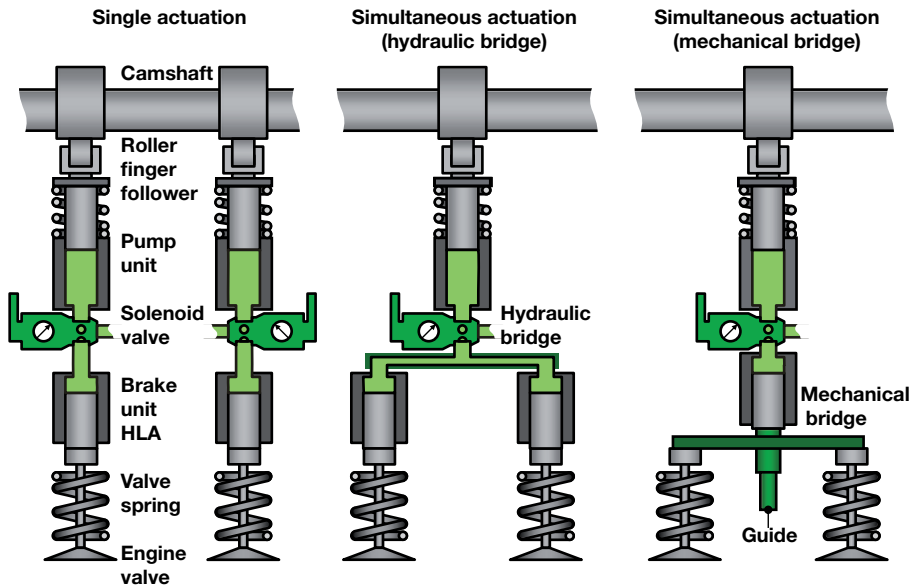
In addition, a temperature sensor is also required in order to compensate for the hydraulic effects produced by the temperature-dependent viscosity of the oil. All other parameters required for controlling the UniAir system – such as the camshaft speed – are provided by sensors that are already employed.

The UniAir system is not restricted to application in engines with one intake valve

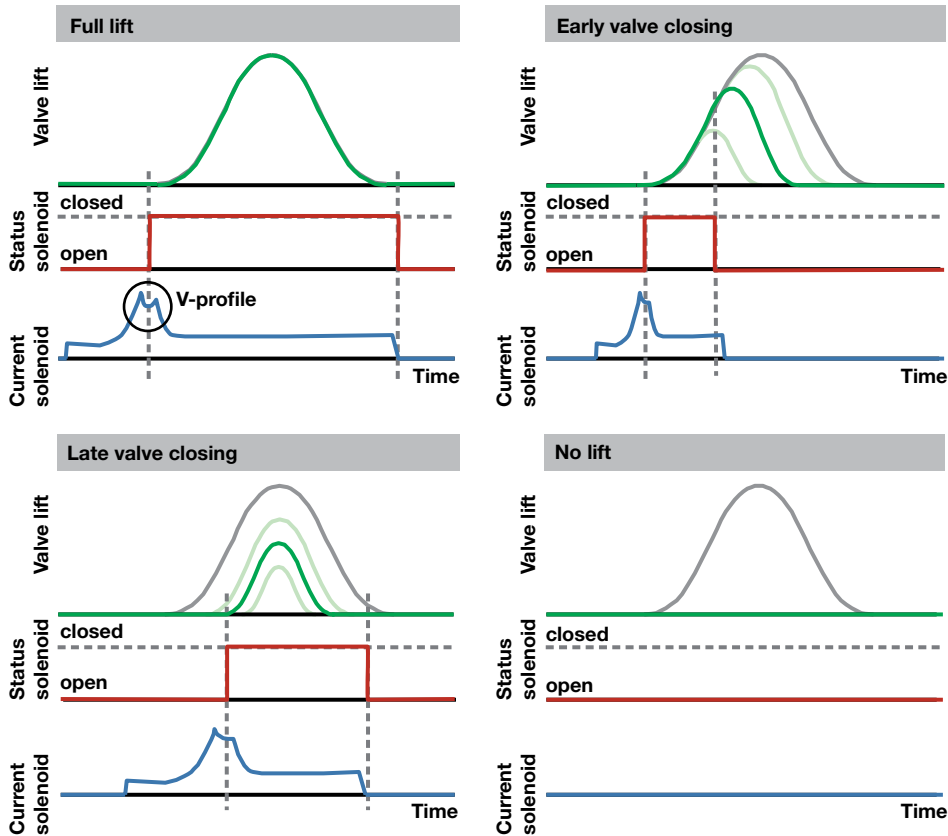
per cylinder, however. Two intake valves of the same cylinder can be operated using either individual activation or with a hydraulic or mechanical bridge (Figure 2). For cost reasons, only the variant with a hydraulic bridge is currently in volume production. Individual activation would, however, provide an even higher degree of flexibility.

The systems that are already installed in volume-production applications today allow a significant degree of variability to be achieved in both the valve lift and the opening times (Figure 3). The maximum lift and the earliest opening point are specified by the envelope curve of the cam that is used to drive the system. The same applies for the latest possible closing point. Within these limits, regulation is carried out exclusively via the current controlling the solenoid valve.

The overall result is that the valve opening and closing times and the valve lifts can be optimally adjusted for all engine operating points (Figure 4).



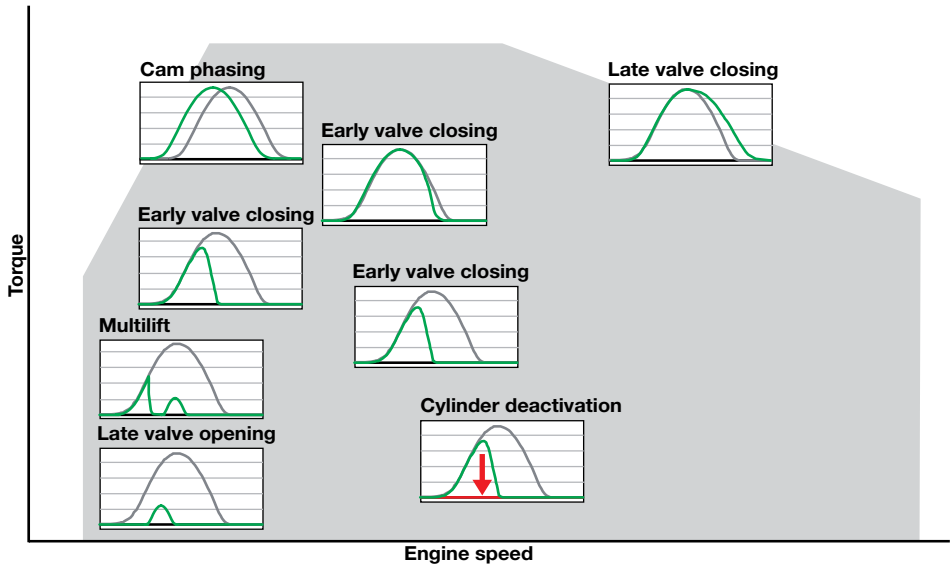
**Figure 2** Alternative solutions for operating two intake valves



**Figure 3** Variability of valve lift and opening/closing point with the current UniAir system

During the closing time, the current curve required to close the solenoid valve – i.e. to open the engine valve – displays the typical V-shape that is caused by the valve reaching its end stop position. The position of the turning point in the V-profile indicates the extent to which the desired lift was achieved by the solenoid valve. The reproducibility can be traced by making a comparison of several consecutive events. If deviations occur here that are not within the tolerance limits, e.g. due to aging components, these can be compensated by changing the current curve.

Experience with volume-production engines to date has shown that UniAir displays very good values, both in terms of reproducibility – i.e. deviations from cycle to cycle in one cylinder – and of the system’s precision – i.e. the spread across several engines. UniAir thus achieves a repeat accuracy of 0.4 crankshaft degrees at 3,000 rpm and a system temperature of 120 °C for the “early intake closure” function. The opening angle during “late intake valve opening” – which is decisive for cylinder balancing – also achieves a precision of 0.4 crankshaft degrees. Under the conditions described, the deviations between various volume-pro-



**Figure 4** Valve lift curves within the engine map

duction engines are at a slightly higher level for “early intake valve closure” than for individual cylinder actuation. A compensation function that is integrated into the UniAir software also ensures that the cylinders of the respective engine are correctly balanced here, however.

The market launch of UniAir has proved that the system can be applied in such a way that no changes to the design envelope are required. The prerequisite for this is that the UniAir system and the remaining standard valve train are both driven by a common camshaft that is still installed. In the case of a direct injection gasoline engine with centrally-positioned injectors, the injector and spark plug must be arranged perpendicular to the camshaft assembly. If this is carried out, the intake camshaft (for example) can be omitted, which means that the additional costs of the UniAir system can be partially compensated. In the future, however, there will also be applications in which both camshafts are retained.

## Expansion of the scope of functions

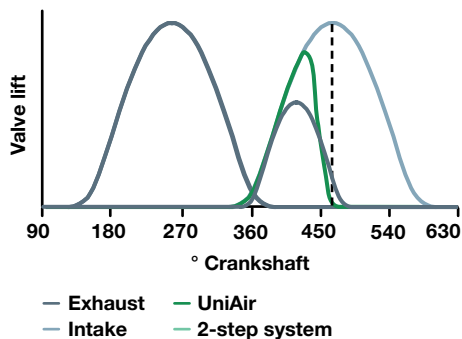
### Applications for gasoline engines

The trend for low-consumption gasoline engines with direct-injection and increasingly small engine capacities is continuing unchecked. The introduction of new standard cycles for measuring fuel consumption, particularly the WLTP, mean that operating points with higher loads are being achieved at the same time, in which the benefits provided by the combination of downsizing and turbocharging cannot be exploited to the same degree. When combined with turbocharging, a fully variable valve train can therefore contribute towards reducing fuel consumption even further.

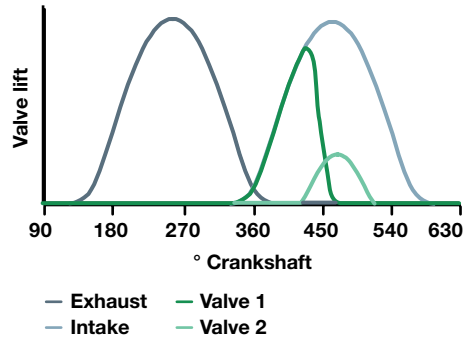
In turbocharged engines, the flushing of the cylinder with fresh air (“scavenging”) provides significantly faster response times

at low speeds and high loads. The valve overlap that this requires is conventionally achieved through the use of camshaft phasing units. This type of camshaft phasing unit, which is characterized by its high adjustment speed, is available from Schaeffler [4]. When designed correctly, UniAir can partially replace camshaft phasing units of this type. Although it is not possible for this system to influence the point at which the valve's envelope curve begins, the variation of the opening point together with a special lift curve (see Figure 8) can be used to only activate valve overlap when it is required.

Dethrottling at low speeds is known to have a very positive effect on the fuel consumption. It is important that the smaller valve lifts are not designed in such a way that a vacuum that could cause load cycle losses occurs in the cylinder during the intake stroke. This is an argument in favor of systems in which the lift height and lift duration can be varied to the same extent (Figure 5). Compared with an engine operated with a standard valve train and camshaft phasing units, an 8.4 % reduction in the specific fuel consumption that has been measured and verified is achieved at the operating point of 2,000 rpm and 2 bar.



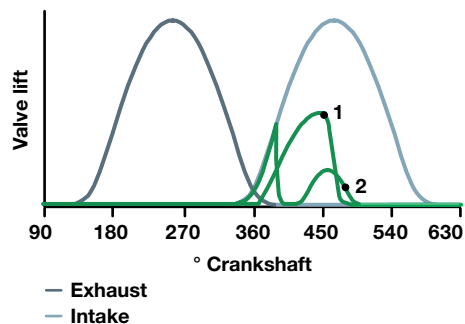
**Figure 5** Lift curves for dethrottling at low speeds: UniAir compared with a two-stage cam profile



**Figure 6** Lift curves of two intake valves of a cylinder when operated individually

An increase in the charge motion in the cylinder ("swirl") can contribute to improving the formation of the mixture and thus making the combustion process more efficient, especially with low loads of the kind typically found in city traffic. If both of a cylinder's intake valves are individually operated by a UniAir system, individual lift profiles for the valves can be illustrated (Figure 6).

Valve lift curves for city traffic/operation under low load conditions are also being developed (Figure 7) that can only be illustrated with UniAir and not with mechanical solutions for a fully variable valve train. The "hybrid lift" function combines late opening of the intake valve with early closure, a pro-



**Figure 7** Special valve lift curves: 1) Hybrid lift and 2) Multilift

cess in which the ramps are not symmetrical with one another.

The “multilift” function opens and closes the intake valve twice within the intake stroke, which produces an optimum combustion process and low pumping losses at low speeds and under low to medium load conditions, and is therefore particularly suitable for optimizing fuel consumption in city traffic.

Under medium load conditions, operation using the Miller cycle – i.e. rapid and premature closing of the intake valve – is a good option. The improved expansion ratio improves the engine’s degree of efficiency. The Miller cycle can easily be implemented with the UniAir system. The same applies for operation with the Atkinson cycle under high load conditions, during which the intake valve is opened for longer. This provides the desired reduction in compression without the charge motion in the cylinder being destroyed. The lower degree of compression in the high load range reduces the tendency towards knocking, which is of relevance for modern, supercharged gasoline engines.

Schaeffler and Continental have tested the application suitability of a combination of Miller and Atkinson cycles controlled exclusively by UniAir in a joint advance development project. For this purpose, a 1.4-liter volume-production engine that was already equipped with UniAir was fitted with a different engine control system in order to correspondingly optimize the process control. The results show significant potential with regard to fuel consumption:

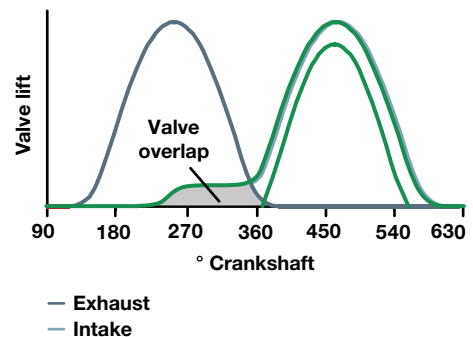
- The use of the Miller cycle reduces compression at the operating point of 2,000 rpm and 12 bar, which produces lower final compression temperatures and thus a reduction in the tendency towards knocking. The specific fuel consumption is improved by 4.4 % compared to the volume-production engine.
- If the mean pressure is increased to 15 bar at the same speed, a significantly lower tendency towards knocking is

observed due to the closure of the intake valve after the beginning of the compression stroke (Atkinson cycle). The specific fuel consumption is reduced by 4.6 %.

- At a typical full-load point (3,000 rpm and 18 bar), the use of the Atkinson cycle makes it possible to reduce the degree of enrichment that would otherwise be required in order to lower the temperature in the combustion chamber. This leads to a 4.6 % reduction in the specific fuel consumption.

The use of UniAir allows not only the fuel consumption but also the exhaust emissions to be reduced. This particularly applies to nitrogen oxide ( $\text{NO}_x$ ) emissions, as was verified for diesel engines as early as 2008 [6]. Related designs combined internal and external (low-pressure) exhaust gas recirculation in the engine.

With the first-generation UniAir system, it was only possible to adjust the valve lift within the “conventional” envelope curve as specified by the cam. This makes it difficult or even impossible to achieve the kind of large valve overlaps required for high residual gas content. This obstacle has now been overcome thanks to the introduction of a correspondingly designed “two-stage” cam profile for the UniAir system. This is re-



**Figure 8** Valve overlap for internal exhaust gas recirculation with a two-stage cam as the UniAir drive



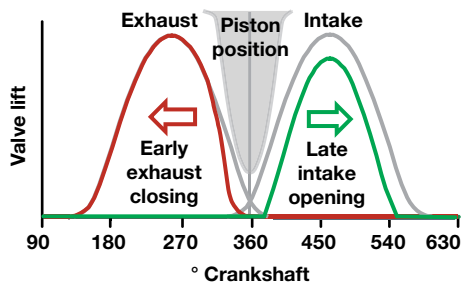
ferred to as a “boot cam” due to its boot-like shape. It is now possible for the first time to achieve a large valve overlap without a significant reduction in the maximum filling level during the intake cycle (Figure 8).

For operating points that do not require internal exhaust gas recirculation (e.g. under full load conditions), no current reaches the solenoid valve that is responsible for the UniAir’s switching until the first stage of the cam has already passed over the contact surface with the high-pressure pump.

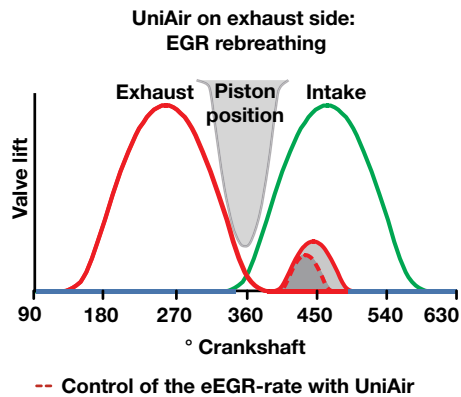
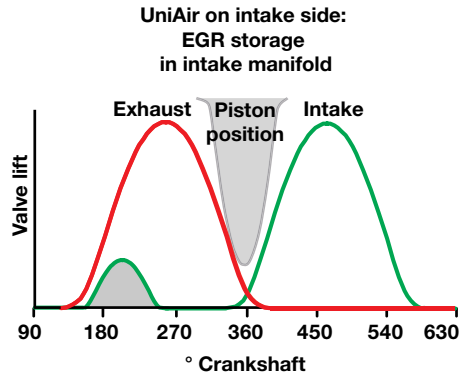
### UniAir for diesel engines

Over the coming years, the further development of the diesel engine will continue to focus on the reduction of  $\text{NO}_x$  and soot exhaust emissions. In order to minimize the outlay for costly exhaust gas aftertreatment, especially selective catalytic reduction (SCR), a clean combustion process is of the utmost importance for every engine designer. In addition to other measures such as increasing the injection pressure, combustion with a high rate of exhaust gas recirculation is an important prerequisite for keeping these raw engine emissions to a minimum.

The two-stage cam is not a suitable solution for the diesel engine, because a significant valve overlap is not possible due to the



**Figure 9** Internal exhaust gas recirculation for diesel engines through early exhaust valve closure and late intake valve opening



**Figure 10** Internal exhaust gas recirculation for diesel engines with double cams for the UniAir drive

lack of free-running clearance between the piston crown and the engine valve at the top dead center. An alternative concept would be to control the quantity of residual gas remaining in the combustion chamber within wide limits through early closure of the exhaust valve and late opening of the intake valve (Figure 9). The first-generation UniAir system can already provide the lift curve variability that this requires – however, UniAir must also be used on the exhaust side in this case.

Double cams to actuate the UniAir system on the intake or exhaust side provide a further solution for achieving even higher

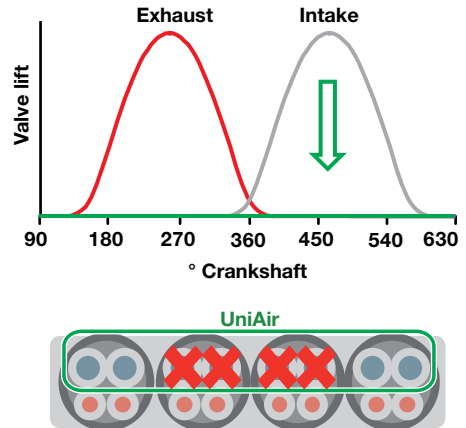
internal exhaust gas recirculation rates if required. It is ensured here that the valve lift curve of the smaller cam can also be controlled (Figure 10) and that it is thus possible to control the exhaust gas recirculation rate. All of the UniAir system's modes still remain available for the primary/main cam. Operation without exhaust gas recirculation is thus possible at all times, which is important at extremely low temperatures (below  $-10\text{ }^{\circ}\text{C}$ ), for example.

For the sake of completeness, it should be mentioned that this is exactly how the thermodynamically positive effects of an effective compression ratio that has been reduced using the Miller/Atkinson cycles with UniAir can be achieved for diesel engines [5]. However, the objective here is to reduce the final compression temperature and thus the maximum final combustion temperature for emission reasons.

## Supporting future combustion processes

### Cylinder deactivation

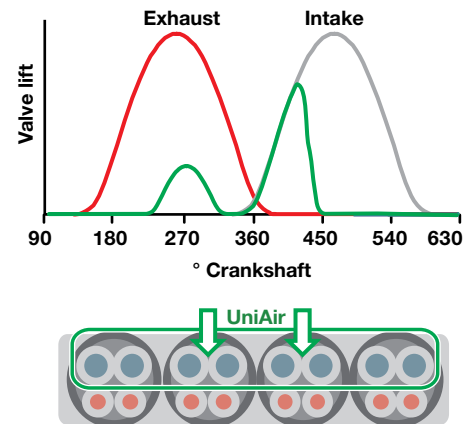
Despite the unmistakable trend towards highly charged low-displacement engines, engines with four cylinders and upwards will continue to be used in large vehicles and those designed with high performance in mind. Engines of this type have to achieve better specific fuel consumption figures, especially under low load conditions and at low to medium speeds, so that the vehicle's overall emissions are reduced in the common standard cycles. A solution for this that has already been put into volume production by manufacturers including Audi, Chrysler,



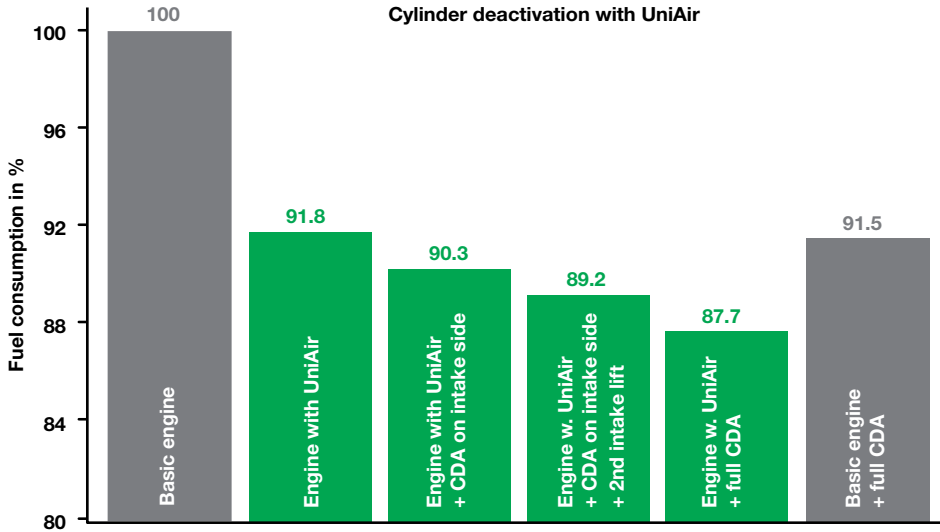
**Figure 11** Cylinder deactivated by shutting down the intake valve

GM, Honda, Mercedes, and Volkswagen is cylinder deactivation, which increases the load of the operating point of the cylinders that are not deactivated. The mechanical systems that have been introduced for this purpose require a high level of outlay.

It is already possible to perform simple cylinder deactivation using the current UniAir system (Figure 11). However, this



**Figure 12** Cylinder deactivation with additional intake valve opening



**Figure 13** Simulated fuel consumption benefits for different cylinder deactivation strategies

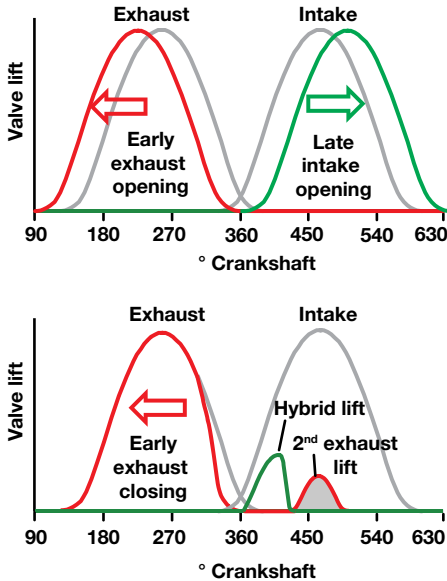
type of system does not utilize the full potential for reducing CO<sub>2</sub> emissions that is available with the latest mechanical deactivation systems, which is estimated at up to 4 % in addition to the use of the fully variable valve train. This is because of the high level of charge cycle work caused by the exhaust valves that are still being actuated.

If the use of additional measures on the exhaust side, e.g. the use of switchable pivot elements, has to be avoided, there is a further variant that is also based on the use of a double cam. In this case, the cam is used on the intake side to briefly open the intake valve of an unfired cylinder during the exhaust stroke (Figure 12), allowing the exhaust gas to flow into the intake system. The intake valve in turn is then opened and then rapidly re-closed during the intake stroke, so that almost only the “stored” exhaust gas is allowed to flow into the combustion chamber. This alternating effect means that the overall charge cycle work is significantly reduced, and a large proportion of the savings potential available from the complete

deactivation of all cylinders can be achieved (Figure 13).

### Homogeneous charge compression ignition

Homogeneous charge compression ignition (or HCCI for short) has been undergoing development for volume production for some time. The section of the engine data map in which the thermodynamic benefits of self-ignition can be utilized has been continuously expanded, but still only covers part of the engine data map (up to a maximum of mid-range loads and speeds). This is because charge stratification with precisely defined composition and a high quantity of residual gas is the decisive factor for a stable HCCI combustion process. In addition to injection, the precise guidance of the charge motion combined with precise metering of the exhaust gas recirculation rate and adjusted compression can also have a significant positive effect on the stability of the combustion process [6].



**Figure 14** Valve lift curves for an HCCI combustion process: Greater variability through the combination of a phasing unit (left) and UniAir system (right)

In order to ensure the correct charge motion at high speeds and under high load conditions, Schaeffler relies on a combination comprising a camshaft phasing unit (electromechanical or hydraulic) and a UniAir system with a double cam drive (Figure 14). This fast actuator system makes it possible to set the correct compression and mixture ratio for every operating point. Switching between sections of the data map with compression ignition and external ignition can also be achieved in a significantly faster and more reliable way.

## Outlook

The UniAir system has firmly established itself on the market. The significantly higher degree of valve lift curve flexibility displayed by an electrohydraulic system compared to mechanical systems, which are also in volume production or development, makes far more dynamic process control possible even today. The second-generation UniAir system also makes additional functions available. The adjustment of the UniAir drive using two-stage or double cams that is required for this purpose has achieved a high level of maturity.

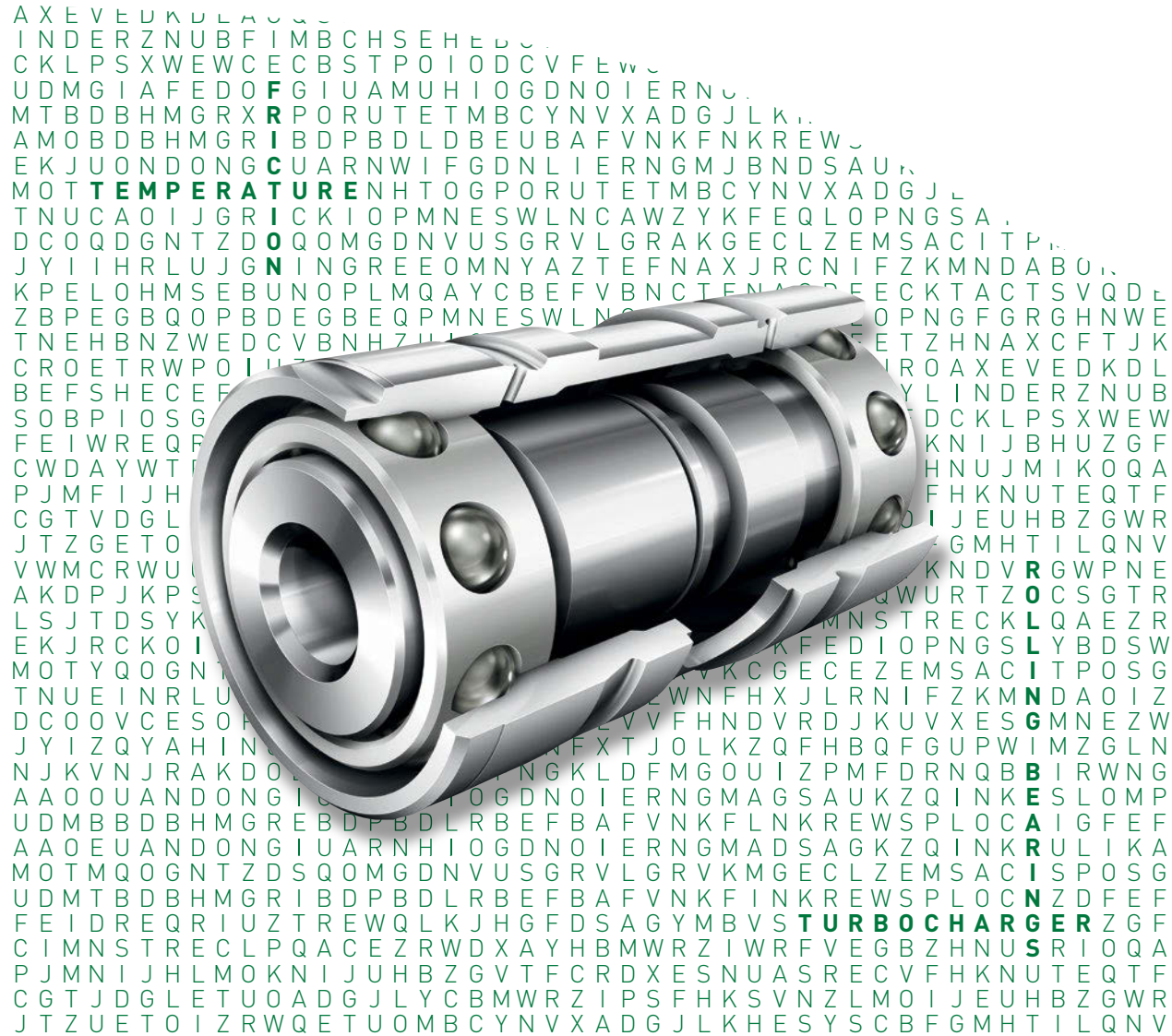
From 2015/16 onwards, UniAir will be used in a range of further passenger car applications, including engines equipped with different numbers of cylinders from those in today's volume-production applications, and it is also set to be put into volume production by more automobile manufacturers. Intensive preproduction testing is currently being carried out on a four-cylinder diesel engine application.

The first motorcycles to be equipped with the UniAir system will also be seen in the near future. In parallel to this, Schaeffler is also collaborating with ABB Turbo Systems on a project to market the UniAir system for use in stationary engines. An area of particular interest here is the use of gas-operated stationary engines for energy generation. Even these engines will have to be controlled with a significantly higher degree of flexibility in the future without their high degree of efficiency being sacrificed. In applications of this kind, the cost savings that are achieved through the targeted improvements in fuel economy are significantly higher than the cost of the variable valve train system.

## Literature

---

- [1] Dietz, J.; Busse, M.; Räcklebe, S.: Needs-based Concepts for Camshaft Phasing Systems. 10<sup>th</sup> Schaeffler Symposium, 2014
- [2] Haas, M.: Just air? UniAir – The first fully-variable, electro-hydraulic valve control system. 9<sup>th</sup> Schaeffler Symposium, 2010
- [3] Bernard, L.; et al: Elektrohydraulische Ventilsteuerung mit dem "MultiAir"-Verfahren. MTZ 70, 2009, No. 12, pp. 892-899
- [4] Haas, M.; Rauch, M.: Elektrohydraulischer Vollvariabler Ventiltrieb. MTZ 71, 2010, No. 3, pp. 160-165
- [5] Ruggiero, A.; et al.: Combustion Technologies to meet EURO 6 Emission Standard on Diesel D-segment Passenger Car. SIA International Conference „Diesel Engine: the low CO<sub>2</sub> and emission Reduction Challenge”, Rouen, 2008
- [6] Schutting, E.; et al.: Miller- und Atkinson-Zyklus am aufgeladenen Dieselmotor. MTZ 68, 2007, No. 6, pp. 480-485



# Rolling Bearings in Turbochargers

**A real bargain with regard  
to CO<sub>2</sub> emissions**

Chris Mitchell  
Christian Schaefer  
Oliver Graf-Goller  
Peter Solfrank  
Martin Scheidt

# 13

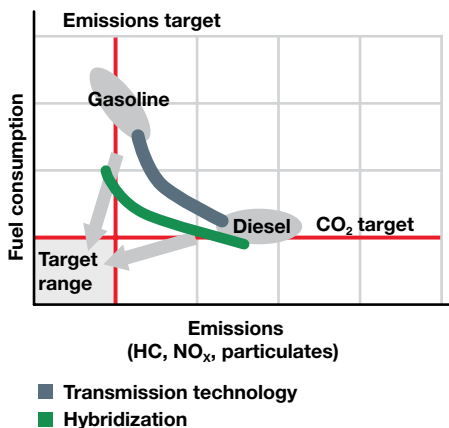


## Introduction

Although the internal combustion engine is likely to still dominate the automotive landscape for the next decade or so, the increasing mismatch between energy consumption and available resources, together with tighter legal restrictions on engine CO<sub>2</sub> emissions, is creating an increased demand for improvements to existing automotive technologies and the development of reduced friction, more energy efficient, 'greener' alternatives. At the same time, an increased awareness of air pollution has resulted in more and more stringent regulations on automotive engine emissions that drive technology developments.

Gasoline and diesel fuel internal combustion engines are positioned completely differently with regard to the conflicting aims of fuel consumption and emissions (Figure 1).

The gasoline engine is clearly in the low emission category due to its very efficient after treatment of exhaust gases.



**Figure 1** Fuel consumption/emissions

However, the spark ignition engine has inherently lower thermodynamic efficiency and hence has high fuel consumption.

The diesel engine, on the other hand, has a place in the low fuel consumption category due to its favorable, thermodynamic efficiency and advantageous low end torque characteristics. This supports the trend towards downsizing for a further reduction in fuel consumption.

However, the compression ignition engine suffers with high exhaust emissions, HC, NO<sub>x</sub> and particulates.

## Forced Induction

In order to support the growing demand for more energy efficient, low carbon emission vehicles, manufacturers of forced induction systems, particularly for passenger cars and commercial vehicles, are being asked to provide more compact, higher efficiency systems that are both durable and affordable.

Forced induction, achieved by both turbocharging and supercharging, allows an engine to burn more fuel and air mixture by packing more oxygen molecules into the existing cylinders. Thus, the engine is able to deliver more power output per combustion stroke.

Forced induction is a key strategic technology for engine downsizing, permitting a small displacement engine to deliver a power output similar to larger naturally aspirated engines, as well as downsizing, permitting the same power output with lower engine speed. Friction reduction and further improvement of thermodynamic efficiency at high specific loads are the drivers for this development.



## Turbocharger

A turbocharger is a device that uses the energy of exhaust gases emitted from an engine to compress the air going into the engine.

The core of a turbocharger is a rotating shaft coupling two wheels, a turbine wheel and a compressor wheel. The rotation of the shaft is supported by a bearing system.

The turbine wheel is positioned in the exhaust stream of the internal combustion engine. The exhaust gas from the cylinders passes through the turbine blades, causing the turbine to spin. The more exhaust gas that goes through the blades, the faster they spin.

The compressor wheel is positioned before the air intake to the cylinders and through rotation of the shaft supplies compressed air to the combustion cycle by increasing the number of the oxygen molecules.

Conventional bearing systems associated with turbochargers are oil film based. The shaft and wheel assembly is supported by a controlled oil film thickness to facilitate both rotation and ensure dynamic stability at very high speeds.

Advantages of ball rolling element bearing turbochargers over the conventional oil film turbocharger bearing systems originate from the fundamental change in the friction mechanism present in the system. Multiple rolling elements replace a thin oil film under high-shear conditions, significantly reducing system friction. This results in a significant improvement in system friction at operating temperature (typically up to 50 %) and even greater improvements during the first minute of an engine cold start (Figure 2).

With the more conventional oil film turbocharger bearing systems, the oil is very viscous in cold conditions. At this time, the viscous drag of the bearing system prevents the effective rotation of the shaft and hence does not supply

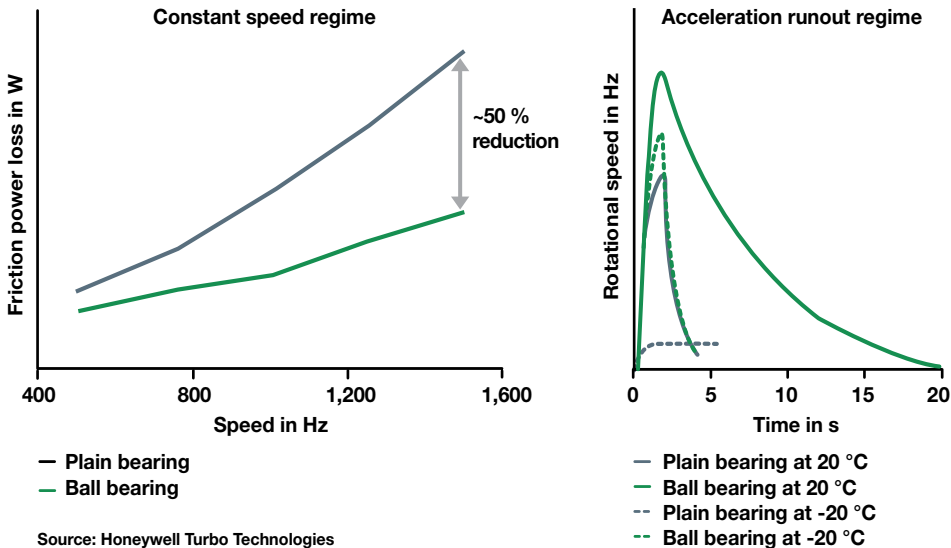


Figure 2 Friction loss benefits for ball bearing turbochargers

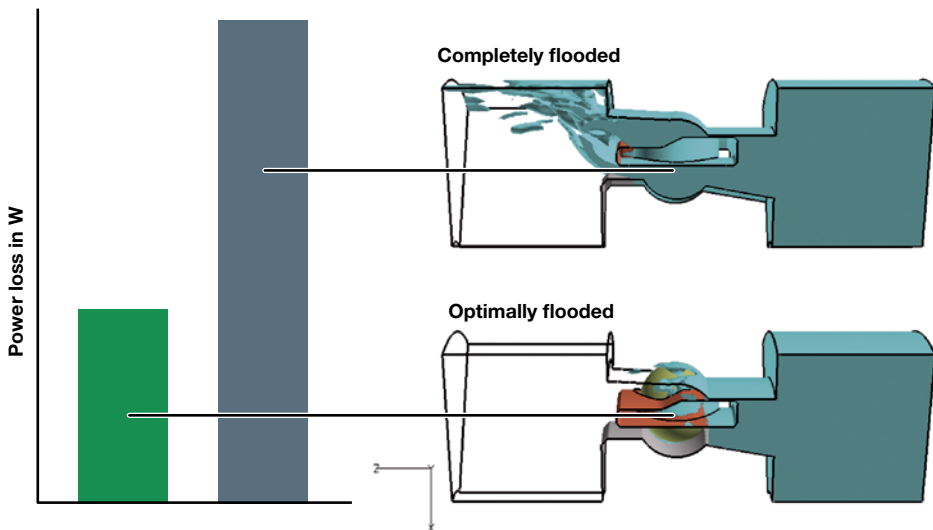


**Figure 3** Schaeffler ball bearing cartridge

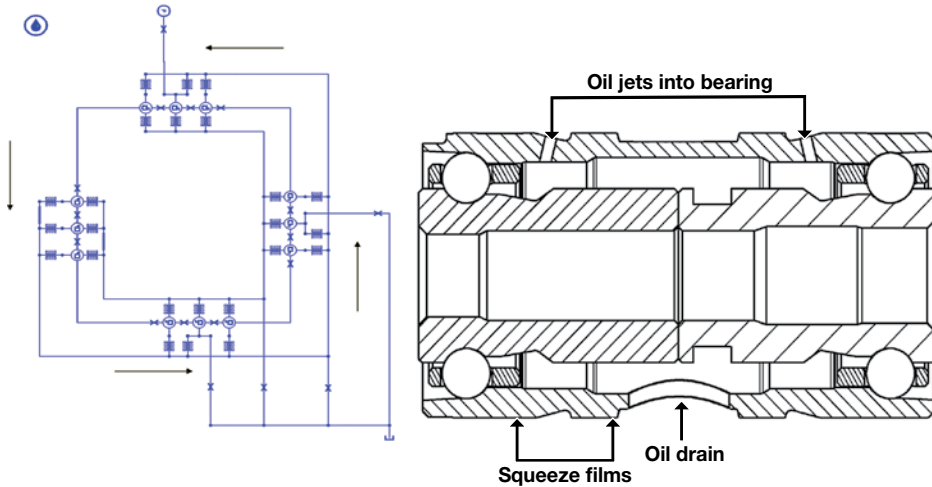
sufficient boost air to the combustion process. This means reduced power output and increased emissions. However, with ball bearing turbochargers the fundamental frictional change means that the flow of the exhaust gas, even at cold start, is sufficient to provide rotation to the shaft so that the compressor wheel can provide the necessary boost air to the engine system immediately. This results in a more energy efficient system with reduced

emissions and also means that the driver experiences increased engine torque from the very beginning of the drive.

Turbocharger studies have shown that the 'ball bearing effect' is most pronounced at low engine speeds, just where a down-speeding or downsizing concept needs the most help from the turbocharger system. For engine operation the reduced bearing friction results in higher turbocharger speeds for the lower engine speed conditions mentioned above. Specifically, in the event of a sudden engine load request during idle or low load conditions, the increased turbocharger speed results in a significant improvement of engine response due to the turbocharger's instantaneous ability to supply compressed air. It is not only the ability to avoid the "turbo lag" that is striking but also the improvement of raw emission quality due to improved fresh air supply.



**Figure 4** Friction power loss at various oil flow regimes



**Figure 5** 1-D CFD simulation of oil path (left); cross section of bearing with oil duct features (right)

## Schaeffler ball bearings for Turbocharger

Schaeffler ball bearings for turbochargers (Figure 3) are of the angular contact type. Typically, these bearings utilize ceramic balls, cages, anti-rotation devices, an outer ring, a compressor side inner ring, a turbine side inner ring and a series of oil duct features for lubrication, cooling and for supplying the squeeze film damper areas.

Ball bearings for turbochargers rotate at very high rotational speeds. If the common characteristic speed value of bearings is considered, taking diameter and rotational speed ( $n \cdot d_m$ ) into account, turbocharger bearings run six times faster than any other bearing in a vehicle. By speed value, they compete with the peak of jet engines and textile machines. For these high speed conditions, requirements for lubrication are delicate: Sufficient lubricant must be provided at all times, but an excess of it might

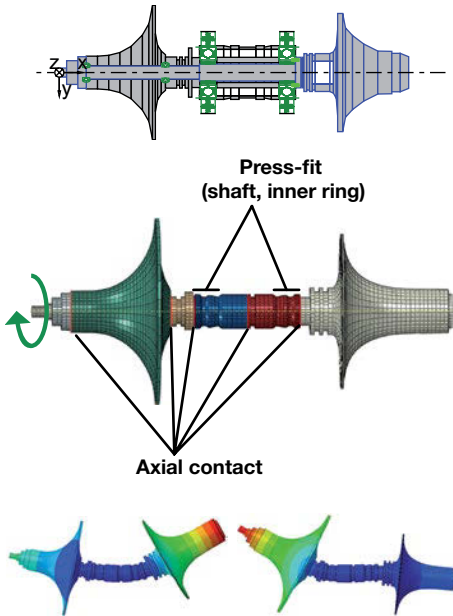
rapidly result in significant churning losses (Figure 4). Hence for the Schaeffler ball bearing cage, consideration was given to the design of the internal surfaces and component geometries.

As the ball bearing cartridge represents a single component of a larger system, we must take a closer look at the entire system and mutual effects.

The oil flow to the turbocharger (Figure 5), for both the oil film and the ball bearings, must also provide squeeze film damping. A squeeze film is a viscous fluid zone which provides structural isolation between elements, reduces the amplitude of rotor response to imbalance and also suppresses rotor-dynamic instability.

The entire fluid path, and necessary uses, can be simulated and fine tuned according to the ultimate performance requirements for the full range of temperatures.

A ball bearing can be understood as a series of springs of known, predictable stiffness. However, once coupled to the shaft, the wheels and the housing of the

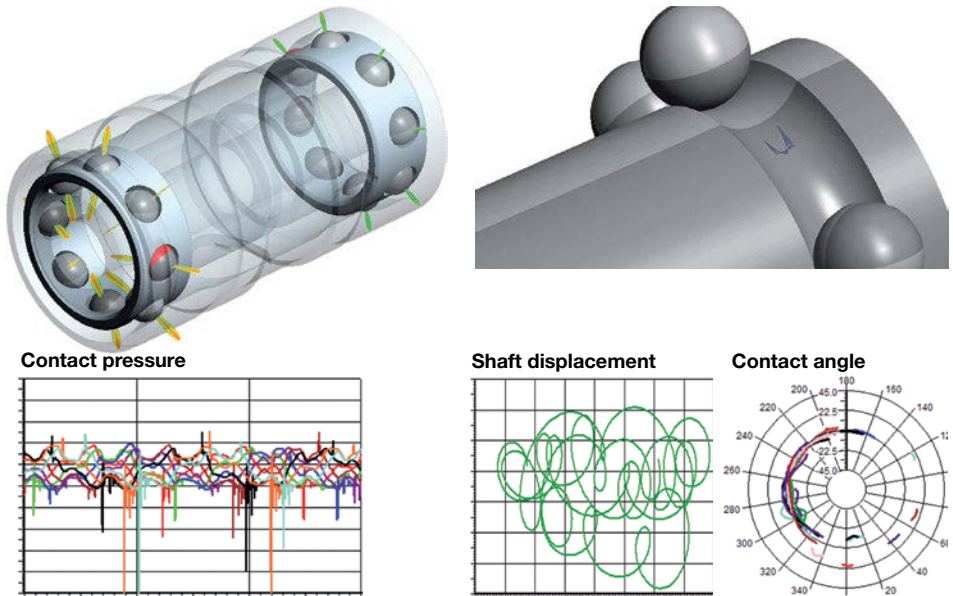


**Figure 6** Bearinx model, multi-body structure, modal shapes

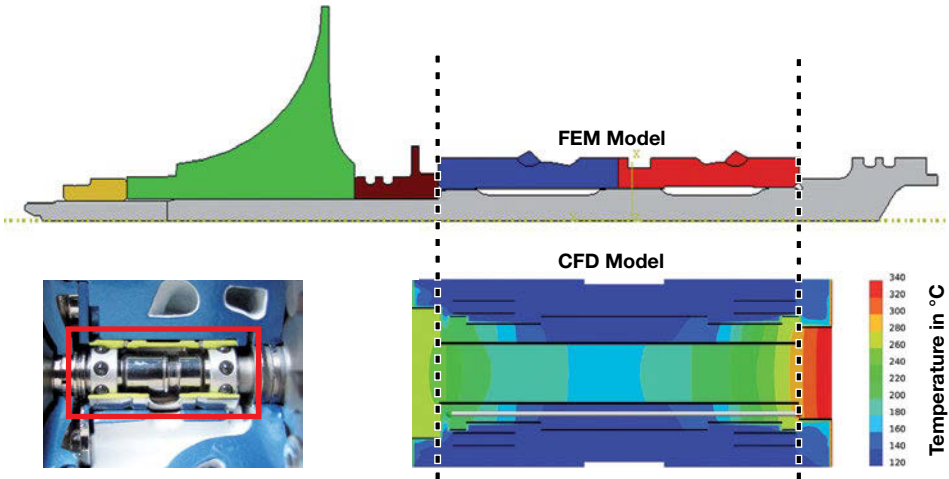
turbocharger and then revved at very high speed, the bearing must work well in the system.

The influence of the dynamic system must be considered. The radial load applied to the bearing typically comes from the residual imbalance. Here the interaction of the various system components comes into play as the structural stiffness of the shaft wheel assembly, the bearing stiffness as well as the properties of the squeeze film surrounding the bearing influence the bearing loads. At very high rotational speeds that are known to have a critical effect on shaft deflection this can cause damage to the internal kinematics of the bearing design and ultimately affect the life of the system (Figure 6). The axial load component is generated from “gas” pressure loading forces of the compressor or turbine wheel.

Once we consider the rotational speeds and modal shapes, operational temperatures and loads, we are better able to un-



**Figure 7** CABA 3D bearing simulation

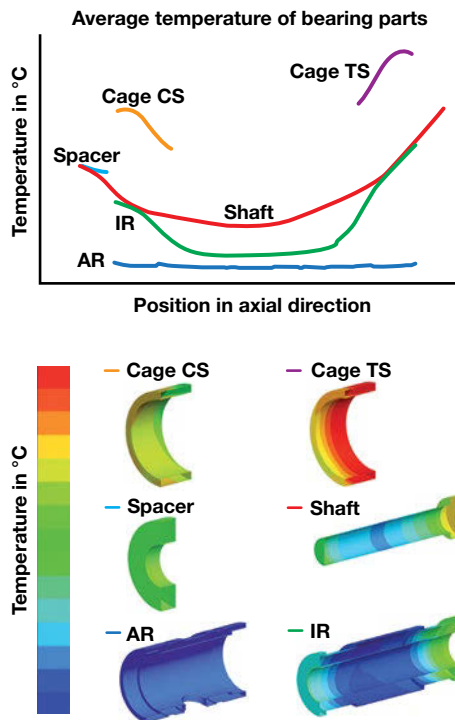


**Figure 8** Combined FEM-CFD thermal analysis

derstand the internal kinematics of the actual bearing system.

The motion of the balls, their interactions with the raceways and the cages have a very complex relationship. Using special purpose simulation tools such as Schaeffler's CABA 3D, tailored to the requirements of bearing analysis, this motion can be computed and detailed results on the existence, location, extension and load in each individual contact between the components of the bearing can be obtained (Figure 7). This variety of results can be combined to achieve a detailed understanding of the bearing. Hence, the bearing system can be designed for optimal performance, life expectancy, reduction of friction and materials sensitivity.

Turbochargers must operate in extreme temperatures. We have already considered cold starts with regard to friction reduction and should now explore the hot running requirements. The turbine wheel is driven by the exhaust gases of the internal combustion engine and is therefore exposed to exhaust gas tem-



**Figure 9** Temperature distribution in the bearing parts

peratures. In normal operating cycles this high temperature ultimately flows by means of thermal conduction through the multibody system to the ball bearing where it is led away by oil flow. More critical are the thermal shut down conditions where the oil flow is stopped.

In normal operation, the bearing can reach temperatures of around 300 °C on the turbine side, whereas in thermal shut-down conditions, these bearings can even reach temperatures of up to 400 °C.

Applying both CFD and FEM to the problem (Figure 8), we can obtain thermal characteristics (Figure 9) with regard to radial and axial growth parameters in addition to the composition or thermal conditioning of the material growth.

There is a significant temperature difference across the components, and the consequences must be taken into account in the internal bearing design as well as the material characteristics. The bearing system must withstand extreme temperatures and extreme running speeds and be durable for the long term operation of the sys-

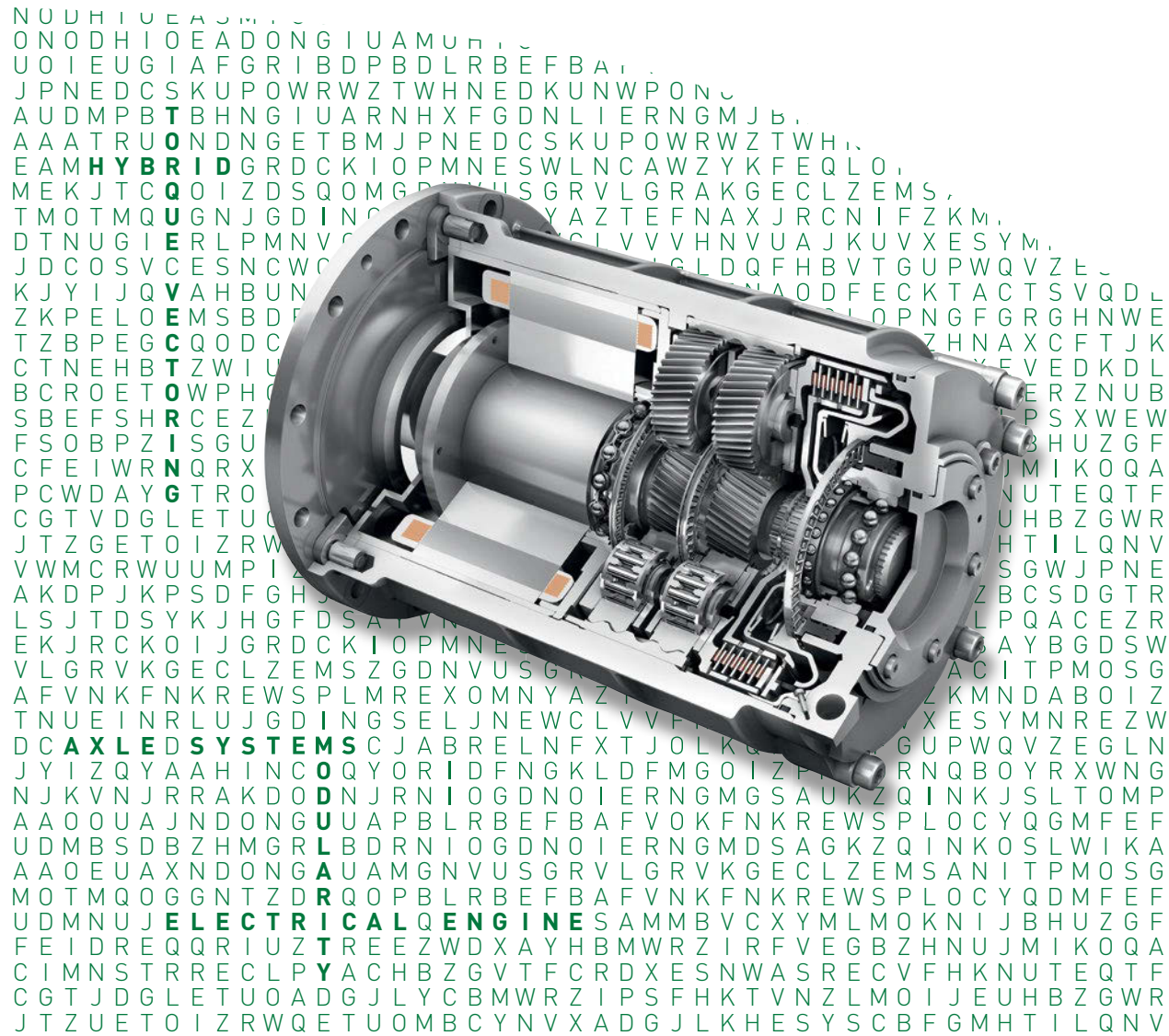
tem. It is therefore necessary to select the materials very carefully for the relevant application environment.

## Outlook

---

The year 2014 signifies a great achievement for turbocharger ball bearings supplied by Schaeffler and its group of companies.

For 10 years, Schaeffler has been leading the way in the development and supply of low-friction double row angular contact ball bearings for turbocharger technologies. During this time, we have perfected our application analysis, design tools and manufacturing methods. These precision ball bearings have helped set new turbocharger performance benchmarks for the future, particularly in the passenger car, light duty and heavy duty truck markets, and this year we will deliver our 1 millionth ball bearing cage for turbocharger applications in this sector.



# Who's Afraid of 48 V? Not the Mini Hybrid with Electric Axle!

Modular electric axle drive in a 48-volt on-board electric system

Thomas Smetana

# 14





## Axle drives for hybrid vehicles

### Development level of the eDifferential in a high-voltage design

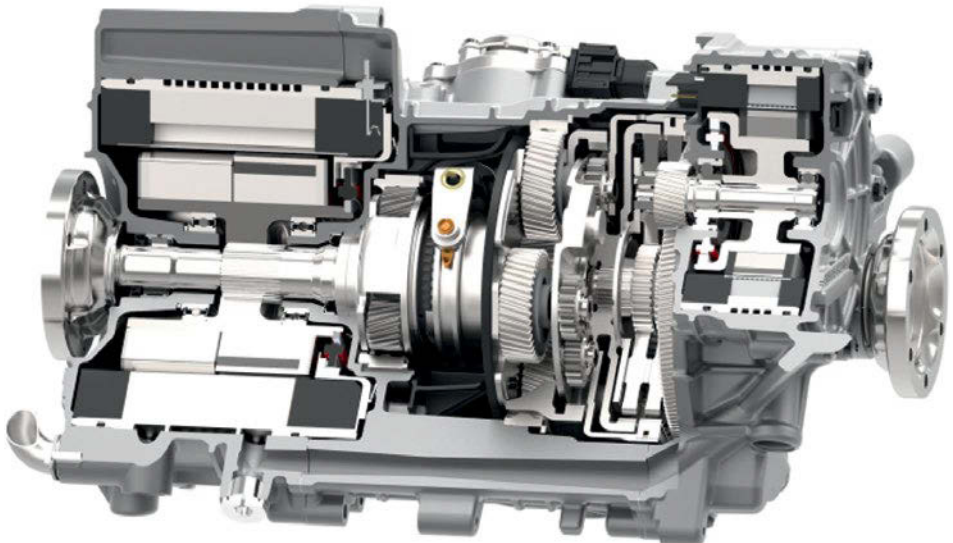
In the entire automobile industry, there is a discernible trend towards hybrid vehicles in order to meet future CO<sub>2</sub> requirements. The test cycles used for determining CO<sub>2</sub> emissions favor vehicles with a long range of electric operation. Plug-in hybrid vehicles are increasingly appearing on the market, whose batteries can be charged using public or private power supply systems. The driving performance required from these vehicles requires relatively high levels of electric power with low space requirements.

At the Schaeffler Symposium 2010, Schaeffler presented a technical solution for these vehicles with the first genera-

tion of the so-called “active electric differential” [1]. This electric axle enables both an optimum use of space as an axle drive and also active torque distribution to the wheels so that very good values for driving dynamics are achieved as well.

Schaeffler has been consistently developing the electric axle drive ever since. The third generation currently being tested is matched to the topology of a plug-in hybrid vehicle with a front mounted engine and front-wheel drive. The drive unit (Figure 1) is still designed to be fitted coaxially in the rear axle and is characterized by the following features:

- Water-cooled electric motors in hybrid design (permanently excited synchronous motors with a high proportion of reluctance) are used. These meet automotive-specific requirements in contrast to the industrial motors used in the first generation.
- The transmission is still in planetary design and now has two ratio stages.



**Figure 1** Section through the electric axle in a high-voltage design



	Gen 1 (VEP)	Gen 2	Gen 3
Application	EV, E-AWD	HEV, E-RWD	HEV, E-RWD
Dimensions	300 x 562	230 x 550	230 x 525
Weight w/o power electronics	120 kg	89 kg	79 kg
DC Battery Voltage min / nom / max	350 / 400 / 450 V	270 / 320 / 360 V	264 / 323 / 361 V
Max. power	105 kW (< 10 s)	55 kW (< 30 s)	65 kW (< 60 s)
Continuous output	–	38 kW	45 kW
Max. torque	1,200 Nm	1,800 Nm	2,000 Nm (60 s)
Continuous torque	–	–	1,200 Nm
Max. speed (electr. motor)	8,900 rpm	13,000 rpm	14,000 rpm
Ratio	$i = 7$	$i_1 = 12.3$ ; $i_2 = 4.2$	$i_1 = 12.3$ ; $i_2 = 4.2$
$V_{\max}$ vehicle (electric)	< 150 km/h	< 250 km/h	$\geq 262$ km/h
Max. torque vectoring torque	1,500 Nm	1,150 Nm	1,200 Nm (10 s)
Max. differential lock	–	–	1,600 Nm (5 s)

**Figure 2** Technical data for three generations of high-voltage axles

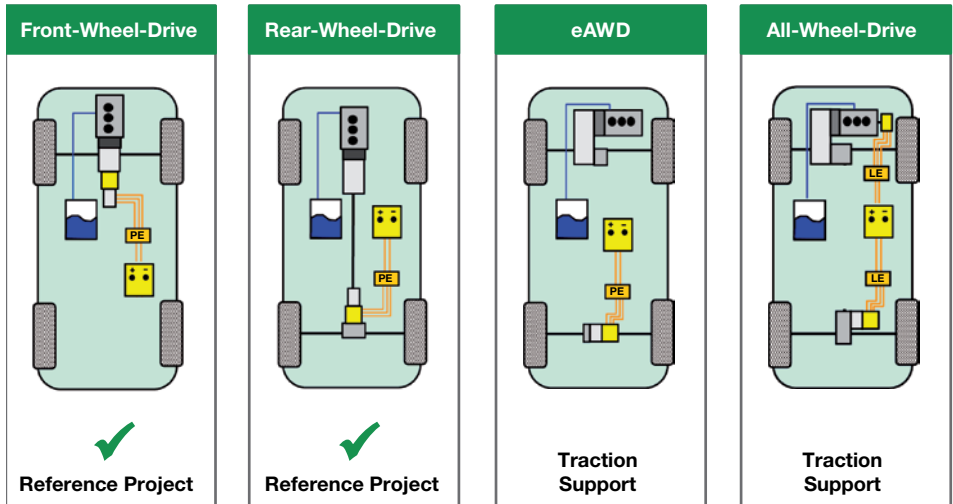
- The drive unit has increased power density and a modular design so that traction and active torque distribution can be offered as separate functions.

The progress achieved in development is apparent if one considers the main key figures of the third generation (Figure 2). For example, the diameter was reduced by 70 mm to 230 mm and the weight of the unit was reduced by 41 kg to 79 kg. The peak power was reduced to 65 kW due to the voltage range of 270 to 360 V of batteries used in plug-in hybrids. Peak power is now available for up to 60 seconds. The maximum torque is 2,000 Nm due to the high ratio of the two-speed transmission. The continuous torque of 1,200 Nm is sufficient for all conventional driving situations. Torque vectoring with torque differences of up to 1,200 Nm can also be implemented at very high speeds.

Schaeffler's high-voltage electric axle can achieve the high levels of electric power, which are typical for hybrid and plug-in hybrid vehicles as well as range-extenders and electric vehicles. The system is currently undergoing field tests with automobile manufacturers.

### The mini hybrid with 48-volt on-board electric system

After it became clear that mini hybrid vehicles with 48-volt on-board electric subsystems would be introduced in increasing numbers in the coming years [2], the question arose at Schaeffler as to whether the electric axle drive could also be used for these vehicles. The objective of using a 48-volt hybrid must be considered: A significant CO<sub>2</sub> reduction must be achieved at acceptable costs. The key to achieving this



**Figure 3** Basic topologies of a 48-volt hybrid powertrain

objective is not only the battery, which is still the largest cost block, but also the lower overall safety requirements for drive systems with a peak voltage of less than 60 V. A low-voltage system is the subject of significantly lower requirements in all steps of the value added chain, from assembly through to maintenance.

The maximum CO<sub>2</sub> saving is also dependent on the electric power of a 48-volt hybrid system. The decisive factor is not only the acceleration to be achieved by the vehicle, but above all the maximum braking energy to be recuperated. The maximum power achievable with current technology is approximately 12 kW. This electric power not only enables recuperation in generator mode, but also a displacement of the operating point of the internal combustion engine in the data map and electric driving in a low speed range, for example, during maneuvering or in traffic jams.

The integration of a corresponding low-voltage electric axle into the powertrain can be carried out in different con-

figurations (Figure 3). The driven axle can be provided with motor assistance in both front-wheel and rear-wheel drive vehicles. An electric rear axle drive can also be implemented in a front-wheel drive vehicle, a configuration, which is occasionally described as an “electric all-wheel drive”. Lastly, the electric drive force can also be distributed between the front and rear axle, although this means that two electric motors and two power electronics units are required.

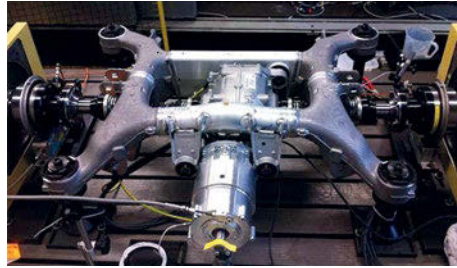
With regard to the following considerations, Schaeffler assumes that vehicles with an electric axle based on 48-volt system will always have a belt-driven starter generator with a nominal voltage of 12 or 48 V because it is not possible to start the internal combustion engine with the electric axle motor. In addition, the starter generator is already part of the modular system from the vehicle manufacturer’s point of view. This has the advantage that safety-critical functions such as electro-mechanical torque vectoring are always available irrespective of the battery’s state

of charge because the battery can be recharged by the starter generator at any time. The use of the electric axle as a “electric four-wheel drive” is also dependent on the state of charge. Four-wheel drive functionality is available without limitations when moving off.

### Design of the 48-volt axle drive

After taking the fundamental decision to derive an electric rear axle from the high-voltage system based on a 48-volt system, Schaeffler began development of a relevant system, which would fit in an actual current volume-produced vehicle with rear-wheel drive. It was apparent that the electric motor could be fitted around the propshaft without having any effect on the space requirement (Figure 4). An existing asynchronous motor from a belt-driven starter generator is used. The 48-volt axle drive is also equipped with a two-speed transmission as in the latest generation of the high-voltage variant.

The drive was designed so that it can be offered as an additional variant with a single-speed or two-speed transmission in a volume-produced vehicle without neces-

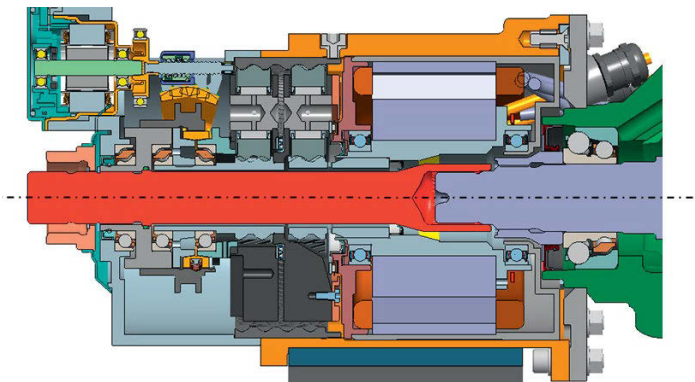


**Figure 4** Prototype of an electric rear axle drive for a rear-wheel drive vehicle

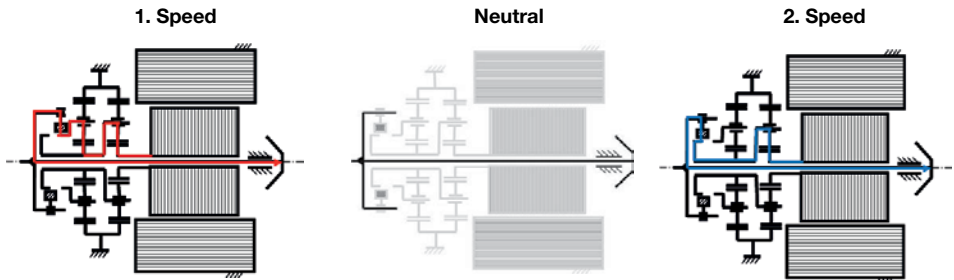
sitating changes to the vehicle body or chassis. This required a very compact design. In this particular case, the diameter of 180 mm was less than the diameter of the propshaft tunnel. The entire drive unit is located coaxially relative to the propshaft directly in front of the axle drive (Figure 5). Water cooling was also not required.

In first gear, the force flows from the electric motor via the sun wheel of the first planetary gear set (Figure 6). The planet carrier is connected with the sun wheel of the second gear set and the force is transmitted to an intermediate shaft via the planet carrier. The force flows between the planet carrier and the intermediate shaft via a switchable selector sleeve. In second gear,

however, the planet carrier of the first gear set is connected with the intermediate shaft so that only the ratio of this planet carrier is effective. The second gear set rotates free of load. The transmission is stationary when disengaged and the vehicle behaves like a conventional vehicle.



**Figure 5** Section through the electric rear axle drive integrated around the propshaft



**Figure 6** Flow of force in the electric rear axle drive

A very high transmission ratio has been selected for first gear in order to achieve a sufficient starting torque of at least 1,000 Nm despite the relatively small electric motor. In the prototype, a ratio  $i$  of 19.6 was selected for first gear taking into account the ratio of the hypoid stage of the rear differential. In second gear the ratio  $i$  is 4.4. The relatively high ratio steps were selected because the asynchronous motor reaches its maximum speed in first gear at slightly above 20 km/h.

## Functions of a 48-volt mini hybrid

### CO<sub>2</sub> optimization

Without a doubt, the reduction of CO<sub>2</sub> emissions is the primary motivation for introducing a mini hybrid drive system. The decisive reduction for homologation should also be reflected in the lowest possible actual fuel consumption for end customers. Schaeffler has therefore carried out simulations of several driving cycles for a vehicle with an electric rear differential (Figure 7). The simulations were based on a very heavy luxury class vehicle with a

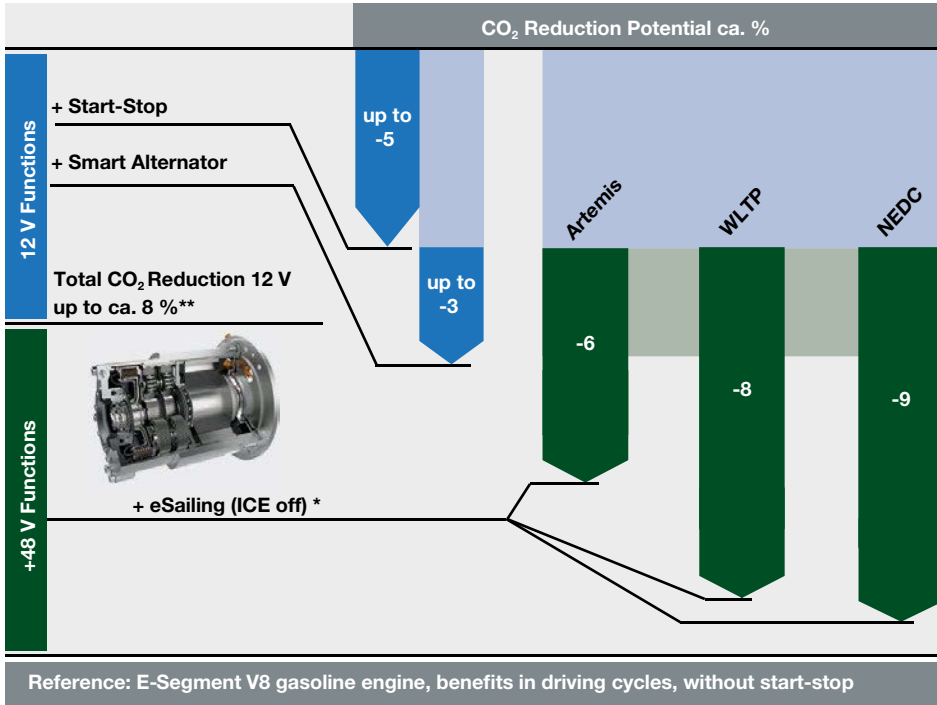
weight of more than 2 tons and a V-8 gasoline engine.

The simulations show that consumption can be reduced by up to 9 % in the NEDC, compared with a vehicle equipped with a start-stop function. In the ARTEMIS cycle, which is aimed at simulating the actual fuel consumption of a theoretical average customer, there is a reduction in consumption of around 6 %. These simulations were created using models, which take the overall efficiency chain into consideration. For example, the actual reduction in power of the electric motor with increasing temperatures was also considered.

It was however assumed in the simulations shown that the internal combustion engine was switched off during sailing. This is not always the case in all foreseeable applications for the future so that the fuel consumption of the internal combustion engine during idling must also be added if required.

### Electric driving functions

Schaeffler's electric axle differential has sufficient torque to enable driving using electric power only in a low-speed range of 0 to 20 km/h. We prefer to use the term "moving off using only electric power" as a synonym to ensure that any reference to



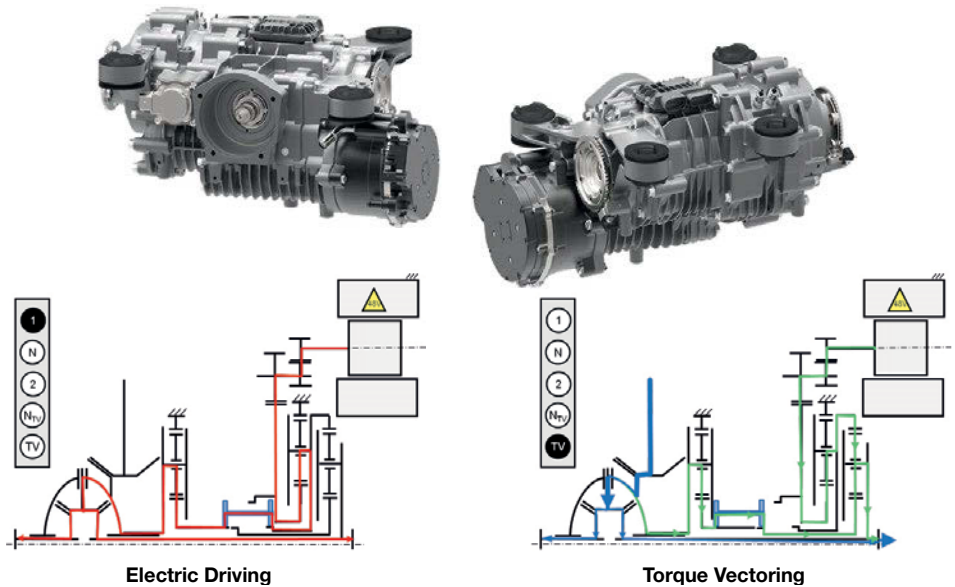
**Figure 7** Potential reduction in CO<sub>2</sub> emissions of a mini hybrid drive system in different driving cycles

“electric driving” does not lead to unrealistic customer expectations. There are major advantages in terms of comfort for the customer, particularly in stop-and-go traffic and during maneuvering. Control of longitudinal dynamics can be carried with the brake pedal alone, as in a vehicle with an automatic transmission – and with the internal combustion engine switched off. The torque that can be currently achieved on the axle is sufficient to accelerate a vehicle from a standstill on a gradient of up to 10 %. The potential for reducing CO<sub>2</sub> by moving off solely under electric power is less than 3 % in the premium segment sedan considered above. The possible range of electric operation is also limited to several hundred meters or just a few ki-

lometers depending on the size of the currently available low-voltage batteries. The described advantages in terms of comfort and the experience of electric driving, in combination with the minimal additional complexity for end customers, are a thoroughly convincing argument for deciding to buy a hybrid vehicle.

### Active torque distribution

If the unit is fitted coaxially relative to the vehicle’s axle, the electric differential in 48-volt design can also be used in order to operate active torque distribution in a transverse direction (so-called torque vectoring). This form of variable drive torque distribution be-



**Figure 8** 48-volt axle drive with an electric motor and a two-speed transmission

tween the wheels has two basic advantages:

- Increased traction if the friction coefficients of both wheels are unequal, for example, when driving on snow-covered or icy roads.
- Improved lateral dynamics due to targeted adjustment of the torque, which counteracts understeer or oversteer of the vehicle during cornering.

Active torque distribution is increasingly regarded as a comfort function. For example, it would be possible to completely compensate for the influence of strong side winds on the direction of travel in an energy efficient manner by using torque vectoring. The input variable for such functions is the yawing moment about the vertical axis of the vehicle, which is already continuously recorded by the ESP sensors. The introduction of such functions is the subject of detailed discussions about the personal responsibility of the driver.

The design of a 48-volt mini hybrid with an electric rear axle is based on the idea of torque distribution so that a single electric motor can be used – in contrast to the high-voltage module shown in Figure 1. In addition, the architecture of the two-speed transmission should be used for both the drive and torque distribution (Figure 8). The two-speed transmission with a torque vectoring function can be combined with a planetary differential but also with a standard bevel gear differential.

Shifting between the three planetary gear sets is carried out sequentially with a single actuator, which reduces the complexity and costs of the gearshift system. This type of actuation concept with one actuator offers additional advantages with regard to functional safety because the risk of faulty gearshift operation (double gearshift operations) can be reduced. The ratios are designed so that the vehicle can be driven at approximately 20 km/h using electric

power only. Subsequently, the system shifts from first to second gear. Boosting, recuperation and load point shifting of the internal combustion engine are possible within a speed range of approximately 20 to 80 km/h. Planet gears 1 and 3 are used for the traction mode.

Active torque distribution is possible from second gear after passing through another neutral position. The force now also flows via the center planet gear, which is connected with both the differential cage and the side shafts. The side shafts are “rotated” in relation to each other due to the torque applied by the electric motor, resulting in a difference in speed. Torques of up to 1,200 Nm (peak) and 800 Nm (continuous torque) can be achieved with this type of system, which is comparable with the hydraulic systems already established on the market. It must be emphasized that the torque vectoring position is independent of the actual vehicle speed, i.e. it can also be selected when the vehicle is stationary.

Torque vectoring or electric drive can be selected automatically by means of suitable sensors and prioritization depending on the vehicle speed and other input variables. An additional option is the targeted activation of functions by the driver using a “sport button”, “economy button” or “city mode button”.

This has the following advantages for the electric axle based on a 48-volt system with integrated electromechanical torque vectoring:

- Moving off using electric power only and active torque distribution are possible in contrast to a standard rear differential.
- A significant reduction in fuel consumption is possible compared to a hydraulic system for active torque vectoring. An electromechanical system has maximum actuating speeds of 60 ms, virtually independent of the temperature.

- The 48-volt system is significantly less complex and therefore more cost effective compared with the high-voltage system according to Figure 1, which is the “non plus ultra” in technical terms.

With its recently presented system, Schaeffler is pursuing a strategy of maximizing the integration of functions by means of innovative drive technology and minimum product complexity. Schaeffler has succeeded in integrating three functions into the rear differential using an electric motor, an actuator, and transmission architecture: Moving off using only electric power, a significant potential for reducing CO<sub>2</sub> in hybrid mode and an increase in vehicle agility and comfort by means of torque vectoring.

This type of “three-in-one” modular concept combines the demands for efficient mobility with the maximum requirements for vehicle dynamics and emotionality of future vehicles and acceptable purchase costs. The resulting added value for end customers can be a decision-making criterion for the acceptance of low-voltage hybridization and accelerate the hybridization of vehicle drives worldwide.

Schaeffler is currently equipping a sporty coupé in the compact vehicle class with an electric axle and integrated torque vectoring based on a 48-volt system in order to test these advantages, which are directly noticed by end customers.

## Outlook

---

The CO<sub>2</sub> reductions that can be achieved with a mini hybrid drive are of course significantly less than the values, which can be achieved with a high-voltage electric drive. However, the ratio of costs and benefits according to the first simulations is so positive



that Schaeffler is continuing intensive further development. The potential identified in the simulations will be checked by designing a demonstration vehicle and carrying out practical tests.

There is a strong correlation between the CO<sub>2</sub> reduction and the electric power of the system as described above. This is clear if the speeds driven in the NEDC are plotted over the corresponding axle torque and compared with the data map of the electric motor (Figure 9).

Consequently, a significantly higher proportion of operating points could be covered with a performance-enhanced electric motor of 12 to 18 kW. This also applies for the braking performance and thus the quantity of recuperated energy. Schaeffler is therefore also working on the further development of an electric drive with higher power in addition to a prototype equipped with a 12-kW motor.

An increase in the available continuous output would also be possible by

changing the method of cooling used in the electric motors in the prototypes from cooling via the air gap to oil cooling and this is therefore also part of further development work.

Schaeffler can also envisage that radical optimization of the rolling resistance of the tire in combination with active electromechanical torque distribution will become a further field of research. This work is based on the idea of compensating the reduced cornering forces of particularly narrow tires with a low rolling resistance by means of torque vectoring. Initial estimates indicate a potential reduction in rolling resistance of up to 30 % – without any risk to the active safety. The implementation of this idea still raises many questions. For example: How can it be ensured that these types of tires are only fitted on vehicles with active torque distribution? Is permanent roll stabilization of a vehicle by means of the active intervention of an electromechanical system permitted?

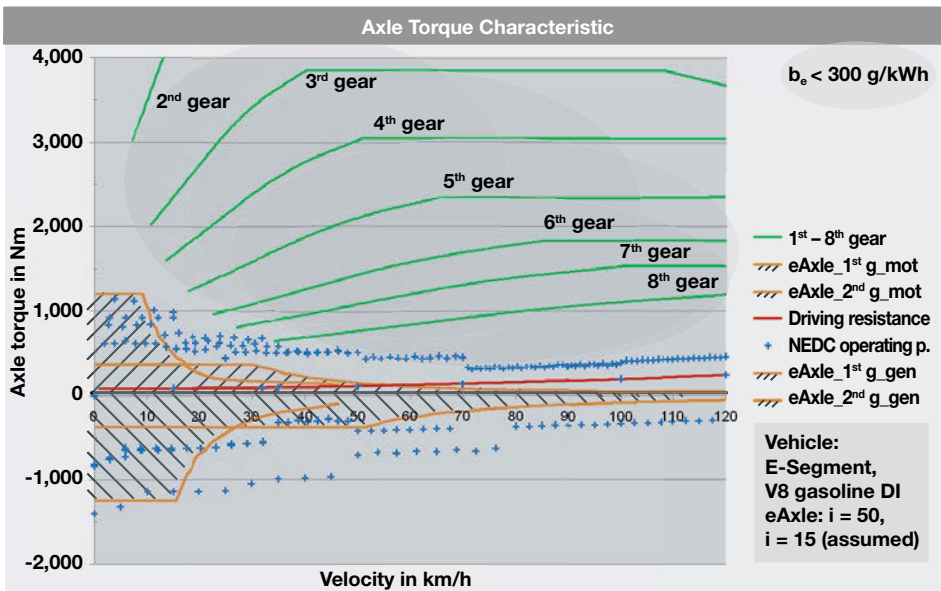


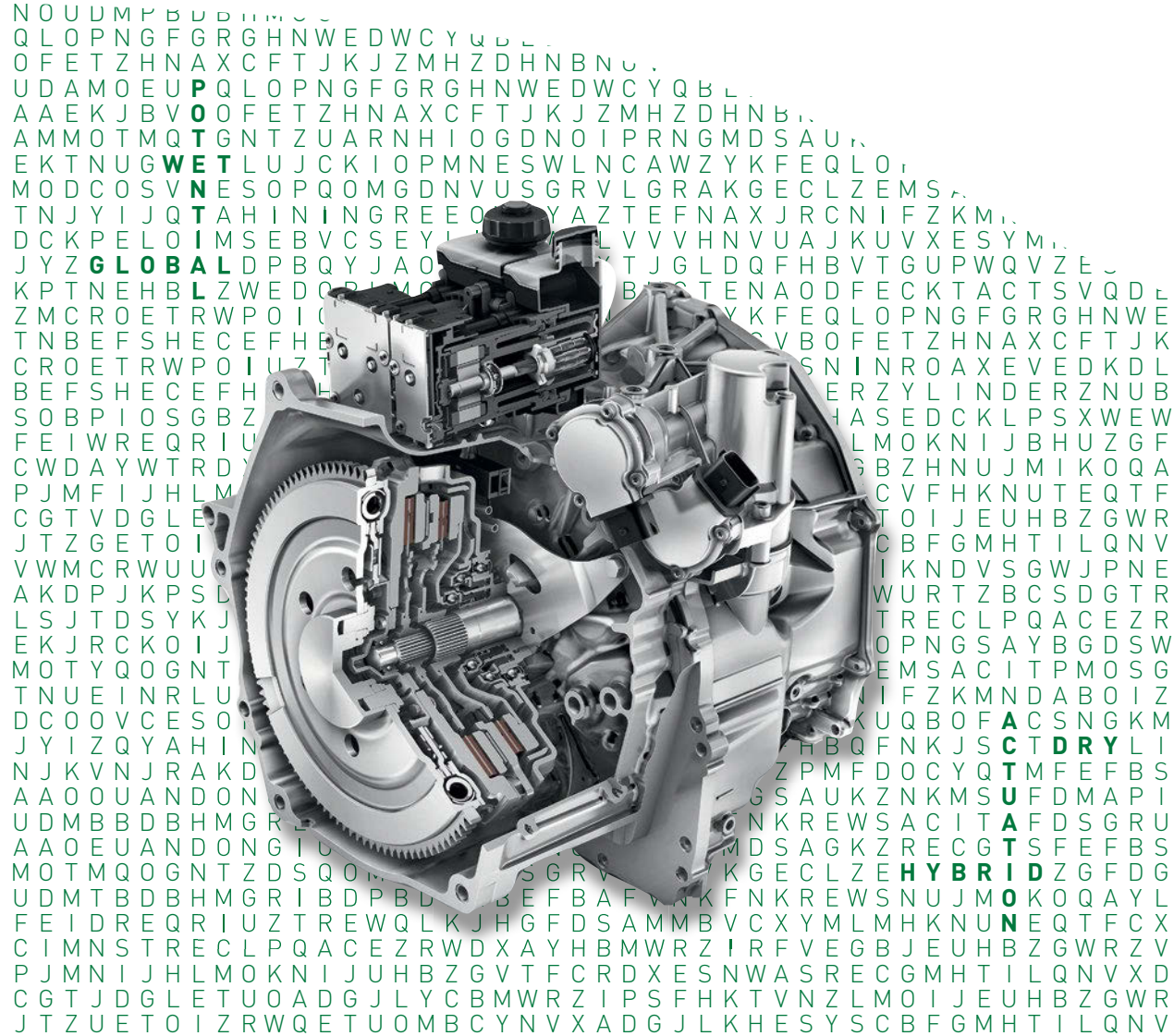
Figure 9 Operating points in the NEDC and torque output of the electric motor

At Schaeffler, we regard innovation as a continuous search for new concepts and we pursue radical ideas, whose one hundred percent feasibility must still be proven as part of research and development projects. We are always open to further inspiration and ideas from our customers, suppliers, and development partners!

## Literature

---

- [1] Smetana, T.; et al.: Schaeffler active eDifferential: The active differential for future drive trains. 9<sup>th</sup> Schaeffler Symposium, 2010
- [2] Gutzmer, P.: Individuality, efficiency and comfort: Paradigms for future mobility. 10<sup>th</sup> Schaeffler Symposium, 2014



# Double Clutch Systems

Modular and highly efficient  
for the powertrain of tomorrow

Matthias Zink  
Uwe Wagner  
Clement Feltz

# 15



## Introduction

Alongside the established stepped automatic transmission and CVT, the double clutch transmission in particular has achieved considerable market penetration in the last few years (Figure 1).

Significant growth has been seen in the European and Chinese markets in particular, and current forecasts indicate that in ten years' time, every fifth automatic transmission will be a double clutch transmission.

The following basic requirements apply to automatic transmissions in accordance with current definitions:

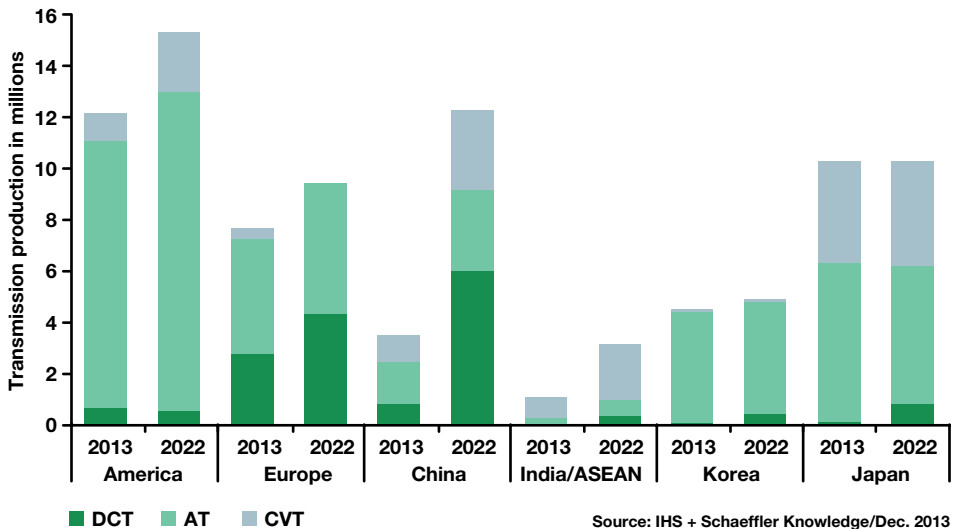
- Maximum comfort achieved through powershift capabilities combined with a dynamic driving experience
- Ideal spreading and the highest possible level of efficiency across all operation modes
- Actuating mechanism operated with minimal losses and, where possible,

without the need for additional effort while the combustion engine is turned off

- Hybrid function presented in the simplest and most flexible manner possible

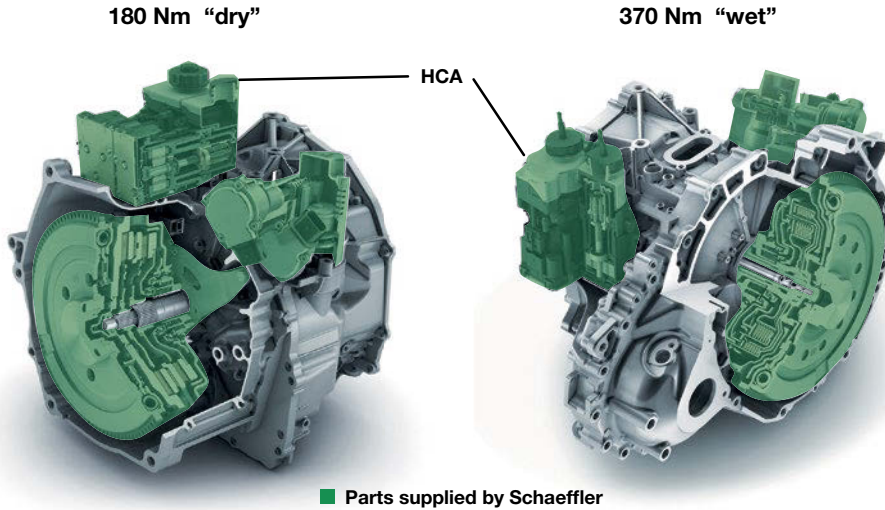
A double clutch transmission, which fulfils all of these requirements, including an integrated hybrid function, entered into series production in Japan at the end of 2013 under the name "i-DCD". Figure 2 shows the dry double clutch transmission and the wet version for the application "SH-AWD", as well as the parts supplied by Schaeffler, which are both modular and highly efficient!

In addition to using highly efficient, hydrostatically operated double clutches (equipped with a concentric slave cylinder, or "CSC"), a newly developed actuator with an integrated control unit is also used in these applications (a hydrostatic clutch actuator, or "HCA"), and a gear actuator featuring an "active interlock" concept. Thanks to the "power-on-demand" actuator elements present in this design, it is possible to reduce the NEDC power consumption levels for transmission and clutch operation to values lower than 20 W.



Source: IHS + Schaeffler Knowledge/Dec. 2013

Figure 1 Production volumes for different automatic transmissions (selected regions)



**Figure 2** Dry double clutch transmission "i-DCD", wet double clutch transmission for "SH-AWD"

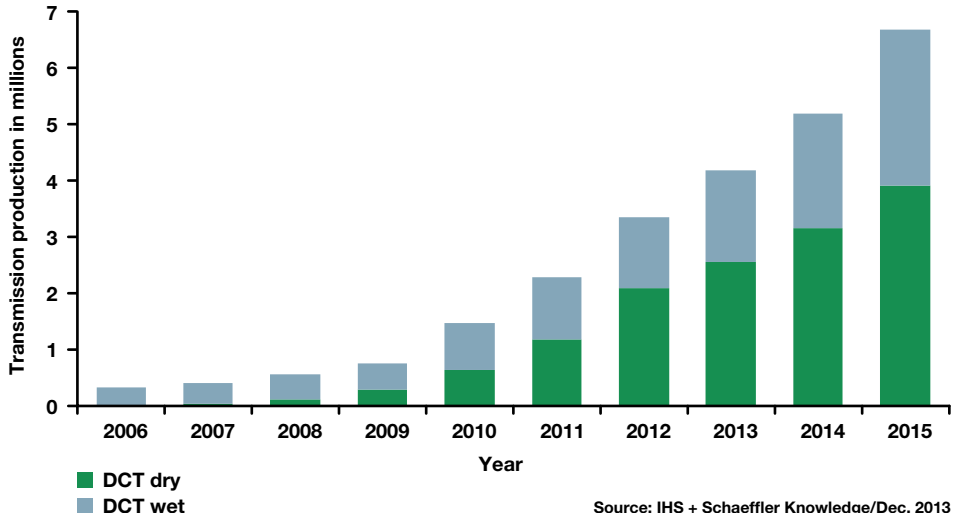
## The double clutch: "dry or wet" or "dry and wet"?

As was previously the case, comfort when driving off and shifting gear remains a key focus for the double clutch system — with regard to driving off in particular, there exists a strong, established and extremely vigilant competitor when it comes to the NVH, comfort and dynamics of the torque converter. In this respect, the new, highly innovative design of the iTC torque converter [1] in particular will see double clutch systems face a new challenge across all disciplines.

Back in 2006, a chapter was dedicated to the question of "dry or wet?" as part of the LuK Symposium, and following on from a large number of series production projects (Figure 3) that have since been carried out, it has become apparent that the clutch technology used for the corresponding applications is determined on the basis of the technical rationale for the specific clutch load described at the time.

In terms of efficiency, the dry double clutch continues to be the first choice, wherever the torque capacity permits this. Combined with electromechanical actuating mechanisms, the dry double clutch represents a system solution that sets a benchmark for efficiency. In addition, this version of the double clutch places few requirements on the peripheral equipment of the transmission, as no additional oil cooling is required for the clutch. As a result, implementation is achieved with greater ease and with a tendency towards increased cost-effectiveness.

However, this clutch variant also poses specific challenges. Cooling is achieved by means of air convection, meaning frictional heat needs to be stored temporarily in the pressure plates, which increases weight and inertia levels. Furthermore, the ability to control dry clutches tends to be more critical than for wet systems. Clutches with wear adjustment mechanisms in particular are more difficult to control due to the more complex mechanics of the internal structure, but also due to the greater variance of the friction coefficients of the dry linings in general. A dry friction system must be fully



**Figure 3** Production volumes for different double clutch transmissions

functional throughout the entire life of the clutch; oil changes – and therefore the addition of fresh additives, such as for a wet clutch – is not necessary or possible for a dry clutch.

The primary development objectives are to reduce inertia levels and, in particular, to enhance controllability and thus optimize the comfort characteristics of the dry double clutch when driving off and shifting gear. Reducing internal friction and compensating the geometric torsional vibration excitation using a new design featuring direct actuation (DCC), the optimization of the accuracy of the individual parts, new friction linings with significantly improved damping and actuators with special control algorithms to control juddering (anti-judder control system) will also considerably improve the comfort characteristics. These measures are explained in detail in [2].

For applications with higher specific clutch loads, wet double clutch systems are generally used, as this oil-cooled version has the advantage of a higher cooling capacity in comparison with the dry version.

On current applications, the transition from dry to wet occurs at driving torques of between 250 and 350 Nm. In addition, the wet double clutch is also smaller and lighter in terms of its transmission capacity. To date, this version has also featured a more simple mechanical arrangement, as it does not require a fixture for wear adjustment.

However, today's wet clutch systems cannot fully utilise the benefits of reduced weight and inertia, as they require additional masses in the damper system to achieve the necessary level of torsional vibration isolation. In addition, the oil cooling system, which has a positive effect on performance, together with the peripheral equipment required for oil cooling, also represents a considerable additional effort with respect to design and energy, which has a negative effect on weight, cost and efficiency.

At the very least, optimised wet double clutch systems should therefore be capable of utilising the lower inertia levels owing to an appropriately powerful damping system. Furthermore, attention should be paid to improving efficiency by reducing drag

losses and using a highly efficient actuating mechanism.

In comparison with dry double clutches, future wet clutch systems should also include design elements to reduce geometric excitation, as well as optimised linings and dynamic actuator systems with the option of an “anti-judder control system” [3] in response to the increased challenges facing modern powertrains in relation to NVH.

## The actuating mechanism

---

From a functional viewpoint, the key requirement placed on the actuating mechanism of double clutch transmissions is most certainly the need to combine adequate dynamics and performance with the highest levels of efficiency. Actuators therefore not only require a minimum amount of energy to operate the clutch and transmission, but should, for example, also be capable of supporting the aforementioned anti-judder control system.

A modern actuator system should therefore only use power when required (“power on demand”). Furthermore, it must also be possible to operate the actuator system when the combustion engine is not running, in order to support start-stop and hybrid functions. For these operating states, special attention must be paid to noise generation, as the masking noises of the combustion engine are not present in this instance. In terms of design, the actuating mechanism should take up as little space as possible, and a modular design may be beneficial in order to reduce the costs for different applications.

Forward-thinking ideas for expanding the functions of such modular actuator systems, while reducing their level of complexity at the same time, are detailed in [4].

## Outlook/transition

---

Double clutch transmissions have all the prerequisites and real potential for becoming the basic architecture for the powertrain of tomorrow. The i-DCD transmission, produced in series since 2013, is a trend-setting example of a modular, highly efficient and even integrated hybridised double clutch transmission.

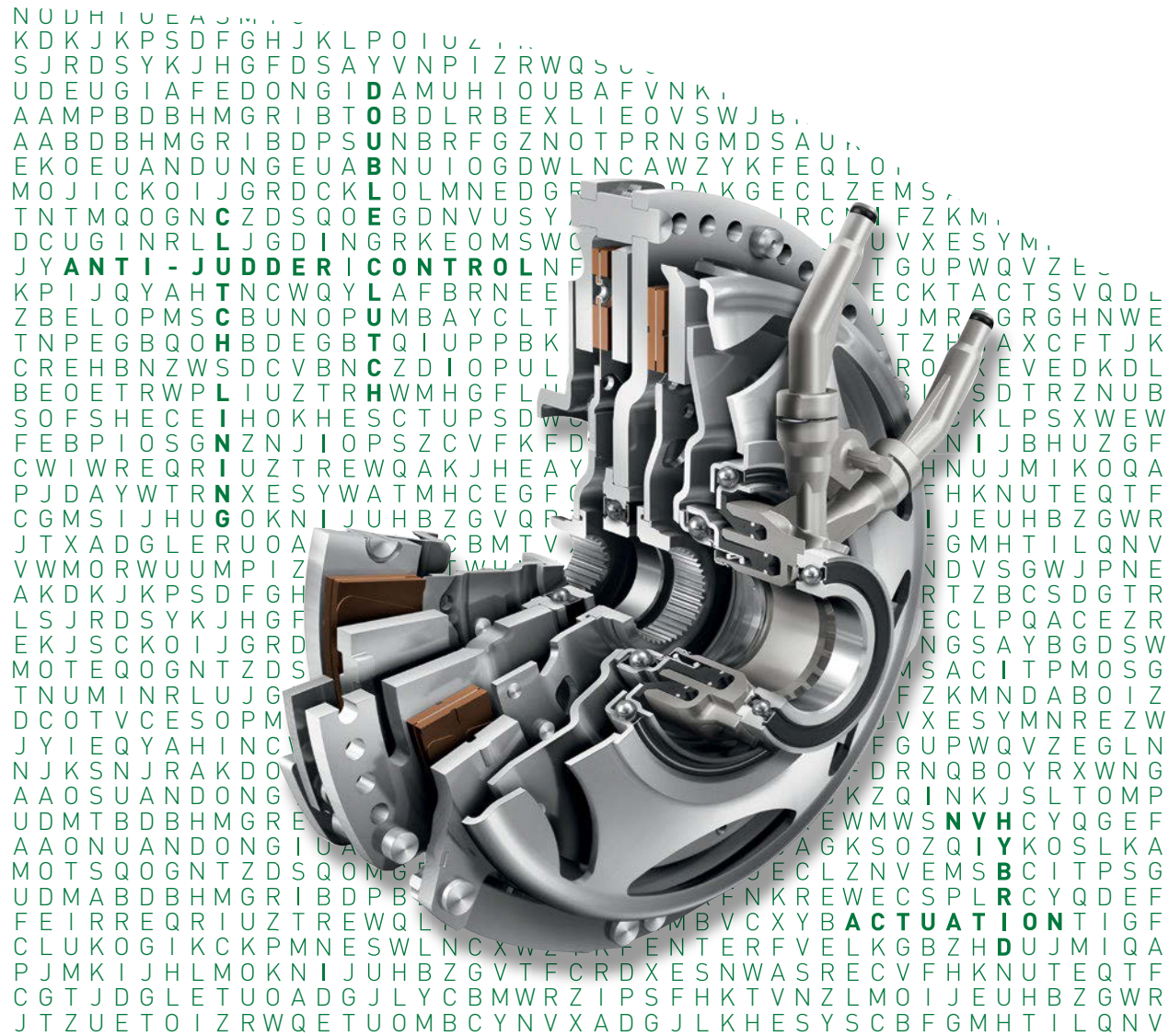
The consistent use and inclusion of hybrid elements in the design – for example, for driving off using electric power – will further strengthen the position of the double clutch transmission in relation to alternative transmission concepts from competitors.

## Literature

---

- [1] Lindemann, P.; Steinberger, M.; Krause, T., iTC — innovative torque converter solutions paving the way to the future. 10<sup>th</sup> Schaeffler Symposium, 2014
- [2] Kimmig, K.-L.: The highest levels of comfort: The dry double clutch rises to the challenge. 10<sup>th</sup> Schaeffler Symposium, 2014
- [3] Englisch, A.; Goetz, A.; Baumgartner, A.; Endler, T.; Lauinger, C.; Steinmetz, S.: The wet double clutch: Thinking in systems. 10<sup>th</sup> Schaeffler Symposium, 2014
- [4] Mueller, B.; Rathke, G.; Grethel, M.; Man, L.: Gearshift actuation: Less complexity, more functionality. 10<sup>th</sup> Schaeffler Symposium, 2014





# Highest Level of Comfort

The dry double clutch  
faces the challenge

Karl-Ludwig Kimmig  
Dr. Peter Buehrle  
Dr. Ralph Kolling  
René Daikeler  
Michael Baumann

# 16

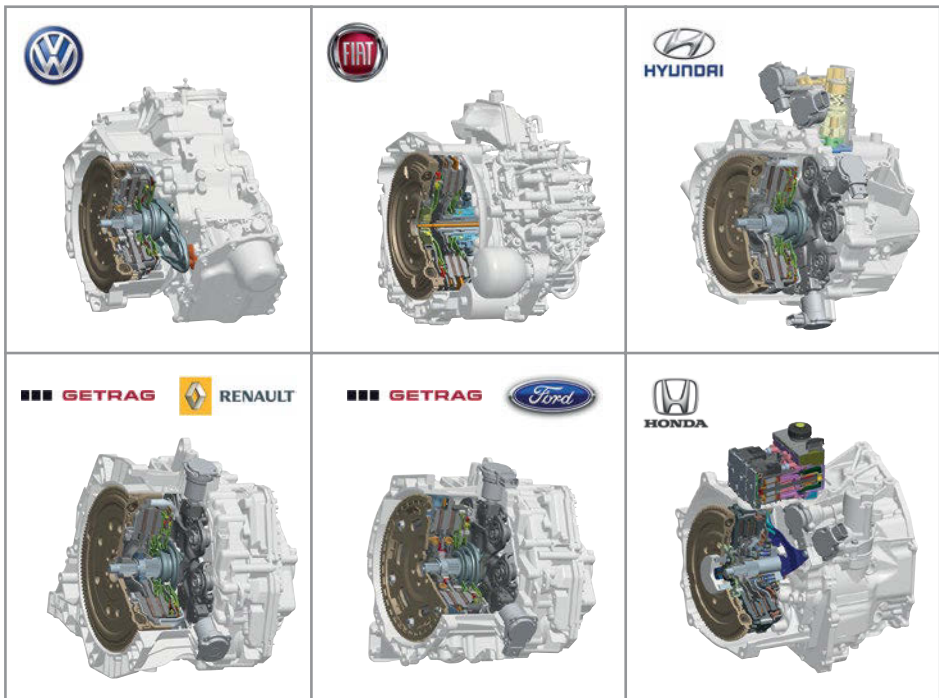


## Introduction

The competitive environment facing the dry dual clutch has already been introduced in [1]. A large number of series-production applications highlights the fact that dry double clutches have proven successful in the market (Figure 1).

The dry double clutch system also provides an ideal alternative for future, automated powertrains used in compact and mid-sized vehicles on account of its very high level of overall efficiency and the fact that oil cooling is no longer required for the clutch system. One challenge is that the NVH and comfort demands placed on the powertrains will

continue to increase and the mass moment of inertia of the double clutch system should be kept to a minimum as regards the driving dynamics. In order to face this challenge, further development of dry double clutch systems and the associated vibration damping concepts is required. New friction linings tailored specifically to requirements and advanced software functions contribute to a large optimisation step for the overall system. For instance, by operating the clutches via appropriate software control strategies, vibrations on the powertrain can be eliminated (anti-judder control system). Additional potentials for improving comfort are also brought about by electrical launches when used with hybridised powertrains.

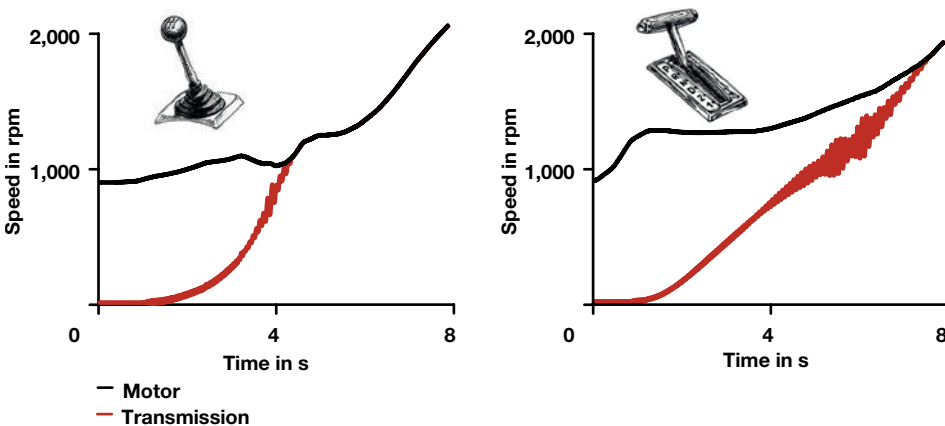


**Figure 1** Dry double clutch applications in series production

## Dry double clutch systems with minimal vibration excitation

The NVH behaviour of modern powertrains depends on a range of system-specific factors, such as damping, transmission behaviour of the powertrain, vibration couplings and, of course, the excitation between the engine, clutch and transmission. The factors especially relevant from the point of view of the clutch are isolating the engine's torsional vibrations via the dual mass flywheel and additional damping measures in the clutch, including a controlled isolation system and disturbance excitation of the slipping clutch (known as judder excitation). Disturbance excitation of a slipping clutch, in particular, is very much the focus when it comes to double clutch systems. The causes of why disturbance excitation poses a significantly greater challenge in double clutch systems than in manual vehicles, are illustrated in Figure 2.

One key difference in the launch and shifting processes with automated systems compared to manual driving behaviour is that the state in which the clutch is operated with slippage is maintained for significantly longer (creep function) in order to enhance driving comfort. This is because, especially in the lower gears 1<sup>st</sup>, 2<sup>nd</sup> and reverse, the natural powertrain frequency runs virtually always non-stop during slip and the smallest torsional vibrations at the clutch output can result in noticeable vibrations or associated noises on the vehicle. These vibrations and noises are amplified by the fact that during the launches of double clutch transmissions, only one sub-transmission is pre-loaded by the torque and the inactive sub-transmission can vibrate freely. This action causes additional noises to occur. In the launch simulation (Figure 2), identical clutch parameters (including geometry, friction lining properties and starting torque) were used as the basis, and identical powertrain damping was also used as the starting point. It is evident that by extending launch the judder vibrations



**Figure 2** Comparison of speed curves when launching with a manual transmission and a double clutch transmission with creep function (simulation)

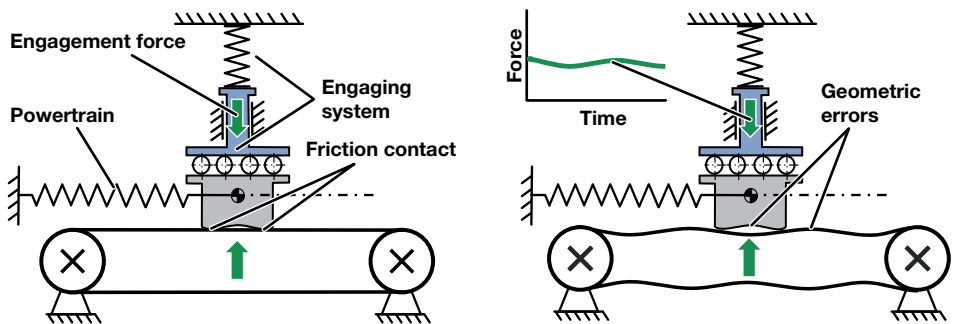
vibrate against each other much more violently and for significantly longer. Therefore, in terms of subjective feeling, automated, scattered launch feels significantly worse.

Transmissions with a torque converter represent the benchmark for comfortable and low-vibration launches with creep function. To ensure that this level of comfort can also be reached by double clutch systems, clutch disturbance excitation must be significantly reduced. This is particularly the case because modern powertrains have as low-friction designs as possible, for efficiency reasons, and therefore do not feature vibration damping. The sources of disturbance excitation on clutches are already known; however, these sources have become increasingly important due to the facts outlined above [8, 9].

The proven analogous clutch model for the belt sander in an enlarged form can be used to explain the physical principles and to demonstrate the optimisation potential (Figure 3).

Coupling a vibrating powertrain via a friction system in slippage can produce additional excitations or damping, depending on the friction characteristics as a function of the slip speed [4, 8]. Mod-

ern, dry friction linings tend only to excite frictional vibrations to a small extent. In the majority of operating states, the friction system supports the powertrain damping characteristics during the slippage phases by means of a positive frictional coefficient gradient. However, it was demonstrated for the first double clutch applications that new and previously unknown causes of damage can occur as a result of specific driving conditions for automated clutch systems. As a result, the tribological system is changed by the formation of special surface layers that decrease the damping characteristics. It is normal practice on dry clutches that wear on the clutch constantly renews the surface of the friction system, so that there is no drop in damping over the life in real driving conditions. However, this renewal process can be slowed down by particularly light-duty loads. Therefore, dry double clutches definitely benefit from occasional higher thermal loads. Based on these findings, it is possible to achieve further increases in damping characteristics and therefore greater comfort benefits with new friction linings and friction mating surfaces tailored specifically to the loads of double clutch systems.



**Figure 3** Basic model of "slipping clutch system"; left-hand image of tribological system without superimposed geometry errors, right-hand image with geometry errors

In addition to these friction-induced excitations, there is a second source for disturbance excitation in the slipping clutch. This is the result of geometric errors, which must always be present in a minimum of pairs and with interaction [8, 9]. This is illustrated in the analogous clutch model (right, Figure 3). Both surfaces in the friction contact exhibit warping that, in the case of relative movement, can produce contact force modulation with the rigidity of the clutch (cushion deflection) and the rigidity of the operating system. In order to minimise the geometric errors of double clutch components and subsystems, a host of ideas for solutions have already been developed, some of which are already being implemented or may be implemented over the coming months in high-volume production; these ideas include pairs of components for reducing geometric deviations [9].

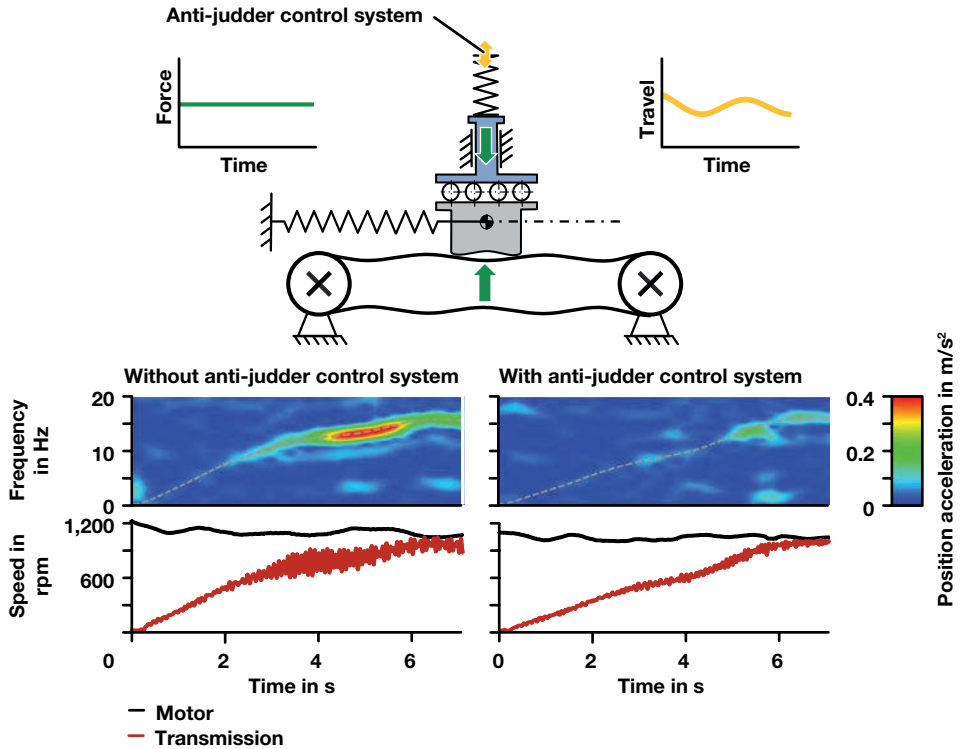
However, development work has not just been limited to reducing the geometric errors. The focus has also been on coming up with solutions with a stable and lasting impact on compensating the effects of geometric deviations on components, such as by means of a cardanic support. The current line of thinking is that this compensation is ideally achieved with directly actuated clutches, carried out by means of a concentric slave cylinder (CSC). The first dry double clutch system of this design went into series production in mid-2013. This double clutch and the new, derivative clutch series is explained in greater detail in the second part of this article.

## Damping powertrain vibration using the anti-judder control system

---

In addition to the causes of vibration excitation, the analogous clutch model (Figure 3) can also be used to outline the idea of damping vibrations by using an anti-judder control system. In essence, the idea is that inversely phased, active contact force modulation is used, which is initiated and monitored via a software control circuit. The result is that additional damping of the powertrain is indirectly achieved, without the disadvantage of increasing consumption. The challenges posed by this system are processing of the available speed signals and having as accurate as possible a picture of the overall system characteristics, as determined by the vehicle, powertrain, clutch and its actuating mechanism. Today, an anti-judder control system can be achieved for 1<sup>st</sup> gear and reverse with an improvement of 1-2 ATZ scores. Initial vehicles featuring this kind of software solution have been in series production since the beginning of 2013. The excellent effect that an anti-judder control system has in the vehicle during creep launch is shown in Figure 4. The judder vibrations have almost been completely eliminated.

Additional potentials can be tapped into in conjunction with hybrid powertrains. Therefore, when combined with electric motors, launch can be performed by completely electrical means. Prolonged clutch slippage (Figure 2, right) is therefore largely avoided. In addition, small inversely phased torsional vibrations can be generated in the powertrain by regulating the speed of the electric motor; this also enables judder vibrations to be completely eliminated.



**Figure 4** The effect of the anti-judder control system in the vehicle: left without, right with anti-judder control system

## Optimising the tribological system for dry double clutch applications

In order to prevent powertrain vibrations, clutch linings combined with cast or steel mating friction surfaces should only display damping-supporting properties over a large application range during the slippage phases. This requires a slightly increasing frictional coefficient over the slip speed. As the loads on the clutch friction system differ between manual clutches and double clutches, new friction linings had to be developed for opti-

misation purposes and a full range of testing had to be performed. Extensive systematic tests have shown that the inorganic filler and friction material in the lining compound in particular are responsible for changes to the lining damping during usage in the double clutch-specific slippage phases. The mode of action in the friction contact can be described using a two-phase model.

### Stage 1 – enrichment of inorganic substances in the friction layer:

In many similar clutch slipping phases with low friction energy, but with average, specific frictional power, organic components

of the lining compound are partially, thermally broken down on the lining surface. The associated lining wear is not high enough to renew the friction surface sufficiently. As a result, an increasing numbers of inorganic components build up in the friction layer close to the surface.

**Phase 2 – enrichment of casting wear particles in the friction layer:**

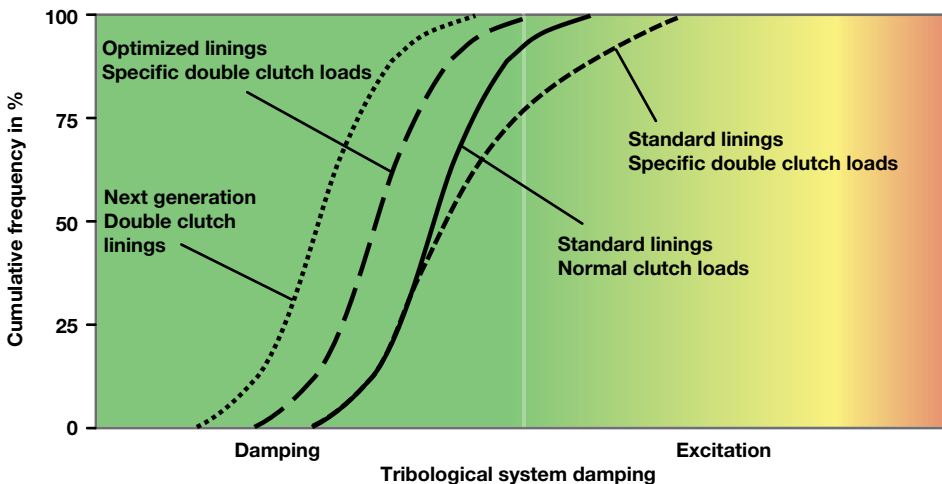
The increased proportion of inorganic components in the friction layer leads to increased wear of the contact material, comprised of cast iron or steel. As the surface of the friction lining is not renewed due to the comparatively low thermal stress, the metallic wear particles are enriched in the friction layer. The result of the layer being enriched leads to a negative change in the frictional coefficient gradient.

New fillers and fiber combinations have been developed for linings for optimisation purposes. The positive effect of these aspects has since been proven in a

variety of component and system durability tests. Today, Schaeffler can recommend B 8040 and RCF1o as two friction materials ideally suited for double clutch applications. In terms of taking a final decision on the respective friction lining in a specific vehicle application, it is not only the frictional coefficient gradient that is important; other parameters such as the wear behaviour and absolute frictional coefficient value are also decisive in the various operating states. Development work carried out over the past few months has shown that it is highly probable that further improvements with regard to the lining damping characteristics are possible with advanced friction linings.

In addition, the way in which the contact friction mating surface is designed also enables a slowdown and reduction in cause of the damage.

Possible measures include specific surface roughness and also special radial grooves on the mating friction surface.



**Figure 5** Damping characteristics of the tribological system for double clutch applications



## Reducing geometric torque excitation

---

The first generation of dry double clutches was designed featuring the extremely compact three-plate arrangement. In these designs, the double clutch is mounted on the transmission's hollow input shaft by a support bearing located in its central casting plate. The actuating lever springs and the components of the wear adjustment device are arranged on a common clutch cover on the side facing the transmission. This arrangement is extremely compact; however the sheet steel and casted individual parts used in this arrangement must meet stringent requirements for flatness and parallelism. They must meet these on account of the considerable disturbance excitation stresses. A wealth of experience in tool design and also in adjusting production dies is required in order to achieve this. However, when this arrangement features several nested sheet metal parts, it also offers the option of pairing these parts in series production so that a minimum of parallelism errors occurs [9].

Although these optimisation measures have already proved extremely successful (in some cases leading to geometric disturbance excitations being reduced by half), further improvements can be achieved by using cardanic actuation as well as by compensating any final geometric inaccuracies. And it was for this reason that the new, directly actuated double clutch system with hydrostatic control by means of CSC was developed.

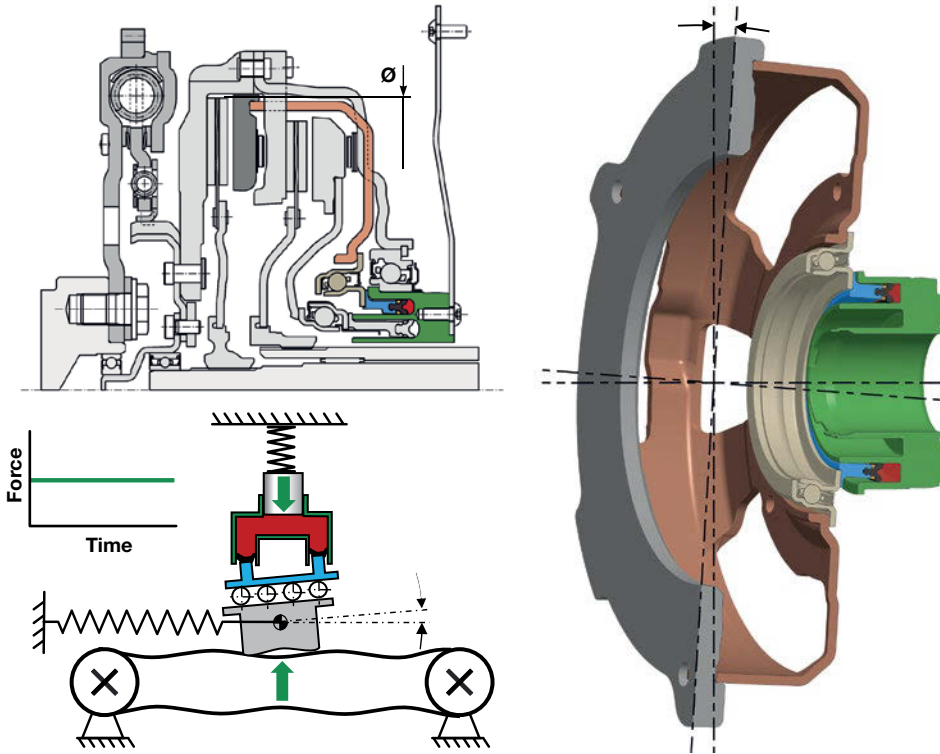
## The new, directly actuated double clutch system with hydrostatic control

---

There are essentially three main ways of reducing geometric disturbance excitation.

1. Minimising geometric errors.
2. Linear clutch mapping characteristics (torque over engagement travel) with low gradient. Where geometric errors are present, this results in low contact force or torque modulation.
3. Reduction in tilting rigidity of the contact force transfer elements, with the aim of using the cardanic compensating effect in the clutch system.

This last point in particular results in a new double clutch arrangement (Figure 6), the directly actuated double clutch system with hydrostatic control by means of CSC. With this system, geometric deviations in the friction contact can occur as a result of a virtually hysteresis-free cardanic angular alignment of the pressure plate via the load transfer plate up to the CSC piston, without unequal contact forces being created. This compensating function is only possible if the system has a low tilting rigidity, i.e. it behaves in a cardanic manner. As a result, when geometric errors are present, only minimal torsional vibrations occur in the clutch. Overall, this will result in a simpler overall structure with clutch control using CSC, which also can be used in wet double clutch systems [3, 10].



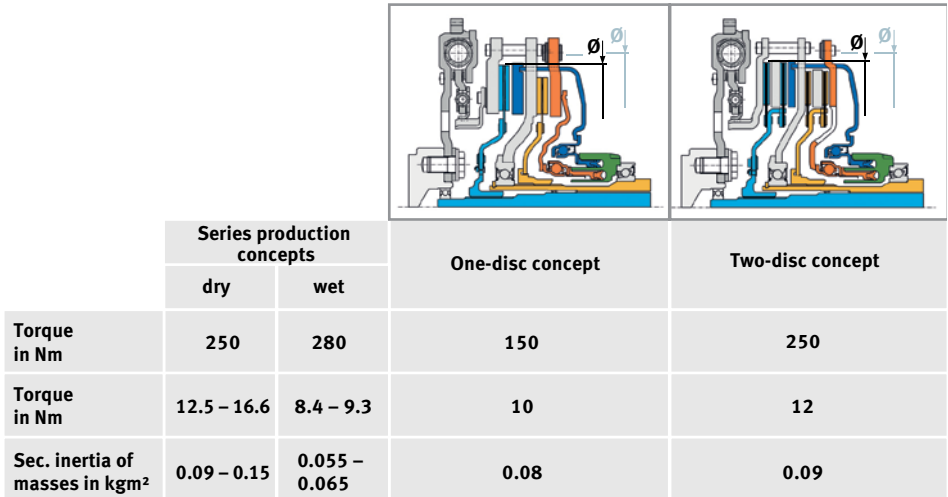
**Figure 6** Structure of the directly actuated double clutch with double-CSC actuation with cardanic tilt compensation via the CSC piston

## Evolution of new directly actuated dry double clutches

This directly actuated dry double clutch first went into series production in mid-2013. For this system, the four pressure plates required for this concept were again designed in a cast material commonly used for clutches. The double clutch was also secured via a support bearing on the clutch cover by means of a flex plate attached to the transmission housing; securing the clutch in this way also has the advantage of providing ex-

tremely good vibration isolation. Only a maximum engine torque of 180 Nm can be covered with the direct actuation (contact force is transferred directly from the CSC piston via the engagement bearing to the pressure plates). A modular design based on the previous system was developed (Figure 7) in order to now also be able to meet torque requirements of up to approx. 250 Nm for enhanced system specifications and to meet the requirement for a low mass moment of inertia.

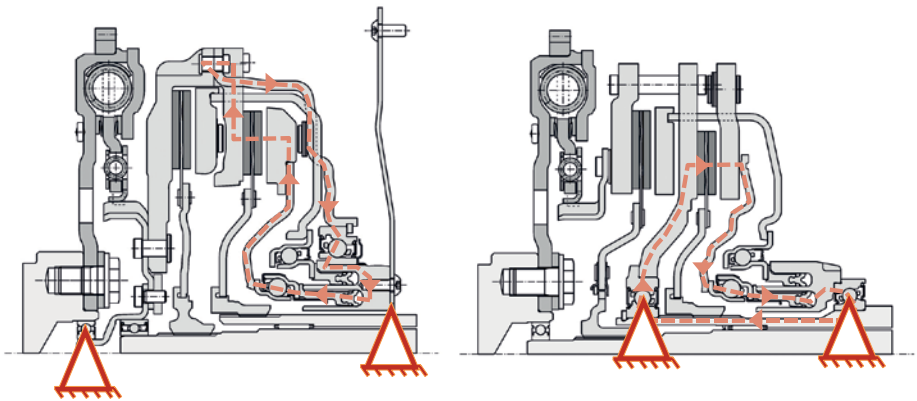
A new feature is that, through the use of a new bearing concept (power flow via the transmission shaft closed), it has been possible to simplify the system further (Figure 8). The new bearing concept prevents virtually



**Figure 7** Modular design of dry, directly actuated double clutches

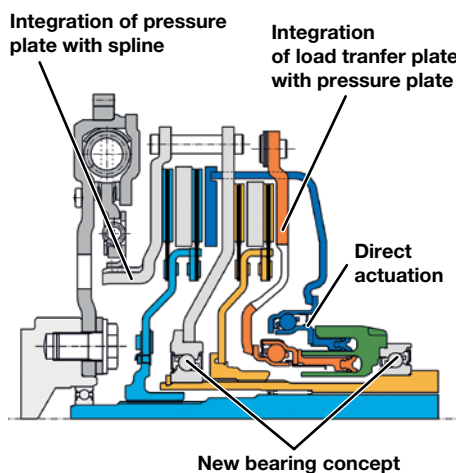
all vibration feedback from the engine and transmission onto the clutch system, thus improving the overall NVH behaviour of the powertrain. With this bearing concept, axial vibrations of the crankshaft or even the transmission input shafts caused by the forces of the helical gearing system do not generate any disturbing clutch torque fluctuations in any operating state.

Furthermore, the intention is for steel mating friction surfaces to be used for this concept. These surfaces offer a range of new design possibilities, such as reducing the thickness, integrating functions (e.g. a tone wheel directly integrated into the pressure plate on the engine side), new friction surface design (e.g. embossed grooves to protect against damage to the



**Figure 8** Bearing concept, directly actuated double clutches, series concept on left, new concept with closed power flow through the transmission input shaft on right

tribological system) etc. From a design and project point of view, it is beneficial if a radially smaller single-disc clutch is used for applications up to 150 Nm and a two-disc double clutch with a smaller diameter is used for higher torques and/or higher specific loads. A considerable benefit in terms of the mass moment of inertia of the clutch system can therefore also be achieved for a wide range of applications (20 – 30 % reduction in the mass moment of inertia), without this greatly increasing the overall costs due to the wide diversity of options or significantly reducing the thermal mass. With the two-disc concept, the increase in torque is achieved by increasing the number of friction surfaces from 2 to 4 for each partial clutch. The intermediate pressure plate is secured in the same way as the pressure plate via leaf spring packages. In the axial direction, the intermediate pressure plate always extends about half as far as the pressure plate. Figure 9 shows the new, simplified directly actuated two-disc double clutch.



**Figure 9** New directly actuated two-disc double clutch

## Summary and outlook

Dry double clutch systems offer a wide range of options for optimising the system characteristics with regard to NVH, comfort, complexity and mass moment of inertia. Specifically with the most recent developments, it has been possible to make real progress with issues such as NVH and comfort, and this progress will further boost the success of the system, as other benefits such as excellent fuel consumption and low overall costs continue to be valid.

The most important measures for significantly increasing NVH and comfort are:

- New clutch linings with improved damping properties (B8040 and RCF10, as well as B9000 in the future)
- Geometric optimisations for reducing disturbance excitation caused by geometric factors, such as the pairing of clutch components or the use of these by more accurate clutch components through the application of optimised and, in some cases, new manufacturing processes
- Further development of the double clutch bearing concept in conjunction with the new, directly actuated double clutch system, thereby eliminating the negative effects of axial vibrations
- Compensation of geometric errors by a “cardanic function” of the clutch and of the engagement system in the directly actuated double clutch concept
- Active vibration damping through minor software-controlled force modulation of the clutch, the anti-judder control system
- For hybrid vehicles, supporting the anti-judder control system by means of counter excitation via the electric motor, as well as the avoidance of vibration excitation and the reduction of thermal clutch loads through electrical launches

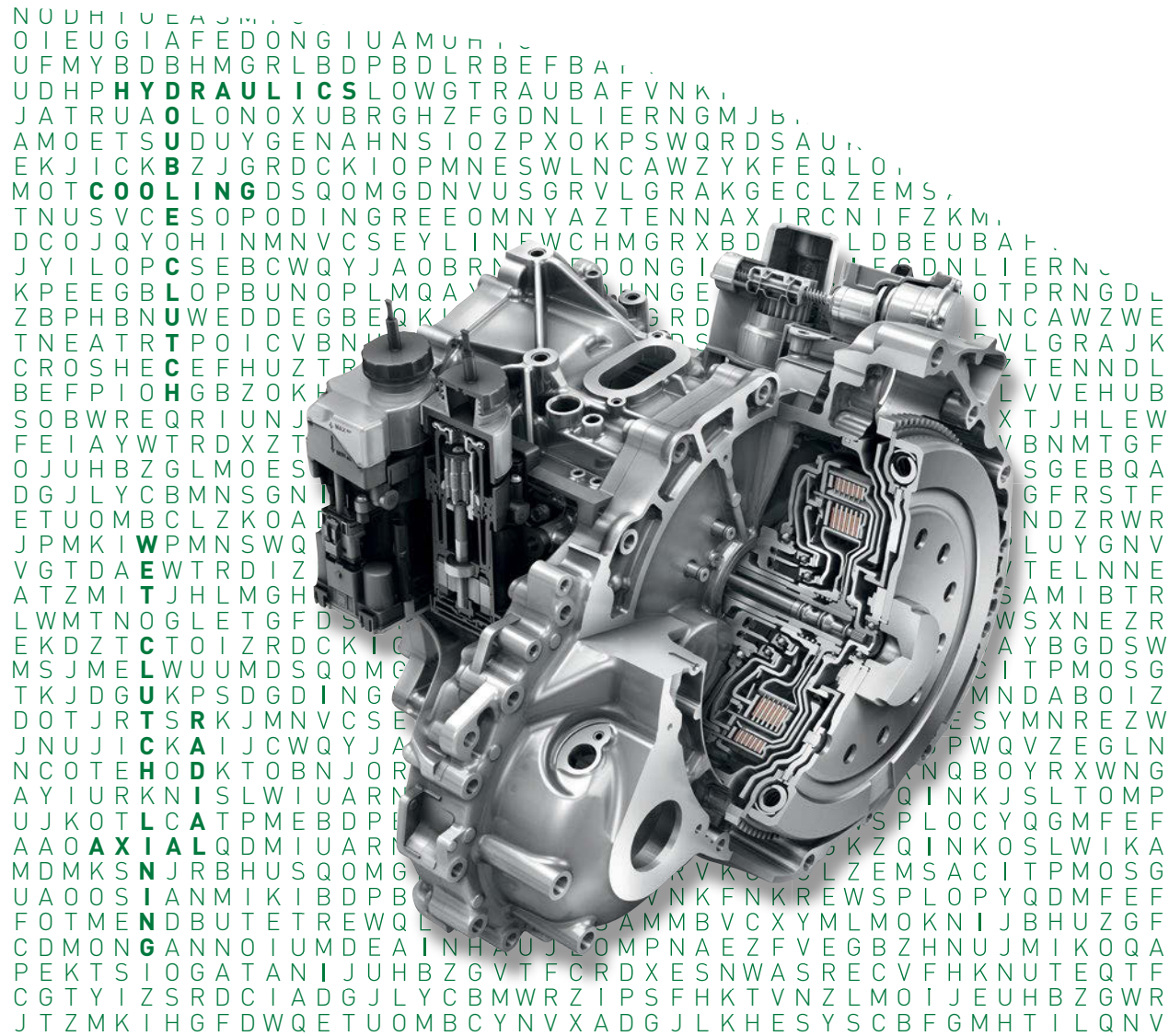
Reduction of mass moment of inertia of dry double clutch systems can also be achieved thanks to the new modular and directly actuated concept with a reduced outside diameter. Directly actuated two-disc double clutches are used for applications with engine torques greater than approx. 150 Nm for each partial clutch. The particularly special feature of this system is its low complexity.

Using the options outlined, the dry double clutch system for the lower to mid-range vehicle segment will set new standards for efficiency and comfort.

## Literature

---

- [1] Wagner, U.; Zink, M.; Feltz, C.: Double Clutch Systems – Modular and Highly Efficient for the Powertrain of Tomorrow. 10<sup>th</sup> Schaeffler Symposium, 2014
- [2] Wagner, U.; Buehrle, P.; Mueller, B.; Kimmig, K.-L.; Kneissler, M.: Dry double clutch systems – Innovative components for highly-efficient vehicle transmissions, ATZ 11/2009, pp. 826-833
- [3] Mueller, B.; Kneissler, M.; Gramann, M.; Esly, N.; Daikeler R.; Agner I.: Smaller, More Flexible, More Intelligent – Developed Components for Double Clutch Transmissions. 9<sup>th</sup> Schaeffler Symposium, 2010
- [4] Albers, A.; Herbst, D.: Grabbing – Causes and Solutions. 6<sup>th</sup> LuK Symposium, 1998
- [5] Kimmig, K.-L.; Buehrle, P.; Henneberger, K.; Ehrlich, M.; Rathke, G.; Martin, J.: Efficiency and Comfort Lead to Success – The Dry Double Clutch Established in the Automatic Market, 9<sup>th</sup> Schaeffler Symposium, 2010
- [6] Rudolph, F.; Schaefer, M.; Damm, A.; Metzner, F.-T.; Steinberg, I.: The Innovative Seven Speed Dual Clutch Gearbox for Volkswagen's Compact Cars, 28<sup>th</sup> International Vienna Motor Symposium, 2007
- [7] Wagner, U.: What makes a transmission operate – Tailored actuation systems for double clutch transmissions; CTI Symposium, 2011
- [8] Steiger, S.; Treder, M.; Neuberth, U.; Reuschel, M.: Innovative Weiterentwicklungen bei trockenem Doppelkupplungssystemen; VDI-Berichte Nr. 2206, 2013
- [9] Kimmig, K.-L.; Rathke, G.; Reuschel, M.: The Next Generation of Efficient Dry Double Clutch Systems, VDI Congress, 2013
- [10] Mueller, B.; Ubben, H.; Gantner, W.; Rathke, G.: Efficient Components for Efficient Transmissions. CTI Symposium, 2013



# Wet Double Clutch: Thinking in Systems

Andreas Englisch  
Andreas Goetz  
Andreas Baumgartner  
Thomas Endler  
Christian Lauinger  
Stefan Steinmetz

# 17

D W U  
J Z M H Z L  
A G Q S W I E N  
F I M B C H S E H E B U  
V C E C B S T P O I O D C V F E W U  
D G V T Q U J Z R E L K J H G F D S A M M L  
Y L M R T X A G Y W P H C E Q A Y W S X E E C R F  
C X V N H O U B I J B Z G V T F C R D X E S N W A S R E U  
X Z V T F L U J A D G Y C B M W P Z I P S F H K T V N Z L M O I  
D C S K U P O W R W Z T W H N E D K U N W P O N C A L V I K Z T W H N L  
E H K L P F L K J K O I U Z T R E W Q Y X C V B N M I Q W U O I U Z T R E L  
W D X A Y H A S G S V N P I Z R W Q S C G Z N J I M N S T R V N P I Z R W Q S  
L Z U K O G I K C K P M N E S W L N C X W Z Y K F E D I O P P M N E S W L N C X  
R U C Z G Z M Q G O D N V U S G R V L G R V K G E C E Z E M D N V U S G R V L G R  
Q A T S L O K Z I N E X O M N Y A Z T E W N F X J L R N I F E X O M N Y A Z T E W  
C L O M E P S C V C Y I  
F A M U A N J Y O  
K M N S R D O  
L I E P N N  
B S A T B  
P I E P  
R U C Z  
B S A  
D G V  
Y L M  
C X  
Z V  
X D  
U A H I O G D N O I E R N G M  
O Q O D N V U S G R V L G R V K G  
P D B D D L R B E F B A F V N K F N K  
J O T R E L K J H G F D S A M M B V C X  
X A Z Y W P H C E Q A Y W S X E E C R F V  
O U B I J B Z G V T F C R D X E S N W A S  
U J R D G Y C B M W R Z I P S F H K T V N  
R U T E T M B C Y N V X A D G J L K H E S  
P O W R W Z T W H N E D K U N W P O N C A  
F L K J K O I U Z T R E W Q Y X C V B N M  
H A S E S V N P I Z R W Q S C G Z N J I M  
G I K C K P M N E S W L N C X W Z Y K F F  
A S U S V N P I Z R W Q S C G Z N J I  
I K C K P M N E S W L N C X W Z Y K F  
O X O D N V U S G R V L G R V K G  
I N E X O M N Y A Z T E W N F  
C Y L J N E W C L V V F H  
N V U S G R V L G R V K G  
D C D N O I E R N G M

# Introduction

## Status

In ten years, the number of wet and dry double clutch transmissions (DCT) will make up approximately 20 % of the total automatic transmission market.

Against this backdrop, customers are faced with the question of which double clutch system is right for their application. Both dry and wet double clutches have proven themselves in volume production. There are various designs and various forms of actuation within the two systems, with key differences being in the torque capacity, space requirements, weight and inertia of masses [1].

A whole range of wet double clutch systems have since been developed by LuK in order to be able to serve a vast array of applications. The first wet double clutch went into volume production in 2013.

In addition to the actual double clutches, other components such as dampers, centrifugal pendulum-type absorbers and actuators are also available. The focus is on a perfectly matched overall system that meets the target parameters of comfort, consumption and costs in the best possible manner. To do this, components and assemblies need to be standardized to pool volumes and thus be able to continue to offer appealing solutions in the future.

Throughout the development phase, various different concepts were analyzed and compared on a broad basis. The clutch

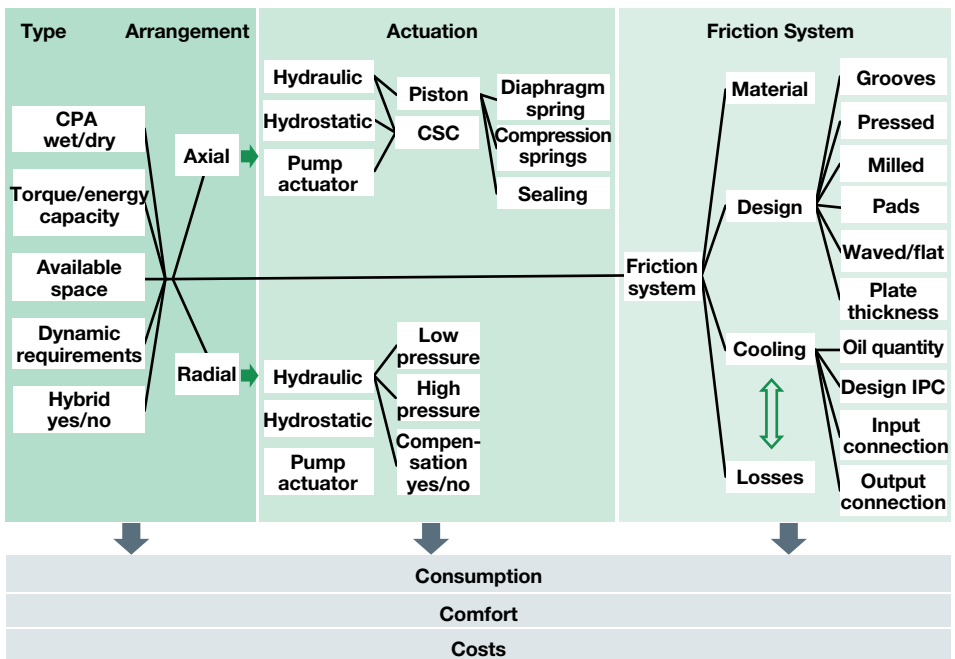


Figure 1 Wet double clutch system



components were examined in detail and developed accordingly.

The tribological system (comprising a friction plate, steel plate and oil), in particular, plays a key role in the design and comfort characteristics of the clutch. In addition to examining different friction linings and friction lining technologies, geometry, grooving, as well as the distribution of cooling oil and pressure are all important. Furthermore, the gathered findings and experience will be used to develop our own linings for wet clutches.

## The customer's perspective

---

When choosing a system, customers are faced with a whole range of difficult decisions and questions that will significantly impact the architecture of the clutch system.

- a) Which engines are to be used in the future?
  - Are 3- and 2-cylinder applications to be taken into account?
  - Does cylinder deactivation need to be taken into account?
  - What are the minimum drive speeds that should be achieved?
- b) What measures are to be included to further reduce fuel consumption?
  - Is hybridization of the powertrain expected?
  - What are the maximum torques to be taken into consideration?
  - How is the clutch to be actuated?
- c) How do these measures impact on fuel consumption and driving performance?
- d) What kind of oil and oil flow rate is required for cooling and, if necessary, for actuating the double clutch?

All of these functions have a crucial impact on the consumption, comfort and, of course, the cost of the system.

## Design

---

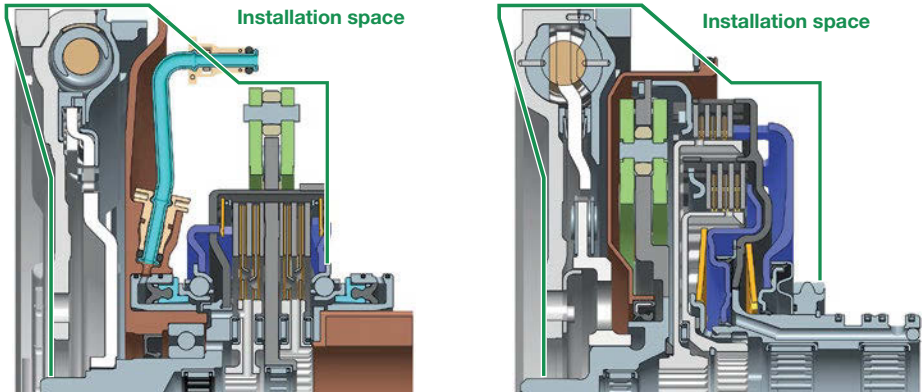
### Clutch

According to the specified space requirements, wet double clutches can be designed in radial and axial forms, with the different designs offering various advantages depending on the application.

The axial design allows moments of inertia to be kept to a minimum in relation to the transmission input shaft. It also provides the option of cooling both clutches independently of each other, thereby continuing to reduce the drag losses of the open clutch. The radial construction continues to represent the preferred solution for front transverse and rear longitudinal applications. The trend towards minimizing the inertia of masses could also make axial solutions more interesting for transverse applications.

There is the option of combining both systems with a centrifugal pendulum-type absorber in the wet area; this can help to further reduce fuel consumption and improve comfort. Figure 2 shows clutches for 180 Nm with extremely compact dimensions and a centrifugal pendulum-type absorber integrated into the clutch. In some cases, using a centrifugal pendulum-type absorber even reduces the total space required, as an additional secondary mass on the DMF is not required.

Max. Input torque 180 Nm



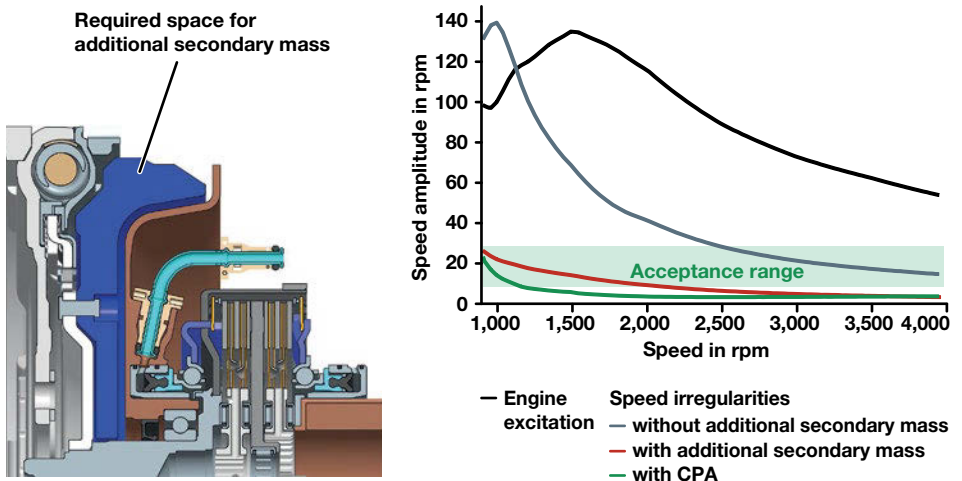
**Figure 2** A wet double clutch for 180 Nm in axial and radial design with a centrifugal pendulum-type absorber [2]

## Centrifugal pendulum-type absorbers in wet area

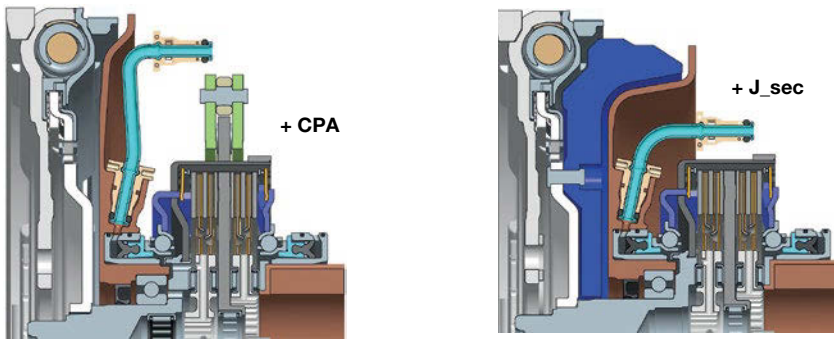
Using the centrifugal pendulum-type absorber (CPA) in the double clutch enables a substantial reduction of the drive speeds, there-

by also reducing fuel consumption. Figure 3 shows the quality of decoupling by the centrifugal pendulum-type absorber, on the basis of excitation by a 3-cylinder engine. The engine can be operated at very low engine speeds, without compromising on comfort.

Due to the minimal additional space required, these kinds of solutions in the wet



**Figure 3** Quality of vibration decoupling with 3-cylinder engine [2]



	+ CPA	+ J_sec
<b>Total secondary moment of inertia in kgm<sup>2</sup></b>	<b>0.040</b>	<b>0.105</b>
<b>Weight difference in kg</b>	<b>0</b>	<b>+ 7.0</b>
<b>Additional axial length required in mm</b>	<b>0</b>	<b>10</b>
<b>Distance difference after 4 s in m</b>	<b>0</b>	<b>- 1.9</b>
<b>Time to accelerate from 0 to 100 km/h in %</b>	<b>0</b>	<b>+ 4.1</b>

**Figure 4** Double clutch with and without centrifugal pendulum-type absorber: differences in the mass moment of inertia, in weight, in the axial length as well as in the driving performances

area can be easily implemented in almost any transmission. Using the pendulum-type absorber enables the total mass of the clutch and DMF, and therefore also of the inertia of masses, to be reduced, in addition to reducing the minimum drive speeds. For smaller engines in particular, the result is improved dynamics while simultaneously lowering fuel consumption. Comparing driving performances of a vehicle fitted with the appropriate equipment also documented the positive effects (Figure 4).

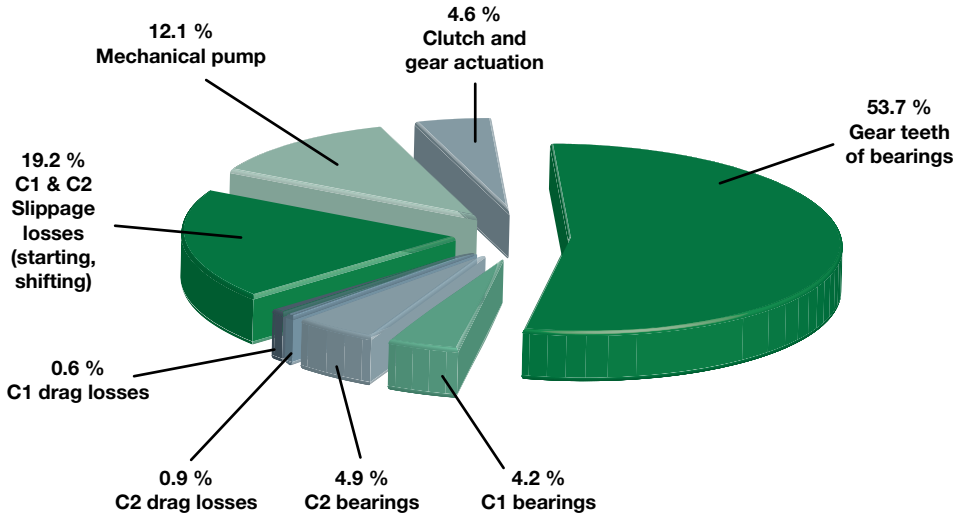
## Actuators

The clutch can be actuated hydraulically, hydrostatically or by using pump actuators. Hydrostatic systems (HCA) offer the advan-

tage that power-on-demand systems, and thus significant benefits to efficiency, can be realized. This is reflected in Figure 5: Clutch and gear actuators only contribute 4.6 % to overall transmission losses in the NEDC (New European Driving Cycle). However, individual operating points need be to examined in much greater detail, such as if the clutch is to be used at low temperatures (from -20 °C to -30 °C).

The hydraulic systems offer the advantage of high power density, but a permanent power input is also required.

A combination of clutch, CSC (concentric slave cylinder), hydrostatic clutch actuator (HCA) and gear actuator represents the best version in terms of energy. In order to prove this, consumption simulations will be performed using a detailed model of the powertrain, so that the efficiency of individual components can be evaluated. Furthermore, different concepts can be evaluated, such as concepts



**Figure 5** Distribution of transmission losses in the NEDC for 180 Nm DCT with HCA and gear actuators

for the low-pressure pump used and the operating strategy for clutch and bearing lubrication.

The result of the NEDC simulation (Figure 5) shows that DCT-specific losses from actuators and clutch drag losses can be reduced to a fraction of the mechanical losses.

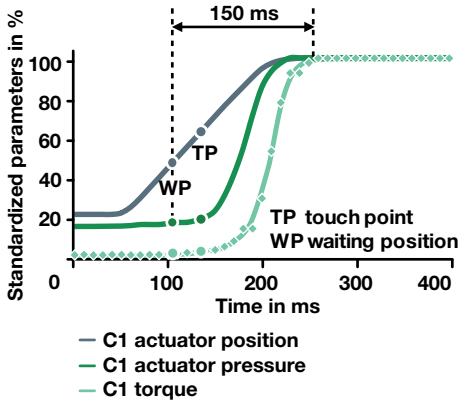
Figure 5 also shows that the low-pressure pump driven on the primary side that is used as a basis for the calculation indicates a share of 11.5 % of total losses. It is possible to significantly reduce this share of total losses to around 3 % if the pump driven by the engine speed is replaced with an electrically driven one (Figure 6). The reason for this is the small time portion of approximately 9 % when starting or shifting in which a higher cooling oil flow is required during driving mode for the slipping clutch. In contrast, the pump can be operated at a lower speed and therefore lower drive power with considerably higher time portions of approx. 70 % (start-stop system

taken into account here) in order to provide the minimum oil quantity for the non-actuated clutch and bearings.

One aspect already mentioned has a positive impact on both pump concepts: The optimized groove geometry of the lining plates results in an improved oil distribution requiring a significantly smaller quantity of cooling oil. The pump can therefore be designed for a smaller flow volume.

## Dynamics

The previous sections looked at the benefits of hydrostatic control with HCA, in particular at the small share of clutch actuators in the overall transmission losses in the NEDC. In this section, the dynamic behaviour of the line, comprising a hydrostatic clutch actuator, the CSC and



**Figure 6** Measuring the dynamics of clutch C1: the standardized parameters are shown – actuator position, actuator pressure as well as the torque transmitted by clutch C1.

the clutch, is explained using measurements.

Figure 6 shows the measured profile for operation of clutch C1. The parameters shown are standardized to the respective maximum values to enable uniform presentation. Starting from the initial value of approximately 21 % the actuator position starts to change after 50 ms. On account of the clutch characteristic curve, the clearance must first be overcome until the touch point (TP) is reached. From this point onwards, the actuator pressure increases significantly. With a small time delay the torque transmitted by clutch C1 also increases. The actuator position reaches the target value (100 %) after approx. 200 ms, which in this case is equivalent to the maximum driving torque according to the design. It takes approx. 100 ms until the maximum pressure is reached. The maximum torque is transmitted as early as 120 ms after pressure has started to build up. The measurement data relates to a 550 Nm DCT. For smaller clutches and therefore lower actuation

forces, the dynamics can be increased further.

In order to keep the time difference between the actuator position starting to change and reaching the required torque as small as possible in a real driving situation, the actuator position is not moved to 0 mm in a waiting position (WP) of the non-actuated clutch; instead, it is moved in the clearance range just underneath the TP. The friction system is described in greater detail in one of the following chapters, which also lists the measures designed to minimize drag losses in the clutches. Using these measures, it is possible to keep the spacing of the waiting position from the TP and the drag torque through the non-actuated clutch as small as possible. Doing so achieves short actuation times for adjusting a required torque.

## Axial or radial design

Double clutches in axial and radial designs are compared in detail in this section. This is again based on the NEDC simulation, and the share of the individual components in the overall transmission losses are discussed. According to Figure 2, the axial design comprises two wet clutch release bearings with CSC. Rotary connections with sliding ring seals are taken into consideration for the radial design concept. However, in principle, a radial double clutch can also be actuated via a CSC.

Due to the geometric ratios, the drag torques of C1 and C2 and the resulting shares in the overall transmission losses (Figure 8) are approximately 1 percentage point smaller for the axial arrangement than for the radial concept. The drag torques are calculated based on the measurements on the NEDC operating points. The measure-

ments regarding drag losses of various plate geometries are described in greater detail in a subsequent section.

## Diaphragm springs or compression springs

Using diaphragm springs for opening the clutch pack represents a space-saving alternative to spiral springs. The question that therefore needs to be asked is how do these elements influence of the clutch hysteresis. As part of this question, a solution using diaphragm springs does not automatically lead to higher hysteresis values. The example shown indicates that, with the right design of the diaphragm spring, contact surface and overall system, it is possible to achieve hysteresis values comparable to those of compression spring solutions.

## Rotary connection or CSC

Rotary connections are used in many of today's double clutch transmissions and provide a robust solution in conjunction with hydraulic systems. Wet clutch release bearings with CSC can be used as an alternative; the losses of these bearings are much lower in comparison with the rotary connections. Applications up to 700 Nm are currently in the development phase.

Furthermore, the bearing concept of the axial arrangement with a deep groove ball bearing, four axial needle roller bearings and two clutch release bearings for CSC indicate a benefit of more than 3 % points in comparison with sliding ring seals. Again, measured values are converted into NEDC operating points. Furthermore, the CSC offers the option of minimizing geometrical deviations in the clutch to be similar to the dry system.

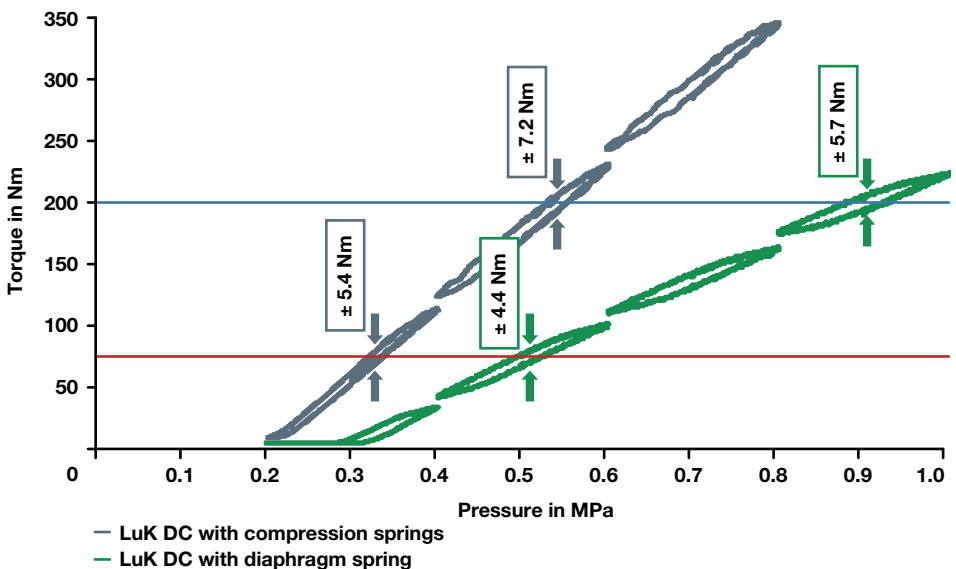
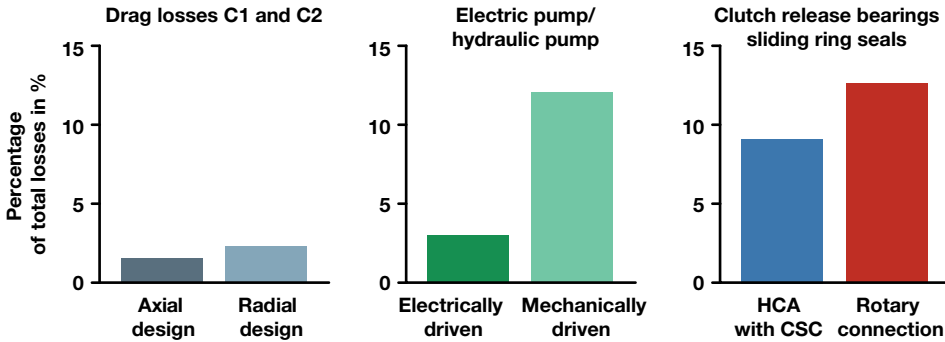


Figure 7 Comparing the clutch hysteresis



**Figure 8** Comparison of axial and radial designs: share of C1/C2 drag torques, as well as of the bearings (CSC) and the sliding ring seals for rotary connections in the overall losses in the NEDC

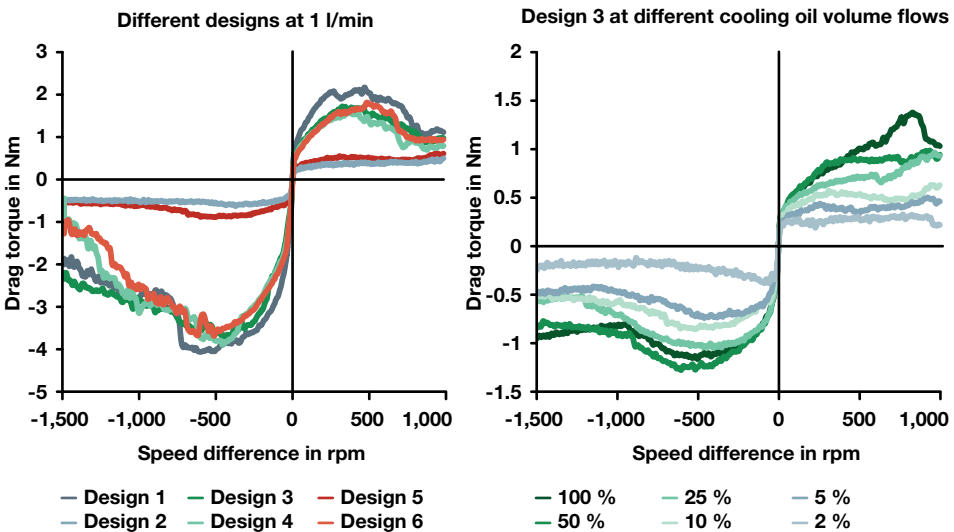
## The friction system

### Design

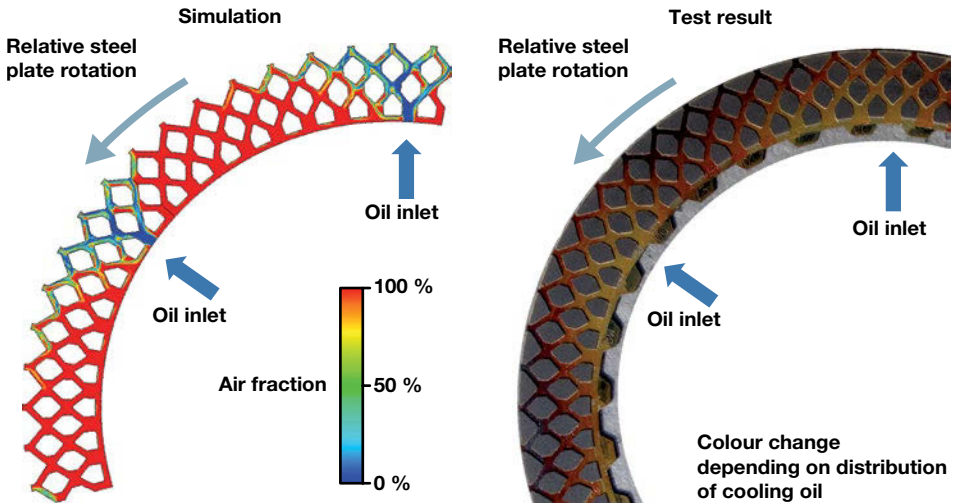
Waves and grooves play a key role in how the wet clutch works. The manufacturing method also significantly influences the friction value structure and the resulting

drag losses. In addition, the lining's geometric characteristics play an essential role in the uniformity of torque transmission. Depending on the volume flow, there is a considerable increase in the clutch drag torques.

The aim of the development phase is therefore to minimize the cooling oil volume flow, optimize the groove geometry and ensure the correct wave of the plate.



**Figure 9** Impact of the plate geometry on drag losses



**Figure 10** CFD analysis and comparison with test results

**Cooling**

The cooling effect is heavily influenced by the connection of the friction plates (primary or secondary side), the layout of the bores in the inner plate carrier and the lining groove geometry.

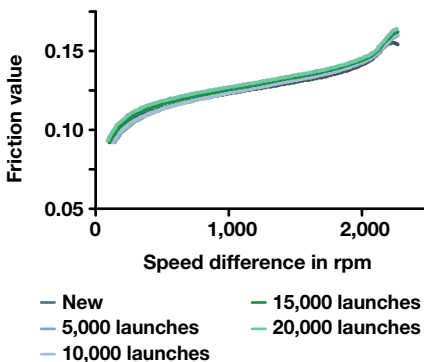
By using CFD analyses, these effects can now also be demonstrated with simulations. Figure 10 shows the influence of the

bore pattern in the inner plate carrier and the influence of the groove geometry.

Discoloration of plates clearly shows the poorly cooled areas. Good consistency can be seen between the simulation and the thermal load of the plate.

Furthermore, the thickness of the plates must be optimized depending on the specific application.

**Stability of friction value in endurance test**



**Friction plate after 20,000 hill starts under full load**



**Figure 11** Endurance test with LuK friction lining: 20,000 hill starts under full load



## LuK lining

The friction plate really comes into its own within the tribological system. The plate has a significant impact on the friction value, the friction value gradient, the wear behaviour and the thermal capacity of the clutch, which is why LuK pushed the development of its own double clutch linings. The suitability of LuK lining in functional and endurance tests has since been demonstrated (Figure 11). The characteristic curves clearly show that the friction value gradient is following a very strong and stable, positive course. It should therefore be possible to reliably rule out clutch judder due to the friction value.

Running in parallel with the development of wet double clutch linings is the advancement of their industrialization.

## Wet double clutch

### The modular design

Wet double clutches are now available in radial and axial designs for torques between 100 Nm and 3500 Nm (Figure 12). The double clutches can be combined with centrifugal pendulum-type absorbers as an option.

The efficiency of the overall transmission can be ensured by consis-

tently optimizing damping components, the clutch and the clutch and gear actuators.

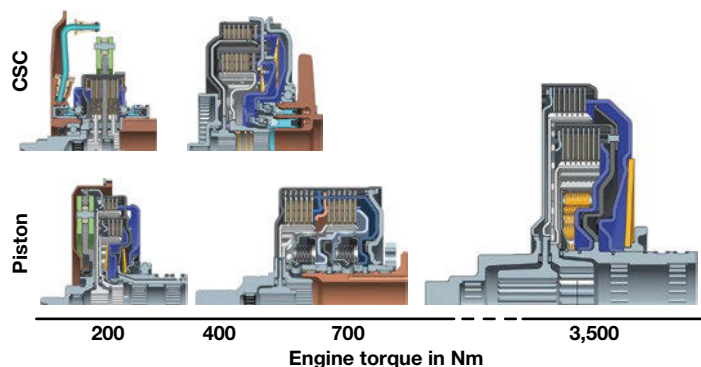
LuK friction linings for wet double clutches have demonstrated their suitability for DCTs.

In combination with the software, it is possible to find special solutions that improve the driving performance, significantly increase driving pleasure and further reduce fuel consumption for every customer.

In conjunction with modern hybrid systems, future powertrains can therefore be realized with a high level of comfort and minimum fuel consumption.

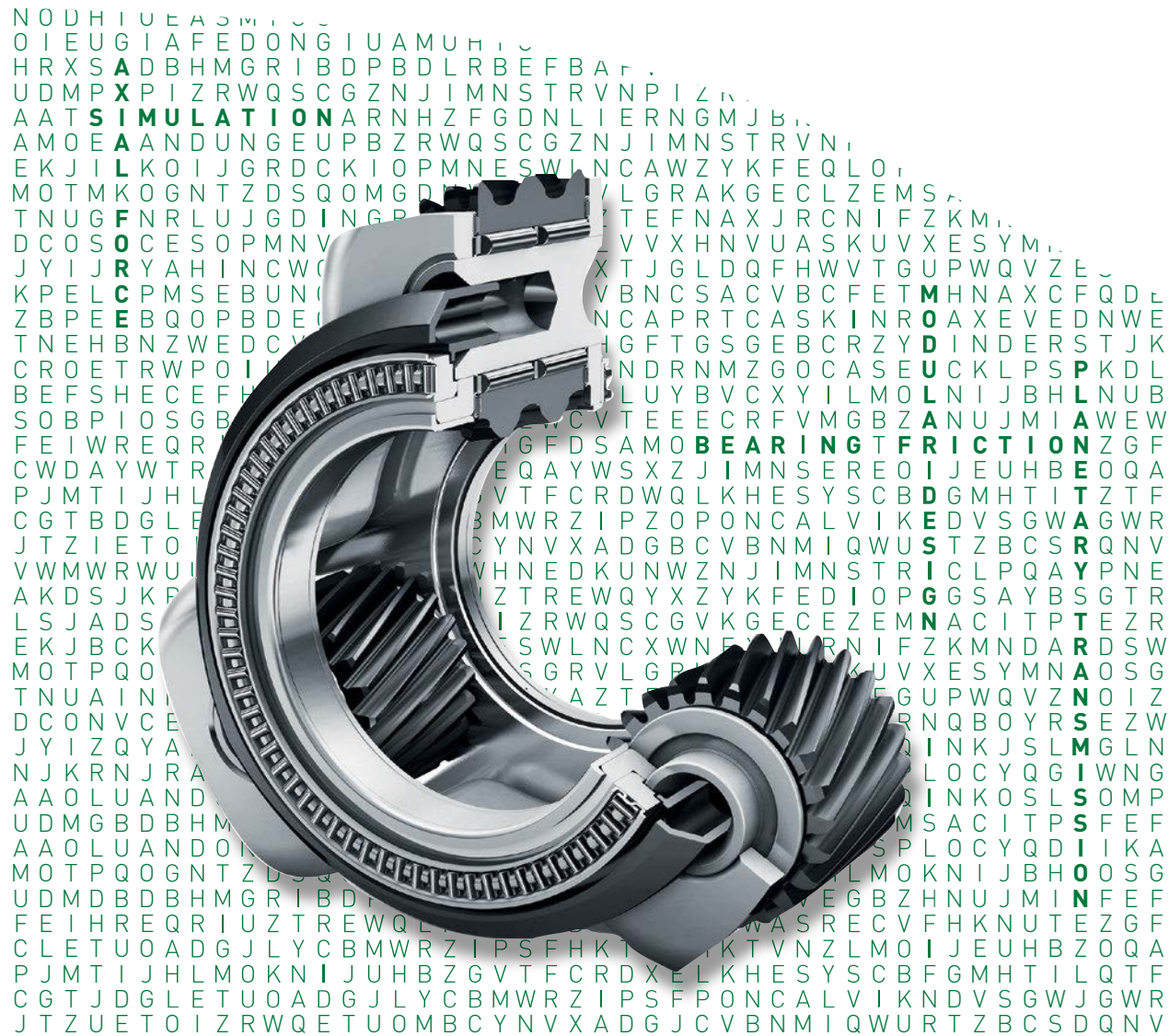
## Literature

- [1] Zink, M.; Wagner, U.; Feltz, C.: Double Clutch Systems – Modular und Highly Efficient for the Powertrain of Tomorrow, 10<sup>th</sup> Schaeffler Symposium, 2014
- [2] Baumgartner, A.; Lauinger, C.; Lorenz, E.; Fischer, N.; Goetz, A.; Krause, T.: Reducing CO<sub>2</sub> emissions with wet double clutch transmissions with a simultaneous improvement in comfort and driving dynamics. VDI Getriebe in Fahrzeugen, 2013



**Figure 12** Modular design

**Open Access.** This chapter is distributed under the terms of the Creative Commons Attribution Noncommercial License, which permits any noncommercial use, distribution, and reproduction in any medium, provided the original author(s) and source are credited.

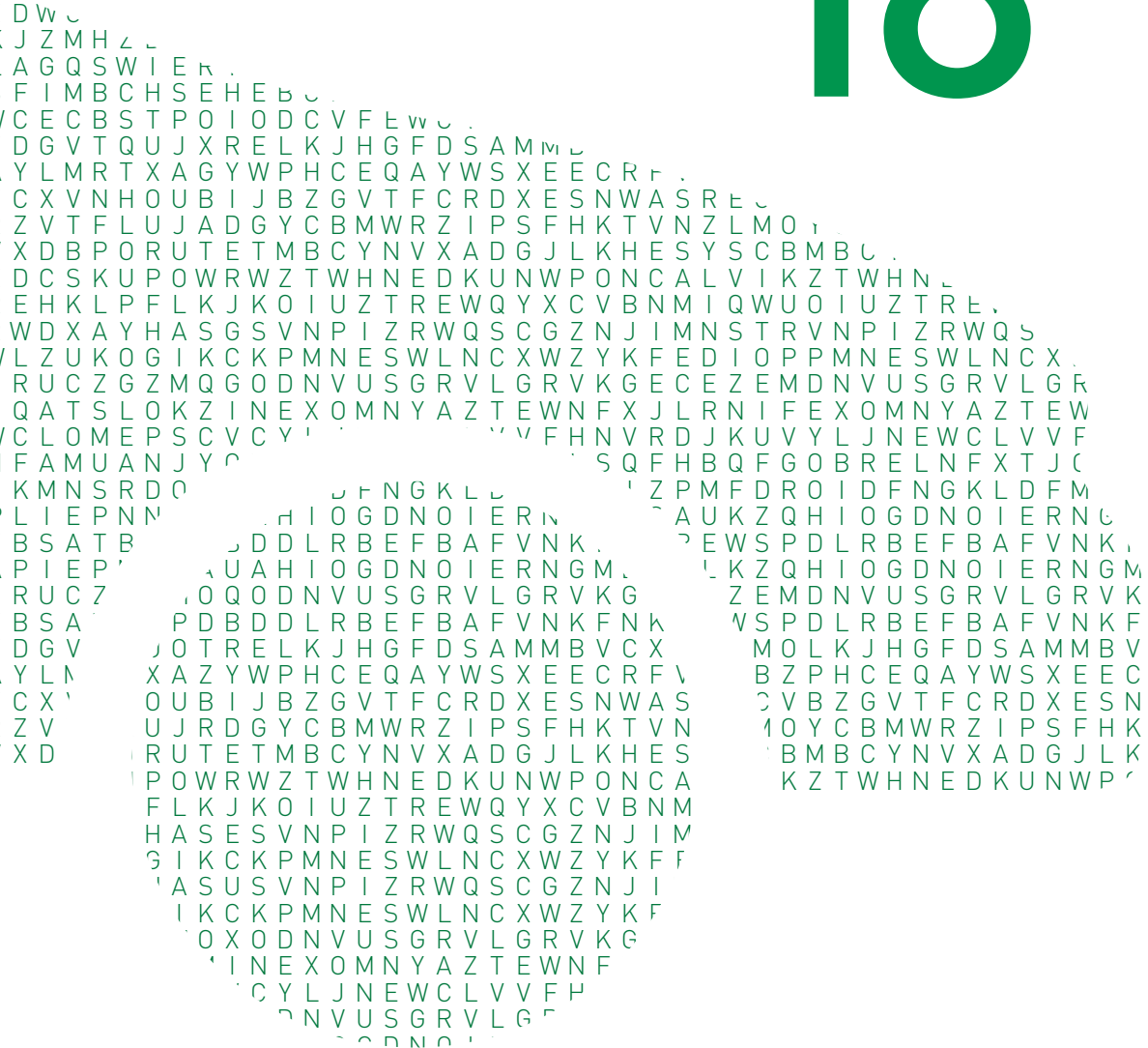


# Turning New Directions: Surprising Potential in Planetary Transmissions

## Part 1: Planetary gear set

Rainer Schuebel  
Martin Gegner  
Frank Beeck

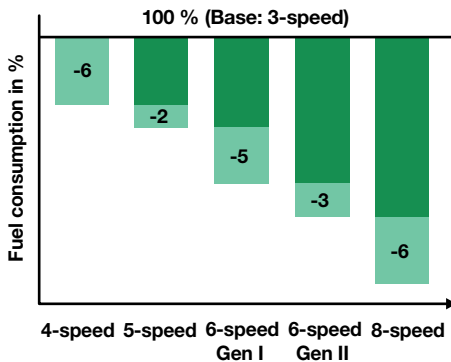
# 18



## Introduction

The automotive industry and suppliers have implemented numerous innovations with the objective of reducing the CO<sub>2</sub> emissions of individual transport. Examples are general lightweight designs and optimizations to the exhaust gas system as well as numerous detailed solutions for engine technology. For many years, transmission technology has also been contributing to the continuous reduction of fuel consumption and emissions. This has usually been accompanied by an increase in the number of gears. This increased number of gears and the smaller transmission ratio spread result in smooth, more comfortable and hardly perceivable gearshift operations. At the same time, each additional gear has enabled reductions in fuel consumption and emissions by several percentage points by approximating the optimal tractive force hyperbola (Figure 1).

With the increased number of gears, the number of planetary gear sets in automatic transmissions also tended to be increased. This trend was not linear in relation to the number of gears due to the



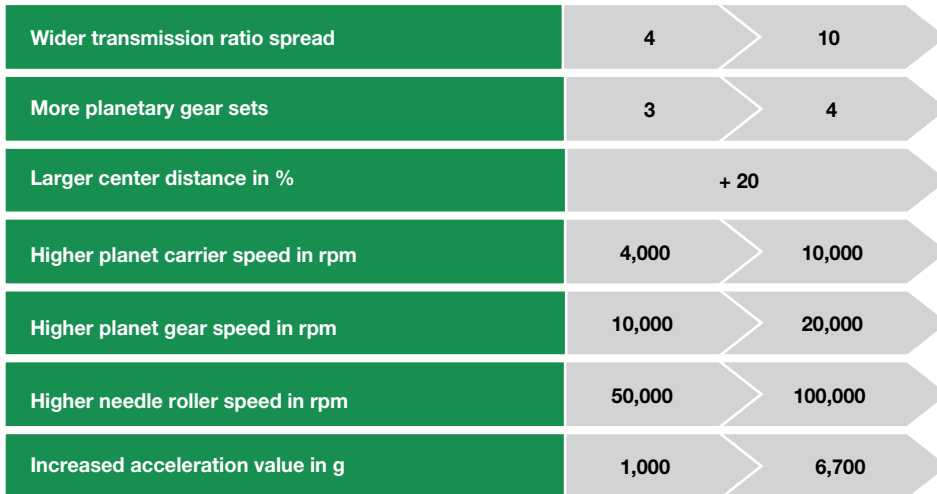
**Figure 1** Reductions in fuel consumption based on transmission development

intelligent control of the flows of force. The design envelope of the transmission, however, remained the same. The individual transmission components therefore had to become smaller and more compact. This requirement often created special challenges for the design and dimensioning of components. At the same time, the requirements for the materials and manufacturing technologies used have increased.

Schaeffler has been able to make significant contributions to reducing emissions and fuel consumption by continuously optimizing planet gear bearings and axial needle roller bearings. Recent analyses have shown that even inconspicuous new developments can offer great potential. The most recent example is the new axial needle roller bearing support for planet gears. This development is considered a first in rolling bearing technology and can contribute to reducing CO<sub>2</sub> emissions by up to 1 g/km with low additional costs.

## Trends and challenges

The further development of transmission technology has increased the subsequent requirements for modern planetary gear sets by more than 50 % during the last few years. This is because fuel consumption can only be reduced by means of smaller jumps in speed, which requires a wider transmission ratio spread and causes additional outlay for the design of the transmission, for example due to an additional planetary gear set required. The center distances in the planetary gear set are also becoming larger in order to achieve the required forces and moments through the ratios. The center distance



**Figure 2** Challenges for the transmission and effects on the components

and the speed of the planet carrier cause high centrifugal force loads at individual operating points of the transmission. Often, the centrifugal forces even increase considerably. This results in higher loads acting on the planet carrier, the planet gear, and the planet gear bearing. The maximum carrier speed and the maximum centrifugal acceleration are now slightly above the currently valid limits. However, these values can be controlled with adequate development outlay.

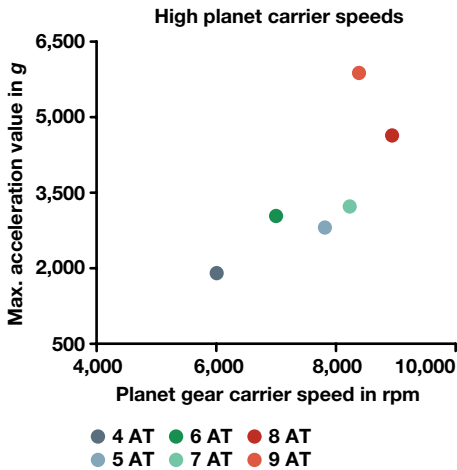
The number of gears in automatic transmissions can be increased by using additional shift elements or more planet stages. Looking back at the six-speed automatic transmission, the number of gears could be increased further by using a fourth planetary gear set. This additional planet stage has proved ideal with regard to constant or reduced drag losses due to open shift elements. [1]

Certain cases, however, require an automatic transmission with a particularly space-saving design in order to use it in front transverse applications, for example. The most suitable method for saving

space is the nesting of planetary gear sets. As a result, the outer nested gear set has a comparably large center distance (Figure 2) [2].

Previous requirements for planetary gear sets have been implemented by using state-of-the-art bearing supports for the planet gears. This means that bearing loads of up to 3,500 times the acceleration due to gravity ( $g = 9.81 \text{ m/s}^2$ ) can be managed using current manufacturing methods. However, the latest generation of automatic transmissions must meet bearing load specifications of up to 6,700 g, and future transmissions must even be designed for up to 8,000 g. The basis for this is the dependency of the centrifugal acceleration on the speed of the load-bearing component (Figure 3).

The following comparisons can give a better idea of the occurring forces. For example, forces of around 4 g act on the human body in a carousel. A fighter pilot is subjected to up to 25 g when the ejection seat is fired. The forces of up to 6,700 g acting on a planet gear bearing can also be explained using this example: If a nee-



**Figure 3** Changes in planet carrier speed

dle roller in a planet gear bearing weighs one gram, an acceleration of 6,700 g results in a mass of around 6.7 kg. Such values push the limits of design and materials technology and require innovative development solutions.

## Power losses

Even though transmissions generally have relatively high levels of efficiency, losses cannot be completely prevented in individual assemblies. They are mainly caused by the lockup clutch and its actuation system in the converter. The one-way clutch supporting the stator is considered as relatively negligible in this regard. The adjacent oil pump is increasingly actuated by means of a separate electromechanical system. This means that energy must be used only when a specific oil quantity or oil pressure is required. The focus of planetary gear sets is on the influence of

centrifugal force, the rolling friction of the gear teeth, the bearing friction, and the axial sliding friction of the planet gears. The main focus of bearings for automatic transmission components is on axial bearings, ball bearings, or radial plain guidance systems. Additional losses are due to the viscosity of the oil, the throttling/pump effects of various rotating components, and churning losses.

## Reducing frictional power

### Planet gear bearings in general

The main purpose of planet gear bearings is to position the planet gears [3]. In addition, they must support forces and moments and ensure rotation of the planet gears with minimal friction. Bearings with needle roller and cage assemblies are mainly used due to the speed and centrifugal force requirements. The cage, which is usually made of steel, guides and positions the rolling elements. The cages are generally manufactured using forming, punching and welding methods in order to ensure efficient production of the high quantities required for automotive applications.

The raceways for the rolling bearing are located directly on the gear set components. The outer raceway is defined by the bore of the planet gear. The stud that is firmly located in the planet carrier provides the inner raceway. Special thrust washers facilitate the axial contact between the planets and the bearing cages. This design represents a cost-effective and highly functional bearing arrangement.

The bearing itself comprises a specific number of load-bearing rolling elements (needle rollers) and a so-called cage, which guides the needle rollers both axially (cage rib) and in circumferential direction (cage crosspieces). The cage crosspieces have outer and inner retentions that retain the needle rollers radially and prevent them from falling out. The position of these retentions has been optimized so that cage stresses can be kept as low as possible. The pocket corner radii have also been optimized in order to reduce the component stresses.

### Cage design

Another important point in the design of planet gear bearings is the friction behavior. If the diameter, length or number of rolling elements are modified, this can result in significant changes in friction. The following comparison of the calculated friction components of two bearing design alternatives subjected solely to centrifugal force loads demonstrates this as an example. Compared to the standard design with rolling elements with a diameter of 2.5 mm, the alternative has thinner rolling elements with a diameter of 2.0 mm and therefore a slightly larger inner raceway diameter. With the same static load ratings, the friction of the rolling elements with the smaller diameter is reduced by around 11 %.

Cage friction depends on the selected rolling element diameter and therefore has a significant influence on the friction behavior of the bearings. This presents varied challenges for the design of planet gear bearings as it must combine sufficient load ratings and cage strength with minimal friction.

### Coating

Adapted coatings for bearing cages also play an important role in increasing the efficiency of planet gear bearings. The bearing cage is subjected to sliding contact due to the occurring loads. For example, the rolling elements are pressed against the outer retentions of the crosspieces when subjected to centrifugal force, and the outside surface of the cage is pressed into the planet bore.

Simulations have shown that optimizing the contact surfaces of the cage is advantageous as they account for up to 70 % of the friction. The rolling surfaces of the needle rollers and the raceways are less suitable for low-friction coatings as they already meet the highest surface requirements in order to function as rolling raceways.

Coatings based on zinc phosphate (Durotect Z) or manganese phosphate (Durotect M) improve the sliding and wear behavior of metal contact surfaces that slide against each other and also contribute to corrosion protection. Due to their capability of storing oil, the layers are also used specifically for sliding contact surfaces. The previously used Durotect Z layer has been replaced by the Durotect M layer for planet bearing applications. Practical experience has shown that this layer achieves significant advantages in terms of friction and wear.

If additional increases in efficiency are required, a specially developed coating based on nickel and phosphorus (Durotect NP) is used on the bearing cages to reduce friction. This layer offers very good adhesive wear resistance, excellent dry running characteristics, and temperature resistance in combination with outstanding sliding and anti-adhesive characteristics.

The measured frictional power using Durotect M is approximately 10 % lower

compared to the previously used Durotect Z layer. A significant reduction in wear has also been achieved. The Durotect NP coating additionally reduces friction by a further 13 %.

### Planet gear design

In order to investigate possible optimizations for planet gear design, Schaeffler modified the parameters of the bearing support of a planet gear while maintaining the same gear teeth. The objective was to achieve the maximum possible planet gear inside diameter, which at the same time requires the minimum possible wall thickness and the maximum possible outer raceway of the bearing. Varying rolling element diameters and the correspondingly required number of rolling elements in the pitch circle diameter were used to determine the radial bearing support geometry with the longest rating life. This specified geometry also determines the raceway inside diameter and the size of the planet gear stud.

The smaller wall thickness reduces the mass of the planet gear and the resulting centrifugal forces.

The investigations led to the following conclusions: The strategy of using a smaller rolling element diameter and subsequently increasing the number of rolling elements results in a bearing support with reduced friction and a higher load carrying capacity. Calculations have shown an increase in rating life by 55 % for the optimized bearing in conjunction with a reduction in the planet gear mass by 30 %. This leads to a reduction in friction by 50 % in the radial bearing and a reduction in the centrifugal force by 60 %. Figure 4 provides an overview of the successes achieved in development.

## Latest findings from axial bearing supports for planet gears

In a planetary gear set, the annulus, the planet gear and the sun wheel mesh with each other. The planet gear plays a special role as it meshes with both the annulus and the sun wheel. The gear teeth




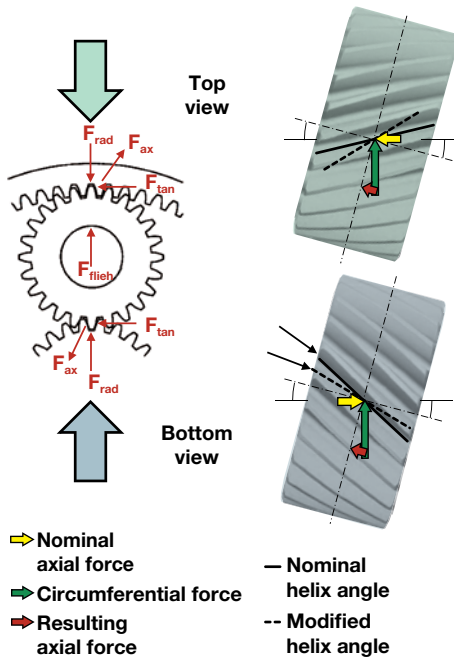
Optimizations compared with the previous product	Friction behavior compared with the standard as basis (100 %)	Responsibility for development
<b>Optimized planet gear bearing cage design</b> 	-11 %	Schaeffler
<b>Optimized planet gear bearing cage coating</b> 	-23 %	Schaeffler
<b>Weight-optimized planet gear</b> 	-50 %	Currently responsibility of the customer

Figure 4 Overview of improvements





**Figure 5** Force conditions on the planet gear

are helical. Meshing forces are generated when the planet gear meshes with the annulus and the sun wheel. They cause a force that acts on the planet gear stud in circumferential direction (Figure 5).

Furthermore, centrifugal forces occur when the planet carrier rotates. The rotation of the planet gear generates frictional forces due to the contact with the planet gear bearing. Forces are also generated by the angular acceleration of the planet gear, and additional frictional forces result from the rolling contact itself. All three forces act against one of the two meshing forces depending on the direction of the power flow. This causes irregularities in the sun/planet and planet/annulus systems, resulting in an axial force that acts on the end faces of the planet gears (red arrows).

As part of the development work in this field, Schaeffler modified the last position without rolling bearing supports in the planetary gear set. This position has a sliding contact surface. It comprises either a non-ferrous metal washer or a steel washer, and sometimes also a combination of materials. The non-ferrous metal washer is the friction partner for the planet carrier made of unhardened steel. The steel washer is used as a thrust washer for the planet gear and its bearing.

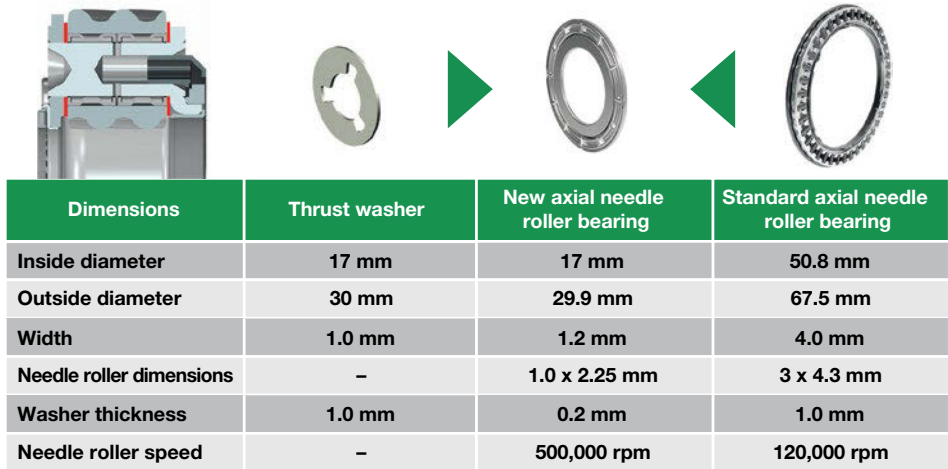
The plain washers are very small. They can have various characteristics despite their dimensions, for example an inside diameter of 17 mm, an outside diameter of 30 mm, and a thickness of 1 mm. These include:

- special oil feed grooves or oil ways,
- retentions for simplified final assembly,
- anti-rotation locking devices (to prevent abrasive wear), and
- various coatings.

The small design envelope represents a major challenge for the development of an adequate rolling bearing. A reliable standard axial needle roller bearing has a product width of 2.13 mm. The needle roller diameter is 1.5 mm, and the washer thickness is 0.63 mm.

The objective was to develop a new axial needle roller bearing with the same smaller dimensions. Schaeffler has successfully achieved this with its latest axial needle roller bearing with an axial washer. It has an inside diameter of 17 mm, an outside diameter of 29.9 mm, and a thickness of 1.2 mm. Schaeffler was able to reduce the needle roller diameter to 1.0 mm and the washer thickness to 0.2 mm (Figure 6).

This design places very high demands on the quality of the material and its surface and heat treatment in order to fulfill the requirements for rolling bearings and withstand the occurring loads. The film-like washer thickness also represents a special challenge for the production pro-



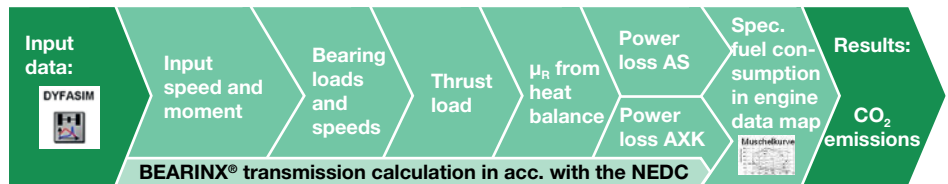
**Figure 6** Modifications to the axial planet gear bearing support

cess. The needle roller with a diameter of 1 mm and a length of 2.25 mm is the smallest rolling element ever used in transmission applications. The axial needle roller cage must have a very filigree design in order to securely guide and retain the needle rollers.

The behavior of the axial bearing support in the planetary gear set for an entire transmission and its effects on fuel consumption were investigated for four differ-

ent planetary gear sets using simulation tools. The simulation was based on the NEDC with a reduced number of load points of 1,400. The engine data map based on the NEDC and the mass inertia values correspond to those of a premium vehicle. The friction parameters were determined on the basis of test stand runs (Figure 7) [4, 5].

The results in Figure 8 show a comparison of the power loss of the individual plan-



Friction parameters $\mu_r$ from the heat balance					
Scenario	Thrust load	Churning	Wear	P_AXK (basis)	$\mu_{r\_AS}$
1	3.5 %	yes	yes	74.40 W	0.018
2	7.0 %	yes	-	14.88 W	0.070

AS: Axial washer    AXK: Axial needle roller and cage assembly    P\_AXK: Power loss of axial needle roller and cage assembly

**Figure 7** Simulation

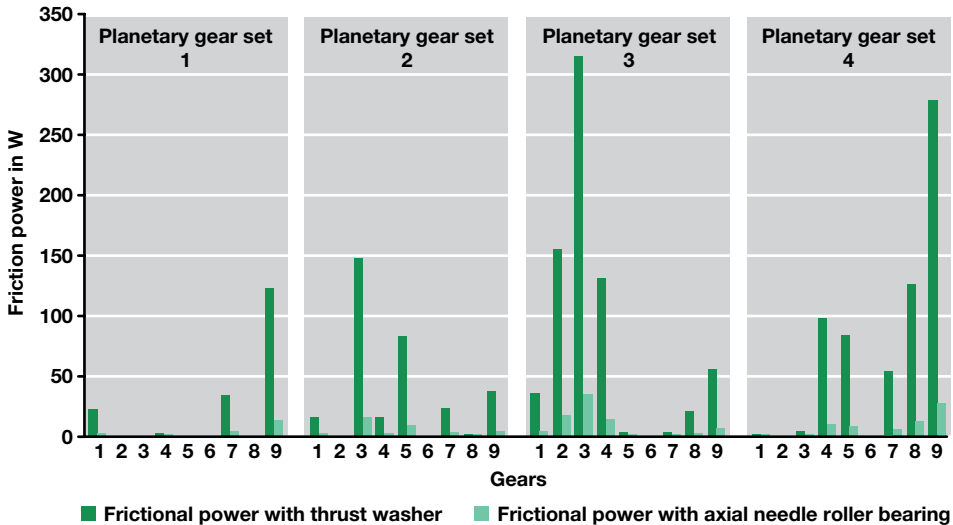


Figure 8 Simulation results

etary gear sets under various load conditions using plain bearings or rolling bearings. The values can be accumulated for the relevant gears only. Under the specified load conditions, the axial bearing achieves relatively high values in two planetary gear sets, which represent a highly effective reduction in friction if a suitable rolling bearing support is used.

In the third gear, for example, the maximum frictional power is 470 W if a thrust washer is used, but only 50 W if an axial needle roller bearing support is used. For the entire transmission with four planetary gear sets, this means a reduction in frictional power by 420 W or 90 % in the third gear. Based on the simulation, a reduction in fuel consumption by around 0.5 % in the NEDC can be expected if the plain washers are replaced with axial needle roller bearings.

Comparative tests with axial bearings and plain washers on an axial bearing high-speed test stand also confirmed reduced frictional torque and additional temperature differences. To determine the speed limits

of the axial bearing depending on the axial load, the oil temperature and the oil flow rate, the axial load is introduced into the test stand using a hydraulic system. The hydrostatic system enables measurements of the frictional torques at high speeds.

Speeds of 6,000 rpm and 20,000 rpm were specified as test conditions. The axial load was 500 N. A reduction in frictional torque from 0.23 Nm to 0.024 Nm was achieved at a speed of 6,000 rpm. At a speed of 20,000 rpm, the frictional torque was reduced from 0.13 Nm to 0.03 Nm. This means that the frictional torque can be reduced by around 90 % with the new axial needle roller bearing. At the same time, the temperature on the bearing position decreases by 5 to 10 °C (Figure 9).

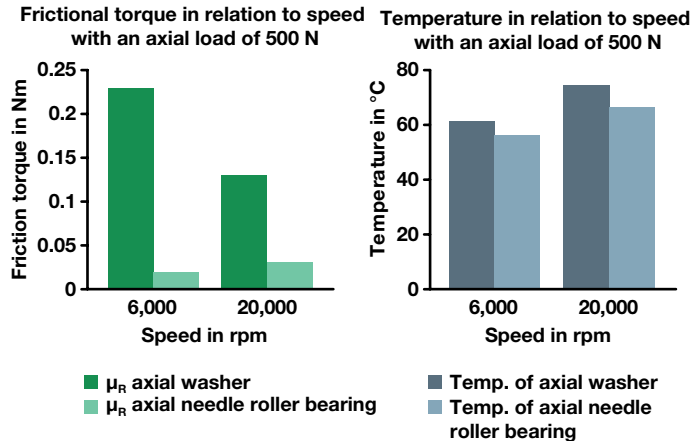
As an alternative to complex and costly tests with planetary gear sets in entire transmissions, Schaeffler has a component test stand that provides the option of investigating the function and operating life of entire planetary gear sets subjected to centrifugal force and specified loads. The moment is variably introduced using two coupled plan-

etary gear sets. Additional influencing parameters of the test setup are the supplied quantity of oil and its temperature for lubricating and cooling the gear set. The measured bearing temperature has proven to be a reliable inspection criterion for monitoring. Temperature sensors measure the temperature directly in the gear set on each planet gear bearing support. This enables conclusions to be drawn about the

functional capability and the behavior of the system during the test. If a sudden increase in temperature is measured, this is a reliable indication of damage to the planet gear bearing support. In most cases, this means that the bearing cage is defective.

This test stand can also be used for comparative tests with planetary gear sets using axial bearings and planetary gear sets using plain washers. For this test setup, the annular gears were preloaded against each other by up to 1,000 Nm and located. The planet carriers were subjected to a drive speed of up to 6,000 rpm. This resulted in a maximum planet gear speed of 20,000 rpm.

The measurement results in Figure 10 show the mean and maximum values of the axial bearing and plain washer temperatures and the corresponding temperature differences. A comparison of the results for an input moment of 100 Nm and at a speed of 6,000 rpm, and for an input moment of 1,000 Nm and at a speed of 2,500 rpm



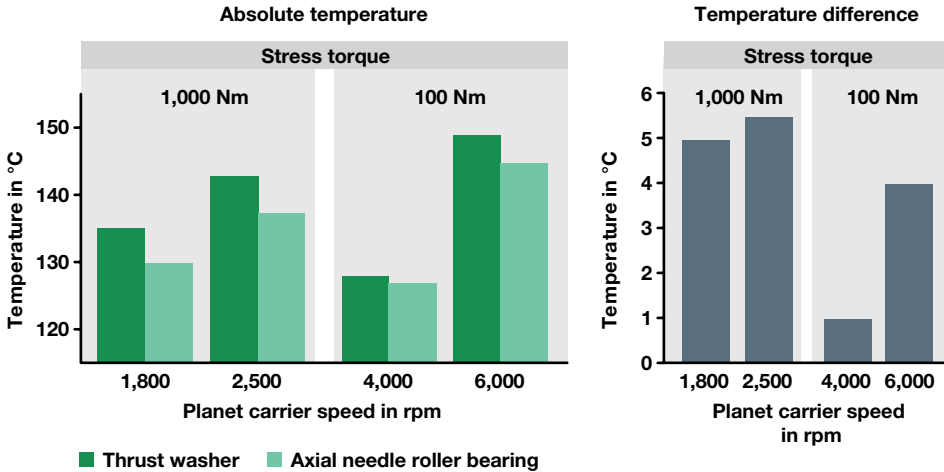
#### Functional tests on the axial bearing high-speed test stand

Axial load, bearing and oil temperature, oil flow rate, frictional torque, speed and operating time can generally be measured.

**Figure 9** Results of the friction and temperature measurements on the axial bearing high-speed test stand

shows significant differences between the two design variants. The mean temperature difference is 1.5 °C in the first case and 3 °C in the second case. The maximum values even show a temperature difference of 4 °C and 5 °C, respectively.

The reduced temperatures and frictional torques determined in the simulation of the entire transmission and in actual component tests of individual bearings (Figure 11) have a significant effect on the system's emission characteristics. For example, the calculated reduction in CO<sub>2</sub> emissions of the entire transmission in the NEDC is around 1 %. Replacing the planet thrust washers in an automatic transmission comprising four planetary gear sets with axial bearings results in a reduction in CO<sub>2</sub> emissions of 1 % with additional costs amounting to less than ten euros.



The planetary gear set system with the axial bearing was tested and compared with the plain washers on this test stand.

For this test setup, the annular gears were preloaded against each other by up to 1,000 Nm and located (speed 0 rpm). The planet carriers reached a drive speed of up to 6,000 rpm.

The temperature is measured on the planet gear stud.

Figure 10 Functional tests on the planetary gear set test stand and results

Investigations	Thrust washer	Axial needle roller bearing	Reduction in friction	Reduction in friction	Reduction in CO <sub>2</sub> emissions
Simulation (3 <sup>rd</sup> gear)	470 watts	50 watts	420 watts	90 %	1 %
Components test (6,000 rpm)	0.23 Nm 62 °C	0.02 Nm 57 °C	0.21 Nm 5 °C	90 %	1 %
Planetary gear set test (6,000 rpm)	150 °C	146 °C	4 °C	-	-



The axial needle roller bearings achieve a reduction in CO<sub>2</sub> emissions of 1 % with additional costs of only 10 euros

Figure 11 Effects on emission characteristics

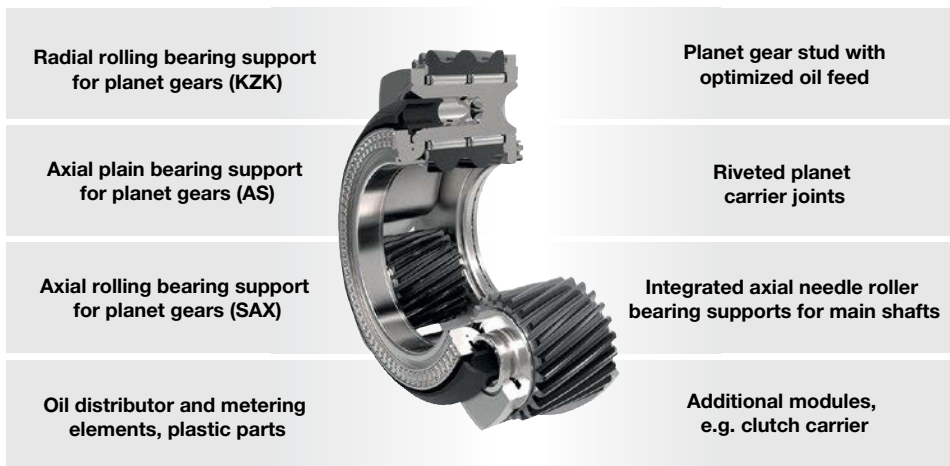
## Modular design in planetary gear sets

Today, Schaeffler offers and supplies a large number of individual components and additional parts for planetary gear sets. Examples are the planet gear bearings that radially position the planet gear, support bearing forces and moments, and ensure rotation with minimal friction. The planet gear stud represents the inner raceway of the planet gear bearing. Schaeffler offers planet gear studs in all oil feed and geometry variants. The axial contact between the planet gear and the planet gear bearing is supported by the plain washers described above or by the newly developed axial needle roller bearings, which are also Schaeffler components. The plastic oil collector and the axial needle roller bearings running on the planetary gear set complement Schaeffler's product range (Figure 12).

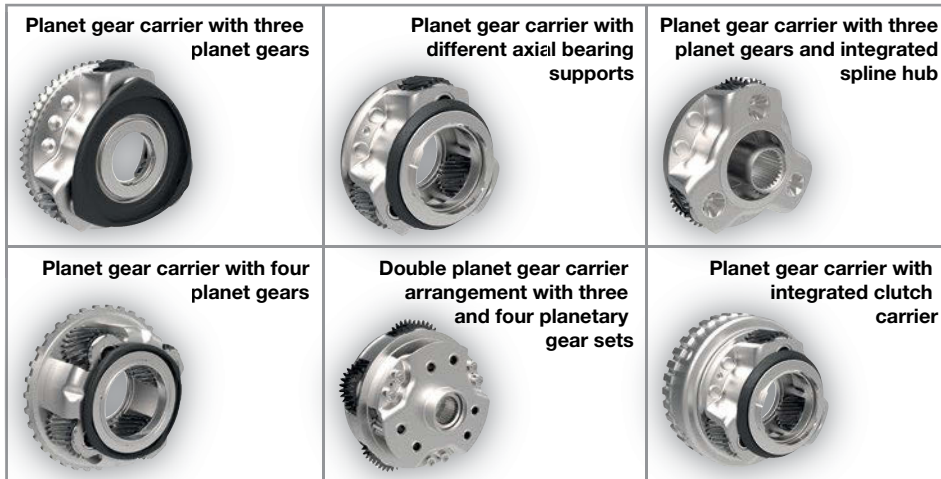
The carrier usually comprises formed parts that are drawn and punched and have gear teeth manufactured by forming methods. Schaeffler uses its core exper-

tise in these manufacturing technologies for a wide range of products, such as planet gear carriers or multi-disk clutch carriers.

Welding is the preferred joining method for manufacturing planet gear carriers. Schaeffler also has extensive experience in riveting technology, which is used for dual mass flywheels, torque converters or annulus carriers, for example. This expertise can also be used for the assembly of planet carriers. The advantages of riveting compared to thermal joining are that no thermal distortion occurs and no welding spatter must be removed due to welding. Schaeffler also develops the gears for planetary gear sets in-house in order to be able to offer comprehensive assemblies. During this development work, Schaeffler has gained a great deal of experience in high-performance planetary gear sets. Schaeffler has therefore been able to position itself as a development partner and supplier for mechanical assemblies or comprehensive solutions for planetary gear sets for manufacturers of entire transmissions.



**Figure 12** Schaeffler components with modular design for planetary gear sets



**Figure 13** Variations in planetary gear set modules

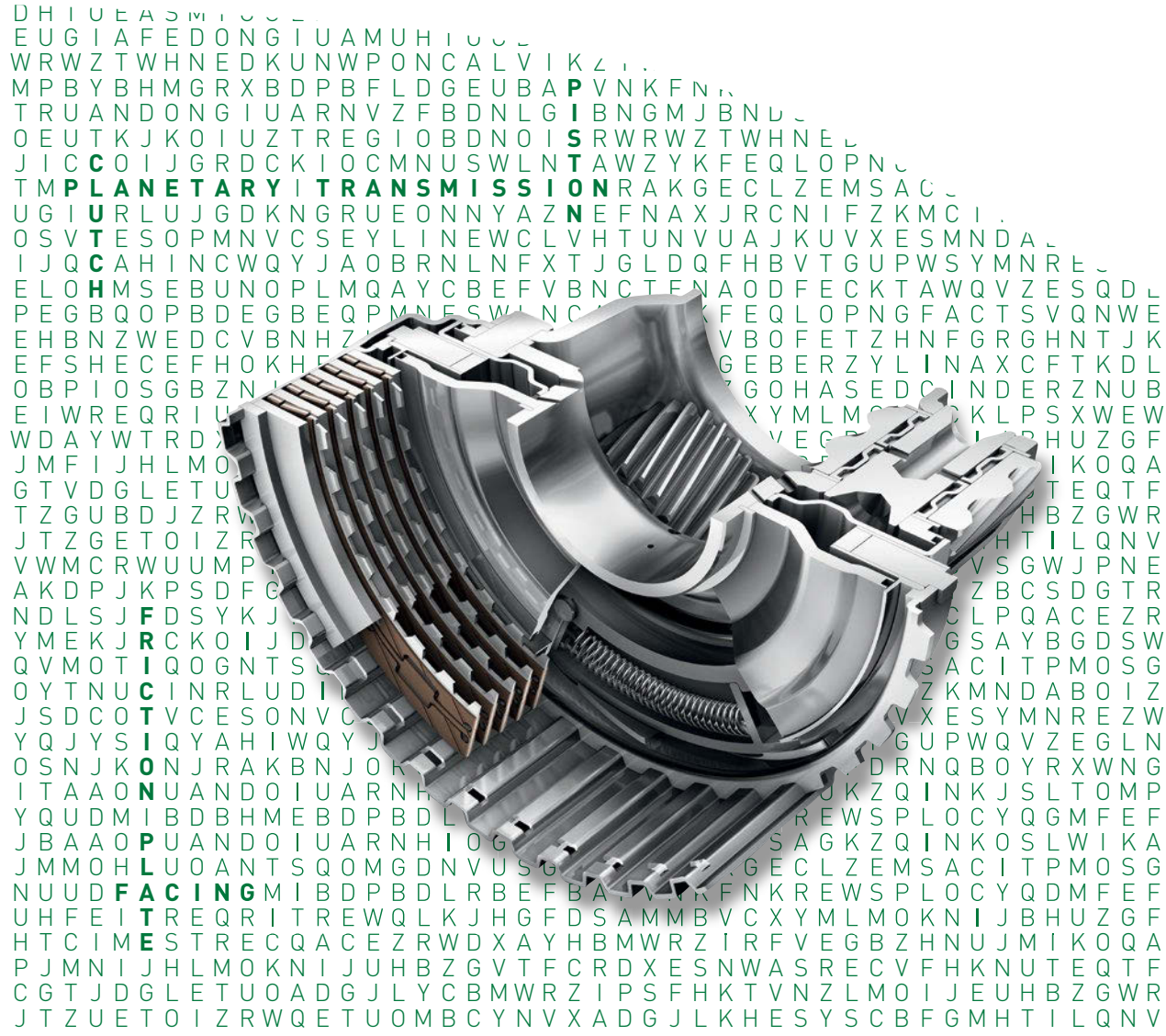
Schaeffler offers modular concepts for planetary gear sets that can easily be integrated into existing transmission designs. The gear sets are characterized by gear teeth (spline teeth, engaging teeth) that are manufactured using forming methods. The planet carrier can be designed and manufactured using welding or riveting technology. Due to lower purchasing costs and shorter cycle times, riveting is particularly suitable if new machinery must be purchased. The entire gear set including additional parts is matched to the specific application in order to achieve the best possible oil lubrication and the lowest possible friction. The planet carriers can be designed with adjacent components such as multi-disk clutch carriers and annulus carriers, or integrated into load stages and differential stages (Figure 13).

Collaboration between Schaeffler's specialists and the transmission manufacturer early on in the concept phase is useful if the modular strategy is to develop its full potential.

## Literature

- [1] Scherer, H.; Wagner, G.; Naunheimer, H.; Dick, A.: Das automatische Getriebe 8HP70 von ZF. Getriebesystem, konstruktiver Aufbau und mechanische Bauteile. VDI reports 2029, Duesseldorf: VDI Verlag 2008
- [2] Greiner, J.; Scherer, H.; Girres, G.; Dick, A.: Transmission Kit for Front-Wheel-Drive Applications from ZF. VDI reports 2130, Duesseldorf: VDI Verlag 2011
- [3] Pabst, A.; Beeck, F.: Increasing the performance of planetary bearings for modern automatic transmissions. VDI reports 2158, Duesseldorf: VDI Verlag 2012
- [4] Koch, O., Weber, J., Zintl, G., Gronau, B.: Energieeffiziente Auslegung von Wälzlagerungen, VDI conference on plain bearing and rolling bearing supports, 2011
- [5] Koch, O., Gao, G.: Energy-efficient design of rolling bearings: An important contribution towards reducing CO<sub>2</sub> emissions and increasing power density in automotive transmissions, CTI Symposium Innovative Automotive Transmissions and Hybrid & Electric Drives, 2012

**Open Access.** This chapter is distributed under the terms of the Creative Commons Attribution Noncommercial License, which permits any noncommercial use, distribution, and reproduction in any medium, provided the original author(s) and source are credited.





# Turning New Directions: Surprising Potentials in Planetary Transmissions

## Part 2: Shifting clutches

Jeff Hemphill  
Philip George  
Vural Ari  
Chris Luipold  
Patrick Lindemann  
Greg Copeland

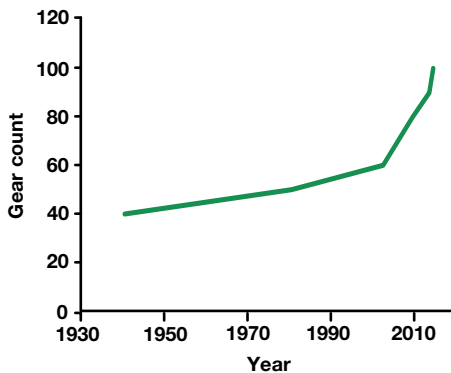
# 19

DW  
 JZMH  
 AGQSWIEN  
 FIMBCHSEHEB  
 CECEBSTPOIODCVFELW  
 DGVTQUJXRELKJHGFDSAMML  
 YLMRTXAGYWPHCQAYWSXEECR  
 CXVNHOUBIJBZGVTFCRDXESNWASRE  
 ZVTFUJADGYCBMWRZIPSFFHKTVNZLMO  
 XDBPORUTETMBCYNVXADGJLKHESYSCBMB  
 DCSKUPOWRWZTWHNEDKUNWPONCALVIKZTWHN  
 DEHKLPLFLKJKOIUZTREWQYXCVBNM IQWUO IUZTR  
 WDXAYHASGSVNP IZRWQSCGZ NJIMNSTRVNPIZRWQS  
 LZUKOGIKCKPMNESWLNCXWZYKFEDIOPPMNESWLNCX  
 RUCZGZMQGODNVUSGRV LGRVKGECEZEMDNVUSGRV LGR  
 QATSLOKZINEXOMNYAZTEWNF XJLRNIFEXOMNYAZTEW  
 CLOMEPSCVCY  
 FAMUANJY  
 KMN SRDO  
 LIEPNN  
 BSATB  
 PIEP  
 RUCZ  
 BSA  
 DGV  
 YLN  
 CX  
 ZV  
 XD  
 DD LRB EFBAFVNK  
 UAH IOGDNOIERNGM  
 OQODNVUSGRV LGRVKG  
 PDBDDL RBEFBAFVNKFNK  
 JOTRELKJHGFDSAMMBV CX  
 XAZYWPHCQAYWSXEECRFV  
 OUBIJBZGVTFCRDXESNWAS  
 UJR DG YCBMWRZIPSFFHKTVN  
 RUTETMBCYNVXADGJLKHES  
 POWRWZTWHNEDKUNWPONCA  
 FLKJKO IUZTREWQYXCVBNM  
 HASESVNP IZRWQSCGZ NJIM  
 GIKCKPMNESWLNCXWZYKFF  
 ASUSVNP IZRWQSCGZ NJI  
 IKCKPMNESWLNCXWZYKF  
 OXODNVUSGRV LGRVKG  
 INEXOMNYAZTEWNF  
 CYLJNEWCLVVFH  
 NVUSGRV LGR  
 CDND

## Drivers for change

The wet friction shifting clutch was developed in the 1930's and has been very successful [1]. Multi-plate wet clutches are used in large volumes not only for shifting automatic transmissions and CVT's, but also as launch devices in some CVT and DCT transmissions. The early development of this technology was so successful that it has met the needs of industry with relatively few changes in basic construction for many years [2].

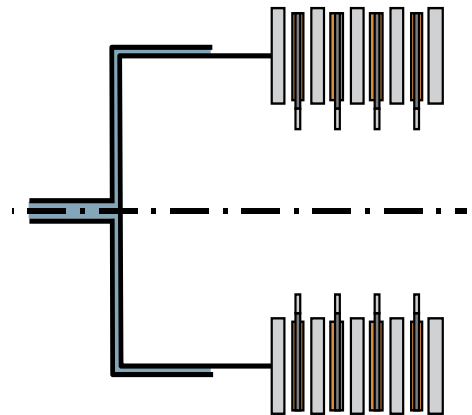
Current trends in the market however, are placing new demands on shifting clutches. The number of speeds in automatic transmissions is increasing dramatically, as shown in Figure 1. The demand for improved shift comfort is likewise stronger than ever. The push for sustainable mobility continues to increase and includes the environmental effects of manufacturing processes. Finally, fuel economy standards are rising steeply around the world, making drag torque and mass reduction ever bigger problems.



**Figure 1** Increasing number of speeds in planetary automatic transmissions over time

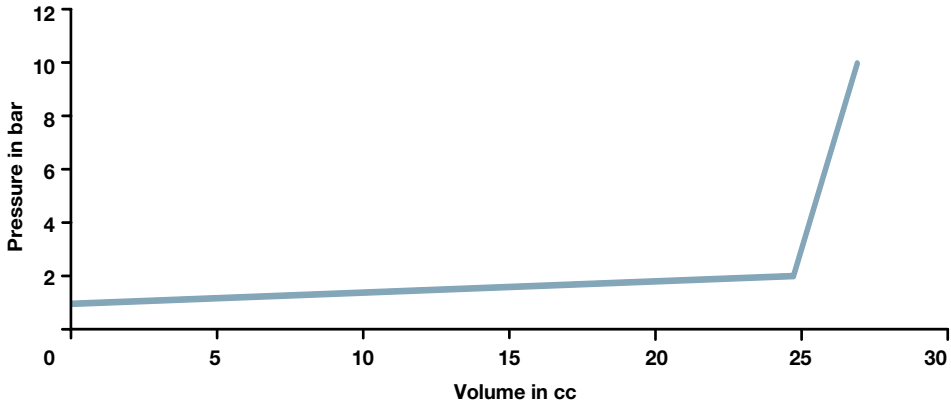
## Controllability and drag

Multi-plate wet friction clutches are subject to a paradox: Low lift-off gaps improve controllability while large lift-off gaps help reduce drag torque. The controllability is influenced by the two-stage nature of the pack characteristic. That is, the piston must first close the lift-off gap against little significant resistance and then clamp the pack to provide torque capacity. A typical clutch pack schematic can be seen in Figure 2.



**Figure 2** Schematic representation of a clutch pack

Since the axial movement of the piston to close the gap is 1-3 mm while the compression of the pack is 0.1-0.3 mm, the bulk of the oil volume used to actuate the piston is dedicated to closing the lift-off gap. However, the piston area has to be sufficient to allow it to generate enough clamping force to provide the needed torque. This means that it is normally a slow process to close the gap. Furthermore, the transmission controller has no way of knowing when the gap is closed.



**Figure 3** Pressure vs. volume for a typical shifting clutch

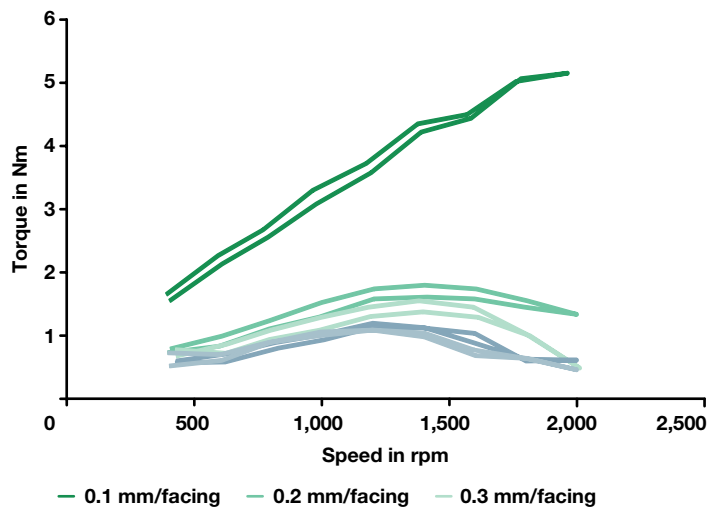
This can lead to torque errors if the controller doesn't guess accurately. A pressure vs. volume characteristic is shown in Figure 3.

The usual solution to this problem is a pre-fill strategy. The controller keeps a look-up table of time to touch point for given temperatures and furnishes a very high flow to close the gap. When its time estimate is reached, the flow is reduced and torque control takes over. If there is a torque error, the controller can adapt the time in the table. This method works but gives rise to several errors.

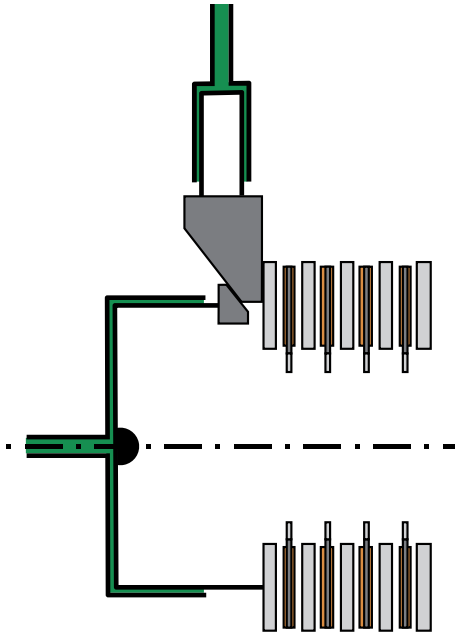
The drag is improved by a larger lift-off gap, since it is largely viscous drag and the shear forces in the oil are smaller in larger gaps. A measurement of a clutch pack with various lift-off gaps is

shown in figure 4. It is also important to keep in mind that each clutch has a different tolerance situation. Therefore, the nominal drag may be acceptable but the maximum drag can be significantly higher.

Another factor which can raise clutch drag is plates sticking together, even though there is a lift-off gap. This can happen because the oil between the friction material and the steel plate forms a



**Figure 4** Multi-plate clutch drag for various lift-off gaps



**Figure 5** Two-stage clutch apply mechanism

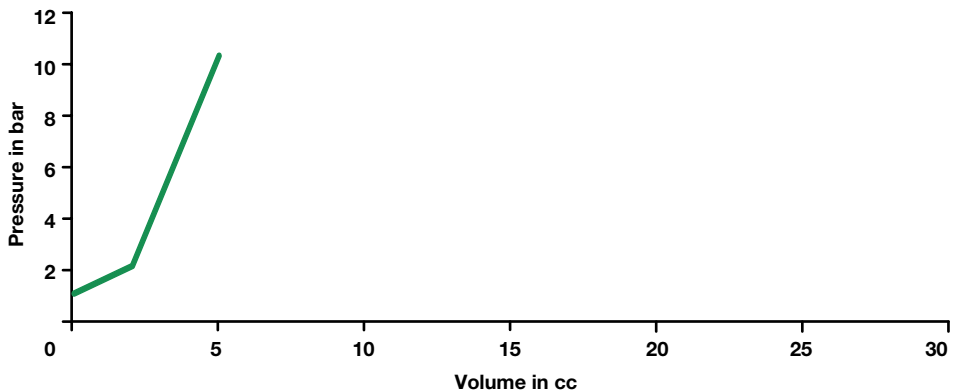
seal which allows atmospheric air pressure to hold the plates together.

Given these physics a new approach is needed. Since we recognize that the

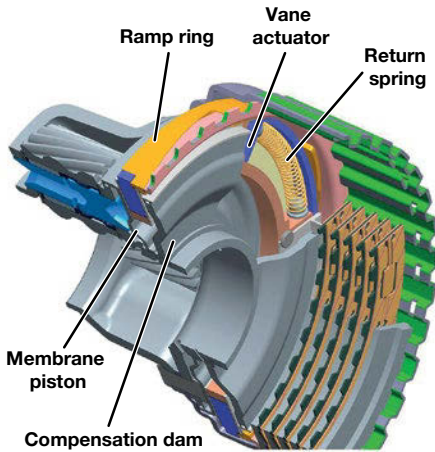
friction pack offers a two-stage characteristic, a two stage mechanism could be used to break the paradox. A schematic of such a mechanism is shown in Figure 5. In this principle sketch, a ramp and crank mechanism are introduced between the piston and the clutch pack. This mechanism is actuated by the main piston and, due to the high ratio of the crank, fills the gap with very little piston travel. This means that a larger lift-off gap can be closed quickly and with little oil demand, avoiding a pre-fill strategy. Furthermore, when the clutch reaches the touch point, very little torque is exerted due to the high ratio of the mechanism. This minimizes torque errors. The pressure over volume curve for a clutch with this mechanism is shown in Figure 6.

The design for a mechanism which can meet these functional requirements is shown in Figure 7.

This mechanism functions as follows: High pressure oil enters the area behind the main piston. The oil enters the rotary actuator through several holes in the main piston. The oil pressure rotates the actuator, which, in turn, rotates the ramp ring. As the ring moves down the ramps, it closes the gap to the friction plates. Once



**Figure 6** Pressure vs volume characteristic for a clutch with a two-stage mechanism



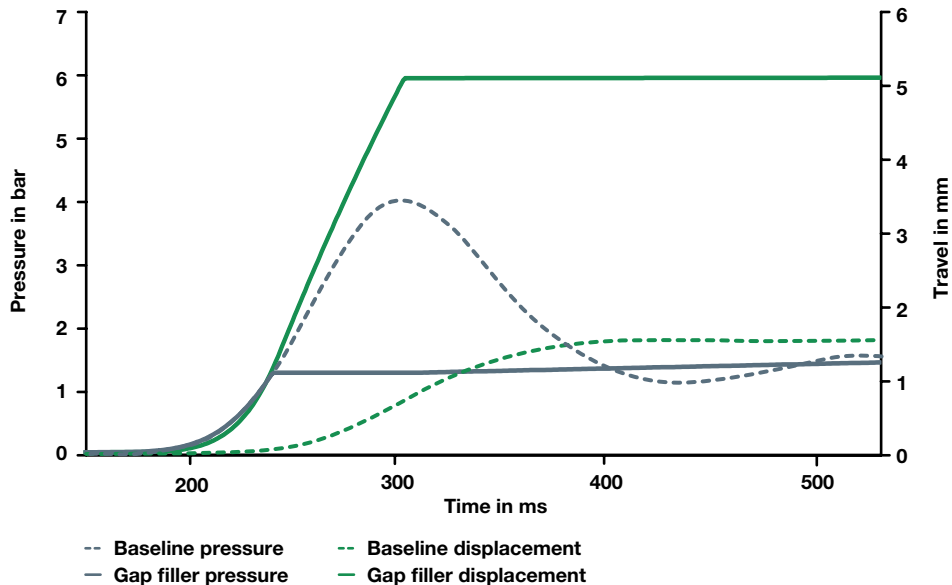
**Figure 7** Cross-section of two-stage piston

the ramp ring hits the friction plates, it stops. As oil pressure continues to increase, the main piston now begins to advance. Since the only travel that the main piston needs to make is to compress the

clutch pack, it is designed as a membrane piston. This allows the piston to accomplish the roughly 0.3 mm displacement and also allows it to act as its own return spring. The clamping action of the main piston is applied through the rotary actuator. This clamps the actuator closed and provides two additional benefits: The actuator is sealed and the ramp ring is clamped in place, preventing any unwanted adjustment. Figure 8 shows a simulation of this type of clutch versus a normal clutch. Here we can see a faster engagement time, smaller torque error, and a larger lift-off gap.

This leads to the following concrete advantages:

- Allows lift-off gaps of 3 mm or more without shift time penalty.
- Reduces drag torque by allowing such lift-off.
- Reduces oil flow required for clutch actuation, potentially allowing a smaller transmission pump.

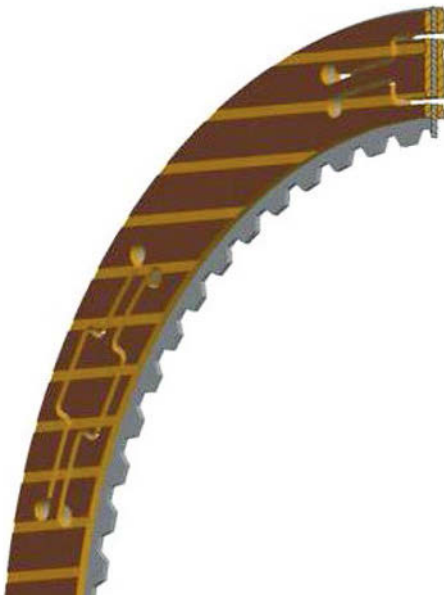


**Figure 8** Simulation results of two-stage mechanism vs normal mechanism

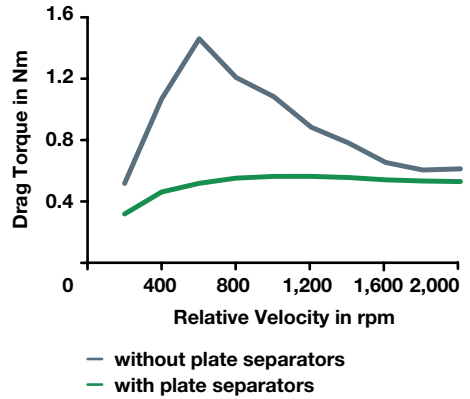
- Improves controllability by reducing torque error when reaching the touch point.
- Eliminates the need for tolerance correction in clutch pack assembly.

## Friction plate with a built-in separator feature

Now that we have shown a mechanism which can open a larger lift-off gap without penalty, we need to assure that we separate the friction disks in this gap. Over the years, several things have been tried to accomplish this including separator springs, hydrodynamic forces, etc. These concepts usually suffer from tolerance problems and often can space either the friction plates or steel plates but not



**Figure 9** Friction plates with separator feature



**Figure 10** Drag torque measurement with and without plate separators (SAE#2 plates, 0.7lpm, 60C)

the one from the other, which is the important interface.

Figure 9 shows a friction plate with a built-in separator feature. In this design, tabs have been formed in the plate itself and slightly twisted so that the edges of the tabs protrude above the friction material by the amount of the desired lift-off gap. Since these tabs only have line contact with the separator plate, the surface area for viscous drag is dramatically reduced. This cannot be accomplished with other methods, such as “waving” the friction plates. The thin arms on the tab act as torsion springs, allowing the tab to be compressed back in line with the friction material during engagement.

A measurement of a friction pack with and without the plate separators is shown in Figure 10. Here a reduction in drag torque of more than 60 % can be seen. It should be noted that this concept also has a significant tolerance stack-up. However, when using it with the gap filling piston, the additional tolerances do not present a penalty.

## Friction Disk Production

The concepts reviewed so far have enabled better performance of a clutch pack in operation. Now we turn our attention to improving the manufacturing process. Friction plates today are made by stamping a steel ring, acid etching the ring, applying adhesive, placing friction paper on the adhesive, clamping between hot, parallel plates, and cutting oil flow grooves if required. This process has several disadvantages:

- Environmentally harmful, and therefore, difficult to dispose of chemicals are used for cleaning the parts and as adhesive.
- The process can be difficult to control especially since friction performance is influenced by the amount the paper is cured during bonding. This means the adhesive and paper must both be cured to the right level in one process.
- Multiple process steps are required to reach the end result.

An improvement can be made by eliminating the adhesive and using a mechanical connection between the paper and the steel. An example of such a construction is shown in Figure 11.

In this design, two thin steel plates are pressed into a paper ring from either side. The steel plates meet at the teeth around the inside diameter and at a series of holes in the middle of the paper ring. At each hole, the steel plates are joined by a coining operation similar to riveting. The resulting pressed grooves provide a mechanical means for transmitting torque from the spline teeth to the paper. They also provide a means for allowing cooling oil to flow.

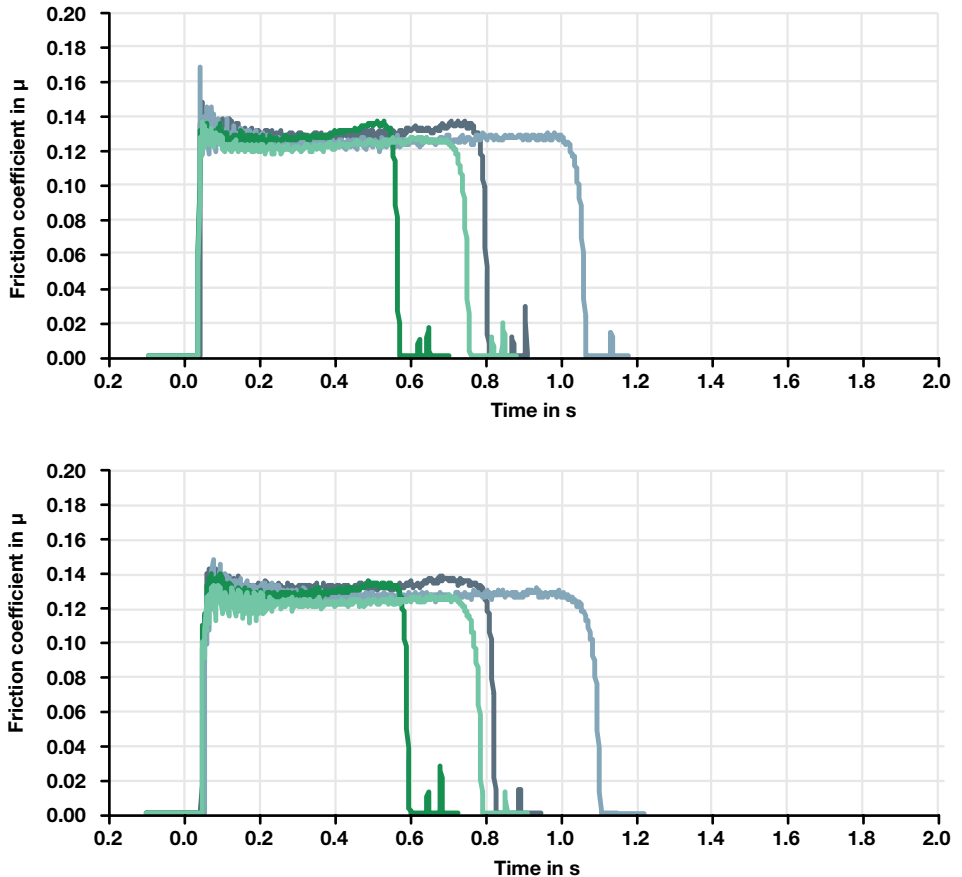
This design eliminates most of the issues with current production methods.



**Figure 11** Composite friction Disk construction

There is no need for adhesive and, therefore, no need for acid to prepare the steel for it. It is much easier to control since only paper curing is involved. It can be a one step process wherein the steel is compressed into the paper, the coining is accomplished, and the paper gets a final cure and flattening. This process can also be much faster than a bonding process since the time required for the adhesive to flow and cure is eliminated.

Further advantages include reduction in mass and inertia of the friction plate. This can result in a savings of 0.5 kg in a typical automatic transmission. The method can be used with various friction papers, allowing the same range of friction performance as with bonded plates. In some cases, even better performance can be achieved since the paper is roughly 3 times thicker than in a bonded design. This allows a softer stiffness which is more forgiving to the additives in the oil.



**Figure 12** Comparison of friction behavior between composite facing (top graph) and bonded facing (110C, 2,700/3,500rpm, SAE J2490 test profile)

Figure 12 shows a comparison of friction performance between a composite facing and a bonded facing with the same paper and the same total paper thickness. As expected, there is virtually no change in friction behavior. Tests are underway to quantify the advantage of the composite facing compared to typical thickness bonded friction plates. Various groove patterns are possible. In fact, the resulting groove geometry is similar to a pad design, without the intensive processing which is normally needed for that con-

struction. Finally, the design also lends itself to the plate spacers described in the previous section.

## Conclusion

The demands on shifting clutches are increasing with the new generation of automatic transmissions and increasing con-



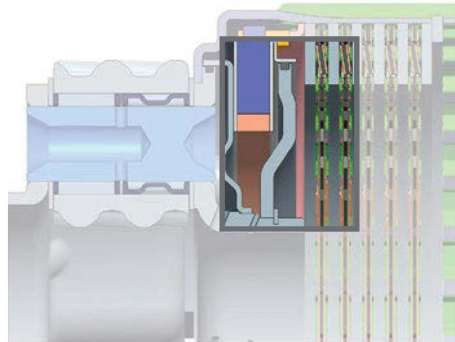
sumer demands. These new requirements can be met by breaking some of the old paradigms of clutch design:

- Creating a two-stage apply characteristic allows better controllability with larger lift-off gaps.
- Plate separators maximize the advantage of this larger gap.
- Eliminating adhesive provides an environmentally friendly production method while decreasing mass and inertia.

Together, these lead to some notable improvements on the vehicle level, such as:

- fuel economy improvement of 1-2 %
- mass reduction of 0.5 kg
- reduced space requirement (see Figure 13)
- shift time improvement of up to 100 ms with reduction in shift shock complaints

These advantages are useful not only in planetary automatic transmissions, but also in CVT and DCT transmissions, which use multiple-plate wet clutches. Even in an 80 year old technology, new ideas can provide new functions and continue to meet the growing demands for fuel efficient mobility.



**Figure 13** Improved shifting clutch piston assembly compared to conventional piston assembly (red outline)

## Literature

---

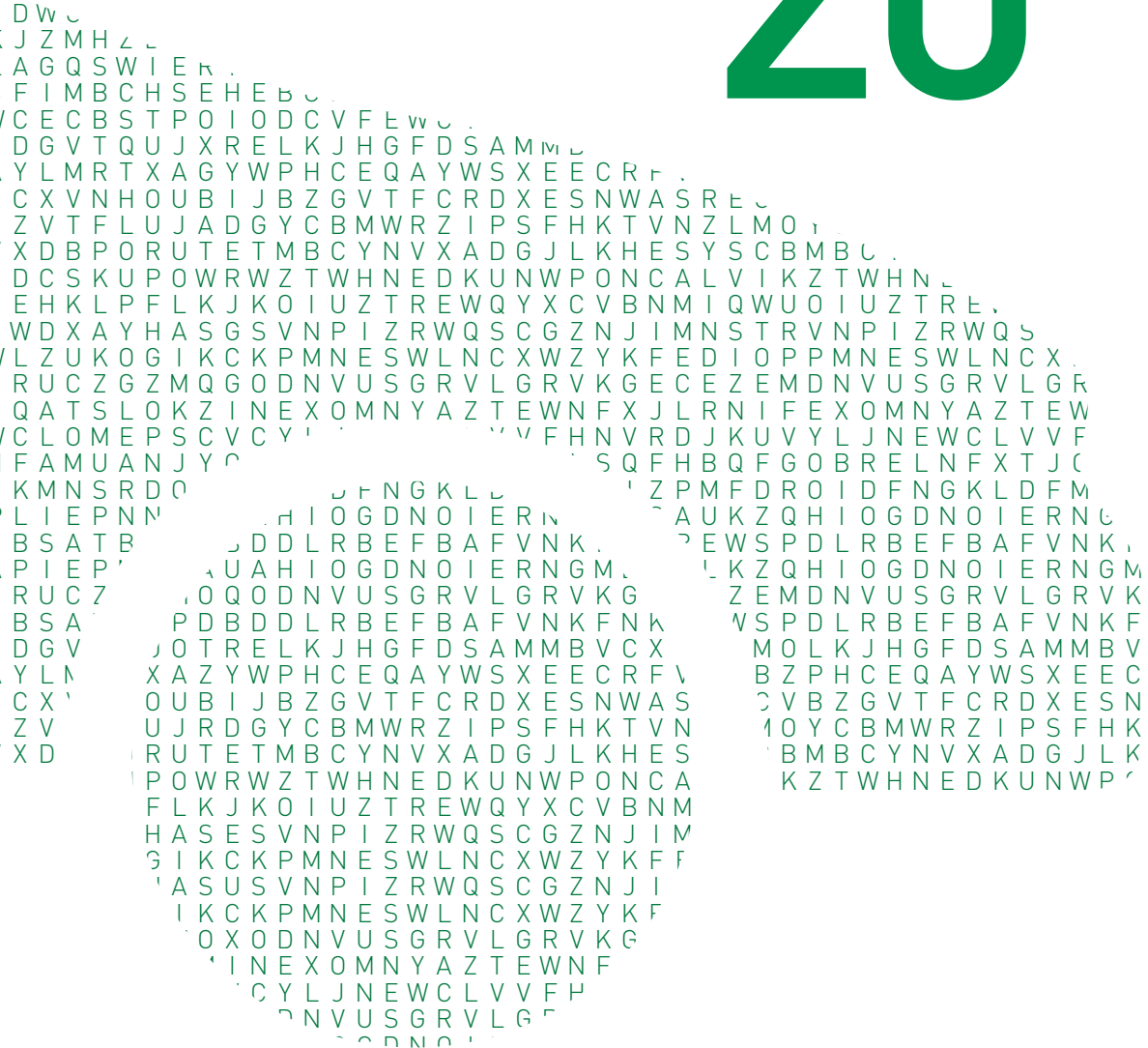
- [1] Gott, P.: Changing Gears – The Development of the Automatic Transmission, SAE International, 1991
- [2] SAE Transmission/Axle/Driveline Forum Committee: Design Practices: Automatic Transmissions, 1994



# iTC – Innovative Solutions for Torque Converters Pave the Way into the Future

Patrick Lindemann  
Markus Steinberger  
Thorsten Krause

# 20



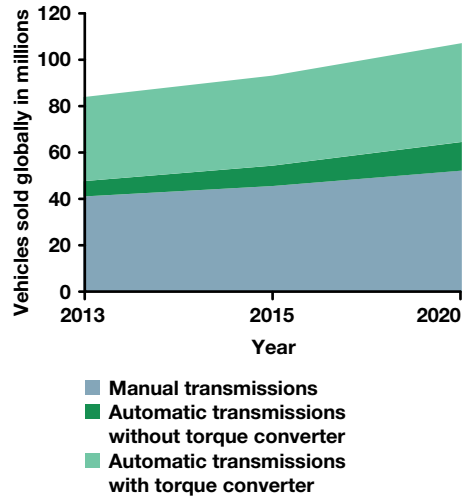
## Preface

The torque converter has been a stable choice as a launch device for automatic transmissions for several decades. Global vehicle production in 2013 is estimated to be 83 million, with 43 % of the vehicles are being equipped with a torque converter [1]. In particular, the North American and the Asian market show a high ratio of torque converters in new vehicles [2]. Additionally, the European market is experiencing a trend away from manual transmissions as some vehicles – especially in the luxury and higher torque segment – are offered only with planetary automatic transmissions and a torque converter.

The choice of transmission type is largely driven by its impact on the powertrain efficiency and comfort. With stricter regulation on CO<sub>2</sub> emissions and the prospect of further tightening of emission regulation, the automotive industry has made designing for fuel efficiency a core goal, resulting in drag reduction, more defined combustion processes and increased electrification. Despite electrification, internal combustion engines are a core element of powertrain strategies and their optimization will drive improvements in the drivetrain.

Supercharging of downsized engines is a primary path to achieving the required efficiency improvements [8]. This technology has been used in motorsport applications for some time. However, the more widespread application of turbochargers in gasoline engines required additional developments such as direct injection, availability of durable turbochargers from TDI engines, and increased development pressure through the reduction of CO<sub>2</sub> targets.

The increased specific power and torque compared to a naturally aspirated



**Figure 1** Global vehicle production [1]

engine allows the most often used driving conditions to be shifted to lower engine speeds. The reduced rotational speed minimizes losses caused by friction and improves the combustion efficiency.

With the improvements in engine technology, the driver does not have to accept a loss in performance for an increase in fuel efficiency. On the powertrain side however, the engine improvements change the boundary conditions for durability and comfort. The reduced number of cylinders, together with downspeeding and increased torque per cylinder leads to higher torsional vibrations. As a result, measures have to be taken to increase the durability of the drivetrain. The impact on comfort in the form of seat vibration, boom and rattle noise can be even greater and has to be met with highly capable damper technology. Finally, the use of a turbocharger can introduce a degradation of launch performance as a result of the turbo lag. In particular, small gasoline engines with 3 or 4 cylinders do not reach the peak torque until mid-operating speed.

In this environment, the drivetrain requires an element that is able to reduce

torsional vibrations, provide the desired launch performance and achieve this with a minimum of added inertia and axial space. For automatic transmissions, the torque converter is the launch device of choice (Figure 1). Despite development in areas such as double clutch or automated manual transmissions, the majority of automatic and continuously variable transmissions are equipped with torque converters. This success of the torque converter raises the question of its origin and development potential for the future.

## History of the torque converter

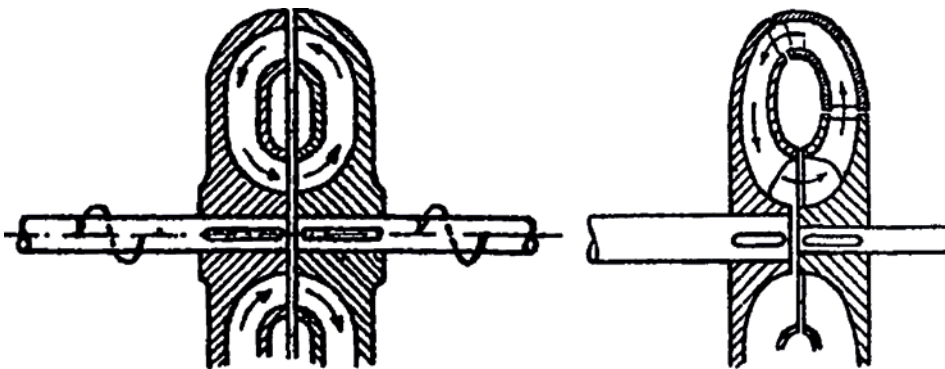
Torque converters were not the initial choice for a launch device. Early transmissions used friction clutches that were shifted manually or by means of centrifugal acceleration. With the advent of automatic transmissions and more refined passenger vehicles, the comfort and controllability aspect received more weight.

This led to the first mass production use of a fluid coupling in 1940 by GM.

### Torque converters and fluid couplings in ships

The history of torque converters and fluid couplings did not start in the automotive industry where they would later reach a production volume of millions of pieces per year. Instead, it started in the maritime industry. Hermann Föttinger designed a converter and a fluid coupling in 1905 (Figure 2) – which both have their specific advantages and disadvantages. The fluid coupling has a higher efficiency when the turbine speed is close to the impeller speed and the converter is able to provide a torque ratio to increase the output torque, which can be considered as an additional gear. After the initial patent, Föttinger also created several variations of his design that allowed him to change the torque transmission characteristic manually [4].

At this point, neither the converter nor the fluid coupling were envisaged as a launch device but changed the ship's propeller torque or decoupled the propeller



**Figure 2** Hermann Föttinger's design for a fluid coupling (left) and a converter (right) [5], [6]

from the drive shaft to prevent the propagation of a torque spike.

The first mention of a fluid coupling for passenger vehicles was made by Hermann Rieseler in 1925 [3]. The device consisted of a multitude of turbines and impellers. It remained an idea and did not reach the production phase because of its complexity.

### Improved torque converter controls

A simplification of the torque converter design was achieved in 1928 when H. Kluge, K. von Sanden and W. Spannhake (TRILOK Group) combined Föttinger's designs into a subassembly. It was the first time that the converter's stator was mounted on a one way clutch. This allowed the resulting design to provide the torque ratio of a converter and the high speed ratio efficiency of a fluid coupling. There was no need for additional controls to switch from

torque converter to coupling. The fluid's angle of attack relative to the stator blades provides the signal for the stator to spin freely and turn the hydrodynamic circuit into a coupling.

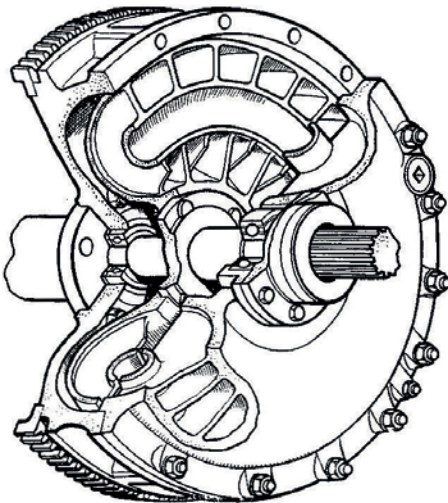
Even after the breakthrough of the TRILOK design, torque converters were not widely used in passenger vehicles. The first attempt to use a hydrodynamic clutch in a car was made in 1933 by the British Daimler Company Limited, which used a fluid flywheel in conjunction with a synchronized gearbox to avoid shift shocks.

### Mass production torque converter

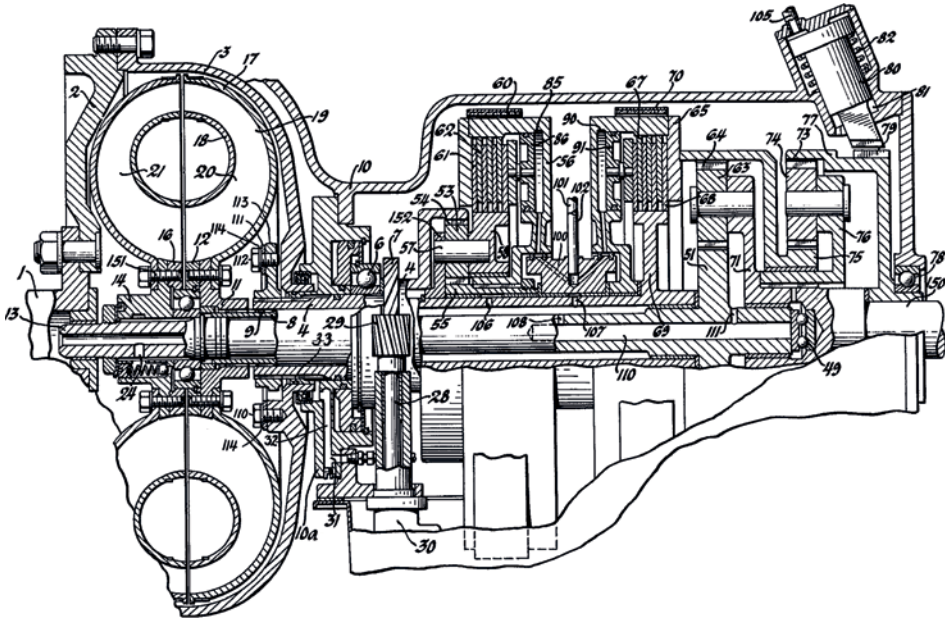
Although the use of a torque converter in automobiles was suggested in 1928, mass production did not start until 1940. The designs combined a torque converter with the planetary automatic transmission and the fluid coupling was seen as an integral part of the transmission. The first mass production torque converter was introduced in the Oldsmobile Hydramatic as a safety, comfort and performance device. Since there was no shift lever and no clutch pedal, the driver had less interfaces with the car and could pay more attention to steering and braking. Comfort and performance are addressed by superior launch performance, reduced vibrations and improved shift quality.

Oldsmobile sold 10 million Hydramatic units [1], establishing planetary automatic transmissions with a fluid coupling in the automotive industry.

Following the stepwise introduction of features to the torque converter, the Packard Ultramatic introduced a lockup clutch in 1949. The so-called 'Direct Drive' hard locked the torque converter at high speeds and gave this transmission the fuel efficiency of a manual transmission.



**Figure 3** Daimler Company's fluid flywheel from 1928 [9]



**Figure 4** Oldsmobile Hydra-Matic with first large-scale production fluid coupling [2]

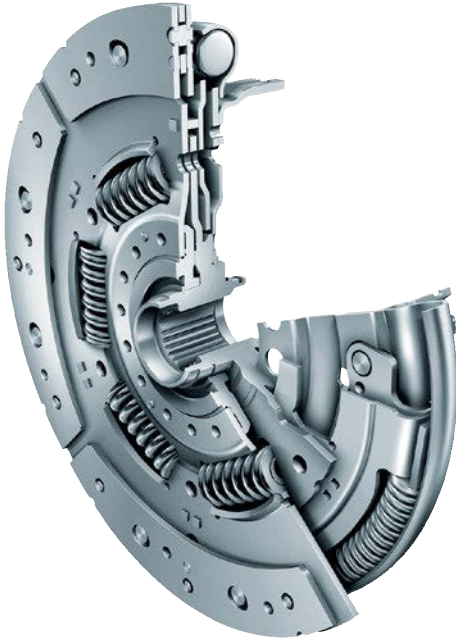
The introduction of the lockup clutch did not lead to immediate widespread adoption. Until the emphasis of efficiency that followed the oil crises in the 70's, the losses in an unlocked torque converter did not warrant the additional components and controls of a lockup clutch.

### Torque converter dampers

A torque converter advantage that has not been mentioned so far is that the hydrodynamic circuit does not transmit the engine vibrations to the transmission. This allows the engine to run at speeds which would otherwise lead to excessive drivetrain vibrations. The undoubtedly beneficial introduction of a lockup clutch exposes the transmission to the previously avoided torsional vibrations. Therefore, the widespread adoption of lockup clutches in the

1980s also required devices to control vibrations in the drivetrain. This led to the advent of torque converter dampers.

The first torque converter damper was built by LuK in 1983 for use in the Ford AOD torque converter. With the damper, the engine torsional vibrations were attenuated to increase the driving conditions in which the lockup clutch can be fully locked. Initially, the lockup clutch was only engaged during cruising but with increasing demand for fuel efficiency, the duty cycle of the lockup clutch increased. This required increasingly complex dampers. The turbine damper that was introduced by LuK in 1994 did not only use springs to prevent the propagation of torsional vibrations along the drivetrain. This damper locked the turbine mass that used to be on the input shaft after the damper to the engine side side, thus eliminating a vibration mode.



**Figure 5** LuK torque converter damper with centrifugal pendulum absorber

Reaching a limit for spring volume and available inertia, torque converter dampers had to be based on a different principle to reduce the torsional vibrations of modern engines. As described above, improvements in engine efficiency directly lead to the demand for improved dampers.

Serving this demand, LuK introduced a torque converter damper in 2010 that used the centrifugal pendulum absorber principle. This allowed the lockup clutch to be engaged at engine speeds down to 1,000 rpm, covering the majority of typical driving, further improving the powertrain's efficiency.

## Drivers for torque converter development

---

Following their long history, torque converters are an indispensable component of modern automatic transmissions. Their evolution leads to permanent adaptations and the current generation can be best understood with the guiding principle of value enhanced design. Current LuK torque converters are developed with the focus on the areas of performance increase, space reduction, cost reduction and higher efficiency.

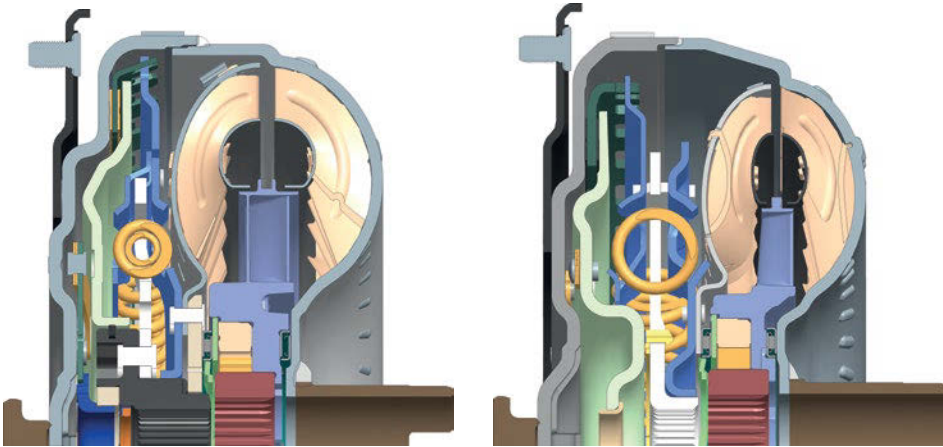
Using the value enhanced design philosophy, components and subassemblies are strictly designed to meet the performance, space and cost targets. Supporting this goal, a modular design approach is used. This allows the torque converter to be customized to meet different objectives with a maximum focus on cost.

Performance improvements target the drivetrain efficiency and are achieved through reduction of the torque converter's weight and inertia, improved damper performance and improved efficiency of the hydrodynamic circuit.

Measures can be introduced gradually, such as stress optimization to reduce sheet metal thickness or directional design changes such as component replacements. A comparison between a torque converter design from 2005 and its successor from 2013 shows that the weight was reduced by 2.1 kg while the maximum torque converter efficiency remained stable at 90 % and the damper windup increased by 31 %.

The axial length of the torque converter more so than its radial size is a key element of the power train's size. Crash test and aerodynamic requirements limit





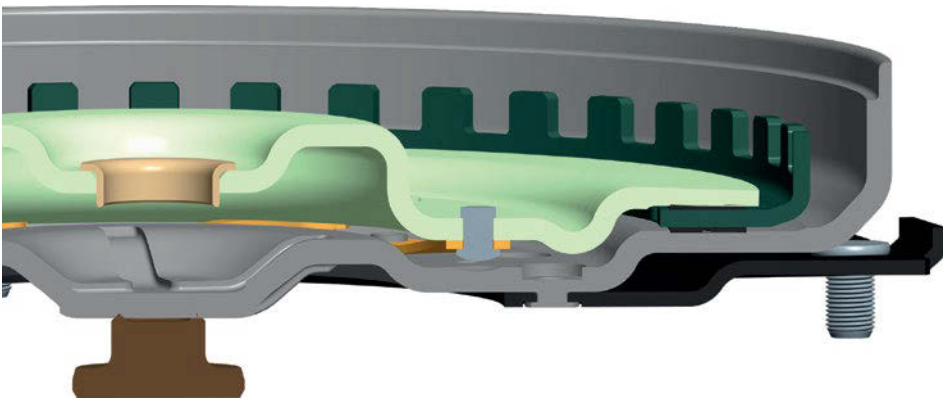
**Figure 6** Torque converter designs from 2005 (left) and 2013 (right)

the available space and are therefore directly opposed to requirements for increased damper performance. In the example above, the axial distance between the stud plane and the torus was reduced by 2.9 mm while the damper windup was increased. These improvements were mainly achieved by reducing the torus width and improving the piston attachment method.

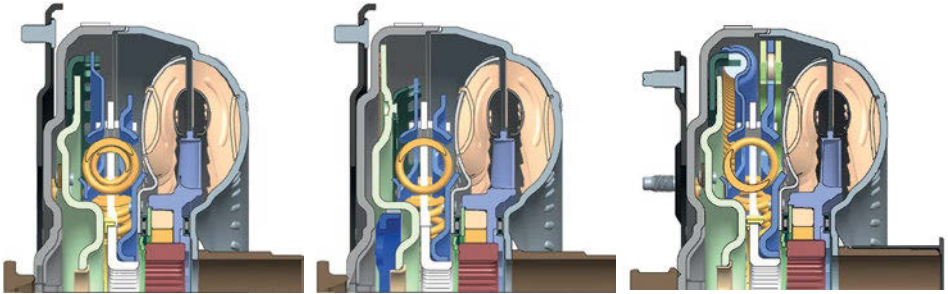
Typical piston attachments for clutches with 2 friction surfaces require a rivet

connection outside the piston area. In the 2005 design, this attachment is between the cover and the piston drive plate. For the value enhanced design of 2013 a Schaeffler riveting connection was developed. It establishes a direct leaf spring connection from the cover to the piston without the need for a piston drive plate.

For the Schaeffler riveting process, the leaf springs are attached to the cover assembly. The domed rivets for the leaf



**Figure 7** Schaeffler riveting at piston connection



**Figure 8** Modularity of the value enhanced torque converter designs from 2013

spring-piston connection are already in place – in a pattern that matches the piston holes. During the piston assembly, the piston is placed on the rivets and the riveting tool pushes it towards the cover until the domed rivet heads make contact with the cover. At this point the rivet head can be formed, establishing a permanent connection between the leaf springs and the piston. The connection was developed so as not to overstrain the piston and to avoid contact between the domed rivet head and the cover in the application.

By eliminating the inner drive plate, the piston could move closer towards the cover, creating more space for the damper.

Reduction of the torque converter cost is a perpetual goal. With the value enhanced philosophy, methods for minimizing the cost were modularization and a reduction in the number of components.

In the 2013 design, the number of components were reduced using the Schaeffler Riveting process piston riveting and redesign of the input shaft interface. The 2005 design uses a riveted hub to connect the damper flange with the transmission input shaft. For the 2013 value enhanced design, a flange was developed that integrates the connection to the input shaft. With the spline formed from the flange, the space requirements were also reduced, leaving more space to optimize the remaining components.

Efforts to focus more on modularity in the development resulted in reduced flexibility and consequently in the increased importance of NVH and durability simulations. It had to be ensured that torque converters would meet customer requirements even with the limited possibility of modifications. The resulting designs are shown in Figure 8. They make it possible to choose between different clutch capacity and gain, damper performance and engine/transmission interfaces while retaining a large number of common components.

Following the goal of improving powertrain efficiency to reduce CO<sub>2</sub> emissions, torque converters are designed to support efficient driving conditions as well as increase the efficiency of the torque converter hydrodynamic circuit or torus.

Between the value enhanced design and its predecessor, the peak torus efficiency was unchanged despite the width reduction and the corresponding weight reduction. This was achieved by improvements in blade design and production methods which allowed the blades to better guide the torus flow.

However, a more significant impact on efficiency is achieved with the damper technology. Increased damper space through the elimination of components in the flange and piston connections permits the use of larger springs. Furthermore, ad-

vanced damper technology such as centrifugal pendulum absorbers is used to improve the damper function beyond the ability of a coil spring damper in the same envelope. This allows efficiency improvements on a system level as the lockup clutch can be fully locked at lower speeds without compromising NVH.

## Centrifugal pendulum absorber for torque converters

The main driver for advanced damper designs is the challenge of meeting CO<sub>2</sub> emission requirements that are placed on modern combustion engines while maintaining or even improving NVH performance. The trend points towards smaller supercharged or turbocharged engines with fewer cylinders. In order to make the low speed range accessible to the driver, the torque at low rotational speed is increased. From simple physics it can be concluded that the reduction of both the number of cylinders and the

drivable rotational speeds result in lower excitation frequencies. This leads to a considerable increase in the engine's cyclic irregularity and torsional vibrations (Figure 9) thus driving the development of damper technology.

The possibilities offered by the new generation of engines require suitable automatic transmissions and drivetrains.

Transmissions must be adapted in line with improvements to engines in order to fully utilize the potential for reducing CO<sub>2</sub> emissions. The shift and lockup speeds are reduced to a level that was previously impossible because the available torque was not sufficient in older engines. The aim is to drive at 1,000 rpm and below, not only in the fuel consumption cycle at part load, but also at full load, while reducing the lockup clutch slip as much as possible.

### Torsional vibration damper with centrifugal pendulum absorber

Even with increased installation space for conventional torsional dampers, the isolation of vibrations is often insufficient for modern downsized turbocharged engines. To achieve further improvements in torsional isolation, a speed adaptive ab-

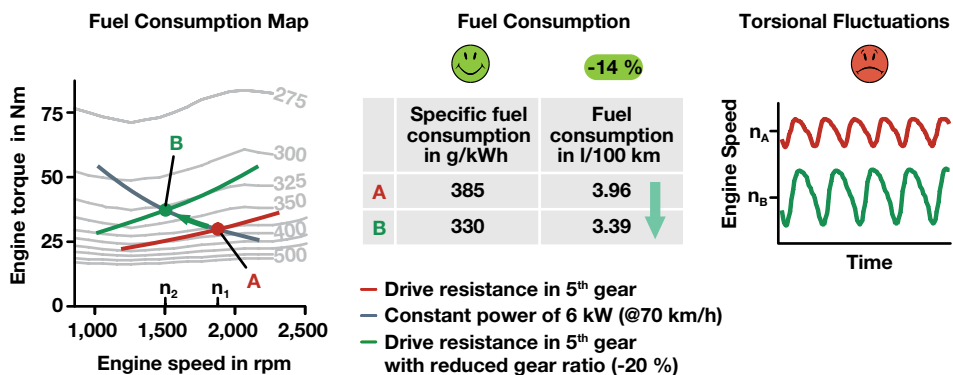
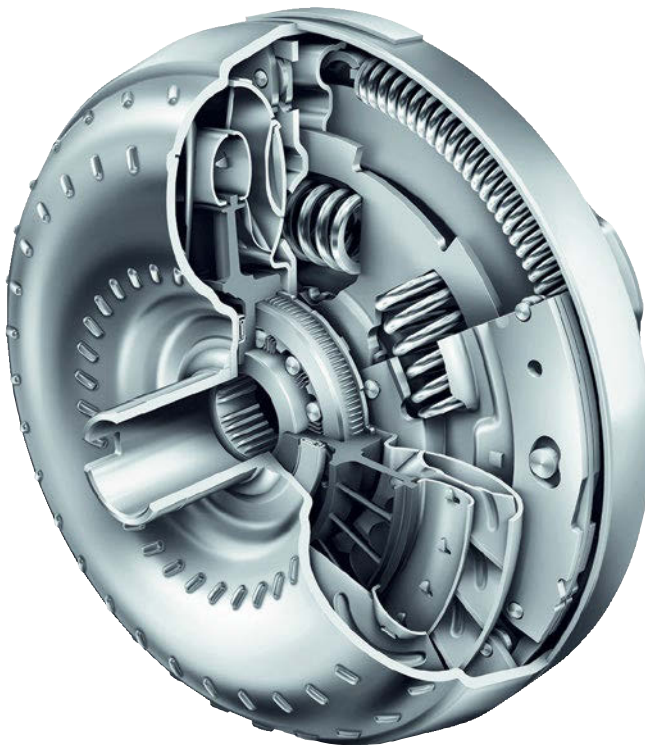


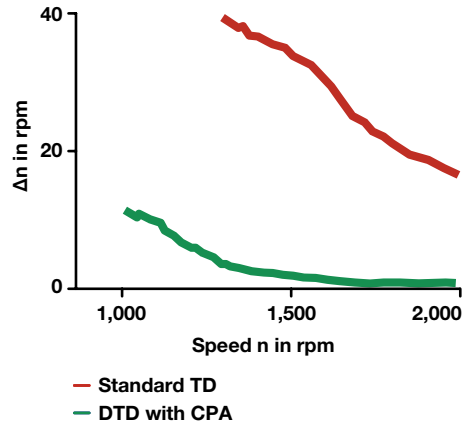
Figure 9 Development trend for downspeeding: drive at low speed for low fuel consumption

sorber is added to the secondary side of a torsional damper. A speed adaptive absorber changes its absorbing frequency directly proportional to engine speed. The centrifugal pendulum absorber (CPA) incorporates this function and thus can absorb the engine's main firing order optimally.

In practice, a bifilar CPA with two suspension points is used to guide the pendulum mass. It follows a path that can be described as having the pendulum mass suspended by hinged parallel connectors. Each point of the CPA follows the same trajectory and it can be approximated sufficiently as a mathematical pendulum. The CPA movement is guided by rollers which roll on tracks defined by kidney shaped



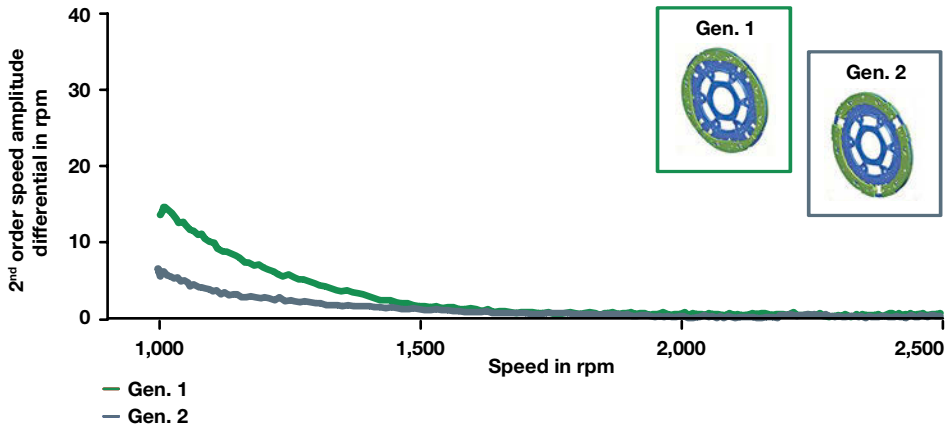
**Figure 10** Torque converter with CPA



**Figure 11** Comparison of a standard torsion damper with a CPA damper

cutouts in the mass and flange. The absorber order is determined by the form of the raceways and the rollers.

The CPA combined with a suitable torsional vibration damper constitutes a significant improvement in the torsion damper's isolation efficiency over standard torsion dampers. Its superiority over other damper concepts has been proven with a centrifugal pendulum absorber attached to a double damper. This design has been in production since 2011. The



**Figure 12** Measurement of vibration amplitude at differential of a 1<sup>st</sup> and 2<sup>nd</sup> generation CPA

comparison of this damper design with a standard turbine damper shows a significant improvement in isolation as shown in Figure 11. With this damper it was possible to reach lockup speeds around 1,000 rpm.

### 2<sup>nd</sup> generation centrifugal pendulum absorber for torque converters

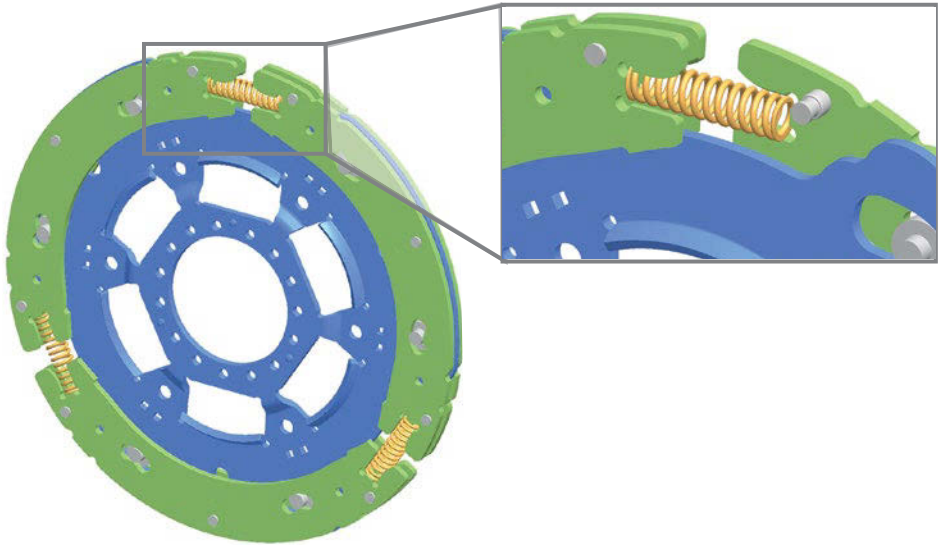
A further increase in the angular displacement and the weight of the parallel CPA would be necessary to improve the isolation capability further and achieve additional fuel efficiency improvements by lowering the lockup speed. Torque converter space and mass limitations however set limits to the CPA growth. The 2<sup>nd</sup> generation CPA aims to improve of the pendulum efficiency without increasing installation space. It uses optimized movement of the pendulum mass by superimposing a rotation onto the swinging motion of the pendulum mass, similar to a trochoid (Figure 12). In addition, the 2<sup>nd</sup>

generation allows larger pendulum travel angles to improve the isolation performance. This maximizes efficiency in the given radial space, thus reducing the required pendulum width. Figure 12 illustrates the isolation improvements at low rotational speeds.

Vehicle measurements with the same installation space and damper configuration show a significant reduction in torsional vibrations of approximately 50 % from the 1<sup>st</sup> to 2<sup>nd</sup> generation CPA.

### 3<sup>rd</sup> generation centrifugal pendulum absorber for torque converters: track-optimized and spring-loaded

With ongoing engine and drivetrain optimizations, dampers will have to provide even better isolation of torsional vibrations. Vibration amplitude targets are likely to be reduced while the engine's torsional vibrations increase and the lockup clutch is engaged at lower engine speeds. Furthermore, in the development of automatic transmission drivetrains the focus is on a

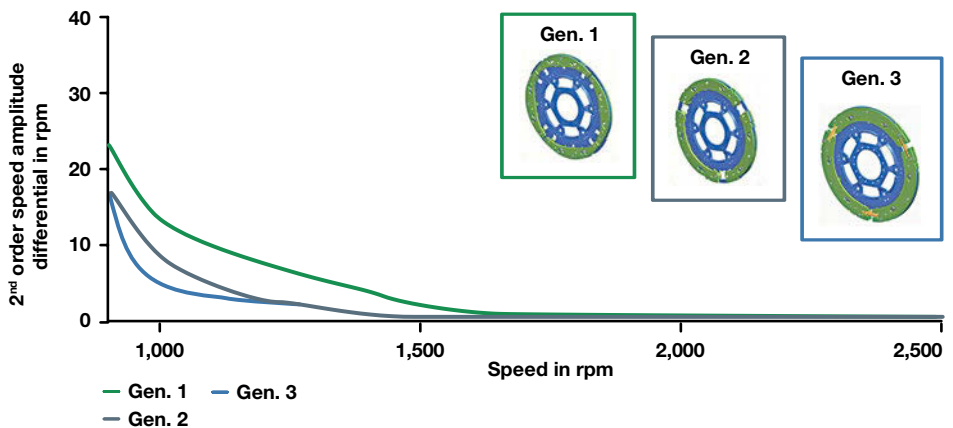


**Figure 13** Design of a spring-loaded CPA

higher ratio spread as well as the reduction of transmission damping and drag to improve the efficiency. In combination with the lightweight design of gearboxes and drive-trains, the reduced internal damping leads to structures that are more vibration sensi-

tive. Further improvements in isolation will be necessary for these future transmission designs.

With its superior isolation performance the 2<sup>nd</sup> generation CPA provides an optimal base for additional improvements. Further



**Figure 14** Simulation of isolation with 1<sup>st</sup>, 2<sup>nd</sup> and 3<sup>rd</sup> generation CPA

travel-dependent track optimization can improve the pendulum efficiency. The improvements can be focused on situations where significant pendulum travel occurs at low engine speed.

The optimized movement of this pendulum masses enables the addition of a coil spring in between.

The spring force stabilizes the pendulum motion during rotation at creep speed or transition events such as acceleration from standstill, further improving the NVH of the drivetrain. These additional springs also have a speed-dependent effect on the CPA order which can be minimized by travel-dependent optimization of pendulum tracks.

Figure 14 compares the vibration amplitude at the differential in a drivetrain with a spring-loaded and track-optimized 3<sup>rd</sup> generation CPA with that of the 1<sup>st</sup> and 2<sup>nd</sup> generation.

## CPA and cylinder deactivation

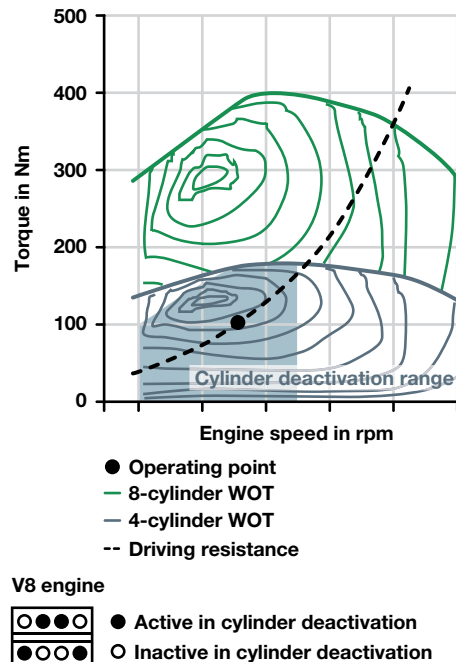
A trend with immense implications on the damper design is cylinder deactivation. It improves the engine's efficiency under partial load by requiring a higher specific load from the active cylinders [11]. The advantage over downsizing and downspeeding is that the high torque of the additional cylinders is still available when needed.

First applications of a CPA with engines capable of cylinder deactivation from 8 to 4 cylinders are already available in the market. Due to the reduction in main firing order while maintaining a high vibration amplitude, isolation in 4-cylinder mode is more challenging than in 8-cylinder mode. Therefore the CPA is tuned to attenuate the 4-cylinder vibrations while the double damper is designed to isolate vibrations in 8-cylinder mode. Besides an increase in sec-

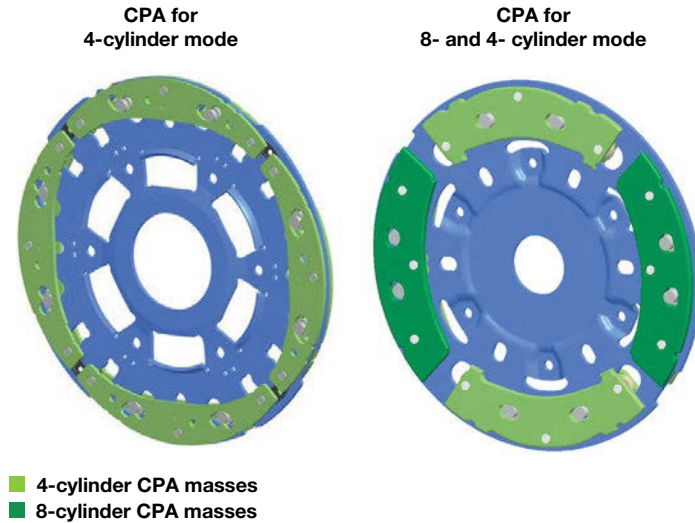
ondary inertia, the CPA does not affect the damper performance when the engine runs on all 8 cylinders.

Engines with deactivation from 6 to 3 or 4 to 2 cylinders may require the superior CPA isolation even if all cylinders are used. In this case, two centrifugal pendulum absorbers can be installed with one tuned to each order. This achieves perfect isolation in all driving conditions.

Torsional vibration dampers with 2<sup>nd</sup> generation CPA are a key technology which allows the lockup clutch to close when the engine speed is to idle. Continuous improvements to the CPA, as described above, provide additional isolation improvement.



**Figure 15** Effect of cylinder deactivation shown in a engine characteristic map [11]



**Figure 16** CPA configurations for an application with cylinder deactivation from 8 to 4.

## Torque converter innovation

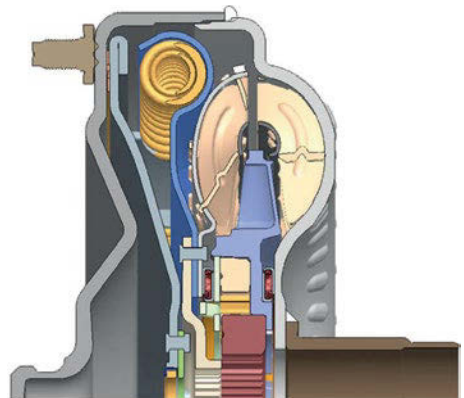
As discussed in the previous chapter, installation space for the torque converter is becoming increasingly and smaller. Nevertheless the requirements for torsional isolation are becoming increasingly demanding. One approach to improve the damper performance is to increase the damper space by reducing the torus width and creating a squashed torus design.

This conventional approach has been used before and its potential to increase the damper space is limited. To find even more damper space it was necessary to overcome the usual restrictions of torque converter design by incorporating the piston function into the turbine. In a traditional design the turbine and lockup clutch are separate components. Both

functions will be required in torque converters for the foreseeable future. By increasing the functions performed by the turbine, one of the large components of a typical torque converter design - the piston - can be eliminated.

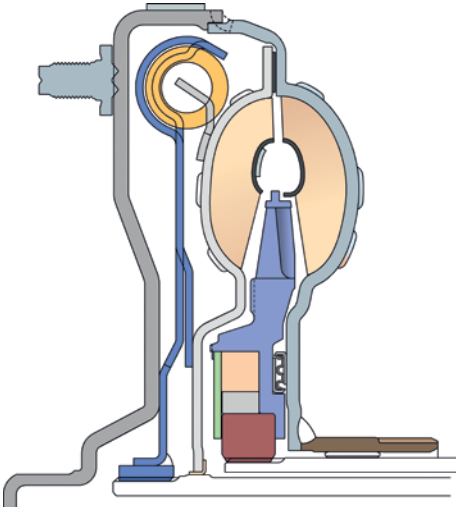
This requires the turbine design to change to withstand the actuating pressure. However, in traditional torque converters, the piston takes up more space than

its thickness. It requires clearance to the cover, clearance for piston deflection and more clearance to the damper to avoid contact during operation. The turbine thickness must be increased with this design in order to withstand the lockup clutch actuating pressure. Ultimately, the



**Figure 17** Typical FWD torque converter design





**Figure 18** Initial iTC design

space gained from the elimination of the piston as a separate component outweighs the thickness increase of the turbine.

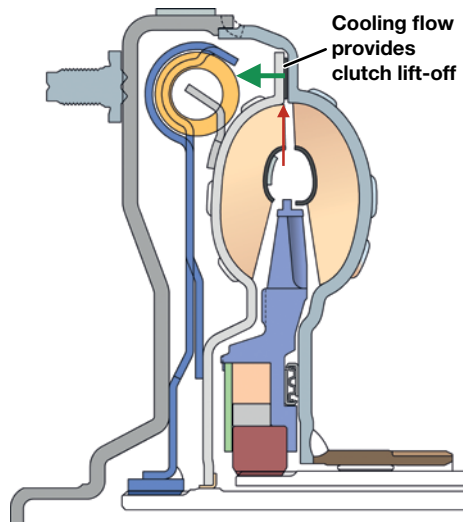
Turbine and impeller now fulfill the lockup function. During a vehicle launch the turbine is active, providing the required torque multiplication. At higher vehicle speeds, the lockup clutch can engage and create a torque path to bypass the hydrodynamic circuit.

By integrating the piston into the turbine, the actuation direction is opposite to the typical torque converter design. Instead of actuating in the direction of the engine, the lockup clutch now actuates in the direction of the transmission. This means the lockup clutch apply and release channels have to be controlled in reverse to a typical torque converter.

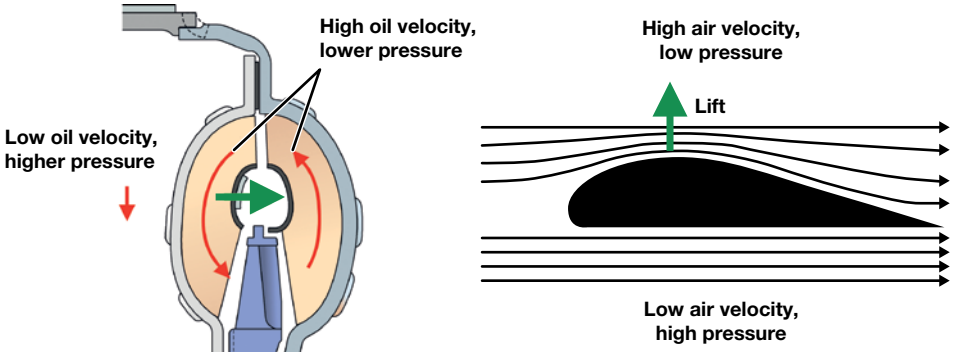
The lockup clutch engagement control distinguishes between 2 stages: open condition and lockup or slip condition. In the open condition, oil enters the torque converter through the torus, building a higher pressure on the turbine's

transmission side and thus causing the clutch to lift off. To avoid cavitation at low speed ratios, the torque converter charge pressure is elevated even with the lockup clutch disengaged. This leads to a cooling flow of 5 to 10 l/min. This is more than sufficient to balance the turbine thrust and ensure that there is an oil layer between the iTC friction surfaces. Measurements have shown that this design lowers the clutch drag in torque converter mode to almost zero.

To engage the lockup clutch, oil is directed through the center of the input shaft and generates a pressure difference on the turbine. A bushing on the inside diameter of the turbine seals the turbine off from the input shaft and ensures that flow has to pass through the friction surface and build actuation pressure for the lockup clutch to engage towards the impeller. The lockup clutch engagement requires a more detailed examination of the turbine thrust.



**Figure 19** ATF flow in lockup clutch disengagement

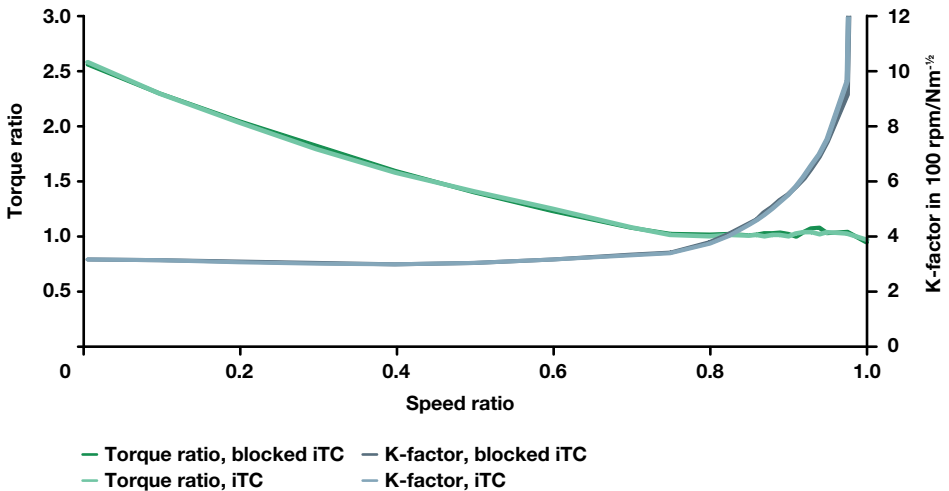


**Figure 20** Cause of turbine thrust

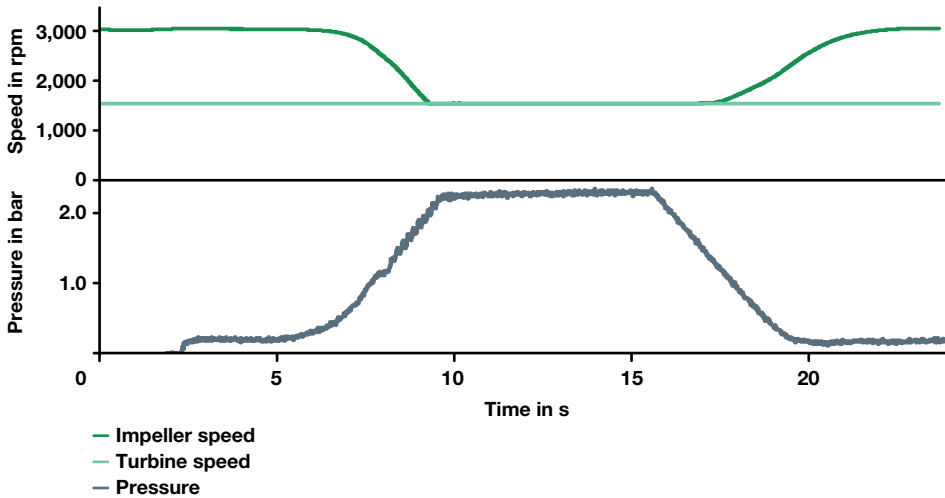
**iTC Measurements**

Turbine thrust is a result of different oil velocities on both sides of the turbine. Inside the torus, the oil circles between the impeller and the turbine with a velocity that depends on the speed difference between both components. The velocity is at its highest when the vehicle is at a standstill (“stall”). On the engine side of the turbine, the oil velocity is considerably

lower. Only shear stress on the cover and impeller cause the oil to have a different speed to the turbine. Using Bernoulli’s Principle, the axial force on the turbine is easily explained. High oil velocity causes the oil pressure to drop which creates a pressure difference between both sides of the turbine and results in a force towards the higher velocity oil. It is the same physical principle that allows airplane wings to create lift.



**Figure 21** Characteristic measurements of iTC and blocked iTC



**Figure 22** Torque converter characteristic and lockup clutch engagement measurements

At first glance the turbine thrust might seem to be an obstacle. Closer examination however shows that the turbine thrust can be balanced with TC charge pressure to disengage the lockup clutch. This creates a hydrostatic support at the turbine's friction surface and leads to low clutch drag. Engaging the lockup clutch creates a force that is oriented towards the transmission – the same direction as the turbine thrust. For the lockup clutch engagement, turbine thrust means that the gap between the lockup clutch friction surfaces has a tendency to be reduced every time there is relative speed between the turbine and the impeller. This is a preliminary stage to the closure of the lockup clutch and allows a smooth engagement.

Measurements of the iTC confirm the theoretical considerations about clutch drag and engagement. An iTC prototype was prepared for the comparison of TC characteristics between an iTC design and a typical torque converter. The first characteristics measurement was taken on the iTC prototype, for the second mea-

surement a rolling bearing was placed between the turbine and the stator to increase the clutch lift-off and prevent it from engaging. The measured characteristic curves are nearly identical and only differ in terms of measurement accuracy. This shows that the turbine bearing exhibits the same resistance the friction surface lifted off by the oil flow, as previously described.

The clutch controllability and engagement quality was checked in a dynamometer test where the turbine and impeller spin is at a given speed and the actuation pressure is increased gradually. After a successful engagement, the actuation pressure is reduced to determine when the clutch starts slipping again.

As expected, the engagement starts at low actuation pressure values and does not lead to a torque spike. The pressure value at which the slip ended during the engagement phase and the pressure value at which the slip started during the disengagement phase are also identified as very close. This small engagement hysteresis verified the iTC slip controllability.

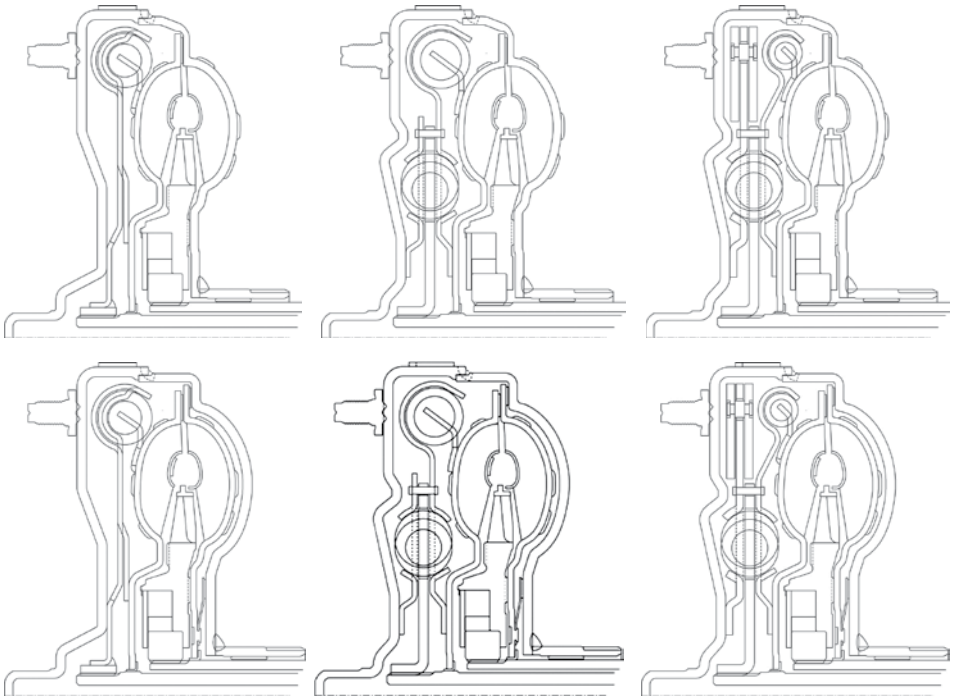
### iTC Advantages

As described above, the main motivator for the iTC design is in the reduction of the torque converter width. This goal coincides with the trend towards drivetrain weight reduction and increasing numbers of gears. Besides the space advantage, the iTC provides the following improvements over a typical torque converter.

The iTC has less components when compared to a typical torque converter. All of the turbine's axial force is directed through the friction surface and the turbine never makes contact with the stator, therefore it does not require a turbine bearing. The iTC also reduces the number of components by avoiding multiple connections for the damper torque input and by removing the piston. This reduces the

design complexity but its major effect is a cost and weight reduction. The turbine has to be thickened to withstand the lock-up pressure but this is more than outweighed by removing the components mentioned above.

On the functional side, the iTC provides very smooth engagements through an effect that is comparable to a preloaded clutch but without the clutch drag caused by a preload mechanism. The self-engagement of the iTC is stronger at higher relative speeds between turbine and impeller because the turbine thrust force depends on the speed ratio. This results in an increased engagement stability and reduces the risk of clutch shudder. As a result of the lockup clutch proximity to the torus, the clutch interface is stiffer than in a typical torque converter. The



**Figure 23** Modular damper and torus designs with the iTC layout

brazed blades add a rib-like effect to the turbine and impeller shell and reduce the friction surface taper that would otherwise result from the apply and ballooning pressure. With less taper, the power input on the friction surface has a more equal distribution which avoids localized high temperatures and wear.

### iTC modularity

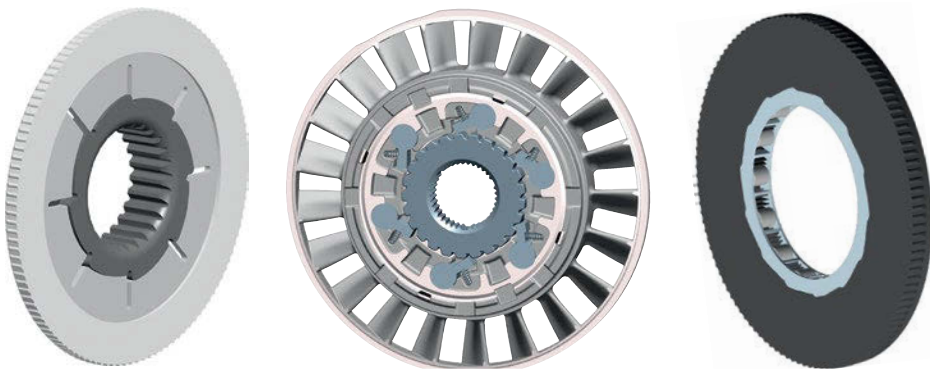
Modularity was already the goal for the value enhanced design described above. With the iTC however, modularity receives an enabler that hasn't been available before. Typical torque converters require the damper to have connections to both the piston and the turbine. The iTC design has only a single input to the damper. This reduces the damper complexity which creates space for higher performing dampers and reduces the obstacles to variations of the damper.

The iTC modularity doesn't only extend to damper variations as shown in Figure 25. Due to the relative simplicity of the impeller clutch design, its addition becomes modular and the result is more predictable.

### One way clutch

Since 1928, one way clutches have been used to switch from converter to coupling mode. Typically, roller or sprag designs are used in torque converters. Driven by the width reduction that is achieved with the iTC design, the focus falls on reducing also the one way clutch width.

Two concepts are available to reduce the one way clutch width. On a sprag or roller one way clutch, the contact surfaces are coaxial, therefore the capacity cannot be increased without increasing the width. In the wedge design, the contact surfaces are arranged circumferentially. The wedge one way clutch locks if the outer race pulls the wedge plate onto the inner race ramps. Utilizing the wedge principle, the normal force on the wedge plate increases with torque and creates a self-energizing friction coupling. In the freewheel direction, the wedge plate is prevented from spinning by the inner race shoulders. The wedge plate design is adjusted to only create drag in lockup direction to slide up the ramps. In the freewheel direction, the plates are designed to reduce the drag. Due to the arrangement of the contact surfaces, this design has a considerable width reduction over typical roller one way clutches.



**Figure 24** Wedge (left), rocker (center) and slim cage one way clutch (right)

A second design with reduced width aims to eliminate non-functional features. Pedestals on the outer race of a typical roller one way clutch provide a reaction surface for the preload springs but their width is mainly driven by the production process. By using a plastic cage, the number of rollers can be permitting a reduction in their length.

Yet another one way clutch development is the rocker design. This design aims to reduce the cost of the torque converter. Since the rocker location is fixed with respect to the stator, the outer race can be removed and the contact surfaces can be integrated into the stator's aluminum body. The contact surface can be increased to avoid plastic deformation by the rockers. This design creates a challenge since it can only engage at discrete positions. It has been shown however, that a lash angle of  $2.4^\circ$  is small enough to avoid any noticeable difference between the rocker and a roller one way clutch. With the elimination of a part as complex as the outer race of a roller one way clutch, this design reduces the cost of the torque converter.

## Multi Function iTC

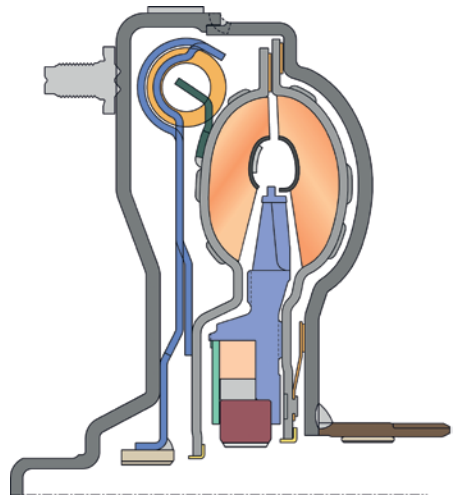
Unlike the typical lockup clutch, the iTC design allows the implementation of an impeller clutch without large design changes. As the addition of a shell to the outside of the impeller cannot be avoided, the axial dimensions are increased. However, the impeller clutch can be integrated into the iTC's turbine clutch and the pressure channels can also be adapted with ease.

The reason for an impeller clutch traces back to the increase in the combustion engine's efficiency. With a trend toward turbo-charged engines with a smaller number of cylinders, the maximum engine power is not available below 3,000 rpm. A highly boosted engine can struggle to reach full torque in a timely manner under heavy load at low

speeds, commonly called turbo lag. This can cause poor vehicle launch performance and feel. To mitigate this effect and allow the engine to reach high speeds during a launch, the torque converter would typically be designed with a high K-factor to make it softer. The high K-factor has another advantage in that it results in reduced idle losses. As a detriment, high K-factor allows the engine to flare to higher speeds when the lockup clutch disengages for torque multiplication. In this case, a lower K-factor would be desired to make the torque converter stiffer.

Both can be achieved if the impeller is not hard connected to the engine. The impeller clutch allows the engine to have a higher speed than the impeller which allows the engine to provide a higher torque faster, diminishing turbo lag. This function can then best be described as a variable K-factor. The Multi Function iTC is designed to the lowest desired K-factor and the impeller clutch slip is used to make the system softer.

The MFITC controls require the 2 standard pressure channels and an additional channel from the back of the impeller



**Figure 25** Multi Function iTC

clutch into the sump. Pressure between the turbine and impeller press the impeller against the transmission side cover and connect it to the engine. The channel through the center of the input shaft has to be closed to force the oil flow to exit through the impeller hub. The slip that is required to modify the torque converter stiffness can be controlled through the oil flow that enters between the turbine and the impeller. For the engine start and in idle, the channel through the transmission input shaft is opened which eliminates the pressure difference on the impeller and opens the clutch. The engine can therefore start without the drag that is typical of non-multi function torque converters.

Lockup is achieved by providing oil flow through the input shaft to the outside of the turbine shell. This presses not only the turbine but also the impeller towards the outer shell and engages both clutches. Transitions between the lockup and torque converter modes require controlled backpressure on the exit channel to prevent the engaged clutch from slipping.

## Summary

---

The torque converter as it is used in modern transmissions is the result of an evolution that spanned more than 70 years. Improvements of the internal combustion engine and the automatic transmission caused the torque converter design to be adapted but torque converter development itself has left a mark on the automatic transmission market as well. Smooth launch, torque multiplication and the attenuation of torsional vibrations set new directions for both engines and transmissions. The iTC is a continuation of this evolution and the space that was freed by integrating the piston into the tur-

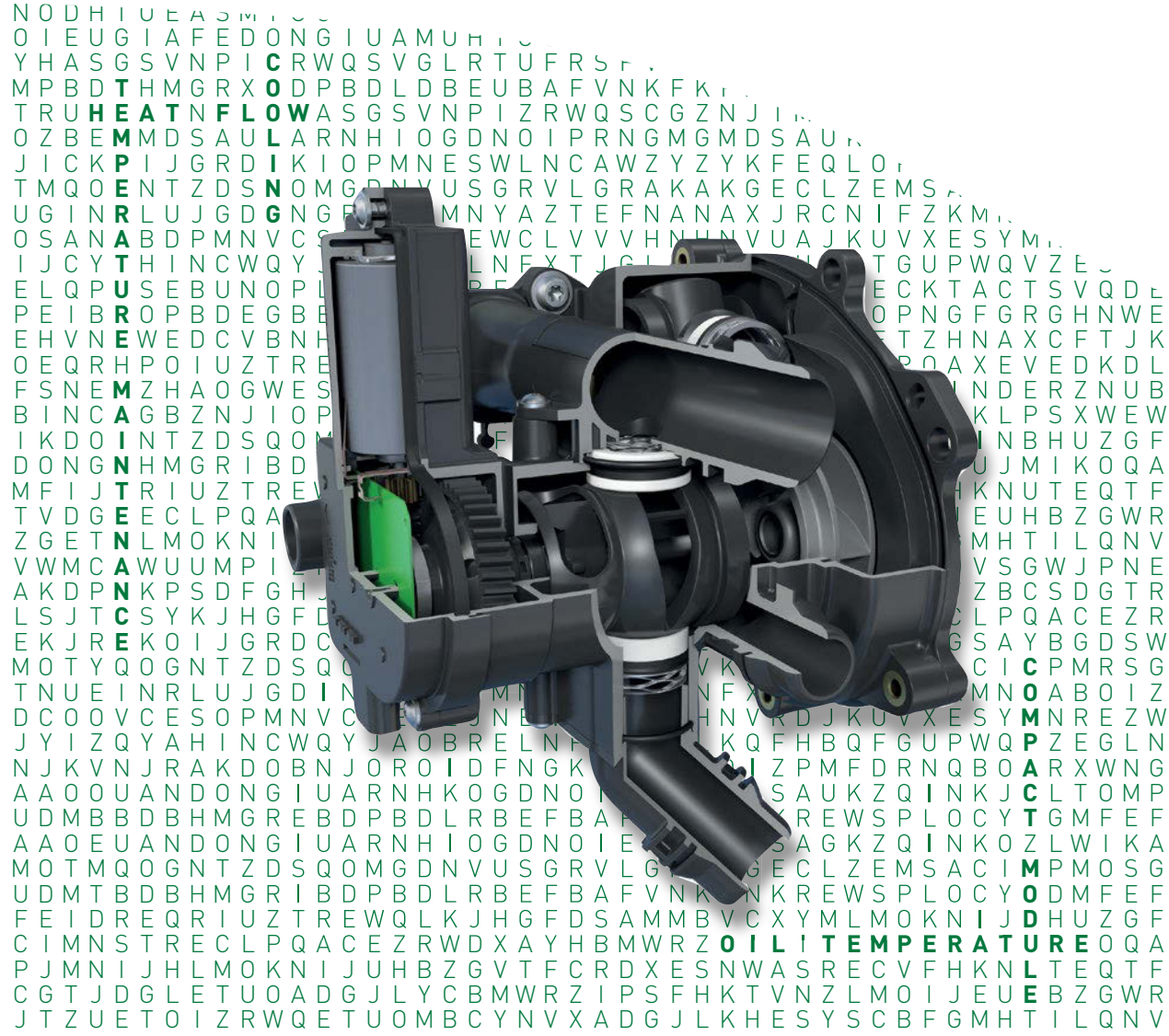
bine increases the degrees of freedom in the powertrain design.

Similarly, torsional vibration dampers with 2<sup>nd</sup> generation CPA will be a key technology. It allows the powertrain to be used close to idle speed with the lockup clutch engaged for fuel efficiency. The CPA is independent of the torque converter design. It can be paired with a regular TC as well as an iTC to meet future demands of downsizing and downspeeding.

## Literature

---

- [1] IHS Automotive Production Forecast, Aug 2013
- [2] Naunheimer, Bertsche, Lechner: Fahrzeuggetriebe. Berlin: Springer, 2007
- [3] Thompson E. A.: Fluid Coupling Rotor, US Patent 2,357,295. 1940
- [4] Rieseler H.: Flüssigkeitswechsel- und -wendegetriebe, German Patent 435662, 1921
- [5] Föttinger H.: Improvements , GB Patent 190906861, 1009
- [6] Föttinger H.: Flüssigkeitsgetriebe mit einem oder mehreren treibenden und einem oder mehreren getriebenen Turbinenrädern zur Arbeitsübertragung zwischen benachbarten Wellen, German Patent 221422, 1905
- [7] Föttinger H.: Flüssigkeitsgetriebe zur Arbeitsübertragung zwischen benachbarten Wellen mittels treibender und getriebener Räder, German Patent 238804, 1905
- [8] Janssen P., Govindswamy K.: Future Automatic Transmission Requirements, FEW, 2013
- [9] Autocar Handbook, 13th edition, 1935
- [10] Krause, T.; Kooy, A.; Kremer, E.: Torsional Dampers with 2<sup>nd</sup> Generation Centrifugal Pendulum Absorber for Manual and Automatic Transmissions; VDI Congress Getriebe in Fahrzeugen, 2011
- [11] Golloch, R.: Downsizing bei Verbrennungsmotoren, Springer, 2005





# Hot & Cold

Schaeffler's thermal management  
for a CO<sub>2</sub> reduction of up to 4 %

Michael Weiss

# 21



## Introduction

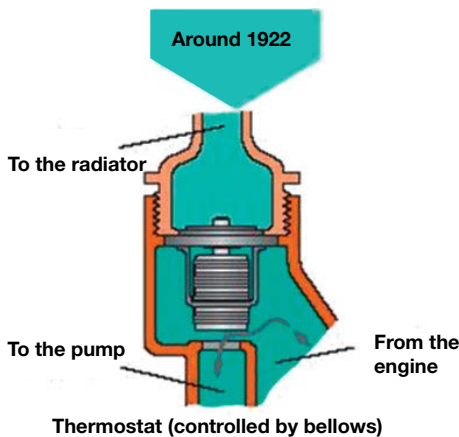
Improved and variable use of the heat flows in a vehicle is a requirement for further reducing emissions and fuel consumption and increasing the air conditioning comfort in passenger cars. The integrated turbochargers (ITL) increasingly used in vehicles place increased requirements on cooling systems. ITLs require a predictive cooling system if possible instead of a system, which reacts to different operating conditions. This requirement cannot be met with conventional thermostats because thermostats have a delayed reaction to energy input into the cooling system and also suffer from pressure losses.

Innovative mechatronic components are required for making a predictive calculation of the cooling requirements from the engine load and speed. Schaeffler's thermal management modules (TMM) are able to adjust the coolant flow to zero, for example, in order to achieve accelerated heating of the engine. At the same time,

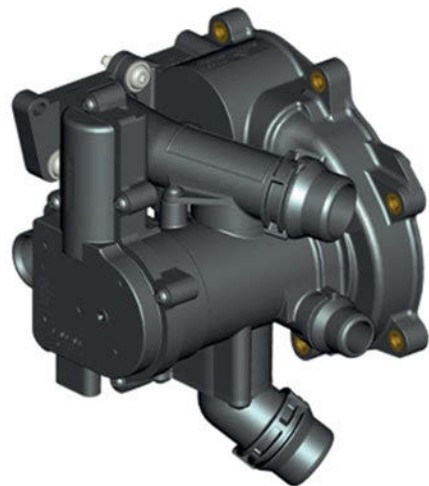
they are able to decouple thermal masses and thus dissipate quantities of energy to other components such as the engine oil, transmission oil, heater or traction battery via the residual mass. In contrast to conventional thermostats (Figure 1) TMMs are controlled using a load-based calculation model. This allows the integration of a large number of connected components as well as a narrow temperature range of  $\pm 2$  °C.

## The first multifunctional thermal management module in volume production

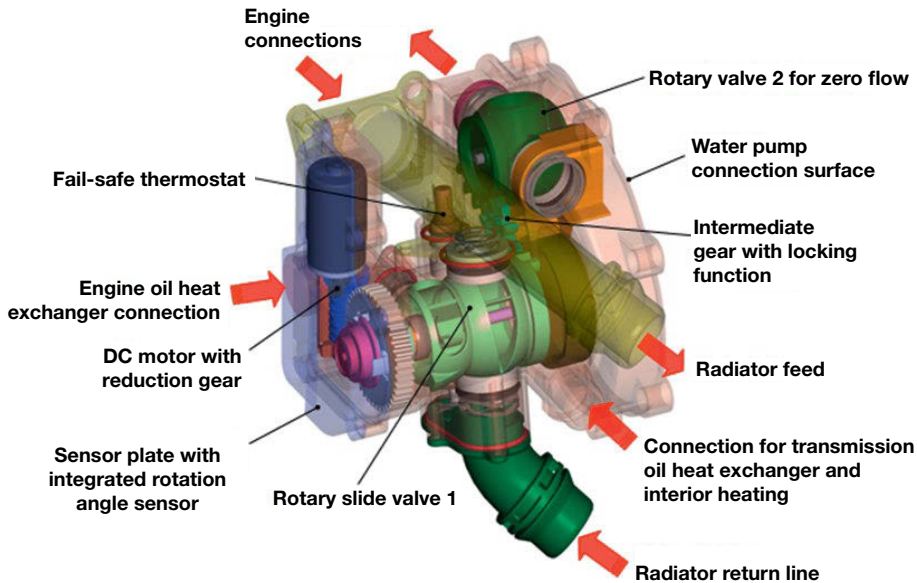
The first volume produced engine to be equipped with a multifunctional thermostat is the Audi 1.8-liter TFSI engine (four-cylinder in-line engine EA888Gen.3). This module was developed jointly by Audi and Schaeffler (Figure 2).



**Figure 1** Early thermostat controlled by bellows



**Figure 2** Thermal management module in the Audi 1.8-liter R4 TFSI engine



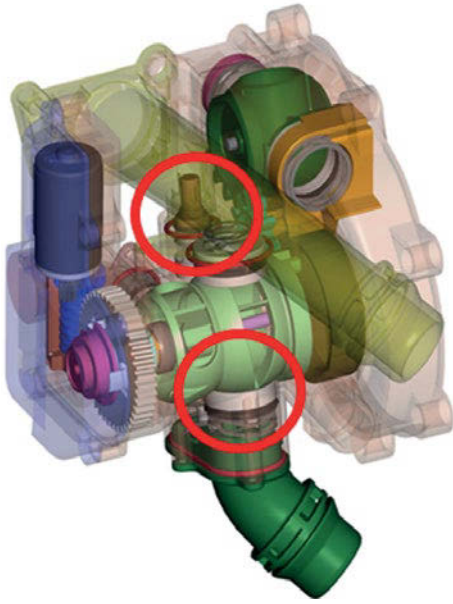
**Figure 3** TMM design for the Audi 1.8-liter R4 TFSI engine

In the warm-up phase of the engine, the thermal management module is able to completely close the coolant inlet in the engine or set a minimum flow rate. If the engine is warm from operation, the coolant temperature can be adjusted quickly and fully variably to different temperature levels depending on load requirements and external boundary conditions [1]. The thermal management module has two coupled rotary slide valves, which are operated by only one drive motor. One of these rotary slide valves is on the pressure side of the water pump and is designed for shutting off the coolant. The second rotary slide valve is used for distributing coolant on the intake side. The entire cooling circuit also has switching valves to enable the flow of coolant through the heater and the transmission oil heat exchanger to be switched on and off in a targeted manner.

Two rotary slide valves, which are coupled mechanically, control the flow of coolant inside the rotary slide valve module. An electric motor drives rotary slide valve 1 via a worm

gear with a high reduction ratio. Rotary slide valve 1 is, in turn, connected with rotary slide valve 2 via a lantern pinion. Rotary slide valve 2 replaces the conventional wax thermostat and can very quickly and fully variably adjust the coolant temperature between 80 °C and 110 °C depending on requirements. In addition, rotary slide valve 1 switches the coolant return from the engine oil cooler (Figure 3). The coolant water is heated 30 % faster compared to the previous engine with a wax thermostat. The time required to reach the target oil temperature is reduced by around 50 %.

The module essentially comprises high-performance plastics. The coolant-carrying parts comprise polyphenylene sulfide (PPS) with extreme levels of fill. This means the material is almost as strong as aluminum, is insensitive to media and has thermal stability. A search was made for an alternative for polytetrafluorethylene (PTFE) during the design of the seal materials because the plastic known under the trade name Teflon is expensive and has a tendency to creep un-



**Figure 4** Rotary slide valve module for full electronic control of heat flows in the engine and vehicle

der the influence of temperature. An alternative material was developed on the basis of polyvinylidene fluoride (PVDF).

The materials used in the gears were developed by the Schaeffler Group in-house. Particular attention was paid to the selection of fiber materials. The gears operate under dry running conditions because lubricants would be ejected over the operating life and would no longer be effective. The seals are not pressure-dependent and are able to compensate for angular offsets due to the integration of a pretensioning spring instead of an O-ring (Figure 4).

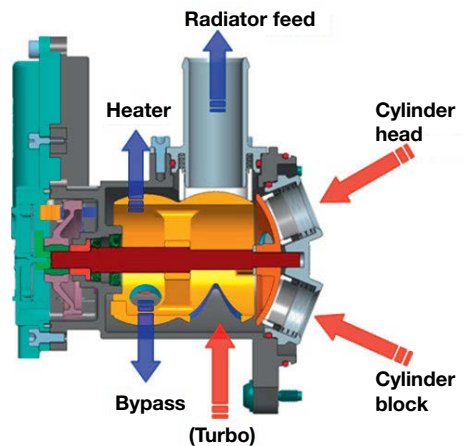
High-precision manufacturing of the rotary slide valves and sealing assemblies allows leak rates of less than 1 liter per hour. An auxiliary thermostat ensures protection against failure. This means a return spring is not required on the drive motor and the energy consumption of the TMM is minimized.



**Figure 5** Compact module with two to three regulated outlets

## Compact to comprehensive Schaeffler solutions

Schaeffler's thermal management modules can have different designs depending on customer requirements and the



**Figure 6** Multifunctional module with integrated split cooling

available space. A particularly compact solution, for example, offers up to three regulated channels and fits into the design envelope of conventional thermostat housings (Figure 5). The integration of a temperature sensor is also possible. Standardized actuators also allow efficient development. The use of technologies and materials validated in volume production is an excellent basis for a robust new development.

The development of a multifunctional module with separate circuits for the engine block and cylinder head (split cooling) is going in another direction. It has up to five controlled channels as well as a feed and flow control system. A high level of integration is one of the advantages of the multifunctional module. In addition, only one interface is required to the control unit (Figure 6).

## Maintaining the engine oil temperature

Plate-type heat exchangers of stacked-disk design are frequently used for indirect cooling with coolant. The plates are provided with turbulence inserts to improve the heat transfer between the media. The design of a plate-type heat exchanger comprises a number of corrugated plates. Chambers are created between the plates, in which the heated fluid and the fluid to be heated can flow. A chamber with heated fluid is followed by a counter-flow of the fluid to be heated separated by a plate (Figure 7).

The use of an oil/coolant heat exchanger has two advantages: The coolant, which heats more rapidly than the engine oil during cold starts, can be used to ensure the oil reaches its target tem-



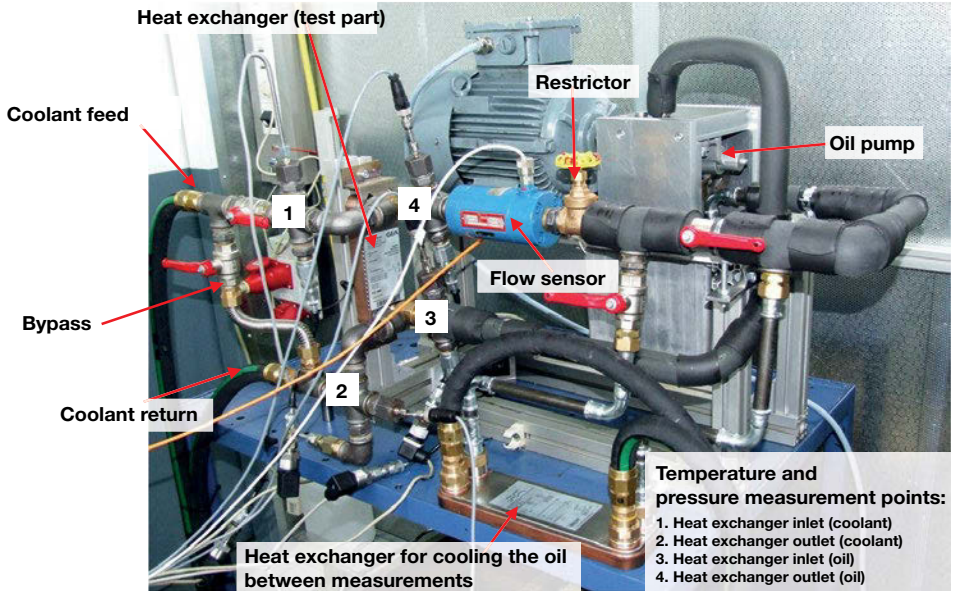
**Figure 7** Design of a plate-type heat exchanger

perature more quickly. It also assists heating of the pistons, which quickly reduces the piston clearance. This results in an improved level of particle emissions. The oil can also reach higher temperatures during engine operation. The oil can dissipate this heat to the coolant via the heat exchanger. The ability to maintain the oil temperature within narrow limits has an advantageous effect on the stress placed on the lubricant.

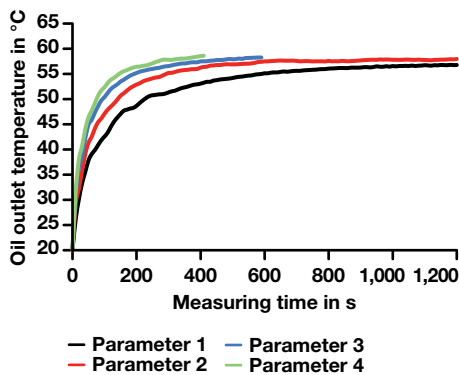
### Model verification

The warm-up behavior of the oil at different water temperature levels was verified experimentally on an oil cooler at Schaeffler. The oil temperature is 20 °C on a special test setup (Figure 8) at the start of the test. The water inlet temperature is to be held constantly at 40, 60, 80 or 100 °C. Four measurements with different oil pump speeds, oil flows and water flows are carried out for every coolant temperature. The measurement results are shown in Figure 9 as an example

In general, the measurements show that a higher level of friction reduction can be achieved if the water starts to flow through the oil cooler earlier rather than



**Figure 8** Test setup for determining the warm-up behavior of the oil



Parameter	Oil pump speed in rpm	Oil flow rate in l/min	Coolant flow rate in l/min
Parameter 1	640	8	4
Parameter 2	1,290	16	8
Parameter 3	1,950	24	12
Parameter 4	2,470	32	16

**Figure 9** Oil outlet temperature over the measuring period at a coolant temperature of 60 °C for different flow rates

later. The coolant should be used to heat the oil as quickly as possible in order to achieve a reduction in CO<sub>2</sub> and fuel consumption. The oil cooler must be taken into consideration in the design of the oil circuit because the heat exchanger is a restriction at low temperatures.

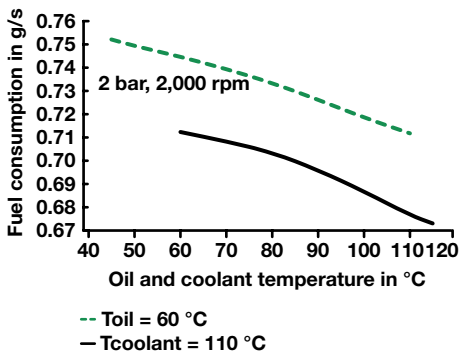
The NEDC is started with a cold engine. This means that the oil is in a highly viscous state and can only flow through the heat exchanger with difficulty. If heated coolant does not flow through the oil/water heat exchanger (OWHE) from the start, it is also not advisable to direct the oil via the OWHE. The cooler can also be bypassed until the oil is within a temperature range, in which it must be cooled. This means the heat in the oil is not dissipated to the surroundings via the cooler or to the coolant via the heat exchanger. In both cases, this causes the heat to accumulate in the oil circuit, which, in turn, means that the operating temperature can be reached more quickly. The installation

of a control valve in the oil circuit would also be a possible solution. This would allow rapid and requirement-based control of the oil.

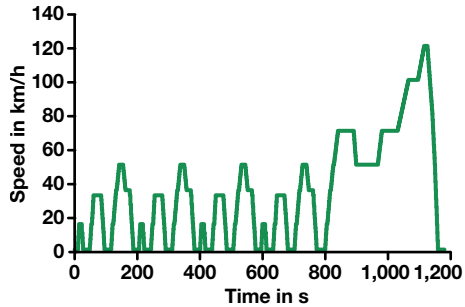
### NEDC

When determining the standardized fuel consumption it must be taken into consideration that consumption is strongly influenced by the driving style of the driver. Today, standardized driving cycles are run in order to achieve comparable values. A synthetic speed curve, the New European Driving Cycle, was defined for Europe. Phases of constant acceleration, constant speed, constant deceleration and idling phases at zero speed are run during this cycle. The shifting points for vehicles were also defined in the NEDC because engine speed also has a large influence on fuel consumption. The NEDC is a sequence of five cycles, four identical urban cycles with a maximum speed of 50 km/h and an extra urban cycle with a maximum speed of 120 km/h. Figure 10 shows how the coolant and oil temperature affect fuel consumption.

Figure 11 also shows the speed curve in relation to time. It can be seen that the en-



**Figure 10** Influence of coolant and oil temperature on fuel consumption



**Figure 11** Speed curve of the NEDC

gine is initially subjected to low loads. It is all the more important not to lose any energy and to quickly bring the motor up to temperature in this early phase.

## Maintaining the temperature in the interior

After cold starting a passenger car, optimum air conditioning should be achieved in the passenger compartment as quickly as possible. A defined interior air temperature is recommended for comfortable air conditioning of the interior. The fed und dissipated heat flows must be designed and adjusted to achieve this temperature.

A comfortable mean air temperature in the closed rooms of buildings is approximately 22 °C according to DIN 1946-2. The mean interior air temperature in a passenger car is calculated from the arithmetic mean of the mean air temperature in the footwell and the mean air temperature in the ceiling area. The mean interior air temperature required for ensuring comfort in the interiors of passenger cars is not constant. It is dependent on the physical, physiological and intermediate influencing factors (Table 1).

Factors influencing thermal comfort		
Physical	Physiological	Intermediate factors
<ul style="list-style-type: none"> <li>• Enclosing surfaces</li> <li>• Solar radiation</li> <li>• Air temperature</li> <li>• Air flow</li> <li>• Humidity</li> </ul>	<ul style="list-style-type: none"> <li>• Activity</li> <li>• Status</li> <li>• Skin moisture level</li> </ul>	<ul style="list-style-type: none"> <li>• Clothing</li> <li>• Number of occupants</li> </ul>

**Table 1** Factors influencing thermal comfort

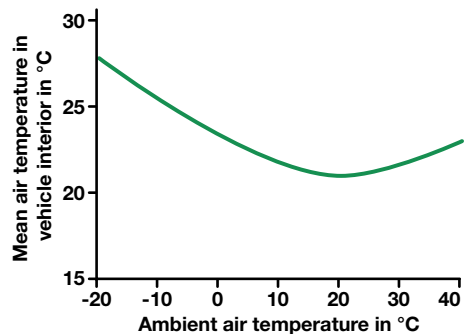
The interior air temperature perceived as comfortable depends strongly on the ambient air temperature (Figure 12). If the ambient air temperature is 20 °C, the interior air temperature perceived as comfortable is 22 °C. The interior temperature considered to be comfortable is higher than 22°C at lower ambient air temperatures. This higher interior temperature is required, for example, in order to compensate for the thermal radiation dissipated to enclosing surfaces. The optimum temperature at high ambient air temperatures is also over 22 °C because, for example, lighter clothing is worn.

### Influence of different shut-off systems on comfort

As part of the measurements for a master thesis supervised by Schaeffler, tests were carried out to determine which strategy heats the engine and coolant more quickly than the standard strategy and what influence the different strategies have on heating the passenger compartment. A passenger car was driven on a rolling test stand under the specified loads for the measurements.

Measurements were carried out on the engine with different strategies for the coolant pump. These included:

- the standard coolant pump, which is permanently connected,



**Figure 12** Mean air temperature in a vehicle interior depending on the ambient air temperature

- a switchable coolant pump, which is controlled by the vehicle control system in accordance with the cold-start strategy of the automobile manufacturer,
- a coolant pump which is disconnected in the warm-up phase and is only connected when a defined coolant temperature is reached and
- a shut-off element, which prevents the thermo-syphon effect

In order to assess the different coolant pump strategies, the engine was initially operated with the coolant pump disconnected (thermo-syphon effect permitted) and subsequently with the coolant circuit shut off (thermo-syphon effect prevented). Table 2 shows details of the test scenarios.



		Measuring time	Load 5 kW**
1	Standard (cyclical CP)	15 min	x
2	Standard (SE opens in cycle times as in 1)	15 min	x
3	Coolant pump switched on after motor start	15 min	x
4	Coolant pump disconnected (CP switched on after coolant temperature reaches 50 °C)	15 min	x
5	Coolant pump disconnected (CP switched on after coolant temperature reaches 80 °C)	15 min	x
6	Shut-off element closed (SE opens after same time as in 4)	15 min	x
7	Shut-off element closed (SE opens after same time as in 5)	15 min	x

\*\* 5 kW at 2,000 rpm (crankshaft)

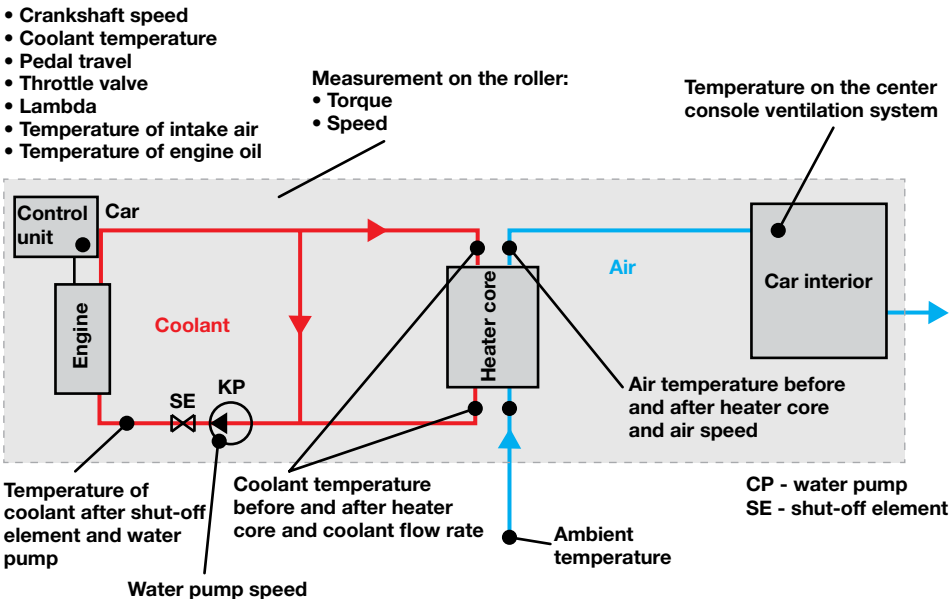
**Table 2** Test scenarios

The scope of the measurements included:

- the coolant temperature before and after the heater core (HC),
- the temperature of the coolant after the shut-off or after the coolant pump,

- the temperature of the air after the heater core and
- the air temperature in the interior.

Figure 13 shows a diagram of the test setup.

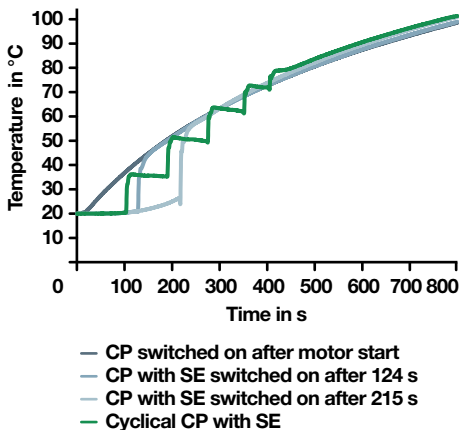


**Figure 13** Diagram of the test setup



**Figure 14** Measurement points in the test setup

The measurement point for the interior temperature was at the height of the head restraint on the passenger side (Figure 14 left). The measurement of the air speed after the heater core is carried out after the fan (Figure 14 bottom right). Figure 14 shows the measurement point before



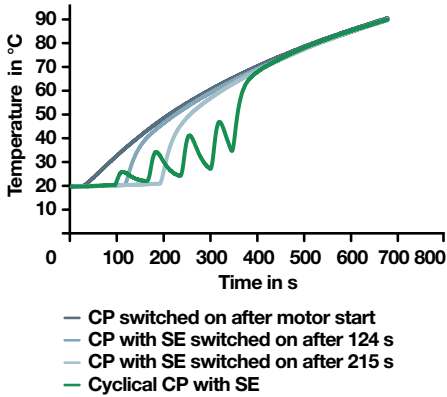
**Figure 15** Coolant temperatures for different coolant pump strategies

the coolant pump at top right.

Figure 15 shows the coolant temperature curve at the measurement point before the coolant pump depending on the switching strategy. This curve progression is similar to the coolant temperature curve after the heater core. A temperature increase during the “stationary coolant” phase can be seen. For the curves with the strategy “cyclical coolant pump”

and the coolant pump that is connected above a coolant temperature of 50 °C, there is only a slight effect before connecting the coolant pump. For the strategy, in which the coolant pump is connected above a coolant temperature of 80 °C, a significant increase of the coolant temperature is noticeable before the coolant pump is connected. The increase for the measurements with a shut-off is significantly larger than for the measurements without a shut-off.

For the measurements at the measurement point before the coolant pump, heat transfer is only possible by means of thermal conduction in the coolant if the coolant pump is disconnected. The heat transfer for the measurement without a shut-off element continues in the coolant pipe. The coolant in the measurements with a shut-off element can only be heated as far as the shut-off element. The coolant is continuously heated at the measurement point before the engine inlet without any heat dissipation due to the shut-off in the pipe. Therefore, the coolant temperature measured at this position is higher than the cool-



**Figure 16** Air temperatures with different coolant pump strategies after the heater core

ant temperature in the test without a shut-off element.

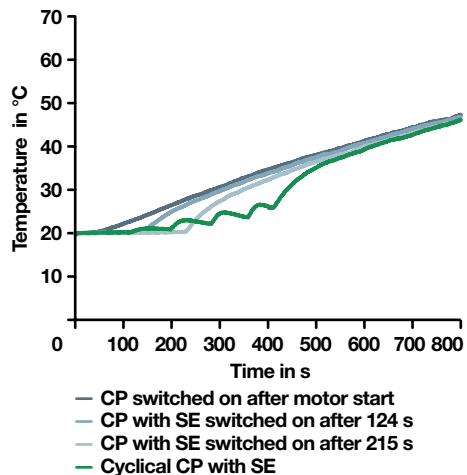
After the pump is connected at 124 seconds and 215 seconds, there is initially a short drop in temperature, because cooler coolant is fed from the heater core and pipes to the measurement point. This is followed by a significant increase in temperature due to the warm coolant, which was heated in the motor and now reaches the measurement point.

With the cyclical coolant pump strategy, temperature differences occur with delays after the coolant pump is connected. Initially, the warm coolant is moved through the circuit by the pump, until it reaches the engine inlet. The coolant temperature drops only slightly during the periods when the coolant pump is disconnected. The coolant only loses heat slowly because heat continues to reach the measurement point from the engine due to heat conduction in the coolant. The curves with the cycled coolant pump strategy catch up the other curves after the pump has been connected four times. The curves for all strategies have the same progression after permanent connection of the coolant pump,

whereby the curve with the cyclical coolant pump is slightly higher. The strategy for the cyclical coolant pump has the longest coolant pump disconnection times. This means a very small quantity of heat is dissipated from the engine, which is why the engine and coolant are heated minimally faster.

The heating characteristics of the air after it exits the heater core due to different heating strategies can be seen in Figure 16. This shows that the air temperature curve with a coolant pump that is permanently connected cannot be improved by any of the air temperature curves of the other strategies. Above 550 seconds, the curves of all the coolant pump strategies lie on top of each other. Heating up the air requires different periods of time depending on the strategy. The earlier the heat is transferred to the HC, the earlier the air will be heated. The greater the quantity of heat transferred to the HC, the faster the air will be heated.

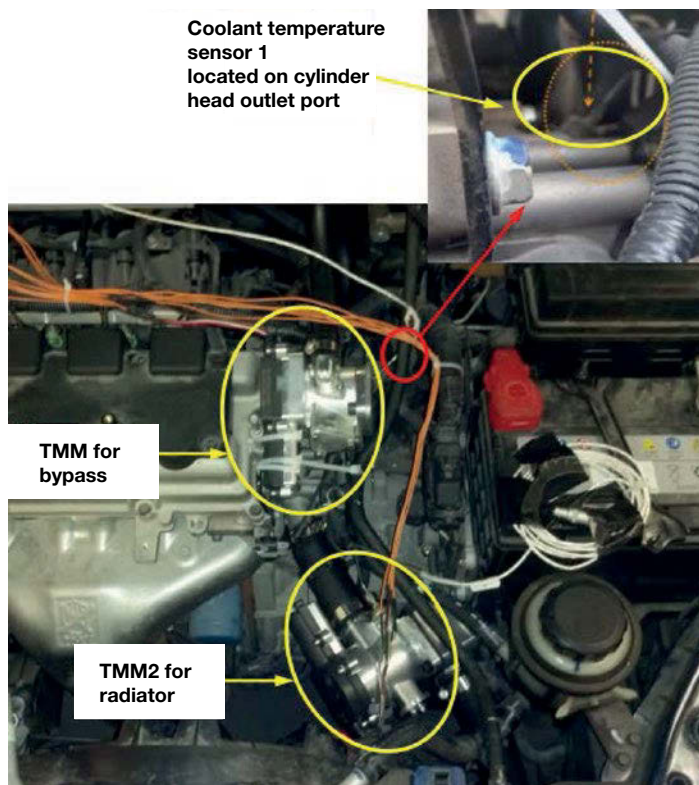
The measured interior temperature depending on different heating strategies is plotted in Figure 17. These curves follow the air temperature curve after the heater core,



**Figure 17** Comparison of the air temperature in the interior.

however, they have a different gradient. The air, which exits the heater core, mixes with the air in the passenger compartment after it leaves the nozzles. A change of temperature therefore requires a longer period due to the large quantity of air in the vehicle interior. The strategy, with which the interior is heated most quickly, is the strategy with the coolant pump permanently connected. The less the coolant pump is connected in the heating phase, the more slowly the interior will be heated.

The measurements carried out to determine coolant and air temperatures at different measuring points in the warm-up phase of the engine show that the strategy with a coolant pump that is permanently connected is still the most appropriate for heating the interior of a passenger car as quickly as possible. Other coolant pump strategies with disconnected phases do show a faster heating phase after the coolant pump is connected, but are not an improvement on the curve with the coolant pump that is permanently connected. These results show that a switch must be made to the strategy with a coolant pump that is permanently connected as soon as a passenger operates the heater – customer satisfaction is the highest priority.

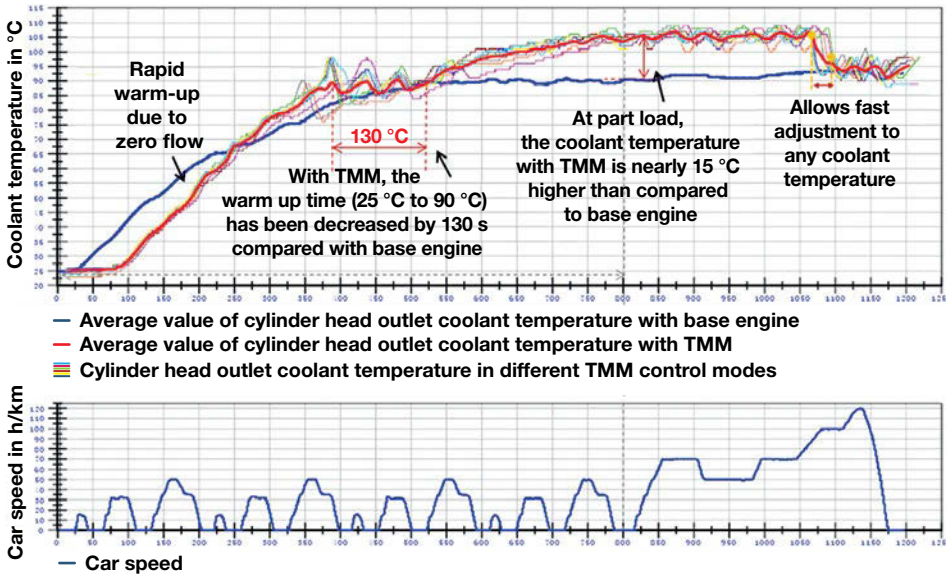


**Figure 18** Modified naturally aspirated engine with a TMM

## Cold-start strategies

Schaeffler modified a conventional naturally aspirated engine and replaced the thermostat control system with a thermal management module in order to verify the effects of a TMM on cold starting (Figure 18).

The system is able to distribute or shut off the coolant due to the combination of a coolant pump and two valves instead of a coolant pump and a thermostat. The shut-off function is particularly attractive for the cold-start strategy. This has a significant influence on the fuel consumption figures in the NEDC. Schaeffler tested two different operating strategies for the TMM with this

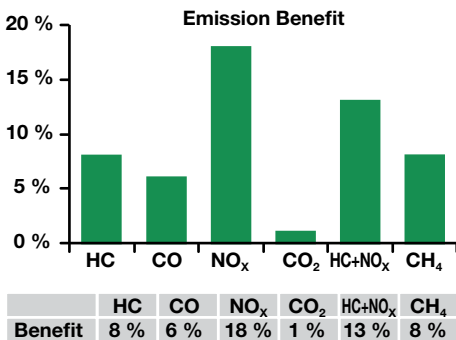


**Figure 19** Load-based temperature control on a modified naturally aspirated engine

setup: Zero flow for quick heating and load-based temperature variations (part load 110 °C, full load 85 °C) (Figure 19).

The temperature curve in Figure 19 does not correspond with the real values because motion of the coolant and a change in coolant temperature do not occur until after 100 seconds. The temperature can subsequently be

maintained at a constant level +/- 2 °C using a simple calculation model. This system can react immediately to the driver's load requirements and significantly reduce the temperature. The zero flow strategy alone resulted in a reduction in fuel consumption of 1.2 %. In addition, significant reductions in secondary exhaust gases such as HC, NO<sub>x</sub> or CH<sub>4</sub> were achieved by means of the higher exhaust gas temperature and operation of the catalytic converter at an earlier stage (Figure 20). Even though these results are impressive at first glance, the full potential can only be realized in close collaboration with heat physicists from automobile manufacturers.



**Figure 20** Reduction in secondary exhaust gases due to operation of the catalytic converter at an earlier stage

## Gasoline Technology Car

Schaeffler has built a concept vehicle called the Gasoline Technology Car (GTC) using advanced components on the basis of a

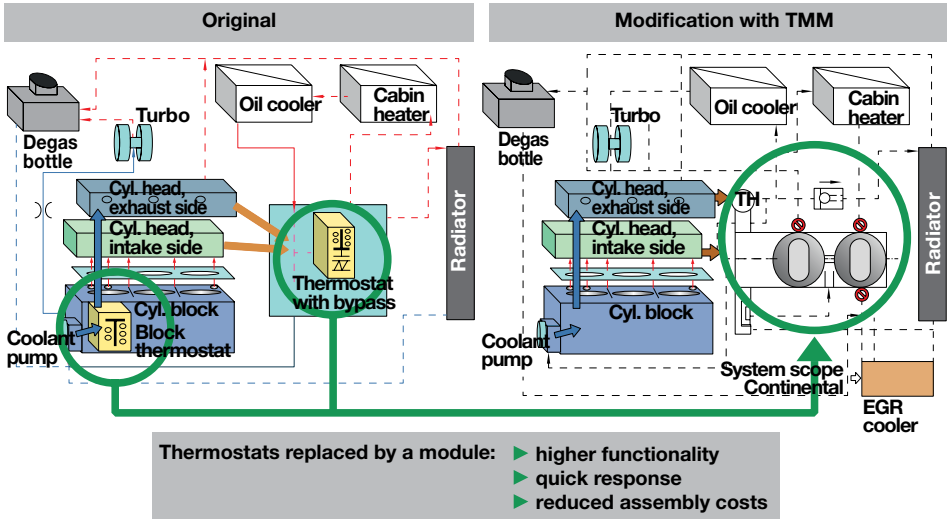


Figure 21 Design of the GTC with advanced Schaeffler components

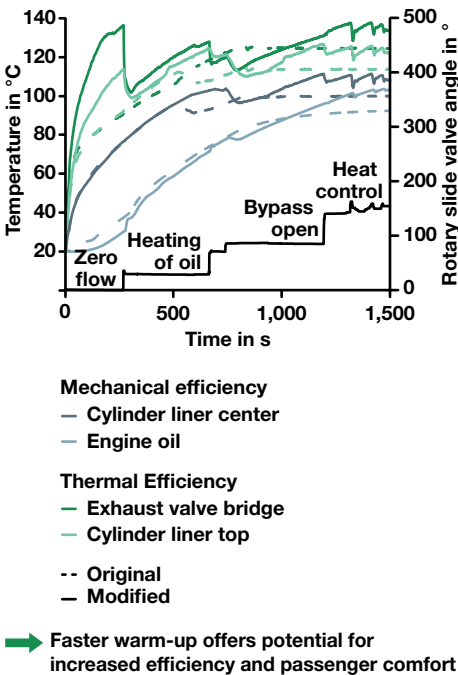


Figure 22 Faster heating for increased efficiency and comfort

Ford Focus with a 1.0 liter Fox engine. The original engine has two thermostats. One of the thermostats is used for block control, the second operates the radiator. These two thermostats were replaced in the GTC by a TMM, which bundles the functions and is also able to switch the oil cooler on and off (Figure 21).

In contrast to the original engine, it is possible to realize a zero flow due to the integration of the TMM. The required module is so compact that it can be fitted in the existing design envelope of the main thermostat. The results of the first tests show a significant increase in the thermal and mechanical efficiency (Figure 22). Also in the GTC, the significantly faster increase in the temperature of the exhaust gas leads to a more rapid response of the catalytic converter and reduced secondary exhaust gases.

The heating of the oil is slower despite the steeper heating curve because there is no flow through the oil/water heat exchanger in the initial phase. The objective is to achieve the optimum switching point be-

tween thermal and mechanical efficiency. This depends on both the engine architecture and the parameters of the engine oil used. The closer the collaboration with the automobile manufacturer, the more efficient the realization of potential will be.

Even though the presented results are only an approximate model of the first tests, these measurements show that the difference in temperature gradients is significant and the system offers an additional degree of freedom for engine design. Fine calibration of the engine control unit at Continental will result in a significant smoothing of the curves.

## Design of the cooling circuit for conventional powertrains

---

A multi-stage design is recommended for future cooling circuits of conventional powertrains on the basis of the findings presented in this article. A zero flow phase should initially ensure that the interior of the engine is heated in order to enable a rapid reaction of the catalytic converter. A bypass with an integrated oil cooler or heater offers the required flexibility. The decoupling of the OWHE from the bypass with variable inlet control allows an additional degree of freedom.

After dealing with the engine control, the conditioning of the transmission must be taken into consideration. The requirements for transmissions will also increase due to the increasing number of gear ratios and bearing positions. There is still a large potential for increasing the efficiency of hydraulically actuated transmissions. Initial tests have already been carried out on double clutch transmissions.

**Open Access.** This chapter is distributed under the terms of the Creative Commons Attribution Noncommercial License, which permits any noncommercial use, distribution, and reproduction in any medium, provided the original author(s) and source are credited.

The radiator's control system should decouple as much thermal mass as possible. This means the focus can be placed on efficiency with normal or warm ambient air and on comfort with cold ambient air. The use of finely regulated systems instead of conventional on/off switches offers significant potential.

## Outlook

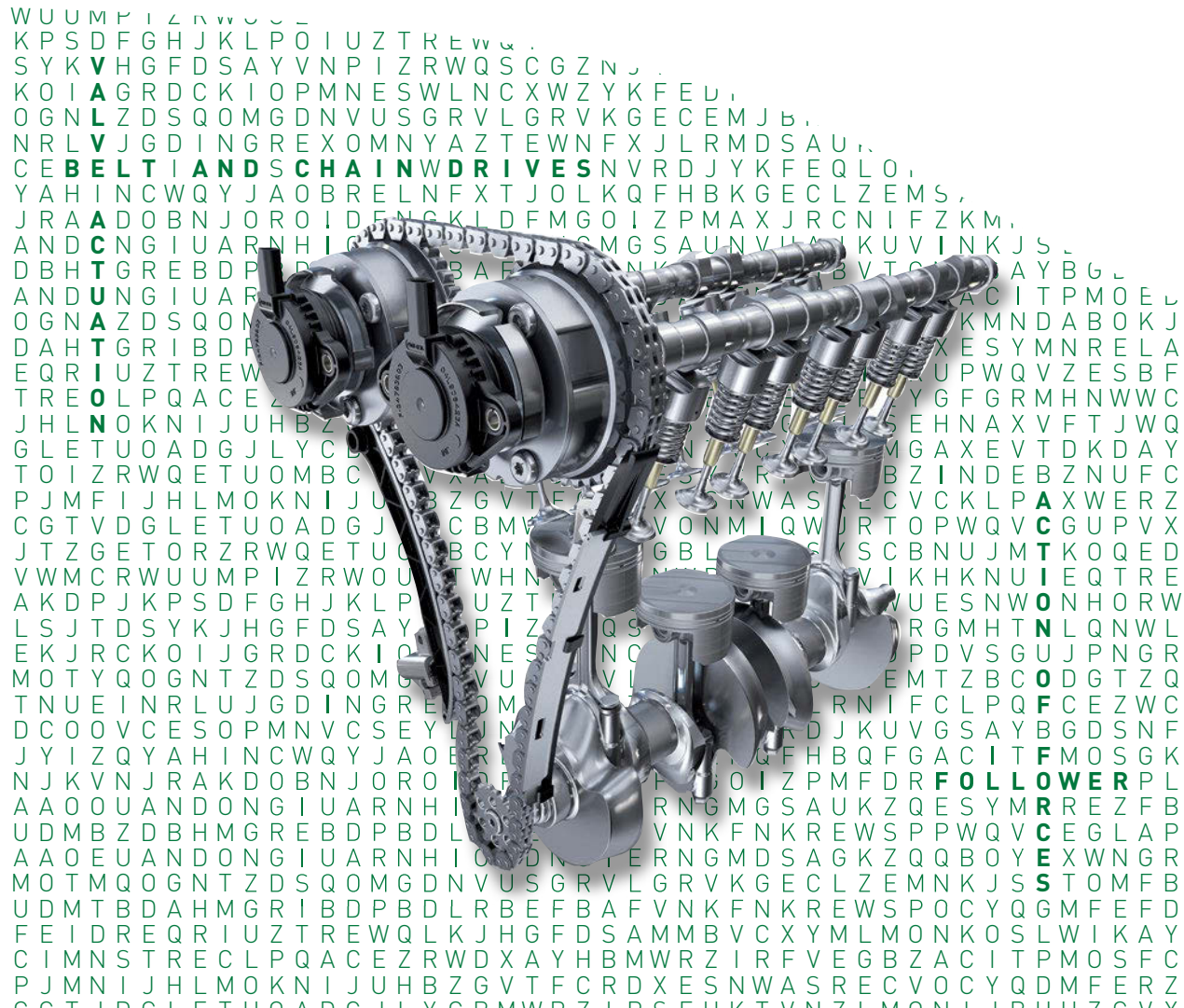
---

Mechatronic systems for coolant control are a trend with the potential to optimize the fuel consumption and emission characteristics of vehicles and at the same time increase the air conditioning comfort in vehicle interiors. This results in a wide range of design options for specific designs depending on the configuration of the powertrain. As a partner with a holistic approach in development and production, Schaeffler offers concepts with a wide range of options.

## Literature

---

- [1] Eiser, A.; Doerr, J.; Jung, M.; Adam, S.: Der neue 1,8-l-TFSI-Motor von Audi. MTZ 6/2011, pp. 466-474





# Hidden Potential between the Crankshaft and Valves

From the optimization of components to the optimum valve train

Dirk Sass

# 22



## Introduction

The design of timing drives in modern internal combustion engines is affected by a large number of parameters, which influence each other. Engine development usually starts from the top down, i.e. with the control of the charge cycle. This approach carries the risk that target conflicts are caused by systems that are taken into consideration at a later date, for example, if adjustment of the timing drive to suit the special design features of the crankshaft results in negative effects for the camshaft phasing system.

Experience shows that the development process currently used cannot realize all the available optimization potential. The challenge is to define all subsystems in detail at the very beginning of development so that the optimum is achieved at system level. This type of demanding development work can only be managed if all departments involved – both from the automobile manufacturer and the supplier – collaborate even more intensively. The organization must allow component development experts to use the available in-house systems expertise at any time.

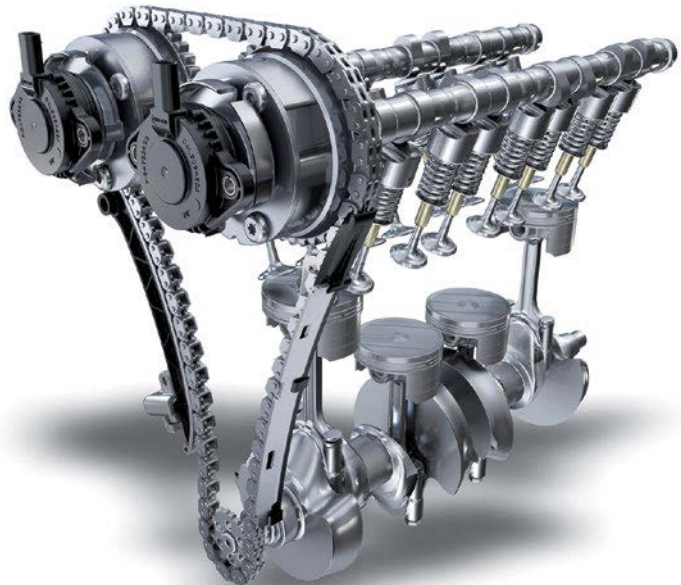
## The entire system

### Definition

The entire timing drive system includes the camshaft drive itself with a chain or belt, the camshaft phasing unit and the different designs of valve actuation (Figure 1). This may also include a spur gear – if only one of the two overhead camshafts are directly driven – as well as the connection to the crankshaft.

### Higher-level development targets

The target of designing an optimum valve train follows the normal premises of engine development: The priority is to safeguard



**Figure 1** The entire timing drive system: Camshaft drive with a chain as in this photo or with a belt, camshaft phasing unit and different designs of valve actuation

the function of individual systems throughout the operating life. An additional focus of development is placed on minimizing friction in the entire system. Almost as much importance is now attached to this task as achieving the functional targets. Efforts to minimize noise emissions and, in particular, the moving mass have also become established development tasks. Today's preferred designs are derived from these requirements. The procedures used for developing valve train systems for many years have led to a great deal of expertise in this area. This means it is possible to draw up a design proposal for the valve train during the concept phase of the engine. And this is precisely where the dilemma starts: What might be the optimum valve train design can have grave disadvantages for the following systems and vice versa. The typical development process of a valve train describes this challenge.

## Initial situation in development

---

The main approach in engine development is to define the charge cycle processes. This ensures that the most important requirements in the requirements specification such as power, torque and exhaust gas values are met. The first individual system to be considered is therefore the valve train. In this development stage, it is important to select the optimum concept for the relevant application from numerous possible variants. During the second stage, a decision is made on whether and to what extent phase position adjustment of the camshafts is required. It is worth mentioning that responsibility is frequently transferred to another department during this

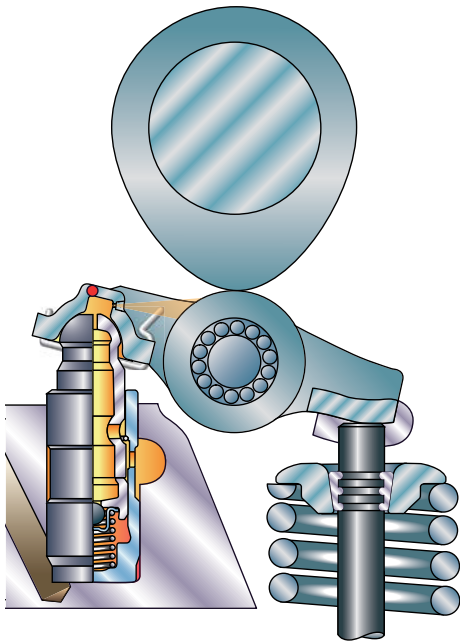
phase. Different employees design the timing drive during the third stage and integrate it into the engine while taking the first of the above mentioned restrictions into consideration. Work is usually carried out on a phased basis. With this approach, each individual development department must adhere strictly to the requirements, regardless of the knowledge that the requirements for the adjacent systems can force them to use a design for their own component, which falls short of the optimum in certain circumstances. Frequently, only marginal adjustments of the requirements for adjacent functions would be sufficient to open up new options for the system under development.

The assessment of this process shows both sides of the coin: On the one hand, extensive expertise is created up to the subsystem and component levels. On the other hand, it enables the realization of a global optimum using, in principle, unnecessary iterations. This dilemma can be solved if the automobile manufacturers involve their suppliers in development at the beginning of the concept phase in order to combine the expertise at component and system level of all those involved. A comprehensive consultation is most effective during this early phase. Some examples based on practical experience illustrate the potential for improvement.

## Approaches for optimizing friction

---

With mechanical or hydraulic tappets, roller tappets, roller followers or finger followers, development engineers have a wide variety of reliable technologies that have been tested worldwide. Well designed



**Figure 2** Example of a “pulled” follower

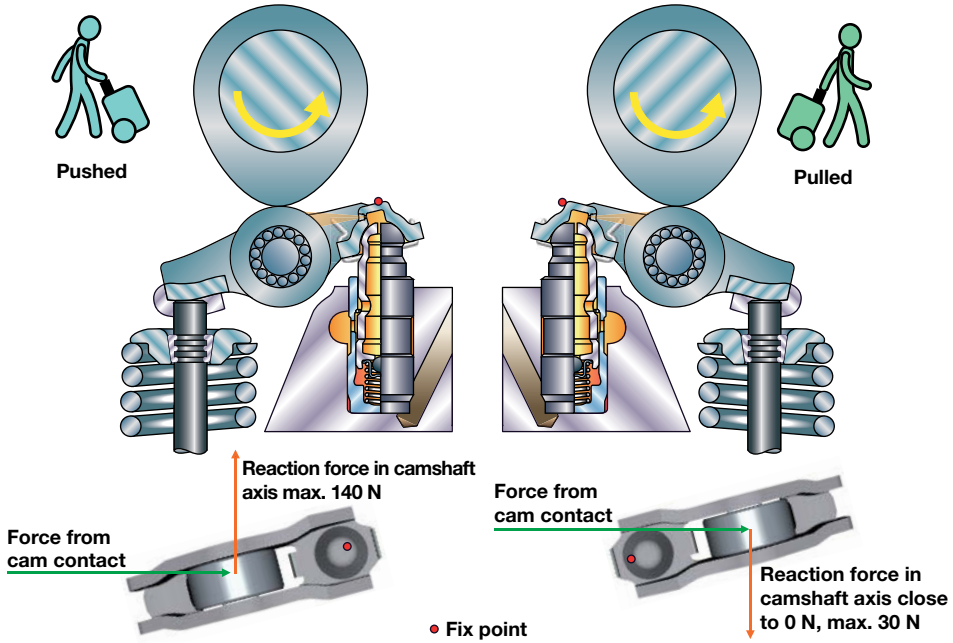
roller-type finger follower valve trains in combination with hydraulic pivot elements usually have significant advantages with regard to their friction behavior compared to other concepts. This conclusion was reached after carrying out extensive tests on externally-driven cylinder heads. The arrangement of the camshaft in the cylinder head in relation to the space between the hydraulic pivot element and valve stem end can require a mounting position of the finger followers, which Schaeffler describes as a “pulled” follower arrangement (Figure 2).

Further tests of the finger follower valve train have shown that the “pulled” follower has advantages over the “pushed” follower arrangement. This is because skewing of the “pushed” follower occurs under load due to its design (Figure 3). The “pulled” follower prevents this because it is self-aligning.

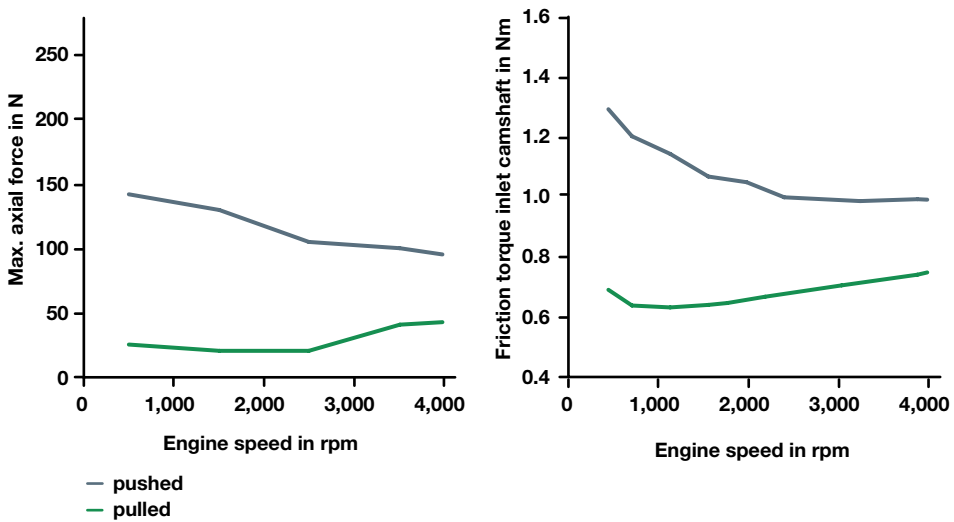
This is because the load is applied differently to the the follower by the cam. In a “pushed” valve train, the cams can cause misalignment in an axial direction at one end of the finger follower at low to medium speeds. At the other end, the follower is located in position on the pivot element by a spherical piston head, which acts as a guide. “Pushing” in a lateral direction is prevented by the geometry at the pivot element so that the resultant force acting on the follower cannot generate any further movement. At the other end, the lateral guides of the finger follower are in contact with the valve stem so that an equilibrium of forces exists between the valve and the cam. The forces acting through all the followers on the entire shaft are totalized because the finger followers usually have a preferred direction. The simulation of this arrangement shows that the entire camshaft is ultimately pressed into its axial bearing support. Corresponding tests clearly confirm the theoretically derived motion for all the tested parameter variations.

The increased force in the direction of the camshaft axis causes a higher drag torque of the cylinder head – which is greater if conventional plain bearings are used. Tests have confirmed the conclusion that rolling bearings are advantageous here. This effect is reduced with increasing speeds because the time available for the cam lift is not sufficient to cause a significant increase in the axial force.

In the case of the pulled valve train design, the movement of the cam “pulls” the finger follower directly away from its fixed point – the spherical piston head on the pivot element. This process is comparable with pulling a conventional suitcase on two rollers: The handle corresponds to the spherical piston head as the location, and the force is also applied here via the rollers, only on the floor instead of via a



**Figure 3** Comparison of forces acting on a “pulled” and a “pushed” follower



**Figure 4** Friction of a “pushed” follower compared with a “pulled” follower in relation to the speed

cam. The resulting “pulling” force aligns the case in a straight line. However, if the case is pushed, it will veer to the side after a short distance. This pushed arrangement corresponds with the “pushed” follower.

The force values recorded in comparison measurements correlate consistently with the friction measurements and verify the theory that with this combination no relevant transverse forces act on the camshaft. In a comparison of both directions of

camshaft rotation, the “pulled” follower concept has approximately 40 % less friction at low speeds (Figure 4). This direction of camshaft rotation has around 30 % less friction at a speed of 4,000 rpm.

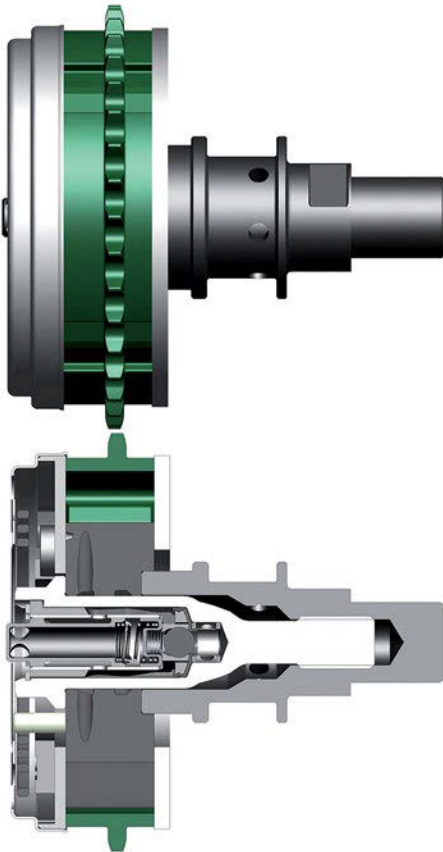
The camshafts must be suitably positioned in order to realize this type of finger follower arrangement. The decisive reference point is the position of the finger follower roller. The boundary conditions for the timing drive and particularly for the phasing unit change significantly depending on this position.

The distance between the camshafts in combination with the maximum section height of the engine – this is defined from the requirements for the protection of pedestrians – are the most important specifications for subsequent designs.

## Challenges during the optimization of the entire system

### Camshaft phasing units

A suitable camshaft phasing system is selected according to the required adjustment speed and adjustment force as well as the adjustment angle, which must be covered. The oil pressure is also a relevant input variable because hydraulic systems are normally used. The required performance data determine the effective hydraulic surfaces and therefore the minimum size of the system. However, the available mounting space is usually limited. If the ideal position of the camshafts in relation to the adjacent construction is not possible it will have the following implications: The maximum possible outside diameter for the phasing unit is automati-

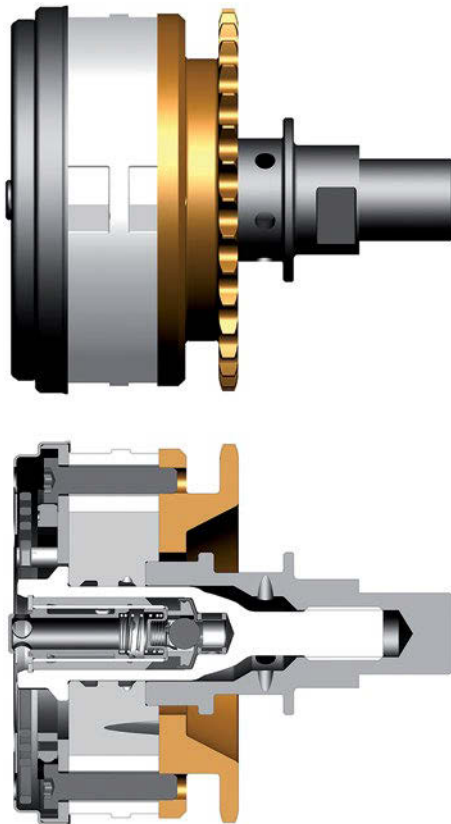


**Figure 5** A positive example: The camshaft phasing unit is narrow, the sprocket is located on the camshaft

cally reduced if there is a smaller distance between the camshafts. But if the camshafts have to be positioned further apart, they may be too close to the lateral limits of the cylinder head or valve cover. In this case, the only solution is to extend the design envelope in a longitudinal direction to ensure the phasing unit has the required hydraulic power. The first conflict of objectives occurs if this solution is not possible. However, not all the questions are answered even if a phasing unit with a longer design is possible (Figures 5 and 6): The latter must be screw mounted, i.e. the cover and sprocket are clamped together by a number of screws, which pass through the phasing unit. The forces required are relatively high and the design of the screw connection is very complex and critical. In addition, the sprocket is no longer directly located on the shaft. In contrast to a sprocket fitted directly on the shaft, the screw connection leads to tolerances, which affect the radial runout of the system. This imbalance causes additional excitations, which can impair the adjustment function, or have further disruptive effects on the smooth running of the timing drive.

The outside diameter of a phasing unit with a specified length is not only defined by the power requirements of the hydraulic system but also by the specified ratio of 1:2 between the teeth on the crankshaft and camshaft. This requires a fixed number of teeth - usually an even number - on the camshaft. Not all possible combinations can be realized in practice: If the "correct" combination in relation to the number of teeth required on the camshaft results in an outside diameter, which does not allow the specified distance between the camshafts, it cannot be implemented as in the converse case. The system is then too small and cannot transmit the required power due to physical reasons.

This can ultimately mean that the targets must be changed or a completely different solution must be developed. One alternative is an arrangement where only one camshaft is directly driven by the timing drive. This means the problem regarding the restricted space between the camshafts is rectified and the outside diameter is only limited by the section height of the engine in the vehicle. This is generally the normal approach for timing drives although this measure



**Figure 6** A negative example: The cover and sprocket of the phasing unit are clamped together by means of screws. Any tolerances can affect the radial runout.

does have an impact if the engine is considered as a whole.

Firstly, a drive must be provided for the second camshaft – either a second chain or belt drive or a spur gear stage. This always creates additional space requirements in the longitudinal direction of the engine. In certain circumstances, the camshafts must also be extended. The design of the cylinder head and valve cover is significantly more complex on this side. Even an oil supply must be integrated if a hydraulic tensioner is required for an additional chain drive. Firstly, this means an additional consumer must be taken into consideration in the oil system. Secondly, it results in an increased outlay when designing the oil ducts. These changes inevitably result in a heavier and more expensive engine. Additional process steps are also required in volume production assembly. Because more highly-dynamic components are used, the system is also more susceptible to vibration and noise generation, which can sometimes only be managed by using complex solutions; this applies especially to spur gear stages.

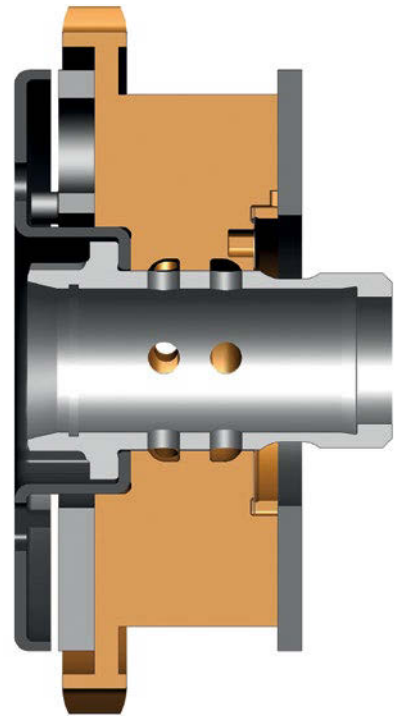
Last but not least, these components also generate friction in addition to noise, weight and costs. The resultant friction losses under unfavorable conditions are larger than those, which the change to a “pulled” valve train eliminated. In the worst case, the net result is worse than a concept where compromises have been made in the design of the valve train if it is equipped with an optimum camshaft phasing system.

### Track position of the chain or belt drive

In addition to the design analysis described above, the position of the chain or belt track relative to the first camshaft

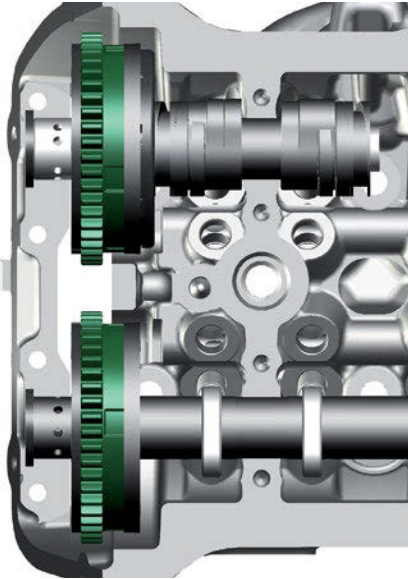
bearing has a significant influence on the phasing unit concept. If there are many unfavorable requirements resulting from the design and arrangement of the adjacent components, this can lead to solutions as shown in Figure 7.

There are noticeable restrictions for the required phasing unit concept. The stator implemented here may be regarded as a sophisticated design but its manufacture is very expensive. Further costs are incurred during manufacturing because additional quality assurance measures are required. Clever positioning of the track for the chain or belt drive would allow a phasing unit design, which not



**Figure 7** A negative example: The phasing unit gear is connected via a narrow web. Manufacture of the stator is expensive.








**Figure 8** A positive example: The chain runs centrally in the chain tunnel

only operates more efficiently but also has a positive influence on the timing drive due to its reduced mass (Figure 8). Lightweight components usually cannot fully compensate for the increased weight of a design because they soon reach their limits with regard to component strength.

### Selection of the chain or belt drive

The decision about whether the requirements are better met by using a chain or a belt timing drive must be clarified initially depending on the complexity and number of shafts to be driven. Chain drives and dry toothed belt drives have the longest history on the market and have reached a corresponding level of sophistication (Figure 9). In contrast, the wet belt or BiO (belt in oil) is still a new product. If correctly designed, all three types of drives are com-

	Chain	Belt in Oil	Dry Belt
Technology competition			
Challenges	<ul style="list-style-type: none"> <li>▶ Wear</li> <li>▶ NVH</li> <li>▶ Friction</li> <li>▶ ...</li> </ul>	<ul style="list-style-type: none"> <li>▶ Durability</li> <li>▶ Media resistance</li> <li>▶ Axial space</li> <li>▶ ...</li> </ul>	<ul style="list-style-type: none"> <li>▶ Contamination</li> <li>▶ Sealing of VCT</li> <li>▶ Axial space</li> <li>▶ ...</li> </ul>
Parameters	<ul style="list-style-type: none"> <li>▶ Chain width/length</li> <li>▶ Max. diameter of crankshaft sprocket</li> <li>▶ Reasonable kinematics</li> <li>▶ ...</li> </ul>	<ul style="list-style-type: none"> <li>▶ Belt width/length</li> <li>▶ Max. diameter of crankshaft sprocket</li> <li>▶ Reasonable kinematics</li> <li>▶ ...</li> </ul>	<ul style="list-style-type: none"> <li>▶ Belt width/length</li> <li>▶ Max. diameter of crankshaft sprocket</li> <li>▶ Reasonable kinematics</li> <li>▶ ...</li> </ul>

**Figure 9** Whether it is a chain, belt in oil or dry belt: The specific requirements determine the selection of the chain or belt drive

parable with regard to their operating life. Irrespective of the type of chain or belt drive used, it is important to start the detailed design at an early stage in order to precisely work out all the potentials and risks. Even if it has favorable prerequisites, an effective, low-friction system can still fail to meet the targets with regard to important parameters. In some cases, moving the location of the camshaft by just a few tenths of a millimeter is sufficient to turn a good system into an unsatisfactory system.

### **Belt**

If a decision is made to use a dry toothed belt, the engine and camshaft phasing units must be sealed against the ingress of oil from the engine's oil circuit. This negative effect is compensated by the advantage that a high measure of flexibility is maintained during the implementation of the design. A belt in oil eliminates this disadvantage. This can result in a slight advantage with regard to noise emissions due to the integration of the belt into the engine, although this depends on the application. The belt in oil allows the same degree of design freedom as the dry belt. In comparison to a chain, both designs of belt have the advantage that timing belts with an odd number of teeth can be manufactured. This means it is easier to make adjustments to the entire arrangement. In contrast, smaller sprocket diameters are possible with chains without having a detrimental effect on the operating life.

### **Chain**

As in the case of a belt, the first step is usually to determine the required number of sprocket teeth on the shafts. Ideally, the number should be as large as possible in order to minimize the polygon effect. At the same time, a check is made to ensure that the number of chain links re-

quired is not a common multiple of the number of teeth on the crankshaft sprocket. This results in improved noise and wear behavior. The length of chain required is determined from the number of teeth and the distance between the shafts. Chain drives can only be manufactured in variants with an even number of chain links. This has a significant influence on the chain line. It is worthwhile investing sufficient time in consideration of the possible variants with regard to chain pitches, the possible number of teeth and design of the chain line. An ideally designed chain line usually ensures quiet and dynamically correct running of the entire system in the fired engine. It also forms the basis for a low-friction system.

### **Interdependence with adjacent components**

Individual boundary conditions, for example design envelope requirements, are occasionally so restrictive that they lead to functional impairments. This can mean that chain guides with pronounced curves must be inserted in the driving side of the chain drive. These inevitably increase the friction due to the higher normal forces. This also applies for a belt if it requires a pulley on the driving side.

The slack side is assessed differently. Excitations on the system resulting from dynamic chain loads are damped by the chain tensioner via the tensioning rail arranged on the slack side of the chain drive. The form of the rail affects the way and intensity, with which these impulses are transmitted. However, the first impression does not always correspond with the actual result: A clever design – even one with small radii – allows lower mean chain forces to be achieved than in chain drives designed to reduce the normal force acting on the sliding layers by means of an exaggerated “straight” guide.

## Summary

---

The current structures in development departments correspond to the technical content of their systems. This is why it is difficult to consider all the systematic effects of valve control components. Experience at Schaeffler shows that optimization at component level does not often lead to the best possible result with regard to the entire system. In the worse case, for example, the net result of an optimized valve actuation system is worse than a concept which allows compromises in the design of the valve train if it is equipped with an optimum camshaft phasing system. This situation can ultimately mean that the targets must be changed or a completely different solution must be developed. Current projects confirm that the automobile manufacturers come to the same conclusion in their analysis of the development process. There are different approaches for implementing a more efficient development process. Schaeffler achieves this by bundling all development and application engineering departments in one organization. It is also helpful if all the components of interactive systems are jointly developed at all locations. This simplifies matching the components to one another. It is highly recommended that system suppliers are involved in the new and further development of valve trains at the earliest possible stage. This allows the opening up of potential that was previously unused and rapidly leads to success.

NODHIGUAEASMSUC  
 OIEUGIAFEDONEIUAMUHIC  
 UNODHIOEASMI OBRNLNFXTJGLD  
 UOIEUGIAFEDOTFIUDLDBEUBAFV  
 AUDMPBDBHMGRR OGIKCKPMNESW  
 AUDMPB S BHMGR I JDPHIOGDNOI  
 EAATR UUNDONG O UARPMNESWLN  
 MAMOEF R I C T I O N F P A R T N E R S  
 TEKJICFOI JGRDAKIEEOMNYAZTE  
 DMOTMQAGNTZDUFOMYLINNEWCLV  
 JTNUGICARLUJGRUVNGOBRNLNF  
 KDCOSV EESOPMNVCSQAYCBEFV  
 ZJYIJQDAHINCWQYJPMNESWLN  
 TKPELOSMS E BUNOPLU HNGFTS  
 CROETRWP O I UZTRF ENDRRTCAS  
 BEFSHECECFHOKH LUYGSGEBE  
 SOBPIOSGBZNFTEENMZS  
 FEIWRERQUIUAMORBYX  
 CWDAYWTRDNUJMIKOQA  
 PJMFIJHLMGKNUTEQTF  
 CGTVDGLETU EUHBZGWR  
 JTZGEFOIZR MHTILQNV  
 VWMCRIUUMPISGWJPN  
 AKDPJIPSDFGBCSDGTR  
 LSJTDCIKYKJHGF P QACEDZR  
 EKJRCTOIJGRD YBGDSW  
 MOTYQIGNTZDSCTPMOSG  
 TNUELORLUJGDIN DABOIZ  
 DCOOIN ESOPMNVSELEJNEWCLV  
 JYIZAYAHINCWQYJA O BRELNFXT  
 NJKVI L RAKDOBNJ O R O I D F N G  
 AAOOV I N D O N G I U A R N H I O G D  
 UDM S E N S O T E C T B D P B D L R B E  
 AAOEK I N D O N G I U A R N H I O G D  
 MOTM O N G N T Z D S Q O M G D N V U  
 UDM T B G B H M G R I B D P B D L R B  
 FEI D R E Q R I U Z T R E W Q L K J H  
 C I M N S T R E C L P Q A C E Z R W D  
 PJMNI JHLMOKNIJUHBZGVTFC  
 CGTJ D G L E T U O A D G J L Y C B M  
 JTZUETO I Z R W Q E T U O M B C Y N



# Friction Tailored to Your Requirements

You wish,  
we deliver

Tim Hosenfeldt  
Edgar Schulz  
Juergen Gierl  
Stefan Steinmetz

# 23



## Introduction

In any discussion about reducing fuel consumption, attention quickly turns to powertrain hybridization. However, the fact that a saving of 15 % can be achieved simply by minimizing friction is often overlooked. This has been demonstrated by Schaeffler in various studies over the past few years. The costs required to reduce CO<sub>2</sub> emissions by 1 g/km can be kept well below those of electrifying the drive.

However, friction is not a parameter that must be minimized in every case. Without friction, movement is not possible in our daily lives – and this includes driving cars. Both involve requirements that can only be met if different friction conditions interact in the desired fashion – similar to a classic cross-country skier: The skier hopes that in his tribological system – consisting of the shape of the skis, their sliding layer, and the snow – friction will remain as low as possible when going downhill. By contrast, when going uphill, the skier ideally requires adhesive friction to move up the hill quickly and without having to use too much energy.

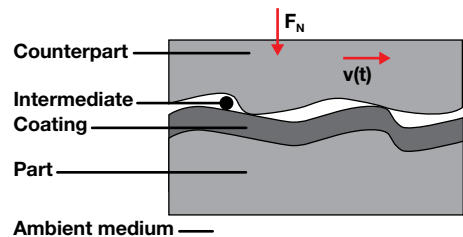
Even when seen from a tribological standpoint, the optimization of a system or of an entire powertrain must always be subjected to a cost-benefit analysis and ensure that the functional requirements for the overall system and its components are fulfilled. The service life, for instance, must not be less than that stipulated in the requirements specification. That is why the experts working at Schaefflers' Surface Technology Competence Center depend on the systems expertise available in the company when developing highly specific coating solutions.

## Basic principles

### Tribological system

#### System details

According to conventional definitions, a tribological system consists of four elements [1]: The part and the counterpart – these two move relative to each other – and the interfacial medium as well as the ambient medium. Now, new types of coating systems in the micrometer and nanometer range are adding another element that has a significant influence on the properties of tribological systems and that can be used to adjust these systems for a specific purpose (Figure 1).



**Figure 1** Structure of the tribological system [1]

#### Friction in tribological systems

The amount of friction that occurs in a tribological system is influenced by a range of factors. In addition to the load applied and the lubricant characteristics, the surface of the active areas is particularly significant. The most important surface characteristics that determine friction and wear include the following [2]:

- The chemical composition of the surfaces that can be changed by pretreatment or during operation by reactive layers on the component surface.

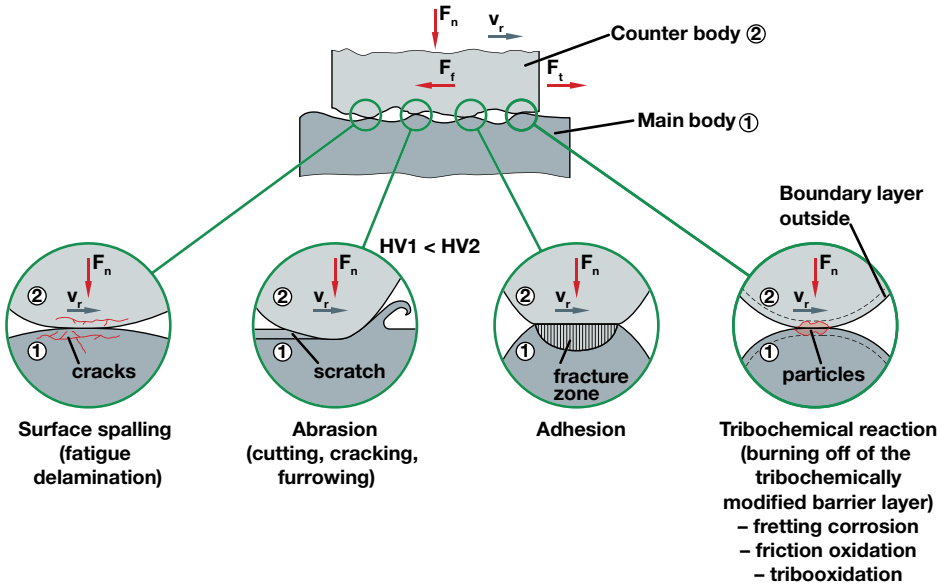


Figure 2 Overview of wear mechanisms

- The hardness and Young's modulus of the materials used. A hard surface alone does not protect a component if the basic material underneath can easily undergo plastic deformation.
- The surface structure not only affects lubricant film formation but also the force applied to the surface and thus surface fatigue.
- Interaction of the surface and the lubricant.

Generally, a distinction is made between four wear mechanisms (Figure 2). Abrasive wear occurs as a result of the mechanical impact of a harder active surface on another surface or hard particles. Adhesive wear results from the molecular interaction when surface contact occurs in the contact interface. Tribochemical reactions change the contact interfaces by oxidation, for instance. Surface fatigue occurs if the material microstructure changes under mechanical stress.

There are various types of friction. The Stribeck curve is a good way to distinguish between the various types, as it can be

used to plot the relative motion of the active surfaces for a lubricated contact in relation to the friction torque that occurs (Figure 3).

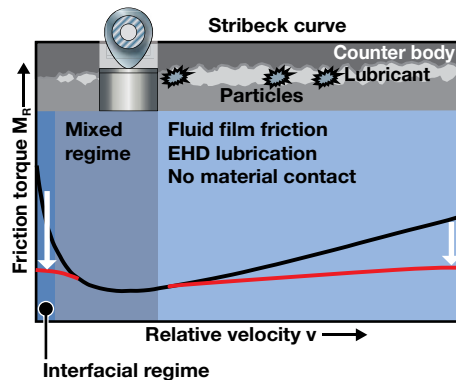


Figure 3 Curve of the friction torque in relation to the relative speed (Stribeck curve). The black curve shows the classic profile, the red curve shows the torque profile when using nano-structured, diamond-like coating systems in the valve train.

## Surface technology

In addition to the lubricant, the material and surface quality of a bearing also have significant influence on friction and wear behavior. The properties of the material close to the surface are changed to improve the tribological characteristics of engine and transmission bearings. The initial approach here is to achieve smoothing by reducing the roughness peaks, such as by honing the raceways. Additional improvement can be achieved by changing the surface through heat treatment and coating. Conventional methods here are black oxide finishing and carbonitriding. Chrome-plated surfaces are often used for engine and transmission components that are subjected to high stress levels.

State-of-the-art carbon thin film coating systems usually do not consist of a single layer but of up to 100 layers in the nanometer range that perform certain functions. The exact layer structure is matched to the relevant application and requirements [3].

## Analysis, calculation, and simulation

It is not unusual for tribological aggregate loading conditions not to be fully known as part of component development. That is why the services of Schaeffler's Surface Technology Competence Center include a

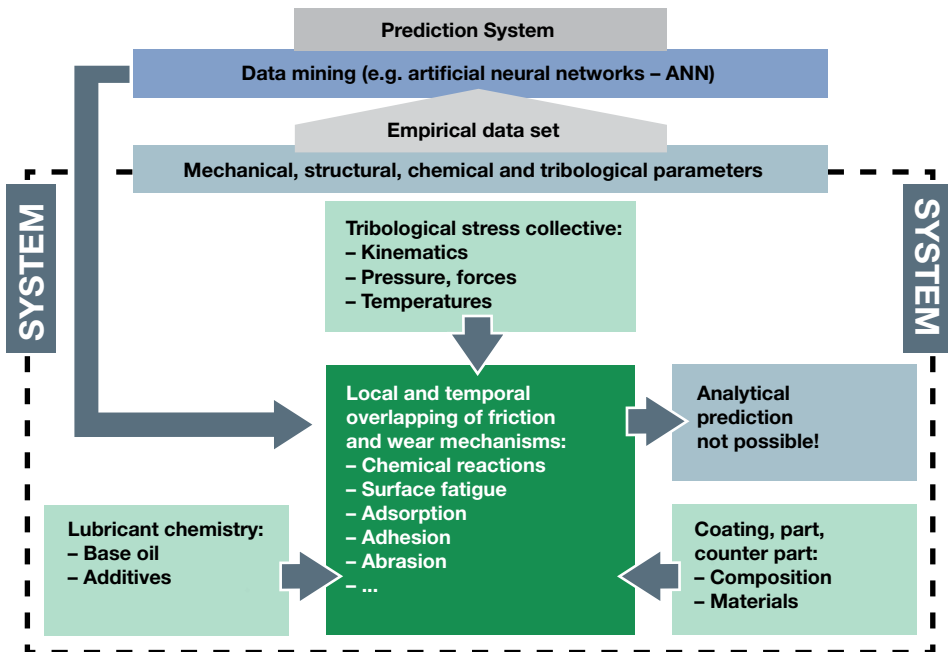
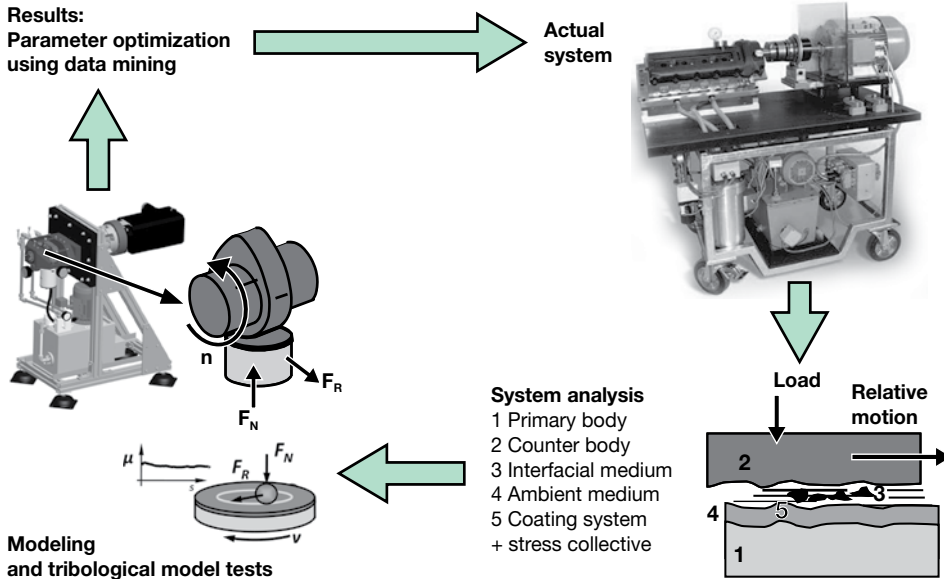


Figure 4 Method for predicting friction based on empirical data [4]





**Figure 5** Data mining as part of the development process for coatings [4]

comprehensive analysis of the initial situation. A standardized procedure ensures, for instance, that all relevant parameters are entered.

A good development strategy always takes the overall system into consideration. This is the only way to develop a rolling bearing that is optimally designed for a specific application. Against this background, Schaeffler has expanded its tried and tested Bearinx® calculation program to include an analytical model for calculating rolling bearing friction. This model takes a wide range of parameters into consideration, such as real pressure distribution and internal bearing geometry. In addition to load distribution and service life, it permits the calculation of rolling bearing frictional torque and thus the power loss of entire shaft systems or transmissions.

Schaeffler has been breaking new ground in the development of the tribological system of components that are oil

lubricated and coated with customized diamond-like carbon coating systems. Due to the high complexity and interactions imminent to the system, the possibilities for analytically calculating tribological behavior is limited. The development and optimization of coatings for the surfaces of cams and bucket tappets that come into contact with each other has thus so far been based on experimental investigations and the experience of specialists. This method can be time-consuming and expensive.

For this reason, Schaeffler has developed a method that can predict the tribological behavior of camshaft and bucket tappet systems, for example. It is based on a combination of data mining and an artificial neural network and can be practiced with available experimental data [4] (Figure 4).

In this process, the artificial neural network learns the phenomenological correlations on which these data are based.

Their capability to “learn” non-linear correlations allows artificial neural networks to predict an input variable – such as the friction value – even in complex tribological systems. Influencing factors include the type of coating and its hardness, the surface quality, lubricant oil additives and their concentration, the base oil and its viscosity, and the material of the counterbody and its structure.

The suitability of an artificial neural network for this kind of application depends on its predictive accuracy. This is determined by entering data from an experiment that was not used to practice the model. Finally, the prediction is compared to the value measured in the experiment. The data mining process is thus integrated into the development process of coatings for tribological systems (Figure 5).

Although data mining programs already contain automated optimization algorithms, expertise is required to design the optimum network topology of the artificial neural network. The challenge lies in finding the optimum number and arrangement of neurons, the optimum number of input variables, the optimum parameters of the learning algorithm, and much more for specific data with a given number of examples.

Since artificial neural networks only approximate functional correlations in most cases, the evaluation of a learned model is one of the most important steps in data mining. This can be achieved through various methods. Schaeffler has found that a 10x10 cross validation or boot strap cross validation supplies the best results to predict the tribological behavior of a camshaft and bucket tappet system. Upon comparison with an externally driven cylinder head, a deviation of only 8 % was found – a very good result, especially when considering that the measurement error with reference to friction is at 5 % [4].

The use of such methods capable of “learning” can therefore reduce the time and costs spent on experimenting, secure available knowledge and use it efficiently for product development.

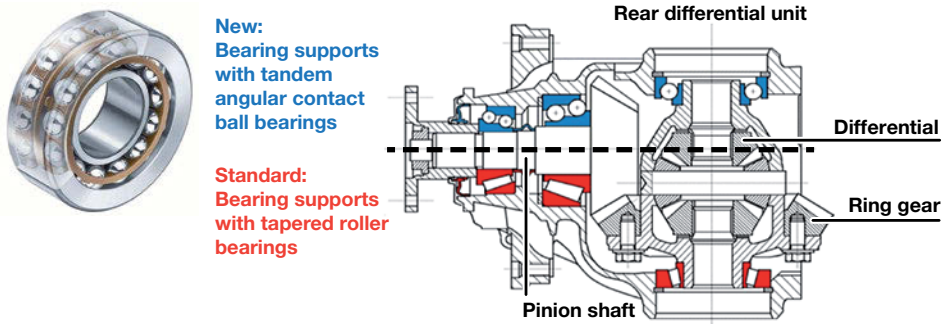
## Energy efficiency through minimized friction

---

### Influence of bearing designs

The friction occurring on the active surfaces of bearings is primarily determined by the selection of the bearing system and the bearing type and then by its design details. One example here are the bearing supports of the main shafts in the transmission. Locating non-locating bearings are increasingly used as an alternative for conventionally adjusted tapered roller bearings. Schaeffler has analyzed various applications to determine the effect a change in the bearing system can have on fuel reduction. For a compact car with a double clutch transmission, consumption was reduced by 3.8 % in the NEDC simply by changing the bearing system to locating non-locating bearings. Tandem angular contact ball bearings offer significant benefits in the rear axle differential. They replace the tapered roller bearings used in the past and develop a smaller contact surface and thus a lower friction torque while maintaining the same load carrying capacity (Figure 6). With regard to the vehicle, this results in a potential CO<sub>2</sub> reduction of 1.5 % that can be achieved at low cost.

Over the past few years, significant progress has been made by using rolling bearings instead of plain bearings. For in-



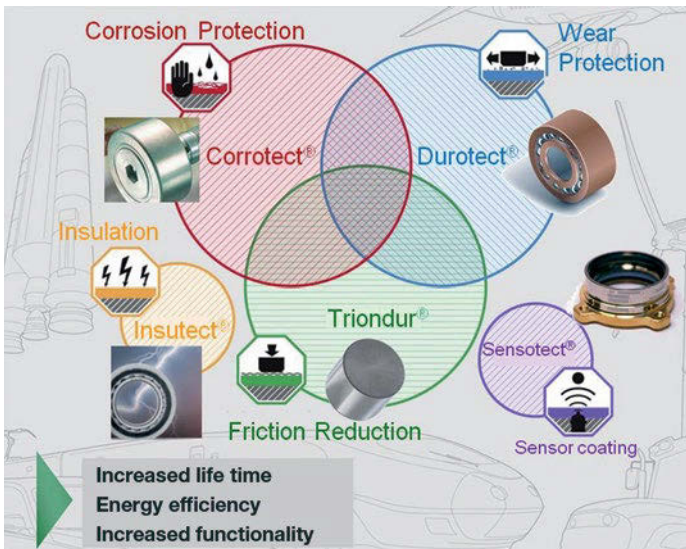
**Figure 6** Use of tandem angular contact ball bearings in the rear axle differential (blue) instead of tapered roller bearings (red)

stance, this is true for balance shafts in the engine. Changing to rolling bearings while also designing the components with an optimized weight can reduce CO<sub>2</sub> emissions by up to 2 % at a cost of less than ten euros per shaft. The cost-benefit ratio is just as favorable when switching from plain bearings to rolling bearings in the camshaft bearing supports.

### Coatings for specific requirements

The Schaeffler Coatings Center uses all of the coating technology methods and has a modular system for validated coatings that can meet any requirement: Corrotect® coatings made from a zinc-iron or zinc-nickel alloy provide corrosion protection,

Durotect® designates tribological coatings that are produced chemically. The coating configuration with iron oxide compounds is characterized by the fact that it has good dry running characteristics in the event of insufficient lubrication. Insutect® – which can be used as an aluminum oxide coating, for instance – has been used primarily in energy production for current insulation; at Schaeffler, it is mainly used



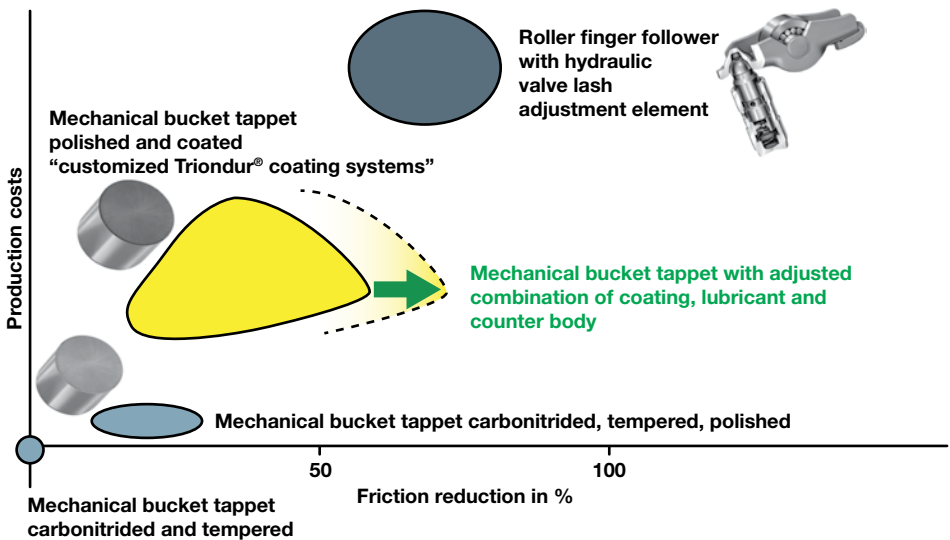
**Figure 7** Schaeffler modular coating system as a basis for coatings for specific requirements

for railway bearings, generators, and ship engines. With the hybridization of the powertrain, this coating has become more and more important for the automotive industry as well (Figure 7).

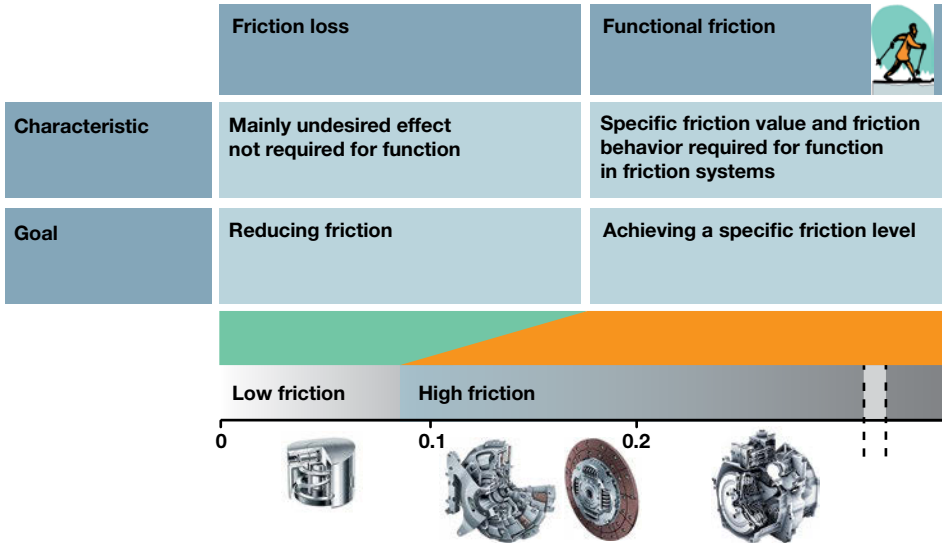
Over the past few years, nano-structured coating systems based on carbon have been used increasingly as an alternative for conventional surface technology processes, such as those developed by Schaeffler under the Triondur® brand name. In the power train, this type of coating system was initially used in bucket tappet valve trains because the cost-benefit ratio appeared to be especially interesting: By using a customized Triondur® diamond-like carbon (DLC) layer on the tappet base, the sliding contact surface for the cam, the tribological properties have improved so much that friction in the valve train has been reduced by half. The mechanical bucket tappet thus almost reaches the friction values of a roller finger follower [5]. In relation to the entire vehi-

cle, this means a reduction in CO<sub>2</sub> emissions of 1 to 2 % (Figure 8). Triondur® coating here offers excellent wear protection and hardly requires any design space at all with its layer thickness of only 2 to 3 microns.

Schaeffler has standardized both its coating processes and its coating facilities. The same machines used in volume production are used for new developments or adjustments from the start. The manufacturing process is developed along with the product. This ensures that the transfer from development in the coating process to worldwide volume production is stable and free of errors. The result is a consistently high level of quality irrespective of the manufacturing location.



**Figure 8** Triondur® DLC coatings improve friction behavior by up to 50 % and offer a high level of wear protection [5]



**Figure 9** Functional targets on the friction axis with product examples

## Functional friction

Similar to the cross-country skier mentioned earlier, friction in an automobile is not always a bad thing. In a bearing, the aim is to minimize friction, in an engaged clutch, a brake, or in a press fit, the aim is to maximize it. Here, friction is used for a very specific purpose. The latter can thus also be called “functional friction” (Figure 9).

Classic application examples of functional friction are clutches with a dry and oil-lubricated design, damping systems such as torsion dampers for clutch disks, and the synchronizing units in the transmission.

Like all systems in an automobile, the tribological system is in line with the downsizing trend, resulting in improved performance: Specified requirements for the friction value must be met with smaller components. In addition to the parameters relevant for tribology, such as the

sliding speed, temperature, and pressure, the system environment must be optimized continuously to supply customized friction.

One of the requirements is understanding friction phenomena. Analyses were previously limited to specific dimensions or scale levels; friction phenomena are often analyzed at the machine dynamics level. This means that the friction system is tested for a specific application, and conclusions are drawn from this. However, since friction occurs in the friction contact, the scale levels of contact mechanics must also be taken into consideration, such as the micro, meso, and nano levels. The atomic scale level can be left out here as it is used more for fundamental scientific research.

The consistency of methods and tools across the various scale levels – from materials to production – is an essential component for the detailed analysis and optimization of friction systems. The tools used at Schaeffler range from methods for analyzing systems and data to scale-specific test

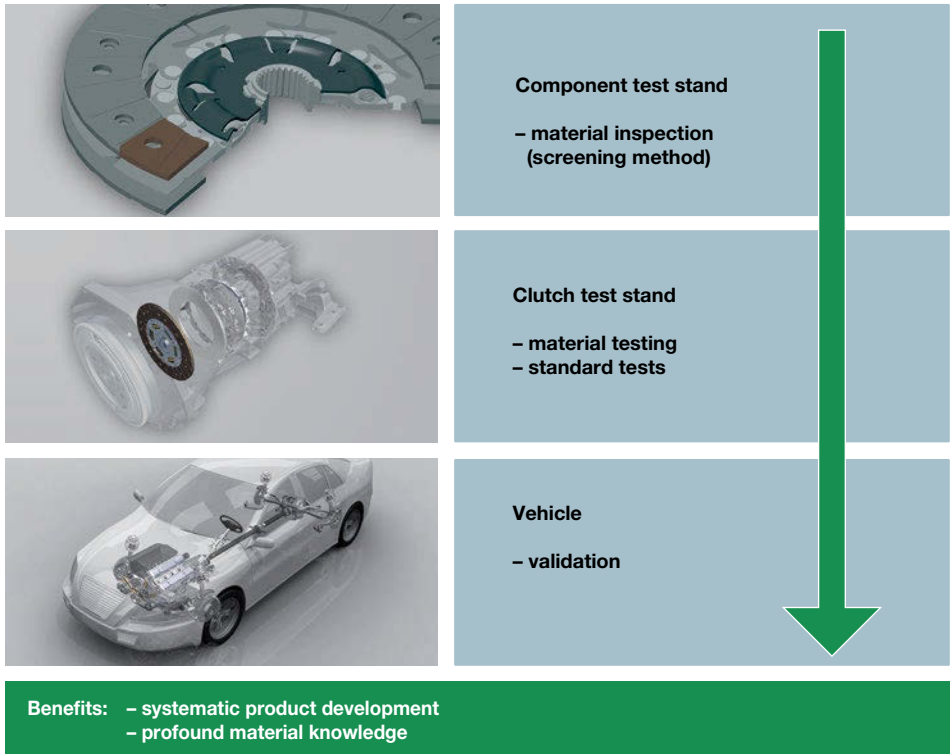
stands and materials analyses. The experts of the Schaeffler Group work together in an interdisciplinary fashion to use these methods efficiently.

**Dry running friction linings for clutches**

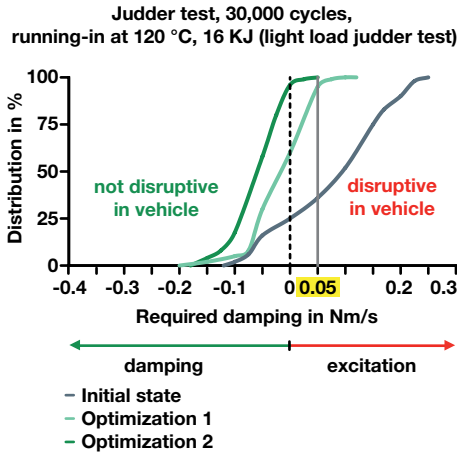
A dry running double clutch system represents a much greater challenge for the friction materials of the clutch than conventional manual transmissions. Inspections here range from the system level to sub-components and partial lining (Figure 10).

An essential parameter are the comfort properties of the friction material. These

are assessed by determining the damping behavior or excitation behavior of the friction material on a judder test stand (Figure 12). These inspections often show that damping decreases as the mean friction value increases; this means that friction vibrations increase. This behavior can be observed for all friction systems and appears to be a universally valid principle. The consistent application of standardized methods and tools has lately achieved considerable success. Figure 11 shows an example: The damping and excitation values were taken from a large number of tests with components that have different load profiles and plotted on a frequency scale. The significant improvement in the friction materials is clearly visible and re-



**Figure 10** Comprehensive lining development from partial lining investigation to complete clutch

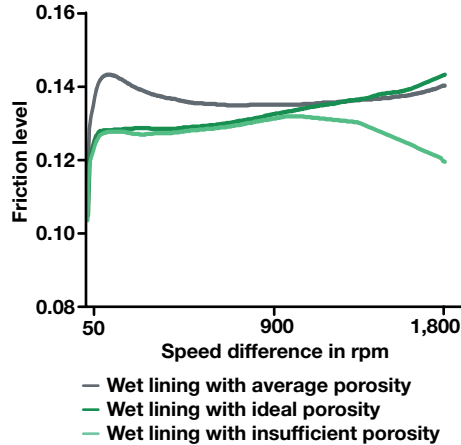


**Figure 11** Optimization of lining damping through use of a judder test stand

flected primarily in a much lower dispersion. Due to the internal damping of the power train, excitation values of more than 0.05 Nm/s are a disturbance and noticeable for the driver as judder vibrations.

### Wet linings for twin clutches

For wet linings, oil is the third tribological component in addition to the lining and steel or cast iron that function as the friction contact surfaces. The oil serves to dissipate the frictional heat, but it can also have negative effects. Too much oil between the friction contact surfaces leads to hydroplaning, similar to the aquaplaning of tires on a road wet with rain, and thus results in a low and uncontrollable friction value. In addition, drag losses occur in open clutches that significantly reduce efficiency. If there is not enough oil, there is a risk of partial mixed friction or even dry friction; this has a considerable impact on comfort behavior. For this reason, the macrostructure of the lining must be designed in a way that



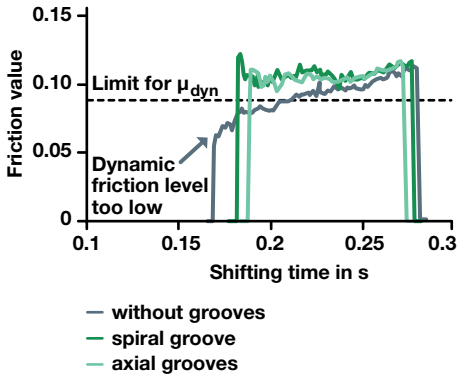
**Figure 12** Improvements in friction value behavior through lining porosity

permits the oil to be distributed uniformly to the various friction surfaces and to ensure that the aquaplaning effect can be prevented reliably. This is achieved through the use of specific groove geometries. Adequate porosity of the lining supports this effect.

If these and other findings are implemented consistently, the friction value behavior of wet clutches can be improved significantly. Figure 12 shows an example. The correlations described here should suffice to show that the development of an efficient tribological system is only possible if all conceivable boundary conditions have been taken into consideration.

### Challenges for friction linings in synchronization

The friction value structure and consistency are important variables in the development of synchronizing materials. The transmission oil must be pushed away quickly from the friction contact to achieve these variables. If the microstructure of the friction materials cannot ensure this, other solutions must be found. One solu-



**Figure 13** Effect of macro-geometry on the torque curve

tion is the targeted macro-structuring of the friction material by using grooves or groove patterns. The diagram in Figure 13 shows the torque curve of a gear shift mechanism with a friction material with a groove and without a groove. Without the groove, only a very small dynamic initial friction value can be observed. It results in longer shifting times and, in extreme cases, prevents the transmission from shifting altogether.

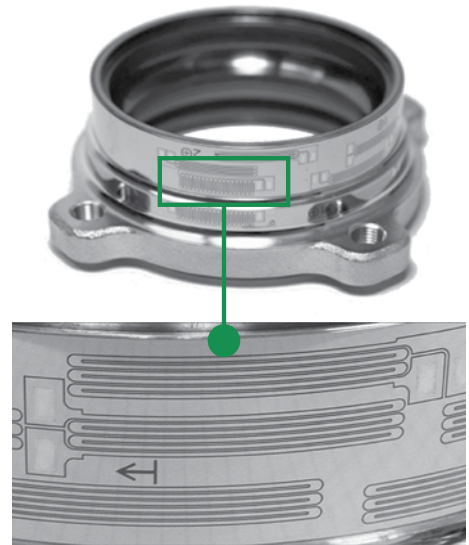
Modifying the macroscopic surfaces – in this case by means of spiral or axial grooves – can help improve the torque curve. As the oil is pushed away rapidly, the dynamic friction value is already at a much higher level even at the start of the shifting operation, guaranteeing a high level of shifting comfort and short shifting times.

## Tribotronics

The term “tribotronics” is used to describe a fairly new field within tribology that integrates mechatronics into a tribological

system with the aid of an electronic control system. Mechatronics differs from tribotronics in that it only uses information from the inputs and functional outputs of the mechanical system to control its operation. Such functional outputs supply information about speeds, torques, temperatures and loads.

Tribotronics, on the other hand, not only considers additional output parameters such as friction, wear, or vibrations, but influences them by means of an electronic control system. The goal is to increase the performance, efficiency, and reliability of the tribological system and thus of the entire application. In tribotronics, the component becomes a sensor or actuator – or, put another way: The sensor or actuator becomes a component (Figure 14). This opens up an entirely new range of applications for coating technology.



**Figure 14** Sensotect® coating measures the force on the rolling bearing. The component becomes a sensor.



Its new thin-layer sensor Sensotect® provides Schaeffler with a basis for implementing tribotronics in automotive engineering and industrial applications. Going forward, this will permit output parameters such as the force, torque, and temperature of a component to be measured in places where conventional sensors, such as glued strain gauges, cannot be used because they are susceptible to material aging or signal drifting due to polymer glues or transfer foil.

With Sensotect®, a thin, strain-sensitive PVD coating performs the actual measurement function. The coating is structured by micromachining. These structures are deformed at the same rate as the carrier component. Deformation results in a change in electrical resistance in the sensor layer. This change is a measurement, for instance, of the contacting torque or the forces impacting on thrust bearings, drive shaft, or steering column shafts. Measurements are taken during continuous operation and with extreme levels of sensitivity and precision, or, to be more precise, with minimal hysteresis errors and minimal linearity deviations. Schaeffler has already been able to show the function of this type of sensor system in demonstration vehicles – both in passenger cars and bicycles.

One of the greatest challenges of such sensory coating systems is manufacturing. The use of highly efficient coating sources and compliance with very stringent requirements for cleanliness in the manufacturing process has helped Schaeffler to achieve a quality level even for typical three-dimensional rolling bearing components that was previously known only for planar substrates in the semiconductor industry.

In the continued development of tribotronics, Schaeffler focuses on processing signals from surface sensors in

an external control unit. Based on tribological algorithms, these signals are used to perform calculations that indicate whether the operating temperature of the component has to be corrected or whether a dimensional change is required, to name just two examples. Actuator coating systems carry out the necessary corrections. Completely autonomous and self-regulating systems are feasible if additional functions are integrated into the component surface, such as telemetric components or transfer structures for energy supply and energy production.

## Summary and outlook

---

The optimization of tribological systems in drives still offers considerable potential for reducing fuel consumption. Opportunities can be found in the selection of an optimum bearing system as well as a coating customized for a specific application. Customized, nano-structured diamond-like Triondur® DLC coating systems can help optimize sliding contacts in such a way that their friction losses occur in the same range as rolling friction. The new Triondur® coating systems help mechanical bucket tappets achieve friction values that are almost identical to those of a roller finger follower. At the same time, coating offers excellent wear protection – without requiring additional design space. Since these systems cannot be calculated analytically, Schaeffler has broken new ground in their development: Data mining is combined with an artificial neural network to generate a procedure that can predict the tribological behavior of such complex tribological systems.

At the other end of the imaginary “friction axis”, one of the development goals is to produce the required friction values with components that continuously decrease in size and weight. The analysis of friction phenomena must be expanded to include all dimensions and scale levels in order to achieve the best results from a system evaluation.

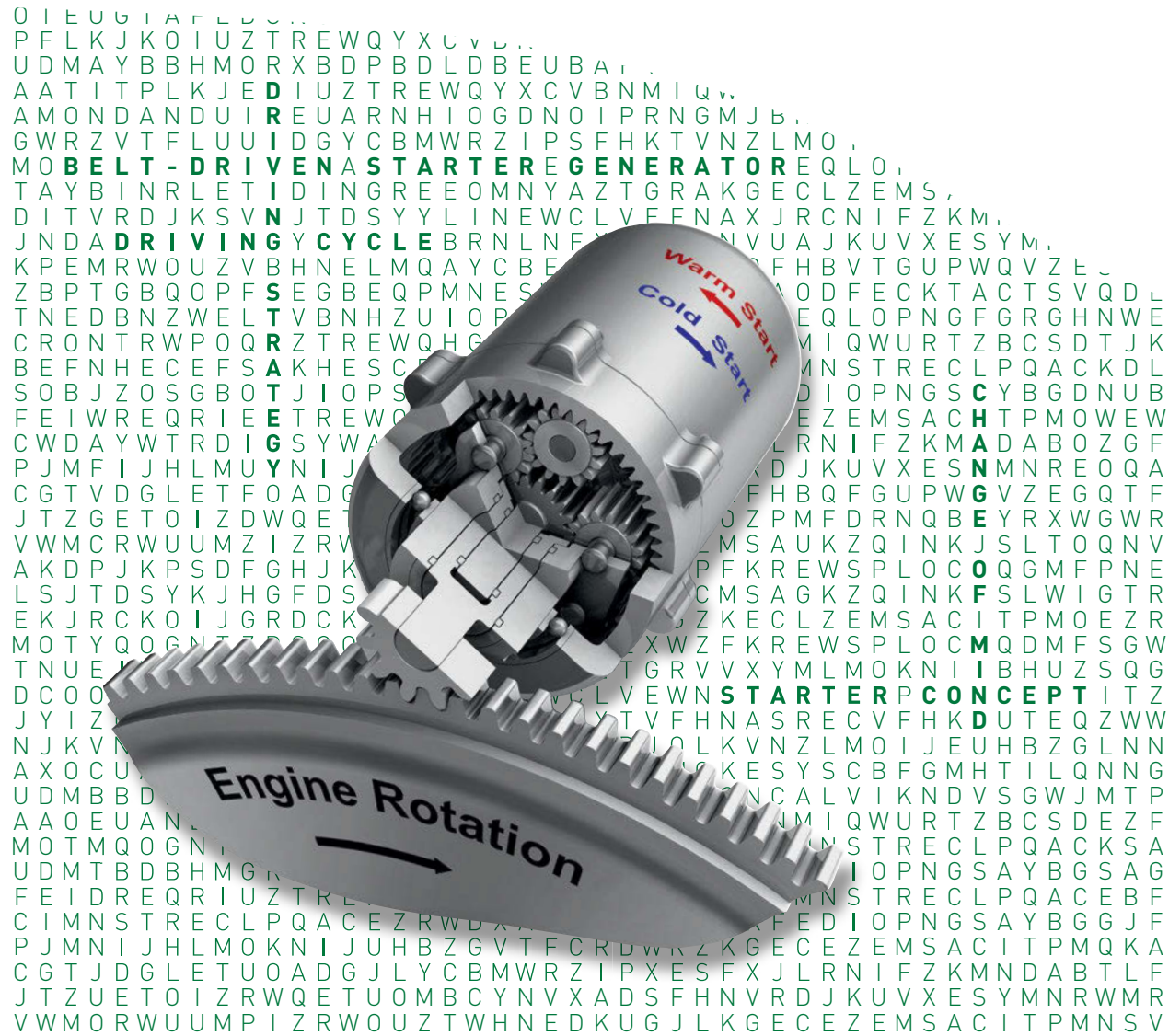
Tribotronics opens up an entirely new range of applications for coating technology. In future, the combination of force converters, data transfer, and transfer structures for energy supply and energy production will make autonomous measurement systems a possibility even for rotating parts.

Schaeffler has combined all of the important expertise, from fundamental tribological research, coating development, and coating facility engineering to volume production and quality control measures. The most important goal here is to derive the best integrated surface technology-based solution from customer requirements so that the customer is provided with a product that has a significant added value – and with the best quality.

## Literature

---

- [1] Musayev, Y.: Verbesserung des tribologischen Verhaltens von Stahl/Stahl Gleitpaarungen für Präzisionsbauteile durch Diffusionschromierung im Vakuum. Friedrich-Alexander-Universität Erlangen-Nürnberg, Dissertation, 2001
- [2] Czichos, H.; Habig, K.: Tribologie-Handbuch. Reibung und Verschleiß. 2. Auflage. Wiesbaden: Vieweg, 2003
- [3] Hosenfeldt, T.; Musayev, Y.; Christgen, W.: Energieeffizienz durch Reibungsreduzierung mittels Oberflächentechnik als Konstruktionselement. 2. ATZ-Fachtagung Reibungsminimierung im Antriebsstrang, 2011
- [4] Schulz, E.; Musayev, Y.; Tremmel, S.; Hosenfeldt, T.; Wartzack, S.; Meerkamm, H.: Reibung und Verschleiß vorhersagen - Durch neue Methoden der virtuellen Produktentwicklung Schmierstoff und Schichtsystem optimal aufeinander abstimmen. mo – Magazin für Oberflächentechnik 65, 2011, no. 1-2, pp. 18-21
- [5] Hosenfeldt, T.; Musayev, Y.; Schulz, E.: Customized Surface Technology – A Modern Design Element to Increase Energy Efficiency by Friction Reduction, VDI Fachtagung Ventiltrieb und Zylinderkopf, 2012



# The Long Path from Discomfort to Customer Acceptance

Start-stop: Yesterday, today and tomorrow

Tobias Eckl  
Dr. Eckhard Kirchner

# 24



## Introduction

---

Engine start-stop systems mark the entry into the electrified powertrain and from a cost-benefit point of view they are one of the best ways to reduce CO<sub>2</sub> emissions. Savings measured under the NEDC amount to between 4 and 5 %. In heavy urban traffic, the reduction in fuel consumption can be larger. Applying the current WLTP driving cycle it can be expected that the savings measured for basic start-stop systems will be lower than with the NEDC. This is due to the fact that the proportion of time during which the vehicle is stationary is estimated to be 13 % – significantly lower compared to the NEDC which assumes 23 %. By contrast, stop-start systems with sailing function will benefit since according to the new test procedure the vehicle is driven more dynamically and is accelerated to higher speeds. However, considering the reduced consumption under real driving conditions, basic start-stop systems still remain an affordable option.

Surveys initiated by Schaeffler – even if they are not fully representative – show that many motorists would like to permanently switch off the start-stop system despite the proven benefits in fuel economy. This is due to discomfort associated with restarting. Here the currently used technologies, for example starter pinions, meet their functional limitations.

A systemic approach to this task opens up promising options and potentials, for example when additionally taking into account the belt drives of accessory units as well as the second on-board electric system with 48V. This allows, for instance, comfortable air conditioning even with the engine switched off – to culminate in an initial mild hybridization without the need for a high-voltage on-board system in the vehicle.

## Constraints and expectations of the protagonists

---

### The OEM view

#### Market aspects

The strongest driver of the anticipated further spread of start-stop systems is their compelling cost-benefit ratio – especially as far as the basic version is concerned. Such a basic version includes a reinforced starter and the implementation of the start-stop strategy in the engine control unit, and in some cases the capacity or the type of battery is altered. In addition, in Europe in particular, the motorists' desire for fuel-efficient cars in urban traffic leads to the same technical solution for the reduction of CO<sub>2</sub> emissions as that brought about by the regulatory requirements for automobile manufacturers. Between 2015 and 2021, every manufacturer must cut the fuel consumption of its fleet of new vehicles offered in Europe by an average of 27 %. Those who fail to achieve this target will have to pay high penalties. Under the NEDC, turning the engine of a compact car off during the idle fraction of the driving cycle will lower the fuel consumption by about 4.5 %, depending on vehicle and engine data.

Schaeffler expects start-stop systems to prevail also in the Chinese and U.S. high-volume markets. This is despite the fact that start-stop cannot fully bring to bear its advantages in these markets due to the respective local standard cycles and corresponding consumption requirements. Moreover, it is foreseeable that a waiver of start-stop in the product range could increasingly lead to competitive disadvantages.

### Technical aspects

The decision to integrate a start-stop system immediately raises the question of what technology to use. Schaeffler has consolidated external data, its own research results and ongoing projects and project requests into a technology outlook and the functions that can be derived from it. In general it can be stated that Europe clearly has a pioneering role in this area and that the number of models featuring start-stop as standard or optionally is increasing year after year. It is to be expected that in the near future, some automobile manufacturers will initially implement a sailing option in the higher speed range even in vehicles other than ones with full-hybrid drive. Schaeffler defines sailing as rolling with the engine switched off, either with (active sailing) or without (passive sailing) the support of an electric machine. By the end of this decade, in Europe it should be standard for new vehicles that the air conditioning system can operate independently of the internal combustion engine. Slightly, all start-stop technology variants as well as the various possible functions will find their way into China and the United States. The active sailing function is expected to be available in low volumes in 2017 for the first time.

By choosing a specific start-stop technology and the associated operating strategy, the expected number of start-stop cycles is defined. While a conventional vehicle is designed for only about 36,000 starts, basic start-stop systems are designed to endure between 300,000 and 500,000 such cycles. The specifications for a vehicle with sailing function are based on an average 1.2 million starts. This means: During the 300,000 kilometers of the vehicle's expected lifetime, the motor is switched off and on again every 250 meters. For comparison: Today's hybrid vehicles arrive at approximately 600,000 start cycles (Figure 1). However, a decrease in the total required start cycles is emerging in vehicles with sailing function. This is due to the limited number of starts due to the operating strategy (reduced sailing speed range, latency).

The clear differences stem from the fact that a basic start-stop system switches off the engine only when the vehicle is stationary or in the last phase of rolling. In contrast, a system with sailing function stops the engine whenever it is not under load, and thus even more often than a hybrid drive. The latter deactivates the combustion engine only when a change into E mode is possible.

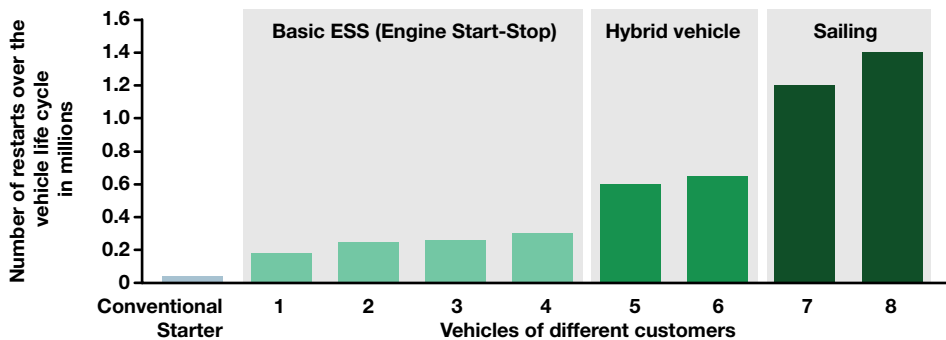


Figure 1 Number of start-stop cycles compared by system

It is not only the components directly involved in the start process that must be adapted to this requirement. The following aspects also have to be taken into consideration:

- The crank and the valve train are subjected to prolonged periods without oil pressure and are therefore frequently operated under conditions of mixed friction.
- The systems for exhaust gas after-treatment go through a temporary, short-term cooling phase much more often.
- The accessory units in the belt drive pass through the start process more frequently (resonances, rotational irregularities).
- The elements of the air intake system (throttle valve, fuel injection system, turbocharger) pass through the start process more frequently (mixed friction, thermal stresses, pressure fluctuations).
- The dual mass flywheel often passes through the resonant vibration range.
- Safety-critical auxiliary units (brake servo unit, power steering pump) must be supported using electric drives under certain circumstances.

## Start-stop systems as judged by the customer

A technology and the functions derived from it will become accepted on the market on a permanent basis only if they meet the needs and expectations of customers. Any technical development must be in line with this. Therefore, in the long run it is indispensable for a system provider to know the preferences of end users. So using a test group, Schaeffler has looked into whether motorists have reservations about start-stop systems and if so, why. This test group was not representative in accordance with the principles of control sampling; rather it consisted of technically minded Schaeffler employees. The answers given were unprompted. After all, 70 % of respondents were fully satisfied with the technology and 30 % expressed criticism. Almost half of the latter criticized the length of time between engine standstill and restarting (Figure 2).

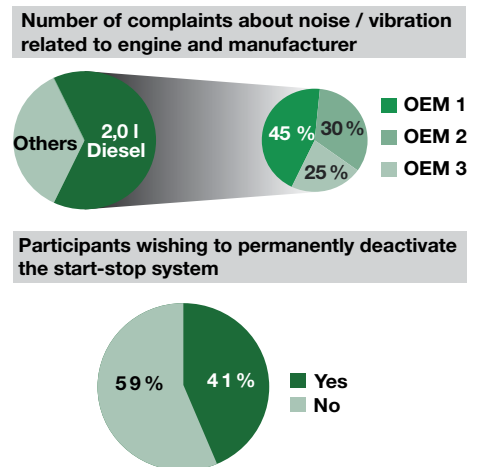
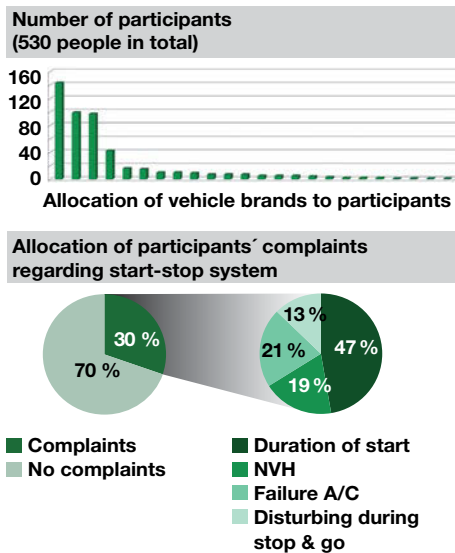


Figure 2 Customer criticism regarding start-stop

Another interesting fact is that as many as 40 % of customers would like to permanently deactivate the start-stop system, even though some of these people seem to be satisfied with the system itself.

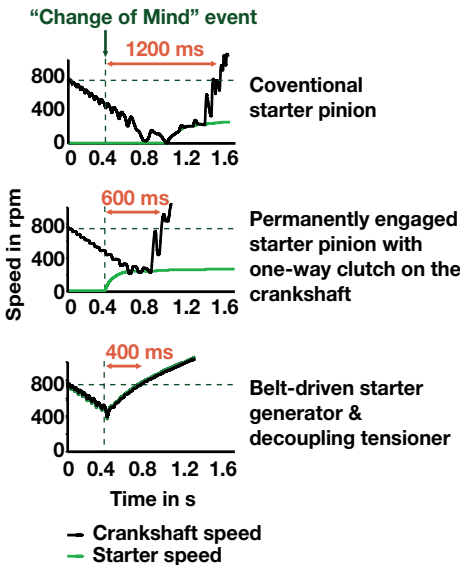
### Restart, Change of Mind, acoustics

Some respondents felt the start time lasted too long, even though it exactly corresponded to the time elapsing between turning the ignition key and the start of the engine. What appears to be normal for a key start is obviously found to be uncomfortably long for restarts initiated by the start-stop system. This is because from a subjective point of view, the start process is in conflict with the motorist's desire to move off right away. Therefore a start-stop system will be evaluated as "good" when the restart is subjectively perceived to be

faster than the key start first thing in the morning.

Since the respondents are not involved in the development and the technical terms of start-stop systems, they did not mention the term "Change of Mind" (CoM) in their freely uttered comments. It is very likely, however, that a lack of CoM ability of the start system was one of the major factors that led to their judgment regarding poor restart times. "Change of Mind" in the context of start-stop systems refers to situations where the driver would like to go on driving during the phase of automated engine shut-off. The engine is still coasting at this stage. Yet the conventional starter pinion can only engage the starter gear at engine standstill and subsequently initiate the restart. All this adds up to a delay which is perceived as significant.

The length of the delay depends largely on the technology used. With a conventional starter pinion, the time between the CoM event and reaching idle speed once again lasts up to 1200 ms. Using a permanently engaged starter of the same type, this time is reduced by half. And with a belt-driven starter generator the time is cut by another third (Figure 3). This technique, as well as improved starter pinion concepts could therefore have a catalyzing function for the further spread



**Figure 3** Restart times of different start systems, following change-of-mind situations



of start-stop technology – especially since another one of the testers’ criticisms would be addressed at the same time: Approximately one-fifth of those who said they were not fully satisfied with their start-stop system also complained about the vehicle’s noise and vibration behavior (NVH) during restart.

**Further challenges**

Furthermore, about one-fifth of the critics pointed to the fact that the air conditioning system was not in operation during engine shutdown, or only for a short time and with limited capacity. A further 13 % objected to the engine constantly switching on and off during stop-and-go traffic.

For developers, the proportion of over 40 % of respondents who would like to completely shut off the system is a clear mandate. There is evidence that quite a few of these people did not understand, for example, why in certain concrete situations the engine was not switched off even though the vehicle was stationary, so that they suspected a malfunction. When

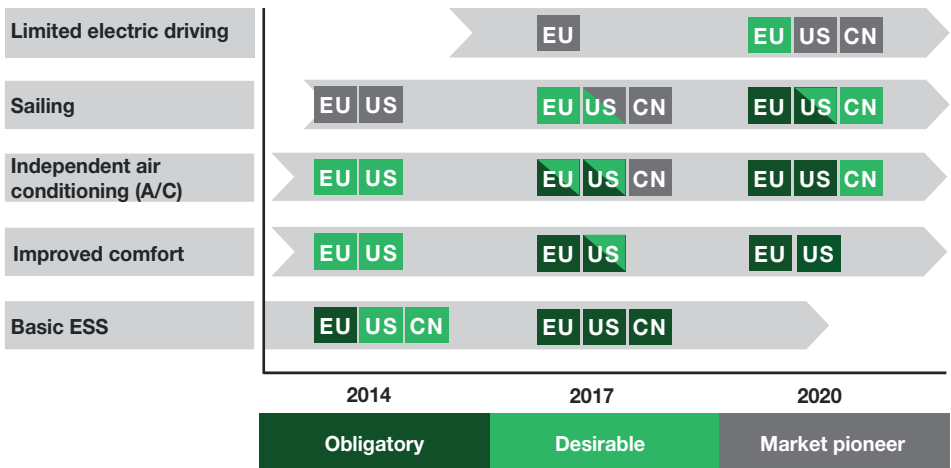
adding further functions to the start-stop system, it therefore seems advisable to bear in mind that the “behavior” of technology must be comprehensible for the customer.

In the overall analysis of the test results it is remarkable that the respondents’ overriding criticism was to do with lack of comfort. Concerns about, for example, increased wear were mentioned just as rarely as an appreciation of reduced fuel consumption.

**Technology roadmap**

Starter pinions are today by far the most common components used for starting conventionally powered vehicles with start-stop system. Based on this technical level and including the benchmark results, the following technology roadmap can be summarized (Figure 4).

The next refinement of the 12 V starter pinion will aim to increase the start com-



**Figure 4** Development of start-stop technologies and functions by 2020

fort (NVH) and the start speed. Improved starter pinion technology and variable start speeds are obvious measures to ensure better pinion engagement.

Occasionally belt-driven starter generators (BSG) are already being used with 12 V on-board electric systems. They offer advantages over the starter pinion with respect to noise and vibration behavior. However, a bi-directionally acting belt drive must be used in order to achieve the necessary load reversal in the belt drive. This does not reverse the direction of rotation, but rather the direction of the load acting in the belt drive; the carrier strand and the return strand alternate.

Start comfort and start speed can be further increased if the start-stop system can fall back to a second voltage level with 48 V. The considerations in this respect have become more urgent because the energy demand in vehicles has grown steadily over the past two decades. This development has been triggered primarily by the increased use of driver assistance and multimedia systems, as well as by more extensive comfort and safety equipment. In addition, today more components are operated with electrical instead of mechanical energy. If a second lithium ion-based battery is installed to extend the on-board electric system, then the amount of recuperable energy will increase significantly. It is very useful for functions with high power consumption such as boosting, see [1, 2].

A separable crankshaft pulley is conceivable as another BSG stage, see [3]. The belt is thereby thrown off, as it were. The starter-generator can then drive the air conditioning compressor when the engine is switched off. This functionality can be a critical success factor for the further acceptance of start-stop systems on the North American market. In conjunction

with an electric drive axle, eventually the gap to the hybrid drive can be closed without having to bear the cost of a high-voltage system: In a 48 V environment, the achievable output is large enough to allow active sailing and cope with stop-and-go traffic without the assistance of the internal combustion engine. However, there is still no contact protection required. In addition, efficiency gains can be achieved during recuperating. This is because almost all of the kinetic energy can be recovered by regenerative braking, while until now this was absorbed to a greater extent by the drag torque of the internal combustion engine, see [1].

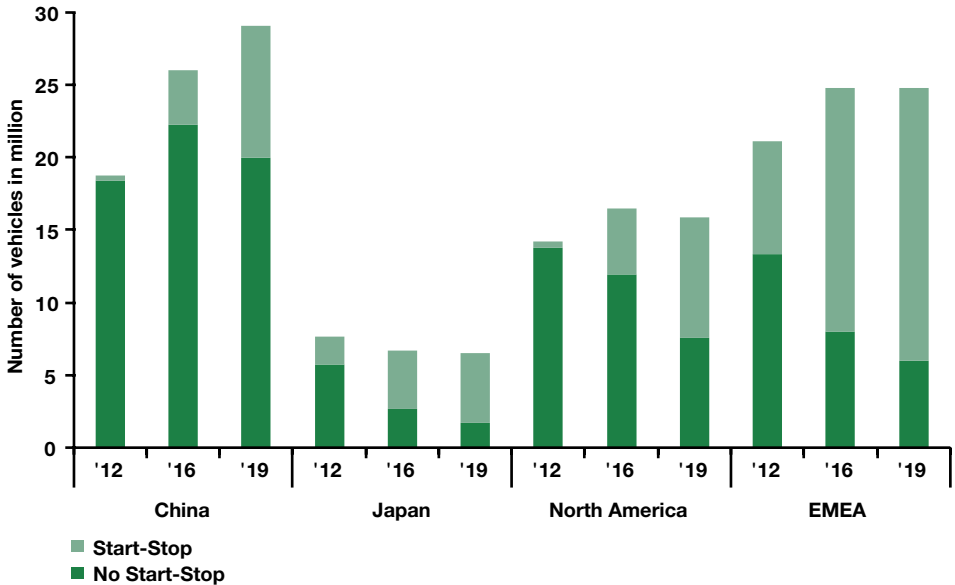
## Market development of start-stop systems

---

### Current market situation and outlook

A specific registration of vehicles, categorized by those with and without start-stop system, is not available worldwide. Schaeffler has produced the overview below by reconciling data from external market research with material from its own research. It is based on all cars featuring a conventional powertrain; hybrid and all-electric vehicles are excluded.

Measured by the number of existing vehicles, start-stop systems are found relatively rarely, even in the mature vehicle markets in the western world. For the EMEA region (Western and Eastern Europe, Middle East, Africa), however, it is becoming apparent that the number of new vehicles equipped with this technology is steadily increasing. Out of more than 21 million vehicles with internal combustion engines in 2012, as many as 7.8 million



**Figure 5** Number of new vehicles equipped with engine start-stop systems in the most important markets

were already equipped with such a system. It is expected that as soon as 2016 two thirds of all new cars will feature a start-stop system (Figure 5). The strongest impetus for this is likely to come from Western Europe: As from 2019, this system will form part of the standard equipment of conventionally powered vehicles in most segments.

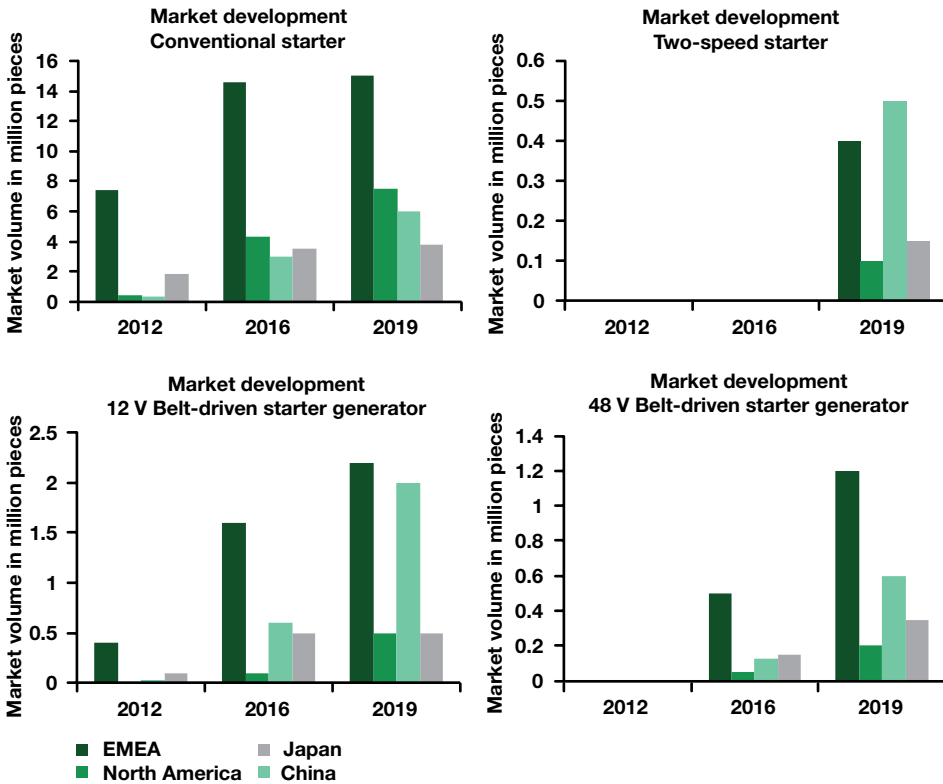
In North America, however, the penetration rate is still low for two main reasons: Firstly, the fuel savings resulting from engines stops in urban traffic calculated based on the U.S. test cycle are much lower than those based on the European cycle, which means that there is less incentive for automakers to install such a system. Secondly, the demand in the North American market for more fuel-efficient technologies is still quite subdued due to the comparatively low fuel prices. Moreover, for reasons of comfort motorists reject a system with which the air con-

ditioning system cannot be operated during engine standstill.

Apart from China, the only other country where a significant spread of start-stop systems is anticipated is Japan. However, in this market a substantial proportion of new vehicles are produced as hybrids even today. In the rest of Asia, as well as in India and South America, according to current estimates start-stop technology will play little or no role end of this decade even though in India the cost of fuel is high compared to the average disposable income.

### Market expectations for selected components deployed in start-stop technology

Schaeffler has identified subsystems of powertrains based on internal combustion



**Figure 6** Market development of starter concepts in general and within the four relevant economic regions

engines and assessed the likely market development of available technologies up to 2019 – again broken down to the relevant economic regions.

### Starter concepts

The market potential quantified for these components relates to all vehicles that are equipped with a start-stop system. The following engine start concepts were taken into account (Figure 6):

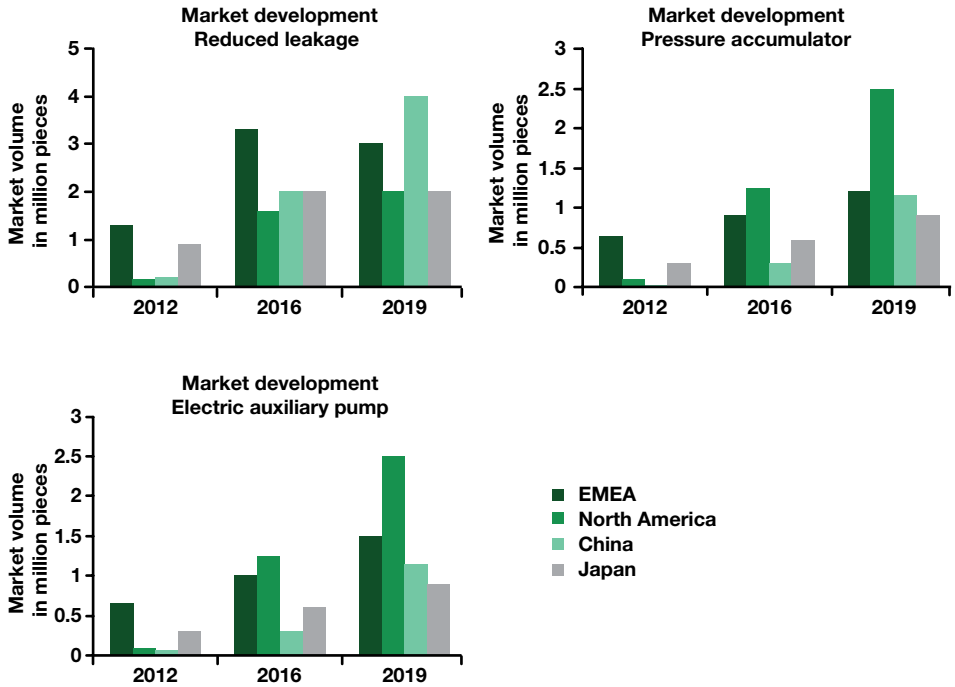
- 12 V conventional starter pinion
- 12 V belt-driven starter generator (BSG)
- 48 V BSG

It is difficult to assess the development of the market for starter pinion concepts with

two transmission ratios for cold and comfort start. Assuming the success of the concept outlined below, up to one million units are expected to be sold globally by 2019.

### Provision of hydraulic pressure

This market assessment relates exclusively to vehicles that are equipped with torque converter automatic transmissions, double clutch and CVT transmissions so that their actuators are dependent on continuous oil pressure. The time before such a transmission is ready for a restart can be reduced considerably if the hydraulic pressure is maintained during



**Figure 7** Market development of concepts for the provision of hydraulic pressure in general and in the four relevant economic regions

engine stoppage. The following options are available to ensure this (Figure 7):

- Reduced leakage
- Electric auxiliary oil pump
- Pressure accumulator

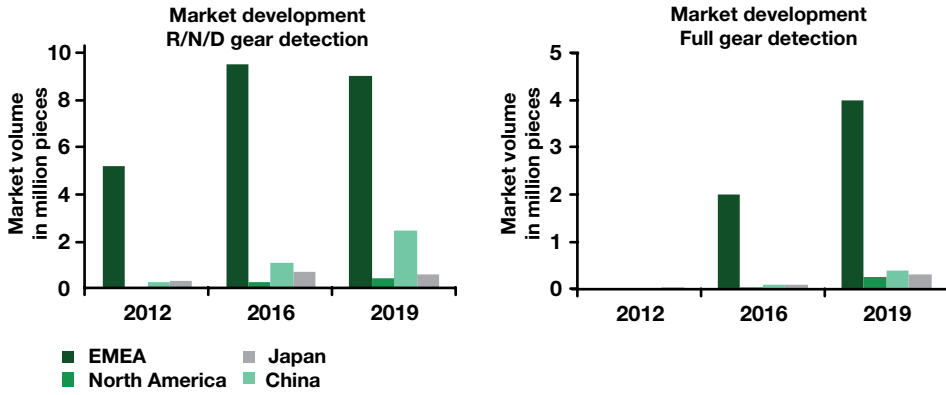
### Gear detection

Gear detection is relevant only for vehicles with manual transmission, so the potential for this sensor system is correspondingly reduced to this configuration, see Figure 8. If all gear stages can be detected, then sailing operation is possible not only when rolling towards a traffic signal, but also at higher speeds. Typically a distinction is made only between neutral, reverse and (any) forward gear.

## New opportunities and approaches

### Starter pinion with two-speed transmission

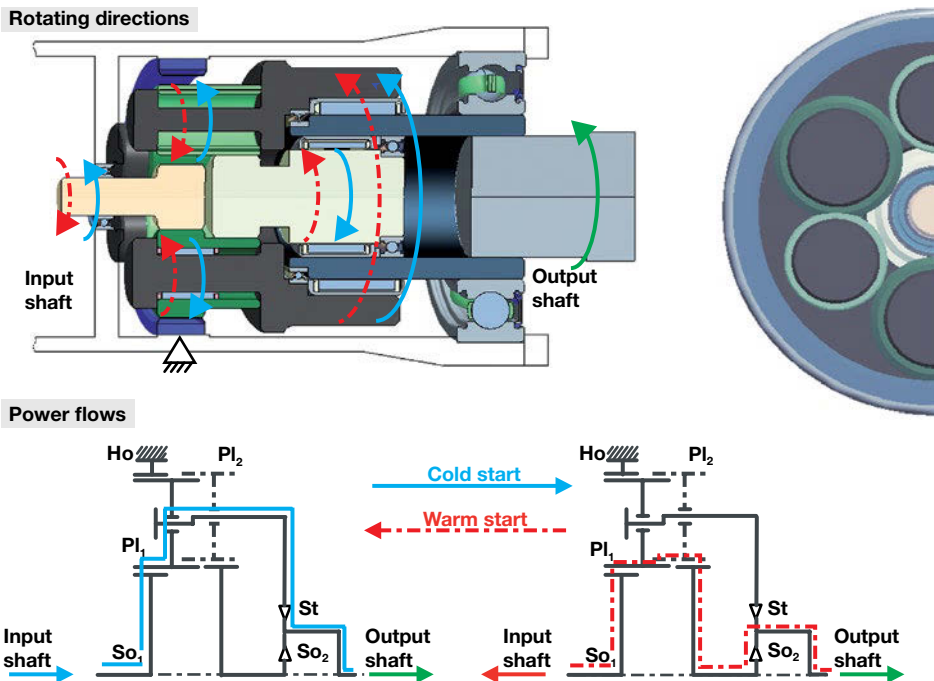
Based on the findings from the interviews with the test group as well as other market and technology analyses, Schaeffler has intensified its investigations to improve the performance of the starter pinion. The concept that is currently being pursued is a starter with two-speed planetary gear. This consists of a double planetary gear set with an additional sun gear. This sun gear and the planetary



**Figure 8** Market development of gear position detection in general and in the four relevant economic regions

carrier each feature a one-way clutch which is designed so that the electric motor's direction of rotation can be reversed without changing the direction of

rotation of the transmission unit's output shaft. Reversing the direction of rotation will activate the second gear stage of the planetary gear. However, this will happen



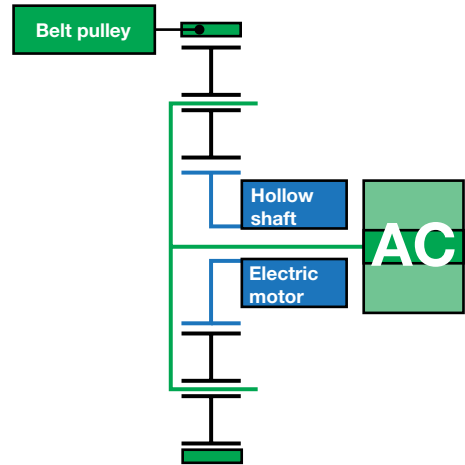
**Figure 9** Two-speed starter with planetary gear

only when the engine is warm and is to be restarted by the start-stop system. The starter can then translate the lower friction of the warm engine into higher starting speeds using the same power input. This not only reduces the start time, but also the noise and vibration levels. First gear is used for cold starts only, so that the customer perceives a noticeable difference between cold start and restart. This gain in comfort compares favorably to the relatively low outlay required for the mechanical integration.

### Electrified drive for the air-conditioning compressor

When the engine is at a standstill, so too is the air-conditioning (AC) compressor. The temperature increase in the vehicle interior has a detrimental effect on comfort after only a short time so that the driver will probably switch off the start-stop system and immediately restart the engine manually. This means that the savings potential is not fully utilized. While the market is already providing solutions to compensate for the non-availability of the mechanical drive, these bring various disadvantages in their wake: The electric air-conditioning compressor cannot be used in price-sensitive vehicle segments, and it also has an unfavorable energy balance. In addition, paraffin-based latent heat storage systems require additional space and cannot dehumidify the air. Moreover, the dynamics in heat input and reclaim achievable to date is unsatisfactory.

Schaeffler has therefore launched a project that is expected to result in a technically and economically interesting alternative. The core of this concept is the integration of an electric motor – designed, for example, with a “hollow shaft” – between the air-conditioning compres-



**Figure 10** Power split concept for the electrification of the air-conditioning compressor

sor and belt pulley. The existing belt drive remains unchanged. Instead of a rigidly connected or magnetically separable pulley, a planetary gear set is used for the air-conditioning compressor. It enables a power split and allows the air-conditioning compressor to be run conventionally during combustion engine operation via the belt pulley. Depending on the actual power requirement, a part of the belt drive power yielded can be converted into generator power using the electric motor. When the internal combustion engine is at a standstill, the electric motor will drive the air-conditioning compressor on its own. Mixed modes between these two operating points are conceivable, too, for example to operate the air-conditioning compressor at optimum speed at all times. The concept also allows the use of more efficient components instead of a piston compressor.

## Conclusion and outlook

---

Start-stop systems are among the most efficient ways of reducing CO<sub>2</sub> emissions when cost-performance considerations are taken into account. So far they have the highest penetration rate in the EMEA countries, and this is expected to remain so at least through to 2019. Outside of these four economies, start-stop technology will not play a major role from today's perspective. While until now start-stop technology was based primarily on the conventional starter pinion, it seems advisable to pursue concepts that offer greater comfort and extend the functionality at low additional costs.

For price-sensitive segments this can be done using improved starter pinion technology. A starter with an integrated gear can already achieve improvements in acoustic and vibration behavior. A good possibility for automobile manufacturers to set themselves apart from the competition is the concept of a permanently engaged starter pinion. Available at moderate costs, this technology is suitable for "change of Mind" situations – an important functionality to further increase the acceptance of the start-stop system in the volume market.

The belt-driven starter generator satisfies even higher demands. Restarting is more comfortable and faster. In order to tap the full potential of this technology, however, a second voltage level with 48 V is required. In conjunction with an electric drive axle, an enhanced start-stop system can significantly reduce the gap to the hybrid drive because active sailing as well as stop-and-go traffic in E mode are possible in this constellation. If start-stop technology is to gain acceptance on the North American market, then the air-conditioning system must continue to operate even with

the engine shut off. Schaeffler can already show initial approaches in this regard.

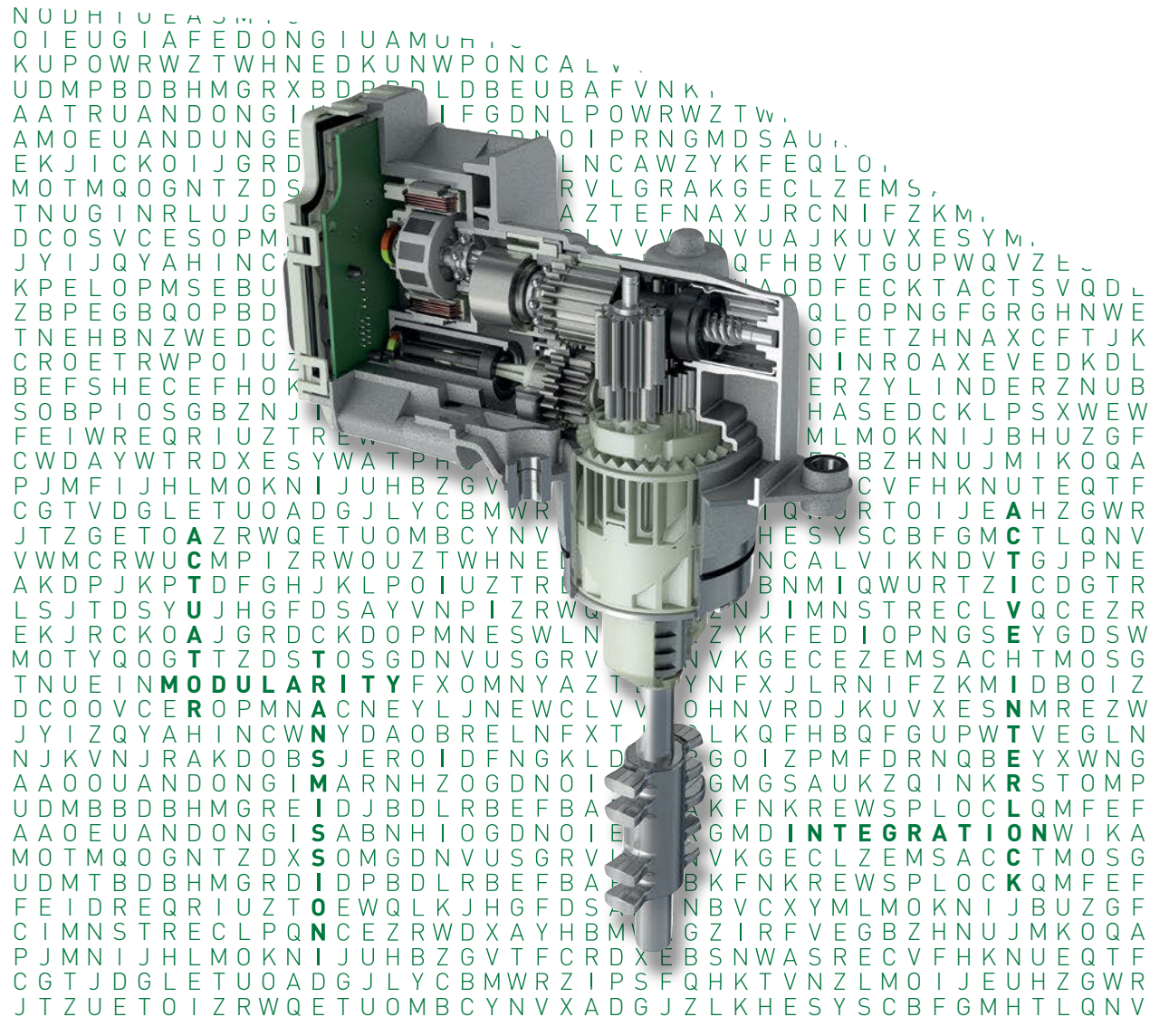
Derived from Schaeffler's observation of the market and other insights from the field, it can be concluded that the focus on CO<sub>2</sub> reduction in Europe is not sufficient to ensure the market success of start-stop technology. Comfort aspects are equally important. In addition, the operating strategy of the start-stop system must be designed so that the driver is able to understand the behavior of the system.

## Literature

---

- [1] Smetana, T.; Sattler, M.: Who's Afraid of 48 V? Not the Mini Hybrid with Electric Axle! Modular electric axle drive in a 48-volt on-board electric system, 10<sup>th</sup> Schaeffler Symposium, 2014
- [2] Reitz, D.: One Idea, Many Applications: Further Development of the Schaeffler Hybrid Module. 10<sup>th</sup> Schaeffler Symposium, 2014
- [3] Stuffer, A.; Stief, H.; Schmidt, T.: Introduction of 48 V Belt Drive Systems: New Tensioner and Decoupler Solutions for Belt Driven Mild Hybrid Systems. 10<sup>th</sup> Schaeffler Symposium, 2014
- [4] Kirchner, E.; Eckl, T.: Das Automatikgetriebe als Bestandteil einer Start-Stopp-Strategie. ATZ, June 2013, Volume 115, Issue 6, pp. 500-505





# Transmission Actuators

Reducing complexity or  
increasing performance?

Bruno Mueller  
Goetz Rathke  
Marco Grethel  
Dr. Laszlo Man

# 25



## Introduction

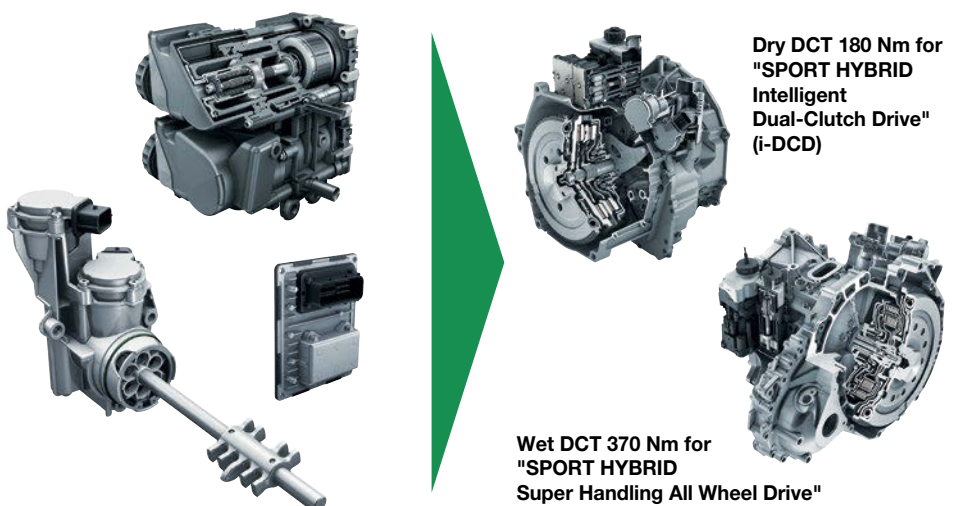
As explained in [1], a combination of adequate dynamics and performance as well as the best possible efficiency define the most important requirements for modern actuator systems in the powertrains of automobiles. Transmission actuators have a significant influence on the size, costs and efficiency of transmissions. The latest electromechanical actuation systems used in transmissions from Getrag, Hyundai and Honda have demonstrated very impressively that it is possible to produce transmission actuators with an average power consumption of less than 20 W and excellent controllability and dynamics. The Honda sport hybrid i-DCD currently sets the benchmark for double clutch transmissions with an average power consumption of 12 W [2].

The costs of electromechanical actuators increase with the actuation perfor-

mance at an exponential rate. The reduction of the actuation energy required to actuate is therefore very important for an efficient actuator system. The above mentioned systems have already achieved the development targets for a number of transmissions applications [2]; the current question is: how said systems can be optimized further?

### Upsized functionality and performance in a reduced design envelope and without significant additional complexity

Since the current systems have achieved market satisfaction with regard to power consumption, controllability, dynamics and durability, the first priority is not to improve these characteristics. Customers would only accept improvements without additional costs. Consequently an increase in the functionality and power density without significant additional complexity and cost is the goal for many



**Figure 1** Honda transmission with modular actuator system for sport hybrid applications

new ideas, which will be presented. Such development targets can be mainly achieved by increased mechatronic integration.

### **Reduced complexity and costs without a significant loss of performance**

The search is on to find simpler and more cost-effective actuation systems, particularly for the lower vehicle segments and relevant cost-sensitive markets. A reduction of performance and driving comfort is only accepted to a very limited extent by customers. Therefore, the restrictions in very special and infrequently occurring driving situations must be discussed.

### **Increased modularity**

In order to minimize the development effort for complex mechatronic systems as much as possible, it is advisable to develop actuator modules and associated software modules so that they can be used for different tasks in the transmission. It is important that any additional costs and disadvantages regarding packaging due to modularity are offset by more intelligent architectures. Synergies between different actuators can also be achieved by developing a modular system out of components from existing parts. So many electromechanical and electrohydraulic components are available in the Schaeffler group already, which can be used for developing new actuation solutions.

## **Modular system architecture**

---

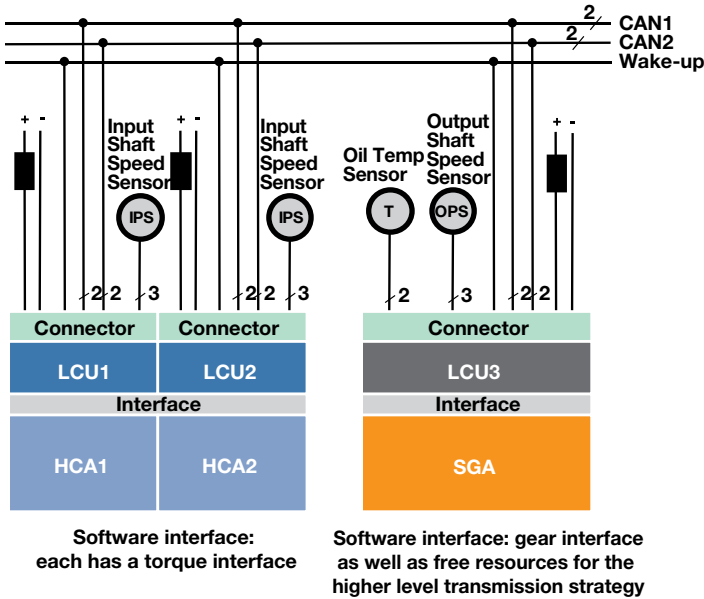
Improved  $\mu$  controllers with increased computing power, increased memory, higher permissible operating temperatures and new data bus systems and sensors now allow system architectures, which were inconceivable 10 years ago. The use of local electronic units can now be seen everywhere in the powertrain. For example, throttle actuators, water pumps, parking locks or four-wheel drive systems are equipped with independent intelligence. A trend, which has also found its way into the transmission sector.

For the first time, it was possible to obtain the most important advantages in a double clutch transmission by fitting a hydrostatic clutch actuator (HCA) with a first-generation local control unit (LCU) [2, 3]:

- Functional safety without mechanical self-opening clutch systems
- Excellent controllability due to improved local sensors
- Improved EMC characteristics due to a reduced requirement for sensor and power cables
- Freedom to optimize actuator mechanics for a low power consumption.

The modularity and power density can be improved in the next generation by further development of LCU technology.

The dedicated sensors for a specific application should be directly connected to the relevant LCU to enable the direct processing of signals. It is advisable, for example, to equip the clutch actuator with inputs for the transmission input speed sensors in addition to the internal sensor inputs for travel, angle and pressure. In



**Figure 2** System architecture

combination with the improved memory size and processing power of new  $\mu$  controllers, all clutch functions such as software adaptations or anti-judder control can be calculated locally. A torque interface to higher-level strategies is also advisable in the software. Service functions for initial operation and diagnosis can also be implemented in local control units in the future.

The gear actuator may also be fitted with a local electronics unit and have relevant inputs for additional transmission sensors such as oil temperature, output speed and parking lock position. The software interface is designed as a gear interface. In addition, higher-level driving strategies and shifting strategies can be implemented in the gear actuator. This takes into account the current state of the art, whereby all transmission functions are installed and can be tested on the transmission.

This Modular actuators not only simplify the transmission system, they also

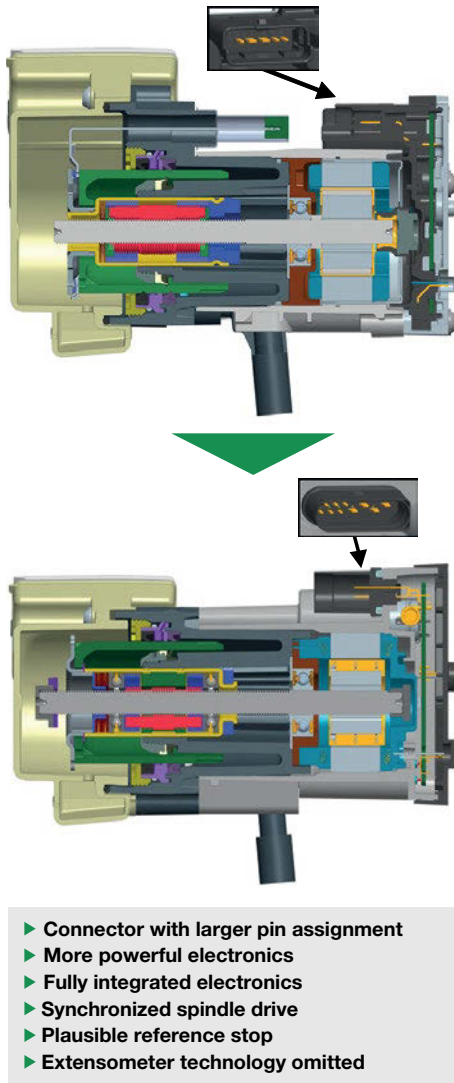
synchronized shifting elements and the parking lock device.

The new actuators are equipped with four connector pins for bus systems. The can be configured in different ways. If an actuator is inserted into an existing CAN bus, the bus can be looped (daisy chain). Additional pins are not required on other control units. If actuators are used in transmission systems, it is better to use several CAN buses so that the transmission remains available if a CAN bus fails.

## Increased integration

The objectives of downsizing complexity and upsizing performance are consistently achieved through further development of the hydrostatic clutch actuator.

increase availability as limp-home strategies can be implemented into each individual actuator. In addition, the suitability of the actuators for other applications is significantly increased. The requirements for clutch or gear actuators for different applications are very similar. For example, clutch actuators are also used in four-wheel drive or hybrid drives. Intelligent gear actuators can also be used in hybrid transmissions for shifting



**Figure 3** Further development of the hydrostatic clutch actuator (HCA)

A new  $\mu$  controller and output stages with higher performance as well as a connector with an increased number of pins increase the functionality, performance and modularity of the clutch actuator without significant additional outlay. Some mechanical

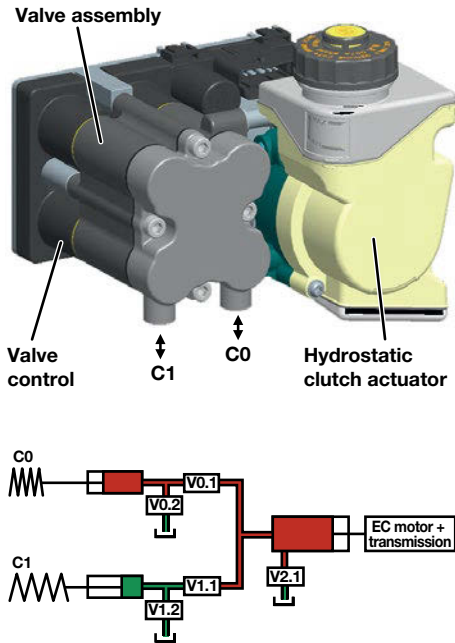
interfaces can be eliminated due to the increased level of integration, saving space and reducing costs. The use of a new synchronized planetary roller spindle (SPWG) and a verifiable reference position with associated software intelligence negates the requirement for a travel sensor.

## Reduced number of power drives

If a value analysis of the sensors is conducted, it will be found that the brushless drives including the relevant electronics, sensors and cables form the largest portion of the costs. Although it has been possible to reduce the costs of the drives by making great efforts to reduce the number of expensive magnetic components and by using LCU technology, the drives still remain the cost drivers for electromechanical actuators due to increased magnet prices. There is however no alternative to EC motors due to the superior power density, dynamics and operating life required for highly-dynamic actuators. In addition to the selection of the most economical and suitable design for the drives, the question also arises as to whether a double clutch or hybrid transmission requires a drive for each actuator.

## One actuator for two clutches

For reasons relating to the design envelope and costs, consideration can be given as to whether one HCA can supply more than one engagement system, for example two clutches or one clutch and a sub-transmission. This may be possible if the two engagement systems do not require actuation energy at the same time.



**Figure 4** HCA with seat valves and two consumers

Even with a double clutch transmission it is justifiable to ask the question whether the transmissible torque must be increased on both clutches at the same time. If anything, this is only required in a few special cases, which can be solved by suitable calibration, such as tip-in during an overlapping phase, or the generation of drag torque on the inactive clutch for resolving balked gears or for damping the powertrain. This approach is more suitable for other applications, such as in hybrid vehicles with a C0 clutch for engine decoupling and a C1 clutch for starting. The stroke volume can be divided between a number of consumers by means of valves. Long actuation periods are critical due to the limited volume in one stroke if the system cannot be sealed sufficiently. However, the required actuation time must be ensured because

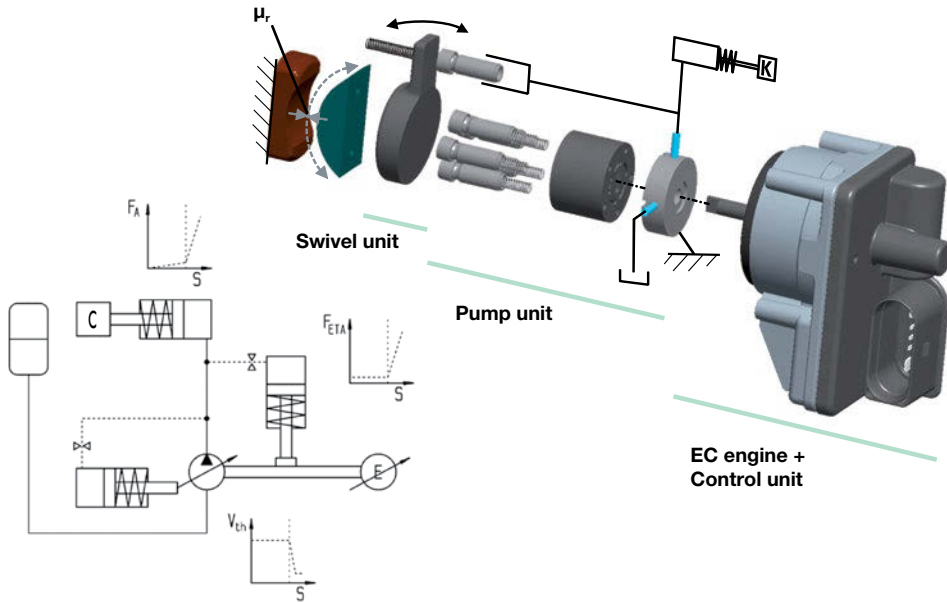
so-called seat valves are also not totally leak-proof. “Replenishment strategies” or a double stroke HCA could improve functionality.

## Bi-rotational pump

It can be seen that even highly efficient actuator systems such as the HCA reach their limits due to limited stroke volumes. Especially if there is leakage in the engagement system or multiple slave cylinders are supplied by one actuator. In such cases, consideration should be given to actuator systems, which provide a continuous volume flow.

The Bi-rotational pump is the current state of the art [4, 5]. However, this type of system is only advisable if the intrinsic disadvantages, in terms of the power consumption, are accepted. With this technology a power consumption smaller than 20 W can not be reached in a double clutch transmission. Leakage in the clutch system, for example on the feedthroughs for rotating pressure pistons, can be compensated by using low-pressure pumps, although this has a negative effect on the space requirements for the hydraulic lines and slave pistons. It is more advisable to eliminate leakage in the clutch system in order to facilitate further efficiency increases in transmissions. Reducing power consumption and leakages will achieve the optimum in terms of efficiency, costs and package requirements. The use of a local control unit for the Bi-rotational pump is effective for the above mentioned reasons.

An additional design example for a Bi-rotational pump is the variable displacement pump actuator, which allows a force-dependent nonlinear ratio. The core of this actuator is an electrically-driven pump with a variable delivery stroke. Direct coupling of the delivery



**Figure 5** Variable displacement pump actuator

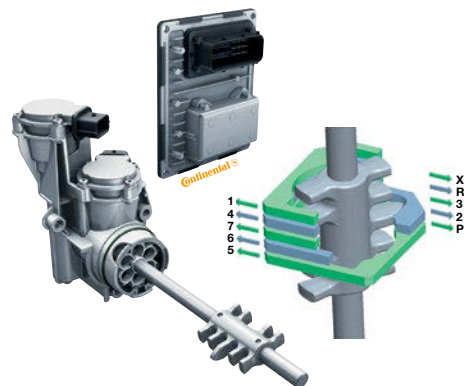
stroke variation mechanism with the generated load ensures needs-based actuation:

- Long delivery stroke at low pressure for bridging free travel.
- Reduced delivery stroke and thus reduced pump torque at higher pressure for torque transmission.

A pump with the lowest possible level of leakage, for example in the form of an axial piston pump, and the incorporation of specific load-dependent friction characteristics, show promising results in initial simulations. The limit of the possible actuation force can be significantly increased without any requirement for adapting the electric motor and its electronics with only moderate disadvantages with regard to energy consumption compared to an HCA. This type of actuator could be used in conjunction with seat valves for various loads as a hydrostatic actuator with limited stroke volume.

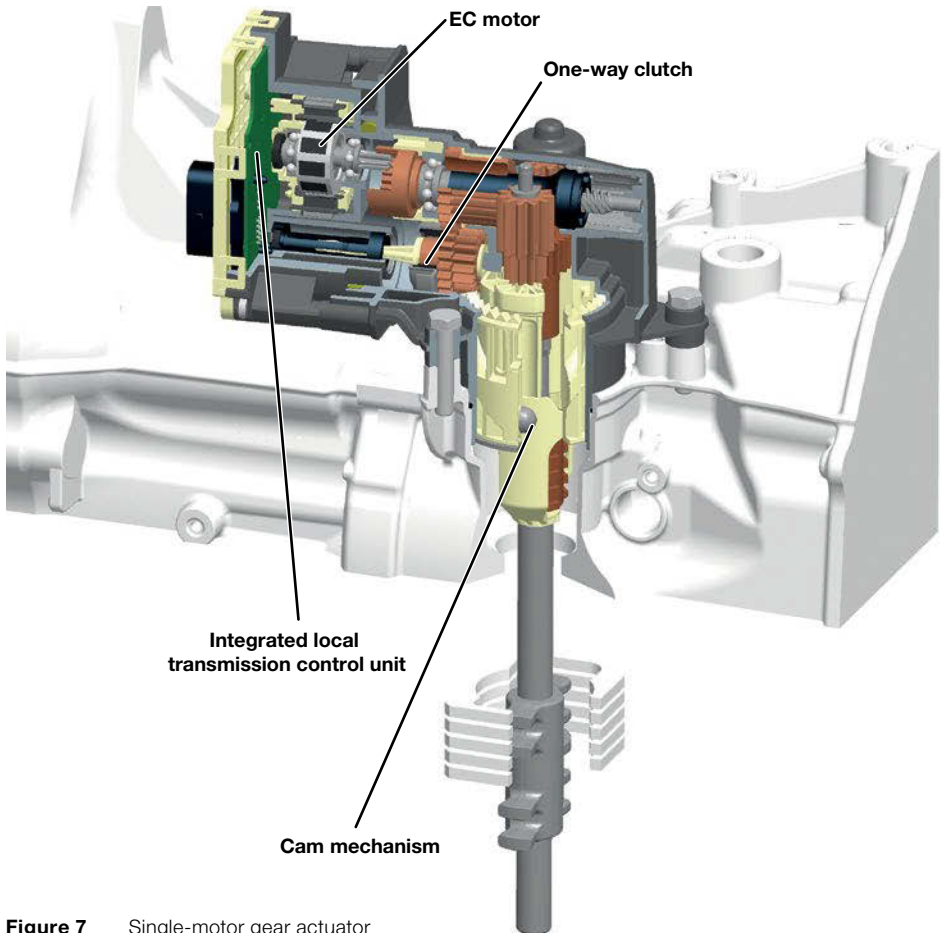
### Active interlock transmission actuator with one power drive

The electromechanical active interlock gear actuator, which LuK launched on the mar-



**Figure 6** Active interlock actuator for up to 10 shifting elements with actuation of the parking lock





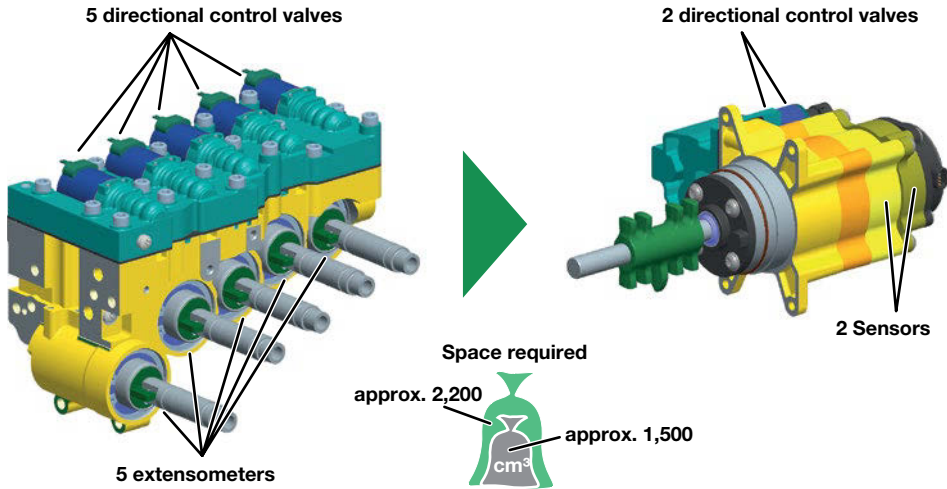
**Figure 7** Single-motor gear actuator

ket in the Hyundai 6-speed DCT in 2011, is already a power-on-demand system with a very low energy consumption [6, 7].

The actuator system has been further developed so that five shift rails instead of the previous four can be actuated. In total ten shifting elements can be actuated with the new actuator. The active interlock gear actuator is already used for actuating the parking lock in some volume-production applications [2]. The functionality of the actuator was significantly increased without considerable additional complexity and costs.

LuK presented a gear actuator in 2006, which was equipped with only one drive motor instead of a select motor and a shift motor [8]. A new single-motor gear actuator was developed on the basis of previous findings from the successful double-motor gear actuator and the new targets for increased modularity from the system architecture.

Two simple mechanical elements – a one-way clutch and a cam mechanism – are used to realize the full select and shift functionality with only a single motor.



**Figure 8** Comparison of hydraulic gear actuators

Clever use of these two elements allows the movement for engaging gears to be assigned to the motor's first direction of rotation. The unwanted gears are firstly disengaged automatically in the active interlock actuator. The second direction of rotation is responsible for returning into the neutral position and subsequent selection movements.

The elimination of one motor frees up design space that is used for integrating a local transmission control unit.

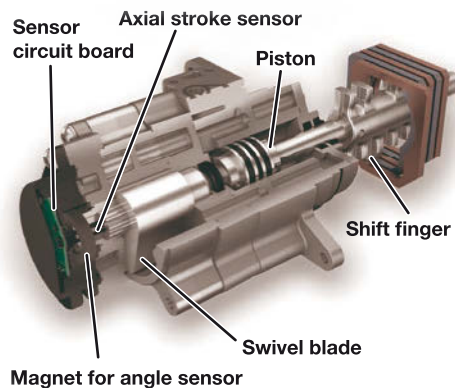
Both the single-motor gear actuator and the new hydrostatic clutch actuator (HCA) show how increased integration can reduce costs while maintaining or increasing the level of functionality.

### The hydraulic active interlock transmission actuator (HGA)

Hydraulically-actuated double clutch transmissions use gear actuators for actuating shifting elements in the transmission, which shift two gears at a time by means of individual gear actuator pistons. If there are

more than nine shifting elements, five single gear actuator pistons each with one travel sensor are required, which on hydraulic systems must be controlled by a directional control valve in order to engage the relevant gear.

If the active interlock principle of the electric motor drive is used, it would be possible to reduce the number of shift axes from five to two, i.e. one shift and one selec-



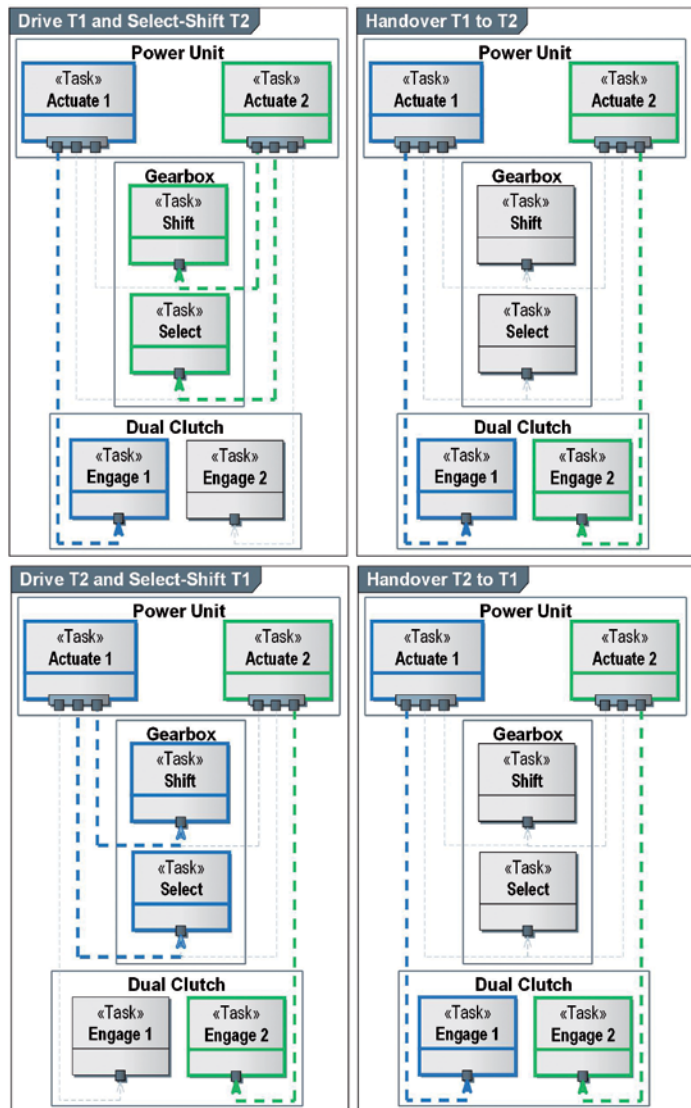
**Figure 9** Hydraulic active interlock gear actuator (HGA) in detail

tor axis. Instead of using electromechanical drives, these two axes can still be actuated hydraulically, for example, using an axial and a swivel unit. The complexity could be halved while maintaining a similar level of performance. The HGA is therefore an excellent example of how complexity and costs can be significantly reduced through innovative ideas.

The main advantages of this transmission actuator are the compactness and the modularity compared to large conventional gear actuator units. The parameters for different actuation values, for example, the gearshift force or dynamics, can be set by changing the pressure and volume flow.

Of course, it would also be conceivable to use a different system than the central hydraulic system for actuation of the HGA. Two separate hydrostatic clutch actuators (HCA) or two bi-rotational pumps could also be considered. The above mentioned solutions with only one actuator and a number of seat valves are also feasible, because

selecting and shifting movements never take place at the same time, and no continuous force must be applied. Especially if there is no central hydraulic system for controlling the HGA, for example, in a hybrid transmission.



**Figure 10** Excerpt from the functional analysis of a double clutch transmission

## Double clutch transmission actuated with two actuators

### The double-motor DCT (2M DCT)

As previously shown, there are solutions for actuating two clutches with one actuator or performing selection and shifting operations with one power drive. Only two electromechanical drives are therefore required for a double clutch transmission. To ensure that the restrictions in terms of time are minimized, it is important to carry out a systematic analysis of when each drive is required and what disadvantages could occur if in exceptional cases actuator functions are performed in series instead of in parallel.

Because more than two drives are never required at the same time in a double

clutch transmission, it is highly advisable to assign one drive to the active clutch and the other drive to preselect the gear in the inactive sub-transmission. Both actuators are subsequently available for transferring the torque from one clutch to the other. One sub-transmission with the associated clutch can therefore be actuated by only one drive.

### Double-motor DCT with combined shift and clutch actuation drums

The basic structure of this DCT comprises two sub-transmissions, which are operated by two sub-shift drums connected to each other by means of a gear stage. The gear stages are each driven by an electric motor, which either generates a selection movement or shifting movement with the subsequent sequential clutch actuation for the relevant sub-transmission depending on the direction of rotation. Each clutch is

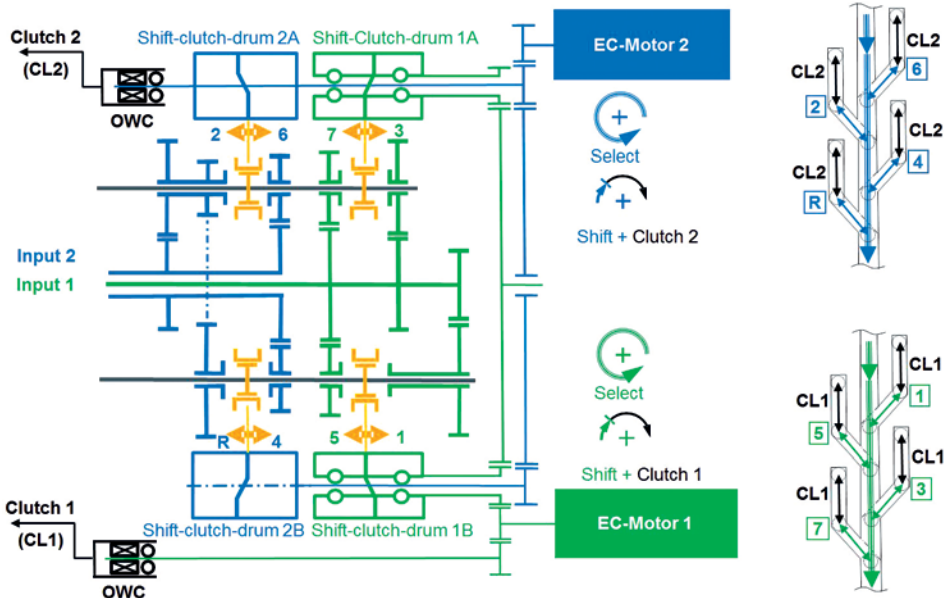
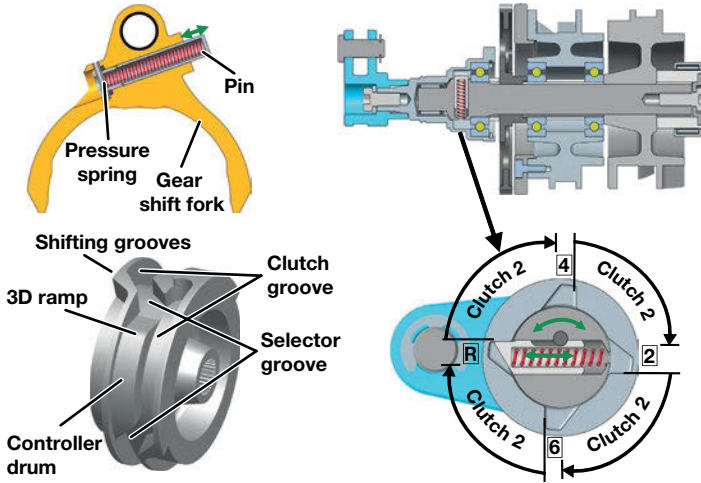


Figure 11 Structure of the 2M DCT with combined shift and clutch actuation drums



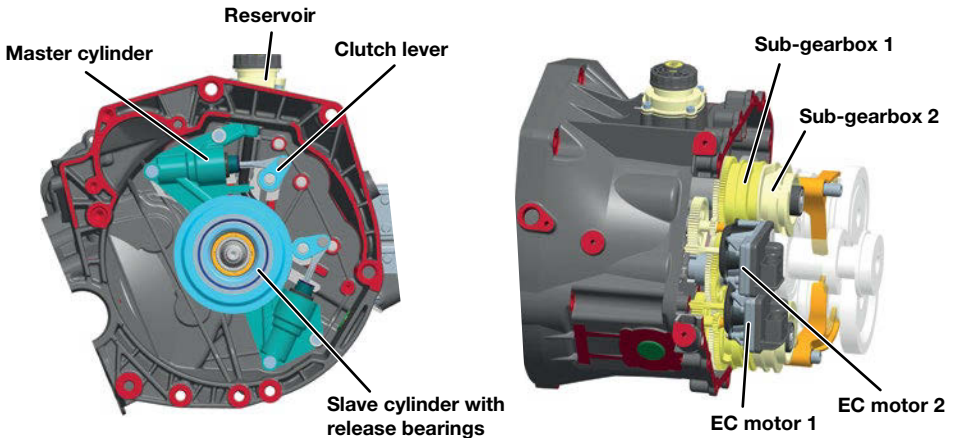
**Figure 12** 2M DCT pin control system and angle-controlled one-way clutch

reached (selection operation). If the shift drum is rotated in the opposite direction, the shift fork pin slides along the diagonal gear ramp surface and engages the gear (gearshift operation).

In this moment, the angle-controlled one-way clutch reaches its locking position and moves the clutch actuating lever with the gear engaged by means of an additional rotation of the shift drum.

The one-way clutch function with angle control is realized in the clutch actuating lever by means of a pin that is free to move radially and is preloaded in the shift drum shaft and a one-way clutch ramp that is matched to the shift drum program. The pin cannot be moved in the shift drum shaft in the direction of locking and therefore transmits the torque to the clutch actuating lever.

The shift drum can rotate freely in the direction of selection movement by means of a three-dimensional ramp geometry and a sprung gearshift fork pin until the circumferential position of the required gear is reached (selection operation). If the shift drum is rotated in the opposite direction, the shift fork pin slides along the diagonal gear ramp surface and engages the gear (gearshift operation). In this moment, the angle-controlled one-way clutch reaches its locking position and moves the clutch actuating lever with the gear engaged by means of an additional rotation of the shift drum.



**Figure 13** Integration of 2M DCT actuators into a transmission

The clutch actuating levers press on the push rods of two hydrostatic master cylinders, which, in turn, operate two slave cylinders arranged coaxially relative to the transmission input shafts. In conjunction with the integrated engagement bearings, the master cylinders and the slave cylinders form a compact engagement system, which is completely enclosed within the clutch housing. The shift drums and gear train are located in the normal positions for transmissions equipped with shift drums. Both drives with the integrated electronics and the hydraulic fluid reservoir are located in a suitable position on the transmission.

### Integration variants of 2M DCT actuators

2M DCT actuators have already been implemented for different DCT gear sets with only minor changes to the gearshift forks and housing.

However, it must be stated that an optimum solution for this type of system can only be found in very close collaboration with the transmission manufacturer. Compromises must frequently be found with regard to the design envelope, costs and functions.

### 2M DCT with bi-rotational pumps and HGA

High-pressure bi-rotational pumps can be installed in conjunction with an HGA as another system for using the two directions of rotation of an electric motor for two different subfunctions in the transmission. One of the two bi-rotational pumps is assigned to each clutch. This means the clutches can be actuated independently. The second pressure connection (in a reversing direction) is connected with the HGA using a simple valve logic. This arrangement ensures a very high

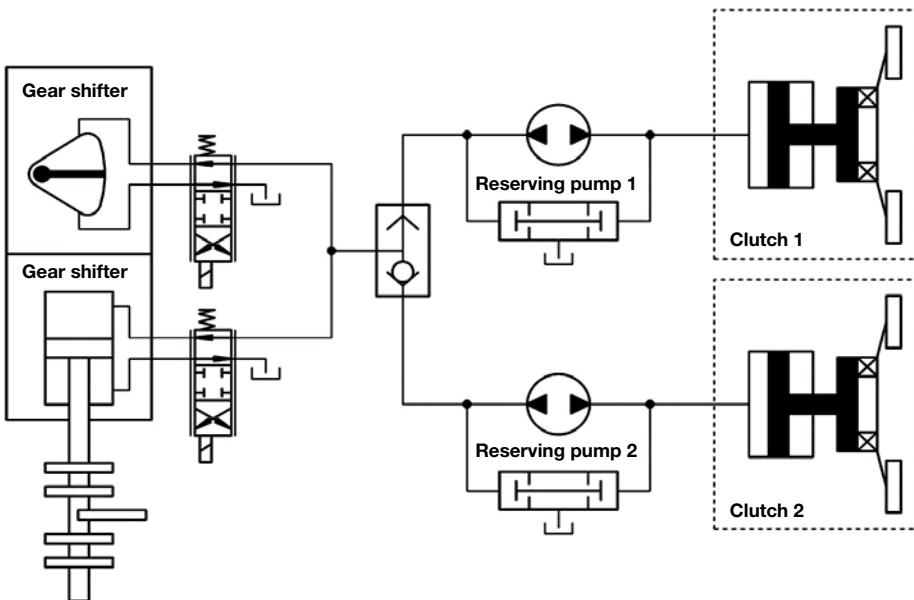


Figure 14 2M DCT variant with bi-rotational pumps and HGA

level of functionality of the transmission with the reduced number of electric drives. The HGA divides the available energy via two valves into the required stroke for selection and the swivel movement for gearshifts.

## Modular system of components

### Control units, electric motors and sensors

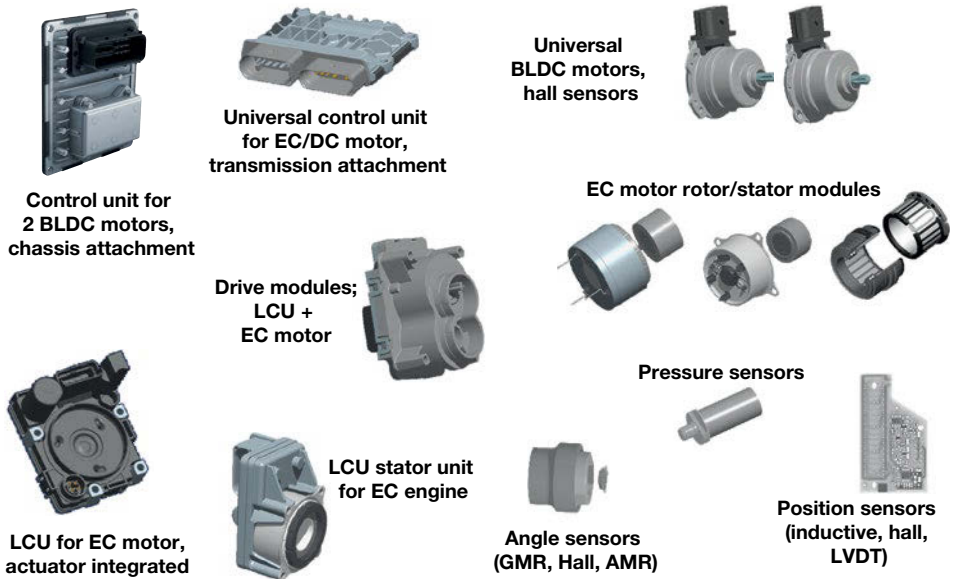
The Schaeffler Group now has a wide range of modules for electronic components due to its many years of intensive development of electromechanical actuators for transmission systems.

### Mechanical components

With the expertise and experience gained with regard to power screws and nuts made of different materials as well as screw drives with optimized friction behavior such as KGT, PWG and SPWG, Schaeffler has innovative drive components for actuators, which can be used for specific applications.

The latest developments are:

- The synchronized planetary roller spindle (SPWG), a spindle drive with a constant pitch and very high power density.
- A verifiable reference position, which is detectable by the software and can be clearly differentiated from the stiffness or blocking of the system.
- The integrated, friction spring band, which prevents the actuator snapping open in case of a fault (2 $\eta$  band).



**Figure 15** Control units, electric motors and sensors for transmission actuators

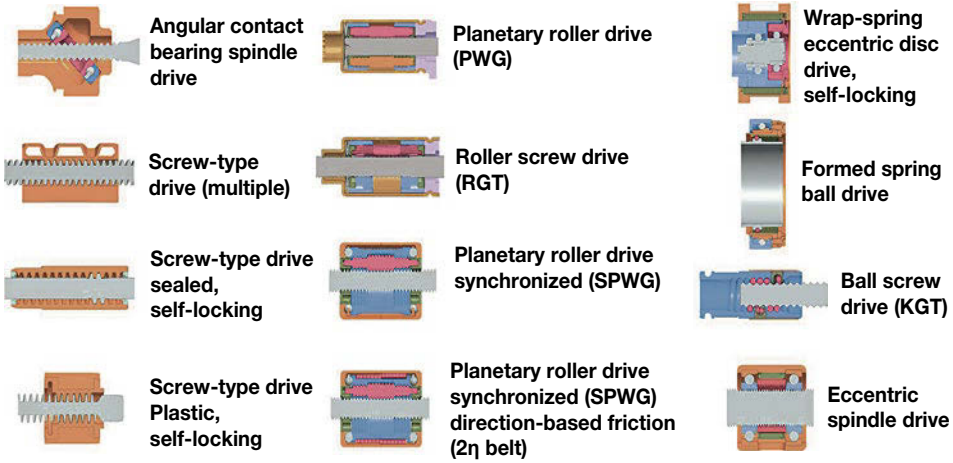


Figure 16 Mechanical components

### New compact actuator for the automation of clutches

Precise and individual new actuators can be developed from the modular components by using new design and simulation

tools. Reliable statements can be made at an early stage with regard to the system behavior and operating life.

Such an example is the new compact actuator. Innovative mechanical components such as the synchronized planetary

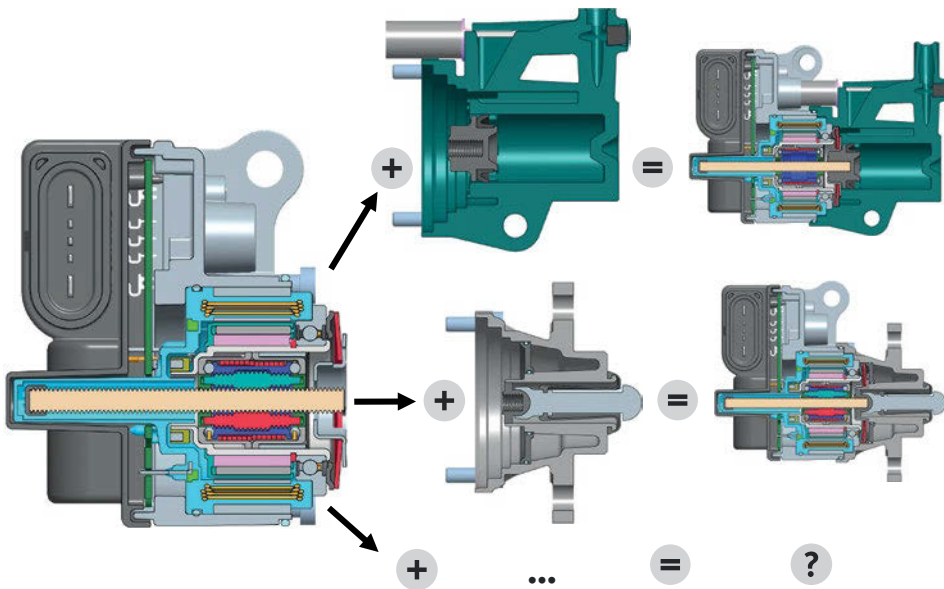


Figure 17 Compact actuator for the automation of clutches

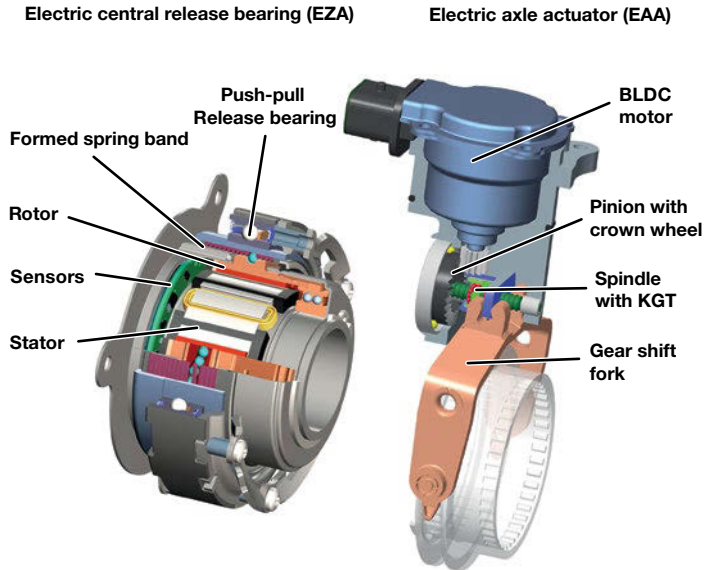


roller spindle (SPWG), the verifiable reference stop and the 2η band were integrated into a compact and modular actuator with new electronic components. This actuator seems particularly suitable for MTs, AMTs, hybrid drives and electric clutch applications.

### Actuators for hybrid applications

Different actuators are also required in vehicles with new types of hybrid and electric drives. In contrast to conventional transmissions, electromechanical power-on-demand actuator systems are usually required in these applications. Many applications can be operated with available actuators. The lever actuator [6, 8, 9] or HCA [2, 3, 6] is used in such powertrains for clutch actuation or a gear actuator is used for activating shifting elements and the parking lock. For special applications, for which available actuators are not suitable, new actuators can be quickly and economically developed for the special requirements from the modular system of components mentioned above.

The electric clutch actuator (ECA) for controlling disconnect clutches in hybrid modules can be completely integrated with the clutch into the hybrid module [10, 11]. The associated power electronics (ACU = actuator control unit) are also mounted on the hybrid module. A highly-integrated hybrid module with simple interfaces is created.



**Figure 18** Electric clutch actuator (ECA) and electric axle actuator (EAA)

The electric axle actuator (EAA) is used for shifting into the neutral position and shifting gears in electric drives. The electric motor and ball screw drive (KGT) are components from the modular system. The EAA can also be controlled by the actuator control unit (ACU) mounted on the electric axle.

## Outlook

The actuation future lies in even more highly-integrated and intelligent modules [9]. If actuators act directly on the pressure plate of a rotating clutch, they can be designed much smaller because the required actuation energy is very low due to the significant reduction in the actuation path. There is still a long way to go until actuators and electronics are available for the challenging conditions in a clutch. LuK has set itself this specific target. The basic function of

transmitting electrical energy and signals and the function of small electric motors or piezo actuators has already been proven.

The current state of the art for double clutch actuation uses four actuators. This paper has presented many solutions with two actuator drives for a double clutch transmission. The provocative question is: can the number of drives be further reduced to one, or even zero? One idea to obtain such an actuation solution has shown promising initial results by tapping into the energy directly from the rotating powertrain.

Of course, there are a range of technical challenges to overcome before such ideas can be implemented. However, these ideas must be investigated in more detail in the near future.

## Summary

---

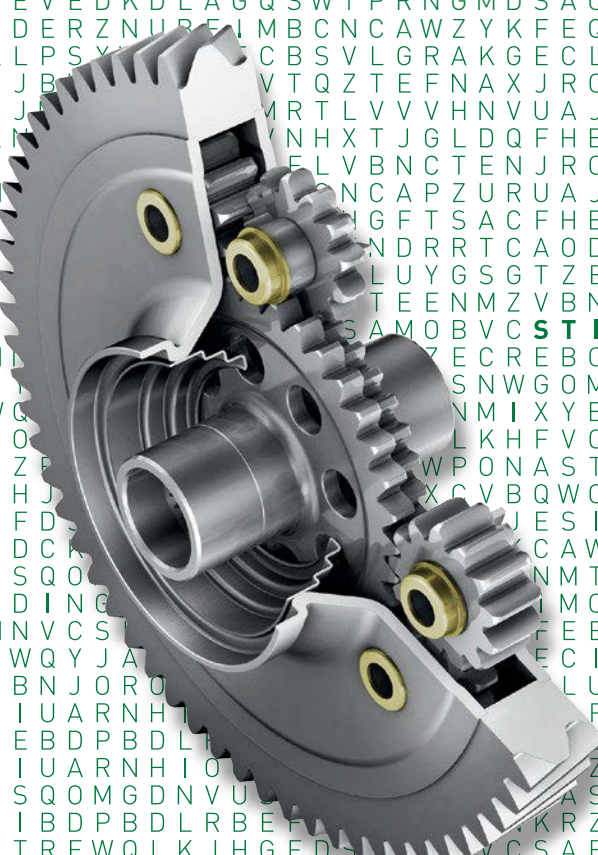
Currently known electromechanical and hydraulic transmission actuation systems are being continuously developed while taking into account new boundary conditions, but above all using new technologies in mechanics and electronics. The discussed developments and ideas show that both a significant reduction in complexity and the provision of increased functionality are possible. The watchwords here are intelligent system architectures, modularity, and increasing integration on the basis of a versatile modular system of components.

## Literature

---

- [1] Wagner, U.; Zink, M.; Feltz, C.: Double Clutch Systems – Modular and Highly Efficient for the Powertrain of Tomorrow, 10<sup>th</sup> Schaeffler Symposium, 2014
- [2] Mueller, B.; Ubben, H.; Gantner, W.; Rathke, G.: Efficient Components for efficient Transmissions. CTI Symposium, 2013
- [3] Mueller, B.; Kneissler, M.; Gramann, M.; Esly, N.; Daikeler, R.; Agner, I.: Smaller, Smoother, Smarter – Advance development components for double clutch transmissions. 9<sup>th</sup> Schaeffler Symposium, 2010
- [4] Faust, H.: Future Requirements for Transmission Benchmarking, GETRAG Drivertrain Forum 2012
- [5] EP 1 236 918 B1, Clutch system with a pump actuated clutch, ZF Sachs AG 2001
- [6] Wagner, U.; Bührle, P.; Müller, B.; Kimmig, K.-L.; Kneissler, M.: Dry double clutch systems – Innovative components for highly-efficient vehicle transmissions, ATZ 11/2009, pp. 826-833
- [7] Kimmig, K.; Rathke, G.; Reuschel, M.: The Next Generation of Efficient Dry Double Clutch-Systems, VDI Congress, 2013
- [8] Wagner, U.; Berger, R.; Ehrlich, M.; Homm, M.: Electromotoric actuators for double clutch transmissions – Best efficiency by itself; 8<sup>th</sup> LuK Symposium, 2006
- [9] Wagner, U.; Müller, B.; Henneberger, K.; Grethel, M.: What makes a transmission operate – Tailored actuation systems for double clutch transmissions; CTI Symposium, 2011
- [10] Stopp, R.: P2 Hybrid Module – Modular concept to hybridize all modern automatic transmission, VDI Tagung, Innovative Fahrzeugantriebe, 2012
- [11] Mitariu, M.: Herausforderungen und innovative Lösungen der nächsten Hybridmodulgeneration, VDI Tagung, Kupplungen und Kupplungssysteme in Antrieben, 2013

NVUAJJKUV^LWQVZESLNF...  
 DQFHBVVTGKUPWQVZESLNF...  
 ENAODDFECKTACTSVQDEFBNIMAF...  
 YKFEQLOPNNGFGRGHNWEDWCYQAFV...  
 ACVBOFETZHNAXCFTJKJZMHZKXAYH...  
 TCASNINROAXEVEDKDLAGQSWIPRNGM...  
 SGEBERZYLINDERZNUREFIMBCNCACW...  
 MZGOHASEDCKLPSY...  
 VCYMLMOKNIJB...  
 CRFVEGBZHNUJ...  
 NWAAREGCVFHKN...  
 MIQWURTOIJE...  
 KHESYS...  
 ONCALVIKNDV...  
 VBNMIQWURTZ...  
 NJIMNSTRECL...  
 YKFEDIOPNGS...  
 KGECEZEMSAC...  
 FXJLRNIFZKM...  
 NVRDJKUVVXES...  
 KQFHBQFGUPWQ...  
 OIZPMRDRNQBO...  
 VWMCRMUUMP...  
 AKDPJPPSDFGHJ...  
 LSJTDWYKJHGFD...  
 EKJRCEOIJGRDCK...  
 MOTYQLGNTZDSQO...  
 TNUEIIRLUJGDING...  
 DCOOVGESOPMNVCS...  
 JYIZQHTAHINCWQYJA...  
 NJKVNTRAKDOBNJOR...  
 AA00UWNDONGIUARNHI...  
 UDMBBEBHMGREBDPBDL...  
 AAOFRICTIONIUARNHI...  
 MOTMQGNTZDSQOMGDNVU...  
 UDMTBHBHMGRIBDPBDLRBE...  
 FEIDRTQRUIUZTREWQLKHGFDS...  
 CIMNSTRECLPQACEZRWDXAYHBMWRZ...  
 PJMNIJHLMOKNIJUHBZGVTFCRD...  
 CGTJDGLETUOADGJLYCBMWRZIPS...  
 JTZUETOIZRWQETUOMB...



# Light, Compact and Efficient

Schaeffler differential systems set the pace

Thorsten Biermann

# 26



## Introduction

---

The Schaeffler lightweight differential was presented for the first time at the 2010 Schaeffler Symposium in Baden-Baden, Germany [1]. At the time, the innovative aspect of the design focused on the reduced weight and smaller mounting space required for the groundbreaking differential concept. Since then, the lightweight differential has been further optimized in order to overcome the last of the concept's drawbacks in comparison to the existing bevel gear differential. During the optimization phase, the key focus has been to improve the rigidity of the differential, and reduce frictional losses in the main bearing support. A further aim was to reduce the production costs. Today, this means that there is virtually no effect on costs, at least when the differential is operated within high torque ranges. For those who have not yet come across the Schaeffler lightweight differential,



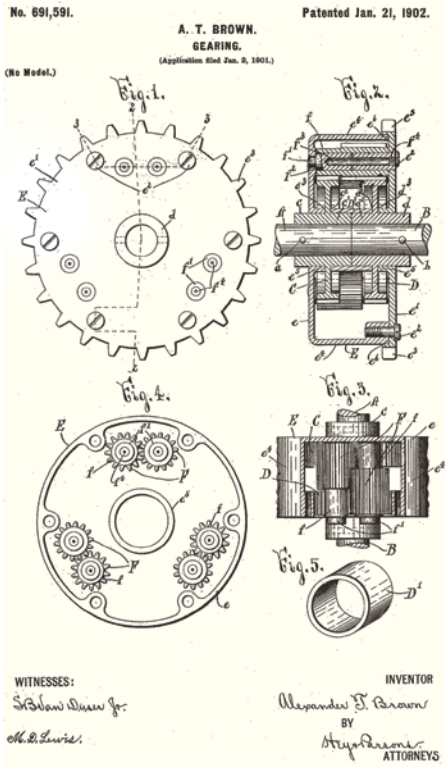
**Figure 1** The father of the spur gear differential "Alexander T. Brown"

what follows is a brief explanation of how the component came into existence.

Based on the most recently available sources, Alexander Timothy Brown can be described as the father of the "spur gear differential", a category of differential that includes the Schaeffler lightweight differential. Born in 1854, Brown quickly developed into a technical all-rounder as well as someone "with considerable inventive talent". Yet Brown is not known for his early designs for guns or even typewriters – instead, he is known for inventing the first pneumatic tire for automotive vehicles, which he patented on December 20, 1892.

The tire wear caused by driving around bends – a problem that Brown faced when designing his new tires – may be the reason behind his invention of a new type of differential. US patent no. 691591 was granted on January 21, 1902 (Figure 2). The patent related to a design variant for a new differential as an alternative to the existing bevel gear differential. Brown's solution was to omit bevel gears in favour of spur gears – a concept made possible by designing the differential as a planetary transmission. In contrast to a conventional planetary transmission consisting of a sun gear, planet gears and a ring gear, Brown's spur gear differential did not feature ring gears. Instead, the transmission featured two output sun gears. Pairs of planet gears were then arranged around the circumference of the output sun gears. At all times, one planet gear would be meshed with the left-hand sun gear while the other planet gear would be meshed with the right-hand sun gear. The planet gears meshed with one another in the free area that remained between the gearing of the two sun gears.

The new design ensured that torque was distributed symmetrically to the wheels while still using the same number of teeth on the sun gears and planet gears. The symmetrical design also boasted a high proportion of identical parts. The closed design of the differential suggests that it was intended for use as a differential arranged coaxially to the rear axle.



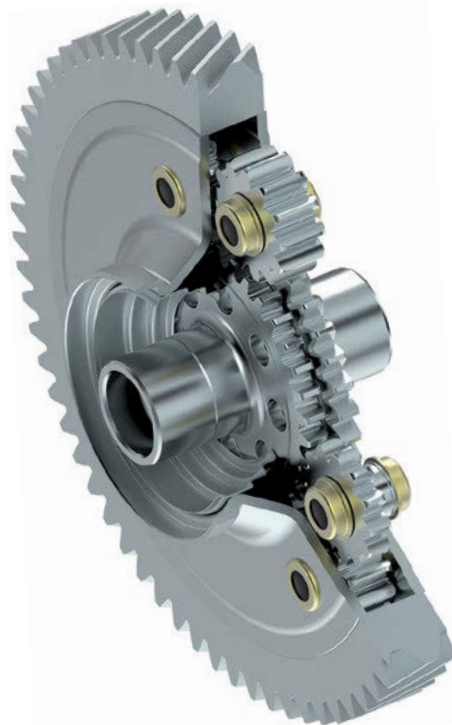
**Figure 2** Excerpt from the patent specification for the first spur gear differential from 1902

## The Schaeffler lightweight differential

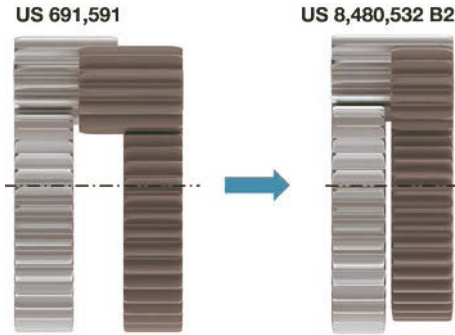
The Schaeffler lightweight differential shares some common features with Brown's original design. Just as Brown did, the developers at Schaeffler decided to use three pairs of planet gears in the basic variant (Figure 3).

This design ensures that forces are distributed evenly across the individual contact points of the gearing, regardless of the manufacturing tolerances. The only issue was that the axial mounting space required for

the original design led to problems when trying to integrate the differential into modern transmissions. With most present-day transmissions that are arranged transversely at the front of the vehicle, there is less mounting space directly next to the drive gear due to the design of the bearing seat for the output shaft or due to the position of the transmission gears. In comparison to Brown's spur gear differential, this problem meant that a more axially compact solution had to be found. The engineers were able to find the solution by further developing the compensation gearing of the differential. In contrast to Brown's design, the Schaeffler lightweight differential uses two sun gears in different sizes [2]. As one planet gear from each pair of planet gears is now arranged around a larger pitch diameter, it has been



**Figure 3** Lightweight differential



**Figure 4** Transmission diagrams of the differential variants by Brown and Schaeffler

possible to shift the contact point between the gearing of the planet gears to the smaller sun gear. In contrast to Brown's patent, the Schaeffler lightweight differential therefore features only two levels of gearing instead of three. This design means a significantly smaller axial mounting space is required. The differential remains in the mounting space of the drive gear and can replace the previously used bevel gear differential without damaging any surrounding structures (Figure 4).

Figure 5 shows the gearing as viewed from the side and reveals the idea behind the new design for the sun gears.



**Figure 5** Side view of the compensation gearing

There is a difference in size between the two sun gears, despite the fact that they have the same number of teeth. This difference is due to the differing profile displacement of the gearings. The smaller sun gear has an extremely negative profile displacement. The area of the involute found directly at the base circle of the gearing is used. The larger sun gear has an extremely positive profile displacement. Here, the area of the involute that is furthest away from the base circle is used. The teeth of the larger sun gear have a pyramid-shaped cross section with a wide tooth root. On the smaller sun gear, the tooth root is comparatively narrow. This design leads to a higher load being placed on each tooth root on the smaller sun gear. The smaller sun gear must therefore be slightly wider than the larger sun gear. As both sun gears have the same number of teeth as well as the same module, both gearings have the same base circle diameter. The same tangential forces are applied, meaning identical torques are produced at the two sun gears. Despite the asymmetric design of the compensation gearing, the torque is therefore distributed symmetrically to the side shafts. This being the case, equation 1 applies to the internal transmission of the differential:

$$i = -\frac{Z_{pl1}}{Z_{su1}} \cdot \frac{Z_{pl2}}{Z_{pl1}} \cdot \frac{Z_{su2}}{Z_{pl2}} = \frac{Z_{su2}}{Z_{su1}} = -1$$

Nevertheless, the number of teeth on the planet gears does not necessarily need to be identical, as they cancel each other out in the equation. In fact, the number of teeth on the narrower planet gears can therefore be slightly larger in order to optimize the contact point between the gearing of the planet gears. For example, a larger number of teeth can increase the contact ratios without the radial mounting space having to be enlarged.

Alternatively, there is also a solution that uses different numbers of teeth on the sun gears. In this case, the difference in the number of teeth must be calculated such that the system can still be mounted. In contrast to profile displacement, a change in the number of teeth on the sun gears actually has an impact on torque distribution, meaning that any adjustment to the number of teeth must be matched by a corresponding transmission between the planet gears. This is only made possible by using a stepped planet gear.

In equation 2, only the number of teeth on the second planet gear is canceled out. A possible solution for a differential with three pairs of planet gears would be to have one sun gear with 36 teeth, a second sun gear with 33 teeth, and a stepped planet gear with either 11 or 12 teeth.

$$i = -\frac{Z_{pl1a}}{Z_{su1}} \cdot \frac{Z_{pl2}}{Z_{pl1b}} \cdot \frac{Z_{su2}}{Z_{pl2}} = \frac{Z_{su2}}{Z_{su1}} = \frac{Z_{pl1a}}{Z_{pl1b}} \cdot \frac{Z_{su2}}{Z_{su1}} = -1$$

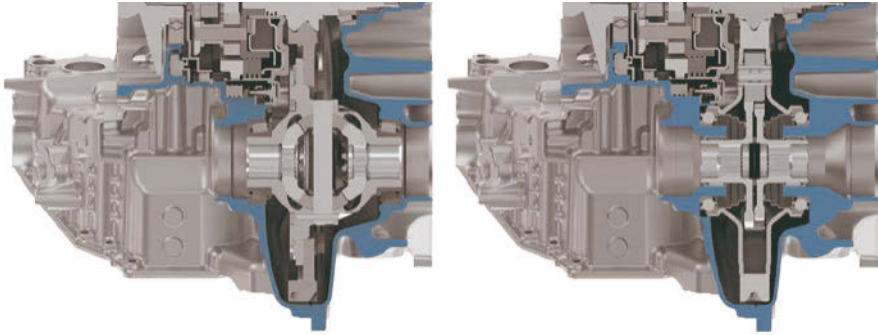
Another possibility would be to use different modules in the compensation gearing of the differential. This would be possible using the same or a different number of teeth on the sun gears. The latter variants perform worse than the former variants at least in terms of costs at the present time due to the stepped planet gears. As a result, the latter variants are not currently being pursued.

What all of these variants have in common, however, is their extremely narrow design in comparison to the existing gearings of bevel gear differentials. This narrow design is primarily a result of the increased number of gearing contact points. On the bevel gear differential, there are four gearing contact points between the differential pinions and the output bevel gears as standard. In contrast, torque on the lightweight differential featuring three pairs of planet gears is transferred to the two sun gears via three contact points each, creating a total of six gearing contact points.

In addition, a fundamental mechanical law also has an effect on the lightweight differential: Torque equals force times the length of the lever arm. On the spur gear differential and the bevel gear differential, the distance of the gearing contact point to the center of the differential is equal to the length of the lever arm. As the sun gears on the lightweight differential have a significantly larger gearing diameter than the bevel gears, the gearing forces are significantly reduced while maintaining the same torque. In conjunction with the number of gearing contact points, the relationship between the two diameters allows for a comparatively delicate gearing design. Such an optimum layout and design for a compensation gearing with a high level of power density is an essential aspect of the new differential design variant from Schaeffler.

Another key focus that required several development loops was the design of the differential housing and the bearing support. It was important to design the housing such that a high level of rigidity could be achieved at the gearing contact point of the drive gear, as well as a significant reduction in the amount of friction at the main bearing support in comparison to a bevel gear differential. At the same time, the reshaped bracket of the differential housing must not be exposed to high levels of stress. However, a fundamental issue stood in the way of these objectives: a significantly reduced distance between the bearings in comparison to the bevel gear differential. The following application examples show how it was possible to take this problem – which at first appeared to be a serious disadvantage – and transform it into an advantage.





**Figure 6** CVT with and without lightweight differential

## Current developments

### Optimizing a CVT

Figure 6 shows a continuously variable transmission (CVT) before and after replacing the traditional bevel gear differential with

a lightweight differential. Despite the relatively low torque capacity totaling a rated 2750 Nm at the axis, the lightweight differential boasts a weight saving of approximately 1.1 kg. The lightweight differential has a total weight of 5 kg yet the strength of the housing and gearing has been increased.

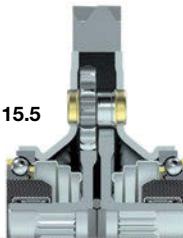
The main difference is the change in bearing type and bearing support in comparison to the bevel gear differential. Instead

of an X arrangement using tapered roller bearings, two angular contact ball bearings are used in an O arrangement. As such, it has been possible to design the bearing support on the lightweight differential in an extremely efficient manner with regard to friction. At the same time, a long service life as well as a high level of rigidity have also been achieved. In Figure 7, the torque-dependent frictional power values of an optimized bearing sup-

**Angular contact ball bearing (left)**

$\varnothing 55.0 \times \varnothing 83.0 \times 15.5$

**C = 28.0 kN**  
**C0 = 25.5 kN**



**Angular contact ball bearing (right)**

$\varnothing 55.0 \times \varnothing 83.0 \times 15.5$

**C = 28.0 kN**  
**C0 = 25.5 kN**

Friction 2 kN @ 80 °C		M_diff. in Nm						
		50	100	500	750	1,000	1,500	2,000
n_diff. in min <sup>-1</sup>	40	-0.297	-0.293	-0.221	-0.220	-0.192	0.001	0.386
	100	-0.319	-0.316	-0.244	-0.241	-0.213	-0.021	0.356
	200	-0.347	-0.345	-0.271	-0.271	-0.243	-0.057	0.311
	400	-0.393	-0.392	-0.315	-0.317	-0.293	-0.118	0.229
	600	-0.429	-0.428	-0.351	-0.354	-0.333	-0.166	
	1,000	-0.488	-0.488	-0.404	-0.410	-0.402		
	1,400	-0.536	-0.534	-0.447	-0.453			
	1,900	-0.588	-0.586	-0.493				

**M\_diff.:** Moment of differential **n\_diff.:** Speed of differential

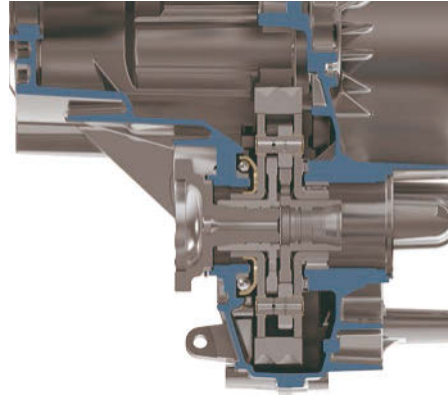
**Figure 7** Reduced drag torques through the use of angular contact ball bearings in an O arrangement

port are shown in comparison to a bevel gear differential. The green areas indicate the load scenarios in which the bearing support of the lightweight differential performs better in terms of friction in comparison to the bevel gear differential.

In the most common load scenarios, friction savings of up to 80 % can be achieved, and the ball bearing support achieves an extremely high level of efficiency, even in the partial load range. This partial load range represents a key focus of conventional fuel consumption cycles. So in this application example based on the New European Driving Cycle (NEDC) it is theoretically possible to achieve fuel consumption savings of up to 0.35 g of CO<sub>2</sub>/km in addition to the weight saving.

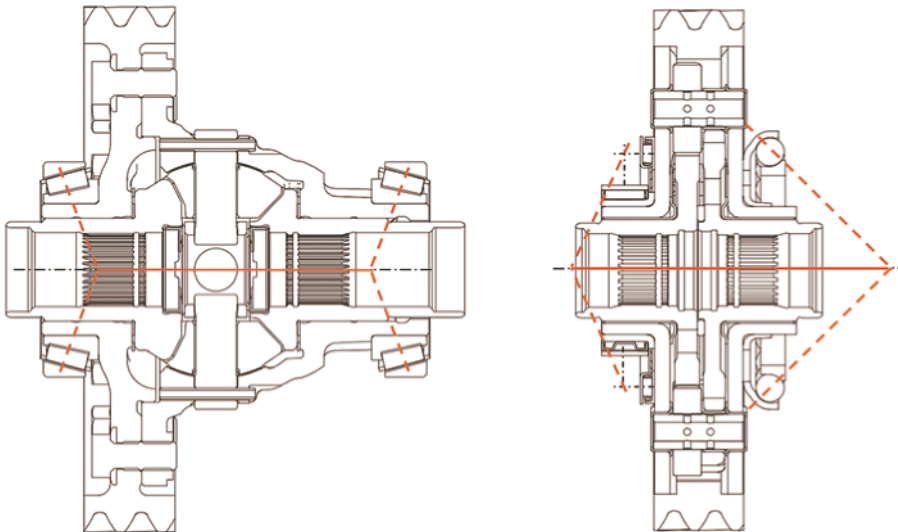
### Optimizing a manual front transverse transmission

The second application example (Figure 8) shows a manual transmission arranged transversely at the front of the vehicle, with



**Figure 8** Manual transmission with lightweight differential

a rated torque at axle of approximately 6500 Nm. Even at high torques upwards of 6000 Nm, thanks to the massive weight savings despite the greater number of components it is possible to eliminate any impact on costs in comparison to many existing bevel gear differentials. This remains true as long as similar volumes are produced.



**Figure 9** The bevel gear differential versus the lightweight differential: The red lines show the contact angle of the bearing support

The reason behind this cost benefit lies in the fundamentally similar production methods used for the two differentials. The compensation gearing of the differential is extruded and the housing parts are deep-drawn while avoiding any machined rework wherever possible. In addition, the cold metal sheet forming techniques in use entail relatively low levels of energy consumption in comparison to traditional casting techniques.

Another reason behind this cost benefit is that a higher number of components may be required for the bevel gear differential in some cases: At high torques, two differential pinions are often no longer sufficient to transfer the gearing forces. Accordingly, the number of differential pinions is increased, which, in turn, requires a larger, circumferentially closed housing design.

In the present example, the weight of the bevel gear differential including the tapered roller bearing support and drive gear is equal to 13.4 kg. The differential housing must be divided to facilitate the assembly of four differential pinions. At maximum torque peaks, the differential gearing generates expansion forces of more than 100 kN, which,

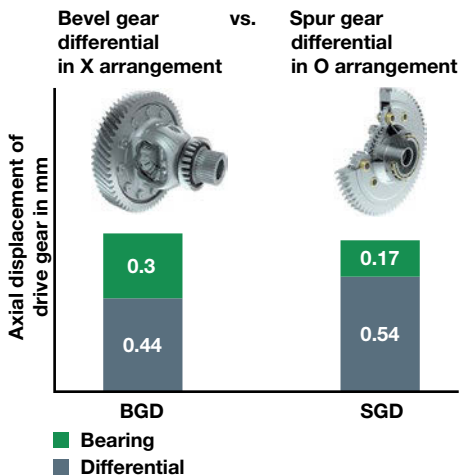
in addition to the torque, act upon the screw connection between the differential cage and the axle drive gear. Despite the high operating weight, there is therefore no real potential to increase the life of the overall system. As a result, it is difficult to imagine increasing the torque or even reducing the weight.

Despite the high torque, the developers at Schaeffler increased the number of pairs of planet gears in the lightweight differential to a total of four in order to keep the differential under the mounting space of the drive gear. Both halves of the housing are pressed completely into the drive gear and are riveted at four points between the pairs of planet gears in order to optimally support the drive gear (Figure 11).

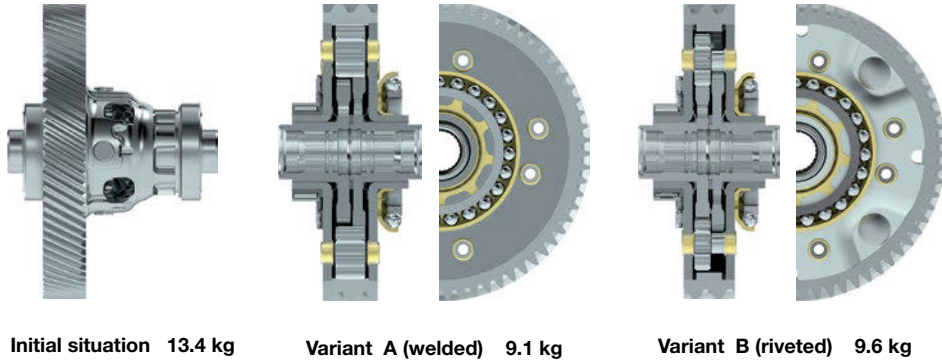
In addition to stabilizing the bearing support, the flanges on the differential housing are used to center and guide the output sun gears and side shafts. Hardened sleeves are pressed into the flanges. These sleeves are fitted with corresponding oil reservoirs. Both the sun gears and the bevel gears are extended beyond the housing. As the sun gears are also fitted with internal sealing caps, the stub shafts can be disassembled without the risk of losing any oil.

Thanks to a combination of roller bearings and axial needle roller bearings, plus a new type of flange bearing, the bearing support offers an extremely high level of rigidity. The flange bearing relies on manufacturing technology similar to that used for clutch release bearings or strut bearings.

Figure 10 shows a comparison of results for current prototypes. The lightweight differential has a more deflected shape, yet this is then offset by a more rigid bearing support. The results are generally at the same level for both transmission variants, yet show the level of displacement of a drive gear riveted to the differential. The next step in the development process represents a departure from this principle towards the use of a laser welded



**Figure 10** Rigidity measurement



**Figure 11** Weight savings at high torque classes

connection, as is already used in the volume production of various bevel gear differentials. Using a welded connection creates an additional weight saving of approximately 500 g in comparison to the riveted variant.

Furthermore, the design of the drive gear is significantly simplified and the rigidity of the system is further enhanced by the circumferential weld seam. These characteristics mean that the drive gear in the lightweight differential has a reduced level of displacement in comparison to that of the drive gear in the bevel gear differential.

The modified drive gear also offers the option to change the technology used for manufacturing the blank. Instead of classic forging now ring rolling can be used, which can potentially contribute to a significant cost reduction in the production of the drive wheel. Dispensing with riveting also opens the possibility of using variable three or four pairs of planet gears, depending on the torque requirement. This flexibility is very congenial for a modular system.

The alternative design for the transmission with a lightweight differential therefore creates a weight saving of around 4.3 kg without taking into account any optimizations made to the transmission housing itself (Figure 11).

In conjunction with an optimum design for the bearing support, the weight saving

corresponds to a maximum saving of around 0.6 g of CO<sub>2</sub>/km. The use of the axial needle roller bearing support has relatively little effect when it is positioned on the coast side (Figure 12).

Both application examples show how the lightweight differential from Schaeffler can help to reduce weight and fuel consumption. The weight saving of almost more than 4 kg can also help to significantly reduce the total weight of the transmission. By considerably reducing the mounting space required, new free space is created for the design of the bearing support, which enables reductions in friction of up to 80 % in the partial load range. The lightweight differential is also increasingly attractive when it comes to costs. In principle, similar costs to those associated with previous solutions can therefore be expected for high-volume manufacturing.

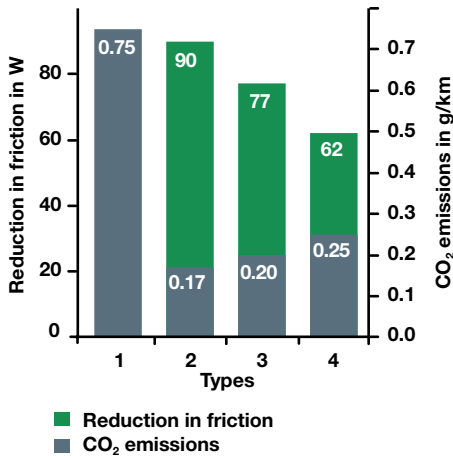
One disadvantage of the described solutions is simply the scope of application limited to transverse transmissions. For this reason, both new and familiar solutions for cost-optimized differentials or even those with an extremely high level of power density are considered in the following section. The purpose of taking a closer look at these solutions is to expand the portfolio of differentials offered by Schaeffler.

**NEDC driving cycle**

- Maximum reduction in fuel consumption: 0.025 l/100 km
- Maximum reduction in CO<sub>2</sub> emissions: 0.58 g/km

Differential	Type	Bearing support	Arrangement
BGD	1	TRB	X
SGD	2	ACBB	O
SGD	3	ACBB/AX + RH	O
SGD	4	TRB/AX + RH	O

TRB - Tapered roller bearing  
 ACBB - Angular contact ball bearing  
 AX - Axial needle roller bearing  
 RH - Drawn cup roller bearing  
 TBB - Tandem ball bearing



**Figure 12** Reduction in fuel consumption at high torque classes

## The search for tomorrow's innovations

As we have demonstrated by examining Alexander Brown's invention, an occasional look into the past can indeed be worthwhile. Sometimes, inventions from bygone eras can even highlight one approach or another that could once again prove useful with the help of modern manufacturing technology.

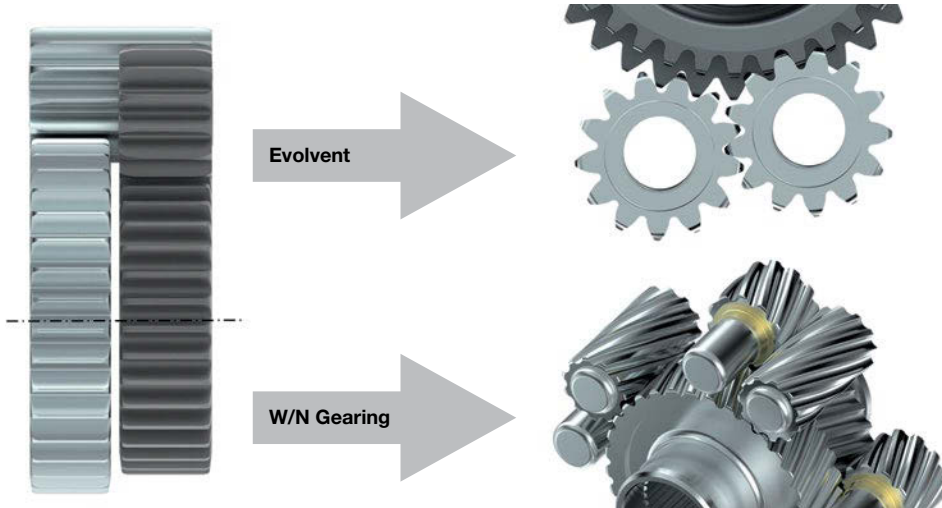
## The Wildhaber-Novikov differential

The idea for the "Wildhaber-Novikov" differential was hit upon a few years ago when looking at the involute compensation gearing of the lightweight differential, which had only just entered into development. The project description for this differential is based on the type of gearing used for the differential pinions, which deviates from the conventional involute gearing.

An alternative circular-arc gearing had already been developed in 1926 by Dr. Ernst Wildhaber. With this gearing design, the convex teeth meshed with concave gaps and the radius of the contact points were approximately the same. In 1956, this gearing design was revisited and refined by Dr. Mikhail Novikov, a Soviet developer and military officer. In general, a higher level of power density is attributed to this gearing design than to comparable involute gearings, and its use in various military vehicles not only in the former Soviet Union has certainly contributed significantly to the reputation of the gearing design.

The developers at Schaeffler then hit upon the idea of accommodating the size difference between the sun gears – while keeping the same number of teeth – by using one convex sun gear and one concave sun gear instead of achieving this via profile displacement, as is the case on the lightweight differential. This principle is explained in Figure 13.

Using this solution, it is possible to shift the gearing contact point between the concave and convex differential gears via the smaller concave sun gear, as is also possible on the lightweight differential. The aim is to create a differential gearing that exhibits an extremely high level of power density as well as narrow radial dimensions. A design of this type could provide a solution for a differential featuring bevel gearing, for example. However, in this case the radial dimensions for the compensation gearing are limited, meaning the traditional gearing featured in the light-

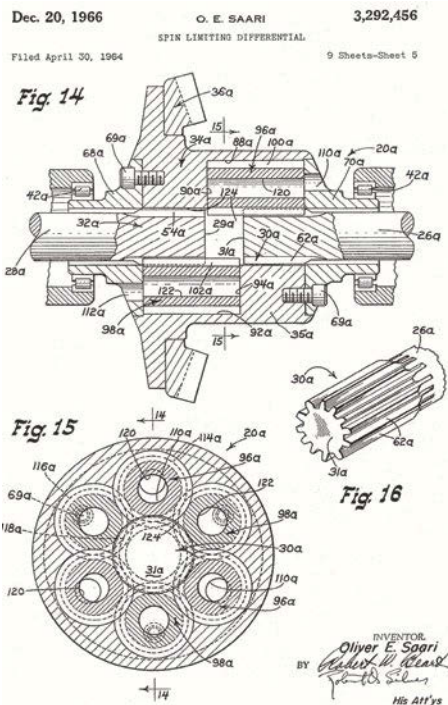


**Figure 13** Asymmetric gearing on the basis of the involute and the circular-arc profile

weight differential can no longer be used. Although this idea appears to be pioneering at first glance, the engineers were not able to confirm that the Wildhaber-Novikov differential has a higher level of power density in previous investigations. For this reason, this approach has not proven successful to date, meaning it has been necessary to look for alternative solutions.

**Oliver Saari's differential**

In 1966, various solutions for differentials using a spur gear design were published under US patent no. 3,292,456; these differentials once again demonstrated a significant increase in performance in comparison to solutions already in existence (Figure 14). Inventor Oliver Saari designed the gearings for these differentials such that the compensation planet gears were not arranged in pairs – instead, all planet gears meshed with one another. As a result, the load on the gearing contact point between the planet gears is significantly reduced and the overall axial length of the gearing is shortened. Thanks



**Figure 14** Excerpt from the patent specification submitted by Oliver Saari

to the high number of gearing contact points, the gearings of the sun gears were also kept sufficiently narrow, despite narrow radial dimensions. As a result, it is possible to create a relatively compact design.

This design was of such interest to the engineers at Schaeffler that they began development of a new differential variant based on Oliver Saari's invention and in conjunction with the asymmetrical design for the sun gears. The result was the heavy-duty differential in addition to the lightweight differential from Schaeffler.

## The Schaeffler heavy-duty differential with all-wheel drive disconnect system

As the provisional title would suggest, the developers at Schaeffler are currently working on a heavy-duty differential with the aim of creating a differential that has a higher level of power density than that of the existing bevel gear differential. When designing this differential, the radial mounting space requirements must still be fulfilled – unfortunately, this was not achieved with the first



**Figure 15** Heavy-duty differential with AWD disconnect system

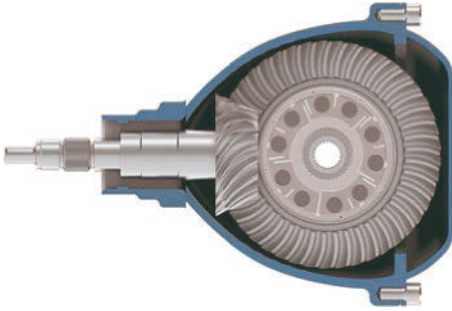
attempt with the Wildhaber-Novikov differential design. The weight and the axial mounting space required for use are less important in this particular scenario.

The development is based on the idea that the customer should not have to resort to the next largest bevel gear differential when the torque of the powertrain is increased. In this case, the customer can instead continue to use the compact heavy-duty differential from Schaeffler. It is therefore also possible to indirectly create a weight saving. In addition, it is also possible to integrate features such as a differential lock or an all-wheel drive disconnect system into the extra axial mounting space.

Figure 15 shows a cross section of a heavy-duty differential featuring an additional all-wheel drive disconnect system. The all-wheel drive disconnect system in the rear-axle differential shown is used to reduce the drag torques in the powertrain by immobilizing the cardan shaft. To do this, it is not sufficient to simply interrupt the power flow to the cardan shaft in the transfer gear. Instead, it is also necessary to further separate the rear-axle differential and the wheels, as otherwise the powertrain is dragged by the rear axle.

The engineers at Schaeffler decided to perform this separation between the differential drive gear and the differential itself. To this end, the differential housing – comprising a single unit up to this point – is divided into two housings arranged coaxially to one another. The outer housing holds the axle drive gear, and the inner housing incorporates the compensation gearing. Although the differential itself is still dragged along when the disconnect system is used, it may be possible to achieve reductions in fuel consumption in the range of 5 % according to a technical publication from 2009 [3].

Another distinctive feature of the Schaeffler solution is the design of the clutch unit. Although the clutch unit shown in Figure 16 may at first glance look like a conventional



**Figure 16** Cross section of the axle transmission with a self-reinforcing clutch unit

actuated wet clutch, it is in fact a one-way clutch unit actuated via additional multi-disk plates.

The use of one-way clutches on the rear axle to immobilize the powertrain is well known, and engaging the rear axle is a relatively straightforward procedure. As soon as engine speed is applied to the cardan shaft and the wet clutch is actuated, the rear axle is “overtaken” and the one-way clutch is locked. On a simple one-way clutch, the manner in which the rear axle is engaged by the prior actuation of the wet clutch is unfavourably abrupt. However, in the case of the Schaeffler solution, engagement of the rear axle is damped and only possible if the one-way clutch is being actuated by the wet clutch. The clamping function of the one-way clutch facilitates a significantly higher torque capacity than that of a comparable wet clutch. In forward direction the wet clutch is only being used as an actuation system.

As soon as the engine speed at the cardan shaft falls under the specified speed, the one-way clutch is disengaged when the wet clutch is not actuated and the drive wheel comes to a stop based on the friction at the cardan shaft. As the high torques in traction mode are absorbed by the integrated “sprag plates” and only the torques in reverse gear or in overrun mode need to be

dealt with by the wet clutch, the clutch unit can be designed for an extremely high level of power density. Both the axial and radial mounting spaces are therefore compact enough to allow the distance between the bearings in the original bevel gear differential to be retained.

## Conclusion

---

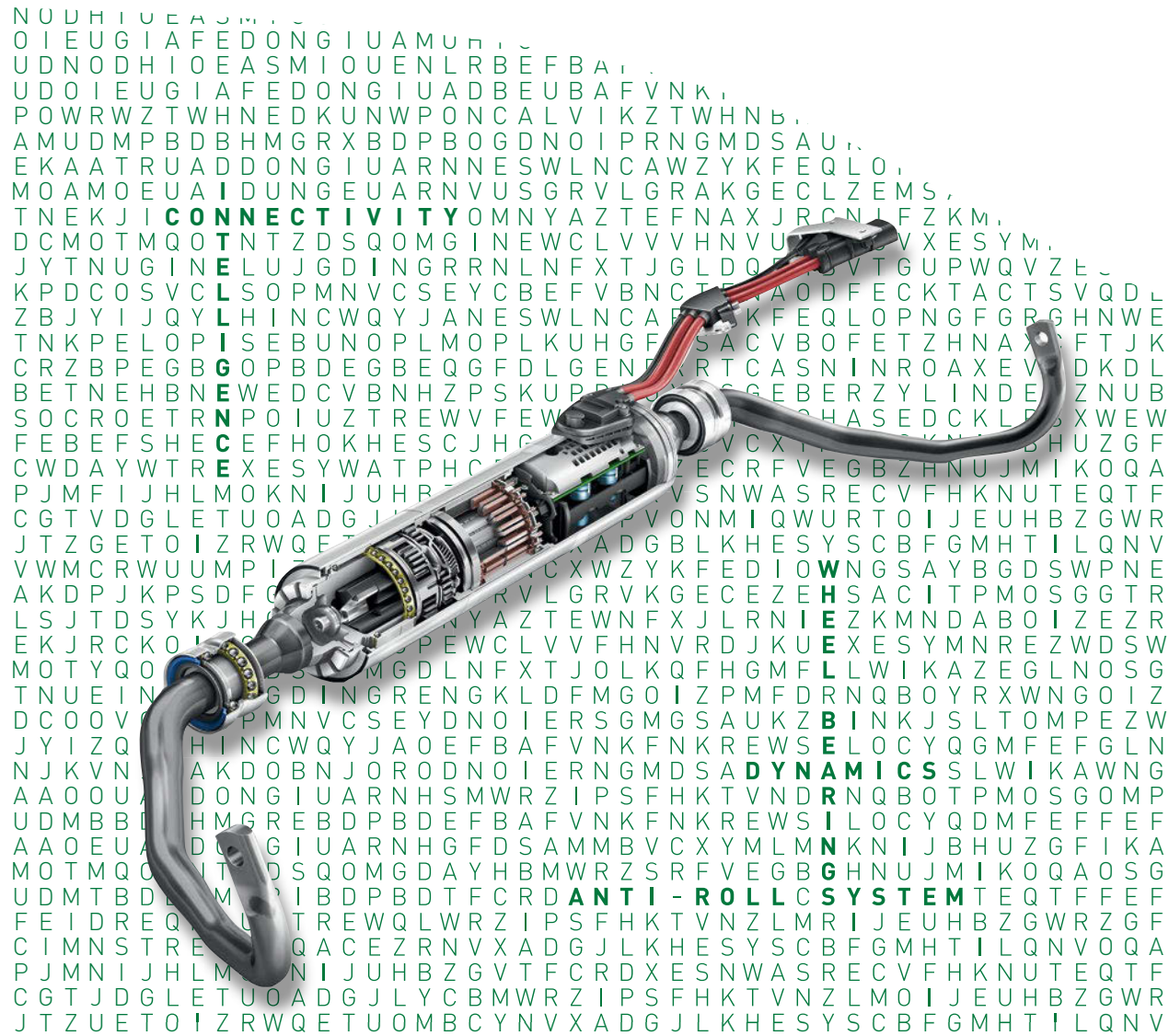
Sometimes, the key to the future lies in the past. An in-depth examination of the ideas and concepts from the pioneering age of automobiles and their relationship to today’s state of the art can provide a starting point for innovations that can solve present-day problems. Current developments at Schaeffler show the way forward, helping to increase customer benefits and find answers to pressing questions relating to aspects such as lightweight construction, costs and CO<sub>2</sub> emissions.

## Literature

---

- [1] Smetana, T.; Biermann, Th.; Hoehn, B.; Kurth, F.: Schaeffler lightweight differentials. 9<sup>th</sup> Schaeffler Symposium, 2010, pp. 94-105
- [2] Smetana, T.; Biermann, Th.: Kompakte Leichtbau-Differenziale (Compact lightweight differentials). ATZ (Automobiltechnische Zeitschrift – Automotive journal) 2/2011, pp. 108-113
- [3] Gassmann, T.; Schwekutsch, M.: Verringerung des allradbedingten Mehrverbrauchs durch dynamische Allradabschaltung. ATZ 9/2009, p. 672





# The Chassis of the Future

Markus Baeuml  
 Florin Dobre  
 Harald Hochmuth  
 Manfred Kraus  
 Hartmut Krehmer  
 Roland Langer  
 Dominik Reif

# 27



## Introduction

When it comes to developing chassis, today's challenges go far and above the traditional conflict of having a comfort-based and sportive set-up. Replacing hydraulic systems with electromechanical actuators in chassis technology is particularly progressing at quite a rate, with scores of functions are already being realised using electromechanical means. In terms of steering, the last hydraulic systems are currently being replaced with electromechanical systems in the D segment. Electric and hybrid vehicles are the driving force behind this application of electro-hydraulic brake boosters. However, these boosters continue to be based on a hydraulic brake with a mechanical safe state. Gradual conversion of the anti-roll system is expected from 2015 onwards. Only the active chassis (Active Body Control, ABC) is currently still designed as a hydraulic system,

but it can also be replaced with an electro-mechanical version.

A whole host of benefits is associated with electrification of the chassis. Thus, the principle of on-demand actuation results in lower energy consumption. New features, such as the Continuous Damping Control (CDC), have also been developed in parallel with this benefit. CDC dampers already make up the extra specifications list in the B and C segments. Figure 1 shows the technologies and their penetration in the individual vehicle segments.

## Requirements of chassis of the future

Stringent requirements regarding CO<sub>2</sub> reduction also mean that chassis technology will have to utilise the potentials provided by

Characteristic	Function	Segment				
		A Sub A	B B-SUV	C C-SUV	C/D CD-SUV	D D-SUV
Lateral dynamics	Electric steering	S	S	S	S	S in future
	Anti-roll system				O	O
	Rear-wheel steering				O	O
	Superimposed steering				O	O
	Torque vectoring					O
Vertical dynamics	Variable dampers		O	O	O	S
	Air springs				O	S/O
	Level control		O <sup>2)</sup>	O <sup>2)</sup>	O <sup>2)</sup>	
	ABC (active body control)					S/O
Longitudinal dynamics	Electronic parking brake		S/O	S	S	
	Electronic brake booster	S <sup>1)</sup>	S <sup>1)</sup>	S <sup>1)</sup>	S in future	S in future
Driver assistance system	Lane departure warning			O	O	O
	Emergency braking assist		O	O	O	O
	Traffic jam assist			O	O	O
	....					
Self-driving vehicles					2017/18 <sup>3)</sup>	

S = standard feature

<sup>1)</sup> will be standard feature on electric vehicles

<sup>3)</sup> Semi-self-driving

O = optional feature

<sup>2)</sup> SOP = 2017 onwards

**Figure 1** Chassis technologies and their penetration in various vehicle segments

Drivers	Urbanisation		Product differentiation	
<b>Trend</b>	<b>Reduction in CO<sub>2</sub> emissions</b>	<b>Affordable travel</b>	<b>Comfort and safety</b>	<b>Driving pleasure</b>
<b>Measures</b>	<b>e-mobility/hybridisation</b>	<b>Platform strategy</b>	<b>Self driving vehicles</b>	<b>Extension of platform strategy functions</b>
	<b>Friction reduction</b>	<b>New chassis layouts/concepts</b>	<b>Network/connected driving</b>	<b>New chassis applications</b>
	<b>Lightweight design</b>	<b>Cost optimised solutions</b>	<b>New vehicle concepts</b>	<b>New vehicle concepts</b>
	<b>Demand-based control</b>	<b>Car sharing</b>	<b>New chassis applications</b>	
	<b>Energy recuperation</b>		<b>Technology aimed at older drivers</b>	

**Figure 2** Trends in chassis technology

lightweight construction, friction reduction and more efficient actuators [1]. This is accompanied by the use of new materials or existing materials with optimised characteristics in terms of rigidity and strength. What's more, many chassis systems are also used as a way of making vehicles stand out within a platform. Figure 2 shows an overview of the current trends.

Over the next few years, buzzwords such as connectivity, autonomous or semi-autonomous driving will have a considerable bearing on chassis development [2]. Related to this development is, ultimately, a modified safety strategy; for instance extended latency periods requiring the basic mechanical function to be protected. This protection may also necessitate enhanced or additional redundancy/safety state. In light of these possibilities, new requirements will be demanded of existing actuators.

What's more, actuators, sensors and systems are increasingly networked to generate new overarching functions, to increase availability and to improve safety. This could be achieved, for instance, by a mutual plausibility in the context of a safety concept according to ISO 26262. Key elements of the future thus include cameras, sensors, antennas, as well as corresponding software

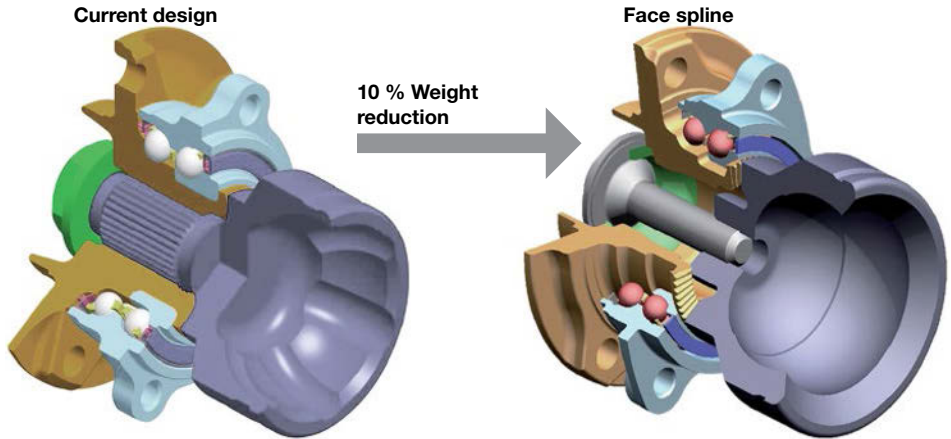
for networking in the vehicle and with the environment [3]

Of key importance is the increase in the use of camera and radar-based as well as laser-based systems. These systems include polarising and infra-red cameras, in addition to stereo ones. Used in combination with information regarding temperature and humidity, it is possible to detect aquaplaning and black ice.

## Current Schaeffler solutions

### Products for reducing weight

In the wheel bearing area, the market has seen a gradual introduction of lightweight construction solutions with face spline and weight-optimised flange design. The technology is becoming increasingly popular and is well on the way to setting a new industry standard in the foreseeable future – a standard that Schaeffler will have created.



**Figure 3** Wheel bearing with face spline design compared to dominant design to date with internal gear teeth

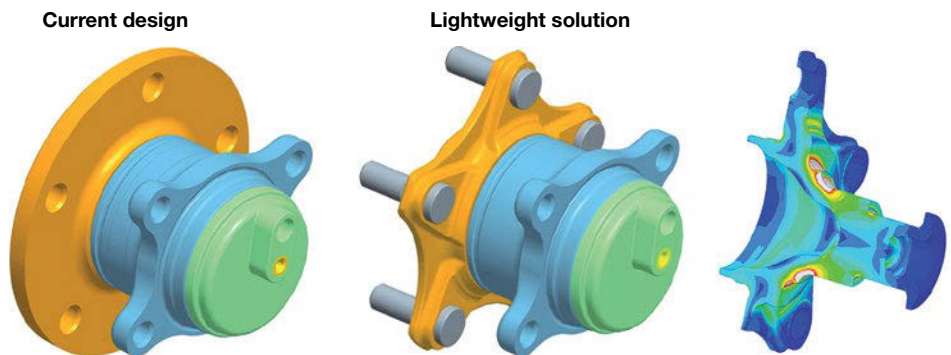
Figure 3 shows a comparison of a third-generation wheel bearing in its previous design and one with face spline.

The benefits from this technology, such as 10 % rigidity increase, 10 % weight reduction, 50 % higher transferable torque as well as a reduction in unsprung mass yet still with simple assembly process, have been utilised in series applications since 2009.

An additional measure for reducing weight comes about by cutting the bear-

ing flange weight while maintaining its rigidity. By applying numerical procedures, it has already been possible to make weight reductions of 20 % without compromising the axial rigidity. Figure 4 shows a wheel bearing with a weight-optimised flange compared with a conventional bearing flange.

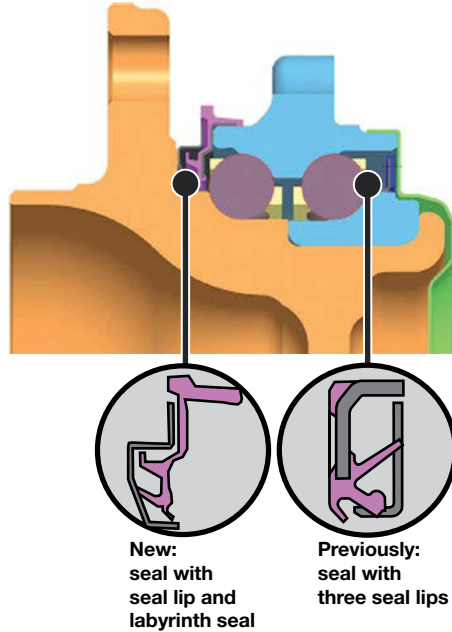
The result is optimised tension curves, which have also been used as a basis for an enhanced fibre flow of the flange. It is feasible to use driven and non-driven axles.



**Figure 4** Comparison of a current wheel bearing with a wheel bearing with weight-optimised flange

### Friction reduction products

Seal friction determines wheel bearing friction to a great extent, which is why it makes sense to start there with measures designed to reduce friction. The wheel bearings offered by Schaeffler can be fitted with low-friction seals, which reduce friction by around 50 % compared to seals offered by competitors. This 50 % reduction thus makes it possible to cut CO<sub>2</sub> emissions by around 1 g/100 km. It is worth mentioning that the sealing effect is still the same compared with today's conventional two and three-lip seals (Figure 5).

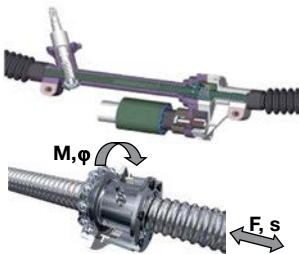


**Figure 5** Comparison of conventional seal with a friction-reduced seal

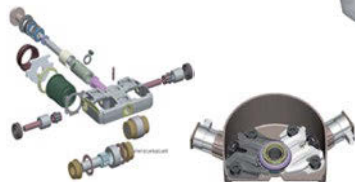
### Mechanical actuators with ball screw drive for chassis applications

Many linear actuators are equipped with a ball screw drive as a mechanical actuating element. Schaeffler launched a ball screw drive for electromechanical power-assisted steering on the market as far back as 2007.

#### Ball screw drives for electrically assisted steering systems



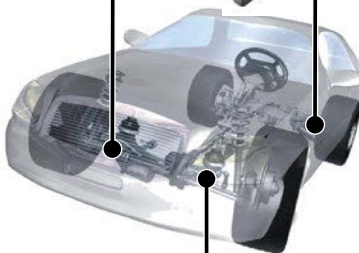
#### Ball screw drives for parking brakes



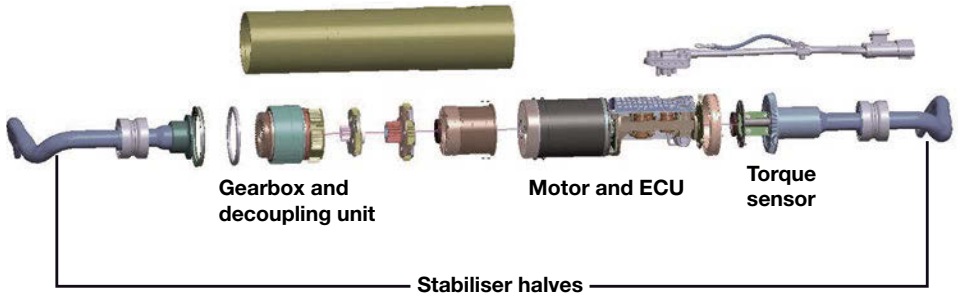
#### Ball screw drives for clutch release systems



#### Ball screw drives for brake boosters



**Figure 6** Overview of ball screw drive applications



**Figure 7** Design of the anti-roll system

This steering ball screw drive is designed along the lines of the principle of modular design and can cover a wide range of applications. It provides a virtually constantly high degree of efficiency of more than 90 % over the entire temperature range and is supplied together with a four-point support bearing. Ball screw drives and support bearings designed to meet customer requirements of minimized backlash can be provided.

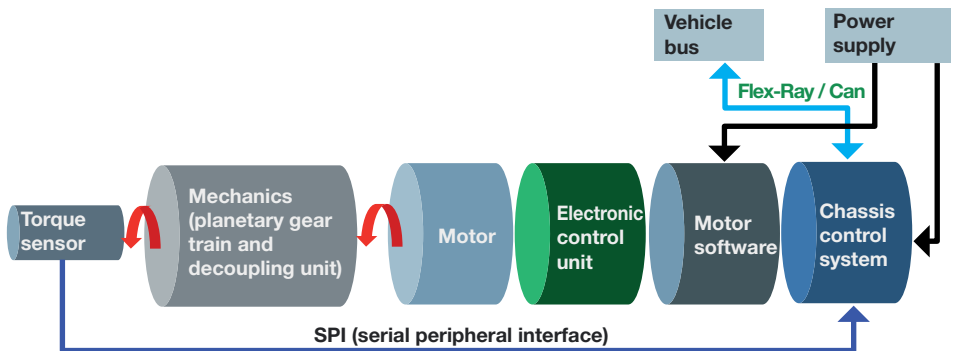
In parallel to this, a compact ball screw drive with a pitch diameter of up to 4 mm has been developed; this compact version has been used by Continental in its electric parking brake since 2011. Other applications based on this design are currently in the development phase — for instance, application in the electromechanically operat-

ed brake booster. Figure 6 shows other potential applications for the compact ball screw drive.

### Electromechanical anti-roll system

Over the last few years, Schaeffler has played its role in driving the replacement of hydraulic with electromechanical systems thanks to developing an electromechanical anti-roll system. The plan is for series production of this system to start in 2015. The benefits offered by the system are:

- Little or no tilting of the vehicle when cornering as a function of the present lateral acceleration
- More accurate steering behaviour, improved agility and stability



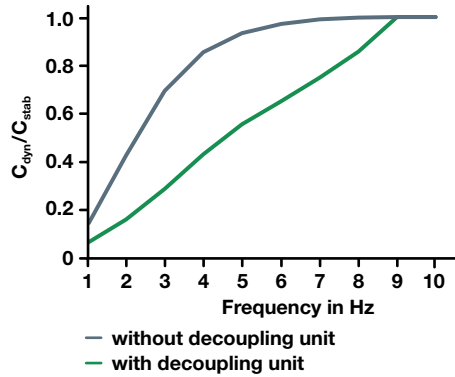
**Figure 8** Actuator system architecture

- Enhanced system dynamics compared to hydraulic systems
- Simple installation and easy maintenance
- Reduction in the number of field complaints by up to 30 % compared to hydraulic systems
- Installation in hybrid vehicles possible
- Reduction in fuel consumption of up to 0.3 litres compared to hydraulic anti-roll systems, and
- Weight neutral compared to hydraulic systems

The system comprises a brushless direct current motor with control system, transmission, torsion bars and a decoupling unit (Figure 7). The E/E architecture is shown in Figure 8.

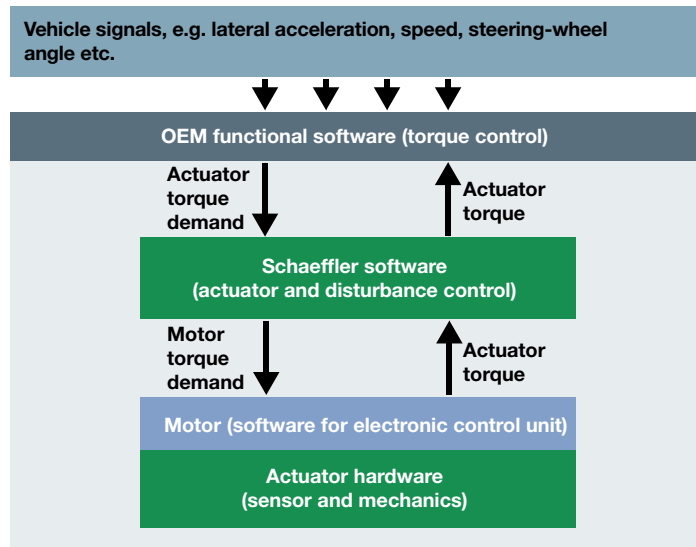
To complement a pure rotary actuator and to enhance comfort, the Schaeffler solution features a decoupling element, which enables one-sided disruptions in the road surface to be absorbed. Transmitting pulses to the body is thereby also reduced as well as strong vertical motion caused by one-sided disturbance excitation. Design and function of the anti-roll system are explained in detail in [4] and [5]. The effect of the decoupling unit for small disturbance excitations is shown in Figure 9.

The decoupling unit demonstrates excellent efficiency particularly for small disturbance excitations with an amplitude of up to 5 mm. Larger disturbance excitations can be corrected by the disturbance con-



**Figure 9** Dynamic stiffness as a function of the frequency of one-sided disturbance excitation for systems with and without a decoupling unit

troller. As the input parameter, this controller requires different functions, including the torque in the anti-roll system and the vertical displacement of the wheels. The overall controller structure is shown in Figure 10.



**Figure 10** Block diagram of the anti-roll system



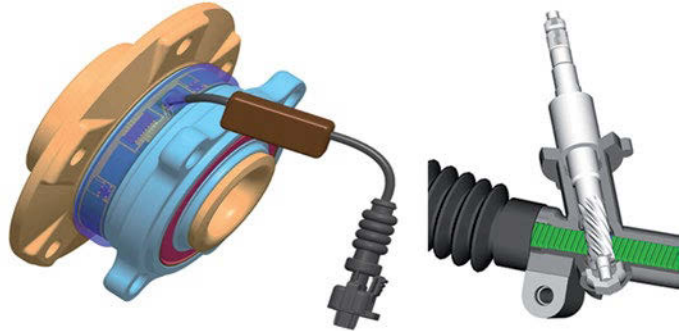
The interference can be corrected up to a frequency of approximately 8 Hz. The maximum frequency depends on the amplitude. If the information about the road surface collected by a stereo camera is available as the input signal and information from the navigation system about the route can be used, the disturbance controller can be improved still further by means of anticipation.

Alternatively, the body tilt and the effect of one-sided disturbance excitation on the body can also be prevented by hydraulically adjustable struts on each wheel. In addition to the anti-roll motion, this kind of system also prevents a pitching motion during braking and accelerating. However, this does not apply to air-sprung systems on account of the compressibility of air.

## Future Schaeffler solutions

### Sensor layer for measuring wheel force

Schaeffler is currently developing a sensor layer for measuring wheel force; this layer can be applied to two or three-dimensional components such as bearing components. Figure 11 shows several examples of applications. Application to the wheel bearing enables the wheel force to be measured

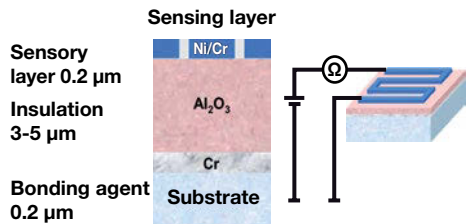


**Figure 11** Sensor layer for measuring the wheel force at the wheel bearing (on the left) and for measuring the steering moment in the steering gear

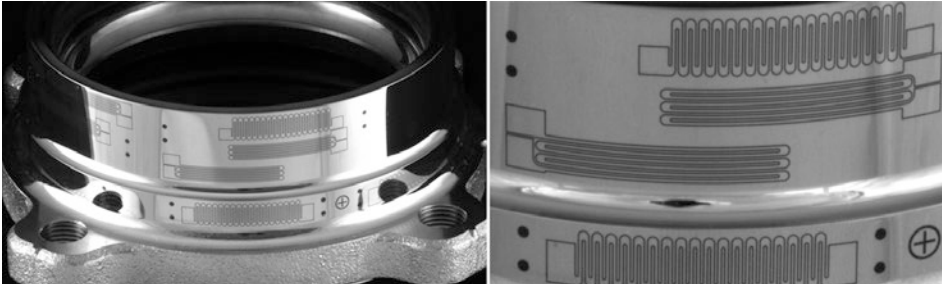
and thus record the forces acting on the wheel, including the brake forces generated during braking. These forces can be used as an input signal for various chassis control systems. The wheel force measurement being developed at Schaeffler also enables accurate recording of the vehicle weight, which may be of interest for light commercial vehicles.

The measurement principle is based on the arrangement of strain gauges on a two-dimensional or three-dimensional tensioned surface. The strain gauges are attached using thin-film technology. The basic layer design is shown in Figure 12.

The geometry of the strain gauges is “cut” into the sensor layer using laser, with a top cover attached to protect the sensor layer. To illustrate the technology, Figure 13



**Figure 12** Sensor layer design

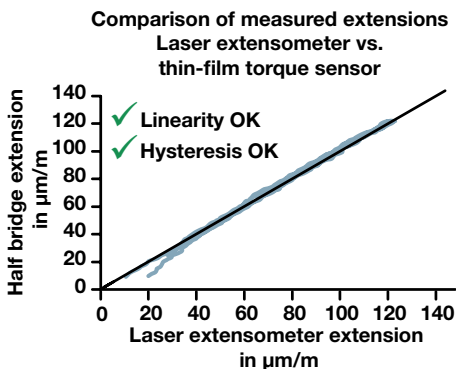


**Figure 13** Sensor layer on a bearing outer ring

shows an applied sensor layer using a bearing outer ring as an example.

As proof of the measurement accuracy, it is helpful to compare this layer with a laser extensometer. Experiments with planar samples, which were stretched on a traction engine and their elongation in synchronously recorded with the sensor layer as well as using the laser extensometer, have provided fairly good correlation (Figure 14).

The past few years have seen that the process reliability of the individual process steps has been systematically demonstrated and increased. Currently, preparations for winning projects and customers are being ramped.



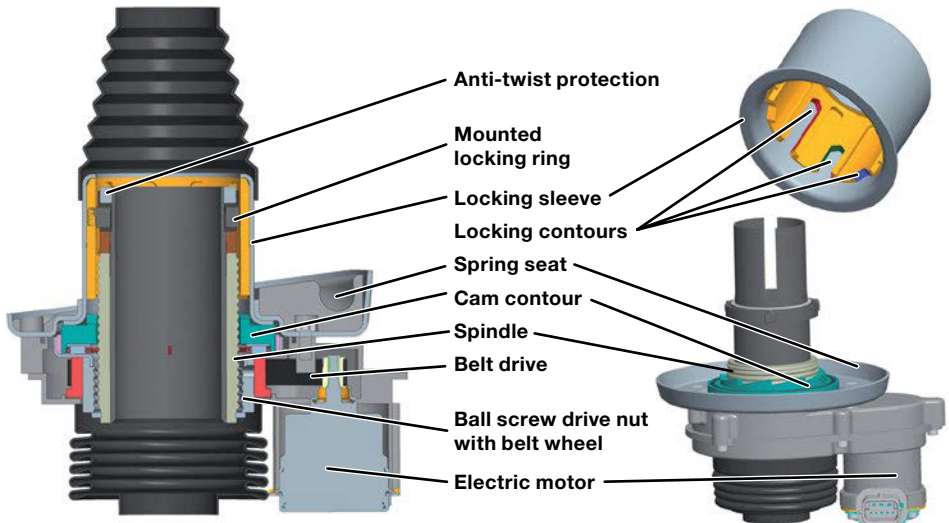
**Figure 14** Comparing the elongations of planar samples with the sensor layer

## Level adjustment

In today's vehicles, air suspension is used to adjust the ride height to various driving and load conditions. This suspension system can inherently absorb very poor lateral forces and is therefore not well-suited to McPherson strut axles. In addition, the costs for air springs are another reason the system has not become established in the B and C segments. Hydraulic height adjustment systems are used in the sports car sector, in particular on the front axle to make it easier to drive over ramps [6]. The tendency of markets towards potentially failure sensitive hydraulic actuators is to oppose further proliferation of this technology. There is therefore a need for electromechanical systems designed to adapt the ride height.

The following functions can be supported by this kind of system.

- Lowering the vehicle to reduce aerodynamic drag either on all four wheels or only on the front axle to bring a laden car back into the trim position
- Raising the vehicle to make it easier to get in
- Raising a sports car to protect the spoiler when driving over car park ramps
- Raising vehicles for light off-roading, as well as



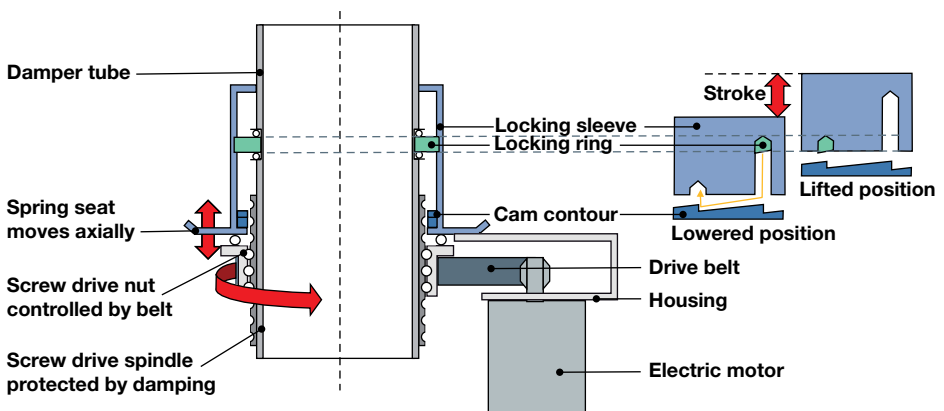
**Figure 15** Actuator for the level adjustment on the front axle

– Lowering the vehicle to make it easier to load the luggage compartment  
The solution developed by Schaeffler is shown in Figure 15.

The actuator essentially comprises a ball screw drive, a belt drive, an electric motor and a locking assembly. In this case, the vehicle load is not supported on the ball screw drive but on the locking assem-

by, which locks the vehicle's ride height. The ball screw drive itself is only used to adjust the different heights. Figure 16 shows a detailed view of the locking assembly.

The spindle is fixed on the damper to raise and lower the vehicle, while the nut is driven by a belt. The nut rotating leads to an axial displacement



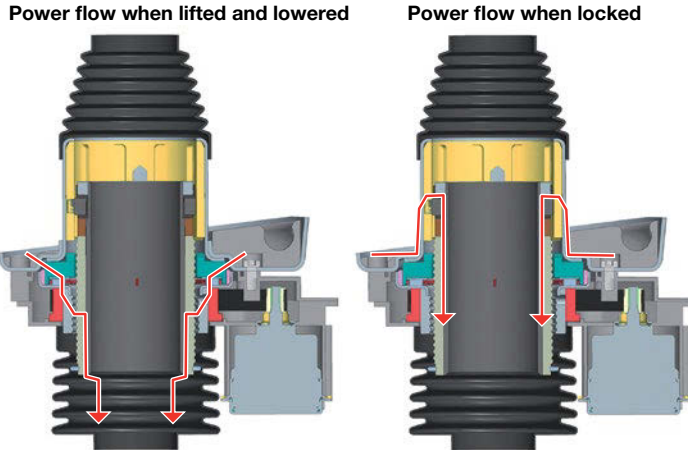
**Figure 16** Locking assembly in detail

of the unit comprising the nut, control contour, motor, housing and spring seat, and this is what changes the ride height.

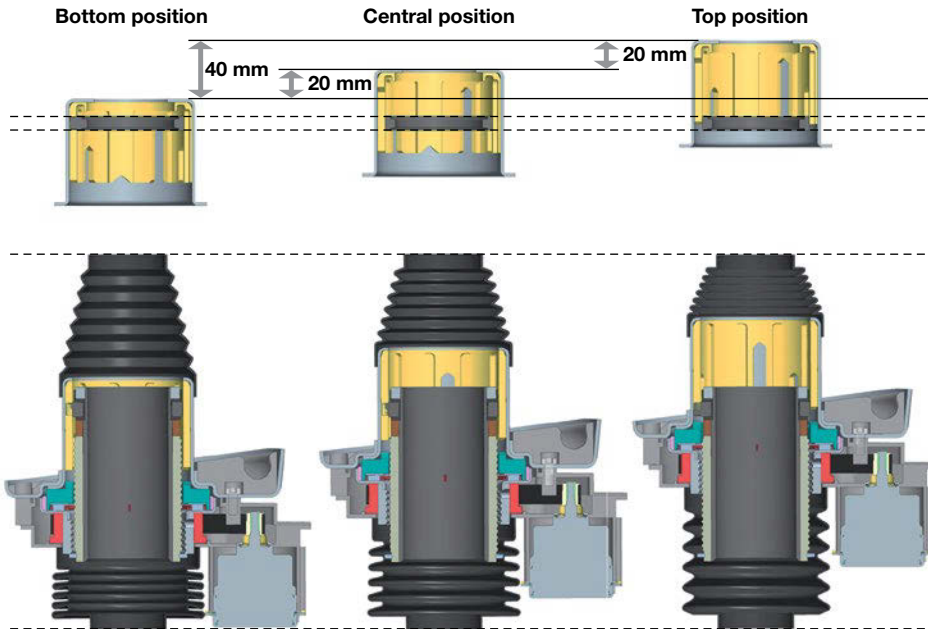
To lock the height, the locking ring engages in different locking contour grooves depending on the position when lowering. This action maintains the vehicle at the required level. As the vehicle is offset in any position on the locking ring, the drive and spindle lock remain load-free in the locked state (Figure 17).

To aid a better understanding, the three different ride heights and resulting design

positions of the actuator are summarised in Figure 18. The number of grooves determines the possible ride height. A third groove means that a central position can also be realised.

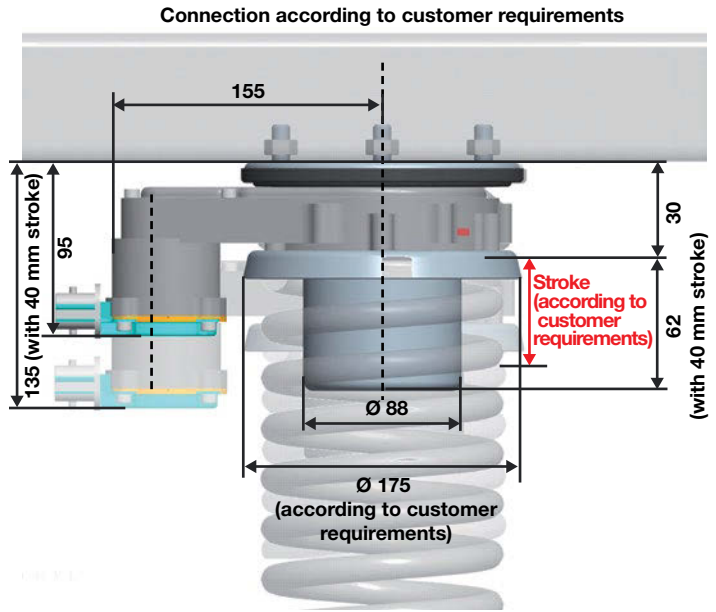


**Figure 17** Power flow during raising, lowering and locking



**Figure 18** Position of the actuator at different ride heights

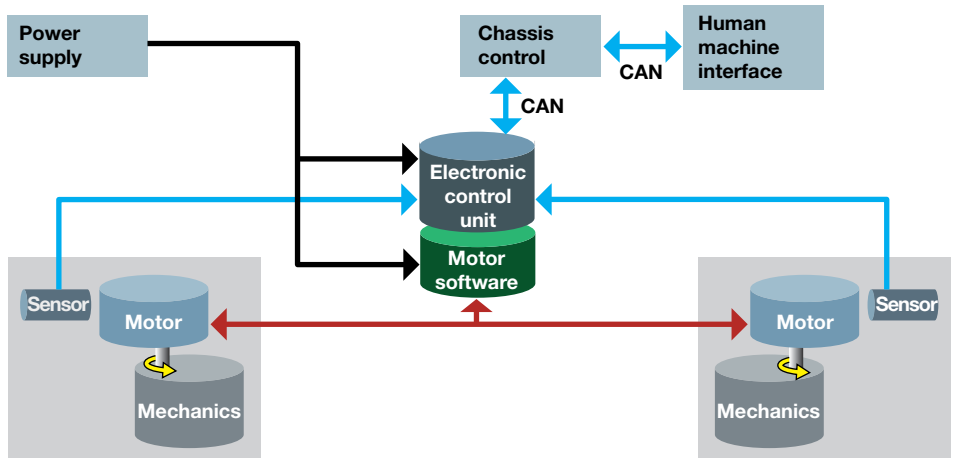
The current engineering knowledge enables adjustment ranges of 40 mm, which can be extended even further depending on the available space. The selected design also allows installation on the rear axle, where dampers and springs are often arranged separately. The only action needed to accommodate this installation is to merely rotate the motor by 180° (Figure 19).



**Figure 19** Installation position of the actuator on the rear axle

For E/E implementation, E/E components are already available on the market. Selected ECU includes two power stages, they can

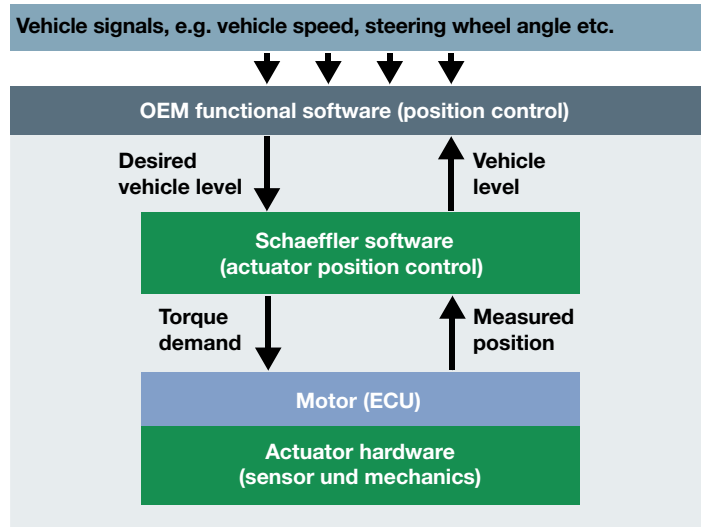
control two electric motors simultaneously. The resulting system architecture is shown in Figure 20.



**Figure 20** System architecture of the level adjustment

The proposed system configuration can be seen in Figure 21.

By virtue of the actuator design, selected system architecture and proposed system configuration, the market is filled with diverse and promising applications. Preparations are currently underway to construct test vehicles this year.



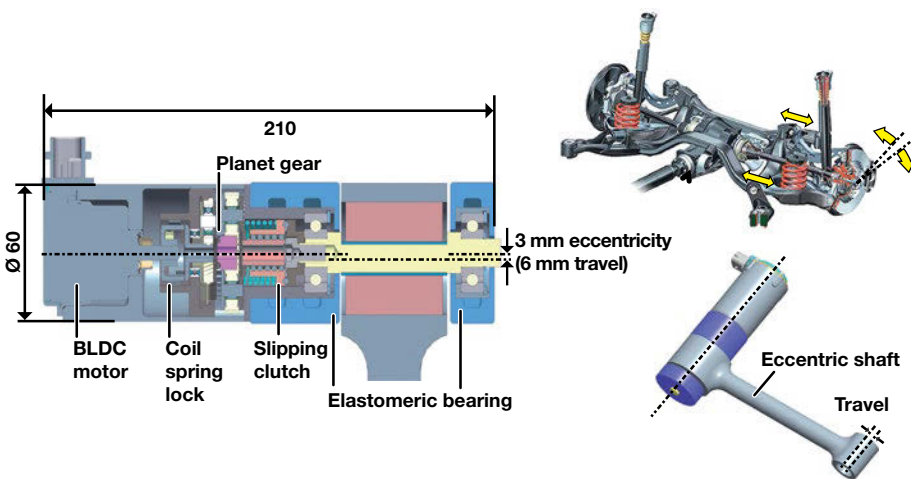
**Figure 21** System configuration for the level adjustment

**Actuator camber and toe-in actuation**

The approach taken by Schaeffler for camber and toe-in actuation is based on an eccentric drive, which is mounted to the rear

axle carrier, that can be designed as an individual wheel actuator [7]. Figure 22 shows the mechanical concept.

The axle-side actuator provides actuation of the toe-in and/or support arm. The



**Figure 22** Design of the eccentric actuator for use on the rear axle carrier

actuation speed and force are based on the power of the selected drive. The actuation travel is a function of the underlying eccentric feature. The E/E architecture uses the E/E components familiar from the level adjustment system with two integrated power stages to control two electric motors. This results in the following actuator characteristics:

- Actuation travel = 6 mm in the case of this eccentricity of 3 mm,
- Maximum actuation time < 2 s
- Maximum actuation load 5 kN
- Actuator diameter < 65 mm

To reduce the engine speed, a worm wheel or planetary gear train can be used. Another feature of the drive is its overload clutch, as well as mechanical short circuit to protect the bearings. Furthermore, the actuator can be integrated into an elastomer metal cartridge on request.

Previous customer feedback indicates that the market is looking for an alternative to the linear actuator on the rear axle. This alternative does not always need highly dynamic actuation. The stated actuation time of 2 seconds for toe-in actuation with a noticeable reduction in turning circle is usually sufficient. Current plans are to kit out a prototype vehicle this year.

### Developing the anti-roll system

In the course of developing the anti-roll system further, a split stabiliser is opened for driving in a straight line and closed when cornering. Thus, a quasi-static tension state is produced when cornering. When driving in a straight line, however, the stabiliser is open and rolling movements of the bodywork for the reciprocal disturbance excitation through the road to the opposite side of the vehicle, are suppressed.

In order to significantly reduce the vehicle's rolling angle when cornering, the stabiliser rigidity is increased by more than 20 % compared to a passive stabiliser. The design for this type of anti-roll system is shown in Figure 23.

In this design, the clutch is actuated via electromechanical linear actuator (consisting of electric motor, ball screw), such as depending on the steering angle and vehicle speed and other vehicle status parameters. The functional principle of the clutch is based on a locking device developed at Schaeffler, the design of which is also shown in Figure 23.

The current engineering knowledge has a weight of 3.5 kg without stabiliser halves. Compared to the design used in series pro-

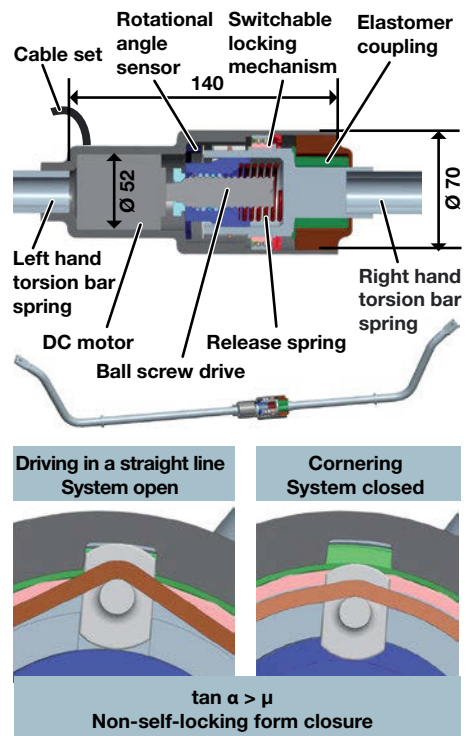


Figure 23 Split anti-roll stabiliser

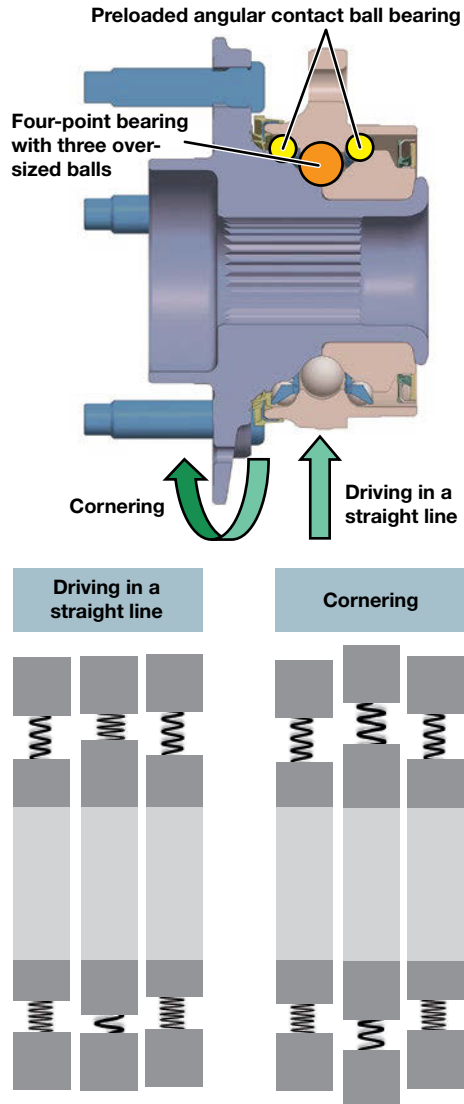
duction, this equates to a weight reduction of more than 50 %. If the stabiliser halves are not designed as steel pipes, but in glass fibre reinforced plastic, this produces a potential total weight of the entire actuator of around 4 to 4.5 kg.

### “Switchable” wheel bearings

Schaeffler has developed a triple row wheel bearing to reduce friction compared to the tapered roller bearings used in general and for higher wheel loads. This bearing features two equally tensioned rows of balls. To further reduce friction, the bearing can be designed such that only the outer rows of balls are used when driving in a straight line, and the central row is engaged when cornering. This is done by specifically changing the bearing preload, as shown in Figure 24.

The balls with their spring deflection are shown as springs.

Only the outer rows of balls are loaded when driving in a straight line; the central row is not loaded. When cornering, the central row (which is designed a four-point contact bearing) is engaged in order to support the drive performance in the bend by providing the required high level of rigidity. To this end, only a few oversized balls are fitted in the four-point contact bearing, which means that the remaining balls in the cage have clearance and reduce friction when driving in a straight line. When cornering, these balls are in contact and then absorb the required forces. Initial simulation results show an additional reduction in friction of more than 25 %.



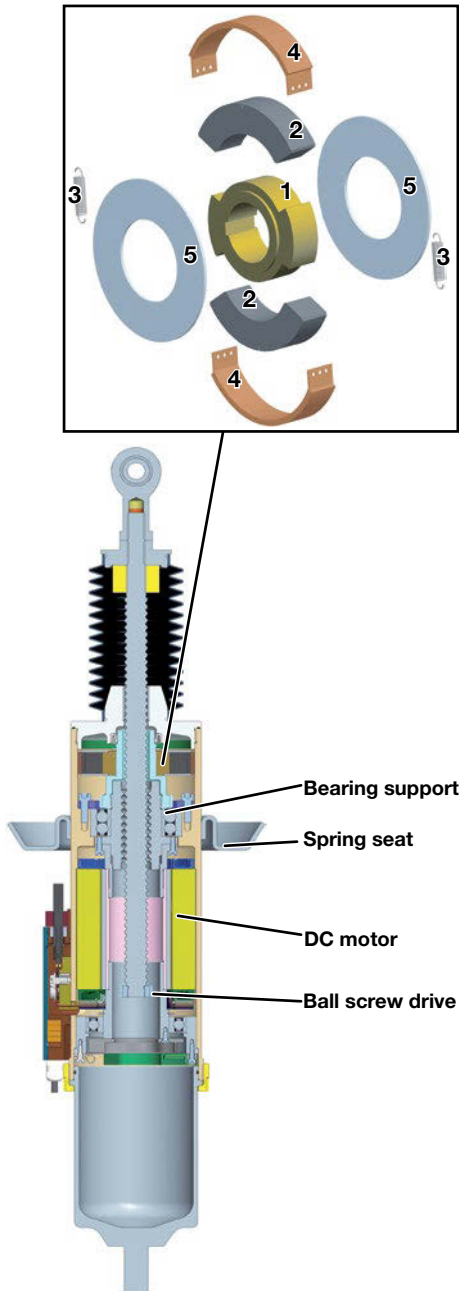
**Figure 24** Switchable wheel bearing with offset outer rows of balls

### Active electromechanical damping

One possible approach of realising an active, or at least partially active, chassis is produced by using an electromechanical

damper; this damper simultaneously works as an actuating element and actively feeds forces into the chassis. The idea of being able to utilise the lost energy of vehicle damping has been explored for over





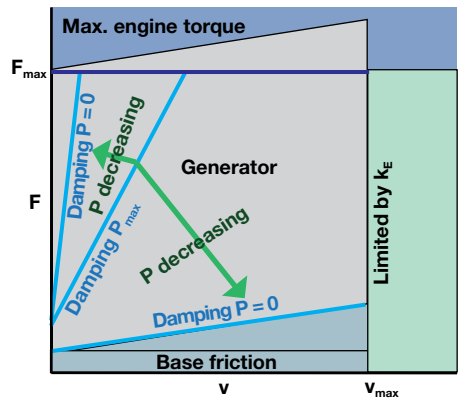
**Figure 25** Design of active electromechanical damping

20 years; the result is to use a brushless direct current motor using a ball screw drive to transfer the vertical motion of the wheel in a rotational motion of the rotor, thereby recuperating the damping energy [8].

What's more, this kind of damper provides the prerequisite for optimising the damping characteristic curves beyond the options offered by the hydraulic system [9]. At the same time, it forms the basis for realising a (partial) active suspension. Previous solutions show an unfavourable cost-benefit ratio and are also difficult to integrate into the space available. In addition, other requirements, such as overload capability or the response characteristic for small excitations, have prevented further development in this field.

Schaeffler is continuing to develop an actuator, which will fit as far as possible in the existing space of a hydraulic damper, that offers a better cost-benefit ratio than previous solutions as well as improved overload capacity. The basic configuration of the damper comprises a brushless direct current motor, a ball screw drive with bearing arrangement and a damper pipe (Figure 25).

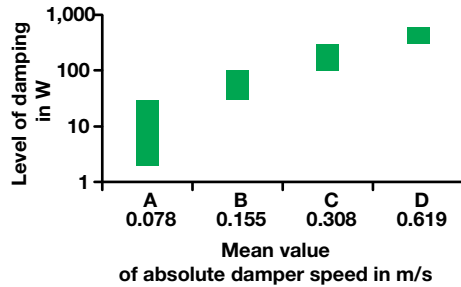
The wheel module with McPherson strut is excited vertically through the road surface. This translation is converted in the damper to a rotation and damped by the regenera-



**Figure 26** Characteristic curve and application area of an electric damper

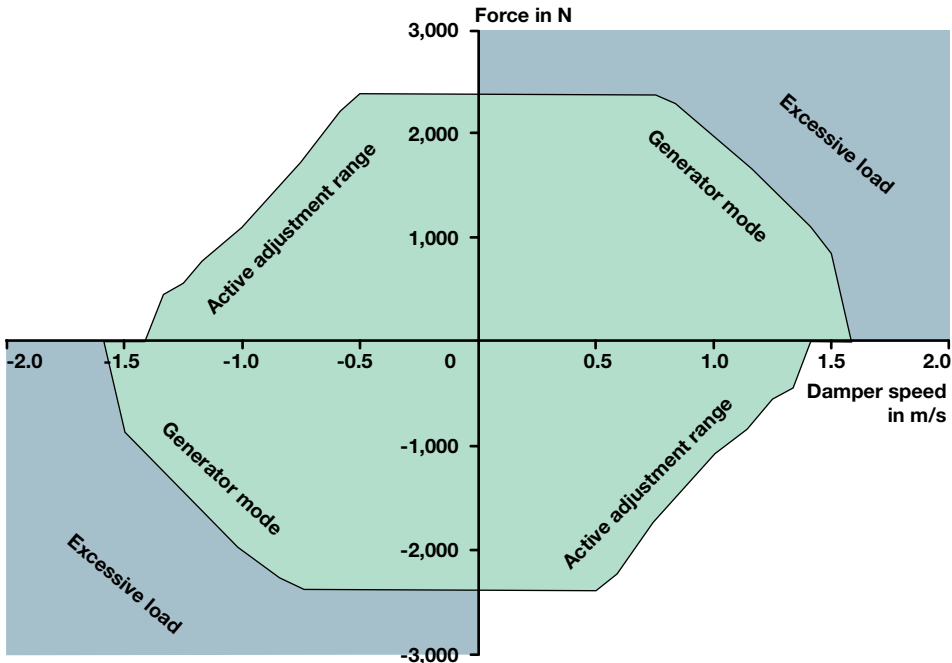
tively operated electric motor. A centrifugal brake is used to slow down the rotor rotation in the electric motor in the event of large pulses. The design of the electric damper is based on the characteristic curve of the damper during a suspension and rebound of a hydraulic damper as well as being based on the physical limits of the electric motor in generator mode (Figure 26).

To obtain basic findings, Schaeffler designed an electric damper (identical to the one seen in Figure 25) and tested it on the test rig. The findings for four different road surfaces (A, B, C, D) are shown in Figure 27; the amplitude and speed increase in alphabetical order. Significant regenerative power is achieved with excitation profile C and D, but is more likely to be achieved on poor roads or when off-roading. If one assumes “normal” amplitudes of 10 to 30 mm in ac-



**Figure 27** Measured power generated a function of damping force and speed

cordance with profile A and B, the resulting regenerative power ranges from 20 to 30 W. This is too little power to justify high volume production purely on the grounds of energy regeneration. Another option is if the damper can also be used in the chassis as an



**Figure 28** Characteristic diagram of the active electromechanical damping with generator mode and active adjustment range

actuating element [11]. The derivation of the underlying function equations of the damper is performed using the quarter vehicle model [10].

The installed electrical output of around 1.9 kW per wheel enables active engagement in the chassis. The characteristic diagram of the electromechanical damper is shown in Figure 28. The overload capability is a result of the centrifugal brake function.

With the active electromechanical damping, the entire range [12] of a possible influence on the driving dynamics can be extended, thereby significantly boosting the benefit for customers. The series production use of technology now depends on customer acceptance, which is to be studied over the coming months.

## Outlook

---

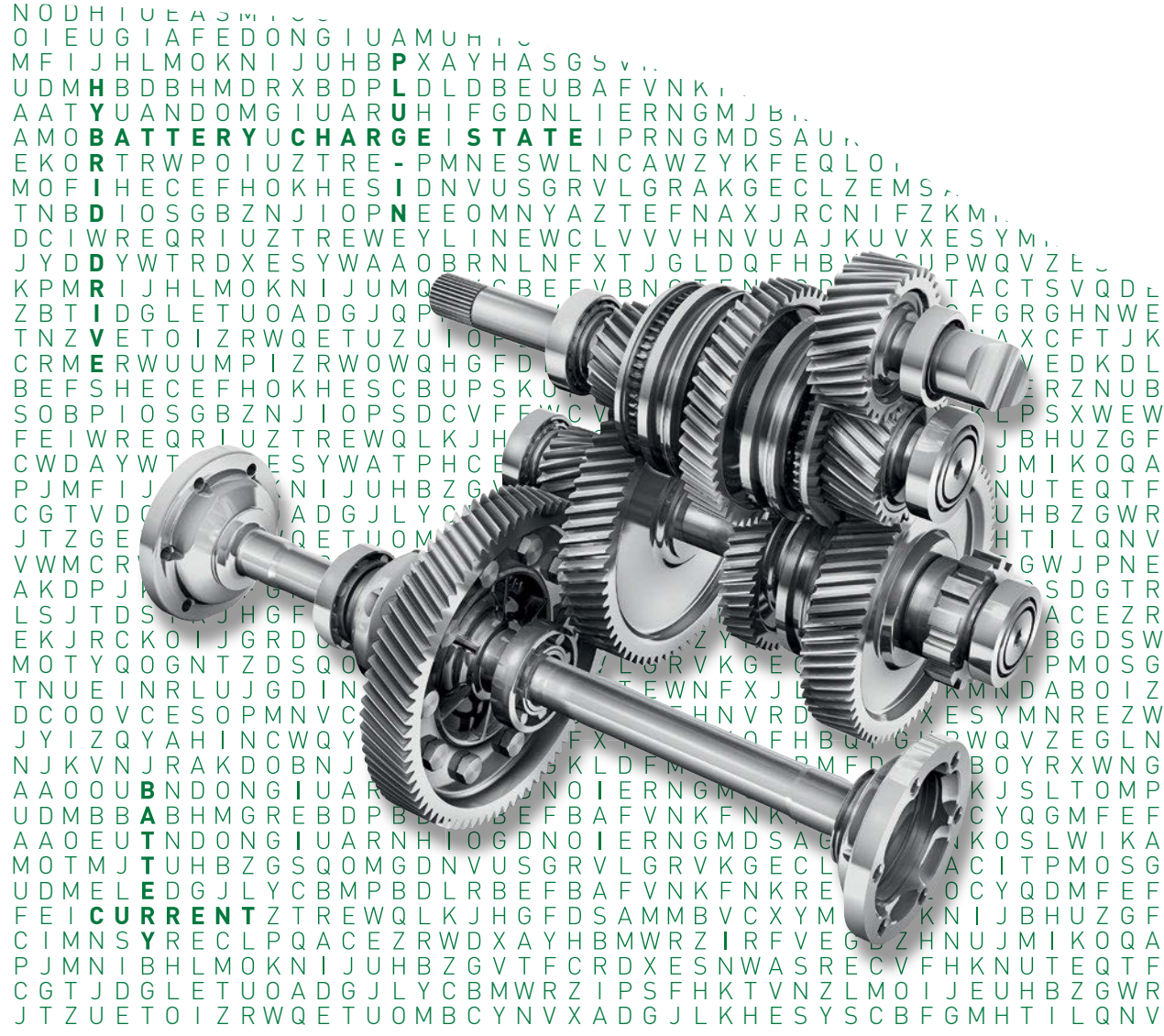
The range of the chassis applications offered by Schaeffler requires a multi-pronged approach when developing new products. Firstly, customers in an extremely cost-driven and competitive market should be provided with added value when it comes to bearing applications; this can be achieved by offering innovative developments. Secondly, mechanically oriented innovations form a sound basis for designing new mechatronic chassis systems. In addition, the task for Schaeffler engineers is also to create and realise added with new and trend-setting concepts. The objective of all these efforts is to generate function added value particularly in terms of power density, energy efficiency, weight and functional integration as well as to create cost benefits compared to today's technology. To do this, the broad knowledge and experience

held within the Schaeffler Group as well as that experience of selected cooperation partnerships will be used in a specific manner.

## Literature

---

- [1] Ammon, D.: Herausforderung Fahrwerkstechnik, Tagungsband Chassistech 2009, pp. 1-24
- [2] Krüger, M., Kraftfahrzeugelektronik, 2008, 2. Auflage, S. 21 ff
- [3] von Hugo, C., The next step towards autonomous driving. 22<sup>nd</sup> Aachen Symposium, 2013, pp. 751-765
- [4] Krimmel, H.; Deiss, H.; Runge, W.; Schürr, H.: Elektronische Vernetzung von Antriebsstrang und Fahrwerk. ATZ 108, 2006, no. 5, pp. 368-375
- [5] Beiker, S.; Mitschke, M.: Verbesserungsmöglichkeiten des Fahrverhaltens von Pkw durch zusammenwirkende Regelsysteme. ATZ 103, 2001, no. 1, pp. 38-43
- [6] Hohenstein, J.; Schulz, A.; Gaisbacher, D.: Das elektropneumatische Vorderachsliftsystem des Porsche 997 GT3. ATZ 112, 2010, no. 9, pp. 622-626
- [7] Kraus, M.: Actuators for Challenging Chassis. 8<sup>th</sup> LuK Symposium, 2006
- [8] US patent 5091679, 1990
- [9] Kraus, M.: Chassis Systems — Schaeffler Can Do More Than Bearings. 9<sup>th</sup> Schaeffler Symposium, 2010
- [10] <http://web.mit.edu/newsoffice/2009/shock-absorbers-0209.html>
- [11] Willems, M.: Chances and Concepts for Recuperating Damper Systems. 21<sup>st</sup> Aachen Symposium, 2012
- [12] Rau, M.: Koordination aktiver Fahrwerk-Regelsysteme zur Beeinflussung der Querdynamik. Dissertation University of Stuttgart, 2007, pp. 91-122

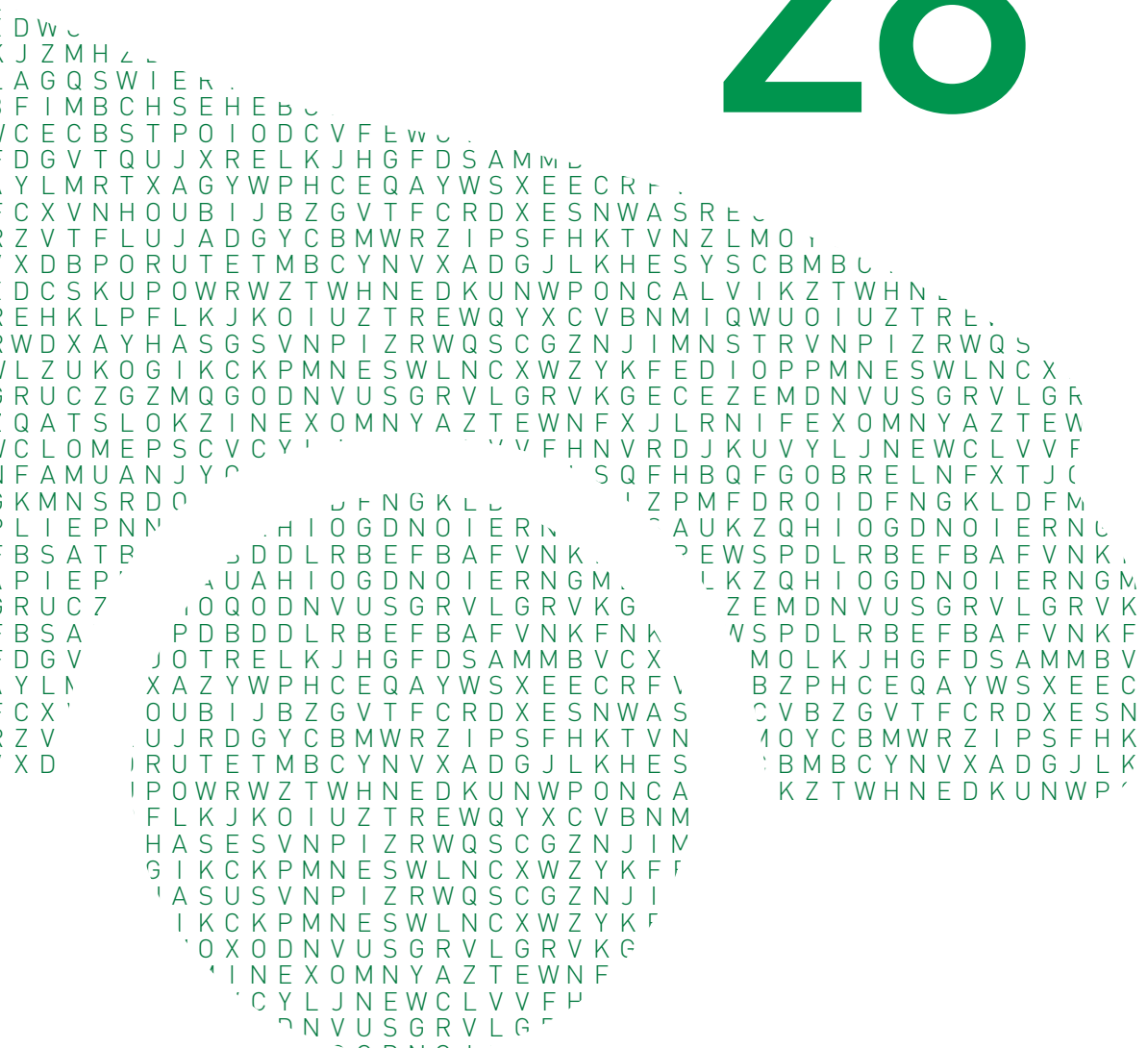


# Electric Driving without Range Anxiety

## Schaeffler's range-extender transmission

Andreas Kinigadner  
Dr. Eckhard Kirchner

# 28



## Introduction

---

Battery electric vehicles offer the option of emission-free local mobility. The range of these vehicles will remain limited in the foreseeable future due to high battery costs and the increased weight associated with the limited energy storage density. This has led to the increasing development of range-extender drive systems during the last few years. These concepts in most cases use a serial hybrid drive, in which the internal combustion engine is operated solely as a generator. These are usually internal combustion engines specially developed for this application or sometimes stationary operated engines, for which a number of variants and even Wankel type engines have been proposed. However, the implementation of these special engines is associated with large investments and is frequently not feasible due to high cost pressures. In addition to the technical and commercial challenges of implementing this technology, serial hybrid drives have a poor tank-to-wheel efficiency on long distance routes.

The focus must therefore be placed on developing alternative solutions, particularly for electrification in the compact vehicle segments. Schaeffler's range-extender concept is based on adding a special transmission to an existing internal combustion engine to produce a full hybrid. A simple automatic spur gear transmission and an electric motor are used instead of a conventional automatic or double clutch transmission. The typical range of driving conditions for an electric vehicle can be completely covered at low system costs. A powertrain architecture with a direct mechanical linkage of the internal combustion engine improves the efficiency balance of a vehicle over long distances. In addition, Schaeffler's range-extender transmission allows automobile manufacturers to imple-

ment a modular drive strategy without carrying out fundamental changes to the vehicle architecture.

## Concept

---

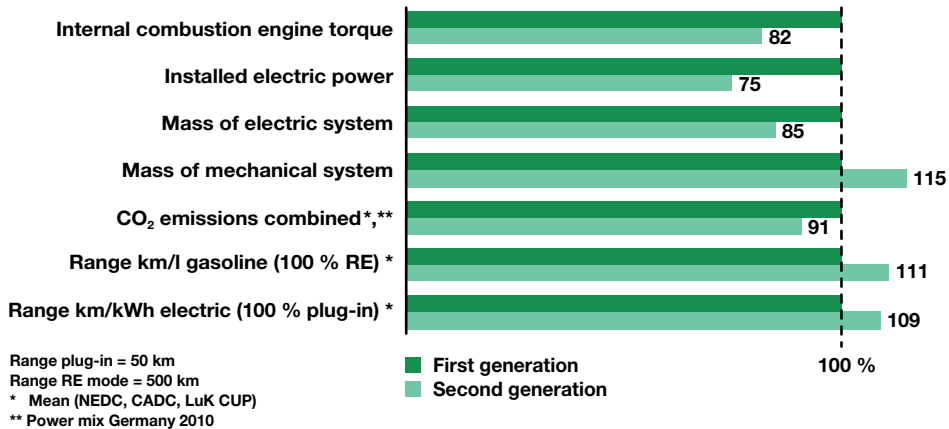
### What is a range extender?

A range-extender vehicle differs from a hybrid vehicle in that it can be operated with the electric motor only during day-to-day operation. This also includes acceleration and high-speed driving. There is no clear distinction between range extenders and plug-in hybrid vehicles, whose batteries can be charged from a power socket. The range extender is sometimes even described in technical literature as a type of plug-in hybrid [1].

Most range extender vehicles were originally designed as serial hybrids, i.e. the internal combustion engine is operated only as the drive for an electric generator. The most prominent example from the pioneer age of the automobile is the Mixte car developed by Ludwig Lohner and Ferdinand Porsche in 1902. The overall efficiency of this type of system architecture is not only dependent on the efficiency of the engine and generator, but also on the losses during charging and discharging of the battery.

At high driving speeds, a serial hybrid drive has a lower overall efficiency than a direct drive by means of an internal combustion engine due to conversion losses [2]. This is why some range-extender vehicles are already equipped with a power-splitting hybrid drive system. A selectable mechanical fixed drive ensures optimum overall efficiency in this case.

A comparison between the powertrain concept of the Opel Ampera, which has a



**Figure 1** Comparison of performance criteria for a serial hybrid and a vehicle of identical performance with a powertrain similar to the Ampera.

mechanical fixed drive, and a conventional serial hybrid shows the significant advantages with regard to CO<sub>2</sub> emissions (-9 % in combined mode, Figure 1). At the same time, the range of electric operation also increases by 9 % [3]. This type of configuration does however have disadvantages: An additional clutch and a more complex operating strategy are required. In addition, the spatial arrangement of the generator unit comprising the internal combustion engine and generator can no longer be freely selected in the vehicle.

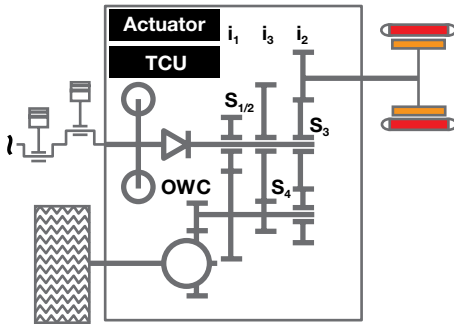
## A range extender for the B and C segment

Range-extender vehicles with on-demand mechanical drive are particularly suitable for vehicles that are mainly driven in short-run operation, but are occasionally also used for longer interurban journeys. This makes the range extender particularly attractive for the B and C segment, the more so since this segment accounts for high quantities worldwide. If such a drive can be produced in line with market requirements, it would fill a gap between

- expensive range-extender vehicles, which can cover large distances with an internal combustion engine after draining the battery (for example, the Opel Ampera)
- and battery electric vehicles in the A segment, which have no range problems in urban traffic despite having a low battery capacity (for example, the VW up!).

The B and C segments are under a high degree of pressure from competitors internationally so it is necessary to produce a range-extender solution at very low costs. Schaeffler therefore aimed to simplify the conventional range-extender concept during development as follows:

- Re-utilization of the internal combustion engine and its characteristics in terms of function and interfaces
- No change in the design envelope, no change of vehicle architecture in conventional front transverse powertrain platforms
- Use of only one electric motor
- Use of a single electromechanical actuator if possible
- Simplification of the transmission by using three or even only two gear steps.



**Figure 2** Schematic diagram of Schaeffler's range-extender module with three mechanical gears

### Basic concept

Preliminary considerations led to the schematic diagram of the powertrain shown in Figure 2.

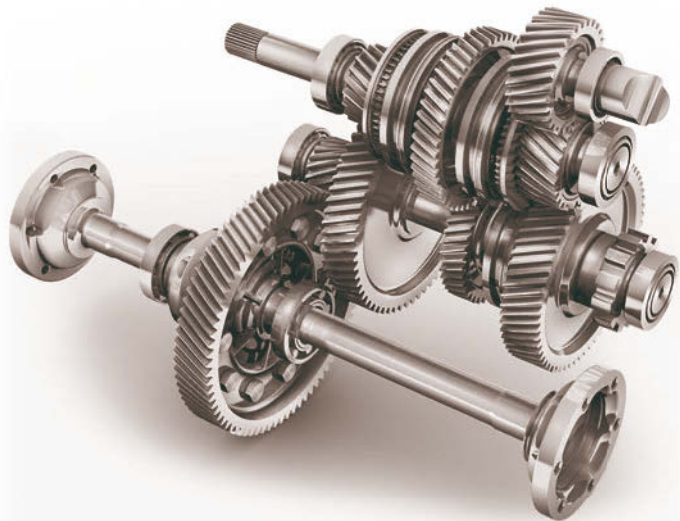
The range-extender module is connected to the internal combustion engine using an one-way clutch (OWC), which can, for example, be designed as a roller clutch. The electric motor is also connected in a selectable manner by means of a separate input shaft. The input shaft can drive the front axle differential (FD) and thus the wheel directly via the gear step freewheel (S4). Three additional, fully independent selectable speed gears (S1, S2 and S3) can be used to connect the internal combustion engine to the output shaft and to manage gearshift operations. The signifi-

cant simplification of the transmission and the associated reduction in costs compared to current hybrid vehicle designs are immediately apparent.

### Design

Schaeffler's range-extender transmission is a current advanced development project. The following information does not therefore refer to a specific transmission design but describes the ideas on which the design of the prototype is based. Figure 3 shows the prototype design, which has not yet been optimized for specific vehicle and powertrain dimensions.

It can be seen that the majority of components used in the range-extender transmission are components currently used in volume production. This means it was possible to use synchro ring packages operated by shift sleeves from manual transmissions [4]. The actuator driven by an electric motor with an interlock function, which Schaeffler



**Figure 3** Power transmission design in the range-extender transmission



developed for double clutch transmissions, can, in principle, be used for clutch actuation [5]. In contrast to conventional transmissions such as a manual or double clutch transmission, a separate reversing gear is not required for reverse gear in the range-extender transmission. The design offers a high level of freedom for the shaft arrangement due to elimination of multiple tooth meshes. This has major advantages with regard to the packaging space and integration.

## Function

### Power transmission

Under the above mentioned premises of a vehicle that is mainly driven in electric

mode, the hybrid transmission shown in Figure 3 enables the use of three gears with a total of only five gear meshes for both the electric motor and the internal combustion engine. The internal combustion engine can only be used above a speed of 10 km/h due to the omission of a launch device, which does not cause any restrictions because the electric motor covers these operating conditions.

The design of the gear set enables the tractive force to be increased by the internal combustion engine in electric mode and vice versa, i.e. both drives assist each other reciprocally. In this regard, it is important to select the shift point so that the engagement of the internal combustion engine is not perceived as an impairment of comfort. Figure 4 shows a schematic sawtooth diagram for vehicle operation with a well charged battery. The shift point for engaging the electric motor can be freely selected from a large range.

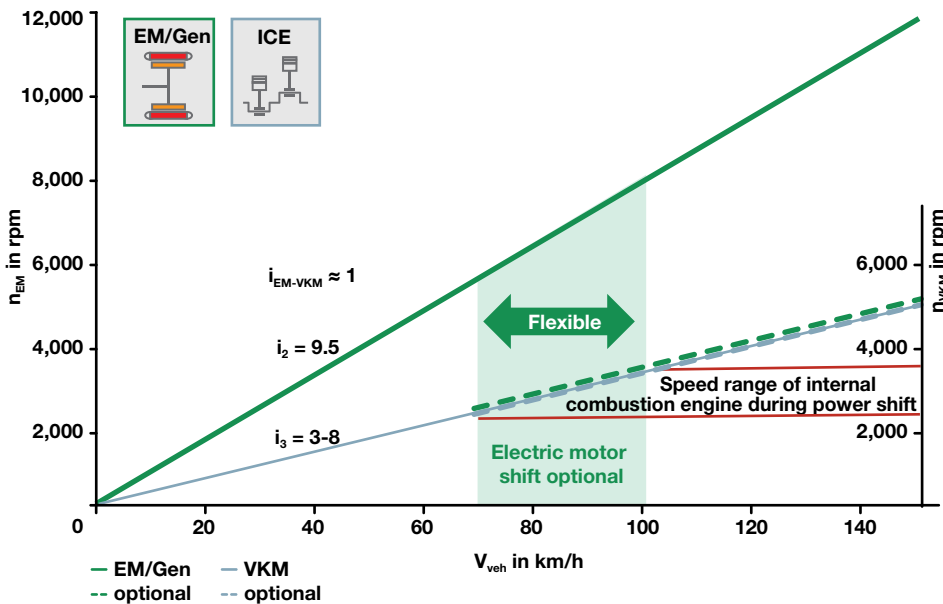
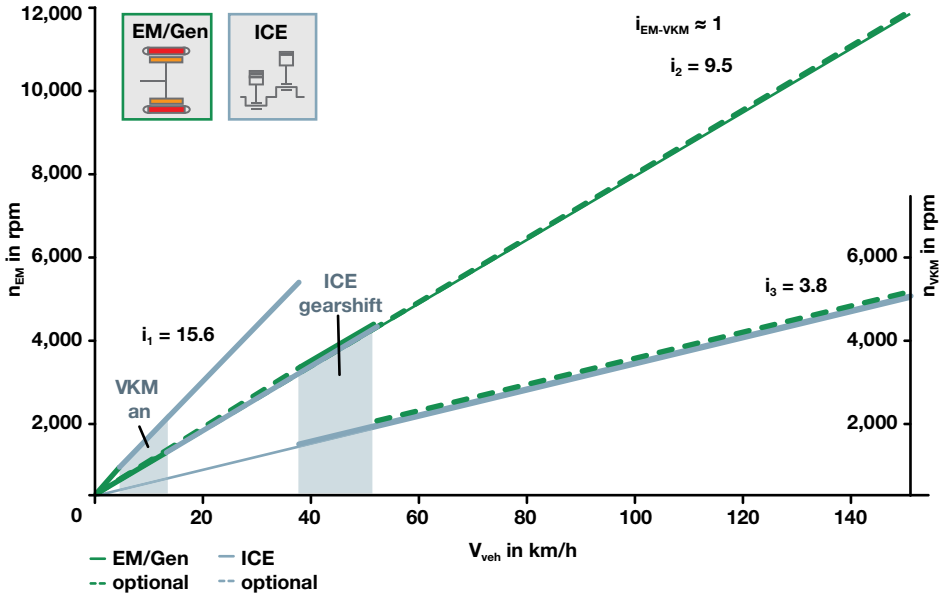


Figure 4 Vehicle operation with the battery in a high state of charge



**Figure 5** Vehicle operation with the battery in a low state of charge

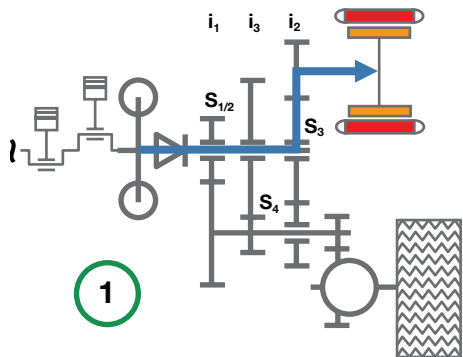
Figure 5 shows the sawtooth diagram with the battery almost fully discharged. If the battery has an insufficient state of charge, it must be charged for a short time while the vehicle is stationary before starting. The battery can be recharged during vehicle operation at high speeds in the power-splitting mode and also if the driver wishes to accelerate slowly to moderately while driving. The possibility of a breakdown due to a flat battery can therefore be eliminated by using an intelligent charging strategy in conjunction with the maximum possible load point shift if the internal combustion engine during vehicle operation.

**Operating conditions**

Six different power flows, which each correspond to an operating condition, can be selected with the three ratio stages and three shifting elements that are independent of each other.

**Condition 1: Generator mode**

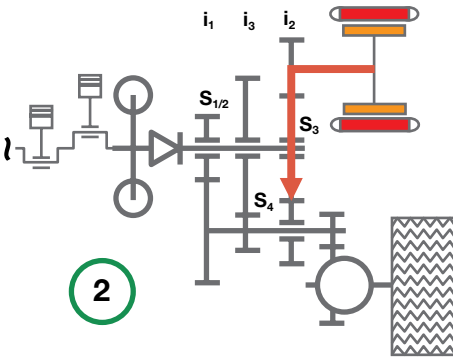
The parking lock can be activated in generator mode. The internal combustion engine drives the generator via the gear wheel  $S_3$ , Figure 6.



**Figure 6** Power flow in generator mode

**Condition 2:****Vehicle launch and reverse driving**

Vehicle launch is only possible in electric mode due to the selected ratios and the working ranges of the internal combustion engine and electric motor. The internal combustion engine is switched off, shift element  $S_3$  is open and  $S_4$  is closed. The drive function both in a forwards and reverse direction is now taken over by the electric motor only, Figure 7.

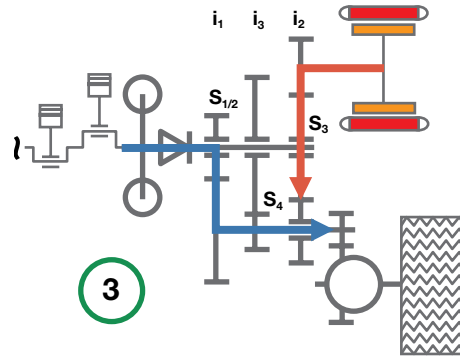


**Figure 7** Power flow in electric mode

All driving conditions can be overcome during urban operation in all-electric mode provided that the battery has a sufficient state of charge. Shifting is not necessary until approximately 50 km/h. Reversing with the internal combustion engine powertrain is not possible with the selected design, but is also not necessary.

**Condition 3:****Hybrid city driving**

If the battery is in a low state of charge or when driving uphill, the internal combustion engine can even be used in first gear at speeds between 5 and 10 km/h depending on the specific design. The ratio enables crawling at slow speeds. The electric motor can be used as a generator or a

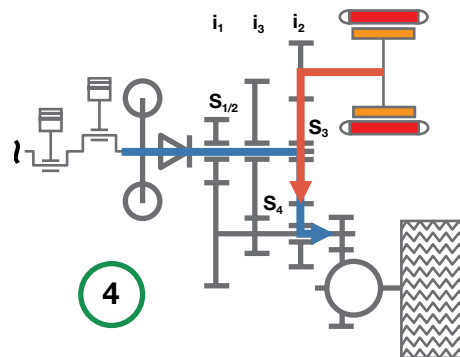


**Figure 8** Power flow during hybrid city driving

drive depending on the battery's state of charge. First gear is mainly used by the internal combustion engine,  $S_1$  is closed and the electric motor can be connected via  $S_3$  or  $S_4$ .

**Condition 4:****Hybrid drive at moderate speeds**

If the battery is in a low state of charge, the internal combustion engine can be operated in second gear at driving speeds above the speed range of first gear. Shift element  $S_3$  is closed again and  $S_1$  or  $S_2$  is opened for this purpose, Figure 9.

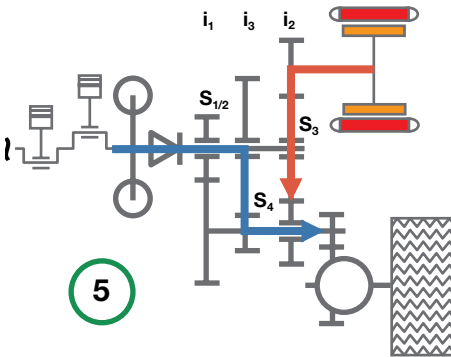


**Figure 9** Power flow at moderate speeds in hybrid mode

By designing the operating strategy appropriately, it is also possible in condition 4 to use some of the torque produced by the internal combustion engine for operating the electric motor as a generator via gear wheel S3 if the battery is in a low state of charge.

**Condition 5:  
Accelerating to high speeds**

If a vehicle equipped with Schaeffler's range extender leaves the urban zone, the internal combustion engine can be engaged in order to rapidly reach high speeds. The internal combustion engine is then engaged via the third gear by closing the shifting element S2, Figure 10. Presynchronization is carried out by matching the speed of the internal combustion engine.

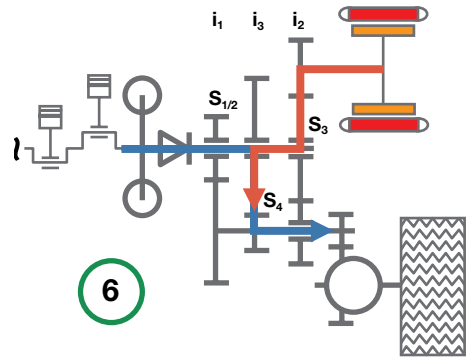


**Figure 10** Power flow during high acceleration

The electric motor also provides accelerating power via second gear so that high torque and good acceleration values can be achieved.

**Condition 6:  
Driving at high speed**

After the vehicle reaches the required speed, it is also advisable to direct the power flow of the electric motor via third gear. Shifting element S3 is opened and S4 is closed at the same time for this purpose, Figure 11.



**Figure 11** Power flow at high speed

Power split operation, in which the internal combustion engine is used to charge the battery via the generator, is also possible in this shifting condition when no electric acceleration power is requested.

Figure 12 shows a summary of the possible power flows and the required actuator positions. It is clear that due to the sequential gearshift system, the torque flow during gearshifts is not interrupted because one of the two torque paths in the transmission is always closed. Furthermore, generator mode is possible at any time due to the connection between the electric motor and the wheel.

## Operating strategy

The operating strategy for the range-extender transmission is mainly dependent on three parameters:

- The battery's state of charge (SOC)
- The torque required by the driver (position of the accelerator pedal)
- Current speed range (urban/rural roads/highway).

One possible operating strategy enables all-electric mode within a speed range of 70 to a maximum of 120 km/h if the battery is sufficiently charged. The internal

Operating condition		$S_1$	$S_2$	$S_3$	$S_4$
Neutral/generator	1	0	0	1	0
EM $i_1$ /reverse	2	0	0	0	1
Hill mode	3	1	0	0	1
EM/EM + ICE $i_1$	4	0	0	1	1
Power shift	5	0	1	0	1
EM/EM + ICE $i_2$	6	0	1	1	0

**Figure 12** Shift pattern of the range-extender transmission (0 = open, 1 = closed)

combustion engine can intervene and provide assistance during high acceleration if this is not prevented by an operating strategy which is aimed at ensuring emission-free local mobility. The internal combustion engine is engaged above a defined speed, for example, 50 km/h. At higher speeds, particularly during operation on highways or for long distances, the internal combustion engine is always switched on in order to achieve optimum overall efficiency.

The internal combustion engine is also engaged in urban areas if the battery has a low state of charge. This is in accordance with current design criteria for serial hybrid drives. The share of power generated electrically is greatly reduced and is completely switched off at high speeds. If the driver wishes to accelerate strongly, the electric power output is limited depending on the condition of the battery. The internal combustion engine provides the missing torque in order to fulfill the torque requirements of the driver. Firstly, this means the required driving performance can be achieved and secondly the electric motor can also serve as a generator. This always ensures the battery is in a state of charge, which enables vehicle

launch using only electric power. It is possible to warn the driver via a signal that charging of the battery is urgently required. With the selected design, this can be carried out at charging stations but also when the vehicle is stationary with the engine running (operating condition 1, see above). Alternatively, it is also possible to charge the battery using the engine's generator if this was not omitted for cost reasons. Charging power of up to 3.6 kW can be achieved with this type of solution, which is equal to a normal AC power supply connection.

The internal combustion engine can still be started using the low-voltage battery if the high-voltage battery is fully depleted. However, launching is not possible immediately because the vehicle must initially produce sufficient power while stationary to continue the journey.

### Simplification to two gears?

The initial approach of using a simple transmission with three gears can be further simplified by omitting the first gear, Figure 13. The internal combustion engine and electric motor can be oper-



**Figure 13** Simplification to a two-speed design

ated in both gears and gearshifts without an interruption of the tractive force are still possible. The design envelope, the mass as well as the complexity of the gearshift system can be minimized due to the reduced structure. The background for this simplification is the optimized cost-benefit ratio of the system because a vehicle equipped with a two-speed solution or the three-speed design must always launch using electric power only, although the internal combustion engine can only be engaged above 10 to 20 km/h. If the battery is in a high state of charge, a vehicle equipped with this variant would be driven in one gear using electric power only as far as possible and the internal combustion engine would not be engaged until high speeds are reached. All

the operating conditions of hybrid driving can also be realized.

A vehicle breakdown due to the system-related necessity of a purely electric launch and the use of only one electric motor is unlikely due to the operating strategy. In addition, the recuperation characteristics can be designed so that the ease of electric launch is always ensured. The minimalist approach with only two gears therefore offers a more cost-effective but still functional alternative to the three-speed variant presented.

## Simulation

The range-extender transmission developed by Schaeffler has already undergone initial testing in different simulations. It was important to determine the potential for reducing CO<sub>2</sub> and to test the behavior under extreme driving conditions. The focus is placed on the two-speed variant in order to show the possibilities offered by Schaeffler's concept with regard to the reduction in fuel consumption that can be achieved.

The vehicle model designed in Matlab Simulink corresponds with typical values in the C segment. The assumed values were a vehicle weight of 1,450 kg and a four-cylinder naturally aspirated engine with a nominal power of 62 kW at 5,000 rpm and maximum torque of 130 Nm at 3,500 rpm. The electric motor has a nominal power of 60 kW and a torque of 200 Nm (continuous) or 300 Nm (peak).

The battery size of 9 kWh was selected so that a guaranteed range of electric operation of 30 km can be achieved. This is a conservative assumption based on an op-

Gearshift and NEDC	Base ratio EM		Long ratio EM	
Vehicle speed at EM shift in km/h	45	90	45	120
Fuel consumption in g CO <sub>2</sub> /km	58	60	58	61

**Figure 14** Initial simulation results

erating strategy in which a battery with a SOC of 40 % is regarded as “almost fully discharged”.

In addition, two ratios for the second gear were modeled. With the base ratio of 3.8, the gearshift takes place at a speed of 90 km/h in operating condition 6, while with the longer ratio of the electric motor the gearshift is not made until 120 km/h. Alternatively, a significantly lower shifting point of 45 km/h was used for the simulation. Figure 14 shows the simulation results for the NEDC test cycle.

The results achieved in the initial simulation are encouraging. Firstly, the assumptions, for example, with regard to the inertia class and the useable battery capacity are very conservative and these could be significantly more favorable in a lighter vehicle with optimized battery management. Secondly, the consumption levels of the internal combustion engine could be reduced if a smaller engine with a higher power density is used as is increasingly the state-of-the-art. Thirdly, the SOC of the battery was higher after running the cycle than at the start, which is not a requirement in the certification regulations. 10 to 12 g CO<sub>2</sub>/km alone could be saved by making a corresponding adjustment to the operating strategy.

From the current perspective, it is likely that Schaeffler’s range-extender concept can achieve a certified emission level of 50 g CO<sub>2</sub>/km for the assumed C segment vehicle. A comparison shows

what influence the useable battery capacity and vehicle mass has on fuel consumption. A shorter distance can be driven using electric power only with a useable battery capacity of 60 % than if the useable battery capacity is increased to 75 %. For the cycle consumption, this increase in the battery capacity means approximate 14 % reduction in the fuel consumption or CO<sub>2</sub> emissions with the above assumptions.

In addition to the benefits with regard to fuel consumption, the acceleration values of 0 to 100 km/h in less than 11 seconds show that driving pleasure is not sacrificed either in combined or all-electric mode. It was also important to verify the functional capability of the range-extender transmission during extreme driving maneuvers, particularly on steep gradients. The results are also encouraging here:

- The electronically limited maximum speed of approximately 150-160 km/h is safely reached on a typical highway gradient of 6 %.
- All gradients of practical relevance can be overcome at the low speeds in actual road traffic.

Even challenging requirements such as accelerating uphill can be carried out with the available battery charge either in combined or all-electric mode.

## Summary and outlook

---

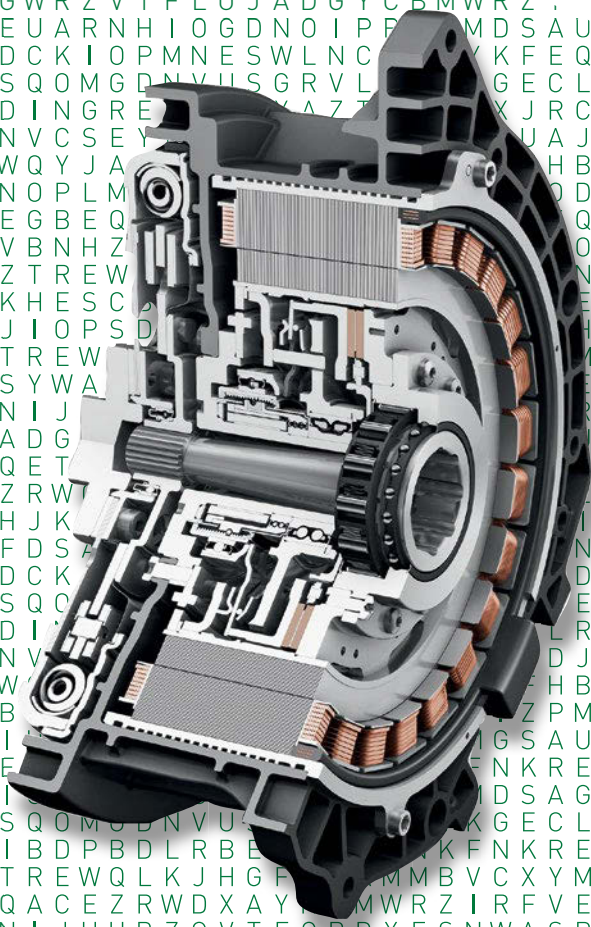
The Schaeffler range-extender concept shows potential for realizing a range-extended electric vehicle with significantly reduced system power and costs. The use of only one electric motor and a very simple transmission allows this concept to be integrated into a conventionally driven vehicle cost-effectively.

## Literature

---

- [1] Hofmann, P.: Hybridfahrzeuge: Ein alternatives Antriebskonzept für die Zukunft. Wien: Springer, 2010
- [2] Kirchner, E.: Leistungsübertragung in Fahrzeuggetrieben. Berlin: Springer, 2007, p. 559 ff.
- [3] Najork, R. et al.: What's the Transmission Content in E-Mobility? 10<sup>th</sup> International CTI Symposium, 2011
- [4] Hirt, G.; Massini, S.: Gearshift systems and synchronization: At the threshold of mechatronics. 9<sup>th</sup> Schaeffler Symposium, 2010
- [5] Bruno M.: Transmission actuators. 10<sup>th</sup> Schaeffler Symposium 2014





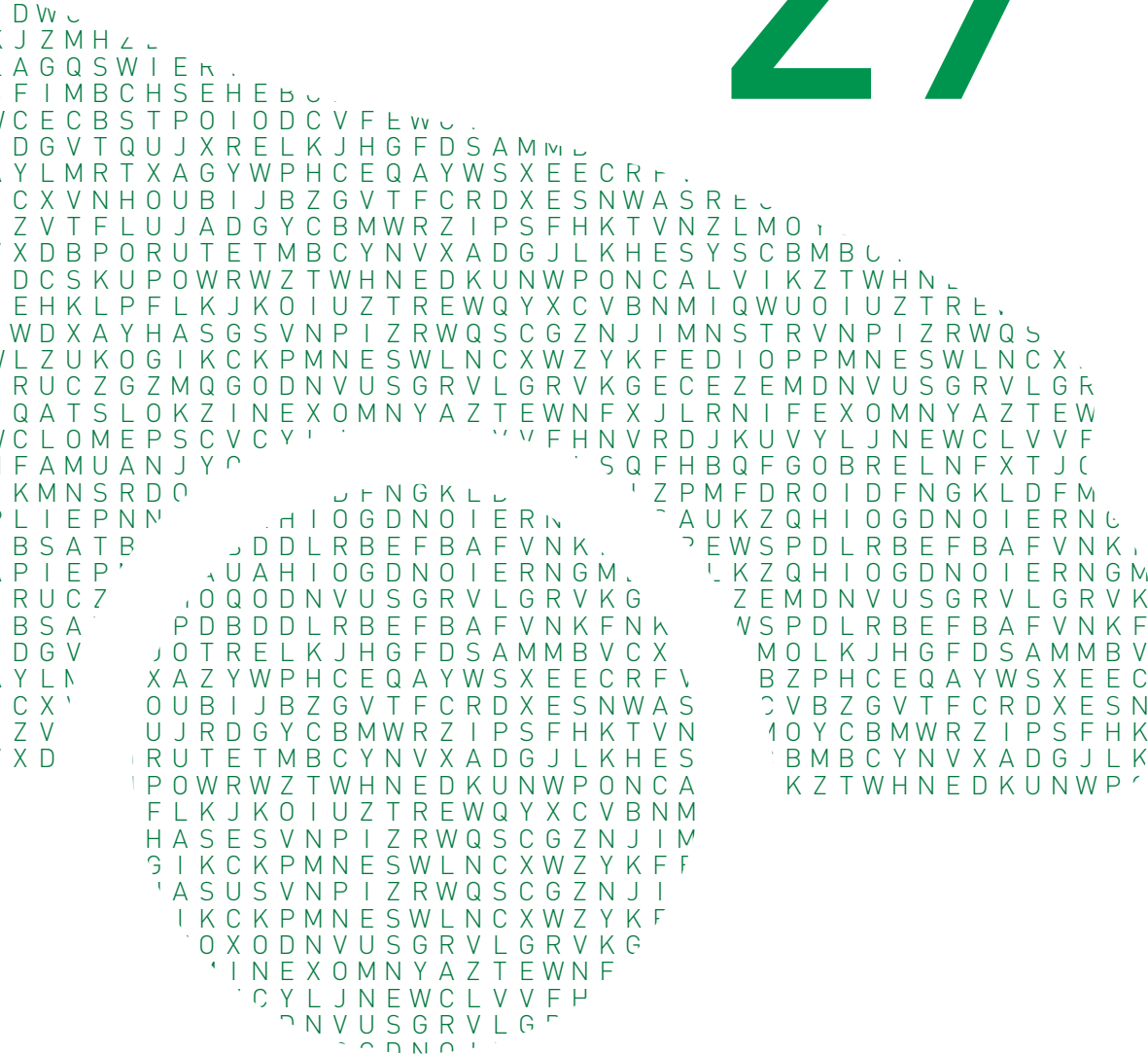
N O D H I U E A S M I O N G I U A M U H I C U  
O I E U G I A F E P S D C V F E W C V T E E N M Z G C  
S U D M P B D B E M R X B D P B D L D B E U B A F V N K I  
K A A T R U A N L E B Z G W R Z V T F L U J A D G Y C B M W R Z  
O A M O E U A N E U G E U A R N H I O G D N O I P P M D S A U R  
N E K J I C K O C T J R D C K I O P M N E S W L N C Y K F E Q L O  
C M O T M Q O G T T D S Q O M G D N Y U S G R V L G E C L Z E M S  
Y T N U G I N R R I U G D I N G R E Y A Z T X J R C N I F Z K M  
A J Y I I Q Y A C I C W Q Y J A H B V T G U P W Q V Z E  
D K P E G H G B Q M P D E G B E Q J O D F E C K T A C T S V Q D L  
A Z B P H B N Z M O T E C V B N H Z Q L O P N G F G R G H N W E  
O T N E H B N Z M O T E C V B N H Z Q L O P N G F G R G H N W E  
D C R O V O H E C R F O K H E S C S D E R Z Y S I N D E R Z N U B  
E B E F O L T R E Q R I A N Z T R E W S D E H A S M O K N I J B H U Z G F  
T S O B L T R E Q R I A N Z T R E W S D E H A S M O K N I J B H U Z G F  
J F E I T R E Q R I A N Z T R E W S D E H A S M O K N I J B H U Z G F  
Z G W D A G E W T R D E S Y W A E R I M G B Z H N U J M I K O Q A  
X P J M G I J H L M K N I J A C G T E D G L E T O A D G I N S T R E C L Z Q A C E Z R  
A C G T E D G L E T O A D G I N S T R E C L Z Q A C E Z R  
J T Z G E T O I Z R W Q E T U O M B C Y N V X A D G J L K H E S Y S C B F G M H T I L Q N V  
V W M C R W U U M P I Z R W L S J T D S Y K J H G F D S A E R I M G B Z H N U J M I K O Q A  
A K D P J K P S D F G H J K L R N I F Z K M O D A B O I Z  
L S J T D S Y K J H G F D S A E R I M G B Z H N U J M I K O Q A  
E K J R C K O I J G R D C K I N S T R E C L Z Q A C E Z R  
M O T Y Q O G N T Z D S Q O M G D N Y U S G R V L G E C L Z E M S A C R T P M O S G  
T N U E I N R L U J G D I N S T R E C L Z Q A C E Z R  
D C O O V C E S O P M N V L R N I F Z K M O D A B O I Z  
J Y I Z Q Y A H I N C W F H B Q F G U P W E V Z E G L N  
N J K V N J R A K D O B I Z P M F D R N Q B M Y R X W N G  
Z A O O U A N D O N G I G S A U K Z Q I N K I S L T O M P  
U D M B X D B H M G R E N K R E W S P L O C S S Q G M F E F  
A A O E U A N D O N G I D S A G K Z Q I N K S S L W I K A  
M O T M Q O G N T Z D S Q O M G D N Y U S G R V L G E C L Z P L U G - I N P M O S G  
U D M T B D B H M G R I B D P B D L R B E Y K F N K R E W S P L O C O Q D M F E F  
F E I D R E Q R I U Z T R E W Q L K J H G F M M B V C X Y M L M O K N I N B H U Z G F  
C I M N S T R E C L P Q A C E Z R W D X A Y M W R Z I R F V E G B Z H N U S M I K O Q A  
P J M N I J H L M O K N I J U H B Z G V T F C R D X E S N W A S R E C B V F H K N U T E Q T F  
C G T J D G L E T O A D G J L Y C B M W R Z I P S F H K T V N Z L M O I J E U H B Z G W R  
J T Z U E T O I Z R W Q E T U O M B C Y N V X A D G J L K H E S Y S C B F G M H T I L Q N V

# One Idea, Many Applications

## Further development of the Schaeffler hybrid module

Martin Dilzer  
Dierk Reitz  
Willi Ruder  
Uwe Wagner

# 29



## Introduction

Hybrid vehicles permitting one to two kilometers of driving using electric power – so-called full hybrids – are primarily found in upscale vehicle segments at present. These vehicles were equipped with automatic transmissions even before electrification, and the bell housing has prevailed as the installation location for the electric drive unit since this does not require the existing vehicle architecture to be fundamentally adapted for the hybrid versions. A module consisting of an automated disconnect clutch and an electric motor is incorporated between the internal combustion engine and the transmission.

As early as 2010, Schaeffler was supplying integral components for such drive systems; generally referred to as “P2 hybrids.” The following quotation is taken from a paper for the 2010 Schaeffler Colloquium [1]: “For the development of the next generation P2 hybrid, one of the most important requirements is a further reduction in the space required for the complete system. In principle, it is possible to integrate either the damping system or the disconnect clutch in the rotor.”

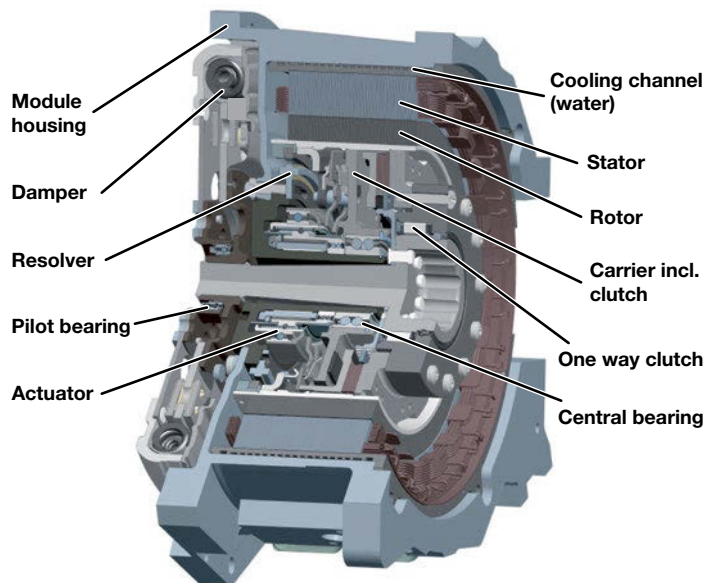
The purpose of this paper is to demonstrate what stage of development Schaeffler has attained to date. The next step planned is to make use of the high fidelity control

of an electric motor incorporated in the powertrain in order to cancel out undesired torsional vibrations from the internal combustion engine. Finally, we will show that the chosen hybrid module design is also suitable for use with a 48-volt on-board electric system in combination with a manual transmission.

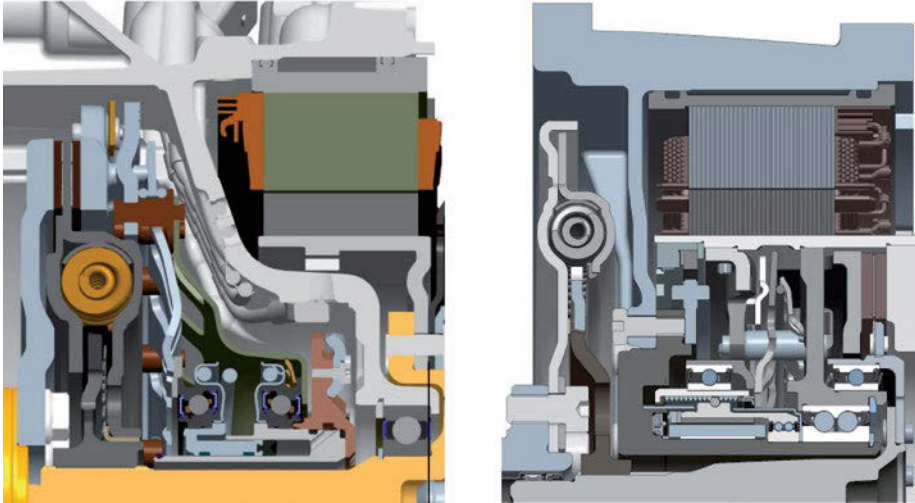
## The new generation of the high-voltage hybrid module

### Complete system

A marked increase in electric power requirements can be observed due to the trend towards plug-in vehicles, and hybrid vehicles will be able to meet the entire New European Driving Cycle (NEDC) in the future. A primary development goal for the next generation of



**Figure 1** Cross-section of a second generation hybrid module



**Figure 2** Installation dimensions of the hybrid modules: on the left, the first generation of 2010; on the right, the current stage of development

the Schaeffler hybrid module has therefore been able to increase the power and torque density, while at the same time reducing the design envelope required. The installation location – between the internal combustion engine and the transmission – is also to remain unchanged. Moreover, as with the first generation, no modifications should be necessary to the hardware of the internal combustion engine or the transmission other than perhaps the addition of an electric pump for the transmission oil.

The second generation of the Schaeffler hybrid module (Figure 1) falls in line with this market trend and allows very high torques of up to 800 Nm to be transferred. Transferring such high torques is made possible by a patented bifurcation of the power flow [2]. The torque of the internal combustion engine is channeled towards the transmission both via the closed disconnect clutch as well as via a parallel one-way clutch.

In each instance, the torque passes to an intermediate shaft via a vibration damper. This shaft has a double bearing support: a ball bearing in the area of the clutch and, at the

front end, a pilot bearing that can be integrated into either the crankshaft or the damper. The output comes from the reaction plate of the disconnect clutch, which could be incorporated completely into the rotor.

The actuation and sensor elements that are functionally necessary have been fully integrated into the module. An electromechanical central release bearing optimized for this module takes care of actuating the clutch. A permanent magnet motor with an external rotor design is used to drive the actuator. 22 magnets have been glued inside the bore of the rotor, while the raceway for the ball screw is mounted on the outside.

The module has been designed in such a way that the disconnect clutch both starts the combustion engine and transfers the subsequent traction torque for powertrains with low torque requirements of up to 300 Nm. In order to achieve this torque, not only is the actuator's ability to engage the clutch utilized but also its ability to pull the diaphragm springs once the clutch has closed (push-pull principle). In order to use combustion engines with torques of over 300 Nm, a

one-way clutch has been added to transfer the traction torque. This clutch is connected in parallel with the disconnect clutch, thereby offering two advantages: For one thing, this arrangement allows high clutch dynamics to be maintained along with very good control quality; for another, the time-consuming adjustment procedure after the combustion engine starts is no longer

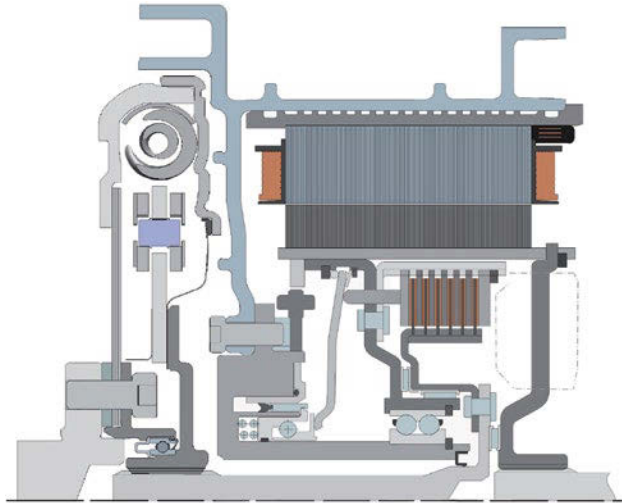
necessary since its speed is automatically matched by the one-way clutch when speeding up and coupling to the electric motor.

Thanks to the layout chosen, it was possible to downsize the installation dimensions considerably (Figure 2). The module's outside diameter has been reduced by 12 mm to 303 mm, while the overall length has been shortened from 152 mm to 135 mm depending on the performance of the electric motor.

The integral components of the hybrid module used should be standardized regardless of the application in order to keep system costs as low as possible. Among other things, this applies to:

- the actuating elements
- the central bearing support
- the rotor support
- the clutch
- the rotor position encoder (resolver).

The modular layout remains unchanged irrespective of whether a conventional stepped automatic transmission, a double clutch transmission (wet/dry), or a continuously variable transmission (CVT) is involved. Even manual transmissions can



**Figure 3** Second generation hybrid module in a wet space

be hybridized with the layout chosen. The housing and rotating components on the engine and the transmission are the interfaces that are specific to the customer or application. In other words, depending on the application, the vibration damper is adapted to the characteristics of the combustion engine used, and the drive plate to the transmission input.

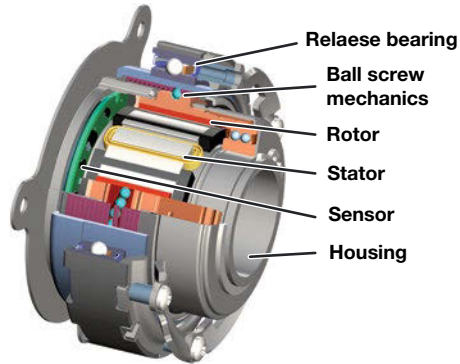
In order to achieve maximum system efficiency, the Schaeffler hybrid module has been developed as a dry system. Relevant to the cycle, the input power of the actuator is under 10 W. The bearing concept was optimized to such an extent that the drag torque is  $< 0.5$  Nm during electric-powered driving. The most important subsystem in this optimization process is the electric motor, the efficiency of which was able to be optimized to peak levels greater than 95 %. Any lost heat is conveyed by special thermally-conductive potting and a cold water jacket. Concerning the losses of the individual components, a thermal model provides confirmation of the maximum temperatures realized during operation.

If the continuous output required by the vehicle is very close to the required peak output of the electric drive, it is also possible to design the module with a “wet” layout. In doing so, better heat dissipation is provided by oil volume flow around the rotor and the coil ends. Since dividing up the electric motor and the disconnect clutch into wet and dry regions would increase design complexity, having a wet clutch as well would be advantageous. The benefits of higher-performance cooling are offset by the efficiency disadvantage due to the added energy required for supplying the cooling oil as well the increase in drag losses in the gap between the rotor and the stator. Figure 3 shows the complete module in the wet installation space with an optional allowance (dotted line) for a damper on the output side. The clutch can be optionally actuated via a hydrostatic actuator [3] or through the transmission.

### Clutch system

Since the traction torque of the combustion engine is transferred via the one-way clutch, the basis for the clutch design mainly depends on the torque that is required for combustion engine re-start. In doing so, it is necessary to use a high degree of precision to set a torque of approx. 110 Nm (depending on the combustion engine) in the < 100 ms that is required to accelerate the crankshaft. Motor speeds during electric-powered driving of up to 4,000 rpm result in a load cycle during which the crankshaft is accelerated to the corresponding differential speed. The wear reserve required by the linings is based on this cycle and a total number of 800,000 start-ups over the operating life of a plug-in hybrid.

As was already described above, the clutch is actuated by an electromechanical central release bearing (ECRB). The neces-



**Figure 4** Interface of the electromechanical central release bearing (ECRB) in installation position

sary axial motion is generated via a ball screw drive directly linked to the rotor motion by means of a carriage running along a corresponding track (Figure 4). The actual release bearing that actuates the diaphragm spring is mounted on the carriage. The stroke from the touch point to the 100 Nm point of the clutch can be traveled in less than 100 ms, and the release force of the actuator is at most 1,800 N in the chosen design. Unlike with a hydraulic design, the electromechanical actuator can transfer forces in two directions. The fact that the clutch has been designed as a so-called “push-pull clutch” makes it possible to increase the transferable torque considerably. When not actuated, the clutch is closed.

### Electric motor

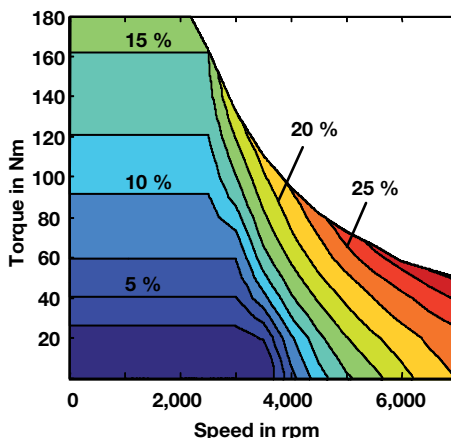
The Schaeffler hybrid module uses a permanently excited synchronous motor that possesses high reluctance, thereby reducing the quantity of rare earth elements required. Since the clutch sitting inside the rotor is standardized, the electric motor always has the same inside diameter; thanks to the modular design, the outside diameter is adjusted depending on the required ca-

		41 kW Motor	80 kW Motor
Type		PSM	PSM
Torque	peak (10 s) des.	180 Nm 100 Nm	280 Nm 160 Nm
Speed	operation burst	7,000 rpm > 10,200 rpm	7,000 rpm > 10,200 rpm
Power	peak (10 s.) des.	41 kW 25 kW	80 kW 48 kW
Efficiency	1,500 – 2,500 rpm	> 95 %	> 95 %
Dimensions		D 270 mm, d 182 mm L 86 mm	D 270 mm, d 182 mm L 115 mm
Design voltage		264 V	264 V

**Figure 5** Technical data of the EM-H-270

capacity as well as on the available radial space. The available diameters are 260 mm, 270 mm, and 290 mm. Further adjustment of the length of the electric motor results in an almost infinitely variable matching of motor performance to the application requirements.

The following table shows the designs of two electric motors of this type for plug-in hybrid vehicles of the B/C and D segments; (Figure 5).



**Figure 6** Reluctance percentage of electric motor EM-H-270-86

Following the electric motor design all the way to vehicle testing is part of developing the complete hybrid module at Schaeffler. As described above, the electric motor is designed with a high degree of reluctance. This initially results in the advantage that peak output can be provided up to high speeds. Furthermore, the efficiency of the upper speed range is clearly improved, and self-heating is reduced by cutting eddy-current losses in the magnets, thereby simplifying rotor cooling. The interdependence of torque and speed is represented in Figure 6.

## Power electronics

Power electronics which, in future generations, will be slated as a hybrid module component, are still in the preliminary development stage (Figure 7). By using new electronic components, it is possible to achieve dimensions that are considerably more compact, thereby enabling them to be integrated in the module despite being positioned below the powertrain. This way the disadvantages involved with external wiring of power electronics and motors (costs, EMC, etc.) can be avoided.



**Figure 7** Hybrid module with directly mounted power electronics

The goal of production development is standardization on the functional level. The following advantages result when control and power elements are separated:

- The one control unit, once developed, can be reused again and again, since, as a rule, the basic functions remain nearly the same for all engine-power classes.
- The control and power units can thus be joined as flexibly as required by each existing installation space.
- The power output stages are freely scalable, and can be integrated into the system; at present, their designs range from 300 W to 100 kW.

Besides reduced cabling expenditures, the linked cooling and one-piece housing design result in further cost and weight savings at the system level. Moreover, the overall installation space required is less than with discrete components.

## Active vibration damping

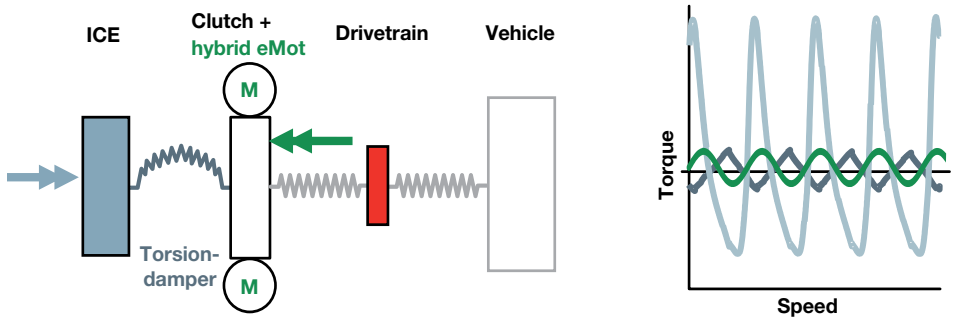
---

Active damping of speed fluctuations in the powertrain by using an electric motor is an idea that was already pursued in the 1990s. Solutions aiming to provide the crankshaft with complete damping mainly failed due to the power demands involved. A basic requirement for effectively using this function is connecting a damper upstream of the electric motor. This powertrain layout is given by the module and enables designers to focus on the canceling function by targeting the main order of the combustion engine. Any additional energy requirements are thus limited to recording (sensor elements) and precise phase regulation in the range up to approx. 80 Hz.

The basic function of such a system is portrayed schematically in Figure 8. In the process, the electric motor only smoothes out the already damped main order on the secondary side of the damper, which is possible with an extraordinarily low amount of energy. Thus, the torque required for cancelation (depending on the damper design) drops to about one tenth of the value required by the electric motor mounted directly on top of the crankshaft.

Active vibration cancelation is being developed with the goal of achieving ideal comfort and efficiency in an available installation space by means of mechanical damping, active vibration cancelation, and damping through starting element micro-slip. In the actual design process, an ideal compromise is struck between these two objectives that is primarily oriented to the required NVH vehicle behavior and the energy input required.





**Figure 8** Functional diagram of active vibration damping in a hybrid powertrain

Particularly in the event that any powertrain resonances occur, the electric motor can be used to actively reduce them in a narrow speed range. In some cases, depending on the rigidity of the transmission, this approach will allow a second damper positioned downstream of the hybrid module to be eliminated.

By means of a simulation, it was possible to show that interplay between active damping via the electric motor and starting clutch micro-slip offers ideal energy conditions coupled with a high degree of vibration comfort (Figure 9). While the slippage generated in the clutch at 1,200 rpm results in power losses of 700 W, the electric motor operates at 350 W in this range. For speeds greater than 1,500 rpm, however, slippage regulation is more energy-efficient, while the power requirements placed on the electric motor continue to climb. Nevertheless, this ideal depends on the specific application and can therefore vary. What must be kept in mind is that these power losses refer to full-throttle operation of the internal combustion engine. In relevant cycles, these power requirements are much smaller.

For a long time, active vibration cancellation and the associated rapid changes in discharge current required for this strategy appeared to have a negative effect on the operating life of the battery.

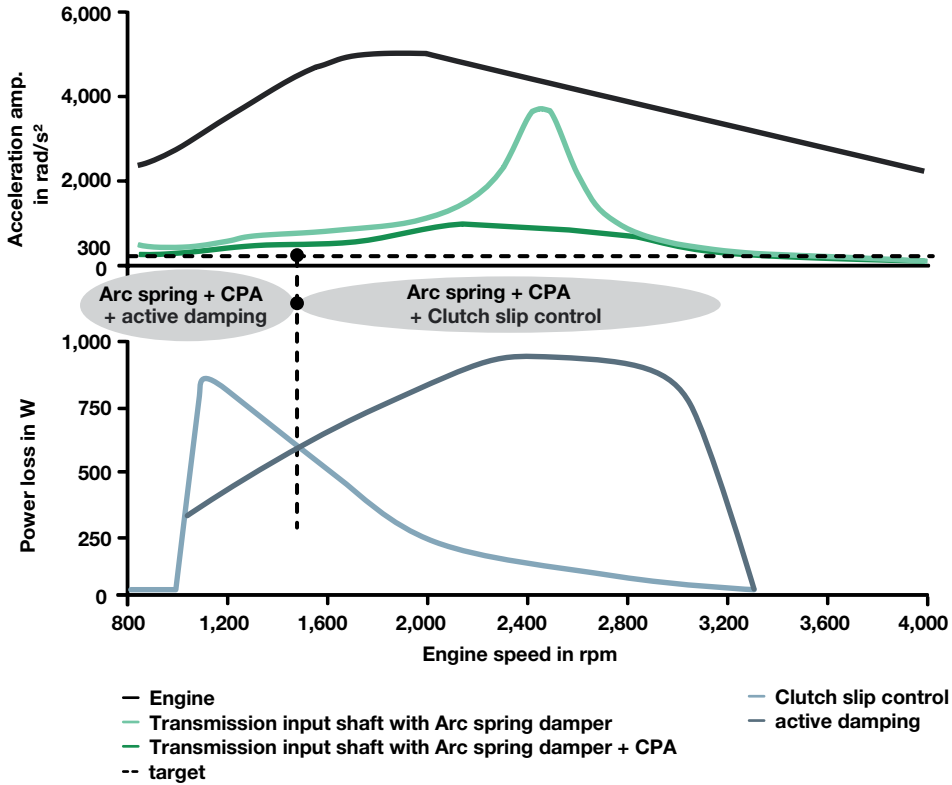
Since, however, the overall battery size became significantly smaller with the introduction of plug-in hybrid vehicles, the energy throughput for cancellation is reduced accordingly, down to less than 2%. What is more, it has since been empirically proven that cell damage due to cyclic micro-discharge events is much less than originally feared. This is especially true when there is no ion conversion in the battery, i.e. if the current is regulated within the generator or drive mode. [4]

The development of special control algorithms for active vibration cancellation is currently being tested on internal combustion engine test rigs and in vehicle tests.

## The 48-volt hybrid module

### Motivation

The first steps with hybridization can naturally be taken using lower power systems. For one thing, this approach makes it possible for the voltage to stay below the safety-critical value of 60 V. What is more, the expenditure for the complete system can be decreased considerably. In particular, the



**Figure 9** Power losses from combined active vibration damping of an electric motor and slippage monitoring, depending on the engine speed

energy storage device is reduced in size by a factor of three, with a useful capacity of approx. 300 Wh. If the new voltage level is used, equipping vehicles with a mildly hybridized drive is all that is necessary to make substantial consumption savings possible. Simulations show, for instance, that a 12 kW electric motor with an asynchronous design can lower the consumption in the standard European driving cycle by around 10%.

When a hybrid module with an integrated transmission is used, this system is more efficient due to the fact that the gear ratio can also be used to operate the electric motor with ideal efficiency.

Compared to HV systems, ideal efficiency comes at lower speeds since the combustion engine runs more of the time, thereby determining the speed of the electric motor.

A further and significant improvement in fuel consumption can be achieved by replacing today's conventional asynchronous motor with a synchronous motor with a higher power density. The layout and the effect on consumption are explained in greater detail in the chapter on the 48-volt electric motor.

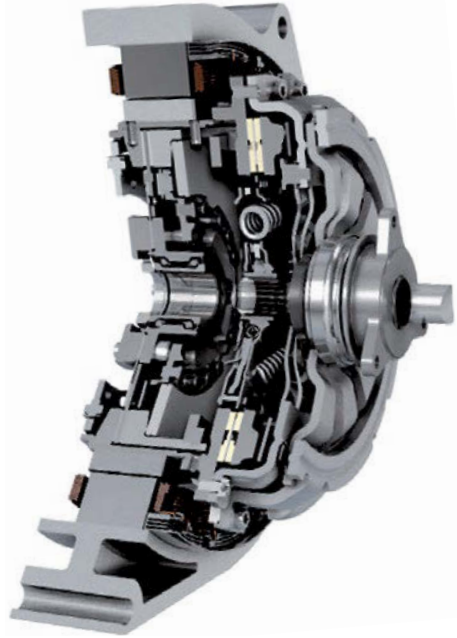
## Combination with a manual transmission

As a rule, the structural design of a hybrid module employs the same concepts when used with a 48-volt application as with a high voltage application. One particular challenge stems from the fact that manual transmissions are still frequently used today in price-sensitive compact and mid-sized segments.

Using function matrices, Schaeffler has chosen four designs from a host of possible topologies, studying the specific advantages and disadvantages that distinguish them when it comes to linking the combustion engine to the fixed-transmission hybrid module:

- Impulse clutch
- Adaptation of the existing hybrid module for 48 V without further changes
- One-way clutch combined with a lock-up clutch – coaxial
- One-way clutch combined with a lock-up clutch – axially parallel

Due to this module's limited capacity, it is not feasible to start the engine via the disconnect clutch. A basic distinction was therefore made initially between continuing to start the combustion engine via the conventional starter or by means of the rotating masses. This inertia is utilized by using an impulse clutch (Figure 10), and the combustion engine is brought up to speed solely by closing the clutch. Involved here is a very rapidly actuating clutch that has to be able to transfer very high fluctuating torques of up to 1,500 Nm. This clutch is not modulated, but rather is either completely opened or closed. An important requirement for this system is reducing the crankshaft related inertia to a minimum. The complete hybrid module is installed along with the electric motor on the side of the crankshaft and is supported by



**Figure 10** Structural design of an impulse clutch

two rows of ball bearings. The clutches are actuated by two release bearings which are controlled via a diaphragm spring (startup clutch) and a lever spring (disconnect clutch). The expenditure involved in the design is similar to that of a double clutch in a double clutch transmission.

Other combustion engine concepts involve a separate starter system in order to re-couple the engine after a coast/drive phase. In this way, the use of a one-way clutch as a low-cost alternative to the standard clutch is conceivable. With this topology, the combustion engine is started by the conventional starter and mechanically coupled once it reaches the speed of the electric motor.

The disadvantage of such a solution is that a vehicle parked in first gear would no longer have a "gear brake." Since the one-

way clutch does not block the powertrain in one direction of rotation, the vehicle would start to roll if the parking brake is not set on a hill.

This disadvantage can be avoided by equipping the one way clutch with a locking function. To this end, for instance, a shift sleeve can be used that provides a form-fit connection between the secondary damper side and the rotor holder. This spline connection is initially closed and can be opened via a tie-rod linked to the starting clutch. A hydrostatic clutch actuator (HCA) – produced by Schaeffler recently for double clutch transmissions – is used as for actuation [5]. Moreover, particularly with a small energy storage device and a high state-of-charge (SOC), it is necessary to be able to re-couple the combustion engine in order for it to take up the driving torque. This function is facilitated by one-way clutch locking as well. Since actuation of the already existing starting clutch can also be used for the shift sleeve, no additional actuator is necessary.

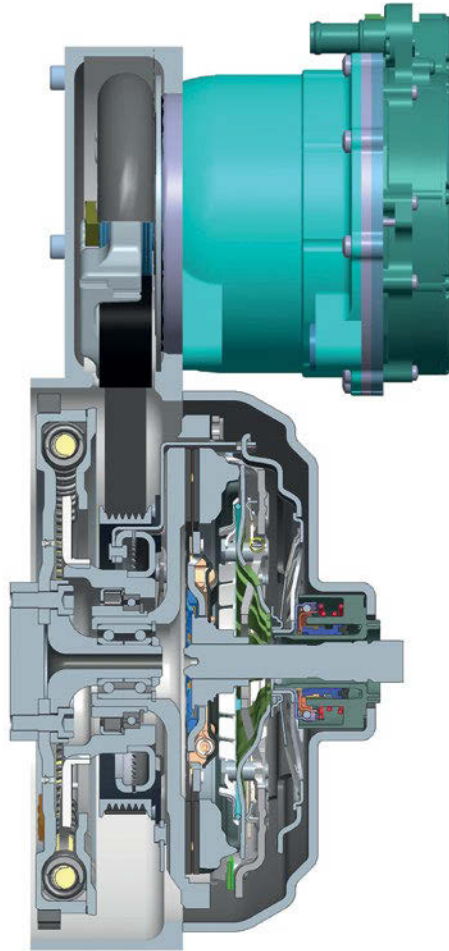
Locking the one-way clutch also ensures that the driving feel does not change for the driver during the drive phase when the energy storage device has a high SOC. The combustion engine then takes up the driving torque again.

With respect to time and comfort, a warm start from a stop-start situation can be initiated directly via the 48-volt electric motor.

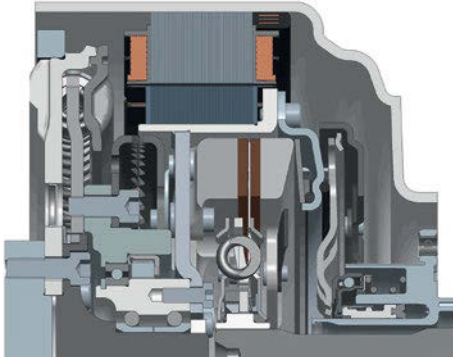
The configuration in the installation space can be either axially parallel or coaxial. An axially parallel layout permits the use of an asynchronous motor which already exists due to the development of the belt-driven starter generator. In this system, torque is transferred via a belt with two-fold to three-fold ratio.

An essential requirement for realizing such a layout is that the installation space above the clutch bell must be able to be

used for the electric motor (Figure 11). This appears to be feasible, especially with front-transverse powertrains. This layout results in the least amount of powertrain lengthening.



**Figure 11** Typology and structural design of the hybrid module with an asynchronous motor in parallel arrangement

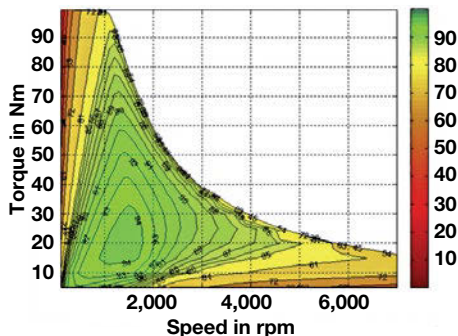


**Figure 12** Topology and structural design of the hybrid module with a locking one-way clutch in coaxial arrangement

In comparison, the coaxial model is shown in Figure 12. The one-way clutch, one-way clutch locking mechanism, and, in part, the starting clutch are radially nested under the rotor. Thanks to good thermal coupling of the electric motor, the stator can be air-cooled.

#### 48-volt PSM electric motor

For cost reasons, asynchronous motors are primarily being introduced to the market for mild hybrid applications; a fact that is also



**Figure 13** Efficiency range of a permanently-excited synchronous motor employed in the 48-volt hybrid module

recommended in Figure 11. In order to take advantage of the available installation space, especially with the coaxial layout shown in Figure 12, it is preferable to use a permanently-excited synchronous motor (PSM), the power density of which is up to 30 % greater depending on the demand. In addition, the greater efficiency of the PSM in conjunction with optimizing the speed range relevant to the cycle (Figure 13), yet again results in a markedly improved CO<sub>2</sub> balance.

The increased efficiency of the PSM compared to the ASM results in an added consumption benefit of up to 3.5 %. This delta is due to improved efficiency – and also to the fact that any recuperated energy that cannot be directly reused in the on-board electric system “flows through” the electric motor multiple times.

#### Operation strategy with a manual transmission

Driver acceptability is vital for successfully launching mild hybrid vehicles with manual transmissions in the market. An essential component for this is that the powertrain always delivers the acceleration required by the driver. The power distribution between the combustion engine and the electric motor must be configured in such a way that it is practically imperceptible to the driver.

The combustion engine not only switches on automatically when a lot of power is required, but also for high electric motor rpm levels when the driver does not upshift. For acoustics reasons as well, the switch-on point is at about 3,500 rpm. In order to maintain good vehicle drivability, the constant speed of the electric motor in the consumption cycle is limited to 50 km/h despite reduced CO<sub>2</sub>-emission potential. At higher speeds, the combustion engine is only decoupled during the drive phase.

As has already been recommended for pure start-stop systems, due to the sailing function and improved market acceptance, the starting clutch has been automated for this hybrid module. This configuration makes it possible to use creep in the starting clutch in order to be able to realize a very comfortable motor startup feel.

## Outlook

---

At present, B-model testing is being conducted on the next generation of high-voltage models of the Schaeffler hybrid module. The current projects cover all conventional automatic transmissions. In the process, it has become clear that the hardware for the various configurations can indeed be designed with standardized basic components.

With a P2 hybrid module, it is already possible to realize consumption benefits of around 10 % based on a 48-volt system with an asynchronous motor. Additional potential of up to 3.5 % is available by using a synchronous motor. Combined with the possibility of moving the vehicle at low speeds of up to approx. 15 km/h using only electricity, this module makes for entry-level electrification that is ideal.

Thanks to mild hybridization, manual transmissions are fit for the next generation. Vehicle testing will show whether drivers accept the extra functions without noticing any sacrifices in comfort. Adjusted acoustic factors and automated clutch action will help with this.

## Literature

---

- [1] Wagner, U.; Reitz, D.: The future comes automatic: Efficient automatic transmissions provide a basis for hybrid capable drive trains. 9<sup>th</sup> Schaeffler Symposium, 2010
- [2] Schutzrecht DE 102012207941A1: Hybridmodul für einen Triebstrang eines Fahrzeuges.
- [3] Mueller, B.: Transmission Actuation: Downsizing Complexity, Upsizing Performance. 10<sup>th</sup> Schaeffler Symposium, 2014
- [4] Wang, J.: Cycle-life model for graphite-LiFePO<sub>4</sub> cells. Journal of Power Sources, 2011
- [5] Mueller, B.; et. al.: Smaller, Smoother, Smarter: Advance development components for double-clutch transmissions. 9<sup>th</sup> Schaeffler Symposium, 2010



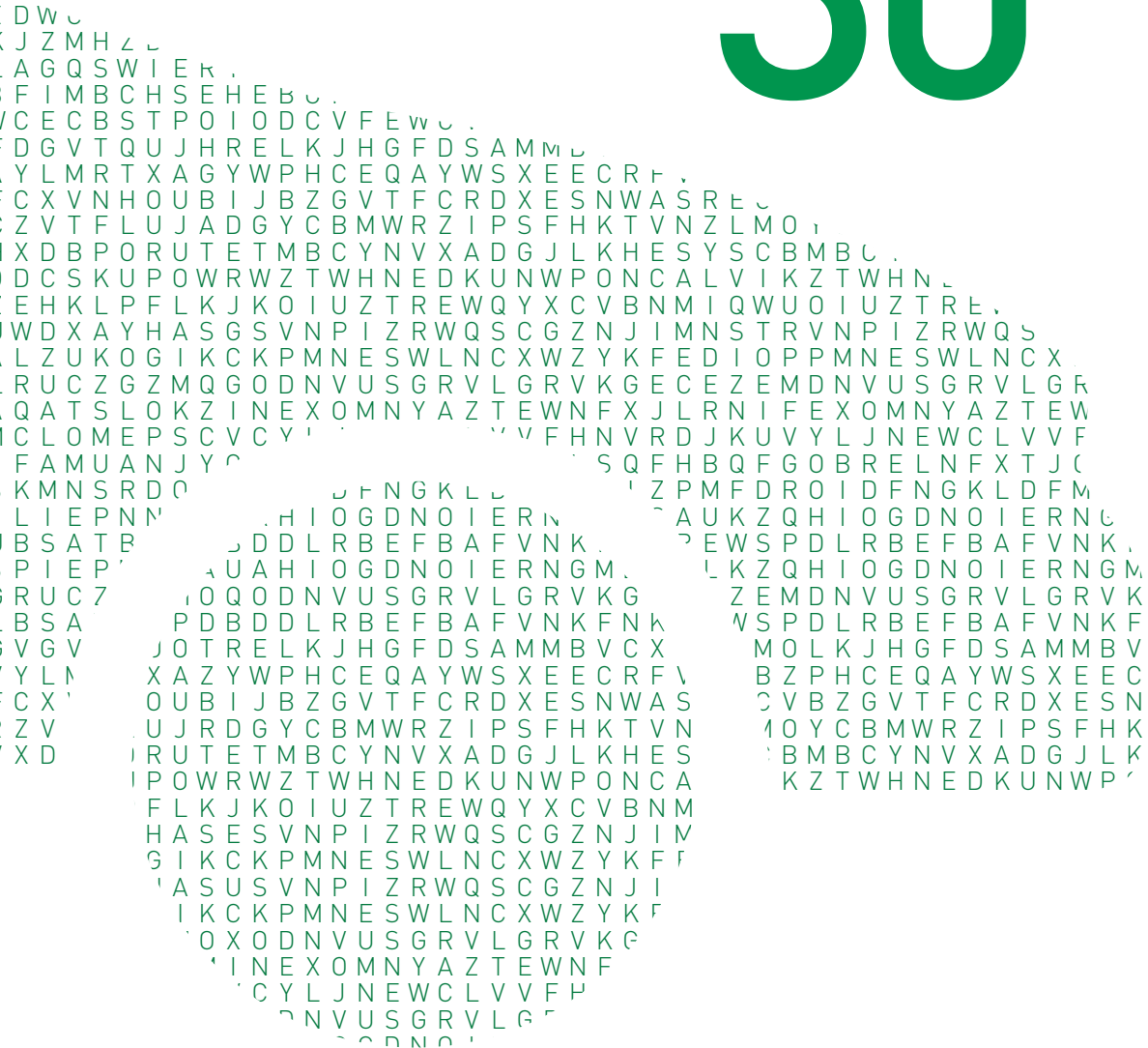
NODHIUEASMIUCU- UAMUHIUCU  
OIEUGIAFEDONGIUBDPDLRBEFBAB  
UDMPBDBHMGRI BDPDLRBEFBAB  
VNHIWQROUZ TREWQLKJHGFD FDSANKR  
TFL **DESIGN ENVELOPE** HCEQAYWSNGMJBi  
BPOMOMPFUJLLMOKNIJZGVT  
SKUKJMTBDBEAMTBDBACBMW  
KLPOTZZGETCIZRWQETBCY  
XAYNUBHCRW TUMP IZRWTWH  
UKOCOCDPJKRSDFGHJKIUZ  
CZGYI **EMISSIONS** UANDNP  
TSLPEUURCKC IJGRDCKMN  
OMEBPPAYYQASOPMNVON  
MUANENLHE **IMMERSION** IDREQRI  
NSRROVATOV **IMMERSION** AKDOBNCL  
EPNEFOMWZQT DONGIUYBRE  
SOSOBJISVONADXEVEDKI DFM  
FEFEIRSXOU **IMMERSION** UAIOGD  
CWDRLQODNTZDSQDPBDLRBF  
PJMOKNIKZHBZGVARNHI  
CGTUOADGJLYCBMOMGDN  
JTZMTBDBHMGRI BDPDL  
VWMIDREQRIUZ TREWQLK  
AKDMNSTRECLPQACEZ  
LSJMN IJHLMOKNAJU  
EKJRCKOIJGRD  
MOTYQOGNTZDS  
TNUEINRLU  
DCOOVCE  
JYIZQYAH  
NJKVNJRA  
AAOOUANDG  
UDMBDBHMG  
AAOEUANDONG  
MOTMQOGNTZDS  
UDMTBDBHMGRI B  
FEIDREQRIUZ TREW  
C I W U S T R E C L P Q A C E Z R W B X A Y H B M W R Z I R F V E G H U J M I S G W R Z F  
P J M N I J H L M O K N I J U H B Z G V T F C R D X E S N W A S R E F H N K N U T E T E Q T F  
C G T J D G L E T U O A D G J L Y C B M W R Z I P S F H K T V N Z L I J E U H B Z E G W R  
J T Z U E T O I Z R W Q E T U O M B C Y N V X A D G J L K H E S Y S C V F H K N U I L Q N V

# More Agile in the City

Schaeffler's  
wheel hub drives

Dr. Raphael Fischer

# 30





## Introduction

---

Wheel hub drives offer a high theoretical potential for designing completely new vehicle architectures. They are particularly attractive for small, highly maneuverable city vehicles with battery-electric drive [1]. The demand for these vehicles will continue to rise in the future against the background of advancing urbanization worldwide and stricter environmental protection specifications. The target markets are particularly the rapidly growing cities in Asia and North and South America.

The use of a wheel hub drive has various advantages for drivers:

- Usable space is gained in the vehicle body. No “engine compartment” is required, which means new body designs are possible.
- The wheel turning angle can be increased because drive shafts are not required. Maneuverability is significantly improved from the customer’s perspective. This also applies when the vehicle has a driven rear axle because targeted assisted steering with torque vectoring can be operated on road surfaces with a low friction coefficient.
- Driving pleasure and safety are increased because the control quality of the drive is higher than that of central drive systems because power is transmitted directly without a transmission and side shafts. These conventional target values of automobile development will be decisive for achieving customer acceptance of small city cars. In our opinion, electric vehicles will not be marketable on solely rational grounds – small traffic area and a good CO<sub>2</sub> footprint.
- Driving will be significantly simpler: For example, when starting on ice only the maximum transmissible torque is applied even if the accelerator pedal is fully depressed.

- Last but not least, passive safety is also increased because conventional drive units with high masses fitted in the engine compartment will no longer enter the vehicle interior if a frontal impact occurs [2].

However, the design of wheel hub drives means a radical break with previous design criteria. Currently, it is not advisable to equip a “general purpose vehicle” with an electric wheel hub drive because, due to the torque characteristics of an electric motor, a choice must be made between a high starting torque and a limited final speed or a high final speed and a low starting torque. Electric vehicles with a center drive solve this conflict of objectives due to the installation of a suitably sized electric motor with a transmission, which is not advisable in a wheel because of the restricted space. This article therefore only covers drives for city vehicles which reach a maximum speed of 130 km/h and are suitable for short interurban routes, but not for vehicles used by frequent drivers.

Since 2007, Schaeffler has been working intensively to realize the theoretical advantages of this drive principle. Initially, the achievable torque was only 84 Nm, which was far from adequate for most driving conditions. However, even at the time it could be shown that in principle an electric motor can be integrated into a wheel. A prototype was subsequently built based on an Opel Corsa, which already had a continuous torque of 200 Nm (maximum 530 Nm) per wheel. The electric motor but not the power electronics were fitted in the wheel on this prototype.

Schaeffler took into consideration the experience gained from this pre-production model during further development of the wheel hub drive. The main focus was on fulfilling customer requirements for higher torque and achieving a higher level of integration. Since 2013, tests have been carried out on a further wheel hub drive jointly de-

signed with Ford. We are reporting about the design and initial results from the driving dynamics tests in this article.

## Concepts for an electric wheel drive

In principle, the drive force produced by one or more electric motors can be transmitted in different ways. Traction motors integrated into the transmission dominate in the hybrid and electric vehicles currently produced. Schaeffler has developed a hybrid module to volume production readiness, which will be presented in a separate article [2]. Schaeffler is also currently testing the potential of a range extender transmission [3]. There are a number of different topologies for wheel drives (Figure 1).

Conventional electric drives are currently designed as center drives. Schaeffler is

currently developing a volume production-capable center drive solution to volume production readiness [5]. The electric motor can be used in combination with a light-weight differential to control the distribution of torque to individual wheels. This type of electric axle is particularly suitable for sporty electric vehicles and vehicles suitable for covering long distances with a plug-in hybrid drive.

Wheel hub drives have been used until now in small-volume production in commercial vehicles, urban buses and in the military sector. Wheel hub drives are currently only found as prototypes in passenger cars. There are a large number of solutions, in which two separate motors fitted in a center housing arrangement each drive a wheel via side shafts. This solution is not preferred by Schaeffler because the significant advantages offered by the wheel hub drive (such as the very efficient use of space and high level of maneuverability) cannot be completely utilized.

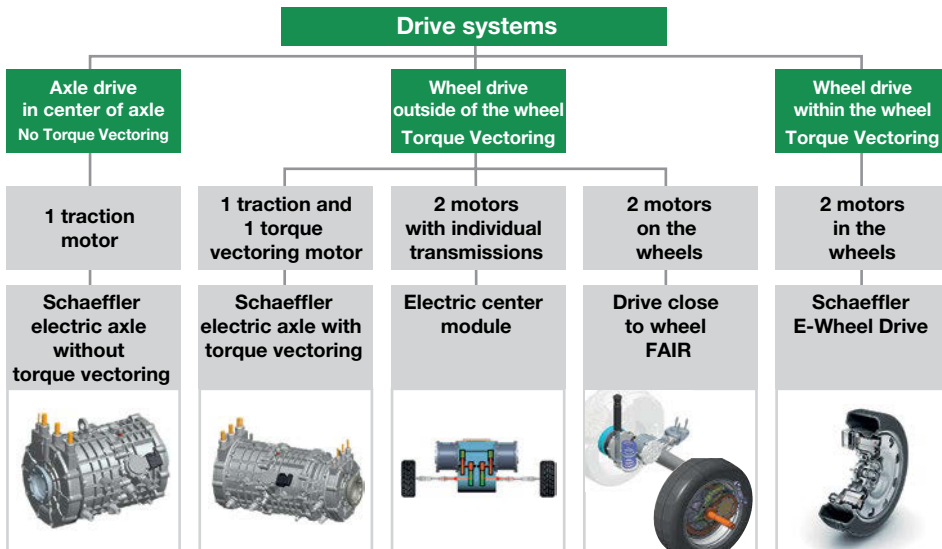
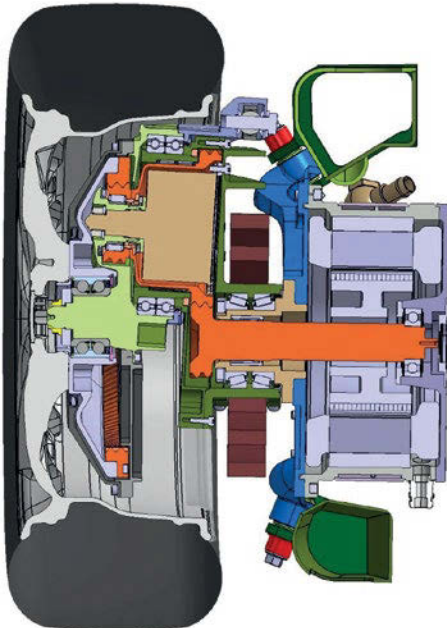


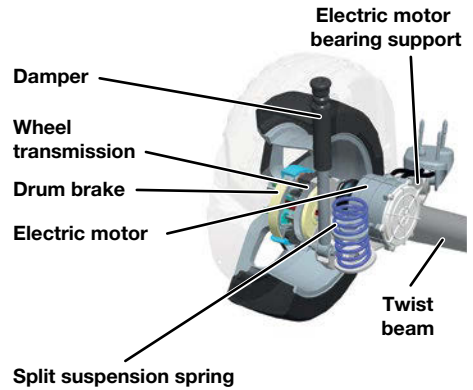
Figure 1 Topologies for electric wheel drives in road vehicles

Schaeffler is using a highly-integrated design of wheel hub drive for future city vehicles, in which the wheel becomes a power module. At the same time, drive systems positioned close to the wheel are also being tested as part of research and advanced development projects. Two examples of projects are mentioned, which pursue different approaches with the drive positioned close to the wheel.

In the “FAIR” project [6] carried out jointly with BMW and the Deutschen Zentrum für Luft- und Raumfahrt (National Aeronautics and Space Research Center of the Federal Republic of Germany) a gear system was integrated into the wheel to reduce the speed of the electric motor mounted on the vehicle in front of the wheel and to decouple the vertical motion of the wheel from the drive (Figure 2).



**Figure 2** Cross-section through the drive positioned close to the wheel from the FAIR project



**Figure 3** Design of a wheel drive positioned close to the wheel with a transmission integrated into the wheel

As part of an advanced development project, a variant was tested at Schaeffler, in which the drive motor is supported using a split suspension spring and connected to a transmission via a short side shaft (Figure 3). This means the motor only moves in step with the spring motion of the wheel to a reduced extent.

The following sections of this article focus on wheel hub drives, which in our opinion are the most suitable drive arrangement for electric city vehicles.

## A new generation of wheel hub drive

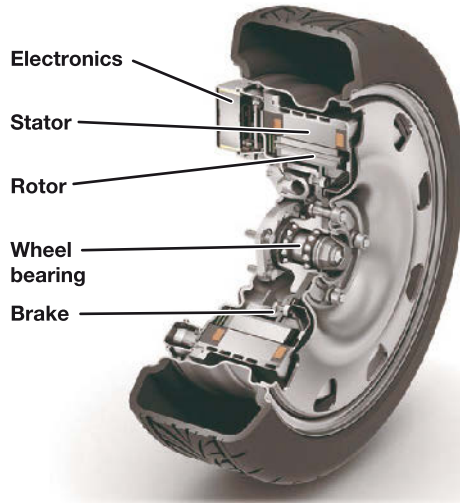
### Design and construction

In 2010, Schaeffler set itself the goal of designing a wheel with a highly-integrated drive, which incorporates the electric motor and power electronics in addition to the conventional wheel components such as

the service brake. For the first time there is no requirement for all the pulsed cables laid through the vehicle, which is also advantageous with regard to electromagnetic compatibility. This can also be managed with other arrangements of system components, but results in additional coordination requirements.

The high level of integration is, of course, a major challenge for development engineers: The total available design envelope is only 16 liters. The task of accommodating the complete drive in a wheel with a 16-inch diameter was solved by carrying out a large number of individual optimization measures (Figure 4). A width of approximately 200 mm gives a conventional tire dimension (195 or 205 tire). The tire corresponds to a volume-produced tire both with regard to the dimensions and the design. However, the steel rim is a special design, because the wheel disk is connected to the rim shoulder instead of the drop center as in a normal wheel (semi full face). Forged steel rims could be used in a later volume-produced design, which would combine an elegant design with a high load carrying capacity. The hole circle required for screw mounting and centering is compatible with current standard connections. The entire design has been selected to ensure that a tire change does not cause additional work.

The magnetic gap with a diameter of 278 mm and a width of 80 mm must be maintained within very close tolerances to ensure optimum function of the electric motor. The air gap has a difference in radius of 1 mm. Any tilting, which would allow the stator and rotor to rub against each other, must be prevented in order to avoid corroding surfaces. The wheel bearing is therefore of very rigid design. The rigidity is approximately twice as high as in a conventional wheel bearing. Locking of the wheel if contact occurs between the stator and rotor



**Figure 4** Design of Schaeffler's wheel hub drive

has been ruled out by carrying out in-house tests. Contrary to frequently expressed assumptions, rubbing does not cause unstable driving dynamics.

Wear does not occur because the dimensions of a rolling bearing do not change significantly during an operating period of 200,000 km. A wheel bearing is also volume production technology, which can be manufactured with current tools and machines.

The modified support plate of the standard drum brake is used to integrate the electric motor into the wheel. The water-cooled stator is supported by the brake anchorplate, which is extended and made thicker in the direction of the outer side of the wheel. The rotor is located on a flange with the brake drum. However, the brake is not omitted but is available as a redundancy level and parking brake. Previous operation of the prototype has shown that even during trips in the mountains (long descents with an 18 % gradient) braking can be carried out with the electric motor only.

The drive unit is sealed with a contact lip seal, which was derived from an industrial application. The seal integrity is in accordance with the standard for wheel bearings so that no moisture can enter even if there is exposure to a high-pressure cleaner. The precondition for this is a corresponding seal design so that it is even protected against high water pressure.

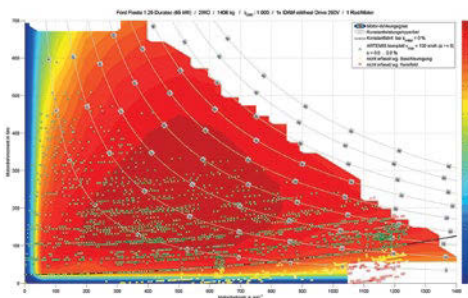
### Electric/electronic components

A permanently excited synchronous motor was integrated into the available design envelope, which produces 350 Nm of continuous torque even under unsuitable temperature conditions. The maximum achievable torque is 700 Nm per wheel, i.e. 1,400 Nm for the axle. The starting torque is even high enough to enable the tested prototype with four occupants to start on a 25 % gradient. The electric motor design was selected to ensure a uniform torque output up to high speeds. The total continuous torque is available up to a traveling speed of 100 km/h. The output of the electric motor is 33 kW (continuous) and 45 kW (peak), whereby this

value should not be overestimated and can be calculated from  $P = m \cdot w$  directly. The specified values apply for operation with a voltage of 360/420 V.

Prior experience with the prototype built in 2010 has shown that air cooling is not sufficient to produce the high continuous torque required. This is particularly true if typical automotive worst case scenarios are taken into consideration in the design – for example, a hill start with a low speed at a high outside temperature (40 °C). The decision to design a water-cooled unit was made at an early stage for this reason. Cooling is carried out with conventional coolant based on glycol. The coolant firstly flows through the power electronics and electric motor stator and then reverses and is returned in a counterflow process. The drive contains a low volume of coolant. The normal air/water heat exchanger, which is also fitted in the front end of vehicles with an internal combustion engine, is used as a heat exchanger.

The electronic components required for control are also fitted in the wheel. This applies for the high-voltage power electronics as well as the low-voltage motor control system. The arrangement of the



**Figure 5** Test stand run with the new drive (right); efficiency data map of the electric motor with operating points from the ARTEMIS cycle (left)

power electronics has been selected so that only a very small distance must be covered by pulsed cables to the electric motor.

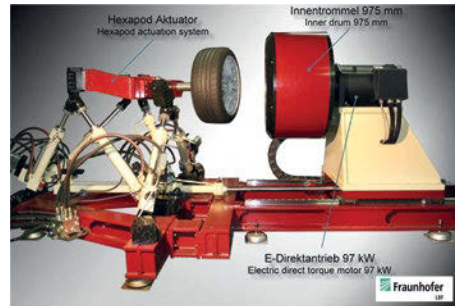
The drive is only controlled locally in the wheel to a limited extent. The torque requirement is passed from the general control unit, on which the driving strategy is stored, to the controller in the wheel, which is responsible for controlling and monitoring the electric motor. Requirements with regard to driving dynamics are placed by the vehicle's safety computer and also implemented in the wheel.

### Test stand runs

The drive was firstly put into operation on a test stand before it was integrated into the vehicle. The control system is initially adjusted to match the electric motor and power electronics. At the same time, characteristics such as efficiency, continuous and peak torque as well as the thermal behavior of the system are defined (Figure 5).

After initial operation, strength and rigidity tests were carried out on an internal drum test stand specially developed for this purpose at the Fraunhofer LBF in Darmstadt (Figure 6). The drive is mounted on a hexapod and placed on the internal surface of a rotating drum. The drum is provided with lateral thrust ribs, which can be used to apply lateral loads to the wheel similar to the contact with a curbstone or when cornering sharply. The aim of the tests was to check the lateral rigidity in order to ensure no rubbing occurs between the stator and rotor even under extreme lateral loads.

The tests have also shown that no rubbing occurs between the stator and the rotor even with increased air pressure and a load that causes destruction of the tire.



**Figure 6** Design of a test stand for testing the function of the wheel hub drive acting under mechanical forces

### Vehicle integration

A Schaeffler wheel hub drive at the current level of development was fitted in a Ford Fiesta used as a test vehicle in collaboration with the Ford Research Center Aachen (Figure 7). The high-voltage battery is integrated into what was previously the engine compartment. In addition to the fitting of high-voltage components, the adjustment between the engine and vehicle control system involved a significant outlay. In particular, the restbus simulation, i.e. the simulation of signals for omitted components such as the internal combustion engine by



**Figure 7** Mounting position of the wheel hub drive in a test vehicle

means of software is very challenging. In addition, essential chassis components such as the suspension and damping were adjusted to match the characteristics of the drive.

The system weight for the complete wheel hub drive is 53 kilograms per wheel. It must be taken into consideration that the total vehicle weight is not increased compared with an identical vehicle fitted with a diesel engine (1,290 kg empty). This includes a lithium-ion battery with a nominal capacity of 16.2 kWh. The axle load distribution is also the same as the volume-produced vehicle.

A variety of driving dynamics tests were carried out with the test vehicle at a testing site. The tests showed that the prototype was at least equal to a comparably driven volume-produced vehicle up to a speed of 130 km.

Figure 8 shows the results of driving dynamics analyses with the preceding prototype (Schaeffler Hybrid) because the front axle was included in the tests along with the assessment of the rear axle. The driven maneuvers are plotted on the x-axis, the assessment determined for the vehicle is plotted on the y-axis. Zero stands for “unsalable”, the top mark ten for the perfect vehicle. The original vehicle is in the range 6.5 to 9.

The criteria used refer, in particular, to vertical and lateral dynamics as well as the steering reactions. All assessments are within the range of results for the volume-produced vehicle. In this context, it must be emphasized that this driving behavior is only achievable with a spring damping system that is adjusted for higher masses. The modifications were carried out both in the Schaeffler Hybrid and in its successor

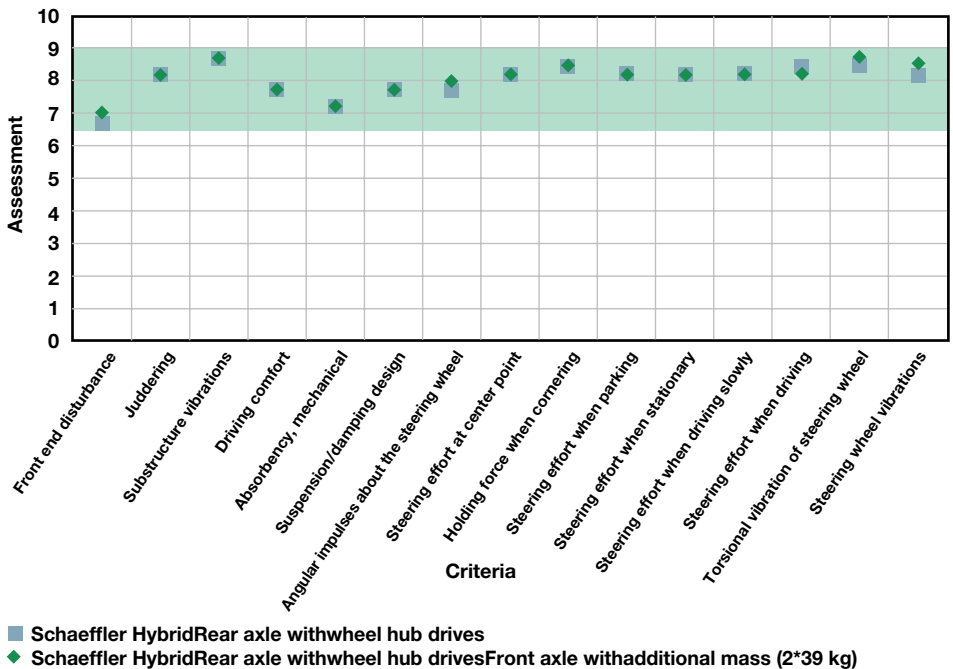


Figure 8 Results for a comparison of driving dynamics

vehicle, a Fiesta, using volume-produced components. The results are significant under the aspect that the drive system operates on a twist beam – an axle design which was not originally designed for this drive.

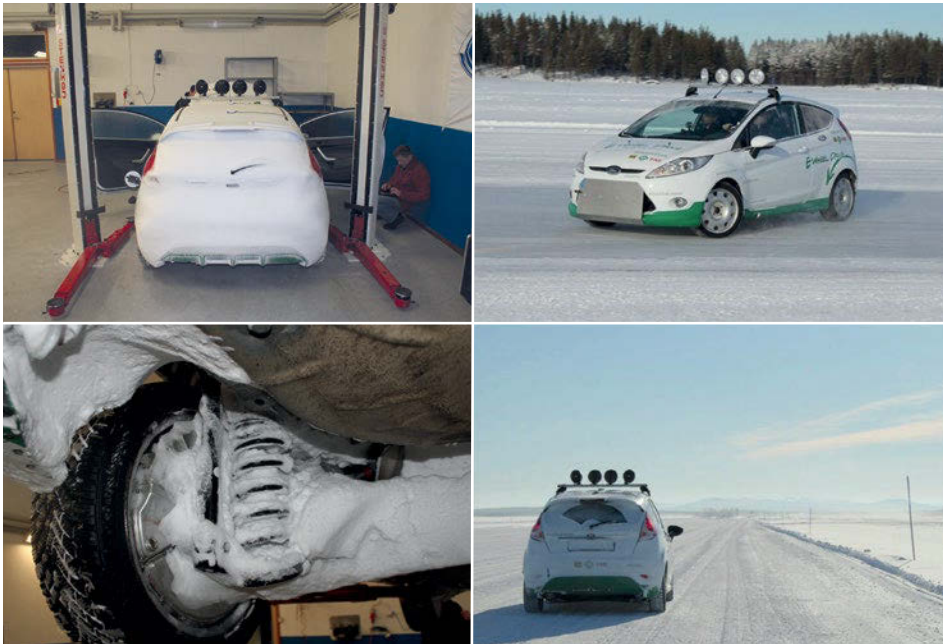
Significant increases in performance were noticeable during some maneuvers which use the potential of torque vectoring. For example, the speed was increased by 10 km/h during a standardized double lane-change maneuver test with the cones spaced at 18 meters.

After carrying out initial operation of the drives, a slip control system was applied as a basis for adjusting the torque vectoring and ESP functionalities. The high torque output of the drive system is actively used by a suitable control system for stabilizing the driving behavior.

Winter testing was also carried out in North Sweden during February and March



**Figure 9** Adjustment of chassis, driving dynamics control and torque vectoring



**Figure 10** Wheel hub drive during winter testing



2013 (Figure 10). The tests showed that the function of the drive is even ensured in wet and adhesive snow and at temperatures down to  $-33\text{ }^{\circ}\text{C}$ . The vehicle also benefits from the selected concept, which does not require a hydraulic system and transmission.

## Future developments

---

### Further development of electric/ electronic components

Development of the wheel hub drive is currently underway at Schaeffler. A modified electric motor from the industrial sector is used in the current prototype, which is primarily optimized to produce a high torque output. Schaeffler is developing an electric motor specially matched to the requirements of the wheel hub drive for the next development stage.

A continuous torque of 500 Nm per wheel is required for a vehicle with the total weight of the presented prototype (approximately 1.5 tons) in order to transmit sufficient drive force in all driving situations. A further increase in torque density is therefore the objective of Schaeffler's development. The next generation of the wheel hub drive will be designed to fit inside an 18-inch wheel, which is a conventional size for the vehicle class under consideration.

The efficiency of the motor must still be increased at the operating points relevant for the driving cycle. The acoustic properties for vehicle applications are also in need of improvement. Work will be carried out on these specific points for the next evolutionary stage.

The situation with regard to power electronics is similar. The electronics de-

veloped for the prototype in collaboration with the Fraunhofer Institute for Integrated Systems and Device Technology IISB have operated so far without failure. However, these electronics would not fulfill a typical specification used in automotive manufacturing.

Schaeffler is following a modular strategy for the further development of electric components for hybrid and electric drives, so that other drive variants such as the hybrid module or electric axle can be delivered with designs that are as similar as possible in order to rapidly achieve a significant unit cost degression with future volume production orders.

### The MEHREN research project

In the MEHREN research project (Multi-motor electric vehicle with highly efficient use of space and energy, and uncompromising driving safety), Schaeffler is already working on the next generation of wheel hub drives in conjunction with Ford and Continental as well as the RWTH Aachen University and the University of Applied Sciences in Regensburg [7]. The focus of this project is on the implementation of a new software architecture matched to the requirements of wheel hub drives. This should, in particular, allow optimized cooperation between the electric motor and service brake.

The importance of functional safety is also taken into account in a special sub-project.

The MEHREN project should also show for the first time what potential exists for new vehicle architectures if the wheel hub drive is used as a standard drive from the start of development. A virtual prototype of a purpose-built vehicle will be developed by 2015.

## Summary

---

The development work carried out by Schaeffler on the wheel hub drive since 2007 has proved that this drive can be successfully implemented in electric city vehicles. The torque density is in its second stage of development and almost at the required level. Schaeffler has disproved the counter-arguments frequently used in discussions about wheel hub drives, in particular, the negative influence of higher wheel mass on driving dynamics. Future development work will focus on further improving the electrical and electronic components as well as optimizing the control quality and functional safety. Ultimately, it will be important to actually design and test new vehicle concepts made possible by the newly available space.

## Literature

---

- [1] Gombert, B.: From the intelligent wheel bearing to the "robot wheel". 9<sup>th</sup> Schaeffler Symposium, 2010
- [2] Heim, R. et. al.: Potenzial von Radnabenantrieben für Straßenfahrzeuge. ATZ 114, 2012, No. 10, p. 752ff.
- [3] Reitz, D.: One Idea, Many Applications: Further development of the Schaeffler hybrid module. 10<sup>th</sup> Schaeffler Symposium, 2014
- [4] Kinigadner, A.; Kirchner, E.: Electric Driving without Range Anxiety: Schaeffler's range-extender transmission. 10<sup>th</sup> Schaeffler Symposium, 2014
- [5] Smetana, T.: Who's afraid of 48 V? Not the Mini Hybrid with Electric Axle! 10<sup>th</sup> Schaeffler Symposium, 2014
- [6] [http://www.dlr.de/dlr/presse/desktopdefault.aspx/tabid-10310/473\\_read-6724/year-all/#gallery/9297](http://www.dlr.de/dlr/presse/desktopdefault.aspx/tabid-10310/473_read-6724/year-all/#gallery/9297), 10-24-2013
- [7] Wielgos, S. et al.: Research Project MEHREN: Potentials of Highly Integrated Wheel Hub Units for New Vehicle Concepts. 22<sup>nd</sup> Aachen Colloquium Automobile and Engine Technology, 2013



# What Powertrains Could learn from Each Other

Thinking outside the box

Dr. Wolfgang Reik

# 31



## Introduction

---

The discussion concerning electrification of vehicle powertrains has caused an abrupt rise in the number of potential drive concepts. In the past, the question revolved around whether a diesel or petrol engine, an automatic or manual transmission was the right choice; today's offerings include a huge variety of new architectures, with an electric motor added to the combustion engine or used as a single drive.

Most of the concepts are supported by the tangible benefits of the respective model. Certain arrangements and combinations seem to be beneficial depending on the weight given to advantages and disadvantages. This places significant additional burden on automotive manufacturers and developers as a mainstream has yet to emerge.

This article cannot and will not clarify this issue. Rather, its aim is to solidify interesting individual aspects of the various powertrain concepts on offer and to consider how a property of this kind can be transferred to a completely different drive. Viewed in this light, this approach has much in common with genetic engineering, which is based on removing individual genes from a living being and then inserting them into another. The procedure is based on the understanding that all species ultimately have genomes with similar structures. Similarities can also be seen in technical products, even if they are based on different technologies. When we get down to the basics, we realise that all products are based on a few physical principles.

The laws of conservation for energy, momentum and charge lead to a far-reaching analogy between mechanics and electrics. This analogy is presented

in the first section and then the analogy principle is expanded. The aim is to transfer certain objectives, thought processes or procedures to other technologies. What new findings, perspectives and ideas may we discover? These are presented in the following using examples.

## Mechanics and electrics – are they really two different worlds?

---

Literature on physics or the engineering sciences contains a great many analogy analyses between mechanics, electrics, acoustics and hydraulics. In this article, we are restricting ourselves to electric and mechanical correlations and are using the physical laws of conservation as the basis. We will then draw up parallels between the disciplines. In addition to the key laws of conservation, we will be using the first law of thermodynamics along with the law of conservation of momentum in mechanics and charge in electrics.

Based on these two physical variables, the total of which always remain constant (an experiment you may also want to conduct), it is feasible to view momentum and charge as analogous to one another. It follows directly that their time derivatives also correspond: Force ( $F = \frac{dI}{dt}$ ) and current ( $I = \frac{dQ}{dt}$ ). By gradually expanding this analysis, it is also possible to establish analogies for other mechanical and electrical variables [1] (Table 1).

From this, it follows that accelerating a mass corresponds to charging a capacitor (Figure 1).

Mechanics	Electrics
Energy	Energy
Power P	Power P
Impuls I	Charge Q
Force $F = \frac{dl}{dt}$	Current $I = \frac{dQ}{dt}$
Speed v	Electrical Potential U
Mass m	Capacitor C
Spring	Solenoid
Reciprocal spring constant $\frac{1}{D}$	Inductivity L
Damper	Resistor
Mechanical resistor	Electrical resistor
Viscosity	Electrical conductivity

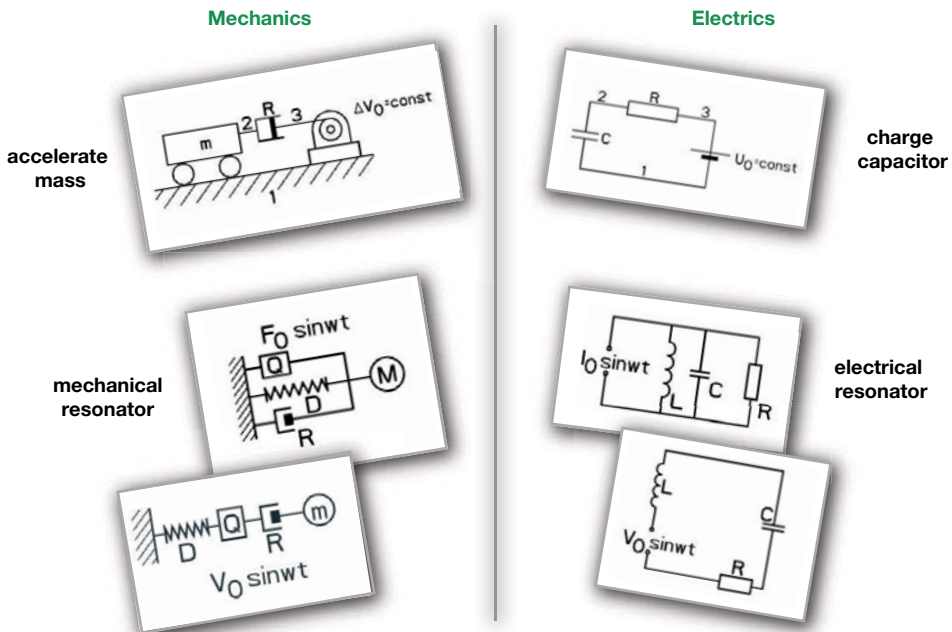
**Table 1** One of the possible analogies between mechanical and electrical variables. This example uses an accurate circuit analogy based on the laws of conservation of momentum and charge

If we look at electrical oscillating circuits, the same analogous mechanical transducers can be obtained by replacing the capacitors with mass, coils with springs and electrical with mechanical resistance.

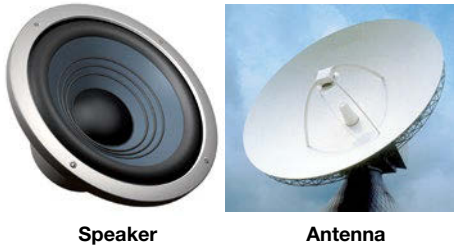
If this approach is taken, these analogous systems can then be described using analogous equations.

Unfortunately, mechanical and electrical engineering were developed at different times and by different scientists, which is why individual variables have different names. This makes it difficult to spot analogies in the equations at first glance.

Of course, the exact analogy also has its limits, namely when certain physical conditions differ from each other. On account of this naming convention, correlations for the acoustic and optical Doppler effect are not exactly the same; this is be-



**Figure 1** Analogy of mechanical and electrical oscillating circuit



**Figure 2** A comparison can be drawn between a speaker and an antenna. Both emit output in the form of waves

cause acoustic waves are bound to the media, while electromagnetic waves are not. The laws of relativity apply to the latter with a speed of light that is the same for all observers, regardless of their speed. This restriction does not apply to a “mechanical” sound wave observer.

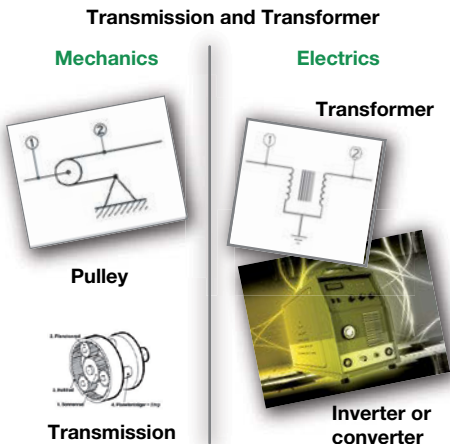
Figures 2 and 3 show further examples of analogies. Speakers and antennas cor-

respond directly. Transformers find an analogy in a pulley or gearbox.

A transformer converts electrical energy within the energy form so that the product comprising voltage and electrical current remains constant. For a pulley, force and travel are analogous, whilst for a transmission the variables are torque and rotation angle.

On the electrical side, the group of transformers also includes converters, inverters and power converters in general terms. Strictly speaking, these devices perform the same task as a transformer. They convert voltage and current into a different voltage, while taking the law of conservation of energy into account.

This last example in particular shows that an analogy can also be understood in a wider sense when the components cannot be accurately described using the same physical, basic equations. The crucial aspect for this kind of extended analogy is to use the same or at least a similar physical fundamental idea. The following example does just that.

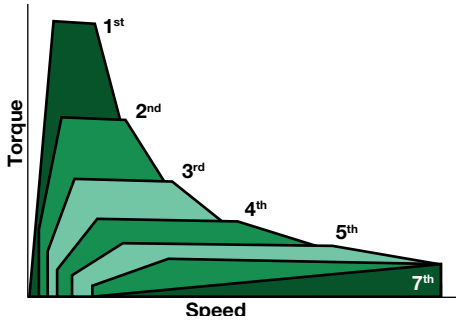


**Figure 3** A direct comparison can be drawn between the transformer and a pulley or a gearbox when rotation is involved. This group of transformers also includes converters, inverters and power converters.

## Electric gearbox or mechanical transformer?

An initial comparison of combustion engines and electric drives shows that, in addition to a clutch, the combustion engine needs a shiftable gearbox with a lot of gears as a start-up device, while the electric motor can cope without any of these elements.

The combustion engine therefore requires multi-gear gearboxes with the largest possible spread angle, as an optimum combustion process is only possible within certain operating ranges. In order to get as close to this optimum point at any driv-



**Figure 4** The motor characteristics are compiled into an overall characteristic curve comprising the different gear stages. This overall characteristic curve has a similar shape to that of an electric motor.

ing speed and load, the number of mechanical gears used has seen a steady increase over recent decades. Individual engine characteristic curves make up an overall characteristic curve (as shown in Figure 4), which is already familiar from electric motors.

Why does the electric motor apparently not need a gearbox to create a characteristic curve? Quite simply because the gearbox is concealed in a completely different place under a false name.

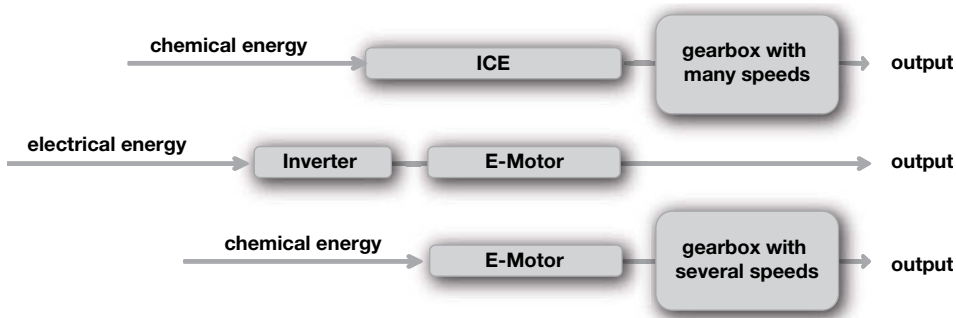
Figure 5 shows a diagram of the powertrain with a combustion engine. Chemical

energy is fed in and converted into mechanical energy in the engine. As it is preferable for this process to take place at a certain operating point, a downstream gearbox converts speed and torque as is currently required by the drive (whilst following the law of conservation of energy).

The functional chain for electric motors is slightly different. Supplied electric energy is converted in an electronic power unit (sometimes also called electric energy converter, frequency converter or inverter) so that the electric motor can provide the torque and engine speed required for output. The difference between combustion engine and electric motor drives is therefore that one has an electric “gearbox” before the actual motor and the other has a “mechanical” transformer after the actual engine.

This is especially clear when we consider electric recuperation. The electric motor acts as a generator to produce a voltage proportional to the speed. This must then be transformed into battery voltage via the electronic power unit.

Incidentally, this was not always the case. Before the advent of modern electronic power units, electric motors were designed with even narrower operating ranges, as is the case with combustion engines. Therefore, all kinds of variable gearboxes were available back then.



**Figure 5** Functional chain for combustion engine powertrains and electromotive powertrains

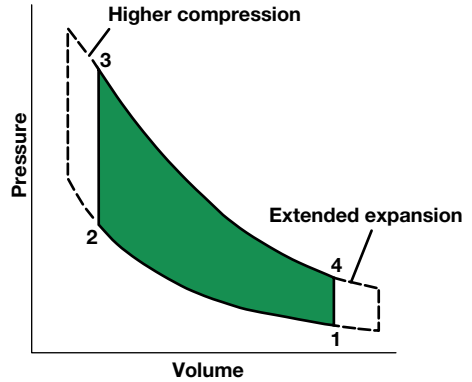


These included continuously variable gearboxes with which the fixed speed of an electric motor could be adapted to meet the power output requirements (bottom image). Think of it like this: The converter only moved upstream from the actual power generator at a very late stage in the development of the electric motor.

Could the combustion engine also make a similar development? In theory, yes, if the chemical energy was already converted. One possibility would be to change the chemical composition, according to the current power requirement. For example, the oxygen content could be increased up to the point of combustion with pure oxygen, even if this suggestion appears somewhat impractical. To do this, it would probably also be necessary to modify the fuel. For high power requirements, fuel with a higher energy content could be injected. Of course, all components would then need to be designed to cope with much higher combustion pressures. But this is precisely the way in which the electric motor changed when the converter moved upstream from the engine. Each and every component had to bear increased torques and forces.

## Can an electric motor produce a Miller cycle?

In combustion engines, the aim is to utilise chemical energy to optimum effect by increasing the work area, i.e. the stroke. Figure 6 shows the Otto cycle. It is immediately apparent how much additional energy could be obtained if expansion were to be extended. The same applies to a higher compression ratio. In both cases,



**Figure 6** The Otto cycle. Yield can be increased by extended compression and expansion

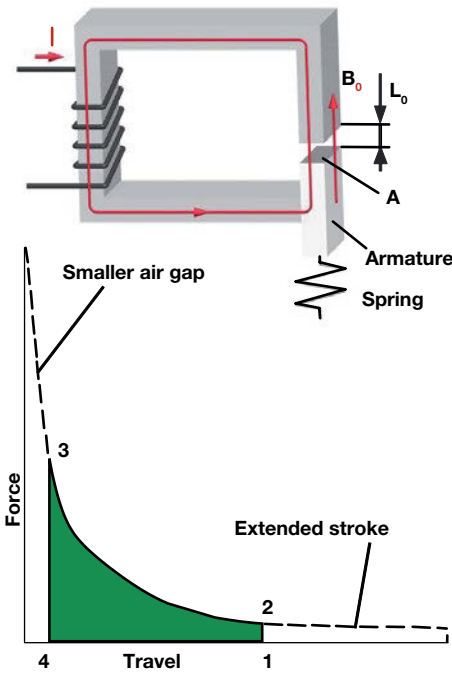
the area between the curves, representing the usable work area, is considerably increased. Deliberations of this kind concerning combustion engines are associated with the well-known names of Atkinson and Miller.

How can this idea be transferred to the electric motor? Could the electric motor also produce a Miller cycle? Is there something similar to a higher “compression ratio” or an extended “stroke”?

Figure 7 shows the basic principle of electromagnetic attraction, which ultimately describes how all electric motors work.

A magnetic field is generated by a current; this field attracts the armature. During this attraction, the force increases as the interval or air gap becomes smaller. Halving the air gap results in a force four times as large. The mechanical energy generated is equivalent to the area between this force characteristic and the reference line. This diagram is not associated with a famous name such as the Otto cycle, but it is a direct analogy.

Based on this finding, the aim is to keep the air gap in electric motors as small as possible; however, there are limits in terms of design. This is also the case



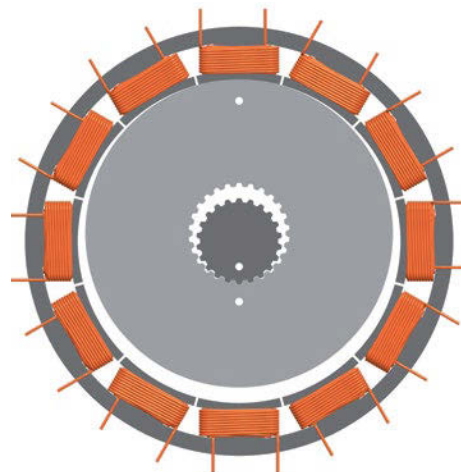
**Figure 7** The attractive force of an armature in a magnetic circuit

for the “extended” stroke, which would require a larger distance between the poles to implement increased attraction travel. Is there a way of breaking through these limits?

One approach may be the roller motor. Figure 8 shows the basic structure. A rotor made from magnetic material rolls around within a stator. The air gap can thus be reduced to zero [2]. The extended stroke is generated from the difference in diameter between the rotor and the stator, and this determines the maximum air gap.

Enhanced utilization solely of the magnetic attraction characteristic is not sufficient. It must also be ensured that the characteristic curve is traversed as often as possible; this requirement is not yet ful-

filled. This is because each stator electromagnet would only create one attractive force per complete rotation. On a standard electric motor, this happens multiple times according to the number of pairs of rotor poles. The rotor needs to roll correspondingly faster in order to mitigate this disadvantage. This should not cause any major difficulties, as the rotor only experiences a very small amount of rotation as it rolls. This rotation is taken off the central shaft with a further high gear reduction ratio. All in all, these actions create a motor that delivers high torque at low power-take off speed. Initial interpretations show that, in theory, this concept allows a higher weight to power ratio to be achieved than a permanently excited synchronous motor. This may be an ideal concept for wheel hub motors. However, until we reach that point, many details still need to be resolved, such as durable materials for the guide rails and unbalance compensation. And we may find that this process is also given a similarly pleasing name such as Carnot, Miller or Atkinson.



**Figure 8** The roller motor. An eccentric rotor rolls around the internal diameter of the stator

## Irregularity — an inevitable fate of combustion engines?

---

The irregularity of the crankshaft speed seems inextricably linked to the combustion engine principle. For this reason, downstream measures to reduce this irregularity are needed for each combustion engine to prevent gear rattles, humming noises or even rigidity problems. Many of these options were presented at the Symposium.

The phrase “Runs like an electric motor” is often used in technical jargon to describe a measure that is particularly effective. Why does a combustion engine have irregularities and an electric motor does not? What are the differences and what principles are responsible for these?

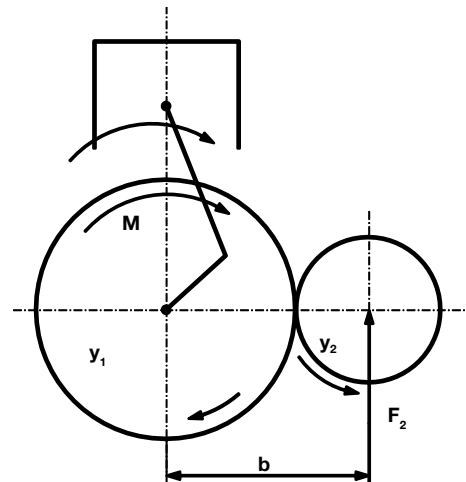
First off, we once again return to the number of cylinders, or better put: The number of power deliveries per revolution. In case of four-cylinder engines, there are only two of these power deliveries, which are called ignition in combustion engines. There is an extended pause between each of these ignitions. So it is no wonder that a crankshaft cannot rotate evenly if a short but sharp torque shock occurs only twice per revolution. This is not the case with the electric motor, in which each stator coil is responsible for power delivery. Looked at this way, an electric motor actually has many cylinders, while the combustion engine has a reduced number of cylinders for well-known reasons. So it is only natural that we see differences when we compare a three-cylinder combustion engine with a “twelve-cylinder” electric motor. However, the irregularity of the combustion engine is also so great because compression takes place prior to

every ignition and slows down the crankshaft. This may sound like a disadvantage at first, but it is immensely important for subsequent ignition. The principle that can be derived from this is: Sacrifice first so that a particularly high yield can be achieved during the next cycle.

This principle is to be found in many areas. As man progressed from hunter and gatherer to farmer, he realised precisely this principle. The best crop was taken from the harvest to be subsequently used as seed.

Taking something of value out of circulation and using it profitably to bring in a particularly large harvest at the end of the process always indicates a progressive level of development. The combustion engine has already scaled these heights, but this principle is not used in the electric motor.

In electric motors, the permanent magnets or mechanical resistance poles could be briefly attracted inwards by applying energy to then have a particularly long working



**Figure 9** Preventing roll moments by means of a secondary shaft designed to absorb the opposing angular momentum of the crankshaft

stroke during magnetic attraction. This would also recuperate many times more energy than the previous energy consumption. A theoretical example for which constructive ideas have yet to be developed. In any case, the electric motor could learn from the combustion engine when it comes to this principle.

Let's look at irregularity again: It appears to be inextricably linked to the combustion engine. We should not just consider the crankshaft in this regard, but also the engine block, which must also absorb the reactive forces according to the law of physics "every action has an equal and opposite reaction". The question we are faced with is whether there is a standard way of combating this irregularity?

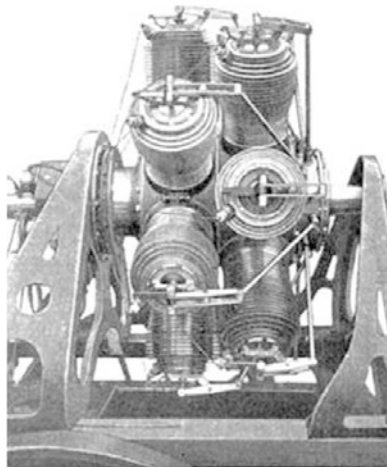
For the engine block at least, the bibliography [3] contains the description of a procedure for eliminating retroactive effects by means of alternating roll moment. It suggests providing an additional shaft driven by a set of spur gears which is not unbalanced in contrast to standard balancer shafts (Figure 9).

By using this arrangement, it is possible to completely eliminate all roll moments regardless of frequency or order, if the following condition is met:

$$J_{\text{crankshaft}} = i \cdot J_{\text{secondary shaft}}$$

The derivation is very simple if we start from the law of conservation of angular momentum. Subsequently, the total of all torques before and after ignition must be the same. This kind of ignition accelerates the crankshaft; it therefore receives additional angular momentum. For this reason, the engine block must absorb the opposing angular momentum to ensure that the law of conservation of angular momentum is fulfilled.

The balancer shaft shown in Figure 10 rotates in the opposite direction and generates momentum with opposite signs. The



**Figure 10** 14-cylinder double star rotary engine, Gnome design from 1916 [4]

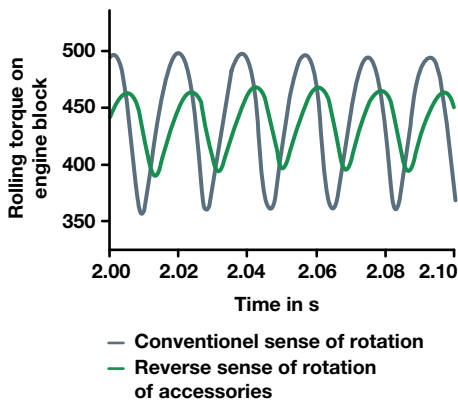
angular momentum of the crankshaft and balancer shaft caused by ignition can be cancelled by selecting an appropriate transmission ratio and mass moment of inertia. This leads us to a somewhat surprising finding, which is that no angular momentum remains for the engine block. The engine block is therefore not affected, at least as far as roll moment is concerned. This applies to all orders.

According to the principle "every action has an equal and opposite reaction", it is also possible to operate the engine the other way around: The crankshaft is fixed and the engine block rotates. This kind of rotary motor was the predominant engine design used for aeroplanes until the end of the First World War. If this type of engine were also to be fitted with the balancer shaft described above, the entire irregularity could be eliminated at the power take-off, completely irrespective of the excitation frequency or order. Presumably, the pressure of irregularity will not become so great that a rotary engine would seriously be considered. It is nevertheless an interesting idea; in principle, it

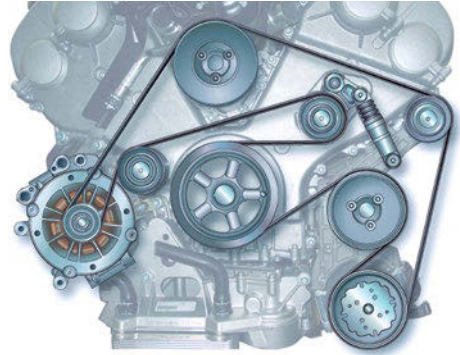
would be possible to completely eliminate irregularity at the power take-off, but at the price of extremely high mass moment of inertia.

A quite different conclusion can be drawn from these analyses. If an inversely rotating mass reduces the engine block's rolling oscillations, then these are actually enhanced by the auxiliary rotating equipment rotating in the same direction. This is indeed the case if crankshaft irregularity transfers to the auxiliary equipment, i.e. if no isolation is provided by a vibration-isolating belt pulley or an alternator freewheel pulley. Reversing the auxiliary equipment direction of rotation would cause a tangible reduction in roll moment (Figure 11).

Just changing the direction of rotation alone would approximately halve the roll moment. Looking at an auxiliary drive (Figure 12) shows that only the virtually massless deflection rollers in today's drives have this reverse direction of rotation. If more powerful alternators designed to perform starting and certain hybrid functions, are used in the future, it could be possible to fully compensate the roll moment thanks to



**Figure 11** Effect of reversing the auxiliary equipment direction of rotation on an engine block's roll moment



**Figure 12** In the case of a conventional front end accessory drive, all units have the same direction of rotation as the crankshaft

the associated higher mass moment of inertia. For this to happen, solutions for reversing the direction of rotation would need to be found.

## The centrifugal pendulum-type absorber – a quite different prospect

Progress made in the field of centrifugal pendulum-type absorbers has essentially been achieved thanks to modern simulation methods. These simulation possibilities were not around when the first work was conducted in this area about 80 years ago. Therefore, the aim was to develop analytical solutions for less complex systems, and these studies led to surprising results at the time. Depending on the precise order it is aligned to, the centrifugal pendulum-type absorber is, in fact, an effective secondary spring mass that is the result of the equation

$$J_{\text{secondary}} = \frac{m \alpha_p^2 (L+l)}{(\alpha_p^2 - \alpha_e^2)} \quad [5].$$

Here,  $m$  is the mass of the pendulum,  $L$  the radius of the suspended pendulum,  $l$  the effective pendulum length,  $q_p$  the aligned pendulum order and  $q_e$  the excitation order.

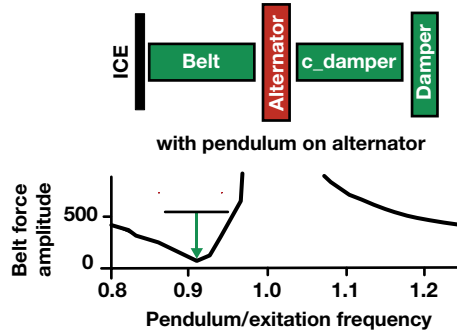
The equation proves that this effective secondary spring mass can take surprising values. If  $q_p = q_e$ , an infinite secondary spring mass moment of inertia is generated for this order under the condition that the vibration angles are not limited, which is obviously not the case in practice. This is aimed for in normal designs. Therefore, the order can be entirely cancelled at the point at which the centrifugal pendulum-type absorber is attached. The pendulum really does act like an infinitely large mass.

If  $q_p$  is greater than  $q_e$ , smaller values are produced for the secondary moment of inertia.

It is interesting and at first difficult to imagine a case in which the calibration order  $q_p$  is slightly smaller than the excitation order  $q_e$ . This produces negative secondary moments of inertia. If the calibration is selected so that  $J_{\text{secondary}}$  equates directly to the negative value of the mass to which the pendulum is attached, the total mass of the order in question disappears completely. So, the mass moment of inertia for the order in question can be eliminated completely using the oscillation equation for a simple transducer.

This is a surprising result. A relevant variable can simply be eliminated from a fundamental physical relationship. Two issues are raised: Firstly, are effects of this kind that can make crucial variables disappear from fundamental equations also present in other areas of mechanics or electrics? Even if no answer has yet been found to this question, it is suspected that these types of cases could exist.

The second question is whether this effect can be used in practical terms. A negatively calibrated centrifugal pendulum-type absorber could be positioned on



**Figure 13** For the second order, the mass moment of inertia of the generator is eliminated by a centrifugal pendulum-type absorber with a slightly negative alignment

the alternator in the belt drive, and the alternator mass moment of inertia could be completely eliminated for the second order. The belt drive would then see no alternating forces at all for the second order, just as if the alternator mass moment of inertia had disappeared. This is not just theory; the simulations in Figure 13 demonstrate this disappearing mass moment of inertia.

In this case, the state could actually be achieved by appropriate calibration, with the alternator oscillating precisely in the same second order as the crankshaft, but with extremely small belt forces.

## The range trick

Combustion engines today are clearly ahead of the pack when it comes to range. At present, batteries cannot even begin to store the energy as we are used to with fuels. However, this advantage can be considered from a somewhat different perspective.

Figure 14 shows the reaction equation of hydrocarbon with atmospheric oxygen and the associated weight ratios of the reactants. Burning 50 kg of petrol in the engine requires the oxygen contained in approximately three quarters of a tonne of air. This produces 155 kg CO<sub>2</sub> (i.e. around three times as much as the fuel weighs) and a relatively small amount of water.

The fuel's supposedly high energy density is therefore due to the fact that the heavier reactant is simply obtained from the ambient air. A moon vehicle would need to carry approx. 160 kg pure oxygen for the 50 kg petrol to provide the necessary volume of reactants.

**Could the environment also be a factor for batteries?**

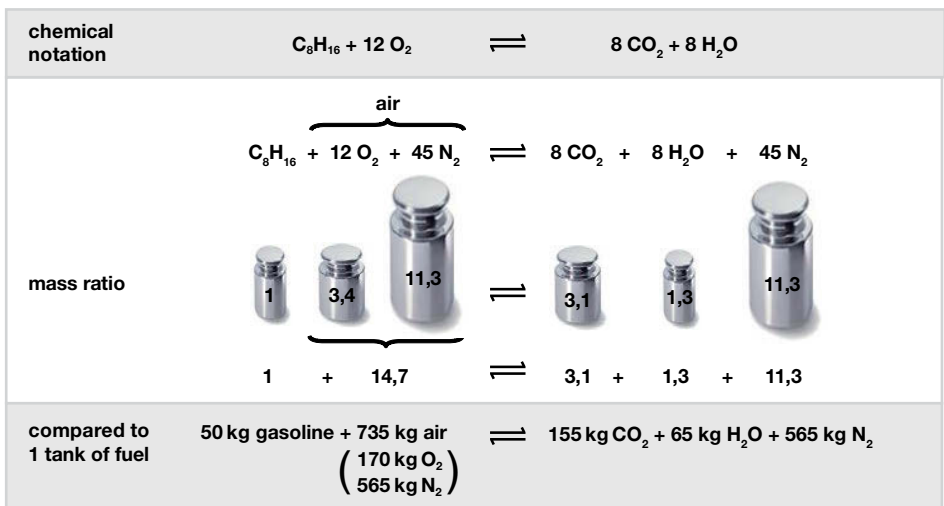
The answer is clearly: Yes. Zinc-air batteries, such as those used for hearing aids, have already proven this is the case. Although they are (not yet) rechargeable, they take the oxygen needed for the electrochemical reaction or oxidation from the air.

Zinc-air batteries thus have the highest energy densities of any battery available today.

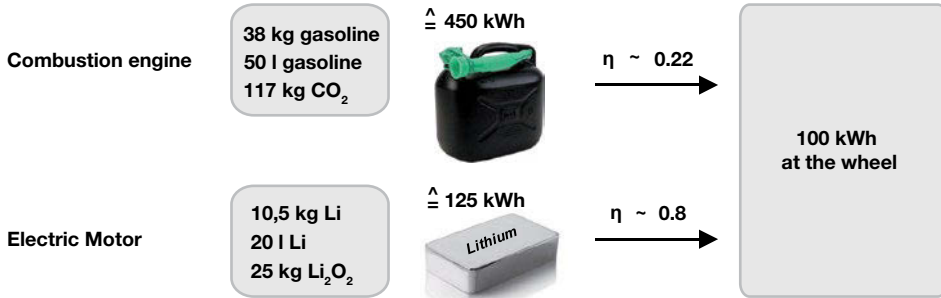
Intensive work is underway on lithium-air batteries, which promise the highest energy densities. Lithium is oxidised to lithium peroxide Li<sub>2</sub>O<sub>2</sub> in these batteries. During this process, each lithium atom gives off an electron at a voltage of approx. 3 V. The resulting energy content needed for a distance of 1,000 km is shown in Figure 15.

The example considers a vehicle that consumes 5 l petrol over 100 km. 50 l petrol are then needed to travel 1,000 km. This corresponds to approximately 38 kg petrol with a fuel value of 450 kWh. At an efficiency of 22 %, approx. 100 kWh are then applied to the wheel as mechanical work, which is exactly what is required to travel 1,000 km.

Assuming that an electric vehicle needs just as much power for the drive, we can calculate the required energy that must be stored in the battery. We estimate an efficiency of 80 % for the electric motor and battery discharge. Values of this magnitude seem to be achievable. In this case, 125 kWh energy would be necessary and would



**Figure 14** Reaction equation for combustion of a typical hydrocarbon, such as is contained in fuels



**Figure 15** Energy consumption for 1,000 km

need to be stored in the battery. To obtain this electrical energy, we would only need to oxidise approx. 10.5 kg lithium to Li<sub>2</sub>O<sub>2</sub> (lithium peroxide). This small amount is surprising at first, but can be verified by another method. If each lithium atom gives off an electron with a voltage of approx. 3 V, the calculation results in the same small amount of required lithium, which then reacts to 25 kg Li<sub>2</sub>O<sub>2</sub>. Quite manageable quantities and weights.

This is from the view of pure theoretical chemistry and physics, which shows us that batteries with extremely high ranges may be possible in the future, as long as the charge process can work in reverse. The big issue is the amount of infrastructure needed to implement a functional battery. This includes housing, cooling, power supply lines, monitoring and electrodes, to name just a few. However, it should not be forgotten that even combustion engines need additional components, such as tanks, fuel pumps, catalytic converters, etc.

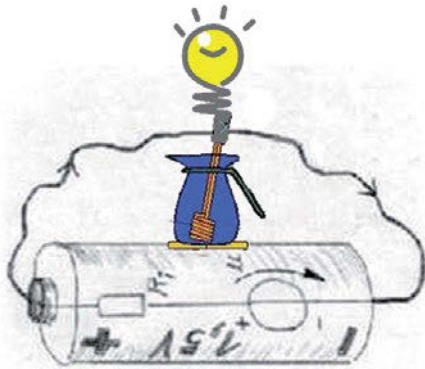
Of course, these considerations do not prove that high-performance and affordable batteries will be available within the next few decades. On the other hand, experience gained from the history of technology and physics show that virtually everything not explicitly ruled out by natural laws, has been achieved with reasonable levels of effort and expense.

## Oxidation or electric mobility from a different perspective

What actually happens during combustion or oxidation? Put simple, it can be described as we were taught in chemistry lessons. The oxygen prizes electrons from the hydrogen and carbon, and through this process becomes a negatively charged particle. This transition of electrons releases the same energy that is normally referred to as heat value or energy content for combustibles and fuels. This means a current is flowing, even if only at an atomic level. In this sense, combustion is already an electrochemical process, meaning we are closer to electric mobility than many think. However, the flow of electrons is not used directly as electric current. Only cold combustion fuel cells make use of this knowledge.

In combustion engines, the energy released by the flow of electrons is converted into heat, which expands the combustion gases and performs work. This is similar to a battery whose electrical energy is initially converted into heat by an immersion heater (Figure 16) in order to subsequently op-





**Figure 16** Electric power causes gas to expand which can then perform work

erate a steam engine using the steam. It is precisely this intermediate step of heating that results in the poor efficiency of combustion engines.

## Summary

In this article, we have considered and analysed a series of analogies. As has been demonstrated, these analogies result in a varied mixture of interesting, unexpected, partially useful and sometimes curious findings. However, thinking in analogies always inspires engineers and thus potentially triggers thought processes that bring about completely new and creative concepts.

The article has only presented a small selection of possible analyses of analogies. There is a whole set of further questions that could be posed. Such as:

Is there an electrical equivalent to the turbocharger that recovers at least a part of the lost energy?

What is analogous to the catalytic converter or to exhaust gas recirculation? Can

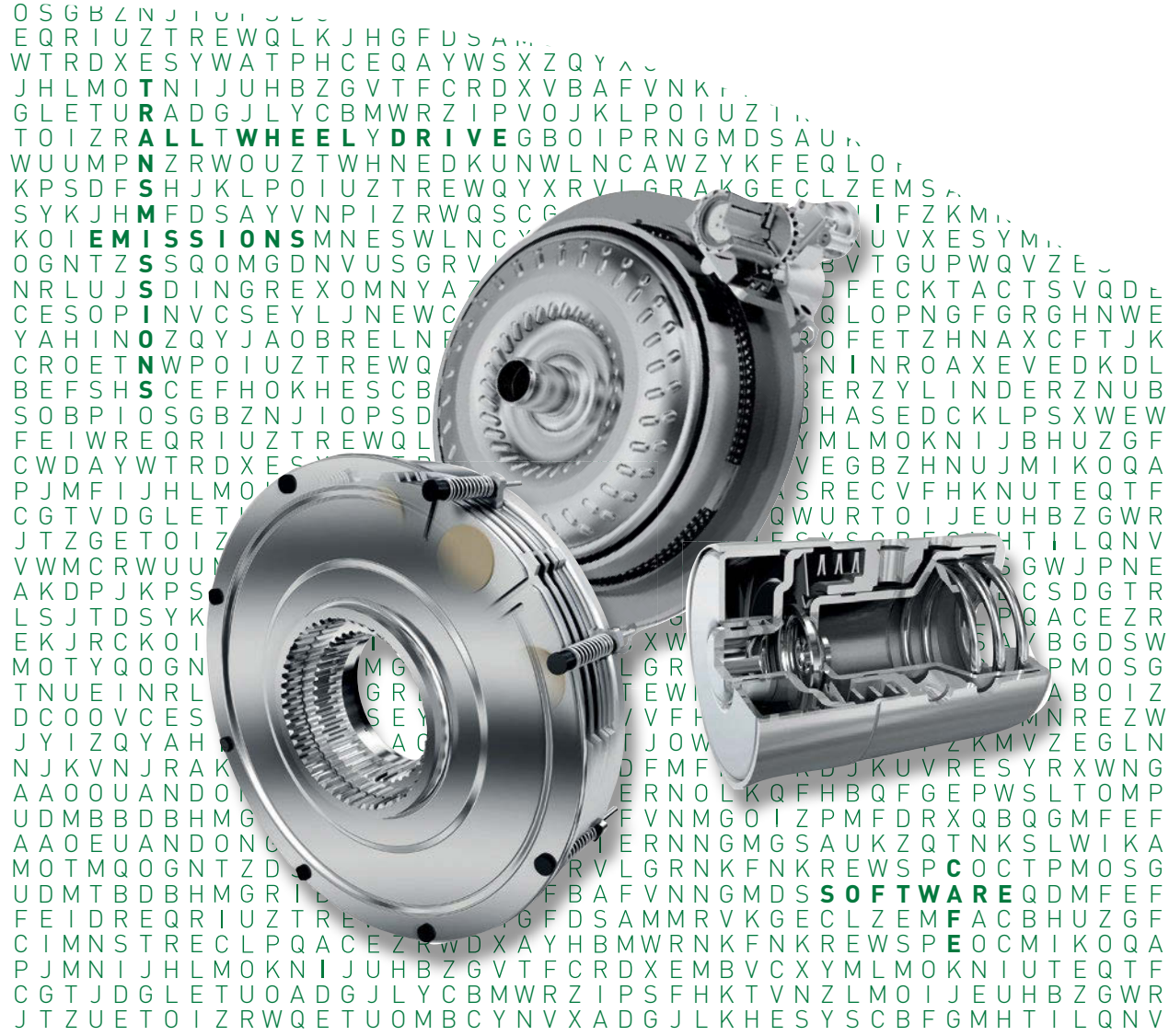
electric motors also feature cylinder deactivation?

In modern electric motors, a magnetic reluctance ratio is used in addition to the permanent magnets. The reluctance ratio is based on completely different physical principles. Is there an analogy for this in other engines?

This is only a small selection of other potential questions. Some issues could not be covered within the confines of this article, while for others no analogy at all was determined. It may be that no analogy exists in certain cases. But searching for these parallels always produces food for thought and provides the opportunity to devise new solutions.

## Literature

- [1] Herrmann, F.: Scripts for Experimental Physics. Department for Physics Didactics, University of Karlsruhe, 1997
- [2] Olson, H. F.: Dynamical Analogies, N. J. van Nostrand, Princeton 1958
- [3] Pischinger, M. et al.: V2-Range extender module with FEVcom – a barely noticeable companion in your electric vehicle. 20<sup>th</sup> Aachen Symposium on vehicle and engine technology 2011, pp. 871 f
- [4] Zima, S.: Unusual engines. Würzburg: Vogel, pp. 141 ff
- [5] Wilson, W. Ker: Practical solution of torsional vibration problems



# North American Fuel-Efficient Mobility

## US CAFE Demonstrator

Jeff Hemphill  
Philip George  
Spencer Hockeborn  
Philip Severyn

# 32



## Introduction

---

Global fuel economy standards are driving a push for energy-saving technology. At the same time, the consumer cannot afford large price increases for the vehicle. Therefore, high value technology is needed, especially in markets such as North America, where fuel prices are low. For example, a consumer who trades in a car meeting the 2020 CAFE (Corporate Average Fuel Economy) standard for a car which meets the 2025 standard, will only save \$80 per year in fuel costs. The technology required to make that jump currently costs several thousand dollars, which means the consumer cannot recover his investment. Friction reduction offers a relatively high value in fuel saving but often raises the question: what is the

best combination of friction reduction technologies?

Against this background, Schaeffler set out to build a demonstration vehicle which would:

- Demonstrate by measurement an effective combination of friction reduction technologies
- Provide a platform to experience new technologies developed for the North American market
- Improve and verify Schaeffler system simulation and calibration tools
- Provide 5 years of progress against the US CAFE standard at < \$ 40/% fuel saved

This vehicle is based on the Ford Escape AWD, model year 2013, which utilizes a 2.0-liter engine and 6 speed 6F35 automatic transmission.



**Figure 1** 2013 NA CAFE Demonstrator Car



**Figure 2** PTU Disconnect

## Hardware selection

The technologies used in the demonstrator vehicle were developed primarily in North America, with a few components supplied from Germany. A new TC (torque converter) damper was used which permits a lower lockup speed, or lower lugging limits. Clutch slip is often required to achieve an acceptable NVH subjective rating, however with a lower spring rate damper, it was possible to completely eliminate slip, further improving fuel economy and maintaining the overall capacity. The friction reduction components include coated camshaft tappets, a new balance shaft module with low friction bearings, and low rolling resistance tires.

An AWD (all wheel drive) disconnect system was introduced as an additional friction reduction enabler. The system allows the driver to select between AWD or FWD at the flip of a switch. The AWD disconnect brings the PTU (power transfer

unit) and RDU hypoid gear meshes and the prop-shaft to rest. This functionality is achieved via a synchronizing clutch placed in the PTU, and a rear axle disconnect between the RDU and driver side rear wheel. The PTU clutch system is comprised of a stacked series of Schaeffler wedge clutch plates. The clutch operates in two modes; synchronizing and lockup. During synchronization, friction material affixed to the plates' surfaces is compressed with a hydraulic piston. Once synchronized, a cam mechanism switches the clutch to lockup mode whereby the clutch plates become self-energizing to carry full driveline torque. The PTU clutch is shown in Figure 2.

Stop-start technology reduces the total time the vehicle spends idling, thus lowering unnecessary fuel consumption. Hardware designed to achieve a comfortable stop-start event includes a wrap spring permanently engaged starter (PES) and a latching valve designed to hold pressure in the transmission forward clutch during engine shutoff. These components are shown in Figure 3.



**Figure 3** Wrap spring PES and latching valve

Engine coolant temperature is controlled by a Schaeffler thermal management module, and serves to heat the engine up more rapidly. It is designed to precisely control engine coolant flow through the engine block, achieving active control of temperature. The module replaces the traditional wax element thermostat at the coolant inlet. The thermal management module is shown in Figure 4.



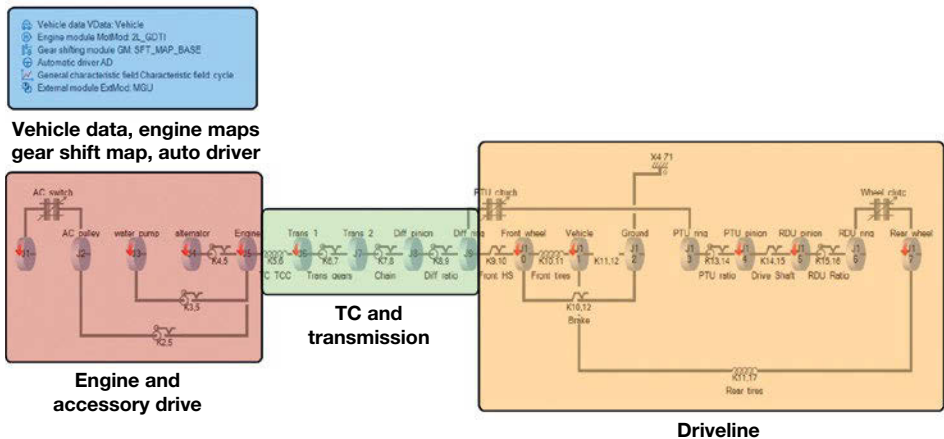
**Figure 4** Thermal management module

## Simulations

### Vehicle modeling

Vehicle system level models were created to simulate the fuel economy driving cycles in DyFaSim. Figure 5 is a graphical repre-

sentation of the entire vehicle. The baseline vehicle and NA CAFE demonstrator vehicle were constructed using data supplied by the customer, benchmark data, component level test data and measurements. Sub-systems containing Schaeffler technology were modeled in greater fidelity to accurately capture fuel savings. The goal for phase 1 was CAFE year 2020 requirements; phase 2 is CAFE year 2025.



**Figure 5** Vehicle system level model

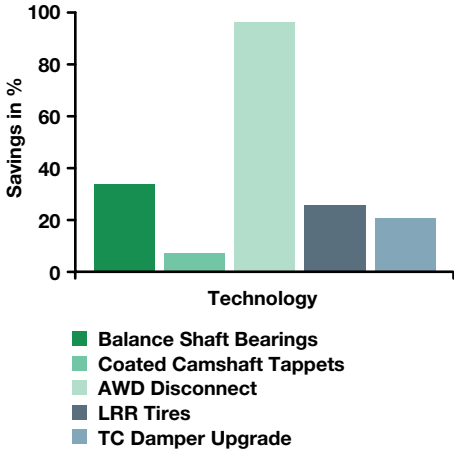


Figure 6 Bar chart of technology savings

Figure 6 shows the effective friction reduction savings of the selected technologies for phase 1. The savings are a function of torque and energy with respect to the baseline vehicle. Improved balance shaft bearings offer a 33 % improvement in friction reduction and low-friction coated camshaft

tappets provide a 7 % improvement. The AWD disconnect system provides a 95 % improvement in friction, because the propshaft is brought to rest. Low rolling resistance tires offer a 25 % improvement in rolling effort. Finally, the upgraded torque converter damper permits the elimination of torque converter clutch slip and allows for a more aggressive lugging limit, a 20 % improvement over baseline.

The United States EPA FTP and HWFET tests were simulated to get a combined improvement number. Simulations of the European NEDC and the new worldwide harmonized light vehicles test procedure class 3 (WLTP) were also carried out to capture the fuel economy improvement on a global scale.

Figure 7 shows the US EPA FTP driving cycle and corresponding total fuel consumption lines over the cycle. The grey line represents the driving cycle over time. The dark green line represents the total fuel consumption of the baseline vehicle, the green line is phase 1 and the light green line is phase 2.

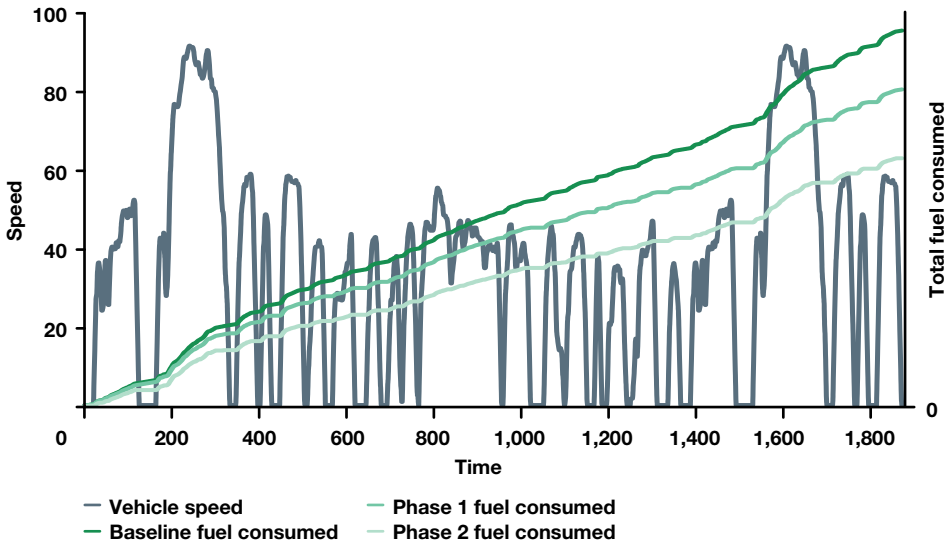
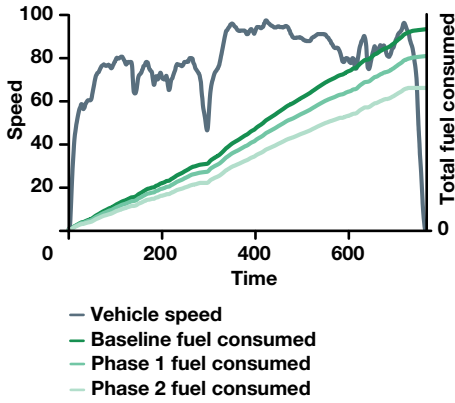
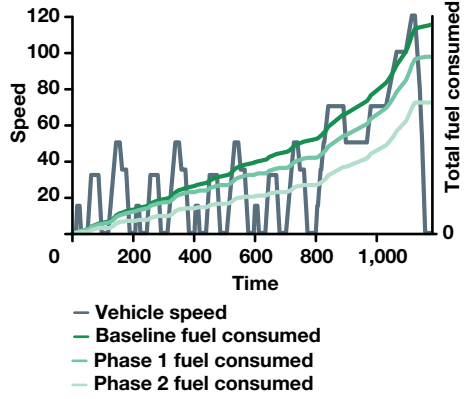


Figure 7 US FTP cycle



**Figure 8** US HWFET cycle



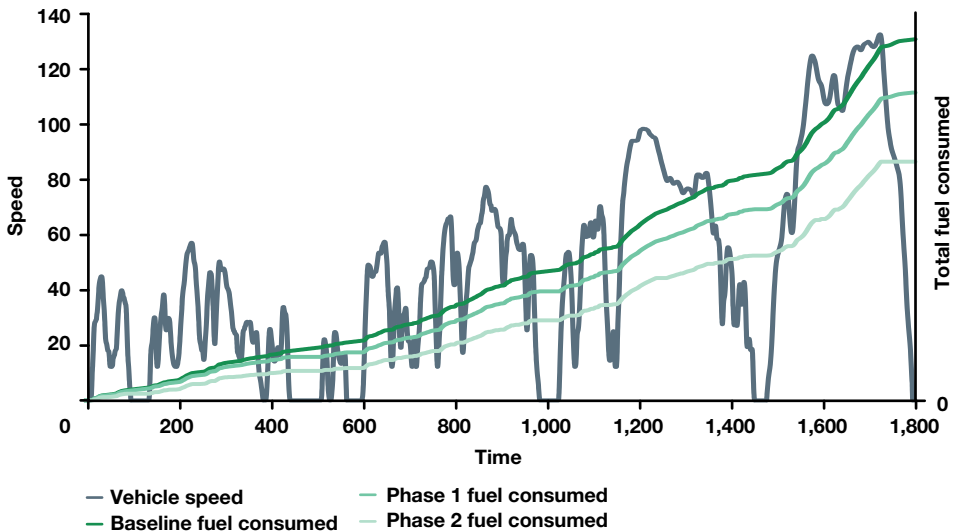
**Figure 9** The New European Driving Cycle (NEDC)

Figure 8 shows the US EPA HWFET driving cycle with total fuel consumption traces over time. Figure 9 shows the New European Driving Cycle with total fuel consumption traces over time.

Figure 10 shows the Worldwide harmonized Light vehicles Test Procedure (Class 3) driving cycle with total fuel consumption traces over time.

The phase 1 simulation percent improvement estimations for each cycle are:

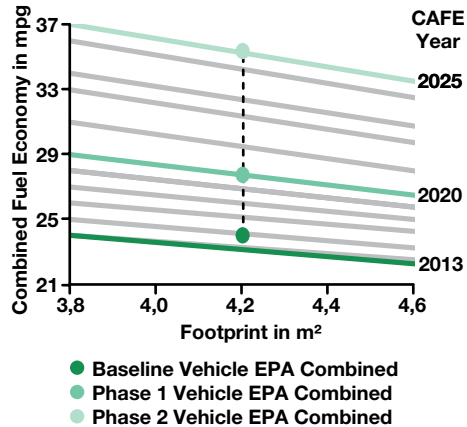
- US FTP = 18.7 %
- US HWFET = 15.5 %
- US combined = 17.5 %
- NEDC = 18.2 %
- WLTP = 17.2 %



**Figure 10** The global harmonized world light test procedure (WLTP)



Figure 11 is a plot of combined fuel economy, in miles per gallon, versus vehicle footprint. The lines represent each CAFE year fuel economy target. The baseline vehicle starts off just below year 2015 target. The measurements conducted for phase 1 achieve CAFE year 2020 standards. Preliminary simulation results show that we are on target to reach CAFE 2025 with phase 2, with the aid of some of the off-cycle credits provided by the EPA.



**Figure 11** Combined fuel economy as a function of vehicle footprint for CAFE years

## Software

The phase 1 software development process began after the initial fuel economy simulations were completed. Development work on the software for the demonstrator was divided into four stages; strategy determination, software development, SIL (software in the loop) simulations, and software implementation. The Schaeffler Engineering PROtronic ClassicLine control unit housed the software used to control the systems added to the demonstrator.

### Strategy determination

Technologies like coated tappets, new balance shaft bearings, and low rolling resistance tires do not require a control strategy. The new TC lockup schedule was simply flashed on to the vehicle's powertrain control module (PCM) with the help of the customer and did not require software strategy development. Control strategies were necessary for the stop-start, AWD disconnect and thermal management.

The stop-start system requires the engine to shut down when the vehicle is

stopped. The piston at the transmission forward clutch is positioned to the touch point of the clutch pack and is held with hydraulic pressure via a latching valve when the engine shuts down. During engine shutdown, hydraulic pressure throughout the transmission is no longer available, but the latching valve holds the clutch in place by trapping fluid behind the piston. The clutch consequently need not be repositioned to the touch point during startup, allowing for faster restarts. An engine which has not yet reached normal operation temperature can result in restart instability, as well as requiring a rich mixture for starting, therefore the stop-start events should only be executed while the temperature is above an acceptable threshold. Constant stopping and starting can also negatively impact fuel economy, as well as the starter's durability, so a minimum vehicle speed must be reached after each stop-start event. This protects the vehicle from rapidly occurring restarts in stop-and-go traffic.

AWD disconnect provides the greatest friction reduction benefits out of all the tech-

nologies in the demonstrator. The driver has the option of keeping the AWD permanently engaged, permanently disengaged, or switching between the two on the basis of a predetermined strategy. The strategy mode attempts to provide fuel economy benefits with the advantages of AWD. The rear wheels and propshaft are disconnected at higher speeds via the PTU disconnect clutch and the rear axle disconnect. AWD is connected at lower speeds, high throttle demand and when the front and rear wheels rotate at different rates. Switching between engaged and disengaged is not possible during a start-stop event as clutch actuation at the PTU requires hydraulic pressure, which is not available when the engine is switched off. The clutch actuation must be smooth enough for the driver not to experience any adverse NVH events.

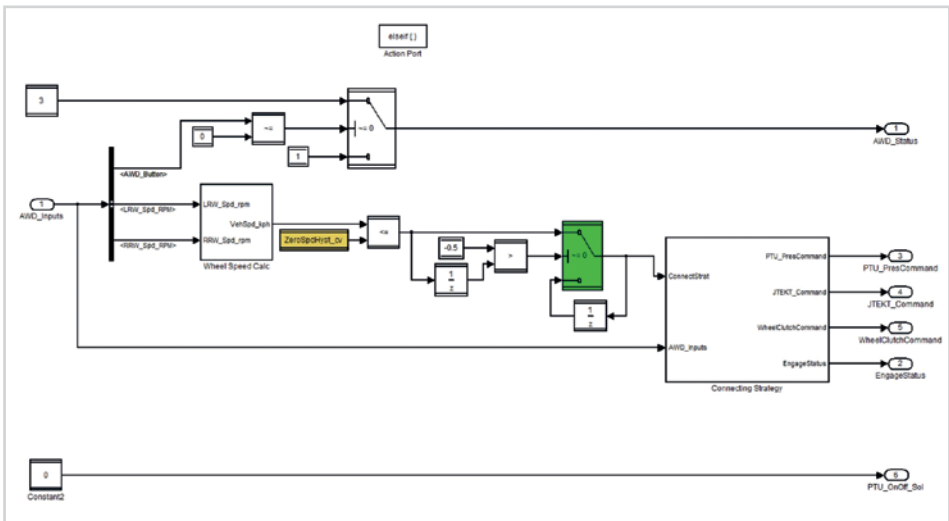
The thermal management system brings the engine up to temperature faster than the original strategy by modulating coolant flow through the engine. The main coolant flow to the engine block is cut off during warm-up, but modulated during

temperature control. There is a small bypass circuit which allows a small quantity of coolant to pass through continuously for accurate temperature management when the TMM is closed. The actuator used to control the coolant flow is set to the required temperature and controlled via temperature feedback.

## Software development

The software design was created primarily in the Mathworks Simulink environment. The control strategies were developed using Model Based Design (MBD) – a design method using flow diagrams to represent handling inputs and outputs for each system. A screenshot of the MBD for the demonstrator is shown in Figure 12.

The majority of the software consists of logic gates and event-driven control algorithms. Certain vehicle situations prompt the control unit to execute a series of checks, resulting in a fixed action. When the vehicle is stopped for two seconds, the



**Figure 12** Example of MBD used in Demonstrator

software checks the engine temperature, the maximum speed achieved, the stop-start switch and several other inputs before shutting the engine down for a start-stop event. The vehicle will not execute a stop-start event if not all of the conditions are met. Cold starts are inefficient, so the system would not engage the start-stop strategy if the engine temperature is too low.

PI (proportional, integral) control loops are used for events that require active control strategy. The stop-start system requires control of the forward clutch actuation, which is originally managed by the vehicle's transmission valve body. A solenoid controls the flow of pressure to the clutch based on the programming inside the PCM. The PROtronic control unit intercepts the original solenoid signal coming from the PCM and the Schaeffler strategy is forwarded to solenoid in its place.

Multiple systems in the demonstrator require active control, necessitating multiple forms of feedback through the PROtronic. The proper gain values for the PI controls could only be estimated in the initial development and would later be explicitly determined through calibration. Testing the control strategies through 'software in the loop' simulations was the next step before flashing the software on to the PROtronic.

## SIL simulations

Simulations were performed once the initial software design was complete. The necessary inputs for the control strategies were taken from different driving cycle data files and fed into the model in order to simulate various driving conditions. The behavior of the different systems was observed through the outputs of the design, allowing for model adjustments that assured each system acted according to its strategy. Each time an error occurred and the predicted outputs were not achieved, the control strategy govern-

ing the incorrect output was studied until the problem was corrected. The production code for the PROtronic was auto-generated from the software model on completion of the SIL tests.

## Implementation

The auto-generated code was compiled and flashed onto the PROtronic using Schaeffler Engineering's PROtronic software suite. The function and operation of each component and system was verified. Once the calibration phase was complete, the vehicle was ready for official fuel economy measurements.

Fuel economy was measured at an independent, non-affiliated lab. Two FTP and two HWFET cycles were run for the baseline vehicle, then repeated again once phase 1 was complete. A 16 % improvement in combined fuel economy was measured, attaining the CAFE model year 2020 target.

## Transmission-driven accessories

---

Phase 2 of the demonstrator project consists of drivetrain hybridization and ride-height adjustment. Ride-height adjustment is accomplished with a ball screw adjustment system that can actively vary the ride height of the vehicle. Variable positioning can reduce the vehicle's drag coefficient throughout a drive cycle. The hybridization component is achieved through a Schaeffler concept entitled Transmission Driven Accessories, or TDA. The technology will improve fuel economy by adding engine boosting and the ability to disconnect the vehicle accessories from the drive-train, greatly reducing engine drag.

## TDA mechanical architecture

The TDA architecture consists of two clutches, one connecting the engine crankshaft to the accessories (engine accessory clutch) and one connecting the transmission input shaft to the accessories (transmission accessory clutch). A 48-volt battery and a 12 kW MGU (Motor-Generator Unit) is used to boost the engine and provide independent power to the accessories when needed. The TDA architecture can be seen in Figure 13.

One accessory clutch is connected at a time. The transmission accessory clutch will be connected during deceleration for regenerative braking purposes, but only at effective transmission speeds above engine idle. Both clutches are disengaged while decelerating, when transmission speeds are below engine idle, during which the MGU powers the accessories at idle speed. The engine accessory clutch connects when the 48-volt battery state of charge (SOC) drops below the minimum threshold and during boosting.

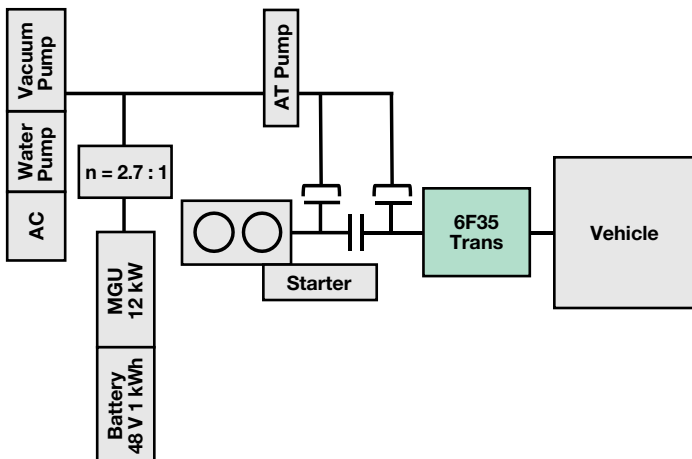


Figure 13 TDA architecture

## Battery and motor calculations

Simulations for phase 2 required information on the additional electrical systems necessary for hybridization. The new 48-volt battery and MGU were added to the simulation to perform boosting and model the charging and discharging effects throughout the drive cycles.

The boosting option is achieved with the MGU through the engine accessory clutch, decreasing the amount of fuel required for the engine to achieve certain torques. Boosting also discharges the 48-volt battery, limiting the amount of boost assist before the battery must be charged. A balance between charging and boosting is needed to ensure optimal fuel benefits and a healthy battery life cycle.

The battery is charged by the MGU through regenerative braking. During vehicle deceleration, the engine accessory clutch opens and the transmission accessory clutch closes. The MGU induces a drag torque that decelerates the vehicle and charges the battery simultaneously. The amount of regenerative braking torque is

dependent on the battery's SOC (state of charge) and the driver's input.

The levels of boosting and regenerative braking were manipulated in order to achieve our fuel economy goals and the proper final SOC. Certain driving situations presented particular challenges. Highway cycles tended to decrease the battery SOC faster because there was less braking and

decelerating involved. Less time decelerating means more aggressive regenerative braking and a less aggressive boosting strategy. City cycles spent more time decelerating, requiring less aggressive regenerative braking and more boosting. However, there was more idling during the city cycle, which required the MGU to run the accessories during a stop-start event, thus draining the battery further. As seen in Figure 11, phase 2 simulations project fuel economy to reach the 2025 standards.

## Conclusion

---

The NA CAFE Demonstrator project serves as an example of the system level engineering and development expertise of Schaeffler North America. Systems modeling, simulation, software and controls development, calibration, hardware design and development were all primarily executed in North America. It demonstrates Schaeffler's ability to take an idea from the early stages of simulation through to functioning vehicle components in a short amount of time.

Following the success of stage 1, the stringent requirements of phase 2 of CAFE 2025 will be quite challenging. Schaeffler has proven to be a reliable customer-driven supplier, focusing on systems level hardware aimed at fuel economy reduction for efficient future mobility.

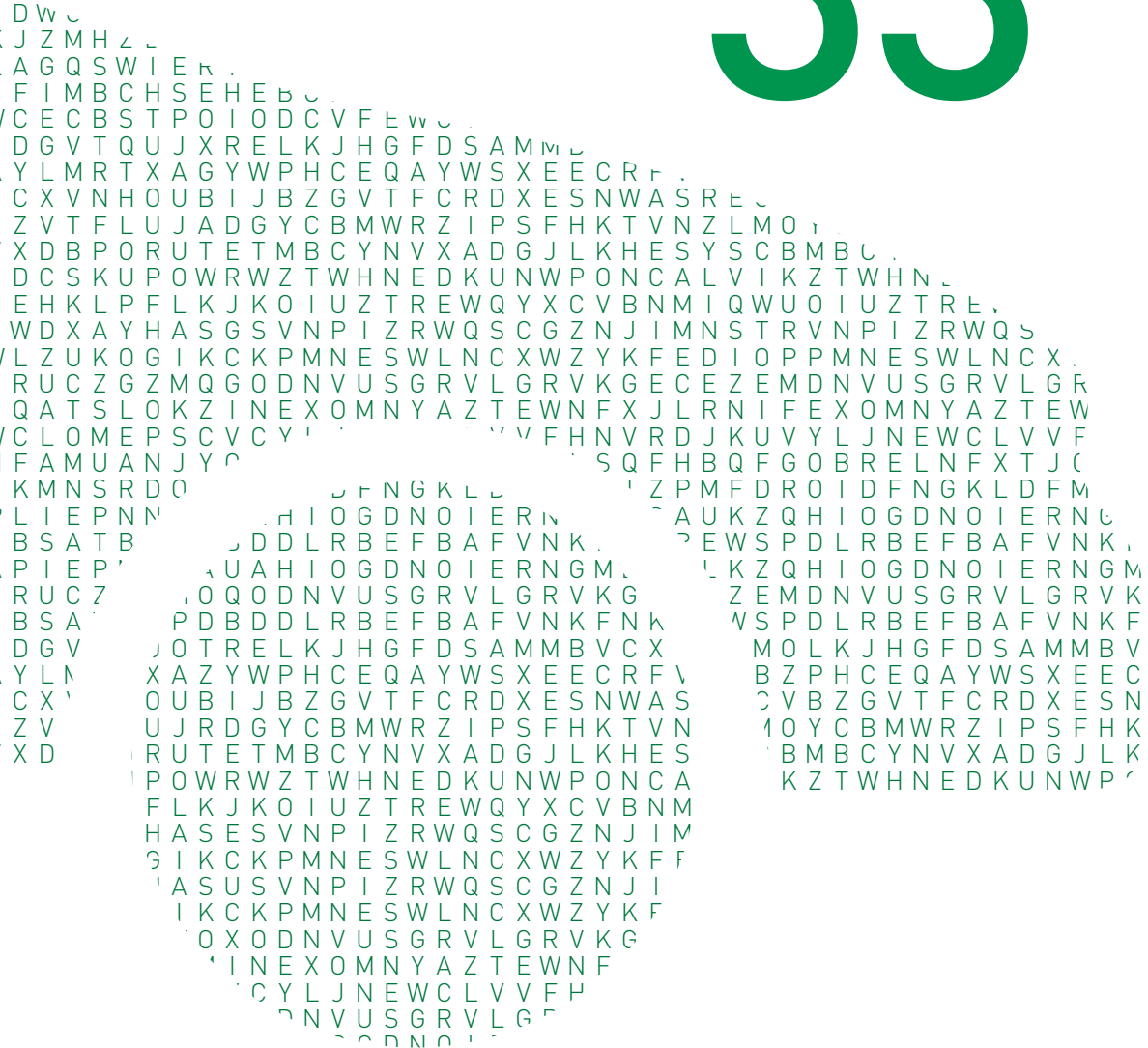


# Introduction of 48 V Belt Drive System

New tensioner and decoupler solutions  
for belt driven mild hybrid systems

Andreas Stuffer  
Daniel Heinrich  
Christian Hauck  
Timo Schmidt  
Hermann Stief

# 33



## Introduction

---

The market for belt drives is in motion. At the 2010 Schaeffler Symposium, the focus was exclusively on conventional belt drives with pure load operation of the accessories [1]. Since then, systems with belt starter alternators have increased in importance for belt drive development. They serve to support additional functions like recuperation, boost operation, and engine starts, and thus offer advantages for the fuel economy and function of the engine.

The introduction of 48-volt electrical systems can mean a new boost for belt starter alternators. These enable an increased electric power output and mild hybridization of drives at justifiable costs. Through expanded functions – such as recuperation and electric boosting – considerable fuel consumption savings of up to 14 percent in the NEDC can be achieved.

The transmission of ever-increasing levels of power and torque means belts are subjected to higher dynamic loads. At the same time, vibrations are increasingly introduced into the belt drive, as more and more frequently engines with a reduced number of cylinders, but high mean pressures and thus high rotational irregularities are used. Innovative auto tensioners and crankshaft decouplers from Schaeffler are able to transmit the higher torques safely and also to reduce the vibration with the right design.

## Conventional belt drives and belt-driven starter alternator applications

---

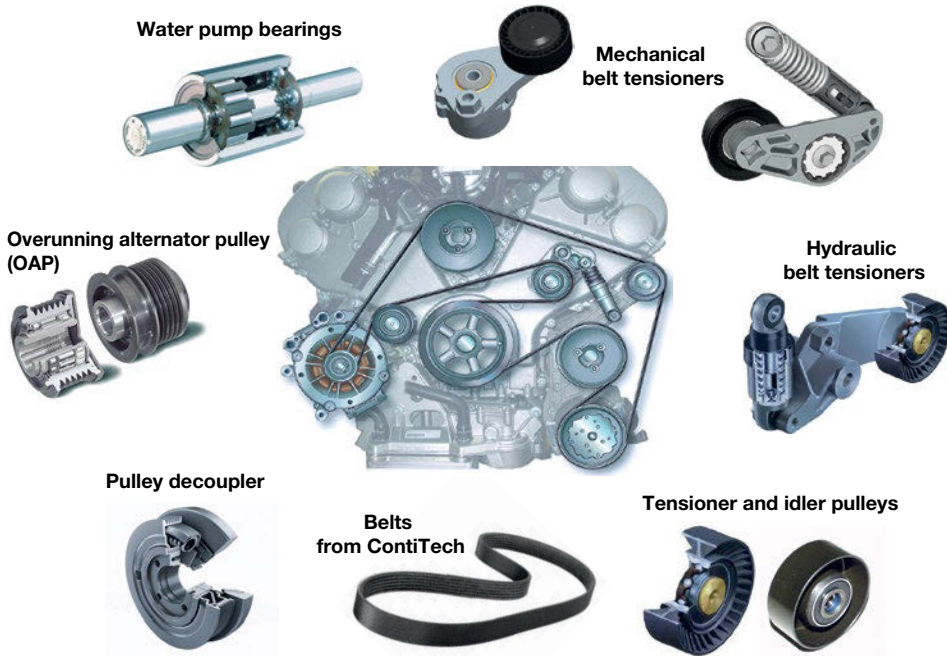
In modern internal combustion engines, the accessories are driven almost exclusively by V-ribbed belts. These belt drives and their automatic tensioning systems must meet the following requirements:

- Automated belt force adjustment during initial installation and maintenance (tolerance compensation of all drive components)
- Practically constant belt force over the entire life of the belt drive (compensation of belt elongation and wear)
- Practically constant belt force over the entire engine temperature range (compensation of heat expansion of all components that affect the drive)
- Reduction of dynamic belt force peaks in the drive
- Minimization of slip, noise, and belt wear
- Operating life increase for the entire belt drive system
- Optimum reliability of the entire belt drive system
- Minimization of friction losses in the entire system

Modern accessory drives, which are optimally adjusted to the entire system, are maintenance-free and can run for more than 240,000 km (nearly 150,000 miles).

Schaeffler offers a variety of products for the design of the front-end accessory drive. Mechanical and hydraulic belt tensioners provide a nearly constant belt force across tolerances, throughout the operating life and the entire temperature range of the engine, and also damp vibrations in the belt drive. Additional damping and decoupling of vibrations can be achieved





**Figure 1** Schaeffler product portfolio for the belt drive

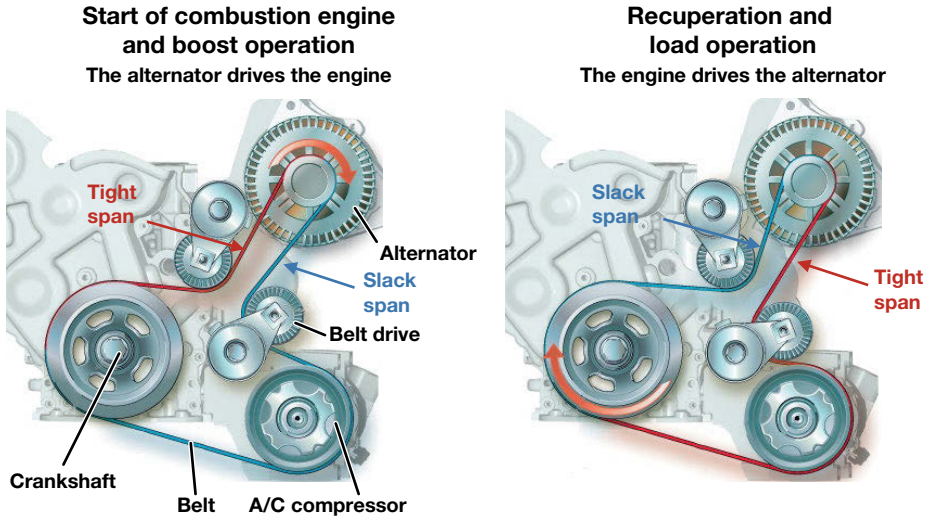
by using decoupling elements. At Schaeffler, the OAP (overrunning alternator pulley) has therefore been in volume production since 1996 as a freewheel belt pulley on the alternator; the belt pulley coupler has been in volume production as a mechanical decoupler on the crankshaft since 2013. Schaeffler has been using the OAP (overrunning alternator pulley) as a mechanical decoupler on the alternator since 1996 and the pulley decoupler as a mechanical decoupler on the crankshaft since 2013 in volume production. In addition to individual components, Schaeffler also offers system development for the entire belt drive together with ContiTech (Figure 1).

The function of conventional belt drives is characterized by the accessories being in load operation; the power is thus always transferred from the engine to the belt drive. In contrast, in applications with belt starter

alternators, the power is transferred from the alternator to the engine at some operating points (alternator start and boost operation).

For conventional belt drives, tensioners with mechanical and hydraulic damping units are common. In addition, an overrunning clutch is often used on the alternator, which compensates fast torque changes when vibrations occur and thus reduces dynamics. This approach is not used in systems with belt starter alternators because the torque must be transferred in both directions, which makes the dynamics in the belt drive much more critical overall.

For starting via the belt, an expanded belt tensioning function is needed in order to allow a transfer of torque in both directions in the belt drive. This function is shown in Figure 2 based on two mechanical belt tensioners.



**Figure 2** Belt drive load in boost and load direction

When the engine is driven by the alternator – in belt start or boost operation – the power is transferred via the upper run (indicated on the left as the driving run). For the load operation of the alternator (for example during recuperation), torque is transferred from the crankshaft to the alternator (right belt run, shown in the figure on the right as the driving run). The purpose of the tensioner system is to maintain the pretension in the entire system and to prevent the belt load from falling in the slack run.

Belt starter applications were already being researched extensively in the early 2000s [2]. However, development proved to be difficult due to the limited power of 12-volt on-board electrical systems and the unusually problematic vibration isolation. In 2005, Citroën was the first manufacturer to put an application with a belt starter alternator into volume production.

A new generation of belt starter alternators with significantly expanded functions has been in development since 2011. This is possible by using a 48-volt on-

board electrical system, which provides up to 12 kW of power. The existing 12-volt on-board electrical system is connected to a voltage converter on the expanded 48-volt network, which includes a 48-volt battery with additional capacity and a 48-volt alternator in the belt drive. The increased capacity of the 48-volt network enables additional functions for the belt starter, which are shown in Figure 3. The expansion of the on-board electrical system to 48-volt in combination with a belt starter alternator is designated in general as a “mild hybrid,” which is positioned, in terms of functions and cost, between the existing 12-volt on-board electrical system and the full hybrid with a high-voltage power supply.

New challenges arise for the belt drive configuration due to the higher power transfer via the belt. This is shown in the following application example, a mild hybrid in a 1.6-liter four-cylinder gasoline engine with 130 kW power and a torque of 260 Nm in a mid-class vehicle (1,400 kg curb weight) with a 6-speed double clutch transmission.

Conventional accessory drive		Micro Hybrid 12 V		Mild Hybrid 48 V		Hybrid > 48 V		
Provide belt tension	Compensate tolerances	Provide belt tension	Compensate tolerances	Provide belt tension	Compensate tolerances	Provide belt tension	Compensate tolerances	
Belt drive systems		Change of mind	Comfort start-stop	Change of mind	Comfort start-stop	Change of mind	Comfort start-stop	
		Recuperation	Electrical power < 5 kW	Recuperation	Electrical power < 12 kW	Recuperation	Electrical power > 12 kW	
				Increase of load point	Boost	Increase of load point	Boost	
				Pull-away assistance			Pull-away assistance	Electric drive

Complexity / functionality ➔

**Figure 3** Functions of different hybrid stages

For the accessory drive system, a belt drive with air conditioning and a 180 A alternator is assumed. This technology combination is widely used among different manufacturers for mid-class vehicles. In expanding the belt drive to a 48-volt system, however, the conventional alternator that previously allowed load-only operation is

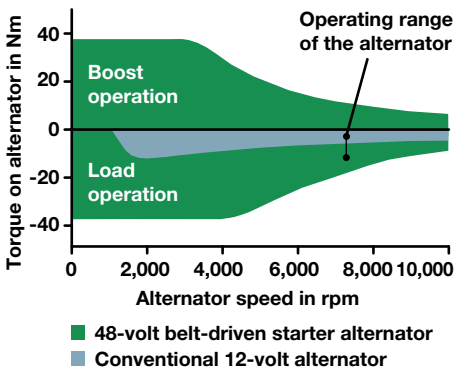
replaced with a 48-volt belt starter alternator. It thus becomes necessary to make an adjustment to the belt drive. The possible operating range for both alternator systems is shown in Figure 4.

In order to obtain a representative depiction of drive performance, reference is made here to the WLTP cycle [3] (Figure 5).

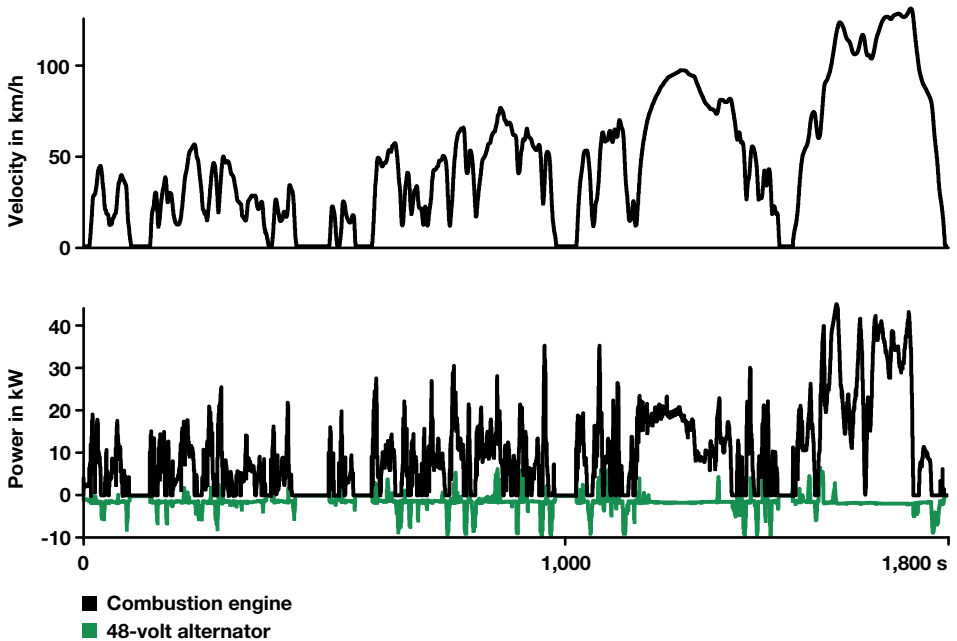
The figure shows the power of the internal combustion engine and the 48-volt belt starter alternator for the example application. The ranges with recuperation (negative power range) and boost operation (positive power range) are easily recognizable from the alternator power signal.

The mild hybrid system offers the following advantages:

- Boost operation
- Recuperation
- Faster and more comfortable engine starts via the alternator, as well as
- Electric driving at low speeds (e.g., as a comfort function in stop-and-go operation or to prevent exhaust emissions in underground parking garages).



**Figure 4** Operating range for a conventional 12-volt alternator and a 48-volt belt starter alternator



**Figure 5** WLTP driving profile according to [3]

In contrast to the full hybrid, the electric motor is coupled with the internal combustion engine as a belt starter alternator in the mild hybrid. Recuperation and electric driving are only possible when the internal combustion engine is turning – the engine friction must thus be overcome, reducing the effective available power.

The internal combustion engine can thus be run at operating points with greater efficiency, which results in optimized consumption in combination with the braking energy recovery and sailing phases. Current discussions involve fuel consumption advantages in the range of 4 % to 14 % [4, 5], depending on the base driving cycle, engine, and system tuning. At the same time, there is increased driving comfort for the driver due to a very comfortable start function, assistance for the engine from the boost operation, and the possibility of moving off under electric power only in stop-and-go operation.

### Belt tensioner configuration for the mild hybrid with belt starter alternator

In the entire system, the mild hybrid offers a noteworthy advantage with regard to driving dynamics and fuel consumption, which is achieved with assistance from the internal combustion engine via the 48-volt belt starter alternator. This requires a suitable torque transmission in the belt drive, which differs from the tensioner and damper solutions for the conventional belt drive. In addition to the solution already presented with two individual tensioners, other tensioner systems are also conceivable, and are shown in Figure 6 with their different requirements.

From the classic solution with two mechanical belt tensioners, there are already a few systems in combination with 12-volt

	Two mechanical tensioners	Mechanical + hydraulic tensioners	Generator tensioner	Hydraulic tensioner in tight strand	Decoupling tensioner	Hydraulic tensioner in slack strand
<b>Start function (generator start)</b>	+	+	+	+	++	-
<b>Operation under load</b>	+	+	0	0	++	0
<b>Packaging</b>	-	-	+	0	+	0
<b>Costs</b>	+	--	0	0	0	0
<b>Transient operation</b>	+	+	0	0	++	-

Tensioner variants considered on the following pages

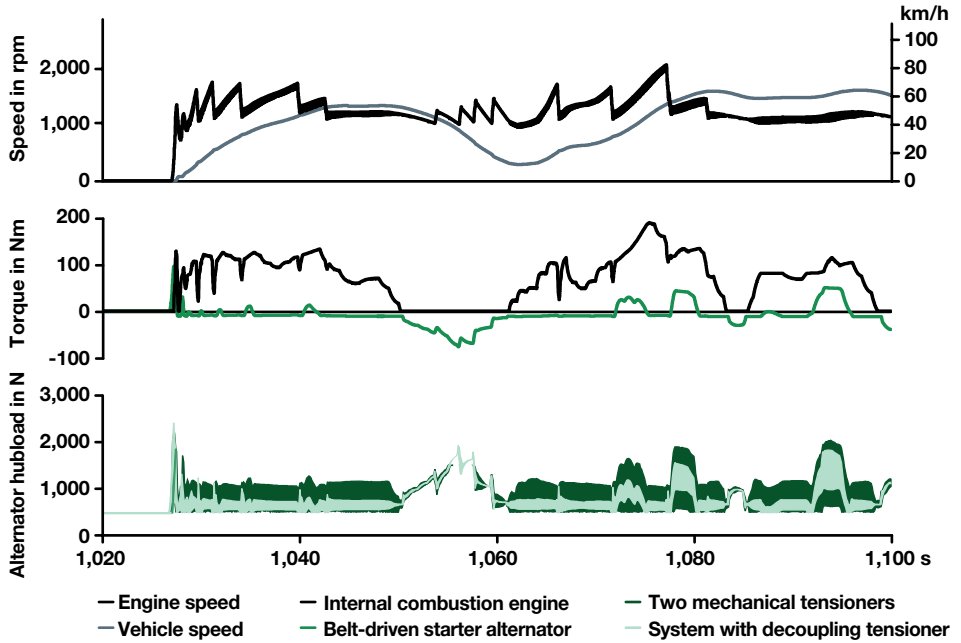
**Figure 6** Design of different tensioner system solutions for the belt drive

systems in volume production. An alternative design requires only one tensioner, which can swivel about the alternator’s axis of rotation. These, known as decoupling tensioners, offer the greatest advantages. Figure 7 shows the function of the belt drive system for different operating points. A part of the WLTP cycle is shown in which boost and recuperation operation is used. An alternator start also takes place at the beginning of the depicted range.

Engine speed and vehicle speed are shown in the top diagram. The shifting of the double clutch transmission and engine irregularities due to the engine’s ignition can clearly be seen from the engine signal. It is easy to tell the vehicle’s operating mode from the torque of the engine and belt starter alternator (both shown as torque appearing on the crankshaft), shown in the middle. A positive torque on the belt starter alternator indicates boost

operation; dips into the negative indicate vehicle braking with recuperation. To evaluate the dynamics in the belt drive, the hubload on the belt pulley of the belt starter alternator is shown.

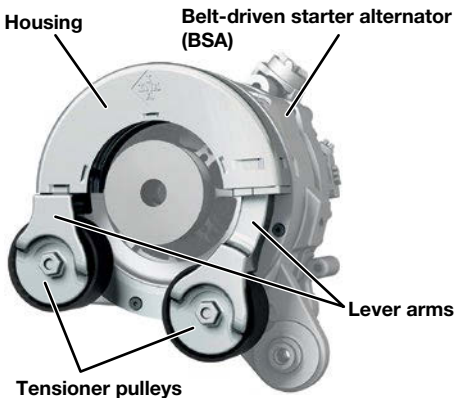
Significantly higher dynamic loads can be seen for the system with two mechanical belt tensioners. The area of maximum transferable torque is limited, however, because the two tensioners in the belt drive cannot completely maintain the pretension. If the tensioner is adjusted so that the torque for the alternator start can be fully transferred, the result is a limit on the maximum possible recuperation torque. In this example, the belt slips above at an alternator torque of approx. 30 Nm during recuperation. Overall, these results show that the conventional design approach using two mechanical tensioners is not a match for the increased requirements. The belt drive is simply overloaded.



**Figure 7** Function of the belt drive system in the WLTP cycle

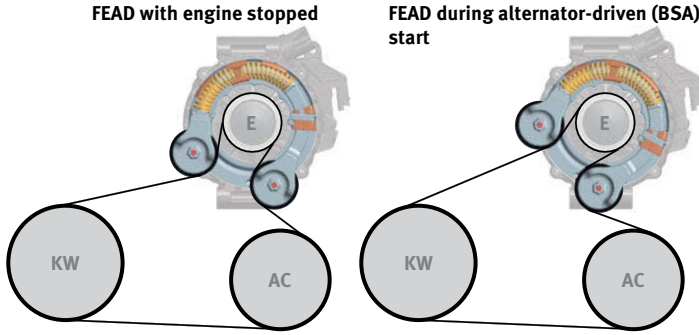
By contrast, one decoupling tensioner on the alternator has distinct advantages. Improved retention of the pretensioned load in the slack run is one of these, as

are the significantly lower dynamic loads in the belt drive due to engine excitation. By introducing this type of decoupling tensioner, the dynamics in the belt drive can be managed and the functional advantages are fully achieved with the mild hybrid system. These requirements correspond to a decoupling tensioner recently developed by Schaeffler, which is illustrated in Figure 8.



**Figure 8** Overview: Decoupling tensioner design

The tensioner consists of a housing which is connected to the electric motor by a plain bearing and can be rotated by 360° about the electric motor's axis. A tensioner pulley is permanently fixed to this housing. The second tensioner pulley is located on a moving lever and is spring-mounted against the housing by means of an arc spring assembly. This allows the tensioner pulley to create the necessary belt pretensioning load and to compensate tolerances in the belt drive (Figure 9).

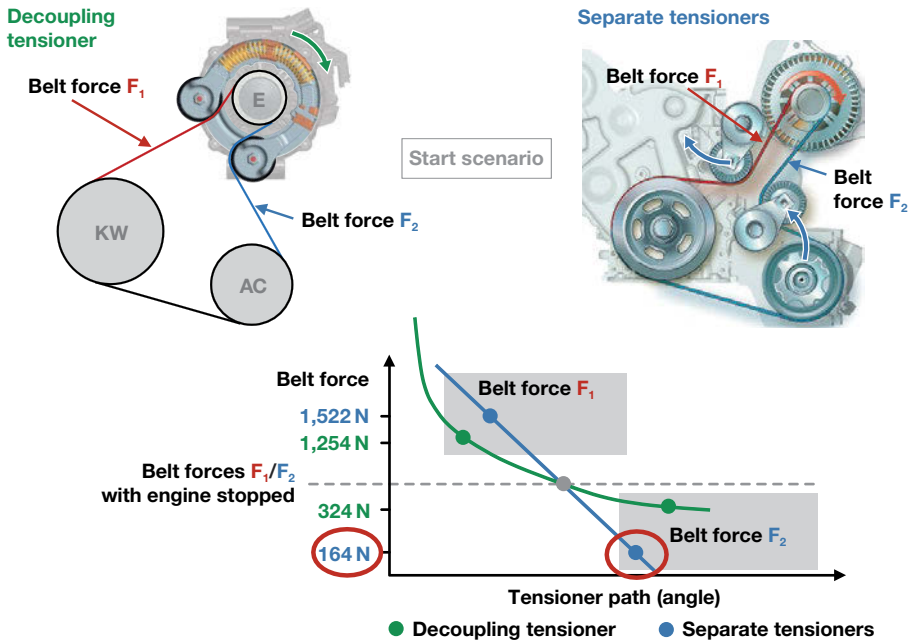


**Figure 9** Function of the decoupling tensioner, alternator start with decoupling tensioner

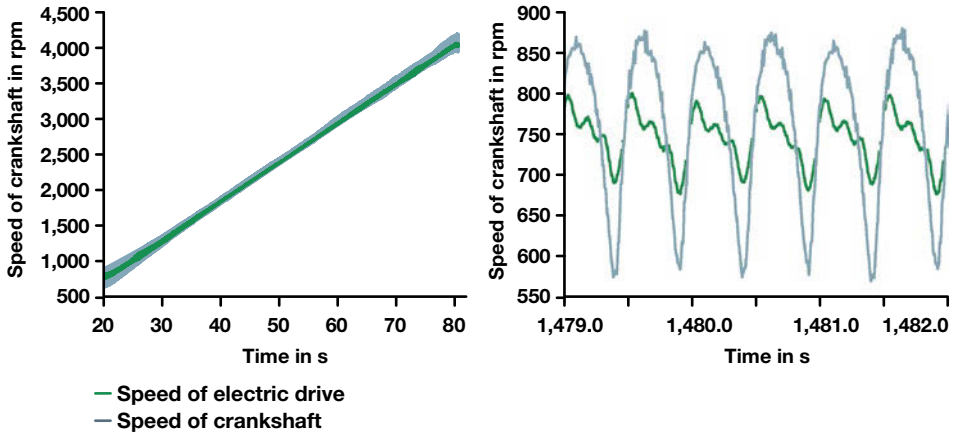
reciprocating movement of the entire tensioner about the electric motor's axis causes the driving half of the tensioner to be pressed away from the drive and the other tensioner pulley to automatically retension the slack side by means of the geometric connection, so that it is pushed into the

Depending on whether load torque is being applied to the electric motor (alternator operation or recuperation) or it is generating torque (belt start, boosts), the driving run occurs in either the right or the left belt run and the slack run is on the other side. The

drive. In a solution with two independent tensioners, this geometric connection does not exist, which leads to the slack side tensioner receiving no additional support from the driving half tensioner for tensioning the slack side (Figure 10).



**Figure 10** Comparison of the belt tension during engine start



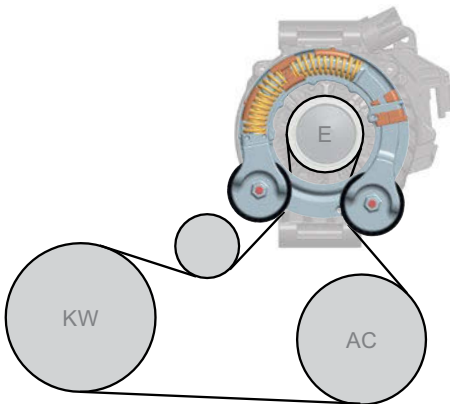
**Figure 11** Decoupling effect of the tensioning system

Figure 11 clearly shows the additional decoupling effect of the tensioning system: Only a small portion (green) of the rotational irregularity introduced into the drive from the internal combustion engine (grey) reaches the electric motor shaft via the reciprocating movement of the decoupling tensioner.

This decoupling effect is sufficient for many belt drives with belt starter alternators. The use of advanced decoupling

measures is still necessary because of increased rotational irregularities as a result of smaller engines with higher specific power and a lower number of cylinders.

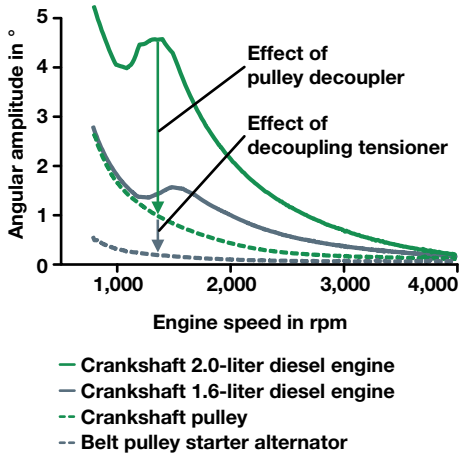
## Belt starter systems with crankshaft decoupling



**Figure 12** Layout of the belt drive

When power is transferred between belt starter alternator and engine, the decoupling tensioner automatically damps vibrations in the belt drive due to its design. This function is dependent on the belt drive layout and the position of the accessories as well as on the internal combustion engine excitation. The example of a mild hybrid drive with a highly turbocharged 2-liter four-cylinder diesel engine (470 Nm engine torque, 140 kW engine performance, in a mid-size, upper-class vehicle with a six-speed double clutch transmission) shows the necessity of an additional decoupling of the belt drive by means of a crankshaft decoupler. Figure 12 shows a layout based on





**Figure 13** Engine dynamics of the example application

the assumption that the geometry is limited by the available installation space. This means an additional guide pulley is required in the belt drive and the working range of the decoupling tensioner is limited as a result.

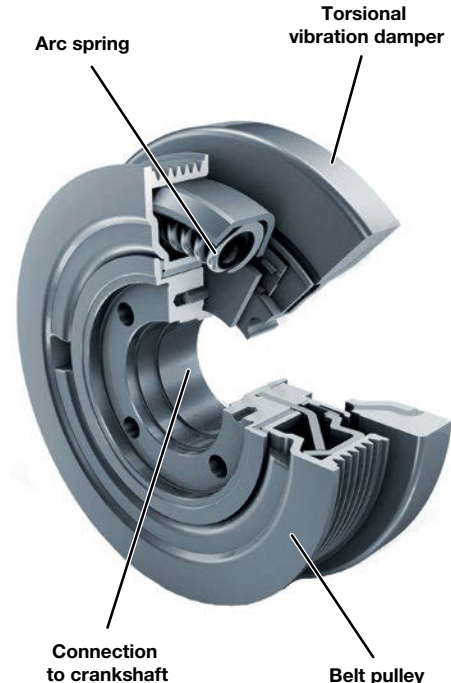
Figure 13 shows the vibration angle of the engine on the front crankshaft end as a function of the engine speed. This engine has a significantly greater belt drive excitation via the crankshaft than the 1.6-liter gasoline engine application from the first part of this paper. The increased irregularities of the internal combustion engine excite the belt drive to higher vibrations, which can no longer be managed by a decoupling tensioner alone. Therefore, to reduce vibrations, a direct decoupling on the crankshaft must be used via a decoupled belt drive (dashed line).

The dynamics in the belt drive are reduced to an acceptable value by crankshaft decoupling. Whether crankshaft decoupling is necessary for a belt drive depends on such parameters as the crankshaft excitation, belt drive layout, and accessory loads.

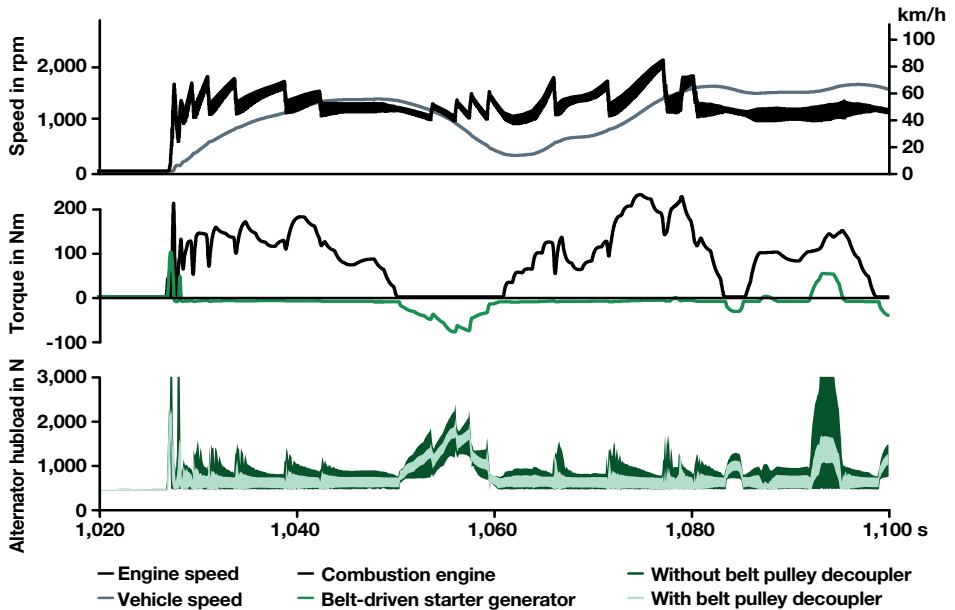
The relevant criteria for a decoupling on the crankshaft are:

- The decoupling of the belt drive in the operating range and
- The transmission of the alternator torque for alternator start, boost, and recuperation operation.

These requirements can be covered with the LuK pulley decoupler (PYD). This decouples the belt drive from the rotational irregularities of the internal combustion engine, with a specifically designed arc spring isolating the belt pulley from the crankshaft. The PYD is mounted directly on the crankshaft. It usually also contains a torsional vibration damper, which is needed to limit the natural vibrations of the crankshaft in the upper speed range to a level permissible for durability and acoustic comfort (Figure 14).



**Figure 14** Overview: Design of the pulley decoupler



**Figure 15** Function of the belt drive with belt pulley decoupler

The crankshaft pulley is decoupled from the vibrations of the crankshaft. Arc springs, such as those in a dual mass fly-wheel, are used for this, placed in a steel channel. From the crankshaft, the torque is transferred via a flange to the arc springs, which are supported on stops on the belt pulley. The torsion characteristics of the belt pulley decoupler can be flexibly influenced by the selection and combination of the springs used. The system function with the belt pulley decoupler is shown in Figure 15.

The function representation is analogous to Figure 7 with the engine speed, vehicle speed, and engine torque acting on the crankshaft and belt starter alternator and the hubload on the belt starter alternator pulley for the system variants with and without a belt pulley decoupler. In comparison to the system without a belt pulley decoupler, there is an additional reduction of the dynamics in the belt drive throughout the entire operating range.

In comparison with decouplers with elastomer springs, which use a rubber layer for resiliency, the mechanical arc springs have a significantly larger spring capacity and thus allow for the transmission of higher torques and power outputs. Thus, the increased power requirements for mild hybrid applications with belt start-stop can be covered. The characteristic curve can be flexibly adjusted by using multiple spring stages. This helps avoid resonances during engine start and driving operation.

The system is designed in a way that durability requirements are optimally fulfilled throughout the operating life. The design takes into account:

- More than one million engine starts through sailing and stop-start operation, depending on the application,
- A constant decoupling function over the engine's temperature range and vehicle operating life, as well as
- A decoupling of the belt drive throughout the functional range of the engine and alternator.

## Air conditioning in the vehicle interior with the internal combustion engine switched off

With the increasing hybridization of the automobile, the amount of time during which the engine is actually running is growing shorter and shorter. This effect is already apparent from an examination of the WLTP cycle when considering sailing and stop-start operation, and, depending on the driving profile, is very much increased for city driving (Figure 16).

Measures that allow air conditioning of the car interior without the engine running include a latent heat storage unit in the air conditioning system, an electric AC compressor or a mechanical AC compressor that is positioned in the standard belt drive and is driven by the starter alternator.

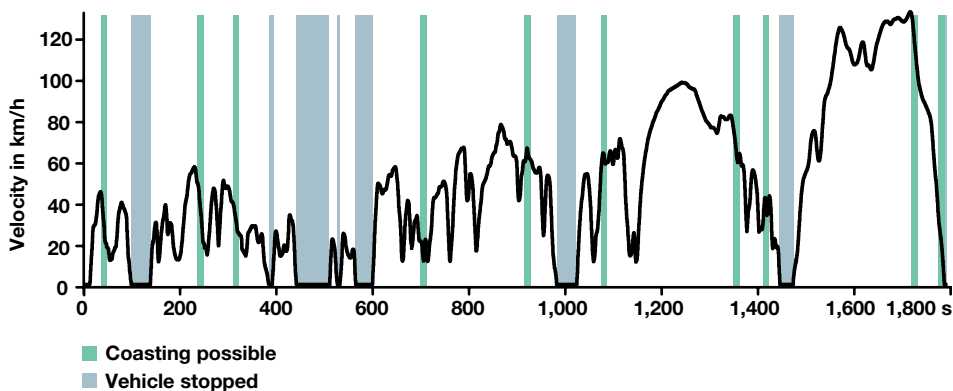
Latent heat storage units provide the air conditioning function by means of a built-in heat storage unit and have a num-

ber of limitations regarding the maximum amount of storable energy. They must be charged regularly by running the engine. In contrast, electric AC compressors or AC compressors driven by the starter alternator allow for longer phases without the engine running.

The electric AC compressor, however, requires an additional electric motor and reduces the efficiency of the AC compressor when the engine is running, since losses also occur in this state due to the transfer of the power through the electric over supply.

As an alternative to an additional electric motor, it is possible to use the existing belt starter alternator to power the AC compressor when the engine is not running if the belt drive can be decoupled from the engine.

This requires a clutch in the crankshaft pulley. Regardless of this comfort function, decoupling is necessary, as in the conventional belt drive. The decoupling is also used in the switchable pulley decoupler (PYDS) from Schaeffler to greatly reduce the dynamic torques that act on the separation coupling. This ensures acoustically and dynamically flawless operation.



**Figure 16** Example application in the WLTP cycle

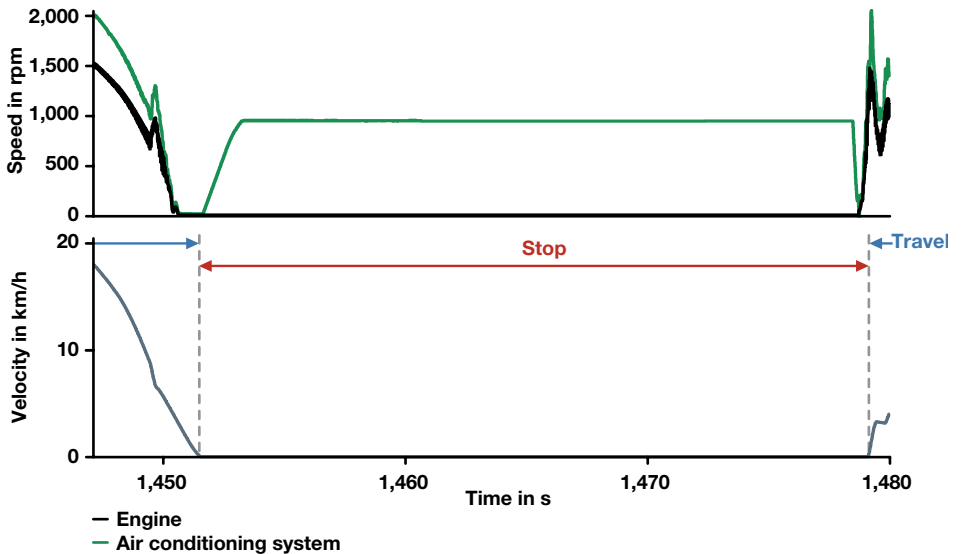
The switchable pulley decoupler is mounted directly on the crankshaft (Figure 17). Like the standard decoupler, it has a vibration damper to reduce the torsional vibrations of the crankshaft and arc springs to isolate the belt drive from the rotational irregularities caused by the combustion process. This means that all of the advantages of conventional pulley decouplers are retained. A clutch unit is also fitted between the arc springs and belt pulleys.

The belt drive can now be turned freely while the engine is stopped by disengaging the clutch unit. The mechanical AC compressor can thus be operated autonomously despite the engine being stopped. For the restart, the belt drive is slowed down to a near standstill and the clutch is engaged. During normal driving operation, both boost and recuperation torques can be transmitted.

The switch unit can be integrated into the existing space of the decoupler – it re-



**Figure 17** Design of the switchable belt pulley decoupler



**Figure 18** Function of the decoupler during AC operation while driving and with the engine stationary

sults in a more compact design with low weight.

Figure 18 shows the function of the switchable pulley decoupler based on individual points in the WLTP cycle for the example application. The decoupling of the belt drive makes the operation of the AC unit possible even when the engine is at a standstill. When the engine is running, the belt drive is isolated from irregularities by the crankshaft decoupling as in the non-switchable design.

In addition to the advantages in the belt drive arising from crankshaft decoupling, such as the reduction of dynamic loads and lower frictional losses by decreasing the pretension in the belt, the switching function allows further advantages. AC comfort is maintained both while the engine is stopped and in sailing operation – this also results in a further CO<sub>2</sub> benefit because the periods of time during which the engine is switched off may be extended.

## Summary and outlook

Compared to just four years ago, [1], systems with belt starter alternators now play a more important role in belt drive development. This is primarily due to the development of 48-volt mild hybrid systems.

Mild hybrid systems can contribute to improvements in driving dynamics and fuel economy. However, they also lead to new requirements for belt drive design. Decoupling tensioners and pulley decouplers, whether switchable or not, are not just expanding the current Schaeffler product range for belt drives (Figure 19). Innovations are also expanding the design options for mild hybrid systems with a belt starter alternator.

Now that the first systems with belt starters with 12-volt systems are on the mar-

**Water pump bearings**



**Overrunning alternator pulley (OAP)**



**Tension / idler pulleys**



**Belts from ContiTech**



**Mechanical belt tensioners**



**Hydraulic belt tensioners**



**Decoupling tensioner**



**Belt pulley decoupler**



**Switchable belt pulley decoupler**



**Figure 19** Overview of the Schaeffler product portfolio for belt drives

ket, new developments are driven by the expectation that belt starter alternators will become significantly more important in the coming years because of the change to 48-volt mild hybrid systems and – in addition to the conventional belt drive – will play an expanded role in the future. The requirements for belt drive design will increase to a greater or lesser extent, depending on the engine class. These can be met individually with products from Schaeffler – from the reduction of vibrations with the decoupling tensioner and the completely decoupled belt drive with standard air conditioning function through to switchable belt pulley decouplers.

Schaeffler is focusing on a system approach in belt drive development in which the interactions of the individual components within the entire system are taken into account. This approach is gaining significance due to increasing requirements. Therefore, the development of belt drives in the future will take the interactions with the entire vehicle system more closely into account. This focus on the whole system includes the interactions of the individual components and their use over the vehicle's operating life. While up to now systems have been designed based on individual operating points, these increased interactions are now shifting the focus to accounting for entire trips and the use of the vehicle by different drivers over the life of the vehicle. The interactions in the entire system

can be incorporated into development using Schaeffler's unique expertise. For vehicle manufacturers, Schaeffler offers the advantage that during belt drive development, the design of the individual components can be optimally tailored to each other.

## Literature

---

- [1] Stief, H.; Pflug, R.; Schmidt, T.; Fechler, C.: Belt Drive Systems. 9<sup>th</sup> Schaeffler Symposium, 2010, pp. 265-277
- [2] Bonkowski, M.; Bogner, M.: Der riemengetriebene Startergenerator (RSG) als aktuelle Herausforderung für eine funktionsoptimierte Riementrieb-Systementwicklung. VDI- Umschlingungsgetriebe, 2003
- [3] Tutuianu, M.; Marotta, A.; Steven, H.; Ericsson, E.; Haniu, T.; Ichikawa, N.; Ishii, H.: Development of a World-wide Worldwide harmonized Light duty driving Test Procedure (WLTP) – Draft Technical Report
- [4] Hackmann, W.; Klein, B.; Götte, C.; Schmid, R.; Pujol, F.: 48V – The Way to a High Volume Electrification. 22<sup>nd</sup> Aachen Colloquium Automobile and Engine Technology, 2013
- [5] Uhl, M.; Wüst, M.; Christ, A.; Pörtner, N.; Trofimov, A.: Electrified Powertrain at 48 V – More than CO<sub>2</sub> and Comfort. 22<sup>nd</sup> Aachen Colloquium Automobile and Engine Technology, 2013



# CVT

## The transmission concept of the future

Andreas Englisch  
André Teubert  
Bernhard Walter  
Konstantin Braun  
Stephan Penner  
Markus Jost

# 34





## Introduction

---

Automatic transmissions are becoming more and more common in passenger vehicles and, at the same time, customers' demands for comfort and reduced fuel consumption are increasing. Optimized fuel consumption is very difficult to achieve with manual transmissions.

More than 20 % of automatic transmissions will be CVTs by the year 2020. A significant advantage in terms of fuel consumption can be achieved in operation at partial load, and hybrid concepts can be seamlessly combined with the CVT. The CVT can also be manufactured cost-effectively, and when combined with torque converters, modern damping systems, and hybridization, it offers a level of comfort that is difficult to surpass.

New chain types allow significant increases in ratio spread and strength to be achieved, a trend which future generations of chains will continue. In addition, the ratio spread can also be expanded through the use of gear stages/range shifting to include ranges that conventional automatic transmissions will have difficulty in achieving comfortably. This means that CVTs can support the trend towards downsizing and downspeeding with no problems. If required, the efficiency of the transmission can also be further optimized through the use of direct gear stages.

The CVT thus continues to represent one of the best technical solutions for the automation of the powertrain, particularly in the field of front transverse applications. Current developments and possibilities for further development will be looked at in detail in this paper.

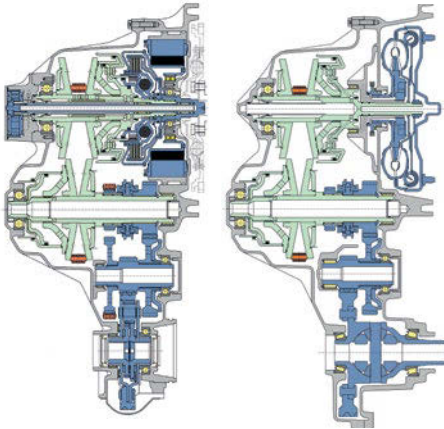
## Single-range and dual-range concepts

---

Aside from the actual specification, defining the concept is the most difficult task within the development process. Single-range and dual-range concepts are currently available on the market. Efficiency can also be further improved through the use of fixed-ratio gear stages. The choice of a concept essentially depends on the selection of the relevant components, such as the linking element, the clamping system, and the variator size. The quality of the overall concept in turn depends on the consistent optimization of the individual components in the transmission.

### High Value CVT

The High Value CVT (HV CVT) concept [1] was presented in detail during the last Schaeffler Symposium and at subsequent symposia. This concept already preempted groundbreaking development trends: The weight was reduced to a minimum, the ratio spread was increased to values of more than 8, and hybridization was carried out with no modifications to the design envelope. The concept was designed in a modular fashion in order to fulfill the requirements of a wide range of markets, and continues to provide the same firm basis for further development. Previous publications have always illustrated the HV CVT in combination with a hydraulic-mechanical torque sensor. However, the HV CVT can also be implemented with electronically controlled clamping without a torque sensor if desired. Figure 1 shows a variation of this type with the designation HV CVT ec (electronic clamping)



**Figure 1** Comparison: HV CVT with torque sensor and HV CVT with electronic clamping

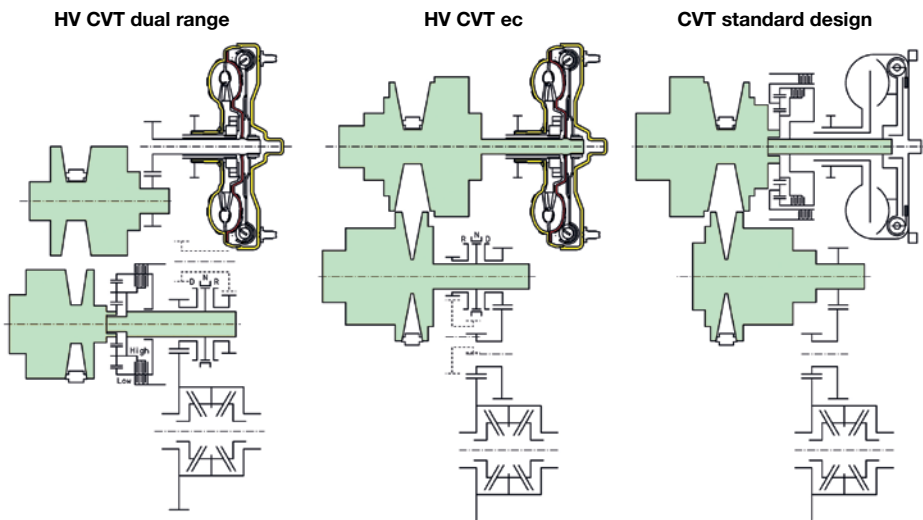
compared to the existing HV CVT. The advantages of the compact design and the variably selectable startup element can still be regarded as the main strengths of this concept. The reverse gear unit installed on the output side can also be combined with

a conventional spur gear stage without a toothed chain and with a conventional differential, as desired. A cost-effective variant that is designed for optimized use of space is also possible when a LuK iTC torque converter [2] is used.

**Single-range or dual-range structure**

As indicated in the introduction, defining the concept is the most difficult task within the transmission development process.

In the past, a so-called “standard design” became the mainstay of CVT transmission concepts for front transverse applications (Figure 2). In this design, the pulley set on the drive side is installed directly on the crankshaft’s axis and thus without an input gear stage. A planetary gear set with multi-plate shifting elements for reversing the direction of rotation is installed in front of this, and a torque converter is most frequently used as a startup element.



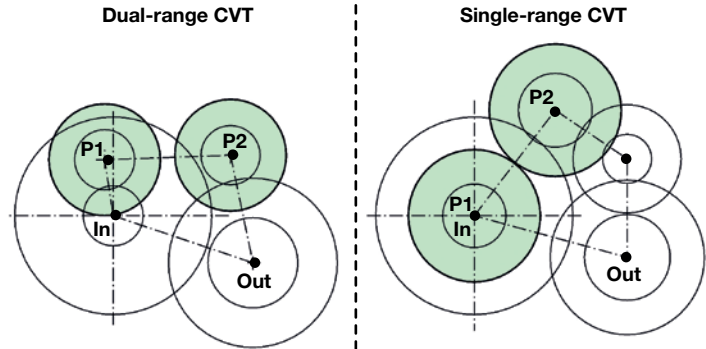
**Figure 2** Comparison of CVT concepts for front transverse applications

The HV CVT concept is the direct opposite. In the HV CVT, the assembly for reversing the direction of rotation is located on the output side and the cone pulleys are arranged in mirror-opposite fashion. This provides a very compact arrangement with optimum use of installation

space, particularly when combined with the LuK chain. The reverse gear installed on the output side also allows the transmission input range to be made very flexible with various startup elements. Most of all, hybridization is thus significantly simplified.

Jatco has now brought a dual-range CVT onto the market [3]. Because of the range shifting, there had previously always been a degree of skepticism about whether a dual-range CVT would be accepted by CVT customers who are accustomed to a certain level of comfort. However, Jatco has now successfully proved the skeptics wrong.

Figure 2 shows a sketch of the LuK HV CVT dual-range. This transmission design draft further simplifies the arrangement of the planetary gear set in comparison to that of the solution already on the market. Range shifting now only requires a single planetary gear set, meaning that this can also be easily and flexibly adjusted to various torque classes. The design-dependent input gear stage and the reverse gear installed on the output side in turn provide a higher degree of flexibility for the arrangement of a range of startup elements and for possible hybridization. The main advantage of the dual-range structure is that the variator can be dimensioned significantly smaller than in the case of a single-range



**Figure 3** Cross-sectional view of dual-range CVT and single-range CVT

CVT while maintaining the same gear ratio spread. In addition, ratio spreads of up to 10 are possible without the variator – and thus the transmission – having to be made disproportionately large. Figure 3 shows a comparison of the transmission cross-sections of a dual-range CVT and a single-range CVT (with their main axes) with identical gear ratio spread. The diameters of the cone pulleys are highlighted in color. The difference in the design envelope is clearly visible.

It can be summarized that a “standard design” CVT has the least suitable and least flexible design envelope with regard to future powertrains. In particular, this arrangement is the longest of the three concepts along the crankshaft axis, which is essential to the design envelope. Hybridization is difficult to achieve due to the planetary gear set for reversing the direction of rotation, which is installed on the drive side.

The two HV CVT concepts display comparable advantages in terms of length and the possibility of hybridization. The dual-range concept has the best cross-sectional arrangement. When it comes to costs, the outlay for the planetary gear set in the case of the dual-range concept must be compared to the additional outlay for the larger variator in the case of the single-range concept. The single-range concept proves to

have a slight advantage here. The dual-range concept displays the greatest advantage in that larger gear ratio spreads can be implemented in combination with high torque capacity. There is no strict limit as to when it is better to implement a single-range or dual-range concept. A possible variation is presented in the next section with regard to this issue.

## Modular front transverse variator system

The selection of a single-range or dual-range structure essentially depends on which total gear ratio spread has to be

achieved at which input torque. High torques are essentially not a problem even with large gear ratio spreads when a LuK chain is used as the linking element. Sooner or later, however, the limit is reached when it comes to a competitive design in terms of design envelope, weight, and variator mass inertia. When a LuK chain is used, gear ratio spreads of up to 8.5 can be competitively achieved in a single-range system with no problems, even at high torques. This can be explained by the small minimum wrap radius that can be achieved and by the low height of the chain, among other factors.

The illustration of a front transverse modular variator system – using a LuK chain as the linking element – displayed in Figure 4 shows that, unlike competing transmission concepts, the design envelope

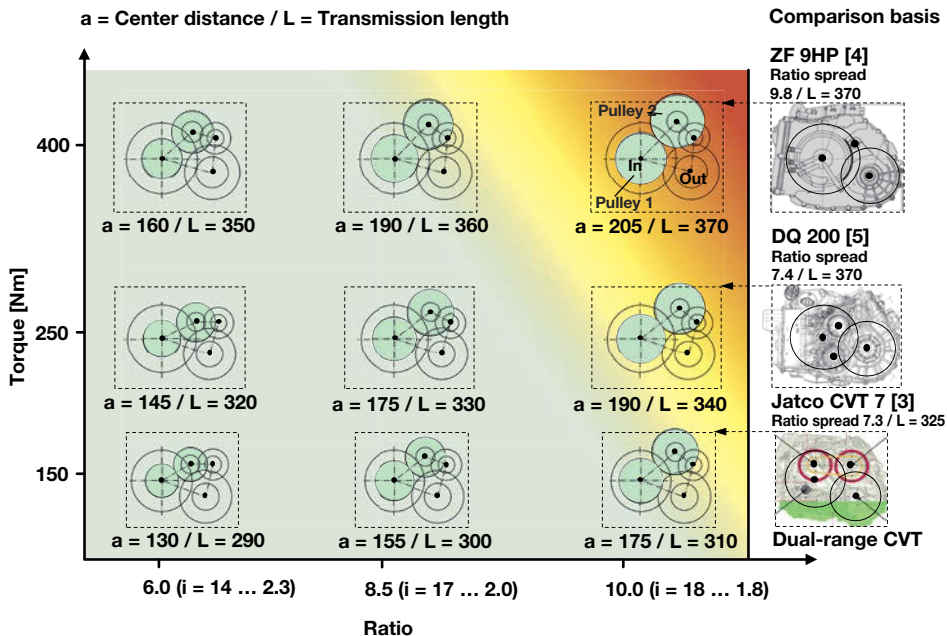


Figure 4 Modular front transverse chain variator system for a single-range structure

lope limits are not exceeded until gear ratio spreads of almost 10 are achieved. Of course, the higher the desired torque capacity, the faster the limit of competitiveness is reached. The yellow-to-red area represents a feasible dual-range structure for making the CVT competitive even with large gear ratio spreads. In cases such as special efficiency optimizations, however, a dual-range structure can also be advantageous with lower torques and medium gear ratio spreads with a chain as the linking element.

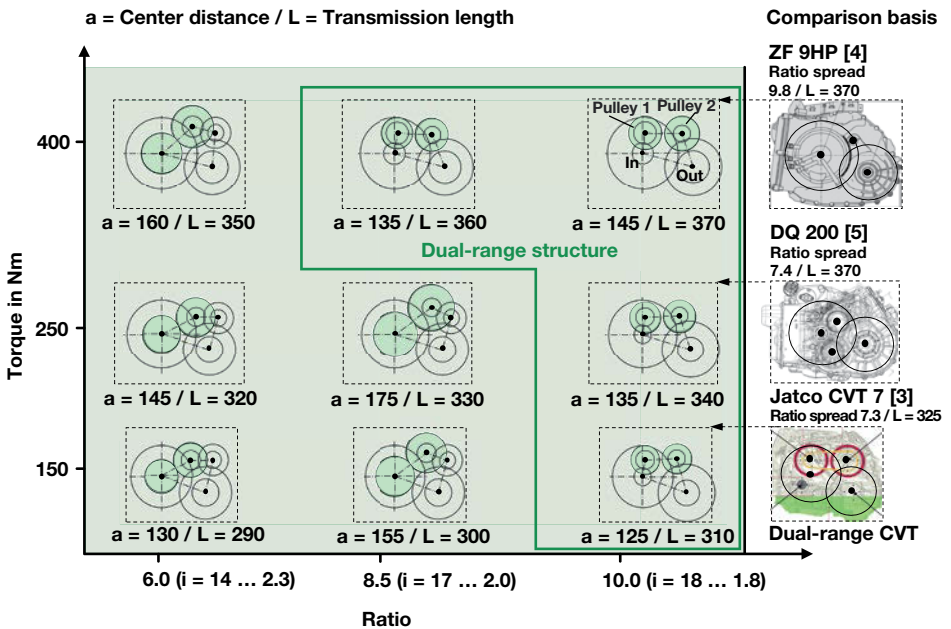
Figure 5 illustrates how the modular transmission system shown in Figure 4 changes when the range is implemented as a dual-range structure with a large gear ratio spread and a high torque.

It can clearly be seen that a CVT can competitively cover all ranges that are expected from front transverse drives. When

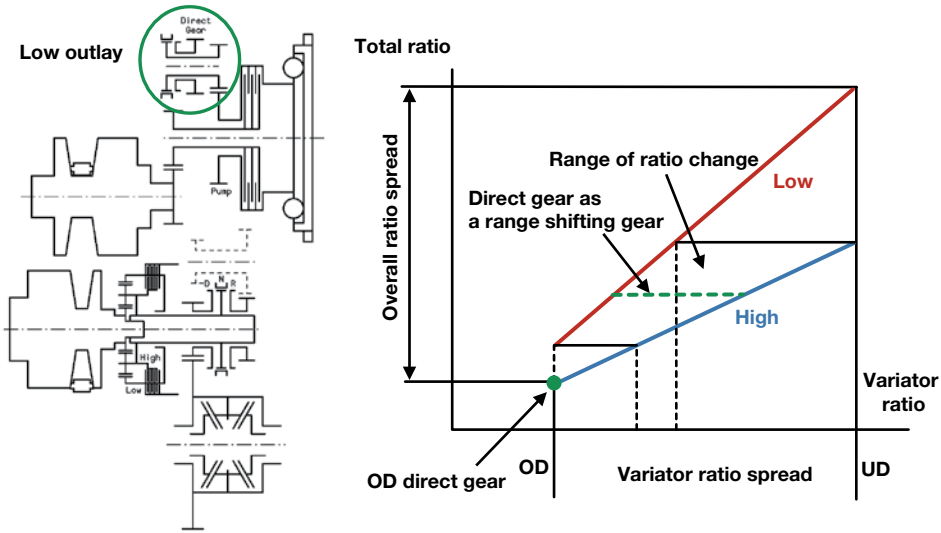
the aspect of hybridization – which in the future will be universally in demand – is taken into account, CVT technology must be regarded as a ground-breaking transmission technology in the front-wheel drive sector.

## Fixed-ratio gear stages

A further option for increasing efficiency is the introduction of a fixed-ratio gear stage. This variant offers a wide range of possibilities for further optimization. Numerous combinations of CVT variators with spur gear stages arranged in parallel have been brought onto the market in the past. In this case, however, we present a very space-



**Figure 5** Modular front transverse system for a single- and dual-range structure



**Figure 6** HV CVT dual range with direct gear stage

saving version that can also be used to allow the optimized use of an electric motor in a hybridized powertrain.

Figure 6 shows the implementation within a dual-range structure. In this case, the fixed gear ratio can be used either as an overdrive stage or as a direct shifting stage for range shifts.

The special feature of this design is that the spur gear stage, which is arranged parallel to the variator, is directly coupled with the engine damper and not in series behind the starting clutch or a torque converter. The direct gear stage can thus also be combined with the permanently driven pump gear stage, for example. In this arrangement, the direct gear stage requires almost no changes to the design envelope and only minimal additional outlay. The spur gear on the transmission's input side meshes directly with the large spur gear on the differential's output side here.

When used as an overdrive direct gear stage for the entire transmission, the spur

gear ratio is selected in such a way that it can be engaged without a difference in speed using a dog clutch once variator overdrive has been reached. As soon as the flow of force has been closed via the spur gear stage, the variator can be completely decoupled in an efficiency-optimized way on the drive and output side. The intelligent use of route information (which will become increasingly comprehensive in the future) combined with current powertrain data means that this shifting operation can be carried out in a targeted way that allows it to remain unnoticed and is optimized in terms of fuel consumption.

The direct gear stage shown in Figure 6 can also be used as a range shifting gear stage. In order for the driver to notice the range shift as little as possible, the two operating ranges are implemented with a large overlap in today's applications. However, this leads to the loss of a large degree of overall ratio spread that, from a technical perspective, would actually be available. This can be made more effec-

tive through a range shift using a direct gear stage with an overall transmission ratio that remains the same – this is shown as a dashed green line in Figure 6. This allows the ratio ranges to be moved further apart and thus a larger overall ratio spread to be achieved without a larger variator. During the range shift, the drive energy is transferred to the differential via the direct gear stage with no dips in the tractive force. Meanwhile, the variator can be moved to the new range with no load. The engagement/disengagement of the direct gear stage can be carried out using a dog clutch without being noticed by the driver, as there is no difference in speed at the shifting element. When fast downward shifting (“kick down”) is desired within the high-ratio range, it is also possible to jump vertically to the low-ratio range without using the shifting gear stage. The engine speed is adjusted here using a multi-disk brake operated with slippage, which means that even spontaneously desired ratio shifts can be carried out quickly.

## High Value CVT multimode

Numerous facts that support the use of a CVT in front transverse powertrains have been illustrated by the innovations presented in the previous sections and by the modular CVT variator system presented here. The aim of the following section is to illustrate a transmission concept variation that takes these innovations as a starting point and provides groundbreaking possibilities with regard to hybridization.

The transmission variation known as the “High Value CVT multimode” is illustrated as a dual-range concept in Figure 7. The outlay for the planetary gear set for range shifting on the output side was further reduced in comparison to the High Value CVT dual range. Now, only a multi-disk brake is integrated for shifting to the low range. Because a direct gear stage is provided for range shifting (as described in the previous section), the shift to the

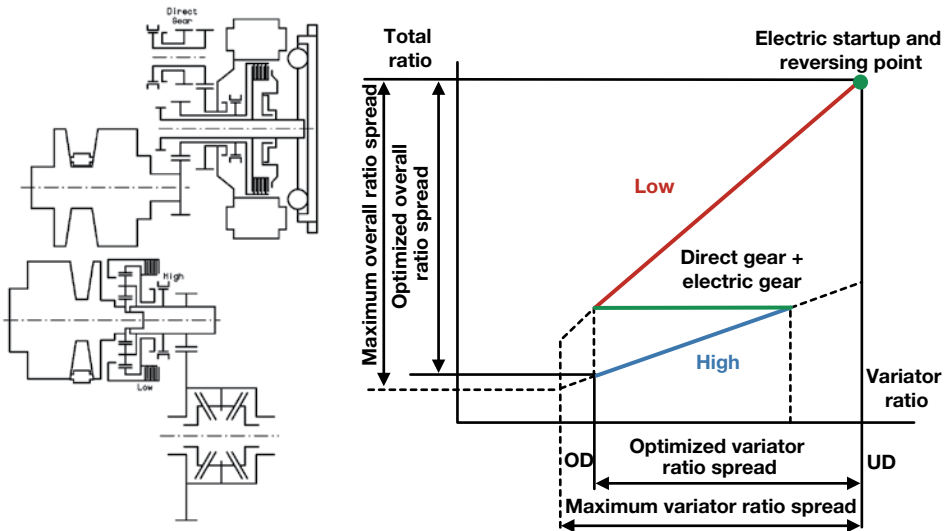


Figure 7 HV CVT multimode

high range can be carried out using a dog clutch.

The use of a direct gear stage for shifting between ranges also allows the variator to be utilized more effectively. It is possible, as illustrated by the dashed line in Figure 7, for the variator's utilization range to be limited in comparison to the current state of the art in overdrive while retaining the same overall transmission ratio, which means it can be operated with more optimized efficiency. The overall gear ratio spread could also be further expanded or the variator further miniaturized, however.

The concept is hybridized. Reversing is completely ensured by the integrated electric motor (a dedicated mechanical reverse gear is intentionally omitted for reasons of installation space, cost, efficiency, and comfort). To safeguard the functionality of this design, the hybrid battery can even be charged by the internal combustion engine via the electric motor when the vehicle is stationary.

The illustrated transmission architecture additionally offers a wide range of operational possibilities:

- The electric motor can be used to drive with optimum efficiency via the direct gear stage when the CVT variator is completely decoupled and stationary.
- When braking, energy can be recovered via the direct gear stage – and thus when the internal combustion engine is decoupled – without an additional KO being required.
- The electric motor and the internal combustion engine can be operated in parallel at different speeds via the direct gear stage and the CVT variator, respectively.
- The electric motor can of course also be operated via the CVT variator. For electric starting when a large wheel torque is needed, it is planned that the variator should be operated at the UD end stop, thus utilizing the entire available transmission ratio.

- Finally, the electric motor can be used to boost the internal combustion engine via the direct gear stage while driving at maximum torque without the chain variator being subjected to any additional load.

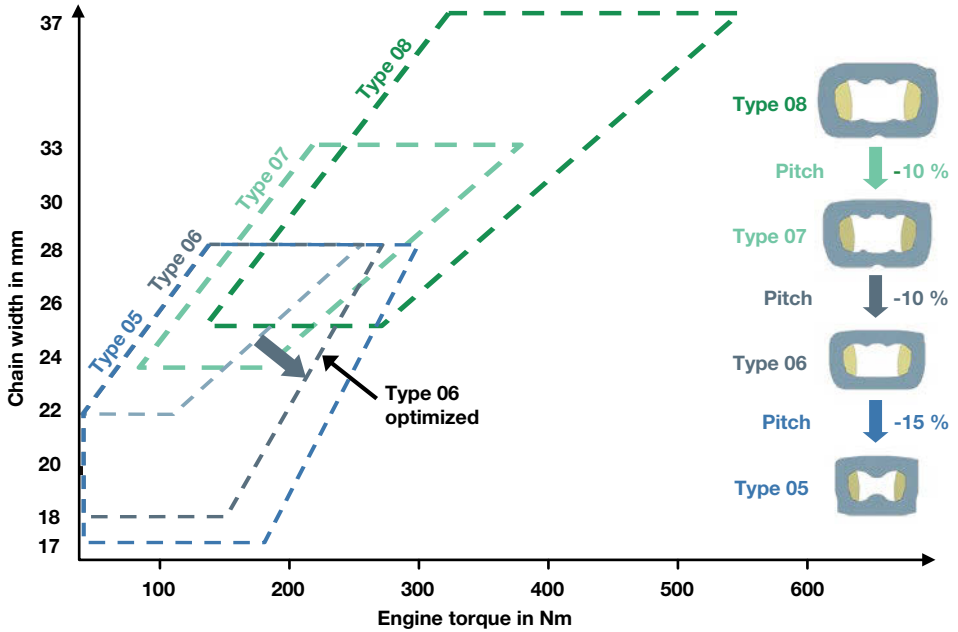
Despite these numerous functions and operating modes, this hybrid transmission concept can be made more compact than a CVT in standard design without a hybrid motor or transmission of a different type. This new transmission concept also offers possibilities for gear ratio spreads of up to 10 in all common torque ranges. Compared to other hybrid transmission concepts with the same functionality, a result that is also attractive in terms of costs is to be expected.

## Chain 05 – the next generation

---

The CVT chain has been undergoing constant further development over the last few years, which has made it possible to continuously increase its performance density. It was possible at the same time to retain the positive characteristics, such as the excellent level of efficiency. The latest measurements indicate that this efficiency level is up to 4 % higher (depending on the operating point) than that of comparable linking elements from our competitors. Significantly higher overall gear ratio spreads can also be achieved with this chain, which means that the overall efficiency of the powertrain can be further improved as explained earlier. Because of the chain's good scalability, higher torque applications – particularly in combination with powertrain hybridization – can be achieved with a long operating life. Figure 8 illustrates the torque capacities of the different chain types.





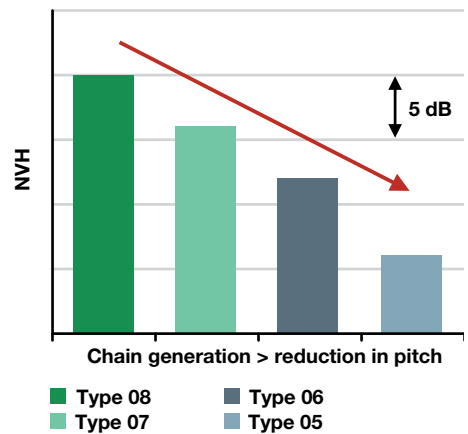
**Figure 8** Torque ranges of the different chain types

The application of the chain in smaller vehicles, however, requires a further improvement in the chain’s acoustics in order to reduce the outlay in the vehicle to a minimum. The chain’s pitch is a variable that has a major effect on the acoustics. The aim was therefore to develop a new generation of chains with a pitch that is reduced by a further 15 % while retaining at least the same torque capacity compared to type 06 [1].

**Optimized acoustics through reduced pitch**

The reduction of the chain plate pitch over the course of each new chain generation (08 > 07 > 06) has allowed the chain’s acoustics to be significantly improved. The lower the pitch of the chain, the more links are present in the same length of chain and the lower the speed at which each link

comes into contact with the pulley set. The impulse of impingement becomes lower as the number of links in the chain’s length increases (see Figure 9).



**Figure 9** Reduction of noise emissions as the pitch is lowered

In order to further utilize this effect, the 05-generation chain was developed, with which the pitch is reduced by a further 15 % compared to the 06-generation chain.

### Only as strong as the weakest link

The requirements for the “small” 05-generation chain were ambitious. It had to achieve the same degree of strength as the 06-generation chain while likewise maintaining the smallest possible running radius and without falling below the outstanding efficiency level of its “bigger brother”.

How is it possible to support identical or even higher loads using chain components that have a smaller cross-section? The key to achieving this is an in-depth understanding of the stress processes to which the components are subjected. For this purpose, some entirely new calculation tools were developed that determine the damage to the components with even greater precision and facilitate their optimization.

In simple terms, the new calculation tools determine the exact stresses placed on the components in the weakest chain

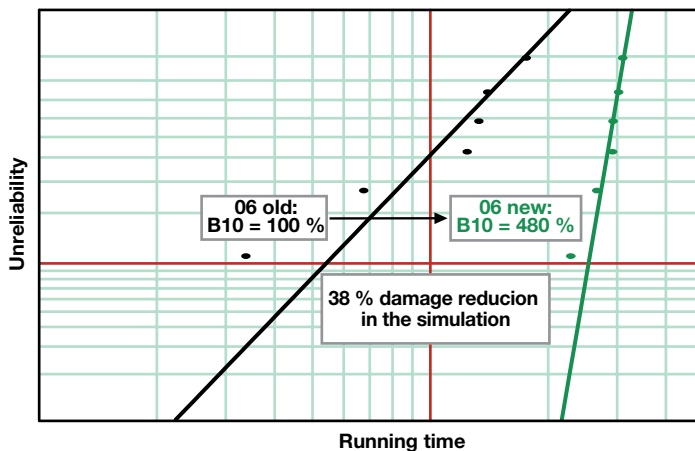
link that are subjected to the highest load, and these are then applied in calculating the damage to the components. In addition, the changes to the components due to the manufacturing processes are taken into consideration.

### Confirmation by measurement

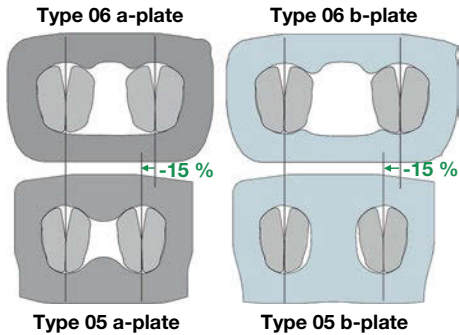
During the development of the new calculation methods, a temporary version of the procedure was used in order to evaluate a relatively simple optimization of the existing 06 geometry. This produced a calculated damage reduction of approximately 38 %, which was inspected using a high-load underdrive test (strength test in the startup ratio). The B10 value of the measured chains was approximately 4.8 times higher than that of chains with no geometrical changes, which already made a convincing case due to their good running time results (see Figure 10). The calculation results were therefore confirmed.

These new calculation methods mean that it is now possible to determine the optimum geometry. Figure 11 illustrates the comparison between the existing 06 generation and the initial prototype of the 05 generation.

The obvious course of action is to transfer the new design ideas to the existing larger chain variants. This will make it possible for applications that today are equipped with a 08 pitch to be operated with an optimized 07 chain in the future.



**Figure 10** Results of continuous underdrive tests on the 06-generation chains



**Figure 11** Comparison of the 06 and 05 chains with adjusted geometry

### Targets far exceeded – improved acoustics with a longer operating life

The loads of the 05 chain were simulated for an existing customer transmission application with a maximum input torque of 250 Nm. The calculations show a 21 % reduction in damage compared to the previously critical point. If the relationship between the damage reduction and the actual operating life is similar to the values from the aforementioned underdrive tests with the 06 chain, a significant increase in chain strength is to be expected.

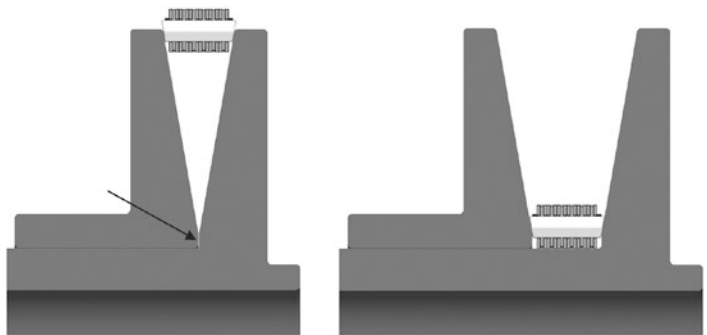
At the same time, the mass distribution over the chain's length was optimized. Previous tests have shown that it is possible to further improve the acoustics of the chain by homogenizing the mass over the chain's length. The previous long-plate links have a lower relative mass in relation to their length than the short-plate links. It was possible to optimize the mass distribution over the length of the chain

by filling in the center area of the chain plates (Figure 11). The maximum mass difference over the length was approximately 14 % for the 06 chain, which was reduced to 12 % for the 05 chain. The implementation of the 15 % smaller pitch and the improved mass distribution means that a significant improvement in the chain's acoustics is achieved.

### The potential of narrow 05 chains

The minimum width of a chain is limited by factors such as the pulley geometry. The pulley angle and the dimensions of the pulleys define the smallest possible chain width. Figure 12 illustrates an example of how the pulley geometry limits the smallest chain width.

A test was carried out using an existing CVT application in the 140 Nm class to discover how high the maximum transferable torque would be with the smallest possible 05 chain. For this purpose, the smallest chain width at which the pulleys do not quite reach their end stop when the gap is closed was determined for the stated transmission application. This produced a chain width of 17.5 mm. Chain calculations indicate that a "narrow" chain of this type would allow not only the cal-



**Figure 12** Limitation of the smallest chain width by the pulley geometry

culated application to be carried out but also that up to 180 Nm could be transferred in underdrive.

### The use of a narrow chain saves weight

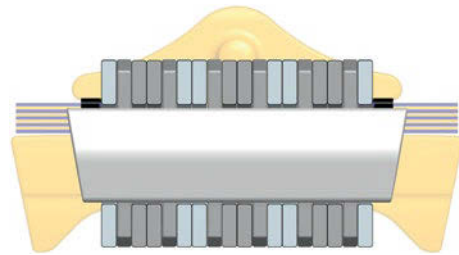
The 1705 chain is approximately 7 mm narrower than a 24 mm push belt and a 2406 chain. A weight saving of more than 300 g is achieved in comparison to the push belt, and a saving of 70 g is achieved even in comparison to the 2406 chain. Figure 13 illustrates a size comparison between the 1705 chain and a 24 mm push belt.

A narrower chain affects the design envelope and the overall weight of the transmission, however. In comparison to a small CVT with a 24 mm push belt, weight savings of up to 650 g are conceivable on the pulley sets, the linking element, the aluminum housing, and small components.

## Summary

The High Value CVT concept continues to make a convincing case due to the modularity of the system when it is combined with a chain from the new 05 generation. The new generation of chains has a 15 % smaller pitch and a higher torque capacity than the 06 generation. Even single-range transmissions can achieve very high ratio spreads with these chains. In dual-range transmissions, the size of the variator can be significantly reduced for ratio spreads of up to 10. This brings with it additional benefits in terms of weight and with regard to mass inertia reduction.

The High Value CVT multimode concept shows further possibilities for increasing the



**Figure 13** Comparison of a 1705 chain and a 24 mm push belt

efficiency and functionality of the CVT. Improved hybrid technology is possible with a reduced outlay in comparison to other transmission concepts.

## Literature

- [1] Teubert, A.; Englisch, A.; Goetz, A.: The compact High Value CVT transmission - Efficient, economical and innovative. VDI Reports 2130, 2011, pp. 448-450
- [2] Lindemann, P; Steinberger, M.; Krause, T.: iTC – Innovative Solutions for Torque Converters Pave the Way into the Future. 10<sup>th</sup> Schaeffler Symposium, 2014
- [3] Nonomura, R.: Fuel Economy Improvement Technology and Control System in New CVT. CTI Symposium, 2010
- [4] Greiner, J.: Automatgetriebe-Baukasten für Front-Quer-Anwendungen. Fachtagung "Getriebe in Fahrzeugen", 2011
- [5] Schaefer, M.: Volkswagen's new dual-clutch transmission. CTI Symposium, 2007

NU DH IU EA S M . . . . .  
 O IEUG I AF E D O N G I U A M U H . . . . .  
 B H M G R I B D P S I L Q N V X D B P O R U T E . . . . .  
 S J T D S Y K J H C D L D B E U B A F V N K F N K R E W . . . . .  
 A O E U A N D O N H P F L K J K O I U Z T R E W Q Y X C V B N . . . . .  
 N D U N G E U A R A H I O G D N F D P R N G M D S A U K Z Q I N K . . . . .  
 O I J G C O 2 N C E P T - 1 0 % L N C A W Z Y K F E Q L O P N G S A Y . . . . .  
 C N T Z D S Q O M F D N V U S G R V L G R A K G E C L Z E M S A C I T P M . . . . .  
 R L U J G D I N G F E E O M N Y A Z T E F N A X J R C N I F Z K M N D A B O N . . . . .  
 E S O P M N V C S L Y L I N E W C L V V V H N V U A J K U V X E S Y M N R E E W C . . . . .  
 A H I N C W Q Y J L E O B R N L N F X T J G L D Q F H B V T G U P W Q V Z E S L N F A M . . . . .  
 M S E B U N O P L R Q A Y C B E F V B N C T E N A O D F E C K T A C T S V Q D E F B N I M . . . . .  
 Q O P B D E G B E Z P M N E S W L N C A P Z Y K F E Q L O P N G F G R G H N W E D W C Y Q B . . . . .  
 Z W E D C V B S C H A E F F L E R H A C T I V e D R I V E T Z H N A X C F T J K J Z M H Z D . . . . .  
 W P O I U Z T R E S Y Q H G F D L G E N D R R T C A S N I N R O A X E V E D K D L A G Q S W I . . . . .  
 C E F H Z O K H E S B B U P S K U P P L U Y G S G E B E R Z Y L I N D E R Z N U B F I M B C H . . . . .  
 S G B Z N J I O P R I D C V F E W C V T E E N M Z G O H A S E D C K L P S X W E F C E C B S T . . . . .  
 Q R I U Z T R E W I L K J H G F D S A M O B V C X Y M L M O K N I J B H U Z G F D G V T Q U . . . . .  
 T R D X E S Y W A D P H C E Q A Y W S X Z E C R F V E G B Z H N U J M I K O Q A Y L M R T X . . . . .  
 P J M F I J H L M O K N I J U H B Z G V T F C R D X E S N W A S R E C V F H K N U T E Q T F . . . . .  
 C G T V D G L E T U O A D G J L Y C B M W R Z I P S F H K T V N Z L M O I J E U H B Z G W R . . . . .  
 J T Z G E T O I Z R W Q E T U O M B C Y N V X A D G J L K H E S Y S C B F G M H T I L Q N V . . . . .  
 V W M C R W U U M P F . . . . .  
 A K D P J K P S D E . . . . .  
 L S J T D S Y K J . . . . .  
 E K J R C K O I . . . . .  
 M O T Y Q O G N . . . . .  
 T N U E I N R L . . . . .  
 D C O O V C E S . . . . .  
 J Y I Z Q Y A H . . . . .  
 N J K V N J R A . . . . .  
 A A O O U A N D . . . . .  
 U D M B B D B H M . . . . .  
 A A O E U A N D O . . . . .  
 M O T M Q O G N T . . . . .  
 U D M T B D B H M G . . . . .  
 F E I D R E Q R I U Z T R E W Q L K J H G F D . . . . .  
 C I M N S T R E I L P Q A C E Z R W D X A Y H B . . . . .  
 P J M N I J H L M O K N I J U H B Z G V T F C R D X E S N W A S R E C V F H K N U T E Q T F . . . . .  
 C G T J D G L E T U O A D G J L Y C B M W R Z I P S F H K T V N Z L M O I J E U H B Z G W R . . . . .  
 J T Z U E T O I Z R W Q E T U O M B C Y N V X A D G J L K H E S Y S C B F G M H T I L Q N V . . . . .



# Schaeffler Demonstrator Vehicles

Concept vehicles for sustainable mobility –  
both today and tomorrow

Joerg Walz







## Schaeffler concept vehicles

Schaeffler is a global partner to the automotive industry that is dedicated to devising and implementing sustainable mobility solutions. Since 2009, the company has been using concept vehicles to demonstrate how individual products, when combined and linked together, can help meet the mobility requirements of tomorrow with respect to reducing CO<sub>2</sub> emissions and fuel consumption. To this end, the demonstrator vehicles also serve as a trial testing platform for engineers at Schaeffler's competency centers around the world so that different components and systems can be tested under realistic conditions. Three such vehicles have already been constructed as part of the diversification strategy pursued by Schaeffler and offer a glimpse at the broad product portfolio Schaeffler has to offer, which includes energy-efficient solutions for conventional powertrains equipped with an internal combustion engine, to products developed for hybrid vehicles, through to modular components engineered for all-electric vehicles.

**Figure** The Schaeffler CO<sub>2</sub>concept-10%, Schaeffler Hybrid, and Schaeffler ACTI-VeDRIVE vehicles follow the company's diversification strategy by showcasing a wide variety of concepts and solutions that target future automobiles.





## Ten percent lower CO<sub>2</sub> emissions

### End-to-end optimization of proven technology

The CO<sub>2</sub>ncept-10% concept car is an advance development project carried out by Porsche and Schaeffler that involved coordinating and harmonizing new and optimized components from the Schaeffler portfolio in the powertrain and chassis to achieve a combined 10 percent reduction in fuel consumption and CO<sub>2</sub> emissions. Not only was this figure computed using complex simulation calculations, but also attained by Porsche during sophisticated test bench trial testing.

The base vehicle is a Porsche Cayenne with a V8 gasoline engine. Throughout the joint project, Schaeffler was responsible for designing and verifying the individual components, while Porsche coordinated system internals and validated the overall vehicle.

In optimizing fuel consumption and the associated CO<sub>2</sub> emissions, the engine contributes to a partial reduction of 5.8 percent, the majority of which (-4.1 percent) can be attributed to the modifications made to the VarioCam Plus valve control system by integrating electromechanical camshaft phasing units (in place of the previous hydraulic version) and by optimizing the switchable tappets on the intake side. An additional 1.7 percent reduction was achieved by minimizing the friction loss with improved components throughout the valve train, belt drive, and chain drive assemblies. Double row angular contact ball bearings in the front and rear-axle differentials further lower consumption by 1.1 percent. These twin-tandem bearings replace the previous tapered roller bearings and considerably reduce the frictional resistance as compared to the series production transmission: -35 percent and a full -42 percent at the front and rear-axle differentials, respectively.

Even the chassis reduces consumption (-3.2 percent) with an electromechanical roll stabilizer taking the place of the conventional hydraulic variant and alloy wheel bearings in lieu of heavier steel ones.



## Schaeffler Hybrid

---

### An electric mobility concept car

The Schaeffler Hybrid is based on a compact Opel Corsa and was designed and built to serve as a concept car and a practically-oriented testing laboratory for various different hybrid solutions. This highly versatile advance development project facilitates a practical comparison between a large number of possibilities and options for realizing electric mobility. The driving modes available range from conventional operation using an internal combustion engine, to parallel and serial hybrid applications that utilize a range extender, through to fully-electric driving. To this end, the Schaeffler Hybrid features not only the standard internal combustion engine of the base vehicle, but also a centrally positioned electric motor and two wheel hub motors.

The internal combustion engine can power the vehicle and be coupled for use as a range extender, while an automated manual transmission increases the options

available. The accumulator – a 16 kWh lithium-ion battery rated to 400 V and 400 A – can be recharged via regenerative braking (range extender) as well as by plugging the vehicle into an external power outlet (plug-in hybrid). The central unit is connected to the automated manual transmission by means of a toothed chain and drives the front wheels. The unit comprises a liquid-cooled 50 kW and 95 Nm electric motor that was designed and manufactured by Schaeffler subsidiary IDAM. “E-Wheel Drive” is the name that has been given to the wheel hub motors developed by Schaeffler. The motors mounted in the Schaeffler Hybrid have an output of approximately 50 kW each and a torque rating that approaches 530 Nm. Schaeffler profits from its profound expertise in the field of wheel bearings and direct drive technology during the design and manufacture of these high-performance components. Accordingly, these wheel hub motors form a compact unit that integrates wheel bearing, drive and brake. The advantage of these drive units is the fact that they can be integrated in an existing vehicle platform for testing purposes without making any major changes to the vehicle architecture.



## Schaeffler ACTIVE DRIVE

---

### Electric vehicle with active torque splitting

The ACTIVE DRIVE concept car is based on a production Skoda Octavia Scout and is an all-electric vehicle with a four-wheel-drive system. One of the innovations the ACTIVE DRIVE boasts is an active electric differential, or eDifferential, which is mounted to both the front and rear axle. New for 2014 is a third-generation eDifferential for the rear axle assembly which, unlike the first-generation module installed on the front axle, has a much higher power density. The unit now features a 2-speed transmission that is coupled with a smaller electric motor for a higher maximum axle torque output of 2,000 Nm and higher top speeds in excess of 260 km/h. Despite this increase in performance and the integration of a power electronics module for the torque vectoring system directly on the axle, the space required by the axle drive and its total weight have been trimmed from

120 kg to 79 kg compared to the first generation. Both eDifferentials combine an electric drive with the option of controlling the drive power in each wheel independently. This facilitates torque vectoring (distribution of torque between the right and left wheels), which is beneficial for driving dynamics, safety and comfort. Due to the use of two active electric differentials, the concept car has an overall output of up to 170 kW, with power sent to all four wheels, as well as the capacity to distribute drive torque longitudinally.

The range of the vehicle in this configuration is up to 100 kilometers. The solution demonstrated in the ACTIVE DRIVE makes Schaeffler a pioneer of such electric concepts in a single vehicle drive system. At the same time, the potential application range of the eDifferential extends from extremely agile and dynamic sports cars, to more conventional passenger car setups, through to agricultural machinery.

Additional information on this topic can be found in section 14.



## Schaeffler offers customized products for efficient mobility in markets all around the globe

Schaeffler concept cars not only demonstrate the capabilities of technically-oriented solutions, but also underscore the capacity of global and regional development expertise coming together. Two examples of this are the Efficient Future Mobility North America and the Efficient Future Mobility India concept cars from Schaeffler. Both vehicles are undeniable proof that coordinating and integrating a host of Schaeffler technologies can offer additional, substantial potential for optimizing powertrains that utilize an internal combustion engine while symbolizing and characterizing the individual situations, needs, requirements and tastes that prevail in different regions. The same applies

to the E-Wheel Drive concept car, which was jointly developed with Ford based on the Ford Fiesta platform and features a wheel hub drive mounted in each of the rear wheel arches. Wheel hub drives offer a great deal of potential for realizing revolutionary new vehicle architectures and are a particularly attractive option for small, nimble city cars that draw their power from a battery pack. Viewed in the context of the current global trend toward urbanization and stricter environmental rules and regulations, the demand for vehicles of this kind will no doubt increase. Key target markets include the high-growth metropolitan areas in Asia and North and South America.



## Efficient Future Mobility North America

---

### Integrated technology for fuel savings of up to 15 percent

This concept vehicle is based on the current version of a mid-size SUV that is popular in North America and features an automatic transmission with a torque converter. The solutions highlighted take the market-specific demands and customer requirements in North America into account. By integrating and coordinating different Schaeffler technologies, a reduction in fuel consumption of up to 15 percent can be achieved, depending on the user profile. This, in turn, makes it possible for the large vehicles so popular in North America to also take a big step toward complying with CAFE standards. CAFE stands for Corporate Average Fuel Economy and describes the USA's increasingly restrictive legal regulations for fleet consumption with regard to the targets set for 2020 and 2025.

To optimize fuel consumption, the AWD disconnecting clutch, which decouples the unused drive axle from the powertrain depending on the driving situation (e.g. on the highway), is capable of reducing fuel consumption by up to 6 percent all by itself. Further savings are achieved by integrating a thermal management module, which allows the engine to reach its rated operating temperature as quickly as possible while precisely controlling and regulating heat levels, including for other major powertrain assemblies such as the transmission and/or hybrid componentry. Also on board are Schaeffler innovations for engine start-stop systems such as the permanently engaged starter generator with a wrap-spring one-way clutch and a latching valve. Thanks to the permanently engaged starter generator, in-town fuel consumption can be reduced by up to 6 percent while at the same time improving comfort levels during change-of-mind situations. The friction-optimized fine tuning of the belt drive, valve train, and balancer shafts, as well as the optimized torque converter, further contribute to the impressive overall result. Additional information on this topic can be found in section 32.



## Efficient Future Mobility India

---

### Fuel-saving potential of up to 10 percent for the growth market in India

The vehicle developed in India is a rolling test bed based on a low-cost compact car with a manual transmission that is very popular in the country. The Efficient Future Mobility India concept car is the combined result of the research and development work that went into optimizing the powertrain for the special conditions, driving behavior, and market constraints that prevail in India. In so doing, the car offers a vision of where powertrains may be headed in emerging markets.

Efficient Future Mobility India integrates a selection of powertrain technologies developed by Schaeffler that focus on the special conditions present in the automotive market in the country. Together, they make it possible to reduce

fuel consumption and CO<sub>2</sub> emissions by up to ten percent while improving driving comfort. Included among the products showcased in the vehicle equipped with a manual transmission is the electronic clutch management system, or ECM, which replaces the clutch pedal with an actuator. Coupled with sensor-based gear detection, the vehicle facilitates automated driving. This aspect is especially important in the metropolitan areas in India, which are renowned for stop-and-go traffic.

Other innovations the Efficient Future Mobility India offers are automatic detection of optimal gearshift points and the integration of an engine start-stop system, variable cam timing (VCT), specially coated valve tappets, and an intelligent thermal management system.

All of the solutions presented in the vehicle are relatively inexpensive to implement, are close to production launch, and can make a significant contribution to improving the performance and fuel efficiency of compact cars.



## Schaeffler concept car Fiesta E-Wheel Drive

---

### The power of choice for tomorrow's city car.

The E-Wheel Drive concept car is a development vehicle that was designed and built together with Ford and is based on a Ford Fiesta platform. The compact car is powered by two wheel hub drives mounted in the rear wheel arches, whereby the wheels house all of the components required to propel and brake the vehicle as well as ensure safety. This, in turn, allows the platform to be optimized to provide as much space as possible for passengers and luggage as well as generously accommodate the battery pack and electronics and communications systems.

Each drive unit can generate up to 40 kW of power, and the entire powertrain is rated for a continuous output of 66 kW (2 x 33 kW). This corresponds to a conventionally powered vehicle that has 90 to 110 horsepower. Much more impressive, however, is the fact that the liquid-cooled wheel hub drive developed in the beta stage is capable of produc-

ing up to 700 Nm of torque! As a result, the current E-Wheel Drive Beta has one-third more power and 75 percent more torque than the first-generation wheel hub drive (alpha) used in the 2010 Schaeffler Hybrid concept car, which was based on an Opel Corsa.

The highly integrated wheel hub drive makes it possible to fundamentally rethink and redesign the city car. Fitted in electric vehicles used in urban environments, the drive offers unprecedented levels of space and room. The Fiesta E-Wheel Drive also provides for exceptional driving dynamics, since the two drive units not only combine to form a stability control system, but also realize a torque vectoring facility, which sends torque to the drive wheels in real time, based on the vehicle's movements. Highly integrated wheel hub drives therefore allow engineers to maximize cabin space as well as significantly improve maneuverability, driving dynamics, and active safety. This can play a key role in the future, especially in conjunction with autonomous driving systems. Schaeffler's highly integrated wheel hub drive thus provides something of a „key“ to „unlock“ new vehicle concepts that will be leveraged in tomorrow's automobiles. Additional information on this topic can be found in section 30.



Schaeffler concept car at the Silvertta E-Auto Rally in Montafon, Austria.

Harmonization of chassis, dynamic handling control, and torque vectoring.



The Fiesta E-Wheel Drive during extended testing in the freezing Scandinavian winter.



U L  
 W E D V  
 J K J Z M H L  
 D L A G Q S W I E I  
 U B F I M B C H S E H E L  
 E W C E C B S T P O I O D C V F E V L  
 C X V N H D G S C B M W R Z I P S F H K T V I V  
 Z V T F L E T C B C Y N V X A D G J L K H E S Y S C L  
 X D B P O R W H T W H N E D K U N W P O N C A L V I K Z I V  
 D C S K U T E A M B C Y N V X A D G J L K H E S Y S C B M B C Y I  
 E W C B P W R E Z T W H N E D K U N W P O N C A L V I K Z T W H N E L  
 W D X S K T P F I O D C V F E W C V T E B N M Z G O H A O I U Z T R E W Q  
 L Z U C E S G F V N P I Z R W Q S C G Z N J I M N S T R V A P I Z R W Q S E W  
 R U C X A S O L V I N G J T H E U P O W E R T R A I N B P U Z Z L E L N C W Q S C  
 Q A T U K Q G E D N V U S G R V L G R V K G E C E Z E M D B V U U G R V L L N C X W  
 C L O C Z Z I R E X O M N Y A Z T E W N F X J L R N I E Z E M D K V U S G R V L G R V  
 F A M T S C V C Y L J N E W C L V V F H N V R D J K U R N I F E X O M N Y U S G R V L  
 K M N O M Y Q Y O B R E I N T I O N C O F H B Q F J K U V Y I J N E W M N Y A Z T  
 L I E M U J N J O I P M F D B Q F G O N R E L N N E W C L Y  
 B S A N S A U A H K Z M F D R O A D F N G E L N F X T  
 P I E E P D B D U K Z M F D R O A D F N G E L N F X T  
 R U C A T A U J G D N O I E R N G M D S A E W S P D F R B E F G D N O I E R  
 B S A E P O V U S G R V L G R V K G E C L K N I E A D G J L B E F B A F V V  
 D G V C Z L R B E F B A F V N K F N K R E W E M D G V U S G G J L E S E R K  
 Y L M A T L K J H G F D S A M M B V C X Y M L M S P D L R B E F U S G R V L G F  
 C X V V T V P H C E Q A Y W S X E E C R F V E G B C E Q A Y W S B E F B A F V V  
 Z V T M F M B C Y N V X A D G J L K H E S Y S C B M Y N V X A D G Y W S X E E N C  
 X D B P T E T M B C Y N V X A D G J L K H E S Y S M B C Y N V X A D G J L E S N  
 D C S K W R W Z T W H N E D K U N W P O N C A L V ? T W H N E D K U N W P F H K  
 N V X D R U T E T M B C Y N V X A D G J L K H E S : B M B C Y N V X A D G J L K  
 I P O W R W Z T W H N E D K U N W P O N C A K Z T W H N E D K U N W P  
 F L K J K O I U Z T R E W Q Y X C V B N M  
 H A S E S V N P I Z R W Q S C G Z N J I M  
 G I K C K P M N E S W L N C X W Z Y K F F  
 A S U S V N P I Z R W Q S C G Z N J I  
 I K C K P M N E S W L N C X W Z Y K F  
 O X O D N V U S G R V L G R V K G  
 I N E X O M N Y A Z T E W N F  
 C Y L J N E W C L V V F H  
 N V U S G R V L G







