

HUMAN-ANIMAL STUDIES



**Animal
Experimentation:
Working Towards
a Paradigm Change**

Edited by Kathrin Herrmann and Kimberley Jayne



BRILL

Animal Experimentation: Working Towards a Paradigm Change

Human-Animal Studies

Series Editor

Kenneth Shapiro
Animals & Society Institute, USA

Editorial Board

Ralph Acampora
Hofstra University, USA

Clifton Flynn
University of South Carolina, USA

Hilda Kean
Ruskin College, Oxford, UK

Randy Malamud
Georgia State University, USA

Gail Melson
Purdue University, USA

VOLUME 22

The titles published in this series are listed at *brill.com/has*

Animal Experimentation: Working Towards a Paradigm Change

Edited By

Kathrin Herrmann
Kimberley Jayne

VOLUME 22



BRILL

LEIDEN | BOSTON



This is an open access title distributed under the terms of the prevailing CC-BY-NC License at the time of publication, which permits any non-commercial use, distribution, and reproduction in any medium, provided the original author(s) and source are credited.

Cover illustration: Long-tailed macaque, Boo, was sent to an animal research laboratory in Europe together with her siblings, Betty and Baloo, where they were used in neurology experiments. Animal Defenders International rescued them in 2009 when they were due to be killed. They now live their lives free from suffering at Lakeview Monkey Sanctuary. We thank Australian contemporary realist artist, Anwen Keeling, for her kind contribution of the cover picture which she painted from a photograph taken by Animal Defenders International after Boo's rescue.

Library of Congress Cataloging-in-Publication Data

Names: Herrmann, Kathrin, editor. | Jayne, Kimberley, editor

Title: Animal experimentation : Working Towards a Paradigm Change / Edited by Kathrin Herrmann, Kimberley Jayne.

Description: Leiden ; Boston : Brill, 2019. | Series: Human-animal studies, ISSN 1573-4226 ; VOLUME 22 | Includes bibliographical references and index.

Identifiers: LCCN 2018048693 (print) | LCCN 2018056495 (ebook) | ISBN 9789004391192 (E-book) | ISBN 9789004356184 (hardback : alk. paper)

Subjects: LCSH: Animal experimentation.

Classification: LCC HV4915 (ebook) | LCC HV4915 .H47 2019 (print) | DDC 179/.4--dc23

LC record available at <https://lcn.loc.gov/2018048693>

Typeface for the Latin, Greek, and Cyrillic scripts: "Brill". See and download: brill.com/brill-typeface.

ISSN 1573-4226

ISBN 978-90-04-35618-4 (hardback)

ISBN 978-90-04-39119-2 (e-book)

Copyright 2019 by The Authors. Published by Koninklijke Brill NV, Leiden, The Netherlands.

Koninklijke Brill NV incorporates the imprints Brill, Brill Hes & De Graaf, Brill Nijhoff, Brill Rodopi, Brill Sense and Hotei Publishing.

Koninklijke Brill NV reserves the right to protect the publication against unauthorized use and to authorize dissemination by means of offprints, legitimate photocopies, microform editions, reprints, translations, and secondary information sources, such as abstracting and indexing services including databases.

Requests for commercial re-use, use of parts of the publication, and/or translations must be addressed to Koninklijke Brill NV.

This book is printed on acid-free paper and produced in a sustainable manner.

This book is dedicated to the non-human animals who suffer in the name of science and whose destiny we are determined to change.



Contents

Foreword	XI
<i>Peter Singer</i>	
Preface	XIV
<i>Kathrin Herrmann and Kimberley Jayne</i>	
Acknowledgements	XVI
Notes on Contributors	XVII
Introduction	XXXIV
<i>Kathrin Herrmann and Kimberley Jayne</i>	

PART 1

Why and How to Shift the Paradigm

- 1 Refinement on the Way Towards Replacement: Are We Doing What We Can? 3
Kathrin Herrmann
- 2 How to Evaluate the Science of Non-human Animal Use in Biomedical Research and Testing: A Proposed Format for Debate 65
Ray Greek and Lisa A. Kramer
- 3 How Can the Final Goal of Completely Replacing Animal Procedures Successfully Be Achieved? 88
Christiane Baumgartl-Simons and Christiane Hohensee
- 4 Disease Prevention with a Plant-based Lifestyle 124
Sabina V. Vyas

PART 2

Politics and Legislation of Animal Experimentation

- 5 Political Campaigning: Where Scientific and Ethical Arguments Meet Public Policy 151
Emily McIvor

- 6 Rethinking the 3Rs: From Whitewashing to Rights 168
Charlotte E. Blattner
- 7 Contesting Animal Experiments through Ethics and
Epistemology: In Defense of a Political Critique of Animal
Experimentation 194
Arianna Ferrari

PART 3

Openness in Animal Experimentation

- 8 The Moral Status of Animal Research Subjects in Industry:
A Stakeholder Analysis 209
Sarah Kenehan
- 9 Increasing the Transparency of Animal Experimentation:
An Australian Perspective 224
Monika Merkes and Rob Buttrose
- 10 Wasted Money in United States Biomedical and Agricultural Animal
Research 244
Jim Keen

PART 4

The Ethics and Philosophy of Animal Experimentation

- 11 Ethics, Efficacy, and Decision-making in Animal Research 275
Lawrence A. Hansen and Kori Ann Kosberg
- 12 Beyond Plausibility Checks: A Case for Moral Doubt in Review Processes
of Animal Experimentation 289
Mara-Daria Cojocaru and Philipp von Gall
- 13 Human Wrongs in Animal Research: A Focus on Moral Injury and
Reification 305
Jane Johnson and Anna Smajdor

PART 5

Effectiveness of the Animal Model

- 14 Critically Evaluating Animal Research 321
Andrew Knight
- 15 Extrapolation of Animal Research Data to Humans: An Analysis of the Evidence 341
Rebecca Ram
- 16 Is Animal-based Biomedical Research Being Used in Its Original Context? 376
Constança Carvalho, Daniel Alves, Andrew Knight and Luis Vicente
- 17 The Scientific Problems with Using Non-human Animals to Predict Human Response to Drugs and Disease 391
Ray Greek and Lisa A. Kramer
- 18 Replacing Animal Tests to Improve Safety for Humans 417
Kathy Archibald, Robert Coleman and Tamara Drake
- 19 Genetic Modification of Animals: Scientific and Ethical Issues 443
Jarrold Bailey
- 20 Animal Research for Alzheimer Disease: Failures of Science and Ethics 480
John J. Pippin, Sarah E. Cavanaugh and Francesca Pistollato
- 21 Behavioral Research on Captive Animals: Scientific and Ethical Concerns 517
Kimberley Jayne and Adam See

PART 6

Animal-free Education and Training

- 22 Modernizing Biomedical Training: Replacing Live Animal Laboratories with Human Simulation 551
John Pawlowski, David Feinstein, Marie L. Crandall and Shalin Gala

- 23 Humane Education: The Tool for Scientific Revolution in Brazil 567
Vanessa Carli Bones, Rita de Cassia Maria Garcia, Gutemberg Gomes Alves, Rita Leal Paixão, Alexandro Aluísio Rocha, Karynn Capilé and Róber Bachinski

PART 7

The Paradigm Shift: Advanced Animal-free Approaches

- 24 Recent Developments in Alternatives to Animal Testing 585
Katy Taylor
- 25 The Changing Paradigm in Preclinical Toxicology: *in vitro* and *in silico* Methods in Liver Toxicity Evaluations 610
Fozia Noor
- 26 The Potential of Organ on Chip Technology for Replacing Animal Testing 639
Malcolm Wilkinson
- 27 When Is an Alternative Not an Alternative? Supporting Progress for Absolute Replacement of Animals in Science 654
Craig Redmond
- 28 Research and Testing Without Animals: Where Are We Now and Where Are We Heading? 673
Thomas Hartung
- Afterword: Evidence over Interests 689
John P. Gluck
- Index 692

Foreword

Peter Singer

From the time when I first became interested in the ethics of our treatment of animals, I have always regarded the use of animals in research as a more difficult ethical issue than the use of animals for food. It is more difficult because we have a wide range of tasty and nutritious food to eat, and it is obvious that we can live healthy, flourishing lives without eating animals or animal products. It is true, sadly, that not everyone in the world has the luxury of being able to choose what to eat. For the vast majority of people living in developed countries, however, there is no need to eat animals or any animal products; and the animal products they eat increase the risks to their health (see Chapter 4 in this Volume). Those who continue to eat animals do it out of habit or because they like the taste. On the other hand, some scientists tell us that to cease using animals in biomedical research would greatly impede medical progress and, in the long run, could lead to millions more premature deaths and additional human suffering.

I am a philosopher, not a scientist, and my approach to issues relating to animals has always been from an ethical perspective. Some people think that taking an ethical approach to animal issues means that scientific claims about the benefits of animal research are irrelevant because, even if research on animals could save many human lives, the end does not justify the means. That is not how I see the issue. Although Kantians, and some other deontologists, hold that the end does not justify the means, consequentialists regard the right action as the one that will bring about the best consequences, so they hold that the end can justify the means. I am a utilitarian, and utilitarianism is the best-known form of consequentialism, so I share that view. As we can see from this book, there is a case to be made for the view that continued animal research could, in fact, be impeding scientific progress.

When it comes to protecting animals and giving proper consideration to their interests, utilitarians have always been in the lead. Jeremy Bentham, the founder of modern utilitarianism, wrote about animals, saying that, "The question is not, Can they reason? Nor, Can they talk? But, Can they suffer?". Implicit in the utilitarian emphasis on the capacity to suffer, and to experience pleasure, is the idea that all sentient beings have interests, and that similar interests should receive equal consideration, irrespective of race, sex, or species. In contrast, the mainstream Abrahamic religions, Judaism, Christianity, and Islam, all treat humans as entitled to use animals more or less as they wish,

often seeing this as stemming from a divine grant of dominion over other animals. Christian teachings, from Augustine through Thomas Aquinas, and innumerable others on into the twentieth century, take this line. Kant also said that we have no direct duties to animals, although the ground he gave for this harsh position is that they are not self-conscious and, so, are merely means to our ends. He does not explain why the absence of self-consciousness should be a sufficient reason for denying that we have duties not to cause gratuitous suffering to sentient beings.

Suppose that research on non-human animals turned out to yield misleading results, and only the use of one hundred human subjects, instead of the one hundred animals, would lead to the cure that would save thousands of lives. Defenders of animal research are loath to acknowledge that one implication of their defense of the use of animals in research might be that, in some circumstances, it would be justifiable to use humans. One objection to substituting humans for non-human animals would be that the greater self-awareness of the humans means that they have more to lose and, so, would suffer more from the knowledge that they are being experimented upon, than would the non-human animals. But not all human beings have more self-awareness than non-human animals. Anencephalic infants do not, nor do people who are brain dead, or in a persistent vegetative state from which they will never recover. The grounds on which Kant insisted that non-human animals are merely means to our ends, rather than ends in themselves, would seem to apply to these human beings as well. If they do not, why not? Should we give preference to human beings, irrespective of their consciousness, merely because they are biologically members of the species, *Homo sapiens*? How is that different to giving preference to members of one race or gender, merely because they are members of that race or gender? The institution of animal experimentation is clearly based on speciesism. Chapters 14 to 20 in this Volume explore the difficulties in extrapolating findings from animals to humans. These difficulties sharpen the question why we are willing to perform painful or lethal experiments on non-human animals, who are clearly capable of suffering, while we are unwilling even to contemplate similar experiments on human beings, who are not capable of experiencing anything at all.

When I wrote *Animal Liberation*, which first appeared in 1975, it was shockingly easy to find accounts of horrific suffering inflicted on animals in the course of experiments. These were not accounts written by animal rights activists (there were virtually none at the time anyway). They were written by the researchers themselves and were published in leading scientific journals. All I had to do to make the case that the interests of the animals were being utterly disregarded was to quote from these journals, and I did so extensively. Since

then, there has been progress in reducing animal suffering. European Union Directive 2010/63/EU has been widely regarded as indicating that, at least in the EU, pain and suffering is kept to a minimum, and animals are being replaced by non-animal-using methods wherever possible. The following pages contain evidence that strongly suggests this is not the case. Particularly telling are the observations, reported in Chapters 1 and 21 in this Volume, of abnormal behavior and signs of stress in animals caused simply by living in standard laboratory conditions. As these and other chapters show, even in Europe, there is no ground for complacency about what happens to animals in science. The situation is likely to be worse still in other countries. Nor should we neglect the cost of using money in ways that are not maximally productive of benefits. Chapter 10 explores the waste of United States public funds in research using animals and asks whether the benefits achieved by such research are sufficient to justify the cost.

This Volume, with its many distinct critical perspectives on research with animals, is therefore very timely, particularly as I write this when Directive 2010/63/EU is under review. I hope it will transform discussion about the ethics and the science of research involving animals.

Preface

For close to a decade, I worked as a federal regulator, inspecting experiments involving non-human animals (hereinafter referred to as animals) in Germany. Because I had always been skeptical about the ethical and most of the scientific justifications given for conducting invasive research on animals, I felt that as a veterinarian I should work within the current system to scrutinize these practices and help improve the lives of individual animals used in the name of science. By inspecting numerous animal laboratories and breeding facilities, and assessing countless animal research proposals and their scientific outcomes (if they were published), I became exceedingly aware of the considerable harms involved and the flaws of animal-based research on all levels—ethical, scientific, legal, political, and economic.

Alongside my work as an inspector, I carried out a PhD project, assessing the use of refinement, the last R of the 3Rs principles, in practice. Refinement refers to methods that ought to reduce animal suffering in the laboratory. I focused on experimental refinements in over 500 animal research applications comprising recovery surgical procedures from around Germany. My results show that the majority of evaluated proposals did not take all possible measures to avoid needless suffering. They confirm the trends found in structured and systematic reviews of published animal studies from around the world. Being a member of the competent authority, I frequently experienced its limits in safeguarding animals due to the way it is set up: decentralized, understaffed, and with limited resources.

Consequently, the political *aims* of reducing and replacing animals in science have remained political *claims*; and authorities are unequipped to ensure that only research projects that have a realistic potential to produce benefits, which outweigh the harms inflicted on the animals, are granted licenses. The poor application of refinement methods in laboratories, and a malfunctioning regulatory body emphasized, for me, the urgency for a paradigm change, away from using animals in science. Fortunately, in some areas this change is already slowly happening. But to accelerate the shift, it is crucial to appraise animal experimentation critically, from all angles, and to publicly discuss the findings—a realization that led me to initiate this book project. The 51 experts who contributed to this volume critically appraise current animal use in science, and they discuss innovative, human-relevant approaches to advance the life sciences and to accelerate the shift towards the replacement of animals in research, testing and education.

– Kathrin Herrmann

I have more than a decade of experience in research and education, working in animal welfare and animal protection. Originally, starting my career in zoos and laboratories, I chose to specialize in animal behavior and welfare because I felt that science had a role in improving the lives of animals used by these industries. However, based on my personal experiences working in these environments and hand-rearing animals to be used for behavioral laboratory research, my moral values shifted. With my increasing knowledge of animal behavior and welfare, I realized that these industries were seriously flawed, both scientifically and ethically. Increasingly, the scientific and educational research about animal behavior that I was exposed to on a daily basis informed me that the animals I was working with should not be used for these purposes.

I now work as a Senior Scientific Researcher for an animal protection organization that promotes phasing out animal use in these industries, particularly in the areas of animals used in research, education, and entertainment. The study of the behavior of all animals is fascinating; but only when the animals can express their natural behavioral repertoire, under natural conditions. I truly believe that furthering our understanding of wild animal behavior through non-intrusive means can help those campaigning and lobbying for greater animal protection, by enhancing appreciation for all species. Through generating more public support and using indisputable scientific rationale, which cannot be ignored, governments and policy makers can be influenced to make progress towards ending the use of animals in these environments.

– *Kimberley Jayne*

We first met back in 2014, at the University of Exeter, during a workshop that aimed to introduce perspectives from the humanities and social sciences to a dialogue with practitioners and stakeholders across laboratory animal science and welfare. Our mutual concerns about animals used in science led us to collaborate on this book project. Since we both work closely with researchers, scholars, and campaigners, who are active in the fields of animal protection, animal replacement technology, and ethical philosophy, the project rapidly evolved into a 28 chapter-volume. Our aim is to not only transform science, education, and policy into a more inclusive environment, but to continue to work on projects that consider the impact of human behavior on all species.

This book may be eye-opening for some and encouraging for others. Its ultimate goal is to motivate everyone to work together in order to end the suffering of our fellow animals.

– *Kathrin Herrmann and Kimberley Jayne*

Baltimore and London, August 2018

Acknowledgements

We greatly appreciate the monetary contributions made by Lush Charity Pot, Cruelty Free International, Lush Prize, The American Fund for Alternatives to Animal Research, Ärztinnen und Ärzte für Tierschutz in der Medizin, Safer Medicines Trust, and a private donor, who have enabled us to make this book freely available online. We are also grateful for the input and suggestions made by anonymous peer reviewers.

Contributors

Daniel Alves

studies the physiology of acoustic communication and has worked with insects and fish. He is currently completing his PhD at the University of Lisbon, Portugal. While a firm believer in the merits of animal experimentation, he believes that any improvement in the humaneness of animal experimentation is a desirable goal, and that science should always strive to ensure that animal sacrifice leads to advancements in human knowledge.

Gutemberg Alves

is a cell biologist with a PhD in biochemistry, and a professor at the Fluminense Federal University, Brazil. As coordinator of the Clinical Research Unit of the Antônio Pedro Hospital, he leads a research line in toxicological *in vitro* assays. Alves is a member of the Pyrogen Testing Consortium, in cooperation with the National Network on Alternative Methods (RENAMA). He is a founding member of the 1R Institute for Promotion and Research for the Replacement of Animal Experimentation (www.Instituto1R.org). As a member of Rede de Desenvolvimento Humano (Human Development Network), Alves also leads the development of strategies for teaching and using *in vitro* assays as alternatives in health and science classes.

Kathy Archibald

is the director of Safer Medicines Trust, United Kingdom. After graduating in genetics from Nottingham University, she worked in drug development for pharmaceutical and biotechnology companies (Searle Pharmaceuticals, MediSense). She then worked as a field teacher for a nature conservation charity, the *Royal Society for the Protection of Birds (RSPB)*, and the children's charity, Action for Children. In 2005, Archibald founded Safer Medicines Trust, to confront the unspoken problem in pharmaceutical research of the poor relevance of much research (based on animals) to human medicine. Safer Medicines Trust exists to improve the safety of medicines for patients through an increased focus on human biology throughout the drug development process.

Rober Bachinski

studied biological sciences (2009), holds a Master's degree in public health and environment with an emphasis on environmental toxicology, and a PhD in science and biotechnology (2015). He is dedicated to the study of new research

methods that do not use animals and is experienced in *in vitro* toxicological methods, cellular interactions, development and validation of analysis methods, humane education, and animal ethics. Bachinski is also working to implement humane education in Brazil and end speciesism in science. He is a founding member and the current Director of the iR Institute for Promotion and Research for the Replacement of Animal Experimentation (www.InstitutoiR.org).

Jarrold Bailey

PhD, is the Senior Research Scientist at Cruelty Free International (formerly the British Union for the Abolition of Vivisection [BUAV]). His chapter on genetically modified animals in this volume reflects his background as a genetics researcher. He spent seven years investigating the possible causes of premature birth in humans and has extensive experience in evaluating the scientific validity and ethics of animal experiments. Bailey has examined and reviewed the limitations of using animals in various fields, including the testing of substances that can cause birth defects and cancer; the use of non-human primates in various forms of medical research, including HIV/AIDS, cancer, and hepatitis; the use of genetically modified animals generally; and the use of dogs, monkeys, and other species in testing new human drugs. He has authored several substantial scientific petitions and submissions of evidence to a variety of inquiries into the validity of animal research worldwide and several book chapters by invitation.

Christiane Baumgartl-Simons

Dr. med. vet., is the deputy chairwoman of Menschen für Tierrechte – Bundesverband der Tierversuchsgegner e.V. (People for Animal Rights Germany – Federal Association Against Vivisection). After studying veterinary medicine and completing her doctorate, Baumgartl-Simons worked in the curative treatment of large and small animals for 14 years. Animal experiments have been of particular interest to her since 1983. She has worked for People for Animal Rights since 1995 and her main focus has been animal experiments, animal-free methods, and lobbying. She is a member of several committees and boards including, German Federal Animal Welfare Committee, Committee Pursuant to Section 15 of the German Animal Protection Act, and Advisory Board for Animal Welfare. For several years, Baumgartl-Simons has considered the strategies for withdrawing from animal experiments. Her work has culminated in ideas for a masterplan in the form of five pillars. She is pleased to have the opportunity to share her ideas in this volume.

Charlotte Blattner

is a postdoctoral fellow at Harvard Law School, Cambridge MA, working at the intersection of environmental law and animal law. Previously, she was a postdoctoral fellow at the Department of Philosophy at Queen's University, Canada, where she explored the utility of thinking about animals as workers. She received a PhD in international and animal law from the University of Basel, as part of the "Law and Animals" doctoral program. In her PhD, Blattner developed ways in which states can respond to the ongoing regulatory race to the bottom in animal law, notably, through extraterritorial jurisdiction. She is a former visiting international scholar at Lewis & Clark Law School and has worked as a research fellow for the foundation Tier im Recht, based in Zürich, Switzerland. Blattner has authored numerous publications in animal law, international and trade law, as well as environmental law. The disconcerting underdevelopment of animal law and the need to evaluate law critically, in light of our growing knowledge of the non-human animal world, prompted her to explore means for a paradigm change for animals in research.

Vanessa Carli Bones

is a postdoctoral fellow at the Federal University of Paraná, Brazil, with an emphasis on the welfare of animals used in laboratories. She studied veterinary medicine at the Federal University of Santa Maria and completed her Master's degree and PhD in veterinary sciences at the Federal University of Paraná. In her Master's and PhD studies, she focused on the welfare of laboratory animals and methods to replace them. During this time, Bones had opportunity to participate in several scientific events in this area, including the World Congress on Alternatives and Animal Use in the Life Sciences. She is experienced in the areas of animal welfare, animal ethics, and alternatives to the use of laboratory animals. At present, she is trying to identify legal violations in the use of animals in laboratories in Brazil and is working as a technical advisor to the Regional Council of Veterinary Medicine of Paraná, Brazil.

Robert Buttrose

has an honors degree in philosophy and a Master's degree in cognitive science from the University of New South Wales, Sydney, Australia. He has worked for the Australian Commonwealth Government, universities, and the private sector. Buttrose is a member of the Victorian Schools Animal Ethics Committee and the management committee of Humane Research Australia, the country's largest anti-vivisectionist organization. He has written articles (in collaboration with Monika Merkes) about animal experimentation, animal ethics

committees, the use of primates for medical research, and the lack of transparency of the animal research industry.

Karynn Vieira Capilé

has an undergraduate in philosophy and veterinary medicine and a Master's degree in veterinary science. She is a doctoral candidate in bioethics, applied ethics, and public health. Her research focuses on animal ethics and alternative methods to replace animal use.

Constança Carvalho

is a psychologist and is currently working on her PhD in biology. Her research focuses on the contribution of non-human animal models to the current understanding of psychiatric disorders (Attention Deficit Hyperactivity Disorder and Major Depressive Disorder). During her training as a psychologist, and in her early years working with human patients, Carvalho was unaware of the number of animals used as models for psychiatric disorders in research. Her ongoing research on this topic has led her to believe that a paradigm shift is crucial since the use of animal models in this field is hardly useful and is, thus, unethical.

Sarah Cavanaugh

received her PhD in microbiology and immunology from Drexel University College of Medicine, Philadelphia, United States. Her research involved utilizing mouse models of viral infection and immunity in the central nervous system. During her time in the laboratory, Cavanaugh began to reflect on the ethics and utility of using animal models to accomplish her goal of contributing to the advancement of global human health. After receiving her doctorate, Cavanaugh opted to leave the bench, and she has used her education and experience to advocate for human-relevant alternatives to animal models in research areas, including Alzheimer disease, infectious diseases, and alcohol abuse.

Mara-Daria Cojocaru

is a lecturer in practical philosophy at the Munich School of Philosophy, Germany. In 2014, the government of upper Bavaria was looking for new members to expand the committees it is legally required to consult in evaluating applications for animal experiments, and Cojocaru agreed to become a member. She expected that she would be able to contribute to debates on animal experimentation that conform to the highest scientific and ethical standards and to do something for laboratory animals. While the experience was conflictual in

many ways, Cojocarú still believes that progress is possible, in particular by developing pragmatic approaches to the problems surrounding animal research and testing. Among other things, that means emphasizing the values integral to science, instead of forcing ethics and science to compete. Cojocarú is also a member of Minding Animals International and Minding Animals Germany. Non-human animals play a prominent role in her non-academic writing as well (www.maradariacojocarú.weebly.com).

Robert Coleman

is a pharmacologist committed to promoting the use of human cells and tissues in the pharmaceutical research and development process. After 30 years in the Glaxo group of companies, he left to co-found Pharmagene (now Asterand Bioscience), the world's first drug research and development company to work exclusively with human cells and tissues. Coleman was awarded an honorary DSc, in 2003, by DeMontfort University, United Kingdom (UK), for achievements in *humanizing* the research and development process. In 2005, he became an independent consultant; and from 2007–2016 he worked with Safer Medicines Trust as Science Advisor, then UK Science Director. Coleman has spoken at many international conferences and has authored more than 90 peer-reviewed papers and book chapters. Most recently, he edited a book in the Royal Society of Chemistry's *Drug Discovery* series, titled, *Human-based Systems for Translational Research*. He retired in 2016.

Marie Crandall

MD, MPH, FACS, is Professor of Surgery at the University of Florida Jacksonville, United States, Director of Research for the Department of Surgery, and Associate Program Director for the General Surgery Residency. She is currently a member of the Division of Acute Care Surgery. Crandall performs emergency general and trauma surgery, staffs the Surgical Intensive Care Unit (SICU), and is an active health services researcher. She has published extensively in the areas of injury risk factors and outcomes, disparities, geographic information systems in trauma research, gun violence, and violence prevention. Crandall is also an animal rights activist and has advocated extensively on behalf of decreasing the use of animals in surgical training, medical training, and medical experimentation.

Tamara Drake

is the Director of Research and Regulatory Policy at the Center for Responsible Science (CRS), United States. Prior to working for CRS, Drake's 30-year career included founding and running a successful nonprofit and working in

busy, high-profile law firms. She was also a volunteer Emergency Medical Technician (EMT) and EMT instructor. CRS was founded to promote advances in regulatory science and advocate for the use of human-relevant test methods in pharmaceutical development by bringing policy up to date with existing science. Drake coordinates research regarding regulatory testing methods for new product development, monitors agency rule-making changes, and drafts guidance policies. She has co-authored three Citizen Petitions to the US Food and Drug Administration, requesting regulatory change to update decades-old preclinical testing requirements, to allow for and incentivize use of human-relevant test methods and to protect clinical trial participants.

David Feinstein

MS, MD, helped establish the Center for Medical Simulation in Boston, United States, and has taught many simulation-based courses over its 25-year history. He helped develop the first simulation-based, clinical anesthesia first year courses, taught by the Harvard anesthesia departments, and has helped develop and teach numerous crisis resource management (CRM) courses for many medical domains. Feinstein helped establish the Carl J Shapiro Simulation and Skills Center at the Beth Israel Deaconess Medical Center. He has extensive training in simulation-based learning and has been an instructor of simulation-based, team training for more than 25 years. He has taught CRM for residents, fellows, and faculty in the Harvard Medical School teaching hospitals. Inspired by his dog Rusty, Feinstein promotes the use of simulation as a replacement to animal models in medical education.

Arianna Ferrari

studied philosophy in Milano and Tübingen and holds a PhD from the University of Tübingen and the University of Torino. Her doctoral research focused on ethical and epistemic issues in the genetic modification of animals in biomedical research. She has worked for several German universities and research centers and is now Head of Strategy at Futurium gGmbH, a museum about the future in Berlin. Ferrari has extensively published on the use of animals in research, in particular, on the exploitation of animals in the life sciences. She coedited the first handbook on human-animal relationships in German.

Shalin Gala

is a vice president of international laboratory methods in the Laboratory Investigations Department at People for the Ethical Treatment of Animals (PETA), where he works on domestic and international campaigns to convince corporations, government agencies, and military officials to replace the use of animals in experiments and medical training exercises. His work has been

covered in numerous publications, including the *New York Times* and *Army Times*. Gala and co-authors published a study in the United States military medical journal, *Military Medicine*, regarding the use of animals in medical training among NATO nations. Gala is involved in supporting legislative efforts to replace the US military's use of animals in trauma training drills with human simulation technology; and he oversees a novel corporate partnership that has mostly replaced animal use in the largest global, civilian-trauma management course. Gala holds a Bachelor's degree in Anthropology from Washington University in St. Louis, US.

Rita de Cassia Maria Garcia

is a Professor in the Veterinary Medicine Department at the Federal University of Paraná, Brazil. She studied veterinary medicine at the Faculty of Veterinary Medicine and Animal Science of the University of São Paulo (1988). She completed her Master's degree (1996) and her PhD (2009) in the Department of Preventive Veterinary Medicine and Animal Health, São Paulo University. Her Master's research focused on experimental epidemiology, applied to the control of zoonoses, on the prophylaxis of human rabies. Her doctoral thesis is titled, *Study of the Canine and Feline Population Dynamics and Evaluation of Strategies for Dogs and Cats Populations Management*. Garcia specialized in public health, animal welfare, clinical pathology, homeopathy, and shelter medicine at the University of Florida and completed a postdoctoral fellowship in the Department of Legal Medicine, Medical Ethics, Social and Work Medicine at the Faculty of Medicine of the University of São Paulo. She is a board member of the Technical Institute of Animal Education and Control (ITEC), the Brazilian Association of Legal Veterinary Medicine (ABMVL) and the Brazilian Veterinary Medical Association of Animal Welfare (AMVEBEEA).

John P. Gluck

is Professor Emeritus at the University of New Mexico and Research Professor at the Kennedy Institute of Ethics, Georgetown University, United States. He earned his PhD in comparative psychology and experimental psychopathology at the University of Wisconsin, under the mentorship of Harry F. Harlow. Gluck completed a Clinical Psychology Fellowship at the University of Washington, Department of Psychiatry, and a Fellowship in Bioethics at Georgetown University and the National Institutes of Health. His writing is concerned with the missing ethical elements of animal research justification and includes the books, *Applied Ethics in Animal Research* published by Purdue University, and *The Human Use of Animals: Case Studies in Ethical Choice*, published by Oxford University Press and co-authored with Tom Beauchamp, F. Barbara Orland, Rebecca Dresser, and David Morton. In 2016, the University of Chicago

published his memoir *Voracious Science and Vulnerable Animals: A Primate Scientists Ethical Journey*.

Ray Greek

graduated from the University of Alabama School of Medicine in 1985 and completed his residency in 1989 at the University of Wisconsin-Madison, United States. While in Madison, Jean Greek completed her DVM. Their careers led the Greeks to discuss anatomy, pathophysiology, drugs, and disease in various species. They pursued this topic, writing numerous books and articles. Ray Greek then collaborated with Niall Shanks PhD, and the two carried out research that led to the concept of *Trans-Species Modeling Theory*. The Greeks are interested in the ethics of animal use as well as the science.

Lawrence Hansen

MD, is professor of Neurosciences and Pathology at the University of California, United States. His motivation for writing a chapter for this book is the conviction that if cruelty to animals is not wrong, then nothing is wrong. Yet, in 40 years at academic medical centers he has witnessed countless instances of animal cruelty committed by otherwise seemingly ethical fellow faculty. When challenged about hurting and killing animals, his colleagues usually respond that vivisection is ethically justified because its results will translate into improved human healthcare and reduced suffering, so the ends justify the means. Hansen's chapter subjects this oft-cited rationale for animal research to empirical analysis by reviewing the clinical efficacy of animal research as determined by meta analyses. He also explores how painful experimentation in the name of sciences escapes society's legal prohibitions, which would otherwise result in prosecution for felonious animal cruelty.

Thomas Hartung

MD, PhD, is the Doerenkamp-Zbinden-Chair for Evidence-based Toxicology with a joint appointment for Molecular Microbiology and Immunology at Johns Hopkins Bloomberg School of Public Health, Baltimore, MD, United States. He holds a joint appointment as Professor for Pharmacology and Toxicology at the University of Konstanz, Germany. Hartung is the Director of the Centers for Alternatives to Animal Testing (CAAT) at both universities. CAAT hosts the secretariat of the Evidence-based Toxicology Collaboration, the Good Read-Across Practice Collaboration, the Good Cell Culture Practice Collaboration, the Green Toxicology Collaboration, and the Refinement Program. As Principal Investigator, he heads the Human Toxome Project

funded by the National Institutes of Health, Transformative Research Grant. Hartung is the former Head of the European Commission's Center for the Validation of Alternative Methods (ECVAM), Ispra, Italy, and has authored more than 500 scientific publications.

Kathrin Herrmann

has always felt a deep connection to other animals and their need for protection. This and her passion for medical science led to her decision to study veterinary medicine and specialize in animal welfare science, ethics, and law. Herrmann currently works at the Center for Alternatives to Animal Testing (CAAT) at Johns Hopkins Bloomberg School of Public Health, Baltimore, MD, United States. She is a Diplomate of the European College of Animal Welfare and Behavioural Medicine and a founding member of Minding Animals Germany and of the European Association for Critical Animal Studies. For almost a decade, Herrmann worked as a federal inspector trying to protect animals used in research and education and, in this way, frequently witnessed the limitations and shortcomings of animal protection laws; the current regulatory system does not properly safeguard non-human animals. She decided to initiate this book project to highlight the problems associated with non-human animal use in science and to show ways to work towards a paradigm change. She feels certain that with the collective competence and knowledge of the 51 featured experts, the shifting paradigm will be accelerated and, one day, will grow into a scientific revolution.

Christiane Hohensee

Dr. rer. nat., is the Scientific Advisor for Menschen für Tierrechte – Bundesverband der Tierversuchsgegner e.V. (People for Animal Rights Germany – Federal Association against Vivisection). She is the project manager for InVitro+Jobs, an information platform on animal-free research and development, as well as SATIS, a platform on animal-free studies and education. Hohensee studied biology and geography at Freie Universität Berlin, as well as toxicology in a Master's course at Charité – Universitätsmedizin Berlin. She completed her Master's thesis at Leibniz Research Institute for Environmental Medicine on mechanistic studies of signal cell migration pathways. Hohensee is a member of the European Society for Alternatives to Animal Testing (EUSAAT) and the SET Foundation (Stiftung zur Förderung der Erforschung von Ersatz – und Ergänzungsmethoden zur Einschränkung von Tierversuchen). She is pleased to contribute her ideas towards the abolishment of animal experiments.

Kimberley Jayne

PhD, MSc, BSc, AFHEA, has over a decade of research and educator experience working to protect animals in zoo and laboratory environments. She started in animal welfare and behavior and is now working exclusively from an animal protection perspective. Jayne works as a Senior Science Researcher for Animal Defenders International and the Lord Dowding Fund for Humane Research, who work to phase out animal use in research and entertainment and fund scientific research into non-animal methods. From her time working in this field, and through co-editing this Volume, she has already seen attitudes shifting about animals used in research among academics and scientists, which is why books such as this are so important to bring together professionals from a diverse range of backgrounds.

Jane Johnson

is an applied philosopher with a longstanding interest in the ethical and epistemological issues generated by the use of non-human animals in research. Her work focuses on reconceptualizing how we think of animals in experimentation with a view to changing how they are regarded and treated. Given her commitment to transforming the situation of animals in research, Johnson embraced the opportunity to contribute to a book dedicated to that purpose.

Jim Keen

has been an academic and the United States government veterinary and biomedical researcher for 27 years. His research emphasis is infectious and zoonotic livestock diseases. As an epidemiologist, his research is observational, i.e. study of disease in its natural habitat – even when that “natural habitat” is a beef feedlot, the most unnatural bovine environment ever conceived. Regrettably, for several years in the 1990s, Keen injected malignant cancer cells into the peritoneal cavity of hundreds of laboratory mice for monoclonal antibody bio-reagent generation. He began a slow conversion from industrial-animal agricultural supporter, apologist and enabler, to livestock well-being advocate in 2009. Keen was a whistleblower of experimental livestock cruelty and abuse at the US Department of Agriculture, Meat Animal Research Center in Nebraska, published on the front page of the *New York Times* in January 2015. His current interests are combating industrial agriculture’s damage to people, the planet, and animals.

Sarah Kenehan

is an Associate Professor of Philosophy at Marywood University in Scranton, United States. She works primarily in areas of social and political philosophy and applied ethics. Her interest in animal ethics, in particular, began with her relationship with her rescue dogs, Jack and Dublin, many years ago, which

then inspired a conversion to veganism and participation in many forms of animal welfare advocacy.

Andrew Knight

caused controversy by refusing to kill animals during his surgical and preclinical training, as a Western Australian veterinary student, in 2000. Instead, he helped establish a humane surgical training program, based partly on neutering homeless animals from animal shelters. Knight is Professor of Animal Welfare and Ethics, and Founding Director of the Centre for Animal Welfare, at the University of Winchester; an EBVS European and RCVS Veterinary Specialist in Animal Welfare Science, Ethics and Law; an American and New Zealand Veterinary Specialist in Animal Welfare; a Fellow of the Royal College of Veterinary Surgeons, and a Senior Fellow of the UK Higher Education Academy. He has over 65 academic publications and a series of YouTube videos on animal issues. These include an extensive series examining the contributions to human healthcare, and to veterinary and other education, of invasive procedures on animals. This work formed the basis for his 2010 PhD thesis and his subsequent book, *The Costs and Benefits of Animal Experiments*.

Kori Ann Kosberg

is a graduate from the University of Wisconsin, United States, with a Bachelor of Science in Bacteriology. She is an animal rights activist and volunteers with the San Diego Humane Society.

Lisa Kramer

is Professor of Finance at the University of Toronto. She has also been a Visiting Scholar in the Department of Psychology at Stanford University and the Rady School of Management at the University of California, United States. She graduated in 1998 with a PhD in Finance from the University of British Columbia. In addition to her primary areas of research in finance and behavioral economics, Kramer is interested in the application of multidisciplinary insights from academic research to the practice of animal advocacy. She previously served as a member of the board of directors for nonprofit organizations, including the Vancouver Humane Society and Mercy For Animals Canada; and she has co-organized large-scale, public-awareness campaigns, such as *Why Love One But Eat the Other?* subway ads that have appeared in Toronto and other cities in Canada and abroad.

Emily McIvor

is Science Policy Advisor for People for the Ethical Treatment of Animals (PETA) United Kingdom. She previously worked on European Union policy for

organizations, including the European Coalition to End Animal Experiments and the Humane Society International. McIvor has been a member of the European Partnership on Alternative Approaches to Animal Testing Mirror Group since 2005, and contributed to the European Commission's Technical Expert Working Group on Revision of Directive 86/609/EEC. In 2008, Emily led the *Make Animal Testing History* campaign, culminating in the European Parliament event *Replace Animal Experiments in Europe*, calling for the remit of the European Commission's Center for the Validation of Alternative Methods (ECVAM) to be extended to include biomedical research. In 2015, she presented at the Citizens' Initiative (*Stop Vivisection*) European Parliament Hearing. In 2011, McIvor received the Henry Spira Award for her contribution to animal welfare; and, in 2013, she was awarded the LUSH Special Prize to celebrate the implementation of the European Union ban on cosmetics animal testing and sale of newly animal tested cosmetics ingredients.

Monika Merkes

holds a PhD in public health from La Trobe University, Australia. She has spent her professional life as a social researcher, developing social and health policy in state and local governments, the community sector, academia and as a consultant. Merkes has a particular interest in the links between the health and wellbeing of humans, other animals, and the environment. She is an Honorary Associate of the Australian Institute for Primary Care & Aging at La Trobe University, the President of Humane Research Australia, and a member of the Victorian Schools Animal Ethics Committee. She blogs at <https://ozsheba.wordpress.com/>.

Fozia Noor

a pharmacy graduate, completed her PhD at Heidelberg University. She worked as a research associate at Saarland University, where she completed her habilitation in 2017. The focus of her research is a systems biology approach to pathways-based toxicology using advanced *in vitro* tools. Noor has developed *in vitro* tools, especially 3D organotypic cultures of liver for long-term toxicity studies; and she has applied *in vitro* metabolomics to these systems to understand pathways involved in adverse effects. Her work on *in vitro* alternatives and *in vitro* metabolomics has been published in leading peer-reviewed journals. Noor is currently working at the Luxembourg Center of Systems Biomedicine in medical translational research.

Rita Leal Paixão

studied veterinary medicine at the Federal Fluminense University, and philosophy at the Federal University of Rio de Janeiro; she has a Master's Degree

in veterinary pathology, a Master's Degree in environmental sciences and a PhD in public health from the Oswaldo Cruz Foundation. Paixão has been a professor at the Fluminense Federal University since 1990. She has experience in veterinary medicine and bioethics, with an emphasis on animal ethics, environmental ethics, research ethics, and animal welfare. She is a founding member and was the director of the Brazilian Society of Bioethics, and is a founding member of the iR Institute for Promotion and Research for the Replacement of Animal Experimentation (www.InstitutoiR.org).

John Pawlowski

PhD, MD, is a professor of anesthesiology at the Harvard Medical School (HMS). His interest in medical simulation started many years ago, as he sought ways to replace the use of dogs in medical education. With the development of high-fidelity, whole body mannequins, important physiology lessons could be taught in place of live animals. He has advanced the use of simulation in the instruction of basic science and patient safety in medicine. At HMS, Pawlowski designed the first simulation-based replacement to the *dog lab*. As Co-Director of the HMS pharmacology course, he pioneered the use of simulation to demonstrate pharmacological principles. As Co-Director of the Simulation and Skills Center at the Beth Israel Deaconess Medical Center, Pawlowski has extended the use of simulation-based educational tools for the training of healthcare providers. He is continuously reminded of the importance of animal-free methods of teaching by his dear sheepdog Cazzie.

John J. Pippin

MD, FACC, is a graduate of Harvard College (Cambridge, MA) and the University of Massachusetts Medical School, Worcester, MA, United States, and completed a cardiovascular research fellowship at the University of Texas Southwestern Medical Center (Dallas, TX), United States. In recent years, Pippin has written on the failure of animal research to translate research findings to human medicine, especially in the areas of Alzheimer disease, diabetes, and heart disease. He strongly believes that progress in the study, prevention, and treatment of Alzheimer disease requires the replacement of unreliable animal research with human-specific research. He is currently Director of Academic Affairs for the Physicians Committee for Responsible Medicine, Washington, DC.

Francesca Pistollato

PhD, has worked for many years in Europe and the United States to promote ethical standards and reliable research outcomes using human-based methods in biomedical research and in Alzheimer disease research, in particular.

During her previous and current work at the European Commission, Joint Research Centre in Ispra, Italy, Pistollato's main research focus has been the implementation of novel, human stem-cell-based *in vitro* models for neurotoxicity and developmental neurotoxicity testing, promoting a paradigm shift in traditional, animal-based methodological approaches in toxicology and biomedical research.

Rebecca Ram

is a scientific research consultant. After a decade working in Phase I–IV clinical trials within the pharmaceutical and contract research organization sector, she became a scientific consultant in order to focus on alternatives to animal experiments and the campaign to replace animal use in research, as well as continue her work in some clinical research projects. She has an MSc in toxicology and a BSc in applied biology. Ram has worked or provided scientific support for a number of organizations, including GlaxoSmithKline, University College London Hospital, Simugen, Genomics England, Cruelty Free International, People for the Ethical Treatment of Animals, Animal Defenders International, Vier Pfoten (Four Paws), Animal Aid, TRACKS Investigations, One Voice, and, most recently, the Lush Prize, Safer Medicines Trust, and Alliance for Human-Relevant Science.

Craig Redmond

is an animal protection researcher and part of the team that coordinates the Lush Prize (www.lushprize.org), the largest annual fund supporting the complete replacement of animals in toxicology research. He has three decades of experience working across a broad range of animal protection and other social justice issues as a campaigner, researcher, investigator, and photojournalist. Seeing animal experimentation as a violation of the rights of animals, Redmond is keen to promote the 1R of absolute replacement as a more ethically and scientifically valid substitute for the 3Rs, which still rely on the exploitation and death of animals. 1R, not 3Rs, is the underlying principal of the Lush Prize, which was founded in 2012.

Alexandro Aluísio Rocha

is a veterinarian, a specialist in clinical treatment and surgery of companion animals. He holds a Master's degree in animal health and is a doctor in the physiology of organs and systems. Rocha is a professor of animal anatomy and physiology in the Department of Animal Science of the Federal University of Vales do Jequitinhonha e Mucuri (UFVJM), Brazil, and a member of the animal ethics committee of UFVJM, as well as the former director of the University's

animal facility. He handles animal welfare and protection projects and helps develop methods that apply the biophysical principles of animals' physiology for their replacement in practical classes of physiology, such methods that seek to provide students with an understanding of the phenomenon present in the physiological mechanisms of the body's organs and systems. In the discipline of animal anatomy, Rocha only uses ethically-obtained cadavers, and he developed artificial models to illustrate the animal body and reduce students' exposure to formaldehyde vapors.

Adam See

is a doctoral candidate in philosophy at the City University of New York, an adjunct Professor of Environmental Ethics at the New Jersey Institute of Technology, and an animal rights activist. His current written work focuses on contemporary intersections between animal ethics and animal cognition, as well as communication and collaboration in great apes. The subject matter of his most recent academic presentations has been issues of animal experimentation, particularly relating to the ethics of behavioral research on non-human primates.

Peter Singer

first became known internationally after the publication of *Animal Liberation* (1975). His other books include: *Democracy and Disobedience* (1973); *Practical Ethics* (1979; 2011, 3rd ed.); *Ethics into Action: Henry Spira and the Animal Rights Movement* (1998); *The Expanding Circle* (1981; 2011, new ed.); *One World* (2002; *One World Now*, 2016, revised ed.); *The Ethics of What We Eat* (2006), co-authored with Jim Mason; *The Life You Can Save* (2009); *The Most Good You Can Do* (2015); *Ethics in the Real World* (2016); and *Utilitarianism: A Very Short Introduction* (2017), co-authored with Katarzyna de Lazari-Radek. Singer is professor of bioethics at Princeton University, an appointment he holds jointly with an appointment as Laureate Professor at the University of Melbourne, Australia. He was made a Companion of the Order of Australia (AC) in 2012. He is the founder and board chair of The Life You Can Save, a nonprofit that fights extreme poverty.

Anna Smajdor

has had a longstanding interest in questions related to animal ethics, since early childhood. Her work in medical and research ethics has contributed to her interest in finding a normative framework that makes sense of both human and non-human animal interests. In particular, Smajdor is interested in looking beyond questions of moral status as determinative of our treatment of

other organisms, to focus on the dispositions of humans as moral agents. As a philosopher working in applied ethics, Smajdor has participated in a number of ethical review and research ethics committees. This experience has strongly influenced her conviction that a different paradigm is needed for the understanding of moral relationships between animals and human beings.

Katy Taylor

is Director of Science and Regulatory Affairs at Cruelty Free International (formerly the British Union for the Abolition of Vivisection [BUAV]) and the European Coalition to End Animal Experiments (ECEAE). She manages the scientific output of both organizations, ensuring their call to end animal testing is supported by sound scientific argument. Taylor represents both organizations at international regulatory forums, including the Organisation for Economic Co-operation and Development in Paris, the European Medicines Agency in London, and the European Chemicals Agency in Helsinki. She has a BSc in zoology from the University of Sheffield, UK, and a PhD in veterinary behavioral epidemiology from De Montfort University, UK. An animal welfare scientist by training, and personally dedicated to animal protection, Taylor is now one of Europe's foremost experts on the scientific, legal, and ethical issues on the use of animals in testing and its alternatives.

Luis Vicente

is a biologist, with a PhD in evolution and habilitation in animal behavior. He has been a professor at the University of Lisbon, Portugal, and other European universities for 40 years. Vicente is the author of more than 200 papers, books, and book chapters. He has broad research interests, including animal behavior, animal ethics, philosophy, and ecology. Vicente is the head of the Philosophy of Life Sciences Department of the Center of Philosophy of Sciences at the University of Lisbon. He is a founding member of the Portuguese Society of Ethology and the Portuguese Association of Primatology. He is the President of the Institute for Territorial Management and Reorganization. In the beginning of his career as a researcher, he used animal models, but he moved away from this paradigm mainly for ethical reasons.

Philipp von Gall

is a postdoctoral researcher in the field of agricultural and animal politics at the University of Hohenheim, Germany, and a freelance consultant for public and nongovernmental institutions. In his research, von Gall focuses on bringing animal philosophy and philosophy of mind to the forefront of social and political conflicts surrounding human-animal relationships. Since 2012, he

has been a member of the animal experimentation commission advising the competent authority on animal research proposals submitted for licensing in Berlin. His experiences with this institution, and with the ethics of animal experimentation, motivated him to contribute to this book. Von Gall believes that in order to achieve a paradigm shift in animal research, we must develop innovative and more effective instruments to represent the interests of non-human animals in legal and political decision making.

Sabina V. Vyas

is a public health consultant focused on advancing chronic disease prevention through plant-based nutrition. She is committed to improving population health by reducing barriers and increasing access to, and availability of, health promoting foods, especially for vulnerable populations. She has worked extensively for leading public health agencies, such as Kaiser Permanente and the Centers for Disease Control and Prevention in United States. Vyas has worked directly with patients, provided training and technical assistance at the population level, and addressed obesity prevention in schools and chronic disease prevention in communities through policy, systems, and environmental improvements. She received her Master's degree in public health degree from the University of Southern California, United States, and is certified in plant-based nutrition by the T. Colin Campbell Center for Nutrition Studies & eCornell.

Malcolm Wilkinson

studied physics at Oxford University. He has been involved in microelectronic and microfluidic technology development in large corporations and start-up companies. Working in Cambridge, United Kingdom, from 1992 to 2006, Wilkinson supported spin-outs from universities and raised over US\$15 million in funding from venture capital and government grants. In 2006, he founded Kirkstall Ltd., a company with a license to cell culture technology from the University of Pisa. Kirkstall developed this research into a commercial interconnected cell culture system, in which organoids mimic human metabolism. Wilkinson is co-author of several papers on *in vitro* models of toxicity and a contributing editor of a recently published book on *In Vitro* testing. Having realized the inadequacy of animal models for predicting human clinical response to drugs, he is now a champion for the use of organ on a chip technology to replace animal testing for the development of safe drugs.

Introduction

Legislative reforms around the world have insufficiently improved the protection of non-human animals (hereinafter referred to as animals). Directive 2010/63/EU of the European Parliament on the protection of animals used for scientific purposes appears rather radical when compared to legislation in other countries. The Directive promotes a paradigm change in articulating the ultimate goal of the “full replacement of procedures on live animals for scientific and educational purposes as soon as it is scientifically possible” (Recital 10). Building on this principal vision of Directive 2010/63/EU, this book aims to illustrate the current situation for animals used in research, testing, and education and to give a future glimpse of what the end of their use may look like. Aside from exploring current ethical challenges, scientific controversies and economic and legal aspects related to animal experimentation, this book discusses ways in which individuals, researchers, regulators, industry, and governments can all contribute to a paradigm change. It includes invited contributions from a range of multidisciplinary scholars, across many fields, who share a vision for how a shift in current thinking can be achieved and how the end of animal experiments can be accelerated. While some argue that full and immediate abolishment of animal use is necessary to encourage science in the direction of human-focused research, others discuss their vision in terms of incremental steps towards the shared goal of total animal replacement. With the intention of encompassing all animal use, this book considers the vision of a paradigm shift at an international level, with the goal to find solutions for this pressing problem that are motivated by a culture of compassion for all animals.

The book starts out with a foreword by Peter Singer who has advocated for the equality of human and other animal interests for several decades. The first half of this book (Chapters 1–13) describes current debates surrounding the issues of using animals in science:

- The first section focuses on why and how to change the current paradigm. Chapter 1 starts out from the last of the 3Rs, refinement, and its flawed application in practice. Chapters 2 and 3 address how to incorporate methods into the current system to prompt a move away from animal models. Chapter 4 presents information on how people can engage in a paradigm shift at an individual level, by adopting a disease preventing lifestyle.
- Section 2, which focuses on politics and legislation in animal experimentation, starts with a chapter on the importance of political campaigning (Chapter 5), followed by a critique of how the 3R principles are applied by

people working in animal research (Chapter 6). Chapter 7 reveals how having a political critique is of utmost importance.

- Section 3 debates the lack of transparency over animals used for experimentation, from the stakeholder perspectives of the animals (Chapter 8) and animal protection groups (Chapter 9). Chapter 10 illustrates how public funding is misappropriated for animal research.
- Section 4 discusses the ethics of using sentient individuals without their consent, including how humans decide upon their respective fates (Chapters 11 and 12) and their political objectification (Chapter 13).

The second half of the book (Chapters 14–28) analyzes the current practice of using animals as scientific models, as well as already available animal-free models:

- Section 5 begins with an overview of the lack of predictivity of animal models over the history of their use (Chapter 14). Chapters 15 and 16 review animal-derived research and its translation to human medical research. Chapter 17 assesses the effectiveness of animal-based models for drug testing and disease modeling. Chapter 18 expands on how animal-based tests are harmful for humans. Chapter 19 reviews the significant increase in use of genetically altered animals, and the impact of this on human-disease modeling. The section concludes with two chapters focusing on the scientific and ethical concerns within specific areas of animal research, namely Alzheimer's Disease (Chapter 20) and behavioral research (Chapter 21).
- Section 6 shows how the future of animal-free research starts with humane education and training for the next generation of researchers who have the potential to change the direction that science takes. Chapter 22 focuses on alternatives available for replacing animals used in biomedical and trauma training, while Chapter 23 presents an example of how humane education has been implemented.
- The final section shows how the paradigm is already shifting, commencing with recent developments in animal-free test methods (Chapter 24). Chapter 25 exemplifies how *in vitro* and *in silico* methods are already being used in certain areas of research. Chapter 26 presents the emerging organ on a chip technology, its enormous future potential and its current limitations. Chapter 27 critically highlights the need to remain cautious about hidden animal use in replacement technologies, followed by the final Chapter 28, which gives an outlook on the future of cruelty-free science and the great promise it holds for animals and humans alike.

The book closes with an afterword by John Gluck, who shifted from being a primate researcher to becoming a strong advocate for animals. Owing to the

range of topics and the various backgrounds of our contributing authors, this volume is intended for a wide prospective readership, offering a broad scope into the key debates around the use of animals for experiments and education. It is written not only for fellow scholars and scientists, but for the interested public.

We are hopeful that this book will help to accelerate the already shifting paradigm. Six decades after Russell and Burch published their, at the time, progressive ideas in the book “Principles of Humane Experimental Technique”, on how to make science humane and rigorous, the time has come where it is impossible to ignore the facts: the flaws and shortcomings of the animal research industry are evident, and the continued use of animal models is ethically and scientifically less justifiable than ever before. This industry wastes intellectual, scientific, and financial resources and causes harms not just to animals but also to humans. With experiments on animals frequently showing little to no benefit to the human species and, therefore, hindering the development of treatments, and with costs borne by the animals used, we should finally accept the irreconcilable species differences. It is time to focus solely on robust, human-relevant approaches, such as *in silico* and *in vitro* models, to conduct human-focused science. For us to continue to evolve ethically as a species, we need to stop causing further needless suffering and start generating a culture of respect and compassion for all animals.

Think occasionally of the suffering of which you spare yourself the sight.

ALBERT SCHWEITZER



PART 1

Why and How to Shift the Paradigm



Refinement on the Way Towards Replacement: Are We Doing What We Can?

Kathrin Herrmann

Freie Universität Berlin, Department of Veterinary Medicine, Institute of Pharmacology and Toxicology, Berlin, Germany; current address: Johns Hopkins University, Bloomberg School of Public Health, Baltimore, MD, United States
kherrmar@jhu.edu

1 Introduction

[R]efinement is never enough, and we should always seek further for reduction and if possible replacement.

RUSSELL and BURCH, 1959, Chapter 4

Russell and Burch introduced the principles of replacement, reduction, and refinement of animal experimentation in 1959 in their groundbreaking book, *The Principles of Humane Experimental Technique*, to eradicate inhumanity towards non-human animals (hereinafter referred to as animals). They utilized the term *inhumanity* to indicate negative mental states experienced by animals used in research and the procedures that cause such mental states. Their goal was to avoid the use of animals wherever possible and to improve significantly the treatment of the animals still deemed indispensable, while improving the quality of scientific and medical research and testing (Russell and Burch, 1959). Since the 1990s, the 3Rs have slowly gained more acceptance within the animal research community. They have been recognized by organizations such as the Council of Europe (1986) and the World Organisation for Animal Health (2018), and they have been implemented in law in several countries, for example in Germany and in the UK (Herrmann, Köpernik and Biedermann, 2009; Zurlo, Rudacille and Goldberg, 1996).

Today, the principles are not only embedded in legislation in the European Union (EU) but around the world (Bayne et al., 2015). In the EU, Directive 2010/63/EU on the protection of animals used for scientific purposes came into effect in 2013, thereby requiring all EU Member States to implement the

3Rs fully. The EU Directive is more far-reaching compared to other legislation since it promotes a strong shift away from animal experimentation, with its goal being “full replacement of procedures on live animals for scientific and educational purposes as soon as it is scientifically possible” (European Parliament, 2010, Recital 10). Furthermore, the EU Directive mandates that replacement should be the first priority, followed by reduction and then refinement to be implemented if animal use is deemed absolutely unavoidable (European Parliament, 2010, Recital 11). Russell and Burch (1959, Chapter 7) proposed the following hierarchy: “Suppose, for a particular purpose, we cannot use replacing techniques. Suppose it is agreed that we shall be using every device of theory and practice to reduce to a minimum the number of animals we have to employ. It is at this point that refinement starts, and its object is simply to reduce to an absolute minimum the amount of distress imposed on those animals that are still used.”

As a result of the incorporation of the 3Rs into legislation, which has mainly been driven by ever-increasing societal concerns (cf. Clemence and Leaman, 2016; European Citizens’ Initiative, 2016; Jones, 2017; Pew Research Center, 2015, 2018), it would seem reasonable to expect changes within the research industry, particularly replacement of animals with non-animal models. However, the cumulative effect of any such replacements has not prevented the overall number of animals used from steadily increasing since the 2000s (European Commission, 2013; Taylor et al., 2008; Taylor and Rego, 2016). When looking at the 3Rs and their impact, it seems that refinement, the R of *ultima ratio*, is receiving the most attention by the laboratory animal science community (AALAS, n.d.; FELASA., 2016), especially in basic and applied research where the majority of animals are utilized (in the EU, 65% of animals; cf. Daneshian et al., 2015). A survey conducted with participants of laboratory animal science training courses in four European countries found that refinement was seen as more feasible and more pressing than replacement and reduction of animal use (Franco, Sandøe and Olsson, 2018).

Due to this focus, the chapter starts by exploring the application of several refinement methods in practice, commencing with current housing and husbandry standards and a discussion about the benefits of a “culture of care”, followed by assessing important experimental refinements. To further assess the quality of animal-based research, it reviews necessary refinements in planning, conduct, and reporting practices of animal studies. The chapter then moves on to look at feasible ways to reduce and replace animal use by, first discussing tools to appraise animal studies whose application could lead to a significant reduction of animal experiments and thus numbers of animals used. It subsequently reflects on what the scientific community has

been doing to move towards replacement of animals in research, testing, and education. Finally, the chapter concludes with recommendations for steps to be taken to work towards using non-animal, human-relevant approaches to biomedical research and testing aimed to protecting human health.

2 Refinement of Animal Housing and Husbandry

Husbandry is a factor for contingent inhumanity in all types of experiment.

RUSSELL and BURCH, 1959, Chapter 4

Animals used in research, testing, and education spend their lives in a captive environment that is very different from their natural environment. Refined housing gives animals the opportunity to cope with some of the stressors imposed by life in the laboratory (Mason, 2006). Improving their living conditions by trying to meet some of the animals' basic behavioral needs is called *environmental refinement* or *environmental enrichment* (EE). Krech, Rosenzweig and Bennett (1960) were the first to report biochemical changes in the brains of rats kept in a complex housing environment and augmented with daily exposure to novel items in an open field. They coined the term EE when describing this paradigm (Benefiel, Dong and Greenough, 2005). Environmental Enrichment is defined as “[a]ny modification in the environment of captive animals that seeks to enhance the physical and psychological well-being of the animals by providing stimuli which meet the animals' species-specific needs” (Baumans and van Loo, 2013). It includes complex social and inanimate object stimulation (Rosenzweig, 1966). Its positive behavioral effects were first described in rats by Hebb in 1947, who kept them as companion animals in his home. He observed that the rats living in a more complex, stimulating environment learned better and more quickly (Hebb, 1947). In addition to enhancing cognition, EE also promotes neuronal activation, signaling and plasticity in a number of brain regions (Nithianantharajah and Hannan, 2006). In the beginning, research on EE was conducted primarily to assess changes in behavior and brain development. With the increased concern for animal welfare and the establishment of animal welfare science as a specific discipline, has EE been applied to improve the animals' daily lives.

Aside from being driven by animal welfare and health concern, many EE-related research projects have also assessed the influence of poor housing conditions on research data. Garner (2005), van Praag, Kempermann and Gage (2000), and Würbel (2001, 2007), among others, demonstrated that life in barren cages leads to abnormal brain development and to physiological and behavioral malfunction. Standard non- to little-enriched cages can cause a variety

of abnormal behaviors, such as stereotypes (abnormal repetitive behaviour patterns) (see e.g., Würbel and Stauffacher, 1994, 1996; Würbel, Stauffacher and Holst, 1996) and inactivity while awake, observed for example in rhesus monkeys (Hennessy et al., 2014) and mice. Inactivity appears to be an alternative to stereotypic behavior and indicates a depression-like state (Fureix et al., 2016).

Nonetheless, for a period of time, a number of laboratory animal scientists strongly believed that standardizing the animals' environment—by housing animals in barren cages—was essential to control environmental variables (e.g., Bayne, 2005; Eskola et al., 1999; Gärtner, 1999; Tsai et al., 2002, 2003, 2006). The assumption was that standardization was crucial to minimize both variation in the data and the risk of obtaining conflicting results in replicate studies. Many laboratory animal scientists were concerned that implementing EE would add undesirable variation to their responses to experimental treatments (e.g., Bayne, 2005; Eskola et al., 1999; Gärtner, 1999; Tsai et al., 2002, 2003, 2006). However, eight mouse strains kept under such uniform, standardized conditions, and tested on highly standardized behavioral tests in different laboratories, showed significant laboratory dependent variations (Crabbe, Wahlsten and Dudek, 1999). Since then, studies by Augustsson et al. (2003), van de Weerd et al. (2002), Wolfer et al. (2004), and Würbel (2007) have demonstrated that housing conditions can be enriched without increasing variability in experimental results. Additional experiments using mice confirmed earlier research findings that basic environmental enrichments (shelters and nesting material) can be used without compromising the research data (André et al., 2018). Furthermore, this study showed that data from mice who had access to shelters and nesting material is comparable to previous data collected under barren housing conditions, consistent with earlier findings (see Augustsson et al., 2003). The authors concluded that the influence of enrichment on research outcomes was trivial, and that nesting material and shelters could be used without negative impact on study outcomes or loss of comparability to previous data obtained from animals living in impoverished cages. (André et al., 2018).

In the future, rather than using more animals in new experiments on this topic, a systematic review (SR) could be undertaken to provide an overview of the accessible evidence and new knowledge without further animal use. It would also point out knowledge gaps and assess the quality and validity of the conducted animal studies (for more on SRs of animal experimentation, see e.g., Systematic Review Center for Laboratory Animal Experimentation, SYRCLE, n.d. a).

This so-called standardization fallacy (Würbel, 2000), the belief that homogenization of study populations (using the same strain, age, sex, weight, housing conditions, etc.) is an essential part of good experimental design, appears to be one driver for the irreproducibility of results and for the lack of external validity (Bailoo, Reichlin and Würbel, 2014). External validity is the

extent to which experimental results can be used as a basis for generalizations to other human and non-human animal populations in other environmental conditions (van der Worp et al., 2010). This is why authors, including Richter, Garner and Würbel (2009), Richter et al. (2010), Würbel (2000), and Würbel and Garner (2007), promote systematic environmental heterogenization, which is a “controlled and systematic variation of the properties of any given animal (or animal population) and its environment within a single experiment” (Richter, 2017, p. 344). Voelk et al. (2018) compared 440 single- and multi-laboratory preclinical animal studies that had used the same overall number of animals. They compared effect size estimates and found that the studies conducted in one laboratory only, in most cases did not predict effect size correctly, whereas multi-laboratory studies generated more consistent and accurate results. Within-study standardization was identified as a major cause of poor reproducibility. Thus, Voelk et al. (2018) advocate for multi-laboratory design with no increase of overall number of animals being necessary to enhance reproducibility and, potentially, external validity.

EE combined with systematic heterogenization contributes to improved quality of animal experiments (Richter, Garner and Würbel, 2009; Richter et al., 2010; Würbel, 2000; Würbel and Garner, 2007), whereas failure to provide animals with living conditions that meet their species-specific needs jeopardizes both their welfare and experimental validity (e.g., Bailey, 2018; Balcombe, 2010; Bayne and Würbel, 2014; Garner, 2005; Messmer et al., 2014; Olsson et al., 2003; Poole, 1997; Sherwin, 2004; Würbel, 2001, 2007; Würbel and Garner, 2007).

2.1 *Examples of Environmental Refinement*

An example of an extensively researched refinement method is providing mice with various types and sufficient amounts of nesting material to build nests, creating a microclimate needed for breeding and for preventing cold stress (Gaskill et al., 2009, 2012; Gaskill and Garner, 2014; Hess et al., 2008). The thermoneutral zone of mice lies between 26°C and 34°C (Gordon, 1993); and standard temperatures in animal vivariums range between 20°C and 24°C. During their inactive phase, mice prefer temperatures of 30°C–32°C (Gordon, 2012). A proper nest is, therefore, essential for reducing cold stress, which not only compromises animal well-being but also scientific data (Gaskill et al., 2009; Karp, 2012; Messmer et al., 2014). Gaskill et al. (2013) additionally demonstrate its negative effect on breeding performance. Nest building is a species-specific behavior of mice, the absence of which can be used as an indicator of illness (Gaskill and Pritchett-Corning, 2016). Another example involves gerbils, who have a high motivation to dig, since they naturally build and live in burrows. In standard laboratory conditions, where there is not enough substrate to dig tunnels, gerbils show stereotypic digging behavior (Wiedenmayer, 1997). One

solution, based on research conducted by Waiblinger and König (2004), is a nesting box with an attached tunnel. The artificial burrow system seems to help reduce stereotypic digging behavior.

Jirkhof (2015) found that housing conditions that meet the needs of mice help them recover better and faster from experimental procedures. The influence of environment on diseases, such as cancer, has also been demonstrated; for example, by Cao et al. (2010). In colon cancer and melanoma research, mice living in an enriched environment showed reduced tumor growth and increased remission compared to those living in a non-enriched environment (Cao et al., 2010). Rabbits who received special positive attention from their care givers showed a markedly increased resistance to the development of atherosclerosis compared to rabbits who received no extra attention (Nerem, Levensque and Cornhill, 1980).

2.2 *Discussion on Environmental Refinement*

It has been established that animals in a monotonous environment frequently display abnormal behaviors, such as stereotypies (Garner, 2005; Garner and Mason, 2002; Gross et al., 2012; Howerton, Garner and Mench, 2008; Würbel and Stauffacher, 1994, 1996; Würbel, Stauffacher and Holst, 1996). Furthermore, research has demonstrated the importance of environmental refinement, not only for animal welfare and for decreasing the negative health effects of life in captivity, but for its benefits for research outcomes in terms of their reliability, replicability, and validity (e.g., Abou-Ismaïl and Mahboub, 2011; Garner, 2005; Weed and Raber, 2005).

Due, at least in part, to enforcement of animal protection laws, housing conditions for laboratory animals have improved over the past decade. In the EU, the Commission Recommendation of 18 June 2007 on guidelines for the accommodation and care of animals used for experimental and other scientific purposes (Commission of the European Communities, 2007)—which was later largely adopted by Directive 2010/63/EU (European Parliament, 2010, Annex III)—helped to enhance the captive environment of laboratory animals. However, exceptions to these minimum requirements may be demanded by researchers for certain experiments. Examples include housing social species, such as rats, pigs, or non-human primates, individually and away from their social groups; or not providing rodents with sufficient nesting material and shelters, to allow easier and quicker monitoring. Yet, in most cases, a solution that considers the animals' well-being and does not further compromise their welfare could probably be found.

Moreover, it should be noted that the term most frequently used when talking about an improved living environment, *environmental enrichment*, can be misleading, since it suggests that the standard cage conditions should be

considered normal or species-typical. However, captive conditions have little in common with the natural habitat of every single species used in research. For example, Lahvis (2017) points out that the floor area in a standard mouse cage is 280,000-times smaller than the animal's natural home range. For rhesus macaques, he calculated it is 7 million-fold smaller. Along with the difference in the size of the animals' habitats, the stimulation provided in laboratories is also different from what animals encounter in their natural environments. Burghardt (1996) argues that it would be more accurate to use the term *controlled deprivation*, since all captive environments deprive animals of some natural stimuli. He points out that these restrictions have various, and oftentimes unpredictable, consequences for the welfare of captive animals (Burghardt, 1996, 1999). In fact, a study by Gross et al. (2012) showed that around 12% of mice who lived in enriched cages which contained nesting material, a shelter and a climbing structure, still revealed stereotypic behavior. Moreover, evidence indicates that when stereotypies are not observed, a potential reason could be that they are only displayed when nobody is watching, e.g., in the nocturnal phase (Wells, 2017); or, since highly stereotypic animals seem to cope better than their identically-treated conspecifics, non-stereotypic animals present an even more abnormal, depression-like state as an alternative to stereotypic behavior (Mason, 2006). It has been shown that sustained, uncontrolled stress can, at least in some mouse strains, foster *learned helplessness* (Cabib, 2006).

2.3 *Challenges in the Implementation of Refined Housing*

The enforcement of animal protection laws has contributed to somewhat improved housing conditions for laboratory animals over the past decade. However, despite the mounting evidence of welfare and scientific problems associated with standardized housing, the implementation of animal husbandry knowledge in laboratories has in the author's experience been a major and elusive challenge.

It is increasingly recognized that experimental animals experience serious and repeated stress and distress, caused by life in the laboratory. Besides being a welfare concern, there are multiple factors that adversely affect the animal's biological systems and thus the data collected from these animals (Bailey, 2018). Examples for stressors and thus potential influences on data, besides the confinement itself, include ultrasonic noises (Baldwin, Primeau and Johnson, 2006; Turner et al., 2005), bedding material and cage cleaning (Burn et al., 2006), handling, blood collection, and orogastric gavage (Balcombe, Barnard and Sandusky, 2004), and the experimenters (Chesler et al., 2002) and their sex (Baldwin, Primeau and Johnson, 2006; Sorge et al., 2014).

Numerous studies have shown that animals living in captive environments are generally abnormal and unhealthy, as such environments change their

behavior as well as immune, nervous, and endocrine functionality. Examples include their altered response to infection (Gurfein et al., 2014), altered immune response (Beura et al., 2016; Messmer et al., 2014), increased rates of obesity, Type II diabetes, high blood pressure, and premature death (Martin et al., 2010), altered brain development (Bennett et al., 1964; Kempermann, Kuhn and Gage, 1997; Lewis et al., 2006; Rosenzweig and Bennett, 1969; Rosenzweig et al., 1962), decreased strength and endurance (During et al., 2015), altered sleep, activity patterns, and blood pressure (Martire et al., 2012), altered growth rates (Serrat, King and Lovejoy, 2008), altered organ development, metabolic, growth, and reproduction rates and behavior (Gordon, 2012), and enhanced tumor growth (Cao et al., 2010; Li et al., 2015). As such, untreated control animals do not represent healthy individuals, since they are metabolically abnormal (Martin et al., 2010). To date, there are only a few studies comparing wild versus confined animals, but they all show immense biological differences in physiology, such as structure variation of the visual cortex among caged and free-roaming Norway rats (Campi et al., 2011), lower levels of cholesterol in wild versus captive animals (Schmidt et al., 2006), and immune system dissimilarities (Beura et al., 2016).

We must acknowledge that even if laboratory animal housing is enriched, it cannot be enriched to an extent that it has no negative effect on the animal's welfare (e.g., Burghardt, 1996; Gross et al., 2012). Well-being can only be achieved if the animal experiences positive welfare states, which require a responsive environment the animal can engage with. Studies show that animals prefer complex environments and are motivated to work for them (Anselme, Robinson and Berridge, 2013; Sherwin et al., 2004). Current minimum legal requirements for animal housing in the European Union, laid out in Directive 2010/63/EU, are still insufficient in meeting all needs of all animals; although they are held to be the most progressive in the world. As shown, problems of confinement are manifold. Animals' lives in captivity are monotonous and, therefore, lead to boredom (Burn, 2017; Meagher and Mason, 2012), learned helplessness and depression (Cabib, 2006; Špinka and Wemelsfelder, 2011), and abnormal behaviors. The effects pose serious welfare concerns and raise concerns about the validity and translatability of data obtained from these unhealthy individuals.

2.4 *Potential Improvements*

In assuming an ethical responsibility to improve the lives of captive animals (Gruen, 2014), the goal of husbandry refinement should be not only to reduce stressors but to promote well-being. It is apparent that current housing conditions do not achieve that. One step towards improving animal housing is to provide cages that allow for more natural behaviors. Makowska and Weary (2016a) investigated the frequency of burrowing, climbing, and standing

upright of rats held in pairs in standard (behaviorally restrictive) laboratory cages in comparison with rats in cages allowing these behaviors (larger cages with lower floors, filled with moist soil, holding five rats per cage) over a period of 13 months. Although climbing bouts decreased with age, standing upright and especially burrowing were still frequent behaviors in older rats. Stretching is a corrective response to stiffness caused by immobility or positional stress (Bertolucci, 2011). Makowska and Weary (2016a) found that standard-housed rats performed 9 times more lateral stretches than rats housed in the semi-naturalistic environment. The authors proposed that standard-housed rats were stretching frequently in an attempt to alleviate stiffness from low mobility associated with standard housing. Improved welfare of the rats housed in the semi-naturalistic cages was observed in an anticipatory behavior test that assessed differences in reward sensitivity performed when the rats were 19 and 21 months old (Makowska and Weary, 2016b).

From the animals' perspective, an even better approach would be the radical solution for housing refinement proposed by Lahvis (2017). Lahvis suggests that research animals should live in the wild or at least roam freely in a large, captive environment under naturalistic conditions. He is confident that with available technologies (e.g., cameras, transponders, magnetometers, pressure sensors, global positioning systems), this novel approach could be accomplished for many experiments. Lahvis (2017) advises that biomedical researchers should work together with behavioral ecologists to develop sufficiently complex environments in order to ensure that test subjects produce scientific data not influenced by husbandry.

3 A "Culture of Care" for Animals as Refinement

The term *culture of care* has frequently been referred to by members of the laboratory animal science community to demonstrate "a commitment to improving animal welfare, scientific quality, care of the staff and transparency for the stakeholders." (Norecopa, 2016a). For instance, a working document on the development of a common education and training framework to fulfill Directive 2010/63/EU requirements mentions the culture of care numerous times (National Competent Authorities for the implementation of Directive 2010/63/EU on the protection of animals used for scientific purposes, 2014). Individuals responsible for the welfare of animals should establish and maintain high standards to champion a culture of care among both husbandry and scientific staff (European Commission, 2014). Entire sessions at conferences have been dedicated to this topic, including sessions at the

European Society for Alternatives to Animal Testing (EUSAAT) Congress in 2015 (EUSAAT, 2015) and at the 10th European World Congress on Alternatives and Animal Use in the Life Sciences in Seattle in 2017 (von Aulock, 2017).

Reinhardt (2003, p. 123) identifies compassion for laboratory animals as a refinement: “Kindness and concern for animals in the laboratory often have been stigmatized as subjective, emotional qualities that can undermine the ‘objectivity’ of biomedical and psychological research.” However, since there is evidence that the human-animal bond helps animals to cope with stressful situations in the laboratory (Wolfe, 1987), compassion for laboratory animals should not be dismissed as emotional and subjective but as a sound methodological base for scientifically valid animal-based research (see Mahoney, 1992; Reinhardt, 2003). Compassion implies an acute awareness of an animal’s state of emotional, behavioral, and physical well-being and the urge to provide them with the conditions essential for optimal well-being (Reinhardt, 2003). According to Herzog, “there is every reason to believe that individuals who care about their wards on a personal level actually treat the animals better.” (2002, p. 30). Morton highlights that, ideally, the staff assessing pain in animals should have an empathetic attitude toward them (Morton, 2000). Such a mindset can also be seen as a protection mechanism to control unrelated, potentially data-influencing, variables (Reinhardt, 2003). Brown (2014) states, “Although there are laws and regulations that govern working with research animals, institutions involved in research, testing, and teaching using laboratory animals should strive to go beyond what is legally required and work to establish a ‘culture of care’ to ensure animals are treated with compassion and respect.” Brown highlights that this culture of care for animals not only benefits animals but the quality of science as well.

3.1 *From Theory to Practice*

How far a culture of care is being implemented on an institutional level is unknown. Personal experiences of this author—as an inspector of animal research institutions in Germany between 2007 and 2016 (Herrmann, 2013; Herrmann and Ratsch, 2010; Maurin, 2012)—revealed differences regarding the level of care for animals within the same institutions, with individual care givers acting more or less compassionately towards their animals. An *institutional* culture of care agenda could not be identified.

The European Commission (EC) (2014) recommends the implementation of such a culture, and other countries have taken steps, in this direction. For example, New Zealand’s National Animal Ethics Advisory Committee guide is called *A Culture of Care: A Guide for People Working with Animals in Research, Testing, and Teaching* (National Animal Ethics Advisory Committee, 2002). Several pharmaceutical companies, such as Sanofi-Aventis

and Merck (Klein and Bayne, 2007), and commercial breeding companies (Brown, 2014) are reported to have established culture of care programs; however, no external review or assessment of these programs has been published.

3.2 *Towards a Culture of Care and Compassion for Animals*

There is potential for a positive impact of a culture of care on animal use and welfare. But how can we implement such a culture? Schuppli et al. (2017) used a new educational approach to test if exposure to socialized rats, who were trained to fulfill several tasks, fostered compassion among animal experimenters. Six rats were trained using positive reinforcement techniques to, for example, jump onto a scale, or to lift objects. Participants observed these rats and engaged with handling them. After the class, researchers (17) discussed their feelings and reactions. Main findings included that all participants were impressed by the rats' abilities and the close relationship with their trainers. They assumed that this positive animal-human interaction decreased stress in the rats. However, various views existed in regard to potential effects on data. The experimenters expressed unease about emotional difficulties in "sacrificing" their experimental animals after having bonded with them (Schuppli et al., 2017). This highlights one of the major obstacles: When animal researchers develop compassion for their research subjects, they face moral difficulties (see Birke, Arluke and Michael, 2007; Gluck, 2016) and moral harms (see Chapter 13 in this Volume, Johnson and Smajdor, 2019) just as animal caretakers and technicians do. However, this could be an important starting point in moving towards a culture of compassion for all animals which could contribute to their replacement efforts.

4 **Refinement of Experimental Procedures**

There are several essential refinement methods to reduce the pain, distress, anxiety, and suffering inflicted during the course of experimenting on the animals. Handling and restraint techniques are a source of potential distress and anxiety (Balcombe, Barnard and Sandusky, 2004; Hurst and West, 2010; Meijer et al., 2006); and these techniques have been investigated in experimental studies on stress (Johnson, Sharp and Miller, 2000). To avoid negative effects on behavior, tail handling of mice should be replaced by using tunnels or cupping mice in the open hand (Gouveia and Hurst, 2013). These and other non-aversive handling practices should be implemented industry-wide, since they have been shown to reduce anxiety (Hurst and West, 2010) and optimize the performance of mice in behavioral tests (Gouveia and Hurst, 2017). A recent study by Clarkson et al. (2018) concluded that particular handling methods can

not only cause anxiety, but they can also alter the hedonic value of reward. Tail-handled mice demonstrated a decreased responsiveness to reward and, potentially, a more depressive-like state compared to tunnel handled conspecifics (Clarkson et al., 2018).

For surgical procedures, basic experimental refinements include: proper acclimatization of the animals to the room where anesthesia will be induced (Flecknell, 2018a); optimal anesthesia, peri- and postoperative analgesia; and adequate postoperative monitoring and care, including pain management (Flecknell, 2016; Herrmann and Flecknell, 2018a). The application of humane endpoints also prevents needless suffering. A humane endpoint (or “less-inhumane endpoint,” see Balls, 1999, p. 1) represents “[t]he earliest indicator in an animal experiment of (potential) pain and/or distress that, within its scientific context and moral acceptability, can be used to avoid or limit adverse effects by taking actions, such as humane killing, terminating the study, or alleviating the pain and distress.” (Hendriksen, Morton and Cussler, 2011, p. 344).

The way an animal is killed is another subject for refinement. Animal care policies in many countries stipulate that death must be painless, and fear and anxiety should be minimized (e.g., Charbonneau et al., 2010; European Parliament, 2010). Less inhumane killing comprises the use of the least distressing and least painful methods that cause rapid loss of consciousness and subsequent death (see e.g., Leary et al., 2013).

The application of our steadily increasing knowledge on experimental refinements should benefit the over 115 million animals who are used annually in research, testing, and education around the world (Knight, 2008; Taylor et al., 2008). However, this benefit cannot be achieved unless the knowledge is translated into practice. In cases where research workers plan to use, for example, less than optimal anesthesia or analgesia protocols, or do not provide other standard veterinary practices, they need to scientifically justify this and demonstrate that the anticipated benefits of the experiments still outweigh the harms inflicted upon the animals (Herrmann and Flecknell, 2018b). Due to the multitude of available means, solutions can be found, in most cases, that help prevent needless animal suffering (Herrmann and Flecknell, 2018a).

4.1 *The Use of Experimental Refinements in Practice*

Several structured and systematic literature reviews have given some insight on certain experimental refinements, notably, killing methods (Pound and Nicol, 2018; Uhlig et al., 2015) and the use of anesthetics and analgesics (Bertrand, Sandersen and Flecknell, 2018; Carbone and Austin, 2016; Coulter, Flecknell and Richardson 2009; Coulter et al., 2011; Pound and Nicol, 2018; Richardson, and Flecknell, 2005; Stokes, Flecknell and Richardson, 2009; Uhlig et al., 2015). For example, animal research involving surgical procedures carried out on

diverse species and published in peer-reviewed journals has been analyzed with regard to analgesic and anesthetic administration (Coulter et al., 2011; Coulter, Flecknell and Richardson, 2009; Richardson and Flecknell, 2005). Stokes, Flecknell and Richardson (2009) focused on studies conducted in two time periods (2000–2001 and 2005–2006), assessing trends in the administration of analgesics and anesthetics to laboratory mice and rats undergoing surgical procedures. The study showed a trend of improvement in terms of safer anesthetic regimens used in the later period examined; however, the findings of this study and an earlier review assessing analgesic use in rodents (Richardson and Flecknell, 2005) show that there was still significant scope for refinement, especially with respect to perioperative care.

A systematic review of anesthesia, analgesia and euthanasia methods used in anesthesiology, respiratory and critical care research in top-10 impact factor ranked journals pointed to insufficient reporting of experimental studies with small laboratory mammals. Despite the poor reporting, the review found shortcomings in the application of refinement (Uhlig et al., 2015). Another recent attempt to assess trends in pain management, this time in papers published before 2011 and from 2014 to 2015, further confirmed that reporting (and probably the use) of experimental refinement methods is still poor (Carbone and Austin, 2016). The review demonstrated that scientific publications still cannot be relied upon to present a detailed description of analgesia and anesthesia protocols, not to mention other experimental refinements.

Another approach employed by the author of this chapter, with Flecknell (2018 a, b, c), was to retrospectively review proposals for authorization of basic and applied animal research studies to learn which experimental refinements were proposed. Over 500 applications submitted to the German competent authorities in 2010 were reviewed. German law stipulates that all possible refinements that are planned in an animal study are described in detail in its proposal. The review's goal was to evaluate the intended application of and, thus, the awareness about possible refinements. Among other results, postoperative analgesia was not proposed for 30% of surgeries; and, in the majority of cases, its scientific necessity was not further discussed. Following 10% of procedures, animals were to be given pain relieving medication only if the investigators decided that it was necessary; however, structured assessments to detect pain were absent (Herrmann and Flecknell, 2018a).

4.2 *Discussion on Refinement of Experimental Procedures*

Structured and systematic literature reviews and the work of this author found strong indications for flaws in the administration of experimental refinement. Refinement methods need to be fully employed in order to minimize stressors that can lead to distress, such as suffering from postoperative pain, or living

in a barren cage. The biological consequences of stress and distress compromise rigor, reliability, and relevance of data collected from these animals (see Bailey, 2018 for a review on how stress of laboratory life and experimentation can adversely affect research data). Animal researchers are responsible for the animals they use (National Health and Medical Research Council, 2013). Thus, they and their animal care staff should know enough about animal behavior to properly assess the health and well-being of their test subjects. In the European Union, they are legally required to be skilled, educated, and equipped to detect and relieve suffering accordingly (European Parliament, 2010, Article 24).

There are several challenging areas of refined care and use that should be addressed. For example, there is a need for automated, remote, 24/7 cage-side monitoring to identify abnormal behavior, which is especially important when assessing the welfare of genetically modified animals, as well as for prey species who tend to mask their medical condition or psychological state. Additionally, there is a need for further development and implementation of valid pain-assessment techniques to determine the efficacy of treatment in the individual animal due to individual variations in pain response. While there is necessity for further research into certain areas of experimental refinement, it is essential that we apply the knowledge we already have, so that immediate improvements in animal welfare can be achieved.

5 Refinement of Experimental Design, Conduct, and Reporting

There have been quality problems throughout medical and biomedical research (Begley and Ellis, 2012; Harris, 2017; Pound and Bracken, 2014; Prinz, Schlange and Asadullah, 2011). “The scandal of poor medical research” with human subjects was discussed in a British Medical Journal (BMJ) editorial in 1994 (Altman, 1994). A biostatistician took a prominent stance against the unethical misuse of statistics (Altman, 1980). In a follow up 20 years later, another BMJ editorial called, “Medical research—still a scandal,” concluded that matters have become worse (Smith, 2014). It is apparent that the quality of *in vivo* research with animal and human subject demands urgent improvement. Weaknesses in design, conduct, and analysis of biomedical and public health research studies yield misleading results and, thus, waste resources (Ioannidis et al., 2014). Since legally-required animal data forms the basis of decisions to move forward to human clinical trials, flawed animal research is additionally problematic.

Aside from evidence that many animal experiments that are performed never get published (Scherer et al., 2018), a large part of what gets published is

incorrect (e.g., Harris, 2017; Ioannidis, 2005; Freedman, Cockburn and Simcoe, 2015). Ioannidis (2005) argues that it is highly probable that most published findings are indeed false. He drew his conclusion after conducting simulation studies and SRS. He calculated that, at best, only one in three publications took basic precautions to minimize bias (Ioannidis, 2005). Freedman, Cockburn and Simcoe (2015) estimated that more than 50% of all preclinical studies in the United States are unreliable, and that the financial damage of these irreproducible preclinical studies is US\$28 billion per year. Their analysis revealed that about 20% of the studies had an untrustworthy experimental design, one quarter used media that contained contaminated cells and antibodies, and in 18% of studies the data analysis was poor. All of these issues have contributed to the so-called *reproducibility crisis* in animal research (e.g., Aarts et al., 2015; Baker, 2016; Begley and Ioannidis, 2015; Bracken, 2009; Collins and Tabak, 2014; Freedman, Cockburn and Simcoe, 2015; Ioannidis, 2005; Perel et al., 2007; Pound et al., 2004; Pound and Bracken, 2014; Reichlin, Vogt and Würbel, 2016; Scannel and Bosley, 2016; Würbel, 2016). A review of the literature by Bailoo, Reichlin and Würbel (2014) strongly suggests that experimental design and conduct of laboratory animal research are in need of improvement. A study by Vogt et al. (2016) revealed that animal researchers working in Switzerland do not apply basic principles of study design to avoid bias and do not properly report their study outcomes. They also found that neither the Swiss regulatory authority nor the international journals and their peer reviewers had adequate knowledge to recognize these flaws.

In an attempt to improve the quality of research reports, several checklists and guidelines have been put in place, such as Consolidated Standards of Reporting Trials (CONSORT) and Standards for Reporting of Diagnostic Accuracy (STARD) for human clinical trials, Preferred Reporting Items for Systematic reviews and Meta-Analyses (PRISMA) for SRS and meta-analyses, and Gold Standard Publication Checklist (GSPC), Animal Research: Reporting of *In Vivo* Experiments (ARRIVE) guidelines for animal research (Glasziou et al., 2014; Hooijmans, Leenaars and Ritskes-Hoitinga, 2010) and HARRP, the harmonized animal research reporting principles, which are a recent attempt by ICLAS (International Council for Laboratory Animal Science) in harmonizing animal research reporting to further improvements in the scientific rigor of animal experiments (Osborne et al., 2018). The ARRIVE guidelines (Kilkenny et al., 2010) are the most widely known for reporting of animal-based experiments. These guidelines have recently been complemented by the Planning Research and Experimental Procedures on Animals: Recommendations for Excellence (PREPARE) guidelines, which help to ensure quality when preparing animal studies (Smith et al., 2017).

The ARRIVE guidelines were adopted by more than 1000 scientific journals, and more than 20 funding agencies were expected to endorse them in 2010 (Baker et al., 2014; Enserink, 2017). Two years later, Baker et al. (2014) assessed the degree to which they had been endorsed by reviewing journals, such as *Nature* and *PloS*, and found that there was little improvement. The knowledge about and the use of reporting guidelines, such as the ARRIVE guidelines, is still not widespread, as a study by Reichlin, Vogt and Würbel (2016) has shown. Reichlin et al. asked animal experimenters in Switzerland to complete a questionnaire regarding their use of measures against risk of bias. Only 16% responded. The ARRIVE guidelines were known by less than half (43.7%). Furthermore, Carbone and Austin (2016) found no increase in reporting of analgesic use in the articles published in journals that had agreed to endorse the ARRIVE guidelines. Results of a recent randomized controlled trial of close to 1,700 scientists, who submitted papers to the scientific journal *PLoS One*, suggest that scientists are either ignoring the guidelines or are still unaware of their existence. Another finding was that, even when an ARRIVE checklist was completed, the correlating papers were actually not more compliant, which may indicate that researchers do not know what is expected of them and why providing this information is crucial, emphasizing the importance of proper training (Enserink, 2017; Hair et al., 2018).

5.1 *Sources of Bias in Animal-based Research*

There is a large number of potential sources of bias in animal research. Not surprisingly, most published animal studies have some risk of bias (Macleod et al., 2015). Safeguards to avoid bias in study design, conduct, and analysis include randomization of treatment groups to eliminate systematic differences between them, blinding of investigator to treatment and to handling of data, and reporting on sample size estimation (Macleod, 2011). Analytical errors may account for close to a quarter of the irreproducible studies (Freedman, Cockburn and Simcoe, 2015); thus, knowledge about statistical methods is essential. Other suggested items for reporting include: a clear description of the hypotheses tested or primary and secondary objectives of the study, housing and husbandry, including welfare-related assessments and interventions, adverse events, and interpretation of results, taking into account the hypotheses/study objectives (Kilkenny et al., 2010). Part of the reproducibility and translatability crisis is considered to be due to poor experimental design and conduct of animal experiments (Bailoo, Reichlin and Würbel, 2014; Ioannidis, 2005; Macleod, 2011; van der Worp, 2010; Würbel, 2016), including the influences of inappropriate animal housing (Lahvis, 2017) and handling (Gouveia and Hurst, 2017), insufficient pain relief (Carbone and Austin, 2016; Herrmann and Flecknell, 2018a),

as well as the absence of other refinements, such as careful monitoring, early humane endpoints, and less inhumane killing methods to reduce pain, suffering, and distress (Herrmann and Flecknell, 2018b and 2018c). The other, and perhaps larger, part is due to insurmountable species differences (Pound and Bracken, 2014; Pound and Ritskes-Hoitinga, 2018), which Russell and Burch already discussed 60 years ago (1959, Chapter 5).

Another source of bias is selective reporting when publishing results of animal experiments (Briel et al., 2013; Ioannidis, 2012; Landis et al., 2012; Lees et al., 2012; Macleod et al., 2004; Pound and Bracken, 2014; Sena et al., 2010; Tsilidis et al., 2013; Würbel, 2016). One problem relates to *negative* findings—studies for which the original hypotheses were not proven. Some of these are not published at all, which has long been recognized as a source of publication bias. The second problem relates to studies that are reported incompletely. For example, only the parts that demonstrate that the treatment is effective are reported, with whole experimental groups excluded from reporting. This is selective outcome and analysis reporting bias (Ioannidis, 2012). These partially or unreported studies may be repeated by others and thus represent an unnecessary waste of animal lives. Incomplete reporting of published findings makes it impossible to replicate studies (Begley and Ellis, 2012). Because negative findings are often not published (Scherer et al., 2018), the value of published findings is over-estimated, which, in part, could explain some of the difficulties in translating promising preclinical results into effective therapies for human disease (Bath et al., 2009; Mergenthaler and Meisel, 2012; Sena et al., 2010).

Yet another pitfall is researchers' freedom of flexibility in data collection, analysis, and reporting, which dramatically increases false-positive rates in the literature and, therefore, contributes to misleading animal research data and overestimation of its significance. Regardless of the nominal endorsement of a maximum false-positive rate of 5% ($p \leq .05$), standards for disclosing details of data collected and analyzed make false positive results very likely (Simmons, Nelson and Simonsohn, 2011). The authors describe this as *p-hacking*. Often-times, an experimenter is more likely to find evidence that an effect exists falsely than to find evidence that it does not correctly. This occurs because of the investigators' degree of freedom with regard to the amount of data collected and analyzed, the exclusion of certain observations made, the comparison or combination of conditions, the variables considered, and so forth. It is uncommon for researchers to make these decisions before undertaking experiments. Their exploratory behavior is explained as ambiguity in how best to make these decisions and the desire to find statistically significant results.

Confirmatory bias is another potential pitfall, since people tend to interpret ambiguous information in such a way that it supports a justifiable

conclusion that matches their own aspirations (e.g., Dawson, Gilovich and Regan, 2002). *HARKing* (i.e., Hypothesizing After the Results are Known) (Kerr, 1998) is another common and problematic practice in science. Statistical tests to differentiate true effects from random noise are designed for confirmatory research, not exploratory research. Thus, when researchers change their *a priori* hypotheses after obtaining their results, this leads to false conclusions.

An additional area that urgently needs refinement is transparency and data sharing to avoid publication bias and needless repetition of studies. Openness is a cornerstone of science and could help in reducing the reproducibility problem science is facing (Errington et al., 2014; Harris, 2017; McNutt, 2014). It is essential to discover and correct errors. The Food and Drug Administration Modernization Act of 1997 (FDAMA) (Food and Drug Administration, 2018) requires scientists to register their hypotheses and endpoints in advance, if they plan to run a clinical trial on potential new pharmaceutical drugs (ClinicalTrials.gov). This new law went into effect in 2000. It also requires pharmaceutical companies to publish their results, thus, avoiding publication bias. Despite the insufficient enforcement of the law, as many scientists still do not report the results of their studies (Harris, 2017), the indispensability of such provisions is demonstrated by the findings of a study conducted by Kaplan and Irvin (2015). They assessed whether the FDAMA had any effect on study outcomes. Before the law was in place, 57% of drugs or supplements showed benefits; after the law was in place, 8% of the studies published confirmed their preregistered hypotheses (Kaplan and Irvin, 2015). Such a prospective registration process is currently exceptional for animal-based studies, but it is unquestionably required in order to enhance transparency, reduce selective reporting bias, and prevent duplication. The Center for Open Science, a nonprofit where researchers can register their hypotheses *a priori* (<https://cos.io>) and Preclinical Trials, a platform for registration at the outset of all types of animal studies (www.preclinicaltrials.eu), will hopefully improve the current situation. An additional measure to improve transparency, and potentially reproducibility, is data sharing, which is a requirement for publication by some major journals but many researchers still refuse to share. By sharing data, errors can be discovered (e.g., Salzberg et al., 2001). This is especially important in animal research, since it helps reduce the number of animals used and sheds light on the real value of animal derived data.

5.2 *Necessary Steps*

The improved quality of human clinical trials was achieved by strategies to minimize bias, *a priori* power analysis and further biostatistics, clear definition of the primary and secondary endpoints, data monitoring and auditing, internationalization and inclusion of multiple centers, external steering committees and safety monitoring, rigid publication standards, trial registries, and

more (Dirnagl and Fisher, 2012). The lessons learned from the improvement of human clinical trial quality should be adopted by preclinical (Dirnagl and Fisher, 2012) and all other biomedical research fields (Hartung, 2013), where relevant and with appropriate changes, since flawed research is unscientific and unethical. The ethical issues with research involving animals become extra critical as needless animal suffering must be avoided, and as preclinical animal data generally forms the basis for decisions whether to proceed to human clinical trials. Thus, in order to adhere to the 3Rs, the following efforts are crucial:

- Education and ongoing training of researchers in experimental design, statistical methods, and model selection (Justice and Dhillon, 2016).
- Close assistance in study design by institutional animal welfare bodies and by biostatisticians.
- As a possible solution for the problem of false positives making their way into the literature, some researchers suggest the p -value threshold should be reduced to 0.005 (Chawla, 2017). Others say researchers should select and justify p -value thresholds for their experiments, before collecting any data. These levels should be based on factors such as the potential impact of a discovery. These thresholds could then be evaluated via *registered reports*, a type of scientific article in which methods and proposed analyses are peer-reviewed *before* any experiments are conducted (Chawla, 2017).
- Transparency must be improved as it is crucial to document all anticipated or exploratory steps in the study. Prospective registration of all animal studies with their hypotheses and endpoints is essential to prevent selective-reporting biases (Ioannidis, 2012) and avoid study duplications (Preclinical Trials, n.d.).
- Disclosure and openness are critical elements of science for self-correction, and they can help avoid poor practices, such as HARKING.
- The use of preparation and reporting guidelines, such as the PREPARE guidelines (Smith et al., 2017) combined with the ARRIVE guidelines (Kilkenny et al., 2010), should be a mandatory, legally required part of funding applications, project license applications, as well as publications. Education on how to fill out the checklists and present the required information in the publication, as well as a focus on enforcement of compliance to both by journals, is critical (Eisen, Ganley and MacCallum, 2014; Enserink, 2017; Hair et al., 2018; Herrmann and Flecknell, 2018a).
- Raw data, analyses, and protocols must be made available to allow other researchers to verify results. This can easily be achieved by using data repositories (e.g., <https://datadryad.org> or <https://figshare.com>).
- Reporting of all study outcomes to avoid traditional reporting bias and selective outcome and analysis reporting bias should be mandatory (Ioannidis, 2012).

- Retrospective assessments of animal studies (see EC Expert Working Group for Project Evaluation and Retrospective Assessment, 2013, pp. 28–32) should be performed comprehensively and by independent experts; and all results should be published to enhance transparency, minimize publication bias, identify animal models lacking external validity, and, thus, improve future research.
- Mandatory data sharing so that other scientists can build on the work and discover errors faster (cf. the error in the Human Genome Project discovered by Salzberg et al., 2001). Data sharing should be compulsory, especially when research is publicly funded.

It is equally important that funding and regulatory bodies, animal ethics committees, animal welfare bodies, journal editors, and peer reviewers have a detailed knowledge of these topics in order to recognize flawed research studies. This requires effective and thorough education and training of funders, animal ethics and welfare committees, and regulatory body members on how to assess animal research proposals (Vogt et al., 2016). Furthermore, in order to review these applications in-depth, enough time and manpower are a prerequisite.

6 Refinement: Are We Doing What We Can?

As presented in this chapter, knowledge about and implementation of refinement of husbandry, experimental procedures and design, conduct, and reporting appears to still be patchy. Since adoption of refinement strategies has been inconsistent, it would seem that rather than use additional animals to carry out more refinement research, we should focus on the comprehensive application of existing refinements in animal laboratories as well as on reducing and replacing animals.

6.1 *But What about the Refinement of Animal Models?*

Animal models ought to describe a biological phenomenon that the model species has in common with the target species. Significance and validity, in terms of the translatability of results produced in an animal model to the human condition, “depend on the selection of a suitable animal model,” writes Hau (2008, p. 4), which is why comprehensive knowledge about comparative anatomy and physiology is essential. A majority of animal models developed with the expectation to study the origin, disposition, and treatment of human disorders and is created through experimental induction, genetic modification, or breeding of disease-causing mutations (Hau, 2008, p. 4). These presumed predictive models are used to find treatments or to assess the toxicity of drugs and other chemicals (Hau, 2008). Hence, they cause conditions

associated with pain and distress up to severe, long-lasting suffering for these animals.

Some laboratory animal scientists focus on the refinement of animal models in an attempt to reduce the suffering caused. Examples for refinement recommendations of animal models include those described for mice and rats who are utilized as models of ischemic stroke (Percie du Sert et al., 2017), for rheumatoid arthritis (Hawkins et al., 2015), in experimental autoimmune encephalomyelitis (EAE) (Wolfensohn et al., 2013a), as models and in procedures involving seizures, convulsions, and epilepsy (Lidster et al., 2016; Wolfensohn et al., 2013b), and as models of sepsis and septic shock (Lilley et al., 2015). If the gathering of such recommendations does not involve additional harmful animal experiments, and in case these guidelines are then applied in practice, they could lead to an improvement of the individual animal's life.

However, due to failure of numerous models to predict human outcomes (e.g., Joffe et al., 2016; Mak, Evaniew and Ghert, 2014; Pharmaceutical Research and Manufacturers of America, 2015, 2016), and due to limited funding, it seems crucial to first assess carefully which research methods and models to use. In the case of sepsis models, for example, there have been multiple publications highlighting the differences in human and mouse immunology (e.g., Mestas and Hughes, 2004; Rittirsch, Hoesel and Ward, 2007; Seok et al., 2013; Shay et al., 2013; Payne and Crooks, 2007). After over 20 years of unsuccessful research in this field, a number of scientists finally investigated why, out of the approximately 150 new compounds that were developed for the treatment of sepsis using mice, not one had beneficial effects for humans. They identified around 5,000 genes that are activated or deactivated by inflammation in humans who suffered from sepsis, trauma, or burns. They went on to look for the same genes in one commonly-used strain of mice and realized that there was no correlation (Seok et al., 2013). As a consequence of the dissimilarity of mouse and human immune systems, the entire field of sepsis research in mice has been called into question, regarding its predictive value for humans. Paradoxically, funding for this kind of animal research, which is also known for causing severe levels of animal suffering, is still ongoing (Leist and Hartung, 2013). At the same time, human-based sepsis research has led to clinical trials of effective therapies (van der Poll, 2012).

7 Reduction and Replacement: Are We Doing What We Can?

Most animal research is being justified as indispensable to furthering human healthcare. However, despite measures being taken to improve the quality of animal-based research, the translational success rate from animal studies to

humans is low: Less than 12% of drugs entering clinical trials result in an approved medicine (Pharmaceutical Research and Manufacturers of America, 2015, 2016); and between 51% and 89% of preclinical studies are not reproducible (Freedman, Cockburn and Simcoe, 2015; Harthorne and Schachner, 2012). There is an ongoing debate among scientists as to why animal models fail to be predictive: Is this mainly due to poor scientific rigor and reporting, to species differences, or to the fact that today we mainly deal with complex, oftentimes, chronic ailments of which many are not well understood and, thus, impossible to model in other animals?

As a consequence of the failure to translate findings to humans, new criteria for mouse models have been described (Justice and Dhillon, 2016). Hoping to enhance animal models of stroke, Dirnagl and Fisher (2012) call for international, multicenter, preclinical Phase III-type studies of promising new ischemic stroke therapies in animals before moving to clinical trial. As Phase III studies would be based on prior studies and would use various strains and species (Dirnagl and Fisher, 2012), as well as older animals with various comorbidities (e.g., diabetes mellitus, obesity, and hypertension) (Mergenthaler and Meisel, 2012), the severity of these experiments and the numbers of animals involved would markedly rise. Of close to 100 interventions that improved the outcome in animal stroke models, which were tested in clinical trials, only one intervention improved the outcome in human patients (O'Collins et al., 2006). Despite decades of research, most translational stroke trials that aim to extrapolate basic research findings into clinical treatments, particularly in the area of neuroprotection, have failed (Mergenthaler and Meisel, 2012). The authors admit that, to date, there is no ideal animal model for stroke, and that more complex models are needed to improve translational success in experimental stroke research (Mergenthaler and Meisel, 2012). Thus, at the time of writing, Mergenthaler and his colleague Stachelscheid are developing human stem cell-derived 2D and 3D models for stroke (vfa, 2017). Building on the latest *in vitro* research to model human brain development and disease, they plan to employ a recently established protocol for generating 3D brain tissue, so-called cerebral organoids, from human pluripotent stem cells that can be applied to study a number of human brain diseases (Lancaster and Knoblich, 2014). Renner et al. (2017) further examined the development and potential differentiation of cerebral organoids, which hold great potential to advance human-relevant stroke research.

7.1 *Potential for Reduction by Critical Appraisal of Animal Studies*

Several unsuccessful animal models have been discussed, such as for Alzheimer disease (Cavanaugh, Pippin and Barnard, 2014; Pippin, Cavanaugh and

Pistollato, 2019, Chapter 20 in this Volume; Pistollato et al., 2016), for stroke (Shuaib et al., 2007; van der Worp et al., 2010), for tuberculosis (Fonseca et al., 2017); for asthma (Mullane and Williams, 2014), for HIV/AIDS, for neurological, menopausal human therapy, and for cancer research as well as drug development (Pippin, 2012). Since only disease models with high predictive validity are likely to yield positive results and treatments for humans, it is critical to assess the reliability, reproducibility, and validity of the animal model first. With the overall low quality and predictive validity of the majority of research studies, it has become evident that animal-based studies require rigorous evaluation (Pound et al., 2004). A solid methodological approach would be to systematically review and to perform meta-analyses of animal studies, as SRS are seen by experts in the field of evidence-based medicine as the highest level of medical evidence (Hooijmans, Leenaars and Ritskes-Hoitinga, 2010).

7.1.1 Systematic Reviews (SRS)

A systematic review (SR) is a literature review that focuses on a specific question with the aim to identify and assess all relevant studies in order to generate new, high-quality evidence. Thus, it enables evidenced-based decision making (Norecopa, 2017). A SR may contain a meta-analysis. In a meta-analysis, the results of a number of independent studies are statistically combined to calculate the average effect of studies addressing the same question, which may lead to more reliable conclusions and may help to minimize needless duplication of animal studies (Hooijmans et al., 2014a). SRS conform with the implementation of the 3Rs concept (Ritskes-Hoitinga, 2016), as their application leads to a more evidence-based choice of animal models (e.g., de Vries et al., 2012; Sloff et al., 2014; Zeeff et al., 2016). They help decrease unnecessary animal studies, the evidence they produce should further responsible animal use, and they increase scientific quality (van Luijk, 2016), as they are an excellent tool to assess study quality by evaluating the internal, external, and construct validity of the models. Internal validity is the degree to which the design, conduct, and analysis of the experiment remove potential bias, so that the interpretation of a causal relationship between an experimental treatment and variation in an outcome measure is secured (Bailoo, Reichlin and Würbel, 2014). The extent to which animal data gives a basis for generalization to other animal and human populations, including other environmental circumstances, represents the external validity; and construct or predictive validity shows how good the model is, the rate to which the sampling properties are representative for the entities they ought to represent (Bailoo, Reichlin and Würbel, 2014; Würbel, 2017). An example for a SR on internal validity is the study of Macleod et al. (2008) and for construct validity, the work of Sena et al. (2010), both focusing on reasons

for translational failure of experimental stroke. SRS are a significant tool to identify quality issues with primary animal studies. For example, a recent SR on the welfare implications of toe clipping and ear notching revealed that the underlying animal experiments were too flawed to draw conclusions (Wever et al., 2017). SRS are excellent to assess the risk of bias in animal studies and thus to evaluate the reliability of the available evidence (van Luijk et al., 2014). Perel et al. (2007) systematically reviewed the success of treatments in animals and in humans, with head injury, hemorrhage, thrombosis due to acute ischemic stroke, acute ischemic stroke, and osteoporosis as well as preventive medication in neonatal respiratory distress syndrome, with their applications in humans with these impairments. Their conclusion was that the incongruity between animal and human studies may be due to bias or to the failure of the animal models to mimic clinical disease (Perel et al., 2007).

SRS of animal studies are still much less common than in the clinical setting, where they are frequently used to make evidence-based decisions on health-care; but awareness of the benefits of the utility of SRS of animal research has been increasing (Hooijmans et al., 2014; van Luijk et al., 2014). The Collaborative Approach to Meta-Analysis and Review of Animal Data from Experimental Studies (CAMARADES) group, at the University of Edinburgh in the UK, and the Systematic Review Center for Laboratory Animal Experimentation (SYRCLE), at Radboud University Medical Center in the Netherlands, provide a supporting framework for groups who are or want to get involved in the SR and meta-analysis of data from experimental animal studies and offer advice and training (CAMARADES, 2014; SYRCLE, n.d. b). SYRCLE has published a step-by-step guide on how to identify all relevant animal studies (Norecopa, 2017), as well as a tool similar to the Cochrane tool for assessing risk of bias in randomized clinical trials (Higgins et al., 2011), to assess the risk of bias in animal-based studies (Hooijmans et al., 2014). It is important to receive proper training first, as one needs to be aware of the pitfalls and limitations of these tools, and how they can be misused and/or misleading (Gurevitch et al., 2018). Various types of reporting biases, together with the limited methodological quality of some studies on which meta-analyses and SRS are based, can impede their conduct and interpretation (e.g., Benatar, 2007). When publication bias against negative animal studies exists, it will lead to an overestimate of the value of animal studies. It is likely that if unpublished studies were to be included, then SRS would show more studies with no effect in animals (Akhtar, Pippin and Sandusky, 2009). Checklists and tools have been proposed to help improve SRS and meta-analyses (Hooijmans et al., 2014; Moher et al., 2009).

The use of SRS should be standard practice within animal-based research, in the same way it has become a vital part of clinical research (Hooijmans, Leenaars and Ritskes-Hoitinga, 2010; Hooijmans and Ritskes-Hoitinga, 2013;

Pound and Bracken, 2014; Pound et al., 2004; Sandercock and Roberts, 2002). SRS should be conducted prior to a new animal study to assess the validity of the proposed animal model and to avoid needless animal use (Ritskes-Hoitinga and Wever, 2018). For example, in refinement research, SRS are an efficient way to gather new high-quality data without having to experiment on additional animals. As shown in this chapter, the implementation of new knowledge about refinements to improve animal welfare has proven very difficult. A prominent example is the use of carbon dioxide to kill animals. Extensive research conducted on this welfare topic has produced overwhelming evidence against its use, but these findings still have not led to the abolishment of this common practice. At the time of writing, Turner et al. are conducting a SR on the use of carbon dioxide as a killing method for mice and rats. Their protocol (SYRCLE, n.d. c), as well as the protocols of others, are published on the SYRCLE website and, since 2018, protocols of SRS relevant to human health can be registered at the international prospective register of SRS, called PROSPERO (<https://www.crd.york.ac.uk/prospero/>).

7.1.2 Other Retrospective Assessments

Conducting retrospective assessments (RAS) is a useful way to identify disease models and research methods that may be of limited value. Since 2013, RAS are mandatory for certain animal studies in the European Union (European Parliament, 2010, Article 39). Members of the animal research inspectorates have been required to assess the outcomes of animal studies that were classified as severe and/or use non-human primates. The animal researcher has to submit the necessary documents so that the competent authority can evaluate whether the study objectives were met, the actual harm inflicted, and whether the severity of procedures coincided with the prospective assessments, and the number of animals used. In addition, the competent authorities must appraise any component that can advance the implementation of the 3Rs (European Parliament, 2010, Article 39).

These RAS could be extremely effective in facilitating a critical review of the use of animals in scientific procedures, if there are sufficient and qualified personnel to conduct them, as the EC's aim with these RAS is to identify 3Rs improvements and enhance transparency to the public (EC Expert Working Group for Project Evaluation and Retrospective Assessment, 2013). Publication of RA results of all studies, including those that produced negative results and may not be published elsewhere, would likely be of significant value. It would increase the knowledge base in a range of disciplines, reduce risks of duplication of studies, and inform the design of future research (EC Expert Working Group for Project Evaluation and Retrospective Assessment, 2013). However, only about one sixth of all EU Member States agreed to make the RA results publicly

available. This is not enough to meet the EC's goals. To achieve maximum benefit, access to study results should be given not only to regulatory authorities but to independent experts, in order for them to perform critical reviews of these data. And all RA results have to be made publicly available. It is possible to do so and still protect intellectual property by redacting and anonymizing certain parts of the documentation.

7.1.3 Necessary Steps

As outlined earlier, the scientific and ethical justification for animal models of human diseases depends on their providing an opportunity to investigate disease biology and to determine potentially beneficial therapies for humans (Benatar, 2007). Thus, only after an animal model has proven to have satisfactory predictive value for humans, should it be refined as much as possible to reduce pain, suffering, distress, and lasting harm. If proven of no value, it should be abandoned. Such models should no longer receive regulatory approval nor funding, nor should they be accepted by scientific journals. SRs and meta-analyses of animal models as well as RAs of all animal experiments performed by independent experts would benefit animals and human patients, as they help to identify flawed studies and to eliminate misleading, invalid models, and experimental designs. Such a rigid quality control of animal-based research would most certainly lead to a significant reduction of animal use and, thus, to an increased effort to find more animal-free, robust, human biology-based models.

7.2 *Is the Biomedical Research Industry Shifting away from Animal Use?*

The problem is that it hasn't worked, and it's time we stopped dancing around the problem. [...] We need to refocus and adapt new methodologies for use in humans to understand disease biology in humans.

ZERHOUNI, former head of the US National Institutes of Health, quoted in McManus, 2013

There is growing recognition that instead of focusing efforts on trying to refine animal experiments, a primary focus on human-relevant data is needed (Collins, 2011; Giri and Bader, 2015; Langley et al., 2015, 2017; Zerhouni, 2014), as a significant challenge that medical research is facing today is the understanding and possible treatment of chronic, complex diseases of which many are not well understood and, thus, cannot be modeled in other animals (Tsukamoto, 2016). Tsukamoto asks in a *Drug Discovery Today* editorial: "How can we replicate human diseases that develop later in life and/or result from a prolonged unhealthy lifestyle, far beyond the lifespan of rodent animals? What makes us expect that the outcomes from carefully controlled animal

experiments can be duplicated in patients with substantial heterogeneity across various aspects (age, gender, genetics, lifestyle, disease stage, etc.)?” Transgenic mice commonly used as disease models, oftentimes contain multiple copies of presumed disease-causing transgenes, and it is dubious “whether phenotypes seen in mice as a result of this ‘genetic exaggeration’ have any relevance to the corresponding human diseases” (Tsukamoto, 2016). Zerhouni (2014) calls for a new approach that redirects the drug-development paradigm that commences with the patient to explore the genetic foundation of molecular changes inherent to human pathophysiology.

As Russell and Burch remarked in 1959, “refinement is never enough, and we should always seek further for reduction and if possible replacement” (Chapter 4). Since 1959, we have gathered immense knowledge about animals and their consciousness, which has led to the public acknowledgment by a group of prominent neuroscientists that other animals are conscious too: The Cambridge Declaration on Consciousness (Low, 2012). Since 1959, the technology revolution has also immensely changed the field of life sciences and, hence, provides us with the tools to move away from using animals (Langley et al., 2015, 2017).

Current legislation, reflecting societal concerns, as well as the scientific failures of animal research should function to drive research, testing, and education away from using live animals. Some areas of education and training are already using animal-free teaching approaches, for ethical reasons and educational advances (see e.g., Bones et al., 2019, Chapter 23; Pawlowski et al., 2019, Chapter 22 in this Volume). In the area of chemical-toxicity testing, some progress has already been made in finding advanced non-animal methods, initiated, for example, through the pioneering *Toxicology in the 21st Century (Tox21)*, a US federal initiative (National Research Council, 2007; National Toxicity Program, 2004; Rovida et al., 2015; Zurlo, 2012). However, the general tendency in toxicology is to introduce new methods without eradicating all the old (animal-based) ones (Rovida et al., 2015). Still, the acceptance of animal-free alternatives by regulators without additional animal-based tests, in the pharmaceutical and food-toxicity testing fields, should be possible when proven scientifically qualified for the specific context of use. However, awareness and acceptance of scientifically-valid, non-animal methods is still low among regulators as well as research workers (Ramirez et al., 2015).

The high failure rate of drugs in the clinical phase (Begley and Ellis, 2012; Food and Drug Administration, 2004; Hutchinson and Kirk, 2011; Kola and Landis, 2004; Olson et al., 2000) indicates not only poor scientific quality and cognitive bias but also that animals are not good models for humans (e.g., Greek and Kramer, 2019, Chapter 17 in this Volume; Kramer and Greek, 2018; Knight, 2019, Chapter 14 in this Volume; Leist and Hartung, 2013); and the same

applies to food-safety testing in animals (Rovida et al., 2015). Already back in 2000, an eye-opening report (Olson et al., 2000) was published about the results of a multinational pharmaceutical company survey, which served to better understand the concordance of the toxicity of pharmaceuticals in humans compared with other animals. The weakness of animal studies to predict the human toxicity of drugs became apparent, as results revealed a human toxicity concordance rate of 71% when tested in multiple rodent as well as non-rodent species. When they compared humans with rodent species only, there was a 43% correlation; humans compared with non-rodent species showed a 63% match. Drug toxicity studies in animals are long-lasting and, hence, may cause severe suffering; and they are frequently not predictive for effects in humans (Hartung, 2009).

Cumulative knowledge is essential for scientific progress. Thus, there is increasing awareness of the importance of data sharing and collaboration to shift the paradigm away from using unsound animal models for drug toxicity testing. The human toxome project, a systematic mapping of the entirety of toxicity pathways, is ongoing in the area of chemical risk assessment. Rovida et al. (2015) suggested that this project should be extended to include the assessment of efficacy and adverse effects of drugs and food ingredients. Continued reliance on animal models appears implausible to enhance the current poor rate of clinical approval of new treatments. This is why Humane Society International initiated the Biomedical Research for the 21st Century (BioMed21) Collaboration. The BioMed21 Collaboration is working internationally with health experts, regulatory and research agencies, funding bodies, and others to develop innovative research roadmaps that focus on understanding human disease pathophysiology. The goal is to further this human-focused approach to studying, preventing, and treating disease (BioMed 21 Collaboration, n.d.). A central recommendation of the BioMed21 2015 workshop was to use the Adverse Outcome Pathway (AOP) concept in biomedical research. AOP, an important concept in toxicology, describes a logical sequence of causally-linked biological events that lead from the first action of a compound to an eventual adverse effect on human health (Langley et al., 2017). Furthermore, it was recommended that technological advances should be combined in human-specific tools and models. The importance of funding these new approaches was highlighted as well as the need for faster validation and acceptance by the scientific community, funding bodies, and scientific journals, who mostly still postulate the use of animals (Langley et al., 2015, 2017).

BioMed21 is a rare example for a non-animal-based approach in the area of applied research, which—together with the field of basic research—uses the majority of animals. Overall, there is little evidence that these fields are reducing the use of animals, as the 3Rs posit we must. Quite the contrary: Animal use

has been increasing in the new century (Taylor and Rego, 2016), mainly due to an increasing generation and use of genetically altered animals (Bailey, 2019, Chapter 19 in this Volume; Carbone, 2004; Ormandy, Schuppli and Weary, 2009; Ram, 2019, Chapter 15 in this Volume), which has, in recent years, been fueled by excitement over new technologies, such as CRISPR, an easier genetic modification technique that will most probably lead to a further steep increase in animal numbers and species modified (Bailey, 2019). These new technologies, however, have not kept their promise of improving translation between animal models and human health, as they have failed to increase the efficiency and the safety of drugs (Hunter, 2011). For a detailed discussion on the scientific and ethical issues of the genetic modification of animals, see Chapter 19 in this Volume (Bailey, 2019).

7.2.1 Funding

Progress in the development of replacement methods seems to be *limited most by the availability of funds*. Some governments and non-governmental organizations around the world are providing scarce funding, especially when compared to funds available for biomedical and life research as a whole. It is unclear how much of the annual worldwide funds—an estimated US\$100 billion for biomedical research alone (Chalmers and Glasziou, 2009) and up to US\$240 billion for all the life sciences (Röttingen et al., 2013)—are currently used for research centered around the use of animals, as it is not differentiated in the statistics (e.g., in Germany, BMBF, 2017). Daneshian (2016) estimated that in 2015, funds for projects with animals in Germany, including animal research facilities, were about €1920 million; funds for replacement methods ranged around €6.45 million. These financial means, mainly derived from German taxes, are distributed in opposition to Germany's declared political goal of working towards replacement of animal use at the national level (BMEL, 2015) as well as the EU level (European Parliament, 2010, Recital 10).

In preclinical human model development, the *Tissue Chips for Disease Modeling and Efficacy Testing* initiative, funded by US National Center for Advancing Translational Sciences (NCATS) of the National Institutes for Health (NIH), is a rare example. Its goal is to explore human microphysiological systems as potential facilitators of drug development in numerous disease areas. Its budget is approximately US\$15 million, annually, for 13 two-year projects (NCATS, 2017); while NIH, being the biggest funder and research organization in the world, has annual funds of about US\$39 billion for medical research alone (NIH, 2019). The EU framework program for research and innovation, Horizon 2020 (European Commission, n.d.), has, at the time of writing, supported 16 research projects devoted to alternative methods to animal testing, with a total of €90 million (European Parliament, 2017). The main research activities

are targeted towards developing complex *in silico* and *in vitro* human-based systems for better and more cost-effective safety and efficacy testing of chemicals, nanoparticles, vaccines, and drugs (European Parliament, 2017).

Between 1981 and 2015, the German Federal Ministry for Education and Research (Bundesministerium für Bildung und Forschung, BMBF) gave €160 million in funding for over 500 3Rs research projects. Aside from not exclusively funding replacement projects, the funds dedicated to the 3Rs were sparse; for example, in the 6-year period between 2010 and 2015, less than €20 million were available (BMBF, 2016). The UK National Centre of the Replacement, Refinement and Reduction of Animals in Research (NC3Rs) is the largest funder of such research in the United Kingdom (Burden et al., 2015). Between 2004 and 2014, NC3Rs awarded 200 grants worth approximately US\$54 million (Burden et al., 2015); the annual overall budget of NC3Rs is approximately €11.2 million (NC3Rs, n.d. d). In contrast, the German national 3Rs center, Zentrum zum Schutz der Versuchstiere (Bf3R), has an annual budget of €1.5 million to run all of its operations (Bundesinstitut für Risikobewertung, 2016) and provides approximately €350,000 to external replacement and refinement research groups per year (Bundesinstitut für Risikobewertung, 2018). Replacement research has to compete with refinement research for these limited funds (BMBF, 2016; NC3Rs, n.d. a).

A donor that exclusively provides money for the first R is the cosmetic company Lush, which in 2012 established the Lush Prize in collaboration with the UK not-for-profit group, Ethical Consumer Research Association (Redmond, 2019, Chapter 27 in this Volume). Lush provides £250,000 in funding each year for the main prize categories, with additional funds for regional awards in Asia and the Americas (Lush Prize, n.d.). An example for a charity providing some funding is People for the Ethical Treatment of Animals (PETA) International Science Consortium (PISC), which, in June 2017, awarded funding to develop four *in vitro* exposure systems to researchers from institutions in the United Kingdom, United States, and Belgium that are leaders in the development of non-animal methods to test the toxicity of airborne substances (PETA International Science Consortium, n.d. a). PISC assists with funding where promising *in vitro* or *in silico* techniques require further development or validation in order to gain regulatory acceptance. PISC focuses on toxicology and until, 2017, it has contributed about €2.9 million towards improving and implementing non-animal research methods (PETA International Science Consortium, n.d. b). The Alternatives Research & Development Foundation (ARDF) funds and promotes the development and validation of non-animal methods in biomedical research, product testing, and education and has provided US\$3.25 million in funds since 1993 (Alternatives Research & Development Foundation, 2018).

The US National Anti-Vivisection Society (NAVS) provides some grants through the International Foundation for Ethical Research (IFER) for early career scientists to develop humane, human-relevant alternatives that replace animal use (NAVS, 2018). Overall, there are a few local and international initiatives and prizes but most focus on animal testing, while non-animal approaches in basic and applied research lag behind. Moreover, to ensure the field of animal-free, human-based research methods and approaches is continually and substantially growing, increased, stable governmental funding must be provided.

7.2.2 Education and Training

Another obstacle in shifting the current research paradigm is the limited availability of educational and training courses on animal-free methods and approaches in all areas of biomedical science, but especially in basic and applied research, since current available guidance documents and databases as well as courses almost exclusively focus on testing alternatives. There are some efforts being made to improve experimental design, conduct, and reporting; for example, online resources are available at some of the national 3Rs centers, such as at Norecopa, Norway's National Consensus Platform for the advancement of the 3Rs (Norecopa, 2016b) and the UK NC3Rs (NC3Rs, n.d. b, c), since quality issues of biomedical research has become apparent.

By EU law, the researcher must be well informed about state-of-the-art developments in the field of investigation, and animals must only be used if all possible alternatives are considered to be inadequate (EC Joint Research Centre, 2013). The EC Joint Research Centre's EU Reference Laboratory for Alternatives to Animal Testing – European Centre for the Validation of Alternative Methods (EURL ECVAM) Search Guide (EC Joint Research Centre, 2013) and Data Base Service on Alternative Methods to animal experimentation (DB-ALM) (EC Joint Research Centre, 2017) ought to assist with the search for alternatives to animal use. However, even for experts in the respective field, it is a lengthy and difficult task, as existing search systems do not support the necessary search strategies.

Altortox Academy, formerly CAAT Academy, offers hands-on training, but primarily for toxicologists, in human-relevant alternative methods and technologies (Altortox Academy, 2018). Education and training courses, mandatory for all animal researchers in the EU, include one animal-free methods module (e.g., FELASA B courses), but of a 40 hour FELASA B course, about one hour is dedicated to replacements, and generally only alternatives used in toxicology testing are covered (e.g., Berliner Kompaktkurse, 2017, p. 23). In 2016, the University of California (UC) San Diego offered a course that introduces participants to the available non-animal research methods, their efficacy, and how to

identify and implement them. It covered more areas than just regulatory toxicology (UC San Diego, 2018). However, detailed courses with extensive modules for all areas of the biomedical sciences currently do not exist.

7.2.3 Search Engine for Alternative Methods

What is urgently needed—aside from specific education and training courses—is an unbiased, freely available search engine that is able to find correlations regarding scientific purpose between animal experiments and alternative methods and, at the same time, 3Rs-relevant deviances in the methodologies (*in vitro* versus *in vivo*). Scientists from the Leibniz Institute for Social Sciences (GESIS) and the German Federal Institute for Risk Assessment (Bundesinstitut für Risikobewertung, BfR) have laid the foundation for such a search engine, using machine learning. The project is called SMAFIRA, which stands for “smart feature-based interactive ranking algorithm.” The goal of SMAFIRA is to develop automated but mechanistically transparent search procedures that focus on such deviations and, thus, to provide an improved automatic support to search for non-animal methods (fisaonline, n.d.). This search engine will drastically reduce the number of documents scientists have to go through (GESIS, n.d.). A first version of the SMAFIRA search engine is anticipated to be available in the second half of 2019 (Daniel Butzke, BfR, personal communication, January 2019).

8 Ways to Work Towards Replacement

Directive 2010/63/EU, a progressive animal protection legislation in the field, sums up some important steps that have to be taken to work towards a paradigm shift, when it states (emphasis added): “The availability of alternative methods is highly dependent on the progress of the research into the development of alternatives. [...] the Commission and the Member States should contribute through research and by other means to the **development and validation of alternative approaches.**” (Recital 46). Article 47 declares: “**The Commission and the Member States shall contribute to the development and validation of alternative approaches** which could provide the same or higher levels of information as those obtained in procedures using animals [...], and they **shall take such other steps as they consider appropriate to encourage research in this field.** [...] Member States should, at national level, ensure the **promotion of alternative approaches and the dissemination of information** [...]”.

8.1 *Political Engagement*

The needed political engagement that Directive 2010/63/EU demands from its Member States to move towards an animal-free world of scientific experimentation was made a priority by the Dutch government in 2016. The Netherlands National Committee for the protection of animals used for scientific purposes (NCad) has developed a vision and plan of action for moving away from laboratory animal use. The Dutch goal is to phase out the utilization of animals in a number of fields by 2025, namely in regulatory testing of chemicals, food ingredients, pesticides and (veterinary) medicines, and biological products, such as vaccines (NCad, n.d.). The Committee also plans to steadily reduce animal involvement in regulatory preclinical research and basic research: “If we are to make the transition to non-animal research methods, we must make a paradigm shift away from existing mindsets and practices” (NCad, n.d., p. 3), a task which seems to be impossible without political involvement. The Dutch strategy holds the potential to act as a driver for other countries to follow this path.

8.2 *Legislative Change*

There is a need for regulators who are brave to move legislative change forward. The reason for the continued use of animals for regulatory testing is legislative, as existing policies require that new drug candidates are tested on animals before they can be assessed in human clinical trials, regardless of the fact that these animal tests are often unreliable in assessing safety and efficacy in humans (Greek and Kramer, 2019, Chapter 17 in this Volume). These regulations need to be amended according to scientific knowledge, and serious efforts need to be made to accelerate the development of advanced, humane, and human-relevant models (Archibald, Coleman and Drake, 2019, Chapter 18 in this Volume).

8.3 *Redeployment of Funds*

Absolutely essential for the paradigm change towards advanced, animal-free science and better healthcare is the redirection of funding. The limited funding for replacement research, oftentimes, has to compete with refinement research (e.g., BMBF, 2016; NC3Rs, n.d. a). These scarce funds should be used to further human biology-based approaches. Also, regarding taxpayers' money, the national governments, arguably, have the responsibility to use the funds in the name of a society that has repeatedly voiced that more needs to be done to replace animals in science. Moreover, our society is ethically evolving, with evidence of dwindling acceptance for animal suffering in the name of science. And it is being increasingly acknowledged that the continued reliance on animal models is unlikely to improve significantly the currently poor rate of

clinical approval of new treatments. Thus, animal-based research also contributes to resources being wasted (Harris, 2017; Ioannidis et al., 2014; Keen, 2019, Chapter 10 in this Volume).

Aside from redeploying funds, partially to preclinical human-relevant disease research (Langley et al., 2017) and to clinical rather than basic research (Pound and Bracken, 2014), a large part of funding should be dedicated to disease prevention efforts. To combat the increasing prevalence of dementia, for example, human-focused, non-animal models and methods, such as computational methods, advanced brain imaging techniques, and epidemiological studies should be given funding preference (Pistollato et al., 2016). Another extremely important area of disease prevention is basic public healthcare (Marks, 2012) as well as nutrition and lifestyle education. In addition, funds should also be used for pollution control, as pollution is currently found to be the largest environmental cause of disease and premature death around the world (Landrigan et al., 2017). The World Health Organization (WHO) estimated that around 3 million people die prematurely every year due to air pollution alone (Watts et al., 2017). In 2015, diseases caused by pollution were responsible for about 16% (9 Mio.) of all human deaths worldwide, which is three times more than deaths from tuberculosis, malaria, and AIDS combined and 15 times more than all wars and other means of violence together (Landrigan et al., 2017).

8.4 *Education and Training*

Education as well as re- and ongoing training about how to conduct *state-of-the-art science* and report it properly, as well as education on *research ethics* and *bioethics* are crucial. They enable students and scientists to gain a solid grounding in science based on non-animal models, while sincerely embracing the hierarchy of the 3Rs. Such learning objectives should be made available and should be mandatory for everyone planning to work or working in biomedical science. Education and retraining are the most important means to move away from the current thought culture and practice of animal use towards a new, humane research paradigm.

8.5 *Scientific Collaboration*

As Russell and Burch observed in 1959, “As we shall see, replacement is widely used in some fields, while in others it is very far from being exploited to the full, if at all. Moreover, such developments have been largely empirical, and largely independent of each other” (Chapter 5). At the moment, 3Rs experts are divided into replacement experts, on the one hand, and refinement experts, on the other. Animal welfare bodies and national committees in the EU (Directive 2010/63/EU, Recital 48), for example, are supposed to advise

scientists about the application of the 3Rs but seem to have little to no knowledge about available replacements and novel animal-free approaches to scientific questions (van Luijk et al., 2012; van Luijk et al., 2013). To achieve the ultimate goal in shifting the focus from refinement of animal use to replacement of animal use the animal research community needs to engage with replacement experts. National 3Rs centers should be equipped with a majority of experts in replacement methods, and a close collaboration between replacement experts and animal researchers appears crucial in moving towards animal replacement. To accelerate the development of new human biology-based approaches, a multidisciplinary approach is essential for bringing together the newest technologies and experts from various disciplines (Langely et al., 2017; Noor, 2019, Chapter 25 in this Volume).

9 Final Remarks

Looking into the future of animal-based science, Carbone (2004) wrote that morality and politics will continue to be the drivers for replacement research. Since the introduction of the principles, it has been widely held that animal researchers have an ethical responsibility to minimize any pain, distress, fear, suffering, and harm caused to animals when keeping them confined and utilizing them for invasive experiments without their consent. To apply the knowledge gained through animal welfare and refinement research is good veterinary and scientific practice, but it is not a substitute for reduction and replacement of animal experimentation. Indeed, Balls warned “that refinement can be used as a convenient way of showing commitment to the 3Rs, while ensuring that animal experimentation is seen as respectable and can be allowed to continue, while the fundamental ethical questions raised by it are avoided” (2010, p. 21). Thus, we have to be on guard that refinement is not used as a whitewashing tool, but its full application, which is an ethical imperative, must be guaranteed during the transition to human-relevant, animal-free methodologies.

Aside from extensive flaws in the way the majority of animals are housed and treated, and the poor conduct and reporting of many animal studies, the general lack of transparency around the use of animals in research as well as the low rate of critical appraisal of animal experiments are apparent. These failings have led to incorrect data and an overestimation of their significance (Cohen, 2018). Unnecessary harm inflicted upon these animals and, in the case of medical research, the harms done to patients who suffer from adverse reactions to drugs that were tested safe in animals or who are urgently waiting for treatments are serious issues that need to be addressed. A commitment to adhere to the 3Rs and to good scientific practice as well as to address societal

concerns about the use of animals in science would require a strong shift away from animals towards the use of human-relevant approaches.

References

- Aarts, A.A., J.E. Anderson, C.J. Anderson, P.R. Attridge, A. Attwood and A. Fedor (2015). Estimating the Reproducibility of Psychological Science. *Science*, 349(6251), pp. 1–8.
- Abou-Ismaïl, U.A. and H.D. Mahboub (2011). The Effects of Enriching Laboratory Cages Using Various Physical Structures on Multiple Measures of Welfare in Singly-Housed Rats. *Laboratory Animals*, 45(3), pp. 145–153.
- Akhtar, A.Z., J.J. Pippin and C.B. Sandusky (2009). Animal Studies in Spinal Cord Injury: A Systematic Review of Methylprednisolone. *Alternatives to Laboratory Animals*, 37(1), pp. 43–62.
- AALAS (n.d.). AALAS National Meeting Abstract Archive. [online] Available at: <https://www.aalas.org/national-meeting/abstract-archive> [Accessed 13 August 2018].
- Altortox Academy (2018). *Hands-on lab trainings and events in alternative methods in toxicology*. [online] Available at: <http://academy.altortox.be> [Accessed 12 August 2018].
- Altman, D.G. (1994). The Scandal of Poor Medical Research. *British Medical Journal*, 308(6924), pp. 283–284.
- Altman, D.G. (1980). Statistics and Ethics in Medical Research. Misuse of Statistics is Unethical. *British Medical Journal*, 281(6249), pp. 1182–1184.
- Alternatives Research & Development Foundation (2018). *ARDF Annual Open Grant Program*. [online] Available at: <http://www.ardf-online.org/ardf-grants.html> [Accessed 12 August 2018].
- André, V., C. Gau, A. Scheideler, J.A. Aguilar-Pimentel, O.V. Amarie, L. Becker, L. Garrett, W. Hans, S.M. Hölter, D. Janik and K. Moreth (2018). Laboratory Mouse Housing Conditions Can Be Improved Using Common Environmental Enrichment Without Compromising Data. *PLoS Biology*, 16(4), p. e2005019. [online] Available at: <http://journals.plos.org/plosbiology/article?id=10.1371/journal.pbio.2005019> [Accessed 18 April 2018].
- Anselme, P., M.J. Robinson and K.C. Berridge (2013). Reward Uncertainty Enhances Incentive Salience Attribution as Sign-tracking. *Behavioural Brain Research*, 238, pp. 53–61.
- Archibald, K., R. Coleman and T. Drake (2019). Replacing animal tests to improve safety for humans. In: K. Herrmann and K. Jayne, eds., *Animal Experimentation: Working Towards a Paradigm Change*, Vol. 22. Leiden: Brill, pp. 417–442.
- Augustsson, H., H.A. van de Weerd, C.L. Kruitwagen, V. Baumans (2003). Effect on Enrichment on Variation and Results in Light/Dark Test. *Laboratory Animals*, 37(4), pp. 328–340.

- Bailey, J. (2018). Does the stress of laboratory life and experimentation on animals adversely affect research data? A critical review. *Alternatives to Laboratory Animals*, 46(5), pp. 291–305.
- Bailey, J. (2019). Genetic modification of animals: scientific and ethical issues. In: K. Herrmann and K. Jayne, eds., *Animal Experimentation: Working Towards a Paradigm Change*, Vol. 22. Leiden: Brill pp. 443–479.
- Bailoo, J.D., T.S. Reichlin and H. Würbel (2014). Refinement of Experimental Design and Conduct in Laboratory Animal Research. *ILAR Journal*, 55(3), pp. 383–391.
- Baker, M. (2016). 1,500 Scientists Lift the Lid on Reproducibility. *Nature News*, 533(7604), p. 452.
- Baker, D., K. Lidster, A. Sottomayor and S. Amor (2014). Two Years Later: Journals Are Not Yet Enforcing the ARRIVE Guidelines on Reporting Standards for Preclinical Animal Studies. *PLoS Biology*, 12(1), p. e1001756. [online] Available at: <http://journals.plos.org/plosbiology/%20article?id=10.1371/journal.pbio.1001756> [Accessed 12 August 2018].
- Balcombe, J. (2010). Laboratory rodent welfare: thinking outside the cage. *Journal of Applied Animal Welfare Science*, 13(1), pp. 77–88.
- Balcombe, J.P., N.D. Barnard and C. Sandusky (2004). Laboratory Routines Cause Animal Stress. *Journal of the American Association for Laboratory Animal Science*, 43(6), pp. 42–51.
- Baldwin, A.L., R.L. Primeau and W.E. Johnson (2006). Effect of Noise on the Morphology of the Intestinal Mucosa in Laboratory Rats. *Journal of the American Association for Laboratory Animal Science*, 45, pp. 74–82.
- Balls, M. (1999). The biomedical sciences and the need for less inhumane animal procedures. In: C.F.M. Hendriksen and D.B. Morton, eds., *Humane Endpoints in Animal Experiments for Biomedical Research*. London: Royal Society of Medicine Press, pp. 1–4.
- Balls, M. (2010). The Principles of Humane Experimental Technique: Timeless Insights and Unheeded Warnings. *Alternatives to Animal Experimentation*, 27(2), pp. 144–148. [online] Available at: http://www.altex.ch/resources/altex_2010_2_144_148_Balls.pdf [Accessed 12 August 2018].
- Bath, P.M.W., L.J. Gray, A.J.G. Bath, A. Buchan, T. Miyata and A.R. Green (2009). Effects of NXY-059 in Experimental Stroke: An Individual Animal Meta-analysis. *British Journal of Pharmacology*, 157(7), pp. 1157–1171.
- Baumans, V. and P. van Loo (2013). How to Improve Housing Conditions of Laboratory Animals: The Possibilities of Environmental Refinement. *The Veterinary Journal*, 195(1), pp. 24–32.
- Bayne, K. (2005). Potential for Unintended Consequences of Environmental Enrichment for Laboratory Animals and Research Results. *ILAR Journal*, 46(2), pp. 129–139.
- Bayne, K. and H. Würbel (2014). The Impact of Environmental Enrichment on the Outcome Variability and Scientific Validity of Laboratory Animal Studies. *Revue*

- Scientifique et Technique de l'OIE*, 33(1), pp. 273–280. [online] Available at: <https://www.oie.int/doc/ged/D13675.PDF> [Accessed 12 August 2018].
- Bayne, K., G.S. Ramachandra, E.A. Rivera and J. Wang (2015). The Evolution of Animal Welfare and the 3Rs in Brazil, China, and India. *Journal of the American Association for Laboratory Animal Science*, 54(2), pp. 181–191.
- Begley, C.G. and L.M. Ellis (2012). Drug Development: Raise Standards for Preclinical Cancer Research. *Nature*, 483(7391), pp. 531–533.
- Begley, C.G. and J.P.A. Ioannidis (2015). Reproducibility in Science. *Circulation Research*, 116(1), pp. 116–126.
- Benatar, M. (2007). Lost in Translation: Treatment Trials in the SOD₁ Mouse and in Human ALS. *Neurobiology of Disease*, 26(1), pp. 1–13.
- Benefiel, A.C., W.K. Dong and W.T. Greenough (2005). Mandatory “Enriched” Housing of Laboratory Animals: The Need for Evidence-Based Evaluation. *ILAR Journal*, 46(2), pp. 95–105.
- Bennett, E.L., M.C. Diamond, D. Krech and M.R. Rosenzweig (1964). Chemical and Anatomical Plasticity of Brain. *Science*, 146(3644), pp. 610–619.
- Berliner Kompaktkurse (2017). *Laboratory Animal Science—Basic Course Main Focus: Mice/Rats*, p. 23. [online] Available at: https://www.berliner-kompaktkurse.de/assets/files/downloads/ph_kk_2017-01_web.pdf [Accessed 1 July 2017].
- Bertolucci, L.F. (2011). Pandiculation: nature’s way of maintaining the functional integrity of the myofascial system?. *Journal of Bodywork and Movement Therapies*, 15(3), pp. 268–280.
- Bertrand, H.G.M.J., C. Sandersen and P.A. Flecknell (2018). Reported analgesic and anaesthetic administration to non-human primates undergoing experimental surgical procedure: 2010–2015. *Journal of Medical Primatology*, 47, pp. 217–225.
- Beura, L., S. Hamilton, K. Bi, J. Schenkel, O. Odumade, K. Casey, E. Thompson, K. Fraser, P. Rosato, A. Filali-Mouhim, R. Sekaly, M. Jenkins, V. Vezys, W. Haining, S. Jameson and D. Masopust (2016). Normalizing the Environment Recapitulates Adult Human Immune Traits in Laboratory Mice. *Nature*, 532(7600), pp. 512–516.
- BioMed21 Collaboration (n.d.). *About us*. [online] Available at: <http://biomed21.org/about-us/> [Accessed on 23 May 2018].
- BMBF (2016). *Alternativen zum Tierversuch. Informationen zur Förderung*. [online] Available at: https://www.bmbf.de/pub/Alternativmethoden_zum_Tierversuch.pdf [Accessed 1 August 2017].
- Birke, L., Arluke, A. and Michael, M. (2007). *The Sacrifice: How Scientific Experiments Transform Animals and People*. Purdue University Press.
- BMEL (2015). “*Mein langfristiges Ziel ist es, Tierversuche komplett zu ersetzen.*” Bundesminister Schmidt eröffnet das Deutsche Zentrum zum Schutz von Versuchstieren. [online] Berlin, 25. September 2015. Available at: https://www.bmel.de/DE/Tier/Tierschutz/_texte/TierschutzTierforschung.html;jsessionid=DB4703F553CD731C7EA41D8F642C806E.2_cid367?docId=6671414 [Accessed 12 August 2018].

- Bones, V.C., R.C.M. Garcia, G.G. Alves, R.L. Paixão, A.A. Rocha, K.V. Capilé and R. Bachinski (2019). Humane education: the tool for scientific revolution in Brazil. In: K. Herrmann and K. Jayne, eds., *Animal Experimentation: Working Towards a Paradigm Change*, Vol. 22. Leiden: Brill.
- Bracken, M.B. (2009). Why animal studies are often poor predictors of human reactions to exposure. *Journal of the Royal Society of Medicine*, 102(3), pp. 120–122.
- Briel, M., K.F. Müller, J.J. Meerpohl, von E. Elm, B. Lang, E. Motschall, V. Gloy, F. Lamontagne, G. Schwarzer and D. Bassler (2013). Publication bias in animal research: A systematic review protocol. *Systematic Reviews*, 2, p. 23. [online] Available at: <https://systematicreviewsjournal.biomedcentral.com/track/pdf/10.1186/2046-4053-2-23> [Accessed 12 August 2018].
- Brown, M.J. (2014). Creating a culture of care. *NC3Rs News & Blog Online*. [online] Available at: <https://www.nc3rs.org.uk/news/creating-culture-care> [Accessed 12 August 2018].
- Bundesinstitut für Risikobewertung (2016). *Fragen und Antworten zum Deutschen Zentrum zum Schutz von Versuchstieren (Bf3R)*. [online] Available at: <http://www.bfr.bund.de/cm/343/fragen-und-antworten-zum-deutschen-zentrum-zum-schutz-von-versuchstieren-bf3r.pdf> [Accessed 12 August 2018].
- Bundesinstitut für Risikobewertung (2018). *Bf3R Research Funding in the area of 3R – Replacement, Reduction and Refinement*. [online] Available at: https://www.bfr.bund.de/en/bf3r_research_funding_in_the_area_of_3r__replacement__reduction__and_refinement-62825.html [Accessed 12 August 2018].
- Burden, N., K. Chapman, F. Sewell and V. Robinson (2015). Pioneering Better Science through the 3Rs: An Introduction to the National Centre for the Replacement, Refinement, and Reduction of Animals in Research (NC3Rs). *Journal of the American Association for Laboratory Animal Science*, 54(2), pp. 198–208.
- Burghardt, G.M. (1996). Environmental enrichment or controlled deprivation? In: G.M. Burghardt, J.T. Bielitzki, J.R. Boyce and D.O. Schaefer, eds., *The Well-being of Animals in Zoo and Aquarium Sponsored Research*. Greenbelt, MD: Scientists Center for Animal Welfare, pp. 91–101.
- Burghardt, G.M. (1999). Deprivation and Enrichment in Laboratory Animal Environments. *Journal of Applied Animal Welfare Science*, 2(4), pp. 263–266.
- Burn, C.C. (2017). Bestial Boredom: A Biological Perspective on Animal Boredom and Suggestions for Its Scientific Investigation. *Animal Behaviour*, 130, pp. 141–151.
- Burn, C.C., A. Peters, M.J. Day and G.J. Mason (2006). Long-Term Effects of Cage-Cleaning Frequency And Bedding Type on Laboratory Rat Health, Welfare, and Handleability: A Cross-Laboratory Study. *Laboratory Animals*, 40(4), pp. 353–370.
- Cabib, S. (2006). The Neurobiology of stereotypy II: The role of stress. In: G. Mason and J. Rushen, eds., *Stereotypic Animal Behaviour: Fundamentals and Applications to Welfare*, 2nd ed. Oxfordshire, UK: CAB International.

- CAMARADES (2014). *Bringing Evidence to Translational Medicine*. [online] Available at: <http://www.dcn.ed.ac.uk/camarades/default.htm> [Accessed 12 August 2018].
- Campi, K.L., C.E. Collins, W.D. Todd, J. Kaas and L. Krubitzer (2011). Comparison of Area 17 Cellular Composition in Laboratory and Wild-Caught Rats Including Diurnal and Nocturnal Species. *Brain, Behavior and Evolution*, 77, pp. 116–130.
- Cao, L., X. Liu, E. Lin, C. Wang, E. Choi, V. Riban, B. Lin and M. During (2010). Environmental and Genetic Activation of a Brain-Adipocyte BDNF/Leptin Axis Causes Cancer Remission and Inhibition. *Cell*, 142(1), pp. 52–64.
- Carbone, L. (2004). *What Animals Want: Expertise and Advocacy in Laboratory Animal Welfare Policy*. New York: Oxford University Press.
- Carbone, L. and J. Austin (2016). Pain and Laboratory Animals: Publication Practices for Better Data Reproducibility and Better Animal Welfare. *PLoS One*, 11(5). [online] Available at: <http://journals.plos.org/plosone/article/related?id=10.1371/journal.pone.0155001> [Accessed 12 August].
- Cavanaugh, S.E., Pippin, J.J. and Barnard, N.D. (2014). Animal Models of Alzheimer Disease: Historical Pitfalls and a Path Forward. *Alternatives to Animal Experimentation*, 31(3), pp. 279–302.
- Center for Open Science (n.d.). *Our Mission is to Increase Openness, Integrity, and Reproducibility of Research*. [online] Available at: <https://cos.io/about/mission/> [Accessed 12 August 2018].
- Chalmers, I. and P. Glasziou (2009). Avoidable Waste in the Production and Reporting of Research Evidence. *Obstetrics & Gynecology*, 114(6), pp. 1341–1345.
- Charbonneau, R., L. Niel, E. Olfert, M. von Keyserlingk and C. Griffin (2010). CCAC Guidelines on: Euthanasia of Animals Used in Science. *Canadian Council on Animal Care*. Ottawa ON, Canada, pp. 1–32. [online] Available at: <https://www.ccac.ca/Documents/Standards/Guidelines/Euthanasia.pdf> [Accessed 12 August 2018].
- Chawla, S.D. (2017). ‘One-size-fits-all’ threshold for *P* values under fire. Scientists hit back at a proposal to make it tougher to call findings statistically significant. *Nature News*. [online] Available at: https://www.nature.com/news/one-size-fits-all-threshold-for-p-values-under-fire-1.22625?WT.mc_id=TWT_NatureNews [Accessed 12 August 2018].
- Chesler, E.J., S.G. Wilson, W.R. Lariviere, S.L. Rodriguez-Zas and J.S. Mogil (2002). Influences of Laboratory Environment on Behavior. *Nature Neuroscience*, 5, pp. 1101–1102.
- Clarkson, J.M., D.M. Dwyer, P.A. Flecknell, M.C. Leach and C. Rowe (2018). Handling method alters the hedonic value of reward in laboratory mice. *Scientific Reports*, 8(1), p. 2448. [online] Available at: <https://www.nature.com/articles/s41598-018-20716-3> [Accessed 12 August 2018].
- Clemence, M. and J. Leaman (2016). *Public Attitudes to Animal Research in 2016*. A report by Ipsos MORI for the Department for Business, Energy & Industrial Strategy, Ipsos MORI Social Research Institute. [online] Available at: <https://www>

- .ipsos.com/sites/default/files/publication/1970-01/sri-public-attitudes-to-animal-research-2016.pdf [Accessed 12 August 2018].
- Cohen, D. (2018). Oxford TB Vaccine Study Calls into Question Selective Use of Animal Data. *British Medical Journal*, 360, p. j5845.
- Collins, F.S. (2011). Reengineering Translational Science: The Time Is Right. *Science Translational Medicine*, 3(90), p. 90cm17. [online] Available at: <https://www.ncbi.nlm.nih.gov/pmc/articles/PMC3101940/> [Accessed 12 August 2018].
- Collins, F.S. and L.A. Tabak (2014). NIH Plans To Enhance Reproducibility. *Nature*, 505, pp. 612–613.
- Commission of the European Communities (2007). Recommendation of 18 June 2007 on Guidelines for the accommodation and Care of Animals Used for Experimental and Other Scientific Purposes (2007/526/EC). *Official Journal of the European Communities*, L197, pp. 1–89. [online] Available at: <https://eur-lex.europa.eu/legal-content/EN/TXT/PDF/?uri=CELEX:32007H0526&from=EN> [Accessed 15 August 2017].
- Coulter, C., P. Flecknell and C. Richardson (2009). Reported Analgesic Administration to Rabbits, Pigs, Sheep, Dogs and Non-Human Primates Undergoing Experimental Surgical Procedures. *Laboratory Animals*, 43(3), pp. 232–238.
- Coulter, C., P. Flecknell, M. Leach and C. Richardson (2011). Reported Analgesic Administration To Rabbits Undergoing Experimental Surgical Procedures. *BMC Veterinary Research*, 7(1), p. 12. [online] Available at: <https://doi.org/10.1186/1746-6148-7-12> [Accessed 12 August 2018].
- Council of Europe (1986). *Convention for the Protection of Vertebrate Animals Used for Experimental and other Scientific Purposes*. European Treaty Series No. 123. [online] Available at: <https://rm.coe.int/168007a67b> [Accessed 12 August 2018].
- Crabbe, J.C., D. Wahlsten and B.C. Dudek (1999). Genetics of Mouse Behavior: Interactions with Laboratory Environment. *Science*, 284(5420), pp. 1670–1672.
- Daneshian, M. (2016). Vergleiche der Förderungen von Alternativen in Deutschland – Europa – USA. In: *Forschung ohne Tierversuche – verliert Deutschland den Anschluss? Zum Weltaktionstag gegen Tierversuche*. Talk, Berlin. [online] Program available at: <https://www.urania.de/forschung-ohne-tierversuche-verliert-deutschland-den-anschluss> [Accessed 6 August 2017].
- Daneshian, M., F. Busquet, T. Hartung and M. Leist (2015). Animal Use for Science in Europe. *Alternatives to Animal Experimentation*, 32, pp. 261–274.
- Dawson, E., T. Gilovich and D.T. Regan (2002). Motivated Reasoning and Performance on the was on Selection Task. *Personality and Social Psychology Bulletin*, 28(10), pp. 1379–1387.
- de Vries, R.B., P. Buma, M. Leenaars, M. Ritskes-Hoitinga and B. Gordijn (2012). Reducing the Number of Laboratory Animals Used in Tissue Engineering Research by Restricting the Variety of Animal Models. Articular Cartilage Tissue Engineering as a Case Study. *Tissue Engineering Part B: Reviews*, 18(6), pp. 427–435.

- Dirnagl, U. and M. Fisher (2012). International, Multicenter Randomized Preclinical Trials in Translational Stroke Research: It's Time To Act. *Journal of Cerebral Blood Flow & Metabolism*, 32, pp. 933–935.
- During, M.J., X. Liu, W. Huang, D. Magee, A. Slater, T. McMurphy, C. Wang and L. Cao (2015). Adipose VEGF Links the White-To-Brown Fat Switch with Environmental, Genetic, and Pharmacological Stimuli in Male Mice. *Endocrinology*, 156, pp. 2059–2073.
- EC Expert Working Group for Project Evaluation and Retrospective Assessment (2013). National Competent Authorities for the implementation of Directive 2010/63/EU on the protection of animals used for scientific purposes. Working document on Project Evaluation and Retrospective Assessment. [online] Available at: http://ec.europa.eu/environment/chemicals/lab_animals/pdf/Endorsed_PE-RA.pdf [Accessed 12 August 2017].
- EC Joint Research Centre (2013). *The EURL ECVAM Search Guide. Good Search Practice on Animal Alternatives*. EUR 24391 EN, Re-edition. [online] Available at: <https://ec.europa.eu/jrc/en/publication/books/eurl-ecvam-search-guide-good-search-practice-animal-alternatives> [Accessed 12 August 2017].
- EC Joint Research Centre (2017). *EURL ECVAM Data Base Service on Alternative Methods to Animal Experimentation (DB-ALM)*. [online] Available at: <https://ecvam-dbalm.jrc.ec.europa.eu/methods-and-protocols> [Accessed 12 August 2018].
- Eisen, J.A., E. Ganley and C.J. MacCallum (2014). Open Science and Reporting Animal Studies: Who's Accountable? *PLoS Biology*, 12(1), p. e1001757. [online] Available at: <http://journals.plos.org/plosbiology/article?id=10.1371/journal.pbio.1001757> [Accessed 12 August 2018].
- Enserink, M. (2017). Sloppy reporting on animal studies proves hard to change. *Science*, 357(6358), pp. 1337–1338.
- Errington, T.M., E. Iorns, W. Gunn, F.E. Tan, J. Lomax and B.A. Nosek (2014). An Open Investigation of the Reproducibility of Cancer Biology Research. *Elife*, 3, p. e04333.
- Eskola, S., M. Lauhikari, H.M. Voipio, M. Laitinen and T. Nevalainen (1999). Environmental Enrichment May Alter the Number of Rats Needed To Achieve Statistical Significance. *Scandinavian Journal of Laboratory Animal Science*, 26, pp. 134–144.
- European Citizen's Initiative (2016). *Stop Vivisection*. [online] Available at: <http://www.stopvivisection.eu/de> [Accessed 12 August 2018].
- European Commission (2013). Report from the Commission to the Council and the European Parliament. Seventh Report on the Statistics on the Number of Animals used for Experimental and other Scientific Purposes in the Member States of the European Union. *COM (2013) 859 final*. [online] Available at: https://eur-lex.europa.eu/resource.html?uri=cellar:e9gd2a56-32fc-4f60-ad69-61ead7e377e8.0001.03/DOC_1&format=PDF [Accessed 12 August 2018].
- European Commission (2014). National Competent Authorities for the implementation of Directive 2010/63/EU on the Protection of Animals Used for Scientific Purposes.

- A working document on the development of a common education and training framework to fulfil the requirements under the Directive. [online] Available at: http://ec.europa.eu/environment/chemicals/lab_animals/pdf/Endorsed_E-T.pdf [Accessed 15 July 2018].
- European Commission (n.d.). *Horizon2020. The EU Framework Programme for Research and Innovation*. [online] Available at: <https://ec.europa.eu/programmes/horizon2020/en/find-your-area> [Accessed 12 August 2018].
- European Parliament (2010). Directive 2010/63/EU of the European Parliament and of the Council of 22 September 2010 on the Protection of Animals Used for Scientific Purposes. *Official Journal of the European Communities*, L276, pp. 33–79. [online] Available at: <http://eur-lex.europa.eu/legal-content/EN/TXT/?uri=CELEX%3A32010L0063> [Accessed 23 July 2017].
- European Parliament (2017). *Parliamentary questions: Question Reference E-004265/2017*. Answer given by Mr Moedas on behalf of the Commission. [online] Available at: http://www.europarl.europa.eu/doceo/document/E-8-2017-004265-ASW_EN.html [Accessed 12 August 2018].
- EUSAAT (2015). *19th European Congress on Alternatives to Animal Testing, 16th Annual Congress of EUSAAT*. Alternatives to Animal Experimentation Proceedings, 4(2). [online] Available at: http://www.eusaat-congress.eu/images/2015/Abstractbook_EUSAAT_2015_Linz_2015.pdf [Accessed 12 August 2018].
- FELASA (2016). *Detailed program FELASA 2016*. [online] Available at: http://felasa2016.eu/wp-content/uploads/2016/06/DETAILED_PROGRAMME_FELASA_2016_V3.6.pdf [Accessed 12 August 2018].
- fisaonline (n.d.). SMAFIRA – Smart Feature-based interactive ranking (SMAFIRA) Project. [online]. Available at: https://fisaonline.de/en/find-institutions/federal-research-institutions/?tx_fisaresearch_federalresearchinstitutions%5Bp_id%5D=4377&tx_fisaresearch_federalresearchinstitutions%5Baction%5D=projectDetails&tx_fisaresearch_federalresearchinstitutions%5Bcontroller%5D=Projects&cHash=1223e8bo7c976b94fi6b67e2foe4afib#more [Accessed 23 January 2018].
- Flecknell, P.A. (2016). *Laboratory Animal Anaesthesia*. 4th ed., London: Academic Press.
- Flecknell, P.A. (2018). Rodent Analgesia: Assessment and Therapeutics. *The Veterinary Journal*, 232, pp. 70–77.
- Fonseca, K., P. Rodrigues, I. Olsson and M. Saraiva (2017). Experimental Study Of Tuberculosis: From Animal Models To Complex Cell Systems and Organoids. *PLoS Pathogens*, 13(8) [online] Available at: <https://doi.org/10.1371/journal.ppat.1006421> [Accessed 12 August 2018].
- Food and Drug Administration (2018). *Food and Drug Administration Modernization Act (FDAMA)* [online] Available at: <https://www.fda.gov/RegulatoryInformation/LawsEnforcedbyFDA/SignificantAmendmentstotheFDCAAct/FDAMA/default.htm> [Accessed 12 August 2018].

- Food and Drug Administration (2004). *Innovation or Stagnation? Challenge and Opportunity on the Critical Path to New Medical Products*. US Department of Health and Human Services, Food and Drug Administration, pp. 1–32. [online] Available at: <http://www.who.int/intellectualproperty/documents/en/FDAproposals.pdf> [Accessed 12 August 2018].
- Franco, N.H., Sandøe, P. and Olsson, I.A.S. (2018). Researchers' attitudes to the 3Rs—An upturned hierarchy?. *PLoS One*, 13(8), p. e0200895. [online] Available at: <https://doi.org/10.1371/journal.pone.0200895> [Accessed 17 August 2018].
- Freedman, L.P., I.M. Cockburn, T.S. Simcoe (2015). The Economics of Reproducibility in Preclinical Research. *PLoS Biology*, 13(6), p. e1002165. [online] Available at: <https://doi.org/10.1371/journal.pbio.1002165> [Accessed 15 July 2017].
- Fureix, C., M. Walker, L. Harper, K. Reynolds, A. Saldivia-Woo and G. Mason (2016). Stereotypic Behaviour in Standard Non-enriched Cages Is an Alternative To Depression-like Responses in C57BL/6 Mice. *Behavioural Brain Research*, 305, pp. 186–190.
- Garner, J.P. (2005). Stereotypies and Other Abnormal Repetitive Behaviors: Potential Impact on Validity, Reliability, and Replicability of Scientific Outcomes. *ILAR Journal*, 46(2), pp. 106–117.
- Garner, J.P. and G.J. Mason (2002). Evidence for a Relationship Between Cage Stereotypies and Behavioural Disinhibition in Laboratory Rodents. *Behavioural Brain Research*, 136(1), pp. 83–92.
- Gärtner, K. (1999). Cage Enrichment Occasionally Increases Deviation of Quantitative Traits. In: *International Joint Meeting 12th ICLAS General Assembly and Conference and 7th FELASA Symposium*. Madrid: SECAL, pp. 207–210.
- Gaskill, B. and J. Garner (2014). Letter-To-The-Editor on “Not so hot: Optimal Housing Temperatures for Mice To Mimic the Thermal Environment of Humans”. *Molecular Metabolism*, 3(4), pp. 335–336. [online] Available at: <https://www.ncbi.nlm.nih.gov/pmc/articles/PMC4060287/> [Accessed 12 August 2017].
- Gaskill, B., C. Gordon, E. Pajor, J. Lucas, J. Davis and J. Garner (2012). Heat or Insulation: Behavioral Titration of Mouse Preference for Warmth or Access To a Nest. *PLoS One*, 7(3), p.e32799. [online] Available at: <http://journals.plos.org/plosone/article?id=10.1371/journal.pone.0032799> [Accessed 12 August 2017].
- Gaskill, B. and K. Pritchett-Corning (2016). Nest Building as an Indicator of Illness in Laboratory Mice. *Applied Animal Behaviour Science*, 180, pp. 140–146.
- Gaskill, B., S. Rohr, E. Pajor, J. Lucas and J. Garner (2009). Some Like It Hot: Mouse Temperature Preferences in Laboratory Housing. *Applied Animal Behaviour Science*, 116(2–4), pp. 279–285.
- Gaskill, B., C. Winnicker, J. Garner and K. Pritchett-Corning (2013). The Naked Truth: Breeding Performance in Nude Mice with and without Nesting Material. *Applied Animal Behaviour Science*, 143(2–4), pp. 110–116.

- GESIS (n.d.). SMAFIRA Computer-aided modeling of signatures and features of relevant scientific content. Available at: <https://www.gesis.org/en/research/external-funding-projects/archive/smafira/> [Accessed 17 August 2017].
- Giri, S. and A. Bader (2015). A Low-Cost, High-quality New Drug Discovery Process Using Patient-derived Induced Pluripotent Stem Cells. *Drug Discovery Today*, 20(1), pp. 37–49.
- Glasziou, P., D.G. Altman, P. Bossuyt, I. Boutron, M. Clarke, S. Julious, S. Michie, D. Moher and E. Wager (2014). Reducing Waste from Incomplete or Unusable Reports of Biomedical Research. *The Lancet*, 383(9913), pp. 267–276.
- Gluck, J.P. (2016). *Voracious Science & Vulnerable Animals. A Primate Scientist's Ethical Journey*. The University of Chicago Press: Chicago and London.
- Gordon, C.J. (1993). *Temperature regulation in laboratory rodents*. New York: Cambridge University Press.
- Gordon, C.J. (2012). Thermal Physiology of Laboratory Mice: Defining Thermoneutrality. *Journal of Thermal Biology*, 37(8), pp. 654–685.
- Gouveia, K. and J.L. Hurst (2013). Reducing Mouse Anxiety During Handling: Effect of Experience with Handling Tunnels. *PLoS One*, 8(6), p. e66401.
- Gouveia, K. and J.L. Hurst (2017). Optimising reliability of mouse performance in behavioural testing: the major role of non-aversive handling. *Scientific Reports*, 7, p. 44999, [online] Available at: <https://www.nature.com/articles/srep44999> [Accessed 12 August 2018].
- Greek, R. and L.A. Kramer (2019). The scientific problems with using non-human animals to predict human response to drugs and disease. In: K. Herrmann and K. Jayne, eds., *Animal Experimentation: Working Towards a Paradigm Change*, Vol. 22. Leiden: Brill.
- Gross, A., S. Richter, A. Engel and H. Würbel (2012). Cage-induced Stereotypies, Perseveration, and the Effects of Environmental Enrichment in Laboratory Mice. *Behavioural Brain Research*, 234(1), pp. 61–68.
- Gruen, L. (2014). *The Ethics of Captivity*. New York: Oxford University Press.
- Gurevitch, J., J. Koricheva, S. Nakagawa and G. Stewart (2018). Meta-analysis and the Science of Research Synthesis. *Nature*, 555(7695), pp. 175–182.
- Gurfein, B.T., O. Davidenko, M. Premenko-Lanier, J.M. Milush, M. Acree, M.F. Dallman, C. Touma, R. Palme, V.A. York, G. Fromentin, N. Darcel, D.F. Nixon and F.M. Hecht (2014). Environmental Enrichment Alters Splenic Immune Cell Composition and enhances Secondary Influenza Vaccine Responses in Mice. *Molecular Medicine*, 20(1), pp. 179–190.
- Hair, K., Macleod, M. R., Sena, E. S. and IICARus Collaboration (2018). A randomised controlled trial of an Intervention to Improve Compliance with the ARRIVE guidelines (IICARus). bioRxiv, p. 370874.
- Hartshorne, J. and A. Schachner (2012). Tracking replicability as a method of post-publication open evaluation. *Frontiers in Computational Neuroscience*, 6, p. 8.

- [online] Available at: <https://www.frontiersin.org/articles/10.3389/fncom.2012.00008/full> [Accessed 12 August 2018].
- Hartung, T. (2009). Toxicology for the twenty-first century. *Nature*, 460(7252), pp. 208–212.
- Hartung, T. (2013). Food for Thought Look Back in Anger—What Clinical Studies Tell Us About Preclinical Work. *Alternatives to Animal Experimentation*, 30(3), pp. 275–291. [online] Available at: <https://www.ncbi.nlm.nih.gov/pmc/articles/PMC3790571/> [Accessed 12 August 2018].
- Harris, R. (2017). *Rigor mortis. How sloppy science creates worthless cures, crushes hope, and wastes billions*. New York: Basic.
- Hau, J. (2008). Animal models for human disease: An overview. In: P.M. Conn, ed., *Sourcebook of Models for Biomedical Research*. Totowa: Humana Press Inc., pp. 3–9.
- Hawkins, P., R. Armstrong, T. Boden, P. Garside, K. Knight, E. Lilley, M. Seed, M. Wilkinson and R. Williams (2015). Applying Refinement to the Use of Mice and Rats in Rheumatoid Arthritis Research. *Inflammopharmacology*, 23(4), pp. 131–150.
- Hebb, D.O. (1947). The Effects of Early Experience on Problem Solving at Maturity. *American Psychologist*, 2, pp. 306–307.
- Hendriksen, C., D. Morton and K. Cussler (2011). Use of humane end points to minimise suffering. In: B. Howard, T. Nevalainen and G. Perretta, eds., *The Cost Manual of Laboratory Animal Care and Use*. Florida: CRC Press, pp. 333–353.
- Hennessy, M.B., McCowan, B., Jiang, J. and Capitanio, J.P. (2014). Depressive-like behavioral response of adult male rhesus monkeys during routine animal husbandry procedure. *Frontiers in Behavioral Neuroscience*, 8, p. 309. [online] Available at: <https://www.frontiersin.org/articles/10.3389/fnbeh.2014.00309/full> [Accessed 17 August 2018].
- Herrmann, K. (2013). Directive 2010/63/EU—A Chance for More Humane Education?. In: 12th FELASA 2013 SECAL Congress “Animal Research: Better Science with Fewer Animals”. Barcelona: SECAL, Abstracts of scientific papers 12th FELASA SECAL Congress, Journal of the American Association for Laboratory Animal Science, 52(3), p. 389. [online] Available at: https://www.researchgate.net/publication/282816209_jaalas_FELASA_2013 [Accessed 12 August 2018].
- Herrmann, K. and P.A. Flecknell (2018a). Retrospective review of anesthetic and analgesic regimens used in animal research proposals. *Alternatives to Animal Experimentation*, 36(1), pp. 65–80. [online] Available at: <https://www.altex.org/index.php/altex/article/view/780/1234> [Accessed 14 September 2018].
- Herrmann, K. and Flecknell, P.A. (2018b): Application of humane endpoints and humane killing methods in animal research proposals – a retrospective review. *Alternatives to Laboratory Animals*, 46(6), pp. 1–17.
- Herrmann, K. and Flecknell, P.A. (2018c): Severity classification of surgical procedures and application of health monitoring strategies in animal research proposals – a retrospective review. *Alternatives to Laboratory Animals*, 46(5), pp. 273–289.

- Herrmann, K., K. Köpernik and M. Biedermann (2009). Ein Leitfaden für die Teilprüfung der “Unerlässlichkeit” im Hinblick auf “Refinement”. In: D. Borchers and J. Luy, eds., *Der Ethisch Vertretbare Tierversuch, Kriterien und Grenzen*, Padaborn: mentis, pp. 219–234.
- Herrmann, K. and H. Ratsch (2010): Bessere Haltungsbedingungen für Labortiere: Überwachung von Versuchstierhaltungen – die Frage des Enrichments. *Deutsches Tierärzteblatt*, 4, pp. 492–499.
- Herzog, H. (2002). Ethical Aspects of Relationships Between Humans and Research Animals. *ILAR Journal*, 43(1), pp. 27–32.
- Hess, S.E., S. Rohr, B.D. Dufour, B.N. Gaskill, E.A. Pajor and J.P. Garner (2008). Home Improvement: C57BL/6J Mice Given More Naturalistic Nesting Materials Build Better Nests. *Journal of the American Association for Laboratory Animal Science*, 47(6), pp. 25–31.
- Higgins, J.P., D.G. Altman, P.C. Gøtzsche, P. Jüni, D. Moher, A.D. Oxman, J. Savović, K.F. Schulz, L. Weeks and J.A. Sterne (2011). The Cochrane Collaboration’s Tool for Assessing Risk of Bias in Randomised Trials. *British Medical Journal*, 343, p. d5928.
- Hooijmans, C.R., J. Int’Hout, M. Ritskes-Hoitinga and M.M. Rovers (2014a). Meta-analyses of Animal Studies: An Introduction of a Valuable Instrument To Further Improve Healthcare. *ILAR journal*, 55(3), pp. 418–426. [online] Available at: <https://www.ncbi.nlm.nih.gov/pmc/articles/PMC4276598/> [Accessed 15 July 2017].
- Hooijmans, C.R., M. Leenaars and M. Ritskes-Hoitinga (2010). A Gold Standard Publication Checklist To Improve The Quality Of Animal Studies, To Fully Integrate The Three Rs, And To Make Systematic Reviews More Feasible. *Alternatives to Laboratory Animals*, 38(2), pp. 167–182. [online] Available at: <http://repository.ubn.ru.nl/bitstream/handle/2066/89153/89153.pdf> [Accessed 15 August 2017].
- Hooijmans, C.R. and M. Ritskes-Hoitinga (2013). Progress in Using Systematic Reviews of Animal Studies To Improve Translational Research. *PLoS Medicine*, 10(7), p. e1001482. [online] Available at: <http://journals.plos.org/plosmedicine/article?id=10.1371/journal.pmed.1001482> [Accessed on 14 November 2017].
- Hooijmans, C.R., M.M. Rovers, R.B. de Vries, M. Leenaars, M. Ritskes-Hoitinga and M.W. Langendam (2014b). SYRCLE’s Risk of Bias Tool for Animal Studies. *BMC Medical Research Methodology*, 14(1), p. 43. [online] Available at: <https://www.ncbi.nlm.nih.gov/pmc/articles/PMC4230647/> [Accessed on 14 November 2017].
- Howerton, C.L., J.P. Garner and J.A. Mench (2008). Effects of a Running Wheel-igloo Enrichment on Aggression, Hierarchy Linearity, and Stereotypy in Group-housed Male CD-1 (ICR) Mice. *Applied Animal Behaviour Science*, 115(1), pp. 90–103.
- Hunter, A.J. (2011). Have Animal Models of Disease Helped or Hindered the Drug Discovery Process. *Annals of the New York Academy of Sciences*, 1245, pp. 1–2.
- Hurst, J.L. and R.S. West (2010). Taming Anxiety in Laboratory Mice. *Nature Methods*, 7, pp. 825–826. [online] Available at: <https://www.nature.com/nmeth/journal/v7/n10/full/nmeth.1500.html> [Accessed on 14 January 2017].

- Hutchinson, L. and R. Kirk (2011). High Drug Attrition Rates—Where Are We Going Wrong?. *Nature Reviews Clinical Oncology*, 8(4), pp. 189–190.
- Ioannidis, J.P.A. (2005). Why Most Published Research Findings Are False. *PLoS Medicine*, 2(8), p. e124. [online] Available at: <https://doi.org/10.1371/journal.pmed.0020124> [Accessed 15 July 2017].
- Ioannidis, J.P.A. (2012). Why Science Is Not Necessarily Self-Correcting. *Perspectives on Psychological Science*, 7(6), pp. 645–654. [online] Available at: <http://journals.sagepub.com/doi/full/10.1177/1745691612464056> [Accessed 15 July 2017].
- Ioannidis, J.P.A., S. Greenland, M.A. Hlatky, M.J. Khoury, M.R. Macleod, D. Moher, K.F. Schulz and R. Tibshirani (2014). Increasing Value and Reducing Waste in Research Design, Conduct, and Analysis. *The Lancet*, 383(9912), pp. 166–175.
- Jirkof, P. (2015). Effects of Experimental Housing Conditions on Recovery of Laboratory Mice. *Lab Animal*, 44(2), pp. 65–70.
- Joffe, A.R., M. Bara, N. Anton and N. Nobis (2016). Expectations for the Methodology and Translation Of Animal Research: A Survey of the General Public, Medical Students, and Animal Researchers in North America. *Alternatives to Laboratory Animals*, 44(4), pp. 361–381.
- Johnson, E.A., D.S. Sharp and D.B. Miller (2000). Restraint as a Stressor in Mice: Against the Dopaminergic Neurotoxicity of d-MDMA, Low Body Weight Mitigates Restraint-induced Hypothermia and Consequent Neuroprotection. *Brain Research*, 875(1), pp. 107–118.
- Johnson, J. and A. Smajdor (2019). Human wrongs in animal research—A focus on moral injury and reification. In: K. Herrmann and K. Jayne, eds., *Animal Experimentation: Working Towards a Paradigm Change*, Vol. 22. Leiden: Brill.
- Jones, J.M. (2017). Americans Hold Record Liberal Views on Most Moral Issues. *Gallup Poll Social Series*. [online] Available at: http://www.gallup.com/poll/210542/americans-hold-record-liberal-views-moral-issues.aspx?g_source=2017+poll+animals&g_medium=search&g_campaign=tiles [Accessed 10 June 2017].
- Justice, M.J. and P. Dhillon (2016). Using the Mouse to Model Human Disease: Increasing Validity and Reproducibility. *Disease Model Mechanisms*, 9(2), pp. 101–103.
- Kaplan, R.M. and V.L. Irvin (2015). Likelihood of Null Effects of Large NHLBI Clinical Trials Has Increased Over Time. *PLoS One*, 10(8), p. e0132382. [online] Available at: <http://journals.plos.org/plosone/article?id=10.1371/journal.pone.0132382> [Accessed 10 June 2017].
- Karp, C.L. (2012). Unstressing Intemperate Models: How Cold Stress Undermines Mouse Modeling. *Journal of Experimental Medicine*, 209(6), pp. 1069–1074.
- Keen, J. (2019). Wasted money in US biomedical and agricultural animal research. In: K. Herrmann and K. Jayne, eds., *Animal Experimentation: Working Towards a Paradigm Change*, Vol. 22. Leiden: Brill.
- Kempermann, G., H.G. Kuhn and F.H. Gage (1997). More Hippocampal Neurons in Adult Mice Living in an Enriched Environment. *Nature*, 386(6624), p. 493.

- Kerr, N.L. (1998). HARKing: Hypothesizing After the Results Are Known. *Personality and Social Psychology Review*, 2(3), pp. 196–217.
- Kilkenny, C., W.J. Browne, I.C. Cuthill, M. Emerson and D.G. Altman (2010). Improving Bioscience Research Reporting: The ARRIVE Guidelines for Reporting Animal Research. *PLoS Biology*, 8(6), p. e1000412. [online] Available at: <http://journals.plos.org/plosbiology/article?id=10.1371/journal.pbio.1000412> [Accessed 14 May 2017].
- Klein, H. and K. Bayne (2007). Establishing a Culture of Care, Conscience, and Responsibility: Addressing the Improvement of Scientific Discovery and Animal Welfare Through Science-based Performance Standards. *ILAR Journal*, 48(1), pp. 3–11.
- Knight, A. (2008). 127 Million Non-Human Vertebrates Used Worldwide for Scientific Purposes in 2005. *Alternatives to Laboratory Animals*, 36(5), pp. 494–496.
- Knight, A. (2019). Critically evaluating animal research. In: K. Herrmann and K. Jayne, eds., *Animal Experimentation: Working Towards a Paradigm Change*, Vol. 22. Leiden: Brill pp. 321–340.
- Kola, I. and J. Landis (2004). Can the Pharmaceutical Industry Reduce Attrition Rates? *Nature Reviews Drug Discovery*, 3(8), p. 711–715.
- Kramer, L.A. and R. Greek (2018). Human Stakeholders and the Use of Animals in Drug Development. *Business and Society Review*, 123(1), pp. 3–58.
- Krech, D., M.R. Rosenzweig and E.L. Bennett (1960). Effects of Environmental Complexity and Training on Brain Chemistry. *Journal of Comparative and Physiological Psychology*, 53, pp. 509–514.
- Lahvis, G.P. (2017). Unbridle Biomedical Research From the Laboratory Cage. *Elife*, 6. [online] Available at: <https://www.ncbi.nlm.nih.gov/pmc/articles/PMC5503508/> [Accessed 4 July 2017].
- Lancaster, M.A. and J.A. Knoblich (2014). Generation of Cerebral Organoids From Human Pluripotent Stem Cells. *Nature Protocols*, 9(10), pp. 2329–2340.
- Landis, S.C., S.G. Amara, K. Asadullah, C.P. Austin, R. Blumenstein, E.W. Bradley, R.G. Crystal, R.B. Darnell, R.J. Ferrante, H. Fillit and R. Finkelstein (2012). A Call for Transparent Reporting To Optimize The Predictive Value of Preclinical Research. *Nature*, 490(7419), pp. 187–191.
- Landrigan, P.J., R. Fuller, N.J. Acosta, O. Adeyi, R. Arnold, A.B. Baldé, R. Bertollini, S. Bose-O, J.I. Boufford, P.N. Breyse and T. Chiles (2017). The Lancet Commission on Pollution and Health. *The Lancet*, pp. 462–512.
- Langley, G., I. Adcock, F. Busquet, K. Crofton, E. Csernok, C. Giese, T. Heinonen, K. Herrmann, M. Hofmann-Apitius, B. Landesmann, L. Marshall, E. McIvor, A. Muotri, F. Noor, K. Schutte, T. Seidle, A. van de Stolpe, H. Van Esch, C. Willett and G. Wozczek (2017). Towards a 21st Century Roadmap for Biomedical Research and Drug Discovery: Consensus Report and Recommendations. *Drug Discovery Today*, 22(2), pp. 327–339.
- Langley, G., C.P. Austin, A.K. Balapure, L.S. Birnbaum, J.R. Bucher, J. Fentem, S.C. Fitzpatrick, J.R. Fowle III, R.J. Kavlock, H. Kitano and B.A. Lidbury (2015). Lessons from

- Toxicology: Developing a 21st Century Paradigm for Medical Research. *Environmental Health Perspectives*, 123(11), p. A268–A272.
- Leary, S., W. Underwood, R. Anthony, S. Cartner, D. Corey, T. Grandin, C. Greenacre, S. Gwaltney-Brant, M.A. McCrackin, R. Meyer and D. Miller (2013). *AVMA Guidelines for the Euthanasia of Animals*, 2013 ed. [online] Available at: <https://www.avma.org/KB/Policies/Documents/euthanasia.pdf> [Accessed 4 July 2017].
- Lees, J.S., E.S. Sena, K.J. Egan, A. Antonic, S.A. Koblar, D.W. Howells and M.R. Macleod (2012). Stem Cell-based Therapy for Experimental Stroke: A Systematic Review and Meta-analysis. *International Journal of Stroke*, 7(7), pp. 582–588.
- Leist, M. and T. Hartung (2013). Inflammatory Findings On Species Extrapolations: Humans Are Definitely No 70 kg Mice. *Archives of Toxicology*, 87(4), pp. 563–567.
- Lewis, M.H., M.F. Presti, J.B. Lewis and L.A. Turner (2006). The neurobiology of stereotypy 1. Environmental complexity. In: G.J. Mason and J. Rushen, eds., *Stereotypic Animal Behaviour: Fundamentals and Applications to Welfare*, 2nd ed. Oxfordshire: CAB International, pp. 190–226.
- Li, G., Y. Gan, Y. Fan, Y. Wu, H. Lin, Y. Song, X. Cai, X. Yu, W. Pan, M. Yao, J. Gu and H. Tu (2015). Enriched Environment Inhibits Mouse Pancreatic Cancer Growth and Down-regulates the Expression of Mitochondria-related Genes in Cancer Cells. *Scientific Reports*, 5, p. 7856. [online] Available at: <https://www.ncbi.nlm.nih.gov/pmc/articles/PMC4297951/> [Accessed 1 July 2017].
- Lilley, E., R. Armstrong, N. Clark, P. Gray, P. Hawkins, K. Mason, N. López-Salesansky, A. Stark, S. Jackson, C. Thiemermann and M. Nandi (2015). Refinement of Animal Models of Sepsis and Septic Shock. *Shock*, 43(4), pp. 304–316.
- Lidster, K., J.G. Jefferys, I. Blümcke, V. Crunelli, P.A. Flecknell, B.G. Frenguelli, W.P. Gray, R. Kaminski, A. Pitkänen, I. Ragan and M. Shah (2016). Opportunities for improving animal welfare in rodent models of epilepsy and seizures. *Journal of Neuroscience Methods*, 260, pp. 2–25.
- Low, P. (2012). *Cambridge Declaration on Consciousness*. [online] Available at: <http://fcmconference.org/img/CambridgeDeclarationOnConsciousness.pdf> [Accessed 1 July 2017].
- Lush Prize (n.d.). *About the Lush Prize*. [online] Available at: <http://lushprize.org/awards/> [Accessed 11 July 2018].
- Macleod, M.R. (2011). Why Animal Research Needs To Improve: Many of The Studies That Use Animals To Model Human Diseases Are Too Small and Too Prone To Bias To Be Trusted. *Nature*, 477(7366), pp. 511–512.
- Macleod, M.R., T. O'Collins, D.W. Howells and G.A. Donnan (2004). Pooling of Animal Experimental Data Reveals Influence Of Study Design and Publication Bias. *Stroke*, 35(5), pp. 1203–1208.
- Macleod, M.R., A. Lawson McLean, A. Kyriakopoulou, S. Serghiou, A. de Wilde, N. Sherratt, T. Hirst, R. Hemblade, Z. Bahor, C. Nunes-Fonseca, A. Potluru, A. Thomson,

- J. Baginskitaie, K. Egan, H. Vesterinen, G. Currie, L. Churilov, D. Howells and E. Sena (2015). Risk of Bias in Reports of In Vivo Research: A Focus for Improvement. *PLoS Biology*, 13(10), p. e1002273. [online] Available at: <https://core.ac.uk/download/pdf/45473665.pdf> [Accessed 11 July 2017].
- Macleod, M.R., H.B. van der Worp, E.S. Sena, D.W. Howells, U. Dirnagl and G.A. Donnan (2008). Evidence for the Efficacy of NXY-059 in Experimental Focal Cerebral Ischaemia Is Confounded by Study Quality. *Stroke*, 39(10), pp. 2824–2829.
- Mahoney, C.J. (1992). Some Thoughts on Psychological Enrichment. *Lab Animal*, 21(5), pp. 27–37.
- Mak, I.W., N. Evaniew and M. Ghert (2014). Lost in Translation: Animal Models and Clinical Trials in Cancer Treatment. *American Journal of Translational Research*, 6(2), pp. 114–118.
- Makowska, I.J. and D.M. Weary (2016a). Differences in Anticipatory Behaviour Between Rats (*Rattus Norvegicus*) Housed In Standard Versus Semi-naturalistic Laboratory Environments. *PLoS One*, 11(1), p. e0147595. [online] Available at: <https://doi.org/10.1371/journal.pone.0147595> [Accessed 8 July 2017].
- Makowska, I.J. and D.M. Weary (2016b). The Importance of Burrowing, Climbing, and Standing Upright for Laboratory Rats. *Royal Society Open Science*, 3(6), p. 160136. [online] Available at: <https://www.ncbi.nlm.nih.gov/pmc/articles/PMC4929907/> [Accessed 8 July 2017].
- Marks, J. (2012). Accept No Substitutes: The Ethics of Alternatives. *Hastings Center Report*, 42(s1).
- Martin, B., S. Ji, S. Maudsley and M.P. Mattson (2010). “Control” Laboratory Rodents Are Metabolically Morbid: Why It Matters. *Proceedings of the National Academy of Sciences*, 107(14), pp. 6127–6133.
- Martire, V.L., A. Silvani, S. Bastianini, C. Berteotti and G. Zoccoli (2012). Effects of Ambient Temperature on Sleep and Cardiovascular Regulation in Mice: The Role of Hypocretin/Orexin Neurons. *PLoS One*, 7(10), p. e47032. [online] Available at: <https://doi.org/10.1371/journal.pone.0047032> [Accessed on 23 February 2017].
- Mason, G.J. (2006). Stereotypic Behaviour in Captive Animals: Fundamentals and Implications for Welfare and Beyond. In: G. Mason and J. Rushen, eds., *Stereotypic Animal Behaviour: Fundamentals and Applications to Welfare*, 2nd ed. Oxfordshire: CAB International, pp. 325–356.
- Maurin, J. (2012). Blutige Bisswunden, hungernde Mäuse. *TAZ*. [online] Available at: <http://www.taz.de/!5095484/> [Accessed on 23 February 2017].
- McManus, R. (2013). Ex-Director Zerhouni Surveys Value of NIH Research. *NIH Record*, LXV(13). [online] Available at: https://nihrecord.nih.gov/newsletters/2013/06_21_2013/story1.htm [Accessed on 23 February 2017].
- McNutt, M., (2014). Journals Unite for Reproducibility. *Science*, 346(6210), p. 679.

- Meagher, R.K. and G.J. Mason (2012). Environmental Enrichment Reduces Signs of Boredom in Caged Mink. *PLoS One*, 7(11), p. e49180. [online] Available at: <https://doi.org/10.1371/journal.pone.0049180> [Accessed on 23 February 2017].
- Meijer, M.K., B.M. Spruijt, L.F.M. Van Zutphen and V. Baumans (2006). Effect of Restraint and Injection Methods on Heart Rate and Body Temperature in Mice. *Laboratory animals*, 40(4), pp. 382–391.
- Mergenthaler, P. and A. Meisel (2012). Do Stroke Models Model Stroke?. *Disease Models & Mechanisms*, 5(6), pp. 718–725.
- Messmer, M.N., K.M. Kokolus, J.W.L. Eng, S.I. Abrams and E.A. Repasky (2014). Mild Cold-stress Depresses Immune Responses: Implications for Cancer Models Involving Laboratory Mice. *Bioessays*, 36(9), pp. 884–891.
- Mestas, J. and C. Hughes (2004). Of Mice and Not Men: Differences Between Mouse and Human Immunology. *The Journal of Immunology*, 172(5), pp. 2731–2738.
- Moher, D., A. Liberati, J. Tetzlaff, D.G. Altman, The PRISMA Group (2009). Preferred Reporting Items for Systematic Reviews and Meta-Analyses: The PRISMA Statement. *PLoS Medicine*, 6(7), p. e1000097. [online] Available at: <https://doi.org/10.1371/journal.pmed.1000097> [Accessed 12 January 2017].
- Morton, D. (2000). A Systematic Approach for Establishing Humane Endpoints. *ILAR Journal*, 41(2), pp. 80–86.
- Mullane, K. and M. Williams (2014). Animal Models of Asthma: Reprise or Reboot?. *Biochemical Pharmacology*, 87(1), pp. 131–139.
- National Animal Ethics Advisory Committee (2002). *A Culture of Care: A Guide for People Working With Animals in Research, Testing and Teaching*. Wellington, New Zealand. [online] Available at: <https://anzccart.org.nz/app/uploads/2017/03/culture-of-care.pdf> [Accessed 10 June 2017].
- National Research Council (2007). *Toxicity Testing in the 21st Century: A Vision and a Strategy*. Washington, D.C.: National Academies Press.
- National Toxicology Program (2004). *A National Toxicology Program to the 21st Century. A Roadmap for the Future*. [online] Available at: https://ntp.niehs.nih.gov/ntp/about_ntp/ntpvision/ntproadmap_508.pdf [Accessed 11 January 2017].
- NCad (n.d.). *NCad opinion Transition to non-animal research*. [online] Available at: <https://www.ncadierproevenbeleid.nl/documenten/rapport/2016/12/15/ncad-opinion-transition-to-non-animal-research> [Accessed 11 July 2017].
- NCATS (National Center for Advancing Translational Sciences) (2017). *Tissue Chips for Disease Modeling and Efficacy Testing*. [online] Available at: <https://ncats.nih.gov/tissuechip/projects/modeling> [Accessed 14 July 2017].
- NAVS (2018). *Fund Smarter Science*. [online] Available at: <https://www.navs.org/what-we-do/fund-smarter-science/#.W1UAPi3Myu5> [Accessed 10 July 2018].
- NC3Rs (n.d. a). *Funding Scheme Priority Areas*. [online] Available at: <https://www.nc3rs.org.uk/funding-scheme-priority-areas#historic> [Accessed 16 July 2018].

- NC3Rs (n.d. b). *Experimental Design*. [online] Available at: <https://nc3rs.org.uk/experimental-design> [Accessed 14 July 2017].
- NC3Rs (n.d. c). *Research Hubs*. [online] Available at: <https://nc3rs.org.uk/resource-hubs> [Accessed 14 July 2017].
- NC3Rs (n.d. d). *Our funding*. [online] Available at: <https://www.nc3rs.org.uk/about-us/funders> [Accessed 16 July 2018].
- Nerem, R.M., M.J. Levensque and J.F. Cornhill (1980). Social Environment as a Factor of Diet Induced Atherosclerosis. *Science*, 208, pp. 1475–1476.
- NIH (2019). *Budget*. [online] Available at: <https://www.nih.gov/about-nih/what-we-do/budget> [Accessed 14 February 2019].
- Nithianantharajah, J. and A. Hannan (2006). Enriched Environments, Experience-dependent Plasticity and Disorders of the Nervous System. *Nature Reviews Neuroscience*, 7(9), pp. 697–709.
- NHMRC (National Health and Medical Research Council) (2013). *Australian code for the care and use of animals for scientific purposes*. 8th ed. [online] Available at: <https://www.nhmrc.gov.au/guidelines-publications/ea28> [Accessed 11 July 2017].
- Noor, F. (2019). The changing paradigm in preclinical toxicology: *in vitro* and *in silico* methods in liver toxicity evaluations. In: K. Herrmann and K. Jayne, eds., *Animal Experimentation: Working Towards a Paradigm Change*, Vol. 22. Leiden: Brill.
- Norecopa (2016a). *Culture of care*. [online] Available at: <https://norecopa.no/more-resources/culture-of-care> [Accessed 11 August 2018].
- Norecopa (2016b). *Design and reporting of animal experiments*. [online] Available at: <https://norecopa.no/more-resources/experimental-design-and-reporting> [Accessed 12 August 2018].
- Norecopa (2017). *Systematic Review Centre for Laboratory Animal Experimentation (SYRACLE)*. [online] Available at: <https://norecopa.no/3r-guide/systematic-review-centre-for-laboratory-animal-experimentation-syracle> [Accessed 12 August 2018].
- O'Collins, V.E., M.R. Macleod, G.A. Donnan, L.L. Horky, B.H. van der Worp and D.W. Howells (2006). 1,026 Experimental Treatments in Acute Stroke. *Annals of Neurology*, 59(3), pp. 467–477.
- Olson, H., G. Betton, D. Robinson, K. Thomas, A. Monro, G. Kolaja, P. Lilly, J. Sanders, G. Sipes, W. Bracken, M. Dorato, K. Van Deun, P. Smith, B. Berger and A. Heller (2000). Concordance of the Toxicity of Pharmaceuticals in Humans and in Animals. *Regulatory Toxicology and Pharmacology*, 32(1), pp. 56–67. [online] Available at: <https://www.gwern.net/docs/statistics/meta-analysis/2000-olson.pdf> [Accessed 12 August 2017].
- Olsson, I.A.S., C.M. Nevison, E.G. Patterson-Kane, C.M. Sherwin, H.A. van de Weerd and H. Würbel (2003). Understanding Behaviour: The Relevance of Ethological Approaches in Laboratory Animal Science. *Applied Animal Behaviour Science*, 81(3), pp. 245–264.

- Ormandy, E.H., C.A. Schuppli, and D.M. Weary (2009). Worldwide Trends in the Use of Animals in Research: The Contribution of Genetically-modified Animal Models. *Alternatives to Laboratory Animals*, 37, pp. 63–68.
- Osborne, N., Avey, M.T., Anestidou, L., Ritskes-Hoitinga, M. and Griffin, G. (2018). Improving animal research reporting standards: HARRP, the first step of a unified approach by ICLAS to improve animal research reporting standards worldwide. *EMBO Reports*, 19(5), p. e46069. [online] Available at: <http://embor.embopress.org/content/19/5/e46069> [Accessed 19 April 2018].
- Pawlowski, J., D. Feinstein, M.L. Crandall and S. Gala (2019). Modernizing biomedical training: replacing live animal laboratories with human simulation. In: K. Herrmann and K. Jayne, eds., *Animal Experimentation: Working Towards a Paradigm Change*, Vol. 22. Leiden: Brill, pp. 551–66.
- Payne, K.J. and G.M. Crooks (2007). Immune-cell Lineage Commitment: Translation From Mice to Humans. *Immunity*, 26(6), pp. 674–677.
- Percie du Sert, N., A. Alfieri, S.M. Allan, H.V. Carswell, G.A. Deuchar, T.D. Farr, P. Flecknell, L. Gallagher, C.L. Gibson, M.J. Haley and M.R. Macleod (2017). The IMPROVE Guidelines (Ischaemia Models: Procedural Refinements Of in Vivo Experiments). *Journal of Cerebral Blood Flow & Metabolism*, p. 0271678X17709185. [online] Available at: <http://journals.sagepub.com/doi/pdf/10.1177/0271678X17709185> [Accessed 18 August 2017].
- Perel, P., I. Roberts, E. Sena, P. Wheble, C. Briscoe, P. Sandercock, M. Macleod, L.E. Mignini, P. Jayaram and K.S. Khan (2007). Comparison of Treatment Effects Between Animal Experiments and Clinical Trials: Systematic Review. *British Medical Journal*, 334, pp. 197–206. [online] Available at: <https://www.bmj.com/content/334/7586/197> [Accessed 12 July 2017].
- PETA International Science Consortium (PISC) (n.d. a). *Awards of VITROCELL In Vitro Inhalation Exposure Systems*. [online] Available at: <https://www.piscltd.org.uk/vitrocell-prize/> [Accessed 10 August 2017].
- PETA International Science Consortium (PISC) (n.d. b). *Funding to Advance the Development and Use of Non-Animal Methods*. [online] Available at: <https://www.piscltd.org.uk/funding/> [Accessed 10 August 2018].
- Pew Research Center (2015). *Public and Scientists' Views on Science and Society: Use of Animals in Scientific Research*. [online] Available at: http://www.pewinternet.org/2015/01/29/public-and-scientists-views-on-science-and-society/pi_2015-01-29_science-and-society-03-05/ [Accessed 10 July 2017].
- Pew Research Center (2018). Americans are divided over the use of animals in scientific research. [online] Available at: <http://www.pewresearch.org/fact-tank/2018/08/16/americans-are-divided-over-the-use-of-animals-in-scientific-research/>. [Accessed 10 July 2017].
- Pharmaceutical Research and Manufacturers of America (2015). *Biopharmaceutical research industry profile*. Washington, DC: PhRMA. [online] Available at: <http://>

- phrma-docs.phrma.org/sites/default/files/pdf/2015_phrma_profile.pdf [Accessed 10 July 2017].
- Pharmaceutical Research and Manufacturers of America (2016). Biopharmaceutical research industry profile. Washington, DC: PhRMA. [online] Available at: <http://phrma-docs.phrma.org/sites/default/files/pdf/biopharmaceutical-industry-profile.pdf> [Accessed 10 December 2017].
- Pippin, J.J. (2012). Animal Research in Medical Sciences: Seeking a Convergence of Science, Medicine, and Animal Law. *South Texas Law Review*, 54, pp. 469–511.
- Pippin, J.J., S.E. Cavanaugh and F. Pistollato (2019). Animal Research for Alzheimer Disease: Failures of Science and Ethics. In: K. Herrmann and K. Jayne, eds., *Animal Experimentation: Working Towards a Paradigm Change*, Vol. 22. Leiden: Brill.
- Pistollato, F., E.L. Ohayon, A. Lam, G.R. Langley, T.J. Novak, D. Pamies, G. Perry, E. Trushina, R.S.B. Williams, A.E. Roher, T. Hartung, S. Harnard, N. Barnard, M.C. Morris, M. Lai, R. Merkley and P.C. Chandrasekera (2016). Alzheimer Disease research in the 21st century: past and current failures, new perspectives and funding priorities. *Oncotarget*, 7(26), pp. 38999–39016. [online] Available at: <https://www.ncbi.nlm.nih.gov/pmc/articles/PMC5129909/> [Accessed 10 July 2017].
- Poole, T. (1997). Happy Animals Make Good Science. *Laboratory Animals*, 31(2), pp. 116–124.
- Pound, P. and M.B. Bracken (2014). Is Animal Research Sufficiently Evidence Based To Be a Cornerstone of Biomedical Research?. *British Medical Journal*, 348, p. g3387.
- Pound, P., S. Ebrahim, P. Sandercock, M.B. Bracken and I. Roberts (2004). Where Is the Evidence That Animal Research Benefits Humans?. *British Medical Journal*, 328(7438), pp. 514–517.
- Pound, P. and C.J. Nicol (2018). Retrospective Harm-benefit Analysis of Preclinical Animal Research for Six Treatment Interventions. *PLoS One*, 13(3), p. e0193758. [online] Available at: <http://journals.plos.org/plosone/article?id=10.1371/journal.pone.0193758> [Accessed 28 March 2018].
- Pound, P. and Ritskes-Hoitinga, M. (2018). Is it possible to overcome issues of external validity in preclinical animal research? Why most animal models are bound to fail. *Journal of Translational Medicine*, 16(1), p. 304. [online] Available at: <https://www.ncbi.nlm.nih.gov/pmc/articles/PMC6223056/> [Accessed 11 November 2018].
- Preclinical Trials (n.d.). *International Register for Preclinical Protocols*. [online] Available at: <https://www.preclinicaltrials.eu> [Accessed 10 December 2017].
- Prinz, F., T. Schlange and K. Asadullah (2011). Believe It or Not: How Much Can We Rely on Published Data on Potential Drug Targets?. *Nature Reviews Drug Discovery*, 10(9), pp. 712–712.
- Ram, R. (2019). Extrapolation of animal research data to humans: an analysis of the evidence. In: K. Herrmann and K. Jayne, eds., *Animal Experimentation: Working Towards a Paradigm Change*, Vol. 22. Leiden: Brill.

- Ramirez, T., S. Beken, M. Chlebus, G. Ellis, C. Griesinger, S. De Jonghe, I. Manou, A. Mehling, K. Reisinger, L. Rossi, J. van der Laan, R. Weissenhorn and U. Sauer (2015). Knowledge sharing to facilitate regulatory decision-making in regard to alternatives to animal testing: Report of an EPAA workshop. *Regulatory Toxicology and Pharmacology*, 73(1), pp. 210–226.
- Redmond, C. (2019). When is an alternative not an alternative? Supporting progress for absolute replacement of animals in science. In: K. Herrmann and K. Jayne, eds., *Animal Experimentation: Working Towards a Paradigm Change*, Vol. 22. Leiden: Brill.
- Renner, M., M.A. Lancaster, S. Bian, H. Choi, T. Ku, A. Peer, K. Chung and J.A. Knoblich (2017). Self-organized Developmental Patterning and Differentiation in Cerebral Organoids. *The EMBO Journal*, p. e201694700. [online] Available at: <http://emboj.embopress.org/content/36/10/1316.long> [Accessed 10 May 2017].
- Reichlin, T.S., L. Vogt and H. Würbel (2016). The Researchers' View of Scientific Rigor—Survey on the Conduct and Reporting of In Vivo Research. *PLoS One*, 11(12), p. e0165999. [online] Available at: <https://doi.org/10.1371/journal.pone.0165999> [Accessed 10 January 2017].
- Reinhardt, V. (2003). Compassion for Animals in the Laboratory: Impairment or Refinement of Research Methodology?. *Journal of Applied Animal Welfare Science*, 6(2), pp. 123–130.
- Richardson, C.A. and P.A. Flecknell (2005). Anaesthesia and Postoperative Analgesia Following Experimental Surgery in Laboratory Rodents: Are We Making Progress?. *Alternatives to Laboratory Animals*, 33, pp. 119–127.
- Richter, S.H. (2017). Systematic Heterogenization for Better Reproducibility in Animal Experimentation. *Lab Animal*, 46(9), pp. 343–349.
- Richter, S.H., J.P. Garner and H. Würbel (2009). Environmental Standardization: Cure or Cause of Poor Reproducibility in Animal Experiments?. *Nature Methods*, 6(4), pp. 257–261.
- Richter, S.H., J.P. Garner, C. Auer, J. Kunert and H. Würbel (2010). Systematic Variation Improves Reproducibility of Animal Experiments. *Nature Methods*, 7(3), pp. 167–168.
- Ritskes-Hoitinga, M. (2016). Systematic Reviews of Animal Studies Equal the Implementation of the 3Rs. In: *20th European Congress on Alternatives to Animal Testing, 17th Annual Congress of EUSAAT*. Linz. [online] Available at: <https://norecopa.no/media/7597/systematic-reviews.pdf> [Accessed 15 December 2017].
- Ritskes-Hoitinga, M. and K. Wever (2018). Improving the Conduct, Reporting, and Appraisal of Animal Research. Editorial. *British Medical Journal*, 360, p. j4935.
- Rittirsch, D., L. Hoesel and P. Ward (2007). The Disconnect Between Animal Models of Sepsis and Human Sepsis. *Journal of Leukocyte Biology*, 81(1), pp. 137–143.
- Rosenzweig, M.R. (1966). Environmental Complexity, Cerebral Change, and Behavior. *American Psychologist*, 21, pp. 321–332.
- Rosenzweig, M.R. and E.L. Bennett (1969). Effects of Differential Environments on Brain Weights and Enzyme Activities in Gerbils, Rats, and Mice. *Developmental Psychobiology*, 2(2), pp. 87–95.

- Rosenzweig, M.R., D. Krech, E.L. Bennett and J.F. Zolman (1962). Variation in Environmental Complexity and Brain Measures. *Journal of Comparative and Physiological Psychology*, 55(6), p. 1092.
- Røttingen, J.A., S. Regmi, M. Eide, A.J. Young, R.F. Viergever, C. Årdal, J. Guzman, D. Edwards, S.A. Matlin and R.F. Terry (2013). "Mapping of available health research and development data: what's there, what's missing, and what role is there for a global observatory?" *The Lancet*, 382 (9900), pp. 1286–1307.
- Rovida, C., S. Asakura, M. Daneshian, H. Hofman-Huether, M. Leist, L. Meunier, D. Reif, A. Rossi, M. Schmutz, J. Valentin, J. Zurlo and T. Hartung (2015). Toxicity Testing in the 21st Century Beyond Environmental Chemicals. *Alternatives to Animal Experimentation*, 32(3), pp. 171–181.
- Russell, W.M.S. and R.L. Burch (1959). *The Principles of Humane Experimental Technique*. Potters Bar, Hertfordshire, England: Universities Federation for Animal Welfare. [online] Available at: http://altweb.jhsph.edu/pubs/books/humane_exp/het-toc [Accessed 12 May 2017].
- Salzberg, S.L., O. White, J. Peterson and J.A. Eisen (2001). Microbial Genes in the Human Genome: Lateral Transfer or Gene Loss?. *Science*, 292 (5523), pp. 1903–1906.
- Sandercock, P. and I. Roberts (2002b). Systematic Reviews of Animal Experiments. *The Lancet*, 360, p. 586.
- Scannell, J.W. and Bosley, J. (2016). When Quality Beats Quantity: Decision Theory, Drug Discovery, and the Reproducibility Crisis. *PLoS One*, 11(2), p.e0147215. [online] Available at: <https://journals.plos.org/plosone/article?id=10.1371/journal.pone.0147215> [Accessed 14 September 2017].
- Scherer, R.W., Meerpohl, J.J., Pfeifer, N., Schmucker, C., Schwarzer, G. and von Elm, E. (2018). Full publication of results initially presented in abstracts. *Cochrane Database of Systematic Reviews* 2018, Issue 11. Art. No.: MR000005. DOI: 10.1002/14651858.MR000005.pub4.
- Schmidt, D.A., M.R. Ellersieck, M.R. Cranfield and W.B. Karesh (2006). Cholesterol Values in Free-ranging Gorillas (*Gorilla Gorilla Gorilla* and *Gorilla Beringei*) and Bornean Orangutans (*Pongo Pygmaeus*). *Journal of Zoo and Wildlife Medicine*, 37(3), pp. 292–300.
- Schuppli, C., A. Walterhouse, V. Chew, N. Hammound, L. Kolody, B. Tan, J. Makowska, S. Mcnamara, J. Sato-Reinhold, V. Wong and D. Weary (2017). A Better Life for Research Animals by Fostering a Culture of Compassion Amongst Researchers. In: *10th World Congress on Alternatives and Animal Use in the Life Sciences (WC10)*. Seattle: Alternatives to Animal Experimentation Proceedings, 6(1), p. 13. [online] Available at: http://www.altex.ch/resources/WC10_entire_issue1.pdf [Accessed 12 September 2017].
- Sena, E.S., H.B. van der Worp, P.M. Bath, D.W. Howells and M.R. Macleod (2010). Publication Bias in Reports of Animal Stroke Studies Leads To Major Overstatement of Efficacy. *PLoS Biology*, 8(3), p. e1000344. [online] Available at: <http://journals.plos.org/plosbiology/article?id=10.1371/journal.pbio.1000344> [Accessed 12 August 2017].

- Seok, J., H.S. Warren, A.G. Cuenca, M.N. Mindrinos, H.V. Baker, W. Xu, D.R. Richards, G.P. McDonald-Smith, H. Gao, L. Hennessy and C.C. Finnerty (2013). Genomic Responses in Mouse Models Poorly Mimic Human Inflammatory Diseases. *Proceedings of the National Academy of Sciences*, 110(9), pp. 3507–3512.
- Serrat, M.A., D. King and C.O. Lovejoy (2008). Temperature Regulates Limb Length in Homeotherms By Directly Modulating Cartilage Growth. *Proceedings of the National Academy of Sciences*, 105 (49), pp. 19348–19353.
- Shay, T., V. Jovic, O. Zuk, K. Rothamel, D. Puyraimond-Zemmour, T. Feng, E. Wakamatsu, C. Benoist, D. Koller and A. Regev (2013). Conservation and Divergence in the Transcriptional Programs of the Human and Mouse Immune Systems. *Proceedings of the National Academy of Sciences*, 110(8), pp. 2946–2951.
- Sherwin, C.M. (2004). The influences of Standard Laboratory Cages on Rodents and the Validity of Research Data. *Animal Welfare*, 13(1), pp. 9–15.
- Sherwin, C.M., E. Haug, N. Terkelsen and M. Vadgama (2004). Studies on the Motivation for Burrowing by Laboratory Mice. *Applied Animal Behaviour Science*, 88(3), pp. 343–358.
- Shuaib, A., K. Lees, P. Lyden, J. Grotta, A. Davalos, S. Davis, H. Diener, T. Ashwood, W. Wasiewski and U. Emeribe (2007). NXY-059 for the Treatment of Acute Ischemic Stroke. *New England Journal of Medicine*, 357(6), pp. 562–571.
- Simmons, J.P., L.D. Nelson and U. Simonsohn (2011). False-positive Psychology: Undisclosed Flexibility in Data Collection and Analysis Allows Presenting Anything as Significant. *Psychological Science*, 22 (11), pp. 1359–1366.
- Sloff, M., R. de Vries, P. Geutjes, J. IntHout, M. Ritskes-Hoitinga, E. Oosterwijk and W. Feitz (2014). Tissue Engineering in Animal Models for Urinary Diversion: A Systematic Review. *PLoS one*, 9(6), p. e98734. [online] Available at: <http://journals.plos.org/plosone/article?id=10.1371/journal.pone.0098734> [Accessed 30 July 2017].
- Smith, A.J., R.E. Clutton, E. Lilley, K.E.A. Hansen and T. Brattelid (2017). PREPARE: Guidelines for Planning Animal Research and Testing. *Laboratory Animals*, pp. 135–141. [online] Available at: <http://journals.sagepub.com/doi/pdf/10.1177/0023677217724823> [Accessed 5 August 2017].
- Smith, R. (2014). Medical Research—Still a Scandal. [Blog] *British Medical Journal Blog*. Available at: <https://blogs.bmj.com/bmj/2014/01/31/richard-smith-medical-research-still-a-scandal/> [Accessed 30 August 2017].
- Sorge, R., L. Martin, K. Isbester, S. Sotocinal, S. Rosen, A. Tuttle, J. Wieskopf, E. Acland, A. Dokova, B. Kadoura, P. Leger, J. Mapplebeck, M. McPhail, A. Delaney, G. Wigerblad, A. Schumann, T. Quinn, J. Frasnelli, C. Svensson, W. Sternberg and J. Mogil (2014). Olfactory Exposure to Males, Including Men, Causes Stress and Related Analgesia in Rodents. *Nature Methods*, 11(6), pp. 629–632.
- Špinka, M. and F. Wemelsfelder (2011). Environmental challenge and animal agency. In: M.C. Appleby, J.A. Mench, I.A.S. Olsson and B.O. Hughes, eds., *Animal Welfare*, 2nd ed. Wallingford: CABI International, pp. 27–43.

- Stokes, E., P. Flecknell and C. Richardson (2009). Reported Analgesic and Anaesthetic Administration To Rodents Undergoing Experimental Surgical Procedures. *Laboratory Animals*, 43(2), pp. 149–154.
- Systematic Review Center for Laboratory Animal Experimentation (SYRCLE) (n.d. a). *Systematic reviews of animal studies*. [video] Available at: <https://www.radboudumc.nl/en/research/radboud-technology-centers/animal-research-facility/systematic-review-center-for-laboratory-animal-experimentation> [Accessed 12 July 2017].
- SYRCLE (n.d. b). *Tools and guidelines*. [online] Available at: <https://www.radboudumc.nl/en/research/radboud-technology-centers/animal-research-facility/systematic-review-center-for-laboratory-animal-experimentation> [Accessed 12 July 2017].
- SYRCLE (n.d. c). Protocols. Turner et al. (2017). The use of carbon dioxide as a method for euthanasia of laboratory mice and rats – a systematic review. [online] Available at: https://issuu.com/radboudumc/docs/the_use_of_carbon_dioxide_as_a_meth?e=28355229/48248733 [Accessed 12 January 2018].
- Taylor, K. and L. Rego (2016). EU statistics on Animal Experiments for 2014. *Alternatives to Animal Experimentation Proceedings*, 33(4), pp. 465–468.
- Taylor, K., N. Gordon, G. Langley and W. Higgins (2008). Estimates for Worldwide Laboratory Animal Use in 2005. *Alternatives to Laboratory Animals*, 36(3), pp. 327–342.
- Tsai, P.P., U. Pachowsky, H.D. Stelzer and H. Hackbarth (2002). Impact of Environmental Enrichment in Mice. 1: Effect of Housing Conditions on Body Weight, Organ Weights and Haematology in Different Strains. *Laboratory Animals*, 36(4), pp. 411–419.
- Tsai, P.P., H.D. Stelzer, H.J. Hedrich and H. Hackbarth (2003). Are the Effects of Different Enrichment Designs on the Physiology and Behaviour of DBA/2 Mice Consistent?. *Laboratory Animals*, 37(4), pp. 314–327.
- Tsai, P.P., H.D. Stelzer, A. Schraepfer and H. Hackbarth (2006). Importance and Effects of Enrichment on Physiology, Behaviour and Breeding Performance in Mice. *Alternatives to Animal Experimentation*, 23, pp. 96–98.
- Tsilidis, K., O. Panagiotou, E. Sena, E. Aretouli, E. Evangelou, D. Howells, R. Salman, M. Macleod and J.P.A. Ioannidis (2013). Evaluation of Excess Significance Bias in Animal Studies of Neurological Diseases. *PLoS Biology*, 11(7), p. e1001609. [online] Available at: <http://journals.plos.org/plosbiology/article?id=10.1371/journal.pbio.1001609> [Accessed 12 January 2018].
- Tsukamoto, T. (2016) Animal Disease Models for Drug Screening: The Elephant in the Room? *Drug Discovery Today*, 21, pp. 529–530.
- Turner, J.G., J.L. Parrish, L.F. Hughes, L.A. Toth and D.M. Caspary (2005). Hearing in Laboratory Animals: Strain Differences and Nonauditory Effects of Noise. *Comparative Medicine*, 55(1), pp. 12–23.
- UC San Diego (2018). *Biomedical Research using Non Animal Models*. [online] Available at: <https://extension.ucsd.edu/courses-and-programs/biomedical-research-using-non-animal-models> [Accessed 12 July 2018].

- Uhlig, C., H. Krause, T. Koch, M.G. de Abreu and P.M. Spieth (2015). Anesthesia and Monitoring in Small Laboratory Mammals Used in Anesthesiology, Respiratory and Critical Care Research: A Systematic Review on the Current Reporting in top-10 Impact Factor Ranked Journals. *PLoS One*, 10(8), p. e0134205. [online] Available at: <http://journals.plos.org/plosone/article?id=10.1371/journal.pone.0134205> [Accessed 18 July 2017].
- van de Weerd, H.A., Aarsen, E.L., Mulder, A., Kruitwagen, C.L., Hendriksen, C.F. and Baumans, V. (2002). Effects of environmental enrichment for mice: variation in experimental results. *Journal of Applied Animal Welfare Science*, 5(2), pp. 87–109.
- van der Poll, T. (2012). Experimental Human Sepsis Models. *Drug Discovery Today: Disease Models*, 9(1), pp. e3–e9.
- van der Worp, H.B., D.W. Howells, E.S. Sena, M.J. Porritt, S. Rewell, V. O and M.R. Macleod (2010). Can Animal Models of Disease Reliably Inform Human Studies? *PLoS Medicine*, 7, pp. e1000245. [online] Available at: <http://journals.plos.org/plosmedicine/article?id=10.1371/journal.pmed.1000245> [Accessed 15 August 2017].
- van Luijk, J. (2016). Improving Animal Research Using a Science Driven Approach: Systematic Reviews of Animal Studies. In: *20th European Congress on Alternatives to Animal Testing, 17th Annual Congress of EUSAAT*. Linz. [online] Available at: <https://norecopa.no/media/7599/systematic-reviews-judith-van-luijk.pdf> [Accessed 15 December 2017].
- van Luijk, J., B. Bakker, M.M. Rovers, M. Ritskes-Hoitinga, R.B. de Vries and M. Leenaars (2014). Systematic Reviews of Animal Studies: Missing Link in Translational Research?. *PLoS One*, 9(3), p. e89981. [online] Available at: <http://journals.plos.org/plosone/article?id=10.1371/journal.pone.0089981> [Accessed 15 August 2017].
- van Luijk, J., Y. Cuijpers, L. van der Vaart, T.C. de Roo, M. Leenaars and M. Ritskes-Hoitinga (2013). Assessing the Application of the 3Rs: A Survey Among Animal Welfare Officers in the Netherlands. *Laboratory Animals*, 47(3), pp. 210–219.
- van Luijk, J., M. Leenaars, A.M. van Dongen, L. van der Vaart and M. Ritskes-Hoitinga (2012). Outcomes of a Dutch Workshop on Improvements for the 3Rs in Daily Practice. *Alternatives to Animal Experimentation*, 29(4), p. 440–443. [online] Available at: <https://www.altex.org/index.php/altex/article/view/439/447> [Accessed 15 August 2017].
- van Praag, H., G. Kempermann and F.H. Gage (2000). Neural Consequences of Environmental Enrichment. *Nature Reviews Neuroscience*, 1(3), pp. 191–198.
- vfa (Die forschenden Pharmaunternehmen) (2017). *Tierschutz. Preise des Landes Berlin für tierfreie Forschung zu Grippeviren und Schlaganfall verliehen*. [online] Available at: <https://www.vfa.de/de/arszneimittel-forschung/forschungsstandort-deutschland/preise-des-landes-berlin-fuer-tierfreie-forschung-zu-grippeviren-und-schlaganfall-verliehen.html> [Accessed 12 October 2017].
- Voelkl, B., Vogt, L., Sena, E.S. and Würbel, H. (2018). Reproducibility of preclinical animal research improves with heterogeneity of study samples. *PLoS Biology*, 16(2), p. e2003693.

- Vogt, L., T.S. Reichlin, C. Nathues and H. Würbel (2016). Authorization of Animal Experiments Is Based on Confidence Rather Than Evidence of Scientific Rigor. *PLoS Biology*, 14 (12), p. e2000598. [online] Available at: <http://journals.plos.org/plosbiology/article?id=10.1371/journal.pbio.2000598> [Accessed 12 July 2017].
- von Aulock, S. (2017). The 3Rs in Action, Session VIII-3: Establishing a Culture of Care Through Assessment, Transparency, and Communication. In: *10th World Congress on Alternatives and Animal Use in the Life Sciences (WC10)*. Seattle: Alternatives to Animal Experimentation Proceedings, 6(1), p. 213. [online] Available at: http://www.altex.ch/resources/WC10_entire_issue1.pdf [Accessed 22 August 2017].
- Waiblinger, E. and B. König (2004). Refinement of Gerbil Housing and Husbandry in the Laboratory. *Alternatives to Laboratory Animals*, 32 (1A), pp. 163–169.
- Watts, N., M. Amann, S. Ayeb-Karlsson, K. Belesova, T. Bouley, M. Boykoff, P. Byass, W. Cai, D. Campbell-Lendrum, J. Chambers and P.M. Cox (2017). The Lancet Countdown on Health and Climate Change: From 25 Years of Inaction to a Global Transformation for Public Health. *The Lancet*, 391 (10120), pp. 581–630.
- Weed, J. and J. Raber (2005). Balancing Animal Research With Animal Well-being: Establishment of Goals and Harmonization of Approaches. *ILAR Journal*, 46(2), pp. 118–128.
- Wells, S. (2017). Pain Assessment and New Innovations. In: *10th World Congress on Alternatives and Animal Use in the Life Sciences (WC10)*. Seattle: Alternatives to Animal Experimentation Proceedings, 6(1), p. 222. [online] Available at: http://www.altex.ch/resources/WC10_entire_issue1.pdf [Accessed 22 August 2017].
- Wever, K.E., F.J. Geessink, M.A. Brouwer, A. Tillema and M. Ritskes-Hoitinga (2017). A systematic review of discomfort due to toe or ear clipping in laboratory rodents. *Laboratory Animals*, 51(6), pp. 583–600.
- Wiedenmayer, C. (1997). Causation of the Ontogenetic Development of Stereotypic Digging in Gerbils. *Animal Behaviour*, 53(3), pp. 461–470.
- Wolfensohn, S., P. Hawkins, E. Lilley, D. Anthony, C. Chambers, S. Lane, M. Lawton, H. Voipio and G. Woodhall (2013a). Reducing Suffering in Experimental Autoimmune Encephalomyelitis (EAE). *Journal of Pharmacological and Toxicological Methods*, 67(3), pp. 169–176.
- Wolfensohn, S., P. Hawkins, E. Lilley, D. Anthony, C. Chambers, S. Lane, M. Lawton, S. Robinson, H. Voipio and G. Woodhall (2013b). Reducing Suffering in Animal Models and Procedures Involving Seizures, Convulsions and Epilepsy. *Journal of Pharmacological and Toxicological Methods*, 67(1), pp. 9–15.
- Wolfer, D., O. Litvin, S. Morf, R. Nitsch, H. Lipp and H. Würbel (2004). Laboratory Animal Welfare: Cage Enrichment and Mouse Behaviour. *Nature*, 432(7019), pp. 821–822.
- Wolfe, T.L. (1987). Control of Stress Using Non-drug Approaches. *Journal of the American Veterinary Medical Association*, 191, pp. 1219–1221.
- World Organisation for Animal Health (OIE) (2018). *Terrestrial Animal Health Code, Ch. 7.8*. Paris: World Organisation for Animal Health, first adopted in 2010; most recent

- update adopted in 2013. [online] Available at: http://www.oie.int/index.php?id=169&L=0&htmfile=chapitre_aw_research_education.htm [Accessed 12 May 2017].
- Würbel, H. (2000). Behaviour and the Standardization Fallacy. *Nature Genetics*, 26, p. 263.
- Würbel, H. (2001). Ideal homes? Housing Effects on Rodent Brain and Behaviour. *Trends in Neuroscience*, 24, pp. 207–211.
- Würbel, H. (2007). Environmental Enrichment Does Not Disrupt Standardisation of Animal Experiments. *Alternatives to Animal Experimentation*, 24, pp. 70–73.
- Würbel, H. (2016). Tierversuch und Irrtum. In: M. Fehlmann, M. Michel and R. Niederhauser, eds. *Tierisch! Das Tier und die Wissenschaft: Ein Streifzug durch die Disziplinen*, Reihe Zürcher Hochschulforum, 55, pp. 97–106.
- Würbel, H. (2017). More Than 3Rs: The Importance of Scientific Validity for Harm-benefit Analysis of Animal Research. *Nature Lab Animal*, 46(4), pp. 164–166. [online] Available at: <https://www.nature.com/articles/labani.1220.pdf> [Accessed 12 June 2017].
- Würbel, H. and J.P. Garner (2007). Refinement of Rodent Research Through Environmental Enrichment and Systematic Randomization. *National Centre for the Replacement, Refinement, and Reduction of Animals in Research (NC3Rs)*. [online] Available at: <https://www.nc3rs.org.uk/sites/default/files/documents/Refinementenvironmental-enrichment-and-systematic-randomization.pdf> [Accessed 12 August 2017].
- Würbel, H. and M. Stauffacher (1994). Standardhaltung für Labormäuse—Probleme und Lösungsansätze. *Tierlaboratorium*, 17, pp. 109–118.
- Würbel, H. and M. Stauffacher (1996). Prevention of Stereotypy in Laboratory Mice: Effects on Stress Physiology and Behaviour. *Physiology & Behavior*, 59(6), pp. 1163–1170.
- Würbel, H., M. Stauffacher and D. Holst (1996). Stereotypies in Laboratory Mice—Quantitative and Qualitative Description of the Ontogeny of ‘Wire-gnawing’ and ‘Jumping’ in Zur: ICR and Zur: ICR nu. *Ethology*, 102(3), pp. 371–385.
- Zeeff, S.B., C. Kunne, G. Bouma, R.B. de Vries and A.A. Te Velde (2016). Actual usage and Quality of Experimental Colitis Models in Preclinical Efficacy Testing: A Scoping Review. *Inflammatory Bowel Diseases*, 22(6), pp. 1296–1305.
- Zerhouni, E.A. (2014). Turning the Titanic. *Science Translational Medicine*, 6(221), p. 221ed2.
- Zurlo, J. (2012). No Animals Harmed: Toward a Paradigm Shift in Toxicity Testing. *Hastings Center Report*, 42(s1). [online] Available at: <http://animalresearch.thehastingscenter.org/report/no-animals-harmed-toward-a-paradigm-shift-in-toxicity-testing/> [Accessed 12 June 2017].
- Zurlo, J., D. Rudacille and A.M. Goldberg (1996). The Three R's: The Way Forward. *Environmental Health Perspectives*, 104(8), pp. 878–880.

How to Evaluate the Science of Non-human Animal Use in Biomedical Research and Testing: A Proposed Format for Debate

Ray Greek

President, Americans for Medical Advancement (AFMA),
California, United States

Lisa A. Kramer

Professor of Finance, University of Toronto, Ontario, Canada

1 Introduction

Over time, the interpretation of science has occasionally been corrupted by vested interest groups, be they financially motivated or ego driven. Scientific consensus and widespread public beliefs usually catch up with the evidence, but this can take a very long time and often costs lives. The use of non-human animals in biomedical research and testing is a scientific endeavor and, as such, can and should be evaluated in light of the best science currently available. But facts that have been accepted in all areas of science are routinely ignored or called into question by well-funded, vested interest groups, compromising the scientific integrity of biomedical research. History is replete with examples of practices deemed scientifically viable in one era, but later abandoned as more facts about the material universe were discovered. There are also many instances of practices being rejected by the scientific establishment, in spite of the fact that they were valid based on scientific criteria. In this chapter, we discuss why science is important in the context of animal modeling, how scientific positions are currently evaluated through the peer-review process, and how an evaluation of the science of animal modeling should be conducted now. We reach the conclusion that, in order to formally evaluate the scientific viability of animal modeling, a debate is urgently needed with experts in the relevant fields of science reviewing pro and con arguments written in position papers.

2 Context

The use of non-human animals in science, in general, and in biomedical research and testing, in particular, has historically been controversial. Formal objections to the practice emerged as early as the seventeenth century, primarily based on moral objections (Franco, 2013). The peak controversy, perhaps, began with the popularization of the animal rights movement, circa 1975. Welfare concerns aside, there are many stakeholders with vested interests in the continued use of non-human animals in research. First, many scientists and nonscientists worldwide are employed, either directly or indirectly, due to the use of non-human animals in biomedical science, with jobs spanning both private-sector and publicly-funded entities. The volume and variety of entities that conduct and/or fund animal-based research complicates any attempt to quantify the dollar magnitude of associated expenditures; but a conservative estimate indicates that at least US\$10 billion is spent annually on animal-based research and testing in the United States, only taking account of funds originating from the National Institutes of Health (Monastersky, 2008). If one considers other grant-funding sources and private-sector sources, both in the US and in the many other countries where non-human animals are used, the amount spent annually is likely many orders of magnitude more than this conservative figure.

Of course, human nature is such that people generally oppose technological changes which may render their own employment obsolete or may otherwise interfere with their personal objectives. Furthermore, people may even be reluctant to embrace technological change that simply alters the specific tasks they undertake in completing their work. For instance, scholarly researchers who have entire laboratories devoted to animal modeling may be reluctant to consider adopting non-animal-based research methods if doing so might require the development of new tools, jeopardizing their publishing prospects or their ability to continue training graduate students to emulate the type of research they have always undertaken. That is, it takes time and effort for people to develop new skills, and people are naturally averse to changes that might require that they do so. Additionally, universities and other research institutions rely on research grant overhead fees as a form of revenue to help cover the administrative costs of running their organizations. When a sizeable portion of that overhead-fee revenue stream originates from grants that fund animal-based research, executives and even employees at those institutions may be reluctant to consider a future free of animal modeling. A researcher at Columbia University wrote that one reason animal modeling continues is due to the “frailties of human nature. Too many eminent laboratories and illustrious researchers have devoted too much of their time to studying malignant

diseases in mouse models, and they're the ones reviewing one another's grants and deciding where the NIH [National Institutes of Health] money gets spent. They're not prepared to concede that mouse models are basically valueless for most cancer therapeutics" (Raza, 2015, p. 232).

In recognition that a wide variety of conflicts of interest can influence scholarly researchers, including non-monetary, *Nature Research* journals, for example, require authors "to declare any competing financial and/or non-financial interests," including "present or anticipated employment by any organization that may gain or lose financially through this publication"; unpaid memberships or advisory positions; writing or consulting for an educational company; and other considerations (see *Nature Research*, 2011). Because of vested interests—whether monetary, emotional, or philosophical—the outcome of any change in the animal-model paradigm has the potential to affect many people adversely, some of whom are represented by societies, lobbyists, nonprofits, nongovernmental organizations, and other groups that may be keen to attract media attention to promote their agendas. Consequently, vested interests can interfere with the adoption of progressive policies and behaviors.

The social and political atmosphere surrounding animal use is similar to that of other science-based controversies (or in some cases, pseudo-controversies), such as vaccines, global warming, and genetically modified organisms (GMOs). There are typically advocates on both sides of such issues, and it is often the case that one needs an advanced science background to understand the relevant issues. Thus, the general public, and even some scientists, may not be able to determine rightly which side the scientific facts actually support. The more money at stake in any given debate (e.g., the interests of the oil and coal industries in the context of the global warming controversy), the more propaganda will likely emerge, potentially confounding the public's ability to understand and evaluate the facts. Even when there is scientific consensus because of overwhelming evidence—as there is on the overall effectiveness of vaccines, the safety of GMOs in terms of human health, and the existence of global warming—the opposition can be so well funded and prone to promoting unscientific points of view that the general public can almost be forgiven for incorrectly believing there exists real controversy on these points.

Regarding the use of non-human animals to model human responses to drugs and diseases, articles questioning the scientific viability of the practice began appearing in the scientific literature in the 1980s. These critiques have taken various forms and, unfortunately, have included arguments that appear on the surface to be science-based, but are in fact not valid science-based attacks. The first four of the following five points list the most common themes of these attacks, and we provide a brief explanation of why each argument

lacks merit. The fifth point represents a valid objection to animal modeling, by which we mean the objection is logical and is based on scientific facts. In the discussion that follows, we make frequent reference to the concept of *predictive value*. We refer the reader to the *empirical evidence* section of Chapter 17 (in this volume), for a detailed discussion of the mathematical calculation of numerical predictive value. Briefly, predictive value is an important metric by which a test or methodology correctly identifies an outcome or condition in humans. The specific threshold by which a particular modality is deemed to have an acceptably high predictive value varies by context. In medicine, where lives lie in the balance, one could argue that nothing short of 100% is acceptable. In some cases, even drugs tested with modalities that offer predictive value as high as 99.9% have been pulled from the market due to life-threatening consequences. In practice, animal models have predictive value below 50%, making them less informative than a coin flip and rendering them of no practical use in predicting human outcomes. Given the poor predictive value of animal modeling, Kramer and Greek (2019) propose existing drug development and disease research resources ought to be redirected towards personalized medicine, a new field which offers the promise of 100% predictive value due to its basis in each patient's own unique genetic makeup.

We now turn to listing the most common critiques of the use of non-human animals to model human responses to drugs.

1. *The methodology of the experiment was poor, and, therefore, animal modeling should be abolished.* This argument is invalid because implicit within the argument is the false premise that if the methodology had been good then that would have reflected well on the viability of the entire paradigm of animal modeling. Of course, the use of good or bad methodology in a given experiment is not sufficient for making general statements about whether animal modeling should be abolished overall.
2. *The history of medical science has not been as dependent on animal modeling as we have been led to believe, and, therefore, animal modeling should be abolished.* This argument is invalid. Whether or not the current state of modern medical science was dependent on researchers having used animal models in the past has no bearing on whether the continued use of non-human animals is vital. Decisions about any future use of animal models should be based on modern scientific knowledge about whether animal models have predictive value for human outcomes, taking into account information that may not have been available or considered when past decisions were made.
3. *Review articles conclude that specific non-human animal species have not been vital to various medical developments, and, thus, animal modeling should be abolished.* This argument is not valid. Even if it were true that

specific non-human animal species were not essential parts of specific medical advancements, this would not be a sound basis for evaluating whether the overall use of animal models has predictive value for human outcomes.

4. *There are now alternatives to using non-human animals, and, therefore, animal modeling should be abolished.* There exist alternatives to many uses of non-human animals in science but not others. Currently, for example, there are no toxicity tests that have high enough predictive value for humans. Nor can we ethically instrument the human brain the way we do in non-human animals. The position in this point is further weakened by the fact that it does not address whether animal modeling is scientifically viable in the first place, nor does it offer a scientific theory to tie together areas where animal use is successful and areas where it is not.
5. *The paradigm of animal modeling is not scientifically viable for predicting human response to drugs and diseases, and, thus, animal models should not be used to predict human response to drugs and diseases.* In contrast to the previous four points, this particular point is based on critical thinking, logic, and scientific facts; and, hence, it is a valid scientific argument. Scientific knowledge from complexity science and evolutionary biology, supported by empirical evidence, establishes that animal modeling does not have predictive value for human outcomes. Past research in these areas was summarized by authors, including Greek and Rice (2012), LaFollette and Shanks (1996), LaFollette and Shanks (1998), and Shanks and Greek (2009), forming the basis for trans-species modeling theory (TSMT): “While trans-species extrapolation is possible when perturbations concern lower levels of organization or when studying morphology and function on the gross level, one evolved, complex system will not be of predictive value for another when the perturbation affects higher levels of organization” (Greek and Hansen, 2013a, p. 245).

In Chapter 17 in this volume, Greek and Kramer (2019) discuss TSMT in great depth. Briefly, TSMT draws on established knowledge in evolutionary biology and complex systems science to draw the conclusion that animal models cannot be predictive of human response to drugs and disease. We refer the interested reader to Chapter 17 for further details. TSMT is the only scientific argument that invalidates using animal models to predict human response to perturbations that occur at higher levels of organization. TSMT is also the only critique of animal modeling that both explains past apparent successes and failures and why future reliance on animal models will lead to continued significant failures in predicting human responses (Greek, 2014; Greek and Hansen, 2013a,b; Greek and Menache, 2013; Greek and Rice, 2012; Jones and Greek, 2013). Unlike TSMT, points 1–4 above do not offer any definitive resolution to

the animal modeling controversy; indeed, many animal modeling advocates agree with various aspects of these points. Furthermore, points 1–4 offer no scientific evaluation of the problem, nor do they make reference to science to support their assertions. Point 5, in contrast, is based on valid scientific foundations, and, hence, we focus here on TSMT as the only viable opposition to the paradigm of animal modeling.

TSMT is a theory and, like all scientific theories, it is consistent with the following definition from the National Academies of Sciences, Engineering, and Medicine (2017): “In everyday usage, “theory” often refers to a hunch or a speculation. When people say, “I have a theory about why that happened,” they are often drawing a conclusion based on fragmentary or inconclusive evidence. The formal scientific definition of theory is quite different from the everyday meaning of the word. It refers to a comprehensive explanation of some aspect of nature that is supported by a vast body of evidence”. Stated differently, fact-supported theories should not be guesses but, instead, must be reliable accounts of the real world. To that end, the facts associated with evolution and complex systems have been established beyond doubt by observation and experiments. Furthermore, there is extensive empirical evidence from animal modeling to support TSMT. Additionally, TSMT is characterized by consilience—it agrees with facts from other fields. It is also falsifiable and generalizable, and it offers predictions for future outcomes. TSMT fulfills all of the qualifications for a scientific theory.

In this chapter, we suggest a peer-reviewed debate process by which scientists and society, in general, could formally evaluate the scientific validity of the statement in point 5 and, in so doing, could resolve the deep disagreement about the predictive value of animal modeling. This process could have been applied in the past and lethal errors would consequently have been avoided. It could also be applied to other science-based controversies facing society. The peer-reviewed debate we recommend is not a panacea appropriate for all disagreements. Many disputes in life (and even those relating to the use of non-human animals in certain contexts) do not center on science but rather arise due to fundamental differences in opinion, which are rooted in ideology. However, the process we propose is appropriate for settling controversies related to science, such as those that arise in the context of using animal models as predictors of human outcomes.

3 Why Science Is Important

The use of non-human animals in science and science education is not confined to biomedical research and testing where predictive value is touted as an

TABLE 2.1 Nine categories of animal use in science and research (Greek and Shanks, 2009)

-
1. Non-human animals are used as predictive models of humans for research into such diseases as cancer and AIDS.
 2. Non-human animals are used as predictive models of humans for testing drugs or other chemicals.
 3. Non-human animals are used as “spare parts”, such as when a person receives an aortic valve from a pig.
 4. Non-human animals are used as bioreactors or factories, such as for the production of insulin or monoclonal antibodies or to maintain the supply of a virus.
 5. Non-human animals and animal tissues are used to study basic physiological principles.
 6. Non-human animals are used in education to educate and train medical students and to teach basic principles of anatomy in high school biology classes.
 7. Non-human animals are used as a modality for ideas or as a heuristic device, which is a component of basic science research.
 8. Non-human animals are used in research designed to benefit other animals of the same species or breed.
 9. Non-human animals are used in research in order to gain knowledge for knowledge sake.
-

objective. There are, in fact, many categories of animal use, as shown in Table 2.1, some of which do not lean on predictive value as a determining factor for using non-human animals.

In general, it may be possible to justify the use of non-human animals associated with Categories 3–9 based on scientific grounds, without reliance on predictive value for perturbations that occur at higher levels of organization. For instance, one can make a logical argument, with valid reference to science, to support the claim that human lives may be saved by using tissue retrieved from an animal (Category 3) or to make the claim that one can learn about the broad structure of lungs in mammals by examining the lungs of rats (Category 6). (This does not rule out the possibility that, in some cases, there may also be valid scientific objections; for example, the risk of facilitating the cross-species transmission of viruses.) Furthermore, there may exist valid ethical objections to the use of non-human animals in specific instances of Categories 3–9. We leave aside possible objections such as these for the purposes of this discussion and focus, instead, exclusively on scientific arguments

regarding utility. Likewise, using some non-human animals in order to learn more about other animals of the same species is scientifically uncontroversial in veterinary medical research. However, it is not scientifically justifiable to use non-human animals in the context of Categories 1 and 2, for reasons based in complex systems science and evolutionary biology (for more details on complex systems science and evolutionary biology, see Chapter 17, the above-cited papers regarding TSMT, and the references therein).

Nevertheless, the literature is filled with cases where researchers make (baseless) claims that animal models have predictive value for human outcomes in the context of drugs and diseases. For example, the widely-used *Handbook of Laboratory Animal Science* states: “[An] important group of animal models is employed as predictive models. These models are used with the aim of discovering and quantifying the impact of a treatment, whether this is to cure a disease or to assess toxicity of a chemical compound” (Hau, 2003, p. 2). A highly cited article in *Clinical Cancer Research* states: “GEMs [genetically engineered mice] closely recapitulate the human disease and are used to predict human response to a therapy, treatment or radiation schedule [...] GEMs that faithfully recapitulate human brain tumors and will likely result in high-quality clinical trials with satisfactory treatment outcomes and reduced drug toxicities” (Fomchenko and Holland, 2006, p. 5296). The popular textbook, *Animal Models in Toxicology* (Gad, 2007), states: “Biomedical sciences’ use of animals as models [is to] help understand and predict responses in humans, in toxicology, and pharmacology [...] [B]y and large animals have worked exceptionally well as predictive models for humans” (Preface). “Animals have been used as models for centuries to predict what chemicals and environmental factors would do to humans [...] The use of animals as predictors of potential ill effects has grown since that time” (p. 2). “If we correctly identify toxic agents (using animals and other predictive model systems) in advance of a product or agent being introduced into the marketplace or environment, generally it will not be introduced” (p. 3). These are but a few of the many instances where researchers make vastly over-reaching claims about the prediction value of animal models. A balanced assessment of the overall evidence shows, instead, that animal models, for all practical purposes, do not have predictive value for human responses to drugs and diseases.

Further to that point, the medical literature contains many papers that show, based on the (standard) statistical concept of predictive value, that there is no basis to continue using non-human animals to predict human response to drugs and diseases (Greek, 2014; Greek and Greek, 2010; Greek and Hansen,

2013a; Greek, Pippus and Hansen, 2012b; Greek and Rice, 2012; Greek, Shanks and Rice, 2011b; Shanks and Greek, 2009; Shanks, Greek and Greek, 2009). Since advocates of animal modeling appeal to the predictive value argument to *justify* their use of non-human animals, the onus is on those advocates to clearly establish predictive value. Yet, such evidence based on predictive value, which may support of the use of animal models, is notably absent from the scientific literature. That evidence is also absent from the legally binding documents that the Institutional Animal Care and Use Committees and funding bodies, such as the National Institutes of Health (NIH) in the US, require animal modelers to sign, testifying that their projects have a reasonable expectation to translate to humans. The lack of evidence is a direct consequence of the fact (shown by the studies cited above, and, in turn, the many studies they cite) that responses to perturbations, such as drugs and diseases, in an animal have effectively no predictive value for responses in humans.

The fact that animal models do not have predictive value for human responses has several important implications, including the following:

1. The extent to which the general public supports the use of non-human animals in research rests on an assumption that the outcome of the research benefits humans directly. For example, writing in *Nature*, Giles states: “public opinion is behind animal research only if it helps develop better drugs.” (2006, p. 981) Since animal models do not have predictive value for human outcomes, their use should be abandoned.
2. Continuing to use non-human animals in the absence of predictive value wastes time and money (see Chapter 10) which could instead be devoted to scientifically valid pursuits.
3. Various members of the pharmaceutical industry and various scientists have acknowledged the failure of the animal model for predicting human responses to drugs and diseases (Arrowsmith, 2011a,b; Ennever, Noonan and Rosenkranz, 1987; Fletcher, 1978; Food and Drug Administration, 2004; Johnson et al., 2001; Kola and Landis, 2004; Kummur et al., 2007; Lumley, 1990; Morgan et al., 2012; Seok et al., 2013; van Meer et al., 2012). Nevertheless, there is a widespread belief among lawmakers and members of the public that animal models cannot be abandoned until “alternatives” have been developed. The logic behind this belief is specious. To demonstrate this, we offer the following thought experiment. Imagine if regulators were to choose which drugs to endorse for human use based on a simple coin flip (e.g., heads, we allow humans to use a given drug; tails, we do not). Such an approach would do nothing to ensure the safety or efficacy of drugs reaching the market. This is because

coin flips do not have predictive value for determining human responses to drugs. Consequently, it would make no sense to continue using coin flips to choose drugs until an alternative to coin flips could be identified. Likewise, animal models do not have predictive value in determining human responses to drugs, and their use must be halted independent of whether an alternative exists.

4. Animal-based research lacks predictive value for human responses to drugs and diseases, and, thus, it is reckless to continue to justify the use of animal models with myths about protecting humans in clinical trials or learning about human disease. Abundant theoretical and empirical evidence has established unequivocally that the animal model does not have predictive value for humans and indeed cannot. Thus, the only scientifically valid conclusion is to stop attempting to use animal models to predict outcomes for humans. See Kramer and Greek (2018) for an extensive discussion of the many ways various groups of human stakeholders, including but not limited to patients, are directly harmed by the continued use of animal models.

While the vested interests we described earlier have served as an obstacle to acceptance of the fact that animal models do not have predictive value for human responses, the truth has, nevertheless, been acknowledged in the scientific literature, on occasion. For example, Markou, Chiamulera, Geyer, Tricklebank (of Eli Lilly) and Steckler (of Johnson and Johnson) state: “Despite great advances in basic neuroscience knowledge, the improved understanding of brain functioning has not yet led to the introduction of truly novel pharmacological approaches to the treatment of central nervous system (CNS) disorders. This situation has been partly attributed to the difficulty of predicting efficacy in patients based on results from preclinical studies [mainly animal studies, although *in vitro* would also be included in preclinical studies] [...] Few would dispute the need to move away from the concept of modeling CNS diseases in their entirety using animals” (Markou et al., 2009, p. 74). Additional examples include: Alini et al. (2008); Arrowsmith (2011a, b); Begley (2003a, b); Butler (2008); Contopoulos-Ioannidis, Ntzani and Ioannidis (2003); Crowley (2003); Dragunow (2008); Editorial (2010, 2012); Ferdowsian and Beck (2011); Geerts (2009); Grant, Green and Mason (2003); Hackam and Redelmeier (2006); Hampton (2006); Höerig and Pullman (2004); Holmes, Solari and Holgate (2011); Hurko and Ryan (2005); Ioannidis (2004); Jin and Wang (2003); Johnston (2006); Kaste (2005); Langley (2014); Ledford (2008, 2012); Leslie (2010); Liebman (2005); Lindl, Voelkel and Kolar (2005); Mankoff et al. (2004); Marincola (2003); Markou et al. (2009); Mullane and Williams (2012); Pammolli, Magazzini and Riccaboni (2011); Philips (2004); Pound et al. (2004); Pound and Bracken

(2014); Reynolds (2012); Rosenberg (2003); Rothwell (2006); Sena et al. (2007); Smith (1987); van der Worp et al. (2010); Xiong, Mahmood and Chopp (2013); and Zerhouni (2005).

Further evidence that animal models are extremely limited in what they can inform, regarding druggable targets and future cures, comes from a comment in the *American Journal of Medicine* about Contopoulos-Ioannidis et al.'s (2003) article:

The article by Contopoulos-Ioannidis et al. in this issue of the *Journal* addresses a much-discussed but rarely quantified issue: the frequency with which basic research findings translate into clinical utility. The authors performed an algorithmic computer search of all articles published in six leading basic science journals (*Nature*, *Cell*, *Science*, the *Journal of Biological Chemistry*, the *Journal of Clinical Investigation*, the *Journal Experimental Medicine*) from 1979 to 1983. Of the 25,000 articles searched, about 500 (2%) contained some potential claim to future applicability in humans, about 100 (0.4%) resulted in a clinical trial, and, according to the authors, only 1 (0.004%) led to the development of a clinically useful class of drugs (angiotensin-converting enzyme inhibitors) in the 30 years following their publication of the basic science finding. They also found that the presence of industrial support increased the likelihood of translating a basic finding into a clinical trial by eightfold.[...] Still, regardless of the study's limitations, and even if the authors were to underestimate the frequency of successful translation into clinical use by 10-fold, their findings strongly suggest that, as most observers suspected, the transfer rate of basic research into clinical use is very low.

CROWLEY, 2003, p. 503

Note that of the 101 articles that formed the primary focus of Crowley's study, about 64% were animal studies. An Editorial (2010, p. 499) in *Nature* supports the above position:

The readers of *Nature* should be an optimistic bunch. Every week we publish encouraging dispatches from the continuing war against disease and ill health. Genetic pathways are unravelled, promising drug targets are identified and sickly animal models are brought back to rude health. Yet the number of human diseases that can be efficiently treated remains low—a concerning impotency given the looming health burden of the developed world's ageing population. The uncomfortable truth is that scientists and clinicians have been unable to convert basic biology advances

into therapies or resolve why these conversion attempts so often don't succeed. Together, these failures are hampering clinical research at a time when it should be expanding.

Given the vast amount of money that funds animal-based research and testing, the many hours of human effort that are devoted to these pursuits, and the reliance of all humans whose well-being relies on scientific knowledge for maintaining health and treating disease, there is an urgent need for unbiased, expert scientists to assess the predictive value of animal models. We propose a debate for this purpose, and we now turn to outlining the parameters for ensuring such a debate is sound.

4 How to Evaluate Scientific Arguments

Science is a process of observing the material universe, possibly conducting experiments related to those observations, and ultimately ascertaining facts. According to E.O. Wilson (1999, p. 58): “Science [...] is the *organized, systematic enterprise that gathers knowledge about the world and condenses the knowledge into testable laws and principles.*” Often, time will determine whether a given scientist's conclusions are representative of the material universe. But in the interim, the best method for separating fact from fiction involves the peer-review process. The peer-review process uses experts in specific areas of science to evaluate the work of others and to determine whether the research and conclusions of that research are reliable enough to be published in a science journal for dissemination to a broad readership.

The peer-review process of scientific journals works as follows. A number of experts are asked to review a submission to the journal and determine (among other factors):

- whether the submission is in accordance with known facts about our current scientific understanding
- whether the terms and assumptions are consistent with proper usage
- whether the methodology is appropriate
- whether the statistics were correctly calculated
- whether or not there are flaws in the authors' reasoning
- whether the findings are likely to be of interest to the scientific community, policy makers, and/or the general public.

This process is not foolproof, but under the appropriate circumstances, it is usually capable of separating potential facts from sheer nonsense. Depending on the contents of the submission, experts from several different areas of science may be asked to review the submission and judge the part of the

submission that falls under his or her area of expertise. We propose that something akin to this peer-review process should be employed in order to evaluate the scientific viability of using one species to predict response for another in the context of developing drugs and treating diseases.

The peer-review process has been used repeatedly to resolve disputes in many scientific settings, for instance at conferences where select scholars presented evidence for and against a particular position in front of an audience of other experts in the field. A consensus is sought, if not in terms of who is right, at least in terms of which statements can be taken as fact and which must still be taken as conjecture. However, many controversies in science have, instead, been left to simply play out on their own without interference in the form of peer review. Some of these events have had lethal consequences. For example, in 1847, Ignaz Semmelweis introduced the idea that the unwashed hands of medical students and physicians spread the disease known as puerperal fever, an infection related to child bearing. Despite the fact that his patients demonstrated a reduced mortality rate after he and his students began washing their hands, his colleagues ostracized him, and his idea died along with many more patients. Had experts been convened to study and debate the evidence, antiseptic techniques would have been developed much sooner and many mothers' lives would have been saved (Ataman, Vatanoglu-Lutz, and Yildirim, 2013). Other prominent examples of scientific breakthroughs being ignored include the following: Barbara McClintock's idea of jumping genes, transposons, was ignored by a mostly male establishment in biology. McClintock could not even find a publisher for her research. Darwin's theory of evolution was almost forgotten in the early twentieth century. Alfred Wegener's idea of continental drift was ignored because he did not propose a mechanism for the notion.

Science has also allowed nonsense to go unchallenged until someone publicly proved the status quo wrong or, occasionally, until disaster occurred. Some cases persisted simply because no one exhibited the courage to disrupt the status quo; unfortunately, history is full of such examples. The *Columbia* disaster of 2003 occurred because the craft was allowed to launch despite engineers knowing there were problems with the tiles (Langewiesche, 2003). Similarly, the space shuttle *Challenger* disaster of 1986 was caused by engineers ignoring a problem with the O-rings. Descartes' unsubstantiated assertions convinced society that non-human animals were not sentient, and some members of society are still clinging to that position. Smoking was defended by some physicians for years because they were employed by the tobacco industry (Jackler, 2015). Scientific consensus can also be wrong. For instance, Earth contraction theory was wrong and was eventually replaced by Wegener's movement of continents and eventually plate tectonics. Newton was shown to be partially wrong by Einstein's theory of relativity. Some of Einstein's objections

to quantum mechanics turned out to be wrong. The notion that ulcers were relieved by decreasing anxiety and drinking milk was abandoned after Marshall proved that ulcers were the result of an infectious disease, and research revealed that milk actually stimulated acid production in the stomach. Peer-review, debate, and the convening of experts at conferences, all played a role in ensuring that obsolete scientific views were replaced by positions rooted in modern knowledge.

Science has historically advanced slowly and by consensus, which is why Planck (1949, pp. 33–34) stated: “A new scientific truth does not triumph by convincing its opponents and making them see the light, but rather because its opponents eventually die, and a new generation grows up that is familiar with it.” Reaching consensus slowly and methodically can have its advantages in certain contexts; but when lives are at stake, as was the case with Semmelweis and is the case with using animal models to predict human outcomes, a slow pace is not acceptable. The debate we propose can help expedite the formal evaluation of conflicting views and is especially appropriate for facilitating discussions about complex topics with foundations that span multiple disciplines.

5 Peer-reviewed Debate

We propose to borrow elements of the process used in peer-reviewed science journals and implement them in a debate format to evaluate the scientific issues surrounding the use of animal models, specifically, to resolve whether non-human animals have a high predictive value in terms of modeling human response to drugs and diseases. The scientific literature contains an abundance of articles that ought to convince a scientifically-minded reader that animal models do not have predictive value for human response to drugs and diseases; a small sampling includes, Arrowsmith (2011a, b); Crowley (2003); Greek (2012, 2016); Greek and Greek (2010); Greek and Hansen (2012, 2013a); Greek, Hansen and Menache (2011a); Greek and Menache (2013); Greek, Menache and Rice (2012b); Greek and Rice (2012); Greek, Shanks and Rice (2011b); Hurko and Ryan (2005); Jones and Greek (2013); Marincola (2003); Mullane and Williams (2012); Shanks and Greek (2008, 2009); and Shanks, Greek and Greek (2009). We propose the debate as a supplement to the existing literature, not only to help promote scientific consensus but also to reach a much broader audience of interested parties, including members of the general public.

A formal debate, sponsored by a government or major science organization and with implications for future funding and legislation, would compel the animal model community to participate and address the problems with

animal modeling. Engaging in less formal debates, including traditional oral debates organized by university departments or student groups (as we have done frequently; see Sandgren and Greek, 2007; Skolnick and Greek, 2005), has far less scope for effecting a change in consensus views about animal modeling. The reasons for this are many, including the fact that layperson members of the audience typically do not understand the science (and there are typically no expert judges present to help the audience evaluate the debaters' positions); if there are judges present, their expertise may not span all the areas of science that are pertinent to a full and careful evaluation of animal modeling; and time and format constraints prevent the debaters from going into sufficient detail to substantiate their cases. We propose a formal debate that would address these issues, permitting a fair evaluation of both sides of the debate. We recommend the following rules for the debate:

1. The subject of the debate will be the position that animal models have insufficient predictive value for human response to perturbations that occur at higher levels of organization (e.g., human response to drugs and diseases) and the implication that the vast majority of animal use in science, in general, and research and testing, in particular, should cease.
2. Each side of the debate will be represented by a single individual who is recognized as an expert by the public and the scientific community. That individual may, in turn, consult any number of experts for input and guidance.
3. A single person or a group of not more than three people will be appointed as moderator(s) of the debate.
4. A panel of scientists who are experts in the relevant fields will act as judges and will evaluate the positions put forward by the debaters. These panel members may come from academia or industry and must be recognized as experts by the public and the scientific community. In all, 12–20 scientists will be selected to serve on the expert panel, and their collective expertise will span and encompasses the following fields:
 - a. clinical medicine, in general, as well as infectious diseases, cancer, heart diseases, and neurology
 - b. statistics
 - c. evolutionary biology, including evolutionary and developmental biology
 - d. clinical research
 - e. drug development
 - f. personalized medicine
 - g. basic research

- h. complexity theory (expert(s) should come from the math or physics department of a university)
 - i. critical thinking, the history of the science behind medical discoveries, and philosophy of science, in general (expert(s) should have extensive training and credentials in science as well as the stated areas).
5. The judges and moderator(s) must have no vested interests in the outcome of the debate, including any of the following:
 - a. a direct financial interest in the outcome of the debate, such as currently receiving money for conducting or facilitating animal-based research
 - b. a significant indirect financial interest that arises from animal-based research or testing
 - c. an indirect vested interest, such as having, at least in-part, made one's reputation through having conducted research using non-human animals
 - d. an indirect financial interest in the form of having a first-degree relative or spouse who currently receives or formerly received funding for animal-based research or testing
 - e. a philosophical or emotional interest in the use of non-human animals in research and testing, such as well-known figures from the animal protection movement or pro-vivisection/pro animal-use movement.
6. The debate itself will consist of the following steps:
 - a. The debaters, panel members, and moderators will agree on a set of panel members, textbooks, or position papers that specify basic principles of science and critical thinking. Any disagreements will be settled by the expert in the relevant area prior to the proceeding with next steps and will be disclosed by the moderator(s) in the last step of the debate. This will encourage all parties to play fairly, as the communications will be a matter of record.
 - b. Each of the debaters will submit a written position paper.
 - c. If the judges have questions or comments about the position papers, they will compile them and submit them to the appropriate debater(s).
 - d. Each debater will have the option to respond in writing to the set of judges' questions/comments.
 - e. The judges will render their judgement after evaluating the position papers and (if appropriate) responses. The judges' evaluations must be based on the validity of each side's position, as stated in the position paper and responses to questions, and each side's adherence to the rules of engagement. In evaluating this set of information, each judge must verify (based on their respective area of expertise) whether

the provided evidence supports the debaters' claims and whether the arguments and reasoning in the position papers are sound and valid.

- f. The judges will compile a list of claims made in each side's position paper which were rejected by the judges as false or unsubstantiated, as well as instances in each position paper which were deemed by the judges to be inconsistent with the agreed-upon principles of critical thinking and science. Advance knowledge that these disclosures will occur, will encourage all parties to play fairly, because all of their statements will be a matter of record.
- g. The full proceedings, including the names of all participants, the position papers, the judges' questions and comments, the debater's responses, the judges' final decision, and the disclosures described above will all be published in a scholarly outlet, such as an open-access journal.

6 Conclusion

Science has evolved since the time when animal modelers first began using non-human animals in earnest in the nineteenth century. But never have experts convened to formally examine the evidence for and against the continued use of non-human animals. The debate we propose for this purpose, conducted in public and judged by unbiased experts, is long overdue. There is no argument in modern society about whether scientists should receive funding to develop a perpetual motion machine; this is because science has established that such a device cannot exist. Analogously, society's continued investment in animal modeling can and should be evaluated based on its scientific merit. Given the fact that governments and businesses devote scarce resources and vast sums of money to the enterprise of using animal models to predict human responses to drugs and diseases, and the fact that human lives are at stake, there is an urgent need to evaluate whether science supports the continuation of this practice. The debate we propose would serve as a significant step forward to that end.

References

- Alini, M., S.M. Eisenstein, K. Ito, C. Little, A.A. Kettler, K. Masuda, J. Melrose, J. Ralphs, I. Stokes and H.J. Wilke (2008). Are Animal Models Useful for Studying Human Disc Disorders/Degeneration?. *European Spine Journal*, 17(2), p. 19.

- Arrowsmith, J. (2011a). Trial Watch: Phase II Failures: 2008–2010. *Nature Reviews: Drug Discovery*, 10, pp. 328–329.
- Arrowsmith, J. (2011b). Trial Watch: Phase III and Submission Failures: 2008–2010. *Nature Reviews: Drug Discovery*, 10, pp. 87–87.
- Ataman, A.D., E.E. Vatanoglu-Lutz and G. Yildirim (2013). Medicine in Stamps-Ignaz Semmelweis and Puerperal Fever. *Journal of the Turkish German Gynecological Association*, 14, pp. 35–39.
- Begley, S. (2003a). Financial Obstacles Help Keep Doctors from Patient Research. *Wall Street Journal*, [online]. Available at: <http://www.wsj.com/articles/SB105182889655321300> [Accessed 1 February 2018].
- Begley, S. (2003b). Physician-researchers Needed to Get Cures Out of Rat's Cage. *Wall Street Journal*, [online]. Available at: <http://www.wsj.com/articles/SB105121836549788500> [Accessed 1 February 2018].
- Butler, D. (2008) Translational Research: Crossing the Valley of Death. *Nature*, 453 (7197), pp. 840–842.
- Contopoulos-Ioannidis, D.G., E. Ntzani and J.P. Ioannidis (2003). Translation of Highly Promising Basic Science Research into Clinical Applications. *American Journal of Medicine*, 114(6), pp. 477–484.
- Crowley, W.F., Jr. (2003). Translation of Basic Research into Useful Treatments: How Often Does It Occur? *American Journal of Medicine*, 114(6), pp. 503–505.
- Dragunow, M. (2008). The Adult Human Brain in Preclinical Drug Development. *Nature Reviews: Drug Discovery*, 7, pp. 659–666.
- Editorial. (2010). Hope in Translation. *Nature*, 467 (7315), p. 499.
- Editorial. (2012). Must Try Harder. *Nature*, 483, p. 509.
- Ennever, F.K., T.J. Noonan and H.S. Rosenkranz (1987). The Predictivity of Animal Bioassays and Short-Term Genotoxicity Tests for Carcinogenicity and Non-Carcinogenicity to Humans. *Mutagenesis*, 2(2), pp. 73–78.
- Ferdowsian, H.R. and N. Beck (2011). Ethical and Scientific Considerations Regarding Animal Testing and Research. *PLoS One*, 6(9), e24059.
- Fletcher, A.P. (1978). Drug Safety Tests and Subsequent Clinical Experience. *Journal of the Royal Society of Medicine*, 71(9), pp. 693–696.
- Fomchenko, E.I. and E.C. Holland (2006). Mouse Models of Brain Tumors and Their Applications in Preclinical Trials. *Clinical Cancer Research*, 12 (18), pp. 5288–5297.
- Food and Drug Administration (2004). *Innovation or Stagnation? Challenge and Opportunity on the Critical Path to New Medical Products*. US Department of Health and Human Services, Food and Drug Administration, pp. 1–32. [online] Available at: <http://www.who.int/intellectualproperty/documents/en/FDAproposals.pdf> [Accessed 16 July 2018].
- Franco, N.H. (2013). Animal Experiments in Biomedical Research: A Historical Perspective. *Animals*, 3(1), pp. 238–273.

- Gad, S. (2007). Preface. In: S. Gad, ed., *Animal Models in Toxicology*. Boca Raton: CRC Press, pp. 1–18.
- Geerts, H. (2009). Of Mice and Men: Bridging the Translational Disconnect in CNS Drug Discovery. *CNS Drugs*, 23 (11), pp. 915–926.
- Giles, J. (2006). Animal experiments under fire for poor design. *Nature*, 444, p. 981.
- Grant, J., L. Green and B. Mason (2003). *From Bedside to Bench: Comroe and Dripps Revisited*. HERG Research Report, No. 30. Middlesex: Brunel University.
- Greek, R. (2012). Animal Models and the Development of an HIV Vaccine. *Journal of AIDS and Clinical Research*, S8, pp. 1–11.
- Greek, R. (2014). The Ethical Implications for Humans in light of the Poor Predictive Value of Animal Models. *International Journal of Clinical Medicine*, 5(16), pp. 966–1005.
- Greek, R. (2016). Comment on “Lessons from Toxicology: Developing a 21st-century Paradigm for Medical Research”. *Environmental Health Perspectives*, 124(5), p. A84.
- Greek, R. and J. Greek (2010). Is the Use of Sentient Animals in Basic Research Justifiable? *Philosophy, Ethics, and Humanities in Medicine*, 5(14), pp. 1–16.
- Greek, R. and L.A. Hansen (2012). The Development of Deep Brain Stimulation for Movement Disorders. *Journal of Clinical Research and Bioethics*, 3(3), pp. 1–21.
- Greek, R. and L.A. Hansen (2013a). Questions Regarding the Predictive Value of one Evolved Complex Adaptive System for A Second: Exemplified by the SOD1 Mouse. *Progress in Biophysics and Molecular Biology*, 113(2), pp. 231–153.
- Greek, R. and L.A. Hansen (2013b). The Strengths and Limits of Animal Models as Illustrated by the Discovery and Development of Antibacterials. *Biological Systems: Open Access*, 2(2) pp. 1–15.
- Greek, R. and L.A. Kramer (2019). The scientific problems with using non-human animals to predict human response to drugs and disease. In: In: K. Herrmann and K. Jayne, eds., *Animal Experimentation: Working Towards a Paradigm Change*, Vol. 22. Brill Human Animal Studies Series, pp. 391–416. Leiden: Brill.
- Greek, R. and A. Menache (2013). Systematic Reviews of Animal Models: Methodology Versus Epistemology. *International Journal of Medical Sciences*, 10(3), pp. 206–221.
- Greek, R. and M.J. Rice (2012). Animal Models and Conserved Processes. *Theoretical Biology and Medical Modelling*, 9(40), pp. 1–33.
- Greek, R. and N. Shanks (2009). *FAQs about the use of animals in science: A handbook for the scientifically perplexed*. Lanham: University Press of America.
- Greek, R., L.A. Hansen and A. Menache (2011a). An Analysis of the Bateson Review of Research Using Nonhuman Primates. *Medicolegal and Bioethics*, 1, pp. 3–22.
- Greek, R., A. Menache and M.J. Rice (2012a). Animal Models in an Age of Personalized Medicine. *Personalized Medicine*, 9(1), pp. 47–64.
- Greek, R., A. Pippus and L.A. Hansen (2012b). The Nuremberg Code Subverts Human Health and Safety by Requiring Animal Modeling. *BMC Medical Ethics*, 13 (16), pp. 1–17.

- Greek, R., N. Shanks and M.J. Rice (2011b). The History and Implications of Testing Thalidomide on Animals. *The Journal of Philosophy, Science & Law*, 11(3), pp. 1–32.
- Hackam, D.G. and D.A. Redelmeier (2006). Translation of Research Evidence from Animals to Humans. *Journal of the American Medical Association*, 296 (14), pp. 1731–1732.
- Hampton, T. (2006). Targeted Cancer Therapies Lagging. *Journal of the American Medical Association*, 296 (16), pp. 1951–1952.
- Hau, J. (2003). Animal models. In: J. Hau and G.K. van Hoosier Jr., eds. *Handbook of Laboratory Animal Science*, 2nd ed. Boca Raton: CRC Press, pp. 1–9.
- Holmes, A.M., R. Solari and S.T. Holgate (2011). Animal Models of Asthma: Value, Limitations and Opportunities for Alternative Approaches. *Drug Discovery Today*, 16 (15–16), pp. 659–670.
- Hörig, H. and W. Pullman (2004). From Bench to Clinic and Back: Perspective on the 1st IQPC Translational Research Conference. *Journal of Translational Medicine*, 2(44), pp. 1–8.
- Hurko, O. and J.L. Ryan (2005). Translational Research in Central Nervous System Drug Discovery. *NeuroRx*, 2(4), pp. 671–682.
- Ioannidis, J.P. (2004). Materializing Research Promises: Opportunities, Priorities and Conflicts in Translational Medicine. *Journal of Translational Medicine*, 2(1), p. 5.
- Jackler, R.K. (2015). Testimony by Otolaryngologists in Defense of Tobacco Companies 2009–2014. *The Laryngoscope*, 125 (12), pp. 2722–2729.
- Jin, P. and E. Wang (2003). Polymorphism in Clinical Immunology—From HLA Typing to Immunogenetic Profiling. *Journal of Translational Medicine*, 1(1), p. 8.
- Johnson, J.I., S. Decker, D. Zaharevitz, L.V. Rubinstein, J.M. Venditti, S. Schepartz, S. Kalyandrug, M. Christian, S. Arbuch, M. Hollingshead and E.A. Sausville (2001). Relationships Between Drug Activity in NCI Preclinical *In Vitro* and *In Vivo* Models and Early Clinical Trials. *British Journal of Cancer*, 84 (10), pp. 1424–1431.
- Johnston, S.C. (2006). Translation: Case Study in Failure. *Annals of Neurology*, 59(3), pp. 447–448.
- Jones, R.C. and R. Greek (2013). A Review of the Institute of Medicine’s Analysis of Using Chimpanzees in Biomedical Research. *Science and Engineering Ethics*, 20(2), pp. 481–504.
- Kaste, M. (2005). Use of Animal Models Has Not Contributed to Development of Acute Stroke Therapies: Pro. *Stroke*, 36 (10), pp. 2323–2324.
- Kola, I. and J. Landis (2004). Can the Pharmaceutical Industry Reduce Attrition Rates? *Nature Reviews Drug Discovery*, 3(8), pp. 711–715.
- Kramer, L.A. and R. Greek (2018). Human Stakeholders and the Use of Animals in Drug Development. *Business and Society Review*, 123(1), pp. 3–58.
- Kummar, S., R. Kinders, L. Rubinstein, R.E. Parchment, A.J. Murgo, J. Collins, O. Pickerai, J. Low, S.M. Steinberg, M. Gutierrez, S. Yang, L. Helman, R. Wilttrout, J.E. Tomaszewski

- and J.H. Doroshow (2007). Compressing Drug Development Timelines in Oncology Using Phase 'o' Trials. *Nature Reviews Cancer*, 7(2), pp. 131–139.
- LaFollette, H. and N. Shanks (1996). *Brute science: Dilemmas of animal experimentation*. London: Routledge.
- LaFollette, H. and N. Shanks (1998). Claude Bernard: The founder of the paradigm. In: M. Bekoff, ed., *The Encyclopedia of Animal Rights*. Westport, CT: Greenwood Publishing, pp. 91–92.
- Langewiesche, W. (2003). Columbia's Last Flight. *The Atlantic Monthly*, pp. 58–88.
- Langley, G.R. (2014). Considering a New Paradigm for Alzheimer's Disease Research. *Drug Discovery Today*, 19(8), pp. 1114–1124.
- Ledford, H. (2008). Translational Research: The Full Cycle. *Nature*, 453 (7197), pp. 843–845.
- Ledford, H. (2012). Drug Candidates Derailed in Case of Mistaken Identity. *Nature*, 483 (7391), p. 519.
- Leslie, M. (2010). Biomedical Research. Immunology Uncaged. *Science*, 327 (5973), p. 1573.
- Liebman, M.N. (2005). An Engineering Approach to Translation Medicine. Physician-Scientists May Benefit from an Approach That Emphasizes Solving Problems Over Generating Hypotheses. *American Scientist*, 93(4), p. 296.
- Lindl, T., M. Voelkel and R. Kolar (2005). Animal Experiments in Biomedical Research. An Evaluation of the Clinical Relevance of Approved Animal Experimental Projects. *Alternatives to Animal Experimentation*, 22(3), pp. 143–151.
- Lumley, C. (1990). Clinical toxicity: Could it have been predicted? Premarketing experience. In: C. Lumley and S. Walker, eds., *Animal Toxicity Studies: Their Relevance for Man*. London: Quay, pp. 49–56.
- Mankoff, S.P., C. Brander, S. Ferrone and F.M. Marincola (2004). Lost in Translation: Obstacles to Translational Medicine. *Journal of Translational Medicine*, 2(1), p. 14.
- Marincola, F.M. (2003). Translational Medicine: A Two-way Road. *Journal of Translational Medicine*, 1(1), p. 1.
- Markou, A., C. Chiamulera, M.A. Geyer, M. Tricklebank and T. Steckler (2009). Removing Obstacles in Neuroscience Drug Discovery: The Future Path for Animal Models. *Neuropsychopharmacology*, 34(1), pp. 74–89.
- Monastersky, R. (2008). Protesters Fail to Slow Animal Research. *The Chronicle of Higher Education* [online]. Available at: <http://chronicle.com/weekly/v54/i32/32a00102.htm> [Accessed 27 April 2017].
- Morgan, P., P.H.V.D. Graaf, J. Arrowsmith, D.E. Feltner, K.S. Drummond, C.D. Wegner and S.D. Street (2012). Can the Flow of Medicines Be Improved? Fundamental Pharmacokinetic and Pharmacological Principles Toward Improving Phase II Survival. *Drug Discovery Today*, 17 (9–10), pp. 419–424.

- Mullane, K. and M. Williams (2012). Translational Semantics and Infrastructure: Another Search for the Emperor's New Clothes?. *Drug Discovery Today*, 17 (9–10), pp. 459–468.
- National Academies of Sciences Engineering Medicine. (2017). *Is Evolution a Theory or a Fact?* [online] Available at: <http://www.nas.edu/evolution/TheoryOrFact.html> [Accessed 27 April 2017].
- Nature (2011). *Nature Research Journals Competing Interests Policy*. [online] Available at: <http://www.nature.com/authors/policies/competing.html> [Accessed 1 February 2018].
- Osborne, N., Avey, M.T., Anestidou, L., Ritskes-Hoitinga, M. and Griffin, G. (2018). Improving animal research reporting standards: HARRP, the first step of a unified approach by ICLAS to improve animal research reporting standards worldwide. *EMBO Reports*, 19(5), p. e46069. [online] Available at: <http://embor.embopress.org/content/embor/19/5/e46069>. [Accessed 20 April 2018].
- Pammolli, F., L. Magazzini and M. Riccaboni (2011). The Productivity Crisis in Pharmaceutical R&D. *Nature Reviews: Drug Discovery*, 10(6), 428–438.
- Philips, H. (2004). The Insider—Focus on Neuroscience. Brainstorming. *New Scientist*, 184 (2469), p. 54.
- Planck, M. (1949). *Scientific autobiography and other papers*. New York: Philosophical Library.
- Pound, P. and M.B. Bracken (2014). Is Animal Research Sufficiently Evidence Based To Be a Cornerstone of Biomedical Research?. *British Medical Journal*, 348 (g3387), pp. 1–3.
- Pound, P., S. Ebrahim, P. Sandercock, M.B. Bracken and I. Roberts (2004). Where Is the Evidence That Animal Research Benefits Humans? *British Medical Journal*, 328, pp. 514–517.
- Raza, A. (2015). Mouse models. In: J. Brockman, ed., *This Idea Must Die: Scientific Theories That Are Blocking Progress*. New York: Edge Foundation, pp. 231–333.
- Reynolds, P.S. (2012). Twenty Years After: Do Animal Trials Inform Clinical Resuscitation Research?. *Resuscitation*, 83(1), pp. 16–17.
- Rosenberg, R.N. (2003). Translating Biomedical Research to the Bedside: A National Crisis and a Call to Action. *Journal of the American Medical Association*, 289 (10), pp. 1305–1306.
- Rothwell, P.M. (2006). Funding for Practice-oriented Clinical Research. *Lancet*, 368 (9532), pp. 262–266.
- Sandgren, E. and R. Greek (2007). *Debate: Ray Greek vs. Eric Sandgren. Are Animal Models Predictive for Humans?* Goleta: Americans for Medical Advancement. [online] Available at: <https://www.afma-curedisease.org/media/27010/GREEKVsandgren.pdf> [Accessed 27 April 2017].

- Sena, E., H.B. van der Worp, D. Howells and M. Macleod (2007). How Can We Improve the Preclinical Development of Drugs for Stroke? *Trends in Neurosciences*, 30(9), pp. 433–439.
- Seok, J., H.S. Warren, A.G. Cuenca, M.N. Mindrinos, H.V. Baker, W. Xu, D.R. Richards, G.P. McDonald-Smith, H. Gao, L. Hennessy, C.C. Finnerty, C.M. López, S. Honari, E.E. Moore, J.P. Minei, J. Cuschieri, P.E. Bankey, J.L. Johnson, J. Sperry, A.B. Nathens, T.R. Billiar, M.A. West, M.G. Jeschke, M.B. Klein, R.L. Gamelli, N.S. Gibran, B.H. Brownstein, C. Miller-Graziano, S.E. Calvano, P.H. Mason, J.P. Cobb, L.G. Rahme, S.F. Lowry, R.V. Maier, L.L. Moldawer, D.N. Herndon, R.W. Davis, W. Xiao and R.G. Tompkins (2013). Genomic Responses in Mouse Models Poorly Mimic Human Inflammatory Diseases. *Proceedings of the National Academy of Sciences of the United States of America*, 110(9), pp. 3507–3512.
- Shanks, N. and R. Greek (2008). Experimental Use of Nonhuman Primates Is Not a Simple Problem. *Nature Medicine*, 14 (10), p. 1011.
- Shanks, N. and R. Greek (2009). *Animal models in light of evolution*. Boca Raton: Brown Walker.
- Shanks, N., R. Greek and J. Greek (2009). Are Animal Models Predictive for Humans? *Philosophy, Ethics, and the Humanities in Medicine*, 4(1), pp. 1–20.
- Skolnick, A. and R. Greek (2005). *Debate: Ray Greek vs. Andrew Skolnick*. Goleta: Americans for Medical Advancement. [online] Available at: <http://www.afma-curedisease.org/images/debate%20transcript.pdf> [Accessed 27 April 2017].
- Smith, R. (1987). Comroe and Dripps Revisited. *British Medical Journal (Clinical Research Edition)*, 295 (6610), pp. 1404–1407.
- van der Worp, H.B., D.W. Howells, E.S. Sena, M.J. Porritt and S. Rewell (2010). Can Animal Models of Disease Reliably Inform Human Studies?. *PLoS Medicine*, 7(3), p. e1000245.
- van Meer, P.J.K., M. Kooijman, C.C. Gispen-de Wied, E.H.M. Moors and H. Schellekens (2012). The Ability of Animal Studies to Detect Serious Post Marketing Adverse Events Is Limited. *Regulatory Toxicology and Pharmacology*, 64(3), pp. 345–349.
- Wilson, E.O. (1999). *Consilience: The unity of knowledge*. New York: Vintage.
- Xiong, Y., A. Mahmood and M. Chopp (2013). Animal Models of Traumatic Brain Injury. *Nature Reviews Neuroscience*, 14(2), pp. 128–142.
- Zerhouni, E.A. (2005). Translational and Clinical Science—Time for a New Vision. *New England Journal of Medicine*, 353 (15), pp. 1621–1623.

How Can the Final Goal of Completely Replacing Animal Procedures Successfully Be Achieved?

Christiane Baumgartl-Simons

Deputy Chairwoman, Menschen für Tierrechte—Bundesverband der Tierversuchgegner e.V. (People for Animal Rights Germany—Federal Association against Vivisection)

baumgartl@tierrechte.de

Christiane Hohensee

Scientific Advisor, Menschen für Tierrechte—Bundesverband der Tierversuchgegner e.V. (People for Animal Rights Germany—Federal Association against Vivisection)

hohensee@tierrechte.de

Introduction

Article 23 of European Union (EU) Directive 86/609/EEC required that Member States promote the development and validation of alternative technologies and stated that the European Commission (EC) “shall report before the end of 1987 on the possibility of modifying tests and guidelines” (European Parliament, 1986, Article 23). This Directive was replaced by Directive 2010/63/EU on the protection of animals used for scientific purposes, which now requires that Member States develop and validate alternative approaches much more precisely and specifies that the ultimate objective is the “full replacement of procedures on live animals for scientific and educational purposes, as soon as it is scientifically possible to do so” (European Parliament, 2010, Recital 10). However, having followed the initiatives of Member States for more than 30 years, we see that developments to replace animal experiments occur more by accident than by design. Directive 2010/63/EU has not changed this either. This chapter explores the reasons why the development and approval of animal-free methods are not advancing more quickly, and why the numbers of animals used is not declining despite the development of new methods. Undoubtedly, there are complex, multifactorial reasons behind this. Our analysis leads us to the heart of the matter. There is no *master plan* and there are no responsible project managers who effectively pursue the objectives of Directive 2010/63/EU at a national or EU level.

In 2015, we started collating individual measures in order to tackle the problems we encounter in our day-to-day work as an animal rights organization, defining five categories (or pillars). We were encouraged to pursue our ideas by developments in the United States through concepts, such as *Toxicology in the 21st Century—A Vision and a Strategy (Tox21)* (Krewski et al., 2010), as well as by the EU ban on the marketing of cosmetics tested on animals, which came into force in 2013. During this time, the Netherlands National Committee for the protection of animals used for scientific purposes (NCad) presented its plan, *Transition to Non-Animal Research*, referred to here as the *NCad report* (NCad, 2016a), becoming the first EU member state to present a road map for phasing out animal procedures and stimulating innovation without laboratory animals. Unfortunately, no EU Member State, so far, has publicly spoken out in favor of the Dutch initiative. On the contrary, its timeline has been criticized as being unrealistic, risking the safety of medical treatment, and hampering basic research. Only the government of the Brussels-Capital Region has put forward a plan to phase out animal experiments along the lines of the NCad report. Member States should show more support for such initiatives, which aspire to achieve the goal of full replacement stated in Directive 2010/63/EU. At the EU level, unfortunately, there is neither an overall strategy for phasing out the use of animals for scientific purposes nor for monitoring the implementation of the paradigm shift. It is important that changes take place, but how they take place is subject to debate.

Writing from the point of view of a German animal rights organization, the main focus of this chapter is Germany. Although Germany claims to be especially committed to developing animal-free methods, it ranks among the highest in terms of animal experiments in the EU, together with France and the United Kingdom.

1 Part 1: How Seriously Do Member States Take the Tasks and Obligations Stated in Directive 2010/63/EU?

A master plan to end animal experiments requires suitable resources for effectively reducing animal experiments and increasing market-ready animal-free methods. In the following we discuss steps towards that final goal.

On 1 December 2016, the Netherlands became the first EU Member State to present a road map for “phasing out animal procedures and the promotion of innovation without laboratory animals” (NCad, 2016a, p. 3). They are convinced that some uses of animals—currently required by law for safety testing of chemicals, food additives, pesticides, and (veterinary) medicines as

well as the commercial launch of biological products (e.g., vaccines)—can be phased out by 2025, while maintaining existing safety levels. However, their road map recommends that regulatory pre-clinical tests for the registration of *new* biological substances/products not be phased out by 2025 because there is a lack of replacement methods. Similarly, animal experiments in the field of “curiosity-driven” (NCad, 2016a, p. 38) basic research is not to be terminated by 2025 because there is a basic right to freedom of research; and, as no one knows the subject of research in advance, animal experiments cannot be easily replaced with new animal-free methods. Therefore, it has been necessary to implement 10-year plans for each individual area of research. In the case of animal experiments in applied and translational research (implementation of preclinical research in clinical development), which are also not to be phased out by 2025, the development of replacement methods is to be accelerated. The aim is to reduce significantly the use of laboratory animals for education and training. The planning encompasses transition objectives, transition strategy, and management of the transition. There is every indication that the NCad report, commissioned by the former Minister for Agriculture, Martijn van Dam, has laid out solid project planning with the goal of effecting system change from animal use to animal-free procedures.

This type of planning should have been initiated at an EU-wide level in 2013 when Directive 2010/63/EU came into effect, requiring the phasing out of animal procedures and the acceleration of innovation without laboratory animals. While no Member State has publicly spoken out in favor of the Dutch initiative, the German research association, Deutsche Forschungsgemeinschaft (DFG) and the Allianz der Wissenschaftsorganisationen (Alliance of Science and Research Organizations) issued a critical assessment of the plan, calling its timeline unrealistic and claiming it would endanger the safety of medical treatment and hamper basic research (BfR, 2017a). According to our organization (People for Animal Rights Germany—Federal Association against Vivisection), a good master plan has the following attributes: it includes all stakeholders, including the scientific community, industry, and animal rights/welfare organizations; it has robust monitoring to assess the paradigm shift towards animal-free science; and it has an active commitment of all stakeholders to implement the plan. The master plan for an end to animal experiments requires suitable resources that purposefully pursue this end by reducing animal experiments and increasing market-ready animal-free methods.

The master plan’s foundation rests on five pillars:

1.1 *Pillar 1: Increased Research Funding for Animal-free Methods Is Necessary*

Here we refer to animal-free research in the field of applied and basic research. This research field includes methods that can replace animal testing in regulatory animal tests (in a narrow sense). The budget for animal-free research methods should be drastically increased, with the EU and its Member States implementing their own funding programs for replacement methods. Germany, for example, is not a suitable role model: at present, “system-changing” replacement methods compete with “system-maintaining” refinement and reduction methods, because the three options are funded by the same programs.

The EU needs to increase the budget for funding animal-free research. In the current funding period, only one program that is dedicated to replacement, EU-ToxRisk, is funded. This European collaborative project is funded by the EU Framework Program for Research and Innovation, Horizon 2020. The project started on January 1, 2016 and will last for six years. It currently has only €30 million at its disposal (EU-ToxRisk, 2016), with 39 participating groups. By comparison, during the last funding period, the EU Seventh Framework Program provided the project cluster, SEURAT-1, with €50 million in funding for work towards the replacement of *in vivo* systemic dose-toxicity testing (which ran until December 2016)—much more than the current funding.

Special funding programs are essential for creating ready-for-series technologies, i.e., mass production in large amounts with a lower product price; for example, the characteristics and viability of current cell systems must be improved to recreate the functions of the natural organ as accurately as possible; current organoid biotechnology needs to replicate the behavior of organs more closely; and the functions of the capillary system and immune system still need to be modeled.

National and European budgets, especially for validation studies, are also necessary and the EU Reference Laboratory for Alternatives to Animal Testing—European Centre for the Validation of Alternative Methods (EURL ECVAM) (EURL ECVAM, 2017a) should be provided with adequate resources. This demands a great deal of work. Validation and qualification of the new *in vitro* systems have been discussed in several workshops across the US. These workshops were hosted by the American Institute for Medical and Biological Engineering (AIMBE) and the National Institutes of Health (NIH) at the NIH campus in Bethesda, Maryland. Representatives of the EURL ECVAM and of some European start-ups also took part. The participants determined

the need for a broader definition of validation for the integration of new platform technologies into preclinical safety evaluation. The new *in vitro* systems, such as the chip technologies (cell and tissue platforms, microelectrode systems with connected measuring devices), biomarkers, and the quality of cell and tissue types derived from human stem cells were also seen as needing evaluation in terms of safety for preclinical applications and efficacy. The pharmaceutical industry, which is the primary customer of the new multi-organ on a chip systems, should also be more involved (AIMBE, 2013).

The EU Member States need to support the concept of Tox21, developed in the US (Krewski et al., 2010). The concept's goal is to provide a new basis for risk and safety assessments of substances and products (i.e., regulatory toxicology), using new techniques that are human-specific; and to promote the use of animal tests only in exceptional cases (see also the Integrated Approaches to Testing and Assessment adopted by the Organization for Economic Cooperation and Development, OECD, 2017). The OECD now includes 35 countries around the world, across North and South America, Europe, and Asia.

A research focus is also needed on the implementation of cell culture media ready for practical application and for which no animals suffer, i.e., without the use of fetal bovine serum (see Redmond, 2018, in this Volume). Researchers in the US have been able to work with serum-free media in a defined system since 1995 (Schaffner et al., 1995).

1.2 *Pillar 2: Animal-free Methods in Teaching and Scientific Research Have to Be Expanded*

The goal of Pillar 2 is to establish academic chairs—with corresponding personnel and financial resources for research and teaching and regular professorships—for animal-free research methods, courses of study in the life sciences that do not use animals, a broad range of papers not based on the use of animals, and an increased number of theses and higher qualifications, with a focus on animal-free methods.

In Germany, for example, individual chairs in some federal states or *Bundesländer* (Baden-Württemberg, Berlin, Hesse, and North Rhine-Westphalia) have been established to develop methods to replace animal use. Researchers are thus able to offer students a perspective to get closer to the topic and to prepare their theses with non-animal methods. However, there are still only a few chairs in some federal states. There is need for courses of study that address scientific questions using new animal-free methods. So far, students in life sciences courses, such as biology or human medicine, must, with few exceptions, participate in courses that use animals. Furthermore, where platforms

for alternatives to animal tests have been set up, the scientists involved usually investigate 3Rs methods (replacement, reduction, and refinement), which means that the scarce resources are spread across all three areas. Instead, the platforms' financial resources need to be exclusively available for replacement methods.

The situation is similar in other European Countries. There are a few national centers for alternatives to animal use, such as, the Finnish Centre for Alternative Methods, which teaches only animal-free replacement methods. In the private sector, Alvertox Academy (formerly the Center for Alternatives to Animal Testing Academy) offers training for young scientists in replacement methods. Others national centers, such as the Danish 3Rs-Center, the Swedish Toxicology Science Research Center, or the Romanian Center for Alternative Test Methods, were founded to implement the mission of Directive 2010/63/EU and teach not only the replacement of animal use but also reduction and refinement. The range of programs of study for animal-free methods (full replacement) should be expanded. It should be possible to choose courses of studies at European universities that will enable students to do research and develop methods without using animals.

1.3 *Pillar 3: Bans on Animal Testing Must Be Consolidated and Expanded*

Since its review in November 2017, Article 58 of Directive 2010/63/EU has barely led to sufficient improvements for laboratory animals. In the next review, the EC must take into account any progress made in the field of alternative methods that may lead to an end to the use of animals, in particular non-human primates. The first step should be to repeal Article 55 of Directive 2010/63/EU, which allows Member States to provide exceptions from the regulations protecting non-human primates (European Parliament, 2010); it also allows exceptions from Article 2, which stipulates that procedures not be performed on animals if they involve severe pain, suffering, or distress. Therefore, with the approval of the EC, Member States may, for example, use monkeys in experiments that involve severe pain, suffering, or distress.

Further bans should be introduced, including: a ban on patenting genetically altered animals; and a full ban on animal tests for household products and their components, including banning the sale of such goods (analogous to the existing provisions for cosmetic products) is essential.

Viable European and national competency centers should be established, with the following tasks: creating transparency for the public, monitoring adherence to EU animal welfare law, and setting up information offices for all stakeholders.

Closer cooperation/collaboration with scientists and agencies in the US, which is more advanced in technological development. The US regulatory authorities are also not hesitant to search for and accept new animal-free methods. Even pharmaceutical and chemical companies think that the EC should be more orientated towards American models, such as the Food and Drug Administration (FDA) and the Environmental Protection Agency (EPA) (Ettel, 2018). Another example is the new Interagency Coordinating Committee on the Validation of Alternative Methods plan (National Toxicology Program, 2018).

1.3.1 Suggestions for Implementing Existing EU Law

The EC Department, Directorate-General for Environment, should have a European competency center, for monitoring adherence to EU law and providing up-to-date information on pain, suffering/distress, and fear as well as on animal-free testing methods and other information relevant to this range of topics.

These additional tasks could also be integrated into existing structures, such as EURL ECVAM's EU Network of Laboratories for the Validation of Alternative Methods (EU-NETVAL), under the umbrella of the EC Directorate-General for Environment. So far, EU-NETVAL comprises laboratories in individual EU Member States that conduct validation studies and assess the reliability and relevance of new animal-free methods (EU-NETVAL, 2018). The European validation authority, EURL ECVAM, could also focus on transparency for the public, provide information offices for all stakeholders, and monitor adherence to EU animal welfare law. It is also vital that a negative list be introduced that will stand up in court, defining tests that may no longer be conducted for ethical reasons.

The establishment of national competency centers as central institutions for informing and educating all stakeholders involved is also necessary. At a national level, these tasks could be completed by the EU National Committees in the Member States. The national information structures established thus far, in accordance with Article 49 of Directive 2010/63/EU, have laid the foundation for such tasks.

The competency centers would be responsible for developing lists of criteria for assessing whether applications for animal experiments fulfill legal requirements, criteria that are lacking, thus far, but are necessary. This requires practicable assessment criteria for qualifying/quantifying the necessity, benefits, and ethical justifiability of the animal procedure as well as specifying the level of distress. The competency centers should also offer education schemes for all

stakeholders. To this end, it would be necessary to develop content and performance records. We recommend developing an education scheme for animal-free testing methods, analogous to the courses of the Federation for Laboratory Animal Science Associations (FELASA, n.d.).

Practical, user-friendly databases should be set up to allow reliable and uncomplicated referencing of animal-free methods.

The approving authorities and monitoring agencies in the Member States should be provided with adequate finances, expertise, and staff.

Steps must be taken to ensure that the Member States implement the requirements set out in Directive 2010/63/EU, without exception. In Germany, for example, although stipulated by Directive 2010/63/EU, the approving authorities currently do not have a comprehensive right for evaluation when assessing applications for animal procedures, due to a decision made by the Higher Administrative Court Bremen (Oberverwaltungsgericht Bremen, 2012). Directive 2010/63/EU stipulates that project evaluation should consist of six evaluation points (European Parliament, 2010, Article 38, Section 2, Subsections a–f). It should include an evaluation of the project objectives, the predicted scientific benefits or educational value, and the severity of the procedures, and a harm-benefit analysis of whether the suffering, pain, and distress inflicted on the animals is justified by the expected outcome, in light of ethical considerations and the ultimate benefit to human beings, animals, or the environment.

1.4 *Pillar 4: Success Monitoring of the Increase of Animal-free Methods and the Reduction of Animal Experiments Is of Particular Importance*

This pillar is especially important. It stands for the need for quality management, as it entails control measures that systematically document the progress of the paradigm shift. Unlike the other pillars, there are no approaches, as yet, to achieve this goal; they have to be established from the start. Definitive parameters should be determined for quantifying and qualifying the reduction of animal experiments and the increase in animal-free methods. A retrospective assessment for all animal tests conducted and the publication of their data crucial. Directive 2010/63/EU expressly provides for such a retrospective assessment (European Parliament, 2010, Article 39).

1.5 *Pillar 5: Complementary Measures Are Necessary*

Complementary measures comprise drastically shortening the time needed for assessing and approving animal-free research methods; researching animal experiment models in order to de-validate them; and introducing a class

action suit for animal welfare in the EU and its Member States, as well as providing adequate resources for law enforcement authorities.

Moving from the development of an animal-free method to its implementation in the regulatory framework, which would lead to a broader range of applications, has taken too long. Periods of 12 to 15 years, or even longer, have been a matter of course (Hartung, 2015). There is a lack of financial support for proof-of-concept studies as well as pre-validation and validation studies, so that developers spend a great deal of time seeking financial support. In addition, regulatory authorities become involved in this process at too late a stage (Hohensee and Brüning, 2016; Schöffl et al., 2000).

According to NCad and other researchers, there is a “growing focus on Synthesis of Evidence”, the experimental design and critical reviewing of existing animal models (Cronin, 2017, p. 39; NCad, 2016a; Varga et al., 2010). Just as the new animal-free methods must be validated, it is also necessary for animal testing to undergo systematic review.

Greater demand for national and international coordination of the promotion and acceleration of validation, regulatory acceptance, and implementation of animal-free methods (NCad, 2016a).

2 Part 2: How Has the Change of Course Been Pursued So Far—Nationally, in the EU, and Internationally?

Directive 63/2010/EU provides for a long-term withdrawal from all animal experiments. Nevertheless, for many researchers, the development of replacement methods has not been the priority it should be. It still has a niche existence. Although some research groups focus on replacement, research and budgets at both the national and European levels are too low and should be embedded in a higher-level context. Here, more efforts are necessary.

2.1 *Setting up Committees in Accordance with Directive 2010/63/EU*

With Directive 2010/63/EU, the EU and its Member States have set the long-term goal of ending animal experimentation and promoting the development of replacement methods for animal experiments. The Directive must be enacted in national law by all Member States. The amended German Animal Welfare Act (Tierschutzgesetz) took effect in July 2013, and the new Animal Welfare Laboratory Animal Regulation (Tierschutz-Versuchstierverordnung) took effect in August 2013. However, while opportunities for achieving a higher level of animal protection should have been put in place, they were forfeited. Although the necessary legal basis exists in primary law, a maximum limit for pain or suffering in animal experiments, and a ban on increasing animal experiments, by

eliminating the exemption clauses, were not enforced in German law (Peters and Stucki, 2012). Furthermore, the comprehensive right of project evaluation pursuant to Article 36 of Directive 2010/63/EU was not implemented and was, instead, replaced by a qualified plausibility check (Hildermann, 2015).

Article 49 of Directive 2010/63/EU states that all EU Member States must establish National Committees for the protection of animals used for scientific purposes (European Parliament, 2010). In Germany, this role is performed by the Federal Institute of Risk Assessment (BfR), which has established the German Centre for the Protection of Laboratory Animals (Bf3R), located at the BfR, as set out in the amendment of the German Animal Welfare Act that took effect on July 13, 2013 (BfR, 2017b). According to Paragraph 45 of the German Animal Welfare Laboratory Animal Regulation, the National Committee advises the competent authorities and animal welfare committees on matters regarding the acquisition, breeding, accommodation, or care of vertebrates and cephalopods (as defined in Paragraph 1, Section 1 of the Regulation); or the use of vertebrates and cephalopods in animal experiments. The National Committee also advises the competent authorities, in accordance with Paragraph 46 of the Regulation, on matters regarding alternatives to animal experiments (Bundesministerium für Justiz und Verbraucherschutz, 2017).

The German Centre for the Protection of Laboratory Animals (Bf3R) was founded in the context of the animal welfare initiative (“Tierwohlinitiative”) of the German Federal Ministry of Food and Agriculture (BMEL) in 2015. While before the establishment of the Bf3R, the Centre for Documentation and Evaluation of Alternatives to Animal Experiments (ZEBET) was of central importance, it has now been integrated into the Bf3R as one of five areas of competence. The competence areas are research and development of methods to reduce pain and suffering of laboratory animals (refinement); the National Committee; development of alternatives in the field of toxicology; and coordination of research funding. The last two areas of competence were formerly tasks of ZEBET. However, the tasks of all competence areas are predominantly performed by Experimental Toxicology and ZEBET (BfR, 2017b). Therefore, alternative methods are investigated, developed, and validated in accordance with the 3R principles. Thereby, the focus has shifted from the development of replacement methods for animal experiments towards the 3Rs. Today, refinement and reduction of animal use is treated of, at least, equivalent importance.

2.2 *Has Funding Been Increased in Recent Years?*

2.2.1 Funding on a National Level (Germany)

Although an increasing number of projects are funded on a national level, those who conduct research in replacement methods criticize that disproportionate

funding for animal experiments and an exaggerated perception of their importance has led to a decades-long neglect of the development of replacement methods and a reticence to promote them actively (Baumgartl-Simons, 2017; Leist, 2016).

2.3 *Programs for the Development of Animal-free Methods: The Funding Has to Be Shared with Refinement Methods*

In Germany, projects are funded mostly by the German Federal Ministry of Education and Research (Bundesministerium für Bildung und Forschung, BMBF). BMBF, Bf3R, and the set Foundation together provide approximately €5.7 million per year in funding for research into the development of replacement and complementary methods for animal experiments based on the 3R principles. A few German federal states have established funding programs of their own, including Baden-Württemberg, which provides €400,000 per year; and Rhineland-Palatinate, €70,000 every two years (see Table 3.1). Some individual projects, such as postgraduate programs, are funded by the German research association, DFG; however, this funding is not dedicated to the development of animal-free methods and, therefore, is not listed here.

Note: This table presents an overview, not an official empirical survey.

On a state level, in Germany, it seems that an expansion of research associations and professorial chairs has slowly begun. Some federal states have established research associations or professorial chairs and are providing initial funding for a finite period. For example, Baden-Württemberg funds the Dorenkamp-Zbinden Chair of *in vitro* Toxicology and Biomedicine/Alternatives to Animal Experimentation with €200,000 to €400,000 annually. However, most of this funding is combined with research for the 3Rs as a whole, so funding for replacement methods alone cannot be quantified. For example, Berlin may soon take over the Berlin-Brandenburg research platform (BB3R), with an integrated postgraduate program; and it plans to establish an institute for alternatives to animal experiments, with €8.6 million, at the Charité University School of Medicine Berlin (Der Regierende Bürgermeister—Senatskanzlei Berlin, 2017). The current BMBF funding has expired and negotiations for funding on a state level are currently in progress. In Frankfurt, a professorship for pharmaceutical technology has been established, with 3R methods as its main research focus. During the next five years, €200,000 will be made available to be shared with another chair for refinement methods. Lower Saxony finances the research initiative R2N—Replace and Reduce, with €4.5 million. North Rhine-Westphalia is funding the Centrum für Ersatzmethoden zum Tierversuch (CERST-NRW), a center for replacement methods for animal experimentation, with €500,000 per year for a period of five years.

TABLE 3.1 Funding for the development of animal-free methods in Germany

A. Chairs and platforms				
Federal state	Subject	Designation	Amount (€)	Financed by
Baden-Württemberg	Chair	The Doerenkamp-Zbinden Chair of in-vitro Toxicology and Biomedicine	200,000–400,000 per annum	Baden-Württemberg
Berlin	3Rs platform/ Research Association	Berlin-Brandenburg research platform BB3R with integrated graduate education	92,000 (2014–2016), negotiations at state level to continue	Federal Ministry of Education and Research (BMBF)
Hesse	Chair	Chair of pharmaceutical technology	200,000 per annum (5 years)	Hesse/Johanna Quandt Foundation
Lower Saxony	Research Association	R2N, replace and reduce in Lower Saxony; replacement and complementary methods for trend-setting biomedical research	4.5 million (4 years)	Lower Saxony
North Rhine-Westphalia	Chair	Centrum für Ersatzmethoden zum Tierversuch (CERST-NRW)	500,000 per annum	North Rhine-Westphalia

TABLE 3.1 Funding for the development of animal-free methods in Germany (*cont.*)

B. Project funding				
Germany-wide	Development, proof-on-concept	Approaches for the development of replacement and complementary methods for animal use	5.7 million per annum	Federal Ministry of Education and Research/ Federal Institute of Risk Assessment/ set Foundation
Baden-Württemberg	Development, proof-on-concept	Development of replacement and complementary methods for animal use	400,000 per annum	Baden-Württemberg
Rhineland-Palatine	Development, proof-on-concept	Development of replacement and complementary methods for animal use	70,000/24 months	Rhineland-Palatine

Since 1981, the BMBF has funded 530 projects for the development of 3R methods (BMBF, 2016). The annual budget totals €5 million (although applicants for funding from this BMBF research budget, and for research prizes awarded for the development of alternatives to animal experiments, include developers of refinement methods for animal experiments, i.e. animal experimenters). So far, more than €170 million in funding has been provided in this area (Hohensee and Brüning, 2016). However, a 2011 study published by the Fraunhofer Institute for Systems and Innovation Research showed that about 30 per cent of the projects funded between 1981 and 2000 focused on refinement (Hüsing et al., 2011). In addition, few institutions or projects receive sufficient funding. For example, the BfR simultaneously supports about ten working groups for up to three years, each with an average of €35,000 per year. By comparison, the

development of the *in vitro* pyrogen test required €6 million from development to implementation. The working group needed €400,000 per year (Thomas Hartung, personal communication, August 2016). Numerous applicants compete for the low project funds. The funding amount of about €5.7 million from the BMBF, set foundation, and Federal Institute of Risk Assessment is far too small, with no budget available for pre-validation and validation studies. Since the developers of refinement methods can also apply for these funds, even less money is available. Funding for refinement methods should have its own budget. The half-hearted funding is intended to give the impression that Germany actively supports the development of new animal-free methods. However, it is not an expression of the decision to phase out animal experiments, instead, it slows down the development.

2.4 Additional Programs

There are a few complementary funding programs to the main program, Alternatives to Animal Experiments, such as eBio-Innovative Competition Systems Biology, which runs until 2020. Systems biology unites complex high-throughput experiments with mathematical modeling of the obtained data, to develop models to predict complex biological processes on cellular, tissue, and organ levels as well as in the entire organism (BMBF, 2011). One of the complementary programs, BioÖkonomie 2030-GO-Bio, aims to further develop innovative research topics in the field of life sciences to the point of making these available for economic implementation, like innovative start-ups (Bundesministerium für Wirtschaft und Energie, 2017). This is interesting for organ on a chip technology developments intended for market launch.

2.4.1 Funding Transregional/On a European Level

There are also a few programs financed by more than one EU Member State, such as InnoSysTox—Innovative Systems Toxicology for Alternative to Animal Testing, a €3 million project financed jointly by Germany and the Netherlands (ZonMw, 2017). The application deadline was December 2014. Another program is the translational funding initiative, Multilateral Collaboration in Computational Neuroscience: Germany—US—Israel—France (BMBF, 2015a). The EU-wide budget is unknown. In Germany, €90,000 – €225,000 in funding was available for a three-year term. The application deadline for the first run was November 2016. However, as previously noted, across the EU there is currently only one program financed by the EU's funding framework Horizon 2020 dealing with animal-free issues, EU-ToxRisk, which deals with feasibility

studies for methods that most urgently need to be developed in toxicology. In EU-ToxRisk, 39 project participants must share a budget of €30 million.

The research guidelines that define what methods are most urgent are set out by the scientists themselves, and not by the EC. This was the case with project cluster SEURAT-1 (SEURAT-1, 2013), which received €25 million in funding from both the EU and the industrial association, Cosmetics Europe. Cosmetics Europe also contributes to the funding for EU-ToxRisk (amount unknown) (Cosmetics Europe, 2017). Especially urgent areas of research should be stipulated, and the development of animal-free methods must have priority. At the EU level, scientists seem to agree on the methods in most urgent need of development; but in Germany, there is no agency that decides which methods need to be developed and provided with preferential funding. Apparently, a particular bone of contention is whether it is better to fund all research indiscriminately, in the spirit of *scientific freedom* or originality, or to demand specific research into solutions for important questions (Hohensee, 2015). In the case of achieving the end goal of full replacement, as set out in Directive 2010/63/EU, the answer is clear: Research developments should not be funded indiscriminately, but rather clear priorities are necessary, with replacement of foremost importance.

2.4.2 Funding on an International Level

The US was the first country to take decisive steps towards ending animal experiments, with the concept Tox21 (National Center for Advancing Translational Sciences, NCATS, 2017a). Tox21 is a collaboration among the NIH, FDA, EPA, and the National Toxicology Program at the National Institute of Environmental Health Sciences, with the goal of achieving better assessment of the toxicity of substances by using faster and more efficient human-specific methods in high-throughput technologies. To this end, *fit-for-purpose* cell models have been developed; and a high-throughput apparatus has been set up, which scans the gene expressions in human cells for alterations after they have been exposed to the test substance. The EPA has established its own National Center for Computational Toxicology, in which prediction models are developed based on the new results (Committee on Toxicity Testing and Assessment of Environmental Agents, 2007; NCATS, 2017b).

A number of organ on a chip start-ups, most of them from the US, have been established to produce lab-scale prototypes. Zhang and Radisic (2017) described the most important 29 start-ups, dividing their work into groups: start-ups developing barrier functions, start-ups developing tissue-interface on a chip, and start-ups developing parenchymal-tissue on a chip. The first scientist to envision the possibility and pioneer the practice of quantitatively-simulating

molecular and cellular biological systems, with *in vitro* devices was Professor Michael L. Shuler of Cornell University, New York (Hurelcorp, 2018). Together with Professor James J. Hickman of the University of Central Florida, Shuler founded the start-up, HESPEROS, in 2014 (HESPEROS, 2017). Hickman developed the first serum-free media for hippocampal neuron cultures in 1995 (Schaffner et al., 1995) and published the first readouts of electrical and mechanical functions of neurons in 1998 (Ravenscroft et al., 1998). Together with Shuler and others, Hickman integrated cardiac, muscle, neuronal, and liver modules in a microphysiological system, under continuous flow conditions in a serum-free defined medium, utilizing a pump-free platform (Oleaga et al., 2016). So far, HESPEROS has successfully tested six organs on a chip (Miller, 2017).

TissUse, a German spin-off from the Technical University of Berlin, was founded by Dr. Uwe Marx in 2010. The initial focus of this company was on the development of two-organ and four-organ models. Today, like HESPEROS, their ultimate goal is to develop a human on a chip, integrating at least 10 organ-like tissue constructs of human origin. Instead of using a gravity-driven flow, like Hesperos, the TissUse platform contains a built-in micropump, driven by an external pneumatic controller. A second microfluidic circuit ensures drainage of the fluid excreted through a kidney's epithelial cell layer. The four-organ chip with intestine, liver, skin, and kidney is already available and can be co-cultured for up to 28 days (Maschmeyer et al., 2015). The Wyss Institute for Biologically Inspired Engineering at Harvard University in Boston has produced 19 university start-ups (Wyss Institute, 2018) and is known for its organ on a chip developments. One of the current research results is a pulmonary thrombosis model on a chip. The research was co-financed by the Defense Advanced Research Projects Agency (DARPA), Janssen Pharmaceuticals (Jain et al., 2018), and funding from NCATS (NCATS, 2018).

The Center for Alternatives to Animal Testing (CAAT) was founded in 1981 by Alan Goldberg, a professor at Johns Hopkins University in Baltimore. CAAT was then financed by the American Cosmetic Toiletry and Fragrance Association (CTFA), which was interested in the development of replacement methods for testing their products (CAAT, n.d. a). CAAT's goal is to create fundamental knowledge regarding possible methods for replacing tests using whole organisms (i.e. living animals) with alternative methods in the development and testing of commercial and therapeutic products. CAAT established its own *in vitro* toxicology laboratory in 1985. In 1988, the cosmetics company, Avon, financed the first program for replacing animal experiments in the field of contact allergies. Since 1989, CAAT has also been supported by government agencies and, as of 1992, by the EPA. CAAT-Europe, at the University of Konstanz in

Germany, the European equivalent to CAAT in the US (CAAT-US), was founded in 2009. CAAT coordinates transatlantic relations between the US and Europe in the field of animal-free methods, by bringing together international stakeholders in congresses and workshops on various topics of non-animal research (Universität Konstanz, 2018). On information days, the public is informed about the latest developments in this field. Both CAAT-US and CAAT-Europe in Germany train young scientists in new animal-free methods (CAAT, n.d. b).

Expanding education and research towards science without animal experiments is crucial, as only a small group of researchers currently work on replacement methods. Despite the aforementioned funded individual professorial chairs, there is still no way of completing a course of studies that would equip students with the professional capacity to develop alternatives to animal experiments. In order to complete a thesis at one of the newly established chairs (see above), the student must first have studied one of the more common courses of studies, such as biology, medicine, veterinary medicine, biochemistry, pharmaceuticals, toxicology, or biophysics, which, for the most part, continue to use animals for training (SATIS, 2017a). Only very few tertiary institutions allow the use of alternatives to animal dissection on ethical grounds. Instead, tolerance towards alternatives to the use of animals in training courses has decreased, depending on the course organizers' attitude. Only four German State Higher Education Acts (North Rhine-Westphalia, Hesse, Saarland, and Bremen) allow the right to decline using animals on ethical grounds (SATIS, 2017b). Most students quickly get used to using animals because they do not want to belong to a fringe group, without prospects of gaining a professional foothold, or they want to keep their options open. The lack of opportunities for attaining qualifications in animal-free courses of studies leads to a lack of qualified young scientists in the area of animal-free methods, so that funding bodies sometimes argue that the reticence in providing finances results from insufficient scientific standards (Hohensee, 2015). The lack of political will means that the subject continues to go in circles.

2.5 *The Time-consuming Validation Process*

The time taken for the validation and approval of animal-free testing methods urgently needs to be shortened. The broadening of funding by the BMBF program, Alternatives to Animal Testing, to include strategies for implementing newly developed methods as replacements for animal experiments (BMBF, 2015b, Module II), is a first step in the right direction; but it is by no means enough. Validation studies, in particular, are extremely expensive and time-consuming and go through the *bottleneck* of the European validation authority, EURL ECVAM, which has limited capacities. There are simply not

enough resources. If a validation study is successfully conducted, the process of recommendation by EURL ECVAM begins with consultations with different committees, including the Preliminary Assessment of Regulatory Relevance (PARERE) and the EURL ECVAM Stakeholder Forum (ESTAF) (EURL ECVAM, 2017b). EURL ECVAM then consults with other EC committees, as well as the other international partners for validation and cooperation on the development of alternative test methods. The general public and companies, who would ultimately implement the development, are given time to submit comments. Only after a long period of time is a Test Guideline drafted, and the method is then included in the annexes of the relevant statutory regulation. This sometimes requires 10 years (Hohensee, 2016a). There are, however, instances where the inventor is not interested in validation because it would tie up resources; for example, Ulrich Stock, who developed a borosilicate chamber with a blood-like solution to test heart valves under human-like conditions in 2011 (personal communication, November 2011). Here an agency is needed to oversee proceedings.

3 Part 3: Why Are There Insufficient Animal-free Test Methods and in Which Areas?

3.1 *In Which Areas Are There Insufficient Animal-free Test Methods and Why?*

In this section, we focus on the field of toxicology alone. Relevant animal-free methods in the field of toxicology could also be applied to other areas. There has been great progress in the development of replacement methods in the area of local toxicity testing (e.g., skin and eye tests), where many animal experiments have already been replaced (AltTox, 2016). However, there are still no replacement methods for long-term studies of the organism as a whole, for example, in the area of inhalation toxicity or tests for reproductive damage and damage caused to offspring. The development of replacement methods for testing environmental toxicity is also only rudimentary.

The goal of the holistic approach is to be able to depict the entire organism in a simplified and miniaturized form. This is a complicated process because individual organs, their biology, and their interactions within the body are highly complex. In order to replace this complex organism in experiments, scientists aim to create a human on a chip, in which all the vital human organs are combined on a chip of miniaturized scale of about 1:10,000. At present, about eight miniaturized organs can be simulated and interconnected (Ingber, 2017). However, to construct a human surrogate for drug screening, scientists

are convinced that it will not be necessary to replicate a perfect human body but simply to provide a better predictive model than animal models (Wang et al., 2016). For such simplified models, many different technical approaches have been developed; for example, according to chip fabrication techniques, medium composition, delivery systems of media, nutrients, oxygen, metabolites, and so forth, have a strong influence on the quality of cell or organ cultures and the results. Wang et al. (2016) provide an exploratory overview of current developments in multi-organ systems and their pro and cons. Since each start-up presently holds only a piece of the entire puzzle, the authors recommend that the multiple companies should be motivated to join forces to combine their techniques and patents, thereby fostering the continued evolution of more advanced products. In many cases, the viability of organoid system cultures cannot, currently, be guaranteed for long-term investigations.

Depending on the laboratory, there are groups whose cell systems can be utilized for just one week (Hohensee, 2017) and others for three months (Epithelix, 2017). These differences may result from the organs' different needs and the difficulties of recreating miniaturized human organs, especially in the case of such vital organs as the liver or kidneys. Wang et al. (2016) discuss the need for a common culture medium, with full chemical definition, as a blood surrogate that can maintain the viability and function of various organ models and by the use of extracellular matrices can influence the reproducibility and physiologically-realistic ratio of liquid to cell volumes in the (multi-) organ on a chip system.

Methods in the field of inhalation toxicology are advanced with superficial and deeper respiratory epithelium *in vitro* and with, in some cases, a viability or usability of more than a month (Epithelix, 2017). Lung models have been in use for quite some time (Esch, Bahinski and Huh, 2015; Huh et al., 2010). One method, having achieved general approval, is currently undergoing a validation study in Germany (Hoffmann et al., 2017). However, it was initially intended for replacing animal experiments in the area of acute toxicity. Developments in the area of long-term toxicity are not as advanced and are being explored in a feasibility study within the framework of the EU project cluster, EU-ToxRisk (EU-ToxRisk, 2016).

Recreating a reproductive tract in a multifluidic system is a particular challenge. Some advancements have already been made, such as the development of 3D cell culture models of animal Fallopian tubes, in which embryos can even develop in the "tubular fluid" (Chen et al., 2017). There are models of the vagina and *in vitro* test systems with ectocervical cells and fibroblasts, which have been developed to test substances for their irritant, toxic, or endocrine disruptive effects (Ayehunie et al., 2016; Landry et al., 2016). An artificial

reproductive cycle has also been created, using murine ovarian follicles *in vitro*, to investigate the mechanisms of reduced fertility (Zhu et al., 2016). First steps have been taken to culture parts of female ovaries, using human follicles, to study the maturation processes (Laronda et al., 2014). There are also initial developments for studying the hormonal cycle, using human ovarian tissue as well as mice and human follicles (Skory et al., 2015). More advanced is a system (EVATAR) to simulate the 28-day hormone profile of the female reproductive tract to study its influence on reproductive tissue (Xiao et al. 2017). However, due to species differences between mice and humans, the use of murine tissue can only be a first step. The goal is to construct models with human-specific tissue material (for an overview see Eddie et al., 2015). A repro-on a chip could be used in the future to recreate mechanistic developments and disorders in the development of the reproductive organs in the field of basic and applied research but not reproductive behavioral disorders or detrimental effects on offspring. Other solutions would have to be found for these. The project cluster EU-ToxRisk is also conducting feasibility studies in the field of developmental and reproductive toxicology (EU-ToxRisk, 2016). Unfortunately, hormonal regulation (feedback loops with hypothalamus, adenohypophysis, and thyroid, which affect the tissues) and immune defense, which would allow the modulation of a miniature human on a chip, are lacking.

What is appealing about this human on a chip technology is that automation could rapidly shorten the time and cost of development by using large rooms filled with robotic systems to simultaneously run tests on a multitude of chips, with different concentrations of a variety of substances, without the disruption of human factors (e.g., introduction of bacteria, measuring errors, or pipetting errors). This would facilitate more targeted, cheaper, and faster development and production and make it more attractive for industry.

3.2 *Why Aren't Developments Progressing More Quickly in Germany?*

The development of animal-free methods primarily depends on the advancement of knowledge (Linz School of Education, 1999; Schmiel, 2006) as well as other factors, such as efficient methods of investigation and measurement, high-performance research facilities with a workplace environment conducive to creativity, innovative staff, and, most significantly, sufficient funds. The following observations regarding these factors are restricted to Germany.

3.2.1 Powerful Methods of Investigation and Measurement

Modern molecular biological and biochemical methods, insights into cell culture, stem cell research, chip technology, omics technologies, computers of high performance, algorithms, potent imaging techniques, and bioprinters

have considerably advanced the development of animal-free testing methods (BMBF, 2016; DFG, 2017). While these powerful methods should also be available to universities and other research facilities, they would involve considerable cost. Several facilities are currently known to need money for 3D bioprinters in order to advance research on non-animal replacements, including the Institute of Veterinary Anatomy of the Free University Berlin. It is possible that some research remains at a certain level of development due to lack of instruments. This situation has been recognized by the German Research Foundation (DFG, 2017). The problem could be addressed by establishing decentralized *method centers*, whose services would be available to all authorized research institutes. Collaborations with extramural institutes (e.g., Fraunhofer Institutes) also need to be facilitated and, perhaps, expanded.

3.2.2 High-performance Research Facilities with a Workplace Environment Conducive to Creativity

In addition to up-to-date research topics, the workplace environment is also important for the research staff, for example, in terms of hierarchy, recognition, and interdisciplinary collaboration. Recent years have seen progress in this regard. New university courses have also been introduced, some of which are suitable for the development of replacement methods for animal experiments, such as Medical Biotechnology (Technische Universität Berlin, TU-Berlin, 2017), Biomedical Computing (xStudy SE, 2017a), Life Science Engineering (Hochschule für Technik und Wirtschaft Berlin, HTW-Berlin, 2017), Biomedical Engineering (xStudy SE, 2017b), and Biochemistry and Molecular Biology (Universität Bayreuth, 2018). There are increasingly more student exchanges between international partner universities (xStudy SE, 2017a).

3.2.3 Innovative Staff

Understandably, aspiring students and postgraduates, among others, are influenced by their career prospects when choosing suitable fields of study. This choice involves assessing how much return they can actually get on their investment in their course of studies. The best employees go to institutes with the best reputations (“everyone wants to go to Harvard”); institutes that do the best research, who are best known, that have significant influence in the scientific community, that are not economically threatened, and that pay their staff well. For this reason, attractive degree courses in the area of animal-free methods are needed (e.g., Medical Biotechnology at TU-Berlin). There should also be a climate of internationality, enabling an exchange of know-how and strategic thinking in problem solving. At present, there are professorial chairs in Germany, where one can learn animal-free research and testing methods;

however, entire courses of studies are not available. Students often must work with animals or animal organs because they must first complete a standard syllabus (e.g., biology), after which they can attend single courses or complete their theses at the newly installed chairs, in places such as Frankfurt, Düsseldorf, and Konstanz (Buchmann Institute for Molecular Life Sciences, 2017; Hohensee; 2016b; University of Konstanz, 2018).

3.2.4 More Capital from the Corporate Sector Is Necessary

Sufficient capital is important. The development of animal-free test methods in Germany is largely financed by state funding. This means that the risks involved with research and development are borne by society (taxpayers), whilst the returns on successfully developed technologies benefit all stakeholders. It would, therefore, make sense to provide not only national and European funding but also more capital from the corporate sector. European organizations, such as Cosmetics Europe and the European Partnership for Alternative Approaches to Animal Testing (EPAA), are good examples (Cosmetics Europe, 2017; EPAA, 2017). Tax relief for companies that invest in research has been demanded for many years and should be implemented (Verband der Chemischen Industrie, 2017). In the US, there are more ambitious programs leading to better and more innovative scientific outputs. NCATS at NIH and DARPA recently funded a US\$150 million program for grants in the field of toxicity testing, drug efficacy evaluation, and disease modeling (Wang et al., 2016). It seems that there is a strong motivation to make the new systems successfully applicable. In Europe, there are no such programs available. Funding programs are fragmented into small individual measures with much smaller budgets. So far, only the Netherlands has clearly expressed its intentions. Other Member States are reserved, expressing themselves at best behind closed doors and referring to their cooperation within the framework of their National Committees. Many researchers who use animal methods likely have little interest in the success of the Dutch plan. Such reservation by Member States could be a barrier towards the success of the plan.

4 Part 4: The Netherlands Makes a Name for Itself

4.1 *Why Is the NCad Report a Good Template for a Paradigm Shift?*

As of May 2017, NCad has published 108 documents, demonstrating its success (NCad, 2016a); however, the Netherlands' former Minister of Agriculture, Martijn van Dam, ambitiously pursued "the final goal of full replacement" as set out in Recital 10 of Directive 2010/63/EU (European Parliament, 2010). The

manner in which Dutch politics has responded to the initiative is truly sensational. On April 8, 2016, the Dutch Minister of Agriculture requested that NCad Chairman, Herman Koëter, develops a phase-out timeline for procedures involving animal use. The plan, *Transition to Non-Animal Research*, was published on December 15, 2016 (NCad, 2016a). The history of its development is as interesting and groundbreaking as the plan itself.

4.2 *The Development of the NCad Report*

The NCad plan is not the result of a whim but rather the product of years of expert preparation, in which all stakeholders were involved. In June 2014, the Dutch Ministry of Economic Affairs commissioned the expert group, The Think Tank on Supplementary Financing for Alternatives to Animal Testing (De Denktank Aanfullende financiering alternatieven voor dierproeven), to develop recommendations for additional funding for the development of “innovations without laboratory animals” (NCad, 2016a, p. 42). The Think Tank presented its 140-page report, *In Transition! The Netherlands leads the way in laboratory animal-free innovations*, in October 2015 (Henneman et al., 2015). Based on this report, on April 8, 2016, the Minister of Agriculture, Martijn van Dam, assigned NCad the task of presenting a strategy for phasing out animal procedures. Van Dam specified that the strategy should involve the National Institute of Public Health and Environmental Protection (Rijksinstituut voor Volksgezondheid en Milieu Netherlands, RIVM). RIVM has significant expertise in toxicity testing and is both national and international coordinator for 3Rs methods. van Dam instructed NCad to name specific phasing-out targets and stated that the legally required toxicity tests should be phased out within 10 years, which would reduce the number of animals used in experiments by 10% in the Netherlands. He also emphasized the goal, formulated in the Think Tank’s recommendations, that the Netherlands become the world leader in laboratory animal-free innovations by 2025 (NCad, 2016b).

NCad conducted two expert workshops on June 9 and July 7, 2016 in cooperation with the RIVM (NCad, 2016a, p. 13). In August 2016, the LinkedIn group, *Towards a Future of Scientific Progress Without the Use of Experimental Animals*, was founded (Koëter, 2016). As of November 17, 2016, the group had 245 members, but unfortunately it delivered *little* of substance (NCad, 2016a, p. 51). A public consultation was held on September 8, 2016 in Den Haag, where a broad range of organizations commented on specific recommendations, such as “It is possible to move away from the regulatory animal procedures within the next ten years” (NCad, 2016a, p. 51). The report, *Transition to Non-Animal Research*, was presented to van Dam and published on December 15, 2016.

4.3 *What Facts and Figures Are Named in the Phase-out Timetable?*

In its report, NCad divided animal experiments into different areas and assessed the possibility of reducing them by 2025. The Netherlands aims to be an international leader in the field of innovation without laboratory animals by 2025 and sees a realistic chance of achieving this goal. Areas and possibilities of reduction, as noted in the NCad report, are:

1. Regulatory tests:
 - “The use of laboratory safety testing for chemicals, food additives, pesticides, and (veterinary) medicines can be phased out by 2025 whilst maintaining the existing safety level” (NCad, 2016a, pp. 3, 17).
 - “The use of laboratory animals in regulatory tests for the release of biological products, such as vaccines, will be phased out by 2025 whilst maintaining the existing safety level” (NCad, 2016a, pp. 17–18).
 - Regulatory preclinical tests associated with the registration of new biological substances/products cannot be phased out by 2025. “At this stage, however, due to the complex composition of these products and generally complex mechanism of action, the regulatory preclinical research associated with the registration of new biopharmaceuticals (such as vaccines or monoclonal antibodies) cannot be phased out at the same pace” (NCad, 2016a, pp. 17–18).
2. Basic scientific and medical research:
 - Animal experiments in the field of “curiosity-driven basic research cannot be phased out by 2025. Therefore, individual ten-year plans are necessary for each area of research” (NCad, 2016a, p. 15). The complex procedures and interactions in an organism as a whole cannot be simulated at the current time.
 - “Within the field of fundamental scientific research, the reduction or phasing out of the use of animals is not realistic in the short term in all areas of research” (NCad, 2016a, p. 18).
3. Applied and translational research:
 - While animal experiments in applied and translational research (implementation of preclinical research in clinical development) cannot be phased out by 2025, the development of replacement methods can be accelerated. This includes investing more in human-specific models and less in animal models. The Netherlands aims to become “an international leader” in this respect (NCad, 2016a, p. 19).
4. Education and training:
 - “By focusing on animal-free practices and actively reflecting on the use of laboratory animals in education, the use of laboratory animals for education and training can be significantly reduced” (NCad, 2016a, p. 19).

4.4 *Transition Objectives, Transition Strategy and Management of the Transition*

NCad has found that there is a realistic chance of completely phasing out animal experiments in the areas of regulatory safety tests (for chemicals, food additives, pesticides, and veterinary and human medical products) and regulatory tests for the release of biological products (e.g., vaccines) by 2025. This requires a transition strategy and management of the transition. The development will not take place on its own. Therefore, we strongly recommend the development of NCad's transition objectives, transition strategy, and program for transition management.

4.4.1 Transition Objectives

The transition objectives refer to a paradigm shift away from existing mind-sets and practices, which are combined with animal use, to a strong focus on innovations without laboratory animals. In regulatory research, this means a significant reduction in the use of laboratory animals; in the field of basic research, the development of a ten-year vision for each area; and in the field of applied and translational research, more rapid progress, for example, through the development of human models for human diseases. Furthermore, the use of animals in education and training can be significantly reduced (NCad, 2016a, pp. 3–4).

4.4.2 Transition Strategy

NCad has stated that the following is necessary for a good transition strategy:

- the use of human data
- international cooperation for a new approach to risk assessment
- multidisciplinary cooperation on the development and approval of replacement methods
- monitoring of the evaluation and dissemination of replacement methods
- monitoring and evaluation of the reduction of animal procedures (since the contribution replacement methods make towards the reduction of the number of animals used in the Netherlands cannot currently be proven)
- development of an innovation index for replacement methods (data warehouse, directory) in collaboration with other countries (NCad, 2016a, p. 24).

4.4.3 Transition Management

The NCad report states that the key to success is (international) collaboration among all stakeholders. The Minister for Agriculture would have the guiding role but also involve other ministries. The existing Interdepartmental Working Group on Alternatives to Animal Procedures would be transformed into an

Interdepartmental Management Group, with the involvement of representatives from several ministries. The Management Group would draft an agenda for the new replacement methods that need to be developed in consultation with all stakeholders.

4.5 *Evaluation and Conclusions*

An analysis of the 108 reports that led to the decisions presented in the NCad report, showed that the phase-out timeline is not an unrealistic idea. The phase-out timeline is based on the results of two years of intense consultation and work, involving representatives of stakeholders from the fields of science, applied research, contract research, laboratory animal science, medicine, replacement of animal testing, and animal welfare (NCad, 2016c, p. 2). The phase-out timeline was developed with all participating groups; as such, the road map is certainly ambitious but by no means unrealistic. It is, therefore, disconcerting that other EU Member States have either ignored or rejected the Dutch plan, and none have expressed support.

5 The Way Forward

What has to be done to rigorously pursue the “phasing out of animal procedures and the stimulation of innovation without laboratory animals” (NCad, 2016a, p. 3)? With the NCad report, *Transition to Non-Animal Research*, the Netherlands has not only presented an *opinion* but has developed a concept for purposefully affecting a paradigm shift. The NCad report contains clear transition objectives, a transition strategy, and a program for transition management. Our association, People for Animal Rights Germany, proposes that the following can be achieved, based on the Dutch concept and including our five pillars and our demand for a master plan for phasing out animal experiments:

- The EU Member States’ National Committees (European Parliament, 2010, Article 49) should endorse the NCad plan. The national responsible ministers (especially the ministers responsible for the animal welfare, science, and research portfolios) should advocate for the adoption of the NCad concept, to encourage the governments of the Member States to implement the Dutch plan in their own countries. Parallel to this, we recommend that the responsible national ministers vote in their respective Councils of Ministers to support the NCad plan at an EU level.
- Based on the national governmental resolutions and the resolutions of the EU Council of Ministers, the EC should adopt the NCad concept as a principle for action for reducing animal testing and funding animal-free

procedures. Political action is also urgently needed to stop the different stakeholders working against each other.

- These objectives can be achieved by the EU Member States’ ministers responsible for the animal welfare, science, and research portfolios, by developing a new approach to assessing the risks posed by substances and asserting this internationally beyond the EU. The pivotal issue is the actual risk (risk assessment) and not the substances’ overall hazard potential (hazard assessment) (NCad, 2016a, p. 20).
- In the short term, the Netherlands intends to compile a priority list for areas of regulatory testing that lack animal-free methods. Other EU Member States should actively support the Netherlands in compiling this list. The EU Member States and the EC should then approve funding programs for these procedures. Funding programs should only be available for animal-free testing methods and provide continuous funding, from development to final validation.
- It is necessary that the responsible ministers in the EU Member States optimize the validation process. The results of methods to be validated must be compared with human data and not with data from animal experiments (NCad, 2016a). The time needed for the validation process should also be shortened.
- The responsible ministers in the EU Member States should agree on the introduction of a monitoring system for quality assurance during the transition process, which would monitor the development and application of animal-free procedures and the phasing out of animal procedures, allowing timely intervention in the case of negative developments.
- The Dutch Minister of Economic Affairs will set up sub-domains in order to draw up ten-year plans for the different areas of basic research. The plans will name realistic objectives for “innovations without laboratory animals” (NCad, 2016a, p. 3). This task is a particular challenge, as basic research has, until now, been regarded as sacrosanct. This makes it all the more important that all EU Member States actively participate in the drawing up of these plans.

6 Final Remarks

We strongly recommend transforming the current plan, *Transition to Non-Animal Research*, proposed by NCad, from an uncoordinated single process to a targeted joint project, in which all stakeholders stand behind the same goals and actively pursue them based on an overall plan. The NCad report describes crucial objectives: ending animal procedures for regulatory tests; listing

and prioritizing the animal-free procedures that need to be developed; and drawing up ten-year plans for phasing out animal procedures in the different areas of basic research. Under the leadership of politics, the principles that underlie the NCad report should be implemented in the EU Member States, supported by the EC, and ideally in step with international regulatory authorities and scientific bodies. The implementation should be ensured by national and international project management, accompanied by a monitoring system, and made transparent to the public. A joint pursuit of the Dutch concept by the other EU Member States would work towards achieving the goal of Recital 10 of Directive 2010/63/EU to replace animals for scientific and educational purposes. This requires a common will and joint preparation of individual plans in European (or even international) workshops with all major stakeholders, in particular science, industry, and public authorities. The successful phase out of animal testing in the field of cosmetics, which is gradually taking place worldwide, as well as current multi-organ on a chip developments across many countries, have shown that it is possible to achieve these goals together.

References

- AIMBE (2013). *Third AIMBE/NIH Workshop – AIMBE*. [online] Available at: <http://aimbe.org/events/third-aimbe-nih-workshop/> [Accessed 11 January 2018].
- AltTox (2016). *Validated & Accepted Alternative Methods*. [online] Available at: <http://alttox.org/mapp/table-of-validated-and-accepted-alternative-methods/> [Accessed 6 August 2017].
- Ayehunie, S., T. Landry, K. LaRosa, M. Klausner and J. Sheasgreen (2011). Identification of Endocrine Disruptors Using an Organotypic Vaginal Tissue Model. *SOT 2011*, Abstract #2373. [online] Available at: <https://www.mattek.com/reference-library/identification-of-endocrine-disruptors-using-an-organotypic-vaginal-tissue-model/> [Accessed 6 August 2017].
- Ayehunie, S., Landry, T., Hayden, P. and Klausner M. (2016). Pre-validation of in vitro - in vivo assays for vaginal irritation. In: Society of Toxicology 2016 Annual Meeting. [online] Available at: <https://www.mattek.com/join-us-at-sot-2016/> [Accessed 6 August 2017].
- Baumgartl-Simons, C. (2017). Das Ende muss endlich wirksam verfolgt werden. *Tierrechte*, 02, p. 4. [online] Available at: https://www.tierrechte.de/images/stories/Presse_und_Magazin_Tierrechte/Magazin_2-17_.pdf [Accessed 11 January 2018].
- BfR (2017a). *Nationaler Ausschuss Tierschutzgesetz – BfR*. [online] Available at: http://www.bfr.bund.de/de/nationaler_ausschuss_tierschutzgesetz.html [Accessed 2 August 2017].

- BfR (2017b). *Fragen und Antworten zum Deutschen Zentrum zum Schutz von Versuchstieren (Bf3R)*. [online] Available at: <http://www.bfr.bund.de/cm/343/fragen-und-antworten-zum-deutschen-zentrum-zum-schutz-von-versuchstieren-bf3r.pdf> [Accessed 4 August 2017].
- BMBF (2011). *Bekanntmachung des Bundesministeriums für Bildung und Forschung von Richtlinien zur Förderung „e:Bio – Innovationswettbewerb Systembiologie“ Vom 17. Dezember 2010*. [online] Available at: <https://www.bmbf.de/foerderungen/bekanntmachung.php?B=608> [Accessed 4 August 2017].
- BMBF (2015a). *Bekanntmachung des Bundesministeriums für Bildung und Forschung von Richtlinien zur Förderung der “Multilateralen Zusammenarbeit in Computational Neuroscience: Deutschland – USA – Israel – Frankreich” Vom 16. Juli 2015*. [online] Available at: <https://www.bmbf.de/foerderungen/bekanntmachung-1068.html> [Accessed 4 August 2017].
- BMBF (2015b). *Bekanntmachung: Richtlinie zur Förderung von “Alternativmethoden zum Tierversuch”*. Bundesanzeiger vom 24.12.2015. [online] Available at: <https://www.bmbf.de/foerderungen/bekanntmachung.php?B=1124> [Accessed 6 August 2017].
- BMBF (2016). *Lebenswissenschaftliche Grundlagenforschung Alternativen zum Tierversuch*. [online] Available at: <https://www.bmbf.de/de/alternativen-zum-tierversuch-412.html> [Accessed 6 August 2017].
- Buchmann Institute for Molecular Life Sciences (2017). *BMLS – Drug Delivery and 3R-models*. [online] Available at: https://www.bmls.de/Drug_Delivery_and_3R-Models/people.html [Accessed 6 August 2017].
- Bundesministerium für Justiz und Verbraucherschutz (2017). *§46 TierSchVersV – Einzelnorm*. [online] Available at: http://www.gesetze-im-internet.de/tierschversv/_46.html [Accessed 4 August 2017].
- Bundesministerium für Wirtschaft und Energie (2017). *Förderdatenbank – Inhaltsverzeichnis*. [online] Available at: <http://www.foerderdatenbank.de/Foerder-DB/Navigation/Foerderrecherche/inhaltsverzeichnis.html?get=ea6079646dcbaff078c1252foaf299d6;views;document&doc=13310> [Accessed 4 August 2017].
- CAAT (n.d. a). *CAAT History*. [online] Available at: <http://caat.jhsph.edu/about/history.html> [Accessed 26 July 2018].
- CAAT (n.d. b). *About Us: Center for Alternatives to Animal Testing*. [online] Available at: <http://caat.jhsph.edu/about/index.html> [Accessed 26 July 2018].
- Chen, S., S.E. Palma-Vera, M. Langhammer, S.P. Galuska, B.C. Braun, E. Krause, A. Lucas-Hahn and J. Schoen (2017). An Air-liquid Interphase Approach for Modeling the Early Embryo-maternal Contact Zone. *Scientific Reports*, 7, 42298 [online] Available at: <https://www.nature.com/articles/srep42298> [Accessed 12 February 2018].
- Committee on Toxicity Testing and Assessment of Environmental Agents (2007). *Toxicity Testing in the 21st Century: A Vision and a Strategy*. [online] Available at: <http://>

- dels.nas.edu/resources/static-assets/materials-based-on-reports/reports-in-brief/Toxicity_Testing_final.pdf [Accessed 5 August 2017].
- Cosmetics Europe (2017). *Promoting Science and Research*. [online] Available at: <https://www.cosmeticseurope.eu/how-we-take-action/promoting-science-research/> [Accessed 4 August 2017].
- Cronin, M. (2017). *Non-animal Approaches — The Way Forward*. Report on a European Commission Scientific Conference. Brussels, Belgium. December 6–7, 2016. [online] Available at: http://ec.europa.eu/environment/chemicals/lab_animals/gr/pdf/scientific_conference/non_animal_approaches_conference_report.pdf [Accessed 26 July 2018].
- Der Regierende Bürgermeister – Senatskanzlei Berlin (2017). *Senat beschließt Entwurf des Charité-Vertrages 2018–2022*. Pressemitteilung [online] Available at: https://www.berlin.de/rbmskzl/aktuelles/pressemitteilungen/2017/pressemitteilung.617676.php#search=%22Tierversuch*%22 [Accessed 4 August 2017].
- DFG (2017). *Hochdurchsatzverfahren: DFG fördert moderne Forschungsinfrastrukturen in den Lebenswissenschaften*. [online] Available at: http://www.dfg.de/service/presse/pressemitteilungen/2017/pressemitteilung_nr_28/index.html [Accessed 6 August 2017].
- Eddie, S.L., J.J. Kim, T.K. Woodruff and J.E. Burdette (2015). Microphysiological Modeling of the Reproductive Tract: A Fertile Endeavor. *Experimental Biology and Medicine*, 239(9), pp. 1192–1202.
- EPAA (2017). *European Partnership for Alternative Approaches to Animal Testing – Wachstum – European Commission*. [online] Available at: https://ec.europa.eu/growth/sectors/chemicals/epaa_de [Accessed 6 August 2017].
- Epithelix (2017). *Toxicity of Inhaled Products: Acute, Long Term or Repeated Dose Testing of Drugs/Formulations or Xenobiotics on Reconstructed Human Airway Tissues (MucilAir™)*. [online] Available at: <http://www.epithelix.com/services/toxicity-of-inhaled-products> [Accessed 6 August 2017].
- Esch, E.W., A. Bahinski and D. Huh (2015). Organs-on-Chips at the Frontiers of Drug Discovery. *Nature Reviews Drug Discovery* 14, pp. 248–260.
- Ettel, A. (2018). *Es wird nicht möglich sein, Tierversuche zu ersetzen*. Welt. [online] Available at: <https://www.welt.de/wirtschaft/article173493400/Tierversuche-Laengst-nicht-alle-Tests-dienen-der-Forschung.html> [Accessed 13 Feb. 2018].
- EU-NETVAL (2018). *EU-NETVAL* (European Union Network of Laboratories for the Validation of Alternative Methods). [online] Available at: <https://eurl-ecvam.jrc.ec.europa.eu/eu-netval> [Accessed 12 February 2018].
- EU-ToxRisk (2016). *EU-ToxRisk – An integrated European “Flagship” Program Driving Mechanism-based Toxicity Testing and Risk Assessment for the 21st Century*. [online] Available at: <http://www.eu-toxrisk.eu/> [Accessed 2 August 2017].

- EURL ECVAM (2017a). *European Union Reference Laboratory for Alternatives to Animal Testing (EURL ECVAM)*. [online] Available at: <https://eurl-ecvam.jrc.ec.europa.eu> [Accessed 4 August 2017].
- EURL ECVAM (2017b). *EURL ECVAM Recommendations*. [online] Available at: <https://eurl-ecvam.jrc.ec.europa.eu/eurl-ecvam-recommendations> [Accessed 6 August 2017].
- European Parliament (1986). Council Directive of 24 November 1986 on the Approximation of Laws, Regulations and Administrative Provisions of the Member States Regarding the Protection of Animals Used for Experimental and Other Scientific Purposes (86/609/EEC). *Official Journal of the European Communities*, L 358/1, p. 5. [online] Available at: <http://eur-lex.europa.eu/legal-content/EN/TXT/PDF/?uri=CELEX:31986L0609&from=EN> [Accessed 5 March 2018].
- European Parliament (2010). Directive 2010/63/EU of the European Parliament and of the Council of 22 September 2010 on the Protection of Animals Used for Scientific Purposes. *Official Journal of the European Communities*, L 276, p. 33–79. [online] Available at: <http://eur-lex.europa.eu/legal-content/EN/TXT/?uri=CELEX:32010L0063>. [Accessed 3 August 2017].
- FELASA (n.d.). *FELASA*. [online] Available at: <http://www.felasa.eu/> [Accessed 3 August 2017].
- Hartung, T. (2015). Food for Thought ... The Human Whole Blood Pyrogen Test – Lessons Learned in Twenty Years. *ALTEX*, 32 (2), pp. 79–100. [online] Available at: http://altweb.jhsph.edu/altex/32_2/FFT.pdf [Accessed at 12 Feb. 2018].
- Henneman, P., van P. Megchelen, M. Pijnappel, H. Smid, J. Wijnja and M. Zuidgeest (2015). *In transitie! Nederland internationaal toonaangevend in proefdiervrije innovaties*. [online] Available at: <http://library.wur.nl/WebQuery/titel/2102149> [Accessed 26 July 2018].
- HESPEROS (2017). *Team*. [online] Available at: <http://www.hesperosinc.com/team/> [Accessed 10 January 2018].
- Hildermann, L. (2015). *Die EU-Tierversuchsrichtlinie und ihre Umsetzung in nationales Recht: unions- und verfassungsrechtliche Aspekte*. Dissertation. Universität Trier.
- Hochschule für Technik und Wirtschaft Berlin, HTW-Berlin (2017). *Bachelor-Life Science Engineering. Official Website Hochschule für Technik und Wirtschaft Berlin*. [online] Available at: <http://lse-bachelor.htw-berlin.de/studium/> [Accessed 6 August 2017].
- Hoffmann, S., N. Möhle, M. Aufderheide, D. Steinritz, A. Tsoutsoulopoulos, A. Breit and O. Krischenowski (2017). *Validation of the CULTEX RFS Method to Assess the Acute Inhalation Toxicity of Dusts*. [online] Available at: <https://www.researchgate.net/project/Validation-of-the-CULTEX-RFS-method-to-assess-the-acute-inhalation-toxicity-of-dusts> [Accessed 6 August 2017].

- Hohensee, C. (2015). *Fachgespräch zu Tierversuchersatzverfahren im Deutschen Bundestag*. [Blog] InVitro+Jobs. Available at: <http://www.invitrojobs.com/index.php/de/neuigkeiten/news-archiv/item/1835-fachgespraech-zu-tierversuchersatzverfahren-im-deutschen-bundestag> [Accessed 4 August 2017].
- Hohensee, C. (2016a). *Berlin: Podiumsdiskussion in der Urania*. [blog] InVitro+Jobs. Available at: <http://www.invitrojobs.com/index.php/de/neuigkeiten/news-archiv/item/2148-berlin-podiumsdiskussion-in-der-urania> [Accessed 6 August 2017].
- Hohensee, C. (2016b). *CERST – Auftaktveranstaltung in Düsseldorf: Vernetzung vorantreiben*. [blog]. InVitro+Jobs. Available at: <http://www.invitrojobs.com/index.php/de/neuigkeiten/news-archiv/item/1986-cerst-auftaktveranstaltung-in-duesseldorf-vernetzung-vorantreiben> [Accessed 6 August 2017].
- Hohensee, C. (2017). *Arbeitsgruppe im Portrait: Leibniz-Institut für Arbeitsforschung an der TU Dortmund*. [blog] InVitro+Jobs. Available at: <http://www.invitrojobs.com/index.php/de/forschung-methoden/arbeitsgruppe-im-portrait/item/2745-arbeitsgruppe-im-portrait-leibniz-institut-fuer-arbeitsforschung-an-der-technischen-universitaet-dortmund-ifado> [Accessed 6 August 2017].
- Hohensee, C. and C. Brüning (2016). *Förderung tierversuchsfreier Verfahren: Gesamtstrategie fehlt. Was bringt das Förderprogramm "Alternativen zum Tierversuch"?* Interview at *tierrechte*, 03, p. 10. [online] Available at: https://www.tierrechte.de/images/stories/Presse_und_Magazin_Tierrechte/Magazin_3-16.pdf [Accessed 4 August 2017].
- Huh, D., B.D. Matthews, A. Mammoto, M. Montoya-Zavala, H.Y. Hsin and D.E. Ingber (2010). Reconstituting Organ-level Lung Functions on a Chip. *Science*, 328(5986), pp. 1662–1668.
- Hurelcorp (2018). *Leadership. Michael L. Shuler, Ph.D.* [online] Available at: <http://hurelcorp.com/shuler.php> [Accessed 10 January 2018].
- Hüsing, B., F.P. Gruber, H. Reinhold and S. Wydra (2011). *Evaluation des Förderschwerpunkts Ersatzmethoden zum Tierversuch*. Abschlussbericht 24. Feb. 2011. Karlsruhe: Fraunhofer-Institut für System- und Innovationsforschung (Fraunhofer ISI) Available at: https://www.ptj.de/lw_resource/datapool/_items/item_2542/schlussbericht.pdf [Accessed 4 August 2017].
- Ingber, D.E. (2017). *Human Organs-on-Chips as Replacements for Animal Testing*. [Talk] Science and cocktails. Available at: https://www.youtube.com/watch?list=PL2c_ujuXhAvQO18KrtERRMjAkjgr-PQ1k&time_continue=193&v=HGoxeVaWzdQ [Accessed 6 August 2017].
- Jain, A., R. Barrile, A.D. van der Meer, A. Mammoto, T. Mammoto, K. De Ceunynck, O. Aisiku, M.A. Otieno, C.S. Loudon, G.A. Hamilton, R. Flaumenhaft and D.E. Ingber (2018). Primary Human Lung Alveolus on a Chip Model of Intravascular Thrombosis for Assessment of Therapeutics. *Clinical Pharmacology and Therapeutics*, 103, pp. 332–340.

- Koëter, H. (2016). *Blog van de voorzitter*. [Blog] Nationaal Comité advies dierproeven. Available at: <https://www.ncadierproevenbeleid.nl/actueel/weblog/weblogberichten/2016/september-2016> [Accessed 6 August 2017].
- Krewski, D., D. Acosta, M. Andersen, H. Anderson, J. Bailar, K. Boekelheide, R. Brent, G. Charnley, V. Cheung, S. Green, K. Kelsey, N. Kerkvliet, A. Li, L. McCray, O. Meyer, R. Patterson, W. Pennie, R. Scala, G. Solomon, M. Stephens, J. Yager, L. Zeise and Staff of Committee on Toxicity Test (2010). Toxicity Testing in the 21st Century: A Vision and a Strategy. *Journal of Toxicology and Environmental Health, Part B*, 13(2–4), pp. 51–138.
- Laronda, M.M., F.E. Duncan, J.E. Hornick, M. Xu, J.E. Pahnke, K.A. Whelan, L.D. Shea and T.K. Woodruff (2014). Alginate Encapsulation Supports the growth and Differentiation of Human Primordial Follicles Within Ovarian Cortical Tissue. *Journal of Assisted Reproduction and Genetics*, 31, pp. 1013–1028.
- Leist, M. (2016). Ohne ausreichende Forschungsförderung kommen Alternativmethoden zu Tierversuchen nicht voran. Eine Debatte der Leibniz-Gemeinschaft: Braucht Forschung Tierversuche?. *Tagesspiegel*. [online] Available at: <https://causa.tagesspiegel.de/opendebate/leibniz-debattiert/braucht-forschung-tierversuche/ohne-ausreichende-forschungsfoerderung-kommen-alternativmethoden-zu-tierversuchen-nicht-voran.html> [Accessed 4 August 2017].
- Linz School of Education (1999). *Der wissenschaftliche Erkenntnisfortschritt. Kriterien der Bewahrung und Verwerfung von Theorien. Methodologien wissenschaftlicher Forschungsprogramme*. Johannes-Kepler-Universität Linz, Abteilung für Bildungsforschung. [online] Available at: <http://paedpsych.jku.at:4711/LEHRTEXTE/Schmid99.html> [Accessed 6 August 2017].
- Maschmeyer, I., A.K. Lorenz, K. Schimek, T. Hasenberg, A.P. Ramme, J. Hübner, M. Lindner, C. Drewell, S. Bauer, A. Thomas, N.S. Sambo, F. Sonntag, R. Lauster and U. Marx (2015). A Four-Organ-Chip for Interconnected Long-Term Co-culture of Human Intestine, Liver, Skin and Kidney Equivalents. *Lab Chip*, 15/12, pp. 2688–2699.
- Miller, N.S. (2017). UCF Startup's Product Could Bypass Drug Tests on Animals. *Orlando Sentinel*, [online] Available at: <http://www.orlandosentinel.com/health/os-ucf-body-on-chip-hesperos-20170302-story.html> [Accessed 14 January 2018].
- National Toxicology Program (2018). *A Strategic Roadmap for Establishing New Approaches to Evaluate the Safety of Chemicals and Medical Products in the United States*. [online] Available at: <https://ntp.niehs.nih.gov/pubhealth/evalatm/natl-strategy/index.html> [Accessed 13 February 2018].
- NCad (2016a). *NCad Opinion: Transition to Non-Animal Research*. [online] Available at: <https://english.ncadierproevenbeleid.nl/latest/news/16/12/15/ncad-opinion-transition-to-non-animal-research> [Accessed 6 August 2017].
- NCad (2016b). *Opinion Provided by NCad as to How the Netherlands Can Become a Pioneer in Non-Animal Research*. [online] Available at: <https://english.ncadierproevenbeleid.nl/latest/news/16/12/15/ncad-opinion-transition-to-non-animal-research>

- ncadierproevenbeleid.nl/latest/news/16/12/15/ncad-opinion-transition-to-non-animal-research [Accessed 6 August 2017].
- NCad (2016c). *Request for Roadmap for Reducing Animal Procedures*. [online] Available at: <https://english.ncadierproevenbeleid.nl/documents/publications/16/9/30/letter-ministry-economic-affairs> [Accessed 6 August 2017].
- NCATS (2017a). *About Tox21*. [online] Available at: <https://ncats.nih.gov/tox21/about> [Accessed 6 August 2017].
- NCATS (2017b). *Tox21 Operational Model*. [online] Available at: <https://ncats.nih.gov/tox21/about/operations> [Accessed 5 August 2017].
- NCATS (2018). *Tissue Chips for Disease Modeling and Efficacy Testing*. [online] Available at: <https://ncats.nih.gov/tissuechip/projects/modeling> [Accessed 11 January 2018].
- Oberverwaltungsgericht Bremen (2012). *OVG: 1 A 180/10; 1 A 367/10*. Bremen: Supreme Administrative Court, p. 24. [online] Available at: <https://dejure.org/dienste/vernetzung/rechtsprechung?Gericht=OVG%20Bremen&Datum=11.12.2012&Aktenzeichen=1%20A%20180/10> [Accessed 3 August 2017].
- Oleaga, C., C. Bernabini, A.S. Smith, B. Srinivasan, M. Jackson, W. McLamb, V. Platt, R. Bridges, Y. Cai, N. Santhanam, B. Berry, S. Najjar, N. Akanda, X. Guo, C. Martin, G. Ekman, M.B. Esch, J. Langer, G. Ouedraogo, J. Cotovio, L. Breton, M.L. Shuler and J.J. Hickman (2016). Multi-organ Toxicity Demonstration in a Functional Human *In Vitro* System Composed of Four Organs. *Scientific Reports*, 6, p. 20030. [online] Available at: <https://www.nature.com/articles/srep20030> [Accessed 5 August 2017].
- Organisation for Economic Co-operation and Development, OECD (2017). *Integrated Approaches to Testing and Assessment (IATA)*. [online] Available at: <http://www.oecd.org/chemicalsafety/risk-assessment/iata-integrated-approaches-to-testing-and-assessment.htm> [Accessed 03 August 2017].
- Peters, A. and S. Stucki (2012). *Rechtsgutachten zu verschiedenen Fragen im Zusammenhang mit der EU-Tierversuchsrichtlinie*. University of Basel. [online] Available at: http://www.djgt.de/system/files/106/original/Rechtsgutachten_Umsetzung_EU-Tierversuchsrichtlinie.pdf [Accessed 26 July 2018].
- Ravenscroft, M.S., K.E. Bateman, K.M. Shaffer, H.M. Schessler, D.R. Jung, T.W. Schneider, C.B. Montgomery, T.L. Custer, A.E. Schaffner, Q.Y. Liu, Y.X. Li, J.L. Barker and J.J. Hickman (1998): Developmental Neurobiology Implications from Fabrication and Analysis of Hippocampal Neuronal Networks on Patterned Silane-Modified Surfaces. *Journal of the American Chemical Society*, 120(47), pp. 12169–12177.
- Redmond, C. (2019). When is an Alternative Not an Alternative? Supporting Progress for Absolute Replacement of Animals in Science. In: K. Herrmann and K. Jayne, eds., *Animal Experimentation: Working Towards a Paradigm Change*, Vol. 22. Brill Human Animal Studies Series, pp. 656–674. Leiden: Brill.

- SATIS (2017a). *SATIS – für humane Ausbildung “Ethik-Hochschulranking”*. [online] Available at: <http://www.satis-tierrechte.de/uni-ranking/> [Accessed 6 August 2017].
- SATIS (2017b). *Wassagen die Hochschulgesetze?* [online] Available at: <http://www.satis-tierrechte.de/wp-content/uploads/2017/01/Was-sagen-die-Hochschulgesetze-1.jpg> [Accessed 6 August 2017].
- Schaffner, A.E., J.L. Barker, D.A. Stenger and J.J. Hickman (1995). Investigation of the Factors Necessary for Growth of Hippocampal Neurons in a Defined System. *Journal of Neuroscience Methods*, 62(1–2), pp. 111–119.
- Schmiel, U. (2006). Erkenntnisfortschritt in der betriebswirtschaftlichen Steuerlehre. In: *Fortschritt in den Wirtschaftswissenschaften*. Wiesbaden: Deutscher Universitätsverlag, p. 148.
- Schöffl, H., H. Spielmann, F. Gruber, H. Appl, F. Harrer, W. Pfaller, H.A. Tritthart, eds. (2000). *Forschung ohne Tierversuche 2000*. Wien: Springer, pp. 123–124.
- SEURAT-1 (2013). *Seurat-1: Towards the Replacement of In Vivo Repeated Dose Systemic Toxicity Testing*. [online] Available at: <http://www.seurat-1.eu/pages/background.php> [Accessed 4 August 2017].
- Skory, R.M., Y. Xu, L.D. Shea and T.K. Woodruff (2015). Engineering the Ovarian Cycle Using *In Vitro* Follicle Culture. *Human Reproduction*, 30(6), pp. 1386–1395.
- Technische Universität Berlin, TU-Berlin (2017). *medbt: Studium*. [online] Available at: <http://www.medbt.tu-berlin.de/menue/studium/> [Accessed 6 August 2017].
- Universität Bayreuth, Lehrstuhl für Biochemie (2018). *Lehre*. [online] Available at: <http://www.biochemie.uni-bayreuth.de/de/teaching/index.html> [Accessed 6 August 2018].
- University of Konstanz (2018). *CAAT-Europe, Activities*. [online] Available at: <https://cms.uni-konstanz.de/leist/caat-europe/activities/> [Accessed 26 July 2018].
- Varga, O.E., A.K. Hansen, P. Sandøe and I.A.S. Olsson (2010). Validating Animal Models for Preclinical Research: A Scientific and Ethical Discussion. *Alternatives to Laboratory Animals*, 38, pp. 245–248. [online] Available at: <https://www.infracontier.eu/sites/infracontier.eu/files/upload/public/pdf/Validating%20animal%20models.pdf> [Accessed 12 Feb. 2018].
- Verband der Chemischen Industrie (2017). *Mehr Mut zur Innovation spürbar – Verband der Chemischen Industrie e.V. (VCI)* [online] Available at: <https://www.vci.de/themen/bundestagswahl/blog/mehr-mut-zur-innovation-spuerbar-editorial-cr-04-2017.jsp> [Accessed 6 August 2017].
- Wang, Y.I., C. Carmona, J.J. Hickman and M.L. Shuler (2016): Multiorgan Microphysiological Systems for Drug Development: Strategies, Advances, and Challenges. *Advanced Healthcare Materials*, 7(2), p. 1701000.
- Wyss Institute (2018). *Wyss Institute, Wyss Institute at Harvard*. [online] Available at: <https://wyss.harvard.edu/> [Accessed 26 July 2018].
- Xiao, S., J.R. Coppeta, H.P. Rogers, B.C. Isenberg, J. Zhu, S.A. Olalekan, K.E. McKinnon, D. Dokic, A.S. Rashedi, D.J. Haisenleder, S.S. Malpani, C.-A. Arnold-Murray, K. Chen,

- M. Jiang, L. Bai, C.T. Nguyen, J. Zhang, M.M. Laronda, T.J. Hope, K.P. Maniar, M.E. Pavone, M.J. Avram, E.C. Sefton, S. Getsios, J.E. Burdette, J.J. Kim, J.T. Borenstein and T.K. Woodruff (2017). A Microfluidic Culture Model of the Human Reproductive Tract and 28-day Menstrual Cycle. *Nature Communications*, 8, 14584.
- xStudy SE (2017a). *Applied Biology (B. Sc.) Hochschule Bonn-Rhein-Sieg, Sankt Augustin / Rheinbach / Hennef*. [online] Available at: <https://studieren.de/applied-biology-hochschule-bonn-rheinsieg-sankt-augustin-rheinbach-hennef.studienprofil.t-o.a-101.c-33409.html> [Accessed 6 August 2017].
- xStudy SE (2017b). *Biomedical Engineering, Master, Universität Lübeck*. [online] Available at: <https://studieren.de/biomedical-engineering-universitaet-zu-luebeck.studienprofil.t-o.a-446.c-259.html> [Accessed 6 August 2017].
- Zhang, B. and M. Radisic (2017). Organ-on-a-Chip Devices Advance to Market. *Lab on a Chip*, 17(14), pp. 2395–2420.
- Zhu, J., Y. Xu, A.S. Rashedi, M.E. Pavone, J.J. Kim, T.K. Woodruff and J.E. Burdette (2016). Human Fallopian Tube Epithelium Co-culture with Murine Ovarian Follicles Reveals Crosstalk in the Reproductive Cycle. *Molecular Human Reproduction*, 22(11), p. 756–767.
- ZonMw (2017). *Meer Kennis met Minder Dieren — In huis workshop systematisch literatuur onderzoek*. [online] Available at: https://www.zonmw.nl/fileadmin/zonmw/documenten/Corporate/Subsidies/PDF_s/Meer_Kennis_met_Minder_Dieren_-_In_huis_workshop_systematisch_literatuur_onderzoek_2.pdf [Accessed 4 August 2017].

Disease Prevention with a Plant-based Lifestyle

Sabina V. Vyas

Public Health Consultant Chronic disease prevention through plant-based nutrition. California, United States

1 Introduction

Animal experiments are commonly conducted to understand human diseases and responses to treatment. As decades of research indicate, the use of non-human animals (hereinafter referred to as animals) to translate the side effects, benefits, and impact of medications and treatments on the human body has been demonstrated to be ineffective; while billions of animals *and* humans have suffered (Shanks, Greek and Greek, 2009). Due to misleading safety and efficacy data from animal experiments, humans are often prescribed medications that may not be as effective or as safe as the patient, or even physician, may have been led to believe (Akhtar, 2015).

In the United States alone, over 820,000 animals were used for research in 2016. This number does not include many species, including mice, rats and aquatic animals, under the Animal Welfare Act (United States Department of Agriculture, USDA, 2017). It is estimated that up to 100 million mice and rats are used for research purposes in the US each year (Carbone, 2004). A number of species of farm animals are also used in research for the purpose of enhancing the agricultural industry. However, from an ethical standpoint, experimenting on animals subjects them to cruelty, costs billions of dollars a year, and often does not provide sufficient results to ensure human safety (Akhtar, 2015). A major reason that animal studies are ineffective is that human bodies are very different physiologically from other animals, including the way we develop diseases and how we absorb nutrients. Many advances have been made to create alternatives to animal testing, which are being adopted by scientists interested in innovative methods in research; and, yet, the use of animals for therapeutic testing is on the rise. To attain more accurate data regarding human health, there are no substitutes for human population- and clinical studies, particularly for lifestyle-related diseases, which may not be relevant to non-humans. This chapter addresses how we can make decisions towards disease *prevention* and reduce the demand for prescription drugs and, in turn, reduce animal research and testing, through the adoption of a whole foods, plant-based diet, which has

demonstrated to minimize and, in some cases reverse, lifestyle-related disease. The chapter focuses on conditions that can be preventable, where medication is avoidable, as opposed to conditions that require management with medical intervention.

2 The Unwanted Effects of Prescription Drugs

The use of medications to treat human diseases, while often a necessity, can also lead to a range of complications. About 4.5 million outpatient and emergency visits occur in the US each year for adverse drug reactions (Sarkar et al., 2011). Of those who are hospitalized, an additional 840,000 patients are given drugs that cause serious adverse reactions during their hospital stay (Light, 2014). In total, about 2.74 million Americans are impacted by complications from prescription drugs each year, and this does not account for the impact of over-the-counter medications (Light, 2014). Even proper use of prescription drugs may lead to death. The European Commission estimates that adverse reactions from prescription drugs cause almost 200,000 deaths a year in Europe (Light, 2014). In the US, an average of 128,000 deaths occur from properly prescribed medications annually. Combined, around 328,000 patients, in the US and Europe, die from properly prescribed prescription drugs each year (Light, 2014).

The global rise in chronic diseases has resulted in an increase in the research, development, and testing of prescription medication to address and stabilize conditions, such as type 2 diabetes, cancer, and heart disease. The Centers for Disease Control and Prevention (CDC) describes chronic diseases and conditions (e.g., heart disease, stroke, cancer, type 2 diabetes, obesity, and arthritis), among the most common, costly, and often *preventable* health issues in the US (CDC, 2017a). The rise in new prescription drugs on the market and increased consumption, due to an increase in lifestyle-related diseases, has resulted in an increase in animal research and testing. For example, according to the US Food and Drug Administration (FDA), new treatments are studied on laboratory animals to first determine potential toxicity before they can be tried on humans (FDA, 2014). These experiments identify side effects and the impact of medications on animals, but do not produce a complete or accurate translation of the medication's function and reaction in humans, including their effectiveness, toxicity, and side effects. Many people with chronic diseases take prescription drugs to better manage their conditions and achieve a better quality of life, although prescription drugs, especially for chronic conditions, often do not cure diseases or address their root causes. Prescription drugs are typically intended to alleviate symptoms or slow the advancement of a disease, and they may

even prolong life, but their side effects may require additional medications that can negatively impact patients' quality of life. Prescription medications can also lead to dependency and drug overdoses (National Institute on Drug Abuse, 2017). In the US alone, there has been a spike in opioid use and dependency, and among 47,055 drug related deaths in 2014, 28,647 (60.9%) involved an opioid (Rudd et al., 2016).

3 The Cost of Chronic Disease

While prescription drugs can prolong and improve patients' quality of life, they also lead to rising costs for patients and public healthcare systems. The United Kingdom (UK) spends £446 million, annually, of its National Health Service (NHS) budget on adverse drug reactions (Specialist Pharmacy Service, 2014). Unlike the UK, the US government does not provide a universal healthcare coverage plan, though it spends substantial funds towards healthcare. US residents with multiple chronic conditions often face extensive out-of-pocket costs for their care, including higher costs for prescription drugs (CDC, 2016a). The high cost of multiple prescriptions, paired with undesirable side effects and reduced quality of life, is a common issue among those living with chronic diseases. Our aging population is growing and the prevalence of risk factors, such as poor diet, obesity, and inactivity, are contributing factors to the prevalence of multiple chronic conditions in young people, adults, and the elderly. Obesity is among the top risk factors, mainly because it is directly linked to conditions, such as heart disease, stroke, type 2 diabetes, and certain types of cancer; these conditions are among the leading causes of preventable death and the most expensive to conditions treat (CDC, 2017a). Globally, we are facing an obesity epidemic; 36% of the world's population is overweight or obese (The GBD 2015 Obesity Collaborators, 2017). In the US, 70.7% of the adult population, 20 years and older, is either overweight or obese; and 37.9% are obese (CDC, 2017a, 2017c).

The burden of multiple chronic conditions affects 1 in 4 Americans, and that number increases to 3 in 4 over the age of 65 (CDC, 2016a). Treating chronic diseases, mental health, and associated high risk behaviors, accounts for 86% of the US government's \$2.7 trillion annual healthcare expenditures (CDC, 2017b). The US government spends more on healthcare than any other developed country, yet they experience the lowest life expectancy (Commonwealth Fund, 2015). A recent epidemiological study of the eating habits of more than 536,000 people linked meat consumption with increased death rates from nine major diseases, including cancer, heart disease, respiratory

diseases, stroke, diabetes, kidney disease, and liver disease (Etemadi et al., 2017). We should invest more funding and resources in a national, comprehensive, chronic disease-prevention approach and address policy, including corporate policies, to improve food creation and distribution standards, systems, and environments. It is with such changes that we can impact the masses and see a decline in new incidences of chronic diseases. Focusing on preventive medicine would allow for further research and application of human-relevant non-animal testing methods, since many chronic conditions that require treatment are influenced by human lifestyle choices. Research on the treatment of lifestyle-related conditions needs to focus on the human and the human lifestyle to be more effective. This focus could lead to a reduced demand for new lifestyle medications and may allow for greater application of innovative, non-animal methods in disease research and testing, consequently, reducing the number of animals used in these experiments. The concept of personalized medicine relies on the fact that humans are different from animals, and we need to rely on human-based research, using predictive human-based testing models, to tailor medicine effectively to the human population (Greek, Menache and Rice, 2012). It is possible to adopt a diet that benefits the health of humans and reduces or avoids the suffering of animals, including animals killed for consumption, animals involved in agricultural research, and animals used for research and testing of drug interventions and diseases. A whole food, plant-based diet, free from animal products, has been shown to be the most nutritious for our health; while it simultaneously avoids animal suffering and improves the sustainability of our environment and the planet.

4 Why Eat a Plant-based Diet?

4.1 *Health*

An abundance of research indicates that a whole foods, plant-based diet is effective in preventing and, in some cases, reversing chronic diseases. The US's Academy of Nutrition and Dietetics states that appropriately planned vegetarian and vegan, diets can be healthful and nutritionally adequate and may provide health benefits for the prevention and treatment of certain diseases (Melina, Craig and Levin, 2016). The British Association of Dietetics aligns with this statement, and states that a well-planned vegan diet supports healthy living for all ages and stages, including pregnancy, lactation, infancy, childhood, adolescence, older adulthood; and for athletes (British Dietetic Association, 2017; Melina, Craig and Levin, 2016). Eating a plant-based diet can help reduce the risk of, and possibly prevent, chronic conditions, such as ischemic heart

disease, type 2 diabetes, hypertension, certain types of cancer, and obesity (Melina, Craig and Levin, 2016). Research in this field has not gone unnoticed, and the US's largest managed care organization, Kaiser Permanente, recommends healthy eating in the form of a plant-based diet, as the first line of treatment against chronic diseases (Tuso, Ismail and Bartolotto, 2013). According to Kaiser Permanente, this diet should include plant foods in their whole form, especially vegetables, fruits, legumes, and seeds and nuts (in smaller amounts). For the greatest health benefits, this diet limits or eliminates animal products. Total fats, such as oils, are generally restricted (Tuso, Ismail and Bartolotto, 2013). In summary, to achieve optimum health whole, plant-based foods are encouraged, while meats, dairy, eggs, and all refined processed foods (including refined sugars) are discouraged. Similarly, the American Medical Association has called for the availability of healthful plant-based meals in schools, food assistance programs, and hospitals. They request that hospitals across the US reduce the availability of sugar-sweetened beverages and eliminate processed meats, in addition to including plant-based meals to improve the health of patients, staff, and visitors (Berg, 2017).

4.2 *Antibiotic Resistance*

An additional health concern associated with consumption of animals and their products, is antibiotic resistance. Animals raised in factory farms are often treated with sub-therapeutic antibiotics to promote growth or reduce the spread of infections among animals, due to the high concentration of animals in confined spaces. Long periods of exposure to antibiotics in animals may lead bacteria to become resistant and survive, and there is strong evidence that antibiotic use in animal livestock can lead to resistant infections in humans (CDC, 2016b). Furthermore, large numbers of animals are used for research and testing of antibiotic resistance, contributing to the number of animals affected by human lifestyle choices. Over 400,000 American residents become ill from antibiotic-resistant foodborne bacteria every year (CDC, 2016d). The top five pathogens that result in hospital stays in the US are salmonella, norovirus, campylobacter, Toxoplasma, and E. coli (CDC, 2016c). Antibiotic resistance is at the forefront of public health issues because it makes illnesses, which were once easily treated with antibiotics, more difficult to cure and more expensive to treat (CDC, 2016b). Humans can contract these infections in a number of ways: (1) Consuming contaminated meat could lead to an infection in humans; (2) Bacteria contaminants in the environment via infected stool can spread to produce through irrigated contaminated water; or (3) Bacteria can contaminate our water supply (CDC, 2016b). All animals carry bacteria in their intestines, and when they are slaughtered, these bacteria can contaminate meat or other animal products, whether antibiotic resistant bacteria or not (CDC,

2016b). Antibiotic resistant bacteria from animals can also contaminate non-animal produce but using care, by washing your hands and produce prior to consuming it, can reduce your risk of food borne illness (US Department of Health and Human Services, n.d.).

Eating health-promoting foods along with physical activity and stress management can help lead to overall well-being. Healthy eating and physical activity both contribute to keeping us healthy, and it is important to remember that while both are crucial, physical activity cannot undo the effects of a poor diet (Malhotra, Noakes and Phinney, 2015). Mental and emotional health are also important to our overall well-being and eating a diet rich in plants may play a role in accomplishing this balance. Research has shown that a plant-based diet not only reduces the risk of chronic diseases but also helps to boost overall mood and reduce anxiety, depression, and fatigue (Agarwal et al., 2015). Choosing to consume more plant-based foods can positively impact your health, both physically and mentally.

4.3 *Animals in Our Food System*

Eating a plant-based diet can also help reduce the contraction of illnesses caused by animal consumption while reducing harm to animals. While millions of animals are harmed each year from animal experimentation, in 2008, it was estimated that over 66 billion land animals were killed globally each year for human consumption (Food and Agriculture Organization of the United Nations, 2014). Farmed animals are not only used for human consumption; many are subject to experimentation under the premise of increasing production and the effectiveness of their use for human consumption (USDA Agricultural Research Service, n.d.). The findings from these experiments are intended to maximize products or outputs from these animals, which can lead to additional animal suffering due to the increased burden. Approximately US\$1.4 billion was spent on American agricultural animal research in 2016; US\$900 million in public funds and US\$500 million by private industry (Keen, 2019, Chapter 10 in this Volume).

To meet the demand for human consumption, billions of animals are raised on industrial factory farms or Concentrated Animal Feeding Operations (CAFOs), and the land area where animals congregate is often amongst feed, manure and urine, dead animals, and production operations (USDA National Resources Conservation Services, n.d.). CAFOs often lack direct sunlight and restrict movement due to the large number of animals held in a confined space to meet consumer demand; these animals may be caged, chained, or tethered. Confinement and lack of outdoor access often contribute to boredom and stress in animals, as they are unable to stretch, self-groom, or even turn their

bodies, which results in physical and psychological distress (Overcash, 2011). Manure can often be found on animals and this waste is often the source of infectious bacteria, such as *E. coli* and *Salmonella*, which affect human populations through contaminated food and water, contributing further to disease (The PEW Charitable Trusts, 2008). This further adds to the use of more antibiotics for both humans and farm animals.

CAFOs are typically large, with at least 1,000 large animals, such as cattle bred for beef. By definition, a CAFO equals 1,000 head of beef cattle, 700 dairy cows, 2,500 swine weighing more than 55 pounds, 125,000 broiler chickens, or 82 thousand laying hens, confined to the site for over 45 days out of the year (USDA National Resources Conservation Services, n.d.). Most farmed animals spend their lives in these conditions. Approximately 98% of the meat in the US comes from CAFOs on an annual basis, including approximately 31 million cattle and calves, 120 million pigs, 450 million hen-laying chickens, 9 billion chickens raised for meat, and 250 million turkeys that are killed for human consumption (USDA National Agricultural Statistics Service, 2017; 2016). Industrialized factory farming of animals began in the US over 50 years ago to increase efficiencies, and since then other countries have followed suit. In fact, the UK now has close to 800 mega farms, with similar concentrations and conditions to the US CAFOs (Wasley and Davies, 2017). The number of land animals killed for human consumption sheds light on the scale of global animal suffering, but the suffering does not end with land animals. The number of aquatic or sea animals killed for food each year is in the trillions, and whether farmed or caught from the wild, their suffering is often severe (Brooke and Mood, 2013). About 50% of the world's fish for consumption comes from fish farms (Food and Agriculture Organization of the United Nations, 2016). Much like CAFOs, the goal of maximizing profits leads to high density fish farms or aquaculture that are often breeding grounds for diseases that enter the water and the human food chain, requiring further research for antibiotics (McKeown and Halweil, 2009).

4.4 *Sustainability and Our Environment*

Plant-based diets are more environmentally sustainable and use fewer natural resources than diets based on animal products (Melina, Craig and Levin, 2016). Raising animals for food not only has significant impact on the suffering of animals, it has dire consequences for our environment as well. Worldwide, animal agriculture contributes to 14.5% of human-produced greenhouse gas emissions, which is more than all emissions from transportation, including planes, trains, and vehicles (Food and Agriculture Organization of the United Nations, 2013). In addition, pesticides, such as glyphosate, sprayed on crops fed to livestock are linked to water contamination. The world's demand for animal

agriculture has resulted in the loss of pastures, including rainforests, to raise livestock. Industrial animal agriculture is the leading cause of overfishing, the destruction of wildlife, deforestation, and the depletion of freshwater resources (United Nations, n.d.). In addition, cattle ranching, due to deforestation, leads to carbon dioxide emissions, loss of biodiversity, soil degradation, and water pollution (Food and Agriculture Organization of the United Nations, n.d.). Growing crops to feed livestock is another burden on the environment. Global agriculture accounts for 30% of greenhouse gas emissions, with a high percentage from animal agriculture and the grains grown to raise them (USDA, 2010). In fact, a third of the world's cereal harvest is fed to factory farmed animals (Compassion in World Farming, 2017). Globally, we could potentially feed 3 billion people with these grains rather than raise animals to be killed for human consumption (Compassion in World Farming, 2017). In the US, consumers eat more meat per capita than any other country in the world, and the hidden consequences of this consumption cost US\$400 billion a year, accounting for negative effects on the environment and human health (Simon, 2013a).

Discussions so far have presented a number of reasons for eating a plant-based diet—for health, including reducing antibiotic resistance, to support the environment, to reduce animal suffering, and reduce food insecurity. However, how do we transition to a more healthful diet that reduces the burden on animals used for experiments, and what are some of the major barriers to eating more healthfully? The following sections address what we can do at the individual level, the challenges we face at the systems, policy, and environmental levels, and how these challenges impact our individual choices to eat more health-promoting foods.

5 Making the Shift

5.1 *The Individual Level—Your Choices Matter*

Every day we make choices on what we eat. Are the foods we consume health-promoting or disease-promoting? Making the choice to consume more health-promoting foods, particularly a whole foods, plant-based diet, with minimally processed or added sugar, increases our ability to control our own health. Eating more plant-based, whole foods can lead to improvements in blood pressure, cholesterol, and blood sugar and may lead to weight loss (Tuso et al., 2013). Addressing these risk factors with food as medicine can be a first line of defense against chronic diseases and may allow you to stave off or reduce the use of expensive life-long medications and/or invasive medical procedures. Individual choices also impact demand in our food supply. For example, consumer

demand for plant-based milks has increased exponentially, and almond milk sales have grown by 250% in the past five years (Nielsen, 2016). In addition, 36% of American consumers prefer plant-based milks over traditional dairy (Nutrition Business Journal, 2015). In contrast, the traditional milk market has decreased by more than \$1 billion (Nielsen, 2016). In fact, the reduced demand for dairy has resulted in the US federal government purchasing a surplus of 11 million pounds of cheese for US\$20 million, to feed participants enrolled in food assistance programs due to a 30-year high surplus (USDA, 2016).

The shift in consuming more plant-based foods is on the rise, especially among the millennial and Z generations. In an age where younger generations have always had access to the internet and are accustomed to gaining information quickly, individuals are often more aware of the foods they eat. Among their top concerns about food are sustainability, animal welfare, and the healthfulness of food. Building awareness of where our food comes from and how it was produced is an important aspect of educating the masses. Being informed and making decisions on what you eat and how that impacts your personal health, animals, and the environment is empowering. At the individual level, the consumer can have an impact on reducing the need for animals in research on animal farming and testing of drugs for lifestyle-related diseases. Making a choice to purchase more whole plant-based foods puts money towards foods that are more sustainable, better for your health, and free of animal cruelty.

6 Challenges to Healthful Eating

Our diets have significantly changed over the past 50 years, and more so over the past 25 years, due to changes in farming practices and increased consumption of processed foods, meat, dairy, and eggs (Food and Agriculture Organization of the United Nations, 2017). At the same time, the number of animals used for disease research and the treatment of lifestyle-related diseases has also grown. We have choices in what we eat, but our choices are often influenced by a number of external factors.

6.1 Advertising

Food and beverage companies spend significant resources on promoting their products and often target children and adolescents. Research shows that advertising to children is an effective tactic to impact their food choices and attitudes towards food; and as most food advertising promotes unhealthy foods, its impact is negative. In 2012, the fast food industry spent US\$4.6 billion

on advertising, and children and teens were one of their primary audiences (Harris et al., 2013). Recent research from the Heart and Stroke Foundation of Canada reveals that “over 90% of food and beverage product ads viewed by kids and teens online are for unhealthy products, and collectively kids between the ages of 2 and 11 see 25 million food and beverage ads a year on their top 10 favorite websites” (Heart and Stroke Foundation of Canada, 2017, p. 8). Exposure to these advertisements may lead to an increase in poor food choices, possibly contributing to the development of obesity and chronic diseases.

6.2 *Funding Scientific Studies*

Large food corporations have large budgets for advertising and many also spend millions of dollars funding scientific research. Research has shown that industry sponsorship of studies often leads to bias in research outcomes (Bes-Rastrollo et al., 2013). For example, The Coca-Cola Company funds scientists and organizations to promote physical activity, as the main driver to reducing obesity, rather than focusing on diet. Examples of funding recipients, include the National Parks and Recreation Association, Boys and Girls Club of America, and the Morehouse School of Medicine, Inc. (The Coca-Cola Company, n.d.). The Coca-Cola Company has also been known to use the influence of food industry representatives over scientific entities and medical associations to guide the debate in the interest of the food industry (Sacks, G. et al., 2017). Large food corporations provide funding to healthcare and nutrition focused organizations as well. By funding scientists and organizations, corporations influence research to focus on physical activity, for example, as the primary contributing factor in obesity rather than diet and healthful eating. A recent study found that 95 national health organizations in the US, including medical and public health institutions that focus on obesity prevention, received funding from either The Coca-Cola Company or PepsiCo from 2011–2015 (Aaron and Siegel, 2017). The Academy of Nutrition and Dietetics, the US’s national association representing dietitians, has corporate sponsors, including Coca-Cola, Kraft Foods, Nestlé, Kellogg, the National Dairy Council, National Cattleman’s Beef Association, ConAgra foods, and General Mills, many of which also provide continuing education credits for attending their educational sessions (Simon, 2013b). Corporate influence over healthcare organizations, scientists, and dietitians, in addition to the advertising and marketing of unhealthy foods, can influence the messages we receive from those we consider experts and lead to confusion about health-promoting foods, consequently, influencing our choices in favor of unhealthful foods.

Food companies have also been found to use animal experimentation to develop new ingredients or test the effectiveness of their food products in

improving health. Animal experiments are conducted with the purpose of making health claims about their food products and generally result in ending animals' lives. Nestlé, Danone, and Yakult are among a few companies that have experimented on animals. Nestlé provides information to consumers on their approach to animal experimentation on their company website (Nestlé, n.d.). Major companies are also expanding their research approaches to include non-animal approaches to ensure consumer safety.

6.3 Access to Healthy Food

Unhealthy foods are profusely advertised in underserved populations, and research shows that people with lower socioeconomic status and communities of color are more likely to have access to an abundance of unhealthy fast foods and less access to healthy foods. Many of these communities are food deserts, where grocery stores or supermarkets are not in close proximity (PolicyLink and The Food Trust, 2013). Unfortunately, the grocery or corner stores in these neighborhoods often show a disparity in the quality, variety, quantity, and price of healthy foods they offer (PolicyLink and The Food Trust, 2013). For those receiving government funding, the US's Supplemental Nutrition Assistance Program (SNAP), formerly called *food stamps*, provides recipients with funds/credit to be used towards the purchase of food; and the SNAP program pays retailers for the amount of food purchased. Currently, the SNAP program does not have a health focus, and funds can be used to purchase meat; dairy products; candy; energy drinks; and, essentially, any food product (USDA Food and Nutrition Services, 2017). Studies have shown that, in some cases, SNAP participants have worse diets and may be more likely to be obese than non-participants (Condon et al., 2015).

6.4 Government and Food

There are a multitude of initiatives focused on countering the obesity epidemic led by government funded surveillance and public health programs, non-government organizations, and healthcare organizations and their affiliates. Public health programs are not funded at the same the level as the food industry's programs, nor are they able to use government funds to lobby for better policies. Public health agencies dedicate significant resources to promote healthy behaviors, but the traditional food and beverage industries have much larger budgets to counteract these efforts. In 2016, food and beverage companies spent over US\$31 million on lobbying to establish legislation to protect or improve the sales of their products or to fight against legislation that could impact their bottom line (Center for Responsive Politics, 2016).

6.5 *Subsidies*

The United States Department of Agriculture (USDA) leads public policy on food, agriculture, natural resources, rural development, nutrition, and related issues (USDA, n.d. a). The top focal areas of the USDA are to support farmers and ranchers, in addition to administering nutrition assistance programs, providing nutrition education, and creating dietary guidelines every five years, in conjunction with the United States Department of Health and Human Services (USDA, n.d. b). The multiple roles the USDA plays are often viewed with scrutiny, since the USDA creates guidelines on what Americans should eat, while supporting the promotion of and financial incentives for farmers of the commodities outlined in their dietary recommendations. For example, the USDA recommends the consumption of the following four food groups for a balanced diet: vegetables, fruits, grains, and proteins and three servings of dairy a day (ChooseMyPlate, n.d.). However, dairy products contain significant amounts of cholesterol and saturated fat, and cheese is the number one source of saturated fat in the American diet (National Cancer Institute Epidemiology and Genomics Research Program, n.d.; Physicians Committee for Responsible Medicine, n.d. b). There are a number of plant-based sources that have equivalent calcium to dairy, or even higher; and consumption of dairy has been shown to have little or no impact on bone health. Indeed, some studies have shown that increased dairy consumption is linked to increased fractures (Schooling, 2014). Furthermore, calcium needs can be met by eating plant-based foods instead (USDA Food Composition Databases, n.d.). The USDA also recommends choosing lean or low-fat meat and poultry and mentions that processed meats have added sodium; but it fails to mention that processed meats are considered a Group 1 carcinogenic food, linked to colorectal cancer; and that red meat was identified as a probable carcinogenic by the World Health Organization (World Health Organization International Agency for Research on Cancer, 2015). Red meat is also linked to increased rates of cardiovascular disease (Pan et al., 2012). Due to its close ties to major stakeholders (i.e., dairy, meat, and egg industries), the USDA would have to consider the economic impact of their actions should they deem these foods unnecessary for a healthy American diet. Recommendations for the Dietary Guidelines are made by researchers and experts in the field of nutrition, but the guidelines appear to include foods not present in these recommendations, such as some forms of dairy and meat (Heid, 2016). Although research supports a plant-forward or plant-based diet, the USDA is in a precarious position, since it is heavily influenced by lobbying (perhaps even data manipulation) by major stakeholders from the meat, dairy, and egg industries (Heid, 2016).

Dairy and animal agriculture are among the commodities that receive the highest subsidies from the government. The US government provides subsidies to farmers and ranchers for commodity crops and livestock, with corn and soy at the top of the list. 63% of food subsidies support crops grown for feed or livestock, of which corn and soy are a major proportion (Physicians Committee for Responsible Medicine, n.d. a). About 20% of subsidies support grains for human consumption; 15% support crops, such as sugars, or crops that become sweeteners, starch, oil, and alcohol for human consumption; and 2% support fruits, vegetables, legumes, and nuts for human consumption (Physicians Committee for Responsible Medicine, n.d. a). This may seem alarming. *More money is spent on subsidies to provide farm animals with feed or to raise livestock than for direct human consumption.* Yes, that is correct. Furthermore, the dairy program alone received US\$5.6 billion in subsidies from 1995–2014 (Environmental Working Group, n.d.). Governmental subsidies saved the animal agriculture industry US\$35 billion from 1995–2005 (Physicians Committee for Responsible Medicine, n.d. a). The breakdown of subsidy allocation is significant because it reflects a misalignment between healthy eating guidance and financial government incentives. to support healthy eating by the government.

In the US, all taxpayers contribute to subsidies that impact their health and environment and contribute to animal suffering. Around 20 billion in tax dollars are used annually to support agriculture subsidies and insurance, a bulk of which goes towards crops for livestock feed (US Government Accountability Office, 2017). US taxpayers contribute to funding for animal experimentation as well. Approximately 47% of the research budget of the National Institutes of Health includes an animal experimentation component, which results in US\$12 billion–US\$14.5 billion spent by taxpayers on animal experimentation annually (Pankevich et al., 2012). In addition to subsidies, the USDA oversees Research and Promotion programs, otherwise known as check-off programs, that support agriculture commodities voted on by farmers. These programs allow the government to use funding for private commercial goals, including advertising campaigns and research on the nutritional quality of agriculture commodities, without highlighting any particular producer or brand (National Agricultural Law Center, n.d.). The goal of these checkoff programs is to help improve the market position of chosen commodities by expanding markets, increasing demand, and developing new uses and markets (National Agricultural Law Center, n.d.). Examples of check-off programs include, “Got Milk?”; “Beef—It’s What’s for Dinner”; and “Pork, The Other White Meat.” Research and promotion check-off programs fund the beef, milk, dairy, lamb, and poultry commodity groups, totaling approximately US\$560 million per year (Simon,

2013a). Ultimately, the money spent on livestock research is for the purpose of increasing meat, dairy, and egg consumption.

6.6 *Policy Shifts*

Subsidies are not unique to the US, and similar programs providing financial incentives, especially for animal agriculture, exist in the European Union and Australia, among others. With the marketing efforts the food industry targets at children and adults, and the subsidies and indirect funds that animal agriculture receives to promote their products and protect their bottom line, the barriers to healthy eating are increasingly apparent. Animal products, such as meat, dairy, and eggs are artificially viewed as cheaper alternatives to plant-based foods, which are healthier and cause less harm to the environment or to animals. Subsidies should be re-visited to assess the need for these programs; and, if they are deemed necessary, they should align with more health promoting commodities used for human consumption. Some progress is being made, for example, the American Medical Association has called on the federal government to provide SNAP recipients with incentives for purchasing healthful foods, in an effort to improve their diets (Berg, 2017). SNAP retailers receive reimbursement for selling healthful foods but not for foods that promote disease. This shift could lead to more retailers stocking fresh produce, whole grains, beans, nuts, and seeds and healthy plant-based packaged foods. This call on the government should be further explored and implemented to improve access to healthful foods for SNAP recipients and underserved communities.

Creating a healthier food environment is an important step in improving access to healthy foods. Policies need to address widespread advertising of unhealthy foods, especially in lower income neighborhoods, while increasing the availability of healthful foods and creating healthier food standards for government assistance programs, such as SNAP and food pantries. In addition, the Dietary Guidelines should reflect current evidenced-based-research and include sustainable sources of food. The government should consider increasing support of farmers that grow plant-based crops, using sustainable farming practices, and offer support to farmers in declining animal agriculture industries to transition their skills, equipment, land, and training to farm plant-based crops, which are thriving, are considered health promoting foods, do not cause harm to animals, and are grown sustainably.

How we look at what constitutes as food is important. Based on centuries of research, we know that eating a diet rich in vegetables, fruits, whole grains, legumes, and nuts in small portions, is good for our health. The tobacco movement has had significant successes in raising awareness of its harmful health effects; and, with system and policy changes, such as implementing taxes on

the sale of tobacco products, it has contributed to the decline in tobacco use. Though policy shifts are challenging to implement, and for tobacco these shifts took decades, the current foods systems across the globe may benefit from adopting proven strategies from the tobacco movement and tailoring them to combat lifestyle-related diseases. By removing subsidies for unhealthy foods, their true cost will be reflected in their price, which alone may create changes in purchasing behavior. The result of removing subsidies for, and possibly implementing taxes on, these foods could lead to a significant reduction in greenhouse gases, hundreds of thousands human lives saved each year from reductions in meat, dairy, and egg consumption (Nature Climate Change, 2016); as well as a reduction in the need for involving animals in research on agriculture and lifestyle-related diseases. In the meantime, individual lifestyle choices can go a long way to prevent the human, animal, and environmental harms caused by animal agriculture.

7 The Gap—Medical Training and Nutrition

When we are ill, we visit our physician in hopes that they will provide a solution to *fix* our ailment. Physicians are seen as the *go-to* source when we are feeling unwell, and rightfully so; they are required to attend numerous years of schooling, pass extremely difficult qualifying exams, and undergo years of training, with long hours in residency and fellowship programs. Based on this extensive training, we assume that physicians are the best source for nutritional advice as well. The surprising fact is that most physicians receive very little nutrition education in their training (on average 20 hours or less) (Krebs and Primak, 2006). The lack of training they receive in medical school does not lend itself to using food as medicine or as the first line of treatment in combatting chronic diseases (Devries et al., 2014). Non-animal technologies, such as the organ on a chip, are contributing to the development of personalized medicine, which can benefit lifestyle disease research. In addition to nutrition training, we also need more training in animal-free research and development and in animal-free education and training (cf. e.g., Bones et al., 2019, Chapter 23; Herrmann, 2019, Chapter 1; Pawlowski et al., 2019, Chapter 22 in this Volume).

While physicians do not receive sufficient training in nutrition, they receive rigorous training in treating diseases with prescription medications in medical school and during their residency (Kshirsagar and Vu, 2016). Pharmaceutical companies reach out directly to physicians to market and provide education on their company's pharmaceutical drugs (Kshirsagar and Vu, 2016). This

marketing entails gifts, sponsored lunches, promotional items, direct mailings, consultations, and samples. Many of the pharmaceutical companies spend more on marketing and promotion than on research and development. Research shows that marketing to physicians often results in an increase in their prescribing the promoted pharmaceuticals (Goodman, 2001). There has also been an increase in direct marketing to consumers by pharmaceutical companies (FDA, 2015). Policy reform should take into account the ethics of these practices, since consumers, like physicians, can be influenced by pharmaceutical marketing to seek out promoted medications that may not align with evidence-based science. What is more, the pharmaceutical industry is one of the main contributors to animal experimentation.

Since physicians are not traditionally trained in the use of a whole foods, plant-based diet to prevent or reverse disease, the status quo of prescribing medications to address symptoms or risk factors for a condition(s) continues. Physicians may have dietitians, nurses, health educators, or health coaches on staff that provide more in-depth nutrition education; but physicians should receive additional training on the benefits of eating a whole foods, plant-based diet to improve health. Increasing the requirements for nutrition education and ensuring physicians are paid for these efforts would be a step towards progress (Greger, 2013).

8 A Plant-based Future

This chapter provides a snapshot of our current food climate and how eating a whole foods, plant-based diet can help improve our health, reduce our demand for prescription drugs for lifestyle-related diseases, reduce the associated intensity of animal-based disease research (for human and agricultural diseases), avoid contributing to farm animal suffering, and protect our environment. Eating a whole foods, plant-based diet can save billions of dollars in personal healthcare costs, as well as costs associated with antibiotic resistance and disease research. It can reduce greenhouse gases and offset the grains used for livestock, to diversify crops and feed millions of people without food security.

Educating populations about the origins of our food and how the choices we make when deciding what goes in our mouth not only impacts our own bodies but the environment and billions of animals. That said, education must be associated with changes to policies and an environment that supports the production and distribution of health promoting foods. This should include

removing subsidies for disease promoting foods, providing incentives to purchase health promoting foods, and creating environments where healthful foods are easily accessible.

To better serve our populations, physicians need more education and training on the role of nutrition in disease prevention while in medical school and through continued training in nutrition research. A shift is needed—the gold standard of using animals in identifying appropriate prescription drugs for humans must be reevaluated and the focus must shift to advancing non-animal research methods that are more accurate and human-relevant (Akhtar, 2015). Animal-free technologies that help develop personalized medicine should be encouraged as well. We must invest in human and clinical studies that reflect human responses to disease rather than relying on results from animal studies. Advocates for non-animal research methods need to continue to build awareness of the benefits and effectiveness of non-animal research and testing methods for helping those suffering from lifestyle-related diseases, while we continue our efforts to improve the population health of our nations.

At an individual level, by opting for a whole foods, plant-based diet, we can help reduce the need for new prescription drugs to treat illnesses and can benefit from advances in animal-free pathways for biomedical research to save animals, our health, the economy, and our environment.

References

- Aaron, D.G. and M.B. Siegel (2017). Sponsorship of National Health Organizations by Two Major Soda Companies. *American Journal of Preventive Medicine*, 52(1), pp. 20–30. [online] Available at: [https://www.ajpmonline.org/article/S0749-3797\(16\)30331-2/fulltext](https://www.ajpmonline.org/article/S0749-3797(16)30331-2/fulltext) [Accessed 21 July 2017].
- Agarwal, U., S. Mishra, J. Xu, S. Levin, J. Gonzales and N.D. Barnard (2015). A Multicenter Randomized Controlled Trial of a Nutrition Intervention Program in a Multiethnic Adult Population in The Corporate Setting Reduces Depression and Anxiety and Improves Quality of Life: The GEICO Study. *American Journal of Health Promotion*, 29(4), pp. 245–254.
- Akhtar, A. (2015). The Flaws and Human Harms of Animal Experimentation. *Cambridge Quarterly Healthcare Ethics*, 24(4), pp. 407–419. [online]. Available at: https://www.cambridge.org/core/services/aop-cambridge-core/content/view/78D1F5E6B65AE7157B7AA85FF3F06017/S0963180115000079a.pdf/flaws_and_human_harms_of_animal_experimentation.pdf [Accessed 29 June 2017].

- Berg, S. (2017). AMA Backs Comprehensive Approach Targeting Sugary Drinks. *American Medical Association (AMA) Wire*. [online] Available at: <https://wire.ama-assn.org/ama-news/ama-backs-comprehensive-approach-targeting-sugary-drinks> [Accessed 24 August 2017].
- Bes-Rastrollo, M., M.B. Schulze, M. Ruiz-Canela and M.A. Martinez-Gonzalez (2013). Financial Conflicts of Interest and Reporting Bias Regarding the Association Between Sugar-sweetened Beverages and Weight Gain: A Systematic Review of Systematic Reviews. *PLoS Medicine*, 10(12), p. e1001578 [online] Available at: <http://journals.plos.org/plosmedicine/article?id=10.1371/journal.pmed.1001578> [Accessed 5 May 2018].
- Bones, V.C., R.C.M. Garcia, G.G. Alves, R.L. Paixão, A.A. Rocha, K.V. Capilé and R. Bachinski (2019). Humane education: The tool for scientific revolution in Brazil. In: K. Herrmann and K. Jayne, eds., *Animal Experimentation: Working Towards a Paradigm Change*, Vol. 22. Location: Brill Human Animal Studies Series, pp. 567–582.
- British Dietetic Association (2017). *British Dietetic Association Confirms Well-planned Vegan Diets Can Support Healthy Living in People of all Ages*. [online] Available at: <https://www.bda.uk.com/news/view?id=179> [Accessed 27 August 2017].
- Brooke, P. and A. Mood (2013). *The Welfare of Fish in Commercial Fishing*. [online] Available at: <http://fishcount.org.uk/published/high/fishcount-presentation1-2013HR.pdf> [Accessed 12 July 2017].
- Carbone, L. (2004). *What animals want: expertise and advocacy in laboratory animal welfare policy*. New York, NY: Oxford University Press.
- CDC (2016a). *Multiple Chronic Conditions: Chronic Disease Prevention and Health Promotion*. [online] Available at: <https://www.cdc.gov/chronicdisease/about/multiple-chronic.htm> [Accessed 13 July 2017].
- CDC (2016b). *Antibiotic Resistance: NARMS*. [online] Available at: <https://www.cdc.gov/narms/faq.html> [Accessed 15 July 2017].
- CDC (2016c). *Burden of Foodborne Illness: Findings*. [online] Available at: <https://www.cdc.gov/foodborneburden/2011-foodborne-estimates.html> [Accessed 20 July 2017].
- CDC (2016d). *Protecting the Food Supply: Antibiotic/Antimicrobial Resistance*. [online] Available at: https://www.cdc.gov/drugresistance/protecting_food-supply.html [Accessed 12 July 2017].
- CDC (2017a). *Adult Obesity Facts: Overweight & Obesity*. [online] Available at: <https://www.cdc.gov/obesity/data/adult.html> [Accessed 5 July 2017].
- CDC (2017b). *Chronic Disease Overview: Chronic Disease Prevention and Health Promotion*. [online] Available at: <https://www.cdc.gov/chronicdisease/overview/index.htm> [Accessed 12 July 2017].
- CDC (2017c). *FastStats Obesity and Overweight*. [online] Available at: <https://www.cdc.gov/nchs/fastats/obesity-overweight.htm> [Accessed 16 July 2017].

- Center for Responsive Politics (2016). *OpenSecrets: Lobbying Spending Database Food & Beverage*. [online] Available at: <https://www.opensecrets.org/lobby/industries.php?id=Noi&year=2016> [Accessed 14 August 2017].
- ChooseMyPlate (n.d.). *MyPlate*. [online] Available at: <https://www.choosemyplate.gov/MyPlate> [Accessed 22 July 2017].
- Commonwealth Fund (2015). *US Spends More on Health Care Than Other High-income Nations but Has Lower Life Expectancy, Worse Health*. [online] Available at: <http://www.commonwealthfund.org/publications/press-releases/2015/oct/us-spends-more-on-health-care-than-other-nations> [Accessed 16 July 2017].
- Compassion in World Farming (2017). *Strategic Plan 2013–2017 for Kinder, Fairer Farming Worldwide*. [online] Available at: https://www.ciwf.org.uk/media/3640540/ciwf_strategic_plan_20132017.pdf [Accessed 11 July 2017].
- Condon, E., S. Drilea, K. Jowers, C. Lichtenstein, J. Mabli, E. Madden and K. Niland (2015). *Diet Quality of Americans by Snap Participation Status: Data from the National Health and Nutrition Examination Survey, 2007–2010*. Walter R. McDonald & Associates, Inc. and Mathematica Policy Research for the Food and Nutrition Service. [online] Available at: <https://www.fns.usda.gov/sites/default/files/ops/NHANES-SNAP07-10.pdf> [Accessed 21 August, 2017].
- Devries, S., J. Dalen, D. Eisenberg, V. Maizes, D. Ornish, A. Prasad, V. Sierpina, A. Weil and W. Willett (2014). *A Deficiency of Nutrition Education in Medical Training*. [online] Available at: <http://dx.doi.org/10.1016/j.amjmed.2014.04.003> [Accessed 25 July 2017].
- Environmental Working Group (n.d.). *EWG's Farm Subsidy Database – Dairy Program Subsidies in the United States Totalled \$5.6 Billion from 1995–2014*. [online] Available at: <https://farm.ewg.org/progdetail.php?fiips=00000&progcode=dairy> [Accessed 23 July 2017].
- Etemadi, A., R. Sinha, M.H. Ward, B.I. Graubard, M. Inoue-Choi, S.M. Dawsey and C.C. Abnet (2017). Mortality from Different Causes Associated with Meat, Heme Iron, Nitrates, and Nitrites in the NIH-AARP Diet and Health Study: Population-based Cohort Study. *British Medical Journal*, 357, j1957. [online] Available at: <http://doi.org/10.1136/bmj.j1957> [Accessed 30 April 2018].
- FDA (2014). *Inside Clinical Trials: Testing Medical Products in People*. [online] Available at: <https://www.fda.gov/drugs/resourcesforyou/consumers/ucm143531.htm> [Accessed 13 July 2017].
- FDA (2015). *The Impact of Direct-to-consumer Advertising*. [online] Available at: <https://www.fda.gov/drugs/resourcesforyou/consumers/ucm143562.htm> [Accessed 26 July 2017].
- Food and Agriculture Organization of the United Nations (n.d.). *Livestock Policy Brief 03: Cattle Ranching and Deforestation*. Rome, Italy: Livestock Information, Sector Analysis, and Policy Branch (AGAL) of the Animal Production and Health Division

- of the Food and Agriculture Organization of the United Nations. [online] Available at: <http://www.fao.org/3/a-a0262e.pdf> [Accessed 11 July 2017].
- Food and Agriculture Organization of the United Nations (2013). *Tackling Climate Change Through Livestock*. Rome, Italy: Food and Agriculture Organization of the United Nations. [online] Available at: <http://www.fao.org/3/i3437e.pdf> [Accessed 15 July 2017].
- Food and Agriculture Organization of the United Nations (2014). *Food and Agriculture Data*. Rome, Italy: Food and Agriculture Organization of the United Nations. [online] Available: <http://faostat.fao.org/> [Accessed 24 June 2017].
- Food and Agriculture Organization of the United Nations (2016). *The State of World Fisheries and Aquaculture 2016. Contributing to Food Security and Nutrition for all*. Rome, Italy: Food and Agriculture Organization of the United Nations. [online] Available at: <http://www.fao.org/3/a-i5555e.pdf> [Accessed 5 July 2017].
- Food and Agriculture Organization of the United Nations (2017). *The Future of Food and Agriculture – Trends and Challenges*. Rome, Italy: Food and Agriculture Organization of the United Nations. [online] Available at: <http://www.fao.org/3/a-i6583e.pdf> [Accessed 22 July 2017].
- Goodman, B. (2001). *Do Drug Company Promotions Influence Physician Behavior?* [online] Available at: <https://www.ncbi.nlm.nih.gov/pmc/articles/PMC1071337/> [Accessed 1 August 2017].
- Greek, R., A. Menache and M.J. Rice (2012). Animal Models in an Age of Personalized Medicine. *Personalized Medicine*, 9(1), pp. 47–64. [online] Available at: <https://doi.org/10.2217/pme.11.89> [Accessed 13 April 2018].
- Greger, M. (2013). *Lifestyle Medicine: Treating the Causes of Disease*. NutritionFacts.org. [online] Available at: <https://nutritionfacts.org/video/lifestyle-medicine-treating-the-causes-of-disease/> [Accessed 25 July 2017].
- Harris, J., M. Schwartz, C. Munsell, C. Dembek, S. Liu, M. LoDolce, A. Heard, F. Fleming-Milici and B. Kidd (2013). *Fast food FACTS 2013: Measuring Progress in Nutrition and Marketing to Children and Teens*. Yale University Rudd Center for Food Policy & Obesity. [online] p. vi. Available at: http://www.fastfoodmarketing.org/media/FastFoodFACTS_Report.pdf [Accessed 23 August 2017].
- Heart and Stroke Foundation of Canada (2017). *The Kids Are Not Alright. How the Food and Beverage Industry Is Marketing Our Children and Youth to Death. 2017 Report on the Health of Canadians*. [online] p. 8. Available at: <https://www.heartandstroke.ca/-/media/pdf-files/canada/2017-heart-month/heartandstroke-reportonhealth2017.ashx> [Accessed 18 July 2017].
- Heid, M. (2016). Experts Say Lobbying Skewed the U.S. Dietary Guidelines. *Time Health*. [online] Available at: <http://time.com/4130043/lobbying-politics-dietary-guidelines> [Accessed 30 April 2018].

- Herrmann, K. (2019). Refinement on the way towards Replacement: Are we doing what we can? In: K. Herrmann and K. Jayne, eds., *Animal Experimentation: Working Towards a Paradigm Change*, Vol. 22. Brill Human Animal Studies Series, pp. 3–64. Leiden: Brill.
- Keen, J. (2019). Wasted money in US biomedical and agricultural animal research. In: K. Herrmann and K. Jayne, eds., *Animal Experimentation: Working Towards a Paradigm Change*, Vol. 22. Brill Human Animal Studies Series, pp. 244–272. Leiden: Brill.
- Krebs, N. and L. Primak (2006). Comprehensive Integration of Nutrition into Medical Training. *The American Journal of Clinical Nutrition*, 83(4), pp. 945S–950S [online] Available at: <https://doi.org/10.1093/ajcn/83.4.945S> [Accessed 13 April 2018].
- Kshirsagar, R. and P. Vu (2016). *The Pharmaceutical Industry's Role in US Medical Education*. [online]. Available at: <http://in-training.org/drugged-greed-pharmaceutical-industrys-role-us-medical-education-10639> [Accessed 1 August 2017].
- Light, D.W. (2014). *New Prescription Drugs: A Major Health Risk With Few Offsetting Advantages*. Harvard University Edmond J Safra Centre of Ethics. [blog] Available at: <https://ethics.harvard.edu/blog/new-prescription-drugs-major-health-risk-few-offsetting-advantages> [Accessed 30 July 2018].
- Malhotra, A., T. Noakes, and S. Phinney (2015). It Is Time to Bust the Myth of Physical Inactivity and Obesity: You Cannot Outrun a Bad Diet. *British Journal of Sports Medicine*, 49, pp. 967–968. [online] Available at: <http://dx.doi.org/10.1136/bjsports-2015-094911> [Accessed 02 July 2017].
- McKeown, A. and B. Halweil (2009). *Vital signs 2009*. Washington DC: WorldWatch Institute, p. 22.
- Melina, V., W. Craig and S. Levin (2016). *Position of the Academy of Nutrition and Dietetics: Vegetarian Diets*. [online] Available at: <http://jandonline.org/article/S2212-2672%2816%2931192-3/fulltext> [Accessed 10 August 2017].
- National Agricultural Law Center (n.d.). *Checkoff Programs*. [online] Available at: <http://nationalaglawcenter.org/research-by-topic/checkoff-programs/> [Accessed 24 July 2017].
- National Cancer Institute Division of Cancer Control and Population Sciences. (n.d). Table 1. Top sources of Saturated Fat Among U.S. Population, 2005–2006 NHANES [online] Available at: https://epi.grants.cancer.gov/diet/foodsources/sat_fat/sf.html [Accessed 26 July 2017].
- National Institute on Drug Abuse (2017). *Opioids*. [online] Available at: <https://www.drugabuse.gov/drugs-abuse/opioids> [Accessed 14 July 2017].
- Nature Climate Change (2016). *Mitigation Potential and Global Health Impacts from Emissions Pricing of Food Commodities*. [online] Available at: <https://www.nature.com/nclimate/journal/v7/n1/full/nclimate3155.html> [Accessed 25 July 2017].

- Nestlé (n.d.). *Do You Test Your Products on Animals?* [online] Available at: <https://www.nestle.com/ask-nestle/products-brands/answers/do-you-test-your-products-on-animals> [Accessed 15 August 2017].
- Nielsen (2016). *Americans Are Nuts for Almond Milk.* [online] Available at: <http://www.nielsen.com/us/en/insights/news/2016/americans-are-nuts-for-almond-milk.html> [Accessed 9 July 2017].
- Nutrition Business Journal (2015). *2015 Food Tribes Report.* [online] Available at: <https://www.prnewswire.com/news-releases/nutrition-business-journal-announces-the-2015-food-tribes-report-300073987.html> [Accessed 9 July 2017].
- Overcash, E. (2011). *Animal Legal & Historical Center: Overview of CAFOs and Animal Welfare Measures.* Animallaw.info [online] Available at: <https://www.animallaw.info/article/overview-cafos-and-animal-welfare-measures> [Accessed 18 July 2017].
- Pan, A., Q. Sun, A.M. Bernstein, M.B. Schulze, J.E. Manson, M.J. Stampfer, W.C. Willett and F.B. Hu (2012). Red Meat Consumption and Mortality: Results from 2 Prospective Cohort Studies. *Archives of Internal Medicine*, 172(7), pp. 555–563 [online] Available at: <https://www.ncbi.nlm.nih.gov/pmc/articles/PMC3712342/> [Accessed 10 August 2017].
- Pankevich, D., T. Wizemann, A. Mazza and B. Altevogt (2012). *International Animal Research Regulations: Impact on Neuroscience Research. Workshop Summary.* Washington, DC: National Academies Press, IOM Institute for Laboratory Animal Research. [online] Available at: <https://www.ncbi.nlm.nih.gov/books/NBK100123/> [Accessed 18 July 2018].
- Pawlowski, J., D. Feinstein, M.L. Crandall and S. Gala (2019). Modernizing biomedical training: Replacing live animal laboratories with human simulation. In: K. Hermann and K. Jayne, eds., *Animal Experimentation: Working Towards a Paradigm Change*, Vol. 22. Brill Human Animal Studies Series, pp. 551–566. Leiden: Brill.
- Physicians Committee for Responsible Medicine (n.d. a). *Agriculture and Health Policies in Conflict: How Subsidies Tax Our Health.* [online] Available at: <http://www.pcrm.org/health/reports/agriculture-and-health-policies-ag-versus-health> [Accessed 24 July 2017].
- Physicians Committee for Responsible Medicine (n.d. b). *Health Concerns About Dairy Products.* [online] Available at: <http://www.pcrm.org/health/diets/vegdiets/health-concerns-about-dairy-products> [Accessed 23 July 2017].
- PolicyLink and The Food Trust (2013). *Access to Healthy Food and Why It Matters: A Review of the Research.* [online] Available at: <http://www.policylink.org/find-resources/library/access-to-healthy-food-and-why-it-matters> [Accessed 23 July 2017].
- Rudd, R., P. Seth, F. David and L. Scholl (2016). Increases in Drug and Opioid-involved Overdose Deaths—United States, 2010–2015. *MMWR Morbidity Mortality Weekly*, Rep 2016, 65, pp. 1445–1452.

- Sacks, G. B. Swinburn, A. Cameron and G. Ruskin (2017). How Food Companies Influence Evidence and Opinion—Straight from the Horse's Mouth, *Critical Public Health*, 28(2), pp. 253–256, [Online] Available at: <https://doi.org/10.1080/09581596.2017.1371844> [Accessed 13 April 2018].
- Sarkar, U., A. López, J.H. Maselli and R. Gonzales (2011). Adverse Drug Events in US Adult Ambulatory Medical Care. *Health Services Research*, 46, pp. 1517–1533. Available at: <https://www.ncbi.nlm.nih.gov/pmc/articles/PMC3168717/>.
- Schooling, C. (2014). *Milk and Mortality*. [online] Available at: <https://doi.org/10.1136/bmj.g6205> [Accessed 23 July 2017].
- Shanks, N., R. Greek and J. Greek (2009). Are Animal Models Predictive for Humans? *Philosophy, Ethics, and Humanities in Medicine*, 4(2). [online] Available at: <https://doi.org/10.1186/1747-5341-4-2> [Accessed 28 June 2017].
- Simon, D.R. (2013a). *Meatonomics: How the Rigged Economics of Meat and Dairy Make You Consume Too Much – and How to Eat Better, Live Longer, and Spend Smarter*. Newburyport, MA: Conari Press.
- Simon, M. (2013b). *And Now a Word from Our Sponsors: Are America's Nutrition Professionals in the Pocket of Big Food?* EatDrinkPolitics. [online] Available at: http://www.eatdrinkpolitics.com/wp-content/uploads/AND_Corporate_Sponsorship_Report.pdf [Accessed 22 July 2017].
- Specialist Pharmacy Service (2014). *Medicines Related Problems on Admission: The Evidence*. Specialist Pharmacy Service—The First Stop for Professional Medicines Advice. [online] Available at: <https://www.sps.nhs.uk/articles/medicines-related-problems-on-admission-the-evidence/> [Accessed 15 July 2017].
- The Coca-Cola Company (n.d.). *Our Commitment To transparency*. [online] Available at: <http://transparency.coca-colacompany.com/our-commitment-transparency> [Accessed 21 July 2017].
- The GBD 2015 Obesity Collaborators (2017). Health Effects of Overweight and Obesity in 195 Countries Over 25 Years. *New England Journal of Medicine*. 377, pp. 13–27. [online] Available at: <http://www.nejm.org/doi/full/10.1056/NEJMoa1614362> [Accessed 15 July 2017].
- The PEW Charitable Trusts (2008). *Putting Meat on the Table: Industrial Farm Animal Production in America*. [online] Available at: <http://www.pewtrusts.org/~media/legacy/uploadedfiles/peg/publications/report/pcifapfinalpdf.pdf> [Accessed 20 July 2017].
- Tuso, P., M. Ismail, B. Ha and C. Bartolotto (2013). Nutritional Update for Physicians: Plant-based Diets, *The Permanente Journal* 2013, 17(2), pp. 61–66. [online] Available at: <https://doi.org/10.7812/TPP/12-085> [Accessed 29 June 2017].
- United Nations (n.d.). *Overfishing: A Threat to Marine Biodiversity*. [online] Available at: <http://www.un.org/events/tenstories/06/story.asp?storyID=800> [Accessed 14 July 2017].

- US Department of Health and Human Services, Foodsafety.gov (n.d.). *Home*. [online] Available at: <http://Foodsafety.gov> [Accessed 10 July 2017].
- US Government Accountability Office (2017). *Key Issues: Farm Programs*. [online] Available at: https://www.gao.gov/key_issues/farm_programs/issue_summary [Accessed 24 July 2017].
- USDA (n.d. a) *About the US Department of Agriculture*. [online] Available at: <https://www.usda.gov/our-agency/about-usda> [Accessed 20 July 2017].
- USDA (n.d. b) *Mission Areas*. [online] Available at: <https://www.usda.gov/our-agency/about-usda/mission-areas> [Accessed 22 July 2017].
- USDA (2010). *Climate Change Science Plan*. The Climate Change Program Office. [online] Available at: https://www.usda.gov/oce/climate_change/science_plan2010/USDA_CCSPlan_120810.pdf [Accessed 12 July 2017].
- USDA (2016). *USDA to Purchase Surplus Cheese for Food Banks and Families in Need, Continue to Assist Dairy Producers*. [online] Available at: https://www.fsa.usda.gov/news-room/news-releases/2016/nr_20160823_re_0181 [Accessed 26 August 2017].
- USDA Agricultural Research Service (n.d.). *US Meat Animal Research Center*. [online] Available at: <https://www.ars.usda.gov/plains-area/clay-center-ne/marc/> [Accessed 6 July 2017].
- USDA Food and Nutrition Services (2017). *Supplemental Nutrition Assistance Program (SNAP) Eligible Food Items*. Food and Nutrition Service. [online] Available at: <https://www.fns.usda.gov/snap/eligible-food-items> [Accessed 22 August 2017].
- USDA Food Composition Databases (n.d.). *Food Composition Databases Show Nutrients List*. [online] Available at: <https://ndb.nal.usda.gov/ndb/nutrients/%20report?nutrient1=301&nutrient2=&nutrient3%20=&fg=11&%20max=25&subset=1&offset=125&sort=f&totCount=134&measureby=m> [Accessed 24 August 2017].
- USDA National Agricultural Statistics Service (2016). *Overview of the United States Slaughter Industry*. (2016). [online] Available at: <http://usda.mannlib.cornell.edu/usda/current/SlauOverview/SlauOverview-10-27-2016.pdf> [Accessed 20 July 2017].
- USDA National Agricultural Statistics Service (2017). *Livestock Slaughter 2016 Summary*. Agricultural Statistics Board. [online] Available at: <http://usda.mannlib.cornell.edu/usda/current/LiveSlauSu/LiveSlauSu-04-19-2017.pdf> [Accessed 20 July 2017].
- USDA National Resources Conservation Services (n.d.). *Animal Feeding Operations*. [online] Available at: <https://www.nrcs.usda.gov/wps/portal/nrcs/main/national/plantsanimals/livestock/afo/> [Accessed 18 July 2017].
- Wasley, A., M. Davies (2017). The Rise of the “Megafarm”: How British Meat Is Made. *The Bureau of Investigative Journalism*. [online] Available at: <https://www>

.thebureauinvestigates.com/stories/2017-07-17/megafarms-uk-intensive-farming-meat [Accessed 17 July 2017].

World Health Organization International Agency for Research on Cancer (2015). *IARC Monographs evaluate consumption of red meat and processed meat*. Lyon, France. [online] Available at: http://www.iarc.fr/en/media-centre/pr/2015/pdfs/pr240_E.pdf [Accessed 23 July 2017].

PART 2

Politics and Legislation of Animal Experimentation



Political Campaigning: Where Scientific and Ethical Arguments Meet Public Policy

Emily McIvor

Science Policy Advisor, People for the Ethical Treatment of Animals (PETA). London, United Kingdom

1 Introduction

The ambition of the paradigm shift we seek is vast, and the obstacles we face are intractable. For anyone opposing the use of non-human animals (hereinafter referred to as animals) in research and testing, the story has been the same from the start. Legitimate concern for animals has been all-too-easily dismissed as misguided sentimentality, and powerful vested interests have claimed scientific, economic, and moral superiority. But the ground is shifting. Animal researchers accept the need to provide scientific justification for their choices, and the protection of animals is increasingly recognized as a public good. Concern among citizens has been translated into hard-and-fast rules, and scientific advances have added weight to the growing demand for change.

In deciding how best to achieve the paradigm shift, the question for animal advocates is how to create the greatest change in the shortest time possible. This chapter deals with political campaigning at the European Union (EU) level, since the adoption of the first EU Directive on the protection of animals used for scientific purposes, and focuses on the main political developments of the past two decades. Historically, much was made of a perceived choice between presenting ethical or scientific arguments; both are powerful drivers, providing evidence that existing practice is flawed. Other chapters in this Volume describe aspects of those approaches in detail; similarly, the question of whether to focus on the 3Rs or replacement only is also covered elsewhere. In this chapter, a pragmatic policy focus is necessary to explore how scientific and ethical objectives can be pursued in order to move forward in the political arena, making full use of existing structures and creating new opportunities. The stakes are high. Our vision requires a revolution in science and in the way animals are treated. Twenty-first century technology should not depend on inhumane practices, just as modern economies should not depend on the destruction of the environment or the exploitation of workers.

Before proposing future strategies, it is useful to reflect briefly on the current situation. In the EU, Directive 2010/63/EU requires Member States to apply the 3Rs and encourages the further development of new 3R methods and techniques. Research funding programs identify the replacement of animal models as scientific and policy objectives; and several publicly funded national centers are now dedicated to developing, validating, and promoting alternative methods. The EU Reference Laboratory for Alternatives to Animal Testing, the European Centre for the Validation of Alternative Methods (EURL-ECVAM) has, among its duties and tasks, the remit to coordinate and promote the development and use of alternatives to procedures in the areas of basic and applied research and regulatory testing (European Parliament, 2010, Directive 2010/63/EU, Annex VII). Each of these achievements has come about because of pressure from citizens and animal advocacy organizations, and each has created a momentum of its own so that further progress is inevitable. At the same time, the number of animals used in scientific procedures in the EU appears to be increasing (Taylor and Rego, 2016); and animal use is robustly defended by powerful commercial, academic, and charitable organizations. It is legal to restrain conscious non-human primates (NHPS), so they are unable to move at all for long periods, and to poison animals to death by applying toxic chemicals to their skin. The scientific revolution is undoubtedly underway, and Directive 2010/63/EU identifies animal welfare as a “value of the Union” (European Parliament, 2010, Recital 2); but current practice has not caught up.

2 The Politics of Animal Experimentation: An Overview

The development of current European regulatory frameworks can be seen as the culmination of a series of historical confrontations between animal users and advocates (Lyons, 2011). By identifying five “critical junctures”, including the adoption of the United Kingdom’s Cruelty to Animals Act in 1876, the Royal Commission of 1912, and the adoption of the Animals (Scientific Procedures) Act in 1986 (UK’s transposition of Directive 1986/609 EEC; Council of the European Communities, 1986), Lyons (2011) traces the evolution, from a largely self-regulating, animal user community to the current regulatory regime. The relevance to our situation is the analysis of power exercised by those who defend animal use. Through early critical junctures, the power to decide whether animal use is justified, to control access to information, and to entrench an establishment view that the use of animals is essential to medical progress, was

firmly placed in the hands of animal users. Only later, with adoption of the 1986 Act, did the necessity for greater public and political scrutiny gain broad support.

Lyons describes key elements of various positions held, including this analysis of an *animal use* ideology (2011, pp. 360–361):

- It claims that animal welfare is secondary to research goals
- It considers animal experimentation *necessary*, and hence permissible, in the pursuit of knowledge without immediate or foreseeable human benefit
- It is opposed to utilitarian scrutiny of experimentation proposals
- It supports professional self-regulation and opposes lay interference in animal experimentation.

This is contrasted with an *animal welfare* belief system:

- It believes that animal welfare should be given significant weight in policy making
- It believes that proposals for harmful uses of animals should be subject to independent utilitarian analysis
- It considers animal experimentation *necessary*, and hence permissible, only to satisfy urgent and pressing human needs
- It supports the requirement of lay control to ensure consideration of wider public and animal interests.

And an *animal rights* philosophy:

- It posits that all sentient animals have inherent value and share human interest in avoiding suffering
- It claims that the fundamental rights of protection from torture, killing, and enslavement should, therefore, extend beyond the human species to other sentient animals
- It argues for the abolition of animal experimentation.

In the political arena, the *welfare* belief system often achieves consensus, and politicians can usually gain majority support for measures appearing to balance competing interests. Furthermore, a welfare agenda represents valuable *middle-ground* when the positions of different interest groups seem so far apart as to be irreconcilable.

Efforts to create a level playing field between industry and civil society groups have proved effective at the EU level (Persson, 2007); but in terms of numbers alone, leaving aside financial resources, industry and animal user groups are better represented than animal advocacy organizations. The UK Home Office public consultation on the European Commission's (EC) proposal to revise Directive 86/609/EEC received only 19 responses from animal

welfare organizations out of a total of 87 submissions, including 33 from academic institutions and 17 from representative bodies (Home Office, 2010). An associated imbalance, concerning access to scientific and political decision makers (Lyons, 2011), again risks leaving animal advocacy organizations severely outdone. However, public opinion is also an important element of the debate, and animal advocacy organizations have been effective in demonstrating that public concern for animals must be taken into consideration.

Polling commissioned by the European Coalition to End Animal Experiments (ECEAE) on the revision of Directive 86/609/EEC—conducted by YouGov (2009) in the UK, France, Germany, Italy, Sweden and the Czech Republic—found that public opinion was not consistent with the EC's legislative proposal; for example, substantial majorities in all countries surveyed favored a ban on experiments causing pain or suffering to NHPS (House of Lords, 2009). UK Government surveys exploring attitudes to animal research (Clemence and Leaman, 2016; Leaman, Latter and Clemence, 2014) note varying degrees of public support or opposition, depending on the phrasing of questions. There was a slight increase, between 2014 and 2016, in respondents who supported a ban on the use of any animals in research, from 23% to 26%. The 2016 survey also found that 59% of people disagreed with the statement “it does not bother me if animals are used in scientific research”, showing concern for animals among a clear majority of respondents. The difference, in policy terms, between the abolitionist view (represented by the UK's 26%) and a gradualist approach is significant; but there is strong agreement (74% of respondents) with the statement that more work is needed on alternatives to using animals in scientific research.

In terms of the wider political debate, even though detailed discussions about animal care and use tend to emphasize differences among stakeholder organizations rather than areas of agreement, promoting the replacement of animal procedures is compatible with all three of the belief systems identified above. Arguing for the increased uptake of human biology-based technologies in biomedical research is not new; but in an era of rapidly developing science and divergent opinion concerning other aspects of the debate, its importance cannot be overestimated. Because of the need for policy makers to arbitrate between opposing views, and the broad appeal of the alternatives' message, a major benefit of effective political lobbying is, therefore, ensuring that the replacement of animal procedures is promoted to the greatest extent possible. This cannot come at the expense of trying to improve conditions for the animals that are used, but it is a powerful driver towards achieving the paradigm shift.

3 Directive 2010/63/EU

The adoption of EU legislation provides multiple access points, and the EC encourages interest group participation in order to meet the objective of connecting the EU more closely to citizens (Persson, 2007). This objective was amply demonstrated during the lengthy process through which Directive 1986/609/EEC was revised and Directive 2010/63/EU came into being. While the revision was underway, the EC adopted an *Interinstitutional Agreement on Better Law-making* (European Commission, 2003, 2003/C321/01), strengthening pre-legislative consultation processes and requiring impact assessments. These access points, while often appearing to delay the process, ensured valuable evidence was gathered, informing both the legislative proposal and further political negotiations. Studies, including the scientific *Opinion by the European Food Safety Authority's Animal Health and Animal Welfare Panel (AHAW)*, and findings from the *Technical Expert Working Group* convened by the EC, created useful evidence and opportunities for further interventions the following years.

The legislative proposal—when finally published in 2008—irritated those defending animal use and, although representing a considerable improvement on previous legislation, it also failed to satisfy animal advocates. The UK animal user community, coming together under the auspices of joint *Bioscience Sector* position papers, identified several areas of concern, including the proposal to protect certain invertebrate species, limits on use of NHPS, and burdensome bureaucracy. The organizations also raised concerns that the draft Directive would undermine UK and European competitiveness, noting that “As well as problems with the content, the wording throughout the Directive requires significant review for scientific accuracy and internal consistency” (Bioscience Sector, 2009, p. 2). While generally supporting the application of the 3Rs, the groups opposed creation of national structures to assist in the validation of new 3R methods, claiming that: “The proposals for National Reference Laboratories are unnecessary and infeasible and would not be effective at developing alternative methods. They would divert research funding away from research which might not only develop alternatives but further benefit biomedical discoveries” (Bioscience Sector, 2009, p. 39).

But by the end of the political negotiation, the new legislation, Directive 2010/63/EU, included a handful of promising elements, alongside several measures that are weaker in terms of animal protection, than those contained in the EC's original proposal. Central to the achievements for animal protection lobbyists is Recital 10 (European Parliament, 2010), which specifies that “this Directive represents an important step towards achieving the final goal of full

replacement of procedures on live animals for scientific and educational purposes as soon as it is scientifically possible to do so.” In response to proactive EU-wide campaigning for greater prominence to the replacement of animal experiments and for the inclusion of basic and applied animal research in the remit of EURL ECVAM, EU Member States are now required to promote development and use of alternatives, establish a single contact point to receive information about new methods, join an EU-wide network of contact points, and require new projects to be authorized only when alternatives have been considered. Campaigns to ensure regular “thematic reviews” on areas, such as the replacement of experiments on NHPS, were partially successful (Article 58); and Recital 10 states that the Directive should be “reviewed regularly in light of evolving science and animal protection measures” (European Parliament, 2010). Emphasis on the use of existing alternative techniques and the further development of new methods is strengthened by requirements for project evaluations, increased transparency, and, most importantly, the retrospective assessment of all projects using NHPS and projects involving procedures classified as “severe” (Article 39).

4 Ending Cosmetics Animal Testing: 20 Years and Counting...

Nowhere is the importance of procedural access points and the willingness of legislators to respond to the wishes of citizens more visibly demonstrated than in the 20-year struggle to end animal testing of cosmetics and the sale of newly animal-tested cosmetics ingredients in the EU. Without detailing every one of the (numerous) twists and turns it took to see the 2013 ban enter into force, one hard-fought measure deserves special mention: the requirement for a full political negotiation in the event of any attempt to delay implementation of the final 2013 deadline. Although the sale ban had been agreed on in 1993 and was due to be implemented in 1998, the EC was permitted, under the 6th Amendment to the Cosmetics Directive (European Commission, 1993), to delay it until 2000 and then to 2002, on the grounds that replacement tests were not fully developed. The delays were agreed on through the comitology process, offering a lower level of access than a full political debate. However, further delays were not permitted beyond the 2002 deadline, by which time a new legislative proposal was published, triggering a full political negotiation before further delays could be adopted.

The point of interest for campaigners is that within the 7th Amendment (European Commission, 2003), new wording deliberately prevented any further delay without a legislative proposal being debated and voted upon by the European Parliament and Council. The 2009 phase of the sale ban gave no

provision for any kind of delay, on any grounds; and the final 2013 phase could only be delayed by new legislation. Creating the requirement for another access point—a 2013 renegotiation in the event that animal tests had not been replaced—was the key compromise that satisfied both industry and animal advocates. As the 2013 deadline approached, the EC opted to implement the ban and avoid any further accusations that they were ignoring the wishes of citizens. However, nothing is safe until full animal replacement is achieved, and although animal organizations rightly view an end to cosmetics animal testing as a political objective, achievable in the absence of alternatives being in place, loopholes putting our achievements at risk are relatively easily disguised. Perceived ambiguities concerning the terms of the ban have led to legal challenges, underlining the need for constant vigilance. Had the wording of Article 13 of the Cosmetics Directive been tighter (European Commission, 2009, Regulation (EC)1223/2009), we could have avoided the threat of further challenges.

On the day the European Parliament's Environment Committee debated their second reading position, a front-page article in the UK's Independent newspaper revealed behind-the-scenes lobbying by a major company to ensure ambiguity persisted, and loopholes were not closed (Woolf, 2002). The article was handed to Members of the European Parliament (MEPs) and while some unhelpful caveats remained, the final wording saw the Parliament successfully overcome opposition from EU Member States and adopt measures that would ban animal testing for cosmetics, and phase in the ban on selling newly animal-tested cosmetics ingredients (Osborn, 2002). The cosmetics campaign and resulting legislation also emphasize the importance of consensus-building around the need to replace animal tests. The 1993 legislation triggered increased efforts to replace animal methods and resulted in valuable contributions from industry, Member States, and the EC. EURL ECVAM became a world-leader in validating alternatives, and the EU entered the twenty-first century expressing a clear aspiration to replace outdated, failing animal methods.

5 REACH, Chemical Testing and Transforming Toxicology

The political negotiation of Registration, Evaluation, Authorisation and Restriction of Chemicals (REACH), the EU Chemicals Regulation (European Commission, 2006, Regulation (EC) 1907/2006), forced stakeholders with different aims to work together. A direct confrontation between industry (who favored lower costs and regulatory burdens) and environmental groups (who called for expensive animal testing and rigorous regulatory processes) left animal advocates needing to tread carefully. However, the animal protection agenda

was in no danger of being ignored. Calculations regarding the number of animal tests that could be required by REACH—varying initially from 9.5 million to 45.8 million (Institute for Environment and Health, 2001)—hit the headlines; but there was an associated danger of animal welfare arguments being co-opted by those simply wanting to reduce test costs. Politicians, more likely to favor environmental concerns, were also those with the strongest policies on animal protection; so a simple alignment with industry would have been highly problematic. Policies on data-sharing and transparency helped to forge links between animal and environmental groups, but the most important development concerned the recognition that animal tests represented outdated science. As the discussions progressed, all players acknowledged that because the future EU chemicals policy would be dependent on animal testing, it was impossible to ignore either the animal welfare or scientific case for replacement.

Between 2001 and 2003 the tone of the European debate around toxicity testing shifted. Publication of the ECEAE report, *The Way Forward: A Non-Animal Testing Strategy for Chemicals* (European Coalition to End Animal Experiments, 2003) was pivotal in defining the debate for decades to come. The ECEAE argued that in an ideal situation, there would be no need to make a choice between saving animals and protecting people. Replacing animal tests provided a win/win solution. New non-animal tests could be better, cheaper, and faster; and reliance on outdated animal tests would waste money and potentially confound those seeking decisive regulatory action. The conclusion of the REACH negotiation in 2006 saw several meaningful animal welfare demands enshrined in legislation, with “promotion of alternative methods for assessment of hazards of substances” becoming one of three objectives of the legislation, listed in Article 1.

The political shift, which started with tentative statements from radical Green Party politicians about the scientific need to replace animal tests, grew to represent the mainstream view of the European Parliament and Council. By the time MEPs of the center left had picked up the new rhetoric, a convincing case had been made, and at first reading the European Parliament’s environmental committee voted for an entirely non-animal testing approach under REACH (Committee on the Environment, Public Health and Food Safety, 2005), marking a significant call on all concerned to do more to replace animal tests. Again, consensus around the need to replace animal methods achieved overwhelming support, and a central requirement of REACH is that animal testing should only be carried out as a *last resort*.

The legislative gains enshrined in REACH built on past success concerning replacement, including the application and development of 3R methods, as mentioned in Directive 1986/609/EEC and required by the 1993 Cosmetics

Directive, and broke new ground by requiring rapid updating of legislation in response to new methods becoming available. What these legal requirements did not do was ensure that regulators and the European Chemicals Agency (ECHA) apply the rules without constant pressure from campaigners, culminating in several rulings against ECHA by the EU Ombudsman for failing to meet regulatory requirements relating to avoidance of animal testing (PETA UK, 2014; ECHA, 2015).

6 2001–2003: Paradigm Shift Meets Parliament

The fifth term of the European Parliament (1999–2004) saw MEPs from across the political divide join forces to push the replacement agenda through legislative debates, Reports and Parliamentary Questions. The fact that REACH and the 7th Amendment to the Cosmetics Directive were on the Parliamentary agenda at the same time, and the EC was working to revise Directive 1986/609/EEC, made for more urgency. The EC/Industry collaboration, the European Partnership for Alternatives to Animal Testing (EPAA), was established during this period, providing a forum in which companies could combine resources and expertise and demonstrate their commitment to implementation of the 3Rs. The EPAA has achieved a number of notable successes, including the study that informed changes to Annex VIII of REACH, ensuring that acute toxicity studies, using the dermal route, can be waived in most circumstances (EPAA, 2014).

In the midst of these political activities, the need for an accelerated process to achieve international adoption of the Organisation for Economic Co-operation and Development (OECD) Test Guidelines was recognized. The International Coalition for Animal Protection in OECD Programs (ICAPO) was formed (ICAPO, n.d.), allowing scientific experts working for international animal protection organizations, to participate in global efforts to implement the 3Rs. The structure of ICAPO has, helpfully, required organizations to maintain a single point of contact with the OECD and to collaborate with each other. To complete the picture, EU Framework Program (FP) funding decisions were taking a positive direction. Under FP6 (2002–2006), 21 projects to advance animal-free methods were funded, with a total of over €63 million, and contained wording—thanks to the European Parliament—concerning the need to replace toxicity testing on animals (European Parliament, 2002, Decision 1513/2002/EC). In this context, during the first years of the twenty-first century, several advances were made, the results of which are still playing out.

7 Post-2010/63/EU: EU Lobbying and the Global Challenge

During the negotiation of Directive 2010/63/EU, information about the intentions of industry and the animal user community crept into the public domain. In the absence of replacement science successfully displacing animal research, the future for animals could look very bleak indeed. In 2009, the UK House of Lords Select Committee on the European Union Subcommittee D (Environment and Agriculture) held an inquiry and reported to Parliament (HL 164 2009–2010). During the evidence sessions, questions were posed about the potential for higher welfare standards in the EU to drive animal use abroad. While there was clear evidence that an EU research base holds several advantages for companies, several contributions were worrying.

Evidence presented in the Memorandum by the Bioscience Sector (House of Lords, 2009) notes the existence of “substantial competition from countries, such as China, India, and Singapore in developing infrastructure to undertake animal research, which includes not just routine toxicity tests but also R & D” (p. 21); and states that “commercial investment [is] increasing faster in countries outside the EU, such as the US, China and India” (p. 19). During the oral evidence session, industry representatives described the experience that “most major pharmaceutical companies are now investing in Asia” (p. 43), with decisions being “influenced very strongly, particularly, by access to non-human primates and developing the Asian market with particular reference to China” (p. 43). One representative went on to describe new facilities in Shanghai, which will focus on cancer research and collaboration with a Chinese institution dedicated to constructing a specific NHP facility.

The view that higher EU welfare standards are unlikely to contribute in the short term to this shift is broadly supported, but the expectation of industry is that growing markets and longer-term projections are contributing to the expansion of animal facilities in countries not governed by EU standards. The fear is not so much that companies will fail to keep pace with, for example, EU standards of housing and care, but that in countries with less rigorous legislation, less attention will be paid to severity limits, reporting, and transparency. This global expansion does not, however, mean that EU political campaigning is any less important. Increased scientific scrutiny, such as that required by European legislation, along with funding for the development of alternatives, is driving global change. We cannot protect NHP in Chinese research facilities, but we can hold the science behind NHP use to account.

8 The EC's Scientific Committee Opinions on NHP Use, 2009 and 2017

Use of NHPs in the EU is highly controversial. Years of public campaigning has raised awareness of NHP suffering and sentience (Jennings, 2010); and the 2007 European Parliamentary Declaration, which called for a timetable for replacing all use of NHPs (European Parliament, 2007, P6_TA(2007)0407) led to the inclusion of proposals to limit NHP use in the EC's legislative proposal of 2008. Alongside this, the EC requested a series of Opinions from its scientific committees concerning the potential to replace NHP use.

Animal advocates have, repeatedly, found the process by which the Opinions have been formulated frustrating and biased. Contributors tend to be NHP users rather than biomedical researchers who use non-animal methods. In the most recent Opinion, released by the Scientific Committee on Health Environmental and Emerging Risks (SCHEER) (SCHEER, 2017), the Committee argues in favor of continued NHP use, while failing to acknowledge key reviews on the ineffectiveness of NHPs as a model for humans or reviews on advances in alternative animal-free methods. Nevertheless, the Committee made a handful of recommendations, including that systematic reviews should be undertaken and the "psychological effect" on NHPs should be better assessed (though this latter recommendation could lead to further research on NHP laboratory welfare).

9 The Citizens' Initiative: *Stop Vivisection*

In this context, it is not hard to see why campaigners have continued to call for an outright ban on all animal experiments. The Lisbon Treaty of 2009 introduced a process by which European citizens can initiate activity by the EC, including proposals for new legislation, if a petition receives one million signatures collected in seven EU Member States within one year (the European Citizens' Initiative, European Commission, 2011). The third successful Citizens' Initiative, *Stop Vivisection*, registered in 2012, called on the EC to "abrogate directive 2010/63/EU on the protection of animals used for scientific purposes and to present a new proposal that does away with animal experimentation and instead makes compulsory the use—in biomedical and toxicological research—of data directly relevant for the human species" (European Citizens' Initiative, 2016). The Citizens' Initiative demonstrated, again, EU-wide support for ending the use of animals in research and testing, raised awareness among policy makers, and generated new commitments from the EC. The European Parliament hearing on the Citizens' Initiative gave MEPs the opportunity to listen to arguments first-hand and question experts (European Parliament, 2015).

The EC's 2015 Communication responding to *Stop Vivisection* (C(2015) 3773) identified four action points:

- (1) Acceleration of progress in the 3Rs through knowledge sharing
- (2) Development, validation, and implementation of new alternative approaches
- (3) Enforcement of compliance with the 3Rs principle and alignment of relevant sector legislation
- (4) Engagement in a dialogue with the scientific community.

The EC's response concluded by welcoming "the mobilisation of citizens in support of animal welfare" stating that "the Citizens' Initiative has provided an opportunity to critically examine how the EU can reinforce its efforts in moving from animal to non-animal based research and testing" (European Commission, 2015, p. 10). However, there is no evidence that relevant decision-making bodies, such as Member State National Committees, referred to in Directive 2010/63/EU, are making the necessary adjustments.

Action 4 committed the EC to organize a scientific conference titled *Non-Animal Approaches – The Way Forward*, which, although supported by a wider-than-usual audience of stakeholders, was boycotted by the organizers of the *Stop Vivisection* Citizens' Initiative, who later made a complaint to the EU Ombudsman, considering that "the [European] Commission had given an inadequate response to the initiative and the detailed proposals put forward in the context of the initiative". The Ombudsman rejected the complaint (EU Ombudsman, 2017); but the substance of the Initiative remains active, and is an important milestone for policy makers at all levels of EU decision making.

10 Conclusion

Scientific progress does not necessarily equate to changes in practice, in public policy, or in legislation; but political progress can drive science. For this reason alone, effective political strategies are essential. The paradigm shift can be accelerated by improvements in transparency, reporting, and protection of animals as well as by increasing levels of scientific scrutiny, funding, and political will. Experience gained at the EU level demonstrates that when public opinion—backed by convincing evidence and practical proposals—can be effectively presented, policy makers are required to balance competing interests and promote workable solutions. In the field of research on animals, this often results in increased efforts to replace animal experiments. Public opinion surveys indicate that legislators have not yet created laws that adequately address citizens' concerns; but continuing public and political pressure has ensured

new initiatives are likely and further access points, in terms of influencing the regulatory agenda, are open to advocacy groups.

Developing a coherent political strategy on the basis of either science or animal protection alone is fraught with difficulties. Heated debate, and regulatory systems attempting to balance animal suffering with expected outcomes have forced animal advocates into the scientific arena and scientists to respond to welfare requirements. Those campaigning for a paradigm shift are gaining scientific weight and credibility, and new technologies are unstoppable.

So, what will end the use of animals in experiments in the shortest possible time? Using the experience gained over the past twenty years of EU-level campaigning, it seems sensible to accept that widely different approaches and organizations all have their place. Welfare advocates who work only with industry can achieve a great deal; the promoters of the Citizens' Initiative, *Stop Vivisection*, caused the EC to set new goals and attempt to create consensus between stakeholders holding radically different views, and EU-level coalitions of national advocacy groups, together with a handful of international organizations, through dogged scrutiny of implementation procedures, maintain public and political pressure. The need for legislators and regulators to demonstrate a willingness to hear the views of a range of stakeholders has allowed animal advocates to find a voice at all levels of political processes and to work with other campaign groups, industry, and academia to promote shared objectives.

The experience of political campaigning described above is offered in the hope that the paradigm shift happens sooner rather than later. The following overview of the points described above and lessons learned may also be of use:

Political Campaigning:

- Make use of all procedural access points, remembering that early intervention works best.
- Work across political divides and with all stakeholders to understand the full range of opinions and differing viewpoints.
- Join expert groups, share expertise, and try to avoid duplicating the work of other, similar organizations.
- Understand the agenda of your opponents and check the meaning of wording that seems unclear. Loopholes can be avoided if spotted early enough.
- Create new access points. Always work for regular reviews, reports, and further studies.
- Find ways to increase transparency. From ensuring all animals are counted to sophisticated prospective and retrospective reviews, transparency is essential.

- Appreciate the work of consensus-based entities. Where there is consensus, meaningful progress should be achievable.

Amplifying Our Message:

- Animal advocacy organizations working together are more likely to succeed. We have seen this through ICAPO and in the political arena. Sharing material early on and avoiding duplication is more likely to ensure initiatives are successful.
- Formulating joint positions with other organizations, such as environment, health, patient, and industry groups, amplifies our message.
- Coalitions and umbrella groups are helpful but need to demonstrate the extent of their supporter base, for example, by directly linking politicians with national organizations and the citizens they represent.

The question of global versus national or regional campaigning answers itself. We need to work at every level, in every forum, using all peaceful, evidence-based, effective means available to us. From handing out leaflets in the street to funding studies by researchers to expose failing animal models of disease, every contribution is valuable and is helping to achieve the paradigm shift.

References

- Bioscience Sector (2009). *A Bioscience Sector Response to the House of Lords European Union Committee Inquiry: Revision of Directive 86/609 on the Protection of Animals Used for Scientific Purposes*. [online] Available at: <https://wellcome.ac.uk/sites/default/files/wtx055911.pdf> [Accessed 15 June 2017].
- Clemence, M. and J. Leaman (2016). *Public Attitudes to Animal Research in 2016*. A report by Ipsos MORI for the Department for Business, Energy & Industrial Strategy, Ipsos MORI Social Research Institute. [online] Available at: <https://www.ipsos.com/sites/default/files/publication/1970-01/sri-public-attitudes-to-animal-research-2016.pdf> [Accessed 15 June 2017].
- Committee on the Environment, Public Health and Food Safety (2005). *Report on the Proposal for a Regulation of the European Parliament and of the Council on the Registration, Evaluation, Authorisation and Restriction of Chemicals (REACH), Establishing a European Chemicals Agency and Amending Directive 1999/45/EC and Regulation (EC) on Persistent Organic Pollutants. (2003/0256(COD))*. [online] Available at: <http://www.europarl.europa.eu/sides/getDoc.do?pubRef=-//EP//TEXT%20REPORT%20A6-2005-0315%2000%20NOT%20XML%20Vo//en> [Accessed July 21 2017].
- Council of the European Communities (1986). Council Directive 86/609/EEC of 24 November 1986 on the Approximation of Laws, Regulations and Administrative

- Provisions of the Member States Regarding the Protection of Animals Used for Experimental and Other Scientific Purposes. *Official Journal of the European Communities*, L 358, pp. 1–28.
- ECHA (2015). *ECHA's Approach on Avoiding Unnecessary Animal Testing, 40th Meeting of the Management Board 16–17 December 2015* [online] Available at: https://echa.europa.eu/documents/10162/1564405/mb_54_2015_avoiding_testing_en.pdf/c30e5e0f-0299-4078-9301-67e402e28257 [Accessed 10 August 2018].
- EPAA (2014). European Partnership for Alternatives to Animal Testing: Achievements. [online] Available at: <https://circabc.europa.eu/sd/a/17b2b74c-015a-495f-ba7f-bb549335efd3/Achievements%2010%20years%20EPAA.pdf> [Accessed 17 October 2018].
- European Citizens' Initiative (2016). *Stop Vivisection*. [online] Available at: <http://www.stopvivisection.eu> [Accessed 21 July 2017].
- European Coalition to End Animal Experiments (2003). *The Way Forward: A Non-Animal Testing Strategy for Chemicals*. [online] http://www.eceae.org/_lib/userfiles/files/Downloads/ECEAE_TheWayForward_part1.pdf [Accessed 10 August 2018].
- European Commission (1993). Council Directive 93/35/EEC of 14 June 1993 Amending, for the Sixth Time, Directive 76/768/EEC on the Approximation of the Laws of the Member States Relating to Cosmetic Products. *Official Journal of the European Communities*, L151, 23/06/1993, pp. 32–37.
- European Commission (2003). Interinstitutional Agreement Between the European Parliament, the Council of the European Union and the European Commission on Better Law-making. *Official Journal of the European Union*, C321, pp. 1–5.
- European Commission (2006). Regulation (EC) 1907/2006 of the European Parliament and of the Council of 18 December 2006 concerning the Registration, Evaluation, Authorisation, and Restriction of Chemicals (REACH), Establishing a European Chemicals Agency. *Official Journal of the European Communities*, L396, pp. 1–849.
- European Commission (2009). Regulation (EC) 1223/2009 of the European Parliament and of the Council of 30 November 2009 on Cosmetic Products. *Official Journal of the European Union*, L 342, 22.12.2009, pp. 59–209. [online] Available at: <https://eur-lex.europa.eu/legal-content/EN/TXT/PDF/?uri=CELEX:32009R1223&from=EN> [Accessed 21 April 2018].
- European Commission (2011). Regulation of the European Parliament and of the Council of February 16, 2011 on the Citizens' Initiative. *Official Journal of the European Union*, L 65, pp. 1–22.
- European Commission (2015). Communication from the Commission on the European Citizens' Initiative "Stop Vivisection". [online] Available at: <http://ec.europa.eu/transparency/regdoc/rep/3/2015/EN/3-2015-3773-EN-F1-1.PDF> [Accessed 15 June 2017].

- European Ombudsman (2017). Decision in Case 1609/2016/JAS on the European Commission's Response and Follow-up to the European Citizens' Initiative "Stop Vivisection." [online] Available at: <https://www.ombudsman.europa.eu/en/cases/decision.faces/en/78182/html.bookmark> [Accessed 15 June 2017].
- European Parliament (2002). Decision 1513/2002/EC of the European Parliament and of the Council of 27 June 2002, Concerning the Sixth Framework Program of the European Community for Research, Technological Development and Demonstration Activities, Contributing to the Creation of the European Research Area and to Innovation (2002 to 2006). *Official Journal of the European Communities*, L232, pp. 1–33. [online] Available at: <https://publications.europa.eu/en/publication-detail/-/publication/5a016937-b81d-41ca-aac5-1b5bedd26f46/language-en> [Accessed 15 August 2018].
- European Parliament (2007). *Declaration of the European Parliament on the Use of Primates in Scientific Experiments*. P6_TA(2007)0407: Plenary Session (23/04/2007). [online] Available at [http://www.europarl.europa.eu/sides/getDoc.do?reference=P6_TA\(2007\)0407&language=EN](http://www.europarl.europa.eu/sides/getDoc.do?reference=P6_TA(2007)0407&language=EN) [Accessed April 8 2018].
- European Parliament (2015). *Stop Vivisection: European Citizens' Initiative Public Hearing*. [online] Available at: <http://www.europarl.europa.eu/committees/en/envi/events-citizint.html?id=20150424CHE00301> [Accessed 15 June 2017].
- European Parliament (2010). Directive 2010/63/EU of the European Parliament and of the Council of 22 September 2010 on the Protection of Animals Used for Scientific Purposes. *Official Journal of the European Communities*, L276, pp. 33–79. Available at: <http://eur-lex.europa.eu/legal-content/EN/TXT/?uri=CELEX:32010L0063> [Accessed 15 June 2017].
- Home Office (2010). *Summary of Responses to the Consultation on Proposals for the Revision of EU Directive 86/609/EEC on the Protection of Animals Used for Scientific Purposes*. [online] Available at: <http://webarchive.nationalarchives.gov.uk/20100408171921/http://scienceandresearch.homeoffice.gov.uk/animal%2Dresearch/legislation/summary-report2835.pdf?view=Binary> [Accessed 20 July 2017].
- House of Lords Select Committee on the European Union Sub-Committee D (Environment and Agriculture) (2009). *The Revision of the EU Directive on the Protection of Animals Used for Scientific Purposes*. Volume 11, Evidence. [online] Available at: <https://publications.parliament.uk/pa/ld200809/ldselect/lddeucom/164/164ii.pdf> [Accessed 22 July 2017].
- ICAPO (n.d.). *About*. [online] Available at: <https://www.icao.org/about> [Accessed 21 July 2017].
- Institute for Environment and Health (2001). *Testing Requirements for Proposals under the EC White Paper "Strategy for a Future Chemicals Policy"*. Leicester, UK: Institute for Environment and Health. [online] Web Report W6. Available at: <http://www>

- .iehconsulting.co.uk/IEH_Consulting/IEHCPubs/HumExpRiskAssess/w6.pdf [Accessed 15 August 2018].
- Jennings, M. (2010). Special Protection for Primates—The Need for Faster Progress. *Alternatives to Animal Experimentation*, 27, Special Issue.
- Leaman, J., J. Latter and M. Clemence (2014). *Attitudes to Animal Research in 2014*. A report by Ipsos MORI for the Department for Business Innovation & Skills. Ipsos MORI Social Research Institute. [online] Available at: https://www.ipsos.com/sites/default/files/migrations/en-uk/files/Assets/Docs/Polls/sri_BISanimal_research_NONTRENDreport.pdf [Accessed 30 July 2018].
- Lyons, D. (2011). Protecting Animals Versus the Pursuit of Knowledge: The Evolution of the British Animal Research Policy Process. *Society & Animals*, 19, pp. 356–367.
- Osborn, A. (2002). Cosmetics Tested on Animals to Be Banned. *The Guardian*. [online] Available at: <https://www.theguardian.com/uk/2002/nov/08/animalwelfare.eu> [Accessed 21 July 2017].
- Persson, T. (2007). Democratizing European Chemicals Policy: Do Consultations Favour Civil Society Participation? *Journal of Civil Society*, 3(3), pp. 223–238.
- PETA UK (2014). *European Ombudsman Ruling on PETA Complaint a Victory for Animals Used in EU Chemical Tests*. [online] Available at: <https://www.peta.org.uk/blog/official-ruling-must-done-minimise-cruel-chemical-tests-animals-europe/> [Accessed 10 August 2018].
- SCHEER (2017). *Final Opinion on the Need for Non-human Primates in Biomedical Research, Production and Testing of Products and Devices* (update 2017). [online] Available at: http://ec.europa.eu/environment/chemicals/lab_animals/pdf/Scheer_may2017.pdf [Accessed 13 August 2018].
- Taylor, K., and L. Rego (2016). EU Statistics on Animal Experiments for 2014. *Alternatives to Animal Experimentation*, 33(4), pp. 465–468.
- Woolf, M. (2002). Cosmetics Company Memo Reveals Plan to Sidestep EU Animal Testing Ban. *The Independent*. [online] Available at: <http://www.independent.co.uk/news/world/europe/cosmetics-company-memo-reveals-plan-to-sidestep-eu-animal-testing-ban-133147.html> [Accessed 21 July 2017].

Rethinking the 3Rs: From Whitewashing to Rights

Charlotte E. Blattner

Postdoctoral Fellow, Harvard Law School, Cambridge MA

charlotte.blattner@gmail.com

1 Introduction: Widespread Acceptance and Regulatory Failure of the 3Rs

Few other issues have prompted as many legislators to adopt legal instruction on the “proper” use of non-human animals (hereinafter referred to as animals) in medical and scientific research. Today, the 3Rs (replacement, reduction, and refinement of animals in scientific procedures) are globally accepted by a vast majority of states (Blattner, 2014); and prominent international organizations, such as the World Organisation for Animal Health (Terrestrial Animal Health Code, 2018, Article 7(8)(3)) and the Council of Europe (Convention for the Protection of Vertebrate Animals Used for Experimental and Other Scientific Purposes, 1986, Articles 6(2), 7 and 8). Widespread acceptance of the 3Rs is a notable achievement, since animal law is a relatively young field of law, and attitudes about the human-animal relationship diverge sharply across societies.

As progressive as this established body of law appears, the rules governing research on animals—especially the 3R maxim that dominate this legal landscape—suffer from regulatory failure. First, and most importantly, despite widespread commitment to replace and reduce animals in research, the number of animals used for experimental purposes worldwide is now the same as it was in the 1980s (the number dropped in the 1990s and 2000s but has been rising ever since; Bayne et al., 2015, p. 3; European Commission, 2013; Taylor, 2013; Taylor et al., 2008; Taylor and Rego, 2016). Second, though the principle of refinement demands that the severity of experiments be diminished, countries are reporting a rising number of research procedures done on animals who are forced to endure the most severe experiments (e.g., *Neue Zürcher Zeitung*, 2016). There is reason to believe that refinement, which seeks to ameliorate the conditions of animals used for a research procedure, fails to fulfill their basic welfare needs. For example, pursuant to the United States’ *Guide for the Care and Use of Laboratory Animals*, a pig who weighs up to 50kg can be housed for up to five years on 15 square feet (0.9m²), without any

access to the outside (National Research Council Institute for Laboratory Animal Research, 2011). The Guide states that thereby “animals can turn around and move freely without touching food or water troughs, have ready access to food and water, and have sufficient space to comfortably rest away from areas soiled by urine and feces” (p. 63). On 15 square feet, however, a pig cannot possibly exhibit normal behavior. No human of the same weight is expected to behave naturally in a 0.9m² elevator and certainly not for a period of five years. Overall, this overview of the achievements of the 3Rs suggests that both in qualitative and in quantitative terms, adopting the 3Rs has not decreased animal suffering.

At the same time, societal demands for better protection of animals are more common than ever before (European Commission, 2016). According to the most recent polls, citizens are increasingly concerned about the welfare of animals used in science and agree that more needs to be done to replace their use (Clemence and Leaman, 2016; European Citizen’s Initiative, 2016; Funk and Rainie, 2015; Jones, 2017). Despite these demands and the reasonable doubts they cast on the potential of the 3Rs to lead to the ultimate replacement of animals in research (see below), the 3Rs continue to be a popular policy tool for legislators and research facilities that use them as an example of their efforts to ameliorate the suffering of animals in research. The worldwide acceptance and simultaneous failure of the 3Rs seem to have turned the maxim, intentionally or not, into a means of whitewashing the images of those profiting from research vis-à-vis the public: scientists, research industries, and regulators. In light of these developments, this chapter takes a functional-comparative approach to scrutinize whether and how we can meet the rising societal demands for replacement. It specifically examines whether the 3Rs bear the potential of meeting this goal, and if so, what reforms are necessary, or whether the 3Rs should instead be abrogated.

2 Abrogating the 3Rs?

The widespread acceptance of the 3Rs, alongside their simultaneous failure, forces us to ask whether the 3Rs should be retired. In 2015, people across the European Union (EU) launched the European Citizens’ Initiative, *Stop Vivisection*, and expressed, with over 1,150,000 signatures, their desire for a paradigm shift away from the use of animals. The European Citizens’ Initiative is a political means at the EU level that makes it possible for 1 million citizens to participate in developing EU strategies, by prompting the European Commission (EC) to

propose a legislative act. The *Stop Vivisection* initiative demanded the use of animals for research purposes be abolished, which would have necessitated abrogating Directive 2010/63/EU (European Parliament, 2010), and with it, the 3Rs. The EC responded to the initiative by issuing a communication that effectively ignored these demands, arguing that the Directive also had replacement as a long-term goal, but that animal research cannot be banned because, “a ban [...] would likely export the biomedical research and testing outside the EU to countries where welfare standards may be lower and more animals may be needed to achieve the same scientific result” (European Commission, 2015, p. 3). As an alternative to the proposed abrogation, the EC promised that it would speed up the expected progress of the 3Rs by sharing knowledge, developing and validating new alternatives, strengthening enforcement, and entering a dialogue with the scientific community, for example, by organizing a conference devoted to this issue (see Holley et al., 2016, on knowledge sharing in the EU). Undoubtedly, these steps may help to enforce Directive 2010/63/EU more effectively, but they do not respond to the criticism that the 3Rs suffer from structural deficits that lead to the perpetuation of animal use in science. In effect, the steps envisaged by the Commission, like the 3Rs as they stand, are unlikely to bring about the full replacement of animal models.

Given these economic fears and political constraints that continue to inform the debate on the replacement of animals in research, it may be more effective to use the worldwide acceptance of the 3Rs as a foundation for working towards a paradigm change, through a *foot-in-the-door* strategy. Theoretically, the 3Rs have many advantages over other types of regulatory approaches. They are simple and intelligible, easily understandable, and catchy. They enjoy a general application, paired with refined conceptualization (compared to the very general objective of avoiding *unnecessary animal suffering* that leaves even more room for interpretation). The 3Rs take an integrative approach by incentivizing innovation, accommodating the interests of various stakeholders, and not discrediting the purposes of research, such as finding causes, treatments, and cures for diseases or enabling novel scientific insights. The 3Rs consider the sentience and suffering of animals a baseline and respond to the needs of animals beyond physiological suffering, such as their needs for social interaction and mental stimulation. Based on the hypothesis that the 3Rs are theoretically expedient, it is worth exploring the potential of this principle to mature into a more viable concept for the future of animal law, in particular with regard to its capacity to preempt the use of animals in research.

3 Reform Proposal 1: Reverse Hierarchy of the 3Rs

Most countries claim that a minimum number of animals should be used to obtain scientific knowledge, but the language of the replacement principle is regularly laxer than that of refinement. For example, in the EU, Directive 2010/63/EU determines that “Member States shall ensure that, *wherever possible*, a scientifically satisfactory method or testing strategy, not entailing the use of live non-human animals, shall be used instead of a procedure” (emphasis added, European Parliament, 2010, Article 4). But given that the Directive fails to determine the probability of possible alternatives, how accessible they ought to be, and the need to invest into them, the norm fails to incentivize researchers to divest from animal research. According to Article 13 of Directive 2010/63/EU, replacement is only necessary if alternatives are recognized under EU law. In addition, legislators often do not necessarily mean replacement in an absolute sense when they call for replacement measures; instead, the use of seemingly *less sentient* animals, like rodents or fish, are readily accepted as a form of replacement (e.g., German Animal Welfare Act 2006, Section 7a(2)(5); India Prevention of Cruelty to Animals Act, Animal Welfare Board of India, 1982, Prevention of Cruelty to Animals Act, 1982, Section 7(2)(e); US Guide for the Care and Use of Laboratory Animals, National Research Council, 2011, p. 5; Scientific Committee on Health Environmental and Emerging Risks, SCHEER, 2017, p. 15).

This clearly runs counter to Russell and Burch’s (1959) definition of replacement as “any scientific method employing non-sentient material” (Chapter 5) and fails to give those animals, whose capacity to sentience is still disputed, the benefit of the doubt (challenging the view that non-human animals lower on the zoological scale lack sentience: Tomasik, 2014). Such lax provisions give ample room for regulatees to avoid actual replacement, and they increase the possibility that certain research procedures may never be replaced. Given the lax practice in replacement and strong accentuation towards reduction and refinement, there seems to be an implicit hierarchical understanding of the 3Rs that gives refinement and reduction priority over replacement (Gerritsen, 2015, p. 38). The marginalization of replacement is especially disconcerting if one looks at the 3Rs from an “animal use” perspective, as seen in Table 6.1.

It is this framework that allows animal researchers to discharge their duties under the 3Rs by engaging in refinement (and marginal reduction) alone. The political and legal preoccupation with refinement and reduction shifts the focus away from where it should be, i.e., on replacement. So, if we continue to accept that legislators and institutions simply refine and marginally reduce the

TABLE 6.1 Refinement and reduction support the use of animals for research procedures and only replacement bears the potential of phasing out animal research in the long term.

	Refinement	Reduction	Replacement
Use of animals	+	+	-

use of animal models—only replacing them “wherever practical” and thereby conceiving themselves as fulfilling their 3R duties—we will end up perpetuating the use of animals in experiments. Contrary to what many practice, the 3Rs ought, however, be interpreted to mandate that replacement be given primary consideration. As the above-mentioned polls show, citizens’ opinions increasingly pressure legislators to come up with a workable plan to phase out the use of animals in research, which necessitates insisting on the replacement of animals in research (see also Goldberg and Locke, 2004). To bring about this paradigmatic change, the 3Rs should be understood hierarchically, where the first goal is replacement, the second reduction, and the third refinement. The imperative for this reversal is based on a historical, teleological, and evolutionary interpretation.

A *historical interpretation* of the 3Rs relies on Russell and Burch’s foundational work on the principle. Russell and Burch, the founders of the 3Rs, clearly stated that the humanitarian problem lies in the severity with which animals encounter stress and the high number of animals affected, and that the very purpose of the 3Rs is to tackle these (Russell and Burch, 1959, p. 93; Blattner, 2014). Russell and Burch further stated that “refinement is never enough, and we should always seek further for reduction and if possible replacement” (Chapter 4). Because replacement does not appear to be a priority of the 3Rs even though it is an explicit goal of the tripartite principle, the law must give more weight to this element when it applies the principle in the future.

A *teleological interpretation* also suggests that the law must reverse the hierarchy of the 3Rs. Indications of this interpretation already exist under current legislation. The *Council of Europe’s Convention for the Protection of Vertebrate Animals used for Experimental and other Scientific Purposes* states in its preamble that its parties are “[r]esolved to limit the use of animals for experimental and other scientific purposes with the aim of replacing such use [...] in particular by seeking alternative measures and encouraging the use of these alternative measures” (Council of Europe, 1986). In Directive 2010/63/EU,

the EU expressed its wish to, “achiev[e] the final goal of full replacement of procedures on live animals for scientific and educational purposes” (European Parliament, 2010, Recital 10). If we interpret the 3Rs based on these stated purposes, replacement must be our top priority. Article 4 of Directive 2010/63/EU, which details the 3R commitments, begins by stating the duty of replacement and, thereby, implies a reverse hierarchical understanding of the principle, as well. Article 13 of the Directive further guides the choice of methods in the scientific and educational use of animals and—unlike the previous regulation, Directive 86/609/EEC (Council of the European Communities, 1986)—does not require replacement methods to be “reasonably, and practically available” (Article 7(2)). Instead, replacement methods are recognized as non-animal methods or testing strategies, even if they are not reasonably and practically available. This wording change, strictly interpreted, means alternatives should be required even where they are costly, have never been used by the researcher, or are not available at the researcher’s home institution.

The polls introduced herein show that the global community has never been more concerned about animals’ well-being than it is today. As a consequence of this burgeoning global conscience, we are witnessing the rise of the general principle of animal welfare, which is developing into a norm of customary international law (Bowman, Davies, and Redgwell, 2010, p. 678; Brels, 2012, p. 37; Sykes, 2014; Trent et al., 2005, p. 77). International documents and the laws of over 60 states worldwide make clear the general moral commitment and the legal requirement that animals be treated humanely and spared suffering (Blattner, 2016, pp. 304–308). The general principle of animal welfare underlines the goal of animal protection as an intrinsic interest of animals. In other words, the suffering of animals matters to the law because it matters to animals (Bolliger, Richner, and Rüttimann, 2011, p. 24–25, n. 14; Leondarakis, 2001, p. 29). Importantly, the general principle of animal welfare not only mandates proper treatment of animals while using them; it also encompasses the aspiration of states to preempt any violation of their intrinsic interests.

Another global principle that requires regulatory frameworks to shift emphasis on animal replacement is the precautionary principle. The precautionary principle commonly applies in decision-making processes and entails that, where there are threats of serious or irreversible damage, lack of full scientific certainty shall not be used as a reason to postpone cost-effective measures to prevent damage. The prime application of the precautionary principle is in environmental law where it covers animals who form an integral part of an ecosystem (Montreal Protocol on Substances that Deplete the Ozone Layer, 1987; United Nations, 1992, Article 8h, 14(1)(d); United Nations General Assembly,

1992, Article 15; World Charter for Nature, 1982, Article 12(b)). But, as the EC states, “in practice, [the] scope [of the precautionary principle] is much wider, and specifically where preliminary objective scientific evaluation indicates that there are reasonable grounds for concern that the potentially dangerous effects on the environment, human, animal or plant health may be inconsistent with the high level of protection chosen for the Community” (Commission of the European Communities, 2000; see also World Health Organization, 1994, Article 5(7)). The precautionary principle demands that we err on the side of caution to prevent dangerous effects on animal health, replacing animals in research rather than regulating and, thus, perpetuating their use by refinement and reduction. We must thus decide in favor of animals wherever and whenever actions impair, or likely will impair, their physical and psychological health and life (Gerick, 2005, p. 213; Kuhlau et al., 2011). An *evolutionary* interpretation, based on the general principle of animal welfare and the precautionary principle therefore indicates that replacement should be given primary consideration among the 3Rs.

4 Reform Proposal 2: Qualitative Balances of Interests, Harm-Benefit Analyses, and Proportionality Tests

Even if replacement is given absolute preference, the 3Rs are still likely to fail because in most jurisdictions they enjoy only relative validity. Researchers do not refine the conditions of animals, do not reduce the number of animals used, and do not replace animals as the primary research model (even where alternatives exist) if human interests justify that decision. The *Swiss Animal Welfare Act 2005*, for example, states that “[p]ain, suffering or harm may be inflicted on or anxiety caused to a non-human animal only if this is unavoidable for the purpose of the experiment” (Article 20(1)). The issue here is that the purpose of the experiment is the only determinant in deciding whether animal suffering is unavoidable, or so-called necessary. The suffering inflicted on animals during experimentation is seen as a *prima facie* harm, but its justifiability—and hence its legality—is fully determined by the purpose of the experiment. Animals’ interests in not suffering, by contrast, do not enter the judgment on necessity.

The *Swiss Animal Welfare Act* seems to have taken a step in the right direction by further providing that animal experimentation is impermissible “if, in relation to the anticipated gain in knowledge, it inflicts *disproportionate* pain, suffering or harm [on the animal]” (emphasis added, Article 19(4)). Similarly, under the United Kingdom’s *Animals (Scientific Procedures) Act 1986*, the

Animals in Science Regulation Unit will assess whether the harms caused by an experiment are “justified by the expected outcome” (emphasis added, Section 5B(3)(d)). This is also the case with Article 38(1)(b) of Directive/2010/63/EU (European Parliament, 2010). These and other laws claim that they determine the legality of an experiment conducted on animals not only by evaluating the necessity of an experiment but by weighing all interests at hand. Such norms bring to application what is sometimes known as the balance of interest tests, harm-benefit analyses, or the proportionality principle.

Pursuant to these tests, animal experiments are evaluated in a two-step procedure. Regulators require the purpose of an experiment to be indispensable (final indispensability), and they require the means to achieve this end to be indispensable (instrumental indispensability or harm-benefit analysis) (Peters, 2012, p. 34ff.; e.g., *German Animal Welfare Act 2006*, Section 7(1)(1); *Swiss Animal Welfare Act 2005*, Article 17). Final indispensability is an analysis of the purpose and legitimacy of an experiment, which answers the *if* question. Instrumental indispensability, on the other hand, answers the *how* and largely refers to the principle of proportionality (e.g., *German Animal Welfare Act, 2006*, Section 7(1)(2)). The proportionality analysis includes the elements of suitability (means must be able to achieve desired ends), necessity (no milder means are available to achieve the end), and proportionality *strictu sensu* (Bolliger and Rüttimann, 2015, pp. 71–73). This final proportionality, *strictu sensu* evaluation includes a duty to diligently balance interests affected by the act at hand and conforms to the harm-benefit analysis (Ferrari and Gerritsen, 2015, p. 140) but with respect to means as opposed to ends.

Let us turn to final indispensability first. Before weighing interests, decision-making bodies usually follow a system that classifies expected harms inflicted on animals. For example, there is a five-step classification system in Canada (Canadian Council on Animal Care, 2011), in New Zealand (New Zealand Government, 2010, Section 2(1)), and in Israel (Kolman et al., 2014, pp. 202–203), a four-tiered scheme in Singapore (National Advisory Committee for Laboratory Animal Research, 2004, Article 5(4)(2)(b)) and the EU (European Parliament, 2010, Articles 15 and 16); and the Philippines has a three-step pain categorization system (Philippines Law on the Use of Animals in Research, 1999, Article 5(2)). Most of these classification schemes determine harm or pain levels based on the severity of a procedure or its duration, or a combination of the two. Article 15 of Directive 2010/63/EU, for example, assesses projects as non-recovery, mild (short-term mild pain, suffering, or distress), moderate (short-term moderate or long-lasting mild pain, suffering, or distress), and severe (severe or long-lasting moderate pain, suffering, or distress) (European Parliament, 2010). To best evaluate harm, psychological spheres of animals must also

be considered because inducing fear or anxiety in an animal negatively affects their well-being (e.g., Council of Europe, 1979, preamble; Swiss Animal Welfare Act, 2005, Article 3(b)(4)).

In contrast to harms, benefits are neither classified nor categorized. For instance, in the UK, where stricter harm-benefit analyses are said to prevail (Perry, 2007, p. 43), benefits are described in a very broad manner, by answering questions such as, what data or products may be acquired by the work, what scientific questions will be answered, what knowledge gaps will be filled, who will benefit from the work, and how and when the benefits will accrue. Quite telling in this respect is the need for scientists to “[e]xplain why the benefits go beyond ‘it would be nice to know’” (UK Home Office, 2014, p. 126; see also European Parliament, 2010, Article 38(2)(a); UK Home Office, 2016, pp. 9–11). Scientifically speaking, to offer benefits, a research project must produce recognizable results of scientific value (e.g., Austrian Animal Welfare Act, 2004, Section 4(3)(a)). From a societal perspective, however, only socially desirable objectives can be pursued in an experiment. Saving labor, time and costs or duplicating research cannot, *prima facie*, be weighed against animals’ interests (e.g., German Animal Welfare Act, 2006, Section 7a(2)(5)).

Though these rules on final indispensability serve an important purpose and help prevent the most unnecessary and atrocious research procedures, they effectively leave untouched the great bulk of research. For example, the societal objectives of curing diseases or producing new scientific knowledge typically operate as a *carte blanche* that legitimate every form of animal exploitation and give the 3Rs only relative validity. But simply dropping the words *cancer research* cannot and should not automatically justify the use of animals. We must introduce a scheme that evaluates the importance of the research, its contribution to the expected goal, and the likelihood of its success; and we must be wary of approving research projects that simply ensure a research facility’s survival and the preservation of jobs, while perpetuating the exploitation of animals (arguing that “[c]onducting animal experiments is a convenient and highly effective way for these researchers to gain career prestige and job security, and for the universities who employ them to obtain lucrative research grants. There is a *quid pro quo* relationship between research institutions and those giving the grants”, Greek and Greek, 2004, p.25). No research that goes beyond “it would be nice to know” is, by itself, morally or legally weighty enough to justify the immense suffering of animals in research. Peters (2015) proposes categorizing human interests into small, moderate, and great benefits to introduce a level field for evaluating human benefits versus animal harms (p. 97). Having precise knowledge about both burdens and benefits allows us to weigh more systematically the importance of the interests at hand, and makes it more obvious when marginal scientific interests

seek to trump animals' fundamental interests in life and bodily and mental integrity.

A further failing within harm-benefit evaluations is that the tests are regularly affected by referring to the legal tools that encapsulate those interests, rather than by the interests themselves. Scholars and individuals around the world have frequently exposed the risks of endowing humans with rights, while endowing animals only with protections. When experiments are evaluated, rights of humans, such as the freedom of research (e.g., Council of Europe, 1950, Article 10) or the freedom to choose an occupation and the right to engage in work (e.g., European Convention, 2000, Article 15), are juxtaposed against (animal) protections (e.g., the 3Rs). The fact that certain interests are legally recognized either as rights or as protections, establishes a disparate and unequal footing for the affected parties. Protections are effectively undermined when confronted with rights in a balance of interests, because they are a weaker legal tool. Consequently, protections only take effect where the rights of humans leave room for them. The *Swiss Animal Welfare Act* (2005) is a prime example of this automatic trumping. It requires anyone who handles animals to ensure their well-being "as far as the intended purpose allows" (Article 4(1)(b)). This not only renders research quintessentially a utilitarian endeavor; but, more notably, it creates a structural deficit to the detriment of animals. The balance of interests ends up being merely perfunctory and legitimizes, in essence rubber-stamps, the exploitation of animals (Ferrari and Gerritsen, 2015, p. 140; Gerritsen, 2015, p. 38).

A prime example of the inherent deficiency created by rights versus protection is the German state objective of animal protection. Prior to the amendment of Article 20a of German Basic Law, scholars viewed the *German Basic Law* as a "constant obstacle" (Evans, p. 326) to the effective protection of animals and were hopeful that the constitutionalization of animal protection, even if it would not create justiciable rights, would put animal protection on par with constitutional rights, as regards governmental value judgments (Gerick, 2005, p. 120). Judiciary practice established since the norm's amendment in 2002, however, shows that the state objective is regularly subordinated to constitutional rights (German Administrative Court, 2006; German Constitutional Court, 2009; German Constitutional Court, 2006; see further Eisen and Stilt, 2017, note 25). The deficiency again is that the balances of interests do not even examine the interests that underlie legal tools. They fail, for example, to acknowledge that what we may be balancing are interests in not being tortured versus interests in making economic profit. Instead, these tests balance interests only with reference to legal tools that protect those interests (rights versus protections)—a practice that structurally favors all human interests in using animals, over all interests of animals in not being used.

The first step towards ensuring a less biased balance of interests is to clearly differentiate between a scientific evaluation of whether animals are required to obtain a scientific result, and an ethical evaluation of whether it is morally justifiable in each individual case to inflict a certain kind of suffering upon an animal for a certain kind of desired objective. The second step to reforming these tests is leveling the position of competing interests, by establishing a reliable framework for a qualitative and non-speciesist balance of interests. Such a qualitative balance of interests demands that identical interests be viewed identically, regardless of the holder of the interest, i.e., be it the interests of humans or the interests of animals (Ferrari and Gerritsen, 2015, p. 139; Robertson, 2015, p. 102). Balancing qualities of the interests at stake should, in principle, prevent marginal research interests from trumping interests in bodily integrity.

5 Reform Proposal 3: Animal Rights

5.1 *Why Reverse Hierarchies and Upgraded Balances of Interests Do Not Suffice*

Even if replacement is considered the primary aim of the 3Rs, and even if we considerably revamp the balance of interests test, the 3Rs will likely continue to fail. The odds against this test are so high because its logic is flawed. The golden standard in animal experimentation is the animal model. The animal model poses ethical problems, has never been validated as a research method, and is strongly criticized for lacking sufficient predictive value to draw inferences about human models (e.g., Baker, 2016; Bailey, Thew and Balls, 2014; Greek and Menache, 2013; Knight, 2011; McIvor, 2019, Chapter 5 in this Volume). Despite these apparent flaws and the structural deficiencies of the animal model, under the 3Rs, a non-animal model not only needs to be as “effective” as the animal model, but (unlike the animal model) it actually needs to work. As Greek points out, this means we are “[w]aiting to abandon a test that does not work until we can find one that does” (Greek, 2015). A recently published report by the *Scientific Committee on Health Environmental and Emerging Risks* (SCHEER) on the need for non-human primates in research even posits that alternative models, which are to be validated against existing animal models, will require—from a legal perspective—using more animals in the validation process (SCHEER, 2017, pp. 20, 56). The odds are thus high that the 3Rs will perpetuate the use of animals in research. A final and crucial *lex ferenda* change that may overturn this deeply ingrained imbalance requires restructuring protections as rights.

5.2 *Prohibitions as Rights?*

Some scholars argue that animals already have at least some rights by arguing that prohibitions are negative freedom rights of animals. Section 85 paragraph 1

of the *New Zealand Animal Welfare Act* (1999), for example, provides that “[n]o person may carry out any research, testing, or teaching involving the use of a non-human hominid unless such use has first been approved by the Director-General and the research, testing, or teaching is carried out in accordance with any conditions imposed by the Director-General” (Section 85(1)). From the general prohibition on using hominids for research, testing, or teaching, some infer that hominids have the right not to be infringed in their life and bodily and mental integrity. Wagman and Liebman (2011), for example, argue that “the ban on certain conduct seems to grant the affected animals the ‘right’ to be free of such conduct. Because of animals’ status as property in every jurisdiction, those rights are naturally limited” (pp. 261; see also McCausland, 2014, p. 27; Robertson, 2015, pp. 3, 5; Sunstein, 2004, p. 99; Waldau, 2011).

If we look at the laws that regulate research on animals, there are several prohibitions that could be posited as negative freedom rights. According to Article 8(2) and (3) of Directive 2010/63/EU, there is a prohibition of the use of great apes and non-human primates for research purposes (cf. European Parliament, 2010, Recital 18). Exceptions are stated in Article 8(2)(a) and (b) for non-human primates and in Article 55(2) for great apes. The *Australian Policy on the Use of Non-Human Primates for Scientific Purposes* (National Health and Medical Research Council, 2003), which declares that research on great apes is legal under narrow conditions, is also sometimes considered to enshrine a freedom right of great apes to not be used in research. Similar prohibitions/rights exist in Austria, Belgium, the Netherlands, Sweden, Switzerland, the UK, and other states (Goldner, 2014). Another type of negative freedom right can be seen in the EU-wide prohibition of experiments that result in severe pain, suffering, or distress for animals and which are likely to be long-lasting (European Parliament, 2010, Article 15(2)). However, these prohibitions are undermined when Member States choose to allow such procedures temporarily (European Parliament, 2010, Article 55(2)–(3)). Member states may, however, decline to adopt exceptions, which scholars support by arguing that certain levels of suffering should not be permitted under any circumstances, regardless of any likely or aspired benefits (Zurlo, Rudacille and Goldberg, 1996). Another type of prohibition is the ban on subjecting vertebrates to research without anesthesia when experiments result in serious injuries (European Parliament, 2010, Article 14(1), Sentence 2). Prohibitions may also preclude certain purposes from justifying animal use in research. Under Puerto Rican law, for example, animal experiments are prohibited if they are done for educational purposes (e.g., Puerto Rico Animal Welfare Act, 2008, Article 19(b); see also Swiss Animal Welfare Ordinance, 2008, Article 138(2)).

Prohibitions are a major step forward for animals, making certain species of animals unavailable to human disposition. In this sense, prohibitions

effectively preempt balances of interests: None of the specified procedures are *prima facie* available to be overridden by human interests. But these prohibitions apply only to a minority of animals (e.g., to iconic or endangered animals) and continue to be undermined by broad exceptions, which in turn promote the continuing use of a majority of animals in research.

5.3 *The Need for Animal Rights*

The whole idea that the duties of some can be translated into the rights of others (to whom the duty is owed); and, thus, that prohibitions are negative freedom rights of animals, is disputed in legal scholarship (Curnutt, 2001, pp. 19ff., 26ff.; Raspé, 2013, p. 282). Contrary to Wagman and Liebman's perspective is the view that specified norms are prohibitions, no more, no less. Rights are only established by unequivocally identifying them as such (e.g., "hominids have a right to life and a right to bodily and mental integrity"). Instead of opting for limited prohibitions that are undermined by numerous and sweeping exceptions, the only way to begin attending to the fundamental interests of animals is to establish rights for them. Rights are those rare tools that ensure that interests are qualitatively balanced, and that the balance is egalitarian and non-speciesist. As Peters (2016) argues: "[A]nimal rights would allow a fair balancing in which the proper value of fundamental animal interests (such as the interest to live) could be integrated. Animal rights would therefore preclude the current routine sacrifice of fundamental animal interests in favor of trite human interests" (p. 49). The demand for fundamental rights for animals is neither utopian nor far-fetched; it is the only option available to move away from our prevailing perfunctory consideration of animals. Particularly in research, where balance of interest tests prevail, establishing rights for animals is indispensable if we seriously want to start envisaging an end to their use in experimentation.

Another notable aspect about rights is that they ensure that rights holders have a sphere of absolute unavailability. In human rights law, this is known as the very substance of a right that may not be restricted or impaired in any way (e.g., European Economic Community, 1957, Article 2; Swiss Constitution, 1999, Article 36(4)). Because animals, under the laws of most states, are denied rights, human interests in exploiting animals take categorical precedence over their most fundamental interests, such as life and freedom. Introducing a sphere of inviolability for the most fundamental interests that animals possess is necessary, if we want to truly take their interests seriously and live up to our recognition of their intrinsic value (Peters, 2015, p. 72). A number of laws already recognize that the interests of animals matter because these interests

matter to them, i.e., that animals have to be protected for their own sake. The Dutch Animal Welfare Act (*Wet dieren* 2011) in this context expresses “recognition of the intrinsic value of the animal” (preamble). Directive 2010/63/EU (European Parliament, 2010) enshrines that “[a]nimals have an intrinsic value which must be respected” (Recital 10) and that they “should always be treated as sentient creatures” (Recital 12). The intrinsic value of animals is also recognized under German law (German Animal Welfare Act, 2006, Section 1); and the preamble to the *Latvian Animal Protection Law* (1999) states that “[t]he ethical obligation of humankind is to ensure the welfare and protection of all species of animals, because every unique being is in itself of value”. Article 3 litera a of the *Swiss Animal Welfare Act* (2005) speaks of the “[i]nherent worth of the animal that has to be respected”. Thailand’s *Ethical Principles and Guidelines for the Use of Animals* (National Research Council of Thailand, 1999) states that “[a]nimal users are to be aware of the value of life of animals” (Principle 1), and that “animal users need to be aware that animals are living beings just as humans are living beings” (Principle 4). The recognition of the intrinsic value of animals is not only ethically relevant, but it carries legal implications (Peters, 2015, p. 70) and should result in rights that protect these individuals’ core interests. Recent case law in India shows that animal rights are on the rise and that they are readily implementable. The High Court of Kerala (2000) declared: “[L]egal rights shall not be the exclusive preserve of the humans which has to be extended beyond people thereby dismantling the thick legal wall with humans all on one side and all animals on the other side” (N.R. Nair and Ors v. Union of India (UOI) and Ors, 2000); and, “animals are born with an equal claim for life without any cruelty to them. Perhaps if this right was given proper recognition by the human-beings, there would have been no necessity to bring on the statute book of the said Act” (People for Animals and Ors. v. State of Goa and Ors, 1997).

Establishing rights, and thereby an essence of inviolability, has a number of implications. Akin to Principle 5 of the *Nuremberg Code* (1949), experiments will not be conducted, “where there is an a priori reason to believe that death or disabling injury will occur” because it violates the core content of a right to life and bodily and mental integrity. And analogous to Principle 8 of the Helsinki Declaration (World Medical Association, 2013), the primary purpose of medical research to generate new knowledge cannot take precedence over the rights and interests of individual research subjects. Today, the duty to rehabilitate animals—sometimes known as the fourth R—could be taken as a useful starting point in this respect. Recital 14 of Directive 2010/63/EU states that methods should avoid death (of animals) as an endpoint. Killing

an animal used for a research experiment is only permitted if they remain in or have recurrent moderate or severe pain, suffering, distress, or lasting harm (European Parliament, 2010, Article 17(2); Government of India, Ministry of Environment and Forests, 2007, Annex 6). Article 17 paragraph 3 of Directive 2010/63/EU further states: “Where an animal is to be kept alive, it shall receive care and accommodation appropriate to its state of health.” India’s *Guidelines on the Regulation of Scientific Experiments on Animals* determine that “investigators are responsible for the aftercare and/or rehabilitation of animals after experimentation” (Government of India, Ministry of Environment and Forests, 2007, Annex 6). If states today are willing to determine that death of animals used in research should be avoided, it is not unreasonable to consider the possibility that they will grant animals a right to life in the future. Thereby, the rehoming duty would be explicitly reframed as a manifestation of a right to life, akin to Principle 5 of the *Nuremberg Code* (1949). A deficiency of current rehoming provisions, however, is that researchers are nudged to use the method that causes lasting moderate and severe pain, so they can put the animal down without having to care for or accommodate them after the conclusion of the experiment. To counter these unwarranted disincentives, the costs of aftercare and/or rehabilitation of animals post-experimentation should be budgeted as a part of research costs when an application is filed (as required by Government of India, Ministry of Environment and Forests, 2007, Annex 6, Principle 4).

5.4 *A Paradigm Shift?*

Animal rights implemented in law would create a paradigm shift because they offer specific advantages over protections. Instead of merely establishing specific and context-dependent prohibitions, rights operate more broadly and are less determinate. This confers advantages to the rights holder, because rights are applicable in a myriad of situations. For example, a right to bodily and mental integrity applies to the general question of whether use of an animal in research is justified. If the answer is yes, then the question must be asked whether and how this right can be guaranteed in research (e.g., by carrying out research that does not inflict any form of suffering, including death). Moreover, animals are empowered by rights because they, by being actionable, grant them access to stronger legal tools of enforcement (Edmundson, 2014, pp. 345ff., 350; Goldner, 2014, p. 53ff.). Only the enforced duty of others to respect the right in question renders its worthiness palpable (Edmundson, 2014, p. 360). Establishing a right of animals to life and bodily and mental integrity would stop perpetuating the use of animals for research and enable us to achieve the primary goal of the 3Rs: the ultimate replacement of animal models.

While funding animal-free alternatives will undoubtedly contribute to this goal, as well (see e.g., Swiss Animal Welfare Act, Article 22(2); European Parliament, 2010, Recital 46), only a paradigm change in the law of animals in research will stop incentivizing research facilities to continue experimenting on animals and will start enabling them to put all their efforts into finding ethically sound (and more scientifically sound) alternatives to the use of animals.

If industries cannot now devise alternatives to animal models, then certain types of research procedures simply should not be carried out until we find alternatives. When the *Helsinki Declaration* (World Medical Association, 2013) came into force, legislators deemed acceptable the burden of looking for alternative models to research on humans. The same change of research procedure is, on the basis of a non-speciesist ethic, reasonable to demand from industries that currently rely on animal models. This route is not utopian but was taken by lawmakers before, such as when the EU decided to give full effect to the *Cosmetics Directive* (European Commission, 2013, p. 3). When discussing the potential postponement of the 2013 marketing ban on cosmetics, since replacement methods for all animal models were not yet available, the EC argued that postponing the ban would “diminish determination to swiftly develop alternative test methods. Past experience demonstrates clearly that animal testing provisions in the cosmetics legislation have been a key accelerator in relation to the development of alternative methods and have sent a strong signal far beyond the cosmetics sector and far beyond Europe” (European Commission, 2013, p. 6). Instead of conceiving rights for animals as a scientific regression, industries will be incentivized to finally spur innovation towards ethically sound and economically accessible alternatives.

The *EU Cosmetics Directive* has had a positive spill-over effect into other areas of animal experimentation, alongside further national bans on cosmetics testing, including Australia (Australian Government, Department of Health, 2018), India (Government of India, Ministry of Health and Family Welfare, 2005, Section 148C), Israel (Israeli Cruelty to Animals Law 1994, Article 2(d); prohibiting cutting into live tissue), Guatemala (Guatemalan Animal Welfare Act 2017, Article 54), New Zealand (New Zealand Animal Welfare Act 1999, Section 84A), South Korea (South Korea Animal Protection Law 2007; in force 2019), and Taiwan (Business Cosmetics, 2016). In September 2016, the Dutch parliament changed its policy on animal research law in an unprecedented way. The parliament passed a motion to phase out all experiments on non-human primates and declared that by 2025, it aims to operate by testing methods that do not make use of animals. The policy areas in which the use of animals must be phased out until 2025 include regulatory testing of chemicals,

food ingredients, pesticides and (veterinary) medicines and biological products, such as vaccines. In the areas of fundamental research, applied and transitional research, as well as education and training, by contrast, no such specific reference date has been announced. The government's next step is for the Dutch National Committee for the Protection of Animals Used for Scientific Purposes (NCad, 2016) to plan a schedule that phases out experiments on animals (which applies to all of the above areas). NCad clearly puts emphasis on innovation and the development of new research methods rather than the abrogation of animal research; yet, its move is historical and will hopefully set a precedent for other states to follow. These developments show that the unavailability of animals for research does not equate with an end to research and advances for human benefit but instead, it heralds the beginning of an ethically and scientifically sound future for research. If devised as rights instead of bans, these regulatory changes would create more secure and justiciable ground for animals and could enable us to work more effectively towards a paradigm change in research.

6 Concluding Remarks

The 3Rs are a primary example of regulatory failure, and yet the concept enjoys an unparalleled acceptance among states and research institutions worldwide. Instead of abrogating the 3Rs (which is demanded by a growing number of citizens), it would be better to leverage the 3Rs' widespread acceptance to enable regulators to fulfil their unachieved regulatory goals and meet the growing demands of citizens for a more just relationship with animals.

This chapter proposed means of bringing about paradigm change, that, although few, are powerful. First, regulators must reverse the hierarchy of the 3Rs, based on a historical, teleological, and evolutionary interpretation, with replacement taking precedence. Second, regulators must introduce qualitative balances of interests, so identical interests are viewed identically, regardless of the interest holder. As a result, marginal scientific or prestige interests cannot trump interests in life and bodily and mental integrity. Third, animals must be accorded explicit rights to life and bodily and mental integrity, based on our legal commitment to protect them for their own sake (intrinsic animal protection), for the following reasons: rights grant more power to rights holders than interests do to interest holders, rights require special justification, give effective weight to animal interests in balancing tests, make the core interests of animals inviolable to human exploitation, and operate broadly. Although

rights will preclude undertaking many research practices that are currently conducted on animals, they spur innovation and help make research more effective and accessible. As the EC (2013) stated with respect to cosmetics, “the possible risks from the 2013 marketing ban can be turned into an opportunity for the Union to set an example of responsible innovation [...] with positive impact beyond Europe” (p. 6). The very same opportunities are available to us in research more generally if we begin to embark on a road of innovation and progress.

If these adjustments are incorporated, we anticipate that the 3Rs can offer a valuable approach to overturning the deeply ingrained default rule of animal experimentation and to incrementally phase out the use of animals in research. But “[f]ully reaping the potential of alternative methods is a challenging endeavor that will require a shift in thinking of all involved” (European Commission, 2013, p. 6; inertia of continued animal use is acknowledged in *Innovate UK*, 2015, p. 14). Legislators must empower scientists and research institutions to take the full replacement road by designing the best possible legal framework for it and by giving them the necessary financial incentives and education to pursue replacement, instead of holding them morally responsible for the continued use of animals, which is in fact a regulatory failure.

References

- Australian Government, Department of Health (2018). *Ban on Cosmetic Testing on Animals*. [online] Available at: <http://www.health.gov.au/internet/main/publishing.nsf/Content/ban-cosmetic-testing-animals> [Accessed 9 October 2018].
- Bailey, J., M. Thew and M. Balls (2014). An Analysis of the Use of Animal Models in Predicting Human Toxicology and Drug Safety. *Alternatives to Laboratory Animals*, 42(3), pp. 181–199.
- Baker, M. (2016). 1,500 Scientists Lift the Lid on Reproducibility. *Nature*, 533(7604), pp. 452–454.
- Bayne, K., G.S. Ramachandra, E.A. Rivera and J. Wang (2015). The Evolution of Animal Welfare and the 3Rs in Brazil, China, and India. *Journal of American Association of Laboratory Animal Science*, 54(2), pp. 181–191.
- Blattner, C. (2014). 3R for Farmed Animals: A Legal Argument for Consistency. *Global Journal of Animal Law*, 1, pp. 1–26.
- Blattner, C. (2016). An Assessment of Recent Trade Law Developments from an Animal Law Perspective: Trade Law as the Sheep in Wolf’s Clothing? *Animal Law Review*, 22, pp. 277–310.

- Bolliger, G. and A. Rüttimann (2015). Rechtlicher Schutz der Tierwürde. In: C. Ammann, B. Chistensen, L. Engi and M. Michel, eds., *Würde der Kreatur: Ethische und rechtliche Beiträge zu einem umstrittenen Konzept*. Zürich, Basel, Genf: Schulthess. pp. 65–92.
- Bolliger, G., M. Richner and A. Rüttimann (2011). *Schweizer Tierschutzstrafrecht in Theorie und Praxis*. Zürich, Basel, Genf: Schulthess.
- Bowman, M., P. Davies and C. Redgwell (2010). *Lyster's International Wildlife Law*. Cambridge, MA: Cambridge University Press.
- Brels, S. (2012). Animal Welfare Protection: A Universal Concern to Properly Address in International Law. *Journal of Animal Welfare Law*, 34, pp. 105–123.
- Business Cosmetics (2016). *Taiwan Bans Animal Testing*. [online] Available at https://www.cosmeticsbusiness.com/news/article_page/Taiwan_bans_animal_testing/122305 [Accessed 9 October 2018].
- Canadian Council on Animal Care (2011). *Categories of Invasiveness in Animal Experiments*. Ottawa: Canadian Council on Animal Care.
- Clemence, M. and J Leaman. (2016). *Public Attitudes to Animal Research in 2016*. A report by Ipsos MORI for the Department for Business, Energy & Industrial Strategy, Ipsos MORI Social Research Institute. [online] Available at: <https://www.ipsos.com/sites/default/files/publication/1970-01/sri-public-attitudes-to-animal-research-2016.pdf> [Accessed 9 October 2018].
- Council of Europe (1950). *Convention for the Protection of Human Rights and Fundamental Freedoms*, as amended by Protocols No. 11 and No. 14. 213 UNTS 221. [online] Available at: <https://rm.coe.int/1680063765> [Accessed 9 October 2018].
- Council of Europe (1979). *Convention for the Protection of Animals for Slaughter*, CETS, No. 102. [online] Available at: <https://rm.coe.int/1680077d98> [Accessed 9 October 2018].
- Council of Europe (1986). *Convention for the Protection of Vertebrate Animals Used for Experimental and other Scientific Purposes*. European Treaty Series No. 123. [online] Available at: <https://rm.coe.int/168007a67b> [Accessed 9 October 2018].
- Council of the European Communities (1986). Council Directive 86/609/EEC of 24 November 1986 on the Approximation of Laws, Regulations and Administrative Provisions of the Member States Regarding the Protection of Animals Used for Experimental and Other Scientific Purposes. *Official Journal of the European Communities*, L 358/1, 18.12.86, pp. 1–28.
- Commission of the European Communities (2000). *Communication from the Commission on the Precautionary Principle*, COM(2000)1, 2 February 2000.
- Curnutt, J. (2001). *Animals and the Law: A Sourcebook*. Contemporary Legal Issues. Santa Barbara, CA: ABC-CLIO.
- Edmundson, W.A. (2014). Do Animals Need Rights? *Journal of Political Philosophy*, 22(2), pp. 345–360.

- Eisen, J. and K. Stilt (2017). Animals. In: R. Grote, F. Lachenmann and W. Rudiger, eds., *Max Planck Encyclopedia of Comparative Constitutional Law*. Oxford: Oxford University Press. pp. 1–71.
- European Citizens' Initiative (2016). *Stop Vivisection*. [online] Available at <http://www.stopvivisection.eu/de> [Accessed 9 October 2018].
- European Commission (2013). *Report from the Commission to the Council and the European Parliament. Seventh Report on the Statistics on the Number of Animals used for Experimental and other Scientific Purposes in the Member States of the European Union*. COM(2013) 859 final. [online] Available at: <https://eur-lex.europa.eu/LexUriServ/LexUriServ.do?uri=COM:2013:0859:FIN:EN:PDF> [Accessed 9 October 2018].
- European Commission (2015). Communication from the Commission on the European Citizens' Initiative "Stop Vivisection", 3773 final.
- European Commission (2016). *Special Eurobarometer 442 Report: Attitudes of Europeans Towards Animal Welfare*. [online] Available at: <http://ec.europa.eu/COMMFrontOffice/publicopinion/index.cfm/Survey/getSurveyDetail/instruments/SPECIAL/surveyKy/2096> [Accessed 9 October 2018].
- European Convention (2000). Charter of Fundamental Rights of the European Union. *Official Journal of the European Communities*, C364/1. [online] Available at http://www.europarl.europa.eu/charter/pdf/text_en.pdf [Accessed 14 March 2018].
- European Economic Community (1957). *Treaty Establishing the European Economic Community*, 298 UNTS. 11, 25 March 1957.
- European Parliament (2010). Directive 2010/63/EU of the European Parliament and of the Council of 22 September 2010 on the Protection of Animals Used for Scientific Purposes. *Official Journal of the European Communities*, L276, pp. 33–79. [online] Available at: <https://eur-lex.europa.eu/legal-content/%20EN/TXT/?uri=CELEX%3A32010L0063> [Accessed 9 October 2018].
- Ferrari, A. and V. Gerritsen (2015). Güterabwägung. In: A. Ferrari and K. Petrus, eds., *Lexikon der Mensch-Tier-Beziehungen*. Bielefeld: Transcript, pp. 139–143.
- Funk, C. and L. Rainie (2015). Attitudes and Beliefs on Science and Technology Topics. In: C. Funk, and L. Rainie. *Public and Scientists' View on Science and Society*, Washington, D.C.: Pew Research Center, Ch. 2.
- Gerick, N. (2005). *Recht, Mensch und Tier: historische und ökonomische Aspekte des tierethischen Problems*. Baden-Baden: Nomos.
- German Administrative Court (Bundesverwaltungsgericht) (2006). *Urteil vom 23.11.2006 – BVerwG Entscheidung 3 C 30.05* [online] Available at: <https://www.bverwg.de/231106U3C30.05.o> [Accessed 9 October 2018].
- German Animal Welfare Act, Tierschutzgesetz (TierSchG) 2006. 18 May 2006*, BGBl. I at 1206. [online] Available at: <https://www.gesetze-im-internet.de/tierschg/BJNR012770972.html> [Accessed 9 October 2018].

- German Basic Law, Grundgesetz (GG) 1949*. Grundgesetz für die Bundesrepublik Deutschland in der im Bundesgesetzblatt Teil III, Gliederungsnummer 100–1, veröffentlicht bereinigten Fassung. [online] Available at: <https://www.gesetze-im-internet.de/gg/BJNR000010949.html> [Accessed 9 October 2018].
- German Constitutional Court (Bundesverfassungsgericht) (2006). *Rechtssprechung BVerfG, 13.12.2006 – 1 BvR 2084/05*. [online] Available at: <https://dejure.org/dienste/vernetzung/rechtsprechung?Gericht=BVerfG&Datum=13.12.2006&Aktenzeichen=1%20BvR%202084/05> [Accessed 9 October 2018].
- Gerritsen, V. (2015). Evaluation Process for Animal Experiment Applications in Switzerland. *Alternatives to Animal Experimentation: Proceedings*, 4(1), pp. 37–40.
- Goldberg, A.M. and P.A. Locke (2004). To 3R is Humane. *The Environmental Law Institute*, July/August 2004, pp. 19–26.
- Goldner, C. (2014). *Lebenslänglich hinter Gittern: Die Wahrheit über Gorilla, Orangutan & Co in Deutschen Zoos*. Aschaffenburg: Alibri Verlag.
- Government of India, Ministry of Environment and Forests (Animal Welfare Division) (2007). *Guidelines on the Regulation of Scientific Experiments on Animals*. Annex 6. [online] Available at: www.gadvasu.in/Welcomedownload/document/21 [Accessed 9 October 2018].
- Government of India, Ministry of Health and Family Welfare (2005). *Drugs and Cosmetics Act and Rules 1945*. [online] Available at: <http://apps.who.int/medicinedocs/documents/s20107en/s20107en.pdf> [Accessed 9 October 2018].
- Greek, J.S. and R. Greek (2004). *What Will We Do if We Don't Experiment on Animals? Medical Research for the Twenty-first Century*. Trafford: Victoria, Canada.
- Greek, R. (2015). The Extreme Consequences of Naivety, Ignorance of Current Science, and Lack of Critical Thinking Skills in the Animal Protection Community. Part 1. *Americans for Medical Advancement*. [blog] Available at: <http://www.afma-curedisease.org/blog/2015/november/30/the-extreme-consequences-of-naivety,-ignorance-of-current-science,-and-lack-of-critical-thinking-skills-in-the-animal-protection-community-part-i.aspx> [Accessed 9 October 2018].
- Greek, R. and A. Menache (2013). Systematic Reviews of Animal Models: Methodology vs Epistemology. *International Journal of Medical Science*, 10(3), pp. 206–221.
- Guatemalan Animal Welfare Act 2017*. Congreso de la República de Guatemala, Decreto Número 5–2017, El Congreso de la República de Guatemala, *Dirario de Centro América*, 3 de Abril de 2017, No 87. Tomo CCVI (Guat.). [online] Available at: <https://www.congreso.gob.gt/wp-content/plugins/acuerdos/includes/uploads/docs/2017/CCCVI0480100010005201707022017.pdf> [Accessed 9 October 2018].
- Holley, T., G. Bowe, I. Campia, S. Belz, E. Berggren, A. Janusch-Roi, C. Wittwehr and M. Whelan (2016). Accelerating Progress in the Replacement, Reduction and refinement of Animal Testing Through Better Knowledge Sharing. *Joint Research Centre (JRC) Science for Policy Report*. Ispra: European Union.

- Innovate UK (2015). *Non-animal Technologies: New Vision, Strategy, and Roadmap for the UK*. Swindon: Technology Strategy Board. [online] Available at: <https://www.gov.uk/government/news/non-animal-technologies-new-vision-strategy-and-roadmap-for-uk> [Accessed 9 October 2018].
- Israeli Cruelty to Animals Law 1994*. Israel Knesset. [online] Available at: https://www.animallaw.info/sites/default/files/stisreal_animal_protection.pdf [Accessed 9 October 2018].
- Jones, J.M. (2017). Americans Hold Record Liberal Views on Most Moral Issues. *Gallup Poll Social Series*. [online] Available at: <https://news.gallup.com/poll/210542/americans-hold-record-liberal-views-moral-issues.aspx> [Accessed 9 October 2018].
- Knight, A. (2011). *The Costs and Benefits of Animal Experiments*. Basingstoke, Hampshire: Palgrave Macmillan.
- Kolman, R., A. Harmelin, E. Ziv and Y. Fischer (2014). Israeli legislation and regulation on the use of animals in biological and medical research. In: J. Guillén, ed., *Laboratory Animals: Regulations and Recommendations for Global Collaborative Research*. San Diego, London, Waltham: Academic Press, pp. 189–204.
- Kuhlau, F., A.T. Höglund, K. Evers and S. Eriksson (2011). A Precautionary Principle for Dual Use Research in the Life Sciences. *Bioethics*, 25(1), pp. 1–8.
- Latvian Animal Protection Act, Dzīvnieku aizsardzības likums 1999*. Latvijas Vēstnesis [Latvian Herald], 444/445. [online] Available at: <https://likumi.lv/doc.php?id=14940> [Accessed 9 October 2018].
- Leondarakis, K. (2006). *Menschenrecht „Tierschutz“: Die Verletzung von Menschenrechten durch die Verletzung von Belangen an Tieren*. Baden-Baden: Nomos.
- McCausland, C. (2014). The Five Freedoms of Animal Welfare Are Rights. *Journal of Agricultural and Environmental Ethics*, 27, pp. 649–662.
- Montreal Protocol on Substances that Deplete the Ozone Layer 1987, Ch. XXVII, 2 a. [online] https://treaties.un.org/doc/Treaties/1989/01/19890101%2003-25%20AM/Ch_XXVII_02_ap.pdf [Accessed 9 October 2018].
- National Advisory Committee for Laboratory Animal Research (NACLAR) (2004). *NACLAR Guidelines*. Agri-Food and Veterinary Authority of Singapore. [online] Available at: https://www.ava.gov.sg/docs/default-source/tools-and-resources/resources-for-businesses/attach3_animalsforscientificpurposes [Accessed 9 October 2018].
- National Health and Medical Research Council (2003). *Policy on the Care and Use of Non-Human Primates for Scientific Purposes*. Canberra: National Health and Medical Research Council. [online] Available at: <https://www.nhmrc.gov.au/guidelines-publications/ea14> [Accessed 9 October 2018].
- National Research Council Institute for Laboratory Animal Research (2011). *Guide for the Care and Use of Laboratory Animals*. 8th ed. Washington D.C.: National Academies Press. [online] Available at: <https://grants.nih.gov/grants/olaw/guide-for-the-care-and-use-of-laboratory-animals.pdf> [Accessed 9 October 2018].

- National Research Council of Thailand (1999). *Thailand Ethical Principles and Guidelines for the Use of Animals*. Chatuchak: National Research Council of Thailand. [online] Available at: <http://www.labanimals.net/images/Download/Ethics/Ethics%20Animal%20Eng.pdf> [Accessed 9 October 2018].
- Netherlands National Committee for the Protection of Animals Used for Scientific Purposes (NCad) (2016). *Transition to Non-animal Research on Opportunities for the Phasing Out of Animal Procedures*. The Hague: NCad. [online] Available at <https://www.ncadierproevenbeleid.nl/documenten/rapport/2016/12/15/ncad-opinion-transition-to-non-animal-research> [Accessed 9 October 2018].
- Neue Zürcher Zeitung (NZZ) (2016). *Zahl der Tierversuche gestiegen*. [online] Available at: <https://www.nzz.ch/schweiz/forschung-zahl-der-tierversuche-gestiegen-ld.110347> [Accessed 9 October 2018].
- New Zealand Animal Welfare Act, Public Act 1999*, No. 142. Last amended 1 March 2017. Parliamentary Council Office. [online] Available at: <http://www.legislation.govt.nz/act/public/1999/0142/56.0/DLM49664.html> [Accessed 9 October 2018].
- New Zealand Government (2010). *Good Practice Guide for the Use of Animals in Research, Testing, and Teaching*. Wellington: National Animal Ethics Advisory Committee. [online] Available at: <https://www.mpi.govt.nz/dmsdocument/3660/loggedIn> [Accessed 9 October 2018].
- N.R. Nair and Ors v. Union of India (UOI) and Ors*. [2000] AIR 2000 Ker 340 (High Court of Kerala). [online] Available at: <https://www.ecolex.org/details/court-decision/nr-nair-and-ors-vs-union-of-india-and-ors-1016af55-5956-4cf5-9bb3-00033c3304e3/> [Accessed 9 October 2018].
- Nuremberg Code (1949). *Trials of War Criminals Before the Nuremberg Military Tribunals Under Control Council Law*. Washington, D.C.: US Government Printing Office, 10(2), pp. 181–182. [online] Available at: http://www.loc.gov/rr/frd/Military_Law/pdf/NT_war-criminals_Vol-II.pdf [Accessed 9 October 2018].
- People for Animals and Ors. v. State of Goa and Ors*. [1997] Writ Petition 347–1996 (High Court of Bombay). [online] Available at: <https://www.legalcrystal.com/case/358093/people-animals-mrs-norma-alvares-vs-state-secretary> [Accessed 9 October 2018].
- Perry, P. (2007). The Ethics of Animal Research: A UK Perspective. *Institute for Laboratory Animal Research Journal*, 48, pp. 42–46.
- Peters, A. (2012). *Rechtsgutachten zu verschiedenen Fragen im Zusammenhang mit der EU-Tierversuchsrichtlinie, insb. zur Unionsrechts- und Verfassungskonformität des Entwurfs eines Dritten Gesetzes zur Änderung des Tierschutzgesetzes sowie des Entwurfs einer Verordnung zur Umsetzung der Richtlinie 2010/63/EU*. Zürich: Schulthess, Schriften zum Tier im Recht.
- Peters, A. (2016). Liberté, Égalité, Animalité: Human-Animal Comparisons in Law. *Transnational Environmental Law*, 5(1), pp. 25–53.

- Philippines Law on the Use of Animals in Research 1999*, Administrative Order 40, Series of 1999. Rules and Regulations on the Conduct of Scientific Procedures Using Animals. Manila: Philippines Department of Agriculture. [online] Available at: http://www.paws.org.ph/uploads/2/1/2/7/21275318/awa_a040-rules_and_regulations_on_the_conduct_of_scientific_procedures_using_animals.pdf [Accessed 9 October 2018].
- Prevention of Cruelty to Animals Act 1982*, as amended by Central Act 26 of 1982, Animal Welfare Board of India. [online] Available at: <http://www.envfor.nic.in/legis/awbi/awbio1.pdf> [Accessed 9 October 2018].
- Puerto Rico Animal Welfare Act, No. 154, 2008*, P.R. Laws Ann. tit. 5, Ch. 58. Legislature of Puerto Rico. [online] Available at: <http://www.alvarezlegalpr.com/Act%20154%20of%20August%204,%202008.pdf> [Accessed 9 October 2018].
- Raspé, C. (2013). *Die tierliche Person*. Berlin: Duncker & Humblot.
- Robertson, I.A. (2015). *Animals, Welfare, and the Law: Fundamental Principles for Critical Assessment*. Oxon, UK: Routledge.
- Russell, W.M.S. and R.L. Burch (1959). *The Principles of Humane Experimental Technique*. London: Methuen. [online] Available at: http://altweb.jhsph.edu/pubs/books/humane_exp/het-toc [Accessed 9 October 2018].
- Scientific Committee on Health Environmental and Emerging Risks, SCHEER (2017). *Final opinion on the need for non-human primates in biomedical research, production, and testing of products and devices*. Brussels, Belgium: European Union.
- South Korea Animal Protection Law (Dongmulbohoeob), Act 8282, 2017*. Ministry of Government Legislation, South Korea. [online] Available at: <http://law.go.kr/engLsSc.do?menuId=0&subMenu=%205&query=%20EB%8F%2099%EB%AC%BC%EB%B3%B4%ED%98%B8%EB%B2%95#> [Accessed 9 October 2018].
- Sunstein, C.R. (2004). *Introduction: what are animal rights?* In: C.R. Sunstein and M.C. Nussbaum, eds., *Animal Rights: Current Debates and New Directions*. Oxford: Oxford University Press, pp. 3–18.
- Swiss Animal Welfare Act (Schweizerisches Tierschutzgesetz, TSchG) 2005*, SR 455. Switzerland. [online] Available at: <https://www.admin.ch/opc/de/classified-compilation/20022103/index.html> [Accessed 9 October 2018].
- Swiss Animal Welfare Ordinance (Schweizerische Tierschutzverordnung, TSchV) 2008*, SR 455.1. Switzerland. [online] Available at: <https://www.admin.ch/opc/de/classified-compilation/20080796/index.html> [Accessed 9 October 2018].
- Swiss Constitution (Schweizerische Bundesverfassung, BV) 1999*, SR 101. Switzerland. [online] Available at: <https://www.admin.ch/opc/de/classified-compilation/19995395/index.html> [Accessed 9 October 2018].
- Sykes, K. (2014). Sealing Animal Welfare into the GATT Exceptions: The International Dimension of animal Welfare in WTO Disputes. *World Trade Review*, 13, pp. 471–498.
- Taylor, K. (2013). *Animals in Research*. In: A. Linzey, ed. *The Global Guide to Animal Protection*. Urbana, Chicago, Springfield: University of Illinois Press. pp. 178–180.

- Taylor, K., N. Gordon, G. Langley and W. Higgins (2008). Estimates for worldwide laboratory animal use in 2005. *Alternatives to Laboratory Animals*, 36(3), pp. 327–342.
- Taylor, K. and L. Rego (2016). EU Statistics on Animal Experiments for 2014. *Alternatives to Animal Experimentation: Proceedings*, 33(4), pp. 465–468. [online] Available at: <https://www.altex.org/index.php/altex/article/view/145> [Accessed 9 October 2018].
- Tomasik, B. (2014). *Suffering in Animals vs. Humans, Essays on Reducing Suffering*. [online] Available at <http://reducing-suffering.org/suffering-in-animals-vs-humans/> [Accessed 9 October 2018].
- Trent, N., S. Edwards, J. Felt and K. O'Meara (2005). *International animal law, with a concentration on Latin America, Asia, and Africa*. In: D.J. Salem and A.N. Rowan, eds., *The State of the Animals III*. Washington, D.C.: Humane Society Press. pp. 65–77.
- UK Animals (Scientific Procedures) Act 1986. Ch. 14. London: Her Majesty's Stationery Office. [online] Available at: <https://www.legislation.gov.uk/ukpga/1986/14/contents> [Accessed 9 October 2018].
- UK Home Office (2014). *Guidance on the Operation of the Animals (Scientific Procedures) Act 1986*. London: Her Majesty's Stationery Office. [online] Available at: <https://www.gov.uk/guidance/guidance-on-the-operation-of-the-animals-scientific-procedures-act-1986> [Accessed 9 October 2018].
- UK Home Office (2016). *Annotated Project License Application Form*. London: Her Majesty's Stationery Office. [online] Available at: https://www.gov.uk/government/uploads/system/uploads/attachment_data/file/670717/Annotated_PPL_v2.0_171221.pdf [Accessed 9 October 2018].
- United Nations (1992). *Convention on Biological Diversity*. 1760 U.N.T.S. 79. [online] <https://www.cbd.int/convention/text/> [Accessed 9 October 2018].
- United Nations General Assembly (1982). *World Charter for Nature*. Resolution A/RES/37/7, UN GAOR 37th Session. [online] Available at: <http://www.un.org/documents/ga/res/37/a37r007.htm> [Accessed 9 October 2018].
- United Nations General Assembly (1992). *Declaration of the United Nations Conference on Environment and Development*. United Nations General Assembly, A/CONF.151/26. [online] Available at: <http://www.un.org/documents/ga/conf151/aconf15126-1annex1.htm> [Accessed 9 October 2018].
- US Animal Welfare Act (AWA) 1966, 7 U.S.C. § 2131. United States Department of Agriculture. [online] Available at: <https://www.nal.usda.gov/awic/animal-welfare-act> [Accessed 9 October 2018].
- Wagman, B.A. and M. Liebman (2011). *A Worldview of Animal Law*. Durham: Carolina Academica Press.
- Waldau, P. (2011). *Animal Rights: What Everyone Needs to Know*. Oxford: Oxford University Press.
- Wet van 19 mei 2011, houdende een integraal kader voor regels over gehouden dieren en daaraan gerelateerde onderwerpen. [online] Available at: <https://zoek.officielebekendmakingen.nl/stb-2011-345.html> [Accessed 9 October 2018].

- World Health Organization (1994). *Agreement on the Application of Sanitary and Phytosanitary Measures*. 1867 U.N.T.S. 493. [online] Available at: https://www.wto.org/english/tratop_e/sps_e/spsagr_e.htm [Accessed 9 October 2018].
- World Medical Association (1964). *Declaration of Helsinki: Ethical Principles for Medical Research Involving Human Subjects. Last Update October 2013*. Ferney-Voltaire: World Medical Association. [online] Available at: <https://www.wma.net/policies-post/wma-declaration-of-helsinki-ethical-principles-for-medical-research-involving-human-subjects/> [Accessed 9 October 2018].
- World Organisation for Animal Health (OIE) (2018). *Terrestrial Animal Health Code*. Paris: World Organization for Animal Health. [online] Available at: <http://www.oie.int/index.php?id=169&L=0> [Accessed 9 October 2018].
- Zurlo, J., D. Rudacille and A.M. Goldberg (1996). The Three R's: The Way Forward. *Environmental Health Perspectives*, 104(8), pp. 878–880.

Contesting Animal Experiments through Ethics and Epistemology: In Defense of a Political Critique of Animal Experimentation

Arianna Ferrari

Head of Strategy and Content, Futurium gGmbH, Berlin, Germany

arianna.ferrari@posteo.de

1 Introduction

Generally, an animal experiment can be defined as an intervention on an animal, which causes suffering, harm, and distress, for scientific purposes. In this definition, animal experiments differ from more general scientific investigations concerning animals, such as observational studies in the wild in the fields of ethology or conservation, in which animals are involved but may not be harmed. Nowadays, the use of the term *vivisection*, in the case of animal experiments, is very controversial. This term originally referred to the cutting of living bodies for scientific purposes and has a long conceptual history (Maehle, 1992). In ancient times, it was used for referring to experiments on animals as well as on humans. Only in modern times, it became a colloquial term for all animal experiments and was much used by opponents in the nineteenth century, as the criticism of animal experiments became organized in a political movement (Maehle, 1990). Many opponents to animal experiments, nowadays, use the term deliberately in a political sense, connecting to past animal protection movements (e.g., the international Citizens' Initiative *Stop Vivisection*, cf. Rippe, 2009). Animal experimenters, on the other hand, oppose the term on the grounds that there is no *chirurgical exploration* of living animals in experiments (e.g., German Research Foundation, DFG, 2016).

Currently, animals are used in different ways for scientific purposes: they are used in basic research; in education in a variety of biomedical disciplines, including veterinary medicine; as so-called *disease models*, to mimic different diseases, mostly human ones; as test subjects in different test settings; in veterinary medicine; in behavioral and cognitive ethological studies; as bioreactors to produce fluids or bodily parts which contain therapeutic substances for human beings (i.e., “gene-pharming”); and as sources of cells, tissues, and

organs for human transplantation. Although the capturing, handling, transporting, confining, and breeding of animals are relevant parts of the practice of animal experimentation, they are not explicitly indicated in many laws as animal experiments. This constitutes a problem because these practices cause major distress in animals. Furthermore, the act of breeding animals for scientific purposes, which has become unavoidable (with rare exceptions), since it ensures the standardization and reproducibility of experimental results (cf. Ferrari, 2008), must be considered an ethical issue. In the practice of animal experimentation, individuals are materially formed in their identity as experimental living beings. These animals are often born with specific characteristics suited to scientific experiments (see Linzey and Linzey, 2015). The fact that breeding is not classified as an animal experiment affects the perception of the suffering and the number of animals used for research. For example, in experiments that make use of genetically altered animals, many individuals are used for the realization and maintenance of a, so-called, transgenic *animal line*, and are not counted in the statistics. Furthermore, many *transgenic lines* are bred in commercial facilities to be ready for use, so that scientists can order them from a catalogue.

This chapter offers a framework for building a convincing critique of animal experimentation. In order to do so, it first explores the framework that justifies animal experiments in the current debate, which relies both on scientific and ethical arguments. It then analyzes the main arguments developed to oppose animal experiments, in terms of epistemic and ethical arguments. Although valuable, these arguments present some pitfalls when considered separately. The chapter concludes that a convincing critique of animal experimentation must be political.

2 How Is the Practice of Animal Experiments Currently Justified?

Although animal experiments are carried out all over the world, in most cases their use is not mandatory. Their main goal is to protect human beings, though protecting non-human animal health and the environment are also goals. This chapter presents the argument that the obligation to perform animal experiments comes from a commonly accepted experimental culture, which is justified on the basis of ethical and epistemic arguments relating to human gains. In the writings which justify animal experiments, often the need to protect human safety is of primary concern. The apparent unavoidability of animal experiments is explained, first through reference to historical arguments and,

second, through the irreducibility of, so-called, *in vivo* experiments to other methods (e.g., *in vitro*, *in silico*, or computer modelling). For example, the Royal Society (2004) has argued that almost every medical achievement in the twentieth century relied on the use of animals in some way. The German Research Foundation (DFG, 2016), in its paper on animal experiments, maintains that even sophisticated computers are unable to model interactions between molecules, cells, tissues, organs, organisms, and the environment. It is argued that animal experiments result from a cost-benefit-analysis, in which the costs for animals have to be balanced with the benefits for the protection of human health and the environment.

The Principles of Humane Experimental Technique (Russell and Burch, 1959) is one of the first documents on the ethical rationale of animal experiments and has become a milestone in the politics of alternative methods. Russell and Burch formed the basis for a new applied science that would improve or substitute the treatment of laboratory animals, while advancing the quality of science in studies that use animals. They claimed that this science must be inspired by the three principles of *replacement*, *reduction*, and *refinement* with regard to the use of animals. It is important to note that Russell and Burch's intent was ethical, but their methods were descriptive and empirical, not normative. Russell and Burch were inspired by the goal, stated by the Universities Federation for Animal Welfare (UFAW) in the United Kingdom, to promote, so-called, *humane* behavior, consisting of reducing pain and fear inflicted upon animals (Tannenbaum and Bennett, 2015). The method of replacing, reducing, or refining the use of animals in studies was defined as an empirical approach. According to this method, inhumanity was associated with physical or psychological distress, unnecessary or avoidable pain, fear, stress, anxiety, and bodily discomfort. However, for Russell and Burch, the goal of lessening distress (inhumanity) in scientific procedures was always subordinate to the goals of conducting science and achieving scientific and medical progress. Russell and Burch, indeed, were not criticizing the use of animals in research as such, but promoted methods to reduce and, whenever possible, eliminate animal distress consistent with the conduct of sound science. Although the concept of alternatives was not present in their 1959 book, the 3Rs have been the foundation for the development of alternative methods, which were formally introduced by Smyth (1978) in *Alternatives to Animal Experiments* (see Tannenbaum and Bennet, 2015). Smyth defined an alternative as any change in experimental methods that results in the application of the 3Rs. Since then, there has been an ongoing debate on the different definitions of these principles and how to apply them to scientific procedures (see e.g., Tannenbaum and Bennett, 2015); but the core of the message remains in favor of animal experiments. Indeed,

more recently, Russell described the word *alternative* as “unfortunate” because it suggests only 1R (Russell, 2005).

The justification of animal experiments has been explained in the clearest and strongest manner in the case of biomedical research. One of the most quoted documents is the *Nuremberg Code*, which followed the Nuremberg Trials after World War II. The *Nuremberg Code* states that, “The experiment should be so designed and based on the results of animal experimentation and a knowledge of the natural history of the disease or other problem under study that the anticipated results will justify the performance of the experiment” (Shuster, 1997, p. 1436). Another widely used document is the *Declaration of the World Medical Association on the Ethical Principles for Medical Research Involving Human Subjects*, first formulated in Helsinki in 1964 (World Medical Association, 1964). This Declaration was formulated as a response to the monstrous threats to humanity during World War II, and it defined the role of animal experiments prior to human exposure: “Medical research involving human subjects must conform to generally accepted scientific principles, be based on a thorough knowledge of the scientific literature, other relevant sources of information, and adequate laboratory and, as appropriate, animal experimentation. The welfare of animals used for research must be respected”. Now known as the *Helsinki Declaration*, it establishes the ethical obligation to carry out animal experiments when results from these experiments are necessary and unavoidable at a given time by the scientific community.

In 2010, inspired by the *Helsinki Declaration*, which changed the landscape of human experimentation, a group of scientists (approximately 4500 individuals, at the time of writing) formulated the *Basel Declaration* (2010) “to further advance the implementation of ethical principles such as the 3Rs whenever animals are being used and to call for more trust, transparency and communication on the sensitive topic of animals in research”. The *Basel Declaration* states the necessity of animal experiments to meet fundamental scientific challenges (such as human and non-human animal diseases and protection of the environment), and that the necessity will remain in the foreseeable future for biomedical research. The first principle of the *Basel Declaration* is “to respect and protect the animals entrusted to us and not inflict unnecessary pain, suffering, or harm to them by adhering to highest standards of experimental design and animal care”. This is very similar in scope and intent to the 3Rs. The principles that follow provide specific care in particular scientific practices, such as the creation and use of genetically modified animals or the use of animals in education (Basel Declaration, 2010). The German Research Foundation (DFG) explains the ethics of animal experimentation through, so-called,

patho-inclusive ethics, which they define as follows: “It is not only reconcilable with valuing human interests over those of sentient animals but also with the position that other human interests, such as life and health, knowledge gain, and pleasure may justify causing distress to animals. Moreover, this view does not preclude the killing of animals, but it does demand that the killing should not cause fear or suffering, if possible” (DFG, 2016, p. 43).

In these texts, the argument that justifies animal research relies on the ethical obligation of a profession, which considers the performance of animal experiments the best scientific standard. In other words, the standard of accepting and promoting some animal experiments is described as a scientific standard, since animal experiments are considered the epistemically best way to achieve certain goals. In addition, the commitment of maintaining good animal welfare is an ethical concern but always subordinate to that of the best science. However, it is not only the professional obligation of scientists to use the best standards at a given time which justifies animal experiments. The professional obligation is based on a more general framework on human-animal relationships, which is anthropocentric at its core. It is a form of (unqualified) speciesism, i.e., the unjustified disadvantageous treatment or consideration of those who do not belong to, or are not categorized as belonging to, a certain species (or group of species). Richard Frey (2005) refers to this position as guided by the “argument from benefit” that is derived from utilitarianism, which justifies the infliction of pain on animals to serve different goals, and is combined with speciesism, which states that a species belonging (i.e. human) justifies a different ethical treatment. Indeed, in the case of animals, the cost-benefit-analysis is accepted; whereas, in the case of humans, it is not: “utilitarianism for animals, Kantianism for people,” as Nozick (1974, p. 39) put it. Cohen (1986) offers a similar defense for animal experiments. Contesting the idea of animal rights because animals lack the capacity to make moral claims, Cohen has argued that we have a strong duty to conduct such experiments to alleviate human suffering and extend human lives.

In summary, defense of animal research is derived from a combination of scientific reasons (the best possible standard at a given time), the ethical obligation of scientists as a professional community (to respect the best possible standards), and speciesism. Although the arguments for animal experiments are accepted by many in society, particularly in terms of regulations and experimental practice, arguments against animal experiments have a long history and have been articulated in different texts and campaigns worldwide. The following sections distinguish between two main arguments against animal experimentation, epistemic (also called, *epistemic antivivisectionism*) and ethical (also called, *ethical antivivisectionism*).

3 The Epistemic Critique of Animal Experiments

At the core of the epistemic critique of animal experiments is the idea that such experiments are *bad science*. *Bad* is used as a synonym for inefficient, scientifically wrong, or misleading. This kind of critique has a long history. Between the third and fourth centuries, BCE, the empiric school of the Ancient Greek rejected the study of anatomical and physiological vivisection, due both to its cruelty and the belief that pain and death would distort the normal appearance of internal organs. In more recent times, some animal welfare and animal rights organizations and philosophers have used examples from the history of biomedical experimentation, and retrospective studies on the influence of animal experiments in human medicine, to criticize the practice. The Italian philosopher, Croce (2000), coined the term, *scientific antivivisectionism* (*antivivisezionismo scientifico*), as a rejection of the idea of the transferability of results from one species to another. According to this rationale, modern animal models are of limited use and can even be dangerous because the data produced are not easily translatable to humans (Croce, 2000; Gericke and Reinke, 2011; cf. Pappworth, 1968).

For LaFollette and Shanks (1996) and Greek and Greek (2003) the idea of the unavoidability of animal experiments is misleadingly taken as the “gold standard” within the scientific community. At the center of this critique is the deconstruction of the claim that animal experiments in biomedicine are predictive of human conditions. LaFollette and Shanks (2004; 2006) provide a critique of the use of *animal models* based on evolutionary theory. They observe that phylogenetically related animals have different mechanisms to achieve the same biological functions, a phenomenon they call “causal-functional asymmetry”. This phenomenon renders cross-species extrapolations as causal explanations impossible. Knowledge of relevant causal differences, i.e., causal dis-analogies (with respect to mechanisms and pathways), which compromise the usefulness of analogical reasoning, is necessary; however, this knowledge is only possible retrospectively, once a property has already been tested on different species. LaFollette and Shanks (1996) argue that the defense of animal experimentation relies on a scientifically misleading interpretation of the epistemic role of animal models in biomedical research. They explain that this defense is a product of Claude Bernard’s legacy, which is based on a hypothetical-deductivist method in biomedicine, coupled with a rejection of statistical laws. Bernard assumed that clinical medicine (including epidemiological studies) could never be a genuine science and believed in the interchangeability of species to test clinical hypotheses (LaFollette and Shanks, 1996).

The argument defending the unavoidability of animal experiments is based on the confusion between what are known as *causal-analogic models* (CAMs) and *hypothetical animal models* (HAMs). Historically, some animal experiments were consistent with hypothetical-deductive methods, in that they were useful to gain knowledge. However, in the present day, with scientific and technical advancements in alternative methods, the potential of molecular biology (together with proteomics and genomics, among others), as well as computer models, animal models have become obsolete and poor scientific practice. As a result, scientists who promote animal models are not adhering to good scientific practice, and continued use of animal models may prevent the attainment of human-relevant results. This critique is apparent in the current debate on the promotion of alternative methods within regulatory toxicology. For example, Hartung (2013) has spoken of “toxic ignorance” and the necessity for a paradigm shift in the twenty-first century that moves away from animal use and embraces new non-animal technologies.

The epistemic critique of animal experiments is supported by considerable literature from retrospective studies, which have established the poor clinical value of animal models (Pound et al., 2004). Though beyond the scope of this chapter, this literature reaches a sobering conclusion that, in many cases, animal experiments show poor methodological quality, problems with evaluation, and limitations of false-positive or false-negative results. Furthermore, there is a visible lack of consistency between the results of animal models and clinical trials, as well as a significant lack of transferability of results (Akhtar, 2015; Knight, 2011). This demonstrates the need for a retrospective evaluation and critical appraisal of the benefits of animal experiments to facilitate a paradigm shift towards non-animal and human-relevant approaches.

4 The Ethical Critique of Animal Experiments

The ethical critique of animal experiments is derived from reflection on the moral status of animals as sentient beings: animal experiments impose suffering and death, so that the animals’ interests are systematically violated. Hence, this practice is not justified, regardless of its “utility”. This kind of critique can be traced to the seventeenth and eighteenth centuries, when a rise in movements opposing cruelty to animals occurred, and men of letters in England denounced the brutality of animal experiments and openly opposed the Cartesian view of animals as automata (Maehle, 1990). The ethical critique of animal experiments explicitly denounces speciesism: “There is only

one serious moral defense of vivisection. That defense proceeds as follows. Human beings are better off because of vivisection. [...] One thing should be immediately obvious. The benefits argument has absolutely no logical bearing on the debate over animal rights. Clearly, all that the benefits argument could possibly show is that vivisection on nonhuman animals benefits human beings. What this argument cannot show is that vivisectioning animals for this purpose is morally justified. Whether animals have rights is not a question that can be answered by saying how much vivisection benefits human beings” (Regan, 2004, p. 174).

The ethical critique attacks the cost-benefits of the animal model in two ways: first, the thesis of inviolable animal rights (right to life and prohibition of the infliction of suffering) intrinsically excludes the institutionalization of a cost-benefit calculation (see Donaldson and Kymlicka, 2011). Second, because the ethical critique denounces that in animal experiments two incomparable magnitudes are compared: the direct, intentional, present infliction and killing of animals and the elaboration of methods to reach future anticipated knowledge that can principally serve to protect humans. In other words, a conflict situation is constructed. Such attempts are part of a long-term strategy for the further development of scientific goals (Wolf, 1988), by which (perhaps) the suffering of some persons (or some animals) can be prevented; and they cannot, therefore, be viewed as a conflict of interest. In the institutionalized practice of animal experiments, animals are born to be experimental tools, they are bred for a purpose, and their biological nature is formed through the identity given to them by human use. If we recognize animals as bearers of fundamental rights, we cannot permit the institutionalization of a cost-benefit measure that violates their life and causes them suffering. The practice of animal experimentation is intrinsically unethical as it forges animals’ identity, puts them in confinement, restricts their species-specific traits, and kills them.

5 The Strengths and Pitfalls of the Epistemic and Ethical Critiques

Both the epistemic and the ethical arguments have a long history in the critique of animal experiments. However, to facilitate a paradigm shift towards ending animal experiments, one must understand the weaknesses of these approaches. The epistemic critique of using animals strikes the scientific justification of animal experiments at its core, because it argues that these methods are simply not the best scientific standards at a given time. The rejection of professional standards is a strong claim because, as previously explained,

the argument in favor of animal experiments is built on professional ethics, in which ethical obligations are derived from epistemic standards. However, in an anti-speciesist framework, the apparent force of the epistemic argument becomes a weakness. The epistemic critique is often too general and runs the risk of making the same mistake as its opponents. There are cases in which knowledge can be transferred from animals to human beings. Since this critique contests a pro-animal experiment position on an empirical level, it runs the risk of failure in cases that animal models may be valuable. LaFollette and Shanks' (1994) critique of the predictability of animal models is based on biomedical research; however, when applied to the field of basic research, as well as cases of species-specific veterinary medicine, their argument is weaker (LaFollette and Shanks, 1996). The experimental system in basic research centers on discovering new fields and new uses of knowledge. This characteristic, on the one hand, can permit the elaboration of more complex alternative methods that mimic dynamics and biological properties in efficient ways; however, on the other hand, it also leads to the establishment of new fields and new uses attached to animals.

The second problem with the epistemic critique to animal experiments is that the rejection of speciesism appears to be subordinate to the argument of utility. The epistemic critique is directed towards the *benefit* side of the cost-benefit-analysis but not the analysis in itself. The largest part of intended *benefits* is human gain. As previously discussed, the protection of human health is the highest priority in the justification of animal use. Therefore, when discussing animal experiments with a rationale, it is close to impossible to reject them. It is important to note that scientists often acknowledge the limitations of their work and express rather *modest* claims in terms of the applicability of the outcomes of their studies. Nevertheless, they maintain that animal use is necessary and important.

The ethical critique of animal experiments offers a strong case against animal experiments, because it refuses to use a cost-benefit model, which prioritizes human gains. However, the ethical critique is, at times, accused of not explicitly addressing the potential loss of knowledge from renouncing animal experiments. This is apparent in the accelerated development of non-animal alternatives since the European ban on cosmetic testing on animals: "Past experience demonstrates clearly that animal testing provisions in the cosmetics legislation have been a key accelerator in relation to the development of alternative methods and have sent a strong signal far beyond the cosmetics sector and far beyond Europe" (European Commission, 2013, p. 6). The human spirit is creative and to renounce particular strategies encourages other pathways of discovering and working.

6 Conclusion: For a Political Critique of Animal Experimentation

Why are animal experiments considered by some as fundamental and important even though they have limitations? It is impossible to answer this question with reference to empirical results alone. This question is more relevant to values and social goals. The praxis of animal research, of each kind of experimental practice, is a practice in a given time and space in society, and it is a reflection of epistemic and ethical values. Scientific practices are not free of ethical values because: (1) they use limited cognitive and financial resources (and thus it is always a matter of choice in which direction these resources should go); and (2) research activities reflect our values; that is, what we are willing to do in a society, what we consider as an acceptable means to reach an end. When we accept the infliction of pain on and killing of sentient beings, we embrace these values as a society. This is apparent in the justification framework of the Declaration of Helsinki. Since the carrying out of animal research is a matter of a professional ethics (despite the possibility of adjustments if, for example, the experiments are not designed properly), once these experiments meet current scientific standards, it is more difficult to criticize them. Therefore, as long as the infliction of harm on animals is justified, as long as animals are ontologically thought of as “*research tools*”, animal use continues. Thus, *overconfidence* in animal experiments as scientific techniques is profoundly linked with an instrumental view of animals and life in general.

The fundamental decision on the acceptability of the infliction of suffering and the killing of animals is a reflection of a social order and, of course, not solely a matter of empirical evidence. As a result, the *necessity* or *inevitability* of a scientific experiment is always a product of decisions and negotiations in a society. In the case of human clinical trials, there are also considerations of possible benefits and costs (in term of risks for the patient); but the situation is fundamentally different because the life and well-being of human beings is considered more significant than those of animals. For example, in the ethical literature about human clinical trials, the language used to contest some experiments is fundamentally different, and it often refers to *vulnerabilities* and possible abuses of particular populations and groups. The *vulnerability* of animals, in contrast, is simply taken for granted in the experimental system. Inasmuch as the idea of human exceptionalism is a political idea (ideology), the possibility of strictly distinguishing epistemic reasons from ethical reasons permits a division of moral labor (e.g., “I conduct science and do not engage with ethical problems, it is not in my field of expertise”), which is highly problematic and, therefore, rejected for human clinical trials.

The dispute on animal experiments cannot be a dispute on (objective) *benefits*; it is a dispute on what we as a society want to justify as practices and how we treat the living beings who are a part of it. Science and its practices are a social project. Can humankind *benefit* from animal abuse? This fundamental political nature of the category of necessity calls for a *political* critique of animal experiments, a critique that combines both the *ethical* and the *epistemic* critical arguments, acknowledging the non-neutrality of scientific decisions. An ethical critique to animal use is weaker, if it is not combined with a critique of the system of experimentation, i.e. the epistemic culture of animal experiments. At the same time, the epistemic critique should free itself from the reference to the category of utility as if it were solely a matter of scientific evidence; resulting in an impasse in front of scientific papers which recognize the limitations of animal models and their perceived importance at the same time, depending on the mechanisms investigated. As previously noted, the choice of renouncing animal experiments in favor of non-animal methods is fundamentally a political choice; this choice should be accompanied by the development of infrastructures and programs to serve as incentives for scientific advancement, and by a new ethos of the scientific community. While these needs have been previously recognized by authors defining animal use as poor science (e.g., LaFollette and Shanks, 1996; Greek and Greek, 2003), it is also important to recognize the political nature of the category of necessity in the experimental practice.

A *political* critique of animal use strives to substitute the epistemic and ethical culture of animal experiments with a culture of compassion and solidarity, independent of the species-belonging. A *political* critique of animal experimentation rejects the fundamental subjugation of animal interests “just because they are animals” and openly argues for the establishment of a different ethical culture. In order to be effective, the political critique must admit that it is necessary to give up certain pathways to knowledge while, at the same time, establishing a system in which it is possible to research and develop technologies without violating the fundamental interests and rights of animals.

References

- Akhtar, A. (2015). The Flaws and Human Harms of Animal Experimentation. *Cambridge Quarterly Healthcare Ethics*, 24(4), pp. 407–419.
- Basel Declaration (2010). Basel Declaration. [online] Available at: <http://www.basel-declaration.org/basel-declaration/> [Accessed 11 August 2018].

- Cohen, C. (1986). The Case for the Use of Animals in Biomedical Research. *New England Journal of Medicine*, 315(14), pp. 865–870.
- Croce, P. (2000). *Vivisezione o scienza. La sperimentazione sull'uomo* (orig. Aus. 1982). Bologna: Calderini.
- DFG (2016). Animal experimentation in Research, Bonn. [online] Available at: http://www.dfg.de/download/pdf/dfg_im_profil/geschaeftsstelle/publikationen/tierversuche_forschung_en.pdf [Accessed 30 July 2018].
- Donaldson, S. and W. Kymlicka (2011). *Zoopolis. A political theory of animal rights*. Oxford, UK: Oxford University Press.
- European Commission (2013). Communication from the commission to the European Parliament and the council on the animal testing and marketing ban and on the state of play in relation to alternative methods in the field of cosmetics. Brussels 11.3.2013. COM(2013) 135 final. [online] Available at: <https://eur-lex.europa.eu/legal-content/EN/TXT/PDF/?uri=CELEX:52013DC0135&from=GA> [Accessed 30 July 2018].
- Ferrari, A. (2008). *Genmaus & Co. Gentechnisch veränderte Tiere in der Biomedizin*. Erlangen: Harald Fischer.
- Frey, R.G. (2005). Animals and their medical use. In: A.I. Cohen and C.H. Wellman, eds., *Contemporary Debates in Applied Ethics*. Oxford, UK: Wiley-Blackwell.
- Gericke, C. and A. Reinke (2011). *Was Sie schon immer über Tierversuche wissen wollten: Daten und Fakten*. Göttingen: Echo Verlag.
- Greek, C.R. and J.S. Greek (2003). *Specious Science: How Genetics and Evolution Reveal Why Medical Research on Animals Harms Humans*. New York: Continuum.
- Hartung, T. (2013). From Alternative Methods to a New Regulatory Toxicology. *Alternatives to Animal Experimentation Proceedings*, 2(1), pp. 21–25.
- Institute for Laboratory Animal Research (2004). *Science, medicine, and animals*. Washington DC: National Academies Press.
- Knight, A. (2011). *The costs and benefits of animal experiments*. Singapore: Palgrave.
- LaFollette, H. and N. Shanks (1994). Animal Experimentation: The Legacy of Claude Bernard. *International Studies in the Philosophy of Science*, pp. 195–210.
- LaFollette, H. and N. Shanks (1996). *Brute science. Dilemmas of animal experimentation*. New York: Routledge.
- Linzey, A. and C. Linzey (2015). *Normalizing the Unthinkable: The Ethics of Using Animals in Research*. Oxford: Working Group of the Oxford Center for Animal Ethics.
- Maehle, A.J. (1990). Literary Responses to Animal Experimentation in Seventeenth and Eighteenth Century Britain. *Medical History*, 34, pp. 27–51. [online] Available at: <https://www.ncbi.nlm.nih.gov/pmc/articles/PMC1035999/pdf/medhist00056-0031.pdf> [Accessed 30 July 2018].
- Maehle, A.H. (1992). *Kritik und Verteidigung des Tierversuchs. Die Anfänge der Diskussion im 17. und 18. Jahrhundert*. Stuttgart: Franz Steiner.

- Nozick, R. (1974). *Anarchy, State, and Utopia*. New York: Basic Books.
- Pappworth, M.H. (1968). *Menschen als Versuchskaninchen. Experiment und Gewissen*. Zürich: Verlag Albert Müller.
- Pound, P., S Ebrahim. P. Sandercock, M.B. Bracken and I. Roberts, Reviewing Animal Trials Systematically (RATS) Group (2004). Where Is the Evidence that Animal Research Benefits Humans. *British Medical Journal*, 328, pp. 514–517.
- Regan, T. (2004). *Empty Cages: Facing the Challenge of Animal Rights*. New York: Rowman & Littlefield Publishers.
- Rippe, K.P. (2009). Die Geburt der klinischen Forschung und der Zerfall der ärztlichen Ethik. In: A. Thurneysen, ed., *Kontraste in der Medizin*. Bern: Lang Peter Verlag, pp. 21–50.
- Royal Society (2004). The use of non-human animals in research: a guide for scientists. [online] Available at: https://royalsociety.org/~media/Royal_Society_Content/policy/publications/2004/9726.pdf. [Accessed 30 July 2018].
- Russell, W.M.S. (2005). The 3Rs: past, present, and future. *Animal Welfare*, 14, pp. 279–286.
- Russell, W.M.S. and R.L. Burch (1959). *The Principles of Humane Experimental Technique*. London, UK: Methuen. [online] Available at: http://altweb.jhsph.edu/pubs/books/humane_exp/het-toc [Accessed 30 July 2018].
- Shuster, E. (1997). Fifty Years Later: The Significance of the Nuremberg Code. *New England Journal of Medicine*, 337(20), pp. 1436–1440.
- Smyth, D.H. (1978). *Alternatives to Animal Experiments*. London, UK: Scholar Press.
- Tannenbaum, J. and B.T. Bennett (2015). Russell and Burch's 3Rs Then and Now: The Need for Clarity in Definition and Purpose. *Journal of the American Association for Laboratory Animal Science*, 54(2), pp. 120–132.
- Wolf, U. (1988). Haben wir moralische Verpflichtungen gegen Tiere?. *Zeitschrift für Philosophische Forschung*, 42(2), pp. 222–246.
- World Medical Association (1964). *Declaration of Helsinki—Ethical Principles for Medical Research Involving Human Subjects*. Adopted by the 18th World Medical Association General Assembly, Helsinki, Finland. [online] Available at: <https://www.wma.net/policies-post/wma-declaration-of-helsinki-ethical-principles-for-medical-research-involving-human-subjects/> [Accessed 30 July 2018].

PART 3

Openness in Animal Experimentation



The Moral Status of Animal Research Subjects in Industry: A Stakeholder Analysis

Sarah Kenehan

Associate Professor, Philosophy Department, Marywood University,
Pennsylvania, United States

1 Introduction

The use of non-human animals (hereinafter referred to as animals) in research and testing is a widely accepted practice in many industries. Millions of animals each year are subjected to painful procedures that include everything from physical mutilation to drug addiction. According to the United States Department of Agriculture (USDA), over 820,812 animals were experimented on in the United States in 2016 (USDA, 2017), though this count does not include rats, mice, or birds, and dubiously relies solely on the self-reporting of laboratories (Humane Society of the United States, 2011; Keen, 2019, Chapter 10 in this Volume). Estimates suggest that a more accurate count – one that includes rats, mice, and birds – brings the number closer to 25 million total animals used in the United States (Humane Society of the United States, 2013). These numbers raise many questions, not least of which is whether this practice is *prima facie* immoral. But this is not the broader question that I address in this chapter. Instead, I look at the continued use of animals for experiments from the point of view of business ethics, in particular, through the lens of stakeholder theory. Specifically, I argue that animals as research subjects are stakeholders in the corporations that practice animal experimentation, and this status demands that their interests be considered with the interests of other stakeholders.

Importantly, while this chapter discusses issues of interest to a broader philosophy audience, it is, nonetheless, situated in a volume whose purpose is, in part, to motivate practical paradigm change in the way that animal advocates think about their work. Not unlike other scholars, my own work is shaped by my personal experiences: I am a philosopher by training and an animal advocate outside the walls of the academy, so my concern for animals is both theoretical and pragmatic. As such, the practical import of this chapter speaks most obviously to people like me, i.e., advocates who are also academics. In particular,

arguing for the stakeholder status of animals in research corporations gives advocates (both academic and traditional) a new tool to use in the fight for the proper consideration of animal interests. It brings the conversation—in an organic and relevant way—to a group of people who would have likely remained uninformed of the issue, and offers defenders of animal interests the opportunity to employ a general method of advocacy that has historically been very successful.

The argument in this chapter proceeds as follows. To begin, I discuss the broad and narrow interpretations of the stakeholder view, and I argue that the narrow view offers a more practical framework for making business decisions. Following this, I will show that, while no iteration of stakeholder theory ever directly identifies animals as stakeholders, the inclusion of research animals in this category is as self-evident as the inclusion of employees; minimally, this demands that the moral manager properly considers the interests that research animals have in not suffering. I then contend that if research animals really are stakeholders, and if their interests really are more urgent than the interests of other stakeholders, then the presumed legitimacy of animal experimentation needs to be reevaluated. Finally, in the last section I offer some responses to three potential objections to the arguments put forth in this chapter. Ultimately, I conclude that, from the point of view of stakeholder theory, animal experimentation, especially when it inflicts suffering on animal subjects, is not justifiable.

2 Narrow and Broad Interpretations of the Stakeholder View

Stakeholder theorists claim that the purpose of the corporation is to harmonize the interests of the stakeholders, though there is not widespread agreement on how to identify stakeholders (Goodpaster, 1991, p. 66). Indeed, Mitchell et al. (1997) have catalogued 27 different conceptions of the stakeholder, including some of the following:

- A stakeholder is/stakeholders are:
- a person or group, “which the organization is dependent on for its continued survival” (Freeman and Reid, 1983, p. 91; Mitchell et al., 1997, p. 858)
 - a person or group, “that benefit[s] from or are harmed by, and whose rights are violated or respected by, corporate actions.” (Evan and Freeman, 1988, p. 79; Mitchell et al., 1997, p. 858)
 - “constituents who have a legitimate claim on the firm [...] established through the existence of an exchange relationship” and who supply “the firm with critical resources (contributions) and in exchange each expects

- its interests to be satisfied" (Hill and Jones, 1992, p. 133; Mitchell et al. 1997, p. 858)
- a person or group "having some legitimate, non-trivial relationship with an organization [such as] exchange transactions, action impacts, and moral responsibilities" (Brenner, 1993, p. 205; Mitchell et al., 1997, p. 858)
 - "the firm is significantly responsible for their well-being, or they hold a moral or legal claim on the firm" (Langtry, 1994, p. 433; Mitchell et al., 1997, p. 858)
 - and "persons or groups with legitimate interests in procedural and/or substantive aspects of corporate activity." (Donaldson and Preston, 1995, p. 85; Mitchell et al., 1997, p. 858).

The most frequently cited stakeholder theorist, Edward Freeman (1984), describes a stakeholder as "any group or individual who can affect or is affected by the achievement of the organization's objectives" (p. 46). Of course, like many of the others, this definition is vague, and much is left to interpretation. But, broadly construed, this definition commonly includes the government, the environment, and many third-party associations (e.g., the suppliers of a supplier), in addition to the commonly recognized stakeholder groups: owners, suppliers, employees, customers, and local community. On this, the *wide interpretation*, the category of stakeholder is quickly rendered unruly and insignificant, as it can be expanded to include just about any person or group (for the origin of this distinction, see Freeman and Reed, 1983). As Orts and Strudler (2002, p. 218) note, "virtually anyone and anything can 'affect or be affected' by the decisions and actions of business enterprise. Expansive views of relevant 'stakeholders' tend easily to become so broad as to be meaningless and so complex as to be useless." Clearly then, we are in need of a refined understanding of the concept of stakeholder.

One such definition proposes that stakeholders be identified as those groups, "who are vital to the survival and success of the firm" (Evan and Freeman 1998, p. 58), or who are "definitional to the firm" (Freeman et al., 2002, p. 31). According to this *narrow view*, stakeholders are much easier to identify, thus, making this view more workable from a management standpoint. Surely, though, one might argue that by limiting the account of stakeholders to the narrow interpretation, we risk overlooking groups and entities that deserve consideration when business decisions are made. But, importantly, stakeholder status is not the sole identifier of moral considerability. For example, Orts and Strudler (2002, p. 221) state that businesses have moral obligations to obey the law, even if it conflicts with stakeholder interests.

Of course, neither the narrow nor the wide view of stakeholder identification is without its difficulties. The most obvious difficulty, for both, is that

regardless of how stakeholders are identified, complications arise in balancing the claims and interests of the various stakeholder groups, as stakeholder identification alone does not address which claims or interests are the most important, at what time. Nonetheless, going forward, I adopt a narrow interpretation of stakeholder identification, as the broad view renders the moral manager impotent in their decision-making. Indeed, the narrow view is most widely defended by stakeholder theorists and is most widely adopted by managers (e.g., see Mitchell et al., 1996, and references therein). Even so, it is not the purpose of this chapter to defend one conception of stakeholder identification over another. Rather, my goal is much less lofty: it is simply to show that even according to the narrow conception of stakeholder (and so presumably also the wide conception), animals who are experimented on can be properly construed as stakeholders in the corporations that conduct these experiments. As such, their interests cannot be disregarded.

3 Research Animals, Stakeholders, Suffering, and Compassion

3.1 *Research Animals as Stakeholders*

As noted, the narrow interpretation of stakeholder restricts stakeholders to those groups “who are definitional to the firm” (p. 31, Freeman et al., 2002). This interpretation is commonly thought to include customers, suppliers, financiers, employees, and parts of the local community. However, given the fact that many businesses rely heavily on research animals to bring products to market, then these animals are very likely stakeholders too, analogous to suppliers and/or employees. Consider, for instance, the use of animals in the Draize eye irritancy test, an experiment that is used by an array of companies to evaluate how irritating a particular substance is. (Notably, the use of this test has decreased, as it was banned for use in cosmetics testing in the EU, India, Israel, and New Zealand, though it is still used quite often in the US and elsewhere (Cruelty Free International, 2017). In this test, animals (typically rabbits) may be unable to move for days while chemicals are applied to their eyes, and usually the animal subjects are given no more than a topical anesthetic, so long as it does not interfere with the experiment. Sometimes these tests result in infection and/or tissue damage that is so severe that the animal is rendered blind (Humane Society International, n.d.). If these animals cannot be re-used in future tests (because of the damage done by previous tests) they are killed, usually by being suffocated, having her neck broken, or by being decapitated (Humane Society of the United States, 2018). Without the information this test supplies, many companies would be unwilling or unable to bring their products to market. Therefore, it may be said that the animals on

whom the Draize test and other such tests rely are central to the successes of the companies that depend on these practices.

Like human employees, research animals offer a very specific type of labor, without which the company would potentially suffer severe financial penalties. These animals are sometimes subjected to painful tests for years at a time without any form of relief or compensation. They are forced to give their freedom, their health, their well-being, and their lives to these companies. And like the suppliers of a company, animal subjects of experimentation provide the business with the raw materials and services that it needs to make its product; but in the case of the laboratory animals, the materials that are being supplied are the bodies and lives of the animal subjects. Without these “materials”, companies would not be able to perform the Draize tests or similar experiments. As such, research animals are stakeholders, even on the narrow conception, in the companies that use them. They are, like an employee or supplier, integral to the operations of the firm, and so, accordingly, their interests must be considered as any other stakeholder’s interests would.

Importantly, establishing that research animals are stakeholders does not help in the identification of the relevant interests deserving of consideration, nor does it tell us how to balance these interests against other stakeholder claims; though, to be clear, this ambiguity does not mean that we are justified in subordinating non-human animal interests to human interests. There are likely to be many workable routes for identifying and managing stakeholder interests, but for brevity, I focus on one possible way to identify the interests that matter in this context, and I will likewise propose one way that we might commensurate the interests of competing stakeholder groups.

3.2 *Commensurating Stakeholder Interests: Suffering and Compassion*

The phrase *to have an interest* means that something (A) has welfare or well-being, such that, “having or doing X would (or we think it would) benefit A, that having or doing X would make a contribution to A’s well-being” (Regan, 1983, p. 88). Based on this understanding, animals, at the very least, have a basic and fundamental interest in not suffering, and they probably also have interests in enjoying their lives and avoiding untimely deaths (though, for the purpose of this chapter, I refrain from relying on the latter two). The interest in not suffering is, as Singer and Bentham point out, a prerequisite for having any other interests, and so it is prior to and more urgent than any other interests (Singer, 2002, p. 7). This establishes one possible way to balance stakeholder interests: the more foundational and urgent the interest, the more heavily it is weighted. To be sure, the experiments that animals are subjected to in research laboratories are directly and obviously contrary to their interest in not suffering. Furthermore, given the fundamental nature of this

interest, and the systematic way in which it is violated, its proper consideration is likely much more urgent and pressing than the consideration of other legitimate stakeholder concerns and so should be prioritized by the decision maker.

Of course, it might be argued that engaging in medical research in which animals are used as test subjects helps us to take account of a sick person's interest in not suffering, an interest that may be just as urgent as the interest of the laboratory animal. Let us assume for the sake of argument that this is true, i.e., that medical research on animals is the only way in which the cures and treatments for some illnesses will ever be discovered. If this is the case, then when we choose not to engage in animal research, are we then also choosing to ignore the interest that sick people have in not suffering? Put in the context of business ethics, the moral manager may be torn between causing suffering to animals and potentially preventing suffering that would otherwise happen to humans, and refusing to impose suffering on animals but allowing sick people to suffer. This is a complex moral issue, but one possible way to navigate through this terrain is to think about those qualities that we would expect the moral manager to have and then explore how those qualities may direct them in this situation.

Surely, one important quality of the moral manager would be compassion. Indeed, Solomon (1999, Chapter 3) lists compassion as one among many of the business virtues, explaining that the directive of compassion is to relieve suffering: "Within the corporation, compassion is often called for [...] Compassion, of course, can be expensive [...] but what is less obvious is the enormous expense of not having or expressing compassion, in further lost time and the distraction that comes of suffering through hardship alone, in the insecurity and consequent lack of devotion of not only the employee in question but of everyone around, in seething resentment. Compassion, like caring, is not merely a humanizing embellishment in the otherwise businesslike life of a corporation. It is essential to the very life of that corporation as a human community." While Solomon beautifully articulates the importance of compassion towards employees as humans, notably absent from this characterization is concern for animal suffering. It is unclear how Solomon thinks that the moral manager should consider animals' interests in not suffering, but regardless of Solomon's own position, the principle of equality requires that, "suffering be counted equally with like suffering—in so far as rough comparisons can be made—of any other being" (Singer, 2008, p. 37). This is a basic principle of fairness, and to violate it on the basis of one's race, gender, or even species would be arbitrary and wrong. Therefore, the moral manager should be concerned not just with the suffering of the humans in their corporate community, but

also with the animals in their corporate community; this is what fairness and compassion demand.

So, the question is now: Can the virtue of compassion help us to mitigate the conflict between the human interest in not suffering and the animal interest in not suffering, as described above? I think so. Consider this dilemma, as explored by Simmons (2016, p. 113):

What is the compassionate thing to do in this case? It seems ambiguous since one can be compassionate to humans by promoting their interests in continued life. I contend, however, that to refrain from killing animals, even at the potential cost of failing to benefit human health, is the more fully compassionate thing to do. To kill animals in order to save human lives entails offensively (i.e., aggressively) and intentionally causing harm to others without their consent. Indeed, it is an act of aggression, violence, and domination, even if done to help others [...] [T]o intentionally, offensively inflict harm on another shows, to some degree, a lack of concern for the other's welfare [...] On the other hand, to refrain from killing animals, at the potential cost of not saving human lives, need not show any lack of concern for human welfare. It is not offensively causing harm to humans; it is merely failing to help them.

Importantly, Simmons (2016) argues that failing to mitigate the harms suffered by the humans that result from their diseases is not actually the result of moral indifference, nor the result of intentionally wanting the humans to suffer. Instead, "A fully compassionate person aims to prevent harm to individuals but will not offensively, intentionally inflict harm on others in the process of doing so" (p. 114). If Simmons is correct, then the moral manager will not allow the infliction of suffering on animals for the sake of preventing human suffering.

Of course, the case above assumes that there will always be a conflict between the animal interest in not suffering and the human interest in not suffering. But, this is a false dichotomy. This supposed conflict rests on two assumptions: first, that medical research nearly always results in cures or treatments that can effectively alleviate human suffering; and second, that the relief of human suffering can only be achieved by inflicting suffering on animals. Neither of these assumptions is valid. Research has actually shown that animal experiments done with the purpose of extrapolating results relevant to human health are notoriously ineffective. Pharmaceuticals tested on animals have a 90% failure rate (Pharmaceutical Research and Manufacturers of America, 2015; 2016); this means that they are certified safe from animal studies, then fail in human clinical trials or once they reach the market. Additionally, there

are many non-animal testing methods that can be used in place of animal experimentation. These include, but are not limited to: epidemiological studies (studies of human populations); clinical research; bioinformatics (statistical evaluation of biology); systems biology (studies of interaction between biological systems); tissue engineering (a combination of engineering principles and biology); microfluidics (organ on a chip); *in vitro* (human cell and tissue cultures) research; *in silico* (computer-based) techniques; stem cell methods; genetic methods; advanced imaging technologies; and safe human-based studies (see Chapters in Part 7 in this Volume: Hartung, 2019; Noor, 2019; Taylor, 2019; Wilkinson, 2019). As such, there are ways to relieve human suffering that do not demand that we inflict suffering on animals. We can conclude, then, that it is unlikely (though not impossible) that the interest humans and non-human animals have in not suffering will not conflict as obviously or as regularly as commonly thought.

3.3 *Summary*

In this section I have argued that, by definition, research animals can be categorized as stakeholders in businesses that engage in animal experimentation or testing. In most cases of animal experimentation, the interest being violated is the animal's interest in not suffering, an interest that is, more often than not, more urgent than the interests of competing stakeholders. And, furthermore, in taking the virtue of compassion seriously, the moral manager can mitigate conflicts that arise between two groups of stakeholders that may both have an interest in not suffering; in particular, compassion demands that we do not intentionally cause harm to one group, even if we do it to prevent harm to another group. As such, stakeholder theory demands that, at a minimum, managers have a moral imperative to stop animal experimentation that inflicts suffering on animal subjects.

4 **Objections**

In this final section, I address some potential objections to my argument.

4.1 *Objection 1: Aren't There Laws in Place that Already Protect the Interests of Animal Subjects?*

Those familiar with the practice of animal experimentation may be tempted to claim that advocating for the interests of animals as stakeholders is unnecessary, since there are already laws and regulations in place that serve

to protect the interests of animal subjects. One such law, in the US, is the US Animal Welfare Act (AWA) (1966, last amended 2013). In fact, the AWA does set minimal requirements for the care of certain animal species used in laboratories, ensuring that they have water, food, and shelter. Even so, these minimal standards fail to adequately protect an animal's interest in not suffering; and further, simple adherence to the AWA is not an appropriate tool for gauging if an animal's interest in not suffering has actually been respected. To begin, the Act only demands adequate food, shelter, and water be provided outside the demands of the experiment; that is, as a matter of experimentation, animals can be denied these things and, worse, for sustained periods of time. Indeed, it is not uncommon for animals to be subjected to radiation exposure; shock therapy; exposure to nerve gas; mutilation; social isolation; drug overdose and addiction; starvation and dehydration; oxygen deprivation; surgery without anesthesia; poisoning; induction of psychopathology, including depression (in higher primates); deprivation studies; extreme temperature exposure; toxicity tests; and immersion and injection studies (Singer, 2002, Chapter 2). Second, the Act does not cover mice, rats, birds, or reptiles; so, these animals—the animals who comprise the majority of laboratory animals—are not guaranteed any protections (US Animal Welfare Act, 1966, last amended 2013). And finally, the Act presumes that experimentation on animals is actually acceptable, thus subordinating the interests of animals from the outset, as do all similar regulations. Clearly then, simply adhering to the Animal Welfare Act (or similar rules in other countries) does not guarantee that a company has rightfully considered the interests of its animal test subjects. As such, there is good reason to identify research animals as stakeholders.

4.2 *Objection 2: What About the Other Stakeholders?*

What if taking this argument seriously meant that a company had to shut its doors? This is an important concern, but I think we can address it by first thinking about a less controversial case. Consider a world in which multi-national corporations that rely on child labor were forced to actually take the interests of their child laborers into consideration, minimally, the children's interests in not suffering. For some corporations, taking these interests seriously may only require making some changes, e.g., finding new laborers, relocating plants, removing some products from the market. But for other corporations, respecting these interests may mean that they have to halt their operations completely. Would we, should we, object to these closures? In doing so, would we not be saying that the protection of the fundamental interests that the children have in not suffering (among other interests) is not as important as the survival of

the corporation? This seems to be an indefensible claim: a concern for maximizing profits does not trump all other concerns. This is not to say that the profit interests of the other stakeholders are not important or serious, but rather, the urgency of the interests being violated in this case gives priority to the children. Put more generally, in instances in which there is a serious and systematic violation of basic interests, we should be comfortable with the closure of companies that rely on these violations for their continuation. This holds whether the interests in question stem from human or non-human stakeholders, as fairness demands that we give equal consideration for equal interests.

Of course, this assumes that the animal experimentation and financial success are necessarily linked, meaning that corporations will disappear without the ability to engage in animal experimentation. But, this is absolutely not the case, since viable alternatives to animal testing exist or can be developed. In fact, many companies have already moved towards this change (many were forced in this direction as a result of the EU ban on cosmetics implemented in 2013). And even other companies have, from their inception, made it part of their mission statement to avoid cruel animal experimentation. The continued success of such companies (and the industries in which they are situated) shows that businesses can remain financially viable without experimenting on animals. So, forgoing animal experimentation does not necessitate that a business close its doors, and this means that the reduction and eventual elimination of animal experimentation would not necessarily conflict with the interests that the other stakeholders have in the financial success of their corporations.

4.3 *Objection 3: Why Business Ethics? (Or, What is the Practical Import of this Argument for the Animal Advocate?)*

One might wonder what value a business ethics approach to this issue offers, given that so many moral theorists have already convincingly argued that animal experimentation is, in most cases, wrong (e.g., DeGrazia, 1996; Regan, 1983; Singer, 2002). Likewise, animal advocates may wonder how this argument practically advances the movement to see the interests of research animals properly protected. As an academic and an advocate, I see these two concerns as inextricably linked, and I strongly believe that the stakeholder approach to considering animal interests is a tool that can be employed in the academy and in the social/political space where traditional advocacy occurs.

Perhaps, unsurprisingly, I agree that there are many compelling arguments that successfully condemn the practice of animal experimentation. Even so, there are several reasons why framing this issue from the point of view of business ethics can be helpful. First, it seems quite obvious—especially in light of

the arguments developed above—that laboratory animals are stakeholders in the institutions that practice animal experimentation. And yet, nowhere in the vast stakeholder literature are these particular animals referenced or acknowledged. Occasionally, a theorist will consider the possibility of the environment as a stakeholder, and so by default the wild animals who live in the environment become stakeholders in a way, but animals confined to a life in a laboratory are never mentioned (e.g., Bowie, 2009; Orts and Strudler, 2002). This seems to me a serious oversight, and so, academically, this subject deserves consideration. But, beyond the rather obvious scholarly omission, business students are unlikely to be taught animal ethics in business school, and it is similarly unlikely that they are required to take courses in ethical theory. Instead, they may be required to take a course in business ethics, where they study stakeholder and stockholder theory, the various forms of contracts, sexual harassment/discrimination, and the like. These issues are undoubtedly important; however, given the moral urgency surrounding the practice of animal experimentation, it is likewise very important to discuss the rightness or wrongness of using animals as test subjects, especially with those who will be in a position to benefit from the practice. Notably, discussing the morality of animal experimentation by exploring the argument that animals are stakeholders allows, in a very natural and cohesive way, business students to think about the use of animals as test subjects, using language and ideas that they are already familiar with and comfortable using, and so this approach offers business students both substantive and directive guidance in considering animal interests. Furthermore, exposing business students to this way of thinking is crucially important, since, in the very near future, many of them may be in a position to make decisions that reflect a real moral concern for animal subjects in a way that other people will never have the opportunity to do (there are only so many of us that will manage laboratories and the like). Thus, I see this argument as giving the academic advocate a route to introducing concern for laboratory animals in a way that utilizes a framework that is already accepted by the typical business student.

In addition, it is also worth noting that, historically speaking, the general method of arguing for stakeholder status is typically a part of any successful route to having an oppressed or exploited group's interests properly considered. Even if the technical language of *stakeholder* is not employed, one way to interpret the historical inclusion of many stakeholder groups is as a fight to have stakeholder status properly recognized. Several examples fit this characterization, including the restriction on child laborers in the late Industrial Revolution and, more recently, the movement to properly recognize the interests of adjunct professors at universities in the US (at some institutions, at least). In these cases and others like them, the moral arguments for

stakeholder status preceded the adoption of legal safeguards that formalized limits on what could be done to these groups in the name of maximizing profits. Many students of business are taught not just to respect these limits legally, but to understand why they are so important. Indeed, many such principles are built into professional codes of ethics and corporate mission statements, both of which help to influence corporate cultures and set expectations for managers. This general sort of social evolution gives us good reason to believe that classifying animals as stakeholders can be understood as a natural extension of the principles and guidelines that many business people and corporations already adhere to and endorse, and that real protections for research animals (as real protections for any other stakeholder group) do not necessarily have to be interpreted as completely and arbitrarily contrary to the profitability of the business.

Finally, and perhaps obviously, my argument could easily be extended to corporations that raise animals for food or use animals in entertainment; any use of animals for the sake of profit-making automatically qualifies them as stakeholder, and so, as such, they should be afforded the rights and considerations of these groups. This means that the case made above will have applicability for animal advocates in ways that extend far beyond the moral and legal consideration of animals used for research and testing.

5 Conclusion

I have argued that research animals are analogous to a company's employees and/or suppliers and can thus be considered stakeholders according to the narrow conception of stakeholder identification. If this categorization is correct, then businesses have an obligation to consider the interests of these animals, including, minimally, their interests in avoiding suffering. In addition, I have argued that the interest in not suffering is very likely more urgent and fundamental than the legitimate interests of the other stakeholder groups and so should be treated as such. Therefore, according to stakeholder theory, corporations should refrain from using animals as test subjects, especially when such testing inflicts suffering on the animal subjects. Moreover, beyond offering an interesting theoretical claim, the arguments in this chapter give advocates (both academic and traditional) a new tool to use in the fight for the proper consideration of animal interests by making the issue relevant to a broader audience. It brings the conversation in a pertinent and topical way to a group of people who would have likely remained uninformed of the topic and offers advocates the opportunity to employ a method of advocacy that

has historically been very successful. There are, then, both moral and practical reasons for including research animals as stakeholders in corporations that engage in animal research and testing.

References

- Bowie, N. (2009). Morality, money, and motor cars. In: T. Beauchamp, N. Bowie, and D. Arnold, eds., *Ethical Theory and Business*, 8th ed. Upper Saddle River: Prentice Hall, pp. 516–523.
- Brenner, S.N. (1993). The Stakeholder Theory of the Firm and Organizational Decision Making: Some Propositions and a Model. In: J. Pasquero and D. Collins, eds., *Proceedings of the Fourth Annual Meeting of the International Association for Business and Society*. San Diego, pp. 853–886.
- Cruelty Free International (2017). *We call on United Nations for a Global Ban on Animal Testing for Cosmetics*. [online] Available at: <https://www.crueltyfreeinternational.org/what-we-do/breaking-news/we-call-united-nations-global-ban-animal-testing-cosmetics> [Accessed 1 August 2018].
- DeGrazia, D. (1996). *Taking Animals Seriously: Mental Life and Moral Status*. Cambridge: Cambridge University Press.
- Donaldson, T. and L. Preston (1995). The Stakeholder Theory of the Corporation: Concepts, Evidence, and Implications. *Academy of Management Review*, 20(1), pp. 65–91.
- Evan, W.M. and E. Freeman (1988). A stakeholder theory of the modern corporation: Kantian Capitalism. In: T. Beauchamp and N. Bowie, eds., *Ethical Theory and Business*, 3rd ed. Englewood Cliffs: Prentice Hall, pp. 97–106.
- Freeman, E. and D. Reed (1983). Stockholders and Stakeholders: A New Perspective on Corporate Governance. *California Management Review* XXV(3), pp. 88–106.
- Freeman, E., T.M. Jones and A. Wicks (2002). Stakeholder theory: The state of the art. In: N. Bowie, ed., *The Blackwell Guide to Business Ethics*. Malden: Blackwell Publishers, pp. 19–37.
- Freeman, R. (1984). *Strategic Management: A Stakeholder Approach*. Boston: Pittman.
- Goodpaster, K. (1991). Business Ethics and Stakeholder Analysis. *Business Ethics Quarterly*, 1(1), pp. 53–73.
- Hartung, T. (2019). Research and testing without animals: where are we now and where are we heading? In: K. Herrmann and K. Jayne, eds., *Animal Experimentation: Working Towards a Paradigm Change*, Vol. 22. Brill Human Animal Studies Series, pp. 675–690. Leiden: Brill.
- Hill, C. and T. Jones (1992). Stakeholder-Agency Theory. *Journal of Management Studies*, 29(2), pp. 131–154.

- Humane Society International (n.d.). *Rabbits: Blinded for Beauty*. [online] Available at: http://www.hsi.org/assets/pdfs/rabbits_blinded.pdf [Accessed 1 August 2018].
- Humane Society of the United States (2018). *Fact Sheet: Cosmetic Testing*. [online] Available at: http://www.humanesociety.org/issues/cosmetic_testing/qa/questions_answers.html [Accessed 1 August 2018].
- Keen, J. (2019). Wasted money in United States biomedical and agricultural animal research. In: K. Herrmann and K. Jayne, eds., *Animal Experimentation: Working Towards a Paradigm Change*, Vol. 22. Brill Human Animal Studies Series, pp. 244–272. Leiden: Brill.
- Langtry, B. (1994). Stakeholders and the Moral Responsibilities of Business. *Business Ethics Quarterly*, 4(4), pp. 431–443.
- Mitchell, R., A. Bradley and D. Wood (1997). Toward a Theory of Stakeholder Identification and Salience: Defining the Principle of Who and What Really Counts. *The Academy of Management Review*, 22(4), pp. 853–886.
- Noor, F. (2019). The changing paradigm in preclinical toxicology: *in vitro* and *in silico* methods in liver toxicity evaluations. In: K. Herrmann and K. Jayne, eds., *Animal Experimentation: Working Towards a Paradigm Change*, Vol. 22. Brill Human Animal Studies Series, pp. 612–640. Leiden: Brill.
- Orts, E. and A. Strudler (2002). The Ethical and Environmental Limits of Stakeholder Theory. *Business Ethics Quarterly*, 2(2), pp. 215–233.
- Pharmaceutical Research and Manufacturers of America (PhRMA) (2015). *Biopharmaceutical Research Industry Profile*. Washington, DC: PhRMA. http://phrma-docs.phrma.org/sites/default/files/pdf/2015_phrma_profile.pdf [Accessed 1 August 2018].
- Pharmaceutical Research and Manufacturers of America (PhRMA) (2016). *Biopharmaceutical Research Industry Profile*. Washington, DC: PhRMA. <http://phrma-docs.phrma.org/sites/default/files/pdf/biopharmaceutical-industry-profile.pdf> [Accessed 1 August 2018].
- Regan, T. (1983). *The Case for Animal Rights*. Berkeley: University of California Press.
- Simmons, A. (2016). Do all subjects of a life have an equal right to life? The challenge of the comparative value of life. In: M. Engel and G.L. Comstock, eds., *The Moral Rights of Animals*. Lanham: Lexington Books, pp. 107–117.
- Singer, P. (2002). *Animal Liberation*. Updated edition, New York: Harper Collins.
- Singer, P. (2008). Practical Ethics. In: S. Armstrong and R. Botzler, eds., *The Animal Ethics Reader*, 2nd ed. New York, Routledge, pp. 36–46.
- Solomon, R. (1999). *A better way to think about business: how personal integrity leads to corporate success*. Oxford: Oxford University Press.
- Taylor, K. (2019). Recent developments in alternatives to animal testing. In: K. Herrmann and K. Jayne, eds., *Animal Experimentation: Working Towards a Paradigm Change*, Vol. 22. Brill Human Animal Studies Series, pp. 587–611. Leiden: Brill.

- The Humane Society of the United States. (2011). *United States Department of Agriculture Animal and Plant Health Inspection Service, annual report animal usage by fiscal year, 2011*. [online] Available at: http://www.aphis.usda.gov/animal_welfare/efoia/downloads/2010_Animals_Used_In_Research.pdf [Accessed 1 November 2014].
- The Humane Society of the United States. (2013). *Questions and answers about biomedical research*. [online] Available at: http://www.humanesociety.org/issues/biomedical_research/qa/questions_answers.html [Accessed 1 November 2014].
- US Animal Welfare Act (AWA) (1966, last amended 2013), 7 U.S.C. § 2131. United States Department of Agriculture. [online] Available at: <https://www.nal.usda.gov/awic/animal-welfare-act> [Accessed 1 August 2018].
- USDA (2017). *Annual Report Animal Usage by Fiscal Year* [online] Available at: https://www.aphis.usda.gov/animal_welfare/downloads/reports/Annual-Report-Animal-Usage-by-FY2016.pdf [Accessed 1 August 2018].
- Wilkinson, M. (2019). The potential of organ on a chip technology for replacing animal testing. In: K. Herrmann and K. Jayne, eds., *Animal Experimentation: Working Towards a Paradigm Change*, Vol. 22. Brill Human Animal Studies Series, pp. 641–655. Leiden: Brill.

Increasing the Transparency of Animal Experimentation: An Australian Perspective

Monika Merkes

President, Humane Research Australia; Honorary Associate, La Trobe University
m.merkes@latrobe.edu.au

Rob Buttrose

Humane Research Australia
rob-buttrose@outlook.com

1 Introduction

Transparency involves communicating meaningful information (e.g. data or details of decision-making processes) to audiences, openly and honestly, with the intention of informing, enabling understanding and meeting responsibilities of accountability.

YEATES and REED, 2015, p. 504

It has been argued that citizen stakeholders would be well served by greater transparency. The Transparency Register of the European Union (EU) (2016), for example, states that “Transparency is [...] a key part of encouraging European citizens to participate more actively in the democratic life of the EU”. But why is transparency in non-human animal (hereinafter referred to as animal) research desirable, or indeed vital? Hadley (2012) argues that the public finance much animal research but do not know what impact their taxes and donations have on animals. Furthermore, he suggests that, since “people enjoy the benefits of animal research when they consume pharmaceuticals or undergo surgical procedures that prolong or improve the quality of their lives, it seems reasonable to inform them of the costs to animals for which their consumer choices are to some extent causally responsible” (Hadley, 2012, p. 105). Good governance is another reason for transparency in animal research. Thus, McLeod and Hobson-West suggest that one of the key themes “in the science governance literature is the linking of transparency and public trust (or mistrust)” (2015, p. 792). Varga et al. concur that “more transparency will increase

public confidence in the appropriate conduct and regulation of animal research and therefore help to maintain public acceptance” (2010, p. 500).

Some in the research community have supported increased transparency to improve the public’s understanding of animal research and boost its acceptability. “Underpinning this idea is a belief that animal rights advocates use public ignorance to benefit their cause. Thus, the only way to counter the damage done to the animal research community’s public image is to increase the lay community’s understanding of research practices” (O’Sullivan, 2006, p. 6). In contrast, animal advocates emphasize the importance of public debate and awareness of the reality of research animals to improve animal welfare and to work towards an end of animal experimentation. In general, animal advocates are confident that the more the public knows about animal research, the less it will be willing to sanction it. In their public pronouncements, then, both researchers and animal advocates consider increased transparency to be in their own best interest (O’Sullivan, 2006). The critical issue is what information should be available and given focus.

Most people know nothing or little about animal research. For example, an opinion poll, commissioned by Humane Research Australia (HRA) in 2013, found that 43% of Australians were not aware that animals are used in experimental research in Australia (Humane Research Australia, 2016a). Few people who live in countries where animal experiments occur know much detail about the numbers and species of animals used, the types of procedures they endure, or the pain and suffering involved (Hadley, 2012), as well as the ineffectiveness of using animals as models for humans. The public is interested, however, in these details. A public consultation in the United Kingdom—to which animal activists and scientists were not invited—found public support for openness and interest in a wide range of key information (Ipsos MORI, 2013). Information of interest includes, for example, details about animal use (e.g., organizations that use animals, numbers and percentages of animal species used, severity of procedures, how animals are killed, and whether there are non-animal alternatives); information about genetically altered animals; outcomes for animals, such as levels of suffering, with examples and images of typical procedures; more information about alternatives to animal use; and reports on finished projects from an animal welfare point of view. Furthermore, people asserted the animal research sector “should subject itself to external scrutiny by those who have an interest in the animals’ welfare, rather than by those who have a vested financial or scientific interest in the research being carried out” (Ipsos MORI, 2013, p. 37). A later Ipsos MORI poll found that 42% of respondents perceive UK organizations that use animals for research as “secretive” (Clemence and Leaman, 2016, p. 2).

In countries, such as Australia and those of the European Union (EU), researchers collect data of interest to the public, but there are differences, as we explore below, in the regulations governing disclosure and the format of the information. Over the past decade, some animal research institutions have, seemingly, made efforts to promote their work and provided information beyond what is legally required. Examples include, the *Concordat on Openness on Animal Research* (Understanding Animal Research, n.d.), a group of more than 100 universities, charities, commercial companies, research councils, umbrella bodies, and learned societies in the UK that have agreed to be more open about their use of animals in research; and the Basel Declaration, signed by scientists and institutions who aspire to speak openly about their work with the public (Basel Declaration, 2011). The Basel Declaration is, however, in large part merely an agreement to abide by legal requirements already governing animal research.

Governments and regulators may also attempt to be more open. For example, in 2015, the UK Government expressed a commitment to increase openness and transparency in animal research with the intention of “giving the public new tools and opportunities to understand how and why such research is carried out and to scrutinize the steps being taken to minimize suffering and find alternatives” (Home Office Department for Business Innovation and Skills and Department of Health, 2015, p. 7). It has been obvious, however, that such openness is selective and “can be viewed as grease in the apparatus of animal experimentation, as a unifying ingredient that permits maintenance of status quo in human/animal relations and preserves existing institutional public/science relations” (Holmberg and Ideland, 2012, p. 354). Holmberg and Ideland observed that the public debate on animal experimentation is constrained by selective openness and by the motivation to enlighten an uninformed public, hoping to gain public acceptance. Thus, they argue, selective openness permits the maintenance of the status quo and preserves existing institutional relations between scientists and the public.

Funding for biomedical research in Australia is substantial. In 2017, the National Health and Medical Research Council (NHMRC) committed more than AUD\$877 million to fund health and medical research (in 2016, more than AUD\$828 million; in 2015, more than AUD\$896; and in 2014, more than AUD\$780 million) (NHMRC, 2018). Australian biomedical research is generally regarded as being of high quality, and it uses many animals. According to information provided by NHMRC staff to HRA, 34% of grant applications in 2015 indicated the use of animals in their research (personal communication, March 2016). In this chapter, we detail attempts by Australia’s largest and most active

anti-vivisection organization, *Humane Research Australia* (HRA), to test the professions of openness and obtain more information than is publicly available about animal research. HRA is a non-profit organization that challenges the use of animal experiments and promotes more humane and scientifically valid non-animal methods of research. Both authors are on HRA's management committee. HRA is abolitionist in aim, but one of its medium-term strategies is to raise public awareness and highlight the failures of the regulatory system, particularly those of animal ethics committees and state animal welfare laws.

In this chapter, we contrast the Australian situation with the EU system, discuss impediments to disclosure, and advocate that reform of animal research regulations in Australia and the EU be focused around these impediments. Furthermore, we provide some suggestions on how reform could be achieved. We argue that such reform and our advocacy will lead to increased scrutiny, which in turn will lead to greater reduction and replacement of animals used in research.

2 Transparency in Australia

Animal research in Australia is guided by the NHMRC's *Australian Code for the Care and Use of Animals for Scientific Purposes* (the Code): "The purpose of the Code is to promote the ethical, humane and responsible care and use of animals for scientific purposes. The Code provides an ethical framework and governing principles to guide decisions and actions of all those involved in the care and use of animals for scientific purposes. The Code details the responsibilities of investigators, animal carers, institutions and animal ethics committees (AECS), and all people involved in the care and use of animals, and describes processes for accountability" (NHMRC, 2013, p. 1).

Under the Australian federal system, responsibility for animal welfare is delegated to the states, and all states and territories have incorporated the Code into state legislation. While being part of a self-regulatory system, the Code "receives its regulatory power by adoption under the state's delegated animal welfare legislation, or through administrative controls, for example referral to it in licenses issued to research establishments" (Whittaker, 2014, p. 3). In the absence of federal regulatory power, statutory provisions relating to animals used in research vary between jurisdictions. Central to the Code is the commitment to minimize harm, pain, and distress to animals used in the laboratory and other research or teaching situations, and "balancing whether the potential effects on the wellbeing of the animals involved is justified by the

potential benefits to humans, animals or the environment” (NHMRC, p. 1). Balancing is to be achieved by applying the 3Rs: replacement (not using animals where possible); reduction (reducing the number of animals used); and refinement (minimizing negative impact on the animals). However, many terms used in the Code are imprecise or undefined (e.g., regularly, suitable, adequate, necessary). While the Code requires that research activities must balance whether the potential effects on the well-being of the animals involved are justified by the potential benefits to humans, there is no explicit requirement that the potential benefits for humans outweigh certain impacts on animals, such as pain and death. This leaves the *balancing* wide open to interpretation.

Animal ethics committees (AECs) are essential to the implementation of the Code. All projects and activities that involve the care and use of animals for scientific purposes are subject to ethical review, approval, and monitoring by an AEC. AECs are composed of a chairperson, a veterinarian, a scientist or teacher, with experience relevant to the institution’s activities, a person with a background and commitment to animal welfare, and an independent community member. Additional members can be appointed, but animal welfare representatives and community members must, together, represent at least one-third of the AEC membership.

2.1 *Animal Use Data*

Unlike many other countries, Australia does not maintain a national collection of animal use data. Moreover, collection and reporting methods vary between states/territories, and delays in making data available can extend up to five years (personal communication, HRA staff, March 2017). Some states and territories do not collect relevant data at all. It is ironic that the only national statistics in Australia are those collated and published by HRA, an anti-vivisectionist organization. HRA gathers annual statistics from the states/territories and makes them available on its website (Humane Research Australia, 2016b). The latest available statistics, at the time of writing, are from 2016 and are only from four states. On the basis of the most recent and previous statistics, HRA estimates that the total number of animals used in Australia in 2016 was over 9 million (Humane Research Australia, 2016c). The information from the states is presented in different formats, using different categories. Not all states collect all of the data recommended by the Code. For example, New South Wales does not collect data from schools, and in Western Australia reporting on research using fish and cephalopods is not mandatory. Due to the discrepancies in data, it is impossible to paint an accurate picture of animal use in research and teaching in Australia. HRA’s estimates are approximate, in part based on averages, and conservative.

2.2 *HRA Attempts to Obtain Animal Research Information*

As an animal advocacy organization, HRA has made systematic attempts to break through the confusing and varied policies on transparency across the Australian states. We make requests to relevant institutions and often follow up with a Freedom of Information (FOI) application, if unsuccessful. Under Australian Commonwealth and state law, government agencies cannot refuse requests by the public for access to information they hold, unless there are good grounds, such as national security or the privacy of individuals, for not doing so. In general, there is a presumption that the public has a right to information. As a result, an FOI request can be a powerful tool. Examples of information disclosed recently include details of sexual assaults at Australian universities, incident logs from Australia's offshore detention centers, and statistics relating to arrests at Melbourne airport concerning prohibited items. Agencies are not always cooperative, however, as we detail in the next section.

HRA asks for documents and reports and information about incidents in laboratories and associated facilities that come to our attention, such as details on the unexpected deaths of two non-human primates at a breeding colony in New South Wales in 2015. In some cases, HRA has asked for a review from the state FOI Commissioner. Generally, because our efforts are more targeted, informed, and sustained, HRA finds more information than is available in the public domain or that individuals could expect to discover. Many requests for information, however, are refused. Agencies give a variety of reasons, many of which are not convincing, and skirt their responsibility, outlined in the previous paragraph, to be transparent; reasons include, for example, that the agency does not hold the information nor does it know who holds it, retrieving the information would be an unwarranted use of resources, or "it is generally understood that this information will not become public" (personal communication, May 2014).

2.3 *Animal Ethics Committee (AEC) Material*

Like many animal advocates (e.g., O'Sullivan, 2006; Varga et al., 2010; Whittaker, 2014), at HRA we believe available information about animal research should enable members of the public to make judgments about whether the use of animals is justified given what was done to them, the benefits realized, and the lack of alternatives to realize the benefits. Uncontroversially, we view this as THE ethical question to ask from a utilitarian perspective, the standard ethical framework in which judgments about human use of animals are usually made.

HRA's primary target, then, is to find information about particular research projects. To enable a judgment about justification, we view the following details as essential:

1. The project proposal
2. Purpose and predicted benefits
3. Detailed consideration of non-animal alternatives
4. Animal species and numbers
5. Impacts on the animals
6. Fate of the animals once the project has been completed
7. Realized benefits of the research.

With the exception of realized benefits of the research, all details about a project are already documented. In Australia, the Code requires they be part of the application process. Although the Code allows some flexibility of implementation, as it does in many matters, most AEC project forms that we were able to access strictly conform to these requirements (e.g., University of Melbourne Office, n.d.). All details then, which in our view are sufficient to make a judgment about justification at the project level, should already exist in various records, reports, and databases. However, we cannot verify whether this collection and compilation of information is always carried out and how well it is done. We cannot verify compliance because these details are not publicly accessible.

Other information we view as important for judging the current level and nature of animal experimentation in Australia is also unavailable for public viewing. These data include summary statistics collected by the states and territories from the AECs (“animal use returns”); and efforts by institutions and other license holders to reduce animal use, as described in the annual AEC reports. HRA’s success rate in gaining access to AEC documents, by directly requesting them, has been disappointing. For example, we contacted all major Australian universities to ask for their annual AEC reports for a range of years. Only in one case did we receive a positive response. In all other cases, we either did not receive a response or the request was refused on the grounds that it was not the practice of the institution concerned to make this material public. Requests for project applications (even redacted versions), progress reports, and final reports were also not granted.

2.4 *License Holder Names*

In 2014, an FOI request was pursued on appeal to the FOI Commissioner in Victoria. The request was for the names of the license holders, the institutions, and other bodies that are licensed to undertake animal research. The request, by one of the authors on behalf of HRA, did not ask for the names of individuals; and this was made explicit in the application. A typical license holder is not a person, but an institution, such as a university or part of a university. HRA has an interest in these details, both to gauge the number and range

(e.g., public versus private) of animal research in the state and to guide our search for publications, which is the most definitive way in which we can establish that particular research has taken place in Australian institutions. We are aware of many of the license holders already, both because of publications found independently and the nature of the institutions, such as universities and research hospitals. Some of these institutions put information about license holders or their AECs on a website. As HRA stressed in its original request and in subsequent appeals, we were not interested in nor seeking to identify any individuals, whether they be institution administrative staff or researchers.

Although our request for the license holder names seems uncontroversial, it was refused. In its decision, the department cited four sections in the *Freedom of Information Act* (1982, last amended 2017), which can be applied to exempt information sharing. Two sections relate to confidential business and commercial details; one to the disclosure of “the personal affairs of [...] person[s]”; and the last to the case where disclosure of a document would or would, likely, “endanger the lives or physical safety of persons [...] who have provided confidential information in relation to the enforcement or administration of the law” (*Freedom of Information Act*, 1982, last amended 2017, 31(1)(e)). Somewhat surprisingly, on appealing this decision, the FOI Commissioner dismissed each ground for exemption except the last. Thus, of all the reasons given by the department’s FOI officer for not making the license holder names public, only the exemption relating to the physical security of individuals was upheld. Such inconsistency in the treatment of requests for information about animal research from Australian regulators is fairly typical in HRA’s experience.

In its submission to the FOI Commissioner, the department’s evidence that revealing license holders would endanger individuals, consisted solely of the claim that, in a previous FOI request, two license holders had concerns about being identified, as they had been the target of threats, disruptive action, and property damage from protesters in the past (FOI Commissioner, personal communication, September 2014). HRA does not find it credible that the security concerns of two out of all license holders in Victoria (HRA estimates this number to be between 50 and 100) were enough to reject the request. We were not provided with any evidence of the claims made by the licensees, and our attempts to verify the incidents with a further FOI request to the Australian Federal Police were not successful. Violence against animal laboratories and infiltrations are rare and have decreased markedly over the past 20 years.

In another sign of inconsistent regulation and policy, this time at the state level, license holder information from other states in Australia has been made available to us on request. In Queensland, the register of scientific animal use

(Queensland Government Department of Agriculture and Fisheries, 2014) can, by law, be inspected by any member of the public. License information is even more accessible in Tasmania, via a website (Tasmanian Government, Department of Primary Industries Parks Water and Environment, 2017). These differences between states call into question the Victorian FOI Commissioner's ruling. If security and risk to individuals are not an issue in other states, why would they be a problem peculiar to Victoria? In 2015, a further FOI application was submitted (after responsibility had been transferred to a different department), asking again for the license holder names. The request was refused on the same grounds, including those previously disallowed by the FOI Commissioner.

3 Transparency in the European Union

3.1 *Concordat on Animal Research*

The *Concordat on Openness on Animal Research* is an initiative that aims to make animal research more transparent in the UK. It came into effect in 2014. More than 100 signatories on the Concordat have made a commitment to:

- Being clear about when, how, and why they use animals in research
- Enhancing communications with the media and the public about their research using animals
- Being proactive in providing opportunities for the public to find out about research using animals
- Reporting on progress annually and sharing their experiences.

The efforts of the parties to meet their commitments vary widely. Some only have a web page describing the institution's efforts in implementing the 3Rs, ethical reviews, and animal welfare standards. Others provide detailed examples of animal research, such as case studies. Some signatories have published the minutes of the *Animal Welfare and Ethical Review Body* (AWERB) meetings on their websites. The 2017 *Concordat Annual Report* (Williams, 2017) makes particular mention of these new efforts at openness. The minutes we accessed were, however, all in a redacted and abbreviated form and, crucially, contained little evidence or detail of ethical review (e.g., University of Nottingham, n.d.). Individual protocol information is lacking, making it difficult to determine what will be done to the animals. The University of Cambridge AWERB minutes, for example, routinely redact the title of project for new and existing licenses (University of Cambridge, 2018). Signatories to the Concordat tend to stress the benefits of animal research, generally, and the importance and necessity of their own researchers' work in particular; while downplaying the

pain and suffering caused to animals and the number of animal deaths. Unsuccessful research and negative findings are not reported (Pound and Blaug, 2016).

The Ipsos MORI poll finding, mentioned above, that respondents equated transparency of the animal research sector with its willingness to subject itself to external scrutiny by those interested in animal welfare, was not honored in the Concordat (Pound and Blaug, 2016). This is despite the fact that the poll was commissioned by UAR, the group responsible for establishing the Concordat. These omissions are significant; but the Concordat, nonetheless, seems a step in the right direction that Australia could follow. There is always the chance that there could be more balanced disclosure over time, not least because of pressure from animal advocates. In Australia, we have nothing even remotely similar to the Concordat. Rather than promoting their animal research, institutions are much more interested in concealing it. Given our previous experience with innocuous requests, such as the names of license holders described above, we expect there would be resistance on the grounds of security. The UK experience, however, suggests this fear would be unfounded: “When the Concordat was developed there was considerable concern cited about the risks of openness and a fear that transparency would bring researchers into physical danger. The information provided by signatory institutions about their communications activities since May 2014 indicates clearly that this has not been the case” (Williams, 2015, p. 4).

3.2 *Non-technical Summaries (NTS) and Retrospective Assessments (RAs)*

Non-technical summaries (NTS) of animal research are mandated by the EU Directive 2010/63/EU (European Parliament, 2010, Article 43). NTS provide information on the objectives of a project; predicted harm and benefits and the number and types of animals to be used; and a demonstration of compliance with the requirement of replacement, reduction, and refinement. NTS are anonymous and do not contain the names and addresses of the user and its personnel. EU Member States are required to publish the summaries, including any updates. In the UK, the Home Office has published summaries on its website since 2014.

While the summaries include answers to the crucial questions about any animal research project, which enable an ethical assessment of harms and benefits to be considered, there is variety in the detail and quality of the information provided. There are, however, some uniformities and generic responses, which are unsatisfactory. In response to the question why animals need to be used and non-animal methods cannot, project applicants routinely claim

that they must develop *in vivo* models because *in vitro* models are inadequate to model the disease, condition, or cell interactions being investigated. With respect to refinement, researchers typically respond with a statement that the methods and procedures are designed to minimize suffering. Invariably, there is an additional statement that anesthesia will be given where required, and that the animals will be constantly monitored for signs of pain and distress and killed if these reach *moderate* severity. Applicants often comment that achievement of the aims of the research limits the minimization of suffering possible.

Directive 2010/63/EU requires retrospective assessments (RAS) of projects using non-human primates and projects involving procedures classified as *severe*. EU Member States may require RAS for additional types of projects as well. However, including an RA of a completed project in the NTS is optional. We found no mention of an RA in any of the NTS we examined (including summaries of projects using non-human primates and involving severe procedures). In the UK, RAS of projects approved by the Home Office are currently under review and will be published in due course. The British Animals in Science Regulation Unit also plans for NTS to be updated with RAS (personal communications of Kathrin Herrmann with the Animals in Science Regulation Unit, June 2017). In Australia, we view an initiative like the provision of NTS, with all its deficiencies, as worthwhile. The categories of information provided are similar to those we would like to see publicly available in Australia, notwithstanding, the lack of clarity regarding the extent of retrospective assessment at this time.

There are, however, several obstacles to the implementation of NTS and RAS in Australia, which do not apply in the EU. First, in the EU, research animal legislation is mostly national rather than state based. To provide summaries of all animal research projects in Australia would require the agreement and cooperation of all state departments, an objective never easily achieved. Second, Australian state government departments do not license projects, institutions do. Investigators are required by the Code to be “competent” in the care and use of animals, but the Code does not state explicitly who makes that judgment. The AECs approve or license projects. Yet, some tentative moves have been made in this direction. As early as 2003, the Australian and New Zealand Council for the Care of Animals in Research and Teaching (2007, pp. 5–6) drafted a proposal for, what it termed, *lay summaries* of animal research to be published. The format for the summaries was as follows:

- Provide the context of the study by way of a brief background
- Describe the aim of the study

- State the necessity of using animals for the study with consideration of alternatives
- Describe the outcomes of the study.

A proposal was sent to a number of AECs in New Zealand for comment (the authors are not aware of a similar survey in Australia). Of the 34 who responded, 21 were not supportive, four had reservations, and nine were supportive. Concerns raised included, intellectual property, confidentiality, and the cost of compliance. Some respondents thought lay summaries would provide ammunition for animal activists. It was also not unexpected that those engaged in “low impact” animal research were, in general, more in favor of the summaries.

4 Beyond Selective Openness

A large section of the public does not feel well informed about animal research (Clemence and Leaman, 2016; Humane Research Australia, 2016a). Citizens are divided over animal research (Funk and Rainie, 2015; Jones, 2017) and want more transparency (Ärzte gegen Tierversuche, n.d.). As we have argued, increased transparency is needed as part of good governance and accountability. In the following, we propose steps to reform the current system.

4.1 *A Register of All Publicly Funded Animal Research Projects*

A recent report by the United Nations Secretary-General’s High-Level Panel on Access to Medicines called for governments to require, “the unidentified data on all completed and discontinued clinical trials be made publicly available in an easily searchable public register” (United Nations, 2016, p. 37), including study designs and protocols, data sets, test results, and anonymity-protected patient data. The current lack of transparency of clinical trials, it is argued, undermines the ability of clinicians, researchers, and patients to make informed decisions about treatments. We argue that the same applies to animal research. To minimize publication and selective reporting biases (Ioannidis, 2012) and to improve accountability to the public, the quality of research, and the effectiveness and safety of new drugs and other treatments, raw data and full protocols of research projects using animals have to be made publicly available before the research starts. A first initiative is taken by the website PreclinicalTrials.org which provides an international online platform to register protocols for preclinical animal studies (PreclinicalTrials, n.d.). The preregistration of

animal studies would also allow experts to advise on available non-animal methods. On completion of the research, we need to know what the research has contributed, and how that is balanced with the suffering of the animals used (Knight, 2011; Lund, Lassen and Sandoe, 2012; Lund et al., 2014). The NTS, as they currently exist in the EU, will not deal with the problem of duplicated research and the unnecessary use of animals because they provide only limited information.

4.2 *Cost-benefit Analysis*

A cost-benefit analysis underpins animal research regulation in most countries. For example, Directive 2010/63/EU on the protection of animals used for scientific purposes (European Parliament, 2010) requires that the likely harm to an animal should be balanced against the expected benefits of the project. A similar, but considerably weaker, criterion appears in the Australian Code, stipulating that the potential effects on the well-being of animals involved in a project be justified by the potential benefits for humans, animals, or the environment.

Proponents of animal research claim that research involving animals has contributed to human clinical knowledge, but there are few systematic reviews of human clinical utility. Those that do exist show poor human utility of animal models for toxicity testing and the development of clinical interventions (Knight, 2011; see also Archibald, Coleman and Drake, 2019, Chapter 18; Greek and Kramer, 2019, Chapter 17; Knight, 2019, Chapter 14; and Ram, 2019, Chapter 15 in this Volume). Scant research exists on how the public views the tension between animal costs and human benefits. A group of researchers in Denmark (Lund et al., 2014) explored this topic in focus groups and an online survey. They found that respondents used cost-benefit approaches in their reasoning, even those who strongly supported or rejected animal research. Animal pain and research purpose were of greater importance in balancing the costs and benefits than the species of the animals. At present, researchers may inform us about the potential benefits of animal research projects; but we need more, as Knight (2011) argues: "To assess the degree to which experimental objectives were successfully met, the costs incurred by research animals, and to inform future research strategy and further experimental licensing decisions, retrospective evaluation of experiments should be mandatory where such experiments are considered likely to result in significant costs to laboratory animals or to public finances, or significant human benefits" (p. 293).

The harm-benefit calculation is at the heart of the ethical assessment of animal research. In the UK, it is conducted by the Home Office when researchers apply for a project license. In Australia, the animal ethics committee makes the determination. In both jurisdictions, there is very little evidence that any

research proposal fails to pass ethical assessment; the purported benefits are always judged to outweigh the costs to the animals (Pound and Blaug, 2016; Russell, 2012). In the UK, there is a detailed description of the methodology used to calculate costs and benefits. The Australian states have similar, though less comprehensive, guides. In both cases, there is fudging on the crucial question of how to *weigh* or *balance* harms against costs. The Home Office guide, for example, considers the process as ultimately a *value-laden judgment* and often subjective. In neither instance can the completed cost-benefit assessments of the Animals in Science Regulation Unit (UK) and the AEC (Australia) be viewed by the public.

4.3 *Ethical Reproducibility*

Although researchers and animal ethics committees are directed to balance the likely harm to the animals against the expected benefits of the project, the public does not know how, or even whether, this occurs. Anderson et al. (2013) pointed out that descriptions of research ethics methods in published papers are minimally informative, and authors are not required to publish them. They suggest that ethical reproducibility requires reporting the concrete features of study design that deal with the specific ethical challenges of a research study. They propose the following guidelines for reporting:

- Report strategies used to avoid or replace the use of animals in research that has the potential to cause them harm
- Report improvements to procedures and husbandry that minimize actual or potential pain, suffering, distress, or lasting harm and/or improve animal welfare in situations in which the use of animals is unavoidable
- Report methods that minimize animal use and enable researchers to obtain comparable levels of information from fewer animals.

Furthermore, Anderson et al. (2013) argue that ethics reporting should be guided by the principles of transparency (i.e., reporting sufficient detail to enable readers to assess and reproduce the research ethics methods used) and proportionality (i.e., providing detail at a level that is proportionate to the ethical complexity and risk to animals).

4.4 *Development of Non-animal Methods and Training*

If they are serious about the implementation of the 3Rs, government funding bodies need to provide support and dedicated resources for the development of non-animal methods, and researchers need training in up-to-date non-animal methods (see Herrmann, 2019 Chapter 1 in this Volume). In Australia, the government body that funds biomedical research, the NHMRC, does not dedicate funding, specifically, to the development of animal-free research methods.

4.5 *Additional Considerations for Australia*

In Australia, animal experimenters, their institutions, and federal and state/territory governments provide far less information of interest to the public about animal research than in EU countries. As a first step, we propose that already existing information be made publicly available, without identifying details. This would include the records of AEC meetings; AEC annual reports to their institutions; licensed institutions' annual reports to their state/territory government; and institutions' reports of AEC external reviews, which are, according to the Code, to be undertaken at least every four years. Monitoring the care and use of animals is one of the responsibilities of the AECs. According to the Code, it is left to them to determine the timing and frequency of inspections. Facility inspections may also be undertaken by state governments. Again, reports about facility inspections exist but the information is not publicly available.

Furthermore, the NHMRC, as the largest funding-body of biomedical research, is the appropriate organization to make the details of funded animal research available. The NHMRC already provides lists of funded projects (NHMRC, 2018). However, from the project descriptions in these lists, it is unclear whether the research uses animals. It should be easy to add this detail. The next step would involve achieving consistency of reporting. An independent animal welfare office at the federal level would be suitable to take on this task. However, so far, Australia does not have such an independent organization. Consistency of reporting would involve consistent categories across all states/territories for animal species, purposes of use, and severity of procedures (Bain and Debono, 2013).

Transparent reporting as part of the research community's accountability to the public and funders requires additional information. Hadley (2012) notes that animal use data are collected by researchers and intended for the public record but are rarely given meaningful media exposure. Hadley suggests that animal researchers provide concise summaries of their projects to journalists and public relations practitioners. We propose that Australia develops a practice similar to the one implemented in the EU, where non-technical, plain language summaries are published online and accessible to the public. We suggest these summaries clearly describe what happens to animals undergoing procedures in a way that the public can understand. This type of openness would provide the public with a more impartial way to evaluate the animals' experiences against the intended benefits of the research conducted upon them.

Bain and Debono call for a "national statistics compilation that systematically reports on the degree of 3Rs implementation" (2013, p. 215). Given that the 3Rs are central to the Code, and AECs are already asking a number of questions

regarding the implementation of the 3Rs, such a compilation would contribute to accountability and transparency of animal research. Furthermore, it would provide benchmark information on how patterns of animal use are changing over time. At present, scant information is provided about the living environments of animals in laboratories, such as enrichment, opportunities to express species-specific behaviors, and whether individual animals are kept in isolation from other animals. This is of interest to the public and could be provided on a website, as some research institutions in the EU already do. Transparency is central to the scientific method and ethical conduct. We trust that genuine transparency will lead to greater scrutiny of animal research projects, which in turn will lead to greater reduction and replacement of animals in research.

5 Conclusion

It is argued, at times, that greater transparency can help the cause of both sides of the animal research debate (Hadley, 2012; O'Sullivan, 2006). Critics have also sought more information to expose the injustice of what is done to animals in the laboratory. On the other side, initiatives such as the Concordat (UK) and the NTS (EU) are viewed by at least some in the research community as opportunities to show the importance of their work and to counter the claims of animal advocates. On balance, though, critics more urgently demand openness than users. Those engaged in animal experimentation do so legally and do not have to convince regulators or funders that they are not doing anything wrong. To deal with public opinion, the default strategy in many countries, including Australia, has been to keep the public largely ignorant.

To date, improved transparency, since the introduction of Directive 2010/63/EU, has not yet led to better implementation of the 3Rs; and, overall, the number of animals used in research has not decreased. We hope, nonetheless, that more openness will be seen in Europe, spread to other countries, and lead to a paradigm change. If this comes about, the public will see:

- More disclosure of impacts, pain, deaths, and fate of animals (in particular, information about the levels of impact by research purpose)
- More unnecessary studies revealed, such as duplicated research, studies for which non-animal alternatives are available, or studies that are trivial and should not have been undertaken
- More clues regarding trends, such as the use of *donated* greyhounds, increasing use of transgenic animals, including non-human primates, or xenotransplantation
- Information on return on investment and transferability of results to humans.

At Humane Research Australia, we are convinced that when this kind of information is revealed, public opinion will swing against animal experimentation. There is also no doubt that we would use such data to continue our advocacy for more ethical and human-relevant research.

References

- Anderson, J.A., M. Eijkholt and J. Illes (2013). Ethical Reproducibility: Towards Transparent Reporting in Biomedical Research. *Natural Methods*, 10(9), pp. 843–845.
- Archibald, K., R. Coleman and T. Drake (2019). Replacing animal tests to improve safety for humans. In: K. Herrmann and K. Jayne, eds., *Animal Experimentation: Working Towards a Paradigm Change*, Vol. 22. Brill Human Animal Studies Series, pp. 417–442. Leiden: Brill.
- Ärzte gegen Tierversuche (n.d.). *Europas Bürger wollen keine grausamen Tierversuche. Umfrage zu Tierversuchen in sechs EU-Ländern*. [online] Available at: <https://www.aerzte-gegen-tierversuche.de/de/infos/statistiken/259-europas-buerger-wollen-keine-grausamen-tierversuche> [Accessed 17 September 2016].
- Australian and New Zealand Council for the Care of Animals in Research and Teaching (2007). Recent Actions Arising from the 2003 ANZCCART Conference. ANZCCART Working Party. *Australian and New Zealand Council for the Care of Animals in Research and Teaching News*, 20(2), pp. 5–6.
- Bain, S. and K. Debono (2013). Australian Scientific Animal Use Statistics: A History of Fragmentation, a Future of Hope. *Proceedings of the 2013 ANZCCART Conference "Can We Do Better?"*. Sydney: Australian and New Zealand Council for the Care of Animals in Research and Teaching Ltd. (ANZCCART). [online] Available at: <https://www.adelaide.edu.au/ANZCCART/publications/proceedings/2013proceedings.pdf> [Accessed 5 May 2017].
- Basel Declaration (2011). Basel Declaration. [online] Available at: <http://www.basel-declaration.org/basel-declaration/> [Accessed 11 August 2018].
- Clemence, M. and J. Leaman (2016). *Public Attitudes to Animal Research in 2016*. [online] Available at: <https://www.ipsos.com/sites/default/files/publication/1970-01/sri-public-attitudes-to-animal-research-2016.pdf> [Accessed 5 May 2017].
- European Parliament (2010). Directive 2010/63/EU of the European Parliament and of the Council of 22 September 2010 on the Protection of Animals Used for Scientific Purposes. *Official Journal of the European Communities*, L276, p. 33–79. Available at: <http://eur-lex.europa.eu/legal-content/EN/TXT/?uri=CELEX:32010L0063> [Accessed 5 May 2017].
- European Union (2016). *Transparency Register. Transparency and the EU*. [online] Available at: <http://ec.europa.eu/transparencyregister/public/homePage.do> [Accessed 11 October 2016].

- Funk, C. and L. Rainie (2015). *Public and Scientists' Views on Science and Society*. [online] Available at: <http://www.pewinternet.org/2015/01/29/public-and-scientists-views-on-science-and-society/> [Accessed 5 May 2017].
- Freedom of Information Act 1982*. Version incorporating amendments as at 1 September 2017. State Government of Victoria, 2018. [online] Available at: [http://www.legislation.vic.gov.au/domino/Web_Notes/LDMS/LTObject_Store/ltobjst10.nsf/DDE300B846EED9C7CA257616000A3571/DD1AE7B0876CA9B9CA25818D0008F72D/\\$FILE/82-9859aa100%20authorised.pdf](http://www.legislation.vic.gov.au/domino/Web_Notes/LDMS/LTObject_Store/ltobjst10.nsf/DDE300B846EED9C7CA257616000A3571/DD1AE7B0876CA9B9CA25818D0008F72D/$FILE/82-9859aa100%20authorised.pdf) [Accessed 10 August 2018].
- Greek, R. and L.A. Kramer (2019). The scientific problems with using non-human animals to predict human response to drugs and disease. In: K. Herrmann and K. Jayne, eds., *Animal Experimentation: Working Towards a Paradigm Change*, Vol. 22. Brill Human Animal Studies Series, pp. 391–416. Leiden: Brill.
- Hadley, J. (2012). Telling It Like It Is: A Proposal to Improve Transparency in Biomedical Research. *Between the Species*, 15(1), 0021.
- Herrmann, K. (2019). Refinement on the way towards Replacement: Are we doing what we can? In: K. Herrmann and K. Jayne, eds., *Animal Experimentation: Working Towards a Paradigm Change*, Vol. 22. Brill Human Animal Studies Series, pp. 3–64. Leiden: Brill.
- Holmberg, T. and M. Ideland (2012). Secrets and Lies: “Selective Openness” in the Apparatus of Animal Experimentation. *Public Understanding of Science*, 21(3), pp. 354–368.
- Home Office Department for Business Innovation and Skills and Department of Health (2015). *Working to Reduce the Use of Animals in Scientific Research. Delivery Report*. [online] Available at: https://www.gov.uk/government/uploads/system/uploads/attachment_data/file/417441/Delivery_Report_2015.pdf [Accessed 5 May 2017].
- Humane Research Australia (2016a). *Australians Say No to Animal Experiments*. [online] Available at: <http://www.humanereseach.org.au/interview/australians-say-no-to-animal-experiments> [Accessed 11 November 2017].
- Humane Research Australia (2016b). *Statistics of Animal Use in Research and Teaching in Australia*. [online] Available at: <http://www.humanereseach.org.au/statistics/> [Accessed 5 August 2018].
- Humane Research Australia (2016c). 2016 Australian Statistics of Animal Use in Research & Teaching. [online] Available at: http://www.humanereseach.org.au/statistics/statistics_2016 [Accessed 11 August 2018].
- Ioannidis, J.P.A. (2012). Extrapolating from Animals to Humans. *Science Translational Medicine*, 4(151), pp. 1–4.
- Ipsos, MORI (2013). *Openness in Animal Research. The Public's Views on Openness and Transparency in Animal Research*. [online] Available at: <https://www.ipsos.com/sites/default/files/publication/1970-01/sri-health-openness-in-animal-research-2013.pdf> [Accessed 5 May 2017].

- Jones, J.M. (2017). *Americans Hold Record Liberal Views on Most Moral Issues*. Gallup Poll. [online] Available at: <http://www.gallup.com/poll/210542/americans-hold-record-liberal-views-moral-issues.aspx> [Accessed 25 August 2017].
- Knight, A. (2011). Weighing the Costs and Benefits of Animal Experiments. *Alternatives to Animal Experimentation Proceedings, Eighth World Congress on Alternatives and Animal Use in the Life Sciences (WC8)*. Montreal, Canada. [online] Available at: http://www.altex.ch/resources/289294_Knight131.pdf [Accessed 5 May 2017].
- Knight, A. (2019). Critically evaluating animal research. In: K. Herrmann and K. Jayne, eds., *Animal Experimentation: Working Towards a Paradigm Change*, Vol. 22. Brill Human Animal Studies Series, pp. 321–340. Leiden: Brill.
- Lund, T.B., J. Lassen and P. Sandoe (2012). Public Attitude Formation Regarding Animal Research. *Anthrozoos: A Multidisciplinary Journal of The Interactions of People & Animals*, 25(4), pp. 475–490.
- Lund, T.B., M.R. Mørkbak, J. Lassen and P. Sandøe (2014). Painful Dilemmas: A Study of the Way the Public's Assessment of Animal Research Balances Costs to Animals Against Human Benefits. *Public Understanding of Science*, 23(4), pp. 428–444.
- McLeod, C. and P. Hobson-West (2015). Opening Up Animal Research and Science – Society Relations? A Thematic Analysis of Transparency Discourses in the United Kingdom. *Public Understanding of Science*, 25(7), pp. 791–806.
- National Health and Medical Research Council (2013). *Australian Code for the Care and Use of Animals for Scientific Purposes. 8th Edition*. Canberra. [online] Available at: <http://www.nhmrc.gov.au/guidelines/publications/ea28> [Accessed 5 May 2017].
- National Health and Medical Research Council (2018). *Outcomes of Funding Rounds*. [online] Available at: <https://www.nhmrc.gov.au/grants-funding/outcomes-funding-rounds> [Accessed 23 January 2018].
- O'Sullivan, S. (2006). Transparency and Animal Research Regulation: An Australian Case Study. *Animal Liberation Philosophy and Policy Journal*, 4(1).
- Pound, P. and R. Blaug (2016). Transparency and Public Involvement in Animal Research. *Alternatives to Laboratory Animals*, 44(2), pp. 167–173.
- PreclinicalTrials (n.d.). About PreclinicalTrials.eu. [online] Available at: <https://www.preclinicaltrials.eu/#aboutSitePage> [Accessed 11 August 2018].
- Queensland Government Department of Agriculture and Fisheries (2014). *Public Access to the Register of Scientific Animal Use*. [online] Available at: <https://www.daf.qld.gov.au/animal-industries/welfare-and-ethics/using-animals-for-scientific-purposes/registering-as-an-animal-user/public-access-to-the-register> [Accessed 14 October 2016].
- Ram, R. (2019). Extrapolation of animal research data to humans: an analysis of the evidence. In: K. Herrmann and K. Jayne, eds., *Animal Experimentation: Working Towards a Paradigm Change*, Vol. 22. Brill Human Animal Studies Series, pp. 341–375. Leiden: Brill.

- Russell, D. (2012). Why Animal Ethics Committees Don't Work. *Between the Species*, 15(1).
- Tasmanian Government, Department of Primary Industries Parks Water and Environment (2017). *Animal Research Statistics Tasmania. Annual Report 21 (2016)*. Hobart. [online] Available at: <http://dpiipwe.tas.gov.au/Documents/Animal%20Research%20Statistics%20Tasmania%20Annual%20Report%2021.pdf> [Accessed 11 August 2018].
- Understanding Animal Research (n.d.). *Concordat on Openness on Animal Research*. [online] Available at: <http://concordatopenness.org.uk/> [Accessed 12 August 2018].
- United Nations (2016). *Report of the United Nations Secretary-General's High-Level Panel on Access to Medicines. Promoting Innovation and Access to Health Technologies*. [online] Available at: <http://www.politico.eu/wp-content/uploads/2016/09/HLP-Report-FINAL-Sept-2016.pdf> [Accessed 11 August 2018].
- University of Cambridge (2018). *University Biomedical Services. Animal Welfare and Ethical Review Body Redacted Committee Minutes*. [online] Available at: <https://www.ubs.admin.cam.ac.uk/animal-welfare-ethical-review-body/redacted-committee-minutes> [Accessed 1 February 2018].
- University of Melbourne (n.d.). *Forms and templates*. [online] Available at: <https://staff.unimelb.edu.au/research/ethics-integrity/animal-ethics/forms-guidance-and-training/forms-and-templates> [Accessed 10 August 2018].
- University of Nottingham (n.d.). *Animal Research at Nottingham. Minutes of Animal Welfare and Ethical Review Body Meetings*. [online] Available at: <https://www.nottingham.ac.uk/animalresearch/awerb/minutes-of-awerb-meetings.aspx> [Accessed 1 February 2018].
- Varga, O., A.K. Hansen, P. Sandøe and I.A.S. Olsson (2010). Improving Transparency and Ethical Accountability in Animal Studies. Three Ways to link Ethical Approvals to Publications. *European Molecular Biology Organization reports*, 11(7), pp. 500–503.
- Whittaker, A. (2014). Animal Research Regulation in Australia—Does It Pass the Test of Robustness? *Global Journal of Animal Law*, 1.
- Williams, A.J. (2015). *Concordat on Openness on Animal Research in the UK. Annual Report 2015*. [online] Available at: http://www.understandinganimalresearch.org.uk/files/g214/4319/6363/UAR_Concordat_Report_2015.pdf [Accessed 5 October 2016].
- Williams, A.J. (2017). *Concordat on Openness on Animal Research in the UK. Annual Report 2017*. London. [online] Available at: <http://concordatopenness.org.uk/wp-content/uploads/2017/12/Concordat-Report-2017.pdf> [Accessed 1 February 2018].
- Yeates, J.W. and B. Reed (2015). Animal Research Through a Lens: Transparency on Animal Research. *Journal of Medical Ethics*, 41(7), pp. 504–505.

Wasted Money in United States Biomedical and Agricultural Animal Research

Jim Keen

University of Nebraska-Lincoln, Lincoln, Nebraska, United States

jekeeng18@gmail.com

1 Background

To kill an error is as good a service as, and sometimes even better than, the establishing of a new truth or fact.

CHARLES DARWIN, 1879

Biomedical and agricultural animal research uses millions of experimental animals and dozens of animal species each year by choice, precedent, or regulatory mandate in basic and applied life science research and toxicity testing of drugs, chemicals, and consumer products. Animal research is a large component of the international US\$270 billion government-subsidized, biomedical industrial ecosystem (Chakma et al., 2014). In the United States (US) and presumably elsewhere, about half of these funds support animal research and testing (Institute of Medicine and National Research Council, 2012). Each year at least 115 million experimental animals (mostly mice and likely a significant underestimate) are used worldwide (Akhtar, 2015). The *status quo* animal research environment provides “ecosystem services” to a large number of inter-dependent “species”, including governments, academia, biotechnology, agri-food and pharmaceutical industries, and publishers. Losers in this system are the conscripted animals (for “labor”) and taxpayers (for “capital”).

Animal research squanders precious public and private monies directly, indirectly, by opportunity cost, and by unintended negative consequences. There is no doubt that biomedical and agricultural animal research have delivered societal dividends. Nevertheless, the questionable benefit-cost ratio and the unquestionable negative repercussions of animal research are enormous for taxpayers, patients, and the public at large. Precise animal research investments and attendant waste are impossible to ascertain, in part because the research community and the US government obfuscate financial and animal use data. However, estimated US tax dollars wasted on animal use in biomedical and

agricultural research range, conservatively, from US\$5 billion to US\$9 billion per year. Even though exact monetary and animal use data are unobtainable, in this chapter I use the best available, if imprecise, estimates. The estimates themselves are arguable, yet the underlying conclusions remain valid.

2 Biomedical Animal Research

Animal experiments are of two types: basic (e.g., investigation of biological phenomena and animal models) and applied (e.g., drug research and development (R&D), and toxicity and safety testing). Applied research can also be preclinical (e.g., molecular biology, cell culture, animal models) or clinical (e.g., human drug or vaccine efficacy trials). The preclinical research goal in animal experimentation is to generate candidate drugs, bio-medical technology or devices and diagnostic tests to evaluate downstream for clinical testing and possibly commercialization, a laboratory-to-patient process called *translation*. Preclinical research also entails toxicity testing of drugs, vaccines, chemicals, cosmetics, and other consumer products, usually in mice and dogs. Veterinary biomedical animal research is structured essentially the same as its human counterpart albeit on a much smaller scale. The desired outcome of preclinical research, mostly performed by government and academia, are scientific papers, the currency (along with grant funds) of research success. The desired outcome of applied research, mostly performed by biotechnology and pharmaceutical firms, are patented biomedical products that reflect successful translation and new revenue streams. Public acceptance of animal research, especially if invasive and painful, is contingent on substantial human benefits and fiscal accountability. Unfortunately, taxpayers often support animal research under the false hype of “breakthrough” animal model-based medical progress.

Most preclinical research is publicly funded. The US National Institutes of Health (NIH), the world's largest biomedical research organization with a 2019 budget of US\$39.2 billion, emphasizes infectious diseases and oncology (NIH, 2019). The biotechnology and pharmaceutical sectors favor product development and commercialization (e.g., bio-engineered drugs, vaccines and clinical trials for cancer, analgesics, anti-diabetic drugs, and some rare diseases). The public sector generally relies more on animals than the private sector. However, the private sector depends indirectly on publicly funded animal research as a pipeline for candidate drugs or technologies to convert into marketable biomedical products (Dorsey et al., 2009; Moses et al., 2015).

Tax-supported animal research and testing is conducted or sponsored by several US agencies, especially the NIH. Federal laws mandate animal testing

of pharmaceuticals, vaccines, and other chemicals to assess their safety and efficacy. The Environmental Protection Agency and the Food and Drug Administration (FDA) are appropriated vast funds for animal testing. Other US agencies that require and/or conduct animal testing include the Department of Agriculture (USDA), the Consumer Product Safety Commission, the Department of Defense, the National Institute of Environmental Health Sciences, and the Department of Transportation. The private sector has decreased animal testing in some areas, especially in pharmaceuticals (due to high cost and animal model failure) and in cosmetics (due to consumer pressure). However, millions of animals are still used annually by private industry for internal or regulatory safety and efficacy testing of agrochemicals, vaccines and other biologics, and chemicals in consumer products (61.8%; US\$71 billion). Private industry is followed by the US government (31.5%; US\$45 billion) nonprofits and charities (3.8%; US\$4.4 billion), and academia (3.0%; US\$3.5 billion). About US\$56.4 billion (49%) is spent on preclinical research, with the NIH providing most funding. About 47% of preclinical research uses animals, of which 51% to 89% is flawed. Thus, US\$14 billion to US\$25 billion (9 million to 15 million out of 17 million laboratory animals) of US animal research is wasted (Freedman, Cockburn and Simcoe, 2015; Moses et al., 2015; National Anti-Vivisection Society, 2018).

2.1 *Many Animals*

Precise animal numbers utilized in US biomedical research are unknown because the large majority (at least 95%) are exempt from the monitoring, care, and reporting requirements of the USDA's Animal Welfare Act (AWA). Mice, rats, birds, and fish are exempt. As a result, it is impossible to know how many mice and rats are used each year for research in the US, for what purposes, and the pain and/or distress these animals experience because this data is not gathered or reported (American Anti-Vivisection Society, 2017). The USDA reported 820,812 AWA-covered animal species used for research, testing, teaching, and experimentation in 2016. About 40% of these animals were reported to be subjected to painful procedures, some with and some without anesthesia or analgesia (USDA, 2017). However, this USDA AWA data (animal numbers, species, painful procedures, etc.) is facility self-reported and thus unverified.

It is estimated that roughly 95% of the animals used in US laboratories are mice and rats. Assuming relative species use comparability of European Union data on vertebrate animals (i.e., mice, rats, birds, fish, and all cold-blooded animals), and an AWA non-exempt research animal population of 821,000, about 16 million mice are used annually. However, the estimated US research mouse population varies between 10 million and 100 million animals, many

genetically engineered (Guarino, 2015). Mouse numbers are growing rapidly (Goodman, Chandna and Roe, 2015). Extrapolation from Goodman, Chandna and Roe's study estimates the US research mouse population at 86 million.

2.2 *The Biomedical Industrial Complex*

The biomedical industrial complex is an international multi-billion-dollar business. Animal experimentation in the biomedical industrial complex (BIC) is pervasive, secretive, profitable, and government-sanctioned. The term "industrial complex" is from the famous and prescient 1961 farewell speech by US President Dwight Eisenhower to "beware the military industrial complex", the semi-opaque, complicated "dark state" network of relationships between governments, the armed forces and the corporate military/security sector that supplies them. Like the military industrial complex, the biomedical industrial complex is an impenetrable, taxpayer-money driven eco-system, where the stated bio-medical and public health missions are sometimes subservient to more self-serving ones (Orzechowski, 2012). This does not impugn or discredit most animal researchers, who usually have good, if misguided, intentions.

There are innumerable inter-dependent BIC beneficiaries. These include millions of investigators (salaries, prestige), thousands of universities and foundations (overhead, patents, jobs), hundreds of funding organizations (jobs, power), numerous biotechnology and pharmaceutical corporations (jobs, profits, patents, products) and venture capitalists (return on investment, ROI). Moreover, there is a vast subtler army of allied industries (e.g., equipment, reagent and animal suppliers, consultants, bureaucrats, veterinarians, regulators, and publishers).

Like all taxpayer subsidized enterprises affiliated with human medicine, prices for products and services are highly inflated. Animal suppliers breed animals, from genetically engineered mice to monkeys, to satisfy researcher demands. A New Zealand white rabbit can cost US\$350, a monkey US\$8,000. In 2010, the Jackson Laboratory sold 2.9 million mice for a revenue of US\$98.7 million. Suppliers of feed, cages, and equipment have profitable businesses. A mouse treadmill may cost US\$10,000. The US scientific publishing industry generates US\$10 billion in annual revenue (Jarvis and Williams, 2016). Biomedical research, with or without animals, is particularly lucrative for US universities who charge *overhead* (facilities and administrative fees) on every research dollar, typically at a 50% rate. About 80% (US\$29.8 billion/year) of NIH's US\$37.3 billion annual funding is awarded to universities and research institutes as extramural competitive grants. Academic "administrative costs" consume one in three research grant dollars, approximately US\$9.3 billion (one-fourth) of the

entire NIH budget. Overhead primarily pays high university executive salaries and building depreciation costs and only marginally supports research and investigators. By comparison, typical overhead (fixed costs) for a private US business is approximately 23% of sales, salaries, and benefits, inclusive.

3 The Failure of the Animal Model Paradigm in Biomedical Research

The problem is that it [animal research] hasn't worked, and it's time we stopped dancing around the problem [...] We need to refocus and adapt new methodologies for use in humans to understand disease biology in humans [...] You've lost the debate if you lose sight of the taxpayers and the patients.

ZERHOUNI, former head of the US NIH, in McManus, 2013

The cornerstone of modern biomedical investigation is animal experimentation, but this practice is in the midst of an existential crisis. Up to 88% of preclinical biomedical experiments, especially those involving animals, are invalid, i.e. derived candidate drugs or vaccines are clinically ineffective or toxic (Freedman et al., 2015; Bock, 2016). This results from poor experimental practices intertwined with the abject failure of synthetic disease in animals, from mice to chimpanzees, to serve as more than skin-deep human disease surrogates.

Animal research has always been ethically contested, but there is now indisputable evidence of animal model failure to recapitulate human disease and provide clinical value (Pound and Blaug, 2016). Public support for animal research is dropping. From 2009 to 2014, Americans opposing animal use in scientific research increased from 43% to 50% (Pew Research Center, 2015). Failed animal models are the root cause of disappointing and diminishing returns on biomedical investments. Poorly designed preclinical animal studies lead to downstream expensive but fruitless clinical trials, exposing people to false hopes, potentially harmful drugs, or withheld beneficial treatments. Poorly conducted studies produce unreliable findings and suffering in millions of animals, nullifying the social and moral justification of laboratory animal use (Pound and Bracken, 2014).

4 Failure and Waste in Preclinical Animal Research

4.1 *Of Mice Not Men: Animals Are Not People*

Hundreds of thousands of peer-reviewed publications are based on the assumption that human-animal similarities enable knowledge from "animal

models” to be extrapolated to people. The belief is entrenched in scientific funding agencies and animal experimentalists. However, even if animal research is conducted faultlessly, animal models have limited success in predicting human clinical outcomes because of inherent evolutionary, genomic, epi-genomic, physiological, and other human-animal differences. Human diseases are artificially induced in animals but fail to reproduce the complexity of human ailments. Animal models are typically generated through genetic manipulation, surgical intervention, or injection of foreign substances, producing ailments with signs similar to a human disease. A common current mouse cancer model harvests human tumor cells, grows them in a petri dish and then transplants tumor tissue beneath the skin of immuno-compromised mice, so that the mice avatars cannot reject the implanted tumors. These so-called patient-derived xenografts are then exposed to drugs whose killing efficiency and toxicity profiles are extrapolated to treat “personalized” human cancers. The cancer research community published an extraordinary 361,693 experimental studies and journal papers according to a PubMed database search I conducted on 8 August 2018 using the terms “Mice” and “Cancer”. PubMed was unable to identify how many successful anti-cancer mouse drugs became FDA-approved for human use but that number is certainly miniscule. Billions of lost dollars clearly show that mice as human disease surrogates are no more analogous than artificially flavored grape drink is to fine French wine. The chimpanzee, who shares 99% of its DNA sequence with humans and should best predict human outcomes, has largely failed as an animal model, certainly in dozens of HIV vaccine trials over the past three decades (Bailey, 2008). A 1% DNA difference apparently outweighs a 99% similarity.

5 Irreproducibility

Science has two aims: to be reproducible (confirmatory) and to contribute to cumulative knowledge (discovery). Confirmatory science has higher value because it defines scientific truth, i.e. the non-repeatable is false. An estimated 51% to 89% of preclinical animal research (US\$13.3 billion to US\$23 billion) is unreliable (see Table 10.1).

About 1.5 million biomedical scientific papers are published per year. Irreproducible but published animal research constitutes severe *literature pollution*, leading other researchers to follow false leads, amplifying waste (see Figure 10.1).

Some cogent and expensive examples of non-repeatable animal experiments are shown in Table 10.2.

TABLE 10.1 Annual US biomedical and agricultural R&D investment and estimated wasted animal research monies

Source	Total research investment: basic, or preclinical, and clinical	Total basic cal (assume 49% of total) ^a	Total animal (assume 47% of preclinical) ^b	Wasted money due to flawed animal research (assume 51% to 89% failure rate) ^a
<i>Biomedical—basic/preclinical and applied/clinical^a</i>				
All	US\$124 billion (100%)	US\$56 billion	US\$26 billion	US\$13.3–US\$23 billion
Industry	US\$71 billion (61.8%)	US\$34.8 billion	US\$16.4 billion ^d	US\$8.4–US\$14.6 billion
Government	US\$45 billion (31.5%)	US\$22 billion	US\$10.4 billion	US\$5.3–US\$9.3 billion
Non-profits and charities	US\$4.4 billion (3.8%)	US\$2.2 billion	US\$1.1 billion	US\$560–US\$970 million
Academia	US\$3.5 billion (3%)	US\$1.7 billion	US\$800 million	US\$410–US\$700 million
<i>Animal agriculture—basic and applied^c</i>				
All	US\$1.4 billion (100%)	US\$686 million ^e	US\$686 million	US\$350–US\$611 million
Industry	US\$500 million (36%)	US\$245 million	US\$245 million	US\$125–US\$218 million
Government	US\$900 million (64%)	US\$441 million	US\$441 million	US\$225–US\$393 million
<i>All 2017 biomedical and agricultural animal research</i>				
All	US\$125.4 billion	US\$61.5 billion	US\$28.9 billion	US\$14.7–US\$25.7 billion

Source	Total research investment: basic, or preclinical, preclinical, and clinical	Total basic cal (assume 49% of total) ^a	Total animal (assume 47% of preclinical) ^b	Wasted money due to flawed animal research (assume 51% to 89% failure rate) ^a
Industry	US\$71.5 billion	US\$35 billion	US\$16.6 billion	US\$8.5–US\$14.8 billion
Government	US\$45.9 billion	US\$22.4 billion	US\$10.5 billion	US\$5.3–US\$9.3 billion

- a Freedman et al., 2015
- b National Anti-Vivisection Society, 2018
- c Clancy, Fugile and Heisey, 2016
- d Probably an overestimate, as industry has a downstream clinical research focus and relies much less on upstream animal research than government or academia.
- e Since animal models are rarely used or needed in agricultural animal research, total basic research and total animal research dollars are assumed to be the same.

The most alarming exemplar of irreproducibility is a 2012 Amgen study that reproduced key findings in only six of 53 (11%) *landmark* preclinical cancer papers, mostly from mouse models, published in premier scientific journals (Begley and Ellis, 2012). NIH director Francis Collins recently wrote, “A growing chorus of concern, from scientists and laypeople, contends that the complex system for ensuring the reproducibility of biomedical research is failing and is in need of restructuring [...] *Preclinical research, especially work that uses animal models, seems to be the area that is currently most susceptible to reproducibility issues*” (emphasis added, Collins and Tabak, 2014). Why do we continue to spend so much on flawed animal models that lack validity, resilience, and repeatability?

6 Non-publishable Research and Publication Bias

A hypothesized treatment in an animal model may be ineffective or toxic, a “failure” considered a “negative result”. Scientists do not want to submit, and

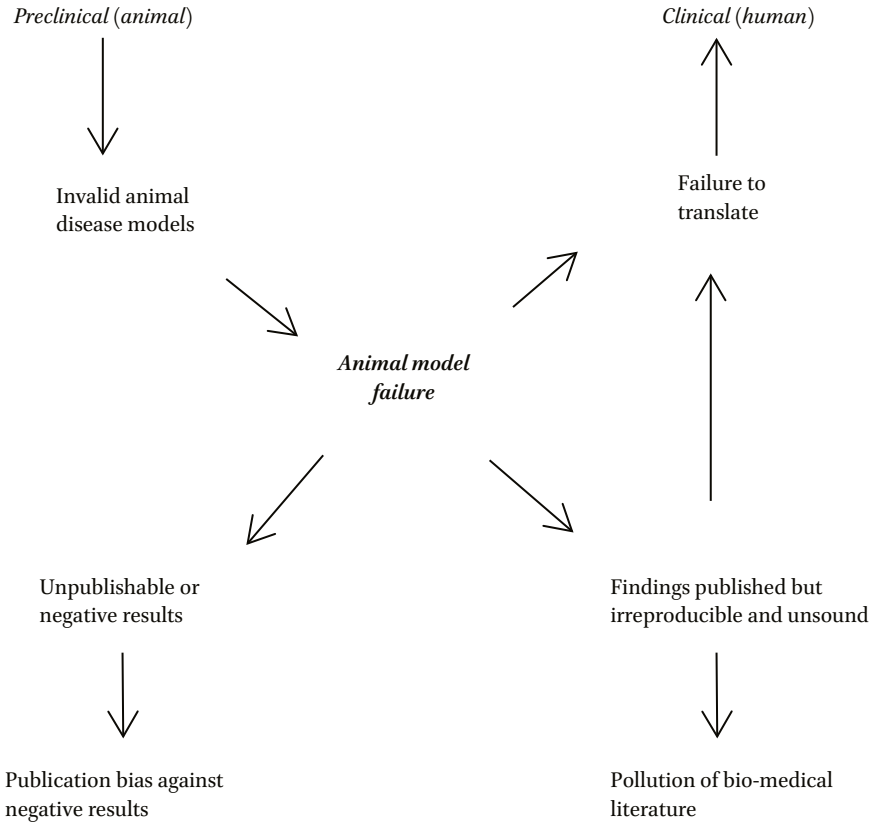

FIGURE 10.1 The animal model of human disease as a major driver of wasted money and translational failure in biomedical research.

journals do not want to publish negative findings because they lack the prestige of novel discoveries. This leads to unnecessary repetition of failed (unknown) research, amplifying wasted money. Published animal trials overestimate by 30% the likelihood of treatment success because of “missing” unpublished negative findings (Sena et al., 2010).

Unpublished or unpublishable results bias the biomedical literature, favoring positive over negative findings and leading to duplicate studies that unnecessarily endanger animal and human subjects and waste resources. Clinical trials funded by NIH (almost exclusively based on the false animal-as-human paradigm) and registered within ClinicalTrials.gov (clinicaltrials.gov), an NIH-run trial registry and results database, showed that fewer than half of 635 NIH funded clinical trials between 2005 and 2008 were published in a

TABLE 10.2 Examples of non-repeatable animal experiments

Research field	Repeatability failure	Estimated wasted money	Reference
Drug discovery: Cancer, women's health, cardiovascular	Bayer reports 43 of 67 (65%) new drug targets failed to repeat academic journal findings.	US\$67 million ^a	Mullard, 2011; Begley and Ellis, 2012
Drug discovery: All biomedical disciplines	50% of published academic studies in top-tier journals cannot be repeated with same conclusions by industrial labs.	Many millions	Osherovich, 2011
Drug discovery: Cancer	Amgen researcher unable to reproduce the findings in 47 of 53 (89%) <i>landmark</i> cancer papers from top journals.	US\$53 million ^a	Begley and Ellis, 2012

a Cost to repeat preclinical work in industrial labs varies from US\$500,000 to US\$2 million per compound and three to 24 months. I used a value of US\$1 million per drug target (see Freedman, Cockburn and Simcoe, 2015).

peer reviewed biomedical journal within 30 months of trial completion. Furthermore, those that were published omitted key, usually detrimental, details (Ross et al., 2012). A 2016 study of 4347 interventional clinical trials across 51 US academic medical centers reported dissemination of results within 24 months of completion ranging from 16.2% to 55.3%. This occurred in spite of a 2008 (unenforced) federal law requiring reporting of clinical trial results within 12 months of completion or termination with a (never applied) \$10,000 per day fine for non-compliance (Chen et al., 2016). My current home institution, the University of Nebraska, is the most flagrant violator of clinical trial reporting among academic institutions, disclosing less than 20% of clinical trial findings from 2015 to 2017 (Pillar and Bronshtein, 2018). *En toto*, the

non-transparent delayed or non-reporting of human clinical trials represents the dual wasteful and unethical suffering of many thousands of laboratory animals, the compromised safety and squandered sacrifice of thousands of participant human subjects and a total disregard for public accountability to US taxpayers.

7 Failure to Translate: Downstream Human Clinical Consequences of Flawed Animal Research

The history of cancer research has been a history of curing cancer in the mouse. We have cured mice of cancer for decades and it simply didn't work in humans. We need to acknowledge the fact that use of animals will not make us better scientists, but bitter scientists.

RICHARD KLAUSNER, former director of the US National Cancer Institute, 1998, in MANDAL and PARIJA, 2013

As the above quote attests, animal model failure has been well known for decades at the highest levels. Animal experiments have contributed to understanding mechanisms of disease and normal animal physiology and biochemistry. However, their record in predicting effectiveness, toxicity of treatment, or preventive strategies in human trials is dismal. In fact, clinical trials are essential precisely because animal studies do not predict with sufficient certainty what will happen in people (van der Worp et al., 2010). The pharmaceutical industry bemoans the near empty pipeline over the past 30 years of new drugs that enter and survive the clinical trial gauntlet to gain FDA approval. Serious biases in animal studies makes it nearly impossible to rely on animal data to predict whether or not an intervention will be toxic or have a favorable clinical benefit-risk ratio in humans (Ioannidis, 2012). Excessive translational risk occurs even though there has never been more public and private money, trained researchers, and better infrastructure, facilities, and biotechnological tools (e.g., "humanized" mice) than at present. Nearly all candidate drugs derived from preclinical research, entailing immense expenditures and use of animal models in which the drugs work well against artificially-induced disease, fail in human trials (Kaur, Sidhu and Singh, 2016). Well-known examples of animal model-to-human clinical failure, costing billions of public and private dollars, are shown in Table 10.3.

Drivers of translation failure include:

- *Irreproducibility*: For decades, the pharmaceutical industry has internally replicated preclinical research findings, published or otherwise, as standard

TABLE 10.3 Examples of non-translatable clinical science based on laboratory animal research, mostly mouse models. The drugs or other interventions “worked” (non-toxic, clinically effective) in animal models but were abandoned for use in people due to toxicity or lack of therapeutic efficacy

Research field	Repeatability failure	Estimated wasted money	Reference
Type 1 diabetes	All 195 methods that prevented or delayed development of type 1 diabetes in mice failed in people.	Billions	Roep, Atkinson and Herrath, 2004
Human immune-deficiency virus (HIV): pre-clinical, and Phase I, II and III vaccine trials	30–40 vaccines in approx. 90 clinical trials, involving more than 20,000 human volunteers, failed; all vaccines <i>worked</i> in non-human primates, especially chimpanzees injected with HIV; one vaccine increased human HIV risk.	Billions; not one HIV vaccine FDA-approved after 30 years	Bailey, 2008
Alzheimer’s disease: preclinical in mice, clinical trials in people	300 different interventions reported effective in the amyloid precursor mouse model; none effective in human trials. Of 1,200 clinical trials, only 5 drugs approved, which treat symptoms but not disease progression.	Billions	Zahs and Ashe 2010; Cavanaugh, Pippin and Barnard, 2014
Ischemic stroke	Two of 500 neuroprotective interventions against stroke successful in human clinical trials; one of the two beneficial drugs was aspirin.	Billions	van der Worp et al., 2010

TABLE 10.3 Examples of non-translatable clinical science based on laboratory animal research, mostly mouse models. The drugs or other interventions “worked” (non-toxic, clinically effective) in animal models but were abandoned for use in people due to toxicity or lack of therapeutic efficacy (*cont.*)

Research field	Repeatability failure	Estimated wasted money	Reference
Inflammation and sepsis	150 clinical trials that tested candidate agents intended to block the inflammatory response all worked in mice; all failed in critically ill patients.	Billions	Seok et al., 2013
Amyotrophic lateral sclerosis (ALS)	100 potential drugs in established animal models, of which eight entered clinical trials with thousands of people, failed. Clinical trials of 24 compounds in 51 studies of 13,000 ALS patients, found 1 beneficial compound.	Billions	Perrin, 2014; Petrov et al., 2017

operating procedure to validate drug targets and initiate internal drug discovery. Non-repeatable results have been disappointing and expensive (see Table 10.2). The pharmaceutical industry has heavily divested and decreased reliance on animals because each translational failure causes significant losses of invested capital. European drug companies decreased animal use by 25% from 2005 to 2008 (Pound and Bracken, 2014).

- *False positive animal model success*: Industry researchers must give up when a drug is poorly absorbed, unsafe, or does not work. Only five in 5,000 compounds that enter preclinical testing make it to human testing. Only one of the five is safe and effective enough to be marketed (FDA, 2017). More than 90% of promising new compounds fail when tested in humans because they are ineffective or toxic, even though each drug performed well in prior multi-species animal tests.

- *False negative toxicity (iatro-epidemics)*: Severe unintended human harms and billions of dollars in damages occur when FDA-approved drugs are non-toxic in laboratory animals but cause serious, sometimes fatal iatro— (medically caused) epidemics after marketplace entry. These *adverse drug reactions* may cause 100,000 US deaths annually, although this is likely a highly inflated number (Lazarou, Pomeranz and Corey, 1998). The FDA Adverse Events Reporting System (FAERS) is a computerized information database designed to support the agency’s post-marketing safety surveillance program for all approved drug and therapeutic biologic products. The FAERS contains almost 16 million reports of adverse events and reflects data from 1969 to 2018, suggesting limitations to the validity of animal drug or biologics toxicity screening (FDA, 2018). For example:
 - The arthritis drug rofecoxib (Vioxx) was safe in eight studies in African green monkeys and five other animal species but caused 140,000 heart attacks and 60,000 to 100,000 deaths before withdrawal in 2004. Merck paid US\$950 million to settle damages in 2011 (Pippin, 2012).
 - Analysis of 780 chemical agents listed in a cancer database found the positive predictivity of animal bioassays, for a definite or probable human carcinogen, to be 20% (Knight, 2007). In addition to risking human welfare from the low predictability of animal bioassays, each assay requires up to millions of dollars and years to execute (Akhtar, 2015).
 - The diet drug, fen-phen (fenfluramine-phentermine), worked well as an appetite suppressant in rats without toxicity. However, this popular drug damaged heart valves and caused pulmonary hypertension in some people in the 1990s. The FDA withdrew it in 1997. The drug’s maker settled damage claims for US\$3.75 billion (Kolata, 1997; Morrow, 1999).
- *False positive drug toxicity*: Just as ineffective and dangerous drugs are approved based on erroneous safety in animals, useful drugs may be toxic in animals but safe for people. Aspirin was patented in 1900, decades before mandated animal testing. When later evaluated, aspirin produced birth defects in mice, rats, guinea pigs, rabbits, cats, dogs, sheep, and monkeys. Post-approval toxicity of penicillin (killed guinea pigs) and tamoxifen (liver cancer in rats) was absent in people. If the animal toxicity were known, these safe drugs would unlikely be on the market today (Akhtar, 2015).
- *Costs of failed clinical trials*: Clinical human research relies on and extends preclinical animal research. Unsound animal research leads to precarious clinical research outcomes. The FDA drug approval process is stringent and tightly controlled and consists of four phases (Phase I to Phase IV). Phase I: Is the drug safe in healthy people?; Phase II: Does the drug work in patients?;

Phase III: Pivotal trials: How does the drug compare to existing treatments?; Phase IV: Post-marketing surveillance: What unknown drug effects (good or bad) happen? Only one in 5000 to 10,000 new chemical compounds derived from preclinical testing proceed to Phase I (Akhtar, 2015). Phase transition success rates are: Phase I to Phase II: 63%; Phase II to Phase III: 31%; Phase III to new drug approval: 85%. The overall success rate from Phase I to FDA-approval is 9.6% (Batelle, 2015).

The immense attrition of drugs entering human clinical trials has made big pharma cautious, even skeptical, of preclinical animal research. In 2013, the average time and cost to develop a new drug was 10 years and US\$2.6 billion (Batelle, 2015). Candidate drugs that fail anywhere in the clinical trial process, prior to FDA-approval, still lose millions of dollars. Drug development losses are recouped as higher prices for pharmaceuticals already on the market. Promising preclinical animal studies that require extensive time, labor, and money rarely translate into successful human therapies. The overwhelming preclinical tendency to use animal models, in spite of their near universal translation failure, invokes the “law of the hammer”, a cognitive bias involving over-reliance on a familiar tool (Kaplan, 1964). Abraham Maslow (1966) said, “I suppose it is tempting, if the only tool you have is a hammer, to treat everything as if it were a nail”. The laboratory mouse is certainly a worn-out bio-hammer.

8 **Animal Agriculture Research: Less Money, Fewer Animals, but Great Waste All the Same**

According to the USDA, in 2016, approximately 80,000 farm animals (pigs, sheep, goats, and cattle) were used in animal testing or biomedical research. This excludes federal government owned agricultural-research animals who are AWA exempt (approximately 50,000 animals). About US\$1.4 billion was spent on US agricultural animal research in 2016, including US\$900 million in public funds (mostly USDA) and US\$500 million by private industry (Clancy, Fuglie and Heisey, 2016) (see Table 10.1). Animal agriculture research has approximately 1% of the budget and uses approximately 0.8% of the animals used in biomedical research. Since experiments are performed directly on the target livestock species, animal research in agriculture has the distinct advantage of not relying on animal models.

8.1 *The Animal Agriculture Industrial Complex*

Animal agricultural research is a cog in the large industrial agri-business ecosystem. It directly and indirectly supports an entourage of scientists, government

agencies, livestock commodity groups, lobbyists, and the animal health, feed and other allied industries (Twine, 2012). The dominant *raison d'être* of livestock research is to benefit people via support of the industrial (“factory farm” or “prison”) paradigm, i.e. intensively managed and densely confined pigs, feedlot beef cattle, dairy cattle, and poultry (Imhoff, 2010). There are three common aims:

- To optimize so called *production efficiency* of meat, milk and eggs i.e. generate the greatest output with the fewest inputs. Three tools accomplish this: genetic selection, feed efficiency and animal health, *writ large*, including growth promoting drugs, disease suppressing antibiotics and numerous vaccines.
- To *maximize consumption* of animal agriculture products.
- To address *unintended consequences* of industrial animal agriculture (e.g., food safety risk, zoonotic pathogens, antibiotic resistance, and pollution from animal wastes).

9 Case Studies in Wasted Money from Animal Research

The Mad Cow Disease iatro-pandemic and new variant Creutzfeldt-Jakob Disease (nvCJD): The best feed for cows ... is cows!

“The road to hell is paved with good intentions”

Saint Bernard of CLAIRVAUX, 1150

Because feed is the greatest expense in raising livestock (65%–75% of total cost), there is an ongoing quest to lower feed costs. A dominant research goal is to increase feed efficiency (feed inputs/outputs of growth, eggs or milk). Feed efficiency research focuses on: (1) drugs (hormones and antibiotics); (2) genetic selection; (3) better nutrition; and (4) low cost “waste products” as feedstuffs.

While corn and soybeans are mainstays in US industrialized livestock rations, less savory ingredients also become animal feeds, especially to meet expensive protein needs. Only 60% of a slaughtered cow is edible (i.e. suitable as human food). The remaining “inedible” 40% (including hides, bones, entrails, lungs, spleens, hooves, fat and gristle, and fetuses, among others), known euphemistically as “by-products”, are not permitted to be used as human food. They can, however, be used in livestock and poultry feeds and pet foods. Rendering plants transform slaughter by-products and animals that are unsuitable for human consumption into animal feed products using grinding, cooking, and pressing processes. Livestock are fed rendered animal fat and protein from slaughtered food animals and their wastes, including chicken feathers, egg shells, poultry litter (bedding and feces), blood, hair, bone marrow, pig

manure, and rumen ingesta. So called “4D” animals (dead, dying, diseased, disabled) also become livestock feed and pet foods. Cost driven same-species feeding (cannibalism) is common and industry-supported in livestock and poultry in most countries (Denton et al., 2005).

Meat and bone meal (MBM, dried and ground), also known as “animal flour”, was a small-scale livestock feed for much of the twentieth century. The Agricultural Research Service, the internal USDA research arm, studied feeding bovine MBM to dairy cattle in the 1960s (Brundage and Sweetman, 1963). However, commercial rendering, industry-sponsored research at the University of Nebraska-Lincoln, in the early 1980s, discovered the “by-pass protein effect” when cattle are fed high protein MBM from dead cattle (Rampton and Stauber, 1997). Proteins from rendered bovine MBM, unlike plant proteins, withstand rumen microbial digestion and are delivered intact to the small intestine, maximizing growth and lactation in high-yield dairy cattle. Additional University-sponsored research confirmed the MBM by-pass protein effect, resulting in many peer-reviewed papers (e.g., Stock et al., 1981; Santos et al., 1998). It should be no surprise that rumen microbes, evolutionarily designed over millions of years to digest forage, are unable to digest MBM, completely foreign nutrients. By analogy, humans would have a difficult time digesting sawdust. By the mid-1980s, MBM bypass protein was widely accepted, especially in Western Europe, as a dairy cattle protein source. MBM use in animal feed was heavily dependent on its price relative to the price of alternative ingredients (e.g., soybeans) with similar nutrient values.

However, this anti-nature Faustian bargain of high milk production in exchange for cannibalism resulted, starting in the mid-1980s, in the bovine spongiform encephalopathy (BSE, “Mad Cow”) pandemic. This new fatal prion (infectious protein) disease spread to cattle eating prion-contaminated bovine MBM, amplified by “recycling” rendered cattle that died of BSE into even more prion-contaminated MBM. In Britain, 185,000 live cattle were BSE-infected, 4.4 million were slaughtered during the 1986–1998 eradication program, and perhaps a million BSE-infected cattle entered the human food chain. Cattle in 30 countries were infected. Thousands of European dairy farmers lost their livelihoods (Brown et al., 2001). Since the 1996 discovery that BSE was transmissible to humans from eating prion-contaminated beef, at least 231 persons in 13 countries died from new variant Creutzfeldt-Jakob Disease (nvCJD), the zoonotic manifestation of BSE (Maheshwari et al., 2015). Since the first US BSE case in 2003, the US cattle industry has forfeited billions of dollars from lost exports, decreased product value, lower consumption, and new regulatory burdens. This tragic MBM cow cannibalism story shows that “production efficiency” research can have incredible negative sequelae and vividly demonstrates

the myth of so-called peer-reviewed sound science. Unfortunately, the BSE experience has not completely tempered the feeding of animal protein to herbivores.

9.1 *Livestock Research at the USDA US Meat Animal Research Center (US MARC)*

I worked at the USDA Agricultural Research Service of the Meat Animal Research Center (MARC) in Nebraska from 1988 to 2014 in various veterinary clinical and research positions for the USDA and the University of Nebraska-Lincoln (UNL). The USDA and UNL jointly operate MARC, the world's largest livestock research center. It has a federal appropriation of US\$22 million per year, plus approximately US\$5 million in annual revenue from livestock sales, a cumulative US\$1.3 billion budget over the half century it has existed. MARC is essentially a 55 square mile (14,200 hectare) ranch surrounding a research campus. Each year, MARC's 6,800 brood cows raise 6,000 calves, 600 sows produce 14,000 piglets, and 2,800 ewes birth 5,000 lambs; 35,000 animals in total. Almost all Agricultural Research Service livestock and meat research is directed toward helping large producers and processors. In particular, much current Agricultural Research Service research addresses the *untended negative consequences* of industrial animal agriculture, for example food safety risk, zoonotic pathogens, drug residues, antibiotic resistance and pollution from animal wastes.

A former MARC Director told me directly that since an executive branch agency (such as the Agricultural Research Service) cannot lobby Congress (the Hatch Act of 1939), he would tell the livestock trade and lobbying associations what research MARC wanted to do. These associations would then lobby Congress on MARC's behalf, often resulting in new funding for MARC, frequently as budgetary earmarks. In return, MARC would (and still does) perform taxpayer-subsidized research directly addressing pressing priority livestock and meat industry concerns.

Thus, in addition to its multi-million dollar federal research budget, MARC performs targeted research on behalf of, or funded by, livestock commodity groups. For example, the National Cattlemen's Beef Association (NCBA), a trade association and lobbying group for mostly large US beef producers and slaughter processors, has a very close and decades-long association with MARC. The NCBA funded at least 52 research projects at MARC between 1999 and 2017. These included one project in genetic selection, nine in meat quality, and 42 in beef safety (zoonotic bacteria and antibiotic resistance). Each NCBA proposal typically provides funding of US\$100,000 for one year and does not cover MARC labor or equipment costs. Thus, this represents a US\$5.2 million

NCBA research investment in MARC over 18 years (National Cattlemen's Beef Association, 2017). However, since MARC provides “free” labor (~80% of the cost of research), this \$5.2 million industry “investment” in MARC signifies a taxpayer gift of at least \$20.8M to the NCBA over 18 years, an impressive return in investment. The North American Meat Institute, a meat and poultry trade association representing meat packers and processors is also a frequent funder of industry research at MARC.

MARC's mission is to apply science and technology for *red meat production efficiency* to benefit consumers, producers, and animal agri-business, with a genetic selection focus. Among livestock producers, animal scientists, and beef geneticists, MARC is a world-famous, NIH-Mayo Clinic equivalent for red meat livestock R&D. Like all industrial livestock based-systems, MARC achieves “production efficiency” using three tools:

- *Genetic selection*: Choose a desirable and heritable production trait (e.g., many offspring; large muscles) and vigorously (hyper) select for this attribute over many generations.
- *Feed efficiency*: Maximize via genetic selection and/or experimental low-cost feeds. For example, in the early 1980s, MARC scientists fed high pH cement kiln dust (a by-product of cement manufacturing) to feedlot steers, sheep, and pigs as a calcium feed supplement and to buffer the dangerously acidic rumen or stomach pH of animals fed high-energy corn rations (Wheeler et al., 1981; Pond et al., 1982). Cement kiln dust is the fine-grained, solid, highly alkaline waste removed from cement kiln exhaust gas by air pollution control devices. Toxicity led to abandonment of these experiments.
- *“Factory farm-acology”*: Use drugs to improve feed efficiency and promote fast lean growth, such as anabolic steroids (hormone implants), antibiotics, ionophores, and beta-agonists (repartitioning agents that convert fat to muscle) (Petersen, 2012). The cumulative drug effects are rapid growth and maximized lean muscle mass.

As a cogent example of MARC funding of industry research, USDA and UNL investigated the growth and “welfare” (body temperature and mobility) effects of zilpaterol, a beta-agonist growth promotant, on MARC feedlot steers (Boyd et al., 2015). Zilpaterol is a failed human asthma drug whose undesirable human side effect of turning fat into muscle was a very desirable outcome in cattle. This drug is approved for use in livestock in only five countries (Centner, Alvey and Stelzleni, 2014). Zilpaterol was voluntarily removed from the market by Merck in 2013 due to serious animal welfare concerns. This zilpaterol research at MARC, tri-funded by USDA, UNL and the Nebraska Beef Council,

not surprisingly reported no welfare problems in using this fat-to-muscle repartitioning agent. Of interest in this MARC feedlot study are: (1) all nine authors were livestock scientists; no person with animal or livestock welfare training or expertise was part of the study; (2) an unreferenced and invalidated meat industry-developed 5-level ordinal lameness scoring metric was employed (Tyson mobility scoring, Tyson Foods, Springdale, AK) and; (3) evaluators were not blinded as to treatment group, a dominant source of experimental bias.

I will recount three examples of MARC research principles in action, all with animal welfare repercussions and massive waste of taxpayer dollars.

9.2 *Twinner Beef Cattle*

Rationale: Cows usually have one offspring. The natural twinning rate in cattle is 1%–2%. Production efficiency would double if cows had twins instead of singlets.

Results: From 1981 until 2011, the twinning rate in a MARC herd rose to approximately 50% (1.6 calves per cow) via intense genetic selection.

Problems: (1) It is bio-unnatural for cows to have twins, fighting against millions of years of evolution favoring singlets; (2) Dystocia, C-sections, mastitis, early calf deaths, and sterile female calves.

Outcome: The project was abandoned after 30 years and approximately 100 million tax dollars. There was no market for twinning cows. Most farmers cull cows with twins due to the well-known problems described above. A beef geneticist said in 2016, “There are animals in this world that God made to have twins or triplets; cows are made to have one” (Simmons, 2016).

9.3 *“Double muscled” Beef Cattle*

Rationale: Cattle with more muscle mass have greater productivity. Belgium blue cattle can have a mutant *myostatin* gene, causing skeletal muscles to grow continuously, producing massive animals.

Results: MARC scientists co-identified the *myostatin* gene mutation as causative for double muscling and developed a test for its genetic selection worldwide. Production efficiency experiments conducted over many years produced cattle with very large muscle mass.

Problems: Dystocia, low fertility, low stress and heat tolerance, poor calf viability.

Outcome: The project started in 1997 and was abandoned after many years and millions of tax dollars. There is no market for these cattle (Elstein and Peabody, 2004; Bassett, 2009).

9.4 “Easy care” Sheep

Rationale: The US commodity sheep industry is becoming extinct. In 2015, there were less than 5 million sheep, a 91% decline since 1950. Labor is costly.

Solution: Increase sheep production efficiency by developing a cross-bred fecund breed. This “easy care” sheep has hair (since US wool has negative economic value) and births twins or triplets. Use brutal neo-Darwinian selection via hands-off husbandry to select sheep that raise lambs, who require minimal labor, feed inputs, and human attention.

Results: From 2002 to 2017, approximately 1,500 easy care ewes gave birth to 3,000–5,000 lambs per year. Rather than the usual summer pasture and winter shed housing and lambing, “easy care” sheep were kept on isolated pastures year-round without shelter or shade. Shepherds were prohibited, by experimental protocol, from intervening to care for ewes or lambs in need. Ewes that survived and reared lambs under these heinous conditions were considered “*successfully genetically selected*”.

Problems: Predictably, human-dependent domestic sheep treated like wild sheep fared very poorly. Lamb mortality ranged from 10% to 50% per year (normal rates are 1%–5%). Over 15 years, 15–20 thousand lambs died (the expected number was 1,200) from coyote predation, starvation, exposure, abandonment, dystocia, and disease.

Outcome: Like the Twinner cattle, the “easy care” sheep project used intense long-term genetic selection in an anti-nature, poor welfare manner to attempt to create a product without commercial demand. The easy (“No”) care sheep research failed completely, unsurprisingly, to reach its scientific goal of a new sheep breed with low labor needs. Over 15 years, the project spent approximately 15 million tax dollars. No scientific papers resulted from this work.

These three MARC projects share several commonalities:

- Intense genetic selection created or attempted to create a livestock product no one wanted where *production efficiency* at all (animal and taxpayer) costs was the focus.
- Genetics were used as a biological hammer to select for abnormal, exaggerated, or unnatural traits that were both costly and harmful to livestock well-being.
- Projects were internally and non-competitively funded for decades with millions of tax dollars.
- MARC livestock, like all federal government-owned agricultural research livestock, are AWA-exempt and subject to almost no internal or external animal welfare oversight which are mandated for other US research animals.

The industrial animal agriculture system does not merit research funding from the public treasury, as exemplified by the decades of failed and unnecessary research and multi-millions of wasted tax dollars at MARC. It is almost impossible to justify research support for an unsustainable system that produces Mad Cow disease, antimicrobial resistance, pollution from livestock wastes, food-borne pathogens (e.g., *E coli* O157), and horrible livestock and poultry welfare. “*Cheap*” factory-farmed eggs, beef, pork and chicken enabled by intensive agricultural animal research are incredibly expensive (Pew Charitable Trusts, 2008).

10 Conclusions

Publicity is justly commended as a remedy for social and industrial diseases. Sunlight is said to be the best of disinfectants; electric light the most efficient policeman.

LOUIS D. BRANDEIS, 1914

It is an economic and ethical imperative to reduce wasted money and animals used in US biomedical and agricultural animal research. These imperatives are unlikely to manifest in the current animal research environment due to perverse incentives. Complete transparency (e.g., costing, specific animal usage, outcomes, evidence of translational success, mandatory public reporting of all government funded research regardless of results) in both the public and private domains will likely be the most effective driver of fiscal responsibility and refining (minimizing experimental suffering), reducing (minimizing animal numbers), and replacing (with non-animal alternatives) research animal use. This will require, at a minimum, sustained public pressure, policy and regulatory changes (e.g., removal of species or institutional exemptions from the AWA), adequate resourcing, and enforced (new or old) legislation.

Animal research is losing its immunity from criticism or challenge. However, it is a multi-billion-dollar industry in which government, academia and private business have high financial stakes (Pound and Bracken, 2014). It is critical to recognize that wasted money in animal research is only germane to laboratory animals and to people excluded from the animal research industrial complex (i.e., taxpayers, patients, investors, and consumers). To those within the animal research ecosystems, there is no waste or cost, only sustenance and benefit. This is a major reason why wasteful, unproductive, and even

counterproductive use of research animals not only continues but is fiercely defended despite obvious limitations and dangers. Supporters of animal research rely on expert opinion (one of the least valid types of evidence) and the occasional translational success story. Opponents have billions of wasted dollars, millions of scientific papers, and decades of evidence against their continued use. Government sponsored animal experiments may continue because they are taxpayer-subsidized and incentivized. The pharmaceutical and biotechnology industries may reduce laboratory animal use in drug discovery and development, because they cannot invest heavily in such an unreliable methodology. Unfortunately, scientific precedent, legal liability concerns, and regulatory approval mandates will ensure enormous use of laboratory animals in the private sector to assess safety of drugs, medical devices, biologics, chemicals, and consumer products and to test vaccines (for potency and by batch), at least in the near term or until regulatory requirements change.

Available and emerging non-animal research approaches and technologies can provide better return on investment, more valid and valuable findings, and better human well-being outcomes and save billions of taxpayer dollars and millions of animal lives (D'Urbino, 2016). Goals should include:

- Abandoning molecular reductionism (e.g., as manifested in genetically modified or “gene knock out” mice).
- Investigating complex naturally-occurring disease in humans and animals instead of artificial and incongruent animal models.
- Implementing more *in vitro* (human or animal cell-based assays) and *in silico* (computer modeling) technologies.
- Resourcing development, validation, and regulatory acceptance of non-animal alternatives (e.g., the Interagency Coordinating Committee on the Validation of Alternative Methods, ICCVAM (National Toxicology Program, 2018)).
- Defunding public biomedical research that uses animal disease models.
- Eliminating non-competitive internal government research funding and halving extramural grant overhead rates.
- Discontinuing the failed research focus in agriculture on industrial livestock “production efficiency” in favor of humane sustainable agricultural research.

References

American Anti-Vivisection Society (2017). *Animal in Science—Which Animals Are Used—Mice and Rats*. [online] Available at: <http://aavs.org/animals-science/animals-used/mice-rats/> [Accessed 9 August 2018].

- Akhtar, A. (2015). The Flaws and Human Harms of Animal Experimentation. *Cambridge Quarterly of Healthcare Ethics*, 24(4), pp. 407–419.
- Bailey, J. (2008). An Assessment of the Role of Chimpanzees in AIDS Vaccine Research. *Alternatives to Laboratory Animals*, 36(4), pp. 381–428.
- Bassett, A. (2009). Welfare and Belgium Blue Cattle. *Animal Welfare Approved Technical Fact Sheet*. PCE4v1-TAFS 1. [online] Available at: <https://agreenerworld.org/wp-content/uploads/2018/05/TAFS-1-Welfare-and-Belgian-Blue-Cattle-v1.pdf> [Accessed 25 July 2018].
- Battelle (2015). *Biopharmaceutical Industry-Sponsored Clinical Trials: Impact on State Economies*. [online] Available at: <http://phrma-docs.phrma.org/sites/default/files/pdf/biopharmaceutical-industry-sponsored-clinical-trials-impact-on-state-economies.pdf> [Accessed 25 July 2018].
- Begley, C.G. and L.M. Ellis (2012). Drug Development: Raise Standards for Preclinical Cancer Research. *Nature*, 483(7391), pp. 531–533.
- Bock, E. (2016). Much Biomedical Research Is Wasted, Argues Bracken. *NIH Record*, LXVIII(14). [online] Available at: https://nihrecord.nih.gov/newsletters/2016/07_01_2016/story3.htm [Accessed 13 August 2017].
- Boyd, B.M., S.D. Shackelford, K.E. Hales, T.M. Brown-Brandl, M.L. Bremer, M.L. Spangler, T.L. Wheeler, D.A. King and G.E. Erickson (2015). Effects of Shade and Feeding Zilpaterol Hydrochloride to Finishing Steers on Performance, Carcass Quality, Heat Stress, Mobility, and Body Temperature. *Journal of Animal Science*, 93, pp. 5801–5811.
- Brandeis, L.D. (1914). *Other People's Money and How the Bankers Use It*. New York: Frederick A. Stokes.
- Brown, P., R.G. Will, R. Bradley, D.M. Asher and L. Detwiler (2001). Bovine Spongiform Encephalopathy and Variant Creutzfeldt-Jakob Disease: Background, Evolution, and Current Concerns. *Emerging Infectious Diseases*, 7(1), pp. 6–16.
- Brundage, A.L. and W.J. Sweetman (1963). Meat and Bone Meal as a Protein Supplement for Lactating Dairy Cattle. *Journal of Dairy Science*, 46(10), pp. 1081–1084.
- Cavanaugh, S.E., J.J. Pippin and N.D. Barnard (2014). Animal Models of Alzheimer Disease: Historical Pitfalls and a Path Forward. *Alternatives to Animal Experimentation*, 31(3), pp. 279–302.
- Centner, T.J., J.C. Alvey and A.M. Stelzleni (2014). Beta Agonists in Livestock Feed: Status, Health Concerns, and International Trade. *Journal of Animal Science*, 92, pp. 4234–4240.
- Chakma, J., G.H. Sun, J.D. Steinberg, S.M. Sammut and R. Jagsi (2014). Asia's Ascent Global Trends in Biomedical R&D Expenditures. *New England Journal of Medicine*, 370(1), pp. 3–6.
- Chen, R., N.R. Desai, J.S. Ross, W. Zhang, K.H. Chau, B. Wayda, K. Murugiah, D.Y. Lu, A. Mittal and H.M. Krumholz (2016). Publication and reporting of clinical trial results: cross sectional analysis across academic medical centers. *British Medical*

- Journal*, p. 352:i637. [online] Available at: <https://www.bmj.com/content/352/bmj.i637> [Accessed 8 August 2018].
- Clancy, M., K. Fuglie and P. Heisey (2016). US Agricultural R&D in an Era of Falling Public Funding. *Amber Waves*. [online] Available at: <https://www.ers.usda.gov/amber-waves/2016/november/us-agricultural-rd-in-an-era-of-falling-public-funding/> [Accessed 8 August 2018].
- Collins, F.S. and L.A. Tabak (2014). NIH Plans to Enhance Reproducibility. *Nature*, 505(7485), pp. 612–613.
- Darwin, C., 1879 [2008]. Letter to A.S. Wilson, March 5, 1879. In: F. Darwin and A.C. Seward, eds., *More Letters of Charles Darwin*, vol. 2, Charleston, SC: BiblioBazaar.
- Denton, J.H., C.N. Coon, J.E. Pettigrew and C.M. Parsons (2005). Historical and Scientific Perspectives of Same Species Feeding of Animal By-products. *Journal of Applied Poultry Research*, 14(2), pp. 352–361.
- Dorsey, E.R., J.P. Thompson, M. Carrasco, J. De Roulet, P. Vitticore, S. Nicholson, S.C. Johnston, R.G. Holloway and H. Moses (2009). Financing of US Biomedical Research and New Drug Approvals Across Therapeutic Areas. *PLoS One*, 4(9), p. e7015. [online] Available at: <http://journals.plos.org/plosone/article?id=10.1371/journal.pone.0007015> [Accessed 13 August 2017].
- D'Urbino, L. (2016). The Mischief of Mice. The World's Favourite Lab Animal Has Been Found Wanting, But There Are New Twists in the Mouse's Tale. *The Economist*. [online] Available at: <https://www.economist.com/news/christmas-specials/21712058-evolution-scientific-mainstay-worlds-favourite-lab-animal-has-been-found> [Accessed 13 August 2017].
- Elstein, D. and E. Peabody (2004). Can You Have Your Beef and Eat It Too? *Agricultural Research*, 52(7), pp. 10–11.
- FDA (2017). *The Beginnings: Laboratory and Animal Studies*. [online] Available at: <https://www.fda.gov/drugs/resourcesforyou/consumers/ucm143475.htm> [Accessed 13 August 2017].
- FDA (2018). *FDA Adverse Event Reporting System (FAERS) Public Dashboard*. [online] Available at: <https://fis.fda.gov/sense/app/d10be6bb-494e-4cd2-82e4-0135608ddc13/sheet/7a47a261-d58b-4203-a8aa-6d3021737452/state/analysis> [Accessed 26 July 2018].
- Freedman, L.P., I.M. Cockburn and T.S. Simcoe (2015). The Economics of Reproducibility in Preclinical Research. *PLoS Biology*, 13(6), p. e1002165. [online] Available at: <http://journals.plos.org/plosbiology/article?id=10.1371/journal.pbio.1002165> [Accessed 13 August 2017].
- Goodman, J., A. Chandna and K. Roe (2015). Trends in Animal Use at US Research Facilities. *Journal of Medical Ethics*, 41, pp. 563–566.
- Guarino, B. (2015). *How Many Lab Mice Did American Researchers Kill in 2015?*. [online]. Available at: <https://www.inverse.com/article/9316-how-many-lab-mice-did-american-researchers-kill-in-2015> [Accessed 16 February 2018].

- Imhoff, D. (2010). *CAFO (Concentrated Animal Feeding Operations): The tragedy of industrial animal factories*. San Rafael, CA: Earth Aware.
- Institute of Medicine and National Research Council (2012). *International Animal Research Regulations: Impact on Neuroscience Research: Workshop Summary*. Washington, DC: The National Academies Press, p. 23. [online] Available at: <https://www.nap.edu/catalog/13322/international-animal-research-regulations-impact-on-neuroscience-research-workshop-summary> [Accessed 13 August 2017].
- Ioannidis, J.P. (2012). Extrapolating from Animals to Humans. *Science Translational Medicine*, 4(151), pp. 1–4.
- Jarvis, M.F., M. Williams (2016). Irreproducibility in Preclinical Biomedical Research: Perceptions, Uncertainties, and Knowledge Gaps. *Trends in Pharmaceutical Science*, 37(4), pp. 290–302.
- Kaplan, A. (1964). *The Conduct of Inquiry: Methodology for Behavioral Science*. San Francisco: Chandler Publishing Co., p. 28.
- Kaur, R., P. Sidhu and S. Singh (2016). What Failed BIA 10-2474 Phase I Clinical Trial? Global Speculations and Recommendations for Future Phase I Trials. *Journal of Pharmacology and Pharmacotherapeutics*, 7(3), pp. 120–126.
- Knight, A. (2007). Systematic Reviews of Animal Experiments Demonstrate Poor Human Clinical and Toxicological Utility. *Alternatives to Laboratory Animals*, 35, pp. 641–659. [online] Available at: http://animalstudiesrepository.org/cgi/viewcontent.cgi?article=1085&context=acwp_arte [Accessed 13 August 2017].
- Kolata, G. (1997). How Fen-Phen, a Diet “Miracle,” Rose and Fell. *New York Times*. [online] Available at: <https://www.dartmouth.edu/~chance/course/Syllabi/97Dartmouth/day-2/fen-phen-1.pdf> [Accessed 13 August 2017].
- Lazarou, J., B.H. Pomeranz and P.N. Corey (1998). Incidence of Adverse Drug Reactions in Hospitalized Patients: A Meta-analysis of Prospective Studies. *Journal of the American Medical Association*, 279(15), pp. 1200–1205.
- Maheshwari, A., M. Fischer, P. Gambetti, A. Parker, A. Ram, C. Soto, L. Concha-Marambio, Y. Cohen, E.D. Belay, R.A. Maddox and S. Mead (2015). Recent US Case of Variant Creutzfeldt-Jakob Disease—Global Implications. *Emerging Infectious Diseases*, 21(5), pp. 750–759.
- Mandal, J. and C. Parija (2013). Ethics Involving Animal Research. *Tropical Parasitology*, 3(1), pp. 4–6.
- Maslow, A.H. (1966). *The Psychology of Science: A Reconnaissance*. New York: Harper & Row, p. 15.
- McManus, R. (2013). Ex-Director Zerhouni Surveys Value of NIH Research. *NIH Record*, LXV(13). [online] Available at: https://nihrecord.nih.gov/newsletters/2013/06_21_2013/story1.htm [Accessed 13 August 2017].
- Morrow, D. (1999). Fen-Phen Make to Pay Billions in Settlement of Diet-injury Cases. *New York Times*. [online] Available at: <http://www.nytimes.com/1999/10/08/business/fen-phen-maker-to-pay-billions-in-settlement-of-diet-injury-cases.html> [Accessed 13 August 2017].

- Moses, H., D.H. Matheson, S. Cairns-Smith, B.P. George, C. Palisch and E.R. Dorsey (2015). The Anatomy of Medical Research: us and International Comparisons. *Journal of the American Medical Association*, 313(2), pp. 174–189.
- Mullard, A. (2011). Reliability of “New Drug Target” Claims Called into Question. *Nature Reviews Drug Discovery*, 10, pp. 643–644.
- National Anti-Vivisection Society (2018). *The Animal Testing and Experimentation Industry*. [online] Available at: <https://www.navs.org/the-issues/the-animal-testing-and-experimentation-industry/#.W23Egy3Mw6i> [Accessed 10 August 2018].
- National Cattlemen’s Beef Association (2017). *Beef Research*. [online] Available at: <http://www.beefresearch.org/search.aspx?as=no&qaw=&qal=Meat%20Animal%20Research%20Center&qep=&quw=&scp=1&sc=&tm=&startPage=1&sort=Rank&rpp=10&sortDirection=Desc> <http://www.beefresearch.org/> [Accessed 13 August 2017].
- National Toxicology Program (2018). *About ICCVAM*. [online] Available at: <https://ntp.niehs.nih.gov/pubhealth/evalatm/iccvam/index.html> [Accessed 26 July 2018].
- NIH (2019). Budget. Available at: <https://www.nih.gov/about-nih/what-we-do/budget> [Accessed 30 January 2019].
- Orzechowski, K. (2012). *Animal Experimentation: The Industries Behind the Industry*. [online] Available at: <http://www.onegreenplanet.org/lifestyle/animal-experimentation-the-industries-behind-the-industry/> [Accessed 13 August 2017].
- Osherovich, L. (2011). Hedging Against Academic Risk. [online] *SciBX: Science-Business eXchange*, 4(15). [online] Available at: <https://www.nature.com/scibx/journal/v4/n15/pdf/scibx.2011.416.pdf> [Accessed 13 August 2017].
- Perrin, S. (2014). Make Mouse Studies Work. *Nature*, 507, pp. 423–425.
- Petersen, M. (2012). As Beef Cattle Become Behemoths, Who Are Animal Scientists Serving? *The Chronicle Review, The Chronicle of Higher Education*. [online] Available at: <http://www.chronicle.com/article/As-Beef-Cattle-Become/131480/> [Accessed 13 August 2017].
- Petrov, D., C. Mansfield, A. Moussy and O. Hermine (2017). ALS Clinical Trials Review: 20 Years of Failure. Are We Any Closer to Registering a New Treatment?. *Frontiers in Aging Neuroscience*, 9, p. 68. [online] Available at: <https://www.frontiersin.org/articles/10.3389/fnagi.2017.00068/full> [Accessed 16 February 2018].
- Pew Charitable Trusts (2008). *Putting meat on the table: Industrial farm animal production in America*. Washington, DC: PEW Charitable Trust, pp. 11–19. [online] Available at: <http://www.pewtrusts.org/~media/legacy/uploadedfiles/peg/publications/report/pcfifapfinalpdf.pdf> [Accessed 13 August 2017].
- Pew Research Center (2015). Chapter 7: Opinion About the Use of Animals in Research. *American Politics and Science Issues*, pp. 141–144. [online] Available at: <http://www.pewinternet.org/2015/07/01/chapter-7-opinion-about-the-use-of-animals-in-research/> [Accessed 13 August 2017].

- Piller, C. and T. Bronshtein (2018). Faced with public pressure, research institutions step up reporting of clinical trial results. *STAT*. [online] Available at: <https://www.statnews.com/2018/01/09/clinical-trials-reporting-nih/> [Accessed 8 August 2018].
- Pippin, J.J. (2012). Animal Research in Medical Sciences: Seeking a Convergence of Science, Medicine, and Animal Law. *South Texas Law Review*, 54, pp. 469–512.
- Pond, W.G., J.T. Yen, D.A. Hill, C.L. Ferrell and L. Krook (1982). Bone Lesions in Growing Swine Fed 3% Cement Kiln Dust as a Source of Calcium. *Journal of Animal Science*, 54(1), pp. 82–88.
- Pound, P. and R. Blaug (2016). Transparency and Public Involvement in Animal Research. *Alternatives to Laboratory Animals*, 44(2), pp. 167–173.
- Pound, P. and M.B. Bracken (2014). Is Animal Research Sufficiently Evidence Based To Be a Cornerstone of Biomedical Research?. *British Medical Journal*, 348.
- Rampton, S. and J. Stauber (1997). *Mad Cow USA*. Monroe, ME: Common Courage Press, pp. 69–70. [online] Available at: <http://www.srwolf.com/reports/mcusa.pdf> [Accessed 13 August 2017].
- Roep, B.O., M. Atkinson and M. von Herrath (2004). Satisfaction (Not) Guaranteed: Re-evaluating the Use of Animal Models. *Nature Reviews Immunology*, 4(12), pp. 989–997.
- Ross, J.S., T. Tse, D.A. Zarin, H. Xu, L. Zhou and H.M. Krumholz (2012). Publication of NIH funded trials registered in ClinicalTrials.gov: cross sectional analysis. *British Medical Journal*, 344:d7292.
- Santos, F.A.P., J.E.P. Santos, C.B. Theurer and J.T. Huber (1998). Effects of Rumen-undegradable Protein on Dairy Cow Performance: A 12-year Literature Review. *Journal of Dairy Science*, 81(12), pp. 3182–3213.
- Sena, E.S., H.B. van der Worp, P.M. Bath, D.W. Howells and M.R. Macleod (2010). Publication Bias in Reports of Animal Stroke Studies Leads to Major Overstatement of Efficacy. *PLoS Biology*, 8(3), p. e1000344. [online] Available at: <http://journals.plos.org/plosbiology/article?id=10.1371/journal.pbio.1000344> [Accessed 13 August 2017].
- Seok, J., H.S. Warren, A.G. Cuenca, M.N. Mindrinos, H.V. Baker, W. Xu, D.R. Richards, G.P. McDonald-Smith, H. Gao, L. Hennessy and C.C. Finnerty (2013). Genomic Responses in Mouse Models Poorly Mimic Human Inflammatory Diseases. *Proceedings of the National Academy of Sciences*, 110(9), pp. 3507–3512.
- Simmons, S. (2016). *Double the Trouble? Twins Increase Labor, Beef Production*. *Tri State Livestock News*. [online] Available at: <http://www.tsln.com/news/double-the-trouble-twins-increase-labor-beef-production/> [Accessed 13 August 2017].
- Stock, R., N. Merchen, T. Klopfenstein and M. Poos (1981). Feeding Value of Slowly Degraded Proteins. *Journal of Animal Science*, 53(4), pp. 1109–1119.
- Twine, R. (2012). Revealing the “Animal-Industrial Complex”—A Concept and Method for Critical Animal Studies?. *Journal for Critical Animal Studies*, 10(1), pp. 12–39.

- USDA (2017). *Annual Report Animal Usage by Fiscal Year, Fiscal Year 2016*. [online] Available at: https://www.aphis.usda.gov/animal_welfare/downloads/reports/Annual-Report-Animal-Usage-by-FY2016.pdf [Accessed 13 August 2017].
- van der Worp, H.B., D.W. Howells, E.S. Sena, M.J. Porritt, S. Rewell, V. O'Collins and M.R. Macleod (2010). Can Animal Models of Disease Reliably Inform Human Studies?. *PLoS Medicine*, 7(3), p. e1000245. [online] Available at: <http://journals.plos.org/plosmedicine/article?id=10.1371/journal.pmed.1000245> [Accessed 13 August 2017].
- Wheeler, W.E., C.H. Noller and J.L. White (1981). Comparison Between Limestone and Cement Kiln Dusts of Similar Rates of Reactivity Used in High Concentrate Diets for Beef Steers. *Journal of Animal Science*, 52(4), pp. 873–881.
- Zahs, K.R. and K.H. Ashe (2010). “Too Much Good News”—Are Alzheimer Mouse Models Trying to Tell Us How to Prevent, Not Cure, Alzheimer's Disease?. *Trends in Neurosciences*, 33(8), pp. 381–389.

PART 4

*The Ethics and Philosophy of Animal
Experimentation*



Ethics, Efficacy, and Decision-making in Animal Research

Lawrence A. Hansen

Professor of Pathology, University of California, San Diego, United States

Kori Ann Kosberg

University of California, San Diego, United States

kosberg@me.com

1 Introduction

The true rule in determining to embrace or reject anything is not whether it has any good in it, but whether it has more of evil than of good. Few things are wholly evil or wholly good. Almost everything is a composite of the two, so that our best judgement of the predominance between them is continually demanded.

ABRAHAM LINCOLN, June 20, 1848, in a speech to the United States (US) House of Representatives on Internal Improvements, suggesting an approach to decision making in ethically complex situations

Few would disagree with the ethical contention that if cruelty to animals is not wrong, then nothing is wrong. In fact, it is not only wrong, but in most states in the US, it is a crime, a felony no less. And yet, intentionally inflicting pain and suffering upon animals, which meets Webster's definition of cruelty, is routinely countenanced when vivisection (from the Latin *vivi*, to be alive, and *secare*, to cut) is performed under license for biomedical research. Deciding to embrace, or reject, or limit animal research demands our best ethical judgment; and it is complicated by factual disputes over the extent to which it benefits human health. Three issues combining facts and ethics need to be considered. First, to what extent does animal research deliver on its promise to improve human health? Second, if the goal of public investment (e.g., tax dollars spent by the National Institute of Health, NIH) on animal research is to improve human health, are we getting sufficient return for the billions spent,

or might the money be better directed towards human-based research or implementing healthcare interventions of proven efficacy? Third, since opinions about *ends justifying means* will vary, who should decide if animal research is ethically justified: the scientists who perform it or representatives of the public at large, who pay for it?

In the US, the biomedical academic research establishment, as currently constituted, empowers animal researchers to determine what animal experimentation is allowed. But this represents an obvious conflict of interest, since the researchers' livelihoods depend on continuing animal use, and their attitudes about the ethical justifications for vivisection are *a priori* set in stone, as evidenced by their career choices. Shifting the ethical paradigm about animal experimentation will require transferring decision-making authority about animal use in science from the animal researchers who carrying out experiments to the public who finances them and who may be less inclined to approve any and all use of animals in experimentation.

2 To What Extent Does Animal Research Improve Human Health?

It is axiomatic, even reflexive, for proponents of animal research to contend that *virtually every medical achievement of the last century has depended directly or indirectly on research with animals*. But it may be wise to consider the source of such a sweeping proclamation. The quotation traces back to a 1994 article in *The Physiologist*, a journal heavily invested in publishing animal research, entitled "The importance of animals in biomedical and behavioral research" where it appears as a bold assertion unaccompanied by any substantiating evidence (Matthews, 2008, p. 95). Does this claim bear up under empirical scrutiny in the modern era of evidence-based medicine?

A recently published summary of systematic reviews investigating the relevance of animal based research to human medicine (Pound and Bracken, 2014) provides a comprehensive consideration of the topic. The authors conclude that animal research is plagued by poor quality, typically fails to address internal and external validity, lacks randomization and blinding, engages in selective analysis and outcome reporting, and suffers from publication bias, all resulting in overstatements about the validity of entire bodies of research. An even more exhaustively referenced review article on the use of animals in medical science research cites multiple studies documenting the failure of animal models to translate into human benefit in HIV/AIDS, stroke, cancer, spinal cord injury, traumatic brain injury, cardiovascular disease, diabetes, and menopausal hormonal therapy (Pippin, 2013). A prescient earlier analysis by Crowley in 2003 (Sung et al., 2003) had already established that out of 25,000 basic

research articles published in the top 6-ranked journals for basic research, only one was associated with a clinically useful new drug in 30 years of publication. The dismal track record of animal research leading to improved human health has been succinctly summarized in yet another study (Tsilidis et al., 2013) reviewing data from the *Collaborative Approach to Meta-Analysis and Review of Animal Data from Experimental Studies*, which concludes that bias in animal studies makes it nearly impossible to rely on most animal data to predict whether or not an intervention will have a favorable clinical benefit-risk ratio in human subjects.

Poor study design contaminated by bias doubtlessly contributes to the irrelevance of most animal research to medical progress. But a deeper, fatal flaw in the entire animal research paradigm may be its assumption that evolutionary continuity between humans and other animals allows valid cross-species extrapolation, essentially a presupposition that what we learn to be true in one species will be true in another (Ioannidis, 2012). Evolutionary continuity can account for the success of animal model extrapolations early in the history of physiology, as when William Harvey, a seminal figure in the development of medicine and physiology, correctly deduced the closed-circuit nature of human blood flow after observing it in non-human animals. But that was in 1628; in the modern era of personalized medicine, when patients' tumors are characterized with chromosomal scanning and cancer gene panels to identify specific mutations directing individualized chemotherapy, the notion that mice represent furry pocket-sized models of humans seems scientifically quaint. Non-human animals are not simplified versions of humans, as the word *model* implies, but are rather evolved systems, differently complex in their own right. Small differences in initial conditions of a complex system, such as diverging regulation and expression of genes, modifier genes, or post-translational protein processing can result in two superficially similar systems (human and non-human animals), exhibiting vastly different responses to the same experimental manipulations (Greek and Shanks, 2009).

If forced to concede by meta-analyses that most animal experimentation bears no clinical fruit, animal researchers defend it by arguing that its critics are insufficiently appreciative of the contributions made by vivisection to our cumulative fund of biomedical knowledge (Carbone, 2012), not only as a curiosity-driven, fact-finding quest for knowledge, but as it applies to the understanding and progression of human disease. This argument justifies animal research as basic rather than applied science. How can opponents of animal research ever know that in the fullness of time an insight into basic biology derived from an animal experiment of no relevance to human health, at the time it was performed, might not, someday, be important to improving health? This rhetorical contention is nebulous enough to be impossible to refute, since

no one knows the future. Any and all research is justified by this argument, and it implies that no ethical balancing of pain and suffering cost to experimental animals against the expectation of human health gain should even be attempted. Basic research that uses animals will continue to find new facts about basic biology, as it has in the past. But to conflate finding new facts with advances in human health as ethical justification for animal research is a disingenuous bait and switch.

3 What Is the Cost to Benefit Ratio of Spending on Animal Research to Improve Health?

Dawning awareness of the failure of most animal based research to benefit human health is reflected in commentary from the current and a former head of the NIH, the agency in charge of funding biomedical research in the US, with a US\$39 billion budget in 2019 (NIH, 2019). Francis Collins, the present head of the NIH, wrote, “The use of animal models for therapeutic development and target validation is time consuming, costly, and may not accurately predict efficacy in humans. As a result, many clinical compounds are carried forward only to fail in phase II or phase III clinical trials: many others are probably abandoned because of the shortcomings of the [animal] model” (Collins, 2011, p. 3). Concerning the same failure of animal models, a former NIH director, Elias Zerhouni, commented more memorably, “We have moved away from studying human disease in humans. We all drank the Kool-Aid on that one [transgenic mouse models], me included [...] The problem is that it hasn’t worked, and it’s time we stopped dancing around the problem [...] We need to refocus and adapt new methodologies for use in humans to understand disease biology in humans” (McManus, 2013).

Among such innovative new methodologies for studying human diseases in humans are organotypic cultures that combine cellular constituents to replicate entire tissues and tumor environments, allowing cellular, subcellular, and molecular biological experiments historically performed on animals to instead be conducted on the species of interest — humans. Bacterial production of insulin has replaced its traditional extraction from bovine or swine pancreas, and chromatography is used to determine drug purity and dosage rather than animal usage (Doke and Dhawale, 2015). Human stem cells are another modern research modality being utilized to study human diseases and develop drugs to combat them. Experimental techniques converging on the goal of personalized medicine include pharmacogenomics and genetic (gene chip) microarrays. These wet bench innovations are complimented by advanced non-invasive imaging methods, such as positron emission tomography,

accelerator mass spectroscopy, and magnetic resonance imaging. These and many other human-species relevant research methods may be far more likely than discredited animal models to advance health.

Proponents of animal research often invoke the ultimate goal of reducing human disease morbidity and mortality as justification for the pain and suffering inherent in animal experimentation. In truth, however, if that is the goal, then from a global health perspective, we would be getting a much better return on healthcare investment by sparing the animals and spending the money on soap and hand-washing. Every year, respiratory infections and diarrhea kill more than 3.5 million children under the age of 5, and that death toll could be cut in half simply with soap and hand-washing. One study found 50% less pneumonia and 53% fewer cases of diarrhea in families given soap and encouraged to wash their hands (Luby et al., 2005). A meta-analysis of similar studies of diarrhea alone concluded that hand washing reduced its incidence by 42%–47%, and that promoting hand washing could save a million lives a year (Curtis and Carincross, 2003). No one expects the US research establishment to redirect any of its funding toward hand washing in the cause of global healthcare or health justice, since the lives to be saved are outside the US. Nevertheless, ethical justification for animal research, as a means for improving human health, should be viewed with some skepticism when far more directly effective, less expensive, and ethically unproblematic means for saving millions of children's lives are immediately at hand but underutilized because of spending priorities.

4 When Is Animal Research Stewardship and When Is It Despotism?

Stewardship is the careful and responsible management of something entrusted to one's care. The concept has Judeo-Christian roots but has acquired a secular meaning in an environmental context, embraced by many with no religious faith at all. Originally, stewardship was an obligation imposed upon humankind by God, when granting humanity dominion over the rest of creation. As is often the case with the exercise of power, this dominion of humans over animals has not worked to the animals' advantage. For millennia, the prevailing human ethos has been instrumentalism, the belief that animals exist for us, to serve our interests and wants. This attitude stems from moral anthropocentrism, the conviction that humans, set above animals by divine edict, should always have absolute priority in our moral reasoning about animal use. While this Judeo-Christian tradition has been hard on animals, at least in theory, obligations of stewardship accompanying dominion should temper our treatment of animals even as we use them for our own ends.

The concept of stewardship persists in altered form, as society has become progressively less religious and more secular, challenging traditional assumptions about humanity's divinely ordained special status in creation. The fact of human dominion remains, even if attributed to evolutionary happenstance, and is recognized in an atheist scientific worldview, now often expressed by the term *homocene* or *anthropocene* to describe a human dominated natural world (Schwagerl and Crutzen, 2014). A secularized version of stewardship endures too, transformed into an ethical environmentalism in which our obligation is to preserve the ecological habitability of the planet we inherited for future generations to enjoy. One ramification of ecological rather than religious stewardship is the recognition that humans are part of rather than over and above the rest of nature. As Darwin initially observed, and subsequent evolutionary biology has confirmed, human and non-human animals are fundamentally more alike than dissimilar (Darwin, 1859). Beyond shared biology, behavioral research shows that many animals exhibit traits once presumed to be uniquely human, including sympathy, empathy, cooperation, a sense of fairness and justice, and a very humanlike capacity for future oriented cognition (Roberts, 2012). The privileged moral status humans continue to assign ourselves is ethically arbitrary and self-serving, more an example of humans as rationalizing than rational creatures, enlisting our intellectual nimbleness in the service of our desires.

Animal researchers should consider themselves doubly obligated by a contemporary secular sense of stewardship. First, society pays for what they do; and the poor translation of most animal research into human health benefits, which is what the public thinks that it is buying, is a failure of financial stewardship. Second, stewardship in a secular scientific age requires a rebalancing of the ethical scales we use in determining what kind of animal use is justifiable. Science informs us that animals are sentient beings like ourselves, capable of pleasure and pain (Griffin and Speck, 2004). They are not just property or tools; they have their own interior life deserving of respect. If a more highly sophisticated capacity for ethical reasoning and morality is what sets humans apart from other animals, then ethical reasoning and morality must always guide us in how we treat them. Cruel basic science, rather than medically relevant experiments performed on empathy-inspiring species, may seem to be the easy case to make against animal research as poor ethical stewardship. Nevertheless, decades of protests, focused on such seemingly easy cases to make, have not, for example, stopped neurophysiological visual tracking research on Rhesus macaques in which they undergo coil implants in both eyes, holes drilled into their skulls for recording electrode placements, and head immobilization surgeries in which screws, plates, and bolts are implanted in their heads.

Following these procedures, the monkeys are dehydrated to provide, what the researchers call, a “work ethic”, so that they will visually track a moving object for a sip of water reward, while tied into a restraining chair with their heads bolted into an immobilizing frame. First impressions are accurate in recognizing animal cruelty, and most of us cannot even bear to look at pictures of these monkeys with bolted heads and electrode-implanted brains being put through their paces in a desperate attempt to get a life sustaining sip of water; but despite ethical revulsion to an easy case of animal cruelty, this research has continued for decades (Ramachandran and Lisberger, 2005); and cats, another favored species, are being treated similarly (Yartsev, 2009), as well as mice (Guo et al., 2014). Making animals suffer this intensely, in pursuit of a basic science research agenda, merely because we can, because we have the power of total control over them, is more despotism than stewardship. “Might makes right” is not an ethical argument.

5 Who Decides if Ends Justify Means in the Ethics of Animal Research?

Animal researchers occupy one end of an ethical opinion spectrum. They have concluded that the hypothetical expanding of scientific knowledge justifies the means they employ, and that the suffering inflicted on experimental animals is acceptable in the pursuit of a greater good. At the opposite pole are animal rights activists, who believe that cruelty to animals is wrong, period, and that no scientific ends can justify means that entail animal pain and suffering. Public opinion polling informs us that most people occupy an ethical middle ground, with approval of animal research contingent upon animals not suffering too much, and only in the service of research likely to benefit human health. 51% of Americans believe medical testing on animals is morally acceptable (Jones, 2017); and 65% of the United Kingdom public supports medical testing in the absence of an alternative model (Clemence and Leaman, 2016). People also express different attitudes towards animal use, depending on the species involved, and are less supportive of research using dogs, cats, and non-human primates than of research with mice, rats, and fish (Ormandy and Schuppli, 2014). 48% of people in the UK believe it is acceptable to use rats in medical research to benefit people, while only 16% approve of using dogs (Clemence and Leaman, 2016). So, how are these ethical differences arbitrated in academic research centers at present? And who gets to decide, in specific instances of proposed animal use, if the end justifies the means?

In the US, federal laws and regulations that govern animal use in research stem from public outrage over cruelty to animals destined for research laboratories exposed in a *LIFE* magazine article in 1966, which prompted the US Congress to pass the Laboratory Animal Welfare Act. Subsequently renamed the Animal Welfare Act (AWA), and repeatedly amended in the decades since, it is administered by the Department of Agriculture (USDA). A 1985 AWA amendment and the *Health Research Extension Act*, also passed in 1985 and administered under Public Health Service (PHS) Policy on Humane Care and Use of Laboratory Animals rules, both mandated the establishment of Institutional Animal Care and Use Committees (IACUCs) at all facilities performing biomedical research on animals (Levin and Reppy, 2015). Minimum IACUC membership requirements, initially set forth in the AWA, balanced public bioethical concerns and scientific expertise, stipulating a three-member committee to include a laboratory animal veterinarian, a committee chair, and one member who is not affiliated in any way with the institution and is not an animal user, who would represent general community interests in the treatment of animals. The minimum PHS IACUC requirements were similarly balanced, stipulating a minimum of five persons, including an institutional laboratory veterinarian, an animal researcher, a member unaffiliated with the institution, and a member whose primary concern was not in the scientific arena (e.g., an ethicist, lawyer, or clergy member) (Hansen, 2013).

The founding directives for IACUC memberships would have created IACUCs that reflected public concern for laboratory animal welfare and performed ethical cost-benefit analyses of proposed animal research, with approval contingent upon a balancing of animal pain and suffering against a reasonable expectation of resultant human benefit. However, institutions heavily incentivized by grant funding attached to animal research realized that the USDA and PHS dictates for IACUC membership were only minimum requirements which did not limit the numbers of additional animal researchers who could be appointed to the committees, tipping their balance to ensure approval of all animal research protocols. They also recognized that, unlike the European Union Directive instituted to address the same bioethical issues in animal research (Directive 2010/63/EU, European Parliament, 2010), neither of the two US regulatory requirements set for IACUCs specifically mandated an ethical review of animal research protocols prior to their authorization (Levin and Reppy, 2015).

Consequently, expanded IACUCs now averaging 23 members rather than three or five, are heavily skewed towards animal researchers (67%) and institutional veterinarians whose livelihoods depend on animal research (15%), and 93% of IACUC chairs are animal researchers (Hansen, 2013). Predictably,

IACUCs in which 82% of members and 93% of chairs have vested interests in continuing animal research approve essentially all proposed animal experiments set before them. 98% of proposed animal experiments are approved according to the most comprehensive analysis available (Plous and Herzog, 2001), without considering an ethical balancing of animal harm against human health gain. An expert on how IACUCs function, and a longtime defender of the system, writes plainly, “Few people realize that virtually nothing is prohibited by the Animal Welfare Act, so long as it can be justified to the IACUC. Nor do IACUCs, by and large, function by rejecting animal protocols when the ethical costs are too high [...] [R]ejection of protocols is not what IACUCs do [...] [E]ven painful animal experiment may be allowed [...] any research protocol may be approved [...] regardless of any weighing of the potential benefits” (Carbone, 2004).

This institutionalized blanket endorsement of all animal use disregards the public’s attitude of contingent approval of animal research, heavily qualified by concerns over limiting suffering, promises of resultant disease treatments, and avoidance of experimentation on favored species, i.e. dogs, cats, and primates (Henry and Roarke, 2009; Swami, Furnah, and Christopher, 2008). An example IACUC ruling from the University of California, San Diego (UCSD), in 2001, illustrates how disconnected the system is from public bioethics. Hundreds of San Diego physicians signed an anti-dog lab petition, urging the Medical School to end dog vivisection and euthanasia teaching exercises in a freshman pharmacology course. These physicians knew from professional experience that killing dogs was unnecessary in becoming a doctor and so filed an appeal to the UCSD IACUC, pointing to PHS guidelines requiring a good-faith effort to replace animal labs in education and research, once alternatives became available. The signatories to the anti-dog lab petition reasoned that since 95% of schools taught the course without killing dogs (Hansen and Boss, 2002), it must be unnecessary for UCSD to do so. The official response of the UCSD IACUC was that vivisection and euthanasia of dozens of dogs in those labs raised *no animal welfare issues*. This seemed like Orwellian newspeak to the doctors, and public protests followed. Finally, after sufficient adverse publicity, the UCSD Faculty Council and School of Medicine Department Chairs ended the unnecessary dog vivisections, accomplishing what the IACUC should have done years before; that is, “respect society’s concerns regarding the welfare of animal subjects” (Hansen, 2013, p. 188), as was stipulated in the AWA amendment of 1985, creating the IACUC system.

So, the answer to the question, *who decides if ends justify means in the ethics of animal research?* is—animal researchers. But the word *decide* is misleading in this context, if it is taken to imply the result of a deliberative process that

could have more than one outcome, as when a jury decides to acquit or convict a defendant. The animal researcher dominated IACUCs have determined *a priori* that experimental animals are of so little ethical worth compared to the value they place on hypothetically increasing scientific knowledge that the ends always justify the means. Decisions from committees of wolves arbitrating the fate of sheep would be less predictable.

6 How Could Research Ethics Be Better Aligned with Public Concern for Animal Welfare?

The IACUC system fails to address ethical issues in animal research which are of concern to the public, because it is dominated by those whose livelihoods, careers, and professional identities are dependent upon the unfettered continuation of animal experimentation. It is asking too much of human nature to expect that committees of animal researchers could set aside their conflicts of interest, inclination to groupthink, and conscious and unconscious biases to look at the ethics of animal use in research as does society at large. Ethical constraints on how animals are treated in research have always been externally imposed on an, oftentimes, resistant biomedical establishment. The latter's ingenuity in evading such constraints is seen not only in its stacking of the IACUC membership deck with animal researchers, but also by its successful lobbying effort to amend the AWA in 2002, so as to exclude from its protections mice and rats who comprise 99% of the animals used in research laboratories (Farm Security and Rural Investment Act, 2002). Even the few favored species of greatest ethical concern to the public, i.e. primates, dogs, and cats, supposedly covered by the nominal protections of the AWA, are routinely subject to medically irrelevant basic science experimentation, which most people would consider cruelty, if it were performed on themselves or their pet dogs or cats.

Two possible solutions to the disconnect between society's nuanced and qualified attitude towards animal research and the IACUC's philosophy of "anything goes" are worth considering, both of which would work towards achieving the paradigm shift in ending animal experimentation. First, the AWA could be amended to restore its initially intended balance between researchers and members representing societal interest in animal welfare. A second more definitive approach would be a legal ban on research using primates, dogs, and cats, leaving researchers with 99% of the animals they are using currently, and respecting the public's ethical qualms about the suffering of their favored species. One precedent for how protecting favored species may succeed is the

constraint recently imposed on chimpanzee research by the NIH, in response to a report from the *Institute of Medicine Committee on the Necessity of the Use of Chimpanzees in Biomedical and Behavioral Research* (Kahn, 2014). If one species of non-human animals can be set off limits to vivisection, solely because of ethical concerns, it raises hopes that others may follow, which is why the constraints were so strongly opposed by animal researchers not using chimpanzees, fearing this precedent may be the thin edge of an ethical wedge. As for legally banning companion animal research, the fact that in 2014 Americans spent over US\$50 billion on their dogs and cats may indicate that there is a deep, yet untapped, reservoir of potential political support for such legislation.

7 Summary and Conclusions

Paradigm shifts in science occur when new theories make more accurate and reproducible predictions than old ones about empirically observed natural phenomena or experimental results. When the term paradigm shift is applied to the ethics of animal experimentation, the concept becomes less scientifically literal, and understanding how ethically seismic paradigm shifts occur in human history is challenging. Once they have occurred, however slow their incubation, they are codified into laws reflecting an altered ethical consensus. Slavery was once legal, now it is not; women now have equality under the law with men, but through most of human history they did not. Changing the ethical paradigm about animal experimentation requires both a scientific analysis of its lack of efficacy in improving human health, and an ethical appeal to broaden our sphere of compassion for our fellow sentient. If successful, such a paradigm change will ultimately outlaw any animal experimentation that causes pain and suffering.

From a purely scientific perspective, multiple meta-analyses indicate that animal based research only rarely translates into improved human health. This failure of to benefit human health can result from poor study design as well as intrinsic evolutionary differences, precluding the extrapolation of results from one species to another; but regardless of its cause, this failure undercuts a major ethical justification for inflicting harm on animals in biomedical research. NIH directors past and present recognize the low yield of animal research in benefitting human health and recommend shifting funding priorities towards new methodologies for use in humans to understand disease biology in humans (McManus, 2013). From a global healthcare perspective, and considering the ethics of healthcare justice, money spent on basic science animal research, if diverted to implementing healthcare interventions of proven efficacy, could save many

millions more human lives. Legal constraints were imposed on animal research by US Congress in response to public outrage over exposés of animal abuse, resulting in the Laboratory Animal Welfare Act in 1966 and the mandated creation of IACUCs in 1985 to address public concerns about laboratory animal welfare. However, IACUCs, as currently constituted, are dominated by animal researchers who have determined, *a priori*, to approve any and all use of animals in biomedical research, without regard to public ethical concerns about limiting animal suffering, which species are used, and relevance to human health.

Because animal researchers now control the use of animals in experimentation, any paradigm change will require wresting authority away from them and investing it in a broader range of ethical stakeholders, specifically the public and its elected representatives who are more inclined than career vivisectionists to weigh the ethical cost to human benefit of animal experimentation. The ban on chimpanzee vivisection, despite the opposition of animal experimenters, may represent a template for moral progress toward the hoped-for paradigm shift. If public empathy for our fellow primates can overcome the resistance of the biomedical academic establishment to banning chimpanzee research, it is cause for optimism that a similar approach to other favored species, such as dogs and cats, may generate an ethical momentum, like falling dominoes, towards finally expanding the circle of human compassion to encompass all creatures capable of pain and suffering.

References

- Carbone, L. (2004). *What Animals Want: Expertise and Advocacy in Laboratory Animal Welfare Policy*. New York: Oxford University Press, pp. 186–188.
- Carbone, L. (2012). The Utility of Basic Animal Research. *The Hastings Center – Bioethics and Public Policy. Supplement*, pp. S12–15.
- Clemence, M. and J. Leaman (2016). *Public Attitudes to Animal Research in 2016*. A report by Ipsos MORI for the Department for Business, Energy & Industrial Strategy, Ipsos MORI Social Research Institute. [online] Available at: <https://www.ipsos.com/sites/default/files/publication/1970-01/sri-public-attitudes-to-animal-research-2016.pdf> [Accessed 10 February 2018].
- Collins, F. (2011). Reengineering Translational Science: The Time Is Right. *Science Translational Medicine*, 3, pp. 1–6.
- Curtis, V. and S. Carincross (2003). Effect of washing hands with soap on diarrhoea risk in the community: a systematic review. *The Lancet Infectious Diseases*, 3, pp. 275–281.

- Darwin, C. (1859). *On the origin of species*. Create Space Independent Publishing Platform.
- Doke, S. and S. Dhawale (2015). Alternatives to Animals Testing: A Review. *Saudi Pharmaceutical Journal*, 23, pp. 223–229.
- European Parliament (2010). Directive 2010/63/EU of the European Parliament and of the Council of 22 September 2010 on the protection of animals used for scientific purposes. *Official Journal of the European Communities*, L276, p. 33–79. [online] Available at: <http://eur-lex.europa.eu/legal-content/EN/TXT/?uri=CELEX:32010L0063> [Accessed 10 February 2018].
- Farm Security and Rural Investment Act* 2002. Public Law, 107–171 § 10301, 116 Stat. 491.
- Greek, J. and N. Shanks (2009). Thoughts on Animal Models for Human Disease and Treatment. *Journal of the American Veterinary Medical Association*, 15, pp. 363–364.
- Griffin, D.R. and G.B. Speck (2004). New Evidence of Animal Consciousness. *Animal Cognition*, 7, pp. 5–18.
- Guo, Z., S. Hires, L. Nuo, D. O'Connor, T. Komiyama, E. Ophir, D. Huber, C. Bonardi, K. Morandell, D. Gutnisky, S. Peron, N. Xu, J. Cox and K. Svoboda (2014). Procedures for Behavior Experiments in Head-Fixed Mice. *PLOS One*, 9, p. e101397. [online] Available at: <http://journals.plos.org/plosone/article?id=10.1371/journal.pone.0088678> [Accessed 10 February 2018].
- Hansen, L.A. (2013). Institutional Animal Care and use Committees Need Greater Ethical Diversity. *Journal of Medical Ethics*, 39, pp. 188–190.
- Hansen, L.A. and G.R. Boss (2002). Use of Live Animals in the Curricula of US Medical Schools: Survey Results from 2001. *Academic Medicine*, 77, pp. 1147–1149.
- Henry, B. and P. Roarke (2009). Individual Difference and Study-specific Characteristics Influencing Attitudes about the Use of Animals in Medical Research. *Society and Animals*, 17, pp. 305–324.
- Ioannidis, J. (2012). Extrapolating from Animals to Humans. *Science Translational Medicine*, 4, pp. 151ps15.
- Jones, J. (2017). Americans hold record liberal views on most moral issues. *Social and Policy Issues*. [online] Available at: <http://news.gallup.com/poll/210542/americans-hold-record-liberal-views-moral-issues.aspx> [Accessed 10 February 2018].
- Kahn, J. (2014). Lessons Learned: Challenges in Applying Current Constraints on Research on Chimpanzees to Other Animals. *Theoretical Biology and Medical Modelling*, 35, pp. 97–104.
- Levin, L.H. and W.A. Reppy (2015). Reforming the Politics of Animal Research. *Journal of Medical Ethics*, 0, pp. 1–4.
- Luby, S.P., M. Agboatwalla, D.R. Feikin, J. Painter, W. Billhimer, A. Altamirano and R.M. Hoekstra (2005). Effect of Handwashing on Child Health: A Randomized Controlled Trial. *The Lancet*, 366, pp. 225–233.

- Matthews, R.A. (2008). Medical progress depends on animal models – doesn't It? *Journal of the Royal Society of Medicine*, 101, pp. 95–98.
- McManus, R. (2013). Ex-Director Zerhouni Surveys Value of NIH Research. *NIH Record*, LXV(13). [online] Available at: https://nihrecord.nih.gov/newsletters/2013/06_21_2013/story1.htm [Accessed 30 January 2019].
- NIH (2019). Budget. Research for the People. [online] Available at: <https://www.nih.gov/about-nih/what-we-do/budget> [Accessed on 30 January 2019].
- Ormandy, E. and C. Schuppli (2014). Public Attitudes Toward Animal Research: A Review. *Animals*, 4, pp. 391–408.
- Pippin, J.J. (2013). Animal Research in Medical Sciences: Seeking a Convergence of Science, Medicine, and Animal Law. *South Texas Law Review*, 54, pp. 469–511.
- Plous, S. and H. Herzog (2001). Animal Research: Reliability of Protocol Reviews for Animal Research. *Science*, 293, pp. 608–609.
- Pound, P. and M.B. Bracken (2014). Is Animal Research Sufficiently Evidence Based to Be a Cornerstone of Biomedical Research? *British Medical Journal*, 30, p. g3387.
- Ramachandran, R. and S. Lisberger (2005). Normal Performance and Expression of Learning in the Vestibulo-Ocular Reflex (VOR) at High Frequencies. *Journal of Neurophysiology*, 4, pp. 2028–2038.
- Roberts, W.A. (2012). Evidence for future-cognition in animals. *Learning and Motivation*, 43(4), pp. 169–180.
- Schwagerl, C. and P. Crutzen (2014). *The Anthropocene: The Human Era and How It Shapes Our Planet*. Santa Fe: Synergetic Press.
- Sung, N.S., W.F. Crowley Jr., M. Genel, P. Salber, L. Sandy, L.M. Sherwood, S.B. Johnson, H. Tilson; K. Getz, E.L. Larson, D. Scheinberg, E.A. Reece, H. Slavkin, A. Dobs, J. Grebb, R.A. Martinez, A. Korn and D. Rimoin (2003). Central Challenges Facing the National Clinical Research Enterprise. *Journal of the American Medical Association*, 289, pp. 1278–1287.
- Swami, V., A. Furnham and A.N. Christopher (2008). Free the animals? Investigating attitudes toward animal testing in Britain and the United States. *Scandinavian Journal of Psychology*, 49, pp. 269–276.
- Tsilidis, K.K., O.A. Panagiotou, E.S. Sena, E. Aretouli, E. Evangelou, D.W. Howells, S.R. Al-Shahi, M.R. Macleod and J.P. Ioannidis (2013). Evaluation of excess significance bias in animal studies of neurological diseases. *PLoS Biology*, 11, p. e1001609.
- Yartsev, M., R. Givon-Mayo, M. Maller and O. Donchin (2009). Pausing Purkinje Cells in the Cerebellum of the Awake Cat. *Frontiers in Systems Neuroscience*, 3(2), pp. 1–9.

Beyond Plausibility Checks: A Case for Moral Doubt in Review Processes of Animal Experimentation

Mara-Daria Cojocaru

Lecturer in Practical Philosophy, Munich School of Philosophy,
Munich, Germany
mara-daria.cojocaru@hfpf.de

Philipp von Gall

Lecturer at the Institute of Social Sciences in Agriculture, University of
Hohenheim, Stuttgart, Germany
philipp_gall@uni-hohenheim.de

1 Introduction: “Don’t Be Emotional, Let’s Focus on the Facts”

The fact that countries all over the world continue to develop new regulations for experimentation on non-human animals testament that this practice raises many doubts. Our aim in this chapter is to show that one important type of doubt should receive more attention: a particular type of *moral doubt* that could play a pivotal role in the ethical review of animal experiments. We assume that there are a range of emotions that indicate morally complex or problematic situations. When one or all of these emotions are experienced, we say that someone is experiencing moral doubt. To illustrate this point, we introduce the concept of *moral doubt* in the context of review processes, as they are legally required in the European Union (EU). Independent evaluation committees review animal research proposals to advise competent authorities whether applications for animal experiments comply with the legal standards. We chose the case of Germany as an example to explain what these committees decide upon and the degree to which their decisions may be influenced by emotions. We develop the argument that acknowledging emotional moral doubt throughout the review process, in specific ways, may have the positive effect of fostering paradigm change in animal experimentation, as envisioned in Directive 2010/63/EU (European Parliament, 2010).

2 Review Processes between Technical Checks and Ethical Advice: Lessons Learned from the German Practice

European animal welfare and protection laws regulate ethical conflict surrounding animal experimentation in the following way: They require that experiments be authorized based on a harm-benefit analysis and that the principles of the 3Rs (replacement, reduction, and refinement) be implemented, as outlined in Directive 2010/63/EU (European Parliament, 2010, Recital 11 and Article 4). Moreover, “animals should always be treated as sentient creatures and their use in procedures should be restricted to areas which may ultimately benefit human or animal health, or the environment” (European Parliament, 2010, Article 12). This is the *extant* ethical consensus, which is reflected in national legislations. We argue that review processes have two functions: a technical function to ensure that this consensus is implemented (*technical function*); and a normative function to identify new reasons for ethical concern (*ethical function*).

2.1 *Evaluation Committees as Legal Advisors in European Animal Law*

Under European Union legal harmonization, EU Member States have introduced review processes (RPs) to evaluate whether applications comply with legal standards. Since information on the many different RPs is scarce, we must rely on Silva et al. (2015), who collected and confirmed data from 20 Member States. However, all Member States have implemented some form of RP. In cases where information is available, Member States require that the opinion of an external evaluation committee must be taken into account by the competent authorities (Silva et al., 2015). The required expertise in such committees varies: most EU Member States require knowledge in technical, medical, or natural sciences as well as veterinary health and welfare. Some Member States require legal expertise (e.g., Finland, Poland, Denmark); others require expertise in ethics (e.g., Belgium, Estonia, Netherlands) or alternatives to animal experimentation (e.g., Latvia, Netherlands). In some states, representatives of interest groups are nominated, such as animal protection (e.g., Poland, Croatia, Sweden); patients (e.g., Denmark and Poland); or general society, as represented by lay persons (e.g., Portugal and the United Kingdom) (see Silva et al., 2015).

Despite the differences in expertise, any RP fulfills two functions. First, to evaluate what applicants describe as the scientific purpose of their experiments, with regards to their plausibility. Part of this plausibility check is an evaluation of whether common means to reduce suffering (refinement) are in place; and whether the smallest necessary number of non-human animals is used (reduction). We call this the *technical function*. However, it is widely

acknowledged that the implementation of Directive 2010/63/EU expects RPs to do more, namely to provide an ethical evaluation independent from the applicant (Hirt, Maisack and Moritz, 2016; Maisack, 2016; Peters and Stucki, 2014). This includes weighing alternatives, including animal-free alternatives (replacement). Indeed, if technical or science-based checks were the only function, there would be no need to include representatives of interest groups or ethical expertise in the committees. Hence, the second *ethical function* of independent committees is to advise the respective authority on a compelling harm-benefit analysis, including the “indispensability” of a planned experiment. We return to this point below because, given the way committees actually work and applicants approach them, the issue is more complex. In theory, at least in cases of severe harm to non-human animals, authorities have to be “satisfied” with the “sufficient importance” of an experiment in order to allow it, as specified in the European Treaty Series (ETS 123) (1986, Article 9).

In cases of substantial conflict of interest, pluralist democracies enable representatives of interest groups to negotiate in parliament in order to achieve compromises that benefit the common good (Fraenkel, 2011). The outcome of such discussions usually leads to a normative decision, in the form of a law, to be enforced by executive forces (e.g., competent authorities). The institutional approach implicit in Article 9 of the ETS (1986) is different because enforcement and normative decisions go hand in hand. Competent authorities in EU countries have to weigh the interests of non-human animals and researchers on a case-by-case basis and, by doing so, implement the law, while allowing for different interpretations. Hence, the weighing process is transferred from the legislative to the executive power. Since this can be problematic, external evaluation committees were introduced to include the contributions of experts and representatives of interest groups, as mentioned above (Silva et al. 2015). For example, in Germany and the United Kingdom, RPs were introduced in 1986 (Biedermann, 2009).

The ethical RP is important when it comes to research competition within the EU. Member states have “a certain flexibility to maintain national rules aimed at more extensive protection of animals” if the functioning of the internal market is not affected (see European Parliament, 2010, Directive 2010/63/EU, Article 7). Presumably, an economized medical and pharmaceutical sector will allocate its research where regulation is low and animal protection measures are least costly. Consequently, if a country uses the right to impose more extensive animal protection measures than those agreed upon at EU level, applicant institutions (e.g. international pharmaceutical companies) may look for other countries where regulations are less extensive. This is why the work of RPs is an important instrument in working towards a paradigm

change in animal experimentation, as requested by EU law; and this is why a harmonization of RPs, as a means to secure implementation of EU regulations, may be desirable as well. In what follows, we discuss some of the shortcomings of the German RP in order to draw conclusions for improving RPs in general.

2.2 *The German “Ethics Committees”: Ethical Review or Technical Plausibility Checks?*

According to most recent reports, over 2.8 million non-human vertebrates were used for scientific purposes in 2017 (Bundesministerium für Landwirtschaft und Ernährung, 2018) which makes Germany Europe’s second highest user of non-human animals for research purposes (Cruelty Free International, 2016). We now turn to the situation of the RP in this country to see how the ethical and technical functions are implemented and to understand some of its complicating factors. The German animal protection law, Tierschutzgesetz (TierSchG 2006, last amended in 2017), requires that competent authorities assess the indispensability of experiments (Section 7a); and that they be assisted by external *committees* (TierSchG 2006, Section 15) in reviewing the animal research proposals. These are the German RPs. The declared intent was that these committees would support authorities with *expert knowledge*, and that animal protection organizations would be given the opportunity to propose members (Deutscher Bundestag Drucksache 10/3158, 1985). The majority of the members have to possess expertise in medicine, veterinary medicine, or natural sciences (Tierschutz-Versuchstierverordnung, TierSchVersV 2013, Section 42(1)). These members may conduct or may have conducted animal experiments themselves; and one third of the members should represent animal protection organizations (TierSchVersV 2013, Section 42(2)). Therefore, committee members from animal protection organizations are the minority (Hirt, Maisack and Moritz, 2016). Moreover, although the law makes reference to the need for *ethical* justification (TierSchG 2006, Section 7a(2)(3)) and for *ethical* expertise (TierSchG 2006, Section 9(1)), what it means is unclear. The fact that members of the committee work under strict confidentiality (presumably in order to protect personnel involved in the research, their families, and the animals themselves) adds to the lack of transparency; the public cannot be consulted on questions where the normative consensus is, arguably, in flux. Efforts have been made, *post factum*, to make basic information regarding authorized experiments easily accessible to the interested public (see <https://www.animaltestinfo.de>); however, the public, who are increasingly willing to stop certain experiments to protect animals (Eurobarometer, 2005; European Citizens’ Initiative, 2016; Greenpeace Magazin, 2003), have no say in the matter. Another complicating factor is the potential tension between animal advocates

and scientists in the committees, which makes an open-minded examination of individual cases difficult. As noted above, unresolved conflicts over animal experimentation at the legal level are, in part, decided on a case-by-case-basis in the committees. At the same time, committee work is supposed to be based on objective standards of evaluation. In practice, it is often unclear who adheres to what standards of debate; and, as a result, work in the committees can oscillate between the search for ethical truth and the quest for political compromise. The final decision on the approval of an application does not have to be unanimous. Six members (normally) have to vote for the decision to be considered by the authorities, who eventually decide whether to grant or prohibit the research. Committee work is voluntary, with little reimbursement for time invested. While medical or veterinary researchers may be permitted to work on applications during working hours, other members are not always able to do so and are thus clearly disadvantaged.

Finally, the problem of finding animal-free alternatives to a proposed experiment remains. While it is incumbent upon the applicant to show that no such alternatives exist, this is often done by a simply stating that that is the case. While committee members are not supposed to be co-researchers, they will do what they can to find out whether that is true. At the same time, they can hardly be experts in all relevant animal research fields. For example, a research consortium proposed to test inequity aversion in mammals, including humans (Bundesinstitut für Risikobewertung, 2015). Not entirely without irony, the idea was to use rats (next to marmosets and tamarins) because of their highly social nature; and it was explicitly stipulated that, in the long run, results from this experiment would allow adaptations in human society that increase prosocial behavior and cooperation. It was also expected that the experiment would promote better protection for non-human animals who, socially, can prove to be much more complex creatures than expected. Six-hundred and four rats were to be confined in standard laboratory cages, and they would be killed at the end of the experiment. Harms inflicted on the non-human animals further included separation of individuals from their group (fear); injection of hormones; and handling. The applicant had to show that there were no non-animal alternatives for the experiment, and that results could not be obtained through observance of the behavior of free living non-human animals. However, one would need to be an expert in behavioral animal sciences and animal cognition to prove this assumption right or wrong. Given that committees do not specialize in certain themes or research topics, it would be a coincidence if a committee member knew the issues involved well enough. And even if such an expert happened to be a member of the group, they would need sufficient time to establish a compelling, suitable alternative to refuse the application.

Note that emotions arguably play a role in the assessment of this experiment; anger and incredulity regarding the supposed transferability of results or the disregard for research in the social, political, and/or economic sciences would likely have occurred. After all, humans are not 70kg rats, in terms of their metabolism, and certainly the complex conditions of inequity present in human societies and the ways in which they can be dealt with cannot be modelled using rats in a cage.

Thus, we can see how the fact that it is often difficult to prove that alternatives exist practically reduces the application of the 3Rs to two, namely, *reduction* of animals involved and *refinement*, i.e., applying all methods and means to reduce pain, distress, harm, and suffering (see Herrmann, 2019, Chapter 1 in this Volume). However, simply living under laboratory conditions is distressing for the animals and raises ethical questions. Hence, we argue that such a reduced evaluation does not meet the ethical principle of the German animal protection law, which states that “experiments on vertebrates and cephalopods may only be conducted, if the expected pain, suffering and harm is ethically justifiable regarding the purpose of the experiment.” (TierSchG 2006, Section 7a(2)(3)). There is, then, a serious tension at the heart of the RP. Although the public is led to believe that ethical justification plays an important role in committee work—colloquially known as *ethics committees* in Germany (Hirt, Maisack, and Moritz, 2016)—the RP practically disregards real ethical alternatives and focuses on minor technical adaptations. Convincing RPs would necessarily involve a much more careful evaluation of the intended infliction of harm on animals, in light of the expected benefits of and possible alternatives to the experiment. In order to achieve this, we propose careful consideration of emotional sensitivities surrounding animal experiments.

There are good reasons to assume that emotions are important in identifying and clarifying ethical questions. Instead of singling out one emotion in particular, we suggest calling the experience of a range of potentially conflicting emotions when confronted with animal experiments *moral doubt*. While we explain this idea in more detail below, we emphasize that the distinction between ethical and technical assessment is not always straightforward. Consider, for example, the so called, *severity assessment* of animal suffering. The estimated individual condition of animals during an experiment can hardly be conducted without an empathetic understanding of the animals' minds; for it is the empathetic engagement with a suffering animal that motivates the individual to alleviate the harm done to them (Aaltola, 2012; Gruen, 2015). Therefore, one cannot assess the urgency to alleviate the suffering—and that precisely must be the idea of a severity assessment—without any empathetic engagement. However, despite their obvious importance in moral and political

life, the role of emotions in ethical inquiry surrounding animal experiments has not been clarified. In the tradition of animal protection in Germany, emotions have been ignored and even treated as unprofessional, non-scientific threats. Calls for more *sobriety* include the explicit demand that emotions ought to be suppressed (see von Gall, 2016). A similar culture of debate can be assumed to surround the current RP in Germany. This shows that, in order to assess the potential of RP to foster paradigm change, the connection between genuine ethical review and mere technical checks is highly relevant.

In 2012, the administrative court in Bremen ruled that competent authorities only need to ensure “qualified plausibility checks” of the experiments and may refrain from ethical assessment of harms and benefits (Higher Administrative Court Bremen, 2012, p. 16). Although this ruling has come under juridical critique and does not meet the requirements of Directive 2010/63/EU (Maisack, 2016; Peters and Stucki, 2014), it mirrors a tendency to focus on technical checks and to neglect more extensive ethical review in current RP practice. This tendency is reinforced by institutional factors, including, but not limited to, the dominance of life scientists in the committees, no proper compensation, lack of time, and the unresolved question of how to better include expertise on non-animal alternatives. Nevertheless, the public is under the impression that competent authorities do everything to seek ethical advice, and that no animal is killed without compelling reason.

3 Emotions in Inquiry and the Case for Moral Doubt in Ethical Review Processes

Now that we have highlighted the tensions surrounding the RP, what is the role of emotions here? Why should a particular form of emotional experience, namely what we term *moral doubt*, be at the heart of a well-functioning ethical review? And how can we achieve concrete improvements of the committees—such as, integrating committee work with the political process, or greater transparency of animal testing where committee members are allowed to voice their concerns publicly—if we take moral doubt seriously?

Emotions, in general, suffer from the stigma of being irrational (Midgley, 1983, Chapter 3). This is true in the context of the RP as well. If committee members show *too much* empathy for animals, they are at risk of being charged with anthropomorphism; they may be accused of being *unprofessional* if they get angry about something that may very well deserve an angry response, such as the general sloppiness of an application; the lack of standard forms of refinement (Herrmann, 2019, Chapter 1 in this Volume); or even the presence

of a palpable contempt for the RP itself. For members who are asked to repress or ignore such emotional responses, this can lead to self-censorship and alienation from the process. While we know of no official qualitative study of committee work, our own experience and unofficial reports substantiate the suspicion that the dynamics of these committees may be analogous to dynamics that have been problematized under the concept of *epistemic injustice* (Fricker, 2007). Epistemic injustice occurs when prejudice operates in ways that lead some knowers to discard the testimony of others for epistemically irrelevant reasons, as in the case of a *white* jury not believing the testimony of a *black* person or a man not believing a woman. In both cases, the individual's epistemic competence is doubted because of a problematic prejudice: that people of color/women are not trustworthy. Experiencing this injustice is considered a harm that can have alienating effects. We argue that something very similar can occur when people who express their moral doubts in emotional terms are regarded as less reliable because of the prejudice that emotions are necessarily irrational. Moreover, in the committee as a whole, it may lead to polarization, and, importantly, to an incomplete grasp of the problem at hand. In what follows, we suggest a more constructive role for emotions in such inquiries. Although, at times, disturbing and difficult to experience, emotions are both important *sources of information* about moral values and intellectual *virtues* (Hookway, 1993), i.e., dispositions to react to information with hope, interpret them charitably, or experience the proverbial love of truth. All of these are easily dismissed and ignored to the detriment of the RP.

3.1 *Emotions, Value Recognition, and the Framework of Directive 2016/63/EU*

While precise philosophical reconstruction is a matter of debate, an important connection is often assumed between emotions and values and our motivations to do something about values (e.g., Deonna and Teroni, 2015; Tappolet, 2016; Kriegel, 2015). To *doubt*, for example, by shaking your head and calling *x* *unbelievable*, crucially involves a hesitation to continue business as usual and a refusal to accept *x* as normal, good evidence, or appropriate; to say that *x* is *disgusting* or *abhorrent* is to identify *x* as predicated by a negative value that motivates a range of actions aimed at changing the situation. Emotions can also act as signals to others (van Kleef, 2009), about what you think or what you are likely to do next, a warning to others or a request for them to attend to a situation more closely. Such evaluations and suggestions regarding what to do are, of course, preliminary and are, at times, affected by other emotions. Your trust in the good intentions of other committee members may lead you to drop

an issue that angered you. Emotions still need to be taken seriously for inquiries to go well, since they help create a complete picture of the circumstances of the inquiry you find yourself in (Hookway, 2003; Szigeti 2013). To suppress all emotions, such as disgust, shame, or fear when entering a committee meeting (or a laboratory, for that matter) on account of *professionalism* is irresponsible because you may fail to notice things that are indeed disgusting, shameful, or scary. These evaluations are not projected upon a supposedly value-neutral, factual situation. Rather, they are part of human practices and objects of inquiry that people must eventually agree upon. To the extent that science, by virtue of being a practice as well, is far from being value neutral (Douglas, 2009; Longino, 1990), it is desirable that a sense of moral integrity is restored at the heart of the highly problematic practice of animal research. Such integrity is minimally defined by the fact that it operates with meaningful moral concepts and value judgments, a core tenet of pragmatism (Putnam, 2010).

Thus, there is a factual component to the question of whether something is, for example, *cruel* or not; and to rid oneself of emotional sensitivity makes it unlikely to discover this. It is important to mention that such sensitivity is already numbed at the level of the analytical terms at the committee members' disposal. This is symptomatic of the misleading, objectifying language that surrounds animal testing (Crary, 2016). To give an example, committee work relies on a severity classification that defines categories of animal suffering, ranging from low to high: non-recovery, mild, moderate, and severe. However, the allegedly lowest category of severity, which most experiments imply, is the killing of animals at the end of the experiment, despite the fact that many of them could live much longer. At the same time, Directive 2016/63/EU requests an acknowledgement of the "intrinsic value of life" of animals (see European Parliament, 2010, Annex v). Similar knowledge of value and commitments are expected by the German animal protection law (TierSchG 2006, Section 1; TierSchVersV 2013, Annexes 2.2, 3.2). The tension between ethical rhetoric and reality provokes emotions and calls for intense debate about cruelty. The same is true for many other cases. For example, the deprivation of social partners for up to 24 hours is classified as *mild*. While most companion dogs are not left to endure prolonged separation from their social partners, why should it be okay for a rat not to know where her cagemates are for a much longer period of time? These examples only scratch the surface of the issue at hand, and we are not even close to evaluating questions involving intentional pain and suffering inflicted on animals. However, the fact that legitimate doubts already appear at this point supports the claim that more ethical inquiries are needed to foster change in the current system.

3.2 *Exercising Moral Doubt in the Context of Animal Testing*

We have discussed the disruptive nature of doubt, disgust, anger, and the like. Here, we illustrate the moral doubt that can arise concerning animal experiments. We follow the tradition of philosophical pragmatism, in that we propose a problem-driven, generally science-friendly approach to reasoning that subscribes to fallibilism and contextualism and maintains that there is no fundamental dichotomy between facts and values (Putnam, 1994), to name the pragmatist tenets that are important to our topic. Accordingly, we suppose that problems occur when our habits to think and to act break down, i.e. when we experience inconsistencies. If, for example, I experience distress from the use of an animal for the purpose of x , believing that x is unproblematic, *my* doubt by virtue of experiencing the creature's distress is a sign that the practice is *not* unproblematic. Ideally, I would pause and reflect. My goal is to establish a belief that will not be easily questioned by future experience, for instance: "I shall not use any an animal for purpose x " or "Purpose x is unproblematic, but I need to change the situation for the animal in ways that eliminate the distress." Emotions that occur in the context of animal experimentation include disgust, anger, compassion, and hope (to name but a few). When we experience one of these emotions, or a mix of them, in ways that demand that we pause and reflect, we experience *moral doubt* that can help us evaluate issues of animal experimentation.

It is important to note that doubts also need to be taken seriously when someone else expresses them, i.e. if I fail to find anything problematic in what I am doing, but someone else alerts to me to potential ethical problems that I may not have noticed (Trout, 2010). This reinforces the issue of diversity in sensitivities within the committees. If I have had to train myself to ignore moral doubts that I may otherwise experience, in order to pursue my career by experimenting on animals, I must rely on someone else's emotional sensitivity whose moral doubt is intact. This is needed at multiple stages, assuming that any inquiry includes acknowledgement of a problematic situation, clarification of what the problem really is, determination of possible solutions, and (hypothetical) reasoning and the testing of the solution (Dewey, 1938, Chapter 6). Moral doubt is relevant because it functions as a sign *that* there is a problem. Moreover, it can entail suggestions as to *what* the problem may be. Finally, emotions are involved in suggesting solutions that are deemed morally appropriate (Fesmire, 2003). They can act as intellectual virtues, such as courage or conscientiousness; and they will play a role both in the hypothetical reasoning and, ideally, in the evaluation of whether the problem has been solved well.

However, emotions are not necessarily constructive. While, for example, *empathy* and *anger* over injustice done to rats, which are part of testing

inequity aversion, are appropriate, it is easy to see how high *hopes* regarding the research proposal or feelings of *loyalty* towards the applicant can lead the RP astray. It is also important to note that the secrecy surrounding committee work can lead to *cowardice* in addressing the concerns that arise in the committees, or in public, for fear of risk to one's career. We have already noted the desirability of restoring moral integrity at the heart of science and addressing the values and value conflicts that arise in inquiry, for which we currently lack appropriate concepts. We propose that committees need to be sensitive to the way in which language surrounding animal experiments obstructs ethical complexities. Committee members need to approach rhetoric within applications cautiously, evaluate experiments at face value, and ensure that the ethical function of the RP is taken seriously. In this, the so-called pragmatic maxim can be of help. It asks us to elucidate concepts in terms of their conceivable effects, which in ethics should be understood as *finding the right words* (Cojocaru, under review). This can help criticize the emptiness of the word *ethics* used in legal documents as well as describe the problems committees are actually dealing with. Systematically applying the pragmatic maxim can help steer through a sea of jargon and euphemisms and render the specific context under evaluation more precise. Emphasizing that the language we use to speak about animals and their suffering matters, because it habituates us to think and act in certain ways, shows that the application of the 3Rs touches upon more than *simple technicalities*; and that they are about scientific *and* moral integrity much more than about plausibility based on the assumption that science is value-free.

In summary, we suggest that the integration of *moral doubt* into RPs can achieve two things. First, it may lead to a more conscientious adaptation of animal protection, already envisioned in Directive 2010/63/EU, by challenging both the relative neglect of the ethical dimension of the RP compared to technical checks and the moral numbness of people planning, conducting, evaluating, and overseeing the experiments. Since the pragmatist methodology emphasizes the importance of learning from errors and insists on the evaluation of tested solutions, a retrospective evaluation of projects that have been granted authorization would be highly desirable as part of the RP. Second, it is likely that some questions of animal testing will not be resolved within the RP, specifically those that are already unanswerable within the existing framework or those that arise when a regulatory framework itself is questionable. When doubt cannot be resolved, the practice should not proceed, so that important opportunities to inquire into value conflicts are not missed. While this may not sound very pragmatic, the principle of *living doubt* may provide a moral compass whenever a, so-called, dilemma between erring on the side of caution

and scientific progress is construed. Any such rhetoric, which, it should be noted, manipulates emotion, should be held in check; and where doubts prevail, members of the RP must suspend judgment; integrate all possible sources of information to get a clear picture of the problem at hand; and engage in public debate, not as moral experts who explain supposed necessities to a sentimental public, but with an intellectually honest request for help.

4 Concluding Comments

Competent authorities throughout the EU face the challenge of ethically evaluating animal experiments, and Directive 2010/63/EU demands that applications be evaluated by third parties other than the applicant. Expert committees may be a suitable model for this purpose, as long as the basic principles of their work are submitted to democratic control. One way or another, experts will have to deal with emotions when deciding on the life and death of countless, sentient animals. The way in which experts deal with their own emotions and those of others is likely to impact their decisions. The question, then, is not *whether* but *how* this influence occurs. While we stress that no comprehensive study of experts' actual emotional regulation has been conducted, in this chapter, we provide an answer to the normative question, whether competent authorities and experts have good reason to articulate and acknowledge clearly their emotional moral concerns and consider them as relevant for decision-making. The answer is, *yes*. We base this answer on a philosophical account of emotional functioning. Moral doubts signal problems in particular situations, say something about the nature of the problem, and push for solutions. In our case, the problem is the suffering of millions of animals subjected to experiments that will hypothetically improve human life—a definitive moral cost for an uncertain benefit. If the RP does not provide room to *find the right words* when articulating these emotional signs, the problem-solving potential is lost. We argue that acknowledging, and not suppressing and ignoring, moral doubts can foster the envisioned paradigm change in animal experimentation. In order to enable such an optimistic perspective, a variety of conditions need to be fulfilled.

In cases where a substantial debate cannot resolve a conflict, the RP should be able to communicate concrete, open-questions to political or legal decision makers. RPs are impeded by lack of clarity in the implementation of vague legal norms, such as the prohibition of *unnecessary* suffering. The public and the legislator need to know about the unanswered questions that follow from these impediments and push for solutions. Interaction should also exist at the

academic level. In cases where doubts about suitable alternatives to an animal experiment exist, applications need to be forwarded to experts on the topic in question, even if they are not part of the committees. Given the variety of research topics, even a medical scientist cannot evaluate any topic in medicine. Aware of such problems in the RP, educational bodies can also take on pivotal issues in moral training. Evaluation committees may not be the only institutions to inform the RP. Non-governmental organizations (NGOs) traditionally play a central role in informing public decision-making about the plurality of different interests, and this work has to be transparent. It is questionable whether scientists in evaluation committees really are independent from special interests and solely rely in their decisions on objective and ethical accounts. A clarification of the vested interests involved in legal decisions can be stipulated by NGOs. Moreover, in order to *evaluate* the evaluations, it is important to review systematically all the research projects that were granted authorization; for example, did they achieve what they had promised, and what happened to the animals involved? More direct monitoring and publication of this data could also help assess whether, for example, the severity classifications help in practice. Such post-hoc evaluations may be both the source and legitimization of moral doubts regarding similar projects in the future.

The tension between the current practice of animal experimentation and the ethical value of unnecessary suffering, hopefully, provokes emotions. Indeed, ethical review must be based on facts. However, given the many uncertainties and problems surrounding the RP, above all, one thing is clear: there is a strongly felt sense that we need non-animal alternatives in research. Ignoring this and continuing to participate in an inherently dubitable practice impedes reasonable solutions. Finding the right words when expressing moral doubts is a technical skill to inform legal decision making, and we currently disregard this skill at the expense of our moral *and* scientific integrity.

References

- Aaltola, E. (2012). *Animal suffering. Philosophy and culture*. Basingstoke: Palgrave Macmillan.
- Biedermann, M. (2009). *Überwachung und Kontrolle genehmigungspflichtiger Tierversuche vergleichend in Deutschland und Großbritannien*. Berlin: Mensch und Buch Verlag. [online] Available at: <https://refubium.fu-berlin.de/bitstream/handle/fub188/12103/Biedermann.pdf?sequence=1> [Accessed 6 August 2018].
- Bundesministerium für Landwirtschaft und Ernährung (BMEL) (Federal Ministry of Food and Agriculture) (2018). *Verwendung von Versuchstieren im Jahr 2017*.

- [online] Available at: https://www.bmel.de/DE/Tier/Tierschutz/_texte/Versuchstierzahlen2017.html#doc1850874bodyText1 [Accessed 20 December 2018].
- Bundesinstitut für Risikobewertung (2015). *Ungerechtigkeitsaversion bei Tieren und der Einfluss zweier Hormone*. [online] Available at: www.animaltestinfo.de [Accessed 20 June 2017].
- Cojocaru, M.D. (under review). Doing Ethics or Changing for the Better? On Pragmatism, Ethics, and Moral Pragmatics.
- Crary, A. (2016). *Inside Ethics. On the Demands of Moral Thought*. Cambridge, MA and London, England: Harvard University Press.
- Cruelty Free International (2016). *Action needed as numbers of animals used in experiments rise in Europe*. [online] Available at: <https://www.crueltyfreeinternational.org/what-we-do/breaking-news/action-needed-numbers-animals-used-experiments-rise-europe> [Accessed 5 August 2018].
- Deonna, J.A. and F. Teroni (2015). Emotions as Attitudes. *Dialectica*, 69(3), pp. 293–311.
- Deutscher Bundestag Drucksache 10/3158 (1985). Deutscher Bundestag: Entwurf eines Ersten Gesetzes zur Änderung des Tierschutzgesetzes (Draft for a first amendment of the animal protection law). [online] Available at: <http://dipbt.bundestag.de/doc/btd/10/031/1003158.pdf> [Accessed 5 August 2018].
- Dewey, J. (1938). *Logic. The Theory of Inquiry*. New York: Henry Holt and Co.
- Douglas, H. (2009). *Science, Policy, and the Value-Free Ideal*. Pittsburgh: University of Pittsburgh Press.
- Eurobarometer (2005). Europeans, Science and Technology. *Special Eurobarometer, 224*, Brussels: Directorate General Press and Communication of the European Commission. [online] Available at: http://ec.europa.eu/commfrontoffice/publicopinion/archives/ebs/ebs_224_report_en.pdf [Accessed 5 August 2018].
- European Citizen's Initiative (2016). *Stop Vivisection*. [online] Available at: <http://www.stopvivisection.eu/de> [Accessed 5 August 2018].
- European Parliament (2010). Directive 2010/63/EU of the European Parliament and of the Council of 22 September 2010 on the Protection of Animals Used for Scientific Purposes. *Official Journal of the European Communities*, L276, p. 33–79. Available at: <https://eur-lex.europa.eu/legal-content/EN/TXT/?uri=CELEX:32010L0063> [Accessed 13 October 2016].
- European Treaty Series (ETS 123) (1986). *European Convention for the Protection of Vertebrate Animals Used for Experimental and Other Scientific Purposes*. [online] Available at: <https://rm.coe.int/168007a67b> [Accessed 6 August 2018].
- Fesmire, S. (2003). *John Dewey and moral imagination. Pragmatism in ethics*. Bloomington and Indianapolis: Indiana University Press.
- Fraenkel, E. (2011). *Deutschland und die westlichen Demokratien*. Stuttgart: Nomos.
- Fricker, M. (2007). *Epistemic Injustice. Power and the Ethics of Knowing*. Oxford: Oxford University Press.

- Greenpeace Magazin (2003). Emnid-Umfrage-Ergebnisse: Tierversuche auf dem Vormarsch. *Greenpeace Magazine*, 5.03. [online] Available at: <https://www.greenpeace-magazin.de/umfrage-tierversuche-auf-dem-vormarsch> [Accessed 6 August 2018].
- Gruen, L. (2015). *Entangled Empathy. An Alternative Ethic for Our Relationships with Animals*. New York: Lantern Books.
- Herrmann, K. (2019). Refinement on the way towards replacement: Are we doing what we can? In: K. Herrmann and K. Jayne, eds., *Animal Experimentation: Working Towards a Paradigm Change*, Vol. 22. Brill Human Animal Studies Series, pp. 3–64. Leiden: Brill.
- Higher Administrative Court Bremen (2012). *Judgement 1A 180/10; 1A 367/10 of 11. December 2012*. [online] Available at: <https://dejure.org/dienste/vernetzung/rechtsprechung?Gericht=OVG%20Bremen&Datum=11.12.2012&Aktenzeichen=1%20A%20180%2F10> [Accessed 5 August 2018].
- Hirt, A., C. Maisack and J. Moritz (2016). *Tierschutzgesetz, Kommentar*. 3rd ed. München: Franz Vahlen.
- Hookway, C. (1993). Mimicking Foundationalism. On Sentiment and Self-control. *The European Journal of Philosophy*, 1(2), pp. 156–174.
- Hookway, C. (2003). Affective States and Epistemic Immediacy. *Metaphilosophy*, 34 (1/2), pp. 78–96.
- Kriegel, U. (2015). *The varieties of consciousness*. Oxford: Oxford University Press.
- Longino, H. (1990). *Science as Social Knowledge. Values and Objectivity in Scientific Inquiry*. Princeton: Princeton University Press.
- Maisack, C. (2016). *Gutachten zu der Frage, ob und ggf. welche Bestimmungen der Richtlinie 2010/63/EU (EU-Tierversuchs-Richtlinie) durch das Dritte Gesetz zur Änderung des Tierschutzgesetzes und die Tierschutz-Versuchstierverordnung nicht oder nicht ausreichend in deutsches Recht umgesetzt worden sind*. Bad Säckingen, Germany: Legal report commissioned by Member of the German Parliament Nicole Maisch.
- Midgley, M. (1983). *Animals and Why They Matter*. Athens: University of Georgia Press.
- Peters, A. and S. Stucki (2014). *Die Tierversuchsrichtlinie 2010/63/EU: Rechtsgutachten zu ihrer Umsetzung in Deutschland*. Zürich: Schulthess.
- Putnam, H. (1994). *Words and life*. Cambridge: Harvard University Press.
- Putnam, R.A. (2010). Dewey's epistemology. In: M. Cochran, ed., *The Cambridge Companion to Dewey*. Cambridge: Cambridge University Press.
- Silva, S., J. Lassen, P. Sandoe and A. Olsson (2015). *ANIMPACT-WP3: The Directive, the Ethical Landscape, and the Practice of Ethical Review*. [online] Available at: <http://www.animpact.eu/news-publications/wp3-results> [Accessed 6 August 2018].
- Szigeti, A. (2013). No Need to Get Emotional? Emotions and Heuristics. *Ethical Theory and Moral Practice*, 16, pp. 845–862.
- Tappolet, C. (2016). *Emotions, Value, and Agency*. Oxford: Oxford University Press.

- Tierschutzgesetz (TierSchG)* in der Fassung der Bekanntmachung vom 18. Mai 2006 (BGBl. I S. 1206, 1313), das zuletzt durch Artikel 141 des Gesetzes vom 29. März 2017 (BGBl. I S. 626) geändert worden ist. (German animal protection law). [online] Available at: <https://www.gesetze-im-internet.de/tierschg/BJNR012770972.html> [Accessed 5 August 2018].
- Tierschutz-Versuchstierverordnung (TierSchVersV)* vom 1. August 2013 (BGBl. I S. 3125, 3126), die zuletzt durch Artikel 394 der Verordnung vom 31. August 2015 (BGBl. I S. 1474) geändert worden ist (Regulation for the protection of animals used for experimental or other scientific purposes). [online] Available at: <https://www.gesetze-im-internet.de/tierschversv/TierSchVersV.pdf> [Accessed 6 August 2018].
- Trout, L. (2010). *The Politics of Survival. Peirce, Affectivity, and Social Criticism*. New York: Fordham University Press.
- von Gall, P. (2016). *Tierschutz als Agrarpolitik — Wie das Deutsche Tierschutzgesetz der industriellen Tierhaltung den Weg bereitet*. Bielefeld: transcript.
- van Kleef, G.A. (2009). How Emotions Regulate Social Life. The Emotions as Social Information (EASI) Model. *Current Directions in Psychological Science*, 18(3), pp. 184–188.

Human Wrongs in Animal Research: A Focus on Moral Injury and Reification

Jane Johnson

Research Fellow, Centre for Values Ethics and the Law in Medicine,
University of Sydney. Scholarly Teaching Fellow, Department of Philosophy,
Macquarie University, Australia

jane.johnson@mq.edu.au

Anna Smajdor

Associate Professor of Practical Philosophy, University of Oslo, Norway

anna.smajdor@ifikk.uio.no

1 Introduction

Most research on non-human animals (hereinafter referred to as animals) involves clear harms for the animals used, either as a direct result of research protocols or by virtue of the conditions under which the animals are kept. Arguably, however, although these harms are widely acknowledged, they have not motivated significant change to the practice of animal research. In this chapter, we focus on the damage to humans that can result from animal experimentation and how this may act as an alternative driver of change.

Humans employed in animal research, whether inside animal housing or the laboratory, confront significant stress as a result of what they routinely do as part of their job, as well as by virtue of how that work is received by “outsiders” to animal research. These workplace stressors can result in physical and psychological harms. It is well known that human patients may also be harmed as a consequence of the epistemological shortcomings of research undertaken on animals, which fails to translate to human clinical settings. Whilst we will briefly discuss these kinds of physical and psychological harms, our primary focus is the *moral injury* that can result from the practice of animal research. Moral injury occurs when a disregard of someone’s well-being causes them harm. Typically, this is understood to encompass the kind of moral wrong that may arise from systematic injustices or from criminal or violent acts. However, moral injury is increasingly recognized as a problem for the *perpetrators* as well as the victims of certain acts. Moral injury, thus, also occurs when a person

is complicit in activities that they feel are morally wrong or transgressive. Moral injury as a phenomenon, in this sense, is well established in military situations, where personnel may undertake or witness actions that would be illegal or immoral in other settings.

Using arguments derived from the work of Axel Honneth (2006), we show that animal research involves an institutionalized failure to recognize non-human animals that not only reifies animals but the human persons engaged in this process, diminishing the scope of their moral agency and causing moral injury. In this chapter, we begin by briefly articulating the harms to animals in research and the more conventional harms to humans that can arise as a result of animal research, before making a case for the ethical damage wrought by the failures of recognition inherent within the system of animal research. We conclude with a brief outline of our approach as a means of effecting change in animal research.

2 Harms to Animals in Research

It is widely acknowledged that animals frequently suffer harms when used in interventional biomedical research directed at human clinical benefit. These harms may be the direct result of research protocols or relate to the conditions in which animals are housed. Animals can experience pain and discomfort when used in toxicology testing, the development of pharmaceuticals, vaccine development, diagnostic techniques, and surgical research. The intervention itself may be the source of distress, or, if the research protocol demands it, prior infliction of an alien disease or condition on the animal may be a source of suffering. Animals used in biomedical research are routinely killed at the completion of a protocol or series of protocols. Although arguments can be made that, in itself death may not amount to a harm for non-humans, the manner in which animals are killed can be a source of concern, and there is disagreement over what constitutes humane euthanasia (Hawkins et al., 2016). Housing can be another source of harm for animals in research, since the environment in which animals are kept may negatively impact their well-being. Housing that is inexpensive, easy to handle, and clean may not provide the best environment to meet the needs of animals. Animals may be harmed by lack of access to conspecifics and adequate stimulation, the intrusion of light and noise, inappropriate cage design, and so on (National Health and Medical Research Council, 2013). Although most of these harms are well known, arguably, they have not motivated significant change in the practice of research. For the remainder of this chapter, we focus instead on harms to humans from animal research, which have received relatively little attention.

3 Harms to Humans — Physical

For some time, it has been acknowledged that there are epistemological problems in translating results obtained from animal experiments into human clinical benefit. A number of reasons can be cited for this failure, including, differences in physiology and metabolism between human and non-human animals (LaFollette and Shanks, 1996); poorly conducted and inappropriately evaluated animal experiments (Perel et al., 2007; Pound et al., 2004); and animal stress due to many of the environmental factors identified above (e.g. small cage size, boredom, high levels of noise, etc.), which in turn has impact on physiology and the reliability of scientific data obtained from animals (Akhtar, Pippin and Sandusky, 2008; Baldwin, Primeau and Johnson, 2006; Burwell and Baldwin, 2006; also see in this Volume: Herrmann, 2019; Jayne and See, 2019).

Irrespective of the reasons behind failures in translation, the consequences are significant for human patients and those who work with animals. First, patients may receive treatment that is inappropriate and harmful, if such treatments have “passed” animal testing but remain dangerous to humans (Pound and Bracken, 2014). In these cases outcomes may include a heightened risk of morbidity or mortality. There are also opportunity costs associated with pursuing one form of intervention rather than another. Second, patients may not receive treatments that could be beneficial, if they have “failed” animal tests, i.e. the development of potentially fruitful interventions for humans may be cut short by unsuccessful animal trials (Pound and Bracken, 2014). In addition, research findings in animals, which have no validity for humans, can lead to the misdirection of future financial resources and research efforts (Pound and Bracken, 2014). The resources of funders, researchers, and human trial participants may be effectively wasted in pursuit of what amounts to futile lines of inquiry. These resources would be better spent on different treatments or different forms of research, such as clinical trials, epidemiological studies, and computer modelling, rather than on animal research.

Those who work in animal research are also at risk of harm. Exposure to workplace stressors is associated with a range of negative outcomes (Britt et al., 2016). People who are directly involved with animal research, whether inside animal housing or the laboratory, face challenging issues in relation to the animals in their care. These workers may witness or directly cause animals to experience discomfort, pain, and suffering as part of an experimental protocol. They may be required to infect animals with a disease, or impair their function in some way, or euthanize them at the completion of the experimental protocol. Research workers can experience a range of negative feelings and health impacts (physiological, psychological, and social) as a result of their involvement in research. During their work, some may experience guilt,

uneasiness, or frustration, as well as grief at the death of an animal in their care (American Association for Laboratory Animal Science, 2003). The culture of secrecy that cloaks much animal research limits discussion of these challenges by workers, exacerbating the problems experienced.

For those who work as animal carers or as laboratory technicians, these difficulties may be particularly pressing. Those who are employed to look after animals, rather than carry out the research per se, have frequently chosen their careers based on a love of animals; as such, they experience the harms to animals in research as especially distressing (Birke, Arluke and Michael, 2007). Furthermore, these individuals may not have been routinized to animal research in the same way as those who have trained as researchers, so they may lack the coping mechanisms that may assist in addressing these issues (Birke, Arluke and Michael, 2007). There is limited discussion of these harms in the literature. In the remainder of this chapter, we focus on an even more neglected area of harm to humans involved in animal research, namely, *moral harm*.

4 Harms to Humans — Moral

In order to make effective use of animals in research, those who work with them must, to some extent, treat them as objects: objects of scientific interest. In order to do this, the subjectivity of the animal is disregarded or denied. Its value comes not from what is intrinsic to it but from what others deem to be useful. The animal is controlled, monitored, manipulated, and measured in ways that, as we have suggested, often cause harm. This is not the same as, for example, deliberate cruelty, sadism, or vindictiveness. The *intention* is not usually to cause suffering but to achieve some other goal, for which the animal's suffering is a *necessary* prerequisite or side effect. The animal is merely a means to a scientific end, and those who are involved in the research must ensure that they are able to view animals in this narrow way and treat them accordingly.

The treatment of human beings as objects or as mere means to scientific ends is uncontroversially regarded as morally problematic. The validity of the animal model aside, whether it is morally wrong to use animals in this way depends partly on what moral theory one subscribes to. Most of those who find it acceptable to use animals for research base their reasoning on the idea that animals have a different moral status from human beings. Accordingly, much of the debate about animal rights has revolved around the question of what capacities are necessary or sufficient for full moral status, and whether animals have these capacities (Bastian et al., 2012; DeGrazia, 1996; Singer, 2013). However, we suggest that there are moral problems associated with the use of

animals in research, regardless of their moral status. This is because, in order to make use of them, we have to adopt a particular stance towards them that requires a subjugation or diminution of our own moral agency. We can choose to treat animals as subjects or as objects for our use. When we choose the latter option, we reify them. *Reification* is a term with a complex political and philosophical history. For the purposes of our discussion, we build primarily on Honneth's use of the term (2006).

5 What Is Reification and How Does It Relate to Other Moral Concepts?

Reification is a *disposition* or a mode of relating to others that can be a product of systems and institutions that compel people to behave in certain ways, to treat others as mere things. It is, as Axel Honneth (2006) puts it, a social pathology (p. 92). The concept of reification has some resonance with Kant's formula of humanity. Kant insists that we should never treat other human beings as mere means to our own ends, but always as ends in themselves. Reification also has some resonance with the concepts of *commodification*, *objectification* and *inattention*. Elisabeth Anderson (1990), for example, discusses the commodification of women's labor in surrogacy. Commodification is bad, she says, because it is *mistaken*. We fail to value the commodified person and this is an error. The woman is inappropriately used — treated as a thing — rather than respected. Anderson's view suggests that there are fixed moral categories, and that we sometimes make mistakes in determining how to categorize others. This implies that commodification is not *intrinsically* wrong, only when we commodify the wrong entity. This is what occurs in surrogacy, according to Anderson, whereas she may not think it wrong to commodify animals used in research. We employ Honneth's (2006) approach to argue a broader and more agnostic view. Given that we are sometimes uncertain of how to respond to others, and we know that we are fallible and self-interested, to cultivate a commodifying disposition may be intrinsically, morally problematic.

Reification has similarities with what Kathie Jenni calls, *vices of inattention* (2003). Jenni argues that it is through *inattention* that people who are horrified when they know about factory farming, nevertheless, eat meat and try to avoid thinking about the horrors involved in its production. Similar claims may be made with regard to our reluctance to think about or discuss animal research. Again, this suggests a specifically epistemological kind of problem: we lack knowledge because we choose to look away instead of properly observing.

In Anderson's (1990) account too, we make an *epistemological* mistake in miscategorizing certain others. However, focusing on accidents, lack of attention, and epistemological mistakes does not adequately capture the very deliberate aspects of what occurs in animal research. It is for this reason that we find *reification* a more compelling descriptor of the situation.

What is involved in animal research is not accidental. Indeed, reification goes hand in hand with a very specific form of attention, certainly in science. It is a *reifying* attention that denies not only the non-thing-ness of the object of research, but also the moral agency of the researcher, since the moral relationship between researcher and research object is fixed by institutional and external factors. The researcher cannot choose to relate to the animal as a non-thing, at least not without sacrificing the scientific mantle.

In developing his understanding of reification, Honneth (2006) discusses Lukács' view of a world where *caring* has been subverted and replaced with a pathological tendency towards reification (Lukács, 1971). Honneth rejects the concept of *care* as the counterpart of reification, in favor of the term *recognition*. The phenomenon of reification and the means of addressing it are central to our purposes, as we examine the ways in which animals are used in research. Reification, according to Axel Honneth, is a deadening tendency that distorts our ability to relate to the world around us. "[T]he subject is no longer empathetically engaged in interaction with its surroundings but is instead placed in the perspective of a neutral observer, psychically and existentially untouched by its surroundings" (2006, pp. 98–99).

Reification is not inherent in specific actions but in a conjunction of the action and disposition/intention. For this reason, there is no single means by which we can point at a class of actions and say they are always wrong. However, as we have suggested, it seems fairly clear that the scientific gaze is likely to be a reifying one, even before any action has been taken. Indeed, doing nothing can be compatible with reifying, if the reason for doing nothing is that one regards the entity that is being ignored as a mere thing; for example, if one fails to rescue an animal from a burning building.

It should be clear from our discussion so far that reification is deeply risky for those who are reified. Whether human or animal, their interests, suffering, and subjectivity are likely to go unnoticed or to be systematically devalued. But the moral problems stemming from reification are not limited, specifically, to the harm that it may cause to those who are reified. This is of particular importance to our analysis of the human harms engendered through animal research. Many people believe that provided certain standards of welfare are met, and research protocols are subjected to ethical review, animal research is not in itself unethical. However, animals remain research objects, and their life

and well-being are precarious, since at the discretion of the researcher, they may be harmed or euthanized. Indeed, one of the clearest indications that research animals *are* reified is the fact that, once their value to an experiment is over, they are generally terminated. Animals will usually fight to preserve their existence; but the intrinsic value of an animal's life to the animal itself is not sufficient, in the research context, to allow it to live. We suggest that animal research will remain morally problematic even if issues of welfare continue to be improved, precisely because the harm suffered by research animals is only a subset of the problem. As long as research involves the reification of other animals, it will cause moral difficulties for those engaged in this research. It is here that the concept of reification is particularly significant in helping us move away from limited questions concerning the capacities or moral status of animals. From Honneth's perspective, this is irrelevant in at least one important sense. "The things we encounter in our everyday dealings with the world must also be regarded as entities to which we relate in an inappropriate way when we apprehend them merely neutrally and according to external criteria" (2006, p. 132).

6 Reification and Moral Injury

We have outlined the ways in which animal research involves the reification of animals. However, a key part of our argument is that this, in turn, impacts the *people* responsible for working with such animals. Reification, aside from anything else, is a diminution, denial, or abrogation of moral agency. This can work in two ways. First, the reifier denies that the entity in question is anything other than a thing. Second, the very process of reification reflects back on the moral agent. The person, who has the capacity to be a moral agent, comes to feel and act as though this were not the case *through* reifying both their own moral agency and the entities that they encounter.

This kind of situation may lead individuals into difficulties regarding whether to continue to do work they find troubling. For example, some of those who work in the animal house and as laboratory technicians construe themselves as a type of intermediary between scientific researchers and animals, advocating and protecting the latter (Birke, Arluke and Michael, 2007). This sets up a kind of cognitive dissonance, which can be exacerbated by pressure from within the organization. For example, informal advice to management from the American Association for Laboratory Animal Science (2003) suggests supervisors remind workers that "if they cannot perform an assigned task, someone else will be required to do so" (p. 3). This means that individuals who care for the

animals they work with, and who have built a rapport with them, can become caught in a cycle whereby they feel personally obliged and institutionally pressured to persevere with this work in spite of the personal cost.

Staff who do care about the animals they work with are themselves being reified by systemic and institutional pressures. The moral agency that enables them to relate to the animal, to have a view as to how and whether something should be done, may be stultified over time. Habermas also identifies this problem — that of our capacity to reify *ourselves* — calling it the “self-instrumentalization of the species” (2014). While Habermas was not concerned with animal research, he, nevertheless, offers a clear illustration of the phenomenon he was concerned with. In seeking to instrumentalize other species, we simultaneously do the same to ourselves.

7 Loss of Moral Agency Leads to Moral Injury

The use of animals in research requires a narrowing of the social sphere, to exclude some entities or to limit the ways in which the interests of these entities can serve to restrict our freedoms to act on them. In this way, moral agency is constrained. In addition, the nature of scientific work often means that people carry out procedures that have been defined and required by others, so that moral implications, in relation to animals, may be doubly removed from the individual’s own sense of moral autonomy or agency. There are some parallels here with the known problem of desensitization: those who cannot successfully desensitize themselves to animal suffering are unlikely to thrive in jobs that require animal research. Therefore there is an inbuilt incentive for scientists and researchers to seek to desensitize themselves actively, by reframing their moral relationship with the animals (Capaldo, 2004).

We hypothesize that habitually narrowing the scope of moral concern is a source of moral injury to those who do it. Institutions and workplaces often require this kind of narrowing. For example, to promote efficiencies, effort is expended on an ever-smaller circle of those who matter. Thus, workers may find themselves told to ignore the mold on the tomatoes in the burgers, or to give parents misleading feedback on their children’s reports, or to prioritize the management’s targets above any other concern they have relating to the patient (Smajdor, 2013). There are many areas of modern life, maybe even most workplaces, where the demands of efficiency are such that reification seems inescapable. To this extent, the situation of those involved in animal research may not be significantly different from those working in factories or universities or engaged in other sorts of scientific or laboratory work. However, there

is an important additional factor that feeds into the mix here. There are some people whose occupations also involve intensely, ethically-charged decisions or practices. These include those working as military personnel, medical professionals, and — we would argue — those involved in animal research.

The damaging effects of breaking strong moral taboos have previously been discussed in the context of military and medical personnel. For example, both medics and military personnel are more likely to witness, bring about, or be involved in the death of other human beings. Both are required to perform actions that cause harm to other individuals. Both may have to overcome feelings of repugnance for what they do and to attempt to distance themselves from normal human responses (Howe, Smajdor and Stöckl, 2012; Smajdor, Salter and Stöckl, 2010). For these reasons and others, medical and military personnel are at risk of moral injury (Litz et al., 2009; Steenkamp et al., 2011), and a variety of strategies have been developed in order to encourage institutions and individuals to identify these risks and deal with them. It may not be immediately obvious that one can draw parallels between animal researchers and soldiers or medics; but, in fact, proximity with death and witnessing or causing trauma is likely to be part of all of these worlds, as is the need to function within highly complex and hierarchical systems. These systems impose their own moral demands and codes, which frequently conflict with the norms and expectations of society. In these circumstances, a combination of strong social taboo attached to the activity, reification, loss of agency, and the ethical complexity of the role lends itself to a far higher risk of moral injury.

It is routinely accepted in modern societies that killing and harming animals is *prima facie* wrong. Indeed, to participate in activities such as these is usually against the law and/or regarded as immoral, unless carried out by designated people. Even, or especially, in developed Western societies, whose farming practices and research activities require that animals are used, killed, or harmed, members of the public are not commonly involved in these practices. What this means is that, just as doctors or members of the military are engaged in breaking taboos, so too are people whose roles involve using or harming animals. Animal researchers must contain their “normal” feelings, to some extent, and refrain from “normal” moral and social judgements just as soldiers do. Shifting between different moral contexts can, in itself, be a risk for moral injury. The switch from war to civilian life is well recognized as a source of stress, and this shift is one that animal researchers may undergo on a lesser scale every day. In some senses, animal research is even more morally taboo than military service. Soldiers can be, and often are, viewed as heroes. In the contemporary environment, it is hard to envisage the same possibility for animal researchers (Birke, Arluke and Michael, 2007, however, note that some

pro-research campaigns seek to cast researchers as heroes for saving patients, especially children). Furthermore, soldiers are often regarded as paradigmatic examples of powerful, attractive men. It is not generally thought *shameful* to be a soldier. Nor would one expect to have to keep this secret. Yet, away from their colleagues, some animal researchers might feel shame, social stigma, and exclusion based on what they do. As a result, they may feel impelled to keep the nature of their work secret. Again, this taboo bears particularly on laboratory technicians as opposed to researchers, since for the former group working with animals in research constitutes the entirety of their role (Birke et al., 2007).

Aside from the elements of cognitive dissonance or shame attached to animal research, which is perhaps a result of its problematic moral status in society, moral injury may arise in this context from a more direct and personal feeling of being involved in wrongdoing. Again, this has parallels with military situations. Moral injury can result from witnessing or being complicit in acts that one feels to be wrong. One does not have to be a perpetrator of the act in question in order to be damaged by it. A sense of helplessness, or perception of being disempowered by the structures and systems within which one works, can lead to situations where one's moral agency comes under threat. Over time, this leads to a gradual hardening, or dissociation, as individuals try to protect themselves from the sense of wrongdoing and become passive and disempowered. If this dissociation is effective, a person may cease to feel distress but may, nevertheless, continue to be damaged physiologically and psychologically (Kammeyer-Mueller, Simon and Rich, 2010; Litz et al., 2009).

8 Addressing the Problem of Reification

Several strategies and remedies could be devised to limit or ameliorate reification and its associated moral harms in the context of animal experimentation. For example, universities, hospitals, and other institutions where animal research takes place could better acknowledge the kind of stresses and pressures placed on their workers and implement policies to support resilience, perhaps akin to those adopted in the military setting. Although this may help workers cope with the issues they confront (which is not insignificant), it does not seem to get to the heart of the problem, namely, that biomedical research requires the reification of animals and, in turn, the humans who work with them. Another strategy may be to radically transform the practice of research in such a way that the harms to animals are minimized and their intrinsic value and subjectivity acknowledged. This could be facilitated by adopting the animals-as-patients model argued for elsewhere (Johnson and Degeling, 2012).

Animal patients shift the balance of harms to benefits for animals in research and address some of the epistemological worries about the failure of animal research to translate into human clinical benefit. A move towards regarding animals as patients could represent one point along the way to a paradigm shift in animal research. This, if successful, would radically alter the relationship between researchers and participants. It would no longer be necessary for researchers to distance themselves from the animals' suffering, and, as with research involving humans, the moral value of the research participant would be an inbuilt aspect of the process.

It seems to us that, as with other major social shifts on complex issues, there will not be a single knock down argument or historical, political, or economic circumstance that will provoke change in animal research. Rather, change will occur when a number of arguments and factors come together that all support a new direction. We hope to have shown that there is a new argument that can be mounted against animal research, one that is grounded in an acknowledgement of the moral harms to humans that can result from involvement in animal experimentation. Contributing an argument that appeals to human self-interest and does not depend on problematic attempts to establish the moral status of animals or on reducing animals to their *welfare*, is, we hope, promising and able to further gird a move away from the current, deeply problematic, practice of animal research.

References

- Akhtar, A.Z., J.J. Pippin and C.B. Sandusky (2008). Animal Models in Spinal Cord Injury: a Review. *Reviews in the Neurosciences* 19, pp. 47–60.
- American Association for Laboratory Animal Science (2003). *Cost of caring: Human emotions in the care of laboratory animals*. Memphis, TN: American Association for Laboratory Animal Science.
- Anderson, E.S. (1990). Is Women's Labor a Commodity? *Philosophy & Public Affairs*, 1, pp. 71–92.
- Baldwin, A.L., R.L. Primeau and W.E. Johnson (2006). Effect of Noise on the Morphology of the Intestinal Mucosa in Laboratory Rats. *Journal of the American Association for Laboratory Animal Science*, 45, pp. 74–82.
- Bastian, B., S. Loughnan, N. Haslam and H.R. Radke (2012). Don't Mind Meat? The Denial of Mind to Animals Used for Human Consumption. *Personality and Social Psychology Bulletin*, 38(2), pp. 247–256.
- Birke, L., A. Arluke and M. Michael (2007). *The sacrifice: How scientific experiments transform animals and people*. West Lafayette, IN: Purdue University Press.

- Britt, T.W., M. Crane, S.E. Hodson and A.B. Adler (2016). Effective and Ineffective Coping Strategies in a Low-autonomy Work Environment. *Journal of Occupational Health Psychology*, 21(2), pp. 154–168.
- Burwell, A.K. and A.L. Baldwin (2006). Do Audible and Ultrasonic Sounds of Intensities Common in Animal Facilities Affect the Autonomic Nervous System of Rodents? *Journal of Applied Animal Welfare Science*, 9, pp. 179–200.
- Capaldo, T. (2004) The Psychological Effects on Students of Using Animals in Ways That They See as Ethically, Morally, or Religiously Wrong. *Alternatives to Laboratory Animals*, 1(32), pp. 525–532.
- DeGrazia, D. (1996). *Taking animals seriously: Mental life and moral status*. Chicago, IL: Cambridge University Press.
- Habermas, J. (2014). *The future of human nature*. Cambridge, UK: Polity Press.
- Hawkins, P., M.J. Prescott, L. Carbone, N. Dennison, C. Johnson, I.J. Makowska, N. Marquardt, G. Readman, D.M. Weary and H.D.R. Golledge (2016). A Good Death? Report of the Second Newcastle Meeting on Laboratory Animal Euthanasia. *Animals*, 6, p. 50.
- Herrmann, K. (2019). Refinement on the way towards replacement: Are we doing what we can? In: K. Herrmann and K. Jayne, eds., *Animal Experimentation: Working Towards a Paradigm Change*, Vol. 22. Leiden: Brill Human Animal Studies Series, pp. 3–64.
- Honneth, A. (2006). *Reification: A Recognition Theoretical View*. The Tanner Lectures on Human Values. University of California, Berkeley. [online] Available at: https://tannerlectures.utah.edu/_documents/a-to-z/h/Honneth_2006.pdf [Accessed 12/02/2018].
- Howe, A., A. Smajdor and A. Stöckl (2012). Towards an Understanding of Resilience and Its Relevance to Medical Training. *Medical Education*, 46(4), pp. 349–356.
- Jayne, K. and A. See (2019). Behavioral Research on Captive Animals: Scientific and Ethical Concerns. In: K. Herrmann and K. Jayne, eds., *Animal Experimentation: Working Towards a Paradigm Change*, Vol. 22. Leiden: Brill Human Animal Studies Series, pp. 517–547.
- Jenni, K. (2003). Vices of Inattention. *Journal of Applied Philosophy*, 20(3), pp. 279–295.
- Johnson, J. and C. Degeling (2012). Animals-as-Patients: Improving the Practice of Animal Experimentation. *Between the Species*, 15(1), pp. 43–58.
- Kammeyer-Mueller, J.D., L.S. Simon and B.L. Rich (2010). The Psychic Cost of Doing Wrong: Ethical Conflict, Divestiture Socialization, and Emotional Exhaustion. *Journal of Management*, 38(3), pp. 784–808.
- LaFollette, H. and N. Shanks (1996) *Brute science*. London: Routledge.
- Litz, B.T., N. Stein, E. Delaney, L. Lebowitz, W.P. Nash, C. Silva and S. Maguen (2009). Moral Injury and Moral Repair in War Veterans: A Preliminary Model and Intervention Strategy. *Clinical Psychology Review*, 29(8), pp. 695–706.

- Lukács, G. (1971). Reification and the consciousness of the proletariat. In G. Lukács. *History and Class Consciousness: Studies in Marxist Dialectics*. Cambridge, MA: The MIT Press.
- National Health and Medical Research Council. (2013). *Australian code for the care and use of animals for scientific purposes, 8th ed.* Canberra: National Health and Medical Research Council.
- Perel, P., I. Roberts, E. Sena, P. Wheble, C. Briscoe, P. Sandercock, M. Macleod, L.E. Mignini, P. Jayaram and K.S. Khan (2007). Comparison of Treatment Effects Between Animal Experiments and Clinical Trials: Systematic Review. *British Medical Journal*, 334, pp. 197–206.
- Pound, P. and M. Bracken (2014). Is Animal Research Sufficiently Evidence Based to be a Cornerstone of Biomedical Research? *British Medical Journal*, 348, g3387.
- Pound, P., S. Ebrahim, P. Sandercock, M.B. Bracken and I. Roberts (2004). Where Is the Evidence That Animal Research Benefits Humans? *British Medical Journal*, 328, pp. 514–517.
- Singer, P. (2013). *In defense of animals: The second wave*. Oxford, UK: Blackwell Publishing.
- Smajdor, A. (2013). Reification and Compassion in Medicine: A Tale of Two Systems. *Clinical Ethics*, 8, pp. 111–118.
- Smajdor, A., C. Salter and A. Stöckl (2010). The Limits of Empathy: Problems in Medical Education and Practice. *Journal of Medical Ethics*, 37, pp. 380–383.
- Steenkamp, M.M., B.T. Litz, M.J. Gray, L. Lebowitz, W. Nash, L. Conoscenti and A. Lang (2011). A Brief Exposure-based Intervention for Service Members with PTSD. *Cognitive and Behavioral Practice*, 18(1), pp. 98–107.

PART 5

Effectiveness of the Animal Model



Critically Evaluating Animal Research

Andrew Knight

Professor of Animal Welfare and Ethics, Centre for Animal Welfare,
University of Winchester, United Kingdom

Andrew.Knight@winchester.ac.uk

1 A Growing Tradition of Laboratory Animal Use

Researchers have sought to understand the mechanisms of human health and disease, for as long as the latter has existed. Serious interest in the structure and functioning of the human body has been evident at least since the ancient Greeks. However, the investigations of Greek physicians into human anatomy and physiology were greatly hampered by social taboos about dissecting human corpses (von Staden, 1989). But non-human animals (hereinafter referred to as animals), were not so revered or feared. Some dissected their corpses, while others, such as Alcmaeon of Croton (sixth–fifth century, BCE), practiced surgical or other invasive procedures on the living (Court, 2005; Maehle and Tröhler, 1990), and conducted some of the first animal experiments ever recorded.

Almost two millennia passed before such social dogmas were seriously questioned. The Renaissance heralded a new era of scientific inquiry, during which Flemish physician and surgeon Vesalius (1514–1564) began to source human cadavers for dissection illegally. He discovered that a number of anatomical structures believed to exist, following animal dissections, were unexpectedly absent in humans. His highly accurate anatomical descriptions challenged the authoritative texts of classical authors (O'Malley, 1964).

Throughout the seventeenth century the spirit of scientific inquiry grew and with it, experimentation on living animals. Some surgical investigations and demonstrations that predated anesthesia were infamously cruel and caused widespread social controversy. However, French philosopher, René Descartes (1596–1650), famously rebutted such critiques, claiming that animals were merely mindless automata, i.e., “machine-like” (Descartes, 1989); their cries were of no greater moral consequence than the squeals of a poorly-oiled machine.

Nevertheless, by the end of the seventeenth century, the question of animal suffering and the acceptability of such procedures had become an increasingly

prominent moral and social concern (Maehle and Tröhler, 1990). Jeremy Bentham (1748–1832), famously asked, “The question is not, Can they *reason*? nor, Can they *talk*? but, Can they *suffer*?” (Bentham, 1823, Chapter 17, footnote). And his concerns have been echoed by many others since.

By the beginning of the nineteenth century, a revolution had begun within medicine. Growing awareness of the poor effectiveness of many traditional therapies led to investigations focused on understanding disease etiology (causation) and pathogenesis (progression), with the intention of increasing diagnostic and prognostic accuracy and treatment efficacy. The use of animals as investigative models increased in the second half of the nineteenth century, often in highly-invasive research and still predating most forms of anesthesia or analgesia. Increasing social unease about such research led to widespread opposition in Europe, and especially Britain, where organizations, such as the National Anti-Vivisection Society (NAVS), founded 1875, (NAVS, 2012) and the British Union for the Abolition of Vivisection, founded 1898, (now Cruelty Free International, n.d.), were established to campaign against it. The Cruelty to Animals Act (1876) entered into force, becoming the first legislation to regulate animal experiments (Franco, 2013).

In the latter part of the twentieth century, social concerns about animal suffering continued to grow, accompanied by a seemingly inexorable rise in animal experimentation. Currently, the most accurate evidence-based estimates of global laboratory animal use describe the year 2005. Approximately 126.9 million non-human vertebrates were used worldwide in that year (Knight, 2008a; Taylor et al., 2008). Driven by increased development and use of genetically-modified animals (Ormandy, Schuppli and Weary, 2009), and by large-scale chemical-testing programs (Knight, 2011), laboratory animal use has steadily increased in most developed countries, ever since.

The single largest category of research conducted today is fundamental biological research, much of which has no obvious application. The European Union (EU) is the world’s largest region that publishes comprehensive analyses of its laboratory animal use. At the time of writing, the most recent published figures describe animal use in the 27 Member States of the EU in 2011 (with one state reporting for 2010). Within this period, 46.1% of the 11.5 million animals were used for this purpose. However, barring 1.6% of animals used for education and training, most of the remaining 52.3% were used in attempts to advance public health—for research, development, or toxicity testing; for quality control of products and devices for human or veterinary medicine and dentistry; or for disease diagnosis and other purposes (European Commission, 2013). Most of these animals would have been used in attempts to advance human, rather than animal, health.

2 Effectiveness of Laboratory Animal Use

Combined, this represents an enormous commitment of animal, scientific, personnel, and financial resources, ostensibly dedicated primarily to the advancement of human health. But how effective has all this research been?

Advocates of such research have regularly claimed it is essential for preventing, curing, or alleviating human diseases (e.g., Brom, 2002; Festing, 2004); and further, that the greatest achievements of medicine have only occurred through the use of animals (e.g., Pawlik, 1998). However, those who champion such claims frequently have careers dependent on such research. Furthermore, counter-narratives by others contest the contributions or necessity of such research for the advancement of medical progress (e.g., Greek and Greek, 2002). To support their argument, advocates on either side regularly cite cases in which animal and human outcomes are similar or different. However, only small numbers of experiments are normally included in such reviews, and their selection may be subject to bias. These are known as *narrative reviews*.

To provide more definitive conclusions, *systematic reviews* of the human clinical or toxicological utility of large numbers of animal experiments are necessary. A systematic review is “a review of a clearly formulated question that uses systematic and explicit methods to identify, select, and critically appraise relevant research and to collect and analyze data from the studies that are included in the review. Statistical methods (meta-analysis) may or may not be used to analyze and summarize the results of the included studies” (Moher et al., 2009). In recent years, systematic reviews have become widely utilized to investigate a broad range of clinical and other research questions. Their aims are to retrieve as much high-quality evidence as possible, relevant to the research question, and to minimize bias during the selection, analysis, and reporting of results. Any conclusions reached should, accordingly, be as close as possible to biological, physical, chemical, or other truths.

A large number of systematic reviews of animal experiments within various research fields have examined their utility for advancing human healthcare, and the results have not been good. Of 20 published systematic reviews examining human-clinical utility located during a comprehensive literature search, animal models demonstrated significant potential to contribute toward clinical interventions in only two cases, one of which was contentious. Included were experiments approved by ethics committees on the basis of claims that medical advances were likely to result; highly-cited experiments published in leading journals; and chimpanzee experiments, utilizing the species most generally predictive of human outcomes. Seven additional reviews failed to demonstrate utility in reliably predicting human toxicological outcomes,

including those associated with the greatest public health concerns, such as carcinogenicity and teratogenicity. Results in animal models were frequently equivocal or inconsistent with human outcomes (Knight, 2011). Since then, numerous additional reviews have yielded similar results. Baker et al. (2014), for example, examined human neurological disease, which has been extensively studied in animal models, resulting in relatively few human treatments (Cheeran et al., 2009; Vesterinen et al., 2010). Similarly, despite reports of the efficacy of more than 1,000 treatments in animal models of multiple sclerosis (MS), very few treatments have progressed to the marketplace (Vesterinen et al., 2010). This usually indicates failures of efficacy or safety concerns in humans. And, despite the widespread use of animal models within stroke research, virtually no interventions described as effective in animal models have proven similarly effective in human patients (Cheeran et al., 2009). There are many other examples.

Several studies have sought to determine the maximal human clinical utility that may be achieved by animal models, by examining chimpanzee experiments, given that chimpanzees are our closest relatives (Knight, 2007); by examining experiments approved by ethics committees on the basis of explicit claims of likely human healthcare benefits (Lindl, Völkel and Kolar, 2005); or by examining highly-cited animal experiments published in leading scientific journals (Hackam and Redelmeier, 2006). Hackam and Redelmeier, for example, located 76 animal experiments, each of which had been cited well over 500 times and published in one of the world's seven top scientific journals when ranked by journal impact factor. Hence, these experiments represented some of the most important and scientifically-interesting animal research published at the time. In only 28 cases (36.8%), animal results were later replicated in humans. Most animal research is neither highly cited nor published in world-leading journals, and successful translation to humans is far lower.

3 Limitations of Animal Models

A variety of factors appear responsible for the poor rates of translation of outcomes from animal studies into human patients and consumers. These relate both to the animal models themselves and to the ways in which they are used. Fundamental biochemical differences between species may result in differences in absorption, distribution, metabolism, and elimination pathways or rates, which may alter *toxico- or pharmaco-kinetics* (i.e., bodily distribution). *Toxico- and pharmaco-dynamics* (mechanisms of action and biological effects) may also be altered. Jointly these factors may contribute to differences in organ systems affected and in the nature and magnitude of those effects (Hartung,

2008; Knight, 2011). Further problems arise from the characteristics of the animals used. Biological variability and predictivity for humans are frequently compromised by restriction to single rodent strains, young animals, and single sexes, usually without concurrent human risk factors, such as common comorbidities, that can alter human responses to *exogenous* (externally-derived) compounds (Hartung, 2008; Knight, 2011).

Additional problems arise from the ways in which the animals are used. Many toxicity tests, for example, rely on *maximum tolerated doses* (above which acute, toxicity-related effects preclude further dosing), and chronic dosing. These factors maximize sensitivity to toxins, with the result that false negative results rarely occur. However, these conditions can also overwhelm the physiological defenses that are effective at environmentally realistic doses, resulting in false positive outcomes. As a result, many compounds that would not normally be considered toxic are falsely indicated as such by animal tests; this substantially decreases the reliability and relevance of any positive result. Additionally, important human routes of exposure (e.g., inhaled) may differ from those tested in animals, requiring extrapolation between routes of exposure, as well as between species, introducing further uncertainty (Gold, Slone and Ames, 1998; Hartung, 2008; Knight, 2011).

Furthermore, animals used in laboratories commonly experience a significant array of stressors. These include stresses incurred during handling, restraint, and other routine laboratory procedures; and, in particular, the stressful routes of dose administration common to toxicity tests. Orogastic gavaging, for example, involves the insertion of a tube into the esophagus for the forced administration of test compounds. Combined with environmental stressors (e.g., due to limited space and environmental enrichment) and social stressors (e.g., due to aggressive interactions between conspecifics), these represent a significant body of stressors. These stressors can alter physiological, hormonal, and immune statuses and even cognitive capacities and behavioral repertoires, in ways that are not always predictable (Balcombe, Barnard and Sandusky, 2004; Balcombe, 2006; Baldwin and Bekoff, 2007). The results may include alterations in the progression of diseases, in bodily responses to chemicals and test pharmaceuticals, and in a range of other scientific outcomes, such as those dependent on accurate determination of physiological, behavioral, or cognitive characteristics (for further discussion see Herrmann, 2019, Chapter 1; Jayne and See, 2019, Chapter 21).

4 Methodological Quality of Animal Studies

As if these were not problem enough, a sizeable body of recent studies and systematic reviews have confirmed the existence of significant methodological

flaws, in most published animal experiments (e.g., Knight, 2008b). Indeed, to date, no systematic reviews appear to have been published in which a majority of animal studies, assessed against appropriate objective criteria, were found to have been of good methodological quality. In particular, a variety of design features must be included within animal experiments to minimize the potential for bias. Hooijmans et al. (2014) described 10 types of bias that have the potential to influence animal experimental results, which they grouped into selection bias, performance bias, detection bias, attrition bias, reporting bias, and other sources of bias. Many of these flaws are highly prevalent within animal studies.

Kilkenny et al. (2009) conducted one of the largest and most comprehensive systematic surveys to date, assessing the experimental design, statistical analysis, and reporting of published animal experiments. 271 papers were examined, which included 72 studies using mice, 86 using non-human primates, and 113 using rats. Most (99%; 269/271) of these papers were published between 2003 and 2005. They covered a wide variety of experimental fields, were published in a comprehensive range of journals, and were funded by leading grant agencies within the United Kingdom and the United States. However, only 59% of these studies clearly stated the hypothesis or objective of the study and the number and characteristics of the animals used. Details, such as animal strain, sex, age, and weight, are all scientifically important and can potentially influence results (Alfaro, 2005; GV-Solas, 1985; Obrink and Reh binder, 2000). Nevertheless, in many cases these details were omitted.

Knowledge of planned treatment (or lack thereof) is one of a number of factors that can unconsciously influence the assignment of animals to treatment groups, for example, when researchers sympathetically select animals they consider weaker, to be used as controls, rather than test animals. The introduction of such confounding factors (in this case, variable animal fitness), can potentially bias results (in this case, selection bias has occurred). Accordingly, randomized selection of animals for treatment groups is mandated, to ensure that outcome differences are most likely due to treatment effects (Festing and Altman, 2002; Festing et al., 2002). Haphazard selection does not give sufficient certainty that results are truly random, so a systematic approach is necessary, such as the use of a random number generator (Kilkenny et al., 2009). Nevertheless, despite its well-acknowledged importance, randomized allocation of animals to test groups was reported in only 12% of these studies.

Another crucial feature of good experimental design concerns the assessment of outcomes. Where qualitative assessments occur, which involve assessor judgements, it is similarly crucial that assessors do not know (are *blinded* to) the treatment (or lack thereof) of the animals assessed, lest such knowledge

subtly affect their judgement (Festing and Altman, 2002). Because, as Cochrane (1972) noted, “When humans have to make observations there is always the possibility of bias,” even unintentional bias. Nevertheless, only 14% (5/35) of all papers in the survey by Kilkenny et al. (2009) that reported qualitative assessment of outcomes, also reported the use of blinding.

Many factors can affect experimental outcomes, so the incorporation of measures to minimize sources of bias is crucial to ensuring the reliability of research results. And yet, 87% of papers, examined by Kilkenny and colleagues, failed to report randomization during animal selection; and 86% failed to report blinded assessment of outcomes. Additionally, only 70% of the publications that used statistical methods described their methods and presented the results with a measure of error or variability. More recently, similar results were found in an even larger study. Vogt et al. (2016) determined the prevalence of seven basic measures against bias (i.e., allocation concealment, blinding, randomization, sample size calculation, inclusion/exclusion criteria, primary outcome variable, and statistical analysis plan), within 1,277 experimental applications approved by Swiss authorities in 2008, 2010, and 2012 and within 50 subsequent publications. Measures against bias were reported at very low rates, both in experimental applications (2%–19%) and in subsequent publications (0%–34%).

The importance of randomization and blinding when comparing two or more experimental groups has been highlighted by reviews of animal research in the field of emergency medicine, which have found that estimates of treatment efficacy were significantly reduced in studies that incorporated these mechanisms to reduce risks of bias (Bebarta, Luyten and Heard, 2003; Macleod et al., 2008). Similar results have been found in numerous other studies. In fact, studies incorporating the fewest measures to minimize sources of bias tended to report the greatest effect sizes (Crossley et al., 2008; Hirst et al., 2014; Macleod et al., 2005; Rooke et al., 2011; Vesterinen et al., 2010). The widespread failure to utilize mechanisms, such as randomization and blinding, appears to result in false expectations of treatment efficacy and reported outcomes in animals often fail to translate into humans. Similar results were reported following a literature review by Holman, Head, Lanfear and Jennions (2015). They found that blind protocols are uncommon in the life sciences, and that non-blind studies tend to report more significant outcomes and higher effect sizes. They noted that: “Observer bias and other ‘experimenter effects’ occur when researchers’ expectations influence study outcome. These biases are strongest when researchers expect a particular result, are measuring subjective variables, and have an incentive to produce data that confirm predictions. To minimize bias, it is good practice to work ‘blind,’ meaning that experimenters

are unaware of the identity or treatment group of their subjects while conducting research” (p. 1).

Another common problem observed by Kilkenny et al. (2009) concerned the transparency of reporting, and the robustness of statistical analysis. Almost 60% of surveyed publications were deficient in these areas. Most studies failed to provide sample sizes or adequate justifications of them. And yet, studies that use too many animals waste animal lives. Conversely, the results of underpowered studies (with insufficient numbers of experimental subjects) cannot be extrapolated to wider populations with sufficient certainty. Accordingly, power analyses or other simple calculations are widely used in human clinical trials to ensure enough subjects (but not more) are present to detect biologically important effects. Indisputably, the same principles should apply to animal studies (Dell, Holleran and Ramakrishnan, 2002; Festing and Altman, 2002).

Unfortunately, methodological flaws appear to be prevalent even within animal research conducted at highly-ranked universities and published in leading journals. After studying 814 randomly-selected studies reporting primary research, 2,671 publications reporting drug efficacy in eight disease models, and 4,859 publications from five UK institutions ranked highest across six units of assessment in biomedical sciences, in the 2008 National Research Assessment Exercise, Macleod et al. (2015) reported that severe deficiencies of experimental design remain the norm. These deficiencies were prevalent in research conducted at leading UK research universities, in research funded by leading UK funding organizations, and in research reported in high-impact journals.

5 Evidence-based Research within Human Clinical Trials

The importance of sound experimental design, and, particularly, the necessity of incorporating factors designed to minimize bias risks have long been recognized within the field of human research. *The Consolidated Standards of Reporting Trials* (CONSORT) Statement for randomized controlled human clinical trials was one of the first guidelines developed to ensure the quality of human-based research. It provides an evidence-based, minimum set of recommendations, including a checklist of 25 recommended items that should be included when reporting randomized human trials (Moher, Schulz and Altman, 2001; Schulz, Altman and Moher, 2010). Since then, more than 90 guidelines have been developed for reporting different types of health research (see Altman et al., 2008; Simera et al., 2010; www.equator-network.org).

An increasing number of leading journals have, subsequently, requested that their authors comply with the CONSORT guidelines (Altman, 2005; Hopewell

et al., 2008). Organizations commending the use of such guidelines include, the Committee on Publication Ethics (n.d.); the Nuffield Council on Bioethics (2005); the Council of Science Editors (2018); and the International Committee of Medical Journal Editors (2015). Subsequent to the widespread endorsement of such guidelines, studies have indicated that the quality and transparency of reports on human clinical trials have improved (Plint et al., 2006; Kane, Wang and Garrard, 2007).

6 Application to Animal Studies

More recently, multiple attempts have been made to introduce similar standards within animal studies. In 2009, Kilkenny and colleagues observed that most biomedical journals provided little or no guidance about the reporting of animal research, other than the requirement to report ethical review of the proposed protocols. They noted the contrast between biomedical journals and those within other several research areas, particularly medical research, in this respect. Accordingly, in 2010, Kilkenny and colleagues proposed the *Animal Research: Reporting of In Vivo Experiments* (ARRIVE) guidelines. Prepared in consultation with scientists, statisticians, journal editors, and research funders, these guidelines comprise a checklist of 20 items, designed to provide minimum information on items, such as the number and specific characteristics of animals used (including species, strain, sex, and genetic background); housing and husbandry conditions; and the experimental, statistical, and analytical methods used. The latter points included measures to reduce bias, such as the random allocation of animals to experimental groups, blinded assessment of outcome measures, statistical justifications of sample sizes, reporting of animals excluded from analyses, exclusion criteria, and any investigator conflicts of interest. The intention was that these items should be included within all scientific publications reporting animal research, thereby allowing critical assessment of methods used and results obtained.

Hooijmans et al. (2010) similarly proposed a *Gold Standard Publication Checklist* (GSPC), which includes 74 items designed to improve the quality of animal studies and to fully integrate 3Rs (“replacement, reduction and refinement”) methods and facilitate their incorporation within systematic reviews and meta-analyses. In 2014, Hooijmans and colleagues also proposed a *Risk of Bias* (RoB) tool to assess methodological quality and risk of bias within animal studies. The tool is based on the similar Cochrane RoB tool (Higgins et al., 2011), which was adjusted for particular aspects of bias that play a role in animal studies.

Other authors have proposed similar guidelines and checklists for the conduct and reporting of animal research. In 2009, Osborne and colleagues from

the Royal Society for the Prevention of Cruelty to Animals (UK) proposed a 12-point assessment scheme for scoring biomedical journals' policies on animal welfare and the 3Rs. And in 2015, Martins and Franco proposed their *Excellence in Editorial Mandatory Policies for Animal Research* (EXEMPLAR) scale, comprising four categories: regulatory compliance, quality of research and reporting of results, animal welfare and ethics, and criteria for the exclusion of papers.

7 Poor Compliance of Animal Studies

Such guidelines provide indisputable benefits in ensuring the reporting of methodological quality, reliability of results, and incorporation of the 3R principles of animal research. The ARRIVE guidelines of Kilkenny et al. (2010) have been published or endorsed by more than 1,000 research journals, including those published by the Nature Publishing Group, PLoS, and BioMed Central (Reichlin, Vogt and Würbel, 2016). They have been similarly endorsed by major UK funding agencies (including the Wellcome Trust, the Biotechnology and Biological Sciences Research Council, and the Medical Research Council); and they also form part of the US National Research Council Institute for Laboratory Animal Research guidelines (Baker et al., 2014). And yet, despite such widespread endorsement, a number of studies have demonstrated that compliance with such guidelines remains poor.

Noting that, "Despite reports of over 1,000 treatments effective in animal models of multiple sclerosis (MS), very few treatments have so far made it to the marketplace following initial development in disease-related animal models (Vesterinen et al., 2010)," Baker et al. (2014) investigated the general adequacy of reporting within animal studies of MS. They uncovered significant inadequacies within the reporting of experimental design, including the selection of appropriate statistical analyses and the application of key points in the ARRIVE guidelines. They observed that the ARRIVE guidelines are not being implemented by authors, reviewers, and journal editors (Baker and Amor, 2012; Landis et al., 2012; Schwarz, Iglhaut and Becker, 2012).

Despite their very widespread publication and endorsement, lack of awareness of such guidelines appears to remain a major problem. After surveying all registered *in vivo* researchers in Switzerland recently, Reichlin et al. (2016) reported that among 302 self-selected participants, 56.3% did not know of the ARRIVE Guidelines. A total of 1,891 researchers were surveyed, but only 302 (16%) returned fully-completed questionnaires and, hence, were not excluded. Even among those whose latest paper was published in a journal that had endorsed the ARRIVE guidelines, 51% had never heard of them.

The failure of biomedical journals to insist on compliance with quality control standards is partly to blame. After surveying 236 biomedical journals' policies on animal research, Osborne et al. (2009) found no mention of animal use, within author guidelines or elsewhere, in 35% of journals studied. In 18% of the journals, animals were mentioned, but no perceptible guidelines were provided; and most of the remaining journals scored poorly, with 37% scoring three or fewer points out of 12 equally weighted items within their quality checklist. Martins and Franco (2015) examined 170 journals that publish studies on animal models of three human diseases, namely Amyotrophic Lateral Sclerosis (ALS, also known as Motor Neuron Disease); Type-1 Diabetes; and Tuberculosis. Their results were broadly similar to the results of a survey by Osborne et al.'s. (2009), when assessing studies using their EXEMPLAR scale. They noted that, "little progress found regarding in-house policies on the ethical treatment of animals is worrisome" (p. 325).

8 Improving Study Quality

A range of measures are strongly warranted to increase the implementation of the 3R principles, the methodological quality of animal research, and the reliability of results and to overcome some of the barriers that currently prevent reliable extrapolation to human outcomes.

Compliance with each of the 3Rs and the ARRIVE guidelines and other best practice standards, during the design, conduct, and reporting of experiments, must become mandatory. Such standards should cover animal sourcing, housing, environmental enrichment, socialization opportunities, appropriate use of anesthetics and analgesics, handling, non-invasive endpoints, and a range of measures designed to minimize sources of bias and to ensure methodological quality. Compliance with such standards should be a necessary condition for securing research funding and ethical approval; licensing of researchers, facilities, and experimental protocols; and publication of subsequent results. Compliance would also facilitate subsequent systematic reviews.

Where journal space constraints limit the description of methodological details, these should be included in supplementary online databases, which are now widely available (Kilkenny et al., 2009). This would also facilitate the transfer of alternative technologies, such as the development of new alternative methods, between institutions (Gruber and Hartung, 2004).

To enable animal researchers and technicians to meet the necessary standards, training and continuing professional development in 3R methodologies and the design, conduct, and reporting of animal research should be compulsory. The existing lack of focus on replacement methods (in favor of refinement methods) must be addressed.

The adoption of measures, such as these, would increase the reliability of research results and would facilitate their use within systematic reviews. Prior to designing any new animal study, researchers should conduct a systematic review to collate, appraise, and synthesize all existing, good-quality evidence relating to their research questions. Such systematic reviews should be similarly required by grant agencies, ethical review committees, other animal-experiment licensing bodies, and journals. Systematic reviews are studies in and of themselves. In recognition of their intrinsic value, and their necessity for informing further research, they should also be readily funded by grant agencies.

To ensure that all such evidence is publicly available, greater efforts must also be made by researchers and editors to publish negative results. Studies that fail to show a treatment effect are often considered less interesting and are, consequently, less likely to be published. The subsequent exclusion of such results from systematic reviews leads to over-estimations of treatment efficacy and partly explains the widespread failures in humans of treatments apparently efficacious in animals.

Within the field of human studies, clinical trial registers allow researchers to learn about existing and prior clinical trials, including those with negative outcomes, before results are formally published. A similar international initiative to register animal studies and their results is warranted (Hooijmans et al., 2014).

Many of these measures will require cooperation and coordination between researchers, regulators, licensing bodies, ethical review committees, funding bodies, journals, and authors. And of course, the necessary willingness, among all parties, to change. If these measures were to be successfully implemented throughout the broad field of animal research, then we may be able to predict treatment effects accurately within the animal species under study. However, interspecies differences will remain in absorption, distribution, metabolism, and elimination pathways or rates, resulting in differing toxico- or pharmaco-kinetics and dynamics and, subsequently, differences in the organ systems affected and in the nature and magnitude of these effects. Such factors, which reflect the intrinsic complexity of living organisms, will continue to pose barriers to extrapolation to humans that will remain insurmountable, in many cases.

9 Impacts on Laboratory Animals

Human patients are far from the only victims of poorly conducted, poorly predictive, animal research. A wide variety of stressors have the potential to

cause significant stress, fear, and possibly distress in laboratory animals. These stressors may be associated with the capture of wild-sourced species, such as primates, to supply laboratories or breeding centers; with transportation, which may be prolonged for some animals; with laboratory housing and environments; and with both routine and invasive laboratory procedures (see Knight, 2011). An *invasive* procedure is an intervention that interferes with bodily integrity through puncture, incision, or insertion of an instrument or foreign material, as in surgical and some experimental procedures (Knight, 2011).

A large minority of all procedures are markedly invasive. These include procedures resulting in death (whether or not the animals are conscious); surgical procedures (excluding very minor operative procedures); major physiological challenges; and the production of genetically-modified animals. Few regions report procedural invasiveness, but Canada does. From 1996–2008 inclusively, the proportion of markedly invasive procedures reported in Canada ranged between approximately 29%–44% (Canadian Council on Animal Care, 2009). These procedures were defined by the Canadian Council on Animal Care (2009) as resulting in moderate to severe stress or discomfort (Category D); or in severe pain near, at, or above the pain tolerance threshold of unanesthetized conscious animals (Category E) compared to procedures resulting in little or no discomfort or stress (Category B) or minor stress or pain of short duration (Category C).

A sizeable majority of all procedures utilize no anesthetics of any kind. Few regions report anesthetic usage, but Britain does. During two recent decades (1998–2009), the proportion of procedures conducted in the UK without anesthesia fluctuated between approximately 59%–69% (Home Office, 2010). For example, in 2009, at the end of this period, 66.7% of cases did not utilize any form of anesthesia. General anesthesia was provided throughout or at the end of terminal procedures in 9.5% of cases. In 17.1% of cases, general anesthesia with recovery was provided, and in 6.7% of cases, local anesthesia (Home Office, 2010).

To assess animal impacts further, it is helpful to know the frequency of analgesic (pain-killer) use, and the level of correlation between markedly invasive procedures and anesthetic or analgesic use (See Herrmann and Flecknell (2018) for a review of original animal research proposals). Painful or invasive procedures warrant anesthesia and/or analgesia. Animal welfare is adversely affected when animals undergoing such procedures are denied these; or conversely, when they are provided without sufficient need (due to their potential side effects), although this is rare in practice. It would also be helpful to study the prevalence of environmental enrichment and socialization opportunities. Unfortunately, such information remains largely unreported.

10 Conclusions

Animal research is a mechanism by which we seek to increase our understanding of the biological world. The major useful applications of this knowledge lie in the development of new therapies for combatting human diseases and in predicting the human toxicity of chemicals used for a wide range of purposes. As we have seen, however, the actual efficacy of animal research for these purposes is very low. This is due to a range of causes, some of which are, at least theoretically, amenable to change and some of which are not.

When formulating social policy pertaining to animal research, the social benefits realized are only part of the equation. The other major part that must be considered concerns the resources consumed by this research. The very substantial financial and scientific resources consumed by animal research are consequently unavailable to other fields, some of which, such as preventative healthcare or human clinical research, may well be expected to produce greater gains for public health. And as we have seen, the impacts on animals are also severe. 127 million living non-human vertebrates were used worldwide in 2005, the most recent year for which an evidence-based global estimate was available. Based on figures from countries, such as Canada and the UK, where these are published, a large minority of all procedures are markedly invasive; and a sizeable majority utilize (or at least report) no anesthetics of any kind.

The core ethical principle underpinning modern animal experimentation regulation and policy is that the likely benefits of such research must outweigh its expected costs. This utilitarian harm-benefit analysis underpins all fundamental regulation governing animal experimentation. For example, European Directive 2010/63/EU on the protection of animals used for scientific purposes, which directs such animal use in all EU Member States, asserts that it is “essential, both on moral and scientific grounds, to ensure that each use of an animal is carefully evaluated as to the scientific or educational validity, usefulness, and relevance of the expected result of that use. The likely harm to the animal should be balanced against the expected benefits of the project” (European Parliament, 2010, p. 37).

When considering harms and benefits overall, one cannot reasonably conclude that the benefits accrued for human patients or consumers, or those motivated by scientific curiosity or profit, exceed the harms incurred by animals subjected to scientific procedures. On the contrary, evidence indicates that actual human benefit is rarely, if ever, sufficient to justify such harms. And those harms are not limited to the many millions of animals used. Others potentially affected include patients and consumers. The social and ethical implications are profound, when consumers suffer serious toxic reactions to products

assessed as safe in animal studies, or if patients with serious conditions are denied effective clinical interventions, partly because potentially more efficacious research fields are under-resourced (Knight, 2011).

A paradigm change in scientific animal use is clearly warranted. Instead of uncritically assuming the benefits of animal research, we must subject it to much more rigorous and critical evaluation. Where animal research continues to persist, a broad range of measures must be implemented to improve substantially its methodological quality and compliance with the 3Rs and to maximize the reliability of subsequent results (Knight, 2011). When such research fails to meet the harm-benefit standards expected by society, which underpin legislative instruments, such as Directive 2010/63/EU, then such research should cease; and the resources consumed by it directed into more promising and justifiable fields of research and healthcare.

References

- Alfaro, V. (2005). Specification of Laboratory Animal Use in Scientific Articles: Current Low Detail in the Journal's Instructions for Authors and Some Proposals. *Methods and Findings in Experimental and Clinical Pharmacology*, 27(7), pp. 495–502.
- Altman, D.G. (2005). Endorsement of the CONSORT Statement by High Impact Medical Journals: Survey of Instructions for Authors. *British Medical Journal*, 330, pp. 1056–1057.
- Altman, D.G., I. Simera, J. Hoey, D. Moher and K. Schulz (2008). EQUATOR: Reporting Guidelines for Health Research. *Lancet*, 371, pp. 1149–1150.
- Baker, D. and S. Amor (2012). Publication Guidelines for Refereeing and Reporting on Animal Use in Experimental Autoimmune Encephalomyelitis. *Journal of Neuroimmunology*, 242, pp. 78–83.
- Baker, D., K. Lidster, A. Sottomayor and S. Amor (2014). Two Years Later: Journals are Not Yet Enforcing the ARRIVE Guidelines on Reporting Standards for Preclinical Animal Studies. *PLoS Biology*, 12(1), p. e1001756.
- Balcombe, J. (2006). Laboratory Environments and Rodents' Behavioural Needs: A Review. *Laboratory Animals*, 40, pp. 217–235.
- Balcombe, J., N. Barnard and C. Sandusky (2004). Laboratory Routines Cause Animal Stress. *Contemporary Topics in Laboratory Animals Science*, 43, pp. 42–51.
- Baldwin, A. and M. Bekoff (2007). Too Stressed to Work. *New Scientist*, 194(2606), p. 24.
- Bebarta, V., D. Luyten and K. Heard (2003). Emergency Medicine Animal Research: Does Use of Randomization and Blinding Affect the Results? *Academic Emergency Medicine*, 10(6), pp. 684–687.
- Bentham, J. (1823). *Introduction to the principles of morals and legislation*, 2nd ed. Oxford: Clarendon Press.

- Brom, F.W. (2002). Science and Society: Different Bioethical Approaches Towards Animal Experimentation. *Alternatives to Animal Experimentation*, 19, pp. 78–82.
- Canadian Council on Animal Care (CCAC) (2009). *2008 CCAC Survey of Animal Use*. Ottawa: CCAC. [online] Available at: http://ccac.ca/Documents/Publications/Statistics/Survey_2008.pdf [Accessed 6 February 2011].
- Cheeran, B., L. Cohen, B. Dobkin, G. Ford, R. Greenwood, D. Howard, M. Husain, M. Macleod, R. Nudo, J. Rothwell and A. Rudd (2009). The Future of Restorative Neurosciences in Stroke: Driving the Translational Research Pipeline from Basic Science to Rehabilitation of People After Stroke. *Neurorehabilitation and Neural Repair*, 23(2), pp. 97–107.
- Cochrane, A.L. (1972). The History of the Measurement of Ill Health. *International Journal of Epidemiology*, 1, pp. 89–92.
- Committee on Publication Ethics (COPE) (n.d.). *COPE Best Practice Guidelines for Journal Editors*. [online] Available at: http://publicationethics.org/files/u2/Best_Practice.pdf [Accessed 12 October 2016].
- Council of Science Editors (CSE)—Editorial Policy Committee (2018). *CSE's White Paper on Promoting Integrity In Scientific Journal Publications, 2018 Update*. [online] Available at: https://www.councilscienceeditors.org/wp-content/uploads/CSE-White-Paper_2018-update-050618.pdf [Accessed 22 January 2010].
- Court, W.E. (2005). Pharmacy from the Ancient World to 1100 AD. In: S. Anderson, ed., *Making Medicines: A Brief History of Pharmacy and Pharmaceuticals*. London: Pharmaceutical Press, pp. 21–36.
- Crossley, N.A., E. Sena, J. Goehler, J. Horn, B. van der Worp, P.M. Bath, M. Macleod and U. Dirnagl (2008). Empirical Evidence of Bias in the Design of Experimental Stroke Studies. A Meta-epidemiologic Approach. *Stroke*, 39(3), pp. 929–934.
- Cruelty Free International (n.d.). *About Us*. [online] Available at: <https://www.crueltyfreeinternational.org/who-we-are/about-us> [Accessed 7 May 2017].
- Dell, R.B., S. Holleran and R. Ramakrishnan (2002). Sample Size Determination. *Institute for Laboratory Animal Research Journal*, 43(4), pp. 207–213.
- Descartes, R. (1989). Animals are machines. In: T. Regan and P. Singer, eds., *Animal Rights and Human Obligations*, 2nd ed., Upper Saddle River, NJ: Prentice Hall, pp. 13–19.
- European Commission (EC) (2013). *Commission Staff Working Document*. Accompanying document to the seventh report on the statistics on the number of animals used for experimental and other scientific purposes in the member states of the European Union. Brussels: EC. [online]. Available at: http://ec.europa.eu/environment/chemicals/lab_animals/reports_en.htm [Accessed 01 October 2016].
- European Parliament (2010). Directive 2010/63/EU of the European Parliament and of the Council of 22 September 2010 on the protection of animals used for scientific purposes. *Official Journal of the European Communities*, L276, pp. 33–79. [online]

- Available at: <http://eur-lex.europa.eu/legal-content/EN/TXT/?uri=CELEX%3A32010L0063> [Accessed 12 August 2017].
- Festing, M.F. (2004). Is the Use of Animals in Biomedical Research Still Necessary in 2002? Unfortunately, "Yes." *Alternatives to Laboratory Animals*, 32(1B), pp. 733–739.
- Festing, M.F. and D.G. Altman (2002). Guidelines for the Design and Statistical Analysis of Experiments Using Laboratory Animals. *ILAR Journal*, 43(3), pp. 244–258.
- Festing, M.F., P. Overend, R. Gaines Das, M. Cortina-Borja and M. Berdoy (2002) The design of animal experiments: Reducing the use of animals in research through better experimental design. In: *Laboratory Animal Handbooks*, 14. London: Royal Society of Medicine Press Ltd., pp. 1–16.
- Franco, N.H. (2013). Animal Experiments in Biomedical Research: A Historical Perspective. *Animals* 3(1), pp. 238–273.
- Gold, L.S., T.H. Slone and B.N. Ames (1998). What Do Animal Cancer Tests Tell Us about Human Cancer Risk? Overview of Analyses of the Carcinogenic Potency Database. *Drug Metabolism Reviews*, 30, pp. 359–404.
- Greek, C.R. and J.S. Greek (2002). *4th World Congress Point/Counterpoint: Is Animal Research Necessary in 2002?*. Los Angeles: Americans for Medical Advancement.
- Gruber, F.P. and T. Hartung (2004). Alternatives to Animal Experimentation in Basic Research. *Alternatives to Animal Experimentation*, 21, pp. 3–31.
- Hackam, D.G. and D.A. Redelmeier (2006). Translation of Research Evidence from Animals to Humans. *Journal of the American Medical Association*, 296, pp. 1731–1732.
- Hartung, T. (2008). Food for Thought ... On Animal Tests. *Alternatives to Animal Experimentation*, 25(1), pp. 3–9.
- Herrmann, K. and Flecknell, P. A. (2018). Retrospective review of anesthetic and analgesic regimens used in animal research proposals. *Alternatives to Animal Experimentation preprint*, [online] Available at: <https://www.altex.org/index.php/altex/article/view/780/1162> [Accessed 14 September 2018].
- Higgins, J.P., D.G. Altman, P.C. Gøtzsche, P. Jüni, D. Moher, A.D. Oxman, J. Savović, K.F. Schulz, L. Weeks and J.A. Sterne (2011). The Cochrane Collaboration's Tool for Assessing Risk of Bias in Randomised Trials. *British Medical Journal*, 343, p. d5928.
- Hirst, J.A., J. Howick, J.K. Aronson, N. Roberts, R. Perera, C. Koshiaris and C. Heneghan (2014). The Need for Randomization in Animal Trials: An Overview of Systematic Reviews. *PLoS ONE*, 9(6), p. e98856.
- Holman, L., M.L. Head, R. Lanfear and M.D. Jennions (2015) Evidence of Experimental Bias in the Life Sciences: Why We Need Blind Data Recording. *PLoS Biology*, 13(7), p. e1002190.
- Home Office (2010) *Statistics of Scientific Procedures on Living Animals: Great Britain 2009*. London: The Stationery Office .

- Hooijmans, C.R., M. Leenaars and M. Ritskes-Hoitinga (2010). A Gold Standard Publication Checklist to Improve the Quality of Animal Studies, to Fully Integrate the Three Rs, and to Make Systematic Reviews More Feasible. *Alternatives to Laboratory Animals*, 38, pp. 167–182.
- Hooijmans, C.R., M.M. Rovers, R.B. de Vries, M. Leenaars, M. Ritskes-Hoitinga and M.W. Langendam (2014). SYRCLE's Risk of Bias Tool for Animal Studies. *BMC Medical Research Methodology*, 14(1), p. 43.
- Hopewell, S., D.G. Altman, D. Moher and K.F. Schulz (2008) Endorsement of the CONSORT Statement by High Impact Factor Medical Journals: A Survey of Journal Editors and Journal "Instructions to Authors." *Trials*, 9, p. 20.
- International Committee of Medical Journal Editors (2015). *Recommendations for the Conduct, Reporting, Editing, and Publication of Scholarly Work in Medical Journals*. [online] Available at: <http://www.icmje.org/icmje-recommendations.pdf> [Accessed 12 October 2016].
- Kane, R.L., J. Wang and J. Garrard (2007). Reporting in Randomized Clinical Trials Improved after Adoption of the CONSORT Statement. *Journal of Clinical Epidemiology*, 60, pp. 241–249.
- Kilkenny, C., W.J. Browne, I.C. Cuthill, M. Emerson and D.G. Altman (2010). Improving Bioscience Research Reporting: The ARRIVE Guidelines for Reporting Animal Research. *PLoS Biology*, 8, p. e1000412.
- Kilkenny, C., N. Parsons, E. Kadyszewski, M.F. Festing, I.C. Cuthill, D. Fry, J. Hutton and D.G. Altman (2009) Survey of the Quality of Experimental Design, Statistical Analysis, and Reporting of Research Using Animals. *PLoS ONE*, 4(11), p. e7824.
- Knight, A. (2007). The Poor Contribution of Chimpanzee Experiments to Biomedical Progress. *Journal of Applied Animal Welfare Science*, 10(4), pp. 281–308.
- Knight, A. (2008a). 127 Million Non-human Vertebrates Used Worldwide for Scientific Purposes in 2005. *Alternatives to Laboratory Animals*, 36, pp. 494–496.
- Knight, A. (2008b). Systematic Reviews of Animal Experiments Demonstrate Poor Contributions to Human Healthcare. *Reviews on Recent Clinical Trials*, 3, pp. 89–96.
- Knight, A. (2011). *The costs and benefits of animal experiments*. Houndmills, Basingstoke, UK: Palgrave Macmillan.
- Landis, S.C., S.G. Amara, K. Asadullah, C.P. Austin, R. Blumenstein, E.W. Bradley, R.G. Crystal, R.B. Darnell, R.J. Ferrante, H. Fillit and R. Finkelstein (2012). A Call for Transparent Reporting to Optimize the Predictive Value of Preclinical Research. *Nature*, 490, pp. 187–191.
- Lindl, T., M. Völkel and R. Kolar (2005). Tierversuche in der Biomedizinischen Forschung. Eine Bestandsaufnahme der Klinischen Relevanz von Genehmigten Tierversuchsvorhaben. [Animal experiments in biomedical research. An evaluation of the clinical relevance of approved animal experimental projects.] *Alternatives to Animal Experimentation* 22(3), pp. 143–151.

- Macleod, M.R., A.L. McLean, A. Kyriakopoulou, S. Serghiou, A. de Wilde, N. Sherratt, T. Hirst, R. Hemblade, Z. Bahor, C. Nunes-Fonseca, A. Potluru, A. Thomson, J. Baginskaite, K. Egan, H. Vesterinen, G.L. Currie, L. Churilov, D.W. Howells and E.S. Sena (2015) Risk of Bias in Reports of *In Vivo* Research: A Focus for Improvement. *PLoS Biology*, 13(10), p. e1002273.
- Macleod, M.R., T. O'Collins, L.L. Horky, D.W. Howells and G.A. Donnan (2005). Systematic Review and Meta-analysis of the Efficacy of FK506 in Experimental Stroke. *Journal of Cerebral Blood Flow and Metabolism*, 25(6), pp. 713–721.
- Macleod, M.R., H.B. van der Worp, E.S. Sena, D.W. Howells, U. Dirnagl and G.A. Donnan (2008). Evidence for the Efficacy of NXY – 059 in Experimental Focal Cerebral Ischemia Is Confounded by Study Quality. *Stroke*, 39, pp. 2824–2829.
- Maehle, A.H. and U. Tröhler (1990). Animal experimentation from antiquity to the end of the eighteenth century: Attitudes and arguments. In N.A. Rupke, ed., *Vivisection in Historical Perspective*. London: Routledge, pp. 14–47.
- Martins, A.R. and N.H. Franco (2015). A Critical Look at Biomedical Journals' Policies on Animal Research by Use of a Novel Tool: The EXEMPLAR Scale. *Animals*, 5(2), pp. 315–331.
- Moher, D., A. Liberati, J. Tetzlaff and D.G. Altman (2009). Preferred Reporting Items for Systematic Reviews and Meta-analyses: The PRISMA Statement. *PLoS Medicine*, 6, p. e1000097. [online] Available at: <http://journals.plos.org/plosmedicine/article?id=10.1371/journal.pmed.1000097> [Accessed 26 June 2017].
- Moher, D., K.F. Schulz and D.G. Altman (2001). The CONSORT Statement: Revised Recommendations for Improving the Quality of Reports of Parallel-group Randomized Trials. *Lancet*, 357, pp. 1191–1194.
- National Anti-Vivisection Society (NAVS) (2012). *The History of the NAVS*. [online] Available at: http://www.navs.org.uk/about_us/24/0/299/ [Accessed 07 May 2017].
- Nuffield Council on Bioethics (2005). Discussion and recommendations. In: *The Ethics of Research Involving Animals*, Chapter 15, 313. [online] Available at: <http://nuffieldbioethics.org/wp-content/uploads/The-ethics-of-research-involving-animals-full-report.pdf> [Accessed 26 January 2010].
- O'Malley, C.D. (1964). *Andreas Vesalius of Brussels*. Berkeley: University of California Press.
- Obrink, K.J. and C. Rehlinger (2000). Animal Definition: A Necessity for the Validity of Animal Experiments?. *Laboratory Animals*, 34, pp. 121–130.
- Ormandy, E.H., C.A. Schuppli and D.M. Weary (2009). Worldwide Trends in the Use of Animals in Research: The Contribution of Genetically-modified Animal Models. *Alternatives to laboratory animals*, 37, pp. 63–68.
- Osborne, N.J., D. Payne and M.L. Newman (2009). Journal Editorial Policies, Animal Welfare, and the 3Rs. *American Journal of Bioethics*. 9, pp. 55–59.

- Pawlik, W.W. (1998). Znaczenie Zwierząt w Badaniach Biomedycznych. [The significance of animals in biomedical research]. *Folia Medica Cracoviensia*, 39, pp. 175–182.
- Plint, A.C., D. Moher, A. Morrison, K. Schulz, D.G. Altman, C. Hill and I. Gaboury (2006). Does the CONSORT Checklist Improve the Quality of Reports of Randomised Controlled Trials? A SYSTEMATIC REVIEW. *Medical Journal of Australia*, 185, pp. 263–267.
- Reichlin, T.S., L. Vogt and H. Würbel (2016). The Researchers' View of Scientific Rigor—Survey on the Conduct and Reporting of *In Vivo* Research. *PLoS ONE*, 11(12), p. e0165999.
- Rooke, E.D., H.M. Vesterinen, E.S. Sena, K.J. Egan and M.R. Macleod (2011). Dopamine Agonists in Animal Models of Parkinson's Disease: A Systematic Review and Meta-analysis. *Parkinsonism Related Disorders*, 17(5), pp. 313–320.
- Schulz, K.F., D.G. Altman and D. Moher (2010). CONSORT 2010 Statement: Updated Guidelines for Reporting Parallel Group Randomised Trials. *British Medical Journal*, 340, p. c332.
- Schwarz, F., G. Iglhaut and J. Becker (2012). Quality Assessment of Reporting of Animal Studies on Pathogenesis and Treatment of Peri-implant Mucositis and Peri-implantitis. A Systematic Review Using the ARRIVE Guidelines. *Journal of Clinical Periodontology*, 39(12), pp. 63–72.
- Simera, I., D. Moher, J. Hoey, K.F. Schulz and D.G. Altman (2010). A Catalogue of Reporting Guidelines for Health Research. *European Journal of Clinical Investigation*, 40, pp. 35–53.
- Taylor, K., N. Gordon, G. Langley and W. Higgins (2008). Estimates for Worldwide Laboratory Animal Use in 2005. *Alternatives to Laboratory Animals*, 36(3), pp. 327–342.
- Vesterinen, H.M., E.S. Sena, C. French-Constant, A. Williams, S. Chandran and M.R. Macleod (2010). Improving the Translational Hit of Experimental Treatments in Multiple Sclerosis. *Multiple Sclerosis*, 16(9), pp. 1044–1055.
- Vogt, L., T.S. Reichlin, C. Nathues and H. Würbel (2016). Authorization of Animal Experiments Is Based on Confidence Rather Than Evidence of Scientific Rigor. *PLoS Biology*, 14(12), p. e2000598.
- von Staden, H. (1989). *Herophilus: The art of medicine in early Alexandria*. Cambridge: Cambridge University Press.
- Working Committee for the Biological Characterisation of Laboratory Animals (GV-Solas) (1985). Guidelines for Specification of Animals and Husbandry Methods When Reporting the Results of Animal Experiments. *Laboratory Animals*, 19, pp. 106–108.

Extrapolation of Animal Research Data to Humans: An Analysis of the Evidence

Rebecca Ram

Clinical Data Management and Scientific Research Consultant

rebeccanram@aol.com

The *ethical* arguments against animal experimentation remain ever-strong. In addition, the *scientific* case against the use of animals in research grows more compelling, with exponential progress in the development of alternative methods and new research technologies. The Dutch authorities recently announced an ambitious, but welcome, proposal to phase out “the use of laboratory animals in regulatory safety testing of chemicals, food ingredients, pesticides and (veterinary) medicines” by 2025, as well as “the use of laboratory animals for the release of biological products, such as vaccines” (Netherlands National Committee for the protection of animals used for scientific purposes, NCad, 2016, p. 3). National government departments (e.g., the United Kingdom, UK, Home Office) have stated that alternatives to animals are now considered necessary for scientific as much as ethical reasons, also conceding that pressure exists within the research community to use animals in order to *get published*. Furthermore, only 20% of animal tests across the European Union (EU) each year are conducted to meet regulatory requirements, with the vast majority carried out as basic research (including basic medical research) or breeding of genetically modified (GM) animals at academic institutions (European Commission, 2013b).

Despite the strength of both scientific and moral arguments, animal research continues to increase worldwide, especially given the rising trend in use of GM animals. A *Catch 22* situation also exists, with regulators largely refusing to break with tradition and continuing to accept only animal data, even when robust human-based data exists. Additionally, when new animal-free, human-relevant methods are developed, regulators often insist that research still be performed on animals; this is considered to be one of the major barriers to achieving change and, in turn, results in an industry reluctant to invest

in non-animal research, if its results are unlikely to be accepted (Schiffelers et al., 2012).

Whilst public engagement, via campaigns to highlight animal suffering, remains vital, a renewed focus on scientific, political, and financial interests is needed. This focus is needed to emphasize the fundamental message that animal research simply does not deliver what is needed, in order to influence those who regulate, finance, or approve animal experiments and have a meaningful impact on their ongoing *reduction* but primarily, their *replacement*. Scientific evidence is needed, on an ongoing basis, of the inadequacy of animal experiments in predicting human outcomes, combined with a focus on the modern, non-animal techniques that have the potential to replace them, to drive an ongoing recognition of the need for genuine, significant investment in human-relevant research. Additionally, not all animal tests *need* replacing, many can simply end; so providing appropriate evidence of these types of tests is also essential.

In striving to achieve a paradigm shift to end animal experimentation, for scientific as much as ethical reasons, an evidence-based approach is required. There remains a vital need for a combination of drivers in innovative, animal-free scientific research, training, and education, as well as continued lobbying and campaigning to key stakeholders (i.e., scientists, regulators, and political audiences).

Animal experimentation falls into two broad categories: basic research (including basic medical research) and a relatively smaller category, toxicity (or safety) testing of new substances, which includes chemicals for use in personal care, household products, industrial substances, foodstuffs, or pharmaceuticals (the latter are also tested for efficacy). There is overlap, to some extent, in these categories, with some animal procedures categorized as “fundamental toxicology”, for example. A two-fold strategy is suggested to end the use of animals in all experimental research. The first should focus on how a large number of procedures performed, both in basic research and product-safety testing, can simply end *today*; in other words, they do not *need* non-animal replacements. The second should focus on procedures that are considered to require replacement. This could be through intelligent and strategic combinations of *existing* non-animal tests (integrated testing strategies) and/or further development of *new* human-relevant models. Examples of these and their success in replacing animals to date are discussed later in this chapter.

A popular argument in support of continuing animal research is that they have been used for decades in the research and development of new medicines. The fact that millions of animals have been used over years, often in the same repeated experiments, is not in dispute. However, their continued

use does not prove *necessity*. It is also relevant to note that from early on in a scientific career, one is discouraged from saying that experiments “didn’t work” but instead, to conclude how further research or new approaches must be tried next, in light of unsuccessful or unexpected results. The use of animals has been grandfathered through, due to convention, anecdotal evidence or belief, rather than robust scientific validity. “*We must use a living system*” ... but it is the *wrong* living system and no matter how many animals are used, they will never provide an appropriate model for humans. This needs to change, particularly when considering the growing industry of breeding and supplying millions of GM animals worldwide each year, in repeated attempts to mimic the human condition.

The vast majority of animals are used either for basic research or breeding of GM strains. This is clear when reviewing recent official statistics for the three highest animal-using countries in the EU; the UK, Germany, and France. For example, more than 3.9 million procedures on animals (mice, rats, rabbits, guinea pigs, dogs, horses, cats, non-human primates, pigs, sheep, cattle, birds, xenopus, and fish, among other species) were carried out in the UK in 2016. Of these, 729,390 were genetically modified, including more than 149,000 animals deliberately bred to suffer a harmful phenotype (a deliberately induced condition, such as cancer, failed immune system, or organ failure to try to simulate disease in humans). There were also increases in the number of experiments across several species, and a significant number of experiments for ingredients in household products (1700 procedures), to meet industrial chemicals legislation requirements, despite a policy on testing for such purposes (Home Office, 2017). In fact, of the total 3.9 million procedures conducted in the UK in 2016, only 13% were carried out for regulatory purposes. Germany bred 1.2 million GM animals in 2015 (with similar numbers of harmful phenotype animals to the UK), representing 42% of the 2.8 million animals used annually (Federal Ministry of Food and Agriculture, 2016). Figures reported for France in 2014 show that 1.8 million animals were used, however the proportion of GM animals was not reported (Ministry of Higher Education & Research, 2016).

Several thousand diseases affect humans. Of these, only 500 currently have FDA-approved treatments available (National Center for Advancing Translational Sciences, 2017). In every discipline of disease research, animals are used on an ongoing basis, yet it is continually reported that mechanisms of human conditions investigated in such animals are still not understood. This is because basic research in animals is a demand-driven and self-perpetuating system, with much research being proposed and licensed on the basis of being repetitively performed on animals (often termed as “well established” or “well documented” models). Such research is neither legally required, nor does it

have to be relevant or applicable to human disease to be licensed. Another key barrier to replacing animals, even when scientifically valid alternatives are available, is awareness and acceptance of their use, both by researchers and regulators (Ramirez et al., 2015).

The first part of this chapter provides an analysis of extrapolation of animal studies to humans, by sampling systematic reviews carried out to assess evidence of clinical translation and incorporating a review of literature on animal toxicity studies for some well-known, established *case study* drugs (e.g., paracetamol, aspirin, penicillin) and animal versus human findings. The second part addresses drivers for change and the development of animal-free (or rather, *human-relevant*) research methods, as well as some examples of procedures that do not need replacing as they can simply stop, when considering that they can logically be avoided or rejected on the basis of a correctly performed (and legally required) harm-benefit assessment. The chapter aims to provide an overview of the above topics and suggestions for the way forward as part of a new paradigm for a global, animal-research free future.

1 Part 1: Analysis of Abstracts from Systematic Reviews of Animal Studies

To carry out an analysis of systematic reviews on animal experiments, a review of a sample of available literature was performed. The intention of this analysis was to provide a generally qualitative review of the literature. To do so, two separate sources were used. First, a search in PubMed (National Centre for Biotechnology Information, 2016) was made using the keyword search of “systematic review animal studies.” This resulted in a total of 163,585 publications. PubMed allows search by *Article Type* and selecting this as “systematic review” further filtered results to 8,291 listings, also sorted by relevance. Second, the Google Scholar database, using the same search terms, “systematic review animal studies,” for consistency, yielded 2,530,000 results (Google Scholar, 2016). Dates of publications ranged from 1999–present. Generally, PubMed provided more recent listings compared to Google Scholar, which resulted in older publications; but this was useful to provide a greater scope for review over the past two decades as well as avoid duplication.

To account for time constraints, while still providing a reasonable sample size, the first 50 abstract listings within each source were reviewed, giving a sample total of 100 (see Table 15.1). If a publication appeared within both sources, this was also accounted for, although duplicates were relatively few. Where publications were found to be not relevant, further listings were reviewed to compensate for this and to maintain a total of 100.

TABLE 15.1 Publications included in abstract review (n=100)

Number	Reference	Source
1	Andersen, K., Pedersen, T.K., Hauge, E.M., Schou, S. and Nørholt, S.E. (2014). Effect of Mandibular Distraction Osteogenesis on the Temporomandibular Joint: A Systematic Review of Animal Experimental Studies. <i>Oral Surgery, Oral Medicine, Oral Pathology, Oral Radiology</i> , 117(4), pp. 407–415	PubMed
2	Belkouch, M., Hachem, M., Elgot, A., Van, A.L., Picq, M., Guichardant, M., Lagarde, M. and Bernoud-Hubac, N. (2016). The Pleiotropic Effects of Omega-3 Docosahexaenoic Acid on the Hallmarks of Alzheimer's Disease. <i>Journal of Nutritional Biochemistry</i> , 38, pp. 1–11.	PubMed
3	Bero, L., Anglemyer, A., Vesterinen, H. and Krauth, D. (2016). The Relationship Between Study Sponsorship, Risks of Bias, and Research Outcomes in atrazine Exposure Studies Conducted in Non-human Animals: Systematic Review and Meta-analysis. <i>Environment International</i> , 92–93, pp. 597–604.	PubMed
4	Briel, M., Müller, K.F., Meerpohl, J.J., von Elm, E., Lang, B., Motschall, E., Gloy, V., Lamontagne, F., Schwarzer, G. and Bassler, D. (2013). Publication Bias in Animal Research: A Systematic Review Protocol. <i>Systematic Reviews</i> , 27(2), p. 23.	PubMed
5	Carvalho-Lobato, P., Garcia, V.J., Kasem, K., Ustrell-Torrent, J.M., Tallón-Walton, V. and Manzanares-Céspedes, M.C. (2014). Tooth Movement in Orthodontic Treatment with Low-level Laser Therapy: A Systematic Review of Human and Animal Studies. <i>Photomedicine and Laser Surgery</i> , 32(5), pp. 302–309.	PubMed
6	Chiu, K., Robson, S., Devi, J., Woodward, A. and Whittem T. (2016). The Cardiopulmonary Effects and Quality of Anesthesia After Induction with Alfaxalone in 2-hydroxypropyl- β -cyclodextrin in Dogs and Cats: A Systematic Review. <i>Journal of Veterinary Pharmacology and Therapeutics</i> , 39(6), pp. 525–538.	PubMed
7	Disma, N., Mondardini, M., Terrando, N., Absalom, A. and Bilotta, F. (2016). A Systematic Review Of Methodology Applied During Preclinical Anesthetic Neurotoxicity Studies: Important Issues and Lessons Relevant to the Design of Future Clinical Research. <i>Paediatric Anaesthesia</i> , 26(1), pp. 6–36.	PubMed
8	Emmens, R., Wouters, D., Zeerleder, S., van Ham, S., Niessen, H. and Krijnen, P. (2016). On the Value of Therapeutic Interventions Targeting the Complement System in Acute Myocardial Infarction. <i>Translational Research</i> , pp. S1931–5244.	PubMed

TABLE 15.1 Publications included in abstract review (n=100) (cont.)

Number	Reference	Source
9	Faggion, C.M. Jr., Chambrone, L., Gondim, V., Schmitter, M. and Tu, Y.K. (2010). Comparison of the Effects of Treatment of Peri-implant Infection in Animal and Human Studies: Systematic Review and Meta-analysis. <i>Clinical Oral Implants Research</i> , 21(2), pp. 137–147.	PubMed
10	Faggion, C., Giannakopoulos, N. and Listl, S. (2011). Risk of Bias of Animal Studies on Regenerative Procedures for Periodontal and Peri-implant Bone Defects. A Systematic Review. <i>Journal of Clinical Periodontology</i> . 38(12), pp. 1154–1160.	PubMed
11	Fliefel, R., Kühnisch, J., Ehrenfeld, M. and Otto, S. (2016). Gene Therapy for Bone Defects in Oral and Maxillofacial Surgery: A Systematic Review and Meta-analysis of Animal Studies. <i>Stem Cells Development</i> , Epub ahead of print.	PubMed
12	Gates, S., Smith, J.L., Ong, G.J., Brace, S.J. and Perkins, G.D. (2012). Effectiveness of the LUCAS Device for Mechanical Chest Compression After Cardiac Arrest: Systematic Review of Experimental, Observational and Animal Studies. <i>Heart</i> , 98(12), pp. 908–913.	PubMed
13	Gulin, J.E., Rocco, D.M. and García-Bournissen, F. (2015). Quality of Reporting and Adherence to ARRIVE Guidelines in Animal Studies for Chagas Disease Preclinical Drug Research: A Systematic Review. <i>Public Library of Science Neglected Tropical Diseases</i> , 20:9(11).	PubMed
14	Hirst, T.C., Watzlawick, R., Rhodes, J.K., Macleod, M.R. and Andrews, P.J. (2016). Study Protocol: A Systematic Review and Meta-analysis of Hypothermia in Experimental Traumatic Brain Injury: Why Have Promising Animal Studies Not Been Replicated in Pragmatic Clinical Trials?. <i>Evidence-based Preclinical Medicine</i> , 3(2), p. e00020.	PubMed
15	Krause Neto, W., Ciena, A.P., Anaruma, C.A., de Souza, R.R. and Gama E.F. (2015). Effects of Exercise on Neuromuscular Junction Components Across Age: Systematic Review of Animal Experimental Studies. <i>BioMed Central Research Notes</i> , 24(8), p. 713.	PubMed
16	Krauth, D., Woodruff, T. and Bero, L. (2013). Instruments for Assessing Risk of Bias and Other Methodological Criteria of Published Animal Studies: A Systematic Review. <i>Environmental Health Perspectives</i> , 121(9), pp. 985–992.	PubMed

- 17 Lee, S.H., van den Noort, M., Bosch, P. and Lim, S. (2016). Sex Differences in Acupuncture Effectiveness in Animal Models of Parkinson's Disease: A Systematic Review. *BioMed Central Complementary and Alternative Medicine*, 3, 16(1), p. 430. PubMed
- 18 Leung, M.C., Yip, K.K., Ho, Y.S., Siu, F.K., Li, W.C. and Garner, B. (2014). Mechanisms Underlying the Effect of Acupuncture on Cognitive Improvement: A Systematic Review of Animal Studies. *Journal of Neuroimmune Pharmacology*, 9(4), pp. 492–507. PubMed
- 19 Li, J., Hernanda, P.Y., Bramer, W.M., Peppelenbosch, M.P., van Luijk, J. and Pan, Q. (2015). Anti-tumor Effects of Metformin in Animal Models of Hepatocellular Carcinoma: A Systematic Review and Meta-analysis. *PLoS One*, 1;10(6), p. e0127967. PubMed
- 20 Liao, Y., Zhang, X.L., Li, L., Shen, F.M. and Zhong, M.K. (2014). Stem Cell Therapy for Bone Repair: A Systematic Review and Meta-analysis of Preclinical Studies with Large Animal Models. *British Journal of Clinical Pharmacology*, 78(4), pp. 718–726. PubMed
- 21 McClelland, J., Bozhilova, N., Campbell, I. and Schmidt, U. (2013). A Systematic Review of the Effects of Neuromodulation on Eating and Body Weight: Evidence from Human and Animal Studies. *European Eating Disorders Review*, 21(6), pp. 436–455. PubMed
- 22 McDonald J., Eng, S., Dina, O., Schooling, C. and Terry, M. (2016). Infection and Pubertal Timing: A Systematic Review. *Journal of Developmental Origins of Health and Disease*, 7(6), pp. 636–651. PubMed
- 23 Mueller, K.F., Briel, M., Strech, D., Meerpohl, J.J., Lang, B., Motschall, E., Gloy, V., Lamontagne, F. and Bassler, D. (2014). Dissemination Bias in Systematic Reviews of Animal Research: A Systematic Review. *PLoS One*, 26, 9(12), p. e116016. PubMed
- 24 Muhlhausler, B.S., Gibson, R.A. and Makrides, M. (2011). The Effect of Maternal Omega-3 Long-chain Polyunsaturated Fatty Acid (n-3 LCPUFA) Supplementation During Pregnancy and/or Lactation on Body Fat Mass in the Offspring: A Systematic Review of Animal Studies. *Prostaglandins, Leukotrienes, and Essential Fatty Acids (PLEFA)*, 85(2), pp. 83–88. PubMed
- 25 Muka, T., Vargas, K.G., Jaspers, L., Wen, K.X., Dhana, K., Vitezova, A., Nano, J., Brahimaj, A., Colpani, V., Bano, A., Kraja, B., Zaciragic, A., Bramer, W.M., van Dijk, G.M., Kavousi, M. and Franco, O.H. (2016). Estrogen Receptor β Actions in the Female Cardiovascular System: A Systematic Review of Animal and Human Studies. *Maturitas*, 86, pp. 28–43. PubMed

TABLE 15.1 Publications included in abstract review (n=100) (cont.)

Number	Reference	Source
26	Naumann, D., Beaven, A., Dretzke, J., Hutchings, S. and Midwinter, M. (2016). Searching for the Optimal Fluid to Restore Microcirculatory Flow Dynamics after Haemorrhagic Shock: A Systematic Review of Preclinical Studies. <i>Shock</i> , 46(6), pp. 609–622.	PubMed
27	Noorimotlagh, Z., Haghghi, N., Ahmadimoghadam, M. and Rahim, F. (2016). An Updated Systematic Review on the Possible Effect of Nonylphenol on Male Fertility. <i>Environmental Science and Pollution Research International</i> , 24(4), pp. 3298–3314.	PubMed
28	Parker, T., Nguyen, A., Rabang, J., Patil, A. and Agrawal, D. (2016). The Danger Zone: Systematic Review of the Role of HMGB1 Danger Signaling in Traumatic Brain Injury. <i>Brain Injury</i> , 7, pp. 1–7.	PubMed
29	Pot, M.W., Gonzales, V.K., Buma, P., IntHout, J., van Kuppevelt, T.H., de Vries, R.B. and Daamen, W.F. (2016). Improved Cartilage Regeneration by Implantation of Acellular Biomaterials after Bone Marrow Stimulation: A Systematic Review and Meta-analysis of Animal Studies. <i>PeerJ</i> , 8, 4, p. e2243.	PubMed
30	Qi, N., Li, W.J. and Tian, H. (2016). A Systematic Review of Animal and Clinical Studies on the Use of Scaffolds for Urethral Repair. <i>Journal of Huazhong University of Science and Technology. Medical Sciences</i> , 36(1), pp. 111–117.	PubMed
31	Raavé R., de Vries, R.B., Massuger, L.F., van Kuppevelt, T.H. and Daamen, W.F. (2015). Drug Delivery Systems for Ovarian Cancer Treatment: A Systematic Review and Meta-analysis of Animal Studies. <i>PeerJ</i> , 10, 3, p. e1489.	PubMed
32	Raynor, H. A., Goff, M.R., Poole, S.A. and Chen G. (2015). Eating Frequency, Food Intake, and Weight: A Systematic Review of Human and Animal Experimental Studies. <i>Frontiers in Nutrition</i> , 2(38), pp. 1–19.	PubMed
33	Reis, J., Monteiro, V., de Souza, R., do Carmo, M., da Costa, G., Ribera, P. and Monteiro, M. (2016). Action Mechanism and Cardiovascular Effect of Anthocyanins: A Systematic Review of Animal and Human Studies. <i>Journal of Translational Medicine</i> , 14(1), p. 315.	PubMed

- 34 Rogers, P.J., Hogenkamp, P.S., de Graaf, C., Higgs, S., Lluch, A., Ness, A.R., Penfold, C., Perry, R., Putz, P., Yeomans, M.R. and Mela, D.J. (2016). Does Low-energy Sweetener Consumption Affect Energy Intake and Body Weight? A Systematic Review, Including Meta-analyses, of the Evidence from Human and Animal Studies. *International Journal of Obesity (London)*, 40(3), pp. 381–394. PubMed
- 35 Sabit, B., Zeiler, F. and Berrington, N. (2016). The Impact of Mean Arterial Pressure on Functional Outcome Post-Acute Spinal Cord Injury: A Scoping Systematic Review of Animal Models. *Journal of Neurotrauma*. doi: 10.1089/neu.2016.4735. PubMed
- 36 Sanadgol, N., Zahedani S., Sharifzadeh, M., Khalseh, R., Barbari, G., and Abdollahi, M. (2016). Recent Updates in Imperative Natural Compounds for Healthy Brain and Nerve Function: A Systematic Review of Implications for Multiple Sclerosis. *Current Drug Targets*. Epub ahead of print. PubMed
- 37 Schmidt, U., Keck, M.E. and Buell, D.R. (2015). miRNAs and Other Non-coding RNAs in Posttraumatic Stress Disorder: A Systematic Review of Clinical and Animal Studies. *Journal of Psychiatric Research*, 65, pp. 1–8. PubMed
- 38 Sendyk, D.I., Deboni, M.C., Pannuti, C.M., Naclério-Homem, M.G. and Wennerberg, A. (2016). The Influence of Statins on Osseointegration: A Systematic Review of Animal Model Studies. *Journal of Oral Rehabilitation*, 43(11), pp. 873–882. PubMed
- 39 Shanbhag, S., Pandis, N., Mustafa, K., Nyengaard, J. and Stavropoulos, A. (2016). Cell Cotransplantation Strategies for Vascularized Craniofacial Bone Tissue Engineering: A Systematic Review and Meta-Analysis of Preclinical *In Vivo* Studies. *Tissue Engineering Part B Reviews*, Epub ahead of print. PubMed
- 40 Sheng, C., Peng, W., Xia, Z.A., Wang, Y., Chen, Z., Su, N. and Wang, Z. (2015). The Impact of Ginsenosides on Cognitive Deficits in Experimental Animal Studies of Alzheimer's Disease: A Systematic Review. *BioMed Central Complementary and Alternative Medicine*, 24(15), p. 386. PubMed
- 41 Simonsen, A. L., Danborg, P.B. and Gøtzsche, P.C. (2016). Persistent Sexual Dysfunction after Early Exposure to SSRIs: Systematic Review of Animal Studies. *International Journal of Risk & Safety in Medicine*, 16,28(1), pp. 1–12. PubMed
- 42 Srouf, N. and Thébaud, B. (2015). Mesenchymal Stromal Cells in Animal Bleomycin Pulmonary Fibrosis Models: A Systematic Review. *Stem Cells Translational Medicine*, 4(12), pp. 1500–1510. PubMed

TABLE 15.1 Publications included in abstract review (n=100) (cont.)

Number	Reference	Source
43	Ting, K.H., Hill, C.L. and Whittle, S.L. (2015). Quality of Reporting of Interventional Animal Studies in Rheumatology: A Systematic Review Using the ARRIVE Guidelines. <i>International Journal of Rheumatic Diseases</i> , 18(5), pp. 488–494.	PubMed
44	Wever, K.E., Bruinjtjes, M.H., Warlé, M.C. and Hooijmans, C.R. (2016). Renal Perfusion and Function During Pneumoperitoneum: A Systematic Review and Meta-analysis of Animal Studies. <i>PLoS One</i> , 11(9), p. e0163419.	PubMed
45	Wever, K.E., Hooijmans, C.R., Riksen, N.P., Sterenborg, T.B., Sena, E.S., Ritskes-Hoitinga, M. and Warlé M.C. (2015). Determinants of the Efficacy of Cardiac Ischemic Preconditioning: A Systematic Review and Meta-analysis of Animal Studies. <i>PLoS One</i> , 10(11), p. e0142021.	PubMed
46	Yarlagadda, S., Coca, S., Garg, A., Doshi, M., Poggio, E., Marcus, R. and Parikh, C. (2008). Marked Variation in the Definition and Diagnosis of Delayed Graft Function: A Systematic Review. <i>Nephrology Dial Transplantation</i> , 23 (9), pp. 2995–3003.	PubMed
47	Yen, C.C., Tu, Y.K., Chen, T.H. and Lu, H. (2014). Comparison of Treatment Effects of Guided Tissue Regeneration on Infrabony Lesions Between Animal and Human Studies: A Systematic Review and Meta-analysis. <i>Journal of Periodontal Research</i> , 49(4), pp. 415–424.	PubMed
48	Zeng, X., Zhang, Y., Kwong, J.S., Zhang, C., Li, S., Sun, F., Niu, Y. and Du L. (2015). The Methodological Quality Assessment Tools for Preclinical and Clinical Studies, Systematic Review and Meta-analysis, and Clinical Practice Guideline: A Systematic Review. <i>Journal of Evidence-Based Medicine</i> , 8(1), pp. 2–10.	PubMed
49	Zhang, M., Sun, W.K., Wu, T., Chen, F., Xu, X.Y., Su, X. and Shi Y. (2014). Efficacy of Combination Therapy of Triazole and Echinocandin in Treatment of Invasive Aspergillosis: A Systematic Review of Animal and Human Studies. <i>Journal of Thoracic Disease</i> , 6(2), pp. 99–108.	PubMed
50	Zwetsloot, P.P., Végh, A.M., Jansen of Lorkeers, S.J., van Hout, G.P., Currie, G.L., Sena, E.S., Gremmels, H., Buikema, J.W., Goumans, M.J., Macleod, M.R., Doevendans, P.A., Chamuleau, S.A. and Sluijter, J.P.(2016). Cardiac Stem Cell Treatment in Myocardial Infarction: A Systematic Review and Meta-analysis of Preclinical Studies. <i>Circulation Research</i> , 5, 118(8), pp. 1223–1232.	PubMed

- 51 Aghajafari, F., Murphy, K., Matthews, S., Ohlsson, A., Amankwah, K. and Hannah, M. (2002). Repeated Doses of Antenatal Corticosteroids in Animals: A Systematic Review. *American Journal of Obstetrics & Gynecology*, 186(4), pp. 843–849. Google Scholar
- 52 Angst, M. and Clark, J. (2006). Opioid-induced Hyperalgesia: A Qualitative Systematic Review. *Anesthesiology*, 104(3), pp. 570–587. Google Scholar
- 53 Antonic, A., Sena, E., Lees, J., Wills, T., Skeers, P., Batchelor, P., Macleod, M. and Howells, D. (2013). Stem Cell Transplantation in Traumatic Spinal Cord Injury: A Systematic Review and Meta-analysis of Animal Studies. *Public Library of Science Biology*, 11(12), p. e1001738. Google Scholar
- 54 Bellomo, R., Ronco, C., Kellum, J., Mehta, R., Palevsky, P. and the ADQI Workgroup. (2004). Acute Renal Failure—Definition, Outcome Measures, Animal Models, Fluid Therapy and Information Technology Needs: The Second International Consensus Conference of the Acute Dialysis Quality Initiative (ADQI) Group. *Critical Care*, 8, R204. Google Scholar
- 55 Bjordal, J., Johnson, M., Iversen, V., Aimbire, F. and Lopes-Martins, R. (2006). Low-level Laser Therapy in Acute Pain: A Systematic Review of Possible Mechanisms of Action and Clinical Effects in Randomized Placebo-controlled Trials. *Photomedicine and Laser Surgery*, 24(2), pp. 158–168. Google Scholar
- 56 Cave, G. and Harvey, M. (2009). Intravenous lipid Emulsion As Antidote Beyond Local Anesthetic Toxicity, A Systematic Review. *Academic Emergency Medicine*, 16(9), pp. 815–824. Google Scholar
- 57 Corpet, D. and Pierre, F. (2003). Point: From Animal Models to Prevention of Colon Cancer. Systematic Review of Chemoprevention in Min Mice and Choice of the Model System. *Cancer Epidemiology, Biomarkers & Prevention*, 12(5), pp. 391–400. Google Scholar
- 58 Corpet, D. and Pierre, F. (2005). How Good Are Rodent Models of Carcinogenesis in Predicting Efficacy in Humans? A Systematic Review and Meta-analysis of Colon Chemoprevention in Rats, Mice and Men. *European Journal of Cancer*, 41(13), pp. 1911–1922. Google Scholar
- 59 Dangour, A., Lock, K., Hayter, A., Aikenhead, A., Allen, E., Uauy, R. (2010). Nutrition-related Health Effects of Organic Foods: A Systematic Review. *American Journal of Clinical Nutrition*, 92(1), pp. 203–210. Google Scholar

TABLE 15.1 Publications included in abstract review (n=100) (cont.)

Number	Reference	Source
60	Falagas, M., Kastoris, A., Karageorgopoulos, D. and Rafailidis, P. (2009). Fosfomycin for the Treatment of Infections Caused by Multidrug-resistant Non-fermenting Gram-negative Bacilli: A Systematic Review of Microbiological, Animal and Clinical Studies. <i>International Journal of Antimicrobial Agents</i> , 34(2), pp. 111–120.	Google Scholar
61	Fehlings, M. and Perrin, R. (2006). The Timing of Surgical Intervention in the Treatment of Spinal Cord Injury: A Systematic Review of Recent Clinical Evidence. <i>Spine</i> , 15;31(11), pp. S28–36.	Google Scholar
62	Giannobile, W. and Somerman, M. (2003). Growth and Amelogenin-like Factors in Periodontal Wound Healing, A Systematic Review. <i>Annals of Periodontology</i> , 8(1), pp. 193–204.	Google Scholar
63	Gibson, C., Gray, L., Bath, P. and Murphy, S. (2008). Progesterone for the Treatment of Experimental Brain Injury; A Systematic Review. <i>Brain</i> , 131 (2), pp. 318–328.	Google Scholar
64	Gibson, C. and Murphy, S. (2010). Benefits of Histone Deacetylase Inhibitors for Acute Brain Injury: A Systematic Review of Animal Studies. <i>Journal of Neurochemistry</i> , 115(4), pp. 806–813.	Google Scholar
65	Hasani-Ranjbar, S., Nayebi, N., Larijani, B. and Abdollahi, M. (2009). A Systematic Review of the Efficacy and Safety of Herbal Medicines Used in the Treatment of Obesity. <i>World Journal of Gastroenterology</i> , 15(25), pp. 3073–3085.	Google Scholar
66	Henderson, V., Kimmelman, J., Fergusson, D., Grimshaw, J. and Hackam, D. (2013). Threats to Validity in the Design and Conduct of Preclinical Efficacy Studies: A Systematic Review of Guidelines for <i>In Vivo</i> Animal Experiments. <i>Public Library of Science Medicine</i> , 10(7), p. e1001489.	Google Scholar
67	Hooijmans, C., Leenaars, M. and Ritskes-Hoiting, M. (2010). A Gold Standard Publication Checklist to Improve the Quality of Animal Studies, to Fully Integrate the Three Rs, and to Make Systematic Reviews More Feasible. <i>Alternatives to Laboratory Animals</i> , 38(2), pp. 167–182.	Google Scholar
68	Horn, J., de Haan, R., Vermeulen, M., Luiten, P. and Limburg, M. (2001). Nimodipine in Animal Model Experiments of Focal Cerebral Ischemia: A Systematic Review. <i>Stroke</i> , 32(10), pp. 2433–2438.	Google Scholar

- 69 Houben, M., van de Beek, D., Hensen, E., de Craen, A., Rauws, E. Google and Tytgat, G. (1999). A Systematic Review of Helicobacter Pylori Scholar Eradication Therapy—The Impact of Antimicrobial Resistance on Eradication Rates. *Alimentary Pharmacology & Therapeutics*, 13(8), pp. 1047–1055.
- 70 Jamaty, C., Bailey, B., Larocque, A., Notebaert, E., Sanogo, K., Google Chauny, J. (2010). Lipid Emulsions in the Treatment of Acute Scholar Poisoning: A Systematic Review of Human and Animal Studies. *Clinical toxicology (Philadelphia, PA)*, 48(1), pp. 1–27.
- 71 Javed, F. and Romanos, G. (2009). Impact of Diabetes Mellitus Google and Glycemic Control on the Osseointegration of Dental Im- Scholar plants: A Systematic Literature Review. *Journal of Periodontology*, 80 (11), pp. 1719–1730.
- 72 Junker, R., Dimakis, A., Thoneick M. and Jansen, J. (2009). Effects Google of Implant Surface Coatings and Composition on Bone Integra- Scholar tion: A Systematic Review. *Clinical Oral Implants Research*, 20 (s4), pp. 185–206.
- 73 Kilkenny, C., Browne, W. J, Cuthill, I.C., Emerson, M., Altman, D.G. Google (2010). Improving Bioscience Research Reporting: The ARRIVE Scholar Guidelines for Reporting Animal Research. *Journal of Pharmacology and Pharmacotherapeutics*, 1(2), pp. 94–99.
- 74 Kwon, B., Okon, E., Hillyer, J., Mann, C., Baptiste, D., Weaver, L., Google Fehlings, M. and Tetzlaff, W. (2011). A Systematic Review of Scholar Non-invasive Pharmacologic Neuroprotective Treatments for Acute Spinal Cord Injury. *Journal of Neurotrauma*, 28(8), pp. 1545–1588.
- 75 Lamontagne, F., Briel, M., Duffett, M., Fox-Robichaud, A., Cook, Google D., Guyatt, G., Lesur, O. and Meade, M. (2010). Systematic Review Scholar of Reviews Including Animal Studies Addressing Therapeutic Interventions for Sepsis. *Critical Care Medicine*, 38(12), pp. 2401–2408.
- 76 Langenberg, C., Bagshaw, S., May, C. and Bellomo, R. (2008). Google The Histopathology of Septic Acute Kidney Injury: A Systematic Scholar Review. *Critical Care*, 12(2), R38.
- 77 Lerchbaum, E. and Obermayer-Pietsch, B. (2012). Vitamin D and Google Fertility: A Systematic Review. *European Journal of Endocrinology*, Scholar 166, pp. 765–778.
- 78 Lucas, C., Criens-Poublon, L., Cockrell, C. and de Haan, R. (2002). Google Wound Healing in Cell Studies and Animal Model Experiments Scholar by Low Level Laser Therapy; Were Clinical Studies Justified? A Systematic Review. *Lasers in Medical Science*, 17(2), pp. 110–134.

TABLE 15.1 Publications included in abstract review (n=100) (cont.)

Number	Reference	Source
79	Mapstone, J., Roberts, I. and Evans, P. (2003). Fluid Resuscitation Strategies: A Systematic Review of Animal Trials. <i>Journal of Trauma-Injury Infection & Critical Care</i> , 55(3), pp. 571–589.	Google Scholar
80	Navas-Acien, A., Silbergeld, E., Streeter, R., Clark, J., Burke, T. and Eliseo Guallar, E. (2006). Arsenic Exposure and Type 2 diabetes: A Systematic Review of the Experimental and Epidemiologic Evidence. <i>Environmental Health Perspectives</i> , 114(5), pp. 641–648.	Google Scholar
81	Perel, P., Roberts, I., Sena, E., Wheble, P., Briscoe, C., Sandercock, P., Macleod, M., Mignini, L., Jayaram, P. and Khan, K. (2007). Comparison of Treatment Effects Between Animal Experiments and Clinical Trials: Systematic Review. <i>British Medical Journal</i> , 334(7586), p. 197.	Google Scholar
82	Perlroth, J., Kuo, M., Tan, J., Bayer, A. and Miller, L. (2008). Adjunctive Use of Rifampin for the Treatment of Staphylococcus Aureus Infections: A Systematic Review of the Literature. <i>Archives of Internal Medicine</i> , 168(8), pp. 805–819.	Google Scholar
83	Pilchera, J., Weatherall, M., Shirtcliffe, P., Bellomod, R., Young, P. and Beasley, R. (2012). The Effect of Hyperoxia Following Cardiac Arrest—A Systematic Review and Meta-analysis of Animal Trials. <i>Resuscitation</i> , 83(4), pp. 417–422.	Google Scholar
84	Rahimi, R., Mozaffari, S. and Abdollahi, M. (2009). On the Use of Herbal Medicines in Management of Inflammatory Bowel Diseases: A Systematic Review of Animal and Human Studies. <i>Digestive Diseases and Sciences</i> , 54(3), pp. 471–480.	Google Scholar
85	Ramberg, J., Nelson, E. and Sinnott, R. (2010). Immunomodulatory Dietary Polysaccharides: A Systematic Review of the Literature. <i>Nutrition Journal</i> , 9, p. 54.	Google Scholar
86	Ren, Y., Maltha, J. and Kuijpers-Jagtman, A. (2003). Optimum Force Magnitude for Orthodontic Tooth Movement: A Systematic Literature Review. <i>The Angle Orthodontist</i> , 73(1), pp. 86–92.	Google Scholar
87	Rice, A., Cimino-Brown, D., Eisenach, J., Kontinen, V., Lacroix-Fralish, M., Machin, I. (on behalf of the Preclinical Pain Consortium), Mogil, J. and Stöhr, T. (2008). Animal Models and the Prediction of Efficacy in Clinical Trials of Analgesic Drugs: A Critical Appraisal and Call for Uniform Reporting Standards. <i>Pain</i> , 139 (2), pp. 243–247.	Google Scholar

- 88 Sculean, A., Nikolidakis, D. and Schwarz, F. (2008). Regeneration of Periodontal Tissues: Combinations of Barrier Membranes and Grafting Materials—Biological Foundation and Preclinical Evidence: A Systematic Review. *Journal of Clinical Periodontology*, 35(8), pp. 106–116. Google Scholar
- 89 Sena, E., van der Worp, H., Bath, P., Howells, D. and Macleod, M. (2010). Publication Bias in Reports of Animal Stroke Studies Leads to Major Overstatement of Efficacy. *Public Library of Science Biology*, 30,8(3), p. e1000344. Google Scholar
- 90 Shalabi, M., Gortemaker, A., Van't Hof, M., Jansen, J. and Creugers, N. (2006). Implant Surface Roughness and Bone Healing: A Systematic Review. *Journal of Dental Research*, 85(6), pp. 496–500. Google Scholar
- 91 Subramaniam, K., Subramaniam, B. and Steinbrook, R. (2004). Ketamine as Adjuvant Analgesic to Opioids: A Quantitative and Qualitative Systematic Review. *Anaesthesia & Analgesia*, 99(2), pp. 482–495. Google Scholar
- 92 Tetzlaff, W., Okon, E., Karimi-Abdolrezaee, S., Hill, C., Sparling, J., Plemel, J., Plunet, W., Tsai, E., Baptiste, D., Smithson, L., Kawaja, M., Fehlings, M. and Kwon, B. (2011). A Systematic Review of Cellular Transplantation Therapies for Spinal Cord Injury. *Journal of Neurotrauma*, 28(8), pp. 1611–1682. Google Scholar
- 93 Ulbrich, B. and Stahlmann, R. (2004). Developmental Toxicity of Polychlorinated Biphenyls (PCBs): a Systematic Review of Experimental Data. *Archives of Toxicology*, 78(5), pp. 252–268. Google Scholar
- 94 van der Spoel, T., Jansen of Lorkeers, S., Agostoni, P., van Belle, E., Gyöngyösi, M., Sluijter, J., Cramer, M., Doevendans, P. and Chamuleau, S. (2011). Human Relevance of Preclinical Studies in Stem Cell Therapy: Systematic Review and Meta-analysis of Large Animal Models of Ischaemic Heart Disease. *Cardiovascular Research*, 91(4), pp. 649–658. Google Scholar
- 95 van der Worp, H., Howells, D., Sena, E., Porritt, M., Rewell, S., O'Collins, V. and Macleod M.R. (2010). Can Animal Models of Disease Reliably Inform Human Studies? *Public Library of Science Medicine*, 7(3), p. e1000245. Google Scholar
- 96 van der Worp, H., Sena, E., Donnan, G., Howells, D. and Macleod, M. Hypothermia in Animal Models of Acute Ischaemic Stroke: A Systematic Review and Meta-analysis. (2007). *Brain*, 130(12), pp. 3063–3074. Google Scholar

TABLE 15.1 Publications included in abstract review (n=100) (cont.)

Number	Reference	Source
97	Vang, O., Ahmad, N., Baile, C., Baur, J., Brown, K., Csiszar, A., Das, D., Delmas, D., Gottfried, C., Lin, H., Ma, Q., Mukhopadhyay, P., Nalini, N., Pezzuto, J., Richard, T., Shukla, Y., Surh, Y., Szekeres, T., Szkudelski, T., Walle, T. and Wu, J. (2011). What Is New for an Old Molecule? Systematic Review and Recommendations on the Use of Resveratrol. <i>PLoS One</i> , 6(6), p. e19881.	Google Scholar
98	Wennerberg, A. and Albrektsson, T. (2009). Effects of Titanium Surface Topography on Bone Integration: A Systematic Review. <i>Clinical Oral Implants Research</i> , 20(4), pp. 72–84.	Google Scholar
99	Wenz, H., Bartsch, J., Wolfart, S. and Kern, M. (2008). Osseointegration and Clinical Success of Zirconia Dental Implants: A Systematic Review. Source. <i>International Journal of Prosthodontics</i> , 21 (1), pp. 27–36.	Google Scholar
100	Wever, K., Menting, T., Rovers, M., van der Vliet, J., Rongen, G., Masereeuw, R., Ritskes-Hoitinga, M., Hooijmans, C. and Warlé, M. (2012). Ischemic Preconditioning in the Animal Kidney: A Systematic Review and Meta-analysis. <i>PLoS One</i> , 7(2), p. e32296.	Google Scholar

Relevant abstracts were assessed overall, depending on the following information:

- Clear concordance between human and animal studies.
- Limited concordance between human and animal studies.
- Lack of concordance between human and animal studies, due to one of the following factors: Unclear reporting, bias, inconsistency, species differences, heterogeneity, and lack of clinical translation.

It should be noted that the term *concordance* in this context refers to a qualitative, rather than quantitative analysis of the literature within the available timeframe. It is also important to note that the systematic reviews analyzed and the studies included within these publications (based on eligibility criteria assigned by the authors) are just a fraction of thousands of papers reviewed but rejected, some spanning four or five decades and using hundreds of thousands of animals.

Of the 100 abstracts reviewed (50 from PubMed; 50 from Google Scholar) none stated unequivocal and conclusive concordance between animals and humans. A low proportion of abstracts (20%) described limited concordance

in specific procedures, but this was generally qualified with an advisory to interpret the findings with caution and the need for more clinical studies to provide better evidence in humans.

Species used in studies included rats, mice, rabbits, cats, dogs, sheep, pigs, and non-human primates, among others. A wide range of disease areas were covered, including several types of cancer, heart disease, stroke, neurological disorders (e.g., Alzheimer's and Parkinson's disease), diabetes, bone defects and facial disorders, dental research, gene therapy and stem cell research, to provide some examples. Several publications were general reviews of how animal data translates to humans, as well as reviews of animal studies in specific disease areas.

The large majority of reviews (75%) found that assessment of human response from animal data is significantly limited due to one or more of the following factors: species differences, lack of clinical translation, poor quality methodology, inconsistency, and publication bias, resulting in overstatement of the benefits of animal use in predicting human disease outcomes or safety. There was a distinct lack of evidence clinically, despite many therapies in use based on animal studies. Numerous reviews highlighted the successes claimed over basic research outcomes or new therapies in animal "models", which have, however, failed to translate to the clinic to help patients (Hirst et al., 2016). Concerns over paucity of evidence, publication bias and consequently, overstatement of benefit in translating animal data to humans have led to many systematic reviews (Briel et al., 2013).

A key finding from this review is that, not only is publication bias very common in animal research, but many additional results considered unsuccessful remain unpublished. This issue was raised in a number of the systematic reviews analyzed, for example in animal models of stroke (Sena et al., 2010). Several reviews also raised concerns over animal studies and human trials being carried out simultaneously (Horn et al., 2001; Lucas et al., 2002). Moreover, this analysis found several studies (5% of the sample reviewed), highlighting animal experiments that could have been entirely omitted and carried out directly and far more effectively and ethically in clinical or observational studies in humans; for example, studies on dietary intake and cardiovascular health (Reis et al., 2016; Raynor et al., 2015), or trials of substances already in human use (Rogers et al., 2016). In many cases, human trials were carried out in parallel with animal experiments, representing examples of animal use that can be *abandoned*. This is discussed later in this chapter in more detail.

The findings from the majority of publications reviewed are consistent with other evidence on the problems of translating animal data to humans; for example, the *Review of Research Using Non-human Primates* (jointly

commissioned in 2006 by a number of major UK research councils and chaired by Sir David Weatherall). A subsequent review in 2011 addressed one of the recommendations in the Weatherall report, to review ten years of brain research in monkeys retrospectively. Not only did the review reveal some disturbing insights into the routine suffering of non-human primates used in neurology, but it reported the equally concerning finding that “In most cases, however, little direct evidence was available of actual medical benefit in the form of changes in clinical practice or new treatments” (Biotechnology and Biological Sciences Research Council, 2011, p. 13). These findings were emphasized more recently in the *Review of the Assessment of Cumulative Severity and Lifetime Experience in Non-human Primates Used in Neuroscience Research*, published in November 2013 by the (then) Animal Procedures Committee (APC, now Animals in Science Committee) (APC, 2013).

Further evidence of increasing concern over the validity of animal research was highlighted in a British Medical Journal review entitled, *How Predictive and Productive is Animal Research?*, which concluded that “Funds might be better directed towards clinical rather than basic research, where there is a clearer return on investment in terms of effects on patient care” (Godlee, 2014, p. 1). This article adds to a wealth of evidence on the poor performance of animals in predicting human responses, with an accuracy of approximately 20%–60%, depending on reviews cited (Perel et al., 2007; van Meer et al., 2012). Additionally, in a series of studies between 2013–2015, a collaboration between the Fund for the Replacement of Animals in Medical Experiments and Cruelty Free International involved the analysis of an unprecedented level of independent data from both preclinical toxicity studies and human clinical trials. The studies revealed the inadequacies of animal toxicity studies in a number of species (i.e., dog, rabbit, mouse, rat, and non-human primate) in predicting human adverse events; and the urgency for more human-relevant methods to be developed (Bailey et al., 2013, 2014, 2015).

To some extent the pharmaceutical industry recognizes that the models it has been using are inadequate. There is encouraging research into alternative approaches and further consideration of the problem in some areas (Bloomberg, 2013). In 2014, the National Institutes of Health (NIH), *Tissue Chip Program*, began the investigation of more than 100 drugs that showed success in rodents but went on to fail in human trials (NIH, 2016).

With regard to the *purpose* of experiments covered by the reviews examined, the majority of publications focused on basic research in animals (66%). This was expected, given that this is the largest area of animal use. The remaining 34% were concerned with reviewing safety or efficacy of substances, including new and existing drugs, herbal therapies, or food related additives or substances (e.g., low calorie sweeteners) (Rogers et al., 2016).

2 Review of Toxicity Studies in Animals, Focusing on Three Well-known Examples

A follow-up literature review was performed to further address publications of toxicity tests in animals. This specific sample of the most recent literature was chosen to provide meaningful case studies on three well-known and widely-used drugs worldwide: paracetamol (acetaminophen), aspirin and penicillin. Information on these studies is presented in Table 15.2, and each drug is briefly discussed below.

2.1 *Paracetamol*

Paracetamol was first marketed in the 1950's (Sneader, 2005) and is well known as one of the world's most common household drugs, traded under many different brand names, including Tylenol and Panadol. Despite being marketed for over five decades and the vast availability of data on global human use, paracetamol continues to be routinely tested on animals, both for "blue sky" research and attempts to market it for new purposes. Using a similar methodology to the previous review, the general key search terms of "paracetamol toxicity animals" resulted in 2,431 listings in PubMed. (Note: Using similar terms "acetaminophen toxicity animals" provided 2,358 listings and a brief review established, as expected, that many of these were the same results).

Review of the first five listings under the above search term, published between 2014–2016, provided extensive evidence of ongoing experimental research into paracetamol in animals. For example, hepatotoxicity has been well known for decades as a risk of paracetamol overdose in humans, yet, inducing such effects in mice is still carried out routinely, worldwide (Pingili et al., 2015). Further recent studies show that macaques are considered a poor model due to their resistance to paracetamol poisoning when compared to humans (Yu et al., 2015). Experimental dosing and killing of newborn mice continues (Viberg et al., 2014), despite paracetamol's widespread global use in children and pregnant mothers, as shown by far more directly relevant clinical or observational studies to check for effects on offspring (Liew et al., 2014). Other experimental studies included, force feeding of GM mice with a drug to inhibit an enzyme that activates the toxic response to paracetamol in order to investigate resistance (Pu et al., 2016), and numerous similar, experimental testing in mice (Hohmann et al., 2013), despite much earlier, advanced human-based studies to investigate resistance to paracetamol toxicity (McCloskey et al., 1999).

Another publication investigated a widely-used industrial chemical that humans are routinely exposed to in the environment via air, diet, and water: aniline. The aim of the study was to investigate aniline's conversion to paracetamol, and its effects on male fertility. Yet, instead of employing the

TABLE 15.2 Review of publications relating to paracetamol, aspirin, and penicillin

Number	Reference	Source
101	Atli, O., Demir-Ozkay, U., Ilgin, S., Aydin, T., Akbulut, E. and Sener, E. (2016). Evidence for Neurotoxicity Associated with Amoxicillin in Juvenile Rats. <i>Human & Experimental Toxicology</i> , 35(8), pp. 866–876.	PubMed
102	Cappon, G., Gupta, U., Cook, J., Tassinari, M. and Hurtt, M. (2003). Comparison of the Developmental Toxicity of Aspirin in Rabbits When Administered Throughout Organogenesis or During Sensitive Windows of Development. <i>Birth Defects Research Part B: Developmental and Reproductive Toxicology</i> , 68(1), pp. 38–46.	PubMed
103	Chao, Y., Lee, C., Liu, K., Wang, Y., Wang, C. And Liu, S.(2015). Sustained Release of Bactericidal Concentrations of Penicillin in the Pleural Space via an Antibiotic-eluting Pigtail Catheter Coated with Electrospun Nanofibers: Results from <i>In Vivo</i> and <i>In Vitro</i> Studies. <i>International Journal of Nanomedicine</i> , 4(10), pp. 3329–3336.	PubMed
104	Feinstein, A., Heinemann, L., Curhan, G., Delzell, E., DeSchepper, P., Fox, J., Graf, H., Luft, F., Michielsen, P., Mihatsch, M., Suissa, S., van der Woude, F. and Willichet, S. (2000). Relationship Between Nonphenacetin Combined Analgesics and Nephropathy: A Review. <i>Kidney International</i> , 58(6), pp. 2259–2264.	PubMed
105	Holm, J., Chalmey, C., Modick, H., Jensen, L., Dierkes, G., Weiss, T., Jensen, B., Nørregard, M., Borkowski, K., Styrihave, B., Koch, H., Severine, M., Jegou, B., Kristiansen, K. and Kristensen, D. (2015). Aniline Is Rapidly Converted into paracetamol impairing Male Reproductive Development. <i>Toxicological Sciences</i> , 148(1), pp. 288–298.	PubMed
106	Hueper, K., Elalfy, M., Laenger, F., Halter, R., Rodt, T., Galanski, M. and Borlak, J. (2012). PET/CT Imaging of c-Myc Transgenic Mice Identifies the Genotoxic N-nitroso-diethylamine as Carcinogen in a Short-term Cancer Bioassay. <i>PLoS One</i> , 7(2), p. e30432.	PubMed
107	Huggett, A., Schilter, B., Roberfroid, M., Antignac, E. and Koeman J.H. (1996). Comparative Methods of Toxicity Testing: Consensus Document Following an International Life Sciences Institute-ILSI Europe Workshop Held in May 1995. <i>Food and Chemical Toxicology</i> , 34(2), pp. 183–192.	PubMed

- 108 Jefferies, S., Saxena, M. and Young, P. (2012). Paracetamol In Critical Illness: A Review. *Critical Care and Resuscitation*, 14(1), pp. 74–80. PubMed
- 109 Jegatheeswaran, S. and Siriwardena, A. (2010). Experimental and Clinical Evidence for Modification of Hepatic Ischaemia—reperfusion Injury by N-acetylcysteine During Major Liver Surgery. *The Official Journal of the International Hepato Pancreato Biliary Association*, 13, pp. 71–78. PubMed
- 110 Li, J., Yu, Y., Yang, Y., Liu, X., Zhang, J., Li, B., Zhou, X., Niu, J., Wei, X. and Liu, Z. (2012). A 15-day Oral Dose Toxicity Study of Aspirin Eugenol Ester in Wistar Rats. *Food and Chemical Toxicology*, 50(6), pp. 1980–1985. PubMed
- 111 López-Ruiz, E., Vega-Flores, G., Contreras-Cisneros, B., Martínez, A. and Rivera-García, A. (2015). Effect of Partial and Generalised Epileptic Seizures on Sleep Architecture in Rats. *Revista De Neurologia*, 1,60(7),pp. 289–295. PubMed
- 112 McGill, M. and Jaeschke, H. (2014). Mechanistic Biomarkers in Acetaminophen-induced Hepatotoxicity and Acute Liver Failure; From Preclinical Models to Patients *Expert Opinion on Drug Metabolism & Toxicology*, 10(7), pp. 1005–1017. PubMed
- 113 Pingili, R., Pawak, A. and Challa, S. (2015). Systemic Exposure of Paracetamol (Acetaminophen) Was Enhanced by Quercetin and Chrysin Co-administration in Wistar Rats and *In Vitro* Model: Risk of Liver Toxicity. *Drug Development and Industrial Pharmacy*, 41(11), pp. 1793–1800. PubMed
- 114 Pu, S., Ren, L., Liu, Q., Kuang, J., Shen, J., Cheng, S., Zhang, Y., Jiang, W., Zhang, Z., Jiang, C. and He, J. (2016). Loss of 5-lipoxygenase Activity Protects Mice Against Paracetamol-induced Liver Toxicity. *British Journal of Pharmacology*, 173(1), pp. 66–76. PubMed
- 115 Raza, H., John, A. and Shafarin J. (2014). NAC Attenuates LPS-induced Toxicity in Aspirin-Sensitized Mouse Macrophages via Suppression of Oxidative Stress and Mitochondrial Dysfunction. *PLoS One*, 9(7), p. e103379. PubMed
- 116 Viberg, H., Eriksson P., Gordh, T. and Fredriksson, A. (2014). Paracetamol (Acetaminophen) Administration During Neonatal Brain Development Affects Cognitive Function and Alters Its Analgesic and Anxiolytic Response in Adult Male Mice. *Toxicological Sciences*, 138(1), pp. 139–147. PubMed

TABLE 15.2 Review of publications relating to paracetamol, aspirin, and penicillin (*cont.*)

Number	Reference	Source
117	Yu, H., Barrass, N., Gales, S., Lenz, E., Parry, T., Powell, H., Thurman, D., Hutchison, M., Wilson, I., Bi, L., Qiao, J., Qin, Q. and Ren, J. (2015). Metabolism by Conjugation Appears to Confer Resistance to Paracetamol (Acetaminophen) Hepatotoxicity in the Cynomolgus Monkey. <i>Xenobiotica</i> , 45(3), pp. 270–277.	PubMed

directly relevant approach of investigating the vast amount of already available clinical and observational exposure data, groups of mice were injected, before being killed and dissected along with their offspring, for examination (Holm et al., 2015).

As well as review of specific experiments on paracetamol toxicity in animals, further publications published between 1996 and 2012 on systematic reviews of paracetamol toxicity were analyzed (see Table 15.2). Included were reviews of translating animal models of paracetamol toxicity to humans, stating that “Considerable effort has been made to predict and model drug-induced liver injury in humans using laboratory animals with only little success and even some controversy” (McGill and Jaeschke, 2014, p. 10). A further review of paracetamol, and similar drugs in its class, concluded that there was insufficient evidence based on animal (and human) tests to assess toxic effects on the human kidney (Feinstein et al., 2000). An analysis of clinical treatment for paracetamol-induced injury during liver surgery documented 19 different studies carried out on mice, rats, dogs, and pigs with varying results, concluding that evidence was insufficient to suggest the therapy was clinically relevant (Jegatheeswaran and Siriwardena, 2010).

The remaining reviews focused on how paracetamol, over two decades ago (as one of a group of “well-studied” hepatotoxicants), highlighted the need to evaluate links between *in vitro* and *in vivo* testing strategies (Huggett et al., 1996); and more recently, despite the extensive toxicity testing of paracetamol, evidence supporting its use in specific groups of patients (e.g., the critically ill) was considered lacking (Jefferies et al., 2012), highlighting the value of data that can only be gathered in clinical research. When taken in normal regular doses, paracetamol is largely considered safe in humans for a number of pain associated conditions. Yet, it causes a wide range of toxicities in many species, for example, cancer in mice and rats (Hueper et al., 2012). In fact, given

requirements today for extensive regulatory toxicity testing in animals, it is highly likely that paracetamol would be denied approval based on its poor safety profile in animals.

2.2 *Acetylsalicylic Acid (Aspirin)*

Acetylsalicylic acid, commonly known as Aspirin, has been in human use for more than a century. It is still considered successful; and given its relatively cheap production costs and widespread use for a number of indications, it is still considered a “blockbuster” drug in terms of revenue (Hartung, 2009). Yet, the human relevant dose of aspirin is lethal to rats and causes toxic effects in many animal species, including embryonic deformities in dogs, cats, mice, rats, monkeys, and rabbits (Barrow, 2002). Like paracetamol, given the poor safety record of aspirin in animals, it would very likely be denied approval for human use if newly marketed, according to today’s regulatory testing requirements (Hartung, 2009). Aspirin continues to be routinely tested on animals, despite availability of vast libraries of both historical and new human data.

With the same methodology and sampling as the previous reviews, the search terms, “aspirin toxicity animals” were used. PubMed revealed experiments carried out between 2012–2016, including 15-day oral toxicity studies of derivatives of aspirin in Wistar rats and subchronic toxicity studies in mice (see Table 15.2). Searching for publications under the terms “acetylsalicylic acid toxicity in animals” resulted in specific studies published between 2000–2013. These included administration of large doses to pregnant rabbits, concluding that aspirin is not teratogenic to them, and highlighting inconsistencies with previous rabbit experiments and species differences with rats, having been “extensively studied” and exhibiting birth defects (Cappon et al., 2003).

2.3 *Penicillin*

Alexander Fleming’s pioneering work on penicillin is well known. Following this, Florey and Chain won a Nobel Prize in the 1940’s for successful results in mice with penicillin; yet, they considered themselves fortunate to have chosen to test mice instead of guinea pigs, who showed lethal side effects to the drug, as Florey later remarked: “Mice were used in the initial toxicity tests because of their small size, but what a lucky chance it was, for in this respect man is like the mouse and not the guinea pig. If we had used guinea pigs extensively we should have said that penicillin was toxic and we probably should not have proceeded to try and overcome the difficulties of producing the substance for trial in man” (Florey, 1953, p. 12).

In fact, penicillin is safe, to some extent, in mice and rats but has severe, often lethal, effects in hamsters and guinea pigs due to their very sensitive

intestinal microbiota, making them particularly susceptible when compared to other species. Animal users are quick to respond to this issue, stating that multiple species are used to assess the most appropriate “model” for humans and account for differences (heterogeneity) in animals. Again, no dispute is made on this; indeed, this has been the tenet in toxicology for decades, testing in different species and varying doses, modifying their condition either genetically, chemically or physically in an attempt to elicit the reaction needed. Yet, the high attrition rate of new pharmaceuticals and lack of progress in key areas of disease research should suggest that something is wrong. The use of animals is the only area of scientific research where the same dated techniques are still being used 60–70 years later, despite their limitations being well known. No other area of science continues to use such a dogmatic approach. As evidence of this, a general literature review of the search terms “penicillin toxicity animals” results in numerous publications over decades, several of the most recent listings (2011–2016, see Table 15.2) involving rats, rabbits, and other animals; even using penicillin in repeated experiments to induce effects, including anxiety and depression (to try to mimic effects in rats already seen in patients), weight loss, organ failure, and deliberate epilepsy to test the effects of other drugs that, like penicillin, are already in extensive global use, with a wealth of clinical toxicity data available.

3 Part 2: Drivers for Change—Development of Animal-free Testing Methods

It should be noted that use of the term *alternatives* in this chapter refers only to methods that *replace* the use of animals and their tissues. It is necessary to make this distinction, given the widely-used terminology of the 3Rs (replacement, reduction and refinement), first proposed in *The Principles of Humane Experimental Technique* (Russell and Burch, 1959). The ultimate goal of Russell and Burch in establishing the 3Rs was *replacement*. While measures to refine methods or reduce animal numbers are, of course, to be encouraged, much attention is devoted to these 2Rs and, to some extent, it has diverted focus from replacement.

Given six decades of the 3R principles, dedicated attention to replacement is long overdue. This is also reflected in European Directive 2010/63/EU on animals used for scientific purposes (European Parliament, 2010, p. 2), which states that it “represents an important step towards achieving the final goal of full replacement of procedures on live animals for scientific and educational purposes as soon as it is scientifically possible to do so. To that end, it seeks to

facilitate and promote the advancement of alternative approaches.” Although the Directive was implemented in January 2013, there has been relatively little decrease and, in many cases, an increase in animal use across individual Member States. Therefore, there is still great scope for improvement, particularly with regard to funding the development, acceptance, and adoption of animal-free, human-based methods.

Furthermore, the broad interpretation of the term *alternatives* under the auspices of the 3Rs is used to describe the use of some animals as “alternatives” to others, for example the use of zebrafish over rodents (Charles River, 2016); transgenic mice to “replace” non-human primates (Home Office, 2014); and even the use of minipigs, instead of dogs, as an “alternative” that may be more acceptable to the public, because they are considered “food animals” (Forster et al., 2010). Aside from the poor ethical argument, replacing one animal with another still fails to address the *wrong model* problem.

Use of public opinion and political lobbying to drive legislative change remains vital to fueling research and developments in animal-free science. The clearest example in recent years is the phased-in bans on animal-tested cosmetics across the EU between 2009–2013 (European Commission, 2013). A testing ban on cosmetic ingredients was enforced from March 11, 2009, along with a partial marketing ban for 10 animal-test requirements. This was eventually followed by a further marketing ban from March 11, 2013 for endpoints considered more complex (i.e., repeat dose toxicity, skin sensitization, reproductive toxicity, carcinogenicity, and toxicokinetics). However, for safety data requirements of cosmetic substances, some of these endpoints are rarely or not required (Nohynek et al., 2010). Despite delays in implementing the bans and legal challenges attempting to abolish them altogether, they had a monumental effect on the industry, with the development of numerous *in vitro* methods to be ready in time. Despite loopholes with conflicting chemicals safety-testing legislation, such as Registration, Evaluation, Authorisation and Restriction of CHemicals (REACH) (European Chemicals Agency, 2007), the bans have been responsible for one of the most significant advances towards replacing animal tests in decades.

The campaign to end cosmetics tests on animals began in the 1970s, and it took until 1993 to see legislation amendments to mark the implementation of official EU bans. After a further two decades of delays, the bans were finally enforced, with significant resistance amid claims that innovation would be stifled and that the development of alternatives would not be possible. Instead, the opposite was achieved. The development of *in vitro* methods was stimulated to address a number of toxicological *endpoints* (the result of a study to determine how toxic a substance is). The endpoints included skin irritation, eye irritation,

skin corrosion, phototoxicity, skin absorption/penetration, acute toxicity, and genotoxicity/mutagenicity. In preparation for the forthcoming bans, around 30 new *in vitro* assays were validated by 2007 (Hartung, 2008), with more developed since and projections that the *in vitro* toxicity testing market will be worth US\$17,227 million by 2018 (PR Newswire, 2014). The bans have also affected positive change outside EU borders, with similar bans now in place in India, Israel, Norway, and New Zealand, as well as partial or full enforcements in many other countries.

4 Methods Now Available, Previously Considered Only Possible in Animals—Some Examples

Replacement can be (and is being) achieved by a number of approaches, including *in vitro* and *in silico* models. Some examples are discussed below.

In its 2014 Delivery Plan, *Working to reduce the use of animals in scientific research*, the UK Home Office devoted much of the text to supporting the continuance of animal research. However, the plan also showcases human *in vitro* methods, for example, using induced pluripotent stem cells (Yusa et al., 2011), which it describes as “work that in the past could only have been modelled in animal systems” (Home Office, 2014, p. 16).

Scientists at the University of Newcastle have developed human skin-based assays, using cells isolated from the blood sample of healthy volunteers to assess new drugs, cosmetics and household products. The technology, now marketed as Skimune by Alcyomics Ltd, could have predicted the adverse effects seen in the volunteers of the TGN1412 monoclonal antibody clinical trial in 2006 (Alcyomics, 2017).

Other high performance initiatives include physiologically-based pharmacokinetic modelling (PBPK), which quantitatively predicts the characteristics of substances in the body (e.g., blood flow or effects on organs). The introduction of *in vitro* PBPK models over the past two decades is credited with reducing drug failure rates from over 40% to under 10% (McKim, 2010). Another major area of replacement research uses devices, known as Multi Organ Chips (MOC), to mimic the human body’s response to chemicals and disease processes, with the ultimate goal being a *human on a chip*. Over the past few years, advances in MOC technology have been exponential. For example, the organ on a chip devices developed at Harvard’s Wyss Institute can mimic events in tissue function and disease, such as air flow, bacterial infection, immune system response, blood clotting, fluid leakage and, most recently, electrical activity across cells, to predict safety and disease mechanisms in patients (Wyss Institute, 2017). For further discussion see Wilkinson, 2019, Chapter 26.

At the United States NIH Chemical Genomics Centre, a major testing program has been underway since 2004, involving a robotic-arm system that tests thousands of chemicals, using patient donated cells. The high throughput system performs approximately 3 million tests per week in relation to a different disease. The success of the system (also funded under the *Toxicology in the 21st Century*, Tox21, initiative) in screening and identifying suitable candidate drugs has dramatically saved time, cost, and resources, resulting in human clinical trials starting within a year.

A further groundbreaking concept is the Adverse Outcome Pathway (AOP), a key component of the paradigm shift towards human-relevant methods and establishing a robust system for predicting human safety. An AOP is a sequence of events that starts by a chemical effect at the molecular level (termed a Molecular Initiating Event) and progresses through changes (termed Key Events) in cells, tissues, and organs to produce an adverse effect in the body. AOPs act as a bridge between emerging methods of safety testing and, ultimately, what happens in the body in response to a particular substance (xenobiotic). With increasing knowledge, AOPs can be linked to form networks, revealing adverse outcomes that share pathways and vice versa. One example is the establishment of *in vitro* test methods that map the three key stages of the AOP for skin sensitization, now accepted at Organisation for Economic Co-Operation and Development (OECD) level (2015). Before the EU cosmetic testing bans were implemented, there was a high level of skepticism over the prospect of testing substances for skin sensitization (and other complex endpoints) without the use of animals; and while further work remains to be done, major progress has been made. The AOP program was established in 2012 and, including skin sensitization, there are now six AOPs approved at the OECD level; five relating to human health effects and one to address potential ecotoxicological effects to wildlife (fish, birds, and amphibians). A further 227 AOPs are in development (OECD, 2017).

In addition to new *in vitro* and *in silico* models to address safety testing, other areas of animal use previously considered essential, such as education, have seen coordinated replacement initiatives. Although animals are still used extensively in this area, great successes have been achieved to date. For example, campaigns by all involved in the International Network for Humane Education (InterNICHE) project to provide training and disseminate information on humane methods in medicine, biology, and veterinary research (e.g., mannequins and simulation techniques) continue to affect great change in universities and schools worldwide (InterNICHE, 2017). Other progress is being made in education as well. In 2016, Washington University announced it would end its 25-year use of cats for intubation training (the last university in the United States still using cats in this way). Instead, it will now use mannequins and advanced

simulators, following significant investment in its simulation center, which made the decision possible, following sustained public awareness campaigns (Physicians Committee for Responsible Medicine, 2016). Also in 2016, Johnson and Johnson subsidiary, Ethicon, finally agreed to remove live pigs from its medical-device training program, stating that it “discontinued live animal use in salestrainingacrossourNorthAmericaregion”(PeoplefortheEthicalTreatmentof Animals, 2016). For further discussion see Pawlowski, et al., 2019, Chapter 22.

In addition to the vast range of human-based technologies now available, another sensible approach is to improve the use of data from clinical, epidemiological, and biomonitoring studies. All of these have been considerably underused to date and could not only improve patient-safety and disease research but avoid the unnecessary use of animals.

5 Abandonment of Redundant and Duplicative Animal Tests

The ethical arguments concerning use of animals and problems with scientific validity are compounded further by the issue of *duplicative* experiments, which is a widespread problem. Many of the same tests are carried out over and over again, often amid claims of needing to maintain confidentiality and preserving intellectual property, despite mandates to share data. One example, a robust analysis of safety data submitted under the REACH program, recently revealed that, incredibly, the Draize eye irritation test had been carried out on rabbits for two chemicals, *go times per substance*. (Luechtefeld et al., 2016).

Not all tests need replacing. Many can end now as they are out of date or have been found to be redundant. A recent case is the deletion of the single-dose toxicity test from the European Medicines Agency guidelines, after it was recognized that information from the test could be obtained elsewhere, and that the test was of *limited value* (European Medicines Agency, 2010). Furthermore, there are many examples of animal tests that require a *root and branch* analysis and retrospective assessment to not only assess whether scientific objectives were met but also whether such procedures should have been approved at all. A case study to demonstrate this further is the European Coalition to End Animal Experiments (ECEAE). In 2014, ECEAE estimated that its strategy of toxicological review and comment on animal testing proposals for chemicals registered under the REACH legislation saved at least 18,000 animals, through rejected and withdrawn proposals. This was achieved on the basis of existing data or evidence that the tests proposed were unnecessary or unjustified (ECEAE, 2014). Another recent example is the welcome decision that the year-long chronic-toxicity test for pesticides is no longer required in dogs, on the basis that it is not scientifically justified (Kobel et al., 2010). The test has

been dropped in the EU, the United States, and Canada. Although there are still requirements for the one-year test to be carried out in other countries, the restrictions mark a change in attitudes and a meaningful review of testing requirements. The campaign continues to see the test abolished worldwide as soon as possible.

6 Conclusion

The aim of this chapter was to provide a qualitative overview of evidence from systematic reviews and some individual studies of not only the flawed approach to the continued use of animals in trying to predict mechanisms of human disease; but also the success of existing and emerging animal-free methods, the opportunities for intelligent use of human-based data, and the distinction between animal tests that require replacement and those that can simply end.

Advances in science, providing better technologies on an ongoing basis, should pave the way for acceptance of non-animal methods. In some areas, such as cosmetics testing, there is unprecedented change and global recognition that animal use must end. Yet, in other areas of animal research, despite a wealth of better science, the realities of some conventional attitudes, resistance to change, and an industry reliant on the continuation of animal experimentation (e.g., major establishments funded by long-term programs of animal research, financial partnerships, GM animal breeding, commercial breeders, suppliers, and transporters of animals) mean that political lobbying, campaigning, and raising public awareness must continue to play a major role. Fortunately, there are a number of animal protection, political, and scientific stakeholders who continue to work in the field, actively pushing for change, to increase recognition that animal research must end and to achieve the paradigm shift that is urgently needed for humans and animals.

Dedication

This chapter is dedicated to Andrew Tyler.

References

Alcyomics Ltd. (2017). *Case Study 1. Northwick Park*. [online] Available at: <http://alcyomics.com/case-studies/northwick-park/> [Accessed 16 February 2017].

- Animal Procedures Committee (APC) (2013). *Review of the Assessment of Cumulative Severity and Lifetime Experience in Non-human Primates Used in Neuroscience Research*. London. [online] Available at: https://www.gov.uk/government/uploads/system/uploads/attachment_data/file/261687/cs_nhp_review_FINAL_2013_corrected.pdf [Accessed 30 November 2016].
- Bailey, J., M. Thew and M. Balls (2013). An Analysis of the Use of Dogs in Predicting Human Toxicology and Drug Safety. *Alternatives to Laboratory Animals*, 41, pp. 335–350.
- Bailey, J., M. Thew and M. Balls (2014). An Analysis of the Use of Animal Models in Predicting Human Toxicology and Drug Safety. *Alternatives to Laboratory Animals*, 42, pp. 181–199.
- Bailey, J., M. Thew and M. Balls (2015). Predicting Human Drug Toxicity and Safety via Animal Tests: Can Any One Species Predict Drug Toxicity in Any Other, and Do Monkeys Help?. *Alternatives to Laboratory Animals*, 43, pp. 393–403.
- Barrow, P. (2002). Preclinical Testing for Teratogenicity and Developmental Toxicity: Methods and Limitations. *Therapie*, 57(2), pp. 109–114.
- Biotechnology and Biological Sciences Research Council (BBSRC) (2011). *Review of Research Using Non-human Primates*. Report of a panel chaired by Professor Sir Patrick Bateson, FRS. London. [online] Available at: <http://www.bbsrc.ac.uk/documents/review-research-using-nhps-pdf/> [Accessed 30 November 2016].
- Bloomberg (2013). Oxford Works with Drug-makers to Reverse 90% Trial Failure Rate. *Bloomberg News*. [online] Available at: <https://www.bloomberg.com/news/articles/2013-05-03/billionaire-li-ka-shing-funds-medical-data-institute-at-oxford> [Accessed 16 December 2016].
- Briel, M., K.F. Müller, J.J. Meerpohl, E. von Elm, B. Lang, E. Motschall, V. Gloy, F. Lamontagne, G. Schwarzer and D. Bassler (2013). Publication Bias in Animal Research: A Systematic Review Protocol. *Systematic Reviews*, 2(23). [online] Available at: <https://www.ncbi.nlm.nih.gov/pmc/articles/PMC3651300/> [Accessed 30 November 2016].
- Charles River Laboratories (2016). *Zebrafish: A Powerful Alternative Model for Developmental Toxicity Testing*. Charles River Technical Sheet. [online] Available at: <http://www.criver.com/files/pdfs/pcs/tox/zebrafish-developmental-toxicity-testing-technical.aspx> [Accessed 11 December 2016].
- European Chemicals Agency (2007). *Registration, Evaluation, Authorisation and Restriction of Chemicals (REACH)*. Helsinki. [online] Available at: <https://echa.europa.eu/regulations/reach/> [Accessed 30 November 2016].
- European Coalition to End Animal Experiments (ECEAE) (2014). ECEAE Claims 18,000 Animals Saved Through REACH Testing Proposals Process. London. [online]. Available at: <http://www.eceae.org/en/category/latest-news/371/eceae-claims-18000-animals-saved-through-reach-testing-proposals-process> [Accessed 3 August 2017].

- European Commission (2013a). *Ban on Animal Testing*. Brussels. [online] Available at: http://ec.europa.eu/growth/sectors/cosmetics/animal-testing_en [Accessed 30 November 2016].
- European Commission (2013b). *Seventh Report on the Statistics on the Number of Animals used for Experimental and other Scientific Purposes in the Member States of the European Union*. Brussels: SWD (2013), 497 final. [online] Available at: <http://eur-lex.europa.eu/legal-content/EN/TXT/PDF/?uri=CELEX:52013DC0859&from=EN> [Accessed 30 November 2016].
- European Medicines Agency (2010). *Questions and Answers on the Withdrawal of the "Note for Guidance on Single Dose Toxicity"*. [online] Available at: http://www.ema.europa.eu/docs/en_GB/document_library/Scientific_guideline/2010/07/WC500094590.pdf [Accessed 30 November 2016].
- European Parliament (2010). Directive 2010/63/EU of the European Parliament and of the Council of 22 September 2010 on the protection of animals used for scientific purposes. *Official Journal of the European Communities*, L276, pp. 33–79. [online] Available at: <http://eur-lex.europa.eu/legal-content/EN/TXT/?uri=CELEX%3A32010L0063> [Accessed 12 August 2017].
- Federal Ministry of Food and Agriculture (2016). *Animal Research Statistics 2015*. Berlin. [online] Available at: http://www.bmel.de/SharedDocs/Downloads/Tier/Tierschutz/Versuchstierdaten2015.pdf?__blob=publicationFile [Accessed 25 May 2017].
- Florey, H. (1953). The Advance of Chemotherapy by Animal Experiment. *Conquest*, 41, p. 12.
- Forster, R., G. Bode, L. Ellegaard, J.W. van der Laan, and Steering Group of the RETHINK Project. (2010). The RETHINK Project: Minipigs as Models for the Toxicity Testing of New Medicines and Chemicals: An Impact Assessment. *Journal of Pharmacological and Toxicological Methods*, 62, pp. 158–159.
- Godlee, F. (2014) How Predictive and Productive is Animal Research? *British Medical Journal*, 348, p. 3719.
- Google Scholar (2016). [online] Available at: <https://scholar.google.co.uk> [Accessed 30 November 2016].
- Hartung, T. (2008). Food for thought ... on Alternative Methods for Cosmetics Safety Testing. *Alternatives to Animal Experimentation*, p. 25.
- Hartung, T. (2009). Per Aspirin Ad Astra. *Alternatives to Laboratory Animals*, 37(2), pp. 45–47.
- Hirst, T.C., R. Watzlawick, J.K. Rhodes, M.R. Macleod and P.J. Andrews (2016). Study Protocol: A Systematic Review and Meta-analysis of Hypothermia in Experimental Traumatic Brain Injury: Why Have Promising Animal Studies Not Been Replicated in Pragmatic Clinical Trials? *Evidence-based Preclinical Medicine*, 3(2), p. e00020.
- Hohmann, S., R. Cardoso, F. Pinho-Ribeiro, J. Crespigio, T. Cunha, J. Alves-Filho, R. da Silva, P. Pinge-Filho, S. Ferreira, F. Cunha, R. Casagrande and W. Verri (2013). 5-lipoxygenase

- deficiency reduces acetaminophen-induced hepatotoxicity and lethality. *BioMed Research International*, 627046.
- Holm, J., C. Chalmey, H. Modick, L. Jensen, G. Dierkes, T. Weiss, B. Jensen, M. Nørregard, K. Borkowski, B. Styrihave, H. Koch, M. Severine, B. Jegou, K. Kristiansen and D. Kristensen (2015). Aniline Is Rapidly Converted into Paracetamol Impairing Male Reproductive Development. *Toxicological Sciences*, 148(1), pp. 288–298.
- Home Office (2014). *Working to Reduce the Use of Animals in Scientific Research: Delivery Plan*. London. [online] Available at <https://www.gov.uk/government/publications/working-to-reduce-the-use-of-animals-in-research-delivery-plan> [Accessed 30 November 2016].
- Home Office (2017). *Statistics of Scientific Procedures on Living Animals, Great Britain 2016*. London. [online] Available at: https://www.gov.uk/government/uploads/system/uploads/attachment_data/file/627284/annual-statistics-scientific-procedures-living-animals-2016.pdf [Accessed 30 November 2016].
- Horn, J., R. de Haan, M. Vermeulen, P. Luiten and M. Limburg (2001). Nimodipine in Animal Model Experiments of Focal Cerebral Ischemia: A Systematic Review. *Stroke*, 32(10), pp. 2433–2438.
- International Network for Humane Education (InterNICHE) (2017). [online]. Available at: <http://www.interniche.org> [Accessed 6 August 2017].
- Kobel, W., I. Fegert, R. Billington, R. Lewis, K. Bentley, W. Bomann, P. Botham, B. Stahl, B. Ravenzwaay and H. Spielmann (2010). A 1-year Toxicity Study in Dogs Is No Longer a Scientifically Justifiable Core Data Requirement for the Safety Assessment of Pesticides. *Critical Reviews in Toxicology*, 40(1), pp. 1–15.
- Lawrence, J. (2014). An Out of Body Experience. *The Pharmaceutical Journal*. [online] Available at: <http://www.pharmaceutical-journal.com/news-and-analysis/feature/organ-on-chip-technology-to-revolutionise-drug-development/20065894.article> [Accessed 30 November 2016].
- Liew, Z., B. Ritz, J. Virk and J. Olsen (2014). Maternal Use of Acetaminophen During Pregnancy and Risk of Autism Spectrum Disorders in Childhood: A Danish National Birth Cohort Study. *Autism Research*, 9(9), pp. 951–958.
- Lucas, C., L. Criens-Poublon, C. Cockrell and R.J. de Haan (2002). Wound Healing in Cell Studies and Animal Model Experiments by Low Level Laser Therapy. Were Clinical Studies Justified? A Systematic Review. *Lasers in Medical Science*, 17(2), pp. 110–134.
- Luechtefeld, T., A. Maertens, D. Russo, C. Rovida, H. Zhu and T. Hartung (2016) Analysis of Draize E Eye Irritation Testing and Its Prediction by Mining Publicly Available 2008–2014 REACH Data. *Alternatives to Animal Experimentation*, 33(2), pp. 123–134.
- McCloskey, P., R. Edwards, R. Tootle, C. Selden, E. Roberts and H. Hodgson (1999). Resistance of Three Immortalized Human Hepatocyte Cell Lines to Acetaminophen and N-acetyl-p-benzoquinoneimine Toxicity. *Journal of Hepatology*, 31(5), pp. 841–851.

- McKim, J. Jr. (2010). Building a Tiered Approach to *In Vitro* Predictive Toxicity Screening: A Focus on Assays with *In Vivo* Relevance. *Combinatorial Chemistry & High Throughput Screening*, 13(2), pp. 188–206.
- Ministry of Higher Education and Research (2016). *Use of Animals for Scientific Purposes in French User Establishments: Statistical Survey 2014*. Paris. [online] Available at: http://cache.media.enseignementsup-recherche.gouv.fr/file/utilisation_des_animaux_fins_scientifiques/84/2/Enquete_2014_-_utilisation_des_animaux_a_des_fins_scientifiques_591842.pdf [Accessed 30 November 2016].
- National Center for Advancing Translational Sciences (NCATS) (2017). *Transforming Translational Science*. [online] Available at: <https://ncats.nih.gov/files/NCATS-factsheet.pdf> [Accessed 7 February 2017].
- National Centre for Biotechnology Information (2016). *PubMed*. [online] Available at: <https://www.ncbi.nlm.nih.gov/pubmed/> [Accessed 30 November 2016].
- National Institutes of Health (NIH) (2016). *About Tissue Chip*. [online] Available at: <https://ncats.nih.gov/tissuechip/about> [Accessed 30 November 2016].
- Netherlands National Committee for the protection of animals used for scientific purposes (NCad) (2016). *Opinion Transition to Non-animal Research*. The Hague. [online] Available at: <https://english.ncadierproevenbeleid.nl/latest/news/16/12/15/ncad-opinion-transition-to-non-animal-research> [Accessed 30 November 2016].
- Nohynek, G., E. Antignac, T. Re and H. Toutain (2010). Safety Assessment of Personal Care Products/Cosmetics and Their Ingredients. *Toxicology and Applied Pharmacology*, 243; pp. 239–259.
- OECD (2017) *Adverse Outcome Pathway (AOP) Knowledge Base*. [online] Available at: <http://aopkb.org/> [Accessed 6 August 2017].
- Organisation for Economic Co-Operation and Development (OECD) (2015). *The Adverse Outcome Pathway for Skin Sensitisation Initiated by Covalent Binding to Proteins*. [online] Available at: <http://www.oecd.org/env/the-adverse-outcome-pathway-for-skin-sensitisation-initiated-by-covalent-binding-to-proteins-9789264221444-en.htm> [Accessed 30 November 2016].
- People for the Ethical Treatment of Animals (PETA) (2016). *Letter from Johnson and Johnson Animal Care and Use Council to PETA Laboratory Investigations Division*. [online] Available at: <http://freepdfhosting.com/be28b65dbf.pdf> [Accessed 6 August 2017].
- Perel, P., I. Roberts, E. Sena, P. Wheble, C. Briscoe, P. Sandercock, M. Macleod, M. Luciano, P. Jayaram and K. Khan (2007). Comparison of Treatment Effects Between Animal Experiments and Clinical Trials: Systematic Review. *British Medical Journal*, 334(7586), p. 197.
- Physicians Committee for Responsible Medicine (2016). *Physicians Committee Commends Washington University for Ending Animal Labs*. [online]. Available at: <https://>

- www.pcrm.org/pcrm.org/media/news/washington-university-ends-live-cat-labs-for-pediatrics-training [Accessed 6 August 2017].
- Pingili, R., A. Pawak and S. Challa (2015). Systemic Exposure of Paracetamol (Acetaminophen) Was Enhanced by Quercetin and Chrysin Co-administration in Wistar Rats and *In Vitro* Model: Risk of Liver Toxicity. *Drug Development and Industrial Pharmacy*, 41(11), pp. 1793–1800.
- PR Newswire (2014). *In Vitro Toxicology Testing Market Worth \$17,227 Million by 2018*. [online] Available at: <http://www.prnewswire.co.uk/news-releases/in-vitro-toxicology-testing-market-worth-17227-million-by-2018-253586361.html> [Accessed 10 July 2017].
- Ramirez, T., S. Beken, M. Chlebus, G. Ellis, C. Griesinger, S. De Jonghe, I. Manou, A. Mehling, K. Reisinger, L. Rossi, J. van der Laan, R. Weissenhorn and U. Sauer (2015). Knowledge Sharing to Facilitate Regulatory Decision-making in regard to Alternatives to Animal Testing: Report of an EPAA Workshop. *Regulatory Toxicology and Pharmacology*, 73(1), pp. 210–226.
- Raynor, H.A., M.R. Goff, S.A. Poole and G. Chen (2015). Eating frequency, food intake and weight: A systematic review of human and animal experimental studies. *Frontiers in Nutrition*, 18(2), p. 38.
- Reis, J., V. Monteiro, R. de Souza Gomes, M. do Carmo, G. da Costa, P. Ribera and M. Monteiro (2016). Action Mechanism and Cardiovascular Effect of Anthocyanins: A Systematic Review of Animal and Human Studies. *Journal of Translational Medicine*, 15–14(1), p. 315.
- Rogers, P.J., P.S. Hogenkamp, C. de Graaf, S. Higgs, A. Lluch, A.R. Ness, C. Penfold, R. Perry, P. Putz, M.R. Yeomans and D. J Mela (2016). Does Low-energy Sweetener Consumption Affect Energy Intake and Body Weight? A Systematic Review, including Meta-analyses of the Evidence from Human and Animal Studies. *International Journal of Obesity (London)*, 40(3), pp. 381–394.
- Russell, W. and R. Burch (1959). *Principles of humane experimental technique*. [online] Available at: http://altweb.jhsph.edu/pubs/books/humane_exp/het-toc [Accessed 30 November 2016].
- Schiffelers, M.J., B. Blaauboer, C. Hendriksen and W. Bakker (2012). Regulatory Acceptance and Use of 3R Models: A Multilevel Perspective. *Alternatives to Animal Experimentation*, 29(3), pp. 287–300.
- Sena, E., H. van der Worp, P. Bath, D. Howells and M. Macleod (2010). Publication Bias in Reports of Animal Stroke Studies Leads to Major Overstatement Of Efficacy. *Public Library of Science Biology*, 30, 8(3), p. e1000344.
- Sneader, W. (2005). *Drug discovery*. West Sussex, UK: John Wiley & Sons, Ltd.
- van Meer, P., M. Kooijman, C. Gispen-de Wied, E. Moors and H. Schellekens (2012) The Ability of Animal Studies To Detect Serious Post Marketing Adverse Events Is Limited. *Regulatory Toxicology and Pharmacology*, 64(3), pp. 345–349.

- Viberg, H., P. Eriksson, T. Gordh and A. Fredriksson (2014). Paracetamol (Acetaminophen) Administration During Neonatal Brain Development Affects Cognitive Function and Alters Its Analgesic and Anxiolytic Response in Adult Male Mice. *Toxicological Sciences*, 138(1), pp. 139–147.
- Wyss Institute (2017). *Wyss Institute's Organ Chips Get Smart And Go Electric*. [online] Available at: <https://wyss.harvard.edu/wyss-institutes-organ-chips-get-smart-and-go-electric/> [Accessed 6 August 2017].
- Yu, H., N. Barrass, S. Gales, E. Lenz, T. Parry, H. Powell, D. Thurman, M. Hutchison, I. Wilson, L. Bi, J. Qiao, Q. Qin and J. Ren (2015). Metabolism by Conjugation Appears to Confer Resistance to Paracetamol (Acetaminophen) Hepatotoxicity in the Cynomolgus Monkey. *Xenobiotica*, 45(3), pp. 270–277.
- Yusa, K. Rashid, S.T., Strick-Marchand, H., Varela, I., Liu P.Q., Paschon D.E., Miranda E., Ordóñez A., Hannan, N.R., Rouhani F.J. and Darche S., (2011). Targeted Gene Correction of α 1-antitrypsin Deficiency in Induced Pluripotent Stem Cells. *Nature*, 478(7369), pp. 391–394.

Is Animal-based Biomedical Research Being Used in Its Original Context?

Constança Carvalho

Centre for Philosophy of Sciences of the University of Lisbon, Portugal
constanca.carvalho@sapo.pt

Daniel Alves

Department of Animal Biology, Centre for Ecology Evolution and Environmental Changes, Portugal Faculty of Sciences of the University of Lisbon

Andrew Knight

Centre for Animal Welfare, University of Winchester, UK

Luis Vicente

Centre for Philosophy of Sciences of the University of Lisbon, Portugal

1 Introduction

Since the second half of the twentieth century, non-human animals (hereinafter referred to as animals) have been widely used as models for researching human disorders. Historically, this occurred for two main reasons: a) animals are complex living systems; and b) it is considered less ethically-contentious as well as easier, quicker, and cheaper to use animals than humans. Their benefit for biomedical advancement is assumed even though systematic evaluations, though uncommon, suggest otherwise. It is crucial to evaluate whether animal-based biomedical research successfully benefits medical research—even through indirect pathways—or if it is being used merely to justify further animal-based research. In this chapter we demonstrate that there is a lack of communication between animal-based research and clinical research. We discuss possible reasons for this and reflect on whether animal use in biomedical research is, indeed, fulfilling its primary purpose.

Humans share a long evolutionary story with the rest of the animal kingdom, which explains common physiological and behavioral traits and adaptations. For example, *basal ganglia*, a set of subcortical nuclei involved in

several motor functions, are present throughout vertebrate *taxa* and are largely similar across species (Lee et al., 2015). Similarly, the rise of body temperature as a response to infection is shared by humans and other mammals (Nesse and Williams, 1996; Schaffner, 2006). Even poikilothermic (cold-blooded) animals, such as lizards, tend to move to warmer places when they are ill, until their body temperature is several degrees above normal (Nesse and Williams, 1996). The relatively recent decoding of genomes had shown an impressive number of genes shared between ourselves and taxonomically-distant species, such as the frog (Hellsten et al., 2010). These similarities provided the basis for the untested assumption that animals provide good research models for human disorders.

However, we know that minimal biological changes can create significant differences between species and individuals. For example, Darwin's finches comprise 14 closely-related species that vary dramatically in their feeding habits, despite their biological proximity (Lack, 1947). Even amongst individuals of the same species, slight and almost undetectable differences can cause very different adaptive responses. For example, human beings with sickle cell trait may have increased protection from malaria but risk sudden death by hypoxia, when visiting high altitudes or performing intense physical exertion (Scheinin and Wetli, 2009; Webber et al., 2016), safe activities for most people.

Despite individual differences, it is obvious that human beings are the best biomedical model for human disorders. However, clinical research is time consuming and can have severe ethical constraints, which is one of the main reasons why animals are widely used as models for human disorders. Recent *in vitro* developments have allowed us to create cultures of human cells and tissues (e.g., Petropolis et al., 2016; Wilson, Ahearne and Hopkinson, 2015) that are considered superior to using animal samples for human-based research (Clemedson et al., 1998; Huhtala et al., 2008; Petropolis et al., 2016). Nonetheless, among the scientific community, the main obstacle to the total replacement of animal use in biomedical research is not a desire to study cells, tissues, or organs, but the desire to study entire, functioning bodily systems. This is considered necessary when objectives include understanding a drug effect in the whole organism or trying to understand the etiology and pathogenesis of multifactorial disorders, such as mental disorders.

In silico techniques have been slowly addressing this issue, creating whole body simulations (e.g., Viceconti, Clapworthy and Jan, 2008; Viceconti, Henney and Morley-Fletcher, 2016). However, the availability of human data limits these models. For example, if a new disease arises, models may fail to predict accurately the response of the human body to the new pathogen due to lack of data. It should be noted that animal models also suffer from failure to predict human

responses accurately. Despite the accepted potential of *in silico* techniques, unvalidated animal models are still commonly believed to be the best available, so far, for studying the entire, functioning human body.

Throughout the years, various authors have asserted that animal research has made only poor contributions to medical progress (e.g., Bailey, 2008; Fadali, 1996; Greek and Greek, 2003; Shapiro, 1998), while others have asserted the opposite (e.g., Illman, 2008; Shively and Clarkson, 2009; Perretta, 2009). Such assertions are based upon historical analyses, investigations into the development of various treatments, and critical reviews of animal model use. Historical accounts are disputed. A classic example is the discovery of the role of the pancreas in diabetes. Many claim that we owe this discovery to experiments conducted by Minkowski and von Mering with dogs, in the second half of the nineteenth century (cited in Bliss, 1982); whereas, others argue that this medical breakthrough was achieved by Thomas Cawley, 100 years earlier, while performing autopsies on patients who died from diabetes (cited in Fadali, 1996).

Investigations into the development of treatments are also controversial. A good example is the development of the poliomyelitis vaccine. Poliomyelitis is a viral disease that reached epidemic proportions in 1916. Some (e.g., Illman, 2008) state that it was the experiments performed on mice and monkeys that allowed scientists to understand its pathogenesis and develop a vaccine. Furthermore, both poliomyelitis vaccines (Salk vaccine and Sabin vaccine) were initially grown in monkey kidney tissue (Dowdle et al., 2003), reinforcing the perception of the central role of animal experiments in the development of poliomyelitis treatment (Illman, 2008). However, others (e.g., Fadali, 1996) claim that animal experiments delayed the vaccine's development. Rhesus monkeys, which provided a widely-used animal model for poliomyelitis, misled scientists to believe that the virus was transmitted via the respiratory, rather than the digestive route (Dowling, cited in Bailey, 2008), as earlier research on humans had suggested (see Fadali, 1996, for a review). This mistake led to an erroneous clinical trial in 1937, in which exposed children suffered olfactory damage (Parish, 1968). Also, the first poliomyelitis vaccines, grown on monkey kidney cells, were responsible for the exposure of millions of American citizens to simian virus 40, found in rare human cancers (Pennisi, 1997). When it comes to non-human primates (NHPS), these disputes are even more contentious, because public opinion is less supportive of the use of NHPS in research (European Commission, 2010). Furthermore, as technology evolves, better methods become available, and the apparent historical necessity of animal experiments becomes of less relevance. For example, vaccines that used to be developed using animal tissues—at times suboptimally due to poor efficiency (e.g., rubella

vaccine developed through duck embryo cells and dog kidney cells) or zoonosis (e.g., the simian virus that reached humans through the first polio vaccines)—are now being developed using human strains (Plotkin, 2017).

Recently more objective tools to assess the contribution of animal models to biomedical progress have emerged. Such is the case of systematic reviews, meta-analyses, and citation analyses. Systematic reviews are literature reviews focused on a research question that aim to identify, appraise, and synthesize all high-quality research evidence relevant to that question. They are generally considered the best tool to produce evidence about the value of animal studies (Pound et al., 2004), not only because they are designed to include all relevant information, drastically reducing the potential for bias; but also because systematic reviews evaluate experimental designs through rigorous and objective peer-reviewed protocols, such as the *Animal Research: Reporting In Vivo Experiments* (ARRIVE) guidelines that apply scientific method to the task of reviewing research evidence (Kilkenny et al., 2010). A meta-analysis can go even further by incorporating a statistical representation of all the reviewed studies as well.

In the past decades, the number of systematic reviews shedding light on the scientific value of animal studies has increased (e.g., Banwell, Sena and Macleod, 2009; Corpet and Pierre, 2005; Lucas et al., 2002; Macleod et al., 2005; Martić-Kehl et al., 2015; Perel et al., 2007). The systematic reviews have revealed: a) poor transferability of animal outcomes to human clinical trials (e.g., Perel et al., 2007); b) simultaneous occurrence of animal and clinical trials, rather than sequentially, as expected given that the animal experiments should be conducted first, to allow detection of possible toxicity (e.g., Lucas et al., 2002); and, c) significant methodological and design flaws in a clear majority of animal experiments (e.g., Martić-Kehl et al., 2015). Consequently, the use of ARRIVE or similar guidelines has become more common, which will hopefully lead to better protocols and reduce redundant studies. As for the poor transferability of animal outcomes to human trials, it can be argued that this is either a consequence of poor experimental design, and/or the fact that animal models are not suitable models for human beings (Bailey and Taylor, 2016).

Another way to determine the value of animal studies is citation analysis, which consists of determining the frequency with which a study is cited in subsequent papers. Several authors have conducted citation analyses on published papers, reporting data from animals used as models for human disorders (e.g., Carvalho et al., 2016; Knight, 2007; Long, Huang and Ho, 2014); results show that these papers have received very few citations in human medical papers. Again, it can be debated whether this occurs due to a false assumption that animal models are suitable models for human disorders or because of methodological errors, or both.

To try to address this issue, we performed a citation analysis on a small sample of papers reporting data from animals used to model two complex psychiatric disorders: attention deficit hyperactivity disorder (ADHD) and major depressive disorder (MDD).

ADHD is a chronic neurodevelopmental condition of multifactorial origin, marked by persistent inattention; hyperactivity; and, occasionally, impulsivity (American Psychiatric Association, APA, 2013). It affects 2.2% of children worldwide (Erskine et al., 2013); and it can be extremely disabling (APA, 2013). MDD is a complex psychiatric mood disorder characterized by a persistent feeling of sadness that seriously impairs normal day-to-day functioning and may even lead to suicide (APA, 2013). Mental disorders are the leading cause of years lived with disability worldwide, and 40.5% of this burden is caused by MDD alone (World Health Organization, 2008).

In this study we categorized the citations obtained into animal *versus* human studies and determined whether human-based and animal-based papers focused on the same disorder investigated by the animal study they were citing. This form of analysis is valuable for shedding light on whether animal-based research is being used to advance human healthcare, or whether it simply fuels further animal-based research. If animal studies are contributing to human healthcare advancements, then we would expect that:

1. The citations made in human-based papers should be a substantial proportion of total citations.
2. The citations should be made mainly by studies focused on the same disorder. Any substantial deviations would signal the possibility that animal-based research is not achieving its primary purpose.

2 Methods

We conducted a citation analysis as defined by Garfield and Merton (1979). Briefly, in a citation analysis, one defines a number of target papers and conducts a search of all papers that cite these target papers. The information obtained can include the total number of citations and patterns of citation. We used a total of 50 target papers: 25 non-human animal studies on ADHD, and 25 non-human animal studies on MDD.

The ADHD papers were selected from the citation analysis database created in the study by Carvalho et al. (2016). We included all papers reporting data collected with primate models (7 papers) and randomly selected 18 papers from the remaining papers, using the free online tool, *Research Randomizer* (www.randomizer.org). The 25 studies were examined to determine the proportion of citations each paper received in human-based papers focused

on ADHD, in human-based papers focused on other subjects, in animal-based papers focused on ADHD, and in animal-based papers focused on other subjects.

The MDD papers were obtained using PubMed to locate original articles using animal models to investigate major depressive disorder (similar to the protocol used in Carvalho et al., 2016). We searched PubMed using the following Medical Subject Heading (MeSH) search terms:

“Major Depressive Disorder” AND (title/abstract): “animal” OR “rat” OR “mice” OR “mouse” OR “*Rattus*” OR “*Mus*” OR “pig” OR “*Cavia*” OR “*Sus*” OR “rabbit” OR “*Leporidae*” OR “*Drosophila*” OR “primate” OR “monkey” OR “*Macaca*” OR “macaque” OR “ape” OR “*rhesus*” OR “chimpanzee” OR “bonobo” OR “*gorilla*” OR “*Pan*” OR “Orang Utan” OR “*Pongo*” OR “gibbon” OR “*Hylobates*” OR “*Colobus*” OR “Baboon” OR “*Papio*” OR “*Mandrillus*” OR “Mandrill” OR “*Cebus*” OR “*Cebuella*” OR “*Brachyteles*” OR “*Loris*” OR “*Nycticebus*” OR “*Lemur*” OR “dog” OR “*Canis*” OR “cat” OR “*Felis*.”

We found 33 published papers using NHPS as models and randomly selected seven, using the same randomizing tool. We found over 1,000 published papers using other animals as models and proceeded, as above, to randomly select 18 papers for the citation analysis. We recorded the number of citations each paper received from subsequent animal research papers and subsequent human research papers. We similarly analyzed the aim of the citing paper (whether it was focused on the same disorder or another), in both animal and human papers.

Using Fisher’s exact test (<http://www.kisnet.or.jp/nappa/software/star-e/freq/ix2.htm>), we investigated whether there was a significant difference between the number of citations of the target animal articles in human research papers and in animal research papers. We also verified whether there was a significant difference between the number of citations in subsequent articles addressing the same disorder and subsequent articles addressing different topics. Differences were considered statistically significant if $p < 0.05$.

3 Results

Regarding our ADHD sample, the 25 original animal studies were cited 660 times. As shown in Figure 16.1, animal studies were mainly cited in other animal research papers (315), of which 82 focused on ADHD and 233 focused on different subjects. The sample resulted in 69 citations in human research papers, of which 30 focused on ADHD and 39 focused on different subjects. The

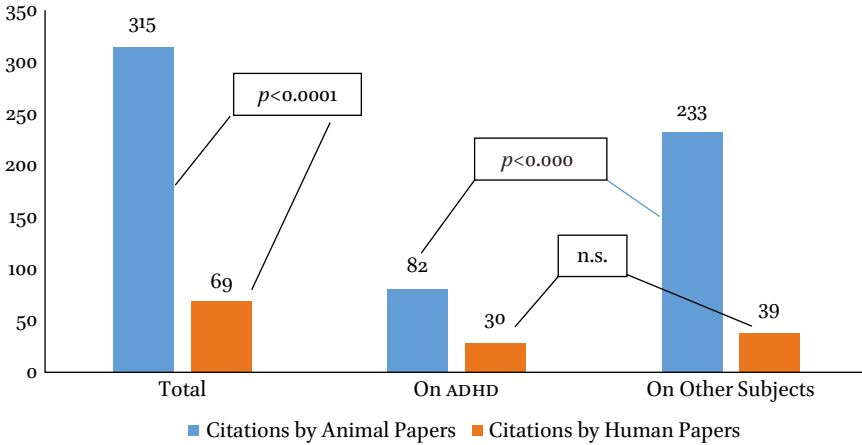

FIGURE 16.1 Citations of animal papers focused on ADHD.

remaining 345 citations were in review articles (198) or papers describing different methods, such as *in silico* or *in vitro* (147).

The columns represent the number of citations of the 25 target papers in animal research papers (blue) and human research papers (orange). The total number (left), as well as the number of citations in papers studying ADHD (middle) and other subjects (right) are presented. Fisher's exact test p -values are also presented for each comparison made (n.s.= non-significant).

The number of citations in animal research papers was far greater than the number of citations in human research papers ($p < 0.0001$). The number of citations in animal research papers focused on ADHD was lower than the number of citations in animal research papers focused on other subjects ($p < 0.0001$). The difference between the number of citations in human research papers on ADHD and human research papers focused on other subjects was not statistically significant ($p = 0.3355$).

Seven of the target papers reported NHP studies. These papers received 274 citations, 94 of which were in subsequent animal research papers and 48 were in human research papers. The remaining 138 citations were in review papers (96) or papers describing different methods, such as *in silico* or *in vitro* (42). The difference between citations in animal research papers and human research papers was statistically significant ($p = 0.0001$). Of the 94 citations in subsequent animal papers, 21 were in papers focused on ADHD, and 73 were in papers focused on other issues. This difference was also statistically significant ($p < 0.0001$).

Of the 48 citations in human research papers, 15 were in papers focused on ADHD, and 33 were in papers describing other disorders. Fisher's exact test showed that in the case of NHPs there was a statistically significant difference

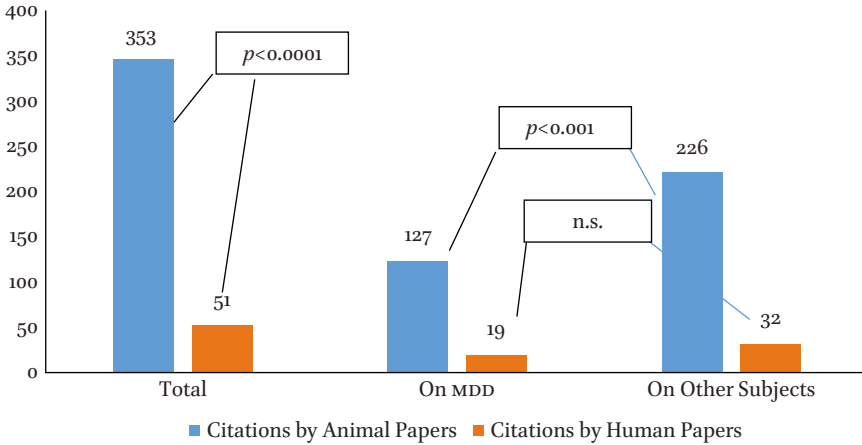

FIGURE 16.2 Citations of animal papers focused on MDD.

between the number of citations in papers on ADHD and papers focused on other subjects ($p=0.0132$).

Regarding the MDD sample, the 25 target animal studies were cited 631 times. As shown in Figure 16.2, animal studies were mainly cited in other animal research papers (353), of which 127 focused on MDD, and 226 focused on different subjects. The sample received 51 citations in human research papers, of which 19 focused on MDD, and 32 focused on different subjects. The remaining 227 citations were in review articles (163) or papers describing different methods, such as *in silico* or *in vitro* (64).

The columns represent the number of citations in animal research papers (blue) and in human research papers (orange) of the 25 cited papers. The total number (left), as well as the number of citations in papers studying MDD (middle) and other subjects (right) are presented. Fisher's exact test p -values are also presented for each comparison made.

The number of citations in animal research papers was substantially greater than the number of citations in human research papers (Fisher's exact test, $p < 0.0001$). The number of citations in animal research papers focused on MDD was lower than the number of citations in papers focused other subjects ($p < 0.0001$). The difference between the number of citations in human research papers focused on MDD and papers focused on other subjects was not statistically significant ($p=0.0919$).

The seven papers reporting on NHP studies received 227 citations, 97 of which were in subsequent animal research papers, and 19 were in human research papers. This difference was statically significant ($p=0.001$). Of the 97

citations in subsequent animal papers, 13 were in papers on MDD, and 84 were in papers focused on other issues. This difference was statistically significant ($p < 0.0001$). Of the 19 citations in human medical papers, six were in papers on MDD, and 13 were in papers focused on other subjects. This difference was not statistically significant ($p = 0.1670$).

4 Discussion

Our results suggest that animal data is mainly used by subsequent animal papers. Another trend that emerged is that papers citing animal research (whether they focus on human medical research or not) focus on disorders that differ from the one targeted in the animal study cited. This trend is stronger in papers focused on animal research.

The tendency for animal research to be cited more in subsequent animal research has been previously described (e.g., Carvalho et al., 2016). This finding contradicts the previously stated assumption that citations in human-focused papers should constitute a substantial proportion of the total number of citations. Clearly, biomedical research focused on animal models does not seem to be considered important by, or particularly visible to, the human medical research community.

Our results also indicate that papers citing data collected from animal models do not necessarily target the disorder described in the animal paper. This difference appears to be more significant in animal research papers citing other animal research papers, than in human research papers that cite animal research. This contradicts the second assumption we tested: that citations should be made mainly by studies focused on the same disorder. This finding reinforces the concern that animal-based research is failing to shape meaningful healthcare advances for humans.

It can be argued that if the same animal model is used for different disorders, it may contribute more to medical research than predicted by the second assumption. For example, DAT knock-out mice comprise a common model for ADHD but are also used to model Parkinson or schizophrenia (Gainetdinov, 2008). Nevertheless, the total citation frequency in human research papers is still very low, regardless of the paper's area of focus (Carvalho et al., 2016; Knight, 2007; Long, Huang and Ho, 2014).

The fact that animal strains are used to model several disorders may help explain the intriguing tendency for animal research papers to be cited more often in papers addressing non-related subjects than in papers focused on the same disorder. This tendency was also apparent in human-based papers that cited animal-based papers focused on MDD. This may have occurred because

there are 6–7 times more papers focused on MDD than on ADHD, which may mean that the 25 papers on MDD were not a representative sample of MDD research. If this phenomenon was to recur with a larger sample, one could argue that this is due to the same animal strain being used for different purposes, as previously mentioned. If the strains used in MDD research are commonly used to model a greater number of disorders than strains used in ADHD research, it would be more probable that human studies focused on unrelated disorders cite studies in these strains. We did not verify this, and it should be explored in future studies.

Our data shows that even though the difference between the total frequency of citations by human papers focused on ADHD and paper focused on other subjects was not statistically significant, there was a bias regarding papers describing NHP models of ADHD. A close examination of the data allowed us to conclude that this bias was due to one paper, cited 18 times in human research papers, 17 of which focused on disorders other than ADHD. This particular paper described the behavioral changes caused by bicuculline microinjections in external *globus pallidus*, a brain structure involved in pathogenesis of ADHD but also in Tourette's syndrome. Most of the 18 citations this paper received in human papers were actually from papers related to Tourette's syndrome. If we discard this outlier, the data on NHP follows the same pattern as other ADHD papers.

Since our two assumptions have been challenged, we must discuss their causes and implications. One possible explanation for these results is that animal models only attempt to model specific symptoms or traits of complex human disorders. This oversimplification may lead to results that are non-applicable or of minimal use for human medicine. Another possible explanation is that funding is more easily attached to studies that claim to have the potential to advance human health. This may lead animal researchers to overestimate the applicability of their projects. A further possible explanation is that communication and sharing of ideas between clinical and preclinical research is insufficient. Moreover, previous studies have shown that clinical and preclinical trials can occur simultaneously (Pound et al., 2004), which emphasizes this lack of communication. Although it is difficult to define an optimum communication level, this issue must be raised in both communities in order to maximize efficiency in scientific research as well as the promotion of animal welfare. An additional possibility is that a substantial amount of animal research is needed in order to achieve a critical mass that can lead to useful breakthroughs in human health. This is a theoretical possibility that is difficult to measure and properly test. However, even if proven correct, the financial and ethical implications of this assumption should be considered. Other methods may prove to be more efficient or ethically acceptable, and this

comparison could lead to a reevaluation of funding priorities. Finally, a conceivable possibility is that animal models are not suitable for biomedical research into complex human disorders. It may be possible that the uniqueness of some human disorders is just not feasibly simulated in non-human animals.

If our last suggested explanation is indeed correct, the implications must be considered. The funding currently allocated to these animal-based studies should still be available for science. While most of it would likely be redirected to other models of these disorders, some of it could be assigned either to other basic research fields or to the care of surplus animals.

Regardless of the possible explanations, our results indicate that animal-based research is failing to reach the human medical community, at least in the case of mental disorders, such as the ones we evaluated. This means that considerable financial investment and considerable suffering inflicted on the animals used for this purpose did not translate into direct medical advances. It would be interesting to survey the practitioners working with mental disorders to assess if this is due to lack of awareness of animal-based findings, or if they consider animal-based data to be inadequate or lacking in relevance.

In conclusion, our analysis suggests that most animal-based research, at least in the case of these mental disorders, is not currently being utilized by human-based researchers. Regardless of the reasons for this, the profound financial and ethical implications should lead to a reevaluation of the current research paradigm, which is heavily reliant on invasive animal use.

Acknowledgments

This study was financed by Animalfree Research – Switzerland and Portuguese National Funds through Centre for Philosophy of Sciences of the University of Lisbon (CFCUL) Unit funding UID/FIL/00678/2013.

References

- American Psychiatric Association (APA) (2013). *Diagnostic and statistical manual of mental disorders*. 5th ed. Arlington, VA: American Psychiatric Publishing.
- Bailey, J. (2008). An Assessment of the Role of Chimpanzees in AIDS Vaccine Research. *Alternatives to Laboratory Animals*, 36(4), pp. 381–428.
- Bailey, J. and K. Taylor (2016). Non-human Primates in Neuroscience Research: The Case Against Its Scientific Necessity. *Alternatives to Laboratory Animals*, 44(1), pp. 43–69.

- Banwell, V., E. Sena and M. Macleod (2009). Systematic Review and Stratified Meta-analysis of the Efficacy of Interleukin-1 Receptor Antagonist in Animal Models of Stroke. *Journal of Stroke and Cerebrovascular Diseases*, 18, pp. 269–276.
- Bliss, M. (1982). *The Discovery of insulin: 25th anniversary edition*. Chicago, IL: Chicago University Press.
- Carvalho, C., M.V. Crespo, L.F. Bastos, A. Knight and L. Vicente (2016). Contribution of Animal Models to Contemporary Understanding of Attention Deficit Hyperactivity Disorder. *Alternatives to Animal Experimentation*, 33(3), pp. 243–249.
- Clemenson, C., M. Andersson, Y. Aoki, F.A. Barile, A.M. Bassi, M.C. Calleja, A. Castano, R.H. Clothier, P. Dierickx, B. Ekwall, M. Ferro, G. Fiskesjö, L. Garza-Ocanas, M.J. Gómez-Lechón, M. Gulden, T. Hall, K. Imai, B. Isomaa, A. Kahru, G. Kerszman, P. Kjellstrand, U. Kristen, M. Kunimoto, S. Kärenlampi, L. Lewan, H. Lilius, A. Loukianov, F. Monaco, T. Ohno, G. Persoone, L. Romert, T.W. Sawyer, H. Segner, H. Seibert, R. Shrivastava, M. Sjöström, A. Stamatii, N. Tanaka, A. Thuvander, O. Torres-Alanis, M. Valentino, S. Wakuri, E. Walum, X.H. Wang, A. Wieslander, F. Zucco and B. Ekwall (1998). MEIC Evaluation of Acute Systemic Toxicity, Part IV. *In Vitro* Results from 67 Toxicity Assays Used to Test Reference Chemicals 31–50 and a Comparative Cytotoxicity Analysis. *Alternatives to Laboratory Animals*, 26, pp. 131–183.
- Corpet, D. and F. Pierre (2005). How Good Are Rodent Models of Carcinogenesis in Predicting Efficacy in Humans? A Systematic Review And Meta-analysis of Colon Chemoprevention in Rats, Mice and men. *European Journal of Cancer*, 41, pp. 1911–1922.
- Dowdle, W., D. Gourville, O. Kew, M. Pallansch and D. Wood (2003). Polio Eradication: The OPV Paradox. *Reviews in Medical Virology*, 13(5), pp. 277–291.
- Erskine, H.E., A.J. Ferrari, P. Nelson, G.V. Polanczyk, A.D. Flaxman, T. Vos, H.A. Whiteford and J.G. Scott (2013). Epidemiological Modelling of Attention-Deficit/ Hyperactivity Disorder and Conduct Disorder for the Global Burden of Disease Study 2010. *Journal of Child Psychology and Psychiatry*, 54, pp. 1263–1274.
- European Commission (2010). *Special Eurobarometer: Science and Technology Report*. [online] Available at: <http://www.eceae.org/no/category/watching-brief/76/euro-barometer-survey-shows-public-concern-on-animal-testing> [Accessed 11 April 2017].
- Fadali, M. (1996). *Animal experimentation, a harvest of shame*. Los Angeles, CA: Hidden Springs Press.
- Gainetdinov, R.R. (2008). Dopamine Transporter Mutant Mice in Experimental Neuropharmacology. *Naunyn-Schmiedeberg's Archives of Pharmacology*, 377(4–6), pp. 301–313.
- Garfield, E. and R.K. Merton (1979). *Citation indexing: its theory and application in science, technology, and humanities*, Vol. 8. New York: Wiley.
- Greek, C.R. and J.S. Greek (2003). *Sacred cows and golden geese, the human cost of experiments on animals*. New York: Continuum.

- Hellsten, U., R.M. Harland, M.J. Gilchrist, D. Hendrix, J. Jurka, V. Kapitonov, I. Ovcharenko, N.H. Putnam, S. Shu, L. Taher, I.L. Blitz, B. Blumberg, D.S. Dichmann, I. Dubchak, E. Amaya, J.C. Detter, R. Fletcher, D.S. Gerhard, D. Goodstein, T. Graves, I.V. Grigoriev, J. Grimwood, T. Kawashima, E. Lindquist, S.M. Lucas, P.E. Mead, T. Mitros, H. Ogino, Y. Ohta, A.V. Poliakov, N. Pollet, J. Robert, A. Salamov, A.K. Sater, J. Schmutz, A. Terry, P.D. Vize, W.C. Warren, D. Wells, A. Wills, R.K. Wilson, L.B. Zimmerman, A.M. Zorn, R. Grainger, T. Grammer, M.K. Khokha, P.M. Richardson and D.S. Rokhsar (2010). The Genome of the Western Clawed Frog "Xenopus Tropicalis". *Science*, 328(5978), pp. 633–636.
- Huhtala, A., L. Salminen, H. Tähti and H. Uusitalo (2008). Corneal Models for the Toxicity Testing of Drugs and Drug Releasing Materials. *Topics in Multifunctional Biomaterials and Devices*, 1(2), pp. 1–23.
- Illman, J. (2008). *Politics, protest, and progress: 100 years of animal research – The history of the research defense society*. London: Research Defense Society.
- Kilkenny, C., W. Browne, I.C. Cuthill, M. Emerson, and D.G. Altman (2010). Animal Research: Reporting *In Vivo* Experiments: The ARRIVE Guidelines. *British Journal of Pharmacology*, 160(7), pp. 1577–1579.
- Knight, A. (2007). The Poor Contribution of Chimpanzee Experiments to Biomedical Progress. *Journal of Applied Animal Welfare Science*, 10, pp. 281–308.
- Lack, D. (1947). *Darwin's finches*. Cambridge: Cambridge University Press.
- Lee, A.M., L.H. Tai, A. Zador and L. Wilbrecht (2015). Between the Primate and "Reptilian" Brain: Rodent Models Demonstrate the Role of Corticostriatal Circuits in Decision Making. *Neuroscience*, 296, pp. 66–74.
- Long, X., J.Z. Huang and Y.S. Ho (2014). A Historical Review of Classic Articles in the Surgery Field. *The American Journal of Surgery*, 208(5), pp. 841–849.
- Lucas, C., L.J. Criens-Poublon, C.T. Cockrell and R.J. de Haan (2002). Wound Healing in Cell Studies and Animal Model Experiments by Low Level Laser Therapy; Were Clinical Studies Justified? A Systematic Review. *Lasers Medical Sciences*, 17, pp. 110–134.
- Macleod, M.R., T. O'Collins, L.L. Horvath, D.W. Howells and G.A. Donnan (2005). Systematic Review and Meta-analysis of the Efficacy of FK506 in Experimental Stroke. *Journal of Cerebral Blood Flow & Metabolism*, 25, pp. 1–9.
- Martić-Kehl, M.I., J. Wernery, G. Folkers and P.A. Schubiger (2015). Quality of Animal Experiments in Anti-angiogenic Cancer Drug Development: – A Systematic Review. *PLoS One*, 10(9), pp. 1–14.
- Nesse, R.M. and G.C. Williams (1996). *Why we get sick: The new science of Darwinian medicine*. New York: Times Books.
- Parish, H. (1968). *Victory with Vaccines. The story of immunization*. Edinburgh: E. & S. Livingstone.

- Pennisi, E. (1997). Monkey Virus DNA Found in Rare Human Cancers. *Science*, 275, pp. 748–749.
- Perel, P., I. Roberts, E. Sena, P. Wheble, C. Briscoe, P. Sandercock, M. Macleod, L.E. Mignini, P. Jayaram and K.S. Khan (2007). Comparison of Treatment Effects Between Animal Experiments and Clinical Trials: Systematic Review. *British Medical Journal*, 334, pp. 197–206.
- Perretta, G. (2009). Non-human Primate Models in Neuroscience Research. *Scandinavian Journal of Laboratory Animal Science*, 36(1), pp. 77–85.
- Petropolis, D.B., D.M. Faust, M. Tolle, L. Rivière, T. Valentin, C. Neuveut, N. Hernandez-Cuevas, A. Dufour, J.C. Olivo-Marin and N. Guillen (2016). Human Liver Infection in a Dish: Easy-to-build 3D Liver Models for Studying Microbial Infection. *PLoS One*, 11(2), p. e0148667. [online] Available at: <http://journals.plos.org/plosone/article?id=10.1371/journal.pone.0148667> [Accessed 11 August 2018].
- Plotkin, S. (2017). *Human Cell Strains in Vaccine Development*. [online] Available at: <https://www.historyofvaccines.org/content/articles/human-cell-strains-vaccine-development> [Accessed 11 April 2017].
- Pound, P., S. Ebrahim, P. Sandercock, M. Bracken and I. Roberts (2004). Where is the Evidence That Animal Research Benefits Humans?. *British Medical Journal*, 328, pp. 514–517.
- Schaffner, A. (2006). Fieber—nützlich oder Schädliches, zu Behandelndes Symptom? [Fever—useful or noxious symptom that should be treated?]. *Therapeutische Umschau*, 63(3), pp. 185–188.
- Scheinin, L. and C.V. Wetli (2009). Sudden Death and Sick Cell Trait: Medicolegal Considerations and Implications. *The American Journal of Forensic Medicine and Pathology*, 30(2), pp. 204–208.
- Shapiro, K. (1998). *Animal Models of Human Psychology: Critique of Science, Ethics, and Policy*. Seattle: Hogrefe & Huber.
- Shively, C.A. and T.B. Clarkson (2009). The Unique Value of Primate Models in Translational Research. Nonhuman Primate Models of Women's Health: Introduction and Overview. *American Journal Primatology*, 71(9), pp. 715–721.
- Viceconti, M., G. Clapworthy and S.V.S. Jan (2008). The Virtual Physiological Human. A European Initiative for *In Silico* Human Modelling. *The Journal of Physiological Sciences*, 58(7), pp. 441–446.
- Viceconti, M., A. Henney and E. Morley-Fletcher (2016). *In Silico* Clinical Trials: How Computer Simulation Will Transform the Biomedical Industry. *International Journal of Clinical Trials*, 3(2), pp. 37–46.
- Webber, B.J., D.J. Casa, A.I. Beutler, N.S. Nye, W.E. Trueblood and F.G. O'Connor (2016). Preventing Exertional Death in Military Trainees: Recommendations and Treatment Algorithms from a Multidisciplinary Working Group. *Military Medicine*, 181(4), pp. 311–318.

- World Health Organization (WHO) (2008). *The Global Burden Of Disease: 2004 Update*. Table A2. Burden of Disease in DALYs by Cause, Sex and Income Group in WHO Regions, Estimates for 2004. Geneva: World Health Organization.
- Wilson, S.L., M. Ahearne and A. Hopkinson (2015). An Overview of Current Techniques for Ocular Toxicity Testing. *Toxicology*, 327, pp. 32–46.

The Scientific Problems with Using Non-Human Animals to Predict Human Response to Drugs and Disease

Ray Greek

President, Americans for Medical Advancement, California, United States

Lisa A. Kramer

Professor of Finance, University of Toronto, Ontario, Canada

1 Introduction

Every year, and in countries around the world, significant time and resources are devoted to the noble cause of developing drugs to treat and cure human disease. With rare exception, drug interventions cannot reach commercialization without safety and efficacy having first been demonstrated in animal models. The intention of regulations, which require the use of animal models in such contexts, is to ensure that only safe and effective drugs end up being used by patients. Similarly, it is standard practice for researchers to employ animal models in their attempts to understand the way diseases present and progress in humans. Unfortunately, there exist serious theoretical and empirical concerns regarding the standard practice of using non-human animals to model human response to perturbations, such as drugs and disease. These concerns are important because conducting disease research and drug development in a manner that is not supported by science will have suboptimal implications for the humans who rely on that research, which encompass the entire population. Based on complexity science, modern evolutionary biology, and empirical evidence, we demonstrate that animal models have failed as predictors of human response. That is, animal models do not and cannot have acceptably high predictive value for human response to drugs and disease. By this we mean that animal modeling, as a methodology, is for all practical purposes not predictive of human response to drugs and disease; and hence it should be abandoned in favor of human-based research and testing, such as personalized medicine, a new field that takes into account the unique genetic make-up of each individual patient.

People are accustomed to hearing about the ethical issues arising from the use of non-human animals in biomedical research, testing, and science in general. But there are scientific issues with the practice as well. Researchers who employ animal modeling often attempt to justify the practice based on claims of accurately predicting human response to drugs and disease. For example, Giles (2006, p. 981) states: "In the contentious world of animal research, one question surfaces time and again: how useful are animal experiments as a way to prepare for trials of medical treatments in humans? The issue is crucial, as public opinion is behind animal research, only if it helps develop better drugs. Consequently, scientists defending animal experiments insist they are essential for safe clinical trials, whereas animal-rights activists vehemently maintain that they are useless".

One need not search hard to find examples claiming non-human animals play an essential role in the quest to treat and cure human disease. For example, the American Physiological Society (APA) (2017) states on its website: "Animals are used in research to develop drugs and medical procedures to treat diseases." Andrew B. Rudczynski, Yale University's associate vice president for research administration, stated in a letter to the editor (2011): "[T]he basic research model used by Yale University and its peer institutions is scientifically valid and predictive of human disease". Michael F. Jacobson, executive director of the Center for Science in the Public Interest (2008) stated: "We must test animals to determine whether a substance causes cancer". Huff, Jacobsen, and Davis (2008, p. 1439) stated: "Chemical carcinogenesis bioassays in animals have long been recognized and accepted as valid predictors of potential cancer hazards to humans." Lin (1995, p. 1008) stated: "Although the validity of animal testing to predict efficacy and or safety in humans has been questioned, it is generally believed that data from animal studies can be reasonably extrapolated to humans with the application of appropriate pharmacokinetic principles [...] From an evolutionary point of view, all mammals are similar, because they originate from a common ancestor, yet they differentiate because of their dissimilar environmental adaptations".

While it can be argued that there may be scientifically justified grounds for the use of non-human animals in some contexts, other than those that involve predicting human responses, it is most common to see attempts to justify the use of non-human animals for applications to human health (see Kramer and Greek (2018), for additional discussion of this point). Therefore, it is appropriate to carefully examine the claimed validity of the animal model for predicting human outcomes.

To that end, consider *Trans-Species Modeling Theory* (TSMT), a concept that was formalized by Greek and Hansen (2013), based on a combination of

extensive previous research on complex systems science and evolutionary biology, as summarized by authors, including Greek and Rice (2012), LaFollette and Shanks (1996), LaFollette and Shanks (1998), Shanks and Greek (2008), and Shanks and Greek (2009). TSMT states: "While trans-species extrapolation is possible when perturbations concern lower levels of organization or when studying morphology and function on the gross level, one evolved complex system will not be of predictive value for another when the perturbation affects higher levels of organization" (Greek and Hansen, 2013, p. 254). That is, according to science, the observation of a drug response in one species is uninformative about the drug response in another species. This theory is based on complexity science, evolutionary biology, and empirical evidence. In the remainder of this article, we explain why the fields of complexity science and evolutionary biology are relevant to understanding animal modeling and evaluating the inability of animal models to predict human response to drugs and disease.

LaFollette and Shanks (1996) and the Medical Research Modernization Committee (2006) were among the first to document systematically the methodological failure of using one evolved complex system to model another, in terms of predicting outcomes. Subsequent work by Greek and Hansen (2013), Greek and Rice (2012), Shanks and Pyles (2007), and Shanks and Greek (2009) then led to the development of TSMT, which is the only theory (we intentionally use the word *theory* as opposed to *hypothesis*; see National Academies of Science Engineering Medicine, 2016) that accounts for both past and present successes and failures of animal modeling. It is also the only theory that explains why animal models will never offer practical predictive value for disease and drug research. To be clear, the aforementioned authors did not discover evolution, complexity science, or any aspect of probability. Rather, they relied on what had been previously published in those disciplines and combined various insights to formalize the case against the use of animal models to predict outcomes in other species.

TSMT was a paradigm shift in animal modeling analysis. Moreover, TSMT was inclusive of valid past criticisms, while simultaneously explaining and taking those criticisms further. For example, TSMT obviated the need to point out that small differences in environments among lab animals influenced results, as many anti-vivisectionists did and continue to do, because even under perfect environmental conditions, one evolved complex system would not be expected to have predictive value for another. Likewise, there is little to no value in analyzing why one species has historically been inadequate for predicting human response, because according to TSMT, no species, regardless of genetic similarity, will ever be similar enough to another to serve as a valid predictive model. TSMT is also more precise and has more explanatory

power than general criticisms, such as *species differ in their metabolisms*. Furthermore, TSMT explains why increasing scientific rigor, the current mantra for justifying the use of animal models, will have no effect on predictive value.

We now turn to examining the three pillars underlying TSMT, comprising complex systems science, evolutionary biology, and empirical evidence.

2 Complex Systems

Advances in the field of complex systems have highlighted the poor predictive value of animal modeling. The study of complex systems and chaotic systems, currently usually classified under the general heading of complex systems, dates back to the 1950s and began a revolution in physics, similar to that of the early 1900s involving relativity and quantum mechanics (Gell-Mann, 1994; Gleick, 2008; Goodwin, 2001).

The following are characteristics of simple systems:

- They are nothing more than the sum of their parts.
- They have predictable behaviors. (There are no unanticipated or unexpected behaviors.)
- They are usually composed of just a few components.
- They can be intuitively understood.
- They are in equilibrium. (They are non-dynamic.)
- There are few interactions and feedback loops. (For example, compare a primitive barter system in contrast to our modern market-based economy).

Rosen (1999, p. 392) states: “A system is simple if all its models are simulable. A system that is not simple, and that accordingly must have a nonsimulable model, is complex”. This should give us pause: A complex system is nonsimulable. Note that *simulable* may mean different things to different people. When scientists state that biological complex systems are nonsimulable, they mean nonsimulable *at the complex level*. The aim of researchers who use animal models is not to gain insight into the simple systems that are basic building blocks of the complex system. For example, at the simple level, we can rely on knowledge about simple systems to extrapolate that the final outcome for two different species will be the same when, for example, they are permanently deprived of water or they are thrown out of an airplane at 30,000-foot elevation. Researchers attempt to use non-human animals to model humans at higher, *complex* levels of organization, because this is the level at which disease and drug effects occur. So, when an animal modeler claims that their model simulates a human, unless they are speaking of low levels of organization (much

simpler than the levels at which drug and disease responses occur), this is not possible.

In contrast to simple systems, complex systems are characterized by the following (see Figure 17.1 for a diagrammatic representation of a complex system):

- Complex systems are composed of many parts that themselves have hierarchical levels of organization.
- Complex systems have feedback loops.
- Complex systems exhibit self-organization.
- Complex systems respond to perturbations in a *nonlinear* fashion. Because small changes in a complex system can result in outcomes that are not proportional to the input, one biological complex system can die because of what, at first, appears to be a minor change or difference between it and another almost identical complex system (Morange, 2001; Pearson, 2002). For example, Northrop (2011, p. xiv) states: “Early bioengineers, biophysicists, and systems physiologists tried to characterize certain physiological regulators as linear and stationary. Initially, linear systems analysis was inappropriately applied to certain complex, physiological regulators and

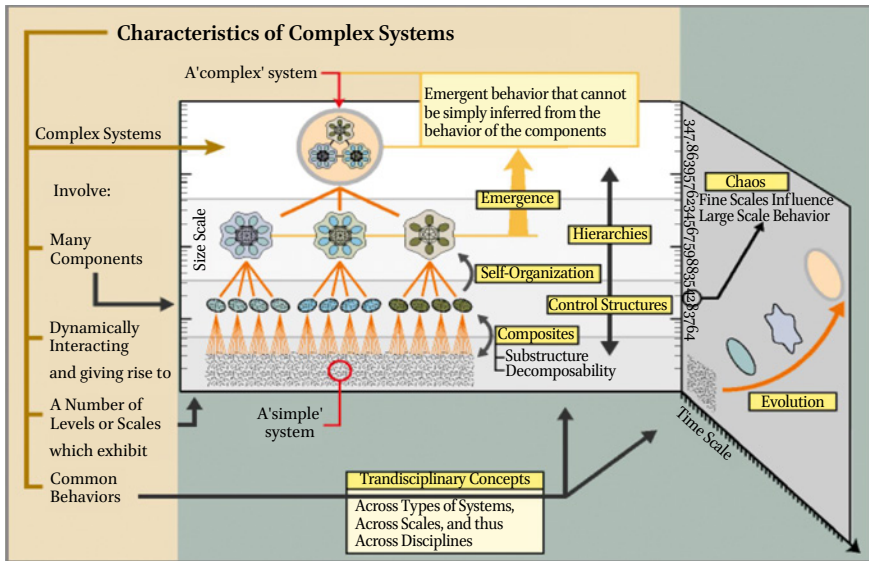

FIGURE 17.1 The characteristics of complex systems.
 SOURCE: MARSHALL CLEMENS/IDIAGRAM ([HTTPS://WWW.IDIAGRAM.COM](https://www.idiagram.com))
 Note: A complex system is built out of simple systems. As more and more of these simple systems combine and form a complex system, the level of organization increases and simulability decreases.

control systems (e.g., pupil regulation and eye movement control), which resulted in *black-box*, closed-loop models in which linear transfer function modules were connected to a nonlinear module in a single feedback loop. These were phenomenological input/output models that gave little insight into the physiology and complexity of the systems”.

- Complex systems demonstrate redundancy and robustness. Complex systems have redundant parts and, therefore, losing a part may not affect function. Adding to this is robustness, which means that perturbations may not result in dysfunction. Complex systems have emergent properties that Aziz-Alaoui and Bertelle (2009, preface) define as follows: “Emergence and complexity refer to the appearance of higher-level properties and behaviors of a system that obviously comes from the collective dynamics of that system’s components. These properties are not directly deductable from the lower-level motion of that system. Emergent properties are properties of the “whole” that are not possessed by any of the individual parts making up that whole. Such phenomena exist in various domains and can be described, using complexity concepts and thematic knowledges.”
- Examples of emergent properties include the following from Van Regenmortel (2002):
 - The three physical states of water and phase transitions, such as boiling point.
 - The viscosity of water (individual water molecules have no viscosity).
 - The color of a chemical.
 - A melody arising from notes.
 - The saltiness of sodium chloride.
 - The specificity of an antibody.
 - The immunogenicity of an antigen.
- The components of complex systems can be grouped as modules, and the modules communicate with each other. Nevertheless, failure in one module does not necessarily spread to the system as a whole because of redundancy and robustness.
- Complex systems are dynamic. They communicate with, and change in response to, their environment.
- The whole of a complex system is greater than the sum of its parts, and hence complex systems have properties that cannot be determined even with total knowledge of the components of the system. This limits the validity of reductionism when studying complex systems.
- Importantly for our discussion, complex systems are also *very dependent on initial conditions*; for example, genetic make-up in the context of individuals or species. This means that a very small change in the initial conditions of

two otherwise identical complex systems (e.g., monozygotic twin humans), may result in sickness for one but not the other. In strains of mice, knocking out one gene has been shown to result in death for one strain, while the other thrives (Belmaker et al., 2012; Bell and Spector, 2011; Bruder et al., 2008; Castillo-Fernandez et al., 2014; Chapman and Hill, 2012; Czyz et al., 2012; Dempster et al., 2011; LeCouter et al., 1998; Raineri et al., 2001; Pearson, 2002).

The sensitivity of complex systems, also known as nonlinear dynamic systems, to initial conditions, in general, was demonstrated in principle in the 1960s by Massachusetts Institute of Technology mathematician, Edward Lorenz, while he was studying a weather model using a computer. Lorenz found significant differences in outcomes using his model, when the initial conditions were changed by a very small amount:

On a particular day in the winter of 1961, Lorenz wanted to re-examine a sequence of data coming from his model. Instead of restarting the entire run, he decided to save time and restart the run from somewhere in the middle. Using data printouts, he entered the conditions at some point near the middle of the previous run and re-started the model calculation. What he found was very unusual and unexpected. The data from the second run should have exactly matched the data from the first run. While they matched at first, the runs eventually began to diverge dramatically — the second run losing all resemblance to the first within a few “model” months.

BRADLEY, 2010



FIGURE 17.2 Plots of the data from two simulations of weather response over time.
SOURCE: BRADLEY (2010)

Plots of the time-series data from two of Lorenz's weather simulations appear in Figure 17.2.

Lorenz rounded off a variable to three digits after the decimal instead of six, and this resulted in the different values shown in Figure 17.2. While no one knows which specific weather condition Lorenz recorded on the Y axis (it is commonly assumed that time is shown on the X axis), we do know the fluctuations shown on the right-most portion of the Y axis are between extreme values, and thus we see that a tiny perturbation in starting values (measured in units smaller than three decimal places), eventually yielded opposite predictions in the simulated weather. This experiment is the origin of expressions, such as, "a butterfly flaps its wings in Brazil, and it rains in America." Very small changes in initial conditions can result in dramatically different outcomes in complex systems. In fact, this behavior is a defining characteristic of a complex or chaotic system (Gleick, 2008). Obviously, Lorenz's computer program was intended to simulate weather, but because it lacked sufficiently detailed inputs, the model yielded dramatically different outputs depending on very small changes in the inputs — the initial conditions. This example demonstrates how a particular model, in this case a computer program, can be inadequate for simulating a complex system. Likewise, animal models are inadequate for predicting human response to drugs and disease.

Examples of complex systems include cells, humans, non-human animals, ecosystems, economies, ant colonies, social interaction, and the United States electrical grid. For more on biological complex systems, see Ahn et al. (2006), Gell-Mann (1994), Goodwin (2001), Greek (2013c), Greek and Rice (2012), Kitano (2002); Morowitz (2002), Solé and Goodwin (2002), Van Regenmortel (2004a, b), Van Regenmortel and Hull (2002), Vojinovic (2015a, b).

It is not easy to understand complex systems. Consider the following summary of the necessary background for understanding complex systems:

This introductory textbook is intended for use in a one-semester course to acquaint biomedical engineers, biophysicists, systems physiologists, ecologists, biologists, and other scientists, in general, with complexity and complex systems. I have focused on biochemical, genomic, and physiological complex systems, and I have also introduced the reader to the inherent complexity in economic systems [...] Reader background: Readers should have had college courses in algebra, calculus, ordinary differential equations, and linear algebra, and, hopefully, engineering systems analysis. They should also have had basic college courses in chemistry, biochemistry, cell biology, and ideally even in human physiology and anatomy. This is the broad background that is required in the

interdisciplinary fields of biomedical engineering, biophysics, systems physiology, and economics.

NORTHROP, 2011, pp. xiii–xvii

Northrop (2011, p. xiii) also notes: “Broadly stated, we consider that complexity is a subjective measure of *the difficulty in describing and modeling a system* (thing or process), and thus being able to predict its behavior” (emphasis added). Again we note the fact that complex systems are difficult to model in terms of being able to predict outcomes to perturbations.

Vicsek (2002, p. 131) states:

In the past, mankind has learned to understand reality through simplification and analysis. Some important simple systems are successful idealizations or primitive models of particular real situations — for example, a perfect sphere rolling down an absolutely smooth slope in a vacuum. This is the world of Newtonian mechanics, and it ignores a huge number of other, simultaneously acting factors. Although it might sometimes not matter that details such as the motions of the billions of atoms dancing inside the sphere’s material are ignored, in other cases reductionism may lead to incorrect conclusions. *In complex systems, we accept that processes that occur simultaneously on different scales or levels are important, and the intricate behaviour of the whole system depends on its units in a nontrivial way. Here, the description of the entire system’s behaviour requires a qualitatively new theory, because the laws that describe its behaviour are qualitatively different from those that govern its individual units.* (Emphasis added)

Animal modeling seeks to use one complex system, be it a mouse or a monkey, to predict responses to perturbations that occur at higher levels of organization, of another complex system — a human. To do so ignores the most basic fundamental features of complex systems, discussed above. Given those features, it is outside the realm of science to use one complex system in expectation of its having predictive value for another, when the perturbation affects higher levels of organization.

3 Evolutionary Biology

Informally, evolution can be thought of as small changes in genes (i.e., initial conditions) that occur over long periods of time, resulting in new species with traits different from those of the ancestor organism. In other words, chimpanzees

and humans are both different from the primate that we descended from, and we are different from each other. But the notion that differences among genes can result in new species is separate from the fact that very small differences in genes can also lead to members of the same species reacting quite differently to drugs and disease. Humans and non-human animals are examples of complex systems that have evolved over time – their initial conditions changed in the form of genetic make-up, and these changes affected the organism in a nonlinear fashion, just as we saw in Lorenz's computer model of weather.

Even for two individuals within the same species, small differences in DNA can mean the difference between life and death. A tiny difference of one amino acid within the human chromosome is all that separates a patient with life-threatening sickle cell anemia from those of us who can live free of that condition. Dramatic differences can exist across species without changes in amino acid sequences. Genes are regulated, turned on and off, by other genes. For example, mice and humans share the gene that allows mice to grow a tail (Graham, 2002). The reason humans do not normally grow a tail during development is that the gene is never turned on (or expressed). Differences in gene regulation and expression vary within and between species and account for differences in response to drugs and disease (Kasowski et al., 2010; Marchetto et al., 2013; Morley et al., 2004; Pritchard et al., 2006; Rifkin, Kim and White, 2003; Rosenberg et al., 2002; Sandberg et al., 2000; Seok et al., 2013; Storey et al., 2007; Suzuki and Nakayama, 2003; Warren et al., 2014; Zhang et al., 2008). So, while it is a fact that humans share a large percentage of their genes with other mammals, this fact is largely immaterial in terms of predicting how humans will respond to perturbations, such as drugs and disease. For example, the progression of HIV to AIDS, which is common in humans, has been very rarely observed in great apes. On the matter of non-human primates, Varki and Altheide (2005, p. 1746) write “[I]t is a striking paradox that chimpanzees are in fact not good models for many major human diseases/conditions”.

Based on facts from the theory of evolution and complexity science, there are robust theoretical reasons to conclude that, for all practical purposes, one species will have no predictive value for the response to perturbations that occur at higher levels of organization; and drugs and disease affect higher levels of organization. Note that we are not saying humans and non-human animals cannot ever respond similarly to the same drug or disease. They do in some instances. However, in order for there to be scientific merit in using non-human animals as predictive models for humans, the models would have to have a *high predictive value* as calculated using concepts we discuss in the following section. Consistent with theory, extensive empirical evidence shows that animal models *do not* have high predictive value for human response to drugs and disease, rendering their use in that context unscientific.

4 Empirical Evidence: The Failure of the Animal Model in Terms of Predictive Value for Humans

We now delve into empirical evidence regarding the inability of the animal model to predict human response to drugs and disease. By comparing how well an animal-based test or research method corresponds to human results, we can determine how much predictive value the modality has. Predictive value is measured in science by using the calculations summarized in Table 17.1. In the discussion that follows, we refer to quantities from this table, such as gold standard, false positive, and false negative. Any given test or system can generally be compared to a gold standard, which is the most accurate one available under reasonable conditions.

For example, the gold standard for determining whether a patient has a collapsed lung is a computerized axial tomography (CT) scan of the chest. Even clinically insignificant cases of a collapsed lung can be detected with a CT scan and clinically significant collapses are detected essentially 100% of the time. In reality, patients are assessed with a chest x-ray instead of a CT scan because an x-ray is quicker, easier, and less expensive than a CT scan, and clinically significant collapses are detected by x-ray a very, very high percentage of the time. To determine the predictive value of the chest x-ray, one would perform both diagnostic tests on a group of patients and the calculations in Table 17.1. A positive chest x-ray (an x-ray that revealed a collapsed lung) in light of a positive CT scan would be counted as a true positive (TP) and listed under gold standard positive; while a negative chest x-ray (no collapsed lung) in light of a negative CT scan would be listed as true negative (TN) and listed under gold standard negative. Similarly, a negative x-ray in light of a positive CT scan would be labeled a false negative (FN); and a positive chest x-ray in conjunction with a negative CT scan would be a false positive (FP) (see Nagarsheth and Kurek, 2011, for an example of this).

In the case of evaluating animal models, outcomes in humans would be the gold standard. These same calculations can be performed for any test or modality where a gold standard can be known in contexts within and outside of biomedical science, for example to determine whether a patient has cancer, to determine whether a computer model can predict an outcome in engineering or business, or to determine the predictive value of drug sniffing dogs in airports. For more details see Greek (2014b).

Not all tests or methods need to have a high predictive value to be useful. For example, if you devised a method of winning at the blackjack table more than 50% of the time and bet appropriately each time and played long enough, probabilistically you would beat the house. But in medical science, we need much higher predictive values than 0.5. Even a probability of 0.999 can be

TABLE 17.1 Binary classification test and formulas for determining how well a test or practice compares with the most accurate test available under reasonable conditions.

		Gold Standard:	
		GS+	GS-
Test:	T+	TP	FP
	T-	FN	TN

Calculations:

Sensitivity = $TP / (TP + FN)$

Specificity = $TN / (FP + TN)$

Positive Predictive Value (PPV) = $TP / (TP + FP)$ = % of all positives that are true positives

Negative Predictive Value (NPV) = $TN / (FN + TN)$ = % of all negatives that are true negatives

Abbreviations:

T- = Test negative

T+ = Test positive

FP = False positive

TP = True positive

FN = False negative

TN = True negative

GS- = Gold standard negative

GS+ = Gold standard positive

inadequate. Drugs that harm even a very small percentage of patients, even one out of 1,000, have been pulled off the market because of life-threatening side effects, such as total liver failure, heart attack, or stroke. Examples of widely-marketed drugs that have been withdrawn due to unanticipated fatalities include Vioxx (rofecoxib), Propulsid (cisapride), and Rezulin (troglitazone). See Graham et al. (2005) and Attarwala (2010) for details on such instances.

So what is an acceptable level of predictive value to expect from animal modeling? To answer this question, first we need to emphasize that acceptable predictive value, like many things in life, varies depending on the context, as the blackjack example illustrates. Consider the case of deeming whether a species exhibits the trait of sentience, which is highly valued in the animal

protection movement as a feature to take into account when considering the ethics of animal modeling. Sentience can be assessed using criteria for which we could attempt to measure predictive value; but, nevertheless, a large gray zone emerges. Chimpanzees are clearly sentient, as are mammals in general. But when we consider invertebrates, the situation becomes less clear. Octopi appear to be both sentient and sapient, but what about sponges, worms, jellyfish, and the common fruit fly? To date we do not have strong evidence that these entities exhibit sentience, but we may simply lack the power to detect sentience in all cases where it exists. Yet, our inability to conclude with certainty that sponges are sentient does not mean we can ignore the fact that chimpanzees do demonstrably exhibit sentience. The precautionary principle should be employed in cases where great suffering is at stake, meaning that our ability to deem a particular species as sentient should not be predicated on the requirement that there exists an assessment method with a predictive value as high as 0.99.

Turning back to the matter at hand, predictive values for responses to drugs in development typically cluster around or below 0.5, which makes them no more useful for prediction than flipping a coin. Predictive values this low are of no use in medical science. When values in the 0.7 to 0.9 range are seen, physicians and medical scientists cannot rely on the results, test, or modality alone, without verifying the item in question with other tests or modalities. To do so would be unethical; the patient deserves greater certainty before proceeding. Science in general relies on consilience, and medical research is not an exception. In this case, when deciding which modality to use, one must consider the mathematics of complex systems and the initial conditions in the form of evolutionary biology. Because animal models are used to make the life-altering decision of whether to take a drug to human trials or to abandon it, even values greater than 0.9 can be deemed inadequate and unacceptably costly in terms of the likelihood of adverse human consequences.

The way around this problem of identifying the *right* predictive value is addressed by Greek and Greek (2004), Greek, Menache and Rice (2012), and Shanks and Greek (2009), and is summarized by Kramer and Greek (2018). The solution involves the use of human-based research and testing through personalized medicine; that is, matching gene(s) to drugs and disease in each patient. Based on the science of complex systems and evolutionary biology, we know categorically that using non-human animal models has unacceptably low predictive value for human responses to drugs and disease. Thus, on balance, the use of animal models in drug development and disease research should be abandoned immediately for the same reasons that society has abandoned wrong or harmful medical practices such as phrenology, bloodletting, and trephination; they were simply ineffective.

We now turn to specific examples of the poor predictive value of animal models, starting with early empirical evidence dating back as early as the 1990s and ending with recent sets of evidence from 2016 that summarize decades of findings.

Data from Suter (1990) and the 11th edition of the *Catalog of Teratogenic Agents* (Shepard and Lemire, 2004) demonstrate the importance of using predictive values. Suter reported on the development of six drugs where humans and non-human animals shared 22 side effects. Suter's data revealed that animal models had a positive predictive value of 0.31. That is, if a side effect was seen in the animal models it had only a 31% chance of being seen in humans for these six drugs. This prediction rate, which is below that expected from a coin toss (heads we abandon the drug because of danger, and tails we continue to develop the drug), illustrates the failure of these animal models as predictors for human response. A naive but common retort to this fact is that if animal models derailed *any* drug that would have harmed humans, it is worth using animal models. The fallacy of this view becomes evident when considering the following assessment of empirical evidence on using animal models to predict human birth defects.

The *Catalog of Teratogenic Agents* lists more than 3,100 agents, of which about 1,500 can produce congenital anomalies (birth defects) in experimental animals but not in humans. These are known as false positives. Furthermore, only about 40 cause birth defects in both humans and non-human animals. These are known as true positives. Based on these numbers and the formulas in Table 17.1, one can calculate a value of 3% for the positive predictive value. A positive predictive value of 3% tells us that for any given birth defect noted in non-human animals, there is only a 3% chance that it will also be seen in humans. A predictive value of 3% is obviously extremely poor but is consistent with the general lack of predictive value in using animal models to determine whether compounds are harmful to developing fetuses (see Greek, Shanks and Rice, 2011, for more on teratogenicity and animal models). This means that for any drug that tests positive for birth defects, when tested for teratogenicity in animal models, there is about a 3% chance that it will harm human babies in utero. Predictive value does not mean that 3% of drugs that would have caused birth defects will be abandoned in development. Instead it means that of 100 drugs tested and shown to harm animal fetuses, about three may harm the human fetus. Unfortunately, we do not know which three. So, abandoning a drug in development based on a test that has a low predictive value does not save babies. Moreover, when human health is involved, low predictive value means anything below 90%–95%; and, often times, even a probability of 99% is inadequate to base treatment on. The predictive value of animal modeling

falls far below 99%; for example, 3% in the above teratogenicity example. For more on this point, see Greek (2013a, b, 2014b), Greek and Greek (2010), and Shanks, Greek, and Greek (2009).

Values this low mean animal modeling per se has, for all practical purposes, *no predictive value* for human response to drugs and disease. Some researchers argue that any predictive value greater than zero means animal models have some predictive value. However, given the scope for serious adverse consequences, including death, the threshold number required in medical science has to be much higher than the typically observed 3% to 55% range of values seen when calculating the predictive value of animal modeling (see previous references); hence the paradigm of animal modeling cannot be justified scientifically in this context. Medical science requires higher predictive values than one needs for winning at the blackjack table.

In our discussion of the predictive value of animal models, we have focused so far on the context of response to drugs. It is also illuminating to consider predictive value in the context of disease research. Scientists are now matching gene response to disease, and great variation is being observed across species. For instance, Seok et al. (2013) studied inflammatory processes, such as sepsis, in mice and humans and found no correlation between what the genes and responses did in mice versus what they did in humans. The following statement, by science journalist Dolgin (2013, p. 118), puts Seok's and colleagues' findings in context: "Yet, despite the fact that some compounds have repeatedly reversed the symptoms of sepsis in animal tests, not a single drug has proven effective in human clinical trials, even though more than 30,000 people have been included in randomized controlled studies, involving candidate antisepsis agents over the past 25 years".

Thus, in searching for a treatment for sepsis, tens of thousands of people were exposed to the risks of a new drug, and billions of dollars were wasted based on animal studies, the results of which proved unrelated to human outcomes. Even more patients were unable to access a potentially effective drug that might have been identified had the resources been dedicated instead to human-based research.

The failure of animal models in these cases appears to be due to differences in gene response between humans and mice (Seok et al., 2013; Warren et al., 2014). Considering that humans and non-human animals are evolved complex systems, there is no reason to expect other diseases or conditions would allow animal models to have high predictive value. Indeed, many diseases have been studied and similarity in responses among species found only at very low rates and usually in retrospect (Enna and Williams, 2009; Hau, 2003; Lin, 1995). (Note that *basic* science research is prone to the same critique. Many researchers now

claim that basic research on non-human animals has high predictive value for humans. See, for example, Devoy et al., 2012; Groenink, Folkerts and Schuurman, 2015; Katzner et al., 2009; National Science Foundation, 2011; Rudczynski, 2011; van Meer, Graham and Schuurman, 2015. Such claims invite the same scrutiny as claims about predictive value in drug development and disease research.)

Based on the track record of drugs that have been tested on non-human animals to date, the poor predictive value of animal models used in preclinical research, and the fact that humans and non-human animals are evolved complex systems, there is every reason to believe yet-to-be-developed drugs identified through the use of animal models will similarly exhibit profoundly different responses in non-human animals versus humans. The exceptions to this rule occur when the perturbation affects levels of organization where the system under analysis is simple or where conserved processes are involved. But even when conserved processes are being studied (e.g., the mechanism for cell replication, the cytochrome P450s, and the presence of various receptors), the outcomes to perturbations to these processes vary among species (Greek and Rice, 2012).

Turning to other medical applications, around 100 vaccines have been shown to be effective against HIV-like viruses in animal models, to date. None have been effective in humans (Bailey, 2008; Editorial, 2007; Gamble and Matthews, 2010). More than a thousand drugs have been seen to protect against nervous system damage in animal models of stroke. Again, none have been protective in humans (Dirnagl, 2006; Dirnagl and Macleod, 2009; Macleod, 2004; O'Collins et al., 2011; O'Collins et al., 2006; Sena et al., 2007). Fouad, Hurd and Magnuson (2013) identify over 10,000 publications modeling spinal cord injury in rats and mice. Many treatments identified in those publications have been effective in non-human animals but failed in humans, and spinal cord injury resulting in paralysis remains incurable in humans.

The predictive value of the above-mentioned medical applications would be roughly zero. In order to prove a test or practice has poor predictive value (as opposed to predictive value numerically equal to zero), one only has to show a relatively small number of failures compared to the successes. The above examples are adequate. Conversely, proving a practice has high predictive value requires examples from a large number of studies. To the best of our knowledge, there are no studies of any kind that show high predictive value of animal models for drugs or disease. Drawing on knowledge from complex systems and the theory of evolution, one can easily infer that the above examples are representative of all animal models and are not exceptions to the rule. Moreover, the studies described above are a small sample of the many such instances that have been recorded in the medical literature showing the

animal model's overall lack of predictive value. For more examples see Arrow-smith (2011a, b), Chiou et al. (2000), Ennever et al. (1987), Fletcher (1978), Grass and Sinko (2002), Hughes (2008), Litchfield (1962), Igarashi et al. (1995, 1996), Johnson et al. (2001), Kola and Landis (2004), Kummar et al. (2007), Lesko and Woodcock (2004), Lumley (1990), Mahmood (2000), Smith and Caldwell (1977), Spriet-Pourra and Auriche (1994), van Meer et al. (2012), and Weaver et al. (2003). Despite the above, important international regulatory bodies still require animal-based research and testing. See for example, the Organisation for Economic Co-operation and Development (2018) and the International Council for Harmonization of Technical Requirements for Pharmaceuticals for Human Use (2011).

The overall consequence of continued reliance on animal models is evident when considering the costly failures seen in drug development. For the past few decades, arguably the period when our advanced scientific sophistication should have been yielding the greatest progress in drug development, the success rate in human clinical trials of drugs that entered those trials, based on data from animals, was about 10% (see, e.g., BIO, Biomedictracker and Amplion, 2016; Smietana, Siatkowski and Moller, 2016). Safety/toxicity and efficacy are the two characteristics researchers seek to evaluate when using animal models in drug development. But drugs developed using animal models have systematically failed in human clinical trials for both safety/toxicity reasons and efficacy reasons. Moreover, even more drugs have failed when prescribed to large numbers of people, dropping the success rate below 10%. Granted there are many reasons that drugs fail to enter the market, but these are rare in comparison to the frequency with which efficacy and safety issues have failed to be revealed by animal modeling.

Based on our discussion above of evolved complex systems, evolution, and the empirical data, we conclude that animal models, overall, do not and cannot have a numeric predictive value above about 50%; and, hence, we conclude that, for all practical purposes, they have no predictive value. By this we do not mean the predictive value of any given animal model is exactly equal to zero, but rather that the predictive value is so low that it is necessarily below any reasonable threshold to be considered useful in medical science in general.

5 Summary

Drawing on theoretical principles, based on evolutionary biology and complex systems, and based on extensive empirical evidence, the position that animal modeling has predictive value for human response to drugs in general has

been falsified. TSMT is a theory, and, like all scientific theories, it is consistent with this definition from the National Academies of Science Engineering Medicine (2016): “In everyday usage, *theory* often refers to a hunch or a speculation. When people say, ‘I have a theory about why that happened,’ they are often drawing a conclusion based on fragmentary or inconclusive evidence. The formal scientific definition of theory is quite different from the everyday meaning of the word. It refers to a comprehensive explanation of some aspect of nature that is supported by a vast body of evidence”.

Researchers who aim to improve human outcomes cannot continue to treat humans and non-human animals as simple systems and expect results based on non-human animals to translate to human patients. TSMT is the first comprehensive theory that explains the past failures and apparent successes of animal modeling and also explains why animal models will never achieve predictive value and, thus, should be abandoned.

We acknowledge that the scientific community as a whole is not yet familiar with TSMT; but we are confident that, in time, a consensus will be reached. Kramer and Greek (2018) explain the obstacles that must be overcome to ensure that drug development and the study of diseases are based on sound science. This will require changes to the regulations that currently mandate the use of animal models. Furthermore, Kramer and Greek (2018) discuss modern techniques that fall under the heading of personalized medicine, which offer treatments and cures that are customized to a patient’s individual genetic make-up and, hence, sidestep the significant risks associated with the continued blind reliance on methods arising from the use of animal models.

Acknowledgements

We thank Marshall Clemens for allowing us to use his complex systems figure.

References

- Ahn, A.C., M. Tewari, C.S. Poon and R.S. Phillips (2006). The Limits of Reductionism in Medicine: Could Systems Biology Offer an Alternative?. *PLoS Medicine*, 3(6), p. e208.
- American Physiological Society (APA) (2017). *Why Do Scientists Use Animals in Research?* [online] Available at: <http://www.the-aps.org/mm/sciencepolicy/animalresearch/publications/animals/questi.html> [Accessed 8 June 2017].
- Arrowsmith, J. (2011a). Trial Watch: Phase II Failures: 2008–2010. *Nature Reviews Drug Discovery*, 10, pp. 328–329.

- Arrowsmith, J. (2011b). Trial Watch: Phase III and Submission Failures: 2008–2010. *Nature Reviews Drug Discovery*, 10, p. 87.
- Attarwala, H. (2010). TGN1412: From Discovery to Disaster. *Journal of Young Pharmacists*, 2(3), pp. 332–336.
- Aziz-Alaoui, M. and C. Bertelle, eds. (2009). *From system complexity to emergent properties*. Berlin: Springer.
- Bailey, J. (2008). An Assessment of the Role of Chimpanzees in AIDS Vaccine Research. *Alternatives to Laboratory Animals*, 36, pp. 381–428.
- Bell, J.T. and T.D. Spector (2011). A Twin Approach to Unraveling Epigenetics. *Trends in Genetics*, 27(3), pp. 116–125.
- Belmaker, R.H., Y. Bersudsky and G. Agam (2012). Individual Differences and Evidence-based Psychopharmacology. *BMC Medicine*, 10:110.
- BIO, Biomedtracker, and Amplion (2016). *Clinical Development Success Rates 2006–2015*. [online] Available at: <https://www.bio.org/sites/default/files/Clinical%20Development%20Success%20Rates%202006-2015%20-%20BIO,%20Biomedtracker,%20Amplion%202016.pdf> [Accessed 1 February 2018].
- Bradley, L. (2010) *The Butterfly Effect*. [online] Available at: <http://www.stsci.edu/~lbradley/seminar/butterfly.html> [Accessed 8 June 2017].
- Bruder, C.E., A. Piotrowski, A.A. Gijssbers, R. Andersson, S. Erickson, T. Diaz de Ståhl, U. Menzei, J. Sandgren, D. von Tell, A. Poplawski, M. Crowley, C. Crasto, E.C. Partridge, H. Tiwari, D.B. Allison, J. Komorowski, G.J. van Ommen, D.I. Boomsma, N.L. Pedersen, J.T. den Dunnen, K. Wirdefeldt and J.P. Dumanski (2008). Phenotypically Concordant and Discordant Monozygotic Twins Display Different DNA Copy-number-variation Profiles. *American Journal of Human Genetics*, 82(3), pp. 763–771.
- Castillo-Fernandez, J.E., T.D. Spector and J.T. Bell (2014). Epigenetics of Discordant Monozygotic Twins: Implications for Disease. *Genome Medicine*, 6: 60.
- Center for Science in the Public Interest (2008). *Longer Tests on Lab Animals Urged for Potential Carcinogens*. [online] Available at: <http://www.cspinet.org/new/200811172.html> [Accessed 8 June 2017].
- Chapman, S.J. and A.V.S. Hill (2012). Human Genetic Susceptibility to Infectious Disease. *Nature Reviews Genetics*, 13, pp. 175–188.
- Chiou, W.L., H.Y. Jeong, S.M. Chung and T.C. Wu (2000). Evaluation of Using Dog as an Animal Model to Study the Fraction of Oral Dose Absorbed of 43 Drugs in Humans. *Pharmaceutical Research*, 17(2), pp. 135–140.
- Czyz, W., J.M. Morahan, G.C. Ebers and S.V. Ramagopalan (2012). Genetic, Environmental, and Stochastic Factors in Monozygotic Twin Discordance with a Focus on Epigenetic Differences. *BMC Medicine*, 10(93).
- Dempster, E.L., R. Pidsley, L.C. Schalkwyk, S. Owens, A. Georgiades, F. Kane, S. Kalidindi, M. Picchioni, E. Kravarti, T. Touloupoulou, R.M. Murray and J. Mill (2011). Disease-associated Epigenetic Changes in Monozygotic Twins Discordant for Schizophrenia and Bipolar Disorder. *Human Molecular Genetics*, 20(24), pp. 4786–4796.

- Devoy, A., R.K.A. Bunton-Stasyshyn, V.L.J. Tybulewicz, A.J.H. Smith and E.M.C. Fisher (2012). Genomically Humanized Mice: Technologies and Promises. *Nature Reviews Genetics*, 13, pp. 14–20.
- Dirnagl, U. (2006). Bench to Bedside: The Quest for Quality in Experimental Stroke Research. *Journal of Cerebral Blood Flow and Metabolism*, 26(12), pp. 1465–1478.
- Dirnagl, U. and M.R. Macleod (2009). Stroke Research at a Road Block: The Streets from Adversity Should Be Paved with Meta-analysis and Good Laboratory Practice. *British Journal of Pharmacology*, 157(7), pp. 1154–1156.
- Dolgin, E. (2013). Animal Rule for Drug Approval Creates a Jungle of Confusion. *Nature Medicine*, 19(2), pp. 118–119.
- Editorial (2007). Cold Shower for AIDS Vaccines. *Nature Medicine*, 13(12), pp. 1389–1390.
- Enna, S.J. and M Williams. (2009). Defining the Role of Pharmacology in the Emerging World of Translational Research. *Advances in Pharmacology*, 57, pp. 1–30.
- Ennever, F.K., T.J. Noonan and H.S. Rosenkranz (1987). The Predictivity of Animal Bioassays and Short-term Genotoxicity Tests for Carcinogenicity and Non-carcinogenicity to Humans. *Mutagenesis*, 2(2), pp. 73–78.
- Fletcher, A.P. (1978). Drug safety tests and subsequent clinical experience. *Journal of the Royal Society of Medicine*, 71(9), pp. 693–696.
- Fouad, K., C. Hurd and D.S.K. Magnuson (2013). Functional Testing in Animal Models of Spinal Cord Injury: Not as Straight Forward as One Would Think. *Frontiers in Integrative Neuroscience*, 7, p. 85.
- Gamble, L.J. and Q.L. Matthews (2010). Current Progress in the Development of a Prophylactic Vaccine for HIV-1. *Drug Design, Development and Therapy*, 5(9), pp. 9–26.
- Gell-Mann, M.. (1994). *The quark and the jaguar: Adventures in the simple and complex*. Boston: Little, Brown and Company.
- Giles, J. (2006). Animal Experiments Under Fire for Poor Design. *Nature*, 444(7122), p. 981.
- Gleick, J. (2008). *Chaos. Making a new science*. London: Penguin Books.
- Goodwin, B. (2001). *How the leopard changed its spots: The evolution of complexity*. Princeton: Princeton University Press.
- Graham, D.J., D. Campen, R. Hui, M. Spence, C Cheetham. G. Levy, S. Shoor and W.A. Ray (2005). Risk of Acute Myocardial Infarction and Sudden Cardiac Death in Patients Treated with Cyclo-oxygenase 2 Selective and Non-selective, Non-steroidal Anti-inflammatory Drugs: Nested Case-control Study. *The Lancet*, 365(9458), pp. 475–481.
- Graham, S. (2002). Mouse Genome Sequenced. *Scientific American*. [online] Available at: <https://www.scientificamerican.com/article/mouse-genome-sequenced/> Accessed 8 June 2017.
- Grass, G.M. and P.J. Sinko (2002). Physiologically-based Pharmacokinetic Simulation Modelling. *Advanced Drug Delivery Review*, 54(3), pp. 433–451.

- Greek, R. (2013a). Animal models in drug development. In: S. Gowder, ed., *New Insights into Toxicity and Drug Testing*. Manhattan: InTech, pp. 124–152.
- Greek, R. (2013b). Animal models of cancer in light of evolutionary biology and complexity science. In: *The Research and Biology of Cancer*. Hong Kong: iConcept Press.
- Greek, R. (2013c). Evolved Complex Systems. *Biological Systems: Open Access*, 2, p. e107.
- Greek, R. (2014a). A Discussion of the Role of Complex Evolved Systems in the Development of invasive Cardiovascular Interventions as Illustrated by the Blalock-Taussig Shunt and Intra-arterial Stents. *Biological Systems: Open Access*, 3, p. 1.
- Greek, R. (2014b). The Ethical Implications for Humans in light of the Poor Predictive Value of Animal Models. *International Journal of Clinical Medicine*, 5(16), pp. 966–1005.
- Greek, R. and J. Greek (2004). *What will we do if we don't experiment on animals?*. Victoria: Trafford Publishing.
- Greek, R. and J. Greek (2010). Is the Use of Sentient Animals in Basic Research Justifiable?. *Philosophy, Ethics, and Humanities in Medicine*, 5:14.
- Greek, R. and L.A. Hansen (2013). Questions Regarding the Predictive Value of One Evolved Complex Adaptive System for a Second: Exemplified by the SOD1 Mouse. *Progress in Biophysics and Molecular Biology*, 113(2), pp. 231–153.
- Greek, R., A. Menache and M.J. Rice (2012). Animal Models in an Age of Personalized Medicine. *Personalized Medicine*, 9(1), pp. 47–64.
- Greek, R. and M.J. Rice (2012). Animal Models and Conserved Processes. *Theoretical Biology and Medical Modelling*, 9:40. [online] Available at: <https://www.ncbi.nlm.nih.gov/pmc/articles/PMC3533755/pdf/1742-4682-9-40.pdf> [Accessed 1 February 2018].
- Greek, R., N. Shanks and M.J. Rice (2011). The History and Implications of Testing Thalidomide on Animals. *The Journal of Philosophy, Science, & Law*, 11(3) pp. 1–32.
- Groenink, L. (2015). Introduction: European Journal of Pharmacology, Special Issue on Translational Value of Animal Models. *European Journal of Pharmacology*, 759, pp. 1–2.
- Hau, J. (2003). Animal models. In: J. Hau and G.L. van Hoosier, Jr., eds., *Handbook of Laboratory Animal Science*, 2nd ed. Vol. 11. Boca Raton: CRC Press, pp. 1–9.
- Huff, J., M.F. Jacobson and D.L. Davis (2008). The Limits of Two-year Bioassay Exposure Regimens for identifying Chemical Carcinogens. *Environmental Health Perspectives*, 116, (11), pp. 1439–1442.
- Hughes, B. (2008). Industry Concern over EU Hepatotoxicity Guidance. *Nature Reviews Drug Discovery*, 7, p. 719.
- Igarashi, T., S. Nakane and T. Kitagawa (1995). Predictability of Clinical Adverse Reactions of Drugs by General Pharmacology Studies. *Journal of Toxicological Science*, 20(2), pp. 77–92.

- Igarashi, T., T. Yabe and K. Noda (1996). Study Design and Statistical Analysis of Toxicokinetics: A Report of JPMA Investigation of Case Studies. *Journal of Toxicological Science*, 21(5), pp. 497–504.
- International Council for Harmonisation of Technical Requirements for Pharmaceuticals for Human Use (ICH) (2011). *ICH Harmonised Tripartite Guideline. Preclinical Safety Evaluation of Biotechnology-Derived Pharmaceuticals S6(R1)*. [online] Available at: http://www.ich.org/fileadmin/Public_Web_Site/ICH_Products/Guidelines/Safety/S6_R1/Step4/S6_R1_Guideline.pdf [Accessed 1 February 2018].
- Johnson, J.L., S. Decker, D. Zaharevitz, L.V. Rubinstein, J.M. Venditti, S. Schepartz, S. Kalyandrug, M. Christian, S. Arbuck, M. Hollingshead and E.A. Sausville (2001). Relationships Between Drug Activity in NCI Preclinical *In Vitro* and *In Vivo* Models and Early Clinical Trials. *British Journal of Cancer*, 84(10), pp. 1424–1431.
- Kasowski, M., F. Grubert, C. Heffelfinger, M. Hariharan, A. Asabere, S. Waszak, L. Habegger, J. Rozowsky, M. Shi, A.E. Urban, M.Y. Hong, K.J. Karczewski, W. Huber, S.M. Weissman, M.B. Gerstein, J.O. Korbel and M. Snyder (2010). Variation in Transcription Factor Binding Among Humans. *Science*, 328(5975), pp. 232–235.
- Katzner, S., I. Nauhaus, A. Benucci, V. Bonin, D.L. Ringach and M. Carandini (2009). Local Origin of Field Potentials in Visual Cortex. *Neuron*, 61(1), pp. 35–41.
- Kitano, H. (2002). Systems Biology: A Brief Overview. *Science*, 295(5560), pp. 1662–1664.
- Kola, I. and J. Landis (2004). Can the Pharmaceutical Industry Reduce Attrition Rates? *Nature Reviews Drug Discovery*, 3(8), pp. 711–715.
- Kramer, L.A. and R. Greek (2018). Human Stakeholders and the Use of Animals in Drug Development. *Business and Society Review*, 123(1), pp. 3–58.
- Kummar, S., R. Kinders, L. Rubinstein, R.E. Parchment, A.J. Murgo, J. Collins, O. Pickeral and J. Low (2007). Compressing Drug Development Timelines in Oncology Using Phase ‘o’ Trials. *Nature Reviews Cancer*, 7(2), pp. 131–139.
- LaFollette, H. and N. Shanks (1996). *Brute science: Dilemmas of animal experimentation*. London: Routledge.
- LaFollette, H. and N. Shanks (1998). Claude Bernard: The founder of the paradigm. In: M. Bekoff, ed., *The Encyclopedia of Animal Rights*. Westport, CT: Greenwood Publishing, pp. 91–92.
- LeCouter, J.E., B. Kablar, P.F. Whyte, C. Ying, M.A. Rudnicki (1998). Strain-dependent Embryonic Lethality in Mice Lacking the Retinoblastoma-related p130 Gene. *Development*, 125, pp. 4669–4679.
- Lesko, L.J. and J. Woodcock (2004). Translation of Pharmacogenomics and Pharmacogenetics: A Regulatory Perspective. *Nature Reviews Drug Discovery*, 3(9), pp. 763–769.
- Lin, J.H. (1995). Species Similarities and Differences in Pharmacokinetics. *Drug Metabolism and Disposition: The Biological Fate of Chemicals*, 23(10), pp. 1008–1021.

- Litchfield, J.T., Jr. (1962). Symposium on clinical drug evaluation and human pharmacology. XVI. Evaluation of the safety of new drugs by means of tests in animals. *Clinical Pharmacology and Therapeutics*, 3, pp. 665–672.
- Lumley, C. (1990). Clinical toxicity: could it have been predicted? Premarketing experience. In: C. Lumley and S. Walker, eds., *Animal Toxicity Studies: Their Relevance for Man*. London: Quay, pp. 49–56.
- Macleod, M. (2004). Systematic Review and Meta-analysis of Experimental Stroke. *International Journal of Neuroprotection and Neuroregeneration* 1, pp. 9–12.
- Mahmood, I. (2000). Can Absolute Oral Bioavailability in Humans Be Predicted from Animals? A Comparison of Allometry and Different Indirect Methods. *Drug Metabolism and Drug Interactions*, 16(2), pp. 143–155.
- Marchetto, M.C., I. Narvaiza, A.M. Denli, C. Denner, T.A. Lazzarini, J.L. Nathanson, A.C. Paquola, K.N. Desai, R.H. Herai, M.D. Weitzman, G.W. Yeo, A.R. Muotri and F.H. Gage (2013) Differential L1 Regulation in Pluripotent Stem Cells of Humans and Apes. *Nature*, 503(7477), pp. 525–529.
- Medical Research Modernization Committee (2006). *A Critical Look at Animal Experimentation*. [online] Available at: http://mrmcmcd.org/Critical_Look.pdf [Accessed 6 February 2018].
- Morange, M. (2001). A Successful Form for Reductionism. *The Biochemist* 23(6), pp. 37–39.
- Morley, M., C.M. Molony, T.M. Weber, J.L. Devlin, K.G. Wewns, R.S. Spielman and V.G. Cheung (2004). Genetic Analysis of Genome-wide Variation in Human Gene Expression. *Nature*, 430(7001), pp. 743–747.
- Morowitz, H.J. (2002). *The emergence of everything: How the world became complex*. Oxford: Oxford University Press.
- Nagarsheth, K. and S. Kurek (2011). Ultrasound Detection of Pneumothorax Compared with Chest X-ray and Computed Tomography Scan. *The American surgeon*, 77(4), pp. 480–484.
- National Academies of Science Engineering Medicine (2016). *Is Evolution a Theory or a Fact?*. [online] Available at: <http://www.nas.edu/evolution/TheoryOrFact.html> [Accessed 8 June 2017].
- National Science Foundation (2011) *Press Release: Of Mice and Men*. [online] Available at: http://www.nsf.gov/news/news_summ.jsp?cntn_id=121653&org=NSF&from=news [Accessed 8 June 2017].
- Northrop, R.B. (2011). *Introduction to complexity and complex systems*. Boca Raton: CRC Press.
- O'Collins, V.E., M.R. Macleod, S.F. Cox, L. Van Raay, E. Aleksoska, G.A. Donnan and D.W. Howells (2011). Preclinical Drug Evaluation for Combination Therapy in Acute Stroke Using Systematic Review, Meta-analysis, and Subsequent Experimental Testing. *Journal of Cerebral Blood Flow and Metabolism*, 31(3), pp. 962–975.

- O'Collins, V.E., M.R. Macleod, G.A. Donnan, L.L. Horky, B.H. van der Worp and D.W. Howells (2006). 1,026 Experimental Treatments in Acute Stroke. *Annals of Neurology*, 59(3), pp. 467–477.
- Organisation for Economic Co-operation and Development (2018). *Animal Welfare*. [online]. Available at: <http://www.oecd.org/chemicalsafety/testing/animal-welfare.htm> [Accessed 1 February 2018].
- Pearson, H. (2002). Surviving a Knockout Blow. *Nature*, 415(6867), pp. 8–9.
- Pritchard, C., D. Coil, S. Hawley, L. Hsu and P.S. Nelson (2006). The Contributions of Normal Variation and Genetic Background to Mammalian Gene Expression. *Genome Biology*, 7:R26.
- Raineri, I., E.J. Carlson, R. Gacayan, S. Carra, T.D. Oberley, T.T. Huang and C.J. Epstein (2001). Strain-dependent High-level Expression of a Transgene for Manganese Superoxide Dismutase Is Associated with Growth Retardation and Decreased Fertility. *Free Radical Biology and Medicine*, 31(8), pp. 1018–1030.
- Rifkin, S.A., J. Kim and K.P. White (2003). Evolution of Gene Expression in the *Drosophila Melanogaster* Subgroup. *Nature Genetics*, 33(2), pp. 138–144.
- Rosen, R. (1999). *Essays on life itself*. New York: Columbia University Press.
- Rosenberg, N.A., J.K. Pritchard, J.L. Weber, H.M. Cann, K.K. Kidd, L.A. Zhivotovsky and M.W. Feldman (2002). Genetic Structure of Human Populations. *Science*, 298(5602), pp. 2381–2385.
- Rudczynski, A.B. (2011). Letter. *New Haven Register*, [online]. Available at: <http://www.nhregister.com/article/NH/20110325/NEWS/303259946> [Accessed 8 June 2017].
- Sandberg, R., R. Yasuda, D.G. Pankratz, T.A. Carter, J.A. Del Rio, L. Wodicka, M. Mayford, D.J. Lockhart and C. Barlow (2000). Regional and Strain-specific Gene Expression Mapping in the Adult Mouse Brain. *Proceedings of the National Academy of Science of the United States of America*, 97(20), pp. 11038–11043.
- Sena, E., H.B. van der Worp, D. Howells and M. Macleod (2007). How Can We Improve the Preclinical Development of Drugs for Stroke? *Trends in Neurosciences*, 30(9), pp. 433–439.
- Seok, J., H.S. Warren, A.G. Cuenca, M.N. Mindrinos, H.V. Baker, W. Xu, D.R. Richards, G.P. McDonald-Smith, H. Gao, L. Hennessy, C.C. Finnerty, C.M. López, S. Honari, E.E. Moore, J.P. Minei, J. Cuschieri, P.E. Bankey, J.L. Johnson, J. Sperry, A.B. Nathens, T.R. Billiar, M.A. West, M.G. Jeschke, M.B. Klein, R.L. Gamelli, N.S. Gibran, B.H. Brownstein, C. Miller-Graziano, S.E. Calvano, P.H. Mason, J.P. Cobb, L.G. Rahme, S.F. Lowry, R.V. Maier, L.L. Moldawer, D.N. Herndon, R.W. Davis, W. Xiao, R.G. Tompkins and Inflammation and Host Response to Injury, Large Scale Collaborative Research Program (2013). Genomic Responses in Mouse Models Poorly Mimic Human Inflammatory Diseases. *Proceedings of the National Academy of Sciences of the United States of America*, 110(9), pp. 3507–3512.
- Shanks, N. and R. Greek (2008). Experimental Use of Non-human Primates Is Not a Simple Problem. *Nature Medicine* 14(10), p. 1012.

- Shanks, N. and R. Greek (2009). *Animal models in light of evolution*. Boca Raton: Brown Walker.
- Shanks, N., R. Greek and J. Greek (2009). Are Animal Models Predictive for Humans?. *Philosophy, Ethics, and Humanities in Medicine*, 4:2.
- Shanks, N. and R.A. Pyles. (2007). Evolution and Medicine: The Long Reach of Dr. Darwin. *Philosophy, Ethics Humanities in Medicine*, 2, p. 4.
- Shepard, T. and R. Lemire (2004). *Catalog of teratogenic agents*, 11th ed. Baltimore: Johns Hopkins.
- Smietana, K., M. Siatkowski and M. Moller (2016). Trends in Clinical Success Rates. *Nature Reviews Drug Discovery*, 15(6), pp. 379–380.
- Smith, R.L. and J. Caldwell (1977). Drug metabolism in non-human primates. In: D.V. Parke and R.L. Smith, eds., *Drug Metabolism. From Microbe to Man*. London: Taylor & Francis, pp. 331–356.
- Solé, R. and B. Goodwin (2002). *Signs of life: How complexity pervades biology*. New York: Basic Books.
- Spriet-Pourra, C. and M. Auriche (1994). *SCRIP reports*, 2nd ed. New York: PJB Publications.
- Storey, J.D., J. Madeoy, J.L. Strout, M. Wurfel, J. Ronald and J.M. Akey (2007). Gene-expression Variation within and among Human Populations. *American Journal of Human Genetics*, 80(3), pp. 502–509.
- Suter, K. (1990). What can be learned from case studies? The company approach. In: C. Lumley and S. Walker, eds., *Animal Toxicity Studies: Their Relevance for Man*. Lancaster: Quay, pp. 71–78.
- Suzuki, Y. and M. Nakayama (2003). Differential Profiles of Genes Expressed in Neonatal Brain of 129X1/SvJ and C57BL/6J Mice: A Database to Aid in Analyzing DNA Microarrays Using Nonisogenic Gene-targeted Mice. *DNA Research*, 10(6), pp. 263–275.
- van Meer, P.J., M.L. Graham and H.J. Schuurman (2015). The Safety, Efficacy, and Regulatory Triangle in Drug Development: Impact for Animal Models and the Use of Animals. *European Journal of Pharmacology*, 759, pp. 3–13.
- van Meer, P.J.K., M. Kooijman, C.C. Gispén-de Wied, E.H.M. Moors and H. Schellekens (2012). The Ability of Animal Studies to Detect Serious Post Marketing Adverse Events Is Limited. *Regulatory Toxicology and Pharmacology*, 64(3), pp. 345–349.
- Van Regenmortel, M. (2002). Reductionism and the Search for Structure-function Relationships in Antibody Molecules. *Journal of Molecular Recognition*, 15(5), pp. 240–247.
- Van Regenmortel, M. (2004a). Biological Complexity Emerges from the Ashes of Genetic Reductionism. *Journal of Molecular Recognition*, 17(3), pp. 145–148.
- Van Regenmortel, M. (2004b). Reductionism and Complexity in Molecular Biology. Scientists Now Have the Tools to Unravel Biological Complexity and Overcome the Limitations of Reductionism. *EMBO Reports*, 5(11), pp. 1016–1020.

- Van Regenmortel, M.H. and D.L. Hull (2002). *Promises and limits of reductionism in the biomedical sciences (Catalysts for fine chemical synthesis)*. West Sussex: Wiley.
- Varki, A. and T.K. Altheide (2005). Comparing the Human and Chimpanzee Genomes: Searching for Needles in a Haystack. *Genome Research*, 15(12), pp. 1746–1758.
- Vicsek, T. (2002). The BIGGER PICTURE. *Nature*, 418(6894), p. 131.
- Vojinovic, M. (2015a). *Reductionism, Emergence, and Burden of Proof — Part I*. Scientia Salon. [online] Available at: <https://scientiasalon.wordpress.com/2015/01/14/reductionism-emergence-and-burden-of-proof-part-i/> [Accessed 8 June 2017].
- Vojinovic, M. (2015b). *Reductionism, Emergence, and Burden of Proof — Part II*. Scientia Salon. [online] Available at: <https://scientiasalon.wordpress.com/2015/01/16/reductionism-emergence-and-burden-of-proof-part-ii/> [Accessed 8 June 2017].
- Warren, H.S., R.G. Tompkins, L.L. Moldawer, J. Seok, W. Xu, M.N. Mindrinos, R.V. Maier, W. Xiao and R.W. Davis (2014). Mice Are Not Men. *Proceedings of the National Academy of Sciences*, 112(4), pp. E347-E348.
- Weaver, J.L., D. Staten, J. Swann, G. Armstrong, M. Bates and K.L. Hastings (2003). Detection of Systemic Hypersensitivity to Drugs Using Standard Guinea Pig Assays. *Toxicology*, 193(3), pp. 203–217.
- Zhang, W., S. Duan, E.O. Kistner, W.K. Bleibel, R.S. Huang, T.A. Clark, T.X. Chen, A.C. Schweitzer, J.E. Blume, N.J. Cox and M.E. Dolan (2008). Evaluation of Genetic Variation Contributing to Differences in Gene Expression Between Populations. *American Journal of Human Genetics*, 82(3), pp. 631–640.

Replacing Animal Tests to Improve Safety for Humans

Kathy Archibald

Director, Safer Medicines Trust

kathy@safermedicines.org

Robert Coleman

Consultant to Safer Medicines Trust and Center for Responsible Science

robt.coleman@btinternet.com

Tamara Drake

Director of Research and Regulatory Policy, Center for Responsible Science

tami.drake@crs501.org

1 Introduction

Animal safety testing for new medicines is arguably the most difficult use of non-human animals (hereinafter referred to as animals) to challenge, for two reasons: first, it is required by governments (regulatory testing); second, protecting patients is a vital goal, and it seems intuitively obvious that animal tests *must* protect patients. Animal testing became institutionalized in the mid twentieth century (Parke, 1994) in response to early drug disasters, with the aim of preventing further tragedies. However, even the laudable aim of protecting patients cannot justify animal testing, unless it is the most effective means to ensure the safety of medicines. European Union (EU) law (European Parliament, 2010, Directive 2010/63/EU) states that animals must not be used if a non-animal method could achieve the same purpose. So, it is crucial to know how well animal tests predict the safety of medicines, and whether any other methods are equally or more predictive. In addition to the question of predictive value, other important issues must also be taken into consideration, including the efficiency of different methods in terms of time and costs; and the ethical acceptability of using animals, if their use is deemed to be of irreplaceable value.

The issue of whether animals should be used as human surrogates for safety testing is highly contentious; individual views range from no use of animals

is acceptable, to any use is justified if it is ultimately for the benefit of human health. In a 2016 Ipsos Mori poll for the United Kingdom government, 35% of respondents felt that “animals should not be used in any scientific research because of the importance I place on animal welfare”; and 51% felt that it is unacceptable to use animals to test chemicals that could harm plants or the environment (Clemence and Leaman, 2016). In the United States (US), a 2017 Gallup poll found that 44% of adults considered medical testing on animals to be morally wrong (Jones and Saad, 2017). A 2015 survey by the US Pew Centre found that 50% of citizens “oppose the use of animals in scientific research” (Pew Research Center, 2015). Thus, it is questionable whether the continued use of animals in research or testing has a mandate from society. What is clear is that their use should be replaced as soon as scientifically possible (European Parliament, 2010, Recital 10), which brings us back to the question of their effectiveness relative to other methods.

Before any new methods can be approved for use in regulatory safety testing, they must be shown to be at least as effective as the methods they are designed to replace, a logic that cannot be faulted. However, herein lie a number of problems. First, we do not know how valuable existing animal-based methods actually are, as none have ever been formally validated in the manner required for potential replacements. One reason for this is that the formal process of test-method validation is so slow, expensive, and demanding, in its current format, that it represents an effective block to testing existing accepted methods and a significant barrier to testing new methods. The situation is further complicated by the fact that the “gold standard” with which new data must be compared, is usually animal data that is of unknown value. We strongly believe that the most relevant gold standard should be human data.

In this chapter, we propose a new, pragmatic approach that could accelerate the replacement of most, if not all, regulatory animal tests with superior tests based on human biology. We also propose that changes to the requirements for safety testing, issued by the US Food and Drug Administration (FDA), must be made in order to enable the use of superior new tests, which are currently disadvantaged by the outdated language of the regulations. But first, it is imperative to establish some level of understanding of the efficacy of existing animal-based methods in order to know whether any possible replacement is better or worse.

2 Learning from Clinical Experience

In order to quantify, as best as we can, the effectiveness of animal tests for predicting the safety of medicines, we can begin by assessing about half a century

of clinical experience. We have a significant amount of information gleaned from the use of approved medicines in human subjects and can identify, for such medicines, where animal-based testing failed to predict human safety issues; and whether non-animal methods now exist that would be able to identify the toxic effects that were missed by animal tests.

Many medicines that have been judged safe enough for testing in humans, following all the required safety tests *in vitro*, and in at least two species of animals, have gone on to cause serious adverse reactions in the first volunteers to try them: participants in clinical trials. The most infamous examples include the trials of the candidate medicines TGN1412 in the UK, BIA 10-2474 in France, and fialuridine in the US. TGN1412 is a monoclonal antibody that was intended to treat B cell chronic lymphocytic leukemia and rheumatoid arthritis. The clinical trial, in London in 2006, hit headlines when all six young men in the Phase I (safety assessment) trial were rushed to intensive care with multiple organ failure. Miraculously, they all survived; but they were told that they face “a lifetime of contracting cancers and all the various autoimmune diseases from lupus to MS, from rheumatoid arthritis to ME” (Leppard, 2006). TGN1412 was shown to be safe in monkeys at doses 500 times higher than those that nearly proved fatal to the volunteers (St. Clair, 2008).

In January 2016, a Phase I study of the drug BIA 10-2474 conducted in Rennes, France, left one initially healthy volunteer dead, and four volunteers with serious neurological damage (Sharav, 2016). The drug was intended to target a wide range of conditions including pain, hypertension, multiple sclerosis, obesity, and cancer. Experts convened by the French National Agency for Medicines and Health Products concluded that the compound being tested had caused an “astonishing and unprecedented” reaction in the brain. Why this was not clear in early trials on animals is “inexplicable,” according to the expert panel’s report (Bisserbe, 2016). The drug had been tested in mice, rats, dogs, and monkeys, with few ill effects, despite doses up to 650 times stronger than those given to the volunteers (Temporary Specialist Scientific Committee, TSSC, 2016). A subsequent study indicates that an off-target effect, which can be species dependent, may explain why animal tests in multiple species did not identify the deadly neurological effects (van Esbroeck et al., 2017). The off-target effect could only be found using human cells *in vitro* and in humans.

In 1993, a combined Phase I/Phase II clinical trial (to test both safety and effectiveness) of fialuridine, a potential hepatitis B treatment, conducted by the National Institutes of Health (NIH) in the US, caused unexpected and devastating reactions, such as jaundice, liver failure, and multiple organ failure. Five of the 15 participants died. Emergency liver transplants saved two others. Previous toxicity tests in animals, including a six-month trial in dogs, had given the drug the green light for testing in humans (Thompson, 1994).

Many more medicines have passed both preclinical (mainly animal-based) safety tests and human clinical trials and still gone on to cause serious adverse reactions in patients. This illustrates how difficult it is to predict safety for humans, in general, and even more so for particular members of the human population. There is enormous genetic variability between people, and individual reactions will vary with age, sex, ethnicity, health, diet, environment, and unique genetic characteristics. Adverse drug reactions (ADRs) are now a leading cause of death, killing 197,000 people in the EU each year (European Commission, 2008), and over 125,000 in the US (Light, 2015). In addition to this devastating human cost, the financial cost of ADRs is astronomical, calculated at €79 billion per annum in the EU (European Commission, 2008). A study of new drugs approved by the US FDA between 2001 and 2010 found that 32% were affected by a post market safety event (Downing et al., 2017). Another study of all 454 drugs approved in the US and Canada from 1992 to 2011, found that 52% (236 drugs) were either withdrawn from the market or restricted by a serious safety (black box) warning within the 20-year period (Rawson, 2013). Black box warnings are reserved for ADRs that may lead to death or serious injury. Half of them are detected and documented within seven years after drug approval, during which time their market uptake and sales volume may be explosive. There is a compelling argument that “when safe and effective therapies already exist, any new drug should be considered a black box” (Lasser et al., 2002). When the costs of withdrawn and restricted drugs, as well as failures during development, are factored into the total cost of developing a successful new drug, this results in an estimated average of US\$4 billion and could reach as high as US\$12 billion (Herper, 2012).

It is argued that most ADRs that were not detected in clinical trials are very rare and/or idiosyncratic, i.e. unique to the individuals who suffered them and, therefore, impossible to identify until large numbers of people are exposed to the drug, once it is on the market. The implication of this position, accepted by our governments, is that we are powerless to prevent rare or idiosyncratic ADRs and must simply accept them as an unavoidable risk of medicine. The problem is that even if an adverse reaction is rare, when millions of people are taking a drug, large numbers will be affected. Not only are hundreds of thousands of people killed, it is estimated that a total of over 80 million ADRs result in 2.7 million hospitalizations each year; in addition, pain, discomfort and dysfunction affect physical or cognitive function and can lead to falls and cause potentially fatal vehicle accidents (Light, 2015). While it can be argued that responsibility for failing to protect participants in clinical trials from dangerous drug candidates lies mainly with animal testing, neither animal tests nor human trials have been able to prevent the large numbers of ADRs

documented above. Clearly, it is imperative to examine all aspects of safety testing, to find every weak point, and to take action to address them all.

3 Clinical Trial Flaws

Many problems with clinical trials have been identified, and are being addressed to varying degrees (Evans, Thornton and Chalmers, 2006; Goldacre, 2012). For example, most volunteers in Phase I trials are young men, who are not representative of the often elderly and/or female patients who will be taking the medicines (Abadie, 2010; Johnson et al., 2014). The conduct and reporting of trials are beset by a host of biases, such as selective reporting of results, to emphasize benefits and disguise risks; and non-publication of trials where the desired outcomes were not achieved (Goldacre, 2012; Harris, 2017). In biomedical research as a whole, 235 types of bias have been documented (Chavalarias and Ioannidis, 2010). Many doctors have been campaigning for many years to tackle these biases, which make a mockery of the evidence base for medical treatments. Doctors and patients are unable to choose the best treatments without full, unbiased disclosure of the magnitude of their benefits as well as their risks. With UN endorsement, the AllTrials campaign (2016) has published a roadmap towards ensuring that all clinical trials are properly reported to improve the evidence base for medicine, which is currently badly incorrect and incomplete.

4 Preclinical Animal Tests

To assess the performance of preclinical animal tests, the most direct comparison is between data obtained during preclinical (animal) and clinical (human) trials. We have already mentioned three extreme examples of disastrous clinical trials, where animal tests failed to predict toxicity with devastating consequences. But are these isolated examples, and do animal tests usually predict serious toxicities before they manifest in people? This is difficult to answer quantitatively because compounds that are shown to be toxic in animal tests do not usually progress to clinical trials. However, we do know that 95% of potential new drugs fail during clinical trials (Arrowsmith, 2012), either because of toxicities that were not predicted, or because they lack the therapeutic efficacy that was predicted. Data obtained by Freedom of Information legislation shows that from 2010–2014, 7,187 people in the UK suffered serious unexpected ADRs during clinical trials and 761 died, although none of the

deaths could be proven to have been “directly caused” by the test drug (Bagot, 2015). More than 2,600 patients participating in clinical trials in India died between 2005 and 2012, and nearly 12,000 suffered serious adverse effects. Of these, 80 deaths and more than 500 serious adverse effects were directly attributed to the drug being trialed (Nair, 2015). Clearly the record of animal tests in predicting safety is poor.

Another example that illustrates the dangers of both misleading preclinical animal studies and non-publication of clinical trials is lorainide, which is estimated to have killed over 100,000 people in the US alone over the course of the 1980s (Bruckner and Ellis, 2017). Lorainide and other anti-arrhythmic drugs (most of which have since been withdrawn) were prescribed routinely to patients recovering from heart attacks, on an assumption, bolstered by the strength of their effectiveness against experimentally induced arrhythmias in animals, that they would help to prevent early deaths. A clinical trial in 1980 indicated that, in fact, they *caused* more deaths; but the trial was not published until 13 years later, to the great regret of the authors, who realize that they could have helped avert tens of thousands of unnecessarily early deaths (Hampton, 2015).

An important point that must be made is the difference between predicting the presence or the absence of toxicity. It seems intuitively obvious that if a compound is overtly toxic for an animal, it is not unreasonable to suspect that it will also be toxic in humans. In a series of studies, Bailey, Thew and Balls (2013, 2014, 2015) examined the likelihood that such suspicions would be correct. They analyzed a data set of 2,366 drugs, for which both animal and human data are available, in the most comprehensive analysis of publicly available animal toxicity data ever compiled. Crucially, they used the appropriate statistical metrics of likelihood ratios, for the first time, to question critically the value of the use of the main preclinical animal species (i.e., rats, mice, rabbits, dogs, and monkeys) in the testing of new human pharmaceuticals. They found that the *presence* of toxicity in animal tests indeed shares some degree of correlation (above random chance) with the presence of toxicity in humans, although such correlation is too variable to be regarded as predictive, as has been demonstrated by many previous studies (Fourches et al., 2010; Geerts, 2009; Green, 2015; Hackam and Redelmeier, 2006; Heywood, 1990; Igarashi, 1994; Ioannidis, 2012; Knight et al., 2006; Matthews, 2008; Pound et al., 2004; Pound and Bracken, 2014; Perel et al., 2007; Salsburg, 1983; Seouk et al., 2013; Spriet-Pourra and Auriche, 1994; Wall and Shani, 2008, van Meer et al., 2012). More importantly, they found that animal tests have essentially no ability to predict the *absence* of toxicity, the very reason for their use in preclinical testing: candidate drugs proceed to testing in humans when no toxicity shows up in tests on animals.

So, while animal tests undoubtedly prevent some toxic compounds from reaching humans, they cannot predict safety for humans. Thus, as we have seen, their use creates a false sense of security. A study published in 2012 found that animal tests missed 81% of the serious side effects of 43 drugs that went on to harm patients (van Meer, 2012). This is disastrous not only for patients but also for the pharmaceutical industry, which is in crisis and urgently needs to stem the unsustainable rate of late-stage attrition of new medicines.

In addition to letting dangerous medicines slip through the net (through *false negative* results), promising medicines may be wrongly discarded due to animal toxicities that do not affect humans (*false positives*). Clear examples of this are few, as any compound causing ADRs in animals is extremely unlikely to progress to the clinic; therefore, its safety profile in humans remains unestablished. However, there are examples. Glivec, an effective cancer treatment, was almost abandoned during development, as it caused liver damage in dogs. Fortunately, its remarkable success in human cells *in vitro* and in early trials in leukemia patients enabled its continued development (Capdeville, 2002). Similarly, tamoxifen was almost lost as a cancer treatment because it causes liver tumors in rats (Carthew, 1995). Evidence for this may also be gleaned from drugs introduced before rigorous safety testing became mandatory. For example, aspirin, introduced over a hundred years ago, has proved useful for pain treatment ever since, but it is highly doubtful it would ever have appeared had it been subjected to modern animal-based safety testing (Hartung, 2009). Other such examples include, benzodiazepines, methylxanthines, such as caffeine, and beta-blockers. It is a similar story with many foodstuffs, such as chocolate and garlic, which are well tolerated by humans but prove toxic to dogs and cats (Cortinovis and Caloni, 2016).

Furthermore, not all failures in animal studies involve adverse events. Many reflect a lack of apparent efficacy in the chosen animal species, a finding that usually consigns a prospective candidate to the waste bin. However, on occasion, a “failed” compound has a champion, sufficiently dogged to proceed despite such a setback. A particularly good example of this are statins (Endo, 2010), the best selling drugs in history, which nearly never emerged from preclinical testing. Based on the belief that elevated levels of cholesterol in the body are, in some way, responsible for coronary heart disease, many approaches to reducing circulating cholesterol have been explored; one of these was through inhibition of HMG-CoA reductase, a key enzyme in cholesterol biosynthesis. In 1976, a report of the first statin, *compactin*, was published (Endo et al., 1976), describing how it inhibited this key enzyme and reduced cholesterol synthesis in isolated mammalian cells. Unfortunately, when tested in rats, this compound proved to be without effect on serum cholesterol levels

(Endo, 2010); and if not for the persistence of the scientists working on the project, this would have been the end of the story. However, despite its lack of effect in rats, compactin was, by chance, found to lower circulating levels of cholesterol in chickens and, subsequently, in other animal species; and the race to develop the ultimate statin was on. Although statins' effectiveness in saving lives is now controversial (de Lorgeril and Rabaeus, 2015), there is no doubt of their effectiveness in lowering cholesterol in humans.

It is hard to imagine a world without antibiotics, the most life-saving class of drugs ever discovered. Yet, the world's first antibiotic, penicillin, was almost lost to humanity because Alexander Fleming concluded that its rapid clearance from the bloodstream in a rabbit would prevent it from being systemically effective (Hare, 1982). For twelve years following his discovery of "mould juice", Fleming pursued its use merely as a topical antiseptic, until Florey and Chain resurrected interest in its greater potential. Fleming later commented to his student, Dennis Parke, who became an extremely influential pioneering toxicologist: "How fortunate we didn't have these animal tests in the 1940s, for penicillin would probably never have been granted a license, and possibly the whole field of antibiotics might never have been realised" (Parke, 1994).

We have discussed, above, examples of *false negatives* and *false positives* for safety, as well as false negatives for efficacy. Finally, there are many examples of false positives for efficacy, i.e. drugs that were effective in animal tests but turned out to be ineffective in humans. They include the vast majority of new cancer treatments, which have one of the highest failure rates (96%) in clinical trials (Hutchinson and Kirk, 2011); all putative disease-modifying treatments (more than 300) for Alzheimer's disease to date (Langley, 2014; Lowe, 2017); more than 100 candidate AIDS vaccines, all of which were effective in non-human primates, as well as other animal models (Sheets et al., 2016); more than 100 drugs for stroke (Collaborative Approach to Meta-Analysis and Review of Animal Data from Experimental Studies, CAMARADES, 2017); and 150 drugs for sepsis, the leading cause of death in intensive care units (Seok et al., 2013).

The CAMARADES group was founded to study the translatability of stroke studies from animals to humans, and later expanded to include a number of other diseases that share a high rate of translational failure. They have found that the poor quality of animal studies confounds research in all areas they have studied, so far (CAMARADES, 2017). These failed treatments have been tested on patients in clinical trials. When the director of the US NIH, Dr. Francis Collins, learned of the poor quality of the animal studies that led to clinical trials of treatments for amyotrophic lateral sclerosis (ALS, also known as motor neuron disease), he said: "Humans were being put at risk based on that kind of data, and that took my breath away" (Harris, 2017). This *reproducibility crisis* is now receiving much attention, and many initiatives have begun to attempt

to improve standards and the quality of animal research and reporting (Harris, 2017). However, a review of developments in the field of stroke found that, despite researchers' adherence to recommendations intended to improve the quality of preclinical stroke studies for over 10 years, there is no evidence of an increased rate of successful translation (Sutherland et al., 2012). It is possible that many years and many precious resources will be invested in attempts to surmount a problem that may ultimately be insurmountable, due to inherent interspecies differences in crucial genetic and biochemical systems. Dr. Fiona Godlee, Editor of British Medical Journal, posed the pivotal question: "Where would you place the balance of effort: investment in better animal research or a shift in funding to more clinical research?" (Godlee, 2014).

5 Other Preclinical Tests in Current Use

Preclinical testing also includes a number of *in vitro* and *in silico* (computer modeling) methods, whose record of predicting safety must also be acknowledged as lamentable. Indeed, the UK government always uses this argument in defense of animal testing, stating that "prior to testing in animals, new drugs are tested in batteries of *in silico* and *in vitro* tests, including, where available and validated, tests using human tissue samples" (UK Department of Health, 2012). However, many of these tests are based on animal cells and tissues; and even the human-based ones generally do not represent the latest state of the art models, which have long ago moved on from 2D to 3D models and recognized the importance of incorporating more realistic physiological features, such as multiple interconnected organs, metabolic activity, and fluid circulation, among others. Technologies are now becoming available that can identify toxic liabilities more accurately than animal tests and furthermore, some of them are able to identify subtle signals of toxicities that only manifest in rare individuals (Xu et al., 2008). This could enable the detection of potential rare ADRs that are currently unpredictable (Kenna, 2017). Thus, these human biology-based technologies should be recognized as a truly disruptive (i.e. revolutionary) technology, with the potential to transform toxicology from an imprecise science based on inter-species extrapolations to a predictive science based on a deep understanding of human pathways of toxicity. A particularly powerful approach has recently been described by Theil et al. (2017), in which they use a system to "contextualize *in vitro*" data to reflect an *in vivo* situation in patients through computer modeling, using data derived from both human cells and clinical experience. A system such as this allows the identification of potential biomarkers of toxicity, and the use of these biomarkers in an *in vitro* setting to predict potential toxicity in clinical use.

6 Non-animal Technologies

Remarkable scientific advances have created a new generation of more relevant and predictive toxicological tools. They include human tissue created by reprogramming cells from people with the relevant disease (dubbed *patient in a dish*); *organ on a chip* devices, where living human tissue samples on a silicon chip are linked by a circulating blood substitute; a variety of computer modeling approaches, such as virtual organs, patients, and clinical trials; and microdosing studies, where tiny doses of drugs given to volunteers allow scientists to study their metabolism in humans, safely and with unsurpassed accuracy. There are also humbler, but no less valuable, studies in ethically donated “waste” tissue. Together, these innovations provide invaluable insight into the functioning of the integrated human system. Such tests are frequently able to detect side effects that were missed by preclinical animal tests. For example:

- A micro-liver (called HepatoPac) comprising human liver cells is able to predict liver damage from fialuridine, the potential hepatitis B treatment that killed five patients in the devastating 1993 clinical trial (Baker, 2011). Furthermore, the same technology is able to identify many other liver-toxic drugs that were missed by animal testing (Xu et al., 2008).
- Following the trial of TGN1412, a method using human cells was rapidly developed to model the *cytokine storm* experienced by the volunteers (Stebbins et al., 2007).
- The US government’s initiative, *Toxicology in the 21st Century* (Tox21), has tested 10,000 chemicals using a panel of human cell-based assays (National Center for Advancing Translational Sciences, 2016). These are automated high-throughput screening assays that expose cells to chemicals and then screen them for changes that could suggest toxic effects. The use of this panel of assays enabled the identification of important safety aspects of drugs and chemicals “markedly better” than toxicity tests in animals (Huang et al., 2016). The human *in vitro* data were mainly assessed against rodent data, as human *in vivo* data are sparse. As expected, the Tox21 data better predicted human toxicity endpoints than rodent data.

Non-animal tests are often faster and cheaper, as well as more accurate and reliable (Balijepalli and Sivaramkrishan, 2017; Bracken, 2009; Garner et al., 2017; Krul, 2014; NIH, 2008). Some of the more valuable technologies are expensive, but worth it—there is nothing more expensive than getting the wrong answer. Human tissue company, Bioptra (2017), estimates an average saving of US\$7 for every US\$1 invested in predictive human assays. Director of the US NIH, Dr. Francis Collins, recently predicted before US Congress that within 10 years, human biochips “will mostly replace animal testing for drug toxicity and

environmental sensing, giving results that are more accurate, at lower cost, and with higher throughput” (US Senate Committee on Appropriations, 2016). However, new methods will not automatically implement themselves. Pharmaceutical companies would make much greater use of them if governments encouraged it, but inflexible requirements for animal tests are a major deterrent. Reliance on animals is so entrenched and institutionalized, that the system is “locked-in” (Frank, 2004). Intervention is necessary to overcome the many factors contributing to entrenchment against change.

7 Validation

Quite correctly, new technologies must be shown to be robust, reliable, and fit for purpose before they can be recommended for use in any regulatory safety-testing regime. The current validation process involves testing by several different laboratories and is tremendously demanding, taking an average of 10 years and costing up to US\$1 million (Hartung, 2013). This approach protects the status quo by making the bar for acceptance so high and so unaffordable for small technology providers. Moreover, in this fast-moving field, by the time a new technology has finally been validated, it will already have been superseded. Most ironically, new technologies are assessed on how well they can predict the “gold standard” animal data; thus ensuring that they *cannot* succeed, if the drug affects animals differently from humans, which we now know is very often the case (Hartung, 2007, 2010; Leist et al., 2012). The very concept of the use of animal data as a useful standard is fundamentally flawed, as no species is truly representative of any other (Hartung, 2009; Wang & Gray, 2015; Perlman, 2016). Indeed the ability of rats to predict for carcinogenicity in mice has been shown to be useful in less than 60% of cases (Gray et al., 1995).

8 A Way Forward: Pragmatic Evaluation

The need for better ways to protect the public from the ever-increasing epidemic of ADRs is so urgent that a new approach to implementing more predictive methods is critical. This is now widely recognized and much attention is being devoted to making validation more flexible. The FDA is considering accepting methods that have been through a process of “qualification”, rather than traditional validation (Food and Drug Administration, FDA, 2017). Others have suggested streamlining validation, through greater use of reference chemicals and performance standards and the development of an objective, transparent, online peer review process (Judson et al., 2013).

We believe most strongly that any superior system must be based on *human* biology, and if that aim is compromised, predictive value is bound to fall. Advocates of animal testing say that this is unrealistic, and that it is not possible to gain sufficient understanding of the intact human system from isolated cells and tissues. However, if we look at other fields of technology, such as computing, automotive manufacture, telephonic communication, or space exploration, we see that yesterday's impossibility becomes today's challenge and tomorrow's commonplace. There is no reason why this should not equally apply to safety testing. In all other areas, technological advances are made in a step-wise fashion, seldom, if ever, in a single leap. We argue that the only practical way forward is a process of pragmatic evaluation of new technologies, whereby those that demonstrate success in predicting safety issues for humans, where the current system failed (as well as where it succeeded), should be accepted for use in appropriate circumstances and with sufficient justification. This approach will be iterative, and as shortcomings of the new tests are identified, further tests may be developed to overcome these problems. The truth is that we may never identify tests that will allow prediction of all safety issues, but by tackling these in a manageable fashion, we will get much closer than we can currently manage using animal-based approaches.

Of course, we cannot test potential new medicines on humans prospectively, using new methods in place of old ones, in case they perform less well. Therefore, new methods must be evaluated using historical "legacy" data. By studying the safety profiles of drugs that have been extensively used in human subjects, which will have necessarily passed the mandatory animal-based safety tests, we can identify where those tests failed to detect safety issues in human subjects. A selection of drugs whose toxicities were missed by animal tests can then form the basis of a test panel, to be submitted to a range of non-animal tests. In this way, the predictive performance of the new tests can be compared to that of the animal-based methods. To increase the scientific rigor of such studies, pairs of closely-related compounds should be used, where one has a particular toxicity that the other does not share. This will identify tests that are capable of differentiating between toxic and non-toxic compounds, the key attribute of any desirable test. Rather than assessing each new test in isolation, different types of tests will be combined in testing batteries, designed to complement each other in their ability to detect a variety of toxicities. Different batteries will be appropriate for different types of compounds. We need to forget the beguilingly simplistic approach of attempting to model humans with one system, even when that system is an integrated whole animal. No single test, however integrated, will ever be an adequate model for the breadth of human genetic variability. Combinations of tests at the molecular, cellular, organ, and system levels will need to be performed to generate sufficient

confidence to advance into cautious first-in-human testing, using safe approaches, such as microdosing, before proceeding to test therapeutic doses in patients in carefully designed adaptive clinical trials.

The Evidence-Based Toxicology Collaboration (EBTC) at the Johns Hopkins Bloomberg School of Public Health, is currently undertaking an evidence-based evaluation study, as described above. Using systematic reviews, they are comparing drug-induced toxicity in humans to preclinical animal data and to *in vitro* data from the Toxicity Forecaster (ToxCast) program of the US Environmental Protection Agency. The results will provide an objective comparison of the relative predictive abilities of animal versus non-animal methods. If successful, this study will demonstrate that a limited compound set can be used, if proper negative and positive controls are present, to compare the performance of a battery of tests relative to the current system. A clear demonstration of multiple successes, especially where the current regime has failed, would create a powerful impetus for governments and pharmaceutical companies to allocate more resources to tackling this problem more urgently. Substantial funding is required, as is greatly increased access to data.

Pharmaceutical companies are sitting on a treasure trove of preclinical and clinical data, which could yield immensely valuable information if made available for analysis. Former FDA Commissioner, Robert Califf called for a preclinical database to be established (Scott, 2016). This initiative must be seized; it has the potential to save time, money, and animals by avoiding futile repetitive testing; and, more importantly, the potential to revolutionize the evaluation of both old and new technologies, through statistical comparisons with a gold mine of millions of data points.

9 Regulatory Change

Former NIH Director, Elias Zerhouni, and former FDA Commissioner, Margaret Hamburg, state that the “regulation of drugs can either grease the wheels of progress or throw a wrench in the works” (Zerhouni and Hamburg, 2016). Calling for global harmonization of regulatory requirements, they note that differences between regulations in different countries create unnecessary barriers to the efficient delivery of safe, innovative, and effective treatments to patients. They acknowledge that regulatory authorities are struggling to keep up with rapid advances in science and technology and advocate high-level cooperation to ensure progress is not delayed by bureaucratic stagnation that promotes the status quo. Change needs to be driven by a *top-down* strategy to drive harmonization forward, urgently (Zerhouni and Hamburg, 2016).

Decades-old regulations have not been updated to reflect rapid advances in science and technology. It is acknowledged that regulations requiring the use of animal tests are a major barrier to adoption and use of more predictive human-relevant test methods (Malloy, 2016). Without regulatory updates reflecting the acceptability of the most predictive test methods available, the scientific advancements of the past decade will not be utilized.

International guidelines for preclinical testing remain focused on the use of traditional animal tests and merely mention the availability of more predictive human-relevant test methods. The International Council for Harmonisation of Technical Requirements for Pharmaceuticals for Human Use (ICH), *Guidance on Nonclinical Safety Studies for the Conduct of Human Clinical Trials and Marketing Authorization for Pharmaceuticals*, states: "The development of a pharmaceutical is a stepwise process involving an evaluation of both animal and human efficacy and safety information" (ICH, 2009). While the ICH guideline states that consideration should be given to the 3Rs, specifically reduction of the use of animals, and suggests consideration of the use of *in vitro* methods that could possibly replace animals, it does not discuss specifics of acceptable non-animal methods. This focus on reduction of animal use addresses only the ethics of animal testing, not the safety of human patients. From a public health perspective, the focus must be shifted to the replacement of animal tests with human-relevant test methods to provide safer, more effective medicines.

One has only to look at the FDA regulations on investigational new drugs and devices to understand the regulatory barrier to acceptance and adoption of modern test methods. FDA claims that the regulations give them the flexibility to accept modern, non-animal test methods (NATMs), such as *in vitro* studies, or prior experience with the drug or biological product in humans (Dorsey, 2010); however, current FDA regulations explicitly require animal testing. This requirement discourages the use of NATMs, which may be more predictive of human response. Twenty-nine FDA regulations clearly require animal testing and promote the status quo, creating an unreceptive environment that fails to encourage innovation and development of more predictive test methods (Center for Responsible Science, 2015). Modification of regulatory language would promote use of existing modern test methods and encourage further development to advance modernization of preclinical testing. Regulations must be changed to state clearly that the test most predictive of human response should (or even must) be used. In 2015, a coalition of non-profits, technology developers, and patient advocacy groups petitioned the FDA to make modest, non-controversial regulation amendments that would be an important first step in advancing the use of NATMs (Center for Responsible Science, 2015). These minor amendments to outdated existing regulations would have great impact

on the use and development of better tools for drug and device development. For example, when a current regulation states, “...*extensive animal and clinical tests are required as a condition of approval*,” the petition proposes a change of wording to state, “...*extensive preclinical and clinical tests are required as a condition of approval*.” Adoption of these test-neutral, conservative regulatory amendments would be an important first-step in moving forward. The FDA has yet to provide a substantive response to the petition.

While the US is a world leader in biomedical research and technology development, it lagged behind the EU in developing a strategy and *roadmap* for the advancement and use of new technology, until very recently. In December 2017, the FDA’s *Predictive Toxicology Roadmap* was issued to advance predictive toxicology in regulatory risk assessments (FDA, 2017). In January 2018, after considering input from 16 federal agencies, the Interagency Coordinating Committee on the Validation of Alternative Methods (ICCVAM) issued its *Strategic Roadmap for Establishing New Approaches to Evaluate the Safety of Chemicals and Medical Products in the United States* (ICCVAM, 2018). Both *roadmaps* outline a way forward to successful implementation of new technology. Crucially, they have been issued by government agencies, which should ensure that real progress is achieved; indeed, many activities towards implementation are already underway. The European roadmap calls for many things, including a joint taskforce to gather all current data on a wide variety of compounds into a toxicity database; abolition of useless tests; and, crucially, reasonable investment (Basketter et al., 2012). However, without an effective *top-down* (i.e., government-led) implementation strategy, advances in science and technology will languish and the EU will lag behind.

Evidence shows that animal methods are often still used, both in the US and the EU, even when superior validated methods are available. This is likely due to existing regulations that explicitly require animal tests. Applicants worry that forgoing the inclusion of animal data in product submissions risks rejection by regulatory reviewers, which would be costly in time and expense for drug sponsors. For example, since 2005, the FDA has informally stated that Draize data are not required for primary skin and eye irritation testing; yet, drug sponsors continue to submit Draize data. A review of the 137 New Molecular Entities approved by the FDA between 2011–2014 showed that the Draize test was used in 94% of all skin irritation and 60% of all eye irritation tests, despite the availability of validated methods that are more predictive of human response (Archibald, Drake and Coleman, 2015).

Regulatory submission reviewers require continuing education to be up to date on available new technologies. Without reviewer education and uniform acceptance criteria, variability between reviewers’ acceptance of new

technologies will discourage their use and cause confusion for sponsors on their acceptability. It is essential that regulators become knowledgeable about available NATMs to facilitate early communication with sponsors on their acceptability.

10 Conclusions

There is a clear ethical imperative to replace unreliable animal-based safety tests, not just for the animals but to protect human safety. Remarkable knowledge and tools are emerging from projects, such as ToxCast; Tox21; Innovative Medicines Initiative; Safety Evaluation Ultimately Replacing Animal Testing (SEURAT); Integrated European “Flagship” Program Driving Mechanism-based Toxicity Testing and Risk Assessment for the 21st Century (EU-ToxRisk); and the Precision Medicines Initiative. These initiatives have the potential to revolutionize our ability to advance and protect human health, but only if they are implemented. A 2018 report by the UK BioIndustry Association and the Medicines Discovery Catapult emphasizes that *humanizing* the process of drug discovery and testing is the most important way to ease the *productivity crisis* in pharmaceutical research.

We must acknowledge that predicting the safety of medicines is an enormous challenge, and that a major obstacle to paradigm change is lack of confidence in the new methods. To tackle this, we suggest that a new, pragmatic approach to demonstrating that novel methods are more fit for purpose than existing methods could help to accelerate the replacement of most, if not all, animal toxicity tests with superior tests based on human biology. We believe that only through utilizing human-based systems to evaluate new medicines can we truly gain confidence in their clinical safety. In a 2014 debate on the proposal that “Animal experimentation in toxicology can be phased out in five-years’ time,” there was unanimous agreement that disruptive technologies must be properly funded and that more systematic, comparative data is needed (van der Meer, 2014).

In 2007, the US National Research Council called for a “paradigm shift from the use of experimental animals [...] toward the use of more efficient *in vitro* tests and computational techniques” in their landmark report, *Toxicity Testing in the 21st Century: A Vision and a Strategy*. The authors expected the paradigm shift to encounter resistance, as toxicological testing practices are “deeply ingrained.” They envisioned that “toxicity testing will be radically overhauled over the next 10 years, with the animal testing component virtually, if not actually, eliminated within the next 20 years” (National Research Council, 2007).

The science of toxicity testing has indeed been transformed over the past 10 years; but in the absence of any regulatory pressure, practical change has been occurring at a glacial pace, while revolution rather than evolution is required (Hartung, 2017). Deadlines create tremendous impetus for change, as can be seen with the EU Cosmetic and Registration, Evaluation, Authorisation and Restriction of CHemicals (REACH) regulations. If we are serious about reducing the ever-increasing burden of death and disability caused by ADRs, we must agree on a deadline for the adoption of more human-relevant methods, and the phasing out of methods whose predictive ability has not been proven. As with the replacement of horses by cars, there will need to be a brief period of *sharing the road*, while confidence in the new methods grows. The Netherlands now leads the world with its announcement that it intends to phase out all legally prescribed, animal-based safety testing by 2025 (Netherlands National Committee for the protection of animals used for scientific purposes, NCad, 2016). The Committee recognizes that the transition will not happen of its own accord and will require clear strategic direction to change attitudes and practices.

Crucially, the regulations that govern how drugs are tested must be updated to encourage the adoption of the best new approaches. Current regulations are stifling innovation by failing to keep pace with scientific progress. We argue that several aspects of current practice can no longer be justified:

1. The continued use of testing methods that have never been validated, while novel methods must demonstrate a level of performance that current methods not only have never been asked to perform but are clearly unable to perform.
2. Resistance to the adoption of non-animal methods that, although not formally validated, show greater predictive performance than animal tests.
3. The continued *blind eye* turned to the use of animal-based tests, where viable non-animal methods exist, on the pretext that they may be required by regulators at home or abroad.
4. The exposure of human patients and volunteers to potentially unsafe substances on the basis of demonstrably unreliable animal data.
5. The risk of the loss of potentially life-saving/modifying treatments on the basis of demonstrably unreliable animal data.

In March 2016, Safer Medicines Trust commissioned a survey of 2,500 UK healthcare professionals. 79% agreed that pharmaceutical companies should be legally obliged to test new medicines using methods demonstrated to be the most predictive of safety for humans (Dods Information, 2016). Governments must act to protect the public by updating regulations, whose *raison d'être* is patient safety, that now prevent their own aim from being realized.

References

- Abadie, R. (2010). *The professional guinea pig: Big pharma and the risky world of human subjects*. Durham, NC: Duke University Press.
- AllTrials (2016). *A Roadmap to Clinical Trial Transparency*. [online] Available at: <http://www.alltrials.net/news/roadmap/> [Accessed 13 October 2016].
- Archibald, K., T. Drake and R. Coleman (2015). Barriers to the Uptake of Human-based Test Methods, and How to Overcome Them. *Alternatives to Laboratory Animals*, 43, pp. 301–308.
- Arrowsmith, J. (2012). A Decade of Change. *Nature Reviews Drug Discovery*, 11, pp. 17–18, Figure 2: Probability of success to market from key milestones.
- Bagot, M. (2015). Trial and Error: Thousands Left Seriously ill or Disabled by Clinical Tests of New Drugs. *The Mirror* [online] Available at: <http://www.mirror.co.uk/news/uk-news/trial-error-thousands-left-seriously-5867052> [Accessed 13 October 2016].
- Bailey, J., M. Thew and M. Balls (2013). An Analysis of the Use of Dogs in Predicting Human Toxicology and Drug Safety. *Alternatives to Laboratory Animals*, 41(5), pp. 335–350.
- Bailey, J., M. Thew and M. Balls (2014). An Analysis of the Use of Animal Models in Predicting Human Toxicology and Drug Safety. *Alternatives to Laboratory Animals*, 42(3), pp. 181–199.
- Bailey, J., M. Thew and M. Balls (2015). Predicting Human Drug Toxicity and Safety Via Animal Tests: Can Any One Species Predict Drug Toxicity in Any Other, and Do Monkeys Help?. *Alternatives to Laboratory Animals*, 43 (6), pp. 393–403.
- Baker, M. (2011). Tissue Models: A Living System on a Chip. *Nature*, 471, pp. 661–665.
- Balijepalli, A. and V. Sivaramakrishnan (2017). Organs on Chips: Research and Commercial Perspectives. *Drug Discovery Today*, 22(2), pp. 397–403.
- Basketter, D.A., H. Clewell, I. Kimber, A. Rossi, B.J. Blaauboer, R. Burrier, M. Daneshian, C. Eskes, A. Goldberg and N. Hasiwa (2012). t4 Report: A roadmap for the Development of Alternative (Non-animal) Methods for Systemic Toxicity Testing. *Alternatives to Animal Experimentation*, 29(1), pp. 3–91.
- BioIndustry Association and Medicines Discovery Catapult (2018). *State of the Discovery Nation 2018 and the Role of the Medicines Discovery Catapult* [online] Available at: <https://md.catapult.org.uk/report-state-of-the-discovery-nation-2018/> [Accessed 15 February 2018].
- Biopta (2017). *How We Help*. [online] Available at: <http://www.biopta.com/How%20zowe%20help.cfm> [Accessed 17 May 2017].
- Bisserbe, N. (2016). Drug's Toxicity Caused Clinical-trial Death, Panel Says. *The Wall Street Journal*. [online] Available at: <http://www.wsj.com/articles/drugs-toxicity-caused-clinical-trial-death-panel-says-1461092409> [Accessed 13 October 2016].

- Bracken, M.B. (2009). Why Animal Studies Are often Poor Predictors of Human Reactions to Exposure. *Journal of the Royal Society of Medicine*, 102(3), pp. 120–122.
- Bruckner, T. and B. Ellis (2017). *Clinical trial transparency: A key to better and safer medicines*. Bristol, UK [online] Available at: <https://www.scribd.com/document/347308262/Clinical-Trial-Transparency-A-Key-to-Better-and-Safer-Medicines-Till-Bruckner-and-Beth-Ellis-2017> [Accessed 22 May 2017].
- Capdeville, R., E. Buchdunger, J. Zimmermann and A. Matter (2002). Glivec (STI571, imatinib), A Rationally Developed, Targeted Anticancer Drug. *Nature Reviews Drug Discovery*, 1, pp. 493–502.
- Carthew, P., E.A. Martin, I.N. White, F. De Matteis, R.E. Edwards, B.M. Dorman, R.T. Heydon and L.L. Smith (1995). Tamoxifen Induces Short-term Cumulative DNA Damage and Liver Tumors in Rats: Promotion by Phenobarbital. *Cancer Research*, 55(3), pp. 544–547.
- Center for Responsible Science (2015). *Citizen Petition to Food and Drug Administration, requesting that the FDA modify existing regulations in Title 21 of the Code of Federal Regulations (CFR) that govern requirements for investigational new drug (IND) applications, investigational device exemptions (IDE), and new drug applications (NDAs)*. [online] Docket ID: FDA-2015-P-2820. Available at: <https://www.regulations.gov/docket?D=FDA-2015-P-2820> [Accessed 13 October 2016].
- Chavalarias, D. and J. Ioannidis (2010). Science Mapping Analysis Characterizes 235 Biases in Biomedical Research. *Journal of Cardiovascular Electrophysiology*, 63(11), pp. 1205–1215.
- Clemence, M. and J. Leaman. (2016). *Public Attitudes to Animal Research in 2016*. A report by Ipsos MORI for the Department for Business, Energy & Industrial Strategy, Ipsos MORI Social Research Institute. [online] Available at: <https://www.ipsos.com/sites/default/files/publication/1970-01/sri-public-attitudes-to-animal-research-2016.pdf> [Accessed 18 May 2017].
- Collaborative Approach to Meta-Analysis and Review of Animal Data from Experiment (CAMARADES) (2017). *About CAMARADES*. [online] Available at: <http://www.dcn.ed.ac.uk/camarades/default.htm> [Accessed 24 May 2017].
- Cortinovis, C. and F. Caloni (2016). Household Food Items Toxic to Dogs and Cats. *Frontiers in Veterinary Science*, 22(3), p. 26.
- De Lorgeril, M. and M. Rabaeus (2015). Beyond Confusion and Controversy. Can We Evaluate the Real Efficacy and Safety of Cholesterol-lowering with Statins? *Journal of Controversies in Biomedical Research*, 1(1), pp. 67–92.
- Dods Information (2016). *Health Care Workforce Perceptions of Pharmaceutical Testing Regulations, A Study Conducted on Behalf of Safer Medicines Trust*. Dods Parliamentary Communications, Ltd. [online] Available at: <http://www.safermedicines.org/pdfs/dods-health-care-springs-survey.pdf> [Accessed 13 October 2016].

- Dorsey, D. (2010). *Food and Drug Administration Office of the Commissioner Response Letter to Meyer Glitzenstein and Crystal Physicians Committee for Responsible Medicine PCRM*. Petition Denial, 3–4. [online] Available at: <https://www.regulations.gov/document?D=FDA-2007-P-0109-0012> [Accessed 10 October 2018].
- Downing, N.S., N.D. Shah, J.A. Aminawung, A.M. Pease, J.D. Zeitoun, H.M. Krumholz and J.S. Ross (2017). Post market Safety Events Among Novel Therapeutics Approved by the US Food and Drug Administration Between 2001 and 2010. *Journal of the American Medical Association*, 317(18), pp. 1854–1863.
- Endo, A., M. Kuroda and Y. Tsujita, (1976). ML-236A, ML-236B, and ML-236C, New inhibitors of cholesterol synthesis produced by *Penicillium citrinum*. *The Journal of Antibiotics*, 29(12), pp. 1346–1348. [online] Available at: https://www.jstage.jst.go.jp/article/antibiotics1968/29/12/29_12_1346/_article [Accessed 10 October 2018].
- Endo, A. (2010). A historical perspective on the discovery of statins. *Proceedings of the Japan Academy, Series B, Physical and Biological Sciences*, 86(5), pp. 484–493. [online] Available at: <https://www.ncbi.nlm.nih.gov/pmc/articles/PMC3108295/> [Accessed 10 October 2018].
- European Commission (2008). *Strengthening Pharmacovigilance to Reduce Adverse Effects of Medicines*. [online] Available at: http://europa.eu/rapid/press-release_MEMO-08-782_en.htm?locale=en [Accessed 13 October 2016].
- European Parliament (2010). Directive 2010/63/EU of the European Parliament and of the Council of 22 September 2010 on the protection of animals used for scientific purposes. *Official Journal of the European Communities*, L276, p. 33–79. [online] Available at: <http://eur-lex.europa.eu/legal-content/EN/TXT/?uri=CELEX%3A32010L0063> [Accessed 13 October 2016].
- Evans, I., H. Thornton and I. Chalmers (2006). *Testing treatments*. London, UK: The British Library.
- Fourches, D., J.C. Barnes, N.C. Day, P. Bradley, J.Z. Reed and A. Tropsha (2010). Cheminformatics Analysis of Assertions Mined from Literature That Describe Drug-induced Liver Injury in Different Species. *Chemical Research in Toxicology*, 23(1), pp. 171–183.
- Frank, J. (2004). Technological Lock-in, Positive Institutional Feedback, and Research on Laboratory Animals. *Structural Change Economic Dynamics*, 16, pp. 557–575.
- Garner, J.P., B.N. Gaskill, E.M. Weber, J. Ahloy-Dallaire and K.R. Pritchett-Corning, (2017). Introducing Therioepistemology: The Study of How Knowledge Is Gained from Animal Research. *Nature Lab Animal*, 20, pp. 103–113. [online] Available at: <https://www.nature.com/articles/labani.1224> [Accessed 13 August 2018].
- Geerts, H. (2009). Of Mice and Men: Bridging the Translational Disconnect in CNS Drug Discovery. *CNS Drugs*, 23, pp. 915–926.
- Godlee, F. (2014). How Predictive and Productive Is Animal Research?. *British Medical Journal*, 348: g3719.
- Goldacre, B. (2012). *Bad pharma*. London, UK: Fourth Estate, Harper Collins.

- Gray, G.M., P. Li, I. Shlyakhter and R. Wilson, (1995). An Empirical Examination of Factors Influencing Prediction of Carcinogenic Hazard Across Species. *Regulatory Toxicology and Pharmacology*, 22(3), pp. 283–291.
- Green, S. (2015). Can Animal Data Translate to Innovations Necessary for a New Era of Patient-centred and Individualised Healthcare? Bias in Preclinical Animal Research. *BMC Medical Ethics*, 16(1), p. 53.
- Hackam, D. and D. Redelmeier (2006). Translation of Research Evidence from Animals to Humans, *Journal of the American Medical Association*, 296, pp. 1731–1732.
- Hampton, J. (2015). Therapeutic Fashion and Publication Bias: The Case of Antiarrhythmic Drugs in Heart Attack. *Journal of the Royal Society of Medicine*, 108(10), pp. 418–420.
- Hare, R. (1982). New Light on the History of Penicillin. *Medical History*, 26, pp. 1–24.
- Harris, R. (2017). *Rigor mortis. How sloppy science creates worthless cures, crushes hope, and wastes billions*. New York: Basic.
- Hartung, T. (2007). Food for thought...on validation. *Alternatives to Animal Experimentation*, 24, pp. 67–80.
- Hartung, T. (2009a). Per Aspirin ad Astra... *Alternatives to Laboratory Animals*, 37(2), pp. 45–47.
- Hartung, T. (2009b). Toxicology for the Twenty-first Century. *Nature*, 460, pp. 208–212.
- Hartung, T. (2010). Evidence-based Toxicology – The Toolbox of Validation for the 21st Century?. *Alternatives to Laboratory Animals*, 27, pp. 253–263.
- Hartung, T. (2013). Look Back in Anger – What Clinical Studies Tell Us About Preclinical Work. *Alternatives to Laboratory Animals*, 30(3), pp. 275–291.
- Hartung, T. (2017). Evolution of Toxicological Science: The Need for Change. *Journal of Risk Assessment and Management*, 20(1–3), pp. 21–45.
- Herper, M. (2012). The Truly Staggering Cost of Inventing New Drugs. *Forbes Magazine*. [online] Available at: <https://www.forbes.com/forbes/2012/0312/strategies-pharmaceuticals-lilly-stagger-cost-inventing-new-drugs.html> [Accessed 23 May 2017].
- Heywood, R. (1990). Clinical toxicity – Could it have been predicted? Post-marketing experience. In: C. Lumley and S. Walker, eds., *Animal Toxicity Studies: Their Relevance for Man*. Lancaster: Quay, pp. 57–67.
- Huang, R., M. Xia, S. Sakamuru, J. Zhao, S.A. Shahane, M. Attene-Ramos, T. Zhao, C.P. Austin and A. Simeonov (2016). Modelling the Tox21 10 K Chemical Profiles for *In Vivo* Toxicity Prediction and Mechanism Characterization, *Nature Communications*, 7, pp. 10425.
- Hutchinson, L. and R. Kirk (2011). High Drug Attrition Rates—Where Are We Going Wrong?. *Nature Reviews Clinical Oncology*, 8, pp. 189–190.
- Igarashi, T. (1994). The duration of toxicity studies required to support repeated dosing in clinical investigation—A toxicologist's opinion. In: C. Parkinson, C. Lumley and

- S. Walker, eds., *CMR Workshop: The Timing of Toxicological Studies to Support Clinical Trials*. Boston: Kluwer, pp. 67–74.
- International Council for Harmonisation of Technical Requirements for Pharmaceuticals for Human Use (ICH) (2009). *Guidance on Nonclinical Safety Studies for the Conduct of Human Clinical Trials and Marketing Authorization for Pharmaceuticals*. [online] Available at: https://www.ich.org/fileadmin/Public_Web_Site/ICH_Products/Guidelines/Multidisciplinary/M3_R2/Step4/M3_R2__Guideline.pdf [Accessed 10 October 2018].
- Interagency Coordinating Committee on the Validation of Alternative Methods (ICCVAM) (2018). *Strategic Roadmap for Establishing New Approaches to Evaluate the Safety of Chemicals and Medical Products in the United States*. [online] Available at: https://ntp.niehs.nih.gov/iccvam/docs/roadmap/iccvam_strategicroadmap_january2018_document_508.pdf [Accessed 11 February 2018].
- Ioannidis, J.P.A. (2012). Extrapolating from Animals to Humans. *Science Translational Medicine*, 4, pp. 1–3.
- Johnson, P.A., T. Fitzgerald, A. Salganicoff, S.F. Wood, J.M. Goldstein and Y.L. Colson (2014). *Sex-specific Medical Research – Why Women’s Health Can’t Wait*. [online] A Report of the Mary Horrigan Connors Center for Women’s Health & Gender Biology at Brigham and Women’s Hospital. [online] Available at: <https://www.brighamand-womens.org/assets/BWH/womens-health/pdfs/ConnorsReportFINAL.pdf> [Accessed 10 October 2018].
- Jones, J. and L. Saad (2017). *Gallup Poll Social Series: Values and Beliefs*. Gallup News Service. [online] Available at: http://www.gallup.com/poll/210542/americans-hold-record-liberal-views-moral-issues.aspx?g_source=2017+poll+animals&g_medium=search&g_campaign=tiles [Accessed 29 August 2017].
- Judson, R. R. Judson, R. Kavlock, M. Martin, D. Reif, K. Houck, T. Knudsen, A. Richard, R.R. Tice, M. Whelan, M. Xia and R. Huang (2013). Perspectives on Validation of High-throughput Assays Supporting 21st Century Toxicity Testing. *Alternatives to Laboratory Animals*, 30(1), pp. 51–56.
- Kenna, J.G. (2017). Human Biology-based Drug Safety Evaluation: Scientific Rationale, Current Status and Future Challenges. *Expert Opinion on Drug Metabolism & Toxicology*, 13(5), pp. 567–574.
- Knight, A., J. Bailey and J. Balcombe (2006). Animal Carcinogenicity Studies: 1. Poor Human Predictivity. *Alternatives to Laboratory Animals*, 34, pp. 19–27.
- Krul, C. (2014). *SLiM Project Final Symposium Report*. [online] Available at: <http://www.innovativetesting.nl/slim-project-final-symposium-report> [Accessed 24 May 2017].
- Langley, G. (2014). Considering a New Paradigm for Alzheimer’s Disease Research. *Drug Discovery Today*, 19(8), pp. 1114–1124.
- Lasser, K.E., P.D. Allen, S.J. Woolhandler, D.U. Himmelstein, S.M. Wolfe and D.H. Bor (2002). Timing of New Black Box Warnings and Withdrawals for Prescription Medications. *Journal of the American Medical Association*, 287(17), pp. 2215–2220.

- Leist, M., N. Hasiwa, M. Daneshian and T. Hartung (2012). Validation and Quality Control Of Replacement Alternatives – Current Status and Future Challenges. *Toxicology Research*, 1, pp. 8–22.
- Leppard, D. (30 July 2006). Elephant Man Drug Victims Told to Expect Early Death. *The Sunday Times*. [online] Available at: <https://www.thetimes.co.uk/article/elephant-man-drug-victims-told-to-expect-early-death-cm5287v9bxn> [Accessed 23 May 2017].
- Light, D. (2015). Serious Risks and Few New Benefits from FDA-approved Drugs, *Health Affairs*. [online] Available at: <http://healthaffairs.org/blog/2015/07/06/serious-risks-and-few-new-benefits-from-fda-approved-drugs/> [Accessed 13 October 2016].
- Lowe, D. (2017). *Guess How This Latest Alzheimer's Trial Came Out*. In the Pipeline. [online] Available at: <http://blogs.sciencemag.org/pipeline/archives/2017/02/15/guess-how-this-latest-alzheimers-trial-came-out> [Accessed 24 May 2017].
- Malloy, T. (2016). Implementing the Vision for Toxicity Testing in the 21st Century: If You Build It, Will They Come?. *Scientific Advisory Committee on Alternative Toxicological Methods*. Available at: http://ntp.niehs.nih.gov/ntp/about_ntp/sacatm/2016/september/presentations/malloy_visionfortoxtest_508.pdf [Accessed 13 October 2016].
- Matthews, R. (2008). Medical Progress Depends on Animal Models—Doesn't It? *Journal of the Royal Society of Medicine*, 101, pp. 95–98.
- Nair, A. (2015). Clinical Research: Regulatory Uncertainty Hits Drug Trials in India. *The Pharmaceutical Journal*. [online] Available at: <http://www.pharmaceutical-journal.com/news-and-analysis/features/clinical-research-regulatory-uncertainty-hits-drug-trials-in-india/20068063.article> [Accessed 13 October 2016].
- National Center for Advancing Translational Sciences (2016). *Toxicology in the 21st Century (Tox21)* [online] Available at: <https://ncats.nih.gov/tox21> [Accessed 24 May 2017].
- National Institutes of Health (NIH) (2008). *NIH Collaborates with EPA to Improve the Safety Testing of Chemicals – New Strategy Aims to Reduce Reliance on Animal Testing*. [online] Available at: <https://www.nih.gov/news-events/news-releases/nih-collaborates-epa-improve-safety-testing-chemicals> [Accessed 23 May 2017].
- National Research Council (2007). *Toxicity Testing in the 21st Century: A Vision and a Strategy*. The National Academies Press [online] Available at: <http://www.thecrc.org/forum8/wp-content/uploads/2016/05/EPI-Toxicity-Testing-in-21st-Century.pdf> [Accessed 23 May 2017].
- National Toxicology Project Scientific Advisory Committee on Alternative Toxicological Methods (2016). *A Strategy for Implementing the Vision for Toxicity Testing in the 21st Century*. [online] Available from: http://ntp.niehs.nih.gov/ntp/about_ntp/sacatm/2016/september/vision20160927_508.pdf [Accessed 13 October 2016].
- Netherlands National Committee for the protection of animals used for scientific purposes (NCad) (2016). *Transition to Non-animal Research – About the Possibilities*

- for Phasing Out Animal Procedures and Stimulating Innovation without Laboratory Animals*. [online] Available at: <https://www.ncadierproevenbeleid.nl/documenten/rapport/2016/12/15/ncad-opinion-transition-to-non-animal-research> [Accessed 17 May 2017].
- Parke, D. (1994). Clinical Pharmacokinetics in Drug Safety Evaluation. *Alternatives to Laboratory Animals*, 22, pp. 207–209.
- Perel, P., I. Roberts, E. Sena, P. Wheble, C. Briscoe, P. Sandercock, M. Macleod, L.E. Mignini, P. Jayaram and K.S. Khan (2007). Comparison of Treatment Effects Between Animal Experiments and Clinical Trials: Systematic Review. *British Medical Journal*, 334(7586), p. 197.
- Perlman, R. (2016). Mouse Models of Human Disease: An Evolutionary Perspective. *Evolution, Medicine, and Public Health*, 1, pp. 170–176.
- Pew Research Center (2015). *Public and Scientists' Views on Science and Society: Use of Animals in Scientific Research*. [online] Available at: http://www.pewinternet.org/2015/01/29/public-and-scientists-views-on-science-and-society/pi_2015-01-29_science-and-society-03-05/ [Accessed 13 October 2016].
- Pound, P., S. Ebrahim, P. Sandercock, M.B. Bracken and I. Roberts (2004). Where Is the Evidence That Animal Research Benefits Humans?. *British Medical Journal*, 328, pp. 514–517.
- Pound, P. and M. Bracken (2014). Is Animal Research Sufficiently Evidence Based to Be a Cornerstone of Biomedical Research?. *British Medical Journal*, 348:g3387.
- Rawson, N. (2013). New Drug Approval Times and Safety Warnings in the United States and Canada, 1992–2011. *Journal of Population Therapeutics and Clinical Pharmacology*. 20(2):e67–e81.
- Salsburg, D. (1983). The Lifetime Feeding Study in Mice and Rats – An Examination of Its Validity as a Bioassay for Human Carcinogens. *Fundamental and Applied Toxicology*. 3, pp. 63–67.
- Scott, D. (2016). Califf's Big Idea: Build a Database for Research Done Before Clinical Trials, *STAT News*. [online] Available at: <https://www.statnews.com/2016/06/10/califf-database-preclinical-trials/> [Accessed 13 October 2016].
- Seok, J., H.S. Warren, A.G. Cuenca, M.N. Mindrinos, H.V. Baker, W. Xu, D.R. Richards, G.P. McDonald-Smith, H. Gao, L. Hennessy and C.C. Finnerty (2013). Inflammation and Host Response to Injury, Large Scale Collaborative Research Program. Genomic Responses in Mouse Models Poorly Mimic Human Inflammatory Diseases. *Proceedings of the National Academy of Science USA*. 110, pp. 3507–3512.
- Sharav, V. (2016). *A Recent Deadly Drug Experiment – BIA 10-2474 – Rennes, France*. [Blog] Alliance for Human Research Protection. [online] Available at: <http://ahrp.org/a-deadly-drug-experiment-bia-10-2474-rennes-france/> [Accessed 13 October 2016].

- Sheets, R., T. Zhou and I. Knezevic (2016). Review of Efficacy Trials of HIV-1/AIDS Vaccines and Regulatory Lessons Learned: A Review from a Regulatory Perspective. *Biologicals*, 44(2), pp. 73–89.
- Spriet-Pourra, C. and M. Auriche (1994). *Drug withdrawal from sale*. New York: PJP Publications.
- St Clair, E.W. (2008). The Calm After the Cytokine Storm: Lessons from the TGN1412 Trial. *Journal of Clinical Investigation*, 118(4), pp. 1344–1347.
- Stebbing, R., L. Findlay, C. Edwards, D. Eastwood, C. Bird, D. North, Y. Mistry, P. Dilger, E. Liefvooghe, I. Cludts and B. Fox (2007). “Cytokine Storm” in the Phase I Trial of Monoclonal Antibody TGN1412: Better Understanding the Causes to Improve Preclinical Testing of Immunotherapeutics. *The Journal of Immunology*, 179(5), pp. 3325–3331.
- Sutherland, B.A., J. Minnerup, J.S. Balami, F. Arba, A.M. Buchan and C. Kleinschnitz (2012). Neuroprotection for Ischaemic Stroke: Translation from the Bench to the Bedside. *International Journal of Stroke*, 7, pp. 407–418.
- Temporary Specialist Scientific Committee (TSSC) (2016). *Minutes of the TSSC meeting on “FAAH (Fatty Acid Amide Hydrolase) inhibitors”*, 15 February 2016. [online] Available at: http://ansm.sante.fr/content/download/86439/1089765/version/1/file/CR_CSST-FAAH_15-02-2016_Version-Anglaise.pdf [Accessed 22 May 2017].
- Theil, C., H. Cordes, L. Fabbri, H.E. Aschmann, V. Baier, I. Smit, F. Atkinson, L.M. Blank and L. Kuepfer (2017). A Comparative Analysis of Drug-induced Hepatotoxicity in Clinically Relevant Situations. *PLoS Computational Biology*, 13(2), p. e1005280. [online] Available at: <https://journals.plos.org/ploscompbiol/article?id=10.1371/journal.pcbi.1005280> [Accessed 10 October 2018].
- Thompson, L. (1994). The Cure That Killed. *Discover Magazine*, 15(3): pp. 56–62.
- UK Department of Health (2012). *Response to Safer Medicines Campaign*. [online] Available at: <http://transparency.dh.gov.uk/2012/03/30/response-to-safer-medicines-campaign/> [Accessed 13 October 2016].
- US Department of Health and Human Services, National Toxicology Program. *Alternative Methods Accepted by US Agencies* [online] Available at: <https://ntp.niehs.nih.gov/pubhealth/evalatm/accept-methods/index.html> [Accessed 10 October 2018].
- US Food and Drug Administration (FDA) (2017). *FDA’s Predictive Toxicology Roadmap*. [online] Available at: <https://www.fda.gov/downloads/ScienceResearch/SpecialTopics/RegulatoryScience/UCM587831.pdf> [Accessed 11 February 2018].
- US Senate Committee on Appropriations (2016). *Hearing on FY2017 NIH Budget*. Testimony of Collins, Francis S., M.D., Ph.D., Director, National Institutes of Health. [online] Available at: <http://www.appropriations.senate.gov/hearings/hearing-on-fy2017-national-institutes-of-health-budget-request> [Accessed 13 October 2016].

- van der Meer, A. (2014). *Can We Get Rid of Animal Experimentation in Toxicology within Five Years?* [blog] Available at: <http://www.andriesvandermeer.com/2014/06/can-we-get-rid-of-animal.html> [Accessed 13 October 2016].
- van Esbroeck, A., A.P.A. Janssen, III Cognetta, D. Ogasawara., G. Shpak., M. van der Kroeg., V. Kantae., M.P. Baggelaar., F.M.S de Vrij., H. Deng., M. Allara., F. Fezza., Z. Lin., T. van der Wel., M. Soethoudt., E.D. Mock., H. den Dulk., I.L. Baak., B.I. Florea., G. Hendriks., L. De Petrocellis., H.S. Overkleeft., T. Hankemeier., C.I. De Zeeuw., V. Di Marzo., M. Maccarrone., B.F. Cravatt., S.A. Kushner. (2017). Activity-Based Protein Profiling Reveals Off-target Proteins of the FAAH Inhibitor BIA 10-2474. *Science*, 356, (6342), pp. 1084–1087.
- van Meer, P.J., M. Kooijman, C.C. Gispen-de Wied, E.H. Moors and H. Schellekens (2012). The Ability of Animal Studies to Detect Serious Post Marketing Adverse Events Is Limited. *Regulatory Toxicology and Pharmacology*, 64(3), pp. 345–349.
- Wall, R. and M. Shani (2008). Are Animal Models as GOOD as We Think?. *Theriogenology*, 69(1), pp. 2–9.
- Wang, B. and G. Gray (2015). Concordance of Noncarcinogenic Endpoints in Rodent Chemical Bioassays. *Risk Analysis*, 35, pp. 1154–1166.
- Xu, J., P. Henstock, M. Dunn, A. Smith, J. Chabot and D. de Graaf (2008). Cellular Imaging Predictions of Clinical Drug-induced Liver Injury. *Toxicological Sciences*, 105, (1), pp. 97–105. [online] Available at: <https://academic.oup.com/toxsci/article/105/1/97/1662976> [Accessed 10 February 2018].
- Zerhouni, E. and M. Hamburg (2016). The Need for Global Regulatory Harmonization: A Public Health Imperative. *Science Translational Medicine*, 8(338), p. 338ed6. [online] Available at: <http://stm.sciencemag.org/content/8/338/338ed6.short> [Accessed 10 February 2018].

Genetic Modification of Animals: Scientific and Ethical Issues

Jarrod Bailey

Senior Research Scientist, Cruelty Free International, United Kingdom
jarrod.bailey@crueltyfreeinternational.org

1 Introduction

The scientific method demands a willingness to correct and integrate previous knowledge, based on observable, empirical, measurable evidence and subject to laws of reasoning; yet, it has scarcely been applied to non-human animal (hereinafter referred to as animal) research. Nevertheless, animal use in science started declining in the mid 1970s, at least in the United Kingdom, resulting in a drop in the number of animals used approaching 50% between the mid-1970s and mid 1980s (UK Home Office, 2016)—perhaps a tacit admission of problematic species differences that render animals poor models for humans. This trend was, however, reversed with the advent of genetically modified (GM) animals, animals whose genetic material has been deliberately altered in some way by insertion, deletion, or substitution of DNA. While the decline in use of non-GM animals continued steeply well into the new millennium, overall numbers have been rising for some time, solely due to increased utilization of GM animals (Ormandy, Schuppli and Weary, 2009). UK statistics for 2015 show that more than two million procedures involved the creation and breeding of GM animals, who were not subsequently used in further research (around 50% of the total); and there were 720,000 procedures on GM animals in further experiments, representing 35% of the total animals used in actual experiments (Hendriksen and Spielmann, 2014; UK Home Office, 2016). Trends in GM animal use for the rest of the world are difficult to determine due to different reporting requirements, but they are likely to be similar, with up to 50% of the approximately 13 million animals used annually in research in the European Union (EU) (Taylor and Rego, 2016), and the estimated 115 million animals used globally (Taylor et al., 2008).

This chapter aims to summarize and analyze this shift in the use of animals in experiments and, without being overly technical, to ask critically why GM

animals have been so embraced in research. Is this justified? Have they fixed problems with species differences and made animal research more human relevant? Are there still issues with species differences, and to what extent? Does the new Clustered Regularly Interspaced Short Palindromic Repeats (CRISPR) technique help? Can GM animals ever provide data sufficiently applicable to humans? If so, what are the ethical costs? How much pain, suffering, and death is involved?

2 What GM Animals Are, How They Are Made, and Problems of Efficiency and Specificity

The genome—an organism's complement of genetic material comprising its entire collection of genes and associated elements—comprises long molecules of DNA, present in almost all cells. There are many genes along its length, each with a defined function(s), and serving as a template(s) for the manufacture of the proteins and enzymes that are the structural and chemical basis of life. The genes themselves are made up of subunits, called nucleotides, the exact sequence of which determines each gene's function. The human genome contains an estimated 20,000 genes and more than three billion nucleotides. Between the genes are other regions of DNA that serve, in various ways, to control the expression of those genes, i.e. when the genes are *on* or *off*, or to what degree the proteins they produce are synthesized.

Because our genes are fundamental to many normal biological processes, they are also at the root of perturbations of these processes that can cause things to go wrong, resulting in illness and diseases. Genetic studies have, therefore, been pivotal to much biomedical research, attempting to understand the basis of diseases and what can be done to prevent, treat, and cure them. Because animal approaches increasingly appear to be of poor human relevance, due to the very genetic differences that make species dissimilar and unique, some scientists have modified genes in animals used in experiments to attempt to overcome these differences and make them more relevant to human biology.

Broadly speaking, genes may be inserted or *knocked in* to animals, their own genes may be deleted or otherwise rendered non-functional or *knocked out*, or existing genes may be modified or repaired to alter their function. Creating GM animals has undoubtedly become more efficient and specific since their emergence, with the first reports of GM mice in 1974 (Jaenisch and Mintz, 1974). Much of what is involved is technical in nature, so it will

not be discussed in detail here; suffice to say that various methods are available to introduce the DNA of interest—the DNA, synthesized in the laboratory, which will induce the desired genetic modification—into the zygotes (fertilized eggs) or embryos of the animals to be modified. Briefly, it may be injected into fertilized eggs (pronuclear microinjection) or into embryonic stem cells (ESCs or ES cells)—cells in a developing embryo with the capacity to become one of many different, specialized types of cell—that are removed from an embryo for manipulation and, subsequently, re-injected into developing embryos. These are subsequently surgically implanted into surrogate mothers, in which the embryos will develop, as intended, to term and result in live births of GM offspring. There are many welfare issues throughout this process, which are described later in this chapter. Initially, the technology was crude, with the cutting and splicing of DNA and insertion of new genes being fairly random and with concomitant high wastage of animal lives due to its lack of precision and efficiency. While gene editing in ESCs improved the process, it should be noted that, “while it is commonly and frequently claimed that genome editing has become significantly (perhaps radically) quicker, cheaper, more efficient, easier to use, and therefore more accessible, care is needed when interpreting these claims” (Nuffield Council on Bioethics, 2016, Section 2.6); “progress has often been technically challenging [...] ES cells have not been obtained for most species and, even in mice, where the technology is relatively refined, it is time-consuming, expensive, variable, often highly inefficient, and requires a special skill set” (Section 1.11 Skarnes, 2015).

One important welfare issue for GM animals, aside from the obvious outcome of their genetic modification, is the poor efficiency (on-target efficiency), and associated undesired (off-target) effects, of the process. On-target efficiency has increased and off-target effects have decreased significantly with the relatively recent discovery of new methods (Hsu, Lander and Zhang, 2014), especially the RNA-guided *programmable nuclease* gene-editing platform, CRISPR (CRISPR/Cas9 system) (see e.g., Chandrasekaran, Song and Ramakrishna, 2017). CRISPR has generated particularly significant excitement, having “swept through labs around the world”, at a “breakneck pace [that] leaves little time for addressing the ethical and safety concerns such experiments can raise.” (Ledford, 2015, pp. 20–21). This is because, in relation to other methods, it is less expensive (Ledford, 2015; various components of CRISPR experiments can be bought for as little as US\$30), less technically challenging, and less time consuming (Caplan et al., 2015). It, therefore, deserves particular attention. CRISPR derives from a bacterial immune system (Fineran and Charpentier, 2012), and has two components: a single guide RNA molecule (sgRNA), which

is specifically designed to seek and bind to precise targets in the genome that are to be modified; and an associated enzyme, Cas9, which cuts the DNA at the target site and initiates the genetic modification process. Put simply, CRISPR causes complete (double-stranded) breaks in the DNA at (in theory) specific targeted sites, which are subsequently repaired by the cell's own DNA-repair systems.

However, the repair process is inherently error prone and generates small insertions or deletions of DNA at the break sites, which can be used to disrupt gene function or, in the presence of engineered DNA molecules introduced experimentally, to alter the DNA specifically at that site. While this method is generally considered to be much more efficient and specific compared to other approaches, any accurate, definitive, quantitative estimation of the efficiency of CRISPR is difficult to find, as estimates vary considerably and are affected by many factors, including the nature of the target site and the CRISPR molecule used. Generally, the method has improved over time, but there is a strong argument that CRISPR remains far from good enough, scientifically and ethically. One 2017 review reported that "knock-in efficiencies are still low and highly variable," with different genetic loci in zebrafish embryos having genes successfully knocked in, in 45% and 70% of cases, though only in 1.7% and 3.5% respectively, with any real precision. Associated successful germline modifications to produce founder fish for breeding occurred on average just 3.8% of the time (Albadri, Del Bene and Revenu, 2017, p. 8). Another recent study found an average of 9.2% of transferred embryos resulted in mouse pups, and an average of 76% of these had been successfully knocked out for a specific gene. The generation of pups harboring specific point mutations was lower: 6.5% of transferred embryos produced pups, though less than 8% of these had the desired mutation (Nakagawa et al., 2016). In cell lines, mutation efficiencies are generally higher, though they range from lower than 5% up to 90%, and gene knock in less than 10% up to 66% (see Bortesi et al., 2016).

Regardless of on-target efficiency, one issue has plagued the creation of GM animals: off-target effects, or mutations induced by the GM process that are not intended but affect other non-specific sites in the genome (Fu et al., 2013; Hsu et al., 2013; Pattanayak et al., 2013). This is a significant scientific and welfare issue, which raises serious concerns over the wider application of genetic modification in science, medicine, and agriculture (Kanchiswamy et al., 2016; Kleinstiver et al., 2016). These concerns include: the low birth rates of animals with the desired genetic modification and the associated high "wastage", or animals that may suffer and/or be killed as a result; and many animals who harbor off-target mutations adversely affecting the animal's characteristics (phenotype) (Guha, Wai and Hausner, 2017). Significant off-target DNA cleavage

and mutation results in toxicity to those cells in which it occurs (Kim et al., 2009), and their repair causes chromosomal rearrangements, which can activate genes that can cause cancer (Cradick et al., 2013; see also Cho et al., 2014). Not surprisingly, “major concerns of off-target mutations have been observed in medical and clinical studies,” as well (Kanchiswamy et al., 2016, p. 564). This leads to difficulty in interpreting data but may also cause these animals further pain and suffering, due to the off-target effects, and death as they succumb to adverse off-target effects or are killed because they are of no experimental use.

Despite the considerable effort put into improving the situation, the extent of off-target effects is still a matter of serious debate (Bassett, 2017). Astoundingly, they are thought to be up to 50% more common than the desired on-target mutation efficiency, and they may occur at sites quite different to the target site, both of which are of serious concern (Fu et al., 2013; see also Bortesi et al., 2016; Komor, Badran and Liu, 2017). Many computational approaches to assessing potential CRISPR off-target problems exist. Though useful, each is biased regarding the type of off-target sites it may or may not fail to predict. It is therefore widely accepted that other, unbiased methods of assessment must be used to help avoid missing off-target effects that may be seen experimentally (see Bolukbasi, Gupta and Wolfe, 2016; D’Agostino and D’Aniello, 2017; Tsai et al., 2015). Some CRISPR experiments show more than 100 off-target mutations, while others appear to show none (Bolukbasi et al., 2016). Some analyses have suggested little or no off-target activity for some CRISPR molecules, though these analyses examined preselected genomic sites only so are likely to suffer from bias (see Bortesi et al., 2016). Any single technique will miss off-target sites that others will detect; and, unfortunately, the most comprehensive method—whole genome sequencing—is technically difficult and expensive. For example, a rare mutation (0.1% frequency) would require sequencing 1,500 genomes to give a 95% probability of finding this mutation at least once (Sluch et al., 2015).

A recent (2017) study attempted to complete a comprehensive whole-genome analysis to determine the actual prevalence of all off-target mutations in a CRISPR-edited mouse, not only the larger mutations, such as insertions and deletions (indels) of DNA but also the smaller, though no less important, single nucleotide variants (SNVs) that are often not sought. Schaefer and colleagues, reported “an unexpectedly high number of SNVs,” in addition to an average of 146 indels, with many of these in known genes (Schaefer et al., 2017, p. 547). The authors concluded that “concerns persist” over the unpredictable nature of CRISPR off-target mutation sites, which were likely to have a detrimental impact on key cellular processes and would likely manifest in adverse phenotypes. This specific issue remains, however, highly controversial. In March

2018, Schaefer and colleagues retracted their paper—in the face of pressure from some members of the scientific community working on CRISPR—on the grounds that the study results were irreproducible and unsupported by the data, and the study lacked key controls (Editorial, 2018; Schaefer et al., 2018). Retraction of this paper does not, of course, remotely prove or even suggest that CRISPR is sufficiently free of off-target effects to be safely used in humans. Most stakeholders who have opined in its wake have urged further progressive, yet cautious, research to elucidate the situation and stopped short of inferring an *all clear* from the authors' most recent work (Schaefer et al., 2018). With particular regard to their revision, Schaefer et al. are careful to note (correctly) that their latest data suggest that, “in specific cases, CRISPR [...] may not introduce numerous, off-target mutations” (Abstract). Others note that this simply means that the concern over off-target effects “just isn't perhaps as big as that initial study suggested.” (Brown, 2018). More generally, all involved appear to accept that far too little data exist to reach any robust, definitive conclusions about off-target effects associated with CRISPR, either way. This sensible, evidence-based view is supported by the many studies that exist, with a full spectrum of results (such as those referenced in this chapter), that serve only to rubber stamp the view that this field is young, and the question of off-target effects is still completely wide open.

Crucially, just before this Volume went to press, this caution was further justified by a detailed study published in *Nature Biotechnology*, which showed that the specificity of CRISPR-induced genetic alternations had been overestimated to date, due to exploration of them being “limited to the immediate vicinity of the target site and distal off-target sequences” (Kosicki et al., 2018). The authors' more thorough and detailed investigations revealed that—in two different types of mouse cells and a differentiated human cell-line alike—mutagenesis at the target sites was often much more significant than intended/expected. Instead of the aforementioned small insertions or deletions of DNA, the resulting CRISPR-mediated genetic alterations were frequently “large deletions and more complex genomic rearrangements”, often extending to many kilobases. Further, off-target lesions often resulted in “genomic damage”, which “may have pathogenic consequences.” The important warnings of their conclusions bear repeating here: extensive on-target genomic damage is a common outcome; consequences are not limited to the target locus but will affect more distal genes; some repercussions may initiate neoplasia (cancer); it is likely that some cells in each protocol would contain important pathogenic lesions, some of which would become cancer-causing in time; and others. Such frequent and extensive genetic damage is and has been undetectable by the means often used to identify it, leading to its under-reporting and under-appreciation, and so much more comprehensive analysis of the genetic

consequences of CRISPR experiments is warranted and necessary. This may be of urgent concern due to the fact that six clinical trials of CRISPR are currently underway, for various malignancies/cancers, including esophageal, nasopharyngeal, gastric, non-small cell lung cancer, leukemias/lymphomas and other hematological malignancies (see Clinicaltrials.gov).

Clearly, off-target mutations remain a major issue, with *persistent targeting* of unintended genomic loci (Bisaria, Jarmoskaite and Herschlag, 2017, p. 21; see also Tsai and Joung, 2016), even as steps are taken to mitigate their occurrence and effects, such as using engineered/modified CRISPR components (see e.g. Bayat et al., 2017; Chandrasekaran, Song and Ramakrishna, 2017; Combes and Balls, 2014; Ding et al., 2016; Guha, Wai and Hausner, 2017). It is widely believed that the factors controlling CRISPR's precision and accuracy "are still not fully understood," and obstacles remain on the path to any clinical application (Jiang and Doudna, 2017, p. 524). "Much remains to be learned regarding the efficiency and specificity of CRISPR/Cas9-mediated gene editing in human cells, especially in embryos." (Liang et al., 2015, p. 364) It is considered "necessary" to develop methods of detecting off-target mutations that are much more sensitive (Tsai and Joung, 2016, p. 310); but it is also thought that these will never be removed completely (Bassett, 2017), and that off-target effects will still occur often, no matter how high the on-target specificity (Liang et al., 2015). Off-target mutations remain stubbornly numerous and confounding in spite of many, multi-faceted efforts to reduce them and their impact; and this may have serious consequences for the use of CRISPR, even in laboratory-based research, where there will be more acceptance of them. This means that the role of off-target effects in any observations cannot be ruled out, but especially in clinical settings, where safety is paramount and even off-target mutation frequencies as low as 0.1% can have serious consequences (Tsai and Joung, 2016).

Finally, shortly before this Volume went to press, yet another, but different, clarion call for great caution came in the form of two papers published in *Nature* (Ihry et al., 2018; Haapaniemi et al., 2018). The double-strand DNA breaks created by CRISPR/Cas9 as part of its mechanism of action activate a gene called p53, which is known as the "guardian of the genome"—involved in the repair of DNA damage and, if that damage is sufficiently significant, in apoptosis, or the destruction of the cell containing the damaged DNA. It is because of these functions that p53—a tumor suppressor gene—is known to be mutated in more than half of all human cancers (Hollstein et al., 1991; Foronda and Dow, 2018); if p53 cannot carry out its normal activities, damaged cells may go on to become tumorous (Ferrarelli, 2018). This is an issue because, as one might expect, p53 blocks CRISPR/Cas9 activity; and it therefore follows

that cells that *are* experimentally modified by CRISPR, must, thus, tolerate DNA damage, and so must have deficient p53. In selecting for CRISPR-modified cells, therefore, one may be selecting for cells that could lead to tumor formation, which could be clinically catastrophic. As one of the authors opined, “By picking cells that have successfully repaired the damaged gene we intended to fix, we might inadvertently also pick cells without functional p53. If transplanted into a patient, as in gene therapy for inherited diseases, such cells could give rise to cancer, raising concerns for the safety of CRISPR-based gene therapies.” (Karolinska Institutet, 2018).

It has been suggested that such cells could be identified and eliminated by *in vitro* screening (Foronda and Dow, 2018), but various problems remain. Just one, single DNA break seems to be sufficient to prime p53 activity, and lead to cell arrest or death (Foronda and Dow, 2018; Ihry et al., 2018), so the problem may be greater than first thought. Some have inferred or implied that this is a new discovery, but it is not: almost quarter of a century ago, this was demonstrated in human fibroblasts (Di Leonardo et al., 1994). Further, CRISPR-editing issues were reported in 2016 with some types of cells, including primary and stem cells (Hockemeyer and Jaenisch, 2016; Carroll, 2018), the latter being the type of cell involved in one of the recent Nature papers (Ihry et al., 2018)—so this may be another illustration of lack of caution among some CRISPR researchers and advocates, and further reason to doubt that due caution and critical approach are being applied widely enough—particularly as the underlying mechanism was not pursued (Carroll, 2018). As stated in a recent, highly relevant review, “It is surprising that this phenomenon was not recognized much earlier.” (Carroll, 2018). Because break-induced toxicity has not been detected in all cell types, but also due to it not being seen in some cell types that *do* have functional p53, it means that “the induced arrest phenomenon will have to be tested and addressed for each type of target cell” as “that pathway is not the whole story” (Carroll, 2018). Finally, while selection is possible *in vitro*, it is not an option for *in vivo* somatic gene correction, in which this would have serious consequences for animals and humans (Foronda and Dow, 2018).

3 Current and Intended Uses of GM Animals

3.1 *Biomedical*

Many GM animals are used in *basic research* with no direct application (for example, to a particular therapy for a specific disease), but with aims to investigate the functions of particular genes, for example, and the nature of their regulation. Others are used as specific models for many different human diseases,

including multiple infectious diseases, such as HIV, immune system defects, blood and metabolic disorders, muscular dystrophy, cancer immunotherapies, among others (Cornu, Mussolino and Cathomen, 2017). Gene therapy interventions for some of these diseases have already reached clinical trials, such as HIV/AIDS therapies (Cornu, Mussolino and Cathomen, 2017); though there are some serious concerns over potential immune reactions in humans to two of the most common proteins used in the CRISPR/Cas9 system. Recent analysis of human blood samples revealed the presence of antibodies to Cas9 proteins in 65%–79% of individuals; and around half of all the blood samples harbored immune cells with the potential to destroy human cells, containing one of the Cas9 proteins (Charlesworth et al., 2018). The potential severity of any immune reaction in patients is unknown, but it could range from making CRISPR non-functional, to dangerous inflammatory reactions.

Efforts are being made to use CRISPR to deactivate and render some viruses non-infectious and/or non-pathogenic, such as hepatitis B and C viruses and HIV (Doerflinger et al., 2017; Huang et al., 2017; Li et al., 2017; Moyo et al., 2017; Soppe and Lebbink, 2017). Serious caution has been advised, however, due to the risk of causing mutations that increase, rather than decrease, virulence (Wang et al., 2016). It is claimed that CRISPR *holds the key* to translating data from rodent models of psychiatric disorders and neurobehavioral traits to humans, including disorders associated with anxiety, mood, and substance and impulse-control (Baud and Flint, 2017, p. 373). CRISPR's potential for cancer biology has been expounded, as it can recreate potential cancer-causing mutations identified in human tumors, in both cell lines and GM animals (Guernet and Grumolato, 2017). Some GM animals are used in attempts to produce medically important proteins, for example, in cows' milk, which can be generated in high volumes and purified from the milk for clinical use. Examples include treatments for some blood disorders, osteoporosis, and emphysema (Moura, Melo and de Figueiredo Freitas, 2011). GM animals are central to efforts to use animals as a source of organs for human transplantation (xeno-transplantation), targeting biological pathways involved in immune rejection of transplanted organs.

3.2 *Farm/Food Animals*

A major application of GM technology (GM also can mean *genetic modification* or *manipulation*, as well as *genetically modified*) is the engineering of animals used for food (Ledford, 2015). Examples include, chickens producing only female offspring for egg-laying, cows producing only male offspring for better meat yield, pigs who can be fattened with less food, cashmere goats producing more meat from greater muscle mass and longer hair for greater wool yield;

and efforts to facilitate greater stocking density, such as cattle without horns and animals with greater resistance to disease (see Frewer et al., 2013; Nuffield Council on Bioethics, 2016). *Double-muscled* pigs (Cyranoski, 2015), rabbits (Lv et al., 2016), sheep and cows (Proudfoot et al., 2015; Luo et al., 2014) have been created for human consumption, though many died early and were unhealthy, and birthing difficulties occurred due to their size (Cyranoski, 2015). Cows without horns can be housed more densely with lower risk of goring injuries (Loria K, 2016; Carlson et al., 2016). While there may be welfare benefits—millions of cattle would no longer need to be dehorned, which can be very painful—they would be farmed more intensively and have less space to live in, further compromising their welfare. Other efforts include cows that produce milk that does not induce allergies in humans (Yu et al., 2011); milk with altered fatty acid content, and milk that contains high levels of lactoferrin (Yang et al., 2008a); cows who produce “tastier beef” because their flesh contains more fat (Guo et al., 2017); and pigs who bleed out more efficiently at slaughter (Hai et al., 2014) and have omega-3 fatty acids in their flesh (Lai et al., 2006). GM salmon, modified so that they grow at twice the rate of normal salmon and can be housed in tanks on land, have been approved for human consumption in the United States (US) (Connor, 2015). Much of this is undoubtedly the result of lobbying by vested interests that stand to profit from these projects, who assert that, for instance, the Earth’s growing population and shifting appetites will necessitate considerable increases in food production that cannot be achieved by any other means alone; yet, there is strong counter evidence and opinion that alternative strategies could meet that need, such as reducing food wastage; changing consumer demand and preferences for meat, dairy, and eggs; and improving farming and production methods by other means (High Level Panel of Experts on Food Security and Nutrition, 2014). Despite the potential for both direct and indirect effects on animal welfare in this area, it is acknowledged that too little attention has been devoted to the genetic modification of “farm animals” and to the regulation of the practice (Nuffield Council on Bioethics, 2016).

However, the creation of GM animals commonly used for food is not limited to making them easier to manage or more profitable for their meat and milk. Pigs are touted as being more appropriate models of human diseases than mice, for example, for cystic fibrosis, cancer, diabetes, neurological disorders, high cholesterol, and muscular dystrophy; while a gene associated with achondroplasia has been targeted in cattle (Carlson et al., 2012; Petersen and Niemann, 2015).

3.3 *Dogs and Monkeys*

Concerns that less strict regulations in countries outside of the EU and the US may lead to GM projects that may not be approved elsewhere appear to

have substance. Prior to CRISPR, a Chinese group created transgenic dogs who emitted red fluorescent light (Hong et al., 2009). This was far from efficient. 344 embryos transferred to 20 surrogate mother dogs, resulted in seven pregnancies and six live births. More recently, another Chinese laboratory created GM dogs using CRISPR, knocking out a gene controlling muscle growth, resulting in dogs who were “much more muscular” (Doane, 2016; Zou et al., 2015). Their work was defended via a tenuous link to the creation of future dogs who could model, for example, Parkinson’s disease; but only two of 60 edited embryos were “successful.” Elsewhere in China, GM monkeys have been created with apparently similar characteristics to autism. Eight macaques (out of “dozens” of GM embryos) were born with a gene (MECP2) linked to autism in humans, who showed signs such as running “obsessively in circles”, ignoring their peers, and grunting anxiously when stared at (Cyranoski, 2016b; Liu et al., 2016; Snowden, 2016).

Interestingly, when espousing the use of “large animals” as GM models for human diseases, those who may otherwise stoutly defend GM mice are open to criticizing them. For example, one recent paper, authored by scientists creating GM livestock, noted that “the drawbacks of using rodents to model humans are well established [...] mice make poor models for reproductive physiology, pulmonary problems, metabolic regulation, and many other fields of inquiry” (West and Gill, 2016). Unfortunately for such advocates, as discussed in this chapter and in works referenced in it, it appears that “larger animals”, GM or not, remain poor models for these areas and more, and can only ever be so. This is compounded by the same, or even greater, confounding issues of low efficiency and a variety of limitations and complications (see section on non-human primates, NHPS, below).

4 Suffering, Welfare, and Ethical Issues with GM Animals

Many animal researchers acknowledge that creating GM animals involves suffering at every step, from generating sufficient eggs to embryos for modification, through to the pain and suffering experienced by many progeny (Laboratory Animal Science Association, 2008; Robinson, Jennings and Working, 2004).

4.1 *Breeding and the GM Process*

Producing eggs for the embryos used in the GM process involves drug-induced superovulation of females, whose fertilized eggs are collected post-mating, which may involve killing the females, a common practice in rodents, or at least surgery under general anesthesia (more “valuable” species). Approved killing methods for rodents are, commonly, neck dislocation or carbon dioxide

suffocation, which can both (not surprisingly) cause distress (Robinson et al., 2004). Both superovulation and fertilized-egg collection can cause discomfort, stress, and post-operative pain (Camara, et al., 2008). After modification, embryos are implanted into surrogate mothers in the form of pseudopregnant females, who have been previously mated with vasectomized males (The Boyd Group, 1999). Pre- and post-natal death of offspring may be significant. One report showed that an average of just 29% of implanted embryos survived to weaning, and only a quarter of these (7% of implanted embryos) (Hubrecht, 1995), or an average of 15% (Robinson et al., 2004), may be GM. Miscarriages may cause pain and distress, and such poor efficiency means that many donor and recipient animals must be used to produce a relatively small number of desired GM individuals. Genotyping of resultant offspring may involve blood sampling or tissue biopsy. Invasive methods are still common, including tail snipping, ear snipping/punching, or even toe amputation, all causing pain in mice (Robinson et al., 2004). The genetic modification process has been documented, at least in larger animals, such as sheep and cattle, as a factor in increased gestation length, greater body weight, risk of dystocia (difficult birth), and various perinatal anomalies and loss. In mice, there is also evidence of increased embryonic and fetal loss (Camar et al., 2008).

4.2 *Animal Lives Wasted*

The persistent inefficiency of the GM process is a serious welfare issue (Boyd Group, 1999; Camara et al., 2008; Laboratory Animal Science Association, 2008; Robinson et al., 2004). It is difficult to quantify, as many countries do not require the reporting of GM-animal statistics (Taylor et al., 2008). In the UK, statistics indicate a high degree of wastage (around 50% of a total of more than 4 million animal procedures in 2015, involved the creation and breeding of GM animals not used in subsequent experiments), and specific GM license applications are revealing: seven projects from 2014–2015 proposed using a total of almost 27,000 animals (UK Home Office, 2014).

4.3 *Effects of Genetic Modification*

Inserted genetic material may have adverse effects on GM embryos/animals. Some may be unpredictable, such the aforementioned off-target effects; while others are expected and the result of on-target effects, such as GM mice who will develop painful cancers. Naturally, the GM process may not *necessarily* adversely impact welfare; but the critical point is that, frequently, the welfare consequences of the GM process cannot be predicted in detail, nor can they be assessed properly. Welfare assessments are by their nature wide open to subjectivity and opinion, and much more research needs to be done in this

area to increase objectivity, if indeed this is possible to any significant degree (Hawkins et al., 2011, Wells et al., 2006). Therefore, it is acknowledged that reduced viability or impaired health may be *expected* (Bundesamt für Veterinärwesen, 2006); while some estimates suggest around 20% of GM animals suffer *minor discomfort*, 15% *severe discomfort*, and 30% increases in mortality and susceptibility to disease (Thon et al., 2002).

Indications may include, for instance, developmental abnormalities, such as cleft palate; perinatal and post-weaning mortality; skeletal abnormalities, including malformed limbs; discharge from eyes and ears; diarrhea; poor posture, gait, and ataxia; stereotypies, such as lack of alertness, poor or over-grooming, circling in cage; absence of teeth; poor mothering; poor thermoregulatory ability; enhanced growth of tumors and development of metastases, often at atypical sites; increased aggression; seizures; a range of diseases, including diabetes, osteoporosis, degenerative joint disease, inflammatory bowel disease, and ulcerative colitis; sensory and locomotor abnormalities affecting sight, hearing, smell, balance, and social interactions; and increased incidence of infectious disease (Dennis, 2002). GM mice databases reveal progressive hearing loss and deafness; development of diabetes; impaired movement and coordination, including tremors and involuntary movements, difficulty in initiating movement, abnormal posture, and paralysis; susceptibility to infectious disease; colitis; progressive muscle weakness; kidney inflammation; premature death; intestinal obstruction; respiratory distress; hyperactivity; heart failure; internal bleeding/brain hemorrhage; self-harm; seizures; vision problems and blindness; and many more (e.g., Mouse ENCODE Consortium, mouseencode.org; Mouse Genome Informatics, MGI, database, informatics.jax.org). The Mouse Genome Informatics (MGI) database lists mice under the following categories (among others): with *abnormality of* blood, connective tissue, head or neck, limbs, metabolism, prenatal development/birth, cardiovascular system, digestive system, ear, eye, genitourinary system, immune system, musculature, nervous system, respiratory system, skeletal system, and cancers. The scale of this must also be mentioned: as of July 2017, the MGI database cites 51,000 mutant alleles in mice, with more than 3,100 human disease models; the International Mouse Strain Resource (findmice.org) lists around 40,000 strains as available worldwide; the International Knockout Mouse Consortium has generated around 5,000 mutant mouse lines (Rosen, Schick and Wurst, 2015); and the International Mouse Phenotyping Consortium intends to generate 20,000 knockout mouse strains (mousephenotype.org) (Koscielny et al., 2014).

Off-target modifications may induce mutations that abrogate gene function and/or cause rearrangements of the genome with other, subsequent mutational effects on other genes. In assessing effects of GM on welfare, it has been

cautioned that setting a “normal” baseline must be done carefully. For example, it is normal for GM mice engineered to have vestibular abnormalities to spend much time circling in their cages. This may be normal for these mice but should not be considered normal from a welfare perspective (Hawkins et al., 2011).

4.4 *Increasing Numbers of GM Animals*

Many of these welfare issues are not exclusive to CRISPR and exist for other GM methods. It has been argued that CRISPR should mitigate many of these, with its simplicity and greater efficiency, and so should be welcomed by animal advocates. To some extent this may be true, in time. However, the corollary gives great cause for concern, that this simplicity and efficiency will also “not only increase in the range and diversity of transgenic rodent strains but will greatly expedite transgenesis in other species, including non-human primates” (Combes and Balls, 2014, p. 137). In this regard, CRISPR is described as a *mixed blessing* (Hendriksen and Spielmann, 2014); and animal ethicist Bernard Rollin (2015) accepts that easier GM techniques would undoubtedly lead to an increase in the number of animals used “as more researchers engage in hitherto impossible animal research”. It has been said that CRISPR will *revolutionize* mouse genetics by reducing the time it takes to create a new GM model from years to months, or even weeks (Fellmann et al., 2017). In other words, for any reduction and refinement in any specific GM experiment due to CRISPR, a greater overall number of GM experiments will offset this, compounded by more experiments on a wider range of species, including dogs and monkeys.

This is not mere speculation. Aside from being logical, and in addition to multi-stakeholder enthusiasm for CRISPR and associated market projections, it is clear from current scientific literature. Many speculative claims for CRISPR reflect an excitement that, in part, is responsible for the great expansion of interest in the technology and in the creation of greater numbers of GM animals in academe, biotech firms, and large pharmaceutical companies (Cornu et al., 2017). For example, it is estimated that by 2021, the GM market will be worth US\$6.28 billion (MarketsandMarkets, 2017). It has, therefore, been strongly suggested that the welfare consequences of genetic modification for all species should be monitored and explored in greater detail. Perhaps, at least, an in-depth, systematic, critical assessment of the rationale for using GM animals in human disease research is warranted; and projects involving GM animals should be approved only in “extremely exceptional circumstances” (Combes and Balls, 2014, p. 143; see also Mephram et al., 1998). Unfortunately, interest in CRISPR is, at least for now, manifesting in substantial animal use. The scientific literature shows (as of June 2017) more than 6,000 publications, up from fewer than 4,000 just a year earlier (June 2016), and just over 600, 18 months prior to that (Nuffield Council on Bioethics, 2016).

4.5 *Increasing Numbers of Non-Human Primates (NHPs)*

There is, therefore, great, well-founded, concern that this interest will translate into greater creation of GM monkeys (e.g. Liu et al., 2014; Niu et al., 2014). Examples of GM primates have already been mentioned (Cyranski, 2016b; Liu et al., 2016; Sasaki et al., 2009; Snowdon, 2016), following on from, for example, the first reports of GM macaques in 2001 (Chan et al., 2001), and a GM NHP model of Huntington's disease (Yang et al., 2008b). Some scientists are calling for further increases. To illustrate, a 2016 paper lamenting the failure of animal research (including NHPs) to translate to a greater understanding of human brain disorders and their treatment—largely due to “lack of good animal models” and “profound differences in brain and behavior” between humans and nonhumans—puts its weight firmly, and speculatively, behind GM NHPs as a solution (Jennings et al., 2016, p. 1123). Associated suffering is justified by a brief assurance of veterinary oversight and intervention. While accepting that greatly expanding GM NHP creation and use is challenging in many ways, the authors propose a “concerted international effort” to overcome those challenges (Jennings et al., 2016, p. 1128), involving automated methods for training the animals to comply with the researchers' demands, chronic use of intracranial electrodes, and the creation of an international network of NHP centers and vendors. Overall, a horrifying vision for animal advocates, and scientifically unjustifiable in any case. My colleagues (at Cruelty Free International, and indeed in the wider animal protection community) and I agree that there is a “dismal record of drug development for neurological and psychiatric disease over the past several decades” and that “basic neuroscience has failed to deliver substantially new and effective treatments for many brain disorders, partially because the animal modelling was done in species whose brains are too dissimilar from those of humans” (Jennings et al., 2016, p. 1128). However, we believe that modifying a gene or two in these poor models cannot overcome these problems or lead to research that is any less unethical.

GM NHP creation also suffers from the same problems as GM rodents, even 16 years after the first GM monkey was born (Chan et al., 2001); and so, widespread, efficient, successful, generation of human-relevant GM NHPs may be a forlorn hope anyway (Luo, Li and Su, 2016). Surprisingly little analysis had been done of this until recently. Though CRISPR has intensified the generation of GM NHPs, targeting efficiency in NHPs is still low, “successful gene replacement in monkeys via the CRISPR/Cas9 system remains elusive, possibly due to the complexity of DNA repair mechanisms in monkeys” (Luo et al., 2016, p. 242), and “there are still some technical limitations for its use in non-human primates” (Guo and Li, 2015). A 2017 report acknowledges “the incidence of undesirable outcomes has not been well characterized”. It states: “Most studies

experienced very high rates of developmental arrest (can be 90%) ... [which] further raises concerns about non-genetic technical factors contributing to low rates of survival" (Midic et al., 2017, p. 4). While this study claimed that the creation of GM NHP embryos could be 80%-100% efficient, this does not reflect on the efficiency of generating otherwise healthy adult NHPs with desired genetic modifications, and without confounding and/or welfare-compromising off-target effects. The same study suggests that mosaicism (where offspring contain cells with different genes/gene variants) is "substantial" and is "a significant limitation," and accepts that the creation of GM NHPs to date was "achieved at a very high cost in terms of the number of embryos used," due in part to the "very limited (around 10%) viability of transferred embryos to term" (Midic et al., 2017, p. 15; see also Chen et al., 2015). They conclude that inefficiency remains "a major barrier to practical use of the technology in nonhuman primates" (Midic et al., 2017, p. 15); and that the entire process is financially costly. To illustrate, one effort to generate GM NHPs via CRISPR, with two disrupted genes, reported that of 22 embryos injected, 15 (68%) survived culturing, while on average just over one third of these contained the desired modification (Niu et al., 2014). Subsequent attempts to generate GM monkeys involved injecting 186 zygotes; 83 (45%) were transferred to 29 surrogate females, establishing 10 pregnancies (34%), with 19 fetuses. The paper was published while 8/10 were still pregnant; one miscarried, and the other gave birth to twins, whose genes had been successfully modified, though mosaicism was confirmed, and phenotype had yet to be established.

This is all of particular concern because experimentation on monkeys is opposed much more strongly than on rodents (Aldhous, Coghlan and Copley, 1999; Animal Aid, 2003; Clemence and Leaman, 2016; Leaman, Latter and Clemence, 2014; TNS Opinion & Social, 2010); and genetic manipulation of "higher" organisms evokes stronger concern from the public (Olsson and Sandøe, 2010). The European Science Foundation's European Medical Research Councils group has stated: "Whether a species needs special protection should not be based solely on its phylogenetic relations to humans, but on its potential for suffering. NHPs are distinguished by the very advanced nature of their social, cognitive, sensory, and motor functions" (Olsson and Sandøe, 2010, p. 185).

5 Failure of GM Animals and Consequences for Animals and Humans

Much has been published on the failures of GM animals to live up to their promise, though criticisms of GM animals are frequently understated, couched, for example, as follows: *they do not always accurately reflect the human condition;*

they have limitations; data must be interpreted carefully; and so on. Examples of failures are numerous, and include Parkinson's and Alzheimer's diseases, cystic fibrosis, type I and type II diabetes, amyotrophic lateral sclerosis, Kallmann's syndrome, Lesch-Nyhan's disease, ataxia-telangiectasia, sickle-cell anemia, deafness, visual defects, Duchenne muscular dystrophy, Down's syndrome, and schizophrenia (Pratt et al., 2012), multiple sclerosis, cancers, and immunotherapy (Ruggeri, Camp and Miknyoczki, 2014), migraine (Storer, Suprongsinchai and Srikiatkachorn, 2015), pain (Craig, 2009; Mogil, 2009), and depression (Benatar, 2007; Bhogal and Combes, 2006; Davis, 2008; McGonigle, 2014; Norgren, 2004; Webb, 2014). It is, however, increasingly acknowledged in scientific literature that GM animals are failing to deliver by any measure. For example, GM-based "advances" in animal models of many human conditions and diseases "have not made a significant increase in improving the rate of success in Phase II proof-of-concept studies"; in other words, GM animals are not leading to more, better, safer drugs and indeed may well be hindering the process because they are misleading (Hunter, 2011, p. 1). GM-animal models of CNS disorders "have been increasingly criticized in the wake of numerous clinical trial failures of NCEs [new chemical entities, or new drugs] with promising preclinical profiles" (McGonigle, 2014, p. 140), and they are "criticized for their limited ability to predict NCE efficacy, safety and toxicity in humans" (McGonigle and Ruggeri, 2014, p. 162). Clinical trials of gene therapy for heart failure and muscular dystrophy, despite early promise, have failed (Hulot, Ishikawa and Hajjar, 2016; Lu, Cirak and Partridge, 2014). And despite many years of substantial effort in the field of xenotransplantation, and early promises that successful transplantation of pig organs into humans would be realized by 2010 and worth multiple billions of dollars, the most recent developments claim no more success than a GM pig's heart surviving in a monkey for 51 days (Johnston, 2016), or in the abdomen of a baboon in addition to its own heart for just over two years, until they were rejected when immunosuppressive drugs were reduced (Mohiuddin et al., 2016; Servick, 2016).

Attempts to overcome other significant hurdles continue, such as porcine endogenous retrovirus (PERV) in pigs, which can cause problems in humans (Yang et al., 2015); but there remain persistent issues, such as immune rejection; transmission of infectious agents; ethical problems and boundaries; aspects of physiological compatibility, such as discrepancies in coagulation and metabolism; and others (Niemann and Petersen, 2016). Some argue xenotransplantation is not needed anyway. Prevention of much of the need for transplantation via education and health measures, improved donor recruitment, and mandated choice and presumed consent/opt-out schemes, and others have all had positive outcomes in countries that have adopted them (Perera, Mirza and Elias, 2009).

With specific regard to CRISPR, there is also evidence to question claims that it can improve matters and facilitate more accurate and human-relevant models. An approach utilizing *Morpholino oligomers* (MOs) has been widely used to investigate gene function in zebrafish, but attempts to confirm findings for specific genes using CRISPR have been extremely confounding. One study reported that most genes altered by CRISPR failed to show similar phenotypes to experiments that altered the expression of the same genes using MOs, which the authors attributed to differing off-target effects from the techniques (Kok et al., 2015). This is mirrored in a study comparing selected genes affected by CRISPR and a gene-silencing method using short hairpin RNAs (shRNA). These methods were found to have similar precision; but each affected “numerous” genes that the other did not, attributable to differences in off-target effects and in the timing of each (Morgens et al., 2016). To illustrate, a recent study revealed that previous research implicating the *MELK* gene in certain breast cancers—with sufficient certainty to prompt pharmaceutical companies to develop drugs to block its activity, some of which proceeded to human trials—may be unreliable. When the *MELK* gene was knocked out using CRISPR, cancer cells multiplied unexpectedly, and drugs that targeted *MELK* still stopped their growth. This casts doubt on the role of *MELK*, and suggests that drugs targeting *MELK* work through other targets (Lin et al., 2017).

It is often, perfectly reasonably, asked if such failures may be balanced against any successes of GM technology. This is not the purpose of this chapter, which is to highlight issues and caveats with it and to supply a more critical argument against its use. However, any claimed successes, in which it is implied that the use of GM animals has resulted directly in human benefit, must fulfil the following criteria: data from the GM animal experiments must be reliably and sufficiently translatable to humans; these experiments must have provided data that could not have been obtained in any other way; and these data must have been critical to the ultimate human benefit. Even if, for the sake of argument, one assumes such examples exist, they still must be balanced against an objective appraisal of the scale of failure and against the ethical cost of the animal research involved.

6 Reasons for These Failures

Reasons proffered for this scale of failure include the evolutionary distance of humans and non-human species—approximately 65 million years for humans and mice—and all consequent differences in gene complement and expression, the artificiality of induced diseases, and the inbred strains of

animals often used (Davis, 2008). See also two comprehensive reviews of genetic differences between humans and chimpanzees (chimpanzees were used in science in the US until very recently), and humans and monkeys (Bailey, 2011, 2014). Even with current knowledge, limited because such differences have barely been sought, they are much more widespread and extensive, with significant and varied consequences, than is generally accepted. There are significant differences in gene complement, but more importantly, in gene expression, i.e., how these genes are regulated and used in the organism, even where they are common to both species. These differences affect all biological systems, but notably the immune system, the brain, and the liver, which are fundamental to much biomedical research involving infectious agents and disease, autoimmunity and inflammation, neuroscience and neurological diseases, and drug safety and efficacy. It is these differences that underpin the failures of animal research, whether GM or not, discussed in this chapter.

Of course, genetic differences between humans and NHPS, as appreciable as they are, are not as great as those between humans and mice, who constitute the greatest numbers of GM animals used in science. These differences have not yet been elucidated in detail, but illustrative examples exist. For example, a systematic comparison of the mouse and human genomes has revealed that there is significant conservation of functional genes themselves, with around half of human DNA aligning with mouse DNA when directly compared; however, this of course means that half of it does not. Furthermore, there are, crucially, “wide ranging differences” in many biological pathways and cellular functions, which show “considerable divergence”; and the areas of the genome that control and regulate gene expression are substantially different (Yue et al., 2014, p. 355). Indeed, many disease-causing mutations are in these areas, rather than in the main protein-coding parts of genes themselves. Because these differ, particularly between species, this can make direct animal-human comparisons not just difficult and uncertain, but impossible (Bassett, 2017). Even when humans and mice share genes, they can show functional differences: a study of 120 genes that are known to be essential for life in humans, revealed that almost one quarter of them are *not* essential for life in mice (Liao and Zhang, 2008).

The problem with a shift toward GM NHPS, in the hope of greater human relevance, is that there is little or no evidence to support this, even if NHPS are evolutionarily less removed from humans. While it is true to some extent that NHPS “are genetically and phenotypically closer to humans, particularly in regards to anatomy, physiology, cognition, and gene sequences,” it does not follow that they are, therefore, “optimal animal models for genetic modification in an attempt to understand human biology” (Luo et al., 2016, p. 241.). This is

only valid if this results in better translation of NHP data to human benefit. I argue that it does not, because there is simply no evidence that it does.

One positive for animal advocates, while reading myriad literature on the burgeoning creation of GM animals, is that there now appears to be more honesty about, and criticism of, the human relevance of *non*-GM animals. A paper in the prestigious journal, *Nature*, cited the wholesale failure of new drugs to treat amyotrophic lateral sclerosis (ALS), a fatal neurodegenerative condition, known as Lou Gehrig's or motor neuron disease, despite success in animal models of the disease, as well as similar failures in Alzheimer's and cancer, among others (Perrin, 2014). Contemporary criticisms of animal research are welcome because they have been scant from the scientific community for decades. Ironically, many criticisms are akin to those made by animal advocates for many years, which were roundly dismissed. What seems commonplace, however, is the unfortunate and groundless assertion that genetic modification will instantly make failed animal models more human relevant. Evidence suggests otherwise.

7 Alternatives to GM Animals—The Way Forward

If not GM animals, what is the way forward to understand the myriad human diseases and realize treatments and cures for them? Modeling human diseases in cultured human stem cells continues to take great leaps forward and will surely become a mainstay of biomedical research that “could rival the use of GM mice in popularity” (Musunuru, 2013, p. 90). Somatic cells (cells from various parts of the body, other than reproductive cells, such as sperm and eggs, often skin biopsies or blood) can now be *reprogrammed* to act as cells in early-stage embryos, able to develop into many different specialized cell types (Takahashi et al., 2007; Takahashi and Yamanaka, 2006). Immense collaborative efforts now collect and characterize cells from many thousands of healthy and diseased human individuals, many with a wide variety of disorders, and use these *induced pluripotent stem cells* (iPSCs) for comparative studies of normal and diseased states and screening of potential new drugs and therapies, including the study of polygenic disorders (diseases involving many genes). The development of 3D cell cultures and organoids (cultured miniature organs) is likely to increase the *in vivo* relevance of this approach, with more faithful and accurate cellular phenotypes (see Bassett, 2017). Organoids successfully developed to date include, brain, intestine, stomach, salivary gland, esophagus, pancreas, liver, breast, lung, prostate, fallopian tube, and taste bud (see Driehuis and Clevers, 2017). Genetically modifying such iPSCs and organoids adds another level

of sophistication, allowing potential causative gene variants or mutations to be introduced for further study, for example, to validate mutations implicated in causing disease and/or for attempts at repairing faulty genes.

Cell lines for these studies have been generated for many diseases, including Parkinson's, Alzheimer's, Huntington disease, various immune disorders, cardiomyopathy, and cystic fibrosis (Brookhouser et al., 2017; Nishizaki and Boyle, 2017); and efforts at repairing mutated genes in these systems have been promising in, for example, cystic fibrosis and cancers (Driehuis and Clevers, 2017), and retinopathies (Quinn, Pellissier and Wijnholds, 2017). The combined use of genome editing and iPSCs offers the ability to study genes and mutations in different human genetic backgrounds, which is especially important for the study of complex neurological disorders. This approach has been found to "closely mimic cellular and molecular features of human diseases." (Heidenreich and Zhang, 2016, p. 42) CRISPR has also aided the derivation of retinal ganglion cells from human PSCs, to model human optic nerves *in vitro* for research into optic nerve disease (Sluch et al., 2015). The very high efficiency of these types of methods, coupled with the relative ease and speed of the process, and the ability to use and screen many thousands of cell lines in parallel, means that this type of approach to understanding the basis of human disease and to identify therapeutic targets and therapies must be the way forward, in place of creating GM animals (see Bassett, 2017). While the aforementioned off-target effects are a confounding factor, they matter much less in cell lines than in animals, because there are no ethical problems; and cell lines can be produced, screened, and evaluated much more quickly and efficiently.

8 Summary

Acknowledgement of the suffering of GM animals has, at least, led to some efforts to reduce it, even if these have not, to date, led to overall reductions in their creation and experimental use. Guidelines for the use and care of GM animals, for example, are welcome. Working Groups and international guidelines have been commissioned to this end (Wells et al., 2006) and are at least intended to reduce the number of GM animals created and improve the welfare of those who are. These include requiring attempts to establish the appropriateness of generating any GM animal, both scientifically and with regard to welfare, involving a harm-benefit analysis; and a stipulation that new animals should not be generated if similar suitable lines already exist, and/or if an *in vitro* method could be used instead (Rose et al., 2013). These guidelines need to be widely adopted and enforced, but also greater training of staff

responsible for care, for example, can only make little or no impact on the welfare of the many millions of GM animals that will end up in laboratories worldwide. Ultimately, guidelines or not, GM animals suffer greatly, in their tens of millions each year. Controversially, one developing effort to address this, already attempted in rats, is to make GM animals who—while still able to sense pain—are incapable of finding its sensation unpleasant (Shriver, 2015).

Yet, the public demands that such pain and suffering is avoided or controlled at all costs for them to accept animal research, GM or not (Aldhous et al., 1999; Animal Aid, 2003; Clemence and Leaman, 2016; Leaman, Latter and Clemence, 2014; TNS Opinion & Social, 2010). Generally, people are much less accepting of GM animals than they are of GM plants and GM food compared to other GM applications. While perceptions of risk are offset by perceived benefits (Frewer et al., 2013), there is evidence that the EU populace has in the past “morally rejected genetic engineering of animal models of disease,” which is incompatible with the direction in which worldwide attitudes and laws are moving (Rollin, 2015, p. 114). Utilitarians may argue that human benefit outweighs this pain and suffering. But, given the degree of animal pain and suffering involved, both qualitatively and quantitatively, the relatively small number of people who stand to benefit from any breakthrough for many of the rare genetic diseases that may be modelled, and how unlikely GM animals are to contribute to breakthroughs given the burgeoning evidence against them, how can this be so? This is especially true if any harm-benefit analyses applied to license applications for animal experimentation are conducted properly and more stringently, as there are calls for authorities to ensure (Würbel, 2017).

Even if one presumes sufficient human benefit from research on GM animals, which I (and many others) believe is not supported by evidence, there remain serious scientific issues with, and ethical/welfare consequences of, genetic engineering. Despite the best currently available method of CRISPR having “swept through labs around the world” recently, and being touted as a “revolution” (Ledford, 2015, pp. 20–21), it is still considered as being “in an immature phase of development” and “not yet ready for therapeutic applications in humans given the low editing efficiency” (<15%) (D’Agostino and D’Aniello, 2017, p. 4). This is also due to the persistent concerns over the stubborn nature of off-target mutations, occurring at frequencies of up to 60%, more than the best efficiency of intended on-target modifications. Even if off-target issues can be greatly reduced, which is questionable, they are still of concern clinically, as “Even low-frequency events could potentially be dangerous if they accelerate a cell’s growth and lead to cancer” (Ledford, 2015, p. 22).

The efficiency of CRISPR translation to clinical applications is also of concern. Scientists using CRISPR to correct a disease-causing mutation in mice in a gene therapy experiment had to “pump large volumes of liquid into blood vessels—something that is not generally considered feasible in people” and this corrected the mutation in just 0.4% of the mice’s cells, not enough to be effective (Ledford, 2015, p. 21). Delivery methods for introducing the CRISPR apparatus to cells also need optimizing (Peng, Lin and Li, 2016). Carrier DNA used to introduce CRISPR to target cells may become integrated into the host genome, causing off-target effects, which may disrupt the genome editing process and can cause toxicity. Alternative methods may be stressful to cells, altering gene expression, or leading to high off-target effects (Peng, Lin and Li, 2016). Despite these concerns, the first clinical trial involving CRISPR commenced in October 2016, when knockout immune cells were injected into patients as potential therapy for metastatic non-small cell lung cancer (Cyranoski, 2016a); and now CRISPR is already part of ten clinical trials just a few years after it became mainstream (clinicaltrials.gov). It remains to be seen if they will be successful, and if so, how much they rely on GM animal research.

9 Conclusion

GM animal creation and experimentation takes the lives of tens of millions of animals each year and involves considerable suffering at every stage. Its scientific value is extremely poor, to the point of it being unnecessary, misleading and therefore harmful not just to the animals involved, but also to people, who depend on good science to understand, treat, and cure the diseases that affect us all. The continued insistence of many who practice and fund GM research that animals must be used is without foundation. Non-human animals have always been bad models for humans due to species differences, and no amount of genetic modification can remedy that, even if it were perfect. GM processes are far from perfect, however. Even the best is extremely inefficient, and confounded not just by those species differences, but also by off-target effects of the GM process. These issues are at the root of animal research failing to be relevant and reliable for humans, of animals being poor models for disease right across the spectrum, and of the failure of 90%-95% of new drugs in human trials that were successful in animal tests (Bailey, Thew and Balls, 2013; Bailey, Thew and Balls, 2014; Bailey, Thew and Balls, 2015). Moving away from animal research, including the use of GM animals, has never been more imperative.

References

- Albadri, S., F. Del Bene and C. Revenu (2017). Genome Editing Using CRISPR/Cas9-based Knock-in Approaches in Zebrafish. *Methods*, 121, pp. 77–85.
- Aldhous, P., A. Coghlan and J. Copley (1999). Animal Experiments: Where Do You Draw the Line? Let the People Speak. *New Scientist*, 162(2187), pp. 26–31.
- Animal Aid (2003). *Public Says “no” to Primate Research*. [online] Available at: https://web.archive.org/web/20160812204605/http://animalaid.org.uk/h/n/NEWS/news_experiments/ALL/136/ [Accessed 30 July 2018].
- Bailey, J. (2011). Lessons from Chimpanzee-based Research on Human Disease: The Implications of Genetic Differences. *Alternatives to Laboratory Animals*, 39(6), pp. 527–540.
- Bailey, J. (2014). Monkey-based Research on Human Disease: The Implications of Genetic Differences. *Alternatives to Laboratory Animals*, 42, pp. 287–317.
- Bailey, J., M. Thew and M. Balls (2013). An Analysis of the Use of dogs in Predicting Human Toxicology and Drug Safety. *Alternatives to Laboratory Animals*, 41, pp. 335–350.
- Bailey, J., M. Thew and M. Balls (2014). An Analysis of the Use of Animal Models in Predicting Human Toxicology and Drug Safety. *Alternatives to Laboratory Animals*, 42, pp. 189–199.
- Bailey, J., M. Thew and M. Balls (2015). Predicting Human Drug Toxicity and Safety Via Animal Tests: Can Any One Species Predict Drug Toxicity in Any Other, and Do Monkeys Help? *Alternatives to Laboratory Animals*, 43, pp. 393–403.
- Bassett, A.R. (2017). Editing the Genome of hiPSC with CRISPR/Cas9: Disease Models. *Mammalian Genome*, [Epub ahead of print], pp. 1–17.
- Baud, A. and J. Flint (2017). Identifying Genes for Neurobehavioural Traits in Rodents: Progress and Pitfalls. *Disease Models and Mechanisms*, 10(4), pp. 373–383.
- Bayat, H., M. Omid, M. Rajabibazl, S. Sabri and A. Rahimpour (2017). The CRISPR growth Spurt: From Bench to Clinic on Versatile Small RNAs. *Journal of Microbiology and Biotechnology*, 27(2), pp. 207–218.
- Benatar, M. (2007). Lost in Translation: Treatment Trials in the SOD1 Mouse and in Human ALS. *Neurobiology of Disease*, 26(1), pp. 1–13.
- Bhagal, N. and R. Combes (2006). The Relevance of Genetically Altered Mouse Models of Human Disease. *Alternatives to Laboratory Animals*, 34(4), pp. 429–454.
- Bisaria, N., I. Jarmoskaite and D. Herschlag (2017). Lessons from Enzyme Kinetics Reveal Specificity Principles for RNA-guided Nucleases in RNA Interference and CRISPR-based Genome Editing. *Cell Systems*, 4(1), pp. 21–29.
- Bolukbasi, M.F., A. Gupta and S.A. Wolfe (2016). Creating and Evaluating Accurate CRISPR-Cas9 Scalpels for Genomic Surgery. *Nature Methods*, 13(1), pp. 41–50.
- Bortesi, L., C. Zhu, J. Zischewski, L. Perez, L. Bassié, R. Nadi, G. Forni, S.B. Lade, E. Soto, X. Jin, V. Medina, G. Villorbina, P. Muñoz, G. Farré, R. Fischer, R.M. Twyman,

- T. Capell, P. Christou and S. Schillberg (2016). Patterns of CRISPR/Cas9 Activity in Plants, Animals and Microbes. *Plant Biotechnology Journal*, 14(12), pp. 2203–2216.
- Boyd Group (1999). *Genetic Engineering: Animal Welfare and Ethics. A Discussion Paper*. [online] Available at: https://web.archive.org/web/20070714154044fw_/http://www.boyd-group.demon.co.uk/genmod.htm [Accessed: 30 July 2018].
- Brookhouser, N., S. Raman, C. Potts and D.A. Brafman (2017). May I Cut In? Gene Editing Approaches in Human Induced Pluripotent Stem Cells. *Cells*, 6(1), p. 5.
- Brown, K.V. (2018). *The Scientists Who Sparked CRISPR Panic Couldn't Reproduce Their Study Results*. [online] Available at: <https://gizmodo.com/the-scientists-who-sparked-crispr-panic-couldnt-reprodu-1824181703> [Accessed: 30 July 2018].
- Bundesamt für Veterinärwesen (2006). *Statistik der Tierversuche in der Schweiz 2005*. [online] Available at: <https://www.admin.ch/gov/de/start/dokumentation/medienmitteilungen.msg-id-5911.html> [Accessed: 8 August 2017].
- Camara, D., I. Dimitrova, M. Doynova, L. Jachacz, D. Kachakova, M. Kepka, C.B. Ould Isselemou, J.P. Vorniere and T. Yungarva (2008). *Transgenic and Cloned Animals: Ethical Problems?* EU Socrates Erasmus European Community. Agro Campus Ouest.p. 20 [online] Available at: http://bioethics.agrocampus-ouest.eu/infogluce/DeliverLive/digitalAssets/74558_transgenic_r.pdf [Accessed: 30 July 2018].
- Caplan, A.L., B. Parent, M. Shen and C. Plunkett (2015). No Time to Waste. The Ethical Challenges Created by CRISPR: CRISPR/Cas, Being an Efficient, Simple, and Cheap Technology to Edit the Genome of any Organism, Raises Many Ethical and Regulatory Issues Beyond the Use to MANIPULATE HUMAN GERM LINE CELLS. *EMBO Reports*, 16(11), pp. 1421–1426.
- Carlson, D.F., C.A. Lancto, B. Zang, E.S. Kim, M. Walton, D. Oldeschulte, C. Seabury, T.S. Sonstegard and S.C. Fahrenkrug (2016). Production of Hornless Dairy Cattle from Genome-edited Cell Lines. *Nature Biotechnology*, 34(5), pp. 479–481.
- Carlson, D.F., W. Tan, S.G. Lillico, D. Stverakova, C. Proudfoot, M. Christian, D.F. Voytas, C.R. Long, C.B. Whitelaw and S.C. Fahrenkrug (2012). Efficient Talen-mediated Gene Knockout in Livestock. *Proceedings of the National Academy of Sciences of the United States of America*, 109(43), pp. 17382–17387.
- Carroll, D. (2018). p53 Throws CRISPR a Curve. *Trends in Pharmacological Sciences* 39, pp. 783–784.
- Chan, A.W., K.Y. Chong, C. Martinovich, C. Simerly and G. Schatten (2001). Transgenic monkeys Produced by Retroviral Gene Transfer into Mature Oocytes. *Science*, 291(5502), pp. 309–312.
- Chandrasekaran, A.P., M. Song and S. Ramakrishna (2017). Genome Editing: A Robust Technology for Human Stem Cells. *Cellular and Molecular Life Sciences*, 74(18), pp. 3335–3346.
- Charlesworth, C.T., P.S. Deshpande, D.P. Dever, B. Dejene, N. Gomez-Ospina, S. Mantri, M. Pavel-Dinu, J. Camarena, K.I. Weinberg and M.H. Porteus (2018). Identification

- of Pre-Existing Adaptive Immunity to Cas9 Proteins in Humans. *bioRxiv*. Preprint. doi.org/10.1101/243345.
- Chen, R.J., G. Kelly, A. Sengupta, W. Heydendael, B. Nicholas, S. Beltrami, S. Luz, L. Peixoto, T. Abel and S. Bhatnagar (2015). Micrnas as Biomarkers of Resilience or Vulnerability to Stress. *Neuroscience*, 305, pp. 36–48.
- Cho, S.W., S. Kim, Y. Kim, J. Kweon, H.S. Kim, S. Bae and J.S. Kim (2014). Analysis of Off-target Effects of CRISPR/Cas-derived RNA-guided Endonucleases and Nickases. *Genome Research*, 24(1), pp. 132–141.
- Clemence, M. and J. Leaman (2016). *Public Attitudes to Animal Research in 2016*. A report by Ipsos MORI for the Department for Business, Energy & Industrial Strategy, Ipsos MORI Social Research Institute. [online] Available at: <https://www.ipsos.com/sites/default/files/publication/1970-01/sri-public-attitudes-to-animal-research-2016.pdf> [Accessed 30 July 2018].
- Combes, R.D. and M. Balls (2014). Every Silver Lining Has a Cloud: The Scientific and Animal Welfare Issues Surrounding a New Approach to the Production of Transgenic Animals. *Alternatives to Laboratory Animals*, 42(2), pp. 137–145.
- Connor, S. (2015). Genetically Modified Salmon Becomes First to Be Approved for Human Consumption - But It Won't Have to Be Labelled as GM. *The Independent*. [online] Available at: <http://www.independent.co.uk/news/science/genetically-modified-sa-approved-for-human-consumption-but-it-wont-have-to-a6741031.html> [Accessed: 30 July 2018].
- Cornu, T.I., C. Mussolino and T. Cathomen (2017). Refining Strategies to Translate Genome Editing to the Clinic. *Nature Medicine*, 23(4), pp. 415–423.
- Cradick, T.J., E.J. Fine, C.J. Antico and G. Bao (2013). CRISPR/Cas9 Systems Targeting β -globin and CCR5 Genes Have Substantial Off-target Activity. *Nucleic Acids Research*, 41(20), pp. 9584–9592.
- Craig, A.D. (2009). A Rat Is Not a Monkey Is Not a Human: Comment on Mogil. *Nature Reviews Neuroscience*, 10(6), p. 466.
- Cyranoski, D. (2015). Super-muscly Pigs Created by Small Genetic Tweak. *Nature*, 523(7558), pp. 13–14.
- Cyranoski, D. (2016a). Crispr Gene-editing Tested in a Person for the First Time. *Nature*, 539(7630), p. 479.
- Cyranoski, D. (2016b). Monkeys Genetically Modified to Show Autism Symptoms. *Nature*, 529(7587), p. 449.
- D'Agostino, Y. and S. D'Aniello (2017). Molecular Basis, Applications and Challenges of CRISPR/Cas9: A Continuously Evolving Tool for Genome Editing. *Briefings in Functional Genomics*, 16(4), pp. 211–216.
- Davis, M.M. (2008). A Prescription for Human Immunology. *Immunity*, 29(6), pp. 835–838.

- Dennis, M.B. (2002). Welfare Issues of Genetically Modified Animals. *Institute for Laboratory Animal Research Journal*, 43(2), pp. 100–109.
- Di Leonardo, A., S.P. Linke, K. Clarkin and G.M. Wahl (1994). DNA damage triggers a prolonged p53-dependent G1 arrest and long-term induction of Cip1 in normal human fibroblasts. *Genes and Development*, 8, pp. 2540–2551.
- Ding, Y., H. Li, L.L. Chen and K. Xie (2016). Recent Advances in Genome Editing Using CRISPR/Cas9. *Frontiers in Plant Science*, 7, p. 703.
- Doane, S. (2016). China Building Bigger, Strong Beagles Through Genetics. *CBS News*. [online] Available at: <http://www.cbsnews.com/news/genetic-modifying-of-beagles-a-controversial-practice-in-china/> [Accessed: 30 July 2018].
- Doerflinger, M., W. Forsyth, G. Ebert, M. Pellegrini and M.J. Herold (2017). CRISPR/Cas9, The Ultimate Weapon to Battle Infectious Diseases. *Cellular Microbiology*, 19(2), Epub 2016 Dec 6.
- Driehuis, E. and H. Clevers (2017). CRISPR/Cas 9 Genome Editing and Its Applications in Organoids. *American Journal of Physiology, Gastrointestinal and Liver Physiology*, 312(3), pp. G257–G265.
- Editorial (2018). CRISPR Off-targets: A Reassessment. *Nature Methods* 15, pp. 229–229.
- Fellmann, C., B.G. Gowen, P.C. Lin, J.A. Doudna and J.E. Corn (2017). Cornerstones of CRISPR-Cas in Drug Discovery and Therapy. *Nature Reviews. Drug Discovery*, 16(2), pp. 89–100.
- Ferrarelli, L.K. (2018). CRISPR, cancer, and p53. *Science Signalling*, 11(539), p. eaau7344.
- Fineran, P.C. and E. Charpentier (2012). Memory of Viral Infections by Crispr-Cas Adaptive Immune Systems: Acquisition of New Information. *Virology*, 434(2), pp. 202–209.
- Foronda, M. and L.E. Dow (2018). CRISPR: Stressed about p53. *Trends in Molecular Medicine*, 24, pp. 731–733.
- Frewer, L.J., G.A. Kleter, M. Brennan, D. Coles, A.R. Fischer, L.M. Houdebine, C. Mora, K. Millar and B. Salter (2013). Genetically Modified Animals from Life-science, Socio-economic, and Ethical Perspectives: Examining Issues in an EU Policy Context. *Nature Biotechnology*, 30(5), pp. 447–460.
- Fu, Y., J.A. Foden, C. Khayter, M.L. Maeder, D. Reyon, J.K. Joung and J.D. Sander (2013). High-frequency Off-target Mutagenesis Induced by CRISPR-Cas Nucleases in Human Cells. *Nature Biotechnology*, 31(9), pp. 822–826.
- Guernet, A. and L. Grumolato (2017). CRISPR/Cas9 Editing of the Genome for Cancer Modeling. *Methods*, 121–122, pp. 130–137.
- Guha, T.K., A. Wai and G. Hausner (2017). Programmable Genome Editing Tools and Their Regulation for Efficient Genome Engineering. *Computational and Structural Biotechnology Journal*, 15, pp. 146–160.
- Guo, X. and X.J. Li (2015). Targeted Genome Editing in Primate Embryos. *Cell Research*, 25(7), pp. 767–768.

- Guo, Y., H. Li, Y. Wang, X. Yan, X. Sheng, D. Chang, X. Qi, X. Wang, Y. Liu, J. Li and H. Ni (2017). Screening Somatic Cell Nuclear Transfer Parameters for Generation of Transgenic Cloned Cattle with Intragenomic Integration of Additional Gene Copies That Encode Bovine Adipocyte-type Fatty Acid-binding Protein (a-fabp). *Molecular Biology Reports*, 44(1), pp. 159–168.
- Haapaniemi, E., S. Botla, J. Persson, B. Schmierer and J. Taipale (2018). CRISPR-Cas9 genome editing induces a p53-mediated DNA damage response. *Nature Medicine* 24, pp. 927–930.
- Hai, T., F. Teng, R. Guo, W. Li and Q. Zhou (2014). One-step Generation of Knockout Pigs by Zygote Injection of CRISPR/Cas System. *Cell Research*, 24(3), pp. 372–375.
- Hawkins, P., D.B. Morton, O. Burman, N. Dennison, P. Honess, M. Jennings, S. Lane, V. Middleton, J.V. Roughan, S. Wells, K. Westwood and UK Joint Working Group on Refinement (BVAAWF). (2011). *A Guide to Defining and Implementing Protocols for the Welfare Assessment of Laboratory Animals*. Eleventh report of the BVAAWF/FRAME/RSPCA/UFaw Joint Working Group on Refinement. *Laboratory Animals*, 45(1), pp. 1–13.
- Heidenreich, M. and F. Zhang (2016). Applications of CRISPR-Cas Systems in Neuroscience. *Nature Reviews Neuroscience*, 17(1), pp. 36–44.
- Hendriksen, C. and H. Spielmann (2014). New Techniques for Producing Transgenic Animals - A Mixed Blessing from both the Scientific and Animal Welfare Perspectives. *Alternatives to Laboratory Animals*, 42(2), pp. 93–94.
- High Level Panel of Experts on Food Security and Nutrition (2014). *Food Losses and Waste in the Context of Sustainable Food Systems*. [online] Available at: <http://www.fao.org/3/a-i3901e.pdf> [Accessed 30 July 2018].
- Hockemeyer, D. and R. Jaenisch (2016). Induced Pluripotent Stem Cells Meet Genome Editing. *Cell Stem Cell*, 18, pp. 573–586.
- Hollstein, M., D. Sidransky, B. Vogelstein and C.C. Harris (1991). p53 mutations in human cancers. *Science*, 253, pp. 49–53.
- Hong, S.G., M.K. Kim, G. Jang, H.J. Oh, J.E. Park, J.T. Kang, O.J. Koo, T. Kim, M.S. Kwon, B.C. Koo, J.C. Ra, D.Y. Kim, C. Ko and B.C. Lee (2009). Generation of Red Fluorescent Protein Transgenic Dogs. *Genesis*, 47(5), pp. 314–322.
- Hsu, P.D., E.S. Lander and F. Zhang (2014). Development and Applications of CRISPR-Cas9 for Genome Engineering. *Cell*, 157(6), pp. 1262–1278.
- Hsu, P.D., D.A. Scott, J.A. Weinstein, F.A. Ran, S. Konermann, V. Agarwala, Y. Li, E.J. Fine, X. Wu, O. Shalem, T.J. Cradick, L.A. Marraffini, G. Bao and F. Zhang (2013). DNA Targeting Specificity of RNA-guided Cas9 Nucleases. *Nature Biotechnology*, 31(9), pp. 827–832.
- Huang, Z., A. Tomitaka, A. Raymond and M. Nair (2017). Current Application of CRISPR/Cas9 Gene-editing Technique to Eradication of HIV/AIDS. *Gene Therapy*, 24(7), pp. 377–384.

- Hubrecht, R. (1995). Genetically Modified Animals, Welfare and UK Legislation. *Animal Welfare*, 4, pp. 163–170.
- Hulot, J.S., K. Ishikawa and R.J. Hajjar (2016). Gene Therapy for the Treatment of Heart Failure: Promise Postponed. *European Heart Journal*, 37(21), pp. 1651–1658.
- Hunter, A.J. (2011). Have Animal Models of Disease Helped or Hindered the Drug Discovery Process?. *Annals of the New York Academy of Sciences*, 1245, pp. 1–2.
- Ihry, R.J., K.A. Worringer, M.R. Salick, E. Frias, D. Ho, K. Theriault, S. Kommineni, J. Chen, M. Sondey, C. Ye, R. Randhawa, T. Kulkarni, Z. Yang, G. McAllister, C. Russ, J. Reece-Hoyes, W. Forrester, G.R. Hoffman, R. Dolmetsch and A. Kaykas (2018). p53 inhibits CRISPR-Cas9 engineering in human pluripotent stem cells. *Nature Medicine*, 24, pp. 939–946.
- Jaenisch, R. and B. Mintz (1974). Simian Virus 40 DNA Sequences in DNA of Healthy Adult Mice Derived from Preimplantation Blastocysts Injected with Viral DNA. *Proceedings of the National Academy of Sciences of the United States of America*, 71(4), pp. 1250–1254.
- Jennings, C.G., R. Landman, Y. Zhou, J. Sharma, J. Hyman, J.A. Movshon, Z. Qiu, A.C. Roberts, A.W. Roe, X. Wang, H. Zhou, L. Wang, F. Zhang, R. Desimone and G. Feng (2016). Opportunities and Challenges in Modeling Human Brain Disorders in Transgenic Primates. *Nature Neuroscience*, 19(9), pp. 1123–1130.
- Jiang, F. and J.A. Doudna (2017). CRISPR-Cas9 Structures and Mechanisms. *Annual Review of Biophysics*, 46, pp. 505–529.
- Johnston, I. (2016). Transplanted Pig's Heart Survives in Monkey for at least 51 Days in New Record. *The Independent*. [online] Available at: <http://www.independent.co.uk/news/science/pig-heart-monkey-51-days-survival-transplant-a7420446.html> [Accessed: 30 July 2018].
- Kanchiswamy, C.N., M. Maffei, M. Malnoy, R. Velasco and J.S. Kim (2016). Fine-tuning Next-generation Genome Editing Tools. *Trends in Biotechnology*, 34(7), pp. 562–574.
- Karolinska Institutet (2018). Press release: Genome-editing tool could increase cancer risk. Available: <https://ki.se/en/news/genome-editing-tool-could-increase-cancer-risk> [Accessed 13 Sep 2018].
- Kim, H.J., H.J. Lee, H. Kim, S.W. Cho and J.S. Kim (2009). Targeted Genome Editing in Human Cells with Zinc Finger Nucleases Constructed Via Modular Assembly. *Genome Research*, 19(7), pp. 1279–1288.
- Kleinstiver, B.P., V. Pattanayak, M.S. Prew, S.Q. Tsai, N.T. Nguyen, Z. Zheng and J.K. Joung (2016). High-fidelity CRISPR-Cas9 Nucleases with No Detectable Genome-wide Off-target Effects. *Nature*, 529(7587), pp. 490–495.
- Kok, F.O., M. Shin, C.W. Ni, A. Gupta, A.S. Grosse, A. van Impel, B.C. Kirchmaier, J. Peterson-Maduro, G. Kourkoulis, I. Male, D.F. DeSantis, S. Sheppard-Tindell, L. Ebarasi, C. Betsholtz, S. Schulte-Merker, S.A. Wolfe and N.D. Lawson (2015). Reverse Genetic Screening Reveals Poor Correlation Between Morpholino-induced and Mutant Phenotypes in Zebrafish. *Developmental Cell*, 32(1), pp. 97–108.

- Komor, A.C., A.H. Badran and D.R. Liu (2017). CRISPR-based Technologies for the Manipulation of Eukaryotic Genomes. *Cell*, 168(1–2), pp. 20–36.
- Koscielny, G., G. Yaikhom, V. Iyer, T.F. Meehan, H. Morgan, J. Atienza-Herrero, A. Blake, C.K. Chen, R. Easty, A. Di Fenza, T. Fiegel, M. Griffiths, A. Horne, N.A. Karp, N. Kurbatova, J.C. Mason, P. Matthews, D.J. Oakley, A. Qazi, J. Regnard, A. Retha, L.A. Santos, D.J. Sneddon, J. Warren, H. Westerberg, R.J. Wilson, D.G. Melvin, D. Smedley, S.D. Brown, P. Flicek, W.C. Skarnes, A.M. Mallon and H. Parkinson (2014). The International Mouse Phenotyping Consortium Web Portal, A Unified Point of Access for Knockout Mice and Related Phenotyping Data. *Nucleic Acids Research*, 42(Database issue), pp. D802–9.
- Kosicki, M., K. Tomberg and A. Bradley (2018). Repair of double-strand breaks induced by CRISPR-Cas9 leads to large deletions and complex rearrangements. *Nature Biotechnology*, [Epub ahead of print].
- Laboratory Animal Science Association (2008). *Transgenics*. Position paper. [online] Available: http://www.lasa.co.uk/pdf/position_transgenics.pdf [Accessed 30 July 2018], p. 4.
- Lai, L., J.X. Kang, R. Li, J. Wang, W.T. Witt, H.Y. Yong, Y. Hao, D.M. Wax, C.N. Murphy, A. Rieke, M. Samuel, M.L. Linville, S.W. Korte, R.W. Evans, T.E. Starzl, R.S. Prather and Y. Dai (2006). Generation of Cloned Transgenic Pigs Rich in Omega-3 Fatty Acids. *Nature Biotechnology*, 24(4), pp. 435–436.
- Leaman, J., J. Latter and M. Clemence (2014). *Attitudes to Animal Research in 2014*. A report by Ipsos MORI for the Department for Business Innovation & Skills. Ipsos MORI Social Research Institute. [online] Available at: https://www.ipsos.com/sites/default/files/migrations/en-uk/files/Assets/Docs/Polls/sri_BISanimalresearch_NONTRENDreport.pdf [Accessed 30 July 2018].
- Ledford, H. (2015). CRISPR, The Disruptor. *Nature*, 522(7554), pp. 20–24.
- Li, H., C. Sheng, S. Wang, L. Yang, Y. Liang, Y. Huang, H. Liu, P. Li, C. Yang, X. Yang, L. Jia, J. Xie, L. Wang, R. Hao, X. Du, D. Xu, J. Zhou, M. Li, Y. Sun, Y. Tong, Q. Li, S. Qiu and H. Song (2017). Removal of Integrated Hepatitis B Virus DNA Using CRISPR-Cas9. *Frontiers in Cellular and Infection Microbiology*, 7, p. 91.
- Liang, P., Y. Xu, X. Zhang, C. Ding, R. Huang, Z. Zhang, J. Lv, X. Xie, Y. Chen, Y. Li, Y. Sun, Y. Bai, Z. Songyang, W. Ma, C. Zhou and J. Huang (2015). CRISPR/Cas9-mediated Gene Editing in Human Trippronuclear Zygotes. *Protein and Cell*, 6(5), pp. 363–372.
- Liao, B.Y. and J. Zhang (2008). Null Mutations in Human and Mouse Orthologs Frequently Result in Different Phenotypes. *Proceedings of the National Academy of Sciences of the United States of America*, 105(19), pp. 6987–6992.
- Lin, A., C.J. Giuliano, N.M. Sayles and J.M. Sheltzer (2017). CRISPR/Cas9 Mutagenesis Invalidates a Putative Cancer Dependency Targeted in On-going Clinical Trials. *eLife*, 6, p. e24179.

- Liu, H., Y. Chen, Y. Niu, K. Zhang, Y. Kang, W. Ge, X. Liu, E. Zhao, C. Wang, S. Lin, B. Jing, C. Si, Q. Lin, X. Chen, H. Lin, X. Pu, Y. Wang, B. Qin, F. Wang, H. Wang, W. Si, J. Zhou, T. Tan, T. Li, S. Ji, Z. Xue, Y. Luo, L. Cheng, Q. Zhou, S. Li, Y.E. Sun and W. Ji (2014). TALEN-mediated Gene Mutagenesis in Rhesus and Cynomolgus Monkeys. *Cell Stem Cell*, 14(3), pp. 323–328.
- Liu, Z., X. Li, J.T. Zhang, Y.J. Cai, T.L. Cheng, C. Cheng, Y. Wang, C.C. Zhang, Y.H. Nie, Z.F. Chen, W.J. Bian, L. Zhang, J. Xiao, B. Lu, Y.F. Zhang, X.D. Zhang, X. Sang, J.J. Wu, X. Xu, Z.Q. Xiong, F. Zhang, X. Yu, N. Gong, W.H. Zhou, Q. Sun and Z. Qiu (2016). Autism-like Behaviours and Germline Transmission in Transgenic Monkeys Overexpressing MeCP2. *Nature*, 530(7588), pp. 98–102.
- Loria, K. (2016). Cows with Horns May Soon Be a Relic of Farming's Painful Past. *Business Insider*. [online] Available at: <http://uk.businessinsider.com/recombinetics-genetically-edited-cattle-without-horns-2016-5?r=us&ir=t> [Accessed: 30 July 2018].
- Lu, Q.L., S. Cirak and T. Partridge (2014). What Can We Learn from Clinical Trials of Exon Skipping for DMD. *Molecular Therapy, Nucleic Acids*, 3, p. e152.
- Luo, J., Z. Song, S. Yu, D. Cui, B. Wang, F. Ding, S. Li, Y. Dai and N. Li (2014). Efficient Generation of Myostatin (MSTN) Biallelic Mutations in Cattle Using Zinc Finger Nucleases. *PLoS One*, 9(4), p. e95225.
- Luo, X., M. Li and B. Su (2016). Application of the Genome Editing Tool CRISPR/Cas9 in Non-human Primates. *Dongwuxue Yanjiu*, 37(4), pp. 214–219.
- Lv, Q., L. Yuan, J. Deng, M. Chen, Y. Wang, J. Zeng, Z. Li and L. Lai (2016). Efficient Generation of Myostatin Gene Mutated Rabbit by CRISPR/Cas9. *Scientific Reports*, 6, p. 25029.
- MarketsandMarkets (2017). *Genome Editing/Genome Engineering Market by Technology (CRISPR, TALEN, ZFN), Application (Cell Line Engineering, Animal Genetic Engineering, Plant Genetic Engineering), End User (Biotechnology & Pharmaceutical Companies, CROs) - Global Forecast 2022*. [online] Available at: <https://www.marketsandmarkets.com/Market-Reports/genome-editing-engineering-market-231037000.html> [Accessed: 30 July 2018].
- McGonigle, P. (2014). Animal Models of CNS disorders. *Biochemical Pharmacology*, 87(1), pp. 140–149.
- McGonigle, P. and B. Ruggeri (2014). Animal Models of Human Disease: Challenges in Enabling Translation. *Biochemical Pharmacology*, 87(1), pp. 162–171.
- Mepham, T.B., R.D. Combes, M. Balls, O. Barbieri, H.J. Blokhuis, P. Costa, R.E. Crilly, T. de Cock Buning, V.C. Delpire, M.J. O'Hare, L.M. Houdebine, C.F. van Kreijl, M. van der Meer, C.A. Reinhardt, E. Wolf and A.M. van Zeller (1998). The Use of Transgenic Animals in the European Union: The Report and Recommendations of ECVAM Workshop 28. *Alternatives to Laboratory Animals*, 26(1), pp. 21–43.

- Midic, U., P.H. Hung, K.A. Vincent, B. Goheen, P.G. Schupp, D.D. Chen, D.E. Bauer, C.A. VandeVoort and K.E. Latham (2017). Quantitative Assessment of Timing, Efficiency, Specificity, and Genetic Mosaicism of CRISPR/Cas9 Mediated Gene Editing of Hemoglobin Beta Gene in Rhesus Monkey Embryos. *Human Molecular Genetics*, 26(14), pp. 2678–2689.
- Mogil, J.S. (2009). Animal Models of Pain: Progress and Challenges. *Nature Reviews Neuroscience*, 10(4), pp. 283–294.
- Mohiuddin, M.M., A.K. Singh, P.C. Corcoran, M.L. Thomas, T. Clark, B.G. Lewis, R.F. Hoyt, M. Eckhaus, R.N. Pierson, A.J. Belli, E. Wolf, N. Klymiuk, C. Phelps, K.A. Reimann, D. Ayares and K.A. Horvath (2016). Chimeric zC10R4 anti-CD40 Antibody Therapy Is Critical for Long-term Survival of GTKO.hCD46.hTBM Pig-to-primate Cardiac Xenograft. *Nature Communications*, 7, p. 1138.
- Morgens, D.W., R.M. Deans, A. Li and M.C. Bassik (2016). Systematic Comparison of CRISPR/Cas9 and RNAi Screens for Essential Genes. *Nature Biotechnology*, 34(6), pp. 634–636.
- Moura, R.R., L. Melo and V.J. de Figueiredo Freitas (2011). Production of Recombinant Proteins in Milk of Transgenic and Non-transgenic Goats. *Brazilian Archives of Biology and Technology*, 54, pp. 927–938.
- Moyo, B., K. Bloom, T. Scott, A. Ely and P. Arbuthnot (2017). Advances with Using CRISPR/Cas-mediated Gene Editing to Treat Infections with Hepatitis B Virus and Hepatitis C Virus. *Virus Research*, [Epub ahead of print].
- Musunuru, K. (2013). Genome Editing of Human Pluripotent Stem Cells to Generate Human Cellular Disease Models. *Disease Models and Mechanisms*, 6(4), pp. 896–904.
- Nakagawa, Y., T. Sakuma, N. Nishimichi, Y. Yokosaki, N. Yanaka, T. Takeo, N. Nakagata and T. Yamamoto (2016). Ultra-superovulation for the CRISPR-Cas9-Mediated Production of Gene-knockout, Single-amino-acid-substituted, and Floxed Mice. *Biology Open*, 5(8), pp. 1142–1148.
- Niemann, H. and B. Petersen (2016). The Production of Multi-transgenic Pigs: Update and Perspectives for Xenotransplantation. *Transgenic Research*, 25(3), pp. 361–374.
- Nishizaki, S.S. and A.P. Boyle (2017). Mining the Unknown: Assigning Function to Non-coding Single Nucleotide Polymorphisms. *Trends in Genetics*, 33(1), pp. 34–45.
- Niu, Y., B. Shen, Y. Cui, Y. Chen, J. Wang, L. Wang, Y. Kang, X. Zhao, W. Si, W. Li, A.P. Xiang, J. Zhou, X. Guo, Y. Bi, C. Si, B. Hu, G. Dong, H. Wang, Z. Zhou, T. Li, T. Tan, X. Pu, F. Wang, S. Ji, Q. Zhou, X. Huang, W. Ji and J. Sha (2014). Generation of Genetically Modified Cynomolgus Monkey via Cas9/RNA-mediated Gene Targeting in One-cell Embryos. *Cell*, 156(4), pp. 836–843.
- Norgren, R.B.J. (2004). Creation of Non-human Primate Neurogenetic Disease Models by Gene Targeting and Nuclear Transfer. *Reproductive Biology and Endocrinology*, 2, p. 40.

- Nuffield Council on Bioethics (2016). Genome Editing: An Ethical Review. [online] Available at: <http://nuffieldbioethics.org/project/genome-editing/ethical-review-published-september-2016> [Accessed: 30 July 2018].
- Olsson, I.A. and P. Sandøe (2010). "What's Wrong with My Monkey?" Ethical Perspectives on Germline Transgenesis in Marmosets. *Transgenic Research*, 19(2), pp. 181–186.
- Ormandy, E.H., C.A. Schuppli and D.M. Weary (2009). Worldwide Trends in the Use of Animals in Research: The Contribution of Genetically-modified Animal Models. *Alternatives to Laboratory Animals*, 37(1), pp. 63–68.
- Pattanayak, V., S. Lin, J.P. Guilinger, E. Ma, J.A. Doudna and D.R. Liu (2013). High-throughput Profiling of Off-target DNA Cleavage Reveals RNA-programmed Cas9 Nuclease Specificity. *Nature Biotechnology*, 31(9), pp. 839–843.
- Peng, R., G. Lin and J. Li (2016). Potential Pitfalls of CRISPR/Cas9-mediated Genome Editing. *The FEBS Journal*, 283(7), pp. 1218–1231.
- Perera, M.T., D.F. Mirza and E. Elias (2009). Liver Transplantation: Issues for the Next 20 years. *Journal of Gastroenterology and Hepatology*, 24 Suppl 3, pp. S124–31.
- Perrin, S. (2014). Preclinical Research: Make Mouse Studies Work. *Nature*, 507(7493), pp. 423–425.
- Petersen, B. and H. Niemann (2015). Molecular Scissors and Their Application in Genetically Modified Farm Animals. *Transgenic Research*, 24(3), pp. 381–396.
- Pratt, J., C. Winchester, N. Dawson and B. Morris (2012). Advancing Schizophrenia Drug Discovery: Optimizing Rodent Models to Bridge the Translational Gap. *Nature Reviews Drug Discovery*, 11(7), pp. 560–579.
- Proudfoot, C., D.F. Carlson, R. Huddart, C.R. Long, J.H. Pryor, T.J. King, S.G. Lillico, A.J. Mileham, D.G. McLaren, C.B. Whitelaw and S.C. Fahrenkrug (2015). Genome Edited Sheep and Cattle. *Transgenic Research*, 24(1), pp. 147–153.
- Quinn, P.M., L.P. Pellissier and J. Wijnholds (2017). The CRB1 Complex: Following the Trail of Crumbs to a Feasible Gene Therapy Strategy. *Frontiers in Neuroscience*, 11, p. 175.
- Robinson, V., M. Jennings and G. Working (2004). Refinement and Reduction in the Production of Genetically Modified Mice: Sixth Report of the BVAWF/FRAME/RSPCA/UFAW Joint Working Group on Refinement. *Alternatives to Laboratory Animals*, 32(Suppl. 1A), pp. 373–375.
- Rollin, B.E. (2015). Telos, Conservation of Welfare, and Ethical Issues in Genetic Engineering of Animals. *Current Topics in Behavioral Neurosciences*, 19, pp. 99–116.
- Rose, M., J. Everitt, H. Hedrich, J. Schofield, M. Dennis, E. Scott, G. Griffin and International Council for Laboratory Animal Sciences (ICLAS) Working Group on Harmonization (2013). ICLAS Working Group on Harmonization: International Guidance Concerning the Production Care and Use of Genetically-altered Animals. *Laboratory Animals*, 47(3), pp. 146–152.

- Rosen, B., J. Schick and W. Wurst (2015). Beyond Knockouts: The International Knock-out Mouse Consortium Delivers Modular and Evolving Tools for Investigating Mammalian Genes. *Mammalian Genome*, 26(9–10), pp. 456–466.
- Ruggeri, B.A., F. Camp and S. Miknyoczki (2014). Animal Models of Disease: Preclinical Animal Models of Cancer and Their Applications and Utility in Drug Discovery. *Biochemical Pharmacology*, 87(1), pp. 150–161.
- Sasaki, E., H. Suemizu, A. Shimada, K. Hanazawa, R. Oiwa, M. Kamioka, I. Tomioka, Y. Sotomaru, R. Hirakawa, T. Eto, S. Shiozawa, T. Maeda, M. Ito, R. Ito, C. Kito, C. Yagihashi, K. Kawai, H. Miyoshi, Y. Tanioka, N. Tamaoki, S. Habu, H. Okano and T. Nomura (2009). Generation of Transgenic Non-human Primates with Germline Transmission. *Nature*, 459(7246), pp. 523–527.
- Schaefer, K.A., W.H. Wu, D.F. Colgan, S.H. Tsang, A.G. Bassuk and V.B. Mahajan (2017). Unexpected Mutations after CRISPR-Cas9 Editing *In Vivo*. *Nature Methods*, 14(6), pp. 547–548.
- Schaefer, K.A., B.W. Darbro, D.F. Colgan, S.H. Tsang, A.G. Bassuk and V.B. Mahajan (2018). Corrigendum and Follow-up: Whole Genome Sequencing of Multiple CRISPR-edited Mouse Lines Suggests No Excess Mutations. *bioRxiv*. Preprint. doi.10.1101/154450.
- Servick, K. (2016). Researchers Keep Pig Hearts Alive in Baboons for More Than 2 Years. *Science*. American Association for the Advancement of Science. [online] Available at: http://www.sciencemag.org/news/2016/04/researchers-keep-pig-hearts-alive-baboons-more-2-years?utm_campaign=news_daily_2016-04-05&et rid=80753971&et_cid=393886 [Accessed: 30 July 2018].
- Shriver, A. (2015). Would the Elimination of the Capacity to Suffer Solve Ethical Dilemmas in Experimental Animal Research?. *Current Topics in Behavioral Neurosciences*, 19, pp. 117–132.
- Skarnes, W.C. (2015). Is Mouse Embryonic Stem Cell Technology Obsolete?. *Genome Biology*, 16, p. 109.
- Sluch, V.M., C.H. Davis, V. Ranganathan, J.M. Kerr, K. Krick, R. Martin, C.A. Berlinicke, N. Marsh-Armstrong, J.S. Diamond, H.Q. Mao and D.J. Zack (2015). Differentiation of Human ESCs to Retinal Ganglion Cells Using a CRISPR Engineered Reporter Cell Line. *Scientific Reports*, 5, p. 16595.
- Snowdon, K. (2016). Chinese Scientists Create “Autistic” Monkeys in “Cruel” Research Study Slammed by Cruelty Free International. *Huffington Post*. [online] Available at: http://www.huffingtonpost.co.uk/2016/01/28/chinese-scientists-autistic-monkeys_n_9101858.html [Accessed: 30 July 2018].
- Soppe, J.A. and R.J. Lebbink (2017). Antiviral Goes Viral: Harnessing CRISPR/Cas9 to Combat Viruses in Humans. *Trends in Microbiology*, 25(10), pp. 833–850.
- Storer, R.J., W. Suprinsinchai and A. Srikiatkachorn (2015). Animal Models of Chronic Migraine. *Current Pain and Headache Reports*, 19(1), p. 467.

- Takahashi, K. and S. Yamanaka (2006). Induction of Pluripotent Stem Cells from Mouse Embryonic and Adult Fibroblast Cultures by Defined Factors. *Cell*, 126(4), pp. 663–676.
- Takahashi, K., K. Tanabe, M. Ohnuki, M. Narita, T. Ichisaka, K. Tomoda and S. Yamanaka (2007). Induction of Pluripotent Stem Cells from Adult Human Fibroblasts by Defined Factors. *Cell*, 131(5), pp. 861–872.
- Taylor, K. and L. Rego (2016). EU Statistics on Animal Experiments for 2014. *Alternatives to Animal Experiments*, 33(4), pp. 465–468.
- Taylor, K., N. Gordon, G. Langley and W. Higgins (2008). Estimates for World-wide Laboratory Animal Use in 2005. *Alternatives to Laboratory Animals*, 36(3), pp. 327–342.
- Thon, R., J. Lassen, A. Kornerup Hansen, I.M. Jegstrup and M. Ritskes-Hoitinga (2002). Welfare Evaluation of Genetically Modified Mice: An Inventory Study of Reports to the Danish Animal Experiments Inspectorate. *Scandinavian Journal of Laboratory Animal Science*, 29(1), pp. 45–53.
- TNS Opinion & Social (2010). *Science and Technology Report*. Special Eurobarometer 340/wave 73.1. [online] Available at: http://ec.europa.eu/public_opinion/archives/ebs/ebs_340_en.pdf [Accessed: 30 July 2018].
- Tsai, S.Q. and J.K. Joung (2016). Defining and Improving the Genome-wide Specificities of CRISPR-Cas9 Nucleases. *Nature Reviews, Genetics*, 17(5), pp. 300–312.
- Tsai, S.Q., Z. Zheng, N.T. Nguyen, M. Liebers, V.V. Topkar, V. Thapar, N. Wyvekens, C. Khayter, A.J. Iafrate, L.P. Le, M.J. Aryee and J.K. Joung (2015). GUIDE-seq Enables Genome-wide Profiling of Off-target Cleavage by CRISPR-Cas Nucleases. *Nature Biotechnology*, 33(2), pp. 187–197.
- UK Home Office (2014). *Non-technical Summaries Granted in 2014*. [online] Available at: <https://www.gov.uk/government/collections/non-technical-summaries-granted-in-2014> [Accessed: 30 July 2018].
- UK Home Office (2016). *Statistics of Scientific Procedures on Living Animals: Great Britain 2015*. [online] Available at: <http://www.gov.uk/government/statistics/statistics-of-scientific-procedures-on-living-animals-great-britain-2015> [Accessed: 30 July 2018].
- Wang, Z., Q. Pan, P. Gendron, W. Zhu, F. Guo, S. Cen, M.A. Wainberg and C. Liang (2016). CRISPR/Cas9-Derived Mutations Both Inhibit HIV-1 Replication and Accelerate Viral Escape. *Cell Reports*, 15(3), pp. 481–489.
- Webb, D.R. (2014). Animal Models of Human Disease: Inflammation. *Biochemical Pharmacology*, 87(1), pp. 121–130.
- Wells, D.J., L.C. Playle, W.E. Enser, P.A. Flecknell, M.A. Gardiner, J. Holland, B.R. Howard, R. Hubrecht, K.R. Humphreys, I.J. Jackson, N. Lane, M. Maconochie, G. Mason, D.B. Morton, R. Raymond, V. Robinson, J.A. Smith and N. Watt (2006). Assessing the Welfare of Genetically Altered Mice. *Laboratory Animals*, 40(2), pp. 111–114.

- West, J. and W.W. Gill (2016). Genome Editing in Large Animals. *Journal of Equine Veterinary Science*, 41, pp. 1–6.
- Würbel, H. (2017). More than 3Rs: The Importance of Scientific Validity for Harm-benefit Analysis of Animal Research. *Lab Animal (NY)*, 46(4), pp. 164–166.
- Yang, L., M. Güell, D. Niu, H. George, E. Lesha, D. Grishin, J. Aach, E. Shrock, W. Xu, J. Poci, R. Cortazio, R.A. Wilkinson, J.A. Fishman and G. Church (2015). Genome-wide Inactivation of Porcine Endogenous Retroviruses (PERVS). *Science*, 350(6264), pp. 1101–1104.
- Yang, P., J. Wang, G. Gong, X. Sun, R. Zhang, Z. Du, Y. Liu, R. Li, F. Ding, B. Tang, Y. Dai and N. Li (2008a). Cattle Mammary Bioreactor Generated by a Novel Procedure of Transgenic Cloning for Large-scale Production of Functional Human Lactoferrin. *PLoS One*, 3(10), p. e3453.
- Yang, S.H., P.H. Cheng, H. Banta, K. Piotrowska-Nitsche, J.J. Yang, E.C. Cheng, B. Snyder, K. Larkin, J. Liu, J. Orkin, Z.H. Fang, Y. Smith, J. Bachevalier, S.M. Zola, S.H. Li, X.J. Li and A.W. Chan (2008b). Towards a Transgenic Model of Huntington's Disease in a Non-human Primate. *Nature*, 453(7197), pp. 921–924.
- Yu, S., J. Luo, Z. Song, F. Ding, Y. Dai and N. Li (2011). Highly Efficient Modification of Beta-lactoglobulin (blg) Gene Via Zinc-finger Nucleases in Cattle. *Cell Research*, 21(11), pp. 1638–1640.
- Yue, F., Y. Cheng, A. Breschi, J. Vierstra, W. Wu, T. Ryba, R. Sandstrom, Z. Ma, C. Davis, B.D. Pope, Y. Shen, D.D. Pervouchine, S. Djebali, R.E. Thurman, R. Kaul, E. Rynes, A. Kirilusha, G.K. Marinov, B.A. Williams, D. Trout, H. Amrhein, K. Fisher-Aylor, I. Antoshechkin, G. DeSalvo, L.H. See, M. Fastuca, J. Drenkow, C. Zaleski, A. Dobin, P. Prieto, J. Lagarde, G. Bussotti, A. Tanzer, O. Denas, K. Li, M.A. Bender, M. Zhang, R. Byron, M.T. Groudine, D. McCleary, L. Pham, Z. Ye, S. Kuan, L. Edsall, Y.C. Wu, M.D. Rasmussen, M.S. Bansal, M. Kellis, C.A. Keller, C.S. Morrissey, T. Mishra, D. Jain, N. Dogan, R.S. Harris, P. Cayting, T. Kawli, A.P. Boyle, G. Euskirchen, A. Kundaje, S. Lin, Y. Lin, C. Jansen, V.S. Malladi, M.S. Cline, D.T. Erickson, V.M. Kirkup, K. Learned, C.A. Sloan, K.R. Rosenbloom, B. Lacerda de Sousa, K. Beal, M. Pignatelli, P. Flicek, J. Lian, T. Kahveci, D. Lee, W.J. Kent, M. Ramalho Santos, J. Herrero, C. Notredame, A. Johnson, S. Vong, K. Lee, D. Bates, F. Neri, M. Diegel, T. Canfield, P.J. Sabo, M.S. Wilken, T.A. Reh, E. Giste, A. Shafer, T. Kutayavin, E. Haugen, D. Dunn, A.P. Reynolds, S. Neph, R. Humbert, R.S. Hansen, M. De Bruijn, L. Selleri, A. Rudensky, S. Josefowicz, R. Samstein, E.E. Eichler, S.H. Orkin, D. Levasseur, T. Papayannopoulou, K.H. Chang, A. Skoultchi, S. Gosh, C. Disteche, P. Treuting, Y. Wang, M.J. Weiss, G.A. Blobel, X. Cao, S. Zhong, T. Wang, P.J. Good, R.F. Lowdon, L.B. Adams, X.Q. Zhou, M.J. Pazin, E.A. Feingold, B. Wold, J. Taylor, A. Mortazavi, S.M. Weissman, J.A. Stamatoyannopoulos, M.P. Snyder, R. Guigo, T.R. Gingeras, D.M. Gilbert, R.C. Hardison, M.A. Beer, B. Ren and E.N.C.O.D.E.C. Mouse (2014). A Comparative Encyclopedia of DNA Elements in the Mouse Genome. *Nature*, 515(7527), pp. 355–364.

Zou, Q., X. Wang, Y. Liu, Z. Ouyang, H. Long, S. Wei, J. Xin, B. Zhao, S. Lai, J. Shen, Q. Ni, H. Yang, H. Zhong, L. Li, M. Hu, Q. Zhang, Z. Zhou, J. He, Q. Yan, N. Fan, Y. Zhao, Z. Liu, L. Guo, J. Huang, G. Zhang, J. Ying, L. Lai and X. Gao (2015). Generation of Gene-target Dogs Using CRISPR/Cas9 System. *Journal of Molecular Cell Biology*, 7(6), pp. 580–583.

Animal Research for Alzheimer Disease: Failures of Science and Ethics

John J. Pippin

Physicians Committee for Responsible Medicine, Washington, DC,
United States
jpippin@pcrm.org

Sarah E. Cavanaugh

Rockville, Maryland, United States

Francesca Pistollato

European Commission, Joint Research Centre, Ispra, Italy

1 Introduction

This is a uniquely human disease, with impairments in abstract reasoning and judgment. We've cured mice engineered with this disease over 500 times. The mouse models don't translate into humans. We know for a fact that mice don't write books.

HOWARD FILLIT, Chief Science Officer, Alzheimer's Drug Discovery Foundation, in Shakoor et al., 2017

Perhaps the most impactful and foreboding development in chronic diseases in recent decades has been the increasing prevalence and awareness of dementia. The various dementias, especially Alzheimer disease (AD), have derailed and ended the lives of tens of millions in America and worldwide. It is a truism that AD patients die twice. First the mind dies, and only later does the body. AD uniquely and unremittingly affects not only patients, but their families, caregivers, and communities. In recent years, AD may have displaced cancer as the most feared disease among Americans. As with other diseases that have no meaningful methods for prevention and treatment, research targeting AD has primarily focused on preclinical approaches, predominantly using animals. Nonetheless, decades of animal research have failed to translate into significant advances in the prevention or treatment of AD. In view of this failure, a different and human-relevant approach is critically needed.

This chapter addresses the epidemiology and current understanding of AD as a scientific and societal challenge, reviews the uses and results of animal research in basic science and drug development, and discusses risk factors and funding. Important follow-up topics, including current and in-development, human-relevant approaches for replacement of the failed animal research paradigm, deserve comparable treatment and hence are not addressed here. The reader is referred to the list of recommended readings at the end of the chapter for further discussion of these topics.

The ethics of continued use of the animal-based approach in AD is troublesome in at least two respects. First, regardless of where one stands on the ethical spectrum of animal use for medical research, certainly the inhumane and lethal use of animals for demonstrably faulty research is unethical. Second, the ethical responsibility to AD patients, their families, and the larger community demands reliable and useful results, which in turn demand a revised research approach, emphasizing human-relevant methods.

2 Epidemiology and Current Status

Dementia can be defined as a disorder of mental capabilities caused by brain disease or injury and marked by memory disorders, impaired thought and reasoning, diminished judgment, social withdrawal, and altered personality. Except for several reversible causes, dementia is a chronic and unremitting disease with a fatal outcome. AD is the most common form of dementia, accounting for 60%–80% of all dementia diagnoses in the United States (US) (Alzheimer's Association, 2017). The next four most prevalent categories of dementia (vascular dementia, dementia with Lewy bodies, frontotemporal dementia, and mixed dementia) account for all but a small percentage of the other diagnoses. Vascular and mixed dementia overlap considerably with AD; nearly all cases of vascular dementia display characteristics of AD (Thal, Grinberg and Attems, 2012), and prevalence figures do not include the AD precursor, mild cognitive impairment (MCI), making the percentage of dementia and incipient dementia attributable to AD even higher (Lopez et al., 2012; Mitchell and Shiri-Feshki, 2009; Roberts et al., 2014a; Ward et al., 2013). AD prevalence increases with age and varies based on diagnostic criteria and death records. It can only be definitively diagnosed by postmortem examination of the brain, though recent advances in neuroimaging and cerebrospinal fluid analysis offer strong clinical evidence and presumptive diagnosis. AD is almost certainly underdiagnosed and underreported, both among persons who die *of* AD and

those who die *with* AD (James et al., 2014; Taylor et al., 2017; Wachterman, Kiely and Mitchell, 2008; Weuve et al., 2014).

A reasonable estimate of AD prevalence in the US is 3% of persons aged 65–74 years, 17% of persons aged 75–84 years, and 32% of persons aged 85 years and older (Hebert et al., 2013), though some sources estimate the risk for persons 85 years and older as nearly 50% (Alzheimer's Association, 2012; Chai, 2007; Gatz et al., 2006). About 5.5 million Americans (two-thirds of whom are women) currently have AD, and this number is expected to increase to nearly 14 million by 2050 (Hebert et al., 2013). The number of people living with dementia worldwide is estimated at 47.5 million and is projected to increase to 75.6 million by 2030 and more than triple by 2050 (World Health Organization, 2015). The estimated global cost of AD in 2015 was US\$818 billion (McDade and Bateman, 2017), which according to the International Monetary Fund (2017) and the World Bank (2017), would rank as the 18th highest national gross domestic product worldwide.

Conversely, evidence has emerged in recent years suggesting that the incidence and prevalence of AD and other less common dementias have been decreasing in some populations, perhaps for more than three decades (Langa et al., 2017; Satizabal et al., 2016). Improved risk factor management has been suggested as mitigating AD incidence and prevalence. However, a recent report from the US Centers for Disease Control and Prevention, using state- and county-level death certificate data from the National Vital Statistics System for the period 1999–2014, demonstrates that the AD death rate increased by 54% between 1999 and 2014 (Taylor et al., 2017). Between 2000–2014, the annualized number of deaths from AD in the US increased by a remarkable 89% (Alzheimer's Association, 2017); while deaths from heart disease, stroke, and HIV decreased by 14%, 21%, and 54%, respectively (Shakoor et al., 2017). The reported increases in AD deaths and death rate are likely partly attributable to more careful reporting of the disease.

AD is the sixth leading cause of death in the US, the fifth leading cause of death for persons 65 years old and older, and among the leading causes of disability and chronic poor health. Among the ten most common causes of death, AD is the only one with no effective approach for prevention, slowing disease progression, or cure. AD ranked 25th among diseases in the US, in terms of disability-adjusted life-years lost in 1990 and 12th in 2010, the largest change among the 30 leading diseases (US Burden of Disease Collaborators, 2013). It is not surprising that the public's fear of AD is escalating. In 2012, a Marist poll of 1,247 US adults found that AD was the most feared disease, chosen by 44% of participants compared to 33% for cancer, the second most feared disease (Help for Alzheimer's Families, 2012).

3 Animal Basic Science Research and Correlations

Most basic science research of AD has used animals, predominantly mice (transgenic, inbred, and wild-type), but also rats and, to a lesser degree, other species, such as rabbits, dogs, and non-human primates. Numerous genetic mutations have been suggested to contribute to the pathological changes in the brains of AD patients, resulting in the selective breeding and research utilization of many transgenic strains of mice and rats expressing those mutations (Cavanaugh, Pippin and Barnard, 2014; Do Carmo and Cuello, 2013; Jackson Laboratory, 2017; Webster et al., 2014). Because gene-disease links have been associated predominantly with autosomal dominant, early-onset familial AD (accounting for fewer than 5% of cases), transgenic animal models have been based on early-onset disease; and the resultant data have been extrapolated to relate to the much more common, late-onset sporadic AD. Researchers thus seek to recapitulate the genetic and pathological elements of human AD, thereby deriving mechanistic and therapeutic knowledge that is hoped to translate to the human condition.

The business of breeding transgenic animal strains for AD research has flourished, and there are several commercial sources for these animals (Alzforum, 2017; Charles River, 2017; Jackson Laboratory, 2017; Taconic Biosciences, 2017). Extensive lists of animal models for AD basic science research and drug development have been published, including information on specific genetic configurations and how these animals have been used (Cavanaugh, Pippin and Barnard, 2014; Kumar et al., 2016; Neha et al., 2014; Puzzo et al., 2014).

Because postmortem studies have identified specific brain pathologies among AD patients, most notably extracellular beta-amyloid (A β) plaques and intracellular neurofibrillary tangles (NFT), the great majority of basic science research has used genetically modified animals to produce similar brain pathologies. A β plaques have been associated with localized inflammation, contributing to the neuronal and synaptic network damage believed to be related to AD symptoms and disease progression (Eikelenboom et al., 1989; Eikelenboom and Veerhuis, 1996; Rosenberg, 2005; Veerhuis, 2011). The ability to produce A β plaques and NFT in animal models has been available for more than three decades (Glenner and Wong, 1984; Kosik, Joachim and Selkoe, 1986; Wood et al., 1986). A β plaques are also formed, then often broken down and removed in healthy human brains; but they persist and accumulate in AD brains. Further complicating the relationship between A β plaques and AD, studies have shown that 14%–21% of clinically diagnosed patients have zero or minimal brain A β plaques on postmortem examination (Beach et al., 2012; Beekly et al., 2007; Serrano-Pozo et al., 2014).

Tau proteins serve an essential role in the structure and function of microtubules that regulate intracellular transport of important nutrients. NFT consist of hyperphosphorylated tau proteins, resulting in characteristic fibrillar structures and microtubule dysfunction, contributing to neuronal destruction as well as disruption of axonal growth and plasticity (Kosik, Joachim and Selkoe, 1986; Wood et al., 1986). Both extracellular A β and intracellular NFT are believed to extend damage to the brain's connecting network of dendrites and axons, thereby disrupting intercellular communication and contributing to loss of neurons and neuronal networks. The postulated causative role for A β and NFT in clinical AD is further confounded by findings that both pathologies have been identified in the brains of patients with frontotemporal dementia, Parkinson disease, Huntington disease, Down syndrome, and amyotrophic lateral sclerosis, as well as in normal brains (Cavanaugh, Pippin and Barnard, 2014; Masters et al., 1985; Ross and Poirier, 2004).

Mutations in genes encoding amyloid precursor protein (APP), as well as the gamma secretase catalytic proteins presenilin 1 (PSEN1) and presenilin 2 (PSEN2), have also been linked to familial AD and have been employed in the study of the disease in animals (Borchelt, et al., 1997; Chartier-Harlin et al., 1991; Goate et al., 1991; Levy-Lehad et al., 1995; Mullan et al., 1992). Inheritance of the apolipoprotein E type 4 allele (ApoE4) has been linked to an increased risk for late-onset AD, though the gene-disease link is weakened by the fact that the ApoE4 allele is neither necessary nor sufficient to predict AD (Corder et al., 1993; Rossor et al., 1996; Sadigh-Eteghad et al., 2012; Strittmatter et al., 1993). Numerous transgenic or double-transgenic animal models have induced and accelerated the development of A β plaques and have produced associated brain inflammation with cognitive and behavioral pathologies. These models have not produced NFT, but NFT have been produced in conjunction with cognitive deficits by animal models expressing mutated tau protein. A triple transgenic mouse model expressing mutated human A β precursor protein, PSEN1, and tau protein was developed to generate both A β plaques and NFT; this model also produced associated gliosis, synaptic pathology, and impaired memory (Oddo et al., 2003).

The senescence-accelerated mouse prone 8 (SAMP8) strain with a mean lifespan of 9.7 months is considered by researchers to be more suitable to investigate late-onset AD (Pallàs, 2012). SAMP8 mice exhibit dendritic spine loss, spongiosis, gliosis, and forebrain cholinergic deficits, while developing A β deposits and aberrant hyperphosphorylated tau-like NFTs (Cheng, Zhou and Zhang, 2014). Despite extensive characterization of SAMP and the SAMP8-APP/PSEN1 mouse model (i.e., double transgenic for amyloid precursor protein and PSEN1 in the senescence-accelerated background of SAMP8) (Lok et al., 2013; Porquet et al., 2015), the genes responsible for senescence and the observed pathological traits are largely unknown. Moreover,

SAMP8-APP/PS1 mice exhibit significant differences in A β plaque formation and cognitive abnormalities when compared with human AD (Porquet et al., 2015).

Further information, regarding the specific animal models, their phenotypic results, and their contributions to the knowledge base for animal surrogates of human AD and some important biological and outcome differences, is available (e.g., Cavanaugh, Pippin and Barnard, 2014; Esquerda-Canals et al., 2017; Geerts, 2009; Kumar et al., 2016).

Many of the animal experiments have been successful in determining the pathogenesis and progression of simulated AD-like disorders at the molecular, cellular, and behavioral levels *for the transgenic species studied*. Some topics, such as steps in amyloid and tau pathways, have prospered from transgenic animal studies. However, though various transgenic models develop specific phenotypical aspects of AD— not only A β plaques and NFT, but also related gliosis, synaptic alterations, neurodegeneration, behavioral changes, and memory deficit—no individual animal model or combination of models replicates the clinicopathological complexity of human Alzheimer or translates to improved outcomes for Alzheimer patients (Dodart et al., 2002; Duyckaerts, Potier and Delatour, 2008).

What are the correlations between the extensive animal-derived knowledge and the etiology, risk factors, clinical course, pathophysiology, treatments, and outcomes of AD, and what is the payoff expected from basic science research? It is now well understood that, despite the plethora of Alzheimer animal models in use, the interspecies translation is poor for genetic, physiological, and technical reasons (Neha et al., 2014). No matter how close two species, or even two strains within a species, may be genetically, there are immutable differences in gene function, gene expression, protein production, and phenotypic or physiological results that render translation unpredictable and unreliable. Description and explanation of many animal-human discrepancies specific to AD are available (see Cavanaugh, Pippin and Barnard, 2014; Langley, 2014). The demonstrated inability to modify animal models to improve translation provides further evidence that only a shift to human-derived and, thus human-relevant, research methods can improve the applicability of basic science research to human AD.

4 Animal Drug Development Research and Outcomes

The translational goal of basic science research for medical diseases is to provide the knowledge required to predict, prevent, identify, treat, and hopefully cure these diseases. As such, the success of this approach for AD can be

measured, in substantial part, by assessing the role of animal research in pharmaceutical development. Over the past three decades, basic and applied science research have identified mechanisms leading to the discovery of drug targets and the development of drugs customized for those targets. An extensive review of these targets, drugs, and clinical trial results is beyond the scope of this chapter but may be found elsewhere (see Berk and Sabbagh, 2013; Cavanaugh, Pippin and Barnard, 2014; Langley, 2014; Schneider et al., 2014).

Though the current discussion is limited to AD, context is also important in fairly assessing the success of preclinical animal research for drug development. For the past eight decades, preclinical testing methods for the safety and efficacy of drugs have relied heavily on the use of animals, not least because this has been the default approach of the US Food and Drug Administration (FDA) and regulatory agencies in most other regions of the world. This animal-testing paradigm has never been subjected to a systematic validation of translation to human medicine or consistency among or within non-human species and different laboratories. Former FDA pharmacology and toxicology reviewer, Anita O'Connor, confirmed this situation in 1998, stating that: "Most of the animal tests we accept have never been validated. They evolved over the past 20 years, and the FDA is comfortable with them." Similarly, in the United Kingdom, Parliamentary Under-Secretary of State, Caroline Flint stated, in 2004, that: "The Home Office has not commissioned or evaluated any formal research on the efficacy of animal experiments" (UK Parliament, 2004). This situation persists not only in these two nations.

As far back as 2003, the FDA reported a clinical trial failure rate of 92% for drugs deemed safe and effective based on preclinical animal studies, a marked increase from the already high 86% attrition rate in 1985, despite purported advances in preclinical drug testing (FDA, 2004; Mitka, 2006; Singh and Henske, 2003). The most recent phase-specific data for drugs tested safe and effective in preclinical animal studies identified clinical trial attrition rates of 56% for Phase I (designed to assess drug safety and estimate dosing); 82% for Phase II (designed to assess proof of concept); and 50% for Phase III (designed to assess safety and effectiveness for humans) (Arrowsmith, 2011a; Arrowsmith, 2011b; Lovell-Badge, 2013)—a cumulative 96% failure rate. When drug withdrawals, duplicative "me too" drugs, and low patient response rates are included, only about one in one hundred drugs that are tested successfully in animals becomes a unique, effective, and safe medication; and then it is very likely to be effective for only a minority of patients and often marginally so. This is certainly the case with the four drugs licensed to treat AD.

There could hardly be stronger evidence that animal use for drug testing is very unreliable and poorly contributes to drug efficacy or safety in the real world. Added to this serious false-positive problem are the missed opportunities

for useful drugs, due to false-negative animal testing and adverse effects that would not translate to humans. The cause-effect relationship between animal testing and clinical trial results was succinctly stated by Stanford's Joseph Garner (Garner, 2014, p. 440):

The logic tying failures in clinical trials to basic research in animals is seductively straightforward. Every drug entering human trials, by definition, "worked" in an animal model in terms of both safety and efficacy, and efficacy is the primary reason drugs fail in human trials. Thus, the primary reason for these failures can be traced back directly to false positives in animal models committing the pipeline to develop a drug that will ultimately fail. Straightforward data can be used to make this case. For instance, as reviewed by Zahs and Ashe (2010), over 200 different interventions have been reported to be effective in the APP mouse model of Alzheimer's disease, yet none has proven effective in human trials.

Animal research addressing drug development for AD is even worse than the overall pattern described above. Despite the 2,204 AD clinical trials (including 1,329 completed, terminated, suspended, and withdrawn drug studies) listed at ClinicalTrials.com on July 24, 2017, only four drugs are currently FDA-approved for treatment of the disease alone or in combination (Table 20.1). Three of these are acetylcholinesterase inhibitors (AChEI), which inhibit the depletion of the crucial neurotransmitter acetylcholine in AD. The fourth drug is a N-methyl-D-aspartate (NMDA) receptor antagonist that inhibits the destructive excitatory action of glutamate at the cellular level.

It is perhaps a measure of the dearth of therapies to address AD that the FDA has approved even these few drugs, which only scratch the surface of AD therapy. The drugs produce very small changes, of dubious clinical relevance, on cognitive and behavioral measurement scales (Delrieu et al., 2011); they typically have mild impact on symptoms in only a minority of patients, have no effect on disease progression or mortality, often lose any effectiveness within several months, and may produce serious adverse effects.

Despite the low bar for FDA approval of AD drugs, the pharmaceutical industry trade group, Pharmaceutical Research and Manufacturers of America (PhRMA), reported that between 1998–2014, 123 drugs failed in AD clinical trials (2015), further supporting the organization's comments in its 2012 report: "The limited utility of current models of the human disease is a huge barrier in preclinical testing of drug candidates [...] Unfortunately, these medical treatments do not always work, they cannot cure the disease or stop its progression, and when they work their efficacy often wears off over time" (PhRMA, 2012).

TABLE 20.1 FDA-approved drugs for Alzheimer disease (2019)

Drug name	Brand name	Category	FDA approval	Approved disease stages	Approved generic
Donepezil	Aricept	AChEI ^a	1996	All stages	Yes
Rivastigmine	Exelon	AChEI	2000	Mild-moderate Moderate-severe ^b	Yes
Galantamine	Razadyne	AChEI	2001	Mild-moderate	Yes
Memantine	Namenda	NMDARI ^c	2003	Moderate-severe	Yes
Donepezil + memantine	Namzaric	AChEI + NMDARI	2014	Moderate-severe	Yes

a Acetylcholinesterase inhibitor

b Patch is approved for moderate-severe

c N-methyl-D-aspartate receptor inhibitor.

The AChEI tacrine was approved for mild-moderate AD in 1993 and withdrawn in 2013 due to severe toxicities

Cummings, Morstorf and Zhong (2014) reported on all registered AD drug trials for the period between 2002–2012, using NIH's ClinicalTrials.gov database to extract drug and trial data. They found that during this period, 244 candidate AD drugs were tested in 413 clinical drug trials. There was a 72% attrition rate for Phase I trials, which reached 92% when Phase II trials were added. Only one drug succeeded in Phase III to achieve FDA approval (memantine in 2003). The failure rate was 99.6% (243 of 244 the drugs tested). An analysis of AD clinical drug trials reported from January 1, 2004 (after memantine approval) through to July 19, 2017, reveals 1,273 completed or closed trials and no approved drugs (ClinicalTrials.gov, n.d.).

PhRMA reported 77 AD drugs in clinical trials in 2016, 21 of which were in Phase III studies (PhRMA, 2016). By May 2017, nine of these drugs had already failed at least one late-stage trial, none had a successful outcome, and numerous others no longer had trials registered on ClinicalTrials.gov. In January 2016, ClinicalTrials.gov listed 93 agents in 115 open AD trials: 24 agents in 36 Phase III trials, 45 agents in 52 Phase II trials, and 24 agents in 27 Phase I trials (Cummings, Morstorf and Lee, 2016). In July 2017, none of these had achieved a successful outcome. Data from the July 2017 Alzheimer's Association International Conference reported 58 Phase II and 32 Phase III AD drugs in development, including 8 Phase II and 27 Phase III drugs expected to launch in the next five years (Henriques, 2017; Us Against Alzheimer's, 2017).

Table 20.2 displays notable drugs that have failed late-stage clinical trials in the past six years. Some drugs have failed several clinical trials and some have

continued to be evaluated in additional late-stage clinical trials. Among drug candidates currently in Phase III trials are A β antibodies aducanumab (Biogen) and crenezumab (Hoffmann-La Roche); BACE1 inhibitors elenbecestat (Biogen) and JNJ-54861911 (Janssen); 5-HT6 antagonist SUVN-502 (Suven Life Sciences); and NMDA receptor antagonist AVP-786 (Avanir).

Cumulatively, Cummings et al.'s (2014) results from 2002–2012 data and results for 2013–2018, shown in Table 20.2, demonstrate that at least 265 AD drugs have failed in clinical trials in the past 15 years. The race between translatable research and burgeoning disease is being lost, with no clear path

TABLE 20.2 Notable Alzheimer drug failures from 2013–2018

Failed drug	Category	Sponsor	Most recent failed trial	Reason for failure
LY 2886721	BACE1 inhibitor	Lilly	2013	Toxicity
Intravenous Ig	Immune modulator	Baxter, Intl.	2013	Ineffective
Begacestat	γ secretase inhibitor	Bristol-Myers Squibb	2013	Ineffective
Bapineuzumab	A β antibody	Pfizer	2014	Ineffective
Affitope AD02	A β vaccine	AFFiRiS AG	2014	Ineffective
PF04447943	PDE9A inhibitor	Pfizer	2014	Ineffective
Gantenerumab	A β antibody	Hoffmann-La Roche	2014 2015	Ineffective Toxicity
BI 1181181	BACE1/2 inhibitor	Boehringer Ingelheim	2015	
ω -3 fatty acid	Dietary supplement	University Hospital, Toulouse, France	2015	Ineffective
Sembragiline	MAO-B inhibitor	Roche	2015	Ineffective
Encenicline	α 7 NAR agonist	FORUM	2015	Toxicity (FDA halted)
Masitinib	Tyrosine kinase inhibitor A β vaccine	AB Science	2015	Ineffective
CAD 106		Novartis	2016	Ineffective
Idalopirdine	5-HT6 antagonist	Lundbeck & Otsuka	2016	Ineffective
PF05212377	5-HT6 antagonist	Pfizer	2016	Ineffective
Bexarotene	Anti-neoplastic	Cleveland Clinic	2016	Ineffective

TABLE 20.2 Notable Alzheimer drug failures from 2013–2018 (*cont.*)

Failed drug	Category	Sponsor	Most recent failed trial	Reason for failure
LMTX	Tau aggregation inhibitor	TauRx	2016	Ineffective
Bryostatin	PKC modulator	Neurotrope	2017	Ineffective
AC-1204	Ketosis inducer	Accera	2017	Ineffective
Intepirdine	5-HT ₆ antagonist	Axovant Sciences	2017	Ineffective
BAN2401	A β antibody	Biogen/Eisai	2017	Ineffective
Solanezumab	A β antibody	Lilly	2018	Ineffective
Pioglitazone	antiglycemic	Takeda/Zinfandel	2018	Ineffective
BI 409306	PDE _{9A} inhibitor	Boehringer Ingelheim	2018	Ineffective
Verubecestat	BACE ₁ inhibitor	Merck	2018	Ineffective
Azeliragon	RAGE inhibitor	vTv	2018	Ineffective
Pimavanserin	5-HT _{2A} antagonist	Acadia	2018	Ineffective
Atabecestat	BACE ₁ inhibitor	Johnson & Johnson	2018	Toxicity
Lanabecestat	BACE ₁ inhibitor	Lilly	2018	Ineffective
Elenbecestat	BACE ₁ inhibitor	Biogen/Eisai	2018	Ineffective

BACE₁=beta-site amyloid precursor protein-cleaving enzyme 1; Ig=immunoglobulin; RAGE=receptor for advanced glycation endproducts; PDE_{9A}=phosphodiesterase 9A; MAO-B= monoamine oxidase B; α_7 NAR= α_7 nicotinic acetylcholine receptor; 5-HT₆=5-hydroxytryptamine (serotonin) type 6 receptor; PKC=protein kinase C; 5-HT_{2A}=5-hydroxytryptamine (serotonin) type 2A receptor.

to improvement other than the replacement of the failed animal research paradigm by a commitment to human-relevant research methods.

5 Whither the Amyloid Cascade Hypothesis?

The amyloid cascade hypothesis, in its initial description (Hardy and Allsop, 1991; Hardy and Higgins, 1992) and in its reappraisal (Hardy, 2006; Hardy and Selkoe, 2002), has been foundational for AD preclinical and clinical research for a quarter of a century. Early and widespread acceptance of the hypothesis has impacted research gatekeepers, such as funding agencies, journal editors, peer reviewers, and pharmaceutical companies. The amyloid cascade hypothesis,

derived from human autopsy studies, identifying the presence and presumed causative roles for A β plaques and tau proteins, proposes that sequential enzymatic cleavage of mutated APP by secretase enzymes results in deposition of soluble A β protein oligomers that coalesce into plaques, and that downstream events include tau protein and NFT formation and cell death. The specifics of inflammation and destruction of neuronal networks were identified with further investigation. This entire process is termed, *neurodegeneration*.

In the pursuit of AD research, abundant information has been obtained casting doubt on the amyloid cascade hypothesis. Paramount among contrary information is the finding that a meaningful percentage of young adult (Baker-Nigh et al., 2015) and older persons (Armstrong et al., 1996; Esparza et al., 2013; Haroutunian et al., 2008; Monsell et al., 2013; Price et al., 2009), without dementia, have substantial A β plaque deposition demonstrated in brain imaging and postmortem studies. In one large review, amyloid biomarkers increased with age and were present in 10%–44% of cognitively normal participants aged 50–90 years (Jansen, et al., 2015). Lon Schneider of the University of Southern California, Keck School of Medicine, stated that: “There are people who die with a head full of amyloid and have no cognitive impairment whatsoever” (Mullin, 2017). Conversely, A β plaques may be absent or minimally present in clinically diagnosed AD patients (Monsell et al., 2015; Morris, Clark and Vissel, 2014; Terry et al., 1991). A recent report demonstrates that tau oligomers, produced subsequent to A β deposition, are also present in the sera of aged normal controls as well as AD patients (Kolarova et al., 2017). It has been reported that some degree of tau pathology is ubiquitous in postmortem human brains (Braak and Braak, 1997; Braak and Del Tredici, 2011).

Since some drugs have successfully removed brain A β plaque without producing improvement in cognition and other symptoms and without improving clinical course or mortality, it has been proposed that A β plaques may not be causative for AD. Tau pathology not only is triggered by A β plaques but also appears to progress unabated even after the removal of A β plaques, suggesting that therapies targeting A β are unlikely to succeed in controlling AD (Hampel et al., 2010; Wang et al., 2016). Some recent basic science and drug development research has focused on a possible AD causative role for tau proteins rather than A β plaques, but the only completed tau-targeting Phase III drug trial (a tau protein aggregation inhibitor known as LMTX, LMTM, or TRx0237) failed to show benefits (Alzforum, 2016a). The true AD target may be the synaptic and neuronal network destruction that is the common final pathway to dementia. An alternative interpretation is that the timing of A β -targeted therapies may be

key: Once A β plaque has formed, it may be too late to reverse the pathological consequences.

AD has appropriately been described as late-life phenotypes, beginning as midlife pathologies with a two-decade or more latency period. There is now a corresponding move towards identifying and validating biomarkers to aid in detecting AD in its earliest stages, or even before symptoms appear, so that the neuronal network damage may be prevented rather than treated (Donohue et al., 2017; Schneider et al., 2014). Foremost among these approaches may be prevention trials enrolling asymptomatic persons, with characteristic neuroimaging pathology or with specific cerebrospinal fluid biomarkers (Donohue et al., 2017; Jansen et al., 2015; Olsson et al., 2016; Ramachandran, 2016), and targeting subsequent cognitive loss and the development of MCI or AD.

Earlier intervention is a logical approach derived from the failure of later clinical intervention, but its value is debatable for at least three reasons. First, the biomarkers indicating risk for AD are not yet sufficiently accurate to exclude persons who would never develop AD or even MCI from clinical trials. Second, fewer than half of persons with MCI will progress to AD, making even this indicator of limited utility and suggesting that earlier biomarkers may be fraught with low specificity and positive predictive value (Mitchell and Shiri-Feshki, 2009; Richard and Brayne, 2014; Roberts et al., 2014a; Ward et al., 2013). Third, this approach does not directly address the failure of animal research to identify disease-modifying therapies, though it is postulated that some failed therapies may be effective if applied earlier.

So, the fate of the amyloid cascade hypothesis remains unknown but appears tenuous; and its demise would seriously compromise decades of basic science, clinical, and pharmaceutical efforts. Outcomes to date have not confirmed, and generally do not support, the amyloid cascade hypothesis; and if current and pending early-stage and presymptomatic A β -targeted studies fail to impact outcomes, it must be presumed to be incorrect. It is axiomatic that the first step in understanding, characterizing, and addressing disease is to determine the cause(s). We have not demonstrably done this for AD, arguably because basic science research, predominantly using transgenic animals, has been unable to accomplish the task despite more than three decades of effort.

6 The Expanding Role of Lifestyle Factors for AD Prevention

Concomitant with the emphasis on earlier detection and preventive measures for AD, there is a need to identify factors that are predictive of,

contributory to, or protective for the development of cognitive impairment and AD. In particular, modifiable lifestyle factors associated with risk for cognitive impairment and AD offer a particularly appealing approach to prevention—lifestyle modifications without adding heretofore failed drug treatments.

Blood pressure—pressure variability rather than absolute systolic, diastolic, or mean blood pressure—has been associated with risk for subsequent cognitive decline and AD in a unique manner. The same pattern of greater cognitive decline with greater blood pressure variability has been established for office (Alpérovitch et al., 2014; Sabayan et al., 2013); ambulatory (McDonald et al., 2017); and home (Matsumoto et al., 2014; Oishi et al., 2017) blood pressure measurements and for day-to-day or month-to-month variability. Though blood pressure variability has also been shown to correlate with cardiovascular event risk and target organ damage (Kikuya et al., 2008; Rothwell et al., 2010); it is unknown whether there are shared mechanisms with cognitive decline, and it is also unknown whether specific blood pressure control efforts impact the cognitive risk (Palatini, 2014). Observational studies of hypertension and cognitive risk have been heterogeneous, but the evidence is strongest for risk correlation between mid-life hypertension and late-life AD and all cause dementia (Kennelly, Lawlor and Kenny, 2009a; Kennelly, Lawlor and Kenny, 2009b; Purnell et al., 2009; Qiu, Winblad and Fratiglioni, 2005), with an estimated relative risk of 1.6 (Barnes and Yaffe, 2011).

Regular *exercise* is a topic of great interest for potential reduction of the risk for cognitive decline and AD. A prospective study of 200 persons with mild dementia evaluated cognitive outcomes of a group receiving 16 weeks of supervised exercise and a non-exercise control group. No differences were seen in objective measures of cognition, quality of life, or ability to perform activities of daily living (Hoffman et al., 2016). This outcome was confirmed in a Swedish study of 186 persons with dementia who participated in an intensive four-month exercise program (Toots et al., 2017). A Western Australia prospective trial evaluated exercise effect on cognition among 138 at-risk older adults, randomized to either 24 weeks of supervised physical activity or no exercise. This methodologically problematic study showed minimal and dubious improved cognitive measures over 18 months (Lautenschlager et al., 2008). In a secondary analysis of the randomized prospective LIFE trial, a 24-month physical activity intervention involving 1,635 sedentary older adults, no exercise-related improvements were seen in global or domain-specific cognitive function (Sink et al., 2015).

In contrast, a 2009 meta-analysis of 16 studies including 163,797 non-demented participants showed an approximate 45% reduced risk for AD and 28% reduction in all-cause dementia, between the highest and lowest physical

activity groups, with a relative risk among inactives of 1.82 for AD (Hamer and Chida, 2009). Another systematic review reported that physical inactivity was linked to an increased risk for cognitive impairment in 20 of 24 included studies (Rolland, Abellan van Kan and Vellas, 2008). A 2010 meta-analysis of 15 prospective studies, including 33,816 nondemented subjects, who were followed for 1 to 12 years, showed a decreased risk for subsequent cognitive decline at all exercise levels (Sofi et al., 2010). These meta-analysis findings were compromised by conflicting results and methodological heterogeneity among the studies reviewed. A secondary analysis of a 30-year questionnaire-based study of midlife exercise found no relationship to subsequent cognitive impairment or dementia (Gross et al., 2017).

The majority of studies evaluating exercise or uncharacterized physical activity as predictors of subsequent cognitive impairment, AD, or all-cause dementia are observational cohort studies, variably compromised by methodological limitations. These limitations include poorly characterized or unsupervised exercise, inconsistent exercise and activity patterns, self-reporting by subjects, questionnaire-based data collection (subject to recall bias), researcher bias, variable influence of the observers on participant performance, and short interventional and observational periods, among other disadvantages. Cumulative findings to date show no significant evidence for exercise benefit regarding progression among persons with dementia, and conflicting evidence for benefit regarding future development of cognitive decline, AD, or all-cause dementia.

The relationship of *diet* to risk for cognitive decline and AD or uncharacterized dementia is a revealing area of investigation. Studies of specific dietary supplements have predominantly failed to show decreased risks for prevalent or incident cognitive decline and dementia, excluding replacement therapy for severe nutritional deficiencies, such as vitamin B₁₂ and niacin. Dietary supplement animal research supports beneficial effects for vitamins C, D, and E (Anastasiou, Yannakoulia and Scarmeas, 2014; Guerrero et al., 1999; Joseph et al., 1998; Socci, Crandall and Arendash, 1995; Yamada et al., 1999). Human studies of dietary vitamin intake have shown inconsistent results. Prospective observational studies in Chicago (Morris et al., 2002) and Rotterdam (Engelhart et al., 2002) showed lower AD risk with greater dietary vitamin E intake, while a similar study in New York showed no association (Luchsinger et al., 2003). The Rotterdam study showed lower AD risk with greater vitamin C intake, but the other two studies did not. The Chicago study also found a worrisome positive correlation between vitamin C intake and the risks for hypertension and stroke. None of the three studies showed benefit from vitamin C or vitamin E supplements.

In a 2014 study of elderly hospitalized patients, blood levels of 25-hydroxy vitamin D did not discriminate among cognitively normal (200); MCI (46); and demented (182) patients, nor did the levels predict conversion to dementia (Graf et al., 2014). Conversely, another observational study showed a relative risk for incident AD of 1.69 for deficient and 2.22 for severely deficient vitamin D levels among 1,658 healthy ambulatory adults (Littlejohns et al., 2014). Overall, human vitamin D study outcomes have been heterogeneous, but the highest quality evidence (clinical trials) does not support vitamin D-related benefit (Anastasiou, Yannakoulia and Scarmeas, 2014).

Dietary saturated fat and trans fat intake have been associated with higher AD risks in human studies (Kalmijn et al., 1997; Luchsinger et al., 2002; Morris et al., 2003), though this correlation disappeared during follow-up in one study (Kalmijn et al., 1997). A more recent systematic review revealed mixed evidence among four observational studies of saturated fat and trans fat intake and MCI or dementia (Barnard, Bunner and Agarwal, 2014). A study of 444 Finnish men linked elevated midlife blood cholesterol with increased subsequent AD risk (Notkola et al., 1998). Observational studies have reported lower AD risk with statin therapy (Jick et al., 2000; Wolozin et al., 2000); but a 2016 Cochrane review found no benefit on five cognitive tests in two randomized placebo-controlled trials of statins, including 26,340 participants (McGuinness, et al., 2016). Diets consisting substantially of meat, dairy, processed and fatty foods, snack foods (often high in trans fats), and high caloric content contribute to known AD risk factors as well as other health risks.

The pattern of accelerated AD and all-cause dementia after adoption of the American-style diet is widely evident, including in Japan (Grant, 2014), China (Chan et al., 2013), rural India (Chandra, et al., 1998), eight developing nations (Grant, 2014), and among participants in the Adventist Health Study (Giem, Beeson and Fraser, 1993). A recent comprehensive review of dietary data and cognitive risks from 2014–2016 presented updated data regarding seafood intake and lines of evidence against cognitive protection, despite the purported favorable effects of the omega-3 fatty acids, eicosapentaenoic acid, and docosahexaenoic acid (Solfrizzi et al., 2017).

Type 2 diabetes mellitus (T2DM) is an AD risk factor, resulting predominantly from the combined and cumulative effects of poor diet, sedentary lifestyle, and obesity. T2DM and AD are known to share pathologies, such as cerebrovascular disease, brain atrophy and diminished brain volume, impaired brain glucose metabolism, and CNS insulin resistance (Asih et al., 2017; Bharadwaj et al., 2017; Sutherland et al., 2017); and both disorders have been linked to tau pathology and neurodegeneration (Sutherland et al., 2017). At the clinical level, T2DM and AD both increase in incidence with age; and risks for

both have been shown for sedentary lifestyle, hypertension, poor diet, obesity, dyslipidemia, and smoking. Overlapping features, including the role of insulin resistance in the brain, have resulted in the designation of AD as “type 3 diabetes” (De La Monte and Wands, 2008).

Observational cohort studies, systematic reviews, and meta-analyses have predominantly identified T2DM in cognitively normal persons as a risk factor for MCI, AD, and all-cause dementia (Barnes and Yaffe, 2011; Biessels et al., 2006; Biessels et al., 2014; Cheng et al., 2012; Cukierman, Gerstein and Williamson, 2005; Exalto et al., 2012; Gudala et al., 2013; Kopf and Frolich, 2009; Lu, Lin and Kuo, 2009; Roberts, et al., 2014b; Yaffe, et al., 2012; Zhang et al., 2017), though some of these studies have methodological flaws and unaccounted bias (Sutherland et al., 2017). This correlation was not confirmed for the progression of cognitive decline among AD patients (Li et al., 2017). Several investigators have estimated the relative risk for AD from T2DM as 1.5 (Chatterjee et al., 2016; Cheng et al., 2012; Gudala et al., 2013), including recent population-based studies of more than 2.3 million (Chatterjee, et al., 2016) and more than 1.7 million persons (Zhang et al., 2017). A combined systematic review and meta-analysis of eight studies of T2DM and AD risk reported that seven studies found a positive correlation, but only two reached statistical significance, and overall relative risk was 1.4. (Lu, Lin and Kuo, 2009).

The risk for development of MCI, AD, and all-cause dementia increases with T2DM duration (Asih et al., 2017; Bruce et al., 2014). Dementia risk appears to be proportional to diabetes severity (Yaffe, et al., 2012), to occur at a younger age when T2DM is present (Zilkens et al., 2013), and to display shorter survival when combined with T2DM (Helzner et al., 2008; Zilkens et al., 2013). The rapidly increasing worldwide prevalence of T2DM, thus, suggests not only more prevalent AD, but also younger onset and shortened survival for AD patients. Conversely, improved T2DM prevention would be expected to have a beneficial effect on AD prevalence, onset, and mortality.

Based on the preceding and similar findings, certain recommendations can be made to minimize modifiable risks for cognitive decline and AD. These recommendations are built on the preponderance of evidence from human studies and the overall beneficial effects for cardiovascular disease, T2DM, obesity, hypertension, and other AD risk factors as well as for the hard endpoints of cognitive decline and dementia. Elements of the lifestyle prescription include, regular exercise or other physical activities; adoption of heart-healthy diets, such as the Mediterranean diet and other plant-based diets emphasizing fruits, vegetables, whole grains, and legumes (with consideration for excluding seafood consumption due to cholesterol content and uncertain benefit); preference for food sources rather than supplement sources of potentially protective dietary components; maintenance of normal body weight, blood

pressure, blood glucose and lipids; and other factors not discussed here, such as not smoking and attainment of at least a high school level of education. As a bonus, and in contrast to drug therapies, the side effects of this prescription are beneficial.

7 Brief Overview of Research Funding

During the first decade of the twenty-first century, AD research funding from NIH was strikingly low, compared to other widespread, lethal, and costly diseases. Passage of the US National Alzheimer's Project Act (NAPA) by Congress in January 2011, focused greater emphasis on AD research, and federal funding increased slowly until the 2016 and 2017 fiscal years showed large increases. In 2012, NIH research funding for AD and AD-related dementias was half a billion dollars, compared to US\$1.3 billion for heart disease, US\$3.1 billion for HIV/AIDS, and US\$5.6 billion for cancers. AD research funding did not exceed US\$600 million until 2015, but it received a 60% increase in 2016 and a 40% increase in 2017 (Alzforum, 2016b; Moore, 2017; NIH, 2016). Projected NIH AD research funding for 2017 is nearly US\$1.4 billion, almost triple the funding of the past five years, while funding for heart disease, HIV/AIDS, and cancers has remained unchanged.

While this is very good news for AD research, the devil is in the details. NIH funding in this area has been heavily weighted towards animal research for at least the past decade, supporting three times as many animal research protocols as human-specific protocols, and spending more than twice as many tax dollars for animal research (Figure 20.1). Total NIH expenditures for AD and AD-related dementia research since 2011 is more than US\$5 billion, with no clinical return on this investment. If this pattern of dependence on animal research is unchanged, genetic principles, interspecies differences, and history tell us that the AD animal research paradigm will continue to fail in producing advances in AD prevention and treatment, regardless of how much money is directed towards that goal.

Some private funding sources, which collectively distribute tens of millions of dollars annually for AD research, have shown a broader perspective regarding the directions for AD research. For example, in 2016 the Alzheimer's Association partnered with philanthropist Michaela Hoag to announce its *Part the Cloud Challenge* and grants totalling US\$7 million to fund clinical trials investigating brain inflammation in AD (Alzheimer's Association, 2016). The Alzheimer's Drug Discovery Foundation (2017) funds many non-amyloid, non-tau research approaches. The Paul G. Allen Family Foundation's US\$7 million award in 2015 sought innovative AD research approaches, emphasizing the

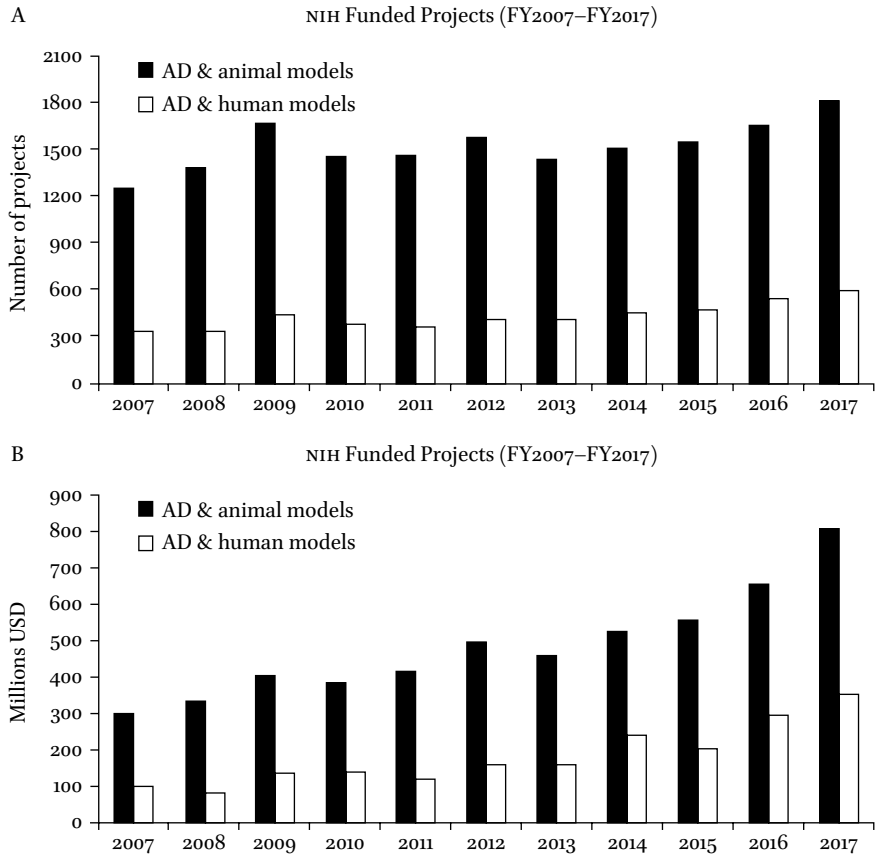

FIGURE 20.1 NIH funding for Alzheimer disease research. Bar graphs report the absolute numbers of Alzheimer's-related projects focused on the use of animal models (black bars) versus projects accounting only for human-relevant models/methods (white bars). (A) and (B) present relative funding provided by the NIH from 2007 to 2017. (Updated from Pistollato et al., 2016)

human disease, and the Microsoft cofounder stipulated that at least one member of each of the five recipient research teams must not be an AD researcher (Begley, 2016; Paul G. Allen Philanthropies, 2015). Similarly, the Darrell K. Royal Research (DKR) Fund for Alzheimer's Disease (2016) "is *interested* in novel, innovative and cutting-edge approaches to Alzheimer's disease, dementia, Traumatic Brain Injury, and related disorders. Additionally, the DKR Fund is particularly interested in non-amyloid and non-tau approaches that may not receive funding through traditional mechanisms. Studies that pilot novel mechanisms and novel therapeutic interventions are particularly encouraged."

(Underline in original.) It is through innovative and nontraditional research design, specifically human-relevant research, that the inability to translate basic science discoveries to AD prevention, treatment, and successful drug development may be overcome.

8 Conclusions: The Process and the Ethics

Perhaps as starkly as for any other disease, AD research ethics must address both animal use and human outcomes. This is because the animals suffer captive breeding and genetic alteration, community disruption, confinement, handling, fear, and painful procedures—and because AD research animals always die. It is also because the human disease is prevalent, frightening, and debilitating and its victims also always die from or with the disease. The animal-use ethical question involves a spectrum of viewpoints, ranging from no concern for the animals to strong objection to any harmful animal use for research purposes. Public surveys over the past few decades have shown a shift towards the latter position or towards restricting animal use to essential and unavoidable circumstances, the definition of which is also variable. But wherever one stands on the animal-use ethical spectrum, hopefully all can agree that the conduct of frightening, painful, and lethal experiments on sentient beings—whether mice, dogs, or monkeys—is unacceptable when the research translates in no significant way to human benefits, despite decades of effort. The authors of this chapter have been animal researchers, and they have first-hand knowledge that the process is unavoidably cruel, painful, unreliable, and ultimately unrewarding. Nonetheless, we have not argued that no useful knowledge ever results from animal experiments, but we have demonstrated that such knowledge is restricted in practical terms to the genetically manipulated experimental species. That is, it is unreliable for human medicine and does not result in meaningful treatments for AD.

In view of the billions of dollars of federal and private research support for AD, now more than one billion dollars annually of taxpayer funds alone, meaningful clinical results are an ethical expectation. Yet, such results remain absent, and there are no current animal research approaches promising translational basic science revelations or improved drug development in the foreseeable future. Spiraling costs related to basic science and clinical research, clinical diagnostics, acute and especially chronic patient care, caregiver support, and the economic consequences facing families, communities, and businesses are on track to decimate federal and private insurance programs and further impair economic productivity.

Arguably the most immediate ethical question regards accountability to AD patients, those at risk for AD, their families and communities. The costs of a failed animal research underpinning for AD are not limited to money spent and strained research resources, and include irretrievable losses in time, hope, and human lives. Of all the ethical accompaniments of AD animal research, the deferred and unrealized obligations to those impacted by AD, the persistence in pursuing a failed research model, the recurring hype surrounding drugs that cannot affect AD or its outcome, the advances perennially “just around the corner” are the real-world human consequences. As a corollary, preclinical researchers in the field have spent years or decades performing productive bench work without contributing to improving quality of life, delaying disease progression, or prolonging the lives of AD patients.

For now, and likely years ahead, there will be nothing more than the four largely inconsequential AD drugs currently available. Neurobiologist, George Perry, Dean of the College of Sciences at the University of Texas at San Antonio, summed this up: “The field has known for over 10 years, probably 15 years, that the models were not Alzheimer disease and could not predict therapeutic efficacy” (Begley, 2016). This paralyzing mindset must be overcome to gain ground on AD, and the replacement of animal research with human-relevant research methods is the path forward.

References

- Allen, Paul G. Philanthropies (2015). *Foundation Awards \$7 million to Reveal Biology of Alzheimer's Disease*. Press Release. [online] Available at: <http://www.pgafamilyfoundation.org/news/news-articles/2015-news-items/adi-alzheimers-press-release> [Accessed 18 May 2017].
- Alpérovitch, A., M. Blachier, A. Soumaré, K. Ritchie, J-F Dartigues., S. Richard-Harston and C. Tzourio (2014). Blood pressure variability and risk of dementia in an elderly cohort, the Three-City Study. *Alzheimer's & Dementia*, 10(5), pp. S330–S337.
- Alzforum (2016a). *In First Phase 3 Trial, The Tau Drug LMTM Did Not Work*. Period. [online] Available at: <http://www.alzforum.org/news/conference-coverage/first-phase-3-trial-tau-drug-lmtm-did-not-work-period> [Accessed 30 May 2017].
- Alzforum (2016b). *Proposed 2016 Budget Boosts Alzheimer's Funding by 60 Percent*. [online] Available at: <http://www.alzforum.org/news/community-news/proposed-2016-budget-boosts-alzheimers-funding-60-percent> [Accessed 17 May 2017].
- Alzforum (2017). *Research Models; Alzheimer's Disease*. [online] Available at: <http://www.alzforum.org/research-models/alzheimers-disease> [Accessed 25 April 2017].

- Alzheimer's Association (2012). *2012 Alzheimer's Disease Facts and Figures*. [online] Available at: https://www.alz.org/downloads/facts_figures_2012.pdf [Accessed 19 April 2017].
- Alzheimer's Association (2016). *Alzheimer's Association Issues \$7 million Challenge to Scientists to Speed Drug Discovery*. [online] Available at: http://alz.org/documents_custom/ptc_grants_080216.pdf [Accessed 11 May 2017].
- Alzheimer's Association (2017). *2017 Alzheimer's Disease Facts and Figures*. [online] Available at: <http://www.alz.org/dementia/types-of-dementia.asp> [Accessed 2 May 2017].
- Alzheimer's Drug Discovery Foundation (2017). *Research Priorities*. [online] Available at: <https://www.alzdiscovery.org/research-and-grants/priorities> [Accessed 18 May 2017].
- Anastasiou, C., M. Yannakoulia and N. Scarmeas (2014). Vitamin D and Cognition: An Update of the Current Evidence. *Journal of Alzheimer's Disease*, 42 (Supp 3), pp. S71–S80.
- Armstrong, R., N. Cairns, D. Myers, C. Smith, P. Lantos and M. Rossor (1996). A Comparison of β -amyloid Deposition in the Medial Temporal Lobe in Sporadic Alzheimer's Disease, Down's Syndrome, and Normal Elderly Brains. *Neurodegeneration*, 5(1), pp. 35–41.
- Arrowsmith, J. (2011a). Phase II Failures: 2008–2010. *Nature Reviews Drug Discovery*, 10(5), pp. 328–329.
- Arrowsmith, J. (2011b). Phase III and Submission Failures: 2007–2010. *Nature Reviews Drug Discovery*, 10(2), p. 87.
- Asih, P., M. Tegg, H. Sohrabi, M. Carruthers, S. Gandy, F. Saad, G. Verdile, L. Ittner and R. Martins (2017). Multiple Mechanisms Linking Type 2 Diabetes and Alzheimer's Disease: Testosterone as a Modifier. *Journal of Alzheimer's Disease*, 59(2), pp. 445–466.
- Baker-Nigh, A., S. Vahedi, E. Davis, S. Weintraub, E. Bigio, W. Klein and C. Geula (2015). Neuronal amyloid- β Accumulation Within Cholinergic Basal Forebrain in Aging and Alzheimer's Disease. *Brain*, 138(6), pp. 1722–1737.
- Barnard, N., A. Bunner and U. Agarwal (2014). Saturated and Trans fats and Dementia: A Systematic review. *Neurobiology of Aging*, 35(2), pp. S65–S73.
- Barnes, D. and K. Yaffe (2011). The Projected Effect of Risk Factor Reduction on Alzheimer's Disease Prevalence. *Lancet Neurology*, 10(9), pp. 819–828.
- Beach, T., S. Monsell, L. Phillips and W. Kukull (2012). Accuracy of the Clinical Diagnosis of Alzheimer Disease at National Institute on Aging Alzheimer's Disease Centers. *Journal of Neuropathology & Experimental Neurology*, 71(4), pp. 266–273.
- Beekly, D., E. Ramos, W. Lee, W. Deitrich, M. Jacka, J. Wu, J. Hubbard, T. Koepsell, J. Morris, W. Kukull and NIA Alzheimer's Disease Centers (2007). The National Alzheimer's Coordinating Center (NACC) Database: The Uniform Data Set. *Alzheimer Disease and Associated Disorders*, 21(3), pp. 249–258.

- Begley, S. (2016). Alzheimer's Researchers Seethe Over Years of Missteps After Latest Drug Failure. [online] Available at: <https://www.statnews.com/2016/07/28/alzheimers-drug-failure> [Accessed 18 May 2017].
- Berk, C. and M. Sabbagh (2013). Successes and Failures for Drugs in Late-stage Development for Alzheimer's Disease. *Drugs & Aging*, 30 (10), pp. 783–792.
- Bharadwaj, P., N. Wijesekara, M. Liyanapathirana, P. Newsholme, L. Ittner, P. Fraser and G. Verdile (2017). The Link Between Type 2 Diabetes and Neurodegeneration: Roles for Amyloid- β , Amylin, and Tau Proteins. *Journal of Alzheimer's Disease*, 59(2), pp. 421–432.
- Biessels, G., S. Staekenborg, E. Brunner, C. Brayne and P. Scheltens (2006). Risk of Dementia in Diabetes Mellitus: A Systematic Review. *Lancet Neurology*, 5(1), pp. 64–74.
- Biessels, G., M. Strachan, F. Visseren, L. Kappelle and R. Whitmer (2014). Dementia and Cognitive Decline in Type 2 Diabetes and Prediabetic Stages: Towards Targeted Interventions. *Lancet Diabetes Endocrinology*, 2(3), pp. 246–255.
- Borchelt, D., T. Ratovitski, J. van Lare, M. Lee, V. Gonzales, N. Jenkins, N. Copeland, D. Price and S. Sisodia (1997). Accelerated Amyloid Deposition in the Brains of Transgenic Mice Coexpressing Mutant Presenilin 1 and Amyloid Precursor Proteins. *Neuron*, 19(4), pp. 939–945.
- Braak, H. and E. Braak (1997). Frequency of Stages of Alzheimer-related Lesions in Different Age Categories. *Neurobiology of Aging*, 18(4), pp. 351–357.
- Braak, H. and K. Del Tredici (2011). The Pathological Process Underlying Alzheimer's Disease in Individuals Under Thirty. *Acta Neuropathologica*, 121(2), pp. 171–181.
- Bruce, D., W. Davis, S. Starkstein and T. Davis (2014). Midlife Predictors of Cognitive Impairment and Dementia in Type 2 Diabetes Mellitus: The Fremantle Diabetes Study. *Journal of Alzheimer's Disease*, 42 (Supp 3), pp. S63–S70.
- Cavanaugh, S., J. Pippin and N. Barnard (2014). Animal Models of Alzheimer Disease: Historical Pitfalls and a Path Forward. *Alternatives to Animal Experimentation*, 31(3), pp. 279–302.
- Chai, C. (2007). The Genetics of Alzheimer's Disease. *American Journal of Alzheimer's Disease and Other Dementias*, 22(1), pp. 37–41.
- Chan, K., W. Wang, J. Wu, L. Liu, E. Theodoratou, J. Car, L. Middleton, T. Russ, I. Deary, H. Campbell and I. Rudan, on behalf of the Global Health Epidemiology Reference Group (GHERG) (2013). Epidemiology of Alzheimer's Disease and Other Forms of Dementia in China, 1990–2010: A Systematic Review and Analysis. *Lancet*, 381 (9882), pp. 2016–2023.
- Chandra, V., M. Ganguli, R. Pandav, J. Johnston, S. Belle and S. DeKosky (1998). Prevalence of Alzheimer's Disease and Other Dementias in Rural India: The Indo-US Study. *Neurology*, 51(4), pp. 1000–1008.
- Charles River (2017). *Alzheimer's Disease Research*. [online] Available at: <http://www.crriver.com/products-services/drug-discovery/therapeutic-areas/central-nervous>

- system/biology/in-vivo-study-models/alzheimer-s-disease-model [Accessed 25 April 2017].
- Chartier-Harlin, M., F. Crawford, H. Houlden, A. Warren, D. Hughes, L. Fidani, A. Goate, M. Rossor, P. Roques, J. Hardy and M. Mullan (1991). Early-onset Alzheimer's Disease Caused by Mutations at Codon 717 of the β -Amyloid Precursor Protein Gene. *Nature*, 353 (6347), pp. 844–846.
- Chatterjee, S., S. Peters, M. Woodward, A. Mejia, G. Batty, N. Beckett, A. Beiser, A. Borstein, P. Crane, M. Haan, L. Hassing, K. Hayden, Y. Kiyohara, E. Larson, C. Li, T. Ninomiya, T. Ohara, R. Peters, T. Russ, S. Seshadri, B. Strand, R. Walker, W. Xu and R. Huxley (2016). Type 2 Diabetes as a Risk Factor for Dementia in Women Compared with Men: A Pooled Analysis of 2.3 Million People Comprising More Than 100,000 Cases of Dementia. *Diabetes Care*, 39(2), pp. 300–307.
- Cheng, G., C. Huang, H. Deng and H. Wang (2012). Diabetes as a Risk Factor for Dementia and Cognitive Impairment: A Meta-analysis of Longitudinal Studies. *Internal Medicine Journal*, 42(5), pp. 484–491.
- Cheng, X., W. Zhou, and Y. Zhang (2014). The Behavioral, Pathological and Therapeutic Features of the Senescence-accelerated Mouse Prone 8 Strain as an Alzheimer's Disease Animal Model. *Ageing Research Reviews*, 13, pp. 13–37.
- ClinicalTrials.gov (n.d.). Search Results for alzheimer| Suspended | Terminated | Completed | Withdrawn Studies. [online] Available at: https://www.clinicaltrials.gov/ct2/results?term=alzheimer&recrs=g&recrs=h&recrs=e&recrs=i&age_v=&gndr=&type=&rslt=&Search=Apply [Accessed 24 July 2017].
- Corder, E., A. Saunders, W. Strittmatter, D. Schmechel, P. Gaskell, G. Small, A. Roses, J. Haines and MA Pericak-Vance. (1993). Gene Dose of Apolipoprotein E Type 4 Allele and the Risk of Alzheimer's Disease in Late Onset Families. *Science*, 261 (5123), pp. 921–923.
- Cukierman, T., H. Gerstein and J. Williamson (2005). Cognitive Decline and Dementia in Diabetes—Systematic Overview of Prospective Observational Studies. *Diabetologia*, 48 (12), pp. 2460–2469.
- Cummings, J., T. Morstorf and K. Zhong (2014). Alzheimer's Disease Drug Development Pipeline: Few Candidates, Frequent Failures. *Alzheimer's Research & Therapy*, 6(37), pp. 1–7.
- Cummings, J., T. Morstorf and G. Lee (2016). Alzheimer's Drug Development Pipeline: 2016. *Alzheimer's & Dementia: Translational Research & Clinical Interventions*, 2(4), pp. 222–232.
- Darrell Royal Research Fund for Alzheimer's Disease (2016). 2016 Request for Funding Application. [online] Available at: http://dkrfund.org/pdfs/DKR2016_RFA.pdf [Accessed 18 May 2017].
- De La Monte, S. and J. Wands (2008). Alzheimer's Disease Is Type 3 Diabetes — Evidence Reviewed. *Journal of Diabetes Science and Technology*, 2(6), pp. 1101–1113.

- Delrieu, J., A. Piau, C. Caillaud, T. Voisin and B. Vellas (2011). Managing Cognitive Dysfunction Through the Continuum of Alzheimer's Disease: Role of Pharmacotherapy. *CNS Drugs*, 25(3), pp. 213–226.
- Do Carmo, S. and A. Cuello (2013). Modeling Alzheimer's Disease in Transgenic Rats. *Molecular Neurodegeneration*, 8(37).
- Dodart, J., C. Mathis, K. Bales and S. Paul (2002). Does My Mouse Have Alzheimer's Disease? *Genes, Brain, and Behavior*, 1(3), pp. 142–155.
- Donohue, M., R. Sperling, R. Petersen, C. Sun, M. Weiner and P. Aisen (2017). Association Between Elevated Brain Amyloid and Subsequent Cognitive Decline Among Cognitively Normal Persons. *Journal of the American Medical Association*, 317 (22), pp. 2305–2316.
- Duyckaerts, C., M. Potier and B. Delatour (2008). Alzheimer Disease Models and Human Neuropathology: Similarities and Differences. *Acta Neuropathologica*, 115(1), pp. 5–38.
- Eikelenboom, P. and R. Veerhuis (1996). The Role of Complement and Activated Microglia in the Pathogenesis of Alzheimer's Disease. *Neurobiology of Aging*, 17(5), pp. 673–680.
- Eikelenboom, P., C. Hack, J. Rozemuller and F. Stam (1989). Complement Activation in Amyloid Plaques in Alzheimer's Dementia. *Virchows Archiv. B, Cell Pathology Including Molecular Pathology*, 56(4), pp. 259–262.
- Engelhart, M., M. Geerlings, A. Ruitenberg, J. van Swieten, A. Hofman, J. Witteman and M. Breteler (2002). Dietary Intake of Antioxidants and Risk of Alzheimer Disease. *Journal of the American Medical Association*, 287 (24), pp. 3223–3229.
- Esparza, T., H. Zhao, J. Cirrito, N. Cairns, R. Bateman, D. Holtzman and D. Brody (2013). Amyloid-beta Oligomerization in Alzheimer Dementia Versus High-pathology Controls. *Annals of Neurology*, 73(1), pp. 104–119.
- Esquerda-Canals, G., L. Montoliu, J. Güell-Bosch and S. Villegas (2017). Mouse Models of Alzheimer's Disease. *Journal of Alzheimer's Disease*, 57(4), pp. 1171–1183.
- Exalto, L., R. Whitmer, L. Kappelle and G. Biessels (2012). An Update on Type 2 Diabetes, Vascular Dementia and Alzheimer's Disease. *Experimental Gerontology*, 47 (11), pp. 858–864.
- Garner, J. (2014). The Significance of Meaning: Why Do Over 90% of Behavioral Neuroscience Results Fail to Translate to Humans, and What Can We Do to Fix It?. *Institute of Laboratory Animal Research Journal*, 55(3), pp. 438–456.
- Gatz, M., C. Reynolds, L. Fratigioni, B. Johansson, J. Mortimer, S. Berg, A. Fiske and N. Petersen (2006). Role of Genes and Environments for Explaining Alzheimer Disease. *Archives of General Psychiatry*, 63(2), pp. 168–174.
- Geerts, H. (2009). Of Mice and Men: Bridging the Translational Disconnect in CNS Drug Discovery. *CNS Drugs*, 23 (11), pp. 915–926.

- Giem, P., W. Beeson and G. Fraser (1993). The Incidence of Dementia and Intake of Animal Products: Preliminary Findings from the Adventist Health Study. *Neuroepidemiology*, 12(1), pp. 28–36.
- Glenner, G. and C. Wong (1984). Alzheimer's Disease: Initial Report of the Purification and Characterization of a Novel Cerebrovascular Amyloid Protein. *Biochemical and Biophysical Research Communications*, 120(3), pp. 885–890.
- Goate, A., M. Chartier-Harlin, M. Mullan, J. Brown, F. Crawford, L. Fidani, L. Giuffra, A. Haynes, N. Irving, L. James, R. Mant, P. Newton, K. Rooke, P. Roques, C. Talbot, M. Pericak-Vance, A. Roses, R. Williamson, M. Rossor, M. Owen and J. Hardy (1991). Segregation of a Missense Mutation in the Amyloid Precursor Protein Gene with Familial Alzheimer's Disease. *Nature*, 349 (6311), pp. 704–706.
- Graf, C., R. Cécile, S. Giannelli, B. Nobari, G. Gold, F. Herrmann and D. Zekry (2014). Vitamin D Is Not Associated with Cognitive Status in a Cohort of Very Old Hospitalized Patients. *Journal of Alzheimer's Disease*, 42 (Supp 3), pp. S53–S61.
- Grant, W.B. (2014). Trends in Alzheimer's disease during the nutrition transition in Japan and developing countries. *Journal of Alzheimer's Disease*, 38(3), pp. 611–620.
- Gross, A., H. Lu, L. Meoni, J. Gallo, J. Schrack and A. Sharrett (2017). Physical Activity in MIDLIFE IS NOT Associated with Cognitive Health in Later Life Among Cognitively Normal Adults. *Journal of Alzheimer's Disease*, 59(4), pp. 1349–1358.
- Gudala, K., D. Bansal, F. Schifano and A. Bhansali (2013). Diabetes Mellitus and Risk of Dementia: A Meta-analysis of prospective observational studies. *Journal of Diabetes Investigation*, 4(6), pp. 640–650.
- Guerrero, A., C. Dorado-Martinez, A. Rodriguez, K. Pedroza-Rios, G. Borgonio-Pérez and S. Rivas-Arancibia (1999). Effects of Vitamin E on Ozone-induced Memory Deficits and Lipid Peroxidation in Rats. *Neuroreport*, 10(8), pp. 1689–1692.
- Hamer, M. and Y. Chida (2009). Physical Activity and Risk of Neurodegenerative Disease: A Systematic Review of Prospective Evidence. *Psychological Medicine*, 39(1), pp. 3–11.
- Hampel, H., K. Blennow, L. Shaw, Y. Hoessler, H. Zetterberg and J. Trojanowski (2010). Total and Phosphorylated Tau Protein as Biological Markers of Alzheimer's Disease. *Experimental Gerontology*, 45(1), pp. 30–40.
- Hardy, J. (2006). Alzheimer's Disease: The Amyloid Cascade Hypothesis: An Update and Reappraisal. *Journal of Alzheimer's Disease*, 9(Supp 3), pp. 151–153.
- Hardy, J. and D. Allsop (1991). Amyloid Deposition as the Central Event in the Aetiology of Alzheimer's Disease. *Trends in Pharmacological Sciences*, 12, pp. 383–388.
- Hardy, J. and G. Higgins (1992). Alzheimer's Disease: The Amyloid Cascade Hypothesis. *Science*, 256 (5054), pp. 184–185.
- Hardy, J. and D. Selkoe (2002). The Amyloid Hypothesis of Alzheimer's Disease: Progress and Problems on the Road to Therapeutics. *Science*, 297 (5580), pp. 353–356.

- Haroutunian, V., M. Schnaider-Beeri, J. Schmeidler, M. Wysocki, D. Purohit, D. Perl, L. Libow, G. Lesser, M. Maroukian and H. Grossman (2008). Role of the Neuropathology of Alzheimer Disease in Dementia in the Oldest-old. *Archives of Neurology*, 65(9), pp. 1211–1217.
- Hebert, L., J. Weuve, P. Scherr and D. Evans (2013). Alzheimer Disease in the United States (2010–2050) Estimated Using the 2010 Census. *Neurology*, 80 (19), pp. 1778–1783.
- Help for Alzheimer's Families (2012). *Americans Rank Alzheimer's as Most Feared Disease*. [online] Available at: http://www.helpforalzheimersfamilies.com/alzheimers-dementia-care-services/alzheimers_feared_disease/ [Accessed 18 April 2017].
- Helzner, E., N. Scarmeas, S. Cosentino, M. Tang, N. Schupf and Y. Stern (2008). Survival in Alzheimer Disease: A Multi-ethnic, Population-based Study of Incident Cases. *Neurology*, 71 (19), pp. 1489–1495.
- Henriques, C. (2017). 35 Therapies in Phase 2 and 3 Clinical Trials Raise Hopes in Alzheimer's Community. *Alzheimer's News Today*. [online] Available at: alzheimersnewstoday.com/2017/07/19/alzheimers-community-takes-hope-from-the-many-therapies-that-are-in-or-heading-for-trials [Accessed 24 July 2017].
- Hoffmann, K., N. Sobol, K. Frederiksen, N. Beyer, A. Vogel, K. Vestergaard, H. Brændgaard, H. Gottrup, A. Lolk, L. Wermuth, S. Jacobsen, L. Laugesen, R. Gergelyffy, P. Høgh, E. Bjerregaard, B. Andersen, V. Siersma, P. Johannsen, C. Cotman, G. Waldemar and S. Hasselbalch (2016). Moderate-to-high Intensity Physical Exercise in Patients with Alzheimer's Disease: A Randomized Controlled Trial. *Journal of Alzheimer's Disease*, 50(2), pp. 443–453.
- International Monetary Fund (2017). *Report for Selected Countries and Subjects*. [online] Available at: <http://www.imf.org/external/pubs/ft/weo/2017/01/weodata/index.aspx> [Accessed 23 August 2017].
- Jackson Laboratory (2017). *Alzheimer's Mouse Model Resource*. [online] Available at: <https://www.jax.org/research-and-faculty/research-centers/alzheimers-disease-center/alzheimers-mouse-model-repository> [Accessed 20 April 2017].
- James, B., S. Leurgans, L. Hebert, P. Scherr, K. Yaffe and D. Bennett (2014). Contribution of Alzheimer Disease to Mortality in the United States. *Neurology*, 82 (12), pp. 1045–1050.
- Jansen, W., R. Ossenkoppele, D. Knol, B. Tijms, P. Scheltens, F. Verhey, P. Visser and the Amyloid Biomarker Study Group (2015). Prevalence of Cerebral Amyloid Pathology in Persons without Dementia: A Meta-analysis. *Journal of the American Medical Association*, 313 (19), pp. 1924–1938.
- Jick, H., G. Zornberg, S. Jick, S. Seshadri and D. Drachman (2000). Statins and the Risk of Dementia. *Lancet*, 356 (9242), pp. 1627–1631.
- Joseph, J., B. Shukitt-Hale, N. Denisova, R. Prior, G. Cao, A. Martin, G. Taglialetela and P. Bickford (1998). Long-term Dietary Strawberry, Spinach, or Vitamin E Supplementation

- Retards the Onset of Age-related Neuronal Signal-transduction and Cognitive Behavioral Deficits. *Journal of Neuroscience*, 18 (19), pp. 8047–8055.
- Kalmijn, S., L. Launer, A. Ott, J. Witteman, A. Hofman and M. Breteler (1997). Dietary Fat Intake and the Risk of Incident Dementia in the Rotterdam Study. *Annals of Neurology*, 42(5), pp. 776–782.
- Kennelly, S., B. Lawlor and R. Kenny (2009a). Blood Pressure and Dementia — A Comprehensive Review. *Therapeutic Advances in Neurological Disorders*, 2(4), pp. 241–260.
- Kennelly, S., B. Lawlor and R. Kenny (2009b). Blood Pressure and the Risk for Dementia—A Double-edged Sword. *Ageing Research Reviews*, 8(2), pp. 61–70.
- Kikuya, M., T. Ohkubo, H. Metoki, K. Asayama, H. Hara, T. Obara, R. Inoue, H. Hoshi, J. Hashimoto, K. Totsune, H. Satoh and Y. Imai (2008). Day-by-day Variability of Blood Pressure and Heart Rate at Home as a Novel Predictor of Prognosis: The Ohasama Study. *Hypertension*, 52(6), pp. 1045–1050.
- Kolarova, M., U. Sengupta, A. Bartos, J. Rigny and R. Kaye (2017). Tau Oligomers in Sera of Patients with Alzheimer's Disease and Aged Controls. *Journal of Alzheimer's Disease*, 58(2), pp. 471–478.
- Kopf, D. and L. Frolich (2009). Risk of Incident Alzheimer's Disease in Diabetic Patients: A Systematic Review of Prospective Trials. *Journal of Alzheimer's Disease*, 16(4), pp. 677–685.
- Kosik, K., C. Joachim and D. Selkoe (1986). Microtubule-associated Protein Tau (τ) Is a Major Antigenic Component of Paired Helical Filaments in Alzheimer Disease. *Proceedings of the National Academy of Sciences*, 83 (11), pp. 4044–4048.
- Kumar, A., A. Aggarwal, A. Singh and P. Naidu (2016). Animal Models in Drug Discovery of Alzheimer's Disease: A Mini Review. *EC Pharmacology and Toxicology*, 2.1, pp. 60–79.
- Langa, K., E. Larson, E. Crimmins, L.D. Fau, D. Levine, M. Kabeto and D. Weir (2017). A Comparison of the Prevalence of Dementia in the United States in 2000 and 2012. *Journal of the American Medical Association, Internal Medicine*, 177(1), pp. 51–58.
- Langley, G. (2014). Considering a New Paradigm for Alzheimer's Disease Research. *Drug Discovery Today*, 19(8), pp. 1114–1124.
- Lautenschlager, N., K. Cox, L. Flicker, J. Foster, F. van Bockxmeer, J. Xiao, K. Greenop and O. Almeida (2008). Effect of Physical Activity on Cognitive Function in Older Adults at Risk for Alzheimer Disease: A Randomized Trial. *Journal of the American Medical Association*, 300(9), pp. 1027–1037.
- Levy-Lahad, E., W. Wasco, P. Poorkaj, D. Romano, J. Oshima, W. Pettingell, C. Yu, P. Jondro, S. Schmidt, K. Wang, A. Crowley, Y. Fu, S. Guenette, D. Galas, E. Nemens, E. Wijsman, T. Bird, G. Schellenberg and R. Tanzi (1995). Candidate Gene for the Chromosome 1 Familial Alzheimer's Disease Locus. *Science*, 269 (5226), pp. 973–977.

- Li, J., M. Cesari, F. Liu, B. Dong and B. Vellas (2017). Effects of Diabetes Mellitus on Cognitive Decline in Patients with Alzheimer Disease: A Systematic Review. *Canadian Journal of Diabetes*, 41(1), pp. 114–119.
- Littlejohns, T., W. Henley, I. Lang, C. Annweiler, O. Beauchet, P. Chaves, L. Fried, B. Kestenbaum, L. Kuller, K. Langa, O. Lopez, K. Kos, M. Soni and D. Llewellyn (2014). Vitamin D and the Risk of Dementia and Alzheimer Disease. *Neurology*, 83 (10), pp. 920–928.
- Lok, K., H. Zhao, C. Zhang, N. He, H. Shen, Z. Wang, W. Zhao and M. Yin (2013) Effects of Accelerated Senescence on Learning and Memory, Locomotion and Anxiety-like Behavior in APP/PS1 Mouse Model of Alzheimer's Disease. *Journal of the Neurological Sciences*, 335 (1–2), pp. 145–154.
- Lopez, O., J. Becker, Y. Chang, R. Sweet, S. DeKosky, M. Gach, O. Carmichael, E. McDade and L. Kuller (2012). Incidence of Mild Cognitive Impairment in the Pittsburgh Cardiovascular Health Study-Cognition Study. *Neurology*, 79 (15), pp. 1599–1606.
- Lovell-Badge, R. (2013). Nine Out of Ten Statistics Are Taken Out of Context. *Understanding Animal Research*. [online] Available at: <http://www.understandinganimalresearch.org.uk/news/communications-media/nine-out-of-ten-statistics-are-taken-out-of-context> [Accessed 8 May 2017].
- Lu, F., K. Lin and H. Kuo (2009). Diabetes and the Risk of Multi-system Aging Phenotypes: A Systematic Review and Meta-analysis. *PLoS One*, 4(1), pp. 4144ff.
- Luchsinger, J., M-X. Tang, S. Shea and R. Mayeux (2002). Caloric Intake and the Risk of Alzheimer Disease. *Archives of Neurology*, 59(8), pp. 1258–1263.
- Luchsinger, J., M.X. Tang, S. Shea and R. Mayeux (2003). Antioxidant Vitamin Intake and Risk of Alzheimer Disease. *Archives of Neurology*, 60(2), pp. 203–208.
- Masters, C., G. Simms, N. Weinman, G. Mulhaupt, B. McDonald and K. Beyreuther (1985). Amyloid Plaque Core Protein in Alzheimer Disease and Down Syndrome. *Proceedings of the National Academy of Sciences*, 82 (12), pp. 4245–4249.
- Matsumoto, A., M. Satoh, M. Kikuya, T. Ohkubo, M. Hirano, R. Inoue, T. Hashimoto, A. Hara, T. Hirose, T. Obara, H. Metoki, K. Asayama, A. Hosokawa, K. Totsune, H. Hoshi, T. Hosokawa, H. Sato and Y. Imai (2014). Day-to-day Variability in Home Blood Pressure Is Associated with Cognitive Decline: The Ohasama Study. *Hypertension*, 63(6), pp. 1333–1338.
- McDade, E. and R. Bateman (2017). Stop Alzheimer's before it starts. *Nature*, 547 (7662), pp. 153–155.
- McDonald, C., M. Pearce, S. Kerr and J. Newton (2017). Blood Pressure Variability and Cognitive Decline in Older People: A 5-year Longitudinal Study. *Journal of Hypertension*, 35(1), pp. 140–147.
- McGuinness, B., D. Craig, R. Bullock and P. Passmore (2016). Statins for the Prevention of Dementia. *Cochrane*. [online] Available at: http://www.cochrane.org/CD003160/DEMENTIA_statins-prevention-dementia [Accessed 14 August 2017].

- Mitchell, A. and M. Shiri-Feshki (2009). Rate of Progression of Mild Cognitive Impairment to Dementia: Meta-analysis of 41 Robust Inception Cohort Studies. *Acta Psychiatrica Scandinavica*, 119(4), pp. 252–265.
- Mitka, M. (2006). Guidelines Aim to Speed Drug Approval While Protecting Human Subjects. *Journal of the American Medical Association*, 295(9), pp. 988–989.
- Monsell, S., C. Mock, C. Roe, N. Ghoshal, J. Morris, N. Cairns and W. Kukull (2013). Comparison of Symptomatic and Asymptomatic Persons with Alzheimer Disease Neuropathology. *Neurology*, 80(23), pp. 2121–2129.
- Monsell, S., W. Kukull, A. Roher, C. Maarouf, G. Serrano, T. Beach, R. Caselli, T. Montine and E. Reiman (2015). Characterizing Apolipoprotein E ϵ 4 Carriers and Noncarriers with the Clinical Diagnosis of Mild to Moderate Alzheimer Dementia and Minimal β -amyloid Peptide Plaques. *Journal of the American Medical Association, Neurology*, 72(10), pp. 1124–1131.
- Moore, C. (2017). Patient Advocacy Groups Welcome 40% Increase in Alzheimer's NIH Research Funds Authorized by Congress. *Alzheimer's News Today*. [online] Available at: alzheimersnewstoday.com/2017/05/09/alzheimers-groups-welcome-40-increase-nih-research-funds-authorized-congress/ [Accessed 17 May 2017].
- Morris, G.P., I.A. Clark and B. Vissel (2014). Inconsistencies and Controversies Surrounding the Amyloid Hypothesis Of Alzheimer's Disease. *Acta Neuropathologica Communications*, 2(1), p. 135.
- Morris, M., D. Evans, J. Bienias, C. Tangney, D. Bennett, N. Aggarwal, R. Wilson and P. Scherr (2002). Dietary Intake of Antioxidant Nutrients and the Risk of Incident Alzheimer Disease in a Biracial Community Study. *Journal of the American Medical Association*, 287(24), pp. 3230–3237.
- Morris, M., D. Evans, J. Bienias, C. Tangney, D. Bennett, N. Aggarwal, J. Schneider and R. Wilson (2003). Dietary Fats and the Risk of Incident Alzheimer Disease. *Archives of Neurology*, 60(2), pp. 194–200.
- Mullan, M., F. Crawford, K. Axelman, H. Houlden, L. Lilius, B. Winblad and L. Lannfelt (1992). A Pathogenic Mutation for Probable Alzheimer's Disease in the APP Gene at the N-terminus of Beta-amyloid. *Nature Genetics*, 1(5), pp. 345–347.
- Mullin, E. (2017). Amyloid-busting Drugs for Alzheimer's Keep Failing, But So Does Everything Else. *MIT Technology Review*. [online] Available at: <https://www.technologyreview.com/s/603744/amyloid-busting-drugs-for-alzheimers-keep-failing-but-so-does-everything-else> [Accessed 11 May 2017].
- Neha, R. Sodhi, A. Jaggi and N. Singh (2014). Animal Models of Dementia and Cognitive Dysfunction. *Life Sciences*, 109(2), pp. 73–86.
- Notkola, I., R. Sulkava, J. Pekkanen, T. Erkinjuntti, C. Ehnholm, P. Kivinen, J. Tuomilehto and A. Nissinen (1998). Serum total cholesterol, apolipoprotein E epsilon 4 allele, and Alzheimer's disease. *Neuroepidemiology*, 17(1), pp. 14–20.
- O'Connor, A. (1998). Discussion of the validation of animal testing by the FDA. (Personal communication with André Menache).

- Oddo, S., A. Caccamo, J. Shepherd, M. Murphy, T. Golde, R. Kaye, R. Metherate, M. Mattson, Y. Akbari and F. LaFerla (2003). Triple-transgenic Model of Alzheimer's Disease with Plaques and Tangles: Intracellular Abeta and Synaptic Dysfunction. *Neuron*, 39(3), pp. 409–421.
- Oishi, E., T. Ohara, S. Sakata, M. Fukuhara, J. Hata, D. Yoshida, M. Shibata, T. Ohtsubo, T. Kitazono, Y. Kiyohara and T. Ninimiya (2017). Day-to-day Blood Pressure Variability and Risk of Dementia in a General Japanese Elderly Population: The Hisayama Study. *Circulation*, 136(6), pp. 516–525.
- Olsson, B., R. Lautner, U. Andreasson, A. Öhrfelt, E. Portelius, M. Bjerke, M. Hölttä, C. Rosén, C. Olsson, G. Strobel, E. Wu, K. Dakin, M. Petzold, K. Blennow and H. Zetterberg (2016). CSF and Blood Biomarkers for the Diagnosis of Alzheimer's Disease: A Systematic Review and Meta-analysis. *Neurology*, 15(7), pp. 673–684.
- Palatini, P. (2014). Day-by-day Blood Pressure Variability: Cause or Consequence of Vascular Brain Injury? *Hypertension*, 63(6), pp. 1163–1165.
- Pallàs, M. (2012). Senescence-accelerated Mice P8: A Tool to Study Brain Aging and Alzheimer's Disease in a Mouse Model. *International Scholarly Research Notices Cell Biology*, (Article ID 917167), pp. 1–12.
- Pharmaceutical Research and Manufacturers of America (PhRMA) (2012). *Researching Alzheimer's Medicines: Setbacks and Stepping Stones*. [online] Available at: <http://phrma-docs.phrma.org/sites/default/files/pdf/alzheimersetbacksreport.pdf> [Accessed 10 May 2017].
- PhRMA (2015). *Researching Alzheimer's Medicines: Setbacks and Stepping Stones*. [online] Available at: <http://phrma-docs.phrma.org/sites/default/files/pdf/alzheimersetbacksreportfinal912.pdf> [Accessed 10 May 2017].
- PhRMA (2016). *2016 Medicines in Development for Alzheimer's Disease*. [online] Available at <http://phrma-docs.phrma.org/sites/default/files/pdf/medicines-in-development-drug-list-alzheimers.pdf> [Accessed 11 May 2017].
- Pistollato, F., E. Ohayon, A. Lam, G. Langley, T. Novak, D. Pamies, G. Perry, E. Trushina, R. Williams, A. Roher, T. Hartung, S. Harnad, N. Barnard, M. Morris, M. Lai, R. Merkley and P. Chandrasekera (2016). Alzheimer Disease Research in the 21st Century: Past and Current Failures, New Perspectives and Funding Priorities. *Oncotarget*, 7(26), pp. 38999–39016.
- Porquet, D., P. Andres-Benito, C. Grinan-Ferre, A. Camins, I. Ferrer, A. Canudas, J. Del Valle and M. Pallàs (2015). Amyloid and Tau Pathology of Familial Alzheimer's Disease APP/PS1 Mouse Model in a Senescence Phenotype Background (SAMP8). *Age (Dordrecht, Netherlands)*, 37(12), pp. 1–17.
- Price, J., D. McKeel Jr., V. Buckles, C. Roe, C. Xiong, M. Grundman, L. Hansen, R. Petersen, J. Parisi, D. Dickson, C. Smith, D. Davis, F. Schmitt, W. Markesbery, J. Kaye, R. Kurlan, C. Hulette, B. Kurland, R. Higdon, W. Kukull, and J. Morris (2009). Neuropathology of Nondemented Aging: Presumptive Evidence for Preclinical Alzheimer Disease. *Neurobiology of Aging*, 30(7), pp. 1026–1036.

- Purnell, C., S. Gao, C. Callahan and H. Hendrie (2009). Cardiovascular Risk Factors and Incident Alzheimer Disease: A Systematic Review of the Literature. *Alzheimer Disease and Associated Disorders*, 23(1), pp. 1-18.
- Puzzo, D., L. Lee, A. Palmeri, G. Calabrese, and O. Arancio (2014). Behavioral Assays with Mouse Models of Alzheimer's Disease: Practical Considerations and Guidelines. *Biochemical Pharmacology*, 88(4), pp. 450-467.
- Qiu, C., B. Winblad and L. Fratiglioni (2005). The Age-dependent Relation of Blood Pressure to Cognitive Function and Dementia. *Lancet Neurology*, 4(8), pp. 487-499.
- Ramachandran, T. (2016). Alzheimer Disease Imaging. *Medscape*. [online] Available at: <http://emedicine.medscape.com/article/336281-overview> [Accessed 12 May 2017].
- Richard, E. and C. Brayne (2014). Mild Cognitive Impairment — Not Always What It Seems. *Nature Reviews Neurology*, 10, pp. 130-131.
- Roberts, R., D. Knopman, M. Mielke, R. Cha, V. Pankratz, T. Christianson, Y. Geda, B. Boeve, R. Ivnik, E. Tangalos, W. Rocca and R. Petersen (2014a). Higher Risk of Progression to Dementia in Mild Cognitive Impairment Cases Who Revert to Normal. *Neurology*, 82(4), pp. 317-325.
- Roberts, R., D. Knopman, Y. Geda, R. Cha, V. Pankratz, L. Baertlein, B. Boeve, E. Tangalos, R. Ivnik, M. Mielke and R. Petersen (2014b). Association of Diabetes with Amnesic and Nonamnesic Mild Cognitive Impairment. *Alzheimer's & Dementia*, 10(1), Pp. 18-26.
- Rolland, Y., G. Abellan van Kan and B. Vellas (2008). Physical Activity and Alzheimer's Disease: From Prevention to Therapeutic Perspectives. *Journal of the American Medical Directors Association*, 9(6), pp. 390-405.
- Rosenberg, P. (2005). Clinical Aspects of Inflammation in Alzheimer's Disease. *International Review of Psychiatry*, 17 (6), pp. 503-514.
- Ross, C. and M. Poirier (2004). Protein Aggregation and Neurodegenerative Disease. *Nature Medicine*, 10(7), pp. S10-S17.
- Rossor, M., N. Fox, P. Freeborough and R. Harvey (1996). Clinical Features of Sporadic and Familial Alzheimer's Disease. *Neurodegeneration*, 5(4), pp. 393-397.
- Rothwell, P., S. Howard, E. Dolan, E. O'Brien, J. Dobson, B. Dahlöf, P. Sever and N. Poulter (2010). Prognostic Significance of Visit-to-visit variability, Maximum Systolic Blood Pressure, and Episodic Hypertension. *Lancet*, 375(9718), pp. 895-905.
- Sabayan, B., L. Wijsman, J. Foster-Dingley, D. Stott, I. Ford, B. Buckley, N. Sattar, J. Jukema, M. van Osch, J. van der Grond, M. van Buchem, R. Westendorp, A. de Craen and S. Mooijjaart (2013). Association of Visit-to-visit Variability in Blood Pressure with Cognitive Function in Old Age: Prospective Cohort Study. *The British Medical Journal*, 347, p. f4600.
- Sadigh-Eteghad, S., M. Talebi and M. Farhoudi (2012). Association of Apolipoprotein E Epsilon 4 Allele with Sporadic Late Onset Alzheimer's Disease. A Meta-analysis. *Neurosciences (Riyadh)*, 17(4), pp. 321-326.

- Satizabal, C., A. Beiser, V. Chouraki, G. Chêne, C. Dufouil and S. Seshadri (2016). Incidence of Dementia Over Three Decades in the Framingham Heart Study. *New England Journal of Medicine*, 374(6), pp. 523–532.
- Schneider, L., F. Mangialasche, N. Andreasen, H. Feldman, E. Giacobini, R. Jones, V. Mantua, P. Mecocci, L. Pani, B. Winblad and M. Kivipelto (2014). Clinical Trials and Late-stage Drug Development for Alzheimer's Disease: An Appraisal from 1984 to 2014. *Journal of Internal Medicine*, 275(3), pp. 251–283.
- Serrano-Pozo, A., J. Qian, S. Monsell, D. Blacker, T. Gómez-Isla, R. Betensky, J. Growdon, K. Johnson, M. Frosch, R. Sperling and B. Hyman (2014). Mild to Moderate Alzheimer Dementia with Insufficient Neuropathological Changes. *Annals of Neurology*, 75(4), pp. 597–601.
- Shakoor, S. J. Carroll F. Arsalan and Endpoints News Team (2017). Alzheimer's: Learning from a Legacy of Bitter Setbacks. *Endpoints News* [online] Available at: <https://endpts.com/special/alzheimers-2017/> [Accessed 2 May 2017].
- Singh, A. and P. Henske (2003). *Has the Pharmaceutical Blockbuster Model Gone Bust?*. Bain & Company, News release. [online] Available at: <http://www.bain.com/about/press/press-releases/has-the-pharmaceutical-blockbuster-model-gone-bust.aspx> [Accessed 8 May 2017].
- Sink, K., M. Espeland, C. Castro, T. Church, R. Cohen, J. Dodson, J. Guralnik, H. Hendrie, J. Jennings, J. Katula, O. Lopez, M. McDermott, M. Pahor, K. Reid, J. Rushing, J. Verghese, S. Rapp, J. Williamson and LIFE Study Investigators (2015). Effect of a 24-month Physical Activity Intervention Vs Health Education on Cognitive Outcomes in Sedentary Older Adults: The LIFE Randomized Trial. *Journal of the American Medical Association*, 314(8), pp. 781–790.
- Socci, D., B. Crandall and G. Arendash (1995). Chronic Antioxidant Treatment Improves the Cognitive Performance of Aged Rats. *Brain Research*, 693(1–2), pp. 88–94.
- Sofi, F., D. Valecchi, D. Bacci, R. Abbate, G. Gensini, A. Casini and C. Macchi (2010). Physical Activity and Risk of Cognitive Decline: A Meta-analysis of Prospective Studies. *Journal of Internal Medicine*, 269(1), pp. 107–117.
- Solfrizzi, V., C. Custodero, M. Lozupone, B. Imbimbo, V. Valiani, P. Agosti, A. Schilardi, A. D'Introno, M. La Montagna, M. Calvani, V. Guerra, R. Sardone, A. Bellomo, A. Greco, A. Daniele, D. Seripa, G. Logroscino, C. Sabbá and F. Panza (2017). Relationships of Dietary Patterns, Foods, and Micro- and Macronutrients with Alzheimer's Disease and Late-life Cognitive Disorders: A Systematic Review. *Journal of Alzheimer's Disease*, 59(3), pp. 815–849.
- Strittmatter, W., A. Saunders, D. Schmechel, M. Pericak-Vance, J. Englund, G. Salvesen and A. Roses (1993). Apolipoprotein E: High-avidity Binding to Beta-amyloid and Increased Frequency of Type 4 Allele in Late-onset Familial Alzheimer Disease. *Proceedings of the National Academy of Academic Sciences*, 90(5), pp. 1977–1981.

- Sutherland, G.T, Lim J., Srikanth, V. and Bruce, D.G., 2017. Epidemiological approaches to understanding the link between type 2 diabetes and dementia. *Journal of Alzheimer's Disease*, 59(2), pp. 393–403.
- Taconic Biosciences, Inc. (2017). Alzheimer's Disease Models. [online] Available at: <https://www.taconic.com/find-your-model/neuroscience-portfolio/alzheimers-disease-models/> [Accessed 25 April 2017].
- Taylor, C., S. Greenlund, L. McGuire, H. Lu and J. Croft (2017). Deaths from Alzheimer's Disease — United States, 1999–2014. *Morbidity and Mortality Weekly Report*, 66 (20), pp. 521–526.
- Terry, R., E. Masliah, D. Salmon, N. Butters, R. DeTeresa, R. Hill, L. Hansen and R. Katzman (1991). Physical Basis of Cognitive Alterations in Alzheimer's Disease: Synapse Loss Is the Major Correlate of Cognitive Impairment. *Annals of Neurology*, 30(4), pp. 572–580.
- Thal, D., L. Grinberg and J. Attems (2012). Vascular Dementia: Different Forms of Vessel Disorders Contribute to the Development of Dementia in the Elderly Brain. *Experimental Gerontology*, 47(11), pp. 816–824.
- Toots, A., H. Littbrand, G. Boström, C. Hörnsten, H. Holmberg, L. Lundin-Olsson, N. Lindelöf, Y. Gustafson and E. Rosendahl (2017). Effects of Exercise on Cognitive Function in Older People with Dementia: A Randomized Controlled Trial. *Journal of Alzheimer's Disease*, doi: 10.3233/JAD-170014 [Epub ahead of print], pp. 1–10.
- UK Parliament (2004). *Animal Experiments*. [online] Available at: https://www.publications.parliament.uk/pa/cm200304/cmhansrd/voo40331/text/40331w06.htm#40331w06.html_sbhdo [Accessed 8 May 2017].
- Us Against Alzheimer's (2017). *Alzheimer's Drugs in Development Pipeline*. [online] Available at: <http://www.usaagainstalzhaimers.org/sites/default/files/alzheimers-drugs-development-pipeline-2017.pdf> [Accessed 24 July 2017].
- US Burden of Disease Collaborators (2013). The State of US Health, 1990–2010. *Journal of the American Medical Association*, 310(6), pp. 591–608.
- US Food and Drug Administration (FDA) (2004). *Challenges and Opportunities Report — March 2004*. [online] Available at: <http://wayback.archive-it.org/7993/20180125032208/https://www.fda.gov/ScienceResearch/SpecialTopics/CriticalPathInitiative/CriticalPathOpportunitiesReports/ucmo77262.htm> [Accessed 8 May 2017].
- Veerhuis, R. (2011). Histological and Direct Evidence for the Role of Complement in the Neuroinflammation of Alzheimer's Disease. *Current Alzheimer Research*, 8(1), pp. 34–58.
- Wachterman, M., D. Kiely and S. Mitchell (2008). Reporting Dementia on the Death Certificates of Nursing Home Residents Dying with End-stage Dementia. *Journal of the American Medical Association*, 300(22), pp. 2608–2610.

- Wang, L., T. Benzinger, Y. Su, J. Christensen, K. Friedrichsen, P. Aldea, J. McConathy, N. Cairns, A. Fagan, J. Morris and B. Ances (2016). Evaluation of Tau Imaging in Staging Alzheimer Disease and Revealing Interactions Between β -amyloid and Tauopathy. *Journal of the American Medical Association, Neurology*, 73(9), pp. 1070–1077.
- Ward, A., S. Tardiff, C. Dye and H Arrighi (2013). Rate of Conversion from Prodromal Alzheimer's Disease to Alzheimer's Dementia: A Systematic Review of the Literature. *Dementia and Geriatric Cognitive Disorders Extra*, 3(1), pp. 320–332.
- Webster, S., A. Bachstetter, P. Nelson, F. Schmitt and L. Van Eldik (2014). Using Mice to Model Alzheimer's Dementia: An Overview of the Clinical Disease and the Preclinical Behavioral Changes in 10 Mouse Models. *Frontiers in Genetics*, 5, p. 88.
- Weuve, J., L. Hebert, P. Scherr and D. Evans (2014). Deaths in the United States Among Persons with Alzheimer's Disease. *Alzheimer's & Dementia*, 10(2), pp. e40–e46.
- Wolozin, B., W. Kellman, P. Ruosseau, G. Celesia and G. Siegel (2000). Decreased Prevalence of Alzheimer Disease Associated with 3-hydroxy-3-methylglutaryl Coenzyme a Reductase Inhibitors. *Archives of Neurology*, 57(10), pp. 1439–1443.
- Wood, J., S. Mirra, N. Pollock and L. Binder (1986). Neurofibrillary Tangles of Alzheimer Disease Share Antigenic Determinants with the Axonal Microtubule-associated Protein Tau (τ). *Proceedings of the National Academy of Sciences*, 83 (11), pp. 4040–4043.
- World Bank (2017). GDP (current US\$). [online] Available at: http://data.worldbank.org/indicator/NY.GDP.MKTP.CD?year_high_desc=true [Accessed 23 August 2017].
- World Health Organization (2015). *10 Facts on Dementia*. [online] Available at: <http://www.who.int/features/factfiles/dementia/en/> [Accessed 18 April 2017].
- Yaffe, K., C. Falvey, N. Hamilton, A. Schwartz, E. Simonsick, S. Satterfield, J. Cauley, C. Rosano, L. Launer, E. Strotmeyer and T. Harris (2012). Diabetes, Glucose Control, and 9-year Cognitive Decline Among Older Adults without Dementia. *Archives of Neurology*, 69(9), pp. 1170–1175.
- Yamada, K., T. Tanaka, D. Han, K. Senzaki, T. Kameyama and T. Nabeshima (1999). Protective Effects of Idebenone and Alpha-tocopherol on Beta-amyloid-(1-42)-induced Learning and Memory Deficits in Rats: Implication of Oxidative Stress in Beta-amyloid-induced Neurotoxicity *In Vivo*. *European Journal of Neuroscience*, 11(1), pp. 83–90.
- Zahs, K. and K. Ashe (2010). "Too Much Good News." Are Alzheimer Mouse Models Trying to Tell Us How to Prevent, Not Cure, Alzheimer's Disease? *Trends in Neurosciences*, 33(8), pp. 381–389.
- Zhang, J., C. Chen, S. Hua, H. Liao, M. Wang, Y. Xiong and F. Cao (2017). An Updated Meta-analysis of Cohort Studies: Diabetes and Risk of Alzheimer's Disease. *Diabetes Research and Clinical Practice*, 124, pp. 41–47.
- Zilkens, R., W. Davis, K. Spilsbury, J. Semmens and D. Bruce (2013). Earlier Age of Dementia Onset and Shorter Survival Times in Dementia Patients with Diabetes. *American Journal of Epidemiology*, 7(11), pp. 1246–1254.

Recommended Reading, Not Referenced in the Text
AD Risk Factors, Biomarkers, and Management

- Alzheimer's Society (UK) (2017). *Risk Factors and Prevention*. [online] Available at https://www.alzheimers.org.uk/info/20010/risk_factors_and_prevention [Accessed 30 May 2017].
- Hane, F., M. Robinson, B. Lee, O. Bai, Z. Leonenko and M. Albert (2017). Recent Progress in Alzheimer's Disease Research, Part 3: Diagnosis and Treatment. *Journal of Alzheimer's Disease*, 57(3), pp. 645–665.
- Itzhaki, R., R. Lathe, B. Balin, M. Ball, E. Bearer, H. Braak, M. Bullido, C. Carter, M. Clerici, S. Cosby, K. Del Tredici, H. Field, T. Fulop, C. Grassi, W. Griffin, J. Haas, A. Hudson, A. Kamer, D. Kell, F. Licastro, L. Letenneur, H. Löveheim, R. Mancuso, J. Miklossy, C. Otth, A. Palamara, G. Perry, C. Preston, E. Pretorius, T. Strandberg, N. Tabet, S. Taylor-Robinson and J. Whittum-Hudson (2016). Microbes and Alzheimer's Disease. *Journal of Alzheimer's Disease*, 51(4), pp. 979–984.
- Mayeda, E., M. Glymour, C. Quesenberry and R. Whitmer (2016). Inequalities in Dementia Incidence Between Six Racial and Ethnic Groups Over 14 Years. *Alzheimer's & Dementia*, 12(3), pp. 216–224.
- Robinson, M., B. Lee and F. Hane (2017). Recent Progress in Alzheimer's Disease Research, Part 2: Genetics and Epidemiology. *Journal of Alzheimer's Disease*, 57(2), pp. 317–330.
- Sharma, N. and Q. Singh (2016). Exploring Biomarkers for Alzheimer's Disease. *Journal of Clinical and Diagnostic Research*, 10(7), pp. KE01–KE06.
- Vos, S., I.M. van Boxtel, O. Schiepers, K. Deckers, M. de Vugt, I. Carrière, J. Dartigues, K. Peres, S. Artero, K. Ritchie, L. Galluzzo, E. Scafato, G. Frisoni, M. Huisman, H. Comijs, S. Sacuiu, I. Skoog, K. Irving, C. O'Donnell, F. Verhey, P. Visser and S. Köhler (2017). Modifiable Risk Factors for Prevention of Dementia in Midlife, Late Life, and the Oldest-old: Validation of the LIBRA Index. *Journal of Alzheimer's Disease*, doi:10.3233/JAD-161208 (e-pub ahead of print).
- Wingbermhühle, R., K. Wen, F. Wolters, M. Ikram and D. Bos (2017). Smoking, APOE Genotype, and Cognitive Decline: The Rotterdam Study. *Journal of Alzheimer's Disease*, 57(4), pp. 1191–1195.
- Yegambaram, M., B. Manivannam, T. Beach and R. Halden (2015). Role of Environmental Contaminants in the Etiology of Alzheimer's Disease: A Review. *Current Alzheimer Research*, 12(2), pp. 116–146.

Human-relevant Research Methods to Replace Animal Research

- Brownjohn, P., J. Smith, E. Portelius, L. Serneels, H. Kvartsberg, B. De Strooper, K. Blennow, H. Zetterberg and F. Livesey (2017). Phenotypic Screening Identifies

- Modulators of Amyloid Precursor Protein Processing in Human Stem Cell Models of Alzheimer's Disease. *Stem Cell Reports*, 8(4), pp. 870–882.
- Pen, A. and U. Jensen (2017). Current Status of Treating Neurodegenerative Disease with Induced Pluripotent Stem Cells. *Acta Neurologica Scandinavica*, 135(1), pp. 57–72.
- Pistollato, F., S. Cavanaugh and P. Chandrasekera (2015). A Human-based Integrated Framework for Alzheimer's Disease research. *Journal of Alzheimer's Disease*, 47(4), pp. 857–868.
- Pistollato, F., E. Ohayon, A. Lam, G. Langley, T. Novak, D. Pamies, G. Perry, E. Trushina, R. Williams, A. Roher, T. Hartung, S. Harnad, N. Barnard, M. Morris, M. Lai, R. Merkley and P. Chandrasekera (2016b). Alzheimer Disease Research in the 21st Century: Past and Current Failures, New Perspectives and Funding Priorities. *Oncotarget*, 7 (26), pp. 38999–39016.
- Mungenast, A., S. Siegert and L. Tsai (2016). Modeling Alzheimer's Disease with Human Induced Pluripotent Stem (iPS) Cells. *Molecular and Cellular Neuroscience*, 73, pp. 13–31.
- Weiner, M., D. Veitch, P. Aisen, L. Beckett, N. Cairns, R. Green, D. Harvey, C. Jack, W. Jagust, J. Morris, R. Petersen, A. Saykin, L. Shaw, A. Toga, J. Trojanowski and Alzheimer's Disease Neuroimaging Initiative. (2017). Recent Publications from the Alzheimer's Disease Neuroimaging Initiative: Reviewing Progress Toward Improved AD Clinical Trials. *Alzheimer's & Dementia*, 13 (4), pp. e1–e85.

Behavioral Research on Captive Animals: Scientific and Ethical Concerns

Kimberley Jayne

Senior Science Researcher, Animal Defenders International, Lord Dowding Fund for Humane Research, London, United Kingdom. Collective Member, European Association for Critical Animal Studies
kimberley.jayne@outlook.com

Adam See

PhD Candidate, The Graduate Center, City University of New York, New York, United States

1 Modeling Wild Animal Behavior in the Laboratory: Scientific Concerns

– *Kimberley Jayne* –

Behavioral research on non-human animals (hereinafter referred to as animals) can involve the study of their evolution and natural behavior, cognitive abilities and psychological constructs, or welfare and response to stressors, among other areas of natural animal behavior. Behavioral research on animals is also carried out to model human behavior, for example in psychological studies and pharmacological models, as well as for comparative purposes to understand differences and similarities between species. This chapter focuses on the former—where ethology moves into the laboratory environment to model the behavior of free living animals—however, some of the discussion is also relevant to the laboratory animal model in general because of the very nature of using laboratory animals as “models”. For further discussion on animals used to model disease or within pharmacology in particular, see the following chapters in this Volume: Archibald, Coleman and Drake (2019, Chapter 18); Bailey (2019, Chapter 19); Carvalho et al., (2019, Chapter 16); Greek and Kramer (2019, Chapter 17); Pippin, Cavanaugh and Pistollato (2019, Chapter 20); and Ram (2019, Chapter 15). For more on animal models within psychology, see Shapiro (1998).

In comparison to other scientific procedures, such as those within biomedical research, modeling the behavior of wild animals in the laboratory can involve

methods that are physically non-invasive. While it is true that some behavioral studies are accompanied by invasive measures (which can be anything from injecting dye for identification purposes, to drilling into the skull to insert brain implants), for those that are not, physical and psychological suffering may be overlooked. This can also affect the rigor with which the 3Rs are applied, with the implementation of replacement in behavioral research being of particular concern. Nevertheless, the welfare of animals used for behavioral research can suffer as a direct result of: experimental manipulations (e.g., simulating prolonged presence of predators); marking methods (Association for the Study of Animal Behaviour, 2018); from being wild-trapped and transported to a laboratory; or simply living in a laboratory environment can result in various degrees of suffering by impeding an animal from performing natural behavior, imposing a chronic state of fear, or observing them at close proximity (particularly if they are a prey or territorial species). Moreover, research in the name of animal welfare brings about scientific concerns with studying wild animal behavior in the laboratory, as well as problems with the animal model in general.

The first half of this chapter focuses exclusively on animals that are used in laboratory behavioral research to model wild behavior, what is typically involved, problems associated with this practice, and how behavioral research has revealed scientific problems in the animal model. The second half of this chapter then addresses the ethical questions of whether scientific curiosity of animal behavior in general provides any justification for carrying out this research in this first place, with specific focus on non-human primates (NHPS).

1.1 *The Origins of Laboratory Behavioral Research*

The study of animal behavior has a long history, dating back over 2000 years; however laboratory behavioral research became popular in the twentieth century with the rise of behaviorism, with research using animal models to understand more about the human processes of learning and memory and the comparative abilities of animals (Klopfer, 1993). Food deprivation was frequently used as a method to motivate laboratory animals to “perform” and is still frequently used today across behavioral research. For example, early studies by Thorndike in 1898 deprived cats of food and confined them in a “puzzle box”, from which they had to work out how to escape for a food reward (Chance, 1999). In the 1920s, Pavlov used dogs to demonstrate the principals of classical conditioning: a dog was restrained and isolated in a room for use in a series of trials where food was presented with a neutral event (e.g., flashing of a light), so that their salivation response could be recorded (Pavlov, 1927). Still used today (e.g., Meier, Lea and McLaren, 2016), and developed in the 1920s by Skinner, the Skinner Box (sometimes referred to as an “operant chamber”) confines partially food-deprived animals (often pigeons or rats) inside of a box

with a device they must operate to obtain a food reward. Sometimes animals were also given amphetamines to assess the impact on their behavior under these conditions (Dews, 1955). Laboratory research has also used animals to model other aspects of human behavior: Seligman and colleagues gave dogs electric shocks they could not escape to model learned helplessness associated with human depression (Abramson, Seligman and Teasdale, 1978); Harlow (1958) isolated infant rhesus macaques from their mothers to raise them in complete social isolation, or with a “cloth mother” or “wire mother” surrogate. Despite studies with humans being carried out, which reveal human-relevant data, six decades later this type of research continues with infant monkeys (e.g., Massart et al., 2014). So has the use of animal models of learned helplessness, which have been going on for five decades, particularly with rodents (e.g., Greenwood, Strong and Fleshner, 2010; for review see Maier and Seligman, 2016).

Alongside the rise in laboratory behavioral research, a contrasting method of studying the natural behavior of animals, known as ethology, gained popularity during the mid-twentieth century through the work of Lorenz, Tinbergen and von Frisch (Bolhuis and Geraldaue, 2008; Klopfer, 1993). The purpose of ethology was to ask questions about animals in their natural environment, using non-intrusive observational methods or environmental manipulations (Klopfer, 1993). However, for the opportunity to study them close up and/or under controlled conditions, ethologists have frequently brought animals into the laboratory—now common practice in modern behavioral research—and used invasive techniques with free-living, wild animals. For example, early ethological studies used chronically implanted electrodes to stimulate areas of the brain (Klopfer, 1993); and homing pigeons were fitted with contact lenses (Schmidt-Koenig and Schlichte, 1972) and, more recently, had their olfactory nerve cut to study the impact upon their ability to navigate (Gagliardo et al., 2008).

1.2 *Ethology in the Laboratory*

In modern ethology research, animals are studied in the wild and in captivity. Animals that are used in laboratories are either captive bred or caught from the wild in order to study behavior seen in their wild counterparts, but in an environment where they are in closer visual proximity and where their behavior can be observed and manipulated under controlled conditions. The number of animals involved in behavioral research worldwide is unknown because many are not documented and, in the UK, only research that is considered to cause an animal “pain, suffering, distress, or lasting harm” (UK Home Office, 2012) is subject to licensing and therefore reported. However, potentially, a large number of undocumented behavior studies could be carried out that could still

cause an animal a degree of distress, even if the distress is simply a result of the captive environment or being observed. And even more animals may simply be housed in laboratories but not the subject of current procedures (e.g., University College London, 2017). While some countries do not report behavioral research in their statistics, the most recent United Kingdom statistics show that out of 3,936,723 *procedures*, involving the use of live animals, 55,475 come under the category of behavioral research that causes, “pain, suffering, distress, or lasting harm” (accounting for approximately 1.4% of procedures) (UK Home Office, 2017a). This includes research on mice, rats, other rodents, carnivores, pigs, sheep, birds, amphibians, and fish.

Laboratory studies of wild animal behavior cover a wide range of research questions, including questions about their evolution and adaptations, development, cognitive abilities, social behavior, and even how their behavior is affected by captivity, among many other areas. For example, fish are used in large numbers in laboratories (78% of behavioral research in the UK) (UK Home Office, 2017a); and even more fish are bred to maintain genetic lines (e.g., Greenwood et al., 2013), with some taken from the wild to test under laboratory conditions (e.g., Burns et al., 2016). Research can involve exposing animals to aversive stimuli, such as simulating predator presence to observe their anti-predator behavior (e.g., Brilot and Bateson, 2012); manipulating different social conditions, for example, to monitor how males harass females (Killen et al., 2015); and assessing whether specific behaviors are indicative of pain or suffering (Braithwaite and Boulcott, 2007). Both NHPS and birds are frequently used for comparative cognition studies to study how abilities that are characteristically human may have adaptive qualities for animals. For example, to study concepts, such as numerosity, theory of mind, language, economic decision making, tool use, and memory (Call and Tomasello, 2008; Clayton and Emery, 2005; Pepperberg, 2017). In laboratory studies of this nature, an animal will typically be within a confined space and given a problem to solve, for example, using an apparatus or on a computer screen, for which they would receive food as a reward (e.g., Meier, Lea and McLaren, 2016). Some cognition research also involves invasive procedures, such as fixing recording chambers to an animal’s skull (e.g., Schechtman et al., 2016); or being restrained in stereotactic frames (e.g., Neubert et al., 2015), to take brain recordings alongside behavioral measures.

1.3 *Laboratory Animal Welfare Research*

Animals who live in laboratories are affected by their environment in ways that makes their behavior different from free-living animals. These behavioral changes can be negative for the animal, as well as for the scientific output. For this reason, there is a separate field of behavioral research that studies the

welfare of laboratory housed animals, where animals are observed and experimented upon to ascertain how they deviate from their wild counterparts, as a result of the conditions of their captive environment. Therefore, not only do animals suffer as a direct result of experimental procedures but, because the stress and deprivation of a laboratory environment is known to cause welfare concerns, additional animals are housed and experimented upon in order to examine the effects that a laboratory can have upon behavior, welfare, and, ultimately, scientific results.

For animals who live within captive environments the ecological pressures are significantly different from the environment in which their wild counterparts have evolved. Their surroundings are smaller, uncontrollable, and less complex than their natural habitat. They engage in social interaction that is distinct from what they would naturally experience (e.g., in terms of group size, proximity, sex ratio, or hierarchy). Furthermore, they are prevented from performing many of their natural behaviors, such as in preparation for feeding, but are exposed to unnatural routines imposed by their carers (Bassett and Buchanan-Smith, 2007), including: being caught and handled (Gouveia and Hurst, 2017; Hosey, 2005); unfamiliar sounds (including ultrasonic noise from computers); lighting and temperature (Gaskill, 2016; Reardon, 2016); and even cage cleaning, which has been found to disrupt olfactory communication and increase aggressive behavior (Arakawa et al., 2008). The presence of abnormal behaviors is common in captive animals and is considered a direct result of living in these environments. These behaviors can develop as a result of unavoidable stress or fear, as a frustrated response to being prevented from performing a behavior, or through lack of stimulation. The presence of abnormal behavior is considered a significant indicator of reduced welfare. These behaviors can include repetitive locomotor stereotypies, such as somersaulting, pacing or body-rocking, bar-mouthing, and self-injurious behavior (reviewed in Mason and Rushen, 2006). Laboratory animals can even experience “contagious anxiety” physiological changes that occur as a result of observing conspecifics undergoing procedures (Gewin, 2011; Lutz et al., 2016; Novak et al., 2013). The presence of such behavior is absent in free-living animals, making the justification for studying wild-like behavior in laboratory animals questionable, and problematic when animals are used to model human behavior (for further discussion of how laboratory animal behavior and welfare impacts on modeling the human condition, see Herrmann, 2019, Chapter 1 in this Volume).

Nevertheless, to understand more about abnormal behaviors prevalent in existing laboratory animals, experiments are carried out on *more* animals to investigate factors that influence the occurrence of these behaviors and ways to reduce or eliminate them in laboratory-confined animals. For example, to determine whether wild-caught animals might be more susceptible to

laboratory stressors, infant animals are taken from the wild to compare their behavioral responses with those that have been hand-reared in the laboratory (Jayne, Feenders and Bateson, 2013); to assess the effects of different enrichments, some animals are forced to live in barren cages (Abou-Ismaïl and Mahboub, 2011); and to examine the effect of different social conditions, animals are exposed to various stressors, such as predator cues, to measure their stress response (Zoratto et al., 2014).

Welfare research has shown that even small differences across laboratory environments can have varying effects upon stress and the expression of abnormal behavior and development. For example, monkeys that are separated from their mothers and raised by their peers display abnormal behaviors later in life, as well as long lasting effects on their stress hormones, compared to those who do not experience early maternal separation (Feng et al., 2011). Differences in housing and husbandry, such as introducing an artificial burrow, can impact the expression of abnormal behavior (Waiblinger and Koenig, 2007). Having visual access to conspecifics has even been shown to affect stress levels and cognitive performance (Harris, D'Eath and Healy, 2010).

Research has shown that stress of the laboratory environment is not only associated with abnormal behavioral development, but also has long-term effects on abnormal physiological development and even brain functioning, with abnormal behaviors actually thought to reflect permanent brain dysfunction (Knight, 2001). For example, the basal ganglia, responsible for motor control, show altered responding in rodents and birds displaying abnormal behavior (Garner and Mason, 2002; Garner, Mason and Smith, 2003); sensory and motor deprivation are thought to be associated with impaired brain development (van Praag, Kempermann and Gage, 2000); and abnormal repetitive behaviors are considered to originate from chronically thwarted attempts to perform specific behaviors or to gain access to resources (Würbel, 2001). Psychological stress can also affect the body in other physiological ways. For example, sporadic noise stress administered to rats can encourage the display of abnormal rearing behavior, as well as impact their gut morphology (Baldwin, Primeau and Johnson, 2006) and the functioning of their autonomic nervous system (Burwell and Baldwin, 2006), among other stress-related diseases (Gaskill, 2016). In addition, being prevented from performing one's natural behavior can result in reduced physiological condition (Makowska and Weary, 2016). Overall, animals living in the laboratory are vulnerable to abnormal behavior, physiology, and brain development. They do not represent "healthy" models of free-living individuals of their species, thereby questioning the validity of research using these animals to model natural animal behavior within the laboratory (Würbel, 2007). (Note that there are areas of research that indeed require

animal models to display conditions not present in healthy wild populations, such as in disease research, but critique of these models is beyond the scope of this chapter.)

1.4 *The Validity, Reliability, and Replicability of Modeling Wild Animal Behavior in the Laboratory*

For research where “abnormal models” are undesirable, as is the case for modeling wild behavior, the presence of abnormal behaviors has been identified as a scientific problem that can compromise a study’s validity, reliability, and replicability; thereby questioning the wider knowledge that can be gained from such models. Experimental *validity* measures the degree to which a test measures what it is supposed to test, including whether the effects were indeed caused by the treatment (internal validity); and whether the sample used is representative of a target population (external validity). When ethological studies are brought into the laboratory, threats to both internal and external validity are particularly problematic when using abnormally behaving animals to model “normal” behavior (Würbel, 2001, 2007). *Reliability* in an experiment means that the same result would be obtained from repeated observations or from multiple measurement devices. The likelihood that the outcome is reliable is reduced by using animals that show abnormal behaviors in experiments. This increases the amount of interindividual variation in an experiment (Garner, 2005), particularly if that variation affects the natural behavior being modeled. The *replicability* of an experiment refers to the extent to which the results can be repeated, for example, across different laboratories, which is affected by the variability in abnormal behaviors from atypical models seen between different laboratories (Garner, 2005). Garner (2005) describes how the brain mechanism that produces abnormal behavior “can and does” affect experimental outcomes in behavioral studies that measure response latencies, cage activity, behavioral switching, and extinction learning; he shows that different types of housing and laboratory environments can affect the prevalence of these behaviors and, therefore, the validity, reliability, and replicability of a behavioral experiment (p. 112). What is even more concerning from a scientific point of view is the *prevalence* of abnormal behaviors in laboratory animals; for example, it is estimated that 50% of laboratory mice display abnormal behaviors, which they start to develop right after weaning at 21 days old (Würbel and Stauffacher, 1994; Würbel, Stauffacher and von Holst). Therefore, a potentially large number of animals are being used, which are unsuitable for modeling behavior of the same species living in their natural environments, and providing results that are invalid, unreliable, and unreplicable.

1.5 *Other Scientific Concerns*

Some experiments, such as those within animal cognition (e.g., exploring innovative problem solving), over-rely on using a small number of individuals, typically raised in unnatural, barren or restrictive environments, as an exemplar of their species' cognitive capacities (Allen, 2002; Boesch, 2007, 2008; Leavens, Bard and Hopkins, 2010). This is particularly true for research using great apes. These experiments can involve the repetitive use of a small number of the same individuals, animals that have been exposed to countless numbers of trials with different variations of problems they must solve. While measures are taken to try to control for the effect of learning or environment, it is not possible to eliminate these variables as reasons for the findings in these studies; and, hence, they could explain individual differences apparent in studies using animals who have been used many times in previous research (e.g., Tecwyn, 2013; Tecwyn, Thorpe and Chappell, 2012). In particular, there is debate regarding the epistemic legitimacy of drawing species-level generalizations from studies that use captive primates. For example, Tomasello and Call (2008) controversially assert that the cognitive capacities of captive chimpanzees are not affected negatively by their unnatural environment. To the contrary, they note that captive chimpanzees have repeatedly demonstrated a range of impressive abilities not observed in their wild counterparts. In response, Boesch (2007, 2008) argues that the cognitive potential of enculturated chimpanzees is beside the point; the issue lies in making fair cross species comparisons. Boesch (2007) states: "The recent acceptance of experimental studies, with captive individuals considered as fully representative of an entire species, is based on the assumption that socioecological factors play a minimal role in the development of the cognitive and cultural abilities of the individual" (p. 3). Despite legitimate concerns of this nature, the results of experiments on captive populations are often considered—whether tacitly (e.g., Povinelli et al., 2000; Silk et al., 2005) or explicitly (e.g., Tomasello and Call, 1997, 2008)—to be indicative of the cognitive capacities (or lack thereof) of conspecifics across all developmental contexts. Indeed, extensive evidence already exists that different environmental experiences affect not only the cognitive development of NHPs, and other non-human animals (see Nelson, de Haan and Thomas, 2006, for a review), but that of humans as well. For example, human infants raised in different environments perform differently on tests designed to evaluate capacities for spatial reasoning, theory of mind, and numerical ability (see Boesch, 2008, for a review). Furthermore, Boesch (2007) points out that the acceptance of captive studies as representative of species' abilities can strongly discourage more ecologically relevant cognitive studies with wild populations.

A laboratory environment can never adequately simulate the natural life of a wild animal in an ecologically realistic way and with the same ecological pressures; frequently, the experiments they are exposed to, even for ethology laboratory research, do not represent real problems for which they have evolved to solve (Jayne, 2014). While controlling variables under laboratory conditions allows their effects to be studied in isolation from one another, as well as enabling behavior to be studied close up, these measures do not realistically represent how they would appear in wild populations (Leavens, Bard, and Hopkins, 2010), and thus affect the external validity or ecological relevance of a study (Bailoo, Reichlin and Würbel, 2014). For this reason, some experiments that are carried out to model wild behavior cannot always be replicated under controlled laboratory conditions (Jayne, 2014). For example, Boesch and Boesch-Achermann (2000) argue precisely this in relation to theory of mind research carried out in captive chimpanzees:

No captive study has so far attempted to study the chimpanzee's theory of mind, but all have confronted the chimpanzees with totally new situations to pass tests to show the human's theory of mind. This may address the question of [the] chimpanzee[s'] potential, but does not answer questions about the theory of mind that chimpanzees use in their daily lives. If some of these tests did not demonstrate a theory of mind in captive chimpanzees, we should not be surprised but rather ask ourselves "What kind of theory of mind is adaptive for chimpanzees to acquire?" and "When do they use it?". (p. 243)

1.6 *The Utility of Ethological Research in the Laboratory*

In relation to the scientific concerns of modeling wild animal behavior in the laboratory, a further problem is the extent to which the findings are even desirable in advancing our knowledge of behavior in wild-living individuals, given the methods used to obtain them. This is of particular relevance for determining whether the gains of the research, in terms of human knowledge about a species and their behavior, outweigh the harms to the animal, which appears to be played down when planning a laboratory study of wild animal behavior (personal analysis of UK non-technical summaries; UK Home Office, 2017b), although it should be a vital part of all harm-benefit analyses.

Furthermore, while the 3Rs must be addressed for any laboratory animal study that takes place—at least under European Union (EU) regulations, among other systems—the urgency with which they are applied to this type of behavioral research is minimal, in comparison to other fields of animal

research, particularly for replacement (personal analysis of EU funding dedicated to the 3Rs for laboratory behavioral/ethology research, 2017). Any legal requirement to seek non-animal replacements is easily disregarded in behavioral research because animals are the target species (Cuthill, 2007). Some non-animal methods are available for behavioral research and have been around for decades, such as computer modeling for analyzing shoaling and flocking behavior (Huston, 1988; Mwaffo, Butail and Porfiri, 2017); or computer programs with virtual animals that can be used for educational purposes (Graham, Alloway and Krames, 1994; Behavior on a Disk, n.d.); however, these may not be suitable replacements for many types of behavioral study. Thus, because the behavioral studies discussed here are specifically designed to model wild behavior, in close proximity and under controlled conditions not always possible in an animal's natural environment, the requirement for replacement is undermined and, as a consequence, the scientific concerns are given minimal weight.

Although studying the behavior of wild animals in the laboratory is a small field of research, relative to other areas where animals are modeled, phasing out the use of animals for this nature of research is particularly favorable: first, because of the scientific reasons already outlined; and second, because there is an obvious replacement available for researchers to ask the same questions (or at the very least, similar and refined questions) about behavior, namely, observing the natural behavior of wild and free-living animals. And where the study of free-living animals is not feasible, researchers need to consider whether the scientific knowledge gained from using laboratory models is even desirable. In terms of harm-benefit assessment, more critical scrutiny by researchers and licensing bodies should find that the harms do not outweigh the gains to scientific knowledge from attempting to model wild behavior in the laboratory, not least the ethical concerns (which are addressed in the second part of this chapter). This is a field of research where it is practicable to end animal use under these conditions and could be applied with minimal negative outcomes for researchers, who should still be able to continue their study under more scientifically favorable conditions, namely, with wild, free-living animals.

1.7 *Concluding Remarks*

Due to the smaller numbers of animals used, and with typically less invasive procedures, ethology laboratory studies often receive little attention when the 3Rs are discussed. The necessity of the research, however, is a different matter; for example, in cognition research, efforts to test whether animals are "intelligent" focus on their abilities to show human-like capabilities, which is

irrelevant to their evolutionary history or ecological needs (see Bekoff, 2013a, 2013b; and the second part of this chapter, for further discussion).

The Association for the Study of Animal Behaviour (ASAB) states that: “[i]f procedures used in research or teaching involve animals’ exposure to painful, stressful or noxious stimuli, whether through acts of commission or omission, the investigator must consider whether the knowledge that may be gained is justified” (2018, p. III). Ultimately, laboratory behavioral research shows us that the stress animals experience as a result of living in a laboratory impacts the outcomes of experiments in such a way that the information gained from these experiments may not be reliable or valid and, therefore, not justified. ASAB (2018, p. I) also state that “Behavioural studies are of great importance in increasing our understanding and appreciation of nonhuman animals”. Behavioral welfare studies reveal that laboratory animals are a poor scientific model for increasing our understanding of animal behavior and welfare and, particularly, for modeling behavior seen in wild animals (Garner, 2005; Würbel, 2007). In terms of furthering our knowledge and understanding of other animals, there are far more non-intrusive methods, such as ethological field studies where an animal’s natural behavior can be appreciated for its own worth, rather than using animals for hypothetical human gains. The study of the natural behavior of animals is fascinating, and none more so than when they are free to express their full behavioral repertoire in their own habitat. Furthering our understanding of animal behavior is entirely possible using non-intrusive approaches whilst still being grounded in the scientific method, such as through direct observations, or even experimentally by incorporating environmental manipulations (e.g., Jayne, Lea and Leaver, 2015; Klopfer, 1993).

Although laboratory behavioral research may rarely come under the category of causing “severe” suffering (unless being carried out alongside invasive procedures), for ethology studies; we have seen, from the first part of this chapter, that some experimental methods cause animals to experience psychological stress to such a degree that it can affect their long-term physiological development. Even simply living in a laboratory environment can result in a sufficient amount of stress to bring about permanent changes in behavior, physiology, and brain development (e.g., Makowska and Weary, 2016; van Praag, Kempermann and Gage, 2000; Würbel, 2001). Ultimately, a laboratory can never adequately provide an environment for an animal to behave in an ecologically relevant way for experimental findings to inform about natural behavior or evolved abilities. Accordingly, the continued use of laboratory animals for ethology research is not scientifically desirable or necessary, as well as being fraught with ethical problems, as the second part of this chapter illustrates.

2 Behavioral Research on Captive Animals: Ethical Concerns

– Adam See –

The remainder of this chapter focuses on underrepresented ethical issues arising from behavioral research in comparative cognition or, more generally, the study of animal minds. As the range of potential topics of interest here is immense, discussion is limited to the following: 1. behavioral research conducted in captive environments, i.e., zoos and research centers; 2. controlled studies on non-human primates (NHPS); and 3. research motivated solely by scientific curiosity, i.e., *pure* or *basic* research as opposed to *applied* research, such as theory of mind debates. Research in this vein has, to our knowledge, never been subject to sustained ethical scrutiny. The primary aim of what follows is to motivate this conversation.

2.1 Behavioral Research on Non-human Primates

Great ape and monkey species have long been staples of both behavioral and biomedical research in the United States (US) and in the European Union. Biomedical research on great apes has been (mostly) banned in the EU (European Parliament, 2010, Directive 2010/63/EU, Article 8; though see various *safeguard clauses* in Article 55); and in the US, where the Fish and Wildlife Services recently granted chimpanzees endangered species status (2015; more on this law below). However, so-called “non-invasive” or “behavioral” research on great apes, and especially other NHPS, continues largely untouched in these countries.

In the US, the Ape Cognition and Conservation Initiative in Des Moines, Iowa, continues to house, breed, and conduct behavioral studies on bonobos, many of which focus on multi-modal communication (e.g., Tagliabue et al., 2015). The Yale Comparative Cognition Laboratory in New Haven, Connecticut, conducts behavioral research on the origins of human cognitive abilities in a “naturalistic” indoor enclosure, “equipped with natural branches and other toys” (Leimgruber, Rosati, and Santos, 2016; see also Cohen and Santos, 2016; Rosati and Santos, 2016). Behavioral research on monkeys, involving functional magnetic resonance imaging (fMRI), is also being conducted at Rockefeller University in New York City (e.g., Sliwa and Freiwald, 2017). The Yerkes Research Center (Yerkes) houses and breeds NHPS at both Emory University and a second location in Lawrenceville, Georgia. Their current population of NHPS is approximately 3,400, though it is unclear what percentage is used exclusively for behavioral research (Yerkes, n.d.). Much of the behavioral research at Yerkes takes place in “sound attenuating booths” with computer touch screens, as well as a “foraging room” where monkeys “explore and learn in a large area

where food can be hidden and puzzles presented" (Laboratory of Comparative Primate Cognition, n.d.). Recent behavioral research at Yerkes involves monkeys (e.g., Brown, Timpler, and Hampton, 2017; Hassett and Hampton 2017), orangutans (e.g., Diamond et al., 2016), and chimpanzees (e.g., Krachun et al., 2016). What is more, the Comparative Intelligence and Cognition Laboratory at the Language Research Center at Georgia State University conducts a wide range of comparative experiments on chimpanzees, capuchin monkeys, rhesus monkeys, and human infants and adults. Nearly a dozen such experiments were conducted in 2016, with comparable numbers in previous years, focusing on topics, such as numerical cognition, metacognition, strategic economic interactions, prospective memory and planning, self-control and delay of gratification, and perceptual and cognitive illusions (Comparative Intelligence and Cognition Laboratory, n.d.).

Behavioral research on theory of mind, cognitive bias, cooperation, and fairness, among other areas, is also regularly conducted at zoos, such as Zoo Atlanta, which houses the largest population of gorillas, orangutans, and drill monkeys in the US (Zoo Atlanta, n.d.); and the Lester E. Fisher Center for the Study and Conservation of Apes at the Lincoln Park Zoo, which publishes a wealth of studies on sociocognitive abilities in chimpanzees (e.g., Brosnan et al., 2015; Hopper et al., 2015). Finally, behavioral research on NHPs in the US is also performed at *field stations*, such as the National Institutes of Health (NIH) Animal Center at the Laboratory of Comparative Ethology in Poolesville, Maryland (e.g., Dettmer et al., 2016b; Wooddell et al., 2017). This field station is a five acre "naturalistic" environment from which primates are *temporarily removed* for reasons, such as manipulating group dynamics (e.g., "rank changes and troop stability") in their absence (e.g., Wooddell et al., 2017). Some studies involve separation of infant macaques from their mothers (e.g., Ferrari et al., 2009) for up to five intervals during the first month of their lives, while others do not (e.g., Dettmer et al., 2016a).

In the EU, the most prominent institution for behavioral research is the Wolfgang Köhler Primate Research Center (Pongoland) in Leipzig, Germany, which houses 41 great apes. Notable recent studies include, the false-belief experiments of Krupenye et al. (2016) and Kano et al. (2017), which are the first tests in over 40 years of research on this subject, to demonstrate that apes possess an understanding of reality-incongruent mental states in others. The capacity to attribute false beliefs has long been the litmus test for whether chimpanzees possess a theory of mind, making these studies particularly significant.

The above survey of contemporary behavioral research on NHPs is hardly exhaustive, but it gives the reader a sufficient idea of the types of research under discussion here. Behavioral research is not easy to define. It can range from

“purely-observational” research in the field, to controlled experimental trials in captive environments involving touch screens, “non-invasive” neural imaging, and competitive and collaborative activities with humans and conspecifics. It mostly occurs in zoos, sanctuaries, and research centers (laboratories with “naturalistic” enclosures). A great advantage of the mode of argumentation that follows is that concrete definitions are unnecessary. Both the moral principle presented below as well as the challenge that results from this principle are intended to apply to behavioral research in all of its iterations. As will become clear, certain behavioral research may be readily justifiable in accordance with this principle, while other behavioral research will not, and a great many cases will remain up for debate.

2.2 *Scientific Curiosity and the Ethics of Behavioral Research*

In comparative cognition, the vast majority of behavioral research has been, and continues to be, conducted on NHPs bred and raised in captivity (Andrews, 2015, p. 164). As mentioned above, chimpanzees continue to be widely used in behavioral research. Yet, as Birkett and Newton-Fisher (2011, p. 6) state, there is an “urgent need to understand how the chimpanzee mind copes with captivity, an issue with both scientific and welfare implications that will impact potential discussions concerning whether such species should be kept in captivity at all”. Indeed, we share the concerns of Boesch (2007, 2008, 2015) and Leavens, Bard and Hopkins (2010) that there is a desperate need to grapple with serious epistemic and methodological issues that arise from making population-to-species generalizations, based entirely on the behavior of captive chimpanzees. However, the focus in this discussion is on an even less represented issue: the welfare implications of behavioral research on these individuals. While biomedical research on chimpanzees and other non-human primates is a widely contentious issue amongst philosophers, scientists, and the general public alike, behavioral research has rarely been subject to moral scrutiny. Nonetheless, Malone and Palmer (2014, p. 33) are quite right that “although ‘purely observational’ research in the field and the zoo is often regarded as inherently good and only minimally problematic, complex ethical issues accompany research in both these settings”. The same can be said for more hands on behavioral experiments in “naturalistic” indoor and outdoor environments at primate research centers. Over the past few years, behavioral research on chimpanzees has, thankfully, been the subject of several excellent papers (Baker and Dettmer, 2016; Fedigan, 2010; Gruen, Fultz and Pruettz, 2013; Hosey, 2005, 2008; Mackinnon and Riley, 2010; Malone, Fuentes and White, 2010; Malone and Palmer, 2014). This discussion does not summarize the myriad of issues that they raise but rather concludes by highlighting a crucial challenge

to behavioral studies on captive NHPS, which has been largely marginalized by philosophers and primatologists alike.

In the opening pages of her popular primer, *Fundamentals of Comparative Cognition* (2013, pp. 1–2), Shettleworth highlights two motivations for studying the animal mind. First, there are various “practical considerations” for “addressing issues in conservation and animal welfare,” as well as for the construction of animal models for application in fields, such as neuroscience and genetics. Research motivated by these concerns is directly relevant to challenges discussed in the early sections of this chapter. Of special interest in the current discussion, however, is the *second* motivation that Shettleworth discusses: behavioral research motivated strictly by “sheer scientific curiosity.” It is clear, for example, that the longest running and most popular issues regarding animal minds, tackled by philosophers and scientists alike, are chiefly addressed at questions of *human uniqueness*. As Shettleworth (2013, p. 2) claims, “What unifies this diverse field is the overarching question with which the modern study of comparative cognition began, how true is Darwin’s (1871) assertion that humans’ ‘mental powers’ are ‘different in degree but not in kind’ from those of other species?” The question as to whether Darwin was right to challenge this age-old, and still dominant, notion of human uniqueness is commonly thought justifiable *for its own sake*. Povinelli’s work (2000; 2012) on chimpanzee “folk physics” offers a prime example of such research. Based on a series of experiments on captive chimpanzees at the New Iberia Research Center (NIRC), Povinelli argues that chimpanzees understand the physical world in a way that is fundamentally different from humans. It is worth noting, in line with the first part of this chapter, that the ecological validity of Povinelli’s findings has been subject to great scrutiny. Within a year of publication, three scathing reviews of Povinelli’s first book on the subject, by high-profile figures, appeared in comparative cognition (Hauser, 2001; Whiten, 2001; Allen, 2002). This second class of behavioral research (henceforth referred to as *sheer curiosity-based behavioral research* or *SCBB* research) presents a unique ethical challenge that is not faced by other common forms of animal experimentation.

SCBB research can be defined as, *experimental, or purely observational, behavioral research with no expected, or foreseeable, practical consequences*. The motivations of the researchers are essential to this definition. Povinelli’s experiments on the NIRC chimpanzees were not motivated by welfare concerns, nor were they motivated by future use in constructing animal models; rather, Povinelli and collaborators quite simply sought to gain knowledge as to whether chimpanzees understand the physical properties of objects in the same way that humans do (or, in many other of their experiments, whether chimpanzees possess a theory of mind). The majority of behavioral research

on chimpanzees in comparative cognition is guided, first and foremost, by this basic desire to know for the sake of knowing (not to mention, of course, academic eminence, research grants, and the desire to publish). Further research and commentary is encouraged on this final point, as these overarching goals and features of academic culture are clearly relevant to the issue at stake.

When Shettleworth (2013, p. 2) claims that while “practical considerations motivate some research in animal cognition,” an “equally important impetus for studying comparative cognition is sheer scientific curiosity,” she is evoking the classic dichotomy between *pure* and *applied* science. In so doing, Shettleworth is aligning SCBB research with the former. Indeed, much of the animal minds literature tacitly operates under the banner of so-called, *pure science*, i.e., science without clear or direct practical implications. However, as is frequently argued in the philosophy of science, a strong case can be made that science is never entirely *pure*, insofar as the practice of doing science is never entirely value neutral. The costs and benefits of research at every step of the way—from motivating the research program to deciding upon the means to conduct it—are the result of tacit or explicit value judgments, including “a prior judgment to which moral considerations are pertinent” (Kitcher, 2001, p. 90; see also Gonzalez, 2013, for further commentary). With respect to SCBB research, for many experimenters who work in field, zoo, and research centers, traditional ethical criteria (such as the 3Rs) appear “puzzling and irrelevant” (Fedigan, 2010, p. 755); occasionally going “so far as to identify their projects as exempt from the entire oversight process” (Malone and Palmer, 2014, p. 25). While much of the current ethics literature on chimpanzee behavioral research (such as those cited above) provides strong reasons to reject this perspective (i.e., zoological institutions and field research clearly come with their own ethical concerns), in what follows we take a different critical approach by challenging the very basis for conducting some of this research in the first place. As these issues are broken down, scientific curiosity alone emerges as an extremely weak reason for breeding and confining animals.

2.3 *A Moral Challenge*

Practically all discussions of the ethics of animal experimentation (under any guise, context, motivation, or environment) involve some form of *utilitarian* calculus, i.e., “one that tries to weigh the beneficial consequences of experimentation with the costs associated with it” (Gruen, 2011, p. 118). The challenge that we pose to *pure research* facilities that breed and maintain animals solely to satisfy scientific curiosity is that such practices are incredibly difficult to justify on ethical grounds. There is even a crucial sense in which, given a utilitarian calculus, breeding and maintaining animals in captivity for the

sole purpose of studying their behavior is *more* difficult to justify with reasoned arguments than invasive biomedical experiments. Invasive biomedical research clearly evokes more welfare concerns than behavioral research, but the welfare concerns in the former can be, and often are, argued away on the basis of anticipated practical benefit. SCBB research, on the other hand, may be legitimately said to evoke fewer welfare concerns. However, *without any expected* or *foreseeable* practical benefit to fall back on, convincing justification for breeding and maintaining chimpanzees in captivity—rather than placing extant chimps in sanctuary—is by no means obvious. Therefore, despite the wealth of knowledge attained from captive studies, a large amount (perhaps even the *majority*) of behavioral research conducted on chimpanzees (past, present, and future) is far from easy to justify. There is clearly a very real challenge present here worthy of serious consideration.

Those who conduct SCBB research in zoological institutions, such as Frans de Waal at the Arnhem Zoo (e.g., de Waal, 1998) and Michael Tomasello at the Wolfgang Köhler Primate Research Center in collaboration with the Leipzig Zoo (e.g., Tomasello et al., 2007), are capable of offering additional justifications for captivity, e.g., the *conservation efforts* of their host institutions (see later discussion). However, it is very difficult to make a strong case that breeding and maintaining NHPs at *pure research* facilities, such as New Iberia Primate Research Center or the Yerkes National Primate Research Center, is morally justified. There are currently eight National Primate Research Centers in the US, not including many other similar federally-funded institutions, such as the NIRC. Some of these institutions have conducted SCBB research on chimpanzees, in addition to more common biomedical studies. Both the Yerkes facility (Guha and Sullivan, 2015) and, more infamously, the New Iberia facility (Gruen, 2011, p. 116) have been subject to charges of ethics violations by the Humane Society of the United States, ultimately leading to the retirement of 220 New Iberia chimpanzees to the Project Chimps sanctuary in 2016 (New Iberia Research Center, n.d.). Crucially, the line of argumentation presented here is *not* contingent upon these more egregious cases, but rather applies more broadly to challenging the ethical basis for keeping chimpanzees in captivity (even in “enriched” or “naturalistic” conditions) purely to satisfy scientific curiosity.

2.4 *A Moral Principle*

Let us proceed via demonstrative reasoning by agreeing to what we take to be an uncontroversial principle: *interests motivated by the desire to satisfy intellectual curiosity (with no foreseeable or expected practical benefit) should not compromise or outweigh the welfare interests of others, because the former*

type of interests are comparably trivial relative to the latter. This principle is non-speciesist; it applies to research on humans as well as any sentient being capable of having interests. Importantly, it does not make all behavioral research unethical. For many animals raised in captivity, releasing them into the wild would clearly not be in their interests (Gruen, 2011). As such, for many animals already in social groups at zoological institutions, with conservation and/or welfare-directed mission statements, this principle may readily promote their *continued* existence at the zoo, alongside other welfare interests of the NHP populations in question. For example, the Wolfgang Köhler Primate Research Center website claims that, “The breeding program at the zoo is framed within the global strategy of the European Endangered Species Program (EEP); and some research focuses on the husbandry and care of great apes in captivity”. What is more, so long as the experiments themselves conducted in these environments can be convincingly argued to not violate the welfare of the test subjects, the principle is likewise not violated. The principle simply states that X’s interests in bodily mobility, choice of social and sexual relations, general psychological well-being, and so forth, always outweigh Y’s interests in satisfying their intellectual curiosity. It, therefore, follows that whenever X’s interests and Y’s interests are at odds, it is Y’s obligation to explain *why* their interests to conduct SCBB research are *not* trivial when compared to X’s welfare interests; or, that Y’s interests do not actually supersede any of X’s welfare interests (as researchers in zoological institutions may claim). That said, the challenge that we have posed, based on this principle, is vital to future research programs because, if the above reasoning is sound, it seems to follow that *none* of the SCBB research conducted on the New Iberia chimpanzees, for example, was morally justified.

2.5 Counter Argumentation

Let us now consider several logical counter-arguments. To begin, some might take issue with the liberal use of the word *practical* and suggest, rightly, that while it is true that *individual researchers* may take themselves to be merely scratching an intellectual itch, the scientific enterprise *as a collective effort* almost always bears practical fruit, even from the most obscure research programs. If that is true, then the utilitarian calculus suggested here starts to look a lot more complicated. It requires the estimation of *possible future utility* of discoveries arising from research programs that, when undertaken, do not seem to have any practical value. As such, it is far from clear how such a utility calculation could be performed in any rigorous way.

Our response is as follows. When defining the parameters of SCBB research, we stressed the importance of researcher motivations because almost any

pure research could be justified on the basis of *ad hoc* practical applications. Consider the theory of mind research. One foreseeable response to our conclusions is that work on theory of mind in chimpanzees *does* clearly have practical repercussions in the sense that this debate has been “central” to discourse on whether apes should be considered moral or legal persons (Lurz, 2011, p. 4). As such, a potential counter-argument might run along the following lines: as Malone and Palmer (2014, p. 34) note, “caregivers to orangutans at Auckland Zoo expressed the idea that zoo animals serve as ‘martyrs’ for their species, suggesting that individual sacrifice is justified for the sake of the ‘greater good’ of conservation. Similar ideas are often raised in discussions about the benefits of field research, alongside the notion that ‘knowing more’ makes such research inherently good”. With respect to theory of mind research, those who breed and maintain chimpanzees at research facilities could argue that these individuals were, in some sense, “martyrs” for scientific knowledge that has, or may foreseeably have, practical applications regarding the welfare of their entire species.

This potential response is strongly unappealing for a number of reasons. First, there is no clear evidence that theory of mind research *has* led to progress for chimpanzees attaining legal personhood. Second, there is already sufficient evidence that chimpanzees have at least a “minimal” theory of mind (Call and Tomasello, 2008), which should satisfy any salient ethical concerns regarding the concept. Third, it is hypocritical for anyone who is motivated to defend theory of mind studies at research facilities, such as the NIRC, due to concern for the personhood status of chimpanzees, because any presumed or potential personhood status owed to those research subjects would be violated by their being bred and kept in such an environment. Fourth, the chimpanzees themselves quite clearly had no say in their presumed status as “martyrs”. Fifth, as Gruen (2011, p. 129) notes, “Virtually every scientific article ends by claiming ‘that more research is needed’. This is how research scientists make their living”. Theory of mind research is no different; in fact, the theory of mind debate has long been subject to a well-known gridlock since decades worth of experimental and ethological research have failed to mitigate widespread skepticism under the guise of the so-called *logical problem*. Proponents of the *logical problem* claim that all approaches, past and present, that have been used to evaluate cognitive capacities, such as the presence of theory of mind in animals, “cannot provide evidence for this ability even in principle” (Halina, 2015, p. 474). In its basic form, the *logical problem* states that since all we can observe is an animal’s behavior, it is difficult (if not impossible) to determine whether an animal is predicting the behavior of others by means of mental state attribution (e.g., of their underlying intentions and beliefs), or by means

of associative or conditioned response-mechanisms. Since there is little reason to believe that the *logical problem* will be solved (Andrews, 2015), *ad hoc* justifications of SCBB research based on foreseeable ethical consequences of the theory of mind debate are clearly weak. Therefore, this same conclusion applies to any other research program commonly pursued at *pure research* centers for the sole purpose of scientific curiosity.

Another foreseeable counter argument would evoke the “naturalistic” or *enriched* conditions provided by research centers, such as Yerkes. It could be argued that, given these *enriched conditions* the ethics of captivity for primates in research centers deserves to be situated on a moral continuum with the apparent “naturalistic” conditions at zoological institutions, rather than in a separate category. We agree. Our response is that zoological institutions, such as Pongoland, are certainly not off the hook morally. We have excluded zoos from the heart of this discussion because the costs and benefits of their supposed conservation value is under scrutiny elsewhere (e.g., Alroy, 2015; Keulartz, 2015; Marino et al., 2010; Princée, 2016); but we readily grant that zoos and research centers exist on the same moral spectrum. With respect to this issue, we direct the reader to literature that explicitly considers the ethical weighing of zoological conservation efforts and welfare concerns brought upon by captivity (e.g., Davey, 2007; Gruen, 2011; Hosey, 2005, 2008; Keulartz, 2015) and grant that the challenges raised here apply to SCBB research across the map. Nonetheless, in the absence of any clear benefits for the animals themselves, it is evident that SCBB research conducted at institutions, such as NIRC and Yerkes, cannot readily satisfy the self-evident moral principle that we have provided nor can any given utilitarian calculus that one may apply to justify this kind of research. Finally, it must be noted that the above is intended strictly as grounds for positing an important, yet critically underdiscussed, challenge for researchers to contend with—a *moral dilemma that naturally arises when one attempts to justify SCBB studies*—rather than a direct indictment of any particular researchers or institutions.

2.6 *Concluding Remarks*

Those who engage in or otherwise defend SCBB research necessarily face a unique challenge not confronted by other forms of animal experimentation. *All* debates over animal experimentation evoke some sort of messy utilitarian or consequentialist calculus, wherein some foundation (firm or not) is provided to weigh the costs and benefits of breeding, maintaining, and experimenting on animals for research. However, when it comes to breeding primates (or any species, for that matter) purely for scientific curiosity at research centers, the calculus

appears to come out the same every time: SCBB research is unjustified across the board. The extent to which this conclusion may also apply to similar research programs at zoos is far beyond the scope of this chapter but certainly one for further discussion. Also crucial for future discussion are the difficulties associated with justifying continued behavioral research by means of the conservation efforts of particular non-sanctuary research institutions, where such research is conducted (e.g., the Ape Cognition and Conservation Initiative in Iowa).

The following proposal is a corollary of the basic moral principle put forth and defended above; those who study animals in captivity must demonstrate either that:

1. *The welfare interests of their research subjects are not compromised or outweighed in favor of interests derived solely from satisfying intellectual curiosity; and/or that*
2. *The dominant reasons for breeding and maintaining animals in captivity derive more from the welfare interests of the animals themselves than from purely intellectual interests.*

The traditional act of breeding and maintaining non-human primates at research centers cannot readily satisfy these fair-minded conditions.

In terms of logistics, what exactly is being recommended here? We propose that the US Fish and Wildlife Services (FWS) may have already, in part, paved the way. On September 14, 2015, the FWS officially granted endangered species status to chimpanzees living in the wild and in captivity. As a result, in order to use chimpanzees for biomedical research, one must apply for a special permit from the FWS. To date, only one permit has been applied for, which was granted in the interest of developing an Ebola vaccine for wild chimpanzees (Walsh et al., 2017). According to the FWS, however, behavioral research does *not* require such a permit. Such research would only require one, if it involves “actions that harm, stress, harass, or noticeably change the animal’s behavior” (Grimm, 2015). If it can be convincingly argued via a combination of investigative journalism and welfare research on captive primates that these consequences *do* arise in captive chimpanzees, *especially* at *pure research* centers, a double standard could fairly be demonstrated here. Furthermore, “endangered species status” is largely irrelevant to the key issue at stake. One could readily expand this general proposal in the following way: *All biomedical and behavioral research—not only that which involves NHPS, but all research involving captive canids, birds, bears, rodents, and others—should require such a permit.* Research at zoological institutions would very likely be granted one, but it seems unlikely that future breeding and research programs conducted at more laboratory-oriented types of research institutions would.

References

- Abou-Ismaïl, U.A. and H.D. Mahboub (2011). The Effects of Enriching Laboratory Cages Using Various Physical Structures on Multiple Measures of Welfare in Singly-housed Rats. *Laboratory Animals*, 45(3), pp. 145–153.
- Abramson, L.Y., M.E. Seligman and J.D. Teasdale (1978). Learned Helplessness in Humans: Critique and Reformulation. *Journal of Abnormal Psychology*, 87(1), p. 49.
- Allen, C. (2002). A Skeptic's Progress. *Biology and Philosophy*, 17, pp. 695–702.
- Alroy, J. (2015). Limits to Captive Breeding of Mammals in Zoos. *Conservation Biology*, 29(3), pp. 926–931.
- Andrews, K. (2015). *The animal mind*. New York: Routledge Press.
- Arakawa, H., D.C. Blanchard, K. Arakawa, C. Dunlap and R.J. Blanchard (2008). Scent Marking Behavior as an Odorant Communication in Niche. *Neuroscience and Biobehavioral Reviews*, 32(7), pp. 1236–1248.
- Archibald, K., R. Coleman, and T. Drake (2019). Replacing animal tests to improve safety for humans. In: K. Herrmann and K. Jayne, eds., *Animal Experimentation: Working Towards a Paradigm Change*, Vol. 22. Brill Human Animal Studies Series, pp. 417–442. Leiden: Brill.
- Association for the Study of Animal Behaviour (2018). Guidelines for the Treatment of Animals in Behavioural Research and Teaching. *Animal Behaviour*, 135, pp. 1–X.
- Bailey, J. (2019). Genetic modification of animals: Scientific and ethical issues. In: K. Herrmann and K. Jayne, eds., *Animal Experimentation: Working Towards a Paradigm Change*, Vol. 22. Brill Human Animal Studies Series, pp. 443–479. Leiden: Brill.
- Bailoo, J.D., T.S. Reichlin and H. Würbel (2014). Refinement of Experimental Design and Conduct in Laboratory Animal Research. *Institute for Laboratory Animal Research Journal*, 55(3), pp. 383–391.
- Baker, K.C. and A.M. Dettmer (2016). The Well-being of Laboratory Non-human Primates. *American Journal of Primatology*, 79(1), pp. 1–5.
- Baldwin, A.L., R.L. Primeau and W.E. Johnson (2006). Effect of Noise on the Morphology of the Intestinal Mucosa in Laboratory Rats. *Journal of the American Association for Laboratory Animal Science*, 45, pp. 74–82.
- Bassett, L. and H.M. Buchanan-Smith (2007). Effects of Predictability on the Welfare of Captive Animals. *Applied Animal Behaviour Science*, 102, pp. 223–245.
- Behavior on a Disk (n.d.). [online] Available at: <https://norecopa.no/norina/behavior-on-a-disk> [Accessed 05 May 2017].
- Bekoff, M. (2013a). Are Pigs as Smart as Dogs and Does it Really Matter? *Psychology Today: Animal Emotions*. [online] Available at: <https://www.psychologytoday.com/blog/animal-emotions/201307/are-pigs-smart-dogs-and-does-it-really-matter> [Accessed 06 May 2017].

- Bekoff, M. (2013b). Are Pigs as Smart as Dogs, and Does It Really Matter? (Op-Ed). *Live Science*. [online] Available at: <https://www.livescience.com/39717-are-pigs-as-smart-as-dogs.html> [Accessed 18 November 2017].
- Birkett, L.P. and N.E. Newton-Fisher (2011). How Abnormal Is the Behaviour of Captive, Zoo-living Chimpanzees? *PLoS-One*, 6(6), p. e20101.
- Boesch, C. (2007). What Makes Us Human (*Homo Sapiens*)? The Challenge of Cognitive Cross-species Comparison. *Journal of Comparative Psychology*, 121(3), pp. 227–240.
- Boesch, C. (2008). Taking Development and Ecology Seriously When Comparing Cognition: Reply to Tomasello and Call (2008). *Journal of Comparative Psychology*, 122(4), pp. 453–455.
- Boesch, C. (2015). Similarities between chimpanzee and human culture. In: M.J. Gelfand, C.C. Ying-yi Hong, eds., *Handbook of Advances in Culture and Psychology*, Vol. 5. New York: Oxford University Press, pp. 1–37.
- Boesch, C. and H. Boesch-Achermann (2000). *The chimpanzees of the Tai Forest: Behavioural ecology and evolution*. Oxford, UK: Oxford University Press.
- Bolhuis, J.J. and L.A. Giraldeau (2008). The study of animal behavior. In J.J. Bolhuis and L.A. Giraldeau, eds., *The Behavior of Animals: Mechanism, Function and Evolution*. Oxford, UK: Blackwell Publishing.
- Braithwaite, V.A. and P. Boulcott (2007). Pain Perception, Aversion and Fear in Fish. *Diseases of Aquatic Organisms*, 75, pp. 131–138.
- Brilot, B.O. and M. Bateson. (2012). Water Bathing Alters Threat Perception in Starlings. *Biology Letters*, 8, pp. 379–381.
- Brosnan, S.F., L.M. Hopper, S. Richey, H.D. Freeman, C.F. Talbot, S. Gosling, S.P. Lambeth and S.J. Schapiro (2015). Personality Influences Responses to Inequity and Contrast in Chimpanzees. *Animal Behaviour*, 101, pp. 75–87.
- Brown, E.K., V.L. Templer and R.R. Hampton (2017). An Assessment of Domain-general Metacognitive Responding in Rhesus Monkeys. *Behavioural Processes*, 135, pp. 132–144.
- Burns, J.G., A.C. Price, J.D. Thomson, K.A. Hughes and F.H. Rodd (2016). Environmental and Genetic Effects on Exploratory Behavior of High-and low-predation Guppies (*Poecilia Reticulate*). *Behavioral Ecology and Sociobiology*, 70(8), pp. 1187–1196.
- Burwell, A.K. and A.L. Baldwin (2006). Do Audible and Ultrasonic Sounds of Intensities Common in Animal Facilities Affect the Autonomic Nervous System of Rodents? *Journal of Applied Animal Welfare Science*, 9, pp. 179–200.
- Call, J. and M. Tomasello (2008). Does the Chimpanzee Have a Theory of Mind? 30 Years Later. *Trends in Cognitive Sciences*, 12(5), pp. 187–192.
- Carvalho, C., D. Alves, A. Knight, and L. Vicente (2019). Is animal-based biomedical research being used in its original context? In: K. Herrmann and K. Jayne, eds., *Animal Experimentation: Working Towards a Paradigm Change*, Vol. 22. Brill Human Animal Studies Series, pp. 376–390. Leiden: Brill.

- Chance, P. (1999). Thorndike's Puzzle Boxes and the Origins of the Experimental Analysis of Behavior. *Journal of the Experimental Analysis of Behavior*, 72(3), pp. 433–440.
- Clayton, N. and N. Emery (2005). Corvid Cognition. *Current Biology*, 15(3), pp. R80–R81.
- Cohen, P.M., and L.R. Santos (2016). Capuchins (Cebus Apella) Fail to Show an Asymmetric Dominance Effect. *Animal Cognition*, pp. 1–15.
- Comparative Intelligence and Cognition Laboratory (n.d.). [online] Available at: <http://www.mjberan.com/> [Accessed 21 June 2017].
- Cuthill, I.C. (2007). Ethical Regulation and Animal Science: Why Animal Behaviour Is Not So Special. *Animal Behaviour*, 74, pp. 15–22.
- Darwin, C. (1871). *The descent of man and selection in relation to sex*. London, UK: John Murray.
- Davey, G. (2007). Visitors' Effects on the Welfare of Animals in the Zoo: A Review. *Journal of Applied Animal Welfare Science*, 10(2), pp. 169–83.
- Dettmer, A.M., S.S.K. Kaburu, K.L. Byers, A.M. Murphy, E. Soneson, L.J. Wooddell and S.J. Suomi (2016a). First-time Rhesus Monkey Mothers, and Mothers of Sons, Preferentially Engage in Face-to-face Interactions with Their Infants. *American Journal of Primatology*, 78, pp. 238–246.
- Dettmer, A.M., L.J. Wooddell, K.L. Rosenberg, S.S. Kaburu, M.A. Novak, J.S. Meyer, and S.J. Suomi (2016b). Associations Between Early Life Experience, Chronic HPA Axis Activity, and Adult Social Rank in Rhesus Monkeys. *Social Neuroscience*, 1, pp. 92–101.
- De Waal, F.B.M. (1998). *Chimpanzee politics: Power and sex among apes*. Baltimore, MD: Johns Hopkins University Press.
- Dews, P.B. (1955). Studies on Behavior I. Differential Sensitivity to Pentobarbital of Pecking Performance in Pigeons Depending on the Schedule of Reward. *Journal of Pharmacology and Experimental Therapeutics*, 113(4), pp. 393–401.
- Diamond, R.F., T.S. Stoinski, J.L. Mickelberg, B.M. Basile, R.P. Gazes, V.L. Templer, and R.R. Hampton (2016). Similar Stimulus Features Control Visual Classification in Orangutans and Rhesus Monkeys. *Journal of the Experimental Analysis of Behavior*, 105, pp. 100–110.
- European Parliament (2010). Directive 2010/63/EU of the European Parliament and of the Council of 22 September 2010 on the Protection of Animals Used for Scientific Purposes. *Official Journal of the European Communities*, L276, pp. 33–79. [online] Available at: <http://eur-lex.europa.eu/legal-content/EN/TXT/?uri=CELEX%3A32010L0063> [Accessed 12 August 2017].
- Fedigan, L.M. (2010). Ethical Issues Faced by Field Primatologists: Asking the Relevant Questions. *American Journal of Primatology*, 72(9), pp. 754–771.
- Feng, X., L. Wang, S. Yang, D. Qin, J. Wang, C. Li, L. Lv, Y. Ma, and X. Hu (2011). Maternal Separation Produces Lasting Changes in Cortisol and Behavior in Rhesus Monkeys. *Proceedings of the National Academy of Sciences*, 108(34), pp. 14312–14317.

- Ferrari, P.F., A. Paukner, C. Ionica and S.J. Suomi (2009). Reciprocal Face-to-face Communication Between Rhesus Macaque Mothers and Their Newborn Infants. *Current Biology*, 19, pp. 1768–1772.
- Gagliardo, A., P. Ialò, M. Savini and M. Wild (2008). Navigational Abilities of Homing Pigeons Deprived of Olfactory or Trigeminally Mediated Magnetic Information When Young. *Journal of Experimental Biology*, 211(13), pp. 2046–2051.
- Garner, J.P. (2005). Stereotypies and Other Abnormal Repetitive Behaviors: Potential Impact on Validity, Reliability, and Replicability of Scientific Outcomes. *Institute for Laboratory Animal Research Journal*, 46(2), pp. 106–117.
- Garner, J.P. and G.J. Mason (2002). Evidence for a Relationship Between Cage Stereotypies and Behavioural Disinhibition in Laboratory Rodents. *Behavioural Brain Research*, 136(1), pp. 83–92.
- Garner, J.P., G. Mason R. Smith (2003). Stereotypic Route-tracing in Experimentally-caged Songbirds Correlates with General Behavioural Disinhibition. *Animal Behaviour*, 66, pp. 711–727.
- Gaskill, B.N. (2016). *Stressed out! The Consequences of Environmentally Induced Stress on Mouse Models*. Laboratory Animal Sciences Webinar. [online] Available at: <https://www.labroots.com/webinar/stressed-out-the-consequences-of-environmentally-induced-stress-on-mouse-models> [Accessed 05 May 2017].
- Gewin, V. (2011). Rats free each other from cages. *Nature, News*. [online] Available at: <https://www.nature.com/news/rats-free-each-other-from-cages-1.9603> [Accessed 05 May 2017].
- Gonzalez, W.J. (2013). Value ladenness and the value-free ideal in scientific research. In: C. Luetge, ed., *Handbook of the Philosophical Foundations of Business Ethics*. Netherlands: Springer, pp. 1503–1521.
- Gouveia, K. and J.L. Hurst (2017). Optimising Reliability of Mouse Performance in Behavioural Testing: The Major Role of Non-aversive Handling. *Nature, Scientific Reports*, 7. [online] Available at: <https://www.nature.com/articles/srep44999> [Accessed 06 May 2017].
- Graham, J., T. Alloway and L. Krames (1994). Sniffy, the Virtual Rat: Simulated Operant Conditioning. *Behavior Research Methods, Instruments, and Computers*, 26(2), pp. 134–141. [online] Available at: http://www.wadsworth.com/psychology_d/templates/student_resources/0534633609_sniffy2/sniffy/main.htm [Accessed 06 May 2017].
- Greek, R., and L.A. Kramer (2019). The scientific problems with using non-human animals to predict human response to drugs and disease. In: K. Herrmann and K. Jayne, eds., *Animal Experimentation: Working Towards a Paradigm Change*, Vol. 22. Brill Human Animal Studies Series, pp. 391–416. Leiden: Brill.
- Greenwood, A.K., A.R. Wark, K. Yoshida and C.L. Peichel (2013). Genetic And Neural Modularity Underlie the Evolution of Schooling Behavior in Threespine Sticklebacks. *Current Biology*, 23(19), pp. 1884–1888.

- Greenwood, B.N., P.V. Strong and M. Fleshner (2010). Lesions of The Basolateral Amygdala Reverse the Long-lasting Interference with Shuttle Box Escape Produced by Uncontrollable Stress. *Behavioural Brain Research*, 211(1), pp. 71–76.
- Grimm, D. (2015). Has US Biomedical Research on Chimpanzees Come to an End? *Science*. [online] <http://www.sciencemag.org/news/2015/08/has-us-biomedical-research-chimpanzees-come-end> [Accessed 06 May 2017].
- Gruen, L. (2011). *Ethics and animals*. Cambridge, MA: Cambridge University Press.
- Gruen, L., A. Fultz and J. Pretz (2013). Ethical Issues in African Great Ape Field Studies. *Institute for Laboratory Animal Research Journal*, 54(1), pp. 24–32.
- Guha, A. and E. Sullivan (2015). Two Primates Die at Yerkes Due to Alleged Negligence. *The Emory Wheel*. [online] Available at: <http://emorywheel.com/two-primates-die-at-yerkes-due-to-alleged-negligence/> [Accessed 06 May 2017].
- Halina, M. (2015). There is No Special Problem of Mindreading in Non-human Animals. *Philosophy of Science*, 82, pp. 473–490.
- Harlow, H.F. (1958). The Nature of Love. *American Psychologist*, 13(12), p. 673.
- Harris, A.P., R.B. D'Eath and S.D. Healy (2010). A Cage Without a View Increases Stress and Impairs Cognitive Performance in Rats. *Animal Welfare*, 19(3), pp. 235–241.
- Hassett, T.C. and R.R. Hampton (2017). Change in the Relative Contributions of Habit and Working Memory Facilitates Serial Reversal Learning Expertise in Rhesus Monkeys. *Animal Cognition*, 20, pp. 485–497.
- Hauser, M.D. (2001). Elementary My Dear Chimpanzee, *Science*, 291, pp. 440–441.
- Herrmann, K. (2019). Refinement on the way towards replacement: Are we doing what we can? In: K. Herrmann and K. Jayne, eds., *Animal Experimentation: Working Towards a Paradigm Change*, Vol. 22. Brill Human Animal Studies Series, pp. 3–64. Leiden: Brill.
- Hopper, L.M., S.P. Lambeth, S.J. Schapiro and A. Whiten (2015). The Importance of Witnessed Agency in Chimpanzee Social Learning of Tool Use. *Behavioural Processes*, 112, pp. 120–129.
- Hosey, G.R. (2005). How Does the Zoo Environment Affect the Behaviour of Captive Primates? *Applied Animal Behaviour Science*, 90(2), pp. 107–129.
- Hosey, G.R. (2008). A Preliminary Model of Human–animal Relationships in the Zoo. *Applied Animal Behaviour Science*, 109(2–4), pp. 105–127.
- Huston, M., D. DeAngelis and W. Post (1988). New Computer Models Unify Ecological Theory. *BioScience*, 38(10), pp. 682–691.
- Jayne, K. (2014). *Challenges Faced by Foraging Eastern Grey Squirrels, Sciurus Carolinensis: Competition, Pilferage and Predation Risks*. PhD. University of Exeter: UK.
- Jayne, K., G. Feenders and M. Bateson (2013). Effects of Developmental History on the Behavioural Responses of European Starlings (*Sturnus Vulgaris*) to Laboratory Husbandry. *Animal Welfare*, 22, pp. 67–78.

- Jayne, K., S.E.G. Lea and L.A. Leaver (2015). Behavioural Responses of Eastern Grey Squirrels, *Sciurus Carolinensis*, Toggles of Risk While Foraging. *Behavioural Processes*, 116, pp. 53–61.
- Kano, F., C. Krupenye, S. Hirata and J. Call (2017). Eye Tracking Uncovered Great Apes' Ability to Anticipate That Other Individuals Will Act According to False Beliefs. *Communicative and Integrative Biology*, 10(2), p. e1299836.
- Keulartz, J. (2015). Captivity for Conservation? Zoos at a Crossroads. *Journal of Agricultural and Environmental Ethics*, 28(2), pp. 335–351.
- Killen, S.S., D.P. Croft, K. Salin and S.K. Darden (2015). Male sexually Coercive Behaviour Drives Increased Swimming Efficiency in Female Guppies. *Functional Ecology*, 30, pp. 576–583.
- Kitcher, P. (2001). *Science, truth, and democracy*. New York: Oxford University Press.
- Klopfer, P.H. (1993). Ethology and noninvasive techniques. In: M.B. Kapis and S.C. Gad, eds., *Non-Animal Techniques in Biomedical and Behavioural Research and Testing*. Florida: Lewis Publishers.
- Knight, J. (2001). Animal Data Jeopardized by Life Behind Bars. *Nature*, 412, p. 669.
- Krachun, C. R. Lurz, J.L. Russell and W.D. Hopkins (2016). Smoke and Mirrors: Testing the Scope of Chimpanzees' Appearance-reality Understanding, *Cognition*, 150, pp. 53–67.
- Krupenye, C., F. Kano, S. Hirata, J. Call and M. Tomasello (2016). Great Apes Anticipate that Other Individuals Will Act According to False Beliefs. *Science*, 354(6308), pp. 110–114.
- Laboratory of Comparative Primate Cognition (n.d.). [online] Available at: <http://www.psychology.emory.edu/lcpc/lab.html> [Accessed 17 June 2017].
- Leavens, D.A., K.A. Bard and W.D. Hopkins (2010). BIZARRE Chimpanzees Do Not Represent "The Chimpanzee". *Behavioral and Brain Sciences*, 33, pp. 100–101.
- Leimgruber, K.L., A.G. Rosati and L.R. Santos (2016). Capuchin Monkeys Punish Those Who Have More. *Evolution and Human Behavior*, 37, pp. 236–244.
- Lurz, R. (2011). *Mindreading animals: The debate over what animals know about other minds*. Cambridge, MA: Massachusetts Institute of Technology Press.
- Lutz, C.K., K. Coleman, J.M. Worlein, R. Kroeker, M.T. Menard, K. Rosenberg, J.S. Meyer and M.A. Novak (2016). Factors Influencing Alopecia and Hair Cortisol in Rhesus Macaques (*Macaca Mulatta*). *Journal of Medical Primatology*, 45(4), pp. 180–188.
- MacKinnon, K.C. and E.P. Riley (2010). Field Primatology of Today: Current Ethical Issues. *American Journal of Primatology*, 72(9), pp. 749–753.
- Maier, S.F. and M.E. Seligman (2016). Learned Helplessness at Fifty: Insights from Neuroscience. *Psychological Review*, 123(4), p. 349.
- Makowska, I.J. and D.M. Weary (2016). The Importance of Burrowing, Climbing and Standing Upright for Laboratory Rats. *Royal Society Open Science*, 3(6), pp. 160136.

- Malone, N. and A. Palmer (2014). Ethical issues within human-alloprimate interactive zones. In: G.L. Burns and M. Paterson, eds., *Engaging with Animals*. New South Wales: Sydney University Press.
- Malone, N., A. Fuentes and F.J. White (2010). Ethics Commentary: Subjects of Knowledge and Control in Field Primatology. *American Journal of Primatology*, 72(9), pp. 779–784.
- Marino, L., S.O. Lilienfeld, R. Malamud, N. Nobis and R. Broglio (2010). Do Zoos and Aquariums Promote Attitude Change in Visitors? A Critical Evaluation of the American Zoo and Aquarium Study. *Society & Animals*, 18(2), pp. 126–138.
- Mason, G. and J. Rushen (2006). *Stereotypic animal behaviour: Fundamentals and applications to welfare*, 2nd ed. Oxfordshire: CAB International.
- Massart, R., M. Suderman, N. Provencal, C. Yi, A.J. Bennett, S. Suomi and M. Szyf (2014). Hydroxymethylation and DNA Methylation Profiles in the Prefrontal Cortex of the Non-Human Primate Rhesus Macaque and the Impact of Maternal Deprivation on Hydroxymethylation. *Neuroscience*, 268, pp. 139–148.
- Meier, C., S.E.G. Lea and I.P. McLaren (2016). A Stimulus-location Effect in Contingency-governed, But Not Rule-based, Discrimination Learning. *Journal of Experimental Psychology: Animal Learning and Cognition*, 42(2), pp. 177–186.
- Mwaffo, V., S. Butail and M. Porfiri (2017). In-silico Experiments of Zebrafish Behaviour: Modeling Swimming in Three Dimensions. *Scientific Reports*, 7, p. 39877.
- Nelson, C.A., M. de Haa and K.M. Thomas (2006). *Neuroscience of cognitive development: The role of experience and the developing brain*. Hoboken, NJ: John Wiley & Sons.
- Neubert, F.X., R.B. Mars, J. Sallet and M.F. Rushworth (2015). Connectivity Reveals Relationship of Brain Areas for Reward-guided Learning and Decision Making in Human and Monkey Frontal Cortex. *Proceedings of the National Academy of Sciences*, 112(20), pp. E2695–E2704.
- New Iberia Research Center (n.d.). [online] Available at: <https://nirc.louisiana.edu/about-us/our-history> [Accessed 6 January 2018].
- Novak, M.A., A.F. Hamel, B.J. Kelly, A.M. Dettmer and J.S. Meyer (2013). Stress, the HPA Axis, and Non-human Primate Well-being: A Review. *Applied Animal Behaviour Science*, 143(2), pp. 135–149.
- Pavlov, P.I. (1927). Conditioned Reflexes: An Investigation of the Physiological Activity of the Cerebral Cortex. *Annals of Neurosciences*, 17(3), pp. 136–141.
- Pepperberg, I.M. (2017). Animal Language Studies: What Happened?. *Psychonomic Bulletin & Review*, 24(1), pp. 181–185.
- Pippin, J.J., S.E. Cavanaugh, and F. Pistollato (2019). Animal research for Alzheimer Disease: failures of science and ethics. In: K. Herrmann and K. Jayne, eds., *Animal Experimentation: Working Towards a Paradigm Change*, Vol. 22. Brill Human Animal Studies Series, pp. 480–517. Leiden: Brill.

- Povinelli, D.J. (2012). *World without weight: Perspectives on an alien mind*. New York: Oxford University Press.
- Povinelli, D.J., J.E. Reaux, L.A. Theall and S. Giambone (2000). *Folk physics for apes: The chimpanzee's theory of how the world works*. New York: Oxford University Press.
- Princée, F.P.G. (2016). *Avoidance of selection*. In: *Exploring Studbooks for Wildlife Management and Conservation*. Switzerland: Springer International Publishing, pp. 211–217.
- Ram, R. (2019). Extrapolation of animal research data to humans: an analysis of the evidence. In: K. Herrmann and K. Jayne, eds., *Animal Experimentation: Working Towards a Paradigm Change*, Vol. 22. Brill Human Animal Studies Series, pp. 341–375. Leiden: Brill.
- Reardon, S. (2016). A Mouse's House May Ruin Experiments. *Nature, News*, 530, p. 264. [online] Available at: <https://www.nature.com/news/a-mouse-s-house-may-ruin-experiments-1.19335> [Accessed 6 January 2018].
- Rosati, A.G. and L.R. Santos (2016). Spontaneous Metacognition in Rhesus Monkeys. *Psychological Science*, 27(9), pp. 1–11.
- Schechtman, E., M.I. Noblejas, A.D. Mizrahi, O. Dauber and H. Bergman (2016). Pallidal Spiking Activity Reflects Learning Dynamics and Predicts Performance. *Proceedings of the National Academy of Sciences*, 113(41), pp. E6281–E6289.
- Schmidt-Koenig, K. and H.T. Schlichte (1972). Homing in Pigeons with Improved Vision. *Proceedings of the National Academy of Sciences*, 69(9), pp. 2446–2447.
- Shapiro, K.J. (1998). *Animal models of human psychology: Critique of science, ethics and policy*. Kirkland, Washington: Hogrefe & Huber Publishers.
- Shettleworth, S.J. (2013). *Fundamentals of comparative cognition*. New York: Oxford University Press.
- Silk, J.B., S.F. Brosnan, J. Vonk, J. Henrich, D.J. Povinelli, A.S. Richardson and S.P. Lambeth (2005). Chimpanzees Are Indifferent to the Welfare of Unrelated Group Members. *Nature*, 437(7063), pp. 1357–1359.
- Sliwa, J. and W.A. Freiwald (2017). A Dedicated Network for Social Interaction Processing in the Primate Brain. *Science*, 356(6339), pp. 745–749.
- Tagliatalata, J.P., J.L. Russell, S.M. Pope, T. Morton, S. Bogart, L.A. Reamer and W.D. Hopkins (2015). Multimodal Communication in Chimpanzees. *American Journal of Primatology*, 77, pp. 1143–1148.
- Tecwyn, E.C. (2013). *Physical Cognition in Great Apes: Planning and Object Compliance*. PhD. University of Birmingham. UK.
- Tecwyn, E.C., S.K.S. Thorpe and J. Chappell (2012). What Cognitive Strategies Do Orangutans (*Pongo Pygmaeus*) Use to Solve a Trial-unique puzzle-tube Task Incorporating Multiple Obstacles? *Animal Cognition*, 15(1), pp. 121–133.
- Tomasello, M. and J. Call (1997). *Primate cognition*. Oxford, UK: Oxford University Press.

- Tomasello, M. and J. Call (2008). Assessing the Validity of Ape-human Comparisons: A Reply to Boesch, 2007. *Journal of Comparative Psychology*, 122(4), pp. 449–452.
- Tomasello, M., B. Hare, H. Lehmann and J. Call (2007). Reliance on Head Versus Eyes in the Gaze Following of Great Apes and Human Infants: The Cooperative Eye Hypothesis. *Journal of Human Evolution*, 52, pp. 314–320.
- UK Home office (2012). *Consolidated Animals (Scientific Procedures) Act 1986*. Prepared from the Animals (Scientific Procedures) Act 1986 Amendment Regulations 2012. UK Government. [online] Available at: https://assets.publishing.service.gov.uk/government/uploads/system/uploads/attachment_data/file/619140/ConsolidatedASPA1Jan2013.pdf [Accessed 06 May 2017].
- UK Home Office (2017a). *Annual Statistics of Scientific Procedures on Living Animals Great Britain 2016*. [online] Available at: https://www.gov.uk/government/uploads/system/uploads/attachment_data/file/627284/annual-statistics-scientific-procedures-living-animals-2016.pdf [Accessed 06 May 2017].
- UK Home Office. (2017b). *Animal Testing and Research: Non-technical Summaries*. [online] Available at: <https://www.gov.uk/guidance/research-and-testing-using-animals#non-technical-summaries> [Accessed 02 December 2017].
- University College London (2017). *Animal Research: Facts and Figures*. [online] Available at: <http://www.ucl.ac.uk/animal-research/facts-figures> [Accessed 18 November 2017].
- van Praag, H., G. Kempermann and F.H. Gage (2000). Neural Consequences of Environmental Enrichment. *Nature Reviews Neuroscience*, 1, pp. 191–198.
- Waiblinger, E. and B. Koenig (2007). Housing and Husbandry Conditions Affect Stereotypic Behaviour in Laboratory Gerbils. *Alternatives to Animal Experimentation*, 24, pp. 67–69.
- Walsh, P.D., D. Kurup, D.L. Hasselschwert, C. Wirblich, J.E. Goetzmann and M.J. Schnell (2017). The Final (Oral Ebola) Vaccine Trial on Captive Chimpanzees?. *Scientific Reports*, 7, p. 43339.
- Whiten, A. (2001). Tool tests challenge chimpanzees, *Nature*, 409, p. 133.
- Wolfgang Köhler Primate Research Center (n.d.). [online] Available at: <http://wkprc.eva.mpg.de/english/> [Accessed 17 June 2017].
- Wooddell, L.J., S.K.K. Stefano, S.J. Suomi and A.M. Dettmer (2017). Elo-rating for Tracking Rank Fluctuations After Demographic Changes Involving Semi-free Ranging Rhesus Macaques (*Macaca Mulatta*). *Journal of the American Association for Laboratory Animal Science*, 56(3), pp. 1–9.
- Würbel, H. and M. Stauffacher (1994). Standard-Haltung für Labormäuse – Probleme und Lösungsansätze. In Mason, G. and J. Rushen (2006). *Stereotypic animal behaviour: Fundamentals and applications to welfare*, 2nd ed. Oxfordshire: CAB International.

- Würbel, H., M. Stauffacher, and D. von Holst (1996). Stereotypies in laboratory mice – quantitative and qualitative description of the ontogeny of ‘wiregnawing’ and ‘jumping’ in ICR and ICR nu – mice. In Mason, G. and J. Rushen (2006). *Stereotypic animal behaviour: Fundamentals and applications to welfare*, 2nd ed. Oxfordshire: CAB International.
- Würbel, H. (2001). Ideal Homes? Housing Effects on Rodent Brain and Behaviour. *Trends in Neuroscience*, 24, pp. 207–211.
- Würbel, H. (2007). Environmental Enrichment Does Not Disrupt Standardisation of Animal Experiments. *Alternatives to Animal Experimentation*, 24, pp. 70–73.
- Yerkes National Primate Research Center (n.d.). *Home*. [online] Available at: <http://www.yerkes.emory.edu/index.html> [Accessed 20 June 2017].
- Zoo Atlanta (n.d.). *Primate Research*. [online] Available at: <https://zooatlanta.org/project/primate/> [Accessed 20 June 2017].
- Zoratto, F., L. Manzari, L. Oddi, R. Pinxten, M. Eens, D. Santucci, E. Alleva and C. Carere (2014). Behavioural Response of European Starlings Exposed to Video Playback of Conspecific Flocks: Effect of Social Context and Predator Threat. *Behavioural Processes*, 103, pp. 269–277.

PART 6

Animal-free Education and Training



Modernizing Biomedical Training: Replacing Live Animal Laboratories with Human Simulation

John Pawlowski

Assistant Professor of Anesthesia, Department of Anesthesia, Critical Care, and Pain Medicine, Beth Israel Deaconess Medical Center, MA, United States

David Feinstein

Assistant Professor of Anesthesia, Department of Anesthesia, Critical Care, and Pain Medicine, Beth Israel Deaconess Medical Center, MA, United States

Marie L. Crandall

Professor of Surgery, College of Medicine, University of Florida, Jacksonville, United States

Shalin Gala

Vice President, International Laboratory Methods, Laboratory Investigations Department, People for the Ethical Treatment of Animals (PETA), Virginia, United States

ShalinG@peta.org

1 Introduction

Hands-on skills training in biomedical education has traditionally relied on the use of more than 9 million live vertebrate animals each year in the United States (US) alone (Patronek and Rauch, 2007), and more in other countries around the world, ranging from performing minor surgical manipulations and pharmacological interventions to managing major traumatic gunshot wounds, burn injuries, and dismemberments. Recently, however, a paradigm shift has taken place that has seen the full replacement of animal use in civilian medical school curricula and skills-training programs in various countries, along with significant reductions and replacements of animal use in comparable military training drills. The embrace of simulation-based biomedical training has been spurred, in part, by improvements in technological realism that accurately mimics human anatomy and physiology, financial burdens involved with running animal laboratories, heightened public awareness and ethical objections

to the use of animals in experiments, and unique pedagogical advantages inherent in simulation-based training and assessment capabilities.

This chapter reviews the global trend towards a modernization of biomedical education in favor of simulation-based training methods, which studies confirm improve student learning and transference of applied skills to clinical practice, reduce laboratory costs, and spare animals from harmful procedures.

2 Animals Used in Military Medical Training

2.1 *Live Tissue Training*

The first published curtailing of the US military's use of dogs, cats, and non-human primates in invasive wound experiments occurred in 1983. That year, animal protection organization People for the Ethical Treatment of Animals (PETA) publicized plans by the US Department of Defense (DOD) to shoot live dogs to create life-threatening injuries, during a so-called, "wound lab" so that military personnel could practice trauma management. Subsequently, the DOD temporarily halted all animal use for this practice before banning the use of cats, dogs, and non-human primates and allowing for the use of pigs and goats that continues today in, so-called, "live tissue training" (LTT) (Associated Press, 1984). The DOD's present-day incarnation of LTT involves creating penetrating gunshot and stab wounds, burn injuries, and limb amputations in more than 8,500 live pigs and goats each year (Klimas, 2017). Bipartisan legislation has been introduced in the US Congress (*Battlefield Excellence Through Superior Training Practices Act*, 2017) to replace the use of animals in LTT with superior human simulation technology, a transition supported by the *New York Times Editorial Board* and national physicians' organizations, among others (Johnson, 2016; Editorial Board, 2016).

Two PETA eyewitness video investigations of these military drills—one in 2012, showing live goats having their limbs cut off with tree trimmers (Kimberlin, 2012); and one in 2013, showing live pigs enduring gunshot wounds to their faces (Shiffman, 2015)—have exposed LTT to the scrutiny of the public, spurring protests and congressional inquiries (Kheel, 2016). Due in part to these developments, in 2013 the US Army required all non-medical personnel, and certain medical personnel, to use human simulation training methods exclusively, instead of LTT (Brooks, 2013). In 2014, the US Coast Guard cut its use of animals for LTT by more than half (Vergakis, 2014). In 2014, the DOD directed all military service branches to cease using animals for six areas of medical education, including Advanced Trauma Life Support training, obstetrics and gynecology residency training, pediatric intubation training, and certain types

of trauma training among other areas (US Department of Defense, 2014). In 2017, the US Coast Guard fully ended all use of animals for LTT in favor of human simulation models (Seck, 2017).

Internationally, a survey published in 2012 found that 22 of 28 North Atlantic Treaty Organization (NATO) nations, nearly 80% percent, do not use any animals for military medical training programs and instead use human simulation models exclusively (Gala et al., 2012). Of note, animal advocates filed complaints with German authorities about LTT permit applications by the US Army in Germany. In 2010, German officials repeatedly denied requests by the US military to proceed with this activity, concluding that the procedures would “violate host nation animal protection laws” because “effective alternatives to animals are available” (Vandiver and Kloeckner, 2010). Similarly, after animal advocates provided information to military officials about human simulators and other non-animal trauma training methods, in 2013, the Polish Ministry of National Defense ended LTT; and in 2014, the Norwegian Animal Research Authority rejected an LTT application by the Norwegian Armed Forces, since they did not provide evidence that non-animal training methods were inadequate (Baker, 2015).

2.2 *Chemical Casualty Training*

The US Army’s Aberdeen Proving Ground regularly conducted training in the medical management of biological and chemical casualties by exposing as many as 48 live monkeys annually to simulated nerve agents, which can cause uncontrollable twitching, seizures, vomiting, and difficulty breathing (Vastag, 2011). The release of video footage in 2009 from this training by the Physicians Committee for Responsible Medicine (PCRM) (Lawrence, 2009)—followed by public protests, congressional inquiries, and a deluge of letters to military officials by animal advocates—led to the Army’s announcement in 2011 that it would replace the use of animals with trained actors, computer programs, and high-tech human patient simulators (Vastag, 2011). In effect, the animals were replaced with more anatomically correct and physiologically relevant human models, which established a credible gravity to the educational experience (Vastag, 2011).

2.3 *Pediatric Intubation Training*

According to documents obtained by PETA via the US Freedom of Information Act from 2010 through 2014, physicians, pediatric residents, nurses, and medical technicians traditionally learned neonatal intubation by forcing hard plastic tubes down ferrets’ delicate airways, as many as six times per animal each session at both Lackland Air Force Base (AFB) (2007) and Madigan

Health System (2010); as many as five times per animal each session at both Travis AFB (2008) and Keesler AFB (2010); and as many as 10 times per animal each session at Naval Medical Center Portsmouth (Sizemore, 2012). This procedure can cause bleeding, swelling, pain, scarring, collapsed lungs, and even death. Indeed, the approved protocols at these facilities acknowledge that there is pain associated with this procedure, given that in these protocols as many as 100 animals or more were listed in the US Department of Agriculture's Column D, which is reserved for animals experiencing pain or distress (Keesler AFB, 2010; Lackland AFB, 2007; Madigan Health System, 2010; Travis AFB, 2008).

Following numerous letters to the leadership of each military installation by concerned members of the public and military physicians, each facility ended its use of animals for pediatric intubation training. Per a DOD memorandum, by the year 2015, all military facilities fully transitioned to infant simulators, which are able to better represent human anatomy as well as physiological vital signs, to teach pediatric intubation skills (US DOD, 2014).

3 Animals Used in Civilian Medical Training

3.1 *Undergraduate Medical Curricula*

Medical students in the US have historically participated in classroom animal laboratories, such as injecting pharmaceuticals into live dogs to observe adverse side effects and performing invasive procedures on live pigs. However, a confluence of various factors, including sustained advocacy efforts by organizations such as PCRM, constricted institutional educational budgets, and the technological advancement of simulation models, helped to clear the path for the complete end of animal use in the US medical curricula in the year 2016 (Simkin et al., 2017). Canadian medical schools accomplished this feat five years earlier (Blackwell, 2011).

Perhaps one of the largest animal use policy changes in global biomedical training came from India, which for decades required medical students in Bachelor of Medicine and Bachelor of Surgery (MBBS) programs to perform pharmacology and physiology experiments on approximately 1.5 to 2 million live animals each year (Akbarsha, 2012). In part, following meetings with animal advocates, government officials, physicians, and academics, the Medical Council of India amended its MBBS regulations to replace the use of animals with non-animal training methods (DNA Correspondent, 2014). This decision that was replicated by the Pharmacy Council of India (TNN, 2014) for pharmacy training; the Dental Council of India for dental training (Singh, 2013);

and the University Grants Commission for life science and zoology training (Pulla, 2014). These actions, now taken by many of the governing bodies of the educational systems in India, may result in saving millions of animals each year.

3.2 *Neonatal Procedure Training*

Neonatal procedural skills include the practice of infant intubation; neonatal umbilical view cannulation; neonatal chest tube insertion; and cerebrospinal fluid sampling (spinal taps). These procedures have traditionally been taught using live animals. However, the American Academy of Pediatrics (in 2005); the Emergency Nurses Association (in 2008); and the American Heart Association (in 2013) wrote to PETA to embrace the use of animal-free training methods involving human simulation. In 2011, the National Association of Neonatal Nurses (NANN) announced that they would replace their use of animals in training for these procedures with a human simulator-based curriculum, a transition facilitated by PETA, which donated newborn patient simulators (nurse.com, 2011).

At another civilian facility, Washington University in St. Louis, the Pediatric Advanced Life Support (PALS) course announced that it was replacing its use of live cats with simulation-based mannequin training. The program's decision followed complaints by PCRM and PETA's release of eyewitness video footage showing students at times struggling repeatedly to insert breathing tubes in the animals' throats (Salter, 2016).

3.3 *Advanced Trauma Life Support (ATLS) Training*

The American College of Surgeons' (ACS) Advanced Trauma Life Support (ATLS) program was introduced in 1978 and has become the standard of care for initial assessment and treatment of trauma patients. During this course, physicians historically practiced cricothyroidotomy, chest-tube insertion, pericardiocentesis, venous cutdown, and diagnostic peritoneal lavage by cutting crude holes into the chests, throats, abdomens, and limbs of live dogs, pigs, sheep and goats. In 2001, the ACS approved the use of human cadavers and the TraumaMan system (Simulab Corporation, 2017), as full replacements to the use of animals during the surgical laboratory session of the ATLS course (ACS, 2001). The TraumaMan system allows ATLS programs to avoid animal use by allowing students to practice surgical procedures on an anatomically-correct human torso that features lifelike skin, tissue, internal organs and bones, as well as simulated bleeding when cut into and airway response using a ventilator. Due in part to advocacy efforts by PCRM and others, and given the numerous studies confirming the efficacy of simulation-based training, today more than

99% of the 276 ATLS training facilities in the US (PCRM, 2018), and all of the 32 ATLS programs in Canada (Blackwell, 2011), now exclusively use TraumaMan and other ACS-approved non-animal training methods.

Starting in 2012, PETA surveyed international ATLS programs regarding their use of animals or simulators as part of the course's surgical skills laboratory. Numerous international ATLS officials from countries that use animals for this course expressed a desire to switch to non-animal simulation models, yet cited financial constraints as the primary transition barrier. To solve this issue, PETA established a successful groundbreaking program with Simulab Corporation and ATLS leaders in 22 countries to cost-effectively replace their use of animals with TraumaMan models, sparing thousands of animals from undergoing terminal surgical procedures while also improving trauma-skills training for physicians around the world (McNeil, 2014; Belisomo, 2015; People for the Ethical Treatment of Animals, 2017).

4 Use of Animals in Veterinary Medical Training

Concurrent with the advances in the use of simulation for human medical education, a surge of knowledge, curricula, and simulation technologies have been applied to the field of veterinary medicine. In addition to using simulators to teach physical diagnosis skills, these devices have been employed to teach clinical procedures (Hodgson and Pelzer, 2017). In 2010, researchers described the use of simulation-based training to teach the bovine rectal exam (Baillie et al., 2010). Simulators have been used to instruct veterinary students in procedures as well as in laparoscopic surgical techniques (Kilkenny, 2016). Industries (n.d.) has expanded to develop species-specific, whole body simulators for horses, cattle, sheep, dogs, cats, and a variety of other animals. These simulators have the advantage of species-specific physiological and pharmacological models, as well as relevant anatomical structures.

In addition to task and procedural training, veterinary simulators have been applied to teach team training and aspects of professionalism (Caraballo et al., n.d.; Scalese and Issenberg, 2005). Mossop (2012) described the teaching of certain professional traits using veterinary simulators. These traits included communication, ethical reasoning, reflective practice, and learning skills. Communication skills and professionalism are among the most common reasons for failure during clinical rotations and for the filing of malpractice suits (Hoffman, 2016).

Similar to the professional development goals articulated by the Accreditation Council for Graduate Medical Education, the American Veterinary

Medical Association maintains a list of required standards for all graduates from accredited veterinary medical schools. These traits of integrity, teamwork, communication, and honesty can be brought out and discussed during simulated exercises. The simulation encounters can be altered to be more difficult for advanced students or repeated for students who need remediation.

In summary, the field of veterinary medicine has seen a recent expansion of animal simulators and simulation curricula to teach the practical and professional aspects of a veterinary practice. These new simulation-based developments provide humane teaching tools that allow replacement of the harmful use of live animals in veterinary science education.

5 Non-animal Training Methods

Numerous curricular reforms have led to a dramatic decrease in the use of live animals for biomedical training around the world. In most cases, some form of whole body simulation and/or task trainer devices are used as educational tools in place of animals. Implicit in the replacement of animal use is that the simulation-based methods have equal or better pedagogical outcomes for the learners, and several studies confirm this point (Patronek and Rauch, 2007).

5.1 *High-fidelity Simulation Accurately Models Human Patients*

Many whole body mannequins and partial task trainers can bleed, breathe, and simulate realistic surgical procedures. Examples include, Multiple Amputation Trauma Trainer simulator (Kforce Government Solutions, Inc., 2014); high-fidelity SimMan Essential simulator (Laerdal Medical, 2017); Caesar trauma patient simulator (CAE Healthcare, 2017); hyper-realistic Cut Suit model (Strategic Operations, 2015); and TraumaMan model (Simulab Corporation, 2017). Simulators can adapt to medications with changes in heart rate, blood pressure, and respiratory rate. The physiological responses are based on hemodynamic models of humans and, therefore, are well suited to teach medical students. During clinical training, medical students can practice asking questions that probe a patient's medical history, and the mannequin's response to these questions can facilitate further inquiries by the student. This way, the student can piece together essential information to compile a detailed history and differential diagnosis. Far from being limited to simple signs and sounds, whole body simulators can evoke complex cognitive issues and require synthesis, analysis, and processing of medical information to determine the various disease entities. To teach trainees to recognize different pathophysiological

states, the mannequin can demonstrate a number of disease symptoms. For example, the mannequin can wheeze, develop a murmur, or produce muffled bowel sounds. Acute airway obstruction or tension pneumothorax can prompt an emergent clinical response from students, years before they would be ready to treat a patient with assurance.

Surgical procedures can also be taught using either virtual reality simulation or task trainers in conjunction with whole body mannequins. For example, an entire laparoscopic cholecystectomy can be performed in virtual reality, with students manipulating laparoscopic instruments in an environment that mimics the surgical anatomy, duplicates bleeding vessels, and features flaming cautery to coagulate hemorrhage. Task trainers can similarly depict abdominal structures that the student must identify and retract in order to expose and remove the gall bladder. These simulator options can also be used to measure reduction in time to perform a task as a measure of proficiency, record surgical errors, and be accompanied by real-time feedback and deliberate practice (Reznick and MacRae, 2006).

5.2 *Simulators Improve Technical Proficiency*

In a randomized study on emergency procedures, Hall (2011) assigned trainees to complete procedural tasks on human simulators or on live animal tissue models. Results demonstrated that trainees' acquisition of procedural skills were significantly better when simulators were used. Most of the perceived benefits came from the human anatomical features of the simulators. This preference for the human anatomical model was also demonstrated in a study by McCarthy et al. (2002), who compared cricothyrotomy sessions using canine versus human cadaver models. They found that trainees performed procedures more accurately on the latter.

Simulation technologies exist for many levels and subjects in biomedical education. Early training with whole body simulators has been shown to be effective in teaching the principles of physiology to first year medical students. Tan et al. (2002) described the range of simulation-based sessions in preclinical medical school courses, which include introduction of clinical situations and diseases; elements of history taking and empathetic styles; formation of a differential diagnosis; and corroboration of physical examination findings.

5.3 *Simulators Improve Patient and Medical Provider Safety*

Medical students learning either internal medicine or general surgery can benefit from simulation-based teaching. All simulation training avoids the potential risks to the patient of medical trainee-induced complications (Friedrich, 2002). For example, the first needle insertion, suture repair, or incision by a

medical student can be done using a simulator. A hallmark of simulation allows students to perform numerous medical procedures and receive satisfactory assessment by skilled instructors, before any attempts on a live human patient, thereby minimizing patient injury and complications during the period of early training. In addition, the use of simulation can prove to be safer for the medical student. Needle punctures can result in the transmission of disease, such as hepatitis or HIV. Therefore, avoidance of early needle punctures for infected patients using simulators, allows students to gain some proficiency and avoid the risk of self-inflicted needle injury with a contaminated needle. For both the patient and the student, early use of simulators can provide important safety benefits.

5.4 *Simulators Foster Development of Higher-Order Cognitive Skills*

Simulation-based training can also teach a host of higher-order cognitive lessons. In 2006, Takayesu and colleagues examined the use of high-fidelity patient simulation in medical student learning. Participants were asked to report on their experience following a simulation-based clinical exercise. Aside from the simulators' "learning by doing" paradigm that fosters technical skills development, 46 percent of the students felt that simulators are superior to other methods in teaching "clinical decision making" and "communication and teamwork". These subjects are considered more conceptual and complex and require higher-order cognitive skills; and they are often associated with essential elements of professionalism. The authors concluded that simulation exercises help students to integrate pathophysiological concepts into clinical situations in a risk-free environment (Takayesu et al., 2006).

5.5 *Students Benefit from Immersive Simulation-Based Training that Mimics Realistic Clinical Scenarios*

Not only do simulators allow for a fairly realistic depiction of anatomic structures, but they can also allow students to be immersed in a realistic environment that resembles an operating room. Surgical equipment, anesthesia machines, gowns, and gloves can bring the learner into an engaging and realistic clinical space. The level of engagement simulation offers has been well-described, and such levels of activation are crucial to learning (Oriol et al., 2011). In surgical literature, Kaufman (2003) described how simulation not only allows for deliberate technical practice but can also be integrated into the clinical environment. Kaufman described the use of simulation to teach and coordinate the care of military patients in a multi-casualty setting; however, the lessons learned can likely apply to civilian circumstances. All surgical operations involve teams and communication. All surgical procedures have

periods of technical challenge, and other times may include logistical problems. Simulation-based training can provide a realistic situation of urgency, emotional stress, and technical demand that require quick decisions, precise actions, and coordinated follow-up. With trained clinical raters, the participants can receive valuable feedback about their decision making, technical surgical skill proficiency, teamwork, and communication. It is important to note that only a small portion of medical learning objectives involve task completion. Indeed, most of the skills are non-technical and include effective communication, an organized approach, management of resources and people, and maintenance of global awareness. The conversion from animal-based training to the use of simulators allows for a preservation of effective learning and an increase in patient safety (Balcombe, 2004).

5.6 *Simulation Shortens Medical Trainees' Learning Curve*

Issenberg et al. (2005) systematically reviewed the best clinical evidence for the use of simulation in medical education and found that the majority of studies demonstrate the utility of simulation in providing faster learning with better retention of concepts over time. Almost all of the reviewed papers showed that simulation was as least as good as, if not better than, conventional teaching methods. Another study showed that simulation-based training accelerated or shortened the learning curve that any novice or trainee experiences by allowing for ongoing coaching, evaluation, feedback, and correction through deliberate practice (Patel, et al., 2006). In both civilian medicine and military medical training, the use of simulation has become a key component of the curriculum (Hauck, 2016).

6 Harmonization of Best Training Practices

There is a global lack of policy harmonization between countries and locally between laboratories, regarding the use of animals in biomedical education. For example, the United Kingdom prohibits surgical training on live animals, yet other countries still allow the use of animals for this purpose. The US Army has banned the use of animals in trauma training drills by non-medical personnel, yet other US military service branches continue to allow non-medical personnel to use animals in these exercises. Twenty-two NATO nations, including 19 European Union (EU) Member States, have confirmed that they do not use any animals for military medical training (Gala et al., 2012). Yet, six NATO nations continue to use animals for LTT, some of which are EU countries bound by Directive 2010/63/EU (European Parliament, 2010) that requires the

use of non-animal training methods whenever available. Also, many medical schools around the world continue to use animals in physiology and pharmacology training, among other disciplines, even though this practice has been abandoned by all medical schools in the US, Canada, and India.

Efforts should be made to identify procedures, skills, or concepts that are currently taught at certain facilities using simulation technology and advocate for their adoption by comparable training programs still using animals for these lessons. Numerous countries mandate that animal use in biomedical training be justified to obtain animal ethics committee approval. However, when similar procedures, skills, or concepts are taught in one facility with simulation models and at another facility using animals, the latter may encounter difficulty in justifying its use of animals upon scrutiny. Times are changing, with more and more training facilities taking up non-animal methods for the training of their students. In time, it will become more difficult for other training institutions to continue to justify their use of animals in biomedical training, resulting in a new generation of medically trained professionals, who are distanced from the antiquated use of animals in education.

7 Conclusion

The modernization of biomedical education has gone hand-in-hand with an embrace of advanced human simulation technology and a reduction in the use of animals for training. Just as a century ago, the decline in the number of buggy whips produced could portend the acceptance of the automobile, the world-wide decline in the use of live animals used in medical training can provide evidence for the value of simulation training in science and medicine.

References

- Akbarsha, M.A. (2012). Alternatives Session at Medical Students' Forum. *Alternatives to Animal Experimentation*, 29(3).
- Associated Press (1984). Reprieve from Wound Tests Is Ended for Pigs and Goats. *New York Times*, [online] Available at: <http://www.nytimes.com/1984/01/24/us/reprieve-from-wound-tests-is-ended-for-pigs-and-goats.html> [Accessed 10 May 2017].
- Baillie, S., A. Crossan, S.A. Brewster, S.A. May and D.J. Mellor (2010). Evaluating an Automated Haptic Simulator Designed for Veterinary Students to Learn Bovine Rectal Palpation. *Simulation in Healthcare: The Journal of the Society for Simulation in Healthcare*, 5(5), pp. 261–266.

- Baker, B. (2015). Putting an End to Cruel “Danish bacon” Animal Wounding Exercises. *Army Technology*, [online] Available at: <http://www.army-technology.com/features/featureputting-an-end-to-cruel-danish-bacon-animal-wounding-exercises-4505465/> [Accessed 10 May 2017].
- Balcombe, J. (2004). Medical Training Using Simulation: Toward Fewer Animals and Safer Patients. *Alternatives to Laboratory Animals*, 32(1), pp. 553–560.
- Battlefield Excellence Through Superior Training Practices Act 2017*. Washington, D.C.: 115th Congress House Bill. [online] Available at: <https://www.congress.gov/bill/115th-congress/house-bill/1243/text> [Accessed 10 May 2017].
- Belisomo, R. (2015). “Traumaman” Helps Doctors Save Humans, Spares Animals. *Reuters*. [online]. Available at: <http://www.reuters.com/article/us-health-surgeons-traumaman-idUSKCN0RP1O620150925> [Accessed 23 June 2017].
- Blackwell, T. (2011). Canadian Med Schools End Use of Live Animals. *National Post*. [online]. Available at: <http://nationalpost.com/news/canada/canadian-med-schools-end-use-of-live-animals/wcm/b9676995-55d9-459e-bf87-53185368b175> [Accessed 10 May 2017].
- Brooks, D. (2013). Activists: Army to Limit Live Animal Training. *Military.com*. [online]. Available at: <http://www.military.com/daily-news/2013/04/02/activists-army-to-limit-live-animal-training.html> [Accessed 10 May 2017].
- CAE Healthcare (2017). *CAE Caesar Trauma Patient Simulator*. [online] Available at: <https://caehealthcare.com/patient-simulation/caesar> [Accessed 10 May 2017].
- Caraballo, M., Duenas, J.L.P., Tellez, E.I. and Fraga-Sastrias, J.M. (n.d.). The use of a high fidelity simulator for veterinary medicine training. *Laerdal Mexico*. [online] Available at: <https://pdfs.semanticscholar.org/12aa/f696bbbcf439db08ed837135a76f812c689f.pdf> [Accessed 11 October 2018].
- DNA Correspondent (2014). Medical Council of India Stops Use of Animals for Training UG Medical Students. *Daily News & Analysis*. [online] Available at: <http://www.dnaindia.com/mumbai/report-medical-council-of-india-stops-use-of-animals-for-training-ug-medical-students-1981373> [Accessed 10 May 2017].
- European Parliament (2010). Directive 2010/63/EU of the European Parliament and of the Council of 22 September 2010 on the protection of animals used for scientific purposes. *Official Journal of the European Communities*, L276, p. 33–79. [online] Available at: <http://eur-lex.europa.eu/legal-content/EN/TXT/?uri=CELEX%3A32010L0063> [Accessed 12 August 2017].
- Friedrich, M.J. (2002). Practice Makes Perfect: Risk-free Medical Training with Patient Simulators. *Journal of the American Medical Association*, 288(22), pp. 2808.
- Gala, S., J. Goodman, M. Murphy and M. Balsam (2012). Use of Animals by NATO Countries in Military Medical Training Exercises: An International Survey. *Military Medicine*, 177(8), pp. 907–910. [online] Available at: <https://www.ncbi.nlm.nih.gov/pubmed/22934368> [Accessed 10 May 2017].

- Hall, A.B. (2011). Randomized Objective Comparison of Live Tissue Training Versus Simulators for Emergency Procedures. *The American Surgeon*, 77(5), pp. 561–565.
- Hauck, S. (2016). Simulators, Manikins, Key Part of Military Medical Training. *The Daily News*. [online] Available at: <http://www.jdnews.com/news/20161228/simulators-manikins-key-part-of-military-medical-training> [Accessed 10 May 2017].
- Hodgson, J.L. and J.M. Pelzer (2017). *Veterinary medical education: A practical guide*. Hoboken: Wiley-Blackwell.
- Hoffman, J. (2016). Malpractice risks in communication failures. *Crico*. [online] Available at: <https://www.rmhf.harvard.edu/Clinician-Resources/Newsletter-and-Publication/2016/SPS-The-Malpractice-Risks-of-Health-Care-Communication-Failures> [Accessed 10 May 2017].
- Issenberg, B.S., W.C. McGaghie, E.R. Petrusa, D.L. Gordon and R.J. Scalese (2005). Features and Uses of High-fidelity Medical Simulations That Lead to Effective Learning: A BEME Systematic Review. *Medical Teacher*, 27(1), pp. 10–28.
- Johnson, H. (2016). *Leading Medical Groups Endorse Johnson's Military Modernization Bill*. Press Release. Representative Hank Johnson, US House of Representatives. [online] Available at: <https://hankjohnson.house.gov/media-center/press-releases/leading-medical-groups-endorse-johnson-s-military-modernization-bill> [Accessed 10 May 2017].
- Kaufmann, C.R. (2003). Surgical Simulation: A Clinical Perspective. *Military Medicine*, 168(9), pp. 16–20.
- Keesler Air Force Base (2010). Endotracheal Intubation Training Exercise Using a Ferret Model (*Mustela putorius furo*). Protocol No. FKE20100032A.
- Kforce Government Solutions, Inc. (2014). *Multiple Amputation Trauma Trainer (MATT) Series 1500 Trauma Trainer*. [online] Available at: https://www.kforcegov.com/TraumaFX/TraumaFX_Files/KGS%20TraumaFX%20MATT.pdf [Accessed 10 May 2017].
- Kheel, R. (2016). Lawmakers Press Pentagon to Stop Using Animals in Medical Training. *The Hill*. [online] Available at: <http://thehill.com/policy/defense/284262-lawmakers-press-pentagon-on-animal-use-in-medical-training> [Accessed 10 May 2017].
- Kilkenny, J. (2016). Investigation of Laparoscopic Skills in Veterinary Students Using Simulation Technology. *The Atrium*. [online] Available at: https://atrium.lib.uoguelph.ca/xmlui/bitstream/handle/10214/9581/kilkenny_jessica_201603_MSc.pdf?sequence=1 [Accessed 10 May 2017].
- Kimberlin, J. (2012). Military Contractor Cited for Treatment of Goats. *Virginian-Pilot*. [online] Available at: https://pilotonline.com/news/military/local/military-contractor-cited-for-treatment-of-goats/article_3aaef87-114a-5d29-8cb7-d8dba00ceed8.html [Accessed 10 May 2017].
- Klimas, J. (2017). The Military Kills 8,500 Pigs and Goats Every Year for Medical Training. A New Bill Would End That. *Washington Examiner*. [online] Available at:

- <http://www.washingtonexaminer.com/the-military-kills-8500-pigs-and-goats-every-year-for-medical-training-a-new-bill-would-end-that/article/2616416> [Accessed 10 May 2017].
- Lackland Air Force Base. (2007). *Intubation Instruction and Training Utilizing a Ferret (Mustela Putorius) Model*. Protocol No. FWH20090154A.
- Laerdal Medical (2017). *SimMan® Essential*. [online] Available at: <http://www.laerdal.com/us/products/simulation-training/emergency-care-trauma/simman-essential/> [Accessed 10 May 2017].
- Lawrence, C. (2009). Videos Renew Debate on Military Use of Animals. *Cable News Network (CNN)*. [online] Available at: <http://www.cnn.com/2009/POLITICS/06/05/military.animals.training/index.html?iref=24hours> [Accessed 10 May 2017].
- Madigan Health System (2010). *Pediatric Intubation Training Utilizing the Ferret (Mustela Putorius Furo) Model*. Protocol Nos. 204028 and 210043.
- McCarthy, M.C., M.R. Ranzinger, D.J. Nolan, C.S. Lambert and M.H. Castillo (2002). Accuracy of Cricothyroidotomy Performed in Canine and Human Cadaver Models During Surgical Skills Training. *Journal of the American College of Surgeons*, 195(5), pp. 627–629.
- McNeil, D.G. Jr. (2014). PETA's donation to Help Save Lives, Animal and Human. *The New York Times*. [online] Available at: <https://www.nytimes.com/2014/01/14/health/petas-donation-to-help-save-lives-animal-and-human.html> [Accessed 21 June 2017].
- Mossop, L. (2012) *Defining and Teaching Veterinary Professionalism*. PhD. The University of Nottingham [online] Available at: http://eprints.nottingham.ac.uk/12694/1/Fully_corrected_thesis_Liz_Mossop.pdf [Accessed 3 May 2017].
- Nurse.com (2011). *PETA Donates Infant Simulators to National Association of Neonatal Nurses*. [Blog] Available at: <https://www.nurse.com/blog/2011/10/10/peta-donates-infant-simulators-to-national-association-of-neonatal-nurses/> [Accessed 10 May 2017].
- Oriol, N.E., E.M. Hayden, J. Joyal-Mowschenson, S. Muret-Wagstaff, R. Faux and J.A. Gordon (2011). Using Immersive Healthcare Simulation for Physiology Education: Initial Experience in High School, College, and Graduate School Curricula. *Advances in Physiology Education*, 35(3), pp. 252–219.
- Patel, A.D., A.G. Gallagher, W.J. Nicholson and C.U. Cates (2006). Learning Curves and Reliability Measures for Virtual Reality Simulation in the Performance Assessment of Carotid Angiography. *Journal of the American College of Cardiology*, 47(9), pp.1796–1802.
- Patronek, G.J. and A. Rauch (2007). Systematic review of comparative studies examining alternatives to the harmful use of animals in biomedical education. *Journal of the American Veterinary Medical Association*, 230(1), pp. 37–43.
- People for the Ethical Treatment of Animals (PETA) (2017). PETA donates Surgical Simulators, Saving More Animals' Lives. [online] Available at: <https://www.peta>

- .org/blog/peta-donates-more-traumaman-surgical-simulators/ [Accessed 23 June 2017].
- Physicians Committee for Responsible Medicine (2018). *Survey of ATLS programs*. [online] Available at: <http://www.pcrm.org/research/edtraining/ATLS/survey-of-atls-programs> [Accessed 11 October 2018].
- Pulla, P. (2014). Dissections Banned in Indian Universities. *Science*. [online] Available at: <http://www.sciencemag.org/news/2014/08/dissections-banned-indian-universities> [Accessed 13 Mar. 2017].
- Reznick, R.K. and H. MacRae (2006). Teaching Surgical Skills—Changes in the Wind. *New England Journal of Medicine*, 355(25), pp. 2664–2669.
- Salter, J. (2016). Washington University Stops Intubation Training Using Cats. *Associated Press News*. [online] Available at: <https://apnews.com/064e58c1018f464ca4cc4be2b4299130/washington-university-stops-intubation-training-using-cats> [Accessed 10 May 2017].
- Scalese, R.J. and S.B. Issenberg (2005). Effective Use of Simulations for the Teaching and Acquisition of Veterinary Professional and Clinical Skills. *Journal of Veterinary Medical Education*, 32(4), pp. 461–467.
- Seck, H.H. (2017). Ending “Abhorrent” Live Tissue Training Was Right: Coast Guard. *Military.com*. [online] Available at: <https://www.military.com/daily-news/2017/05/18/ending-abhorrent-live-tissue-training-was-right-coast-guard.html> [Accessed 14 February 2018].
- Shiffman, J. (2015). Exclusive: Doctor Who Trained US Troops Suspended for Macabre Techniques. *Reuters*. [online] Available at: <http://www.reuters.com/article/us-usa-doctor-probe-idUSKBN00OzE720150608> [Accessed 10 May 2017].
- Simkin, D.J., J. Greene, J. Jung, B. Sacks and H. Fessler (2017). The Death of Animals in Medical School. *New England Journal of Medicine*, 376(8), pp. 713–715.
- Simulab Corporation (2017). *Surgical Trainer for Chest Tube Insertion, Cricothyroidomy (or Cricothyrotomy), Needle Decompression, Tracheostomy, Pericardiocentesis, and Diagnostic Peritoneal Lavage*. [online] Available at: <https://www.simulab.com/traumaman/about> [Accessed 10 May 2017].
- Singh, V. (2013). Dental Council Bans Use of Animals in Training. *The Times of India*. [online] Available at: <http://timesofindia.indiatimes.com/city/mumbai/Dental-Council-bans-use-of-animals-in-training/articleshow/19110677.cms> [Accessed 13 Mar. 2017].
- Sizemore, B. (2012). Portsmouth Naval Medical Center To End Ferret Use. *Virginian-Pilot*. [online] Available at: https://pilotonline.com/news/military/portsmouth-naval-medical-center-to-end-ferret-use/article_2e9c1f76-8564-566f-a6d7-24cfc80881ee.html [Accessed 10 May 2017].
- Strategic Operations (2015). Surgical Cut Suit. *Strategic Operations*. [online] Available at: <http://www.strategic-operations.com/product/surgical-cut-suit/> [Accessed 10 May 2017].

- Takayesu, J.K., S.E. Farrell, A.J. Evans, J.E. Sullivan, J.B. Pawlowski and J.A. Gordon (2006). How Do Clinical Clerkship Students Experience Simulator-based Teaching? A Qualitative Analysis. *Simulation in Healthcare: The Journal of the Society for Simulation in Healthcare*, 1(4), pp. 215–219.
- Tan, G.M., L.K. Ti, S. Suresh, B.S. Ho and T.L. Lee (2002). Teaching First-year medical Students Physiology: Does the Human Patient Simulator Allow for More Effective Teaching?. *Singapore Medical Journal*, 43(5), pp. 238–242.
- The Editorial Board (2016). Ban Animal Use in Military Medical Training. *New York Times*. [online] Available at: <https://www.nytimes.com/2016/06/26/opinion/ban-animal-use-in-military-medical-training.html> [Accessed 10 May 2017].
- TNN (2014). Pharmacy Students Banned from Dissecting Animals. *The Times of India*. [online] Available at: <http://timesofindia.indiatimes.com/city/bengaluru/Pharmacy-students-banned-from-dissecting-animals/articleshow/41722224.cms> [Accessed 10 May 2017].
- Travis Air Force Base (2008). *Neonatal Resuscitation Training Using the Domestic Ferret, Mustela Putorius Furo*. Protocol No. FDG20080031A.
- US Department of Defense (2014). Determination for the Use of Animals in Medical Education and Training. *The Journal of Special Operations Medicine*. [online] Available at: <https://www.jsomonline.org/TCCCEsp/06%20TCCC%20Documentos%20de%20Referencia/ASDHA%20Memo%20140515%20LTT%20Policy.pdf> [Accessed: 13 Mar. 2017].
- Vandiver, J. and M. Kloeckner (2010). German Ruling Puts USAREUR Plans for Live-animal Medical Training on Hold. *Stars and Stripes*. [online] Available at: <https://www.stripes.com/news/german-ruling-puts-usareur-plans-for-live-animal-medical-training-on-hold-1.114989> [Accessed 10 May 2017].
- Vastag, B. (2011). Army to Phase Out Use of Animal Nerve-agent Testing. *Washington Post*. [online] Available at: https://www.washingtonpost.com/national/health-science/army-agrees-to-phase-out-use-of-animal-nerve-gas-testing/2011/10/13/gIQA1p1PiL_story.html?utm_term=.d6b32c809dd3 [Accessed 10 May 2017].
- Vergakis, B. (2014). Coast Guard Reduces Use of Live Animal Training. *Boston Globe*. [online] Available at: <https://www.bostonglobe.com/news/nation/2014/02/14/coast-guard-reduces-use-live-animal-training/hT16xG4Ij9IDxr26TSoRgL/story.html> [Accessed 10 May 2017].
- Veterinary Simulator Industries (n.d.). *Products*. [online] Available at: <http://vetsimulators.com> [Accessed 3 May 2017].

Humane Education: The Tool for Scientific Revolution in Brazil

Vanessa Carli Bones

Veterinarian, Veterinary Medicine Regional Council of the State of Paraná,
Cascavel, Brazil
vcb.vete@gmail.com

Rita de Cássia Maria Garcia

Professor, Veterinary Medicine Department, Federal University of Paraná,
Curitiba, Brazil

Gutemberg Gomes Alves

Professor, Institute of Biology, Fluminense Federal University, Niterói, Brazil;
iR Institute of Promotion and Research for the Replacement of Animal
Experimentation, Poços de Caldas, Brazil

Rita Leal Paixão

Professor, iR Institute of Promotion and Research for the Replacement of
Animal Experimentation, Poços de Caldas, Brazil; Institute of Biomedicine,
Fluminense Federal University, Niterói, Brazil

Alexandro Aluísio Rocha

Professor, Animal Science Department, Faculty of Agrarian Sciences, Federal
University of Vales do Jequitinhonha e Mucuri, Brazil

Karynn Capilé

PhD Student, Post Graduate Program in Bioethics, Applied Ethics and Public
Health, Fluminense Federal University, Niterói, Brazil

Róber Bachinski

Researcher and Director of the iR Institute, iR Institute of Promotion and
Research for the Replacement of Animal Experimentation, Poços de Caldas,
Brazil.

1 Introduction

Despite the predominance of traditional teacher-centered approaches, educators are constantly changing paradigms and social boundaries, by stimulating criticism with active learning based approaches, which are centered on contexts and experiences. Viewing students as individuals enables paradigm changes and inspires new perspectives on established theories and facts. This chapter discusses education in Brazil, with a focus on *humane education*. Humane education strives to foster compassion and respect for humans, non-human animals (hereinafter referred to as animals), and the environment by creating awareness of the needs of others and the effects of our actions. In this chapter we describe the process of humane education in the context of animals used for teaching. We explore the possibilities of replacing animals and including ethical discussions in the curriculum; the history of Brazilian humane education, considering the Environmental Crimes Act that forbids animal use when alternative methods exist; and the legislation that controls the use of animals for research and teaching purposes in Brazil.

2 Moving towards Humane Education

In the context of animals used for experimentation, education, and training purposes, humane education is a process that leads to a more egalitarian, critical, and fair society that has ethical consideration towards animals (Faver, 2010). To achieve this, we have to consider approaches that include an educational and moral revolution. However, for such a revolution to happen effectively, two common reasons for the justification of animal use need to be considered. First, maintenance of the current paradigm, whereby both academic staff and students use and harm animals. Second, the social speciesism that exists in regarding animals as instruments or tools for science. In terms of maintenance of the current animal experimentation paradigm, harmful animal use puts students in a kill-to-save dilemma, encouraging thinking that animal use in practical classes is necessary. This conflict can result in the exclusion of students who are ideologically oriented against animal experimentation, ultimately leading to their exclusion as potential researchers who could work towards animal replacement methods. Even in situations where academic staff are not comfortable with using animals, the maintenance of this system represents a negative feedback loop for the advancement of scientists favoring animal research. Speciesism is also rife within the current paradigm,

for example, many scientists avoid using some animal species, such as dogs, for training surgery and favor the use of pigs. This situation is common in some veterinary and medical courses in Brazil. The choice for species to be “protected” from experimentation can also originate from social pressure (e.g., the use of animals regarded as “pets”) as well as from ethical restraints. In this situation, the choice of species does not consider nervous system development, the existence of a conscience, or the experience of pain and suffering.

From an anti-speciesist standpoint, animal objectification is a recognized feature of human-animal relations that should be tackled as an unjust social tendency in all areas where it occurs. Education courses that involve animal handling may result in students’ desensitization toward animals’ pain and suffering, as a mechanism to resolve the cognitive dissonance generated by the unpleasant experience of witnessing animal discomfort (Amiot and Bastian, 2015; Woon, 2011; Zanetti, 2010). Thus, students are often led to deny the subjectivity of animals, as well as their cognitive and emotional capacities, regarding them as “things”.

Many students feel uncomfortable when engaging in practices that may cause an animal pain or discomfort however, they are not encouraged to express their concerns (Capilé et al., 2015). In this situation, students should be informed about their right to object, and how they can exercise this right; this is a significant pursuit of humane education (Knight, 2014). Recognizing students’ objections to participating in harmful animal use is essential to the goal of replacing animals in education and training (Seixas et al., 2010). In Brazil, there is a legal provision, whereby one is allowed to be exempt from participating in such acts that offend one’s moral positions or beliefs by expressing consciousness objection (República Federativa do Brasil, 1988). Practicing humane education of students right to withdraw enables protection mechanisms for students to avoid classes that cause mental conflict, encouraging an academic mind shift based on morals and ethics. Furthermore, on a long-term basis, this could nurture students’ interaction with animals more as individuals, enabling these future professionals to participate in building a more ethical mindset in the way humans treat other animals.

3 Animal Replacement for a Humane Science

In analyzing the moral limits of science in human experimentation, Edgar Morin (1990) described the ethics of this science as based on social control and scientists’ awareness of moral barriers. Thus, although biotechnology is

constantly advancing new ways for carrying out research and testing without animals, it is moral barriers and empathic education that can protect animals from the harms of “scientific exploration”. Without a critical animal ethics curriculum for science in schools and higher education, the mindset of the current paradigm of animal use is maintained.

By observing instances where humans have been the subject of experimentation in the past century, we can identify (in addition to political, legal, and regulatory changes) a positive ethical paradigm change based on humane education. Ethical concerns over the use of human experimentation are frequently traced back to the Nuremberg Trials, which resulted in the Nuremberg Code, making informed consent in human experimentation compulsory (Nuremberg Military Tribunals, 1946). However, the existence of this guideline can be traced back as early as the nineteenth century. The Prussian Regulation, published by the Minister for Religious, Educational, and Medical Affairs in 1900, was based on the principle of personal autonomy and presented an early model of informed medical consent (Annas and Grodin, 1992). By 1931, during the political reform of criminal law in Germany, the Dritte Reich government issued the *Guidelines for New Therapy and Human Experimentation*, differentiating between therapeutic and non-therapeutic human experimentation. These regulations were based on patient autonomy and reinforced the doctrine of informed consent (Jochen-Vollmann, 1995; Vollmann and Winau, 1996; Reich Minister of the Interior, 1931). Unfortunately, these legal parameters were not enough to protect vulnerable humans during the Nazi period, as described in the Nuremberg Trials (Nuremberg Military Tribunals, 1946); nor did they prevent other unethical human experimentation across the Western world (Comisión-técnica, 2011; Frieden and Collins, 2010; Horner, 1999; Seidelman, 2012). These historical accounts bring to mind the power relations involved in human and animal experimentation, where sentient beings are transformed into scientific instruments (Comisión-técnica, 2011; Horner, 1999; Teixeira, 2011; Torrey and Yolken, 2010). After the establishment of Nuremberg Code, obtaining data from animal tests became compulsory to protect human volunteers and patients in clinical trials. However, the placement of animal models as simply a protection mechanism for humans, and not because they are an advanced scientific model, demonstrates that the animal experimentation paradigm exists primarily because animals act as a moral barrier to prevent human experimentation.

The criticism around human experimentation, and the public dissemination of examples where humans have been experimented on, ensures consideration of ethical concerns before starting any type of scientific project involving humans. In this case, moral progress is the only factor capable of stopping unethical research. The same should apply to animal experiments. To work towards

a much-needed change of paradigm away from using animals for research, education, and training, we need to start by recognizing that animals are not mere objects for research, but their own individual agents. A humane education system has the potential to deconstruct the speciesism present in current scientific education and training, helping us to consider the basic rights of animals.

4 History of Brazilian Humane Education

At the beginning of the 1990s, the use of animals at Brazilian universities was the norm, particularly for biomedical teaching, continuing the paradigm in which learning is entirely dependent on animal use. Students were coerced into participating in classes using animals and were reluctant to discuss the matter and express their opinions. An investigation carried out at the beginning of the 1990s in Brazil, with students across different education levels, revealed that *vivisection* was an unpleasant practice for the majority; 68% of university students referred to it as a “necessary evil” and 72.4% explicitly talked about their dislike of the method (Lima, 1995).

The debate about animal use for education and training in Brazil started in the late 1990s and has grown ever since. An important landmark was the Brazilian Environmental Crimes Act, Law 9605 of February 12, 1998 (República Federativa do Brasil, 1998). According to this law, a crime can be considered *commissive*, when somebody uses an animal in a way that causes them intentional pain and suffering; or *omissive*, when somebody acts in a neglectful manner towards an animal. Both crimes can be applied to animals that are used for experimentation and education. In the case of *omissive* crimes, the law considers causing animals painful or cruel experiences a crime, even for educational or scientific purposes, when non-animal alternatives are available. With this law, two important shifts occurred: 1. a previously invisible social movement became visible to the media and government in Brazil; and 2. the need to replace the use of animals in education and training became evident.

In 2002, a few years after the publication of the Environmental Crimes Act, a study was conducted to investigate the use of animals and their alternatives in medical education, as well as teachers’ attitudes towards the use of animals for teaching purposes (Bastos et al., 2002). Seven medical schools in the cities of Rio de Janeiro and Niterói were selected to survey teachers who used animals in their courses. The results revealed that four in seven institutions used animals in various courses. Most of the participants were unaware of laws relating to animal use and did not believe in discontinuing these practices. The

study indicated that there was need to raise greater awareness of innovative educational methods and increase discussions about animal ethics in medical education. As a result of increasing awareness of the ethics surrounding animal use and the replacements available, bioethics courses were introduced in Brazil by the end of the 1990s. With the inclusion of bioethics subjects in biological and biomedical courses, the debate on animal use could begin. However, despite these early efforts, a recent study investigating the curricular integration of bioethics and similar learning opportunities in undergraduate biology programs at Brazilian federal institutions found that of 36 programs, only 19 (53%) included bioethics or similar courses for biology degrees (Dória and Moreira, 2011). Furthermore, increased emphasis on bioethics is strongly linked to medical practice, for example, the choice of subjects of study and the academic and professional trajectory of researchers (Diniz and Guilherm, 2002). It is clear that a more holistic approach is needed, one that covers human, animal, and environmental issues in bioethics. Moreover, we need to expand the public discussion of bioethics and include students of veterinary medicine and pharmacy, as well as biology, among others.

Regarding the regulation of animals used in research, education, and training in Brazil, it is noteworthy that the Animal Use Ethics Committees (AUECs), *Comissões de Ética no Uso de Animais* in Portuguese, were only officially established in 2008 (República Federativa do Brasil, 2008). Although AUECs exist in several institutions in Brazil, and their numbers are increasing, several conflicts have occurred in these committees. For example, if a teacher justifies the use of animals as relevant for learning in their course and tells the AUEC that they cannot be replaced, the course will be authorized. However, it is difficult for AUECs members to know if a certain practice is, in fact, performed according to their approval because the actual activities are not monitored. Therefore, once a project is approved by an AUEC, the teaching staff can act as they wish; and proponents of animal use often do not follow AUEC recommendations for the replacement of animals in their teaching. Adding to this issue, there is still no way to gather information about and assess, officially, the situation of animal use in Brazil. Information on numbers, species, procedures, and degree of invasiveness is not publicly available, although a database for this kind of information may be under construction (Bachinski et al., 2015).

5 Implementation of Alternative Methods Following the Publication of the Brazilian Environmental Crimes Act

After the publication of the Brazilian Environmental Crimes Act (República Federativa do Brasil, 1998), several Brazilian institutions and university

departments took a stand against the harmful use of animals in teaching and training, fully replacing this practice in some courses. As such, it is worthwhile to mention some examples:

- In 1990, Federal Fluminense University (UFF) replaced harmful animal use in the physiology classes of the biomedical program with the use of cell cultures; and since then, they have been teaching the relevance of *in vitro* assays as alternatives to animal use (Silva et al., 2012). In 2012, the UFF, together with the Brazilian National Network on Alternative Methods, hosted the Latin American Congress on Alternative Methods, a biannual event that gathers researchers from around the world to discuss developments in alternatives to animal use in science, industry, and education.
- The Federal Rural University of Pernambuco, in the State of Pernambuco, abolished the use of live animals for surgical training, as part of their veterinary medicine training, over 16 years ago. They now use preserved ethically-sourced cadavers, synthetic models, and in-house created simulators and are developing many other materials (Souza, 2014). [The term ethically sourced cadaver refers to cadavers and tissue obtained from animals who died of natural causes or in accidents, or were euthanized because of a terminal disease or non-recoverable injury; and, from humans who, prior to their death, gave permission for their body and tissue to be used (Martinsen and Jukes, 2007)].
- The University of Brasilia, in Distrito Federal, replaced the harmful use of animals with computer simulations in practical classes in 1998. Their microsurgical techniques training was replaced by simulators that use a PVC mouse attached to a computer simulator as a teaching interface (Souza, 2014).
- The team at the Faculty of Veterinary Medicine and Animal Science at University of São Paulo achieved an important milestone for more humane education by gaining international recognition for developing a preservation technique that employs a modified Larssen solution (da Silva, 2003; da Silva et al., 2004). This solution is based on a higher concentration of glycerin and lower concentration of formaldehyde and allows the preservation of ethically-sourced cadavers for up to one year and their thawing between six and 10 times without the loss of organoleptic characteristics. The reduced concentration of formaldehyde makes the modified Larssen solution less toxic, which benefits students, technicians, and teachers. The preserved material retains adequate color and texture, ideal for practical classes in anatomy, surgical techniques, and other disciplines, such as orthopedics. More recently, the research group published a refinement of the first developed model, which consists of adding artificial blood to the system to simulate situations, such as bleeding and the use of hemostatic techniques (de Souza and Matera, 2015).

- In 2007, the Federal University of Pelotas completely banned the harmful use of live animals in all courses.
- Since 2006, the Higher Education Center of Campos Gerais at Paraná State has involved veterinary medicine students in helping develop non-animal models as part of their physiology classes to increase their knowledge and problem-solving skills. In 2015, 27 low-cost models were presented by students to their classmates, including models of renal circulation, respiratory homeostasis, the digestive system of ruminants and non-ruminants, ovulation, spermatogenesis, and synapses (Bachinski et al., 2015; Ruiz, 2014).
- In 2007, the Faculty of Medicine of the Federal University of Rio Grande do Sul implemented the *Laboratory Practice of Surgical Techniques* and promoted the full replacement of harmful animal use for medical training.
- Still in 2007, and as a result of an internal initiative, the Faculty of Medicine at the ABC Foundation, in the State of São Paulo, prohibited the harmful use of live animals. The animals used in practical classes of physiology and pharmacology were replaced by interactive software and ethically-sourced animal cadavers.
- The Catholic University of Pelotas, in the State of Rio Grande do Sul, replaced harmful animal use in practical classes of physiology and pharmacology in 2008.
- At the Regional University of Northwest of the State of Rio Grande do Sul (UNIJUÍ) initiatives to replace animals in education started with the opening of the veterinary medicine program in 2008. For example, in the veterinary surgical course, students practice suturing on foam tissue models or other available non-animal materials. Students then perform surgeries on live animal patients who need certain procedures or who are to be neutered or spayed. The same process has been utilized by other Brazilian universities. Since 2016, the UNIJUÍ also started using other alternative methods, such as artificial bones that simulate fractures and their reconstruction, as well as chemically preserved cadavers using Thiel solution (Thiel, 1992). As part of veterinary anesthesiology classes, students have the opportunity to learn how to restrain an animal and provide drugs using dog mannequins. Furthermore, in 2016, students developed models of different body systems in their physiology class.
- In 2009, the veterinary medicine degree at the University Center Monte Serrat (Unimonte) abolished the harmful use of animals and received the Brás Cubas Merit Medal in April of that year for this move.
- In 2013, the Federal University of Vales do Jequitinhonha e Mucuri at Minas Gerais State provided students the opportunity to develop alternative

methods to animal use in their animal anatomy and physiology classes for agricultural science degrees. The animal anatomy course now allows students to develop anatomical pieces based on ethically-sourced animal cadavers. Animal replacements for students studying animal physiology include, physiological models with molecular and macroscopic levels, such as dynamic models of myosin-actin protein molecule interactions, and models that demonstrate circulation. There are also models that display biophysical components, such as surface tension and pressure variations in vascular beds.

- In the past six years, students and researchers have developed models for veterinary training at the Federal University of Paraná at Paraná State. Alternative methods include, mannequins as a scaffold for training models of different systems, such as cystocentesis, blood collection in dogs and cats, and prostatic palpation.
- More recently, in 2015, a project aiming to develop and implement humane teaching techniques for veterinary and biology courses was carried out at the Rural Federal University of Rio de Janeiro, in Rio de Janeiro State. This project includes the use of ethically sourced cadavers, developing models, as well as interacting with local state schools for the dissemination of humane research methods and scientific communication.

6 Policy Development Related to Animals Used in Research and Teaching in Brazil and Its Relevance to Humane Education

In addition to the Environmental Crimes Act, Brazil regulates animal production and use for research and education purposes by Federal Act 11894/2008, *protecting* vertebrate animals (República Federativa do Brasil, 2008). This Act restricts animal breeding and use for higher education and professional training in biomedical sciences. The Act also created the National Council for the Control of Animal Experimentation (CONCEA), which is a government organization related to the Ministry of Science, Technology, Innovations, and Communications. Invertebrate animals, however, were not included in this Act, which is a critical omission in the protection of animals in Brazil, in comparison to other nations where certain classifications of non-vertebrates, such as cephalopods, are protected (European Parliament, 2010, Article 1).

According to Federal Act 11894/2008 (República Federativa do Brasil, 2008), CONCEA formulates standards for animal use in research and teaching, monitors and evaluates the introduction of alternative techniques that replace their

use, and maintains an updated register of research and teaching procedures and of researchers involved in animal use, among other responsibilities. All institutions with teaching or research activities using animals are obliged to set up AUECs, which are composed of veterinarians and biologists, professors and researchers in specific scientific fields, and a representative of a Brazilian animal protection society. All animal teaching and research procedures must be approved by AUECs and reported to CONCEA. From an organizational standpoint, CONCEA has permanent structures to deliberate about animals used in research, education and training, breeding, and development and use of alternative methods, as well as providing parliamentary and media assistance. The decisions of all chambers are voted on in a plenary meeting of the council, consisting of 14 delegates and their alternate members, totaling 28 councilors: 12 from federal public agencies, 12 from civil non-profit organizations linked mainly to research, and only 4 non-profit civil associations for animal protection. Considering the institutional interests, in general terms, the majority (24 individuals) are interested in the "ethical use of animals" and only 4 individuals, from animal protection groups, aim to recognize and protect animals' interests.

All CONCEA delegates are appointed by their institutions, but animal protection delegates are not elected by direct designation. Delegates from animal protection groups are subjected to an evaluation by an *ad hoc* committee, composed of three CONCEA external members. The final decision regarding the council's composition is made by the Minister of Science, Technology, Innovation, and Communication. Unfortunately, the process of selection may allow the election of delegates with no history of interest in animal protection. For example, a researcher from a Primatology Center has been a representative of animal protection groups at CONCEA, implicating a possible conflict of interest. Nevertheless, animal protection delegates do have the opportunity to be part of the discussions and decisions regarding the use of animals in research and education, although their delegates rarely participate in AUECs. This lack of local representation often comes from a lack of knowledge of the CONCEA legislation and background suited to the ethical and technical discussions. Nonetheless, this should not be considered a barrier to the inclusion of animal protection representatives in AUECs, as many come from scientific and technology backgrounds.

In 2016, CONCEA's teaching chamber organized the first Symposium on Alternative Methods for the Use of Animals in Education, generating a space for discussion and exchange of knowledge on alternative methods used for teaching in Brazil. The event welcomed students, professors, and third

sector organizations. The teaching chamber is also involved in the proposition of regulations for the evaluation of the welfare of animals; promotion of humane education in scientific activities; the establishment of values, principles, and guidelines for animals used in research and education; and support for the development and use of alternative methods in surgical training. It is of utmost importance that the AUECS, in line with CONCEA's actions, are kept informed about all available alternative methods and new learning approaches. With this information, projects proposing the use of animals for education and training can be evaluated according to their merits and whether animal replacement methods are available. Often, harmful animal use is proposed by teachers who have repeated a "tried-and-tested" practice for decades without searching for more technologically advanced methods that do not use live animals; and they do not seek to base their classes on humane, ethical values. To increase consideration and implementation of the 3Rs (replacement, reduction, and refinement) (Russell and Burch, 1959), the AUECS should require that project applications provide a detailed scientific literature review, including search strategy, list of databases used, keywords, and scientific citations (Shapiro, 1999).

7 Final Considerations and Perspectives

Souza (2014) described the evolution of moral and social thinking about the status of animals in Brazil, especially addressing their use as a scientific and training instrument. Following a detailed analysis of literature on humane education and animal use in education and of academics' and students' opinions, Souza concluded that the use of animals in teaching could not be accepted for ethical, legal, and pedagogical reasons. There are economic reasons to avoid their use as well. Research shows that the use of animals for research, education, and training costs more than the use of alternative methods (Bones et al., 2015; Feijó et al., 2008; Fox et al., 2013; Neto, 2011; Ribeiro et al., 2013; Sathyanarayana, 2009; Tudury et al., 2009).

Despite awareness that animals should not be used for education and training purposes, their use continues in some institutions in Brazil. With this consideration, it is important to analyze the main reasons for retaining their use. For example, in a study focusing on animal use for rabies diagnosis, the proportion of tests that used mice was higher in Brazil (75%) than in other countries (32%). Moreover, barriers to the replacement of animal use most frequently cited by respondents in a 2014 study by Bones and colleagues

included: lack of structure, equipment, and materials in the laboratories; lack of financial resources; lack of human resources and professional qualifications; resistance to change; regulatory obstacles, and lack of incentive by the government (Bones et al., 2014). Although this study refers to the use of animals for testing purposes, its findings on barriers to for implementing non-animal methods are indicative to other areas of animal use, including education and training.

Within teaching, resistance to change is one of the most difficult problems at universities in Brazil. Barriers to the replacement of animal procedures could be addressed by focusing on humane education, using a novel tool: a decision tree (DT) approach (Bones et al., 2016). The DT approach discusses barriers that hinder *replacement* and helps to address the main obstacles. If followed in a step-by-step manner, the DT approach can lead to the uptake of alternative methods or their development when alternatives do not already exist. For example, for the resistance barrier, the DT approach suggests the need to obtain financial resources, to develop courses on the 3Rs and courses on the ethics of animal use, and to provide people with information about the Environmental Crimes Act (República Federativa do Brasil, 1998). The DT approach can be applied to laboratory animal use scenarios, where alternative methods already exist, and could contribute to increased compliance with the legal requirement of the 3Rs principles in Brazil.

In addition to the application of DT methods, we suggest other actions to accelerate the process of preventing harmful use of animals in education and training. For example, strengthening student movements that value ending the harmful use of animals; pressuring the government to increase funding for the development of alternative methods; and implementing more humane education discussions. Alongside these actions, both teachers and students need to monitor the availability of alternative methods and legal mechanisms for greater protection of animals used in education. Approaches that involve students in the development of animal-free methods should be a vital part of academic and vocational training (Bachinski et al., 2015).

As a final note, the work of the Brazilian Network for Humane Education (RedEH) needs to be acknowledged. Starting in 2015, this network provides a platform to connect researchers and teachers from various science and educational institutions across the country to engage in promoting scientific education on the replacement of animals used in education and training activities (RedEH: Bachinski et al., 2015). RedEH's main objective is the development and dissemination of new teaching methods and public policies in Brazil and sharing teaching experiences without the involvement of animal harm. RedEH also constitutes a link between teachers and researchers, providing

opportunities for collaboration using new techniques and methods developed by the members. As a result of these actions, several institutions have already stopped harmful animal use in favor of humane approaches. RedEH is gradually expanding its actions in Brazil, each year counting the collaboration of an increasing number of educators. Initiatives involving teacher and student collaboration and including more active engagement can enable a humane scientific paradigm shift among educators and students. As well as working for the replacement of harmful animal use and increasing the ethical regard for animals as individuals, and not as tools, RedEH also works on issues of social equality and justice.

In this chapter we have discussed actions based on social participation in scientific-political decisions. Considering science as a social production, with social limits and social demands, we encourage ideological pluralism in scientific development and looking for new opportunities for a non-speciesist scientific paradigm. Humane education, social participation, and defense for new scientific perspectives that respect basic animal rights are important for any society interested in the development of humane science.

References

- Amiot, C.E. and B. Bastian (2015). Toward a Psychology of Human-animal Relations. *Psychological Bulletin*, 141(1), pp. 6–47.
- Annas, G.J. and M.A. Grodin (1992). *The Nazi Doctors and the Nuremberg Code*. New York NY: Oxford U Press.
- Bachinski, R., T. Tréz, G.G. Alves, R. de CM Garcia, S.T. Oliveira, L.D.S. Alonso, J.X. Heck, C.M.C. Dias, J.M. Costa Neto, A.A. Rocha, V.R.R. Ruiz and R.L. Paixão (2015). Humane Education in Brazil: Organisation, Challenges and Opportunities. *Alternatives to Laboratory Animals*, 43(5), pp. 337–344.
- Bastos, J.C.F., A.M. Rangel, R.L. Paixão and S. Rego (2002). Implicações Éticas do Uso de Animais no Processo de Ensino-aprendizagem nas Faculdades de Medicina do Rio de Janeiro e Niterói. *Revista Brasileira de Educação Médica*, 26(3), pp. 162–170.
- Bones, V.C., H.C. Clemente, D.M. Weary and C.F.M. Molento (2014). Perceived Barriers to the Adoption of Alternatives to Laboratory Animal Use for Rabies Diagnosis. *Alternatives to Laboratory Animals*, 42(3), pp. 171–179.
- Bones, V.C., C. Forte and M. Molento (2016). The Use of a Decision Tree Based on the Rabies Diagnosis Scenario to Assist the Implementation of Alternatives to Laboratory Animals. *Alternatives to Laboratory Animals*, 44(8), pp. 121–128.
- Bones, V.C., A.H. Gameiro, J.G. Castilho and C.F.M. Molento (2015). Comparative Costs of the Mouse Inoculation Test (MIT) and Virus Isolation in Cell Culture (VICC)

- for Use in Rabies Diagnosis in Brazil. *Alternatives to Laboratory Animals*, 43(2), pp. 81–87.
- Capilé, K.V., G.M.B. Campos, R. Stedile and S.T. Oliveira (2015). Canine Prostate Palpation Simulator as a Teaching Tool in Veterinary Education. *Journal Of Veterinary Medical Education*, 42(2), pp. 146–150.
- Comisión-técnica (2011). *Experimentos en Seres Humanos el caso Guatemala 1946–1948*. Guatemala. [online] Available at: <http://www.cityprojectca.org/blog/wp-content/uploads/2012/07/Guatemala-Report-Consentir-Spanish-201110.pdf> [Accessed 26 August 2017].
- da Silva, R.M.G. (2003). *Avaliação do Método de Ensino da Técnica Cirúrgica Utilizando Cadáveres Quimicamente Preservados, Dissertação (mestrado) – Universidade de São Paulo*. Faculdade de Medicina Veterinária e Zootecnia. Departamento de Cirurgia. [online] Available at: <http://revistas.bvs-vet.org.br/recmvz/article/view/3263> [Accessed 26 August 2017].
- da Silva, R.M.G., J.M. Matera and A.A.C.M. Ribeiro (2004). Preservation of Cadavers for Surgical Technique Training. *Veterinary Surgery*, 33(6), pp. 606–608.
- de Souza, I.M.C.C.M. and J.M. Matera (2015). Bleeding Simulation in Embalmed Cadavers: Bridging the Gap Between Simulation and Live Surgery. *Alternatives to Animal Experimentation*, 32(1), pp. 59–63.
- Diniz, D. and D. Guilhem (2002). *O que é bioética*. Coleção Pr. São Paulo, Brazil: Brasiliense.
- Dória, T.A.F. and L.M. de A. Moreira (2011). A Bioética na Formação do Biólogo: Um Desafio Contemporâneo. *Revista Faced*, 20, pp. 99–122.
- European Parliament (2010). Directive 2010/63/EU of the European Parliament and of the Council of 22 September 2010 on the protection of animals used for scientific purposes. *Official Journal of the European Communities*, L276, pp. 33–79. [online] Available at: <http://eur-lex.europa.eu/legal-content/EN/TXT/?uri=CELEX%3A32010L0063> [Accessed 26 August 2017].
- Faver, C.A. (2010). School-based Humane Education as a Strategy to Prevent Violence: Review and Recommendations. *Children and Youth Services Review*, 32(3), pp. 365–370.
- Feijó, A., A. Sanders, A.D. Centurião, G.S. Rodrigues and C.H.A. Schwanke (2008). Análise de Indicadores Éticos do Uso de Animais na Investigação Científica e no Ensino em uma Amostra Universitária da Área da Saúde e das Ciências Biológicas. *Scientia Medica*, 18(1), pp. 10–19.
- Fox, V., C. Sinclair, D.M. Bolt, J. Lowe and R. Weller (2013). Design and Validation of a Simulator for Equine Joint Injections. *Journal of Veterinary Medical Education*, 40(2), pp. 152–157.
- Frieden, T.R. and F.S. Collins (2010). Intentional Infection of Vulnerable Populations in 1946–1948: Another Tragic History Lesson. *Journal of the American Medical Association*, 304(18), pp. 2063–2064.

- Horner, J.S. (1999). Retreat from Nuremberg: Can We Prevent Unethical Medical Research?. *Public Health*, 113(5), pp. 205–210.
- Jochen-Vollmann, R.W. (1995). History of Informed Medical Consent. *The Lancet*, 346(8990), p. 1633.
- Knight, A. (2014). Conscientious Objection to Harmful Animal Use within Veterinary and Other Biomedical Education. *Animals*, 4, pp. 16–34.
- Lima, J.E.R. (1995). *Vozes do Silêncio. Cultura científica: ideologia e alienação no discurso sobre viviseção*. São Paulo, Brazil: Instituto Nina Rosa.
- Martinsen, S. and N. Jukes (2007). Ethically Sourced Animal Cadavers and Tissue: Considerations for Education and Training. *Alternatives to Animal Testing and Experimentation*, 14, Special Issue, Proceedings of the 6th World Congress on Alternatives and Animal Use in the Life Sciences, pp. 265–268. [online] <http://altweb.jhsphe.edu/wc6/paper265.pdf> Available at: [Accessed 26 August 2017].
- Morin, E. (1990). *Science avec conscience*. Librairie Arthème Fayard, 1982; Paris: Seuil. [online] https://monoskop.org/images/e/e5/Morin_Edgar_Science_avec_conscience.pdf Available at: [Accessed 26 August 2017].
- Neto, F.C. (2011). *Desenvolvimento e análise de software educacional alternativo ao uso de animais em aulas práticas de fisiologia: Fisioprat*. Campinas: Universidade Estadual de Campinas.
- Nuremberg Military Tribunals (1946). *Trials of war criminals before the Nuremberg Military Tribunals under Control Council Law no. 10*. Washington D.C.: U.S. Government Printing Office.
- Reich Minister of the Interior (1931). German Guidelines on Human Experimentation 1931. In: Reich, W.T., ed., *Encyclopedia of Bioethics* (1978), Appendix p. 2762–2763.
- República Federativa do Brasil (1988). *Constituição Da República Federativa Do Brasil*. Promulgada em 5 de outubro de 1988. [online] Available at: http://www.planalto.gov.br/ccivil_03/constituicao/constituicao.htm [Accessed 26 August 2017].
- República Federativa do Brasil (1998). *Lei No 9.605, De 12 De Fevereiro De 1998*. Diário Oficial da União. Seção 1 – 13/2/1998, Página 1.
- República Federativa do Brasil (2008). *Lei No 11.794, de 8 de Outubro de 2008*. Diário Oficial da União. Seção 1 – 9/10/2008, Página 1.
- Ribeiro, C.L., C.R. Bittencourt, C.A.C. Ponczek, I.R.B. Filho and S.T. Oliveira (2013). Confecção de Modelos Artificiais de Baixo Custo Como Auxílio Aprendizagem de Acesso Vascular em Pequenos Animais. *Archives of Veterinary Science*, 18(4), pp. 25–30.
- Ruiz, V.R.R. (2014). Preparation of Alternative Teaching Materials to be Applied in the Relation of Teaching: Learning in Veterinary Medicine, *Vigilância Sanitária em Debate*, 2(3), pp. 22.

- Russell, W. and R. Burch (1959). *The principles of humane experimental technique*. Potters Bar, Hertfordshire, England: Universities Federation for Animal Welfare. [online] Available at: http://altweb.jhsph.edu/pubs/books/humane_exp/het-toc [Accessed 15 August 2017].
- Sathyanarayana, M.C. (2009). Need for Alternatives for Animals in Education and the Alternative Resources. *Alternatives to Animal Experimentation Proceedings, Proceedings of Animal Alternatives in Teaching, Toxicity Testing, and Medicine*, 2(1), pp. 77–81.
- Seidelman, W.E. (2012). Dissecting the History of Anatomy in the Third Reich (1989–2010): A Personal Account. *Annals of Anatomy – Anatomischer Anzeiger*, 194(3), pp. 228–236.
- Seixas, M.M., J.H.A. Virgens, S.M.M. Barrouin and A.G.S. van Herk (2010). Consciência na Substituição do Uso de Animais No Ensino: Aspectos Históricos, Éticos e de Legislação. *Revista Brasileira de Direito Animal*, 6(5), pp. 71–96.
- Shapiro, L.S. (1999). *Applied Animal Ethics*. D.T. Learning, Albany: Ari Farms.
- Silva, D.C., J.A. Cortes, R. Bachinski and G. Alves (2012). An Integrated Practical Course on Cell Biology on *in Vitro* Cytotoxicity Assays for Brazilian Health/Biology Undergraduate Students. *Alternatives to Animal Experimentation Proceedings*, 3, p. 154.
- Souza, M.F. (2014). *Status Moral dos Animais: Percepções e Ações Sociais no Brasil*. PhD. Programa de Pós-Graduação em Bioética, Ética Aplicada e Saúde Coletiva – PPG-BIOS, em associação UFRJ, FIOCRUZ, UERJ e UFF.
- Teixeira, M. (2011). Os Experimentos da Guatemala: Infecção Intencional de Presos, Soldados e Insanos pela Laboratório de Pesquisa em Doença Venérea dos EUA, Rev. *Revista Latinoamericana de Psicopatologia Fundamental*, 14(4), pp. 690–698.
- Thiel, W. (1992). Die Konservierung Ganzer Leichen in Natürlichen Farben. *Annals of Anatomy-Anatomischer Anzeiger*, 174(3), pp. 185–195.
- Torrey, E.F. and R.H. Yolken (2010). Psychiatric Genocide: Nazi Attempts to Eradicate Schizophrenia. *Schizophrenia Bulletin*, 36(1), pp. 26–32.
- Tudury, E.A., M.G. Potier and T.H.T. Fernandes (2009). Métodos Alternativos para Aprendizado Prático da Disciplina Técnica Cirúrgica Veterinária. *Ciência Veterinária nos Trópicos*, 11(1), pp. 92–95.
- Vollmann, J. and R. Winau (1996). Informed Consent in Human Experimentation before the Nuremberg Code. *British Medical Journal*, 313(7070), pp. 1445–1449.
- Woon, S.Y. (2011). A Veterinary Student's Perspective on Educational Animal Use and the Potential for Humane Alternatives. *Alternatives to Animal Experimentation Proceedings*, 1(12), *Proceedings of WC8*, pp. 377–385.
- Zanetti, M.B.F. (2010). *Os animais como recurso didático nas aulas de medicina veterinária: Estudo em universidades do estado do paraná*. Federal University of Paraná.

PART 7

*The Paradigm Shift: Advanced Animal-free
Approaches*



Recent Developments in Alternatives to Animal Testing

Katy Taylor

Director of Science and Regulatory Affairs, Cruelty Free International (formerly BUAV) and the European Coalition to End Animal Experiments, London, United Kingdom

1 Introduction to Alternative Methods

At least 115 million animals are thought to be used for scientific purposes every year, worldwide (Taylor et al., 2008). Animals are typically used to test whether an intervention will cause harm to humans or other animals of the same or different species, i.e. safety testing; or whether it will work, i.e. efficacy testing. Interventions can include testing substances (such as cosmetic products, industrial chemicals, drugs, pesticides, food additives, and biocides); medical devices; surgical techniques; environmental changes; or other ways of altering the physiology and/or behavior of a live animal. Safety testing is highly regulated and is often done after any efficacy testing, if necessary, to finally check that an intervention is safe for humans and/or other animals to use. Efficacy testing is less formalized and often occurs in universities as ideas are tested in live animals as a “proof of concept”, often prior to the development of actual interventions to help humans or other animals.

Methods that replace techniques that use live animals, or methods of testing substances without live animal use, are known as *alternatives*, *replacements* or *non-animal methods*. Some prefer the term *advanced technologies* given the fact that they often rely on more sophisticated technology and are more human-relevant than the animal test they replace (see Langley et al., 2015). There have been efforts to replace animal tests since the 1960s. Significant progress initially came in replacing animals used to diagnose human disease; to produce biological drugs (such as vaccines); and to safety test batches of these drugs as they were produced. Concerns about safety were the initial driver for this, as drugs produced using animal material could be contaminated with animal diseases. However, cost, efficiency, and the need for swifter and more accurate predictions also played a part. Some of the earliest replacements are, in fact, no longer referred to as such, as they are now standard practice. For example, the

polio vaccine used to be produced in primary monkey kidney cells, resulting in the death of tens of thousands of monkeys every year. However, by the 1970s, the use of long-lived human or monkey cells in culture was common place and the risk of contamination with animal viruses was also eliminated (Bookchin and Schumacher, 2005). Batches of the vaccine against yellow fever used to be tested for efficacy (potency) on animals in lethal dose tests, but these tests were replaced by a cell culture test, the plaque-reduction neutralization test, in the 1970s (World Health Organization, WHO, 2007).

As analytical techniques improved, as well as scientific understanding, animals were no longer used as indicators of disease because disease-causing agents were now both understood and could be measured directly. For example, every batch of insulin used to be checked using 600 mice and tens of thousands were used in the United Kingdom alone every year. The mouse convulsion test was a particularly unpleasant test, as the number of mice that went into convulsions following injection was used as a measure of the strength of vials of insulin. Now, analytical methods can measure the components of insulin directly (Underhill et al., 1994). Similarly, rabbits were used in the diagnosis of pregnancy. A rabbit was injected with the urine from a potentially pregnant woman, and if the rabbit's ovaries swelled (detected upon killing and dissecting the rabbit), this was considered a good predictor of pregnancy (Friedman, 1939). Now, of course, we know that the substance indicative of pregnancy is gonadotrophin, which can be detected directly using chemical tests.

Nowadays, *alternative methods* can include a range of techniques, including cell-based tests (*in vitro*); tests using tissue taken from dead humans or animals (*ex vivo*); chemical-based analytical tests (*in chemico*); computer-based modelling (*in silico*); and ethical human studies (*in vivo*). Using examples of these types of methods used for regulatory safety testing, this chapter illustrates the difficulties seen in replacing animals and how they can be overcome.

2 Recent Developments in Alternatives to Toxicity Testing

The past 30 years have seen a dramatic increase in the development of alternatives to animals (see Liebsch et al., 2011). Advances in replacements are more recognized in the field of toxicology because it is this area that has received the most attention. Regulatory, typically toxicity testing, is only a small proportion of the global testing on animals (8% in Europe according to Daneshian et al., 2015); but due to the standardized nature of the tests, replacement of just one test has a permanent effect on the use of animals in that area and is, therefore, seen as particularly worthwhile.

Table 24.1 outlines the status of alternatives for the most common tests used for chemical safety testing, which traditionally and in most cases still use animals. Two things stand out in this table. First, that replacement of topical endpoints (i.e., tests that measure effects on the external parts of the body) are almost completely replaced. However, alternative tests for systemic, broad effects, such as repeated dose, do not yet feature in the regulatory acceptance column. Second, there has been significant progress in the past 10 years in regulatory acceptance. Many tests have gained approval from the Organisation for Economic Co-operation and Development (OECD), even if they can only be used in combination with other tests.

TABLE 24.1 Alternatives for standard toxicity tests for chemical safety

Endpoint	Animal test	Alternative tests	Regulatory acceptance
Skin absorption	The substance is rubbed onto the shaved backs of rats, and they are killed the next day (OECD TG 427).	<i>Ex vivo</i> skin-based tests that measure the amount of substance that passes through excised skin.	OECD TG 428 (2004). Standalone replacement.
Acute toxicity	Rats are exposed to a very high dose of the substance, such that a number of them are expected to die (OECD TG 402,403, 420,423,425,436).	Cell-based tests, in particular the NRU ₃ T ₃ , which measures the extent of cell death in the presence of the substance.	Not formally accepted, can be used in combination with other information only.
Skin irritation/corrosion	Substance is rubbed onto the shaved backs of rabbits, and they are killed 2 weeks later (OECD TG 404).	Reconstituted <i>in vitro</i> human skin models that measure the extent of cell death in the presence of the substance.	OECD TG 431 (2004) and 439 (2010), plus others. Testing strategy accepted (OECD, 2014a).
Eye irritation/corrosion	Substance is placed into the eyes of live rabbits who are monitored for up to 3 weeks (OECD TG 405).	Excised eyes from hens and cattle killed for food (<i>ex vivo</i>) can detect non-irritants and severe irritants; human corneal epithelial (HCE) models based on excised human skin or corneas that measure the	OECD TG 437 and 438 (<i>ex vivo</i> , 2009); OECD TG 492 (HCE, 2015). Testing strategies yet to be formally accepted.

TABLE 24.1 Alternatives for standard toxicity tests for chemical safety (*cont.*)

Endpoint	Animal test	Alternative tests	Regulatory acceptance
		extent of cell death in the presence of the substance can detect non-irritants.	
Skin sensitization	The substance is rubbed onto the shaved skin of guinea pigs who are subjectively assessed for allergy (Buehler or the guinea pig maximization test, GPMT; OECD TG 406); or painted onto the ears of mice who are killed 6 days later to assess the immune response (local lymph node assay, LLNA test), (OECD TG 429, 442a/b).	Several tests exist that cover the adverse outcome pathway (AOP) for skin allergy. The direct peptide reactivity assay (DPRA) measures the binding of the substance to proteins (<i>in chemico</i>); and the <i>in vitro</i> keratinocyte assay and the human Cell Line Activation Test (h-CLAT), which are based on human skin cells, measure part of the immune response.	OECD TG 442c (DPRA, 2015); 442d (keratinocyte assay, 2015); and 442e (h-CLAT, 2016). Testing strategies yet to be formally accepted.
Mutagenicity/genotoxicity	The substance is force-fed or injected into mice or rats for 14 days; they are then killed to look at the effects on their cells (OECD TG 474, 475, 483, 486, 488, 489).	Several <i>in vitro</i> tests, including bacteria (Ames) tests, <i>in vitro</i> chromosome aberration, cell micronucleus, and gene mutation tests are available. A battery of two or three cell-based tests is always carried out before conducting an animal test.	OECD TG 471 (1997); 473 (1997); 476 (1997); 487 (2010); 490 (2015). Positive results, however still lead to follow up <i>in vivo</i> .
Repeated dose	Rats (occasionally rabbits, mice, or dogs) are force-fed, forced to inhale, or have the substance rubbed onto their shaved skin every day for 28 or 90 days, before being killed (OECD TGs 407–413).	<i>In silico</i> techniques, such as read across, can be used if the substance is similar to existing ones that have already been tested. A battery of <i>in vitro</i> tests or lab on a chip models are still in the development phase.	Read across is accepted on a case-by-case basis (see OECD, 2014b); battery of <i>in vitro</i> tests or lab on a chip are not yet accepted.

Carcinogenicity	Rats or mice are fed the substance for two years to see if they get cancer (OECD TG 451, 452).	Cell transformation assays (CTA) based on cellular changes to rodent cells have been in use for 50 years and can detect 90% of known human carcinogens.	CTA assays have failed to gain international regulatory acceptance and are used for screening purposes only (OECD 2015, 2016).
Reproductive toxicity	Pregnant female rabbits or rats are force-fed the substance and then killed along with their unborn babies (OECD TG 414).	<i>In silico</i> techniques, such as read across, can be used if the substance is similar to existing ones that have already been tested. The <i>in vitro</i> Embryonic Stem cell (EST) test is based on mouse stem cells. Substances are classed as toxic if they block development into beating heart cells. Other <i>in vitro</i> tests are still in the development phase. Receptor binding assays are <i>in vitro</i> assays that can detect activation of genes involved in hormone production.	Read across is accepted on a case-by-case basis (see OECD, 2014b). EST has failed to gain international regulatory acceptance. Receptor binding assays (OECD TG 455, 2012; 457, 2012; 456, 2011) are accepted to screen for potential endocrine disrupting properties.

For a list of all OECD Test Guidelines referred to in this table, see <http://www.oecd.org/chemicalsafety/testing/oecdguidelinesforthetestingofchemicals.htm>.

It is widely acknowledged that public pressure has played a significant part in encouraging these developments. Public outrage at animal testing for cosmetics started in the 1970s and gained momentum in the 1980s. In Europe, the outcry turned into calls for an actual ban on cosmetics testing on animals, even in the absence of alternatives for all relevant animal tests. From 1993, and finally ending in 2013, a series of deadlines were negotiated and re-negotiated within the European Union (EU) by which the testing had to end, first for the testing of products and then for the testing of ingredients (European Commission, 2017). During this period, the cosmetics industry foresaw that testing any new substances on animals would soon have to end, and they invested in alternatives, as did the European Commission (EC).

The formal encouragement to use alternatives in the EU was set in stone by the EU Directive on animal testing in 1986 (Council of the European

Communities, 1986, Directive 1986/609/EEC) and revised in 2010 (European Parliament, 2010, to Directive 2010/63/EU). Directive 2010/63/EU states that an animal test must not be conducted if an alternative method is available. This rule is unique to the EU; and while not enforced as well as one might hope, it has nonetheless helped encourage the promotion of alternatives internationally. Finally, the overhaul of EU chemicals' legislation in 2006 also played a part in driving the need for alternative methods. The new chemical regulation, Registration, Evaluation, Authorisation and Restriction of CHemicals (REACH) is interesting in that it requires the testing of all new and existing chemicals on animals, unless alternative methods or data already exist (European Parliament and the Council of the European Union, 2006, Regulation 1907/2006). The fact that this could result in the use of up to 38 million animals (Joint Research Centre, 2006), has encouraged both regulators and industry to look for alternatives to keep costs and animal numbers down.

3 Implementation of Alternative Methods

The replacement of an animal test is a laborious and lengthy, scientific and bureaucratic process. Figure 24.1 outlines the steps that typically need to be taken before an animal test can be finally considered *replaced* by another method. Unfortunately, the outlined process is often repeated for each sector of use. For example, the method needs to be validated and accepted for replacing animals to test chemicals and then repeated in order for the method to be considered acceptable to replace animals used in drug testing. This is because the types of chemicals differ in each sector, and there is a fear that the alternative may not work on different chemistries. There is also an element of distrust in alternatives not developed for that sector, and so the industry tends to want to re-evaluate the alternative itself rather than transfer it across immediately.

Development is the stage in which the alternative is created, optimized, and initially tested. Academe plays a large role at this stage. Alternative centers, such as the UK National Centre for the 3Rs and alternatives charities, are vital in funding this kind of work. Researchers may develop spin-off companies to further develop a method. Larger chemical, medical, and cosmetics companies

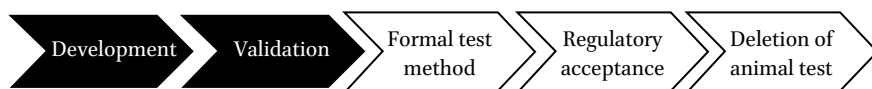

FIGURE 24.1 The process of acceptance of an alternative test method. Steps in black are primarily science driven, steps in white are primarily regulatory driven.

may also develop alternatives, even creating their own spin-off companies or buying existing ones. For example, L'Oréal purchased the rights to EpiSkin in 1997 and bought the SkinEthic company in 2006, so that they could develop and use their own human skin irritation models (Auplat, 2012). Unfortunately, academics may be satisfied by the publication of their method in scientific journals and often leave it to others to ensure it is used more widely. More proactive, academic-driven development may still struggle to grasp the regulatory hurdles that need to be overcome before the method can be used. Unfortunately, industry-driven development can also be rather inward looking. Companies may be satisfied if the method is considered suitable for their own in-house purposes for screening substances; and, often, they have little incentive to donate the method to the wider community, particularly if they have invested heavily in its development, and competitors could gain from its use.

Validation is the stage in which the method is independently assessed to ensure it is reliable and accurate. This step is vital if the method is to progress to acceptance. There are internationally agreed principles for the way a method should be validated; but they are rather vague and not always well understood. The key requirements include, showing that the method produces the same results when tested at different times in the same laboratory and when used by other naive laboratories, and that the results are consistent with what is expected, i.e. the test does what it is designed to do. The process is laborious, requires collaboration between several laboratories, and can be expensive. If things go wrong, the validation stage may have to be repeated. In most cases, historical animal test data is used as the gold standard by which an alternative method is assessed, so no new animal tests have to be done; but there can be problems in ensuring the old animal data is of good quality. Quite often, the fact that the animal test itself was never validated causes problems during validation, as the assessors realize that the animal data is so unreliable or inaccurate that they cannot trust it (Balls, 2006). Species differences also play a significant role in making comparisons between human-based cell tests and animal test results very difficult (Hartung, 2007).

Official bodies are seen as a good way of ensuring a method is correctly validated. In Europe, the European Commission's European Centre for the Validation of Alternative Methods (ECVAM) is an important validation body. There are now equivalent bodies in other countries, such as the United States (US) (Interagency Coordinating Committee on the Validation of Alternative Methods, ICCVAM), and Japan (Japanese Centre for the Validation of Alternative Methods, JaCVAM). Unfortunately, the process of validation and regulatory acceptance is still a bit of a black box. Methods do not have to go through these validation centers to be accepted, but it often helps. Companies with

new methods are often unsure about the process, whether they need to submit their method for official validation or directly to the regulatory body, who they should contact, and what information they need to provide.

Formal test method. Once there is sufficient evidence that an alternative method is valid, the next stage is to write up how the method should be performed as a formal test method. In Europe, the policy is to gain wider agreement on the method via large international collaborations, such as the OECD or the International Council on Harmonization (ICH). This is so that the method, in theory, will be accepted outside Europe and European companies will not be disadvantaged by having to conduct other tests. Negotiating how to conduct the method is often combined with further analysis of the validity of the method and can take several years. This stage can also provide false hope that a method is acceptable in all regions; this is because, although an agreement may be sought in principle, at an international level, the regional acceptance process can be prolonged as regulators still have to decide that the method is relevant and acceptable to the legal framework in their region.

Regulatory acceptance does not automatically happen following the publication of a formal test method, a fact that is often not widely appreciated. Following adoption of a formal test method, typically several regional regulatory agencies have to assess independently whether the method can be used for their sector (e.g., chemical, medicines, or cosmetics). Unfortunately, there is often no official mandate for them to do this, and they may need political pressure to act. Regulators do not have to wait until the method is formally recognized internationally to decide whether they will accept it for their purposes, but they frequently do. Negotiations within each regulatory body can take many months, or even years; and currently, these have to happen separately for each sector and region. Regulators typically accept methods by updating their guidelines, but it is often only when a corresponding legislation is changed that industry becomes aware of the need to use the alternative in place of the animal test.

Deletion of the animal test. Changing sector specific legislation to replace any requirement for a specific animal test with the alternative takes several years and the process is usually not started until the very end of the process. Political pressure is usually needed to instigate the deletion of the animal test, often following pressure from animal protection organizations. For example, there was a delay of seven years from the point in which there was a formal method alternative to the rabbit skin irritation test (Commission of the European Communities, 2009) until the rabbit test was deleted from REACH requirements and replaced with the skin irritation methods (European Commission, 2016a). The process was not initiated until 2012, following a complaint from Cruelty Free International. To date, the rabbit test is still performed in Europe and elsewhere, and the formal test method for the rabbit test (OECD

TG 404) still exists. The only standard regulatory animal test that has been deleted from OECD requirements is the LD₅₀ acute toxicity test (OECD, TG 401) in 2001, which was “replaced” by other animal tests that cause slightly less suffering or equivalent suffering to fewer animals.

Regulatory acceptance is not usually required for methods that replace animals in basic research conducted in academe. Here, the route to acceptance is a less defined, unofficial, and often very slow process. The scientific community may gradually move towards alternative methods, usually through the common scientific channels of publications, conferences, and workshops. There is no body within the medical research establishment tasked with coordinating this process, although national 3R centers may facilitate more rapid progress on a case-by-case basis. Regulators of animal experiments could play a role in ensuring that no animal-based projects are conducted in their region if there is an alternative; but as the line between what is and what is not an accepted alternative is less clear for basic research, they currently do not appear to do so.

In summary, the *development* and *validation* stages are primarily *science-dependent* processes, which can be sped up through appropriate *funding* and *coordination*. The stages of *formal test method*, *regulatory acceptance*, and *deletion of the animal tests* are primarily *regulation dependent* and can be accelerated by *political will* and *regulatory enforcement*.

4 The Future of Alternatives

The difficulties of replacing animal tests, combined with increasing frustration with the lack of reliability of animal tests, have forced scientists, in recent years, to consider whether a paradigm shift is needed. A ground-breaking report to this effect was published by the National Academy of Sciences (NAS) in the US in 2007. Rather than criticizing the ethics of testing on animals, the report focused on better science and set out a future vision for toxicity testing. The idea is that society should move away from using *black box* animal models, where tests depend on simply counting how many animals die rather than on understanding why they die. Instead, toxicology should seek to *map* human reactions at a more molecular and cellular level, something entirely possible *in vitro*. The *Toxicology Testing in the 21st Century* (Tox21) concept was funded on a practical level by the US government under the ToxCast project, which is screening thousands of chemicals using simple *in vitro* tests to help start the process of identifying *toxicity pathways* (Richard et al., 2016).

The NAS report has helped accelerate the concept of Adverse Outcome Pathways (AOPs) which provides the biological explanation for a single toxic event. Some toxic events, such as skin irritation and skin sensitization, may

only have one biological explanation. For example, the AOP for skin sensitization has been described (OECD, 2012) and is made up of four steps: reaction of the substance with proteins in the skin, inflammatory responses in keratinocyte skin cells, activation of dendritic cells, and lastly the proliferation of T-cells. The first three steps now have OECD approved *in chemico* or *in vitro* tests (see Table 24.1); the fourth step is measured in the mouse LLNA.

Unfortunately, some animal tests capture many different types of toxicity, including some that are not relevant to humans. For example, repeated dose toxicity tests assess long term toxicity, which can manifest in a number of ways (e.g. cancer, liver disease, and heart disease, among others). To replace animals for these tests will require the identification of many AOPs and the development of tests for the steps within them. The thinking is that if all possible AOPs relevant to repeated dose toxicity can be mapped, then *in chemico* or *in silico* tests for only some of the key steps will need to be created. The risk is that finding all of these AOPs will take time, and animal tests will not be replaced until that happens. Nonetheless, the concept has now taken hold in Europe, and the OECD is supporting the population of a database of AOPs (OECD, n.d.).

Another development in toxicology that seeks to overcome the criticism that cell cultures are too simplistic, is the *lab on a chip* concept: *body* or *organ on a chip* models vary in size and complexity but essentially use engineering technology to combine small cultures of cells (e.g., liver, brain, and kidney) into a single, tiny device with fluid running between the compartments of each type of cell. The idea is to recreate some of the key organs and processes that occur within a human on a miniature scale (Marx et al., 2012). The concept is proving not as easy as it seems though, with issues regarding how to remove waste products, how to keep cells alive, and how to mimic realistic pressures within the fluidic channels. The lab on a chip and/or the AOP approach will also likely lead to the replacement of animal models for basic research (Langley et al., 2017). In a way, it should be easier to replace animal tests for drug development, since drug discovery itself is already very reductionist. New drugs are usually developed to interact with cell-based mechanisms inside the body that trigger disease. This is similar to the AOP approach, and it should be possible to model it *in vitro*. It is, therefore, rather incomprehensible that researchers look to a more holistic, whole animal approach to demonstrate both the efficacy and safety of a new drug, with all the added complications of lack of relevance and species differences that this brings. Encouraging researchers to justify efficacy based on human cell-based approaches and then testing the drug on a few patients in, so called *futility trials* (see Creanor et al., 2015, for example of a futility trial), could be one approach to speed up drug development and reduce the high number of drugs that fail in clinical trials.

Another approach is to use technology to enable humans to be used safely in studies that would otherwise use animals in a harmful manner. Microdosing exploits the technological advances in analytical techniques to enable volunteers to be injected with novel substances at such low levels, that even potentially harmful substances do not pose a threat (Lappin, 2015). Similarly, improvements in brain imaging technology are enabling researchers to measure human brain activity non-invasively, and at a high level of precision, so that invasive tests in monkeys will soon be considered redundant (Bailey and Taylor, 2016).

5 Barriers to the Implementation of Alternatives and How to Overcome Them

5.1 *The Current Scientific Paradigm*

A major stumbling block when it comes to replacing animals is the current way that hypotheses are tested in science. Figure 24.2 outlines the typical process scientists go through when testing either the safety or efficacy of a substance, or indeed any hypothesis. The process is one of testing in models of increasing complexity with growing confidence in the hypothesis, as it successfully passes each hurdle.

The most common justification for using animals is the apparent need to test a substance or idea in a “complex, whole being” before there is enough confidence that it can be tested safely in humans. The assumption behind this is that the complex, whole being will capture all possible, unforeseen ways in which the substance or idea could be harmful (or not work), avoiding harm to (or wasting time on) human volunteers. This “complexity” argument is one reason for the lack of support for *in vitro* based techniques, as these are seen as less complex and, therefore, inferior. The desire to capture all possible interactions appears to override the very real possibility that many of these interactions are wrong by the very nature of testing in the wrong species. This is very frustrating for those who support alternative approaches; and there appears to be a real gap between the two groups in terms of what is more important, complexity or relevance. Added to that is the fact that demonstration of

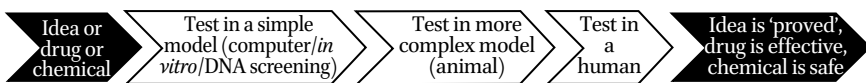

FIGURE 24.2 The standard approach to testing medical hypotheses. Confidence increases as you move from left to right.

the predictivity of alternative methods often fails to convince those who cannot get past the fact that the alternative is simply not a live, complex animal. If an alternative method is found to be 90% predictive of effects in humans, this does not seem to provide confidence. The answer is always, “what if?” This caution has undoubtedly raised the standard by which alternative methods are measured; but some believe that the bar is, in fact, now too high and is still being unfairly applied.

The complexity versus relevance debate may be resolved by greater understanding and uptake of the AOP approach. This approach seeks to break down the complexity of biological processes on a more scientific basis. Alternative methods can be chosen that measure a distinct part of a mechanistic process that leads to an adverse effect (i.e., toxicity). Using an alternative method that is known to predict even just one step in the AOP should give confidence that it is relevant. Combining several methods that test different parts of the AOP should also help address the complexity issue. Lab on a chip methods, as well as more complex *in vitro* methods, such as 3D tissue constructs and *mini-brains* (see Caruso, 2017), are also another solution to increase both relevance and complexity.

5.2 *Interface with Legislation*

Scientists developing alternative methods have historically designed them to give simple answers to the question, is the substance being tested safe or toxic, yes or no? This was seen as a good first step to assist in their validation and initial adoption, even if the animal test they are designed to replace actually produces quantitative (numerical) answers on the extent of toxicity. However, failure of alternative methods to produce equivalent results to the animal tests has been one reason for the delay to their full implementation. For example, the *in vitro* skin irritation/corrosion methods were initially validated to give a yes/no result on whether a substance would cause skin corrosion in 1998 (ECVAM Scientific Advisory Committee, ESAC, 1998). This limited their use because chemical sector regulators actually required these methods to present the result as *not irritant*, *irritant*, or *severely irritant/corrosive*. This is because the results of the animal test are used not only for risk management purposes but for classification and labelling of substances, which is governed by different legislation. It was not until 2007 that a slightly different protocol, using the same skin methods, was validated to provide this information on irritation (ESAC, 2007). Even then, it was not until 2009 (ESAC, 2009)—when a third, more rapid validation was completed because the classification and labelling requirements had changed since the start of the process—that the rabbit test was finally replaced using a combination of two methods.

Since the issue surrounding the validation of the skin irritation methods, there is now greater recognition of the need to be aware of classification and labelling requirements, but problems still occur. For example, the *in vitro* skin sensitization methods were also validated to provide yes/no answers; but the regulators require three answers: *no effect*, *weak effect*, or *strong sensitizing*. It was for this reason that the EC and Member States recently refused to remove the mouse LLNA test from REACH requirements, as they are of the opinion that full replacement for classification and labelling is not yet possible using the *in vitro* methods (European Commission, 2016b).

The issue is further complicated by countries around the world that have different requirements for the classification of substances based on the same toxicity test results. The alternatives are often only validated against one scheme. For chemicals, this is often the United Nations Globally Harmonized System (UN GHS) of Classification and Labelling of Chemicals, but this is not recognized by all countries and all legislations that may have different requirements. So, two additional hurdles are getting those involved in the validation of alternative methods to appreciate the regulatory use of the method and validate it accordingly *and* getting countries to harmonize their regulatory requirements, irrespective of the methods used, to satisfy the requirements. Lack of international harmonization of classification and labelling requirements is one of the reasons why rabbit skin irritation tests are still being conducted in Europe for non-EU regulators, even though the alternatives are now accepted within Europe.

5.3 *Bureaucracy*

Bureaucracy plays a large part in the delay to the implementation of alternatives, in my view, particularly at the regulatory acceptance stage. Much of this bureaucracy could be avoided as illustrated below. It is, in my opinion, in part caused by inertia amongst regulators and a failure to incentivize and reward them for evaluating new methods. The process still largely relies on the goodwill of a few experts from a few countries. Industry are not specifically rewarded for developing alternatives and, indeed, run some risk if the alternative is not accepted (due to wasted development costs). Regulators also run the risk of accepting a method that could fail in the real world, potentially causing harm to humans. Hiding behind bureaucratic delays avoids having to make a decision.

There are bureaucratic delays caused by the desire to harmonize testing requirements internationally. Harmonization is seen as a good thing, as it means that, in theory, a single (animal) test conducted in a laboratory in one country will be accepted for regulatory submission of that substance in all countries that sign on the agreement. This is called Mutual Acceptance of Data (MAD).

There have been tremendous efforts in the past 20 years to encourage the chemical and drug sectors to harmonize their requirements. As alternatives have been developed, they too have had to go through this harmonization process. In theory, this is also a good thing, because once accepted no more animal tests would be required around the world for that specific substance. However, in reality the process of negotiation takes a long time; and to speed up the process, loopholes are placed in documents that can give a false sense that harmonization has actually been achieved. A recent example is skin sensitization, where the alternative methods gained OECD acceptance relatively easily, but on the understanding that they cannot be used as standalone replacements. Therefore, there is no requirement for countries to accept these methods to replace the corresponding animal test, until perhaps another formal document is agreed on at some point in the future that shows how they can be used together.

In the EU the situation is further complicated. The EU defers to the OECD on the basis that international harmonization is preferable to EU acceptance (ignoring the fact that the EU is already a grouping of 28 countries). This causes on average two years' delay to a method that was validated in Europe. They then require that the test method, as agreed by the OECD, be published in the official EU regulations (Commission of the European Communities, 2008, Test Methods Regulation EC440/2008,) in an almost completely bureaucratic process that takes, on average, a further two to three years. For example, the first version of the reconstituted skin model was validated by ECVAM for detecting corrosive substances in 1998 (ESAC, 1998); but it was not adopted by the OECD until 2004 (OECD, TG 431). The first version of the model for skin irritation was validated in 2007 (ESAC, 2007); but it was not adopted by the OECD until 2010 (OECD TG 439). Due to political pressure at the time, the EU adopted an unusual procedure and accepted the skin methods before the OECD in 2000 for corrosion (European Parliament and the Council of the EU, 2000), and in 2009 for irritation (Commission of the European Communities, 2009). The EU has not done this since, even though similar delays have occurred for other methods. For example, the DPRA for skin sensitization was validated in 2012 (ESAC, 2012); but it was not published as OECD TG 44C until 2015. Over two years after its publication in the OECD, it was published in the EU Test Methods Regulation (Commission of the European Communities, 2017).

One could argue that the bureaucratic delay between validation and regulatory acceptance gives industry time to advance their knowledge of the new methods, get them into place and gain confidence in their use. In reality, companies, other than those directly involved in the development and validation of the new method, tend to remain unaware of these methods until they are

accepted. If they do become aware of them, they tend to wait for confirmation that they will be accepted, before investing in using them. One of the reasons for the delays at both the OECD and the EU's Test Methods Regulation is the timing of the cycle for revising test guidelines. The process is annual at the OECD; if you miss the deadline for submitting methods, you lose one year. Given sufficient political will, it should be entirely possible to speed up the process by increasing the cycle of meetings and, in Europe, by accepting that as most EU members are also members of the OECD, there is little need for a second round of negotiation to update the Test Methods Regulation.

5.4 *Lack of Funding*

Obtaining funds to develop replacements for animal tests is still very difficult, despite a few high profile, one-off, significant projects. For example, in response to the imminent cosmetics testing bans in 2009, the EC and the cosmetics industry each contributed €25 million towards the development of alternatives to animals for long-term toxicity testing (SEURAT-1, n.d.). Furthermore, the EC claims it has funded replacement methods in the last main scientific-funding stream, Framework Project 7 (2007–2013), to a total of €180 million (European Commission, 2013). However, compared to overall science funding, the levels of investment are relatively low. The total Framework Project 7 budget was €45.3 billion; as such, the Commission dedicated only 0.4% of its science budget to alternatives to animal testing.

National funding levels are even lower than central funding, perhaps reflecting a general apathy about the need to improve the humanity and reliability of scientific methods. We recently compiled a survey of EU countries and found that direct funding of alternative (3Rs) methods was reported to total only €18.7 million in 2013 (Taylor, 2014). Only seven countries provided this funding: Austria, Belgium, Denmark, Finland, Germany, Sweden, and the UK. Much of this budget was dedicated to support national centers for the 3Rs rather than the development of new methods. Funding by the most generous country, the UK (approximately €11 million), was still only 0.04% of its national science research and development expenditure for that year.

Central and national funding of alternatives, therefore, exists but is relatively very low and *ad hoc*. This compares poorly to the funding given to equally ambitious *big picture* projects. For example, former US President Obama's project to map the human brain was funded by US\$100 million (The White House, President Barak Obama, n.d.); and the human genome project by US\$3.8 billion (Human Genome Research Institute, n.d.). However, these are single projects. Replacing all animal tests, even only in the field of regulatory toxicology comprises many, many projects. Clearly, the rate of change is likely to be slow

unless levels of funding significantly increase and are proportionate to the scale of the problem being addressed.

5.5 *Entrenchment*

Many of the remaining animal tests to be replaced, particularly for regulatory testing, have remained unchanged since they were first developed many decades ago. For example, the pyrogenicity test in rabbits (used to establish if injectable drugs are contaminated) was developed in 1912 (Hort and Penfold, 1912); the Draize skin irritation test on rabbits in 1944 (Draize et al., 1944); and the Buehler guinea pig skin sensitization test in 1965 (Buehler, 1965).

Entrenchment is common in science (Kuhn, 1962). This may seem counter intuitive when one considers that what defines science is its questioning nature. But even those who use animals in research will attest to the difficulty in getting funding for new approaches, as well as the difficulty in publishing research that uses a method that is different from the one everyone else is using. Behind closed doors, researchers will complain about journal editors even asking for their idea to be demonstrated in an animal model before they will publish it (see Cronin, 2017; discussions at the recent EC conference on alternatives). This situation is partly caused by the fact that those who are conducting research, reviewing papers, and reviewing funding applications are usually from within the same scientific peer group. New ideas that threaten the status quo can struggle to gain support; and researchers who are unhappy about their treatment are often afraid to speak up, in case it affects their university tenure or funding.

Preferentially funding scientists who want to use different methods is a system that could work to promote change. However, apart from occasional large projects, such funding is still only taken on by specialist replacement charities with small budgets. Once they are a part of a project to replace animals, however, scientists can create a support network that can help to foster change; but it is crucial that funding is dependable for this to be sustained. Another solution is finding a way to include fresh perspectives on the types of projects being funded. Including experts who are more motivated to challenge the need to test on animals in the ethical review of projects involving animals, such as individuals with expertise in alternatives or in animal protection, could have a big impact. Currently, funding and licensing bodies only tend to include token lay persons in their discussions, who can feel out of depth and overwhelmed. Making applications or, at the very least, the funding policies of granting bodies open to regular public scrutiny could also help.

5.6 *Lack of Enforcement*

If improved funding of alternatives is the carrot, then enforcement is probably the stick. Although, most would say the carrot is the best approach for entrenched issues such as this, enforcement still has a role to play. In Europe, since 1986, it has been illegal, on paper, to conduct an animal test “if another scientifically satisfactory method of obtaining the result sought, not entailing the use of an animal, is reasonably and practicably available” (Council of the European Communities, 1986, Directive 86/609/EEC). Unfortunately, in 2010 this was watered down, to some extent, with a stricter onus being placed on methods that are “recognized under the legislation of the Union,” although the general premise remains. “Member States shall ensure that, wherever possible, a scientifically satisfactory method or testing strategy, not entailing the use of live animals, shall be used instead of a procedure” (European Parliament, 2010).

Technically the onus is on the Member State to not authorize animal tests where alternatives exist, rather than on the researcher. Our experience has shown, however, that if Member States can divest themselves of this, they will. Laboratories are granted *multiple generic licenses* that do not cover the specific substances being tested, which makes it impossible for the authorizing body to make decisions as to whether an alternative method is suitable. This is a particular issue with quality control tests, where the alternative can often be used for some substances and not others. Following an undercover investigation, Cruelty Free International recently demonstrated that a contract testing facility in the UK was testing substances for pyrogens on rabbits, for which the alternative bacterial endotoxin test was suitable, according to the European Pharmacopeia (see Cruelty Free International, n.d.). It was not until we challenged the UK competent authority that they began asking for substance-specific information in advance (Animals in Science Regulation Unit, 2014).

Enforcement of the use of alternatives for basic research is more complex and is currently being largely overlooked by regulators of animal experiments. Due to the myriad of ways in which animals can be used to test medical hypotheses, and the lack of formal standardized approaches, regulators tell us that they cannot really enforce the use of alternatives as they would for safety testing. Currently, in the UK, the onus is on the researcher, rather than the regulator to demonstrate the absence of an alternative approach. The regulator, assessing a potential project that intends to use animals, is not usually an expert in the area; and it is not clear to what extent researchers are really being challenged in their statements that alternatives are not available. The solution is for regulatory bodies to simply take responsibility for upholding the law when an alternative method is available that can prevent animal experiments or at

least partially replace them. Currently, some animal protection organizations see it as part of their role to hold regulators accountable to encourage them to do this. A better solution would be if a tougher stance was accepted internally by the regulators, perhaps as a consequence of a directive from their governments.

6 Targets for Change

It is clear from Table 24.1 that prior to the EU cosmetics testing bans, there was very little regulatory approval of alternative methods. There is a clear acceleration from 2003, the date of the implementation of the first testing ban (for products). But now that Europe has a complete ban on cosmetics testing on animals, it is important that this momentum is not lost. It is possible that, with public support, new bans or deadlines could be put in place. There are already calls for bans on the testing of household products and all testing on dogs and monkeys. Using prohibitions on testing as an incentive for the development of alternatives is, however, hitting a hurdle in these areas. Animal testing for medical purposes is seen as something that cannot end until alternatives are available, and setting a timeline for science to replace animal experiments is not considered by some to be possible or even desirable. In a Nature survey of its readers (over half of whom conducted animal experiments), 63% thought ending animal experiments was a desirable but unachievable goal (Ainsworth, 2006).

The absence of viable *alternatives* has, however, not hindered political agreement in a number of other areas, where the ability to realize the promise relies to some extent on science and technology, such as the case of climate change. Internationally, the Kyoto Protocol was signed by 37 industrialist countries as well as Europe, in 1997, and set the goal of a 5% reduction in carbon emissions below 1990 levels by 2012. The target was met (United Nations Climate Change, n.d.). Europe has a further commitment to reduce levels by 20% by 2020 (European Commission, n.d.). Although countries have signed up to reduce their emissions, no one is suggesting that they cease manufacturing cars or turn the power off in order to do so. Instead, goals to reduce in emissions are being met by increased efficiency and innovation (see European Commission, n.d.). One can see that a reduction in animal testing could also be achieved through more efficient use of animals (e.g., not authorizing the more “blue sky” type of basic research and using less animals for any given purpose) and investment in technology. Setting a target of, for example, a reduction of 50% in national animal experiments by 2025 will enable countries to exert power over experiments

that they feel they could perhaps do without and to prioritize for replacement those that they cannot. Targets will feed into the ethical review committees for animal experiments, who will have to make harder decisions and actually reject some applications. Targets will also seep into the mindset of scientists, who will have to think more carefully about whether they are likely to be accepted before putting forward applications for new animal experiments. There will be more political will to fund alternatives and put in place the necessary governmental and institutional schemes to fund, develop, promote, and implement alternatives.

It is important to remember that reduction in animal experimentation will not always rely on replacement. It is unfortunate that this view, however, prevails even in Directive 2010/63/EU, which states that “this Directive represents an important step towards achieving the final goal of full replacement of procedures on live animals for scientific and educational purposes as soon as it is scientifically possible to do so” (European Parliament, 2010). In the area of basic research in particular, where the majority of animals are actually used (Daneshian et al., 2015), there is much more of an element of choice in conducting an animal experiment. In a world with infinite questions about human biology, there are equally important questions that can be tackled that do not require resorting to animal experiments. Some scientists choose to use animals, but they could choose to study humans, or cells, or computer models and still contribute to the pool of medical knowledge. If we change the goal to one of improving the humanity and quality of medical knowledge, rather than replacing like for like, then, in my opinion, a significant proportion of animal research could end today.

7 Conclusion

The field of alternatives research has accelerated in the past 30 years, largely as a result of legislative pressures on specific sectors to end testing and/or use alternatives. There are now alternatives for a significant proportion of the standard “battery” of animal tests, which are typically required to test the safety of new chemicals and drugs. Unfortunately, the corresponding removal of the animal tests that these new alternatives replace is still forthcoming. There are many reasons why animal testing persists even, when there are alternatives, which have little to do with the scientific limitations of the new tests. Human limitations, including bureaucracy, political malaise, and entrenchment in the scientific establishment are as great, if not greater, barriers to the replacement of animals in testing.

There needs to be a paradigm change in the way science approaches many of its questions. The classic approach of *test your idea or substance in a simple model, such as a cell culture; and then if successful test it in a more complex model, such as an animal*, needs to change. Funding bodies and journals need to stop requiring proof of concept in animal models but in more human-relevant approaches. A more mechanistic approach is one possible way to facilitate the use of alternatives. Breaking down the question you need to answer into questions that can be tested in simpler models would facilitate a speedier uptake of alternatives. Another approach is to employ technology to overcome some of the current problems of using humans ethically or to increase the complexity of cell-based systems. Whether these two approaches will complete or complement each other remains to be seen.

What will encourage science to change its paradigm? Political will needs to be amplified and targets for a reduction of animal experiments are needed. This, in turn, will help increase levels of funding to speed up the development of new approaches and reduce regulatory malaise, so that they are implemented as soon as they appear.

References

- Ainsworth, C. (2006). Scientists Share Thoughts on Animal Research: Poll Reveals Nuanced Views Among Biomedical Researchers. *Nature, News* [online] Available at: <http://www.nature.com/news/2006/061211/full/news061211-9.html> [Accessed 15 February 2018].
- Animals in Science Regulation Unit (2014). *Naming of Products and Substances in Project licenses for Batch Quality Control and Regulatory Toxicology*. London, UK: Home Office.
- Auplat, C. (2012). From technical innovation to innovation in management practice: The case of Episkin. In: H. Fulford, ed., *Case Studies in Innovation for Researchers, Teachers, and Student*, Vol. 1. London, UK: Academic Conferences and Publishing International Limited.
- Bailey, J. and K. Taylor (2016). Non-human Primates in Neuroscience Research: The Case Against Its Scientific Necessity. *Alternatives to Laboratory Animals*, 44, pp. 43–69.
- Balls, M. (2006). International validation and barriers to the validation of alternative tests. In: R.E. Hester, and R.M Harrison, eds., *Issues in Environmental Science and Technology: Alternatives to Animal Testing*. London, UK: Royal Society of Chemistry.
- Bookchin, D. and J. Schumacher (2005). *The virus and the vaccine: Contaminated vaccine, deadly cancers, and government neglect*. New York: St Martin's Press.

- Buehler, E.V. (1965). Delayed Contact Hypersensitivity in The Guinea Pig. *Archives of Dermatology*, 91, p. 171.
- Caruso, C. (2017). The Beauty of “Mini Brains”: Lab-grown Bundles of Brain Cells May Be the Future of Drug Testing. *Scientific American Mind*, 28, p. 76.
- Commission of the European Communities (2008). Council Regulation (EC) No 440/2008 of 30 May 2008 Laying Down Test Methods Pursuant to Regulation (EC) No 1907/2006 of the European Parliament and of the Council on the Registration, Evaluation, Authorisation and Restriction of Chemicals (REACH). *Official Journal of the European Communities*, L 142, pp. 1–739.
- Commission of the European Communities (2009). Commission Regulation (EC) No 761/2009 of 23 July 2009 Amending, for the Purpose of Its Adaptation to Technical Progress, Regulation (EC) No 440/2008 Laying Down Test Methods Pursuant to Regulation (EC) No 1907/2006 of the European Parliament and of the Council on the Registration, Evaluation, Authorisation and Restriction of Chemicals (REACH). Method B.46 of the Annex to 440/2008/EC. *Official Journal of the European Communities*, L 220, pp. 1–94.
- Commission of the European Communities (2017). Commission Regulation (EC) No 761/2009 of 14 February 2017 Amending, for the Purpose of Its Adaptation to Technical Progress, Regulation (EC) No 440/2008 Laying Down Test Methods Pursuant to Regulation (EC) No 1907/2006 of the European Parliament and of the Council on the Registration, Evaluation, Authorisation and Restriction of Chemicals (REACH): Method B.59 of the Annex to 440/2008/EC. *Official Journal of the European Communities*, L 112, pp. 1–402.
- Council of the European Communities (1986). Council Directive 86/609/EEC of 24 November 1986 on the Approximation of Laws, Regulations and Administrative Provisions of the Member States Regarding the Protection of Animals Used for Experimental and Other Scientific Purposes. *Official Journal of the European Communities*, L 358, pp. 1–28.
- Creanor, S., J. Vickery, V. Eyre, J. Zajicek, S. Ball, J. Elm and C. Carroll (2015). Two-arm Randomised Futility Trials: PD-stat, a Futility Trial of a Potential Neuroprotective Treatment in People with Parkinson’s Disease. *Trials*, 16(2), p. 236.
- Cronin, M. (ed.) (2017). *Non-Animal Approaches. The Way Forward*. Report on a European Commission Scientific Conference, Brussels, Belgium, 6–7 December 2016. [online] Available at: http://ec.europa.eu/environment/chemicals/lab_animals/3r/pdf/scientific_conference/non_animal_approaches_conference_report.pdf [Accessed 15 February 2018].
- Cruelty Free International (n.d.). *Animal Experiments at Wickham Laboratories. Exposed: Appalling Suffering at a UK Animal Testing Laboratory*. [online] Available at: <https://www.crueltyfreeinternational.org/what-we-do/investigations/animal-experiments-wickham-laboratories> [Accessed 15 February 2018].

- Daneshian, M., F. Busquet, T. Hartung and M. Leist (2015). Animal Use for Science in Europe. *Alternatives to Animal Experimentation*, 32(4), pp. 261–274.
- Draize, J.H., G. Woodard and H.O. Clavery (1944). Methods for the Study of Irritation and Toxicity of Substances Applied Topically to the Skin and Mucous Membranes. *Journal of Pharmacology and Experimental Therapeutics*, 82, pp. 377–390.
- ECVAM Scientific Advisory Committee (ESAC) (1998). *ESAC Statement on Scientific Validity of EpiSkin (SkinEthic) for Corrosivity Testing*. Ispra, Italy.
- ESAC (2007). *ESAC Statement on Scientific Validity of EpiSkin and EpiDerm for Skin Irritation Testing*. Ispra, Italy.
- ESAC (2009). *ESAC Statement on the Performance under UN GHS of Three In Vitro Assays for Skin Irritation Testing and the Adaptation of the Reference Chemicals and Defined Accuracy Values of the ECVAM Skin Irritation Performance Standards*. Ispra, Italy.
- ESAC (2012). *EURL ECVAM Recommendation on the Direct Peptide Reactivity Assay (DPRA) for Skin Sensitisation Testing*. Ispra, Italy: European Commission, Joint Research Centre, Institute for Health and Consumer Protection (IHC), Nov 2013 EUR 26383 EN.
- European Commission (n.d.). *2020 Climate & Energy Package*. [online] Available at: https://ec.europa.eu/clima/policies/strategies/2020_en [Accessed 15 February 2018].
- European Commission (2013). *Report from the Commission to the European Parliament, the Council, the European Economic, and Social Committee, and the Committee of the Regions in accordance with Article 117(4) of REACH and Article 46(2) of CLP, and a Review of Certain Elements of REACH in line with Articles 75(2), 138(2), 138(3) and 138(6) of REACH*. Brussels, Belgium: 5.2.2013 COM(2013) 49 final.
- European Commission (2016a). Commission Regulation (EU) 2016/863 of 31 May 2016 Amending Annexes VII and VIII to Regulation (EC) No 1907/2006 of the European Parliament and of the Council on the Registration, Evaluation, Authorisation and Restriction of Chemicals (REACH) as Regards Skin Corrosion/Irritation, Serious Eye Damage/Eye Irritation and Acute Toxicity. *Official Journal of the European Communities*, L 144, pp. 27–31.
- European Commission (2016b). Commission Regulation (EU) 2016/1688 of 20 September 2016 Amending Annex VII to Regulation (EC) No 1907/2006 of the European Parliament and of the Council on the Registration, Evaluation, Authorisation and Restriction of Chemicals (REACH) as Regards Skin Sensitisation. *Official Journal of the European Communities*, L 255, pp. 14–16.
- European Commission (2017). *Ban on Animal Testing*. [online] Available at: https://ec.europa.eu/growth/sectors/cosmetics/animal-testing_en [Accessed 12 January 2017].

- European Parliament (2010). Directive 2010/63/EU of the European Parliament and of the Council of 22 September 2010 on the Protection of Animals Used for Scientific Purposes. *Official Journal of the European Communities*, L276, p. 33–79. [online] Available at: <http://eur-lex.europa.eu/legal-content/EN/TXT/?uri=CELEX:32010L0063> [Accessed 15 February 2018].
- European Parliament and the Council of the European Union (2000). EU Directive 2000/33/EU for the 21st Amendment of Annex V of the EU Directive 86/906/EEC for Classification and Labelling of Hazardous Chemicals: Test Guideline B-40 Skin Corrosivity *In Vitro* Method and Test Guideline B-41 Phototoxicity *In Vitro* 3T3 NRU Phototoxicity Test. *Official Journal of the European Communities*, L36, 90–107.
- European Parliament and the Council of the European Union (2006). REACH Regulation (EC) No 1907/2006 Regulation Concerning the Registration, Evaluation, Authorisation and Restriction of Chemicals (REACH), Establishing a European Chemicals Agency (ECHA). *Official Journal of the European Communities*, L36, pp. 1–849.
- Friedman, M.H. (1939). The Assay of Gonadotropic Extracts in the Post-partum Rabbit. *Journal of Endocrinology* 24 (5), pp. 617–625.
- Hartung, T. (2007). Food for Thought...on Validation. *Alternatives to Animal Experimentation*, 24, pp. 67–73.F.
- Hort, E.C. and W.J. Penfold (1912). A Critical Study of Experimental Fever. *Proceedings of the Royal Society B*, 85(578), pp. 174–186.
- Human Genome Research Institute (n.d.). *Research Funding*. [online] Available at: <https://www.genome.gov/researchfunding/> [Accessed 15 February 2018].
- Joint Research Centre (2006). *Briefing Note on Number of Animals Expected to Be Used under REACH: Summary of Re-assessment Performed by the JRC*. Ispra, Italy: European Commission, Directorate General Joint Research Centre, Institute for Health and Consumer Protection.
- Kuhn, T. (1962). *The structure of scientific revolutions*. Chicago, IL: University of Chicago Press.
- Langley, G.R., I.M. Adcock, F. Busquet, K.M. Crofton, E. Csernok, C. Giese, T. Heinonen, K. Herrmann, M. Hofmann-Apitius, B. Landesmann, L.J. Marshall, E. McIvor, A.R. Muotri, F. Noor, K. Schutte, T. Seidle, A. van de Stolpe, H. Van Esch, C. Willett and G. Woszczek (2017). Towards a 21st-century Roadmap for Biomedical Research and Drug Discovery: Consensus Report and Recommendations. *Drug Discovery Today*, 22(2), pp. 327–339.
- Langley, G.R, C.P. Austin, A.K. Balapure, L.S. Birnbaum, J.R. Bucher, J. Fentem, S.C. Fitzpatrick, J.R. Fowle, R.J. Kavlock, H. Kitano and B.A. Lidbury (2015). Lessons from Toxicology: Developing a 21st-Century Paradigm for Medical Research. *Environmental Health Perspectives*, 123(11), pp. A268–A272.

- Lappin, G. (2015). The Expanding Utility of Microdosing. *Clinical Pharmacology and Drug Development*, 4(6), pp. 401–406.
- Liebsch, M., B. Grune, A. Seiler, D. Butzke, M. Oelgeschläger, R. Pirow, S. Adler, C. Riebeling and A. Luch (2011). Alternatives To Animal Testing: Current Status and Future Perspectives. *Archives in Toxicology*, 85(8), pp. 841–858.
- Marx, U., H. Walles, S. Hoffmann, G. Lindner, R. Horland, F. Sonntag, U. Klotzbach, D. Sakharov, A. Tonevitsky and R. Lauster (2012). “Human-on-a-Chip” Developments: A Translational Cutting-edge Alternative to Systemic Safety Assessment and Efficiency Evaluation of Substances in Laboratory Animals and Man?. *Alternatives to Laboratory Animals*, 40(5), pp. 235–257.
- National Academy of Sciences (2007). *Toxicity testing in the Twenty-first Century: A vision and a strategy*. Washington DC: National Academies Press.
- Organisation for Economic Co-operation and Development (OECD) (2012). The Adverse Outcome Pathway for Skin Sensitisation Initiated by Covalent Binding to Proteins. Part 1: Scientific Evidence. *OECD Series on Testing and Assessment*, 168, ENV/JM/MONO(2012)10/PART1.
- OECD (n.d.) *AOP Knowledge Base*. Search portal. [online] Available at: <https://aopkb.oecd.org/search.ashx> [Accessed 15 February 2018].
- OECD (2014a). New Guidance Document on an Integrated Approach on Testing and Assessment (IATA) for Skin Corrosion and Irritation. *OECD Series on Testing and Assessment*, 203, ENV/JM/MONO(2014)19.
- OECD (2014b). Guidance on Grouping of Chemicals, 2nd ed. *OECD Series on Testing and Assessment*, 194, ENV/JM/MONO(2015)18.
- OECD (2015). Guidance Document on the *In Vitro* Syrian Hamster Embryo (SHE) Cell Transformation Assay. *OECD Series on Testing and Assessment*, 214, ENV/JM/MONO(2015)18.
- OECD (2016). Guidance Document on the *In Vitro* Bhas 42 Cell Transformation Assay. *OECD Series on Testing and Assessment*, 231, ENV/JM/MONO(2016)1.
- Richard, A.M., R.S. Judson, K.A. Houck, C.M. Grulke, P. Volarath, I. Thillainadarajah, C. Yang, J. Rathman, M.T. Martin, J.F. Wambaugh and T.B. Knudsen (2016). The Toxic Chemical Landscape: Paving the Road to 21st Century Toxicology. *Chemical Research in Toxicology*, 29(8), pp. 1225–1251.
- SEURAT-1 (n.d.) Towards Replacement of In Vivo Repeated Dose Systematic Toxicity Testing. [online] Available at: <http://www.seurat-1.eu> [Accessed 15 February 2018].
- Taylor, K., N. Gordon, G. Langley, and W. Higgins (2008). Estimates for Worldwide Laboratory Animal Use in 2005. *Alternatives to Laboratory Animals*, 36, pp. 327–342.
- Taylor, K. (2014). EU Member State Government Contribution to Alternative Methods. *Alternatives to Animal Experimentation*, 31, pp. 215–222.
- The White House President Barak Obama (n.d.) The Brain Initiative. [online] Available at: <https://obamawhitehouse.archives.gov/node/300741> [Accessed 15 February 2018].

- Underhill, L.A., R. Dabbah, L.T. Grady and C.T. Rhodes (1994). Alternatives to Animal Testing in the USP-NF: Present and Future. *Drug Development and Industrial Pharmacy*, 20, pp. 165–216.
- United Nations Climate Change (n.d.). *Kyoto Protocol Introduction*. [online] Available at: http://unfccc.int/kyoto_protocol/items/2830.php [Accessed 15 February 2018].
- World Health Organization (WHO) (2007). *Guidelines for Plague Reduction Neutralisation Testing of Human Antibodies to Dengue Viruses*. WHO/IVB/07.07. [online] Available at: http://apps.who.int/iris/bitstream/10665/69687/1/who_ivb_07.07_eng.pdf [Accessed 15 February 2018].

The Changing Paradigm in Preclinical Toxicology: *in vitro* and *in silico* Methods in Liver Toxicity Evaluations

Fozia Noor

Luxembourg Centre for Systems Biomedicine (LCSB), Université du
Luxembourg, Esch-sur-Alzette, Luxembourg

Fozia.noor@uni.lu

1 Toxicology in the 21st Century

Toxicology is one of the sciences that have slowly but surely embraced technology and new methods, focusing on high throughput and high content screenings, *omics* technologies, and mathematical modeling. Thus, a transition in toxicology—from a traditional reductionist paradigm towards 21st century methods based on human biology and holistic multi-*omics* studies—is now becoming a reality. With the recent advances in human-cell cultivation techniques, allowing *in vivo*-like *in vitro* long-term functionality, there is a shift in focus towards the mechanistic details of the adverse effects “over time” aimed at a better understanding of the *dynamics* of biological processes.

In vitro methods, based on human primary cells, cell lines, and genetically modified reporter cell lines, have greatly expanded the scope of *in vitro* toxicology. Other significant progress in the area of human-induced pluripotent stem cells (hiPSCs) (Asgari et al., 2010; Schwartz et al., 2014; Shinde et al., 2016; Shtrichman, Germanguz and Itskovitz-Eldor, 2013) is allowing the application of patient and disease-specific hiPSCs (Ghodsizadeh et al., 2010; McCracken et al., 2014; Siller et al., 2013). Moreover, the tools of precise genome editing with engineered nucleases, such as the zinc finger nucleases (ZFNs), the transcription activator-like effector nucleases (TALENs) and, more recently, the Clustered Regularly Interspaced Short Palindromic Repeats (CRISPR) associated Cas9 technology (Gaj, Gersbach and Barbas, 2013; Kim, 2016; Komor, Badran and Liu, 2017) have opened up tremendous opportunities for the development of cell lines, especially those of human origin (Tobita, Guzman-Lepe and de L'Hortet, 2015). CRISPR/Cas9 technology was reported for genome editing in hiPSCs (Flaherty and Brennand, 2015; Li et al., 2014; Seah et al., 2015; Suzuki et al., 2014). Another study reported on the simultaneous reprogramming and

gene correction of patient fibroblasts (Howden et al., 2015). Since 2015, more than 3,000 articles were published on studies using CRISPR/Cas9 genome editing, including more than 900 articles using the technology in mammalian cells (PubMed, accessed June 11, 2017). With further technological developments, these human *in vitro* cellular models shall be highly useful in the screening of compounds for personalized medicine, allowing optimum therapy with minimum or no adverse effects, and in the study of adverse outcomes in different strata of population. In addition to high-content screening, where several parameters are measured as simultaneous readouts in single cells (Gasparri, 2009), high-content imaging will play an important complimentary role in systems biology approaches (van Vliet et al., 2014). High-content platforms have been already used for the screening of compounds (Bale et al., 2014; Sirenko et al., 2014; Tolosa et al., 2014).

Modern technologies of *omics* and high-content imaging are resulting in immense data sets which require large-scale data-processing tools. Powerful bioinformatics' tools are also required for data integration and the overarching interpretation of biological data from disparate sources. The inherent complexity of biological systems is a challenge that is expected to be overcome by computational modeling of biological systems. Toxicology is, therefore, aiming at the integration of a tremendous amount of diverse information—at various levels of biological hierarchy (genome, transcriptome, proteome, and metabolome) and biological structure (organelles, cells, tissues, organs, and organism)—with computational tools for understanding and predicting biological behavior (e.g., adverse effect) under given conditions (e.g., perturbation due to a *toxin*). This rejuvenated toxicology in modern terms is referred to as *systems toxicology* (see Figure 25.1).

1.1 *Systems Toxicology*

The term *systems toxicology* is derived from systems biology and could be defined as the study of biological systems, using *omics* technologies, with a focus on the mechanisms underlying complex biological processes, their interactions and perturbations in response to a toxin combined with mathematical data integration and modeling. Systems toxicology, therefore, aims at understanding and exploring the way that different biological components are orchestrated as an *ensemble* in cells, tissues, and organisms.

A biological system usually consists of a large number of functionally diverse and/or multitasking components interacting together in a nonlinear fashion in, so-called, biological networks spread over several levels of biological organization (Kitano, 2002). Systems biology aims at understanding the structural and functional connectivity in biological networks or simply the *biological*

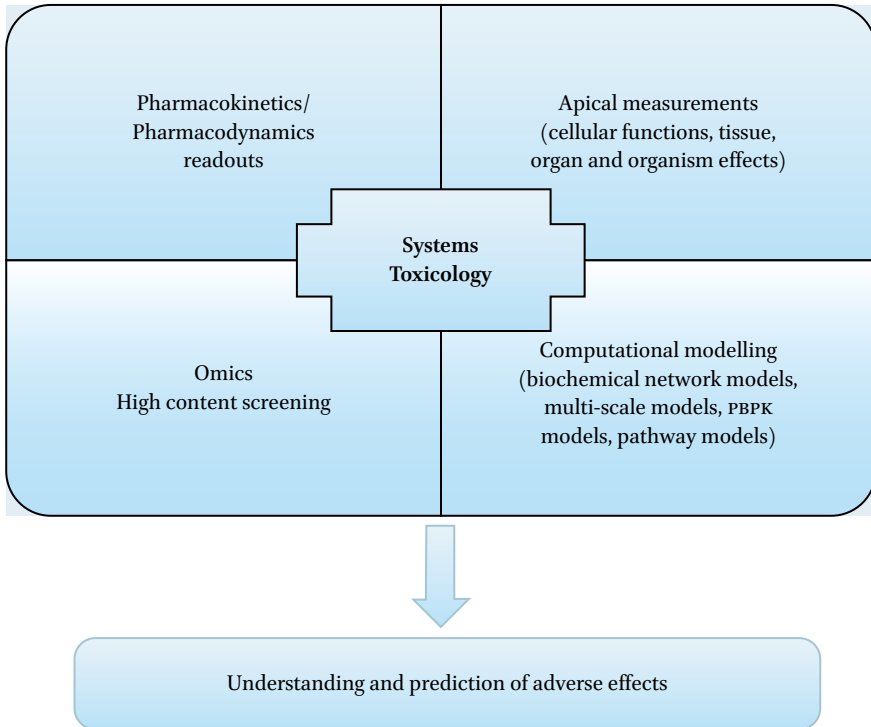

FIGURE 25.1 Modern toxicology leaning towards the systems biology approach to understanding and predicting adverse effects by integrating traditional endpoint measurements and pharmacokinetics/pharmacodynamics information with *omics* data and computational modeling.

homeostasis. Almost 150 years ago, the French physiologist, Claude Bernard, put forward the idea that free life is based on the *constancy* of the internal environment. Later, in 1922, the American physiologist, Walter Canon, described homeostasis as the key principle of life. According to Hans Seyle (1956), since systems are robust, a system under stress will try to achieve a new homeostasis to maintain its functions, until the stress crosses a certain threshold, and the system collapses. Similarly, biological systems exposed to a stressor/toxin will try to adapt and survive. Acute exposure for a short period may constitute a temporary stress that may, or may not, manifest as a toxic effect(s), while the biological system tries to adapt or compensate. However, acute exposure at a very high dose may lead to acute exhaustion of the system's resources to cope and may lead to rapid system breakdown. On the other hand, upon repeated or chronic exposure to low levels of stress, the system inevitably acquires a new homeostasis. This new homeostasis may be accompanied by adverse effects

or disease development (e.g., depression, cancer) over the period of exposure. Upon accumulation of long-term stress, when the system's capacity to maintain altered homeostasis is exhausted, the system will break down, ultimately leading to the extinction of the system.

Understanding biological processes means a step towards understanding the mechanisms of adverse effects, which in turn means understanding the molecular and functional changes in a system upon perturbation of the system's homeostasis. A mechanistic understanding requires system-wide quantitative measurements of these molecular and functional changes. Recent progress in *omics* technologies is playing a decisive role in linking system-level understanding to quantitative molecular knowledge (Ideker, Galitski and Hood, 2001). An essential part of systems toxicology is the mathematical modeling of biological responses based on mechanisms and the use of such computational models for predicting responses by changing the parameters of perturbation. Systems toxicology is, therefore, the integration of traditional toxicology with modern techniques of integrated testing strategies, high-throughput screenings, pharmacokinetics/pharmacodynamics knowledge, high-content screenings, *omics* technologies, *in silico* tools and modeling. Recent advances in cell-culture techniques, mimicking *in vivo* organs, are allowing for the acquisition of physiologically relevant information that will enhance pathways-based understandings for the discovery of novel targets and prediction of risks of adverse outcomes.

1.2 *Pathways of Toxicity*

The concept of *pathways of toxicity* (PoTs) evolved after the famous report from the United States National Research Council in 2007, titled *Toxicology in the 21st Century*, which recommended a shift in testing from animals to human-cell systems for the assessment of *toxicity pathways* (Krewski et al., 2010). Other terms, such as the mode of action (MOA) and the adverse outcome pathways (AOP) are currently used to structure and describe biological processes over biochemical pathways leading to adverse effects. This information can be mapped on various levels of biological organization (e.g., from cells to populations and even ecologies) (see Figure 25.2).

A PoT is a cellular response pathway, which upon sufficient perturbation will lead to an adverse health effect. A PoT should describe the molecular basis of the adverse response. It is assumed that a limited number of PoTs are conserved over cell types, organs, and even species, and should mediate the same adverse outcome (Bouhifd et al., 2015). PoTs aim at molecular annotations of network perturbations and their causes from high-content phenotyping (Hartung and McBride, 2011). It should be possible to derive PoTs from simple *in vitro* tests, as in the ToxCast program in the US, which evaluated 2,000 compounds

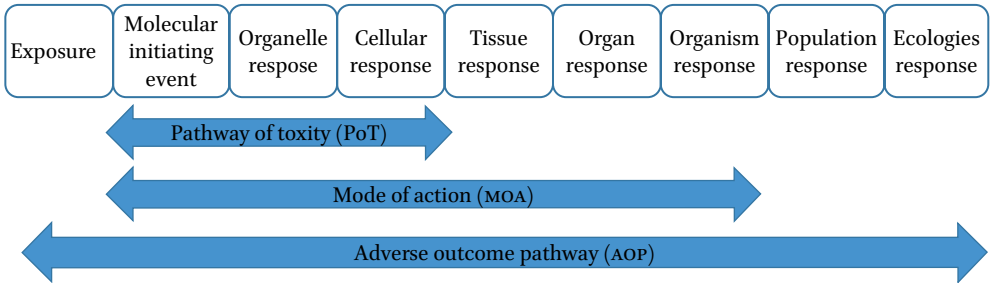

FIGURE 25.2 Organization of scientific information at different levels of biological complexity with commonly used terminologies, such as PoT, MOA, and AOP. ADAPTED FROM GOCHT ET AL. (2015)

in more than 700 assays and around 300 signaling pathways (Attene-Ramos et al., 2013; Hsieh et al., 2017).

The molecular mechanisms over a series of causal events can be described as the MOA. It is important to distinguish a *mechanism of action* from the *mode of action*. A mechanism of action describes the primary chemico-biological interaction between a compound and a structural moiety in a biological system (Blaauboer and Andersen, 2007). This is more or less equivalent to the molecular initiating event in an AOP. The MOA describes functional and structural changes that follow the primary interaction of a compound with its biological target and result in quantifiable changes at the organism level (Blaauboer and Andersen, 2007). The MOA-based paradigm is based on the concept of toxicity pathways. A PoT represents a set of molecular events that ultimately lead to a measurable adverse outcome associated with the stressor/toxin. As such, MOA and AOP are sometimes used in similar contexts.

1.3 Adverse Outcome Pathways

The concept of AOP was developed in the field of ecotoxicology. Ankley et al. (2010, p. 730) defined AOP as “a conceptual construct that portrays existing knowledge concerning the linkage between a direct molecular initiating event and an adverse outcome at a biological level of organization relevant to risk assessment”. The term AOP is a misnomer, since pathways are not intrinsically adverse or non-adverse but they may lead to adverse effects or disease after perturbation. The AOP framework allows the organization and structuring of information for improved decision making in risk assessment (Edwards et al., 2016).

The concept of AOP is now embraced by scientists all over the world, with international efforts for harmonization and guidance on AOP construction and development, such as the Organisation for Economic Co-operation and Development (OECD) guideline (2013) and recently published AOP development strategies, principles, and best practices (Villeneuve et al., 2014a,b). AOPs have

been described for skin sensitization, liver cholestasis, liver steatosis, and fibrosis (OECD, 2012; Vinken et al., 2013; Willett et al., 2014). More recently, there are suggestions that the AOP framework can also be used for organizing, structuring, and describing the pathways involved in diseases (Langley et al., 2017; Noor, 2015).

An AOP will begin upon exposure to a compound. The interaction of that compound with the biological target will depend on its physico-chemical properties and could be analyzed using methods of quantitative structure-activity relationships (QSARS). The interaction of the compound with its biological target is the molecular initiating event. This will in turn lead to causal chain of events at different levels of biological organization, with effects at the organelle, cellular, and tissue levels. Depending on the intensity and duration of the exposure, these effects will affect the function(s) of the organ, which will initially try to adapt to the perturbation to achieve a new homeostasis. However, persistent stress will ultimately lead to adverse effect(s) at the organ level (see Figure 25.3). With time, organ level effects can spread to the whole organism. In epidemiology, many affected organisms will lead to population and ecology effects.

Initially, AOPs were thought to be linear constructs with key events causally linked with each other and occurring at different levels of biological organization (Landesmann et al., 2013). However, biological systems are highly complex and interconnected, in addition to being very robust, and show adaptive responses to stress stimuli. Biological processes are nonlinear and highly *wired* together with feedback loops and cross regulation. Modern AOPs are chemically independent, modular, and connected over networks (Villeneuve et al., 2014a). The concept of *key event relationships* has been used to explain quantitative connections between several AOPs and more than one adverse

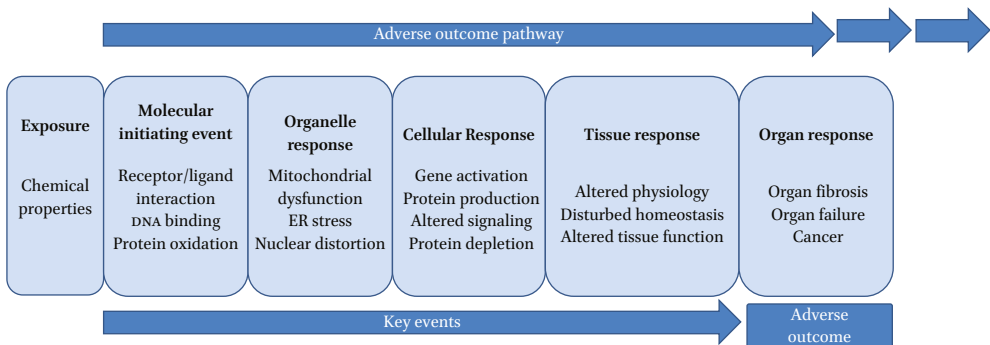

FIGURE 25.3 An AOP framework to explain multilevel effects beginning with an initial triggering event (molecular initiating event), followed by a series of intermediary events (key events) that lead to an adverse outcome.

ADAPTED FROM LANDESMANN ET AL. (2013)

outcome (Figure 25.4). These connections help to identify gaps and uncertainties in an AOP. An adverse outcome may also lead to another adverse outcome. For prediction, quantitative response relationships among key events within an AOP are required and make use of weighting and probabilistic and mechanistic approaches (Becker et al., 2015; Perkins et al., 2015). It is expected that *quantitative AOP* and *quantitative AOP networks* will have *quantitative key event relationships* and this may help define an *AOP score* for the prediction.

Although an AOP is a pragmatic way of organizing information of biological relevance and facilitates causal links with multilevel information, there are many challenges to their wide application. An AOP should not only give information about the structure of the system but also provide important clues

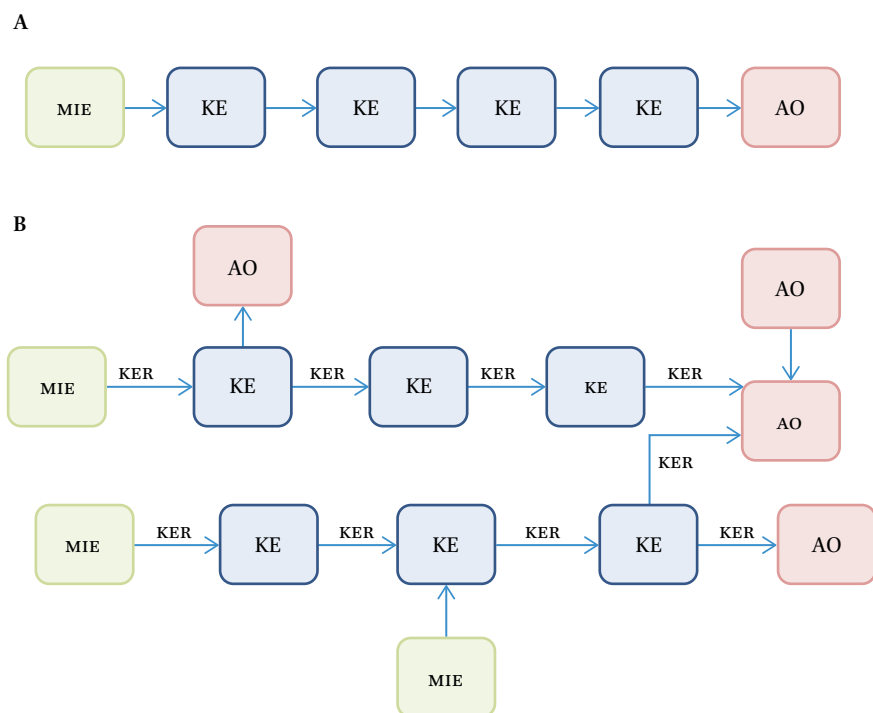

FIGURE 25.4 Adverse outcome pathways. (A) a linear AOP showing molecular initiating event (MIE) as the interaction between chemical and its biological target leading to a chain of causal key events (KE) resulting in an adverse outcome (AO). (B) an AOP network with multiple pathways and key events (KE) leading to one or more adverse outcomes. The quantitative correlation between two key events (KER) would determine the intensity of the involvement of that pathway.

ADAPTED FROM GARCIA-REYERO 2015

on the dynamics of the system. It is highly recommended for an AOP to have direct human relevancy, and an AOP based only on animal data is insufficient. The relationships between molecular initiating events, key events, and adverse outcomes should be predictable. The successful application and adaption of AOPs in toxicology (especially regulatory toxicology) will depend on the effectiveness of an AOP to predict adverse outcomes. Since AOPs are considered *living* documents that will change with the progressive availability of knowledge, the development of AOPs will proceed in parallel with their use; which will inevitably, in some cases, pose uncertainties. The more nonlinear linkages there are over multiple pathways, the more challenging the task of deriving correlations for prediction. As with other sciences, there is an urgent need for standardization, harmonization, and development of common language(s) to connect and understand different application domains.

2 Preclinical Drug Development

From the discovery of new therapeutic entities to the marketing of the final product, the drug development process mainly deals with preclinical development and clinical trials of, so-called, investigational new drugs. Preclinical drug development focuses on the proof of efficacy and safety of new drugs. The immense technological advancements of recent years have rendered the drug discovery and development process more expensive than ever. At the same time, the success rates have fallen, the regulatory requirements are becoming stricter, and the competition has become fierce. According to the Tufts Center for the Study of Drug Development, in 2014, the cost of drug development was around US\$2.6 billion, with preclinical development costs surpassing US\$1 billion (Mullin, 2014). Only one in ten drugs entering the clinical phase is approved by the US Food and Drug Administration (FDA), according to a recent report (Hay et al., 2014). The failure of an investigational new drug in the clinical trials may cost billions of dollars (Horton 2004; Lang 2005). Most investigational new drug failures are due to lack of efficacy and/or clinical toxicity. Human safety issues result in about 20% of failed drugs (Kola and Landis, 2004). In 2010, a 10-year survey showed that safety issues remained one of the major bottlenecks in drug development (Waring et al., 2015). The woes of the pharmaceutical industry can continue even after the approval and marketing of a drug, as there is around 5% risk of post-marketing withdrawal due to adverse effects (Smith and Schmid, 2006).

Liver and cardiac toxicity are the major issues in drug development. Liver toxicity alone (until 2014) has resulted in most drug withdrawals. The

regulatory agencies require the testing of acute and repeated-dose toxicity in animals. Although, the pharmaceutical industry is, at present, using a range of high-throughput *in vitro* assays (some accepted by regulatory bodies) in the initial screening of compounds, there are no accepted *in vitro* models for repeated-dose, long-term toxicity. The next part of the chapter focuses on the limitations of animal models and emerging new models and technology in the assessment of liver toxicity, followed by *in silico* computational methods in drug development.

3 Limitations of Animal Models in Liver Toxicity Evaluations

Although *in vivo* animal testing gives direct evidence of toxicity in a living “intact” organism and allows experiments not possible in humans, it is limited by several serious drawbacks of scientific, economical, and ethical nature. A major limitation is the poor predictive power of animal studies. This poor translation of animal results to humans is mainly due to species-specific differences (Martignoni, Groothuis and de Kante, 2006). Animals predict only 40% of human liver toxicities (Ewart et al., 2014; Olson et al., 2000). Even among different animal species, the correlation is about 60% (Hartung and Daston, 2009), showing differences among test species and the limitation of prediction. The intrinsic differences in animals within the same species provide inconsistent results, especially in the case of oral-dose chronic toxicity. Testing in animals is usually carried out in the highest tolerable doses, which do not reflect human exposure. Equally important, even after standard animal testing, 19% of compounds presumably safe in animals, show toxic effects in human clinical trials and are not pursued further (Sacks et al., 2014). In addition, many drugs proved safe in animal tests and clinical trials, are withdrawn from the market or labeled with black box warnings due to serious side effects. In the past 60 years, there have been more than 450 post-marketing withdrawals of drugs due to hepatotoxicity (Onakpoya, Heneghan and Aronson, 2016).

Species-specific differences are mainly due to differences in the pharmacokinetic parameters, namely absorption, distribution, metabolism, and elimination. Screening in animals is carried out with the assumption that similar reactions of biotransformation and clearance will occur in animals as in humans. However, animals differ from humans in the biotransformation of xenobiotics from Phase 0 (uptake of compounds mainly *via* transporters), to Phase I (CYP450 metabolism), Phase II (conjugation reactions), and Phase III (excretion/eliminations of the parent compound or metabolites or their conjugates mainly *via* the transporters). It is now well known that not only are there

differences in the metabolism of substances between animals and humans, but also many molecular mechanisms of human cellular injury are different (Woolbright et al., 2015).

In addition, due to the characteristics inherent to *in vivo* testing, such testing is excessively precautionary; and, therefore, many *potential* therapeutic compounds are screened out. One such example is aspirin, which is considered safe for human beings; it would not have been possible to market aspirin with current methods and criteria for safety (Hartung, 2009). This means that the current methods of screening may also possibly screen out compounds that could otherwise be useful in the therapy of human ailments. Other technical limitations include, low throughput of animal studies, in addition to prolonged study periods in some cases (e.g., carcinogenicity study) (Bucher, 2002).

Although animal testing has provided significant insights into biological processes and has contributed to human safety, the scientific goal of the 21st century should be a move towards human-based *in vitro* methods, with modern tools of systems biology, to bypass the species barrier and to allow better translation.

4 *In vitro* Models of Liver Toxicity in Preclinical Drug Development

Traditionally, *in vitro* models refer to cell-cultivation methods of primary cells and cell lines, commonly involving plastic or glass cultivation vessels with a cell-culture medium suitable for a given cell type. Wilhelm Roux, a German zoologist, established the basic principles of tissue culture in 1885, by maintaining tissues in a warm saline solution for several days. Julius Richard Petri, a German microbiologist, owns the credit of inventing the Petri dish in the early 1900s. Modern two-dimensional (2D) cell culture is usually carried out in polymer culture flasks and dishes of multitude formats. Ross Granville Harrison, an American embryologist, is considered the pioneer of 3D cell culture using the hanging drop method (Nicholas, 1961).

Today, 2D cultivation techniques are well established and cells (mostly cell lines) of almost all tissues of human or animal origin are available. There are many advantages to the 2D cultivation of cells, such as simplicity; expertise required; low costs; high number of replicates; and, most importantly, application in high-throughput screening in multi-well plates, with the possibility of miniaturization and robotic automation, minimizing human bias and error as well as ensuring high precision. In addition, less material (cells and culture media as well as test substance) is required with fewer ethical concerns. A battery

of simple and complex 2D *in vitro* assays can predict up to 80% of human hepatotoxicity (Noor et al., 2009; Verneti et al., 2017).

Nevertheless, 2D cultivation of cells involves maintaining the cells in an unnatural and artificial environment, whereby they lose their organ- and tissue-specific architecture and organization. Other factors, such as medium change, cell density to surface ratios, lack of flow and sheer tension, and unphysiological oxygen supply are other major limitations. Another commonly encountered problem is the rapid de-differentiation of primary cells, such as the hepatic cells, in 2D cultures, resulting in the loss of functions.

In vivo, cell-to-cell contacts and communication across the extracellular matrix are ensured within a three-dimensional (3D) arrangement. The extracellular matrix regulates cell morphology and gene expression *in vivo* (Bissell, 2007; Bissell, Hall and Parry, 1982; Le Beyec et al., 2007). A 3D environment influences the epigenetic plasticity of the cells (Spencer, Xu and Bissell, 2007; Xu, Spencer and Bissell, 2007). Conventional 2D hepatic cultures rapidly lose liver-like functionality (Godoy et al., 2013; Paine and Andreakos, 2004), leading to poor concordance between experimental *in vitro* data and *in vivo* data, especially with respect to xenobiotic metabolism and transporter activities. Optimization of the culture medium may help in the maintenance of functions for some time (Klein et al., 2014; Mueller et al., 2012). However, modern *in vitro* methods are more and more focused on the 3D cultivation of cells as organoids or micro tissues that ensure cell-to-cell contacts, cells to be surrounded completely by extracellular matrix, facilitating cell-to-cell communication and signaling (Alepée et al., 2014; Mueller, Heinzle and Noor, 2013).

3D cultures of primary human hepatocytes and human-cell lines, such as HepRG and HepG2, retain long-term viability and maintain liver-specific functions *in vitro* (Mueller, Koetemann and Noor, 2011a; Mueller et al., 2011b; Gunness et al., 2013; Mueller et al., 2014; van Grunsven, 2017). 3D cultures (also called 3D micro tissues, organoids, and organotypic cultures) in microfluidic devices, are termed *biochips* (Baudoin et al., 2007), *organs on a chip* (Bhatia and Ingber, 2014) or *body on a chip*, where several tissues or organ systems are represented (Marx et al., 2012; Materne et al., 2015a; Materne et al., 2015b; Sung et al., 2014). These emerging technologies allow the study of human physiology and adverse effects *in vitro*, as they enable analysis of the biochemical and metabolic activities of living cells in functional tissue and organ contexts, while allowing high-resolution, real-time imaging (Bhatia and Ingber, 2014). Although, such advanced 3D culture techniques demand expertise, and usually special equipment/setup, in addition to comparatively higher costs and lower throughputs, they seem to be indispensable for meaningful human-biology based science in future.

Much development effort is underway for a high-throughput generation of the 3D cultures as aggregates (Gevaert et al., 2014), micro-patterned co-cultures (Khetani and Bhatia, 2008) and 3D printing (Billiet et al., 2014). High-content platforms are already used in drug development for the screening of compounds (Bale et al., 2014; Tolosa et al., 2014). At the same time, highly-advanced imaging and other techniques (including automated methods for assessing multiple readouts, such as cell viability, shape of the nuclei, cell area, mitochondrial membrane potential, phospholipids accumulation, cytoskeleton integrity, and apoptosis) are playing an important role in the study of biological pathways (Ramaiahgari et al., 2014; Sirenko et al., 2014). Such high-content and high-throughput platforms are changing the toxicity screening paradigm (Patlewicz et al., 2013), paving the way towards pathway-based, *in vitro* only, safety assessment (Adeleye et al., 2014; Kleensang et al., 2014).

5 Computational *in silico* Tools

In silico methods such as quantitative structure activity relationships (QSARS) in predictive toxicology are not new. More than 150 years ago, Crox (1863) linked the toxicity of primary alcohols to their water solubility. Crum-Brown and Fraser (1869) advanced the idea that the biological activity of a compound was linked to its chemical structure. In the 1980s, when pharmaceutical companies were creating libraries of thousands of compounds, methods of QSARS were refined, automatized, and extensively applied. The idea was that the toxicity of a chemical is dependent on specific features of the structure of that chemical. Therefore, similar chemical features are expected to share similar mechanisms of action and could be used for the prediction of activity. Basically, a set of compounds of known activities are used to train computer algorithms to differentiate between active and inactive compounds (Johnson and Maggiora, 1990). QSARS provide a mathematical relationship between a biological activity and one or more molecular descriptors able to predict the activity. These molecular descriptors are quantifiable and, therefore, give a quantitative relation to the toxicity. Modern QSARS are multidimensional (mQSAR) and include multiple representations of the ligand or protein (Tseng et al., 2012; Vedani, Dobler and Lill, 2006).

QSARS are often used in combination with other methods, such as read-across and weight-of-evidence assessments. Read-across is defined by the European Chemicals Agency (2017, p. 6) as “a technique for predicting endpoint information for one substance (target substance), by using data from the same endpoint from (an)other substance(s), (source substance(s))”. A range of *in silico*

tools are available for grouping the chemicals and read-across (Enoch, Cronin and Ellison, 2011). Publicly available software include, toxicity estimation software tool (TEST), the OECD QSAR toolbox, high-throughput virtual molecule docking (HTVMD), MetaCore, and the TOPKAT model. QSAR methods are increasingly predictive in hazard identification for acute toxicity, genotoxicity, mutagenicity, and bioaccumulation. Nevertheless, QSARs and read-across are limited in the prediction of the pharmacokinetic properties of compounds.

Other *in silico* methods include computational methods for modeling the pharmacokinetics of compounds and linking this to the biological response. Pharmacokinetics deals with the quantification of drug absorption, distribution, and elimination for the investigation and prediction of blood concentration-time profiles. Pharmacokinetic models can be simple to complex, depending on the level and the quality of information available. Simple models are empirical and can be used for the estimation of clearance and half-life, allowing dosage-regimen calculations (Jones, Mayawala and Poulin, 2013; Klein et al., 2015; Wetmore et al., 2012). Models that are more complex are Physiologically Based Pharmacokinetic (PBPK) models, which are compartment models. These compartments represent tissues and organ spaces and their volumes. As early as 1937, Teorell, one of the pioneers of pharmacokinetics, described the basic principles of a PBPK approach (Teorell, 1937). However, its mathematical complexity and the lack of physiological data needed for the model were significant challenges to its widespread application for many years.

At present, PBPK models are mechanism based and allow extrapolation from high doses to lower doses, from one species to another, and between dose routes. Traditionally, data is generated from *in vivo* animal and *in vitro* animal and human studies (see Figure 25.5), in an approach originally described by Sobels for anticancer drugs (Sobels, 1977).

Since PBPK models are based on physiological parameters, it is possible to use them to predict *in vivo* absorption, distribution, metabolism, and excretion. PBPK modeling is still heavily dependent on animal studies, and very few clinical applications of PBPK models have appeared. The major reason is the lack of human data for validation. However, *in vitro* systems can be used, to some extent, for the prediction of distribution, metabolism, and elimination (Poulin, 2013; Poulin et al., 2013a, b; Poulin and Haddad, 2013). Using a PBPK model, *in vitro* tests can also provide parameters that allow the prediction of dose-response *in vivo*. PBPK modeling not only allows simulation of human pharmacokinetics, it also enables *in vitro* to *in vivo* extrapolation. For this purpose, quantitative *in vitro* data, such as data on tissue distribution, rates of metabolism, rates of interactions with biological macromolecules such

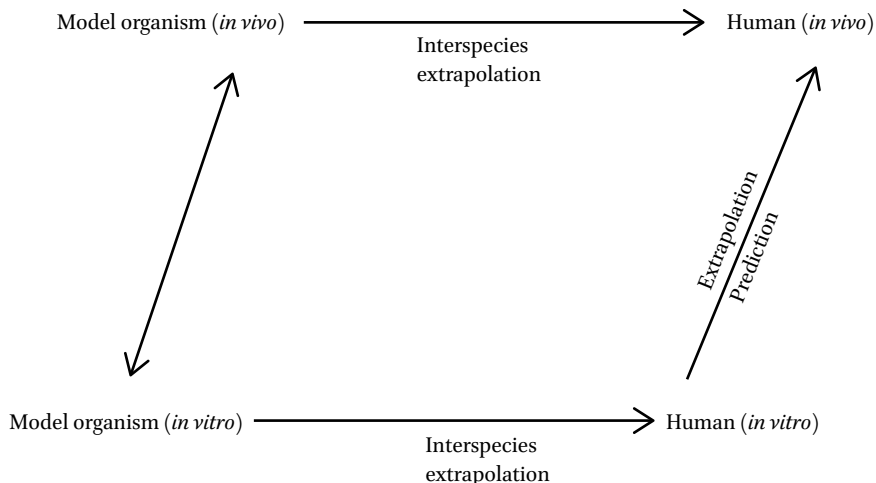

FIGURE 25.5 Traditional approach for risk assessment using animal data.
ADAPTED FROM SOBELS (1977)

as receptors, changes in cell function and viability, is needed. PBPK modeling combined with other *in silico* (chemical-related) and *in vitro* (biology-related) parameter estimations allows for prediction of *in vivo* exposure equivalent to the *in vitro* assay concentrations producing an adverse effect. For reliable predictions using such methods, a thorough experimental design with the characterization of the biological system, including the cell model and its characteristics, is essential. Recently, simple PBPK models were combined with acute and long-term dose-response data to calculate oral equivalent doses (Chang et al., 2015; Hamon et al., 2015; Klein et al., 2015; Rotroff et al., 2010; Wetmore et al., 2012; Yoon et al., 2014).

Models based on a systems biology approach are also being developed (Ideker et al., 2001) to allow firm anchorage of PBPK/pharmacodynamic models on a mechanistic basis. This new developing area, currently also referred to as *quantitative systems pharmacology*, focuses on the drugability of targets in biological systems. Quantitative systems pharmacology, in fact, follows a systems biology approach to drug discovery, aimed at the underlying mechanisms of drug actions on multiscale systems, using iterative computational modeling (Knight-Schrijver et al., 2016; Verneti et al., 2017).

In general, the advantages of *in silico* methods are low costs, standardization, equipment needs, throughput, and the tremendous possibility of virtual expansion in terms of chemical space, numbers, and biological response scenarios. However, these methods have their own limitations, such as reliability

and robustness. These limitations are mainly based on data quality (and in some cases quantity) and the complexity of biological systems. Gene expression and metabolic network models, along with integrated, large multiscale models, are computationally demanding, data intensive, and time consuming.

6 Toxicology in the Coming Years: Challenges and Perspectives

Systems biology—with next generation technologies, such as integrated *omics* techniques, advanced cell-culture methods, and assays, along with better and faster computational *in silico* methods—is playing a key role in changing the global mindset towards toxicology. This shift in paradigm will allow for the integration of a human knowledgebase, including network information and *in vitro* assays providing critical key event parameter values, with less emphasis on *in vivo* animal data (Edwards and Preston, 2008). For optimal application of systems biology tools, the fundamental construct is to develop adequate and fit-for-purpose *in vitro* assays to characterize pathway perturbations and predict adverse outcomes due to these perturbations. Future *in vitro* assays will be based on human cells derived from pluripotent stem cells and human reporter cell lines.

The two most important corner stones of risk assessment are *exposure* and *concentration response*. Systems biology provides the framework for bridging *exposure* to a compound and its causal *adverse outcome* (Sheldon and Cohen Hubal, 2009). It is essential that *in vitro* data provide relevant information on the concentration response over time. The perturbations and the concentration in which they occur should reflect human *in vivo* exposure and effects. However, extrapolation of *in vitro* results to humans *in vivo* is sometimes limited due to the fact that nominal concentrations in the *in vitro* assays are used without consideration of the exposure magnitude, timing, and duration (Coecke et al., 2013). Other factors such as *in vivo* bioavailability and metabolic clearance are not taken into account, in addition to other *in vitro* specific parameters, such as plastic binding, cell-surface binding, compound degradation and evaporation (Groothuis et al., 2015).

Furthermore, better tools for the characterization of the biological perturbations leading to adverse effects are needed for a mechanistic understanding of the perturbed pathways. This will require a recapitulation of the toxicity pathway(s) by *in vitro* assays. In this context, the systems biology approach provides molecular information and key event networks for the comparison of MOA-based pathways. Systems biology measurements will also provide information on overlapping events across multiple pathways. Given that there is often a temporal shift in various *omics* readouts, it is imperative to conduct

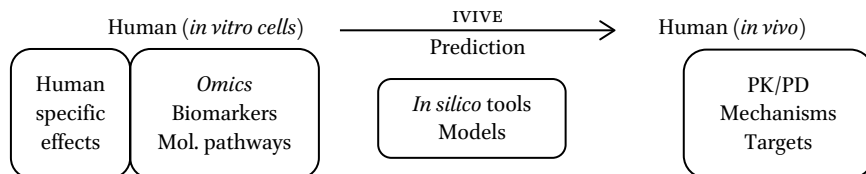

FIGURE 25.6 An ideal shift in paradigm where human-relevant, advanced mechanism-based *in vitro* cells, such as primary human hepatocytes, hiPSCs, derived functional hepatocytes, or cardiomyocytes will provide high-quality data for *in vitro* to *in vivo* extrapolation (IVIVE) of human pharmacokinetics (PK)/pharmacodynamics (PD), identification of targets, and mechanisms that will ultimately lead to the prediction of adverse effects in humans *in vivo*.

kinetic studies, so that time resolved data could be obtained. Careful design and control of the system is necessary to obtain high-quality data and to reduce uncertainties inherent to *in vitro* systems. A fully integrated systems approach would reduce many uncertainties associated with current risk assessment approaches. The aim is to obtain human-specific, high-quality data at different molecular levels and integrate these with *in silico* tools for the extrapolation and prediction of human adverse effects (see Figure 25.6).

Thus, a systems biology approach could help define MOA, species extrapolation, *in vitro* to *in vivo* extrapolation and provide a mechanistic basis for describing the susceptibility of certain subpopulations. An integrated approach of human *in vitro* and *in silico* methods for *in vivo* exposure is expected to provide a reliable prediction of toxicity. An *in vitro* system that is designed and characterized to provide human *in vivo* relevant information will be the key to successful prediction. Combined with qualitative and quantitative knowledge on perturbations in biological pathways over time, this integrated approach could be a powerful tool for *in vivo* relevant toxicity assessment. Finally, the concept of AOP remains to be developed beyond its limitations and deficiencies to be successful and to gain acceptance by the regulatory agencies in human-risk assessment.

Microfluidic systems, using 3D organotypic cultures for compound screening, is another area with great promise. In the case of liver, it will additionally allow measurements of pharmacokinetic and pharmacodynamic parameters *in vitro*. A challenge will be to include more than one organ on such a platform. Although some systems (see Figure 25.7) are already reported, they are still limited in their wide application. A pragmatic solution will be to combine organ-type cells, according to the scientific need and the data needed.

The establishment of complex cellular models based on co-cultures is another active research area with promise in the quantitative understanding of mechanisms in human health and disease. Organs are complex structures and

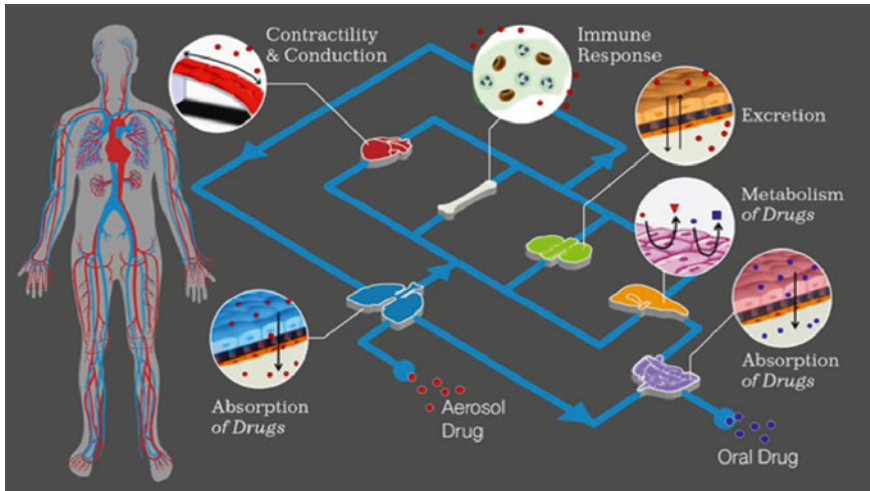

FIGURE 25.7 Body on a chip.

IMAGE COURTESY OF THE WYSS INSTITUTE, HARVARD UNIVERSITY

their response (manifested as adverse effects or disease) is a joint response of many cell types in communication. Combining different cell types is no trivial task, due to the complex environmental needs of each cell type. The *in vivo* relevance of these systems will have to be validated. Advanced microfluidic systems, in future, will include liver zonation (Vernetti et al., 2017).

The application of hiPSC-derived models in human disease research, in future, will move *in vitro* systems from mostly proliferating cell lines towards patient-specific cells and will, thus, facilitate personalized systems medicine. Human-induced pluripotent stem cells have great potential in toxicological screening, since they provide patient-specific pharmacological responses. Hepatocyte-like cells, derived from hiPSCs cultured on a micropatterned co-culture system are reported to predict the hepatotoxicity of test compounds with 65% sensitivity and 100% specificity (Ware et al., 2015). In addition, CRISPER/Cas9 technology provides a range of modified induced pluripotent stem cells (iPSCs), which will allow discovery of novel targets and biomarkers. A whole range of modified iPSCs, after differentiation, could serve not only in regenerative therapy but could be applied in mechanistic research and in the screening of therapeutics (see Figure 25.8).

It is hoped that this shift in paradigm will progress towards evidence-based science and personalized medicine, where clinical observations will be used to design advanced *in vitro* methods based on 3D models, with patient-specific primary or iPSC-derived cellular models (see Figure 25.9). The *omics* data from these models is expected to allow biological target identification and validation. This information will facilitate personalized therapy for a specific patient depending on the patient's genetic background.

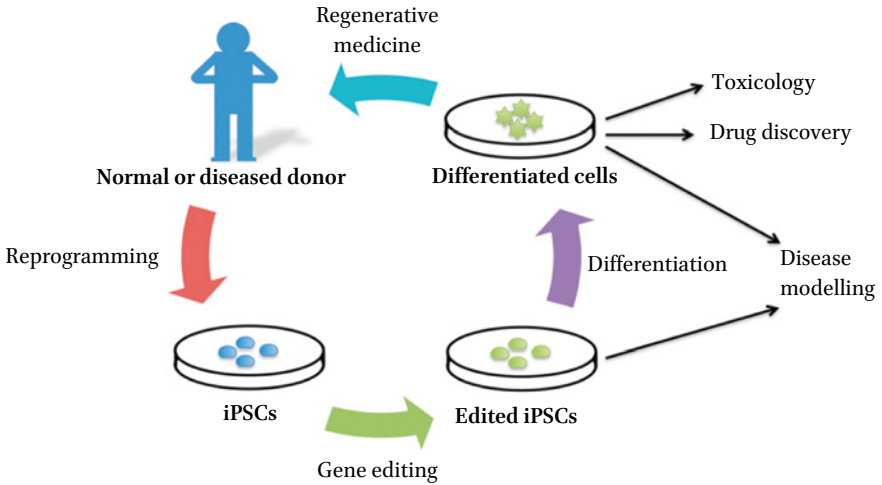

FIGURE 25.8 Modern cell reprogramming and gene editing tools, allowing modifications of patient-specific iPSCs for use in disease research, toxicology, and screening, in addition to the possibility of cell therapy. IMAGE TAKEN FROM SEAH ET AL. (2015)



FIGURE 25.9 The paradigm shift towards clinical, observations-based, mechanistic investigations *in vitro*, using advanced tools of cell culture and *omics*. These should provide potential biomarkers and targets for exploitation in evidence-based personalized therapy and follow-up.

Clinical observations combined with the *omics* information, mechanisms, and biomarkers will iterate the whole process in modern systems toxicology. The impact of this approach is, no doubt, beyond toxicology in other fields of health, medicine, drug development, and basic sciences.

References

- Adeleye, Y., M. Andersen, R. Clewell, M. Davies, M. Dent, S. Edwards, P. Fowler, S. Malcomber, B. Nicol, A. Scott, B. Sun, C. Westmoreland, A. White, Q. Zhang and P.L. Carmichael (2014). Implementing Toxicity Testing in the 21st Century (TT21C): Making Safety Decisions Using Toxicity Pathways, and Progress in a Prototype Risk Assessment. *Toxicology*, 332, pp. 102–111.
- Alepee, N., A. Bahinski, M. Daneshian, De B. Wever, E. Fritsche, A. Goldberg, J. Hansmann, T. Hartung, J. Haycock, H. Hogberg, L. Hoelting, J.M. Kelm, S. Kadereit, E. McVey, R. Landsiedel, M. Leist, M. Lübberstedt, F. Noor, C. Pellevoisin, D. Petersohn, U. Pfannenbecker, K. Reisinger, T. Ramirez, B. Rothen-Rutishauser, M. Schäfer-Korting, K. Zeilinger and M.G. Zurich (2014). State-of-the-art of 3D Cultures (Organs on a Chip) in Safety Testing and Pathophysiology. *Alternatives to Animal Experimentation*, 31, pp. 441–477.
- Ankley, G.T., R.S. Bennett, R.J. Erickson, D.J. Hoff, M.W. Hornung, R.D. Johnson, D.R. Mount, J.W. Nichols, C.L. Russom, P.K. Schmieder, J.A. Serrano, J.E. Tietge and D.L. Villeneuve (2010). Adverse Outcome Pathways: A Conceptual Framework to Support Ecotoxicology Research and Risk Assessment. *Environmental Toxicology and Chemistry*, 29(3), pp. 730–741.
- Asgari, S., B. Pournasr, G.H. Salekdeh, A. Ghodsizadeh, M. Ott and H. Baharvand (2010). Induced Pluripotent Stem Cells: A New Era for Hepatology. *Journal of Hepatology*, 53, pp. 738–751.
- Attene-Ramos, M.S., N. Miller, R. Huang, S. Michael, M. Itkin, R.J. Kavlock, C.P. Austin, P. Shinn, A. Simeonov, R.R. Tice and M. Xia (2013). The Tox21 Robotic Platform for the Assessment of Environmental Chemicals: From Vision to Reality. *Drug Discovery Today*, 18(15–16), pp. 716–723.
- Bale, S.S., L. Vernetti, N. Senutovitch, R. Jindal, M. Hegde, A. Gough, W.J. McCarty, A. Bakan, A. Bhushan, T.Y. Shun, I. Golberg, R. DeBiasio, B.O. Usta, D.L. Taylor and M.L. Yarmush (2014). *In Vitro* Platforms for Evaluating Liver Toxicity. *Experimental Biology and Medicine* (Maywood), 239, pp. 1180–1191.
- Baudoin, R., A. Corlu, L. Griscom, C. Legallais, and E. Leclerc (2007). Trends in the Development of Microfluidic Cell Biochips for *In Vitro* Hepatotoxicity. *Toxicology In Vitro*, 21, pp. 535–544.

- Becker, R.A., G.T. Ankley, S.W. Edwards, S.W. Kennedy, I. Linkov, B. Meek, M. Sachana, H. Segner, B. Van Der Burg, D.L. Villeneuve, H. Watanabe and T.S. Barton-Maclaren (2015). Increasing Scientific Confidence in Adverse Outcome Pathways: Application of Tailored Bradford-Hill Considerations for Evaluating Weight of Evidence. *Regulatory Toxicology and Pharmacology*, 72, pp. 514–537.
- Bhatia, S.N., and D.E. Ingber (2014). Microfluidic Organs on Chips. *Nature Biotechnology*, 32, pp. 760–772.
- Billiet, T., E. Gevaert, T. De Schryver, M. Cornelissen and P. Dubruel (2014). The 3D Printing of Gelatin Methacrylamide Cell-laden Tissue-engineered Constructs with High Cell Viability. *Biomaterials*, 35, 49–62.
- Bissell, M.J. (2007). Architecture Is the Message: The Role of Extracellular Matrix and 3D Structure in Tissue-specific Gene Expression and Breast Cancer. *Pezcoller Foundation Journal*, 16(29), pp. 2–17.
- Bissell, M.J., H.G. Hall, and G. Parry (1982). How Does the Extracellular Matrix Direct Gene Expression?. *Journal of Theoretical Biology*, 99(1), pp. 31–68.
- Blaauboer, B.J. and M.E. Andersen (2007). The Need for a New Toxicity Testing and Risk Analysis Paradigm to Implement REACH or Any Other Large Scale Testing Initiative. *Archives of Toxicology*, 81(5), pp. 385–387.
- Bouhifd, M., M.E. Andersen, C. Baghdikian, K. Boekelheide, K.M. Crofton, A.J. Fornace Jr., A. Kleensang, H. Li, C. Livi, A. Maertens, P.D. McMullen, M. Rosenberg, R. Thomas, M. Vantangoli, J.D. Yager, L. Zhao and T. Hartung (2015). The Human Toxome Project. *Alternatives to Animal Experimentation*, 32(2), pp. 112–124.
- Bucher, J.R. (2002). The National Toxicology Program Rodent Bioassay: Designs, Interpretations, and Scientific Contributions. *Annals of the New York Academy of Sciences*, 982, pp. 198–207.
- Chang, X., N. Kleinstreuer, P. Ceger, J. Hsieh, D. Allen and W. Casey (2015). Application of Reverse Dosimetry to Compare *In Vitro* and *In Vivo* Estrogen Receptor Activity. *Applied In Vitro Toxicology*, 1(1), pp. 33–44.
- Coecke, S., O. Pelkonen, S.B. Leite, U. Bernauer, J.G. Bessems, F.Y. Bois, U. Gundert-Remy, G. Loizou, E. Testai and J.M. Zaldivar (2013). Toxicokinetics as a Key to the Integrated Toxicity Risk Assessment Based Primarily on Non-animal Approaches. *Toxicology In Vitro*, 27, pp. 1570–1577.
- Cros, A.F.A. (1863). Action de L'alcool Amylique sur L'organism. Faculté de Médecine Strasbourg.
- Crum-Brown, A., and T.R. Fraser (1869). On the Connection Between Chemical Constitution and Physiological Action. Part I. *Transactions of the Royal Society of Edinburgh*, 25, pp. 257–274.
- Edwards, S.W. and R.J. Preston (2008). Systems Biology and Mode of Action Based Risk Assessment. *Toxicological Sciences*, 106, pp. 312–318.

- Edwards, S.W., Y.M. Tan, D.L. Villeneuve, M.E. Meek and C.A. McQueen (2016). Adverse Outcome Pathways-organizing Toxicological Information to Improve Decision Making. *Journal of Pharmacology and Experimental Therapeutics*, 356(1), pp. 170–181.
- Enoch, S.J., M.T. Cronin, C.M. Ellison (2011). The Use of a Chemistry-based Profiler for Covalent DNA Binding in the Development of Chemical Categories for Read-Across for Genotoxicity. *Alternatives to Laboratory Animals*, 39(2), pp. 131–145.
- European Chemicals Agency (2017). Read-Across Assessment Framework (RAAF). [online] Available at: https://echa.europa.eu/documents/10162/13628/raaf_en.pdf [Accessed 9 March 2018].
- Ewart, L., M. Aylott, M. Deurinck, M. Engwall, D.J. Gallacher, H. Geys, P. Jarvis, H. Ju, D. Leishman, L. Leong, N. McMahon, A. Mead, P. Milliken, W. Suter, A. Teisman, K. Van Ammel, H.M. Vargas, R. Wallis and J.P. Valentin (2014). The Concordance Between Nonclinical and Phase I Clinical Cardiovascular Assessment from a Cross-company Data Sharing Initiative. *Toxicological Sciences*, 142(2), pp. 427–435.
- Flaherty, E.K. and K.J. Brenndand (2015). Using hiPSCs to Model Neuropsychiatric Copy Number Variations (Cnvs) Has Potential to Reveal Underlying Disease Mechanisms. *Brain Research*, 1655, pp. 283–293.
- Gaj, T., C.A. Gersbach, and C.F. Barbas 3rd (2013). ZFN, TALEN, and CRISPR/Cas-based Methods for Genome Engineering. *Trends in Biotechnology*, 31, pp. 397–405.
- Garcia-Reyero, N. (2015). Are Adverse Outcome Pathways Here to Stay? *Environmental Science and Technology*, 49, pp. 3–9.
- Gasparri, F. (2009). An Overview of Cell Phenotypes in HCS: Limitations and Advantages. *Expert Opinions in Drug Discovery*, 4, pp. 643–657.
- Gevaert, E., L. Dolle, T. Billiet, P. Dubruel, L. van Grunsven, A. van Apeldoorn and R. Cornelissen (2014). High Throughput Micro-well Generation of Hepatocyte Micro-aggregates for Tissue Engineering. *PLoS One*, 9, p. e105171.
- Ghodsizadeh, A., A. Taei, M. Totonchi, A. Seifinejad, H. Gourabi, B. Pournasr, N. Aghdami, R. Malekzadeh, N. Almadani, G.H. Salekdeh and H. Baharvand (2010). Generation of Liver Disease-specific Induced Pluripotent Stem Cells Along with Efficient Differentiation to Functional Hepatocyte-like Cells. *Stem Cell Reviews*, 6, pp. 622–632.
- Gocht, T., E. Berggren, H.J. Ahr, I. Cotgreave, M.T. Cronin, G. Daston, B. Hardy, E. Heinzle, J. Hescheler, D.J. Knight, C. Mahony, M. Peschanski, M. Schwarz, R.S. Thomas, C. Verfaillie, A. White and M. Whelan (2015). The SEURAT-1 Approach Towards Animal Free Human Safety Assessment. *Alternatives to Animal Experimentation*, 32(1), pp. 9–24.
- Godoy, P., N.J. Hewitt, U. Albrecht, M.E. Andersen, N. Ansari, S. Bhattacharya, J.G. Bode, J. Bolleyn, C. Borner, J. Bottger, A. Braeuning, R.A. Budinsky, B. Burkhardt, N.R. Cameron, G. Camussi, C.S. Cho, Y.J. Choi, R.J. Craig, U. Dahmen, G. Damm, O. Dirsch, M.T. Donato, J. Dong, S. Dooley, D. Drasdo, R. Eakins, K.S. Ferreira, V. Fonsato, J.

- Fraczek, R. Gebhardt, A. Gibson, M. Glanemann, C.E. Goldring, M.J. Gómez-Lechón, G.M. Groothuis, L. Gustavsson, C. Guyot, D. Hallifax, S. Hammad, A. Hayward, D. Häussinger, C. Hellerbrand, P. Hewitt, S. Hoehme, H.G. Holzhütter, J.B. Houston, J. Hrach, K. Ito, H. Jaeschke, V. Keitel, J.M. Kelm, B. Kevin, C. Kordes, G.A. Kullak-Ublick, E.L. LeCluyse, P. Lu, J. Luebke-Wheeler, A. Lutz, D.J. Maltman, M. Matz-Soja, P. McMullen, I. Merfort, S. Messner, C. Meyer, J. Mwinyi, D.J. Naisbitt, A.K. Nussler, P. Olinga, F. Pampaloni, J. Pi, L. Pluta, S.A. Przyborski, A. Ramachandran, V. Rogiers, C. Rowe, C. Schelcher, K. Schmich, M. Schwarz, B. Singh, E.H. Stelzer, B. Stieger, R. Stöber, Y. Sugiyama, C. Tetta, W. Thasler, T. Vanhaecke, M. Vinken, T.S. Weiss, A. Widera, C.G. Woods, J.J. Xu, K.M. Yarborough and J.G. Hengstler (2013). Recent Advances in 2D and 3D *In Vitro* Systems Using Primary Hepatocytes, Alternative Hepatocyte Sources and Non-parenchymal Liver Cells and Their Use in Investigating Mechanisms Of Hepatotoxicity, Cell Signaling and ADME. *Archives of Toxicology*, 87, pp. 1315–1530.
- Groothuis, F.A., M.B. Heringa, B. Nicol, J.L. Hermens, B.J. Blaauboer and N.I. Kramer (2015). Dose Metric Considerations in *In Vitro* Assays to improve Quantitative *In Vitro-In Vivo* Dose Extrapolations. *Toxicology*, 332, pp. 30–40.
- Gunness, P., D. Mueller, V. Shevchenko, E. Heinzle, M. Ingelman-Sundberg and F. Noor (2013). 3D Organotypic Cultures of Human HepaRG Cells: A Tool for *In Vitro* Toxicity Studies. *Toxicological Sciences* 133(1), pp. 67–78.
- Hamon, J., M. Renner, M. Jamei, A. Lukas, A. Kopp-Schneider and F.Y. Bois (2015). Quantitative *In Vitro* to *In Vivo* Extrapolation of Tissues Toxicity. *Toxicology In Vitro*, 30(1A), pp. 203–216.
- Hartung, T. (2009). Per Aspirin Ad Astra. *Alternatives to Laboratory Animals*, 37(2), pp. 45–47.
- Hartung, T. and G. Daston (2009). Are *In Vitro* Tests Suitable for Regulatory Use?. *Toxicological Sciences*, 111, pp. 233–237.
- Hartung, T. and M. McBride (2011). Food for Thought ... on mapping the human toxome. *Alternatives to Animal Experimentation*, 28 (2), pp. 83–93.
- Hay, M., D.W. Thomas, J.L. Craighead, C. Economides and J. Rosenthal (2014). Clinical Development Success Rates for Investigational Drugs. *Nature Biotechnology*, 32, pp. 40–51.
- Horton, R. (2004). Vioxx, The Implosion of Merck and Aftershocks at the FDA. *Lancet*, 364, pp. 1995–1996.
- Howden, S.E., J.P. Maufort, B.M. Duffin, A.G. Elefanty, E.G. Stanley, and J.A. Thomson (2015). Simultaneous Reprogramming and Gene Correction of Patient Fibroblasts. *Stem Cell Reports*, 5(6), pp. 1109–1118.
- Hsieh, J.H., R. Huang, J.A. Lin, A. Sedykh, J. Zhao, R.R. Tice, R.S. Paules, M. Xia and S.S. Auerbach (2017). Real-time Cell Toxicity Profiling of Tox21 10K Compounds Reveals Cytotoxicity Dependent Toxicity Pathway Linkage. *PLoS One*, 12(5), p. e0177902.

- Ideker, T., T. Galitski and L. Hood (2001). A New Approach to Decoding Life: Systems Biology. *Annual Review of Genomics and Human Genetics*, 2, pp. 343–372.
- Johnson, M.A. and G.M. Maggiora, eds. (1990). *Concepts and applications of molecular similarity*. 1st ed. Wiley.
- Jones, H.M., K. Mayawala and P. Poulin (2013). Dose Selection Based on Physiologically Based Pharmacokinetic (PBPK) Approaches. *American Association of Pharmaceutical Scientists Journal*, 15(2), pp. 377–387.
- Khetani, S.R. and S.N. Bhatia (2008). Microscale Culture of Human Liver Cells for Drug Development. *Nature Biotechnology*, 26, pp. 120–126.
- Kim, J.S. (2016). Genome Editing Comes of Age. *Nature Protocols*, 11(9), pp. 1573–1578.
- Kitano, H. (2002). Computational Systems Biology. *Nature*, 420, pp. 206–210.
- Kleensang, A., A. Maertens, M. Rosenberg, S. Fitzpatrick, J. Lamb, S. Auerbach, R. Brennan, K.M. Crofton, B. Gordon, A.J. Fornace Jr, K. Gaido, D. Gerhold, R. Haw, A. Henney, A. Ma'ayan, M. McBride, S. Monti, M.F. Ochs, A. Pandey, R. Sharan, R. Stierum, S. Tugendreich, C. Willett, C. Wittwehr, J. Xia, G.W. Patton, K. Arvidson, M. Bouhifd, H.T. Hogberg, T. Luechtefeld, L. Smirnova, L. Zhao, Y. Adeleye, M. Kanehisa, P. Carmichael, M.E. Andersen and T. Hartung (2014). T4 Workshop Report: Pathways of Toxicity. *Alternatives to Animal Experimentation*, 31(1), pp. 53–61.
- Klein, S., S. Maggioni, J. Bucher, D. Mueller, J. Niklas, V. Shevchenko, K. Mauch, E. Heinzle and F. Noor (2015). *In Silico* Modeling for the Prediction of Dose and Pathway Related Adverse Effects in Humans from *In Vitro* Repeated-dose Studies. *Toxicological Sciences*, 149(1), pp. 55–66.
- Klein, S., D. Mueller, V. Schevchenko and F. Noor (2014). Long-term Maintenance of HepaRG Cells in Serum-free Conditions and Application in a Repeated Dose Study. *Journal of Applied Toxicology*, 34(10), pp. 1078–1086.
- Knight-Schrijver, V.R., V. Chelliah, L. Cucurull-Sanchez and N. Le Novère (2016). The Promise of Quantitative Systems Pharmacology Modelling for Drug Development. *Computational and Structural Biotechnology Journal*, 14, pp. 363–370.
- Kola, I. and J. Landis (2004). Can the Pharmaceutical Industry Reduce Attrition Rates?. *Nature Reviews Drug Discovery*, 3(8), pp. 711–716.
- Komor, A.C., A.H. Badran and D.R. Liu (2017). CRISPR-Based Technologies for the Manipulation of Eukaryotic Genomes. *Cell*, 168(1–2), pp. 20–36.
- Krewski, D., D. Acosta Jr, M. Andersen, H. Anderson, J.C. Bailar 3rd, K. Boekelheide, R. Brent, G. Charnley, V.G. Cheung, S. Green Jr, K.T. Kelsey, N.I. Kerkvliet, A.A. Li, L. McCray, O. Meyer, R.D. Patterson, W. Pennie, R.A. Scala, G.M. Solomon, M. Stephens, J. Yager and L. Zeise (2010). Toxicity Testing in the 21st Century: A Vision and a Strategy. *Journal of Toxicology and Environmental Health Part B Critical Reviews*, 13(2–4), pp. 51–138.
- Landesmann, B., M. Mennecozzi, E. Berggren and M. Whelan (2013). Adverse Outcome Pathway-based Screening Strategies for an Animal-free Safety Assessment of Chemicals. *Alternatives to Laboratory Animals*, 41, pp. 461–471.

- Lang, L. (2005). Valdecoxib (Bextra) Withdrawal Leaves Pain Relief Treatment Gap. *Gastroenterology*, 128, pp. 1769–1770.
- Langley, G.R., I.M. Adcock, F. Busquet, K.M. Crofton, E. Csernok, C. Giese, T. Heinonen, K. Herrmann, M. Hofmann-Apitius, B. Landesmann, L.J. Marshall, E. McIvor, A.R. Muotri, F. Noor, K. Schutte, T. Seidle, A. van de Stolpe, H. Van Esch, C. Willett and G. Woszczek (2017), Towards a 21st-century Roadmap for Biomedical Research and Drug Discovery: Consensus Report and Recommendations. *Drug Discovery Today*, 22(2), pp. 327–339.
- Le Beyec, J., R. Xu, S.Y. Lee, C.M. Nelson, A. Rizki, J. Alcaraz and M.J. Bissell (2007). Cell Shape Regulates Global Histone Acetylation in Human Mammary Epithelial Cells. *Experimental Cell Research*, 313(14), pp. 3066–3075.
- Li, M., K. Suzuki, N.Y. Kim, G.H. Liu and J.C. Izpisua Belmonte (2014). A Cut Above the Rest: Targeted Genome Editing Technologies in Human Pluripotent Stem cells. *Journal of Biological Chemistry*, 289, pp. 4594–4599.
- Martignoni, M., G.M. Groothuis and R. de Kanter (2006). Species Differences Between Mouse, Rat, Dog, Monkey, and Human CYP-mediated Drug Metabolism, Inhibition, and Induction. *Expert Opinion on Drug Metabolism and Toxicology*, 2, pp. 875–894.
- Marx, U., H. Walles, S. Hoffmann, G. Lindner, R. Horland, F. Sonntag, U. Klotzbach, D. Sakharov, A. Tonevitsky and R. Lauster (2012). “Human on a Chip Developments”: A Translational Cutting-edge Alternative to Systemic Safety Assessment and Efficiency Evaluation of Substances in Laboratory Animals and Man?. *Alternatives to Laboratory Animals*, 40, pp. 235–257.
- Materne, E.M., I. Maschmeyer, A.K. Lorenz, R. Horland, K.M. Schimek, M. Busek, F. Sonntag, R. Lauster and U. Marx (2015a). The Multi-organ Chip. A Microfluidic Platform for Long-term Multi-tissue Coculture. *Journal of Visualized Experiments*, p. e52526.
- Materne, E.M., A.P. Ramme, A.P. Terrasso, M. Serra, P.M. Alves, C. Brito, D.A. Sakharov, A.G. Tonevitsky, R. Lauster and U. Marx (2015b). A Multi-Organ Chip Co-culture of Neurospheres and Liver Equivalents for Long-term Substance Testing. *Journal of Biotechnology*, 205, pp. 36–46.
- McCracken, K.W., E.M. Cata, C.M. Crawford, K.L. Sinagoga, M. Schumacher, B.E. Rockich, Y.H. Tsai, C.N. Mayhew, J.R. Spence, Y. Zavros and J.M. Wells (2014). Modeling Human Development and Disease in Pluripotent Stem-cell-derived Gastric Organoids. *Nature*, 516(7531), pp. 400–404.
- Mueller, D., E. Heinzle and F. Noor (2013). 3D Hepatic *In Vitro* Models as Tools for Toxicity Studies. *Current Tissue Engineering*, 2, pp. 78–89.
- Mueller, D., A. Koetemann and F. Noor (2011a). Organotypic Cultures of HepG2 for *In Vitro* Toxicity Studies. *Journal of Bioengineering and Biomedical Science*, S2:002.
- Mueller, D., L. Kramer, E. Hoffmann, S. Klein and F. Noor (2014). 3D Organotypic HepaRG Cultures as *In Vitro* Model for Acute and Repeated Dose Toxicity Studies. *Toxicology In Vitro*, 28, pp. 104–112.

- Mueller, D., U. Muller-Vieira, K.M. Biemel, G. Tascher, A.K. Nussler and F. Noor (2012). Biotransformation of Diclofenac and Effects on the Metabolome of Primary Human Hepatocytes upon Repeated Dose Exposure. *European Journal of Pharmaceutical Sciences*, 45, pp. 716–724.
- Mueller, D., G. Tascher, U. Muller-Vieira, D. Knobloch, A.K. Nuessler, K. Zeilinger, E. Heinzle and F. Noor (2011b). In-depth Physiological Characterization of Primary Human Hepatocytes in a 3D Hollow-fiber Bioreactor. *Journal of Tissue Engineering and Regenerative Medicine*, 5(8), pp. e207–e218.
- Mullin, R. (2014). Tufts Study Finds Big Rise in Cost of Drug Development. *Chemical and Engineering News*. [online] Available at: <http://cen.acs.org/articles/92/web/2014/11/Tufts-Study-Finds-Big-Rise.html> [Accessed 9 March 2018].
- Nicholas, J.S. (1961). Ross Granville Harrison. *Biographical Memoirs National Academy of Sciences*, 35, pp. 132–162.
- Noor, F. (2015). A Shift in Paradigm Towards Human Biology-based Systems for Cholestatic-liver Diseases. *The Journal of Physiology*, 593(23), pp. 5043–5055.
- Noor, F., J. Niklas, U. Muller-Vieira and E. Heinzle (2009). An Integrated Approach to Improved Toxicity Prediction for the Safety Assessment During Preclinical Drug Development Using Hep G2 Cells. *Toxicology and Applied Pharmacology*, 237, pp. 221–231.
- OECD (2013). Guidance Document on Developing and Assessing Adverse Outcome Pathways. *Series on Testing and Assessment*, 184. Paris: OECD Publishing. [online] Available at: <http://www.oecd.org/chemicalsafety/testing/series-testing-assessment-publications-number.htm> [Accessed 9 March 2018].
- Olson, H., G. Betton, D. Robinson, K. Thomas, A. Monro, G. Kolaja, P. Lilly, J. Sanders, G. Sipes, W. Bracken, M. Dorato, K. Van Deun, P. Smith, B. Berger and A. Heller (2000). Concordance of the Toxicity of Pharmaceuticals in Humans and in Animals. *Regulatory Toxicology and Pharmacology*, 32(1), pp. 56–67.
- Onakpoya, I.J., C.J. Heneghan and J.K. Aronson, (2016). Post-marketing Withdrawal of 462 Medicinal Products Because of Adverse Drug Reactions: A Systematic Review of the World Literature. *BMC Medicine* 14, pp. 10–21.
- Organisation for Economic Co-operation and Development (OECD) (2012). The Adverse Outcome Pathway for Skin Sensitization Initiated by Covalent Binding to Proteins. Part I: Scientific Evidence. *Series on Testing and Assessment*, 168. Paris: OECD Publishing. [online] Available at: [http://www.oecd.org/officialdocuments/publicdisplaydocumentpdf/?cote=env/jm/mono\(2012\)10/part1&doclanguage=en](http://www.oecd.org/officialdocuments/publicdisplaydocumentpdf/?cote=env/jm/mono(2012)10/part1&doclanguage=en) [Accessed 9 March 2018].
- Paine, A.J. and E. Andreakos (2004). Activation of Signalling Pathways During Hepatocyte Isolation: Relevance to Toxicology *In Vitro*. *Toxicology In Vitro*, 18, pp. 187–193.
- Patlewicz, G., T. Simon, K. Goyak, R.D. Phillips, J.C. Rowlands, S.D. Seidel and R.A. Becker (2013). Use and Validation of HT/HC Assays to Support 21st Century Toxicity Evaluations. *Regulatory Toxicology and Pharmacology*, 65, pp. 259–268.

- Perkins, E.J., P. Antczak, L. Burgoon, F. Falciani, N. Garcia-Reyero, S. Gutsell, G. Hodges, A. Kienzler, D. Knapen, M. McBride and C. Willett (2015). Adverse Outcome Pathways for Regulatory Applications: Examination of Four Case Studies with Different Degrees of Completeness and Scientific Confidence. *Toxicological Sciences*, 148(1), pp. 14–25.
- Poulin, P. (2013). Prediction of Total Hepatic Clearance by Combining Metabolism, Transport, and Permeability Data in the *In Vitro-In Vivo* Extrapolation Methods: Emphasis on an Apparent Fraction Unbound in Liver for Drugs. *Journal of Pharmaceutical Sciences*, 102, pp. 2085–2095.
- Poulin, P. and S. Haddad (2013). Toward a New Paradigm for the Efficient *In Vitro-In Vivo* Extrapolation of Metabolic Clearance in Humans from Hepatocyte Data. *Journal of Pharmaceutical Sciences*, 102, pp. 3239–3251.
- Poulin, P., D.M. Dambach, D.H. Hartley, K. Ford, F.P. Theil, E. Harstad, J. Halladay, E. Choo, J. Boggs, B.M. Liederer, B. Dean and D. Dolores (2013a). An Algorithm for Evaluating Potential Tissue Drug Distribution in Toxicology Studies from Readily Available Pharmacokinetic Parameters. *Journal of Pharmaceutical Sciences*, 102, pp. 3816–3829.
- Poulin, P., C.E. Hop, L. Salphati and B.M. Liederer (2013b). Correlation of Tissue-plasma Partition Coefficients Between Normal Tissues and Subcutaneous Xenografts of Human Tumor Cell Lines in Mouse as a Prediction Tool of Drug Penetration in Tumors. *Journal of Pharmaceutical Sciences*, 102, pp. 1355–1369.
- Ramaiahgari, S.C., M.W. den Braver, B. Herpers, V. Terpstra, J.N. Commandeur, B. van de Water and L.S. Price (2014). A 3D *In Vitro* Model of Differentiated HepG2 Cell Spheroids with Improved Liver-like Properties for Repeated Dose High-throughput Toxicity Studies. *Archives of Toxicology*, 88, pp. 1083–1095.
- Rotroff, D.M., B.A. Wetmore, D.J. Dix, S.S. Ferguson, H.J. Clewell, K.A. Houck, E.L. Lecluyse, M.E. Andersen, R.S. Judson, C.M. Smith, M.A. Sochaski, R.J. Kavlock, F. Boellmann, M.T. Martin, D.M. Reif, J.F. Wambaugh and R.S. Thomas (2010). Incorporating Human Dosimetry and Exposure into High-throughput *In Vitro* Toxicity Screening. *Toxicological Sciences*, 117, pp. 348–358.
- Sacks, L.V., H.H. Shamsuddin, Y.I. Yasinskaya, K. Bouri, M.L. Lanthier and R.E. Sherman (2014). Scientific and Regulatory Reasons for Delay and Denial of FDA Approval of Initial Applications for New Drugs, 2000–2012. *Journal of the American Medical Association*, 311(4), pp. 378–384.
- Schwartz, R.E., H.E. Fleming, S.R. Khetani and S.N. Bhatia (2014). Pluripotent Stem Cell-derived Hepatocyte-like Cells. *Biotechnology Advances*, 32(2), pp. 504–513.
- Seah, Y.F.S., C.A. EL Farran, T. Warriar, J. Xu and Y.H. Loh (2015). Induced Pluripotency and Gene Editing in Disease Modeling: Perspectives and Challenges. *International Journal of Molecular Sciences*, 16(12), pp. 28614–28634.
- Selye, H. (1956). *The stress of life*. New York: McGraw-Hill Book Co.

- Sheldon, L.S., and E.A. Cohen Hubal (2009). Exposure as Part of a Systems Approach for Assessing Risk. *Environmental Health Perspectives*, 117, pp. 119–1194.
- Shinde, V., P. Sureshkumar, I. Sotiriadou, J. Hescheler and A. Sachinidis (2016). Human Embryonic and induced Pluripotent Stem Cell Based Toxicity Testing Models: Future Applications in New Drug Discovery. *Current Medicinal Chemistry*, 23(30), pp. 3495–3509.
- Shtrichman, R., I. Germanguz and J. Itskovitz-Eldor (2013). Induced Pluripotent Stem Cells (iPSCs) Derived from Different Cell Sources and Their Potential for Regenerative and Personalized Medicine. *Current Molecular Medicine*, 13, pp. 792–805.
- Siller, R., S. Greenhough, I.H. Park and G.J. Sullivan (2013). Modelling Human Disease with Pluripotent Stem Cells. *Current Gene Therapy*, 13, pp. 99–110.
- Sirenko, O., J. Hesley, I. Rusyn and E.F. Cromwell (2014). High-content Assays for Hepatotoxicity Using Induced Pluripotent Stem Cell-derived Cells. *Assay and Drug Development Technologies*, 12(1), pp. 43–54.
- Smith, D.A. and E.F. Schmid (2006). Drug Withdrawals and the Lessons Within. *Current Opinion in Drug Discovery and Development*, 9 (1), pp. 38–46.
- Sobels, F.H. (1977). Some Problems Associated with the Testing for Environmental Mutagens and a Perspective for Studies in “Comparative Mutagenesis”. *Mutation Research*, 46(4), 2, pp. 245–260.
- Spencer, V.A., R. Xu and M.J. Bissell (2007). Extracellular Matrix, Nuclear, and Chromatin Structure and Gene Expression in Normal Tissues and Malignant Tumors: A Work in Progress. *Advances in Cancer Research*, 97, pp. 275–294.
- Sung, J.H., B. Srinivasan, M.B. Esch, W.T. McLamb, C. Bernabini, M.L. Shuler and J.J. Hickman (2014). Using Physiologically-based Pharmacokinetic-guided “Body on a Chip” Systems to Predict Mammalian Response to Drug and Chemical Exposure. *Experimental Biological and Medicine* (Maywood), 239, pp. 1225–1239.
- Suzuki, K., C. Yu, J. Qu, M. Li, X. Yao, T. Yuan, A. Goebel, S. Tang, R. Ren, E. Aizawa, F. Zhang, X. Xu, R.D. Soligalla, F. Chen, J. Kim, N.Y. Kim, H.K. Liao, C. Benner, C.R. Esteban, Y. Jin, G.H. Liu, Y. Li and J.C. Izpisua Belmonte (2014). Targeted Gene Correction Minimally Impacts Whole-genome Mutational Load in Human-disease-specific Induced Pluripotent Stem Cell Clones. *Cell Stem Cell*, 15(1), pp. 31–36.
- Teorell, T. (1937). Kinetics of Distribution of Substances Administered to the Body. *Archives Internationales de Pharmacodynamie et de Thérapie*, 57, pp. 205–240.
- Tobita, T., J. Guzman-Lepe and A.C. de l’Hortet (2015). From Hacking the Human Genome to Editing Organs. *Organogenesis*, 11(4), pp. 173–182.
- Tolosa, L., A. Carmona, J.V. Castell, M.J. Gomez-Lechon and M.T. Donato (2014). High-content Screening of Drug-induced Mitochondrial Impairment in Hepatic Cells: Effects of Statins. *Archives of Toxicology*, 89(10), pp. 1847–1860.
- Tseng, Y.J., A.J. Hopfinger and E.X. Esposito (2012). The Great Descriptor Melting Pot: Mixing Descriptors for the Common Good of QSAR Models. *Journal of Computer Aided Molecular Design*, 26(1), pp. 39–43.

- van Grunsven, L.A. (2017). 3D *In Vitro* Models of Liver Fibrosis. *Advanced Drug Delivery Reviews*, 121, pp. 133–146.
- van Vliet, E., M. Daneshian, M. Beilmann, A. Davies, E. Fava, R. Fleck, Y. Jule, M. Kansy, S. Kustermann, P. Macko, W.R. Mundy, A. Roth, I. Shah, M. Uteng, B. van de Water, T. Hartung and M. Leist (2014). Current Approaches and Future Role of High Content Imaging in Safety Sciences and Drug Discovery. *Alternatives to Animal Experimentation*, 31(4), pp. 479–493.
- Vedani, A., M. Dobler, M.A. Lill (2006). The Challenge of Predicting Drug Toxicity *In Silico*. *Basic and Clinical Pharmacology and Toxicology*, 99(3), pp. 195–208.
- Verneti, L.A., A. Vogt, A. Gough and D.L. Taylor (2017). Evolution of Experimental Models of the Liver to Predict Human Drug Hepatotoxicity and Efficacy. *Clinics in Liver Disease*, 21(1), pp. 197–214.
- Villeneuve, D.L., D. Crump, N. Garcia-Reyero, M. Hecker, T.H. Hutchinson, C.A. LaLone, B. Landesmann, T. Lettieri, S. Munn, M. Nepelska, M.A. Ottinger, L. Vergauwen and M. Whelan (2014a). Adverse Outcome Pathway (AOP) Development I: Strategies and Principles. *Toxicological Sciences*, 142(2), pp. 312–320.
- Villeneuve, D.L., D. Crump, N. Garcia-Reyero, M. Hecker, T.H. Hutchinson, C.A. LaLone, B. Landesmann, T. Lettieri, S. Munn, M. Nepelska, M.A. Ottinger, L. Vergauwen and M. Whelan (2014b). Adverse Outcome Pathway Development II: Best Practices. *Toxicological Sciences*, 142(2), pp. 321–330.
- Vinken, M., B. Landesmann, M. Goumenou, S. Vinken, I. Shah, H. Jaeschke, C. Willett, M. Whelan and V. Rogiers (2013). Development of an Adverse Outcome Pathway from Drug-mediated Bile Salt Export Pump Inhibition to Cholestatic Liver Injury. *Toxicological Sciences*, 136(1), pp. 97–106.
- Ware, B.R., D.R. Berger and S.R. Khetani (2015). Prediction of Drug Induced Liver Injury in Micropatterned Co-cultures Containing iPSC-derived Human Hepatocytes. *Toxicological Sciences*, 145(2), pp. 252–262.
- Waring, M.J., J. Arrowsmith, A.R. Leach, P.D. Leeson, S. Mandrell, R.M. Owen, G. Pairaudeau, W.D. Pennie, S.D. Pickett, J.B. Wang, O. Wallace and A. Weir (2015). An Analysis of the Attrition of Drug Candidates from Four Major Pharmaceutical Companies. *Nature Reviews Drug Discovery*, 4(7), pp. 475–486.
- Wetmore, B.A., J.F. Wambaugh, S.S. Ferguson, M.A. Sochaski, D.M. Rotroff, K. Freeman, H.J. Clewell 3rd, D.J. Dix, M.E. Andersen, K.A. Houck, B. Allen, R.S. Judson, R. Singh, R.J. Kavlock, A.M. Richard and R.S. Thomas (2012). Integration of Dosimetry, Exposure, and High-throughput Screening Data in Chemical Toxicity Assessment. *Toxicological Sciences*, 125(1), pp. 157–174.
- Willett, C., J. Caverly Rae, K.O. Goyak, B. Landesmann, G. Minsavage and C. Westmoreland (2014). Pathway-based Toxicity: History, Current Approaches and Liver Fibrosis and Steatosis as Prototypes. *Alternatives to Animal Experimentation*, 31, pp. 407–421.
- Woolbright, B.L., K. Dorko, D.J. Antoine, J.I. Clarke, P. Gholami, F. Li, S.C. Kumer, T.M. Schmitt, J. Forster, F. Fan, R.E. Jenkins, B.K. Park, B. Hagenbuch, M. Olyae and H.

- Jaeschke (2015). Bile Acid-induced Necrosis in Primary Human Hepatocytes and in Patients with Obstructive Cholestasis. *Toxicology and Applied Pharmacology*, 283, pp. 168–177.
- Xu, R., V.A. Spencer and M.J. Bissell (2007). Extracellular Matrix-regulated Gene Expression Requires Cooperation of SWI/SNF and Transcription Factors. *Journal of Biological Chemistry*, 282, pp. 14992–14999.
- Yoon, M., A. Efremenko, B.J. Blaauboer and H.J. Clewell (2014). Evaluation of Simple *In Vitro* to *In Vivo* Extrapolation Approaches for Environmental Compounds. *Toxicology In Vitro*, 28, pp. 164–170.

The Potential of Organ on Chip Technology for Replacing Animal Testing

Malcolm Wilkinson

Chief Executive Officer, Kirkstall Ltd., Rotherham, United Kingdom

malcolm.wilkinson@kirkstall.com

1 What Is Organ on a Chip Technology?

The term *organ on a chip* is used to describe the latest stage of development of *in vitro* cell culture technology. Figure 26.1 shows its steady development since the 1960s. Each step forward has improved our ability to model human-clinical response to new drugs or therapies and has enabled safety risk assessment of existing cosmetics, personal care products, or other chemicals in the environment. Scientific evidence that the predictive power of *in vitro* tests is superior to the use of animals will trigger a major shift in the way that medical research, in many areas, is carried out. In this emerging field, some researchers also refer to organ on a chip as a microphysiological system. As yet, there are few agreed upon standards or definitions for the latest developments.

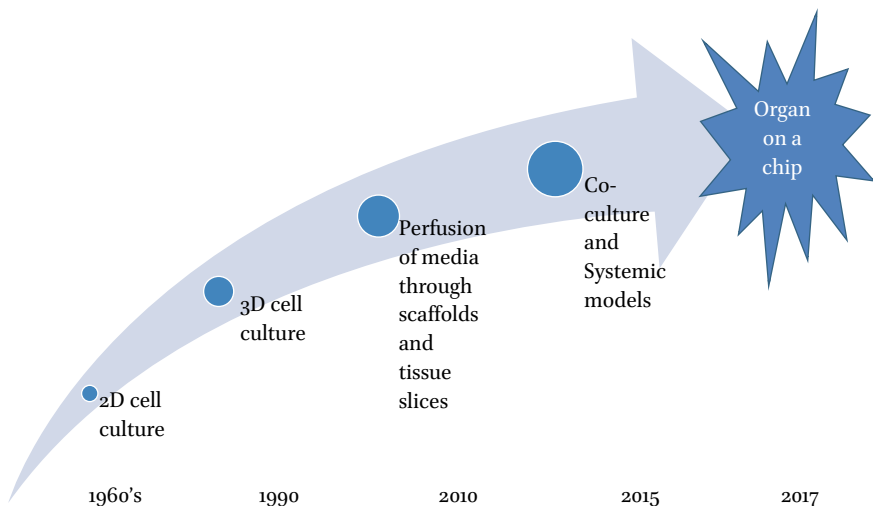

FIGURE 26.1 Developments in *in vitro* cell culture since the 1960s.

In this chapter, the following definitions are used:

2D cell culture. This is the conventional plating of cells in a plastic or glass plate, such as a petri dish, that contains the liquid culture media. In this format, the cells basal side is in contact with the base wall (glass or plastic); and the top or apical side is in contact with the media. A major limitation of this method is that cell-to-cell contact is very limited. The cell-culture dish can be a classic petri dish or, more likely, one of the highly-miniature versions known as microtiter plates. These have been scaled from 6 wells to 24, 96, 384, or even 1,024, configured as regular arrays in a way that allows robotic equipment to load cells and media and sample media for analysis.

3D cell culture. Having recognized the limitation of 2D cell culture, many approaches have been developed to increase the proportion of cell-to-cell contact to create a more physiologically relevant model of the structure of tissue in the human body. Cells can be provided with a soft or rigid matrix or scaffold in which to grow. Many cells have a natural tendency to adhere to the cell-culture dish plastic; but if the plastic is coated with a low adhesion surface, then the cells can clump together to form spheroids containing between 1,000 and 10,000 cells. There are now several well-established commercial systems for producing spheroids in microtiter plates. The main limitation with this method is that cells in the center of larger spheroids are starved of oxygen and media and become necrotic.

Perfusion. In the human body the vascular network links organs and transports oxygen and nutrients to the cells. It is also a vital communication highway for metabolic signaling between tissues. A major current goal of advanced *in vitro* models is to be able to recapitulate the physiological interactions between tissues in the body connected by the bloodstream. This has enormous potential, as it will enable studies on specific two-way or higher-order organ-to-organ and tissue interactions. Perfusion or flow of media across the cell culture is a first step in realizing this objective. Unfortunately, the flow of media past cells can induce flow stress, if the flow is higher than the cells might experience in the body. Hence, control of flow rate is critical. Optimized flow levels (which vary from tissue to tissue) can remove the necrosis in spheroids of tissue slices and upregulate cell activity back to levels observed in freshly isolated human primary cells (Vinci et al., 2011).

Organoids. *In vitro* culture of whole human organs is difficult and expensive. An intense research effort is underway to see if the main functions of a whole organ can be replicated by a much smaller number of cells, perhaps as few as 10,000. When provided with the right physical, biochemical, and other cues, these cells will often spontaneously differentiate into a morphology that can replicate the features of tissue in specific organs. These small samples

of biological material are known as *organoids*. One example is hepatocytes, where bile ducts form (Ramachandran et al., 2015).

Organ on a chip. This is a commonly used term in the popular press that would benefit from a clearer definition. The term *chip* is borrowed from the semiconductor industry and is a shortening of the term *microchip*, which is a small (typically fingernail-sized) crystal of silicon that contains millions of transistor circuits. The implication is that biological circuits will be capable of similar scaling in complexity. Unfortunately, the laws of physics apply. Biological cells and liquid fluids do not continue to function correctly as the size is reduced. This is in stark contrast to electrons on transistor circuits, which operate faster and use less power as they are scaled to smaller geometries. Another feature of microelectronic chips is that they are manufactured thousands at a time on a large wafer of silicon, which is one reason why the cost per-chip can be very low. In contrast, organs on a chip are currently manufactured singly or in small batches. There is very little standardization in the manufacturing processes used between the different laboratories making them, apart from the widespread use of silicone, a flexible rubber-like material, to mold the small channels. The *chips* in this case are typically 2 cm or more per side (i.e., much larger than silicon chips); and many have fluid connections glued in place to allow cell-culture media or test chemicals to be passed over the cells under culture.

Organ on a plate. This is a larger format approach than organ on a chip and typically has multiple cell-culture chambers molded in a plastic plate. The fluid connections between different chambers can be formed as part of the plate or added by connecting flexible tubing, as in the Quasi Vivo® Interconnected Cell Culture System (Yoon et al., 2015). The plastic plate is often designed to meet the industry standard format for 6 well or 24 well to facilitate handling by robotic equipment. Such multi-chamber plates can be used to connect different cell types or run multiple replicates in the same flow system. An integrated systemic view can, thus, be constructed piecewise; and, in the Quasi Vivo® advanced cell culture flow systems, allometry can be used to set up physiologically-relevant connected culture models of biotransformation, distribution, adsorption, and gas exchange (Haycock, Ahluwalia and Wilkinson, 2014).

Microphysiological system (MPS). This terminology was first used by the Defense Advanced Research Projects Agency (DARPA) in the United States that launched the MPS program of research. MPS research aims to develop a reconfigurable platform that permits simultaneous study of 10 or more *in vitro* physiological systems, arranged in any sequence. The goal is to design a flexible, user-friendly, and reliable platform that will allow biological components to interact in a physiologically-relevant manner and will sustain the resident

tissues for up to four weeks. Researchers developing the *in vitro* mimics aim to demonstrate that the engineered tissues function together to reproduce each of the human physiological systems. As these system mimics are integrated into a platform of increasing complexity, researchers must demonstrate that the platform reproduces the physiologically-relevant crosstalk between the systems that normally occurs in humans. To validate its behavior, and its potential value for evaluating drugs and vaccines, test compounds with known effects in humans will be applied to the platform. The effects that the test compounds have on the physiological system mimics will then be extrapolated to humans via computer modeling and compared to the health effects previously observed in humans. Many of the current organ on a chip developments are targeted to meet the requirements of the DARPA program.

2 The Opportunity for Better *in vitro* Methods

Although technological capability has now reached the point where multiple cell types can be cultured together in a single miniature plate, it is important to recognize that routine testing of chemical or drug safety lags behind the state of the art by many years. It is only now, after 10 years in development, that 3D cell culture, in the form of spheroids, is being used routinely by industry. However, 2D cell culture, in 96 or 384 well plates, is still the dominant technology. Considerable evidence of the benefits of any new technique has to be accumulated before industry will adopt it, and it takes even longer before regulatory bodies accept new methods.

One of the driving forces behind the development of the microtiter plate, with 96, 384, or even 1,536 small cavities for cell culture, has been the need to screen very large numbers of chemical compounds for safety or, in the case of the pharmaceutical industry, for their potential as drugs. Historically, the pharmaceutical industry has had access to tens of thousands of chemical compounds that may, potentially, be active drugs. Hence, the need for a very simple go/no go test that could quickly screen a large number of compounds to a more manageable number. Despite the high throughput of tests using microtiter plates, the High Throughput Screening (HTS) assays give very little, if any, information about mechanisms of action. Current HTS assays are very narrowly focused (e.g., receptor binding) and usually use animal-derived cells or subcellular components. If advanced HTS could use human cells/components, they may reveal much more information. Because HTS *in vitro* testing has only provided poor prediction of what is likely to happen in clinical trials, regulatory bodies still demand testing of drug candidates on animals. However, because

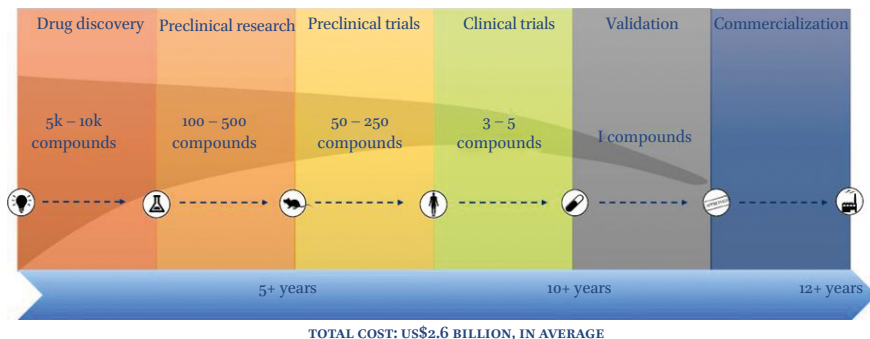

FIGURE 26.2 Summary of the drug development process.
CLERK AND VILLIEN, 2017, REPRINTED WITH PERMISSION

testing on animals is so expensive, pharmaceutical companies try to screen out the more obvious failures before that stage. The drug development process is shown in Figure 26.2. HTS is mainly used in the first stage of drug discovery when the number of candidate drugs to be screened may be as high as 10,000.

There is still considerable opportunity to improve the efficiency of this process despite the billions of dollars invested in it each year. The primary motivation for industry is the immense waste of resources, because around 90% of the drug candidates that enter clinical trials fail to reach the market (Mullard, 2016). This is because both current *in vitro* testing and animal methods are poor predictors of what will happen in clinical trials. It is this need for a more predictive method that is driving the development of organ on a chip and organ on a plate technology.

3 The Functional Requirement for Improved *in vitro* Methods

There is a growing body of knowledge that shows that the use of animal cells in *in vitro* testing is a factor in the poor performance of current methods. Even the use of whole animal models does not replicate what happens in the human body, so it is hardly surprising that animal cells placed in an *in vitro* environment will also give misleading results (Chandrasekera and Pippin, 2014; Cook, Clerk and Sugden, 2009; Mestas and Hughes, 2004; Potashkin, Blume and Runkle, 2011).

The choice to use animal cells is often driven by convenience rather than scientific reasons for further discussion see Redmond, 2019, Chapter 27. Human cells are difficult to obtain, often come from a single diseased patient, and are not representative of a larger pool of donors. Cell lines derived from

human cells are more readily available, but there are issues with the cell lineage. Tumor-derived cell lines readily proliferate; but their functionality may be quite different from healthy tissue; and their very robustness may be a problem, if we are trying to achieve a sensitive test for toxicity of a chemical or drug. Even when a representative supply of cells has been secured, there are other reasons why the models can be inadequate. Current research indicates that 2D static cell culture (no flow of media) is not as good at predicting toxicity as 3D cell culture (Eglen, 2017). There is also a growing body of evidence that perfusion (flow) of media over or through the cells produces a better prediction of IC₅₀ (half maximal inhibitory concentration) levels of drug toxicity than static medium (Davidge and Bishop, 2017).

Using this wealth of research, we can set out a list of requirements that should be met by any advanced *in vitro* method, including organ on a chip:

Biological requirements

- Use of human cells
- Culture conditions that produce physiologically relevant organoid models
- Connected organoids, so that the system models the whole organism
- Long-term culture/homeostasis for repeat-dose testing or low clearance compounds

Practical requirements

- Easy to use and fast to set up in the laboratory
- Robust/repeatable across multiple laboratories
- No air bubbles disrupting flow or blockages caused by biological material

Scale requirements

- Better HTS tests and high-content methods to replace animals
- Ability to test thousands of compounds for improving HTS assays
- Ability to test tens of compounds and replace hundreds of animals used in preclinical screening

Economical requirements

- Capital and consumable cost lower than animal testing
- Even lower cost per test to replace HTS.

The last points in this list suggest that the market for advanced cell culture could become segmented into high throughput approaches and high-content (lower throughput) methods.

4 History and Current Status of Organ on a Chip Methods

The concept of combining of microtechnology and biology to reconstitute the physiological and mechanical functions of human organs is not a new one.

Michael Shuler at Cornell University was one of its pioneers. In 1994, Shuler filed patents on a macro scale *in vitro* system for the physiological and metabolic evaluation of substances for use in living beings. The system included one or more cell culture chambers, each containing cells in a culture medium and a gas-liquid exchange device for contacting the culture medium with oxygen-containing gas. By 2003, Shuler was developing a micro-scale version (Park and Shuler, 2003), which was closely followed by Arti Ahluwalia at the University of Pisa (Ahluwalia, 2004), who filed her first patent in 2004. These pioneers were then followed by a surge of researchers, including Luke Lee at the University of California, Linda Griffith at the Massachusetts Institute of Technology, Donald Ingber at Harvard University, Shuichi Takayama at the University of Michigan, and many more. Sung and Shuler (2010) provide an excellent review of this area of research.

Progress between 2004 and 2014 was slow because of the significant technical challenges encountered in the application of microfluidics to biological systems. Few of the start-up companies that emerged from the early academic laboratories managed to get products to market. Despite these early setbacks there has been a resurgence of interest in the area following significant funding allocated to organ on a chip developers by the US DARPA and the US National Institutes of Health (NIH), who have awarded US\$140 million and US\$76 million, respectively, over a 5-year period, to support developments. In parallel, technology developers have raised more than US\$80 million since 2012 with equity investors. These investments caught the attention of market analysts; and in 2016, the first market forecast specifically aimed at this sector was published (Accuray Research LLP, 2016). In 2017, a more detailed analysis of the market was provided by Yole Research (Clerk and Villien, 2017). Yole's analysts estimated the combined sales of organ on a chip devices and service offerings at no more than US\$7.5 million in 2016.

Most companies in this area are spin offs from university laboratories and are currently developing their organ on a chip devices through projects sponsored by industrial players. Pharmaceutical and cosmetics companies are interested in the emerging technology but remain skeptical about its potential in the short term. Given the experience with 3D spheroid technology, it could be many years before the technology is ready for widespread adoption. However, the belief that such technologies could become a multibillion dollar market in the mid- to long-term future has the potential to accelerate progress, given the billions of dollars they could help the pharmaceutical industry save every year. Ethical concerns are also one of the potential drivers at the heart of this new market. Around the world, at least 115 million vertebrates are estimated to be used for scientific purposes annually (Taylor et al., 2008). Many of these

Organisation	Chip Picture	Controller	Comments
 emulate		 Instrument	Possibly 3 years from marketable product but winning R&D contracts
Hurel (USA)			Hurel offer 24 and 96 well plates ready seeded with hepatocytes as a service
MIT / CNBio (USA / UK)			CNBio offer a service for drug screening. Technology may eventually be available for 3 rd parties to run
Mimetas (NL)			Aiming at high throughput screening market in 96 well plate format.
 TissUSE Emulating Human Biology			Chamber is 24 well plate size. Control system uses complex pneumatic pumping
 Kirkstall			Chamber is 24 well plate format and in volume production with custom peristaltic pump

FIGURE 26.3 Leading contenders in the race to develop organs on a chip and organs on a plate.

animals could be replaced by alternative methods, which may include some elements of microfluidic technology.

Some of the leading developments in organ on a chip are summarized in Figure 26.3.

Summarizing the current developments, we can observe that there is little standardization. Each team is developing its own approach, with its own unique technology. The players are mainly start-up companies commercializing prototypes developed in the local universities. There is widespread use of silicone plastic to fabricate chambers and channels; but Mimetas and Kirkstall have opted to use acrylic-type plastic that can be injection molded and, hence, is amenable to volume production. There are widely differing chamber and plate sizes. Hurel, CN Bio, and Mimetas use 96 well plate size; TissUse and Kirkstall use 24 well plate size; and Wyss/Emulate has custom plates for each organ. Another point of divergence is the way that cell-culture media is fed into the chambers and over the cells. Pneumatic, peristaltic, and syringe pumps, as well as gravity fed flow, are all in use. Although some of the cell-culture chambers look simple, many require complex control systems to set up and maintain the temperature and gas ambient environment. Mimetas,

TissUse, and Kirkstall have all opted to use conventional cell-culture incubators into which their systems are loaded.

Returning to the functional requirements listed in the previous section, we can gauge how well each of the contenders are faring in their endeavor to achieve a technology that will be capable of replacing some of the animal testing in the drug discovery process.

4.1 *Biological Requirements*

Animal cells may be easier to obtain and keep alive than human primary cells, but they are not moving us forward. Human tumor-derived cell lines are easy to culture but are not representative of healthy tissue. Human-induced pluripotent stem cells (hiPSCs) look promising but are currently expensive and need long, complex protocols to create the differentiated cells needed for organ models. Human donor tissue could be considered the gold standard, but cryopreservation is needed to store tissue from donors to match the time window for experiments. Unfortunately, cryopreservation compromises the function of the cells. Esch, Bahinski and Huh (2015) provide a review of the cell types used in organ on chip models.

4.2 *Practical Requirements*

In order for any new technology to achieve regulatory acceptance, it must demonstrate that it is a robust and repeatable method. Many of the organ on a chip methods are a long way from this goal. They are so complex to set up and operate that they are only running in the host developer's laboratory and offered as a service. In contrast, Kirkstall has designed its *Quasi Vivo*[®] organ on a plate platform to be easy to use and fast to set up in the laboratory. It is well on the way to demonstrating that it can be robust and repeatable across multiple laboratories with a current academic-user base of more than 70 universities.

4.3 *Scale Requirements*

Figure 26.2 shows the different points in the drug discovery and development process where organs on a chip could be used. There is a clear divergence between the requirement to screen thousands of compounds and improve HTS assays, and the lower throughput needs to test in-depth tens of compounds and replace hundreds of animals used in preclinical screening. Most of the current organ on chip developments have indicated that the former is their commercial goal. In contrast, TissUse and Kirkstall have opted for 24 well plate size chambers that should be more suited to the latter and a focus on animal replacement.

4.4 *Economical Requirements*

Since so few of the organ on a chip projects have offered products to the market as yet, it is difficult to assess the likely costs involved. Many of the technologies are suitable for scaling to volume production and so, in theory, should be capable of meeting customers' expectations on cost. The economics of animal replacement have been thoroughly researched by Hartung and his team at Johns Hopkins University (Bottini and Hartung, 2009). The cost targets (capital and consumable cost) to replace animal testing are probably easier to meet than those to replace existing HTS.

5 **Barriers and Drivers for Change**

There is a clear market need for improvements in the drug discovery and development process, and this is validated by the eagerness with which pharmaceutical and cosmetics companies are evaluating new technologies, one of which is organ on a chip and *in silico* modeling another. However, inertia among researchers is recognized as a barrier to moving away from existing animal methods (Innovate UK, 2015). In addition, they are conservative and will need time to complete evaluation, validation, and adoption of the technology. Regulatory approval, if required, will take even longer. Apart from the technical challenges yet to be solved, the start-up companies that are championing the new methods face commercial issues. Some have raised significant equity investment to complement government grants and customer-sponsored research and development projects. Government grants to individual companies and to organizations supporting the 3Rs have been particularly helpful. In the United Kingdom, such grants have been part of the Innovate UK's roadmap to support the development of non-animal technologies (Innovate UK, 2015).

The current worldwide market for animal testing is estimated to be in excess of US\$30 billion (Bottini and Hartung, 2010); and it is most likely that the companies involved in that market (including contract research organizations offering animal testing) will fight hard to defend their current business, despite the ethical and scientific pressures for change. It is not only businesses that will fight to defend the status quo. Many academic careers are based on animal models, and it is not easy to make changes late in a career. In contrast, early-career researchers will be highly motivated to learn about new methods, but the peer review system for awarding grants will make it tough for them to get approval for ground-breaking and disruptive ideas. Centers of excellence are emerging to support animal replacement technologies. The Center

for Alternatives to Animal Testing (CAAT) at Johns Hopkins University in the US was one of the first and now has a satellite at the University of Konstanz in Germany. The UK has the Animal Replacement Centre of Excellence (ARC) at Queen Mary University, London; and Canada has just launched the Canadian Centre for Alternatives to Animal Methods (CCAAM) at the University of Windsor, Ontario. These centers will act as nuclei for further awareness creation, research funding, technology evaluation, and industry support. Their most effective action may be to train a new generation of researchers who are aware of the disruptive technology and are willing to become agents for change.

The conservatism of regulators is often cited as one of the most difficult barriers to overcome (Innovate UK, 2015). The production of an overwhelming body of scientific evidence may be the best long-term approach. After all, the regulators' role is to protect the public from the risks of exposure to harmful drugs and chemicals. In the absence of good *in vitro* models and data, they will always revert to what their colleagues have done for years before them, i.e., insist on animal testing. In the short term, there are other ways to introduce the new technology that do not need regulatory approval but utilize *in vitro* tests in parallel to reduce the number of drug candidates before they enter the expensive animal and clinical-testing phases. *In vitro* methods are then effectively being used to cause compounds to fail early, and the potential economic savings are immense. Additionally, as *in vitro* assays are implemented, they will be *validated* by improved success in subsequent clinical trials.

Figure 26.4 shows a representative comparison of the economic benefits of using advanced *in vitro* testing to reduce the number of drug compounds going forward into animal testing. By testing 25 compounds and eliminating 10 that have shown some adverse activity, only 15 go forward. The potential saving is US\$226 million, justifying a significant investment in the additional *in vitro* tests. This approach does not need regulatory approval because animal testing will still be used in the later stages, albeit on a reduced number of compounds. With these potential savings per drug candidate reaching the market, Yole Research's projection that the organ on a chip market could reach between US\$60 million and US\$176 million by 2022 does not seem unreasonable.

6 A Strategy for Accelerating the Paradigm Change Away from Animal Use

The previous sections described the technology, market opportunity, status of current developments, and barriers and incentives for change. Is there any way that we can accelerate this process and speed the adoption of methods that

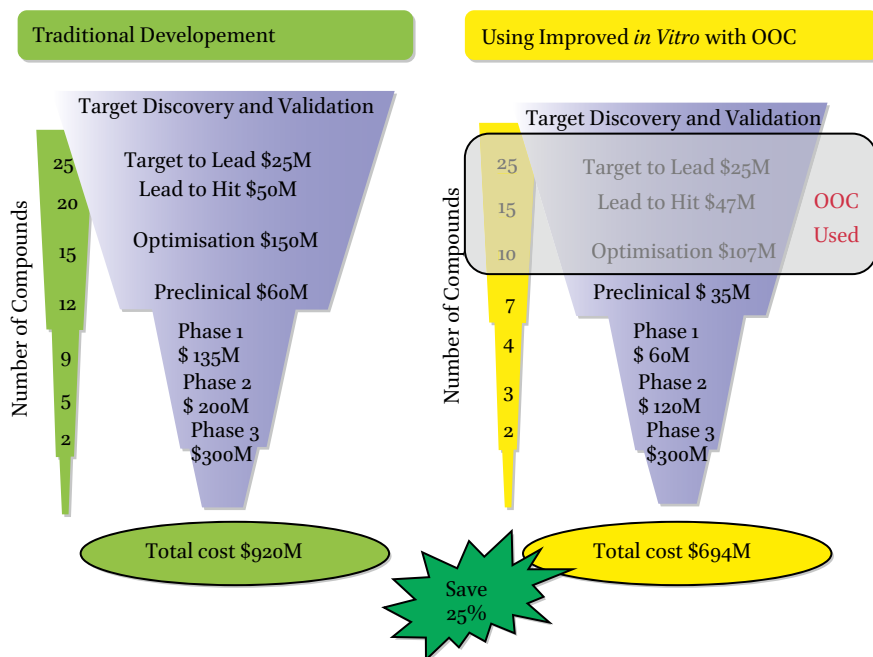

FIGURE 26.4 Potential cost benefits of using advanced *in vitro* methods, such as organ on a chip (OOC).

will save the lives of countless animals and reduce their suffering? Many years of research in the high technology industry show us that incremental change is much easier to push forward than disruptive change. Clearly, the full replacement of animals is a disruptive change. The candidate technology presented here is also disruptive, as it is not a natural outgrowth of existing biology or microtechnology but a fusion of the two. The technical challenges are enormous and require a multidisciplinary effort from biologists, pharmacologists, statisticians, computer modelers, plastic material and fabrication engineers, and many other experts. It is interesting that the challenge of bringing together scientists from different disciplines to work on, so-called, *grand challenges* has been addressed in several universities. Pisa University created the Centro Piaggio and Sheffield University the Kroto Centre with this express goal. Technical brilliance is not enough. The new technology has to be translated into a sustainable business, and that takes a whole different skill set. Entrepreneurship is needed.

The roadmap and strategy presented in Figure 26.5 describes an innovative approach to synthesizing disruptive change from a number of smaller, almost incremental steps. The foundation starts with good science from a few opinion

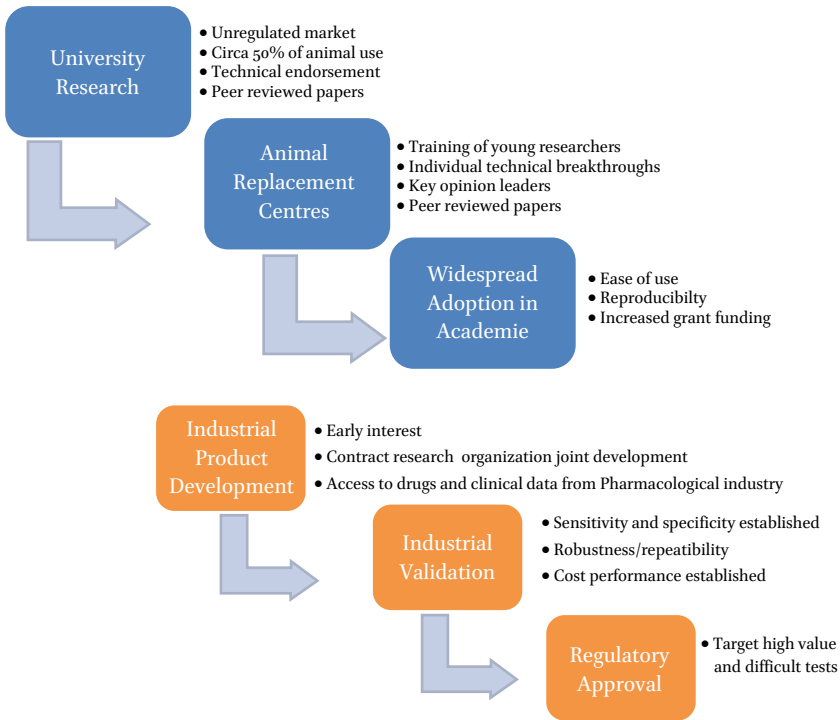

FIGURE 26.5 A roadmap and strategy for accelerating the adoption of alternative methods, showing parallel adoption in academia and industrial research.

leaders in the academic sector but leads on to the creation of centers of excellence that eventually drive widespread adoption of the new paradigm through academe. It is important to note that academic research accounts for about half of the total number of animals used in the UK. Industry adoption follows but is slower at first because of the need for extensive evidence to support claims of superiority for the emerging new technology. The early evidence comes from academics followed by the development of robust protocols by contract research organizations. The pharmacological industry is increasingly using contract research organizations to do validation and development work that may previously have been done in their own research and development laboratories.

Much of the current interest and excitement about organ on a chip technology is fueled by marketing hype and will soon be replaced by disillusionment unless practical working systems are delivered. Many of the venture capitalists investing in organ on a chip will expect immense financial return from the 10% of their portfolio that succeed. There are some very exciting technology

developments under way. Although some of these are several years away from the market, there is no doubt that within the next 3 to 5 years, we will see the start of a significant shift away from the use of animals.

References

- Accuray Research LLP (2016). *Organ on Chip Market Analysis and Trends — Organ, Application — Forecast to 2025*. [online] Available at: <https://www.researchandmarkets.com/reports/3951918/organ-on-chip-market-analysis-and-trends-organ> [Accessed 12 August 2018].
- Ahluwalia, A. (2004). Italian patent application. IT2004P100046.
- Bottini, A.A. and T. Hartung (2009). Food for Thought.... On the Economics of Animal Testing. *Alternatives to Animal Experimentation*, 26(1), pp. 3–16.
- Chandrasekera, P.C. and J.J. Pippin (2014). Of Rodents and Men: Species-specific Glucose Regulation and Type 2 Diabetes Research. *Alternatives to Animal Experimentation*, 31(2), pp. 157–176.
- Clerk, S. and M. Villien (2017). *Organs on Chips 2017, Market and Technology Report*. Yole Développement.
- Cook, S.A., A. Clerk and P.H. Sugden (2009) Are Transgenic Mice the “Alkahest” to Understanding Myocardial Hypertrophy and Failure. *Journal of Molecular and Cellular Cardiology*, 46(2), pp. 118–129.
- Davidge, K.S. and J. Bishop (2017). Improved IC50 Prediction Using Quasi Vivo®. *Society of Toxicology Annual Meeting, 2017*. Baltimore, MD.
- Eglen, R. (2017). The Use of Tumour Spheroids in Cancer Research. [video] Available at: <https://www.youtube.com/watch?v=pQdiAhNNrFY> [Accessed 12 August 2018].
- Esch, E.W., A. Bahinski and D. Huh (2015). Organs-on-chips at the frontiers of drug discovery. *Nature Reviews Drug Discovery*, 14(4), p. 248–260.
- Haycock, J., A. Ahluwalia and J.M. Wilkinson (2014). *Cellular In Vitro Testing: Methods and Protocols*. Singapore: Pan Stanford Publishing, pp. 1–13.
- Innovate UK (2015). *A non-animal technologies roadmap for the UK. Advancing predictive biology*. [online] Available at: https://www.nc3rs.org.uk/sites/default/files/documents/NonAnimalTechCO082_RYE_4_nrfinal2.pdf [Accessed 12 August 2018].
- Mestas, J. and C.C.W. Hughes (2004). Of Mice and Not Men: Differences Between Mouse and Human Immunology. *Journal of Immunology*, 172(5), pp. 2731–2738.
- Mullard, A. (2016). Parsing Clinical Success Rates. *Nature Reviews Drug Discovery*, 15, p. 447.
- Park, T.H. and M. Shuler (2003). Integration of Cell Culture and Microfabrication Technology. *Biotechnology Progress*, 19, pp. 243–253.

- Potashkin, J.A., S.R. Blume and N.K. Runkle (2011). Limitations of Animal Models of Parkinson's Disease. *Parkinson's Disease*, pp. 1–7.
- Ramachandran, S.D., K. Schirmer, B. Münst, S. Heinz, S. Ghafoory, S. Wölfl, K. Simon-Keller, A. Marx, C.I. Øie, M.P. Ebert and H. Walles (2015). *In Vitro* Generation of Functional Liver Organoid-like Structures Using Adult Human Cells. *PLoS One*, 10(10), p. e0139345. [online] Available at: <http://journals.plos.org/plosone/article?id=10.1371/journal.pone.0139345> [Accessed 12 August 2018].
- Redmond, C. (2019). When is an alternative not an alternative? Supporting progress for absolute replacement of animals in science. In: K. Herrmann and K. Jayne, eds., *Animal Experimentation: Working Towards a Paradigm Change*, Vol. 22. Leiden: Brill, pp. 654–672.
- Sung, J.H. and M.L. Shuler (2010). *In Vitro* Microscale Systems for Systemic Drug Toxicity Study. *Bioprocess Biosystem Engineering*, 33, pp. 5–19.
- Taylor, K., N. Gordon, G. Langley, and W. Higgins (2008). Estimates for Worldwide Laboratory Animal Use in 2005. *Alternatives to Laboratory Animals*, 36, pp. 327–342.
- Vinci, B., C. Duret, S. Klieber, S. Gerbal-Chaloin, A. Sa-Cunha, S. Laporte, B. Suc, P. Maurerel, A. Ahluwalia and M. Daujat-Chavanieu (2011). Modular Bioreactor for Primary Human Hepatocyte Culture: Medium Flow Stimulates Expression and Activity of Detoxification Genes. *Biotechnology Journal*, 6(5), pp. 554–564.
- Yoon, M., J. Pedersen, Y. Zhao and H.J. Clewell (2015). Why and How Do We Incorporate Metabolism and Kinetics in Integrated Testing and Assessment. *4th Annual ASCCT Meeting*. Durham, NC.

When Is an Alternative Not an Alternative? Supporting Progress for Absolute Replacement of Animals in Science

Craig Redmond

Lush Prize Management Team, Manchester, United Kingdom

craig@lushprize.org

1 Introduction

Despite a great deal of talk about “alternatives” to animal testing, and “replacing” animal use, there are no clearly agreed upon definitions for these terms. This has led to extensive numbers of animals used and accepted as “alternatives”—including zebrafish, invertebrates, animal tissues, embryos, sera, and animals’ eyes—despite the obvious fact that they will suffer and/or be killed for these methods. Instead, there is a confusing array of reference to live animals, vertebrates, and mammals being termed as “less sentient” or “conscious” species.

Much of the discussion on alternatives is still based around Russell and Burch’s (1959) 3Rs; although few, if any, of the definitions currently in use match their original writings, which were designed to be a foundation for future discussions. In the European Union (EU), Directive 2010/63/EU on the protection of animals used for scientific purposes defines its aim as representing “an important step towards achieving the final goal of full replacement of procedures on live animals for scientific and educational purposes, as soon as it is scientifically possible to do so” (European Parliament, 2010, Recital 10). Although this is a progressive step forward compared to previous legislation, use of the word *live* is often overlooked, as are so many other obstacles to a true end to all animal use in laboratory research. Talk of “replacing animal testing” and “alternatives” comes with little discussion about what those phrases actually mean; while researchers continue to use animal sera, tissues, and live animals that are perceived as less sentient.

This chapter addresses some of the areas in which animals are still used within “alternatives”-based research and calls on animal welfare and *in vitro* organizations to lead the debate and encourage absolute replacement of animal

use in research. Without this, progress to end animal research will always remain limited, despite the paradigm shift seen in recent decades.

2 Russell and Burch

Russell and Burch's concept of the 3Rs was no doubt radical when their book, *The Principles of Humane Experimental Technique*, was published in 1959 (hereinafter referred to as *The Principles*). Alan Goldberg (2010, p. 25), Founding Director of the Center for Alternatives to Animal Testing (CAAT), called it, "a monumental contribution". A special edition, containing the original text, was reissued in 1992; and an abridged version was translated into Mandarin and provided to Chinese public libraries and universities for free in 2014. The 3Rs have also been enshrined into EU legislation on animal experimentation. While *The Principles* has undoubtedly been vital to the discussion on animal research over the past 60 years, how relevant is it to the current situation? Has the scientific community, which often refers to the 3Rs, actually taken much of Russell and Burch's advice on board? These questions are pertinent because, as Tannenbaum and Bennett (2015, p. 120) commented, "*The Principles* was presented not as the final word of this science but as a foundation for future developments".

Russell and Burch (1959/1992) defined the 3Rs as *replacement*: "the substitution for conscious living higher animals of insentient material"; *reduction*: "reduction in the numbers of animals used to obtain information of a given amount and precision"; and *refinement*: "any decrease in the incidence or severity of inhumane procedures applied to those animals which still have to be used". This chapter focuses on *replacement*, and how the terms *replacement* and *alternatives to animal experimentation* are defined across the scientific and non-governmental organization sectors.

3 Replacement: Relative and Absolute

Russell and Burch defined *replacement* as "any scientific method employing non-sentient material" that may replace the use of "conscious living vertebrates". Tannenbaum and Bennett (2015, p. 126) add that *replacement*, "is defined as the use of *insentient* (or non-sentient) material instead of sentient material. Russell and Burch do not define replacement as not using animals because they classify the use of *insentient animals as instances of*

replacement. They distinguish between what they call *relative* and *absolute* replacement.”

3.1 *Relative Replacement*

“In relative replacement, animals are still required, though [...] they are exposed, probably or certainly, to no distress at all. In absolute replacement, animals are not required at all at any stage. It follows from what has been said earlier that absolute replacement may be regarded as the absolute ideal” (Russell and Burch, 1959/1992). Relative replacement may include: “non-recovery experiments on living and intact but completely anesthetized animals”; “experiments in which animals are still required but only to furnish preparations after being painlessly killed”; and “work on the isolated cells, tissues, or organs of vertebrates” (Russell and Burch, 1959/1992). The Institute for Laboratory Animal Research (ILAR) (ILAR, 2011, p. 5) refers to relative replacements as “replacing animals such as vertebrates with animals that are lower on the phylogenetic scale”. ILAR is not unique in its deviation from Russell and Burch’s definition, as it appears common for species of “lower sentience” to be considered as (relative) “replacements”, without any obvious consideration or discussion of what *less sentient* means or what evidence it is based on. This is perhaps one of the reasons why, in recent years, zebrafish have been promoted as an alternative, as the following example shows: “another 3Rs approach involves the replacement of more sentient vertebrates with animals thought to have a lower potential for pain perception, such as the amoeba *Dictyostelium discoideum*, fruit fly *Drosophila melanogaster* and zebrafish” (Tanner and McShane, 2016, p. 3). The examples that Russell and Burch gave of species they considered to be replacements (“the more degenerate metazoan endoparasites”) were included because they believed “that they are completely non-sentient, not because they are *less sentient*” (Tannenbaum and Bennett, 2015, p. 127).

3.2 *Absolute Replacement*

“Turning to absolute replacement, we may distinguish four main subdivisions: the use (outside the vertebrate body) of metazoan endoparasites; higher plants; microorganisms (protozoa, bacteria, molds, etc.); and nonliving physical and chemical systems. First, there is the study of metazoan endoparasites (nematodes, cestodes, and trematodes) *in vitro*, as opposed to their study in the living vertebrate host” (Russell and Burch, 1959/1992). Provisions were still made in *The Principles* for the use of members of the animal kingdom with *absolute* replacement, whereas the more widely accepted opinion now is that no animal or animal-derived material be involved (Gunatilake, 2016; Lidbury and Richardson, 2012). The replacement models that have so far been

introduced by the scientific community are mostly relative, not absolute, and more encouragement needs to be given to progress further in this area. Scientific conferences on alternatives to animal use often seem to focus on reduction and refinement, with very little discussion on replacement. Michael Balls, of the Fund for the Replacement of Animals in Medical Experiments (FRAME) noted that, “it is impossible to avoid the conclusion that it [replacement] is the forgotten R, even though Russell and Burch saw it as of great importance” (2010, p. 21). Balls added that there is “a danger that refinement can be used as a convenient way of showing commitment to the 3Rs, whilst ensuring that animal experimentation is seen as respectable and can be allowed to continue, while the fundamental ethical questions raised by it are avoided”.

4 What Is an Alternative?

Are “alternatives” and “replacement” the same thing? The United States Department of Agriculture (USDA) (2017) refers to *alternatives* as “a term that has different meanings to different people and this difference largely depends on which side of the issue one is found”. “Alternatives” are generally based on the 3Rs, although the terms “alternatives” and “alternative methods” never occur in *The Principles*. The word “alternatives” should be considered to only refer to Replacement, yet this is not how it is always viewed.

The European Union Reference Laboratory for Alternatives to Animal Testing (EURL ECVAM) (2017) defines “alternative” as “generally associated with the Principles of the 3Rs [...] In this context an alternative method serves to fully replace an animal test, to reduce the number of animals needed in a test, or to refine an animal testing procedure in order to reduce pain and suffering.” In its “step-by-step approach to an alternatives search,” CAAT suggests that, in addition to cell culture and tissue culture, researchers “might look for non-mammalian animal models—fish or invertebrates, for example—that would still give you the data you need” (Center for Alternatives to Animal Testing, n.d.). However, even using mammals is not always ruled out. The UK Government has referred to transgenic mice being used “to replace non-human primates” in oral polio vaccine safety tests (Home Office, 2014, p. 14). The EU-funded, RETHINK project evaluated the potential for minipigs “as an alternative approach” to using dogs and non-human primates in regulatory toxicity testing that can contribute to the 3Rs. Although the argument was made that this met the criteria for refinement, Forster et al. (2010) noted that, “the concept of replacement does not embrace the notion of replacing one class of sentient mammal (e.g. primates) by another (minipigs)” (p. 239).

Others consider a non-animal approach to be one that does not use *live* animals (Clippinger et al., 2016, p. 453). AltTox.org (2017), “a website dedicated to advancing non-animal methods of toxicity testing” lists “alternative methods” for assessing eye irritation/serious eye damage for regulatory testing purposes, some of which still use animals, including cow, rabbit, and chicken eyes.

So, does the term “alternative” apply to any of the 3Rs, all live animals, mammals only, or perhaps just vertebrates? The terms “alternatives to animal testing”, as well as “replacement”, appear to be used very loosely by stakeholders on all sides of the discussion. While the general public are often led to believe, or at least not corrected when they do believe, that these terms mean that no animal use whatsoever is involved, this is all too often not the case. Philosopher Joel Marks (2012, p. S18) writes that “the so-called alternatives movement commonly contains a fatal loophole. For while a layperson may assume that the term ‘alternative’ refers to the use of some wholly nonanimal method of research [...] in fact, it often means an animal ‘down the phylogenetic scale’”. Marks believes that, “it is really only full replacement of animals in biomedical research that merits the name ‘alternative’. Any alternative to that understanding of ‘alternatives’ is unjustified, not only in word but in deed.” (2012, p. S18).

5 Which Animals Are Protected?

animal [...] a. A living organism which feeds on organic matter, typically having specialised sense organs and a nervous system and able to respond rapidly to stimuli; any living creature, including man. [...]

b. In ordinary or non-technical use: any such living organism other than a human being.

Oxford English Dictionary, 2016

Legislation to protect animals used in laboratory experimentation does not protect all animals. Directive 2010/63/EU (European Parliament, 2010), the key EU legislation relating to animals used for scientific purposes, applies to the following animals (Article 1 (3)): “1. (a) live non-human vertebrate animals, including: (i) independently feeding larval forms; and (ii) foetal forms of mammals as from the last third of their normal development; 2. (b) live cephalopods.” The Animal Welfare Act (AWA) regulates the use of animals in laboratories in the United States as well as other animal use, including zoos and circuses. The term *animal* in the AWA includes specific species in some, but not all, situations and specifically excludes rats of the genus *rattus* and mice of the genus *mus* as well as birds used in research (USDA, 2017). AWA also excludes

cold-blooded animals (fish, reptiles, and amphibians), as well as farmed animals used in agricultural research (e.g., cows and pigs); as such fewer than 10% of animals in US laboratories are covered by the AWA (New England Anti-Vivisection Society, 2017). Mice alone make up more than three-quarters of the animals used by the top federally-funded US test centers (Kaiser, 2015). Other countries have different legislation on what species (if any) are protected in experimentation.

6 “Alternatives” that Still Exploit Animals

6.1 *Fish*

There has been a greater increase in the use of fish in research in the EU than any other species (European Commission, 2013, p. 9). In the United Kingdom, fish are the second most used animals after mice (Home Office, 2015, p. 11). Zebrafish (*Danio rerio*) have been the focus of much attention, and they now account for 50% of all fish used in UK laboratories, partly due to the availability of genetically altered zebrafish for use in basic and applied biomedical research (Home Office, 2015, p. 23). A major reason for the increase in the use of zebrafish is their reduced cost compared to mammals (Reed and Jennings, 2011, p. 14; maintenance costs are less than 1/1,000th of the cost for mice); and a pair of zebrafish can produce 100–300 eggs per week, making their embryos a “suitable model” for high throughput screening (van Vliet, 2011, p. 24). Zebrafish have now become established as a “widely accepted relative replacement model” (Gunatilake, 2016).

Researchers at the University of British Columbia reviewed existing literature on public acceptance of using particular species in laboratories and found that fish and invertebrates were “typically rated below mammals, and, as such, are often considered an appropriate replacement for mammals in research” (Ormandy, Schuppli and Weary, 2012, p. 321). Although their own study found that when the research was deemed to cause pain to zebrafish (specifically when it came to ENU mutagenesis) survey participants objected to it (p. 331), it may explain why even some *in vitro* organizations promote the use of zebrafish (Gunatilake, Busquet and Akbarsha, 2014; M'Barek et al., 2015). Sweeping statements are often made in support of using fish instead of mammals in research, with no real attempt to back them up. Planchart et al. (2016, p. 435) claim that, “Small freshwater fish models, especially zebrafish, offer advantages over traditional rodent models, including [...] reduced animal welfare concerns”. An article on the website of the British Association of Zebrafish Husbandry claims that, “their mental and physical concerns may be deemed less than those of

a rodent for example [...] Because of the widespread use of the unprotected larval form of zebrafish there is currently little emphasis on replacing aspects of this use" (Nicholls, 2012).

In the UK, the Royal Society for the Prevention of Cruelty to Animals (RSPCA) has highlighted concerns over zebrafish use in research (Reed and Jennings, 2011), including:

- Specific husbandry requirements are still poorly understood.
- The majority of experiments, which involve embryonic and early larval (less than six days post-hatching) stages, would not be covered and reported by legislation.
- Some practices do not require reporting in the annual Home Office statistics, including the humane killing of zebrafish by an approved method in order to obtain tissues, organs, sperm or eggs; and the use of zebrafish in breeding programs (unless they are genetically modified).

Evidence that fish, like all vertebrate animals, feel pain was first presented almost 40 years ago (RSPCA, 1980). The UK government's Farm Animal Welfare Committee (1996) subsequently acknowledged that fish experience fear, stress, and pain when removed from water; and that the physiological mechanisms in fish for experiencing pain are very similar to those in mammals. More recently, fisheries professor, Victoria Braithwaite (2010) wrote that, "I have argued that there is as much evidence that fish feel pain and suffer as there is for birds and mammals—and more than there is for human neonates and preterm babies". Fish behavior and welfare scientist, Yue Cottee, added (2010) that, "We now have logical reason and scientific evidence to start treating fish as sentient creatures" (p. 13); and "it now seems that the question to be asking is not 'Do fish have conscious awareness' but 'What is the level and nature of their conscious awareness?'" (p. 12). The RSPCA conclude that, "Although there has been little specific study involving zebrafish, given the above [evidence that fish feel pain], zebrafish should be given the benefit of any doubt" (Reed and Jennings, 2011, p. 41).

6.2 *Vertebrates in Early Developmental Stages/Use of Animal Embryos*

Under Directive 2010/63/EU (European Parliament, 2010), vertebrates only become protected animals at a particular stage in their development: the last third of gestation (mammals); incubation (birds and reptiles); or the stage when independent feeding occurs (amphibians and fish), for example, early chicken embryos in reproductive toxicity tests. Such cut-off points have been criticized as "arbitrary and unsatisfactory" and not based on any strong scientific basis (Balls, 1994, p. 197).

The fish embryo toxicity (FET) test is considered “a possible alternative to the acute fish [toxicity] test” (PETA International Science Consortium, 2015a). This test exposes at least seven fish to the test substance for a period of 96 hours to record the concentrations that kill 50% of them (LC₅₀) (Organisation for Economic Cooperation and Development, OECD, 1992). FET uses 20 freshly-fertilized embryos per treatment or control (Chemical Watch, 2015), mostly zebrafish, fathead minnow, rainbow trout, bluegill, and Medaka. At an international symposium on using fish and amphibian embryos as alternative models, it was stated that, “In compliance with international animal welfare regulations, the fish and amphibian embryo models provide an ethically acceptable small scale analysis system with the complexity of a complete organism [...] The ultimate goal of the symposium is to promote the development of the fish and frog embryo models as potential alternatives to animal testing.” (Helmholtz Centre for Environmental Research, 2016). A footnote to an article on the Chemical Watch website (2015) about FET highlights some of the ongoing confusion: “This article was amended on 17 April to clarify that the fish embryo toxicity (FET) test is not considered a replacement to animal testing, as fish embryos are animals. However, the use of fish embryos up to a certain age does not fall under Directive 2010/63/EU on the protection of animals used for scientific purposes.”

6.3 *Body Parts*

Animal parts used as “alternatives” to animal testing (or classed as a “non-animal method” (Clippinger et al., 2016), include the eyes of animals slaughtered for consumption. Examples are the Bovine Corneal Opacity and Permeability assay (BCOP), seen as a substitute for the Draize eye irritation test that uses live rabbits (in which a substance is instilled into one of the rabbit’s eyes to assess injury for up to 21 days). The BCOP test method can be used to identify chemicals causing serious eye damage. The OECD (Organisation for Economic Co-operation and Development, 2017) states that the test “uses isolated corneas from the eyes of cattle slaughtered for commercial purposes, thus avoiding the use of laboratory animals”. Along with the isolated chicken eye (ICE) and Isolated Rabbit Eye (IRE) tests, the BCOP assay is validated by regulatory bodies, including the OECD and Interagency Coordinating Committee on the Validation of Alternative Methods (ICCVAM), as well as promoted by *in vitro* and animal protection organizations (Humane Society International, 2013; Institute for In Vitro Sciences, 2014; PETA International Science Consortium, 2015b), although again there appears to be no discussion over the ethical considerations of this.

6.4 *Invertebrates*

Invertebrates are generally exempt from any animal welfare legislation, and little consideration is given to their animal care requirements or suitability for captive conditions (Carere, Wood and Mather, 2011), with one exception. Since 2013, all cephalopod species (e.g., octopus, squid, and cuttlefish) used in research have been regulated within the EU by Directive 2010/63/EU (European Parliament, 2010), giving them the same legal protection as vertebrates because of their capacity to experience pain and suffering. Several other non-EU countries also regulate their use. Some reviewers believe that decapod crustacea (e.g., crabs, lobsters) may receive similar protection in the future “because of the continuing debate about their pain perception” (Fiorito et al., 2014, p. 15). The horseshoe crab, *Limulus polyphemus*, is used in the Limulus amoebocyte lysate (LAL) assay to replace the rabbit pyrogen test for the detection of endotoxin in Hepatitis B vaccines (Park et al., 2005). The rabbit test involves injecting the test substance into the ears of three rabbits (WHO, 2016). However, the LAL assay uses blood cells from the horseshoe crab, with up to 30% mortality due to bleeding (Leschen and Correia, 2010, p. 144).

Russell and Burch (1959/1992) stated that replacement means using *completely insentient* material, animal or non-animal. Tannenbaum and Bennett (2015, p. 127) noted that, “using animals that are *less sentient* [...] is inconsistent with their definition [...] They explicitly argue that, because of more limited mental capacities that prevent them from understanding and dealing with distressful experiences, for lower vertebrates a given level of distress is probably worse than it is for a higher vertebrate species.”

6.5 *Animal-based Sera*

Fetal calf serum (also known as fetal bovine serum) is the most widely-used serum supplement for *in vitro* cell culture (Seralab, 2017). Bovine fetal blood is collected by cardiac puncture, performed by inserting a needle directly into the heart of the unanesthetized fetus in a specially provided area in the slaughterhouse (International Serum Industry Association, 2017). Other products are sold as a lower cost alternative and for veterinary vaccines, such as horse, goat, rabbit, porcine, and chicken serum (Thermo Fisher Scientific, 2017). Blood may be taken at the time of slaughter for consumption or obtained from what is euphemistically called “donor” animals, from whom blood is taken more than once.

In a survey of companies and laboratories involved with the collection and use of fetal calf serum (FCS), Jochems et al. (2002) concluded that:

- The time that elapses between death of the mother cow and the puncture was found to be up to 30 minutes, with the procedure of bleeding itself lasting another 2–5 minutes. So, a bleeding procedure may last up to 35 minutes after the death of the mother (pp. 4–5).

- It is very likely that the fetus is alive at the time of blood collection and “will experience pain and/or suffering at the moment of heart puncture for blood collection and possibly for a period after that, until it actually dies” (p. 8).
 - “Exsanguination and cardiac puncture (penetrating skin, internal and external intercostal muscles, costal pleura, heart muscle, and heart pleura) are both graded as severe discomfort in unanesthetized post-natal bovines. From this, we have to conclude that the current practice of blood collection from fetal bovines causes suffering to these animals” (p. 11).
 - The global number of bovine fetuses used annually is 1–2 million (p. 5).
- Oredsson (2013), a researcher at Lunds University, stated that, “The very use of fetal calf serum actually defeats the purpose of using cell culturing as replacement for animals in research”. Jochems et al. (2002, p. 13) similarly argue that, “The thought that cell culture techniques requiring FBS are a replacement to the use of animals is a misconception.”

6.6 *Antibodies*

Traditionally, antibodies against a specified target are produced by injecting the antigen into an animal and initiating an immune response (Afability, 2017). Animals are repeatedly injected with the molecule to be detected, initiating a hyperimmune response. An unknown number of animals (millions) are used worldwide to generate the antibodies that are extracted at a later stage for the detection of the molecule. Gray et al. (2016) note that, although the extracted antibodies are incorporated into an *in vitro* test, this traditional method is not a replacement of animal testing but simply buries the animal use “several layers deep in the production process, and our ultimate aim, to replace needless animal use, is not achieved” (p. 961). Gray and colleagues have called for the proper implementation of Directive 2010/63/EU, which requires that animals not be used when a non-animal alternative exists. They also recommend that the European Union Reference Laboratory for Alternatives to Animal Testing (EURL ECVAM) extends its activities to include the production of animal-friendly affinity reagents (AFAS) and their subsequent use (p. 967). In addition, there are reported concerns about the quality and unreliability of commercial, animal-derived antibodies (Groff, Brown and Clippinger, 2015, p. 1788); and scientists are being encouraged to use the non-animal affinity reagents that are available.

6.7 *Tissues*

Living material for vertebrate tissue culture has to be obtained from animals or humans. Although it may be sourced from animals killed for food (which, in itself, is an ethical issue to consider), it is more likely to be obtained from animals specifically-bred and killed for the purpose because of requirements,

such as a sterile technique (Balls, 1994, p. 197). Data collected for EU Member States excludes animals killed solely to supply tissues for *ex vivo* or *in vitro* use; but for the six countries that Taylor et al. (2008, p. 331) obtained data, the average percentage of animals killed for their tissues was 21.1%. Philosopher Joel Marks (2012, p. S18) considers it absurd that “the very same animal (both species and individual) can be used as an ‘alternative’. This is due to two additional ambiguities. One of them is between an experiment on a whole animal and an experiment on tissue taken from an animal of the same species. The latter can be considered an ‘alternative’ but of course the animal is still bred, confined, and subject to various procedures”.

7 The Role of Regulatory Bodies in Promoting Animal-based Testing

It has been shown that “alternatives” to animal testing do not always mean that no animals or animal substances are used. Many of the “alternatives” endorsed by EURL ECVAM, ICCVAM, and/or the OECD still use animals in some way, for example (PETA International Science Consortium, n.d.):

- Rat skin transcutaneous electrical resistance (TER) test for skin corrosion
- Murine local lymph node assay (LLNA) for skin sensitization
- Bovine corneal opacity and permeability (BCOP) test method and Isolated Chicken Eye (ICE) test method for eye corrosion/eye irritation
- Whole rat embryo toxicity assay for reproductive toxicity
- FET test and *Daphnia* sp., acute immobilization test for aquatic toxicity.

Scientists and organizations working on promoting absolute replacement of animal tests need to be proactive in ensuring that regulatory bodies are fully aware of these alternatives, and why their validation is preferable to those that currently exploit animals. This may involve training regulatory reviewers in the new methods.

A review of companies manufacturing antimicrobial cleaning products to discover why so few were submitting non-animal data for regulatory purposes (Clippinger et al., 2016, p. 455) found there was a lack of global regulatory acceptance (meaning that animal tests would likely be conducted anyway, since it was required by other countries or authorities); and uncertainty within industry about regulatory reviewers’ familiarity with the framework and their ability to evaluate and interpret non-animal studies, which could influence the likelihood of acceptance. The authors concluded that, “Overcoming institutional inertia at companies and regulatory agencies requires collaboration among a motivated group of people across multiple sectors.” (p. 455). The multistep process of implementation includes education of regulatory and industry personnel before a non-animal method is finally accepted.

8 Encouraging True Replacement: Lush Prize

The Lush Prize is an annual prize fund supporting initiatives across science, campaigns, and regulatory lobbying to end the use of animals in research, particularly toxicology. A joint project between Lush Cosmetics and the Ethical Consumer Research Association, it provides £250,000 in funding each year in the main prize categories, with additional funds provided through regional awards in Asia and the Americas (Lush Prize, 2017a).

Unique in being a 1R award (focusing on absolute replacement as opposed to 3Rs), the Lush Prize has strict eligibility guidelines (Lush Prize, 2017b), including:

- “Non-animal research in this sense means no use of non-human animals (including all vertebrates and invertebrates) or primary animal cells, embryos, tissues, organs and serums. Human biology-based approaches are strongly encouraged, although the use of established cell lines of non-human animal origin shall not necessarily be excluded.” (Immortalized cell lines can keep undergoing division, so no new animals are killed for them).
- “The prize money shall be ring-fenced for non-animal use so that it cannot be used to fund any animal testing whatsoever.”
- “In awarding the prize to academic institutions, priority will be given to research teams or groups which deal exclusively with non-animal research.”

The five categories of prize are designed to complement each other in breaking down the barriers to end animal testing. It supports science, so that scientist can come up with new tests; training, so that scientists can learn how to use the new tests, and young researchers can learn how to discover new tests early in their careers; lobbying, so that governments can be persuaded to make the new tests compulsory; public awareness, so that the governments can be pressured to make these changes (Lush Prize, 2016).

In addition to the financial support, the Lush Prize raises the profile of absolute replacement through an annual conference and a special edition of the *Alternatives to Laboratory Animals* journal, highlighting the work of awarded scientists who are helping to achieve the paradigm shift towards true replacement.

9 Conclusions

Whilst the issue of animal testing is the subject of a great deal of public discourse, there has been little discussion about what defines “replacement” or “alternatives”. Regulatory bodies and many scientists working in “alternatives” are not particularly concerned about some of the animal use mentioned here.

Their focus, as highlighted in Directive 2010/63/EU (European Parliament, 2010), is the use of *live* animals. What is of greater concern is the quiet acceptance, or even active promotion, of animal-based research by animal welfare and *in vitro* organizations. They should be setting the standards and always pushing for absolute replacement; otherwise, progress will remain limited.

The Lush Prize has begun to put this discussion on the agenda, not only with its strict eligibility criteria, but also through its conferences. Its 2014 conference was titled, *Is One R the new Three Rs?*, and asked “Does the consensus building around 21st Century Toxicology—a wholly replacement model (*1R*)—mean that the 3Rs framework (refinement, reduction, replacement) is an idea that has had its day?” (Lush Prize, 2014). There needs to be honesty among regulators and the research community that the use of any animal product is not a complete replacement or an alternative, only then can there be encouragement to fully replace animal testing with ethical and reliable human-relevant models.

Russell and Burch’s 3Rs have played a crucial role in developing ideas on replacing the use of animals in experimentation, and much of what they wrote in 1959 is still valid today. However, we need to update the terms “alternative” and “replacement” to reflect our goal of completely ending the use of all animals in research and stop being complacent in thinking that *partially* replacing animal use is sufficient. It will be the role of non-governmental organizations and those scientists who truly believe in the goal of complete replacement to lead this progression, to agree on definitions and ensure that they begin to be used across all sectors, including industry and academia. As Tannenbaum and Bennett (2015, p. 120) commented, Russell and Burch did not see their writings as the final word on this but “a foundation for future developments”.

References

- Afability (2017). *What Are Antibodies?*. [online] Available at: <http://www.afability.com/services-view/what-are-antibodies/> [Accessed 2 January 2017].
- AltTox.org (2017). *Eye Irritation/Serious Eye Damage*. [online] Available at: <http://alttox.org/mapp/toxicity-endpoints-tests/eye-irritationcorrosion/> [Accessed 4 January 2017].
- Balls, M. (1994). Replacement of Animal Procedures: Alternatives in Research, Education and Testing. *Laboratory Animals*, 28(3), pp. 193–211.
- Balls, M. (2010). The Principles of Humane Experimental Technique: Timeless Insights and Unheeded Warnings. *Alternatives to Animal Experimentation*, 27, pp. 19–23.

- Braithwaite, V. (2010). *Do fish feel pain?* Oxford, UK: Oxford University Press.
- Carere, C., J.B. Wood and J. Mather (2011). Species Differences in Captivity: Where Are the Invertebrates? *Trends in Ecology & Evolution*, 26(5), p. 211.
- Center for Alternatives to Animal Testing (n.d.). *Search for Alternatives*. [online] Available at: <http://altweb.jhsph.edu/resources/searchalt/index.html> [Accessed 4 January 2017].
- Chemical Watch (2015). *Fish Embryo Toxicity Tests Satisfy REACH Requirements*. [online] Available at: <https://chemicalwatch.com/23558/fish-embryos-can-replace-fish-in-reach-testing> [Accessed 26 September 2016].
- Clippinger, A.J., E. Hill, R. Curren and P. Bishop (2016). Bridging the Gap Between Regulatory Acceptance and Industry Use of Non-Animal Methods. *Alternatives to Animal Experimentation*, 33(4), pp. 453–458. [online] Available at: <https://www.altex.org/index.php/altex/article/view/143/123> [Accessed 16 August 2018].
- Cottee, S.Y. (2010). Are fish the victims of 'speciesism'? A discussion about fear, pain and animal consciousness. *Fish Physiology and Biochemistry*, 38(1), pp. 5–15.
- European Commission (2013). *Seventh Report from the Commission to the Council and the European Parliament on the Statistics on the Number of Animals Used for Experimental and Other Scientific Purposes in the Member States of the European Union*. COM(2013)859/final. [online] Available at: <http://eur-lex.europa.eu/legal-content/EN/TXT/?uri=CELEX:52013DC0859> [Accessed 7 January 2017].
- European Parliament (2010). Directive 2010/63/EU of the European Parliament and of the Council of 22 September 2010 on the protection of animals used for scientific purposes. *Official Journal of the European Communities*, L 276, pp. 33–79. [online] Available at: <http://eur-lex.europa.eu/legal-content/EN/TXT/?uri=CELEX:32010L0063> [Accessed 7 January 2017].
- European Union Reference Laboratory for Alternatives to Animal Testing (EURL-ECVAM)(2017). *Alternative Test Methods*. [online] Available at: <https://eurl-ecvam.jrc.ec.europa.eu/glossary/glossary/alternative-test-methods> [Accessed 2 January 2017].
- Farm Animal Welfare Council (1996). *Report on the Welfare of Farmed Fish*. Department for Environment, Food & Rural Affairs, UK Government.
- Fiorito, G., A. Affuso, D.B. Anderson, J. Basil, L. Bonnaud, G. Botta, A. Cole, L. D'Angelo, P. De Girolamo, N. Dennison and L. Dickel (2014). Cephalopods in Neuroscience: Regulations, Research and the 3Rs. *Invertebrate Neuroscience*, 14(1), pp. 13–36.
- Forster, R., G. Bode, L. Ellegaard and J.W. Van der Laan (2010). The RETHINK Project on Minipigs in the Toxicity Testing of New Medicines and Chemicals: Conclusions and Recommendations. *Journal of Pharmacological and Toxicological Methods*, 62(3), pp. 236–242.

- Goldberg, A.M. (2010). The Principles of Humane Experimental Technique: Is It Relevant Today? *Alternatives to Animal Experimentation*, 27, pp. 25–27.
- Gray, A.C., S.S. Sidhu, P.C. Chandrasekera, C.F.M. Hendriksen, C.A.K. Borrebaeck (2016). Animal-Friendly Affinity Reagents: Replacing the Needless in the Haystack. *Trends in Biotechnology*, 34 (12), pp. 960–969. [online] Available at: [https://www.cell.com/trends/biotechnology/fulltext/S0167-7799\(16\)30063-4](https://www.cell.com/trends/biotechnology/fulltext/S0167-7799(16)30063-4) [Accessed 16 August 2018].
- Groff, K., J. Brown, A.J. Clippinger (2015). Modern affinity reagents: Recombinant antibodies and aptamers. *Biotechnology Advances*, 33(8), pp. 1787–1798.
- Gunatilake, M. (2016). Zebrafish, *Danio Rerio* as a Replacement Alternative. In: *Asian Congress 2016 on Alternatives and Animal Use in the Life Sciences*. Saga: Japanese Society for Alternatives to Animal Experiments. [online] Available at: <http://www.asas.or.jp/jsaae/eng/events/pdf/asian2016/AS1-3.pdf> [Accessed 16 August 2018].
- Gunatilake, M., F. Busquet, M.A. Akbarsha (2014). Workshop Report: Alternatives Initiative in Sri Lanka: Pre- and Post-conference Workshops at the Inaugural Scientific Conference of the Sri Lanka Association for Laboratory Animal Science. *Alternatives to Animal Experimentation*, 31(2), pp. 224–226. [online] Available at: http://www.altex.ch/resources/altex_2014_2_224_226_Gunatilake1.pdf [Accessed 16 August 2018].
- Helmholtz Centre for Environmental Research (2016). *Fish and Amphibian Embryos as Alternative Models in Toxicology and Teratology, An International Symposium & Workshop*. France: Helmholtz Centre for Environmental Research (UFZ). [online] Available at: <http://www.ufz.de/fish-frog-embryo/index.php?en=30159> [Accessed 12 January 2017].
- Home Office (2014). *Working to Reduce the Use of Animals in Scientific Research*. UK Home Office Delivery Plan, February 2014. [online] Available at: https://assets.publishing.service.gov.uk/government/uploads/system/uploads/attachment_data/file/277942/bis-14-589-working-to-reduce-the-use-of_animals-in-research.pdf [Accessed 12 January 2017].
- Home Office (2015). *Annual Statistics of Scientific Procedures on Living Animals Great Britain 2014*. [online] Available at: https://assets.publishing.service.gov.uk/government/uploads/system/uploads/attachment_data/file/469508/spanimals14.pdf [Accessed 12 January 2017].
- Humane Society International (2013). *Press Release: Be Cruelty-free Campaign to End Cosmetics Animal Testing in China Launches with Pop Singer Wang Feifei, NGOs, and Industry*. [online] Available at: http://www.hsi.org/news/press_releases/2013/06/bcf_china_launch_062813.html [Accessed 26 September 2016].
- Institute for In Vitro Sciences (2014). *European Association Supports Production of Training Videos for Non-Animal Tests*. [online] Available at: <http://www.prnewswire>

- .com/news-releases/european-association-supports-production-of-training-videos-for-non-animal-tests-282413451.html [Accessed 19 September 2016].
- Institute for Laboratory Animal Research (ILAR) (2011). *Guide for the Care and Use of Laboratory Animals*. 8th ed. Institute for Laboratory Animal Research. [online] Available at: <https://grants.nih.gov/grants/olaw/Guide-for-the-Care-and-Use-of-Laboratory-Animals.pdf> [Accessed 12 January 2017].
- International Serum Industry Association (2017). *How Is Bovine Serum Produced and Tested?*. [online] Available at: <http://www.serumindustry.org/faq.htm> [Accessed 12 January 2017].
- Jochems, C.E., van der J.B. Valk, F.R. Stafleu and V. Baumans (2002). The Use of Fetal Bovine Serum: Ethical or Scientific Problem?. *Alternatives to Laboratory Animals*, 30(2), pp. 219–228.
- Kaiser, J. (2015). PETA Study Finds ‘Dramatic’ Rise in Use of Lab Animals in United States. *Science*, 25.2.15. [online] Available at: <http://www.sciencemag.org/news/2015/02/peta-study-finds-dramatic-rise-use-lab-animals-united-states> [Accessed 12 January 2017].
- Leschen, A.S. and S.J. Correia (2010). Mortality in Female Horseshoe Crabs (*Limulus polyphemus*) from Biomedical Bleeding and Handling: Implications for Fisheries Management. *Marine and Freshwater Behaviour and Physiology*, 43(2), pp. 135–147.
- Lidbury, B.A. and A.M. Richardson (2012). A Pattern Recognition Bioinformatics Alternative System to Rodent Models in Fundamental Research, World Congress in Animal Alternatives in the Life Sciences. *Alternatives to Animal Experimentation Proceedings*, 1, Proceedings of WC8, pp. 515–520. [online] Available at: http://www.alteX.ch/resources/515520_Lidbury21.pdf [Accessed 16 August 2018].
- Lush Prize (2014). *Lush Prize Conference 2014*. [online] Available at: <http://lushprize.org/2014-prize/lush-prize-conference-2014/> [Accessed 11 January 2017].
- Lush Prize (2016). *Story of the Lush Prize* [video]. [online] Available at: <https://vimeo.com/album/4224606/video/189340290> [Accessed 20 January 2017].
- Lush Prize (2017a). *About the Lush Prize*. [online] Available at: <http://lushprize.org/awards/> [Accessed 11 January 2017].
- Lush Prize (2017b). *Eligibility*. [online] Available at: <http://lushprize.org/awards/eligibility/> [Accessed 11 January 2017].
- Marks, J. (2012). Accept No Substitutes: The Ethics of Alternatives. In: S. Gilbert, G.E. Kaebnick and T.H. Murray, eds., *Animal Research Ethics: Evolving Views and Practices*. Hastings Center Report Special Report 42, no. 6. Hoboken: Wiley-Blackwell. [online] Available at: http://www.thehastingscenter.org/uploadedFiles/Publications/Special_Reports/AnimalResearchEthics.pdf [Accessed 11 August 2018].
- M'Barek, S., C. Pellevoisin, C. Chesné, F. Busquet and O. Souilem (2015). Workshop Report: First Training on Alternatives to Animal Experimentation in Tunisia.

- Alternatives to Animal Experimentation*, 32(4), pp. 388–390. [online] Available at: http://www.altex.ch/resources/WE_388_390.pdf [Accessed 16 August 18].
- New England Anti-Vivisection Society (NEAVS) (2017). *Laws and Regulations: Animal Welfare Act*. [online] Available at: <http://www.neavs.org/research/laws> [Accessed 12 January 2017].
- Nicholls, C. (2012). *Zebrafish, the 3Rs, and Animal Welfare Theory. A Historical Perspective*. British Association of Zebrafish Husbandry.
- Oredsson, S. (2013). Neurotoxicity, Genotoxicity and Metabolism of Salinomycin Analogs with Cancer Stem Cell Inhibiting Properties. *Grants in 2013, Swedish Fund for Research Without Animal Experiments*. [online] Available at: <http://forskaoutandjurforsok.se/swedish-fund-for-research-without-animal-experiments/grants/2013-2/> [Accessed 12 January 2017].
- Organisation for Economic Co-operation and Development (OECD) (2017). *Bovine Corneal Opacity and Permeability Test Method for Identifying i) Chemicals Inducing Serious Eye Damage; and ii) Chemicals Not Requiring Classification for Eye Irritation or Serious Eye Damage. Test no. 437*. [online] Available at: http://www.oecd-ilibrary.org/environment/test-no-437-bovine-corneal-opacity-and-permeability-test-method-for-identifying-i-chemicals-inducing-serious-eye-damage-and-ii-chemicals-not-requiring-classification-for-eye-irritation-or-serious-eye-damage_9789264203846-en [Accessed 4 January 2017].
- Organisation for Economic Co-operation and Development (OECD) (1992). *OECD Guidelines for the Testing of Chemicals: Fish, Acute Toxicity Test*. Section 2. Test No. 203 [online] Available at: http://www.oecd-ilibrary.org/environment/test-no-203-fish-acute-toxicity-test_9789264069961-en [Accessed 7 January 2017].
- Ormandy, E.H., C.A. Schuppli and D.M. Weary (2012). Factors Affecting People's Acceptance of the Use of Zebrafish and Mice in Research. *Alternatives to Laboratory Animals*, 40(6), pp. 321–333.
- Oxford English Dictionary (2016). Oxford University Press [online] Available at: <http://www.oed.com/view/Entry/273779?rskey=8fZf8&result=1> [Accessed 7 January 2017].
- Park, C.Y., S.H. Jung, J.P. Bak, S.S. Lee and D.K. Rhee (2005). Comparison of the Rabbit Pyrogen Test and Limulus Amoebocyte Lysate (LAL) Assay for Endotoxin in Hepatitis B Vaccines and the Effect of Aluminum Hydroxide. *Biologicals*, 33(3), pp. 145–151.
- PETA International Science Consortium (2015a). *Webinar 6 Video: Zebrafish Embryo Acute Tox* [video]. [online] Available at: <https://www.youtube.com/watch?v=2zHNxiVnggo> [Accessed 4 January 2017].
- PETA International Science Consortium (2015b). *Webinar Video 3 Eye Damage Irritation* [video]. [online] Available at: <https://www.youtube.com/watch?v=jSgozXPYwYo&feature=youtu.be> [Accessed 4 January 2017].

- PETA International Science Consortium (n.d.). Alternatives Approved by Regulators. [online] Available at: <https://www.piscltd.org.uk/alternatives/> [Accessed 4 January 2017].
- Planchart, A., C.J. Mattingly, D. Allen, P. Ceger, W. Casey, D. Hinton, J. Kanungo, S.W. Kullman, T. Tal, M. Bondesson and S.M. Burgess (2016). Advancing Toxicology Research Using *In Vivo* High Throughput Toxicology with Small Fish Models. *Alternatives to Animal Experimentation*, 33(4), pp. 435–452. [online] Available at: <https://www.altex.org/index.php/altex/article/view/142/122> [Accessed 16 August 2018].
- Reed, B. and M. Jennings (2011). *Guidance on the housing and care of Zebrafish Danio rerio*. Horsham: Royal Society for the Prevention of Cruelty to Animals. pp. 1–62.
- Royal Society for the Prevention of Cruelty to Animals (RSPCA) (1980). *Report of the Panel of Enquiry into Shooting and Angling (1976–1979), RSPCA Medway Report*. Horsham: RSPCA.
- Russell, W.M.S. and R.L. Burch (1959/1992). *The Principles of Humane Experimental Technique*. special ed. [online] Available at: http://altweb.jhsph.edu/pubs/books/humane_exp/het-toc [Accessed 4 January 2017].
- Seralab (2017). *Foetal Bovine Serum*. [online] Available at: <http://www.seralab.co.uk/cell-culture/foetal-bovine-serum> [Accessed 11 January 2017].
- Tannenbaum, J. and B.T. Bennett (2015). Russell and Burch's 3Rs Then and Now: The Need for Clarity in Definition and Purpose. *Journal of the American Association for Laboratory Animal Science*, 54(2), pp. 120–132. [online] Available at: <https://www.ncbi.nlm.nih.gov/pmc/articles/PMC4382615/> [Accessed 16 August 2018].
- Tanner, R. and H. McShane (2016). Replacing, Reducing, and Refining the Use of Animals in Tuberculosis Vaccine Research. *Alternatives to Animal Experimentation*, 34(1), pp. 1–10.
- Taylor, K., N. Gordon, G. Langley and W. Higgins (2008). Estimates for Worldwide Laboratory Animal Use in 2005. *Alternatives to Laboratory Animals*, 36(3), pp. 327–342.
- Thermo Fisher Scientific (2017). *Serum Products Are Commonly Used in Cell Culture Research*. [online] Available at: <http://www.thermofisher.com/uk/en/home/life-science/cell-culture/mammalian-cell-culture/fbs/other-sera.html> [Accessed 12 January 2017].
- United States Department of Agriculture (USDA) National Agricultural Library (2017). *Questions and Answers About the Animal Welfare Act and Its Regulations for Biomedical Research Institutions*. [online] Available at: <https://www.nal.usda.gov/awic/questions-and-answers-about-animal-welfare-act-and-its-regulations-biomedical-research> [Accessed 12 January 2017].
- Van Vliet, E. (2011). Current Standing and Future Prospects for the Technologies Proposed to Transform Toxicity Testing in the 21st Century. *Alternatives to Animal Experimentation*, 28(1), pp. 17–44. [online] Available at: <http://www.altex.ch/>

all-issues/issue/1-11/current-standing-and-future-prospects-for-the-technologies-proposed-to-transform-toxicity-testing-in-the-21st-century [Accessed 16 August 2018].

World Health Organization (2016). Methods of analysis. 3. Biological methods. 3.5 Test for pyrogens. *The International Pharmacopoeia*. 6th ed. World Health Organization. [online] Available at: <http://apps.who.int/p/int/en/p/docf/> [Accessed 12 January 2017].

Research and Testing Without Animals: Where Are We Now and Where Are We Heading?

Thomas Hartung

Director, Center for Alternatives to Animal Testing, John Hopkins University,
Baltimore, MD, United States

1 Introduction

I don't think there's much point in bemoaning the state of the world unless there's some way you can think of to improve it. Otherwise, don't bother writing a book; go and find a tropical island and lie in the sun.

PETER SINGER

Experiments involving non-human animals (hereinafter referred to as animals) were the predominant technology in the life sciences from the 1920s to the 1970s. Increasingly, animal-based procedures have been complemented and superseded by other approaches; yet, they still have an enormous reputation as an apparent definitive answer to many scientific and, especially, regulatory questions. They have been questioned first for ethical reasons: Can we justify making animals suffer for scientific inquiry? Simply said, people have different views on this question, but the general public views animal experimentation more and more critically. The animal research community has sought a compromise between those who would like to see the end to the use of animals sooner rather than later, and those who think animal research is indispensable. The societal response has included regulation and oversight of animal experiments (e.g., requiring formal justifications and permission), as well as support for the development of alternative methods.

2 Progress in Legislation

Building on the legislation of some of the more progressive Member States, the European Union (EU) has twice advanced the legislative oversight of animal experimentation and the push for alternative methods. Already in 1986, European lawmakers reasoned that harmonized animal testing legislation

was needed within the common market, both to level the playing field and to limit animal testing. Since then, and revised and strengthened as Directive 2010/63/EU, the EU requires that practically available alternatives to animal experiments have to be used (European Parliament, 2010). The EU also tasked the European Commission and the Member States with furthering the development and validation of alternatives. The 2010 Directive continued to expand the scope of the legislation and added enforcements. It also included an important reversal of the burden of proof: the legislation does not restrict the free use of animals in science, but it grants an exemption from the prohibition of animal tests upon sufficient justification (Hartung, 2010a). Noteworthy, the scope of Directive 2010/63/EU was extended to include the entire animal life cycle, from breeding to the conclusion of the experiments; and it was extended to late stages (last trimester) of embryonic development as well as to cephalopods, such as octopus and squid. The legislation also requires the application of the 3Rs and encourages their further development, as well as requiring the systematic evaluation of projects, including prospective and, for certain experiments, retrospective assessments of pain, suffering, and distress caused to animals.

While these general provisions apply for basic research as well as the applied use of animals for product development and safety testing, it is quite remarkable that the safety testing part (i.e. toxicology) has become the primary battleground over animal experimentation and its alternatives. This area accounts for only about 10% of overall animal use in science (Daneshian et al., 2015), according to statistics from the EU and elsewhere; yet, it is probably fair to say that 90% of the work to develop alternative methods, in the sense of one-for-one replacement, has taken place in this field (see Stephens and Mak, 2013) for a comprehensive look at the history of pursuing alternative methods in toxicology). Consequently, toxicology has a lighthouse function for other areas. If we can substitute for animals in the area of human safety, we can undoubtedly do the same in other areas.

3 Problems with Animal Models Increasingly Acknowledged

A key recent development is that animal experiments are being challenged on more than just ethical grounds (Hartung, 2017a, b). Animal experimentation is resource intensive, in terms of both expense and duration (Bottini and Hartung, 2009), and we are increasingly realizing the limited predictivity of animal models for humans based on both the limited reproducibility of their results, and the differing results across animal species (Hartung, 2013; Pound et al.,

2004; Pound and Bracken, 2014). Humans are obviously not 70kg rats (Hartung, 2009a). Within toxicology research, the costs have become particularly evident as companies start to tackle the backlog of testing of industrial chemicals under the European Registration, Evaluation, Authorisation and Restriction of CHemicals (REACH) program (Hartung and Rovida, 2009). The comprehensive assessment of a single substance amounts to several million US dollars of testing costs. We simply cannot afford to test tens of thousands of substances using the usual methods, and we also do not even have the laboratory capacities to do so. Often overlooked, we also need about 20kg of a substance to run a comprehensive toxicity profile; for novel and costly substances such an amount is often impractical to synthesize.

The most important issue—the limited predictivity of animal experimentation—was underscored by recent findings that the high failure rate of new substances in the pharmaceutical industry is based, at least in part, on the misleading findings of the animal models used during the course of development (Hartung, 2013). Two major assessments by pharmaceutical companies, one by Amgen and one by Bayer, showed that animal-based research studies were reproducible in only 11% of 53 projects (Begley and Ellis, 2012) and in about 20%–25% of 67 studies (Prinz, Schlange and Asadullah, 2011). This and similar findings have fueled a more general discussion about the *reproducibility crisis* in science (Baker, 2016). It is important to note that this issue is simply one of replicating the findings of earlier animal studies in later animal studies of similar design; this is quite apart from the issue of extrapolating such results to humans. The reproducibility crisis increasingly calls into question whether animal studies should serve as the ultimate gold standard of scientific work in the life sciences. Indeed, more than 95% of substances that show promise in animal experiments (Arrowsmith, 2011a, b, 2012) fail in later stages of drug development when assessed in human trials (Hartung, 2013). To be sure, the drug development process continues to deliver new entities but at costs in the billion US dollar range (DiMasi, Grabowski and Hansen, 2016), making it more and more difficult to sustain this business model.

4 Regulatory Testing as a Role Model for Moving Away from Animal Experimentation as a Whole

A scientific discussion challenging animal experimentation would be fruitless if there were no alternatives. When acknowledging the shortcomings of animal experimentation, many animal researchers will essentially argue that it is better to have something imperfect than nothing at all. But are they

just imperfect, or are they downright misleading? Nobody knows how many promising drugs have never made it to human trials because the animal tests wrongly sorted them out as inefficient or harmful. It is somewhat frightening to realize that aspirin would probably not make it to the market today because it fails a number of animal-based safety tests (Hartung, 2009b).

As stated above, formal replacement of animal-based procedures by alternatives has been pioneered mainly in the field of regulatory testing, i.e. the toxicological assessment of drugs, medical devices, chemicals, pesticides, cosmetics, and other consumer products prior to marketing, as well as the batch-release testing for vaccines. Why the focus here on alternatives to animal-based tests? Governments tend to fund the development of alternatives to the animal procedures they prescribe (safety sciences); and legislation, such as the European cosmetics test ban (Hartung, 2008) and REACH (Hartung, 2010b), have spurred these developments. Hence, regulatory toxicology has the potential to be an important driver for animal replacement research more generally. Noteworthy, the cosmetic ban was the consequence of public pressure voiced by animal protection groups to policy makers, not a consequence of scientific progress or perceived regulatory needs. Much of the new science came after the legislative ban took effect; and after the ban was embraced by industry and regulators, first in the EU and then elsewhere.

Regulatory testing has formed a bit of an island because, until recently, it has been outside of the normal competition of ideas, failing to keep pace with technological advances. In contrast, there is pressure to employ the latest technologies in drug development. After patenting a lead compound, there is a race to bring the drug to the market, as a single day of delay costs the company, on average, US\$1 million to recuperate the almost US\$3 billion of average development costs (DiMasi et al., 2016). This means that drug development companies readily explore and apply technologies that hasten decision making and may bring a competitive advantage. It has been suggested that our knowledge in these areas doubles every seven years. In comparison, many approaches in regulatory science are decades old: acute and repeated-dose testing originate from the 1920s, skin and eye irritation from the 1940s, and reproductive toxicity testing from the 1960s. This unusually static situation has inadvertently allowed the long-term, systematic targeting of these assays in recent decades. In other areas of biomedical research, development and validation projects of 10–20 years (not uncommon in the testing arena) would be quite pointless, because the technology changes so much over time that the validated test becomes obsolete. So, to some extent the development of alternatives for regulatory animal tests has become the sparring partner for other areas of research, as it elucidates general needs for addressing the

definition and reporting of experiments, their combined use, and their relevance, quality assurance, and validation. This also helps to transform, more generally, the mindset of researchers, creating awareness of the availability and the need of alternatives.

Education plays a key role here. By training the next generation of scientists with an openness to the new technologies and with a critical eye towards the use of animals—certainly not hailing them as the ultimate tool of generating knowledge—the basis for a balanced use of different tools is set (Daneshian et al., 2011; Hartung, Blaauboer and Leist, 2009). Internet-based teaching and training is facilitating this sea change. The emerging professorships for alternative methods in Konstanz, and other places in Germany; Baltimore; Utrecht; and elsewhere, and their collaboration with each other, represent an enormous opportunity. An important element is the parallel replacement of animals in the teaching of all areas of the life sciences. Nowadays, alternative teaching models, computer simulations, and movies can effectively substitute for repeatedly carrying out the same demonstration of an animal test. The non-animal approaches help to underscore a mindset of avoiding animal use. But it is not only about the next generation. Especially important is the continuous education of regulators, which at the moment often form a bottleneck for the broader use of new approaches. Such continuing education plays an important role in accelerating change across all areas of animal-based research.

The obvious principal alternatives to animal use are *in vitro* and *in silico* approaches, i.e. methods based on cell culture or on computer modeling. Although not without their own scientific limitations, these approaches can at least be focused on human biology, and they are typically cheaper and faster than animal tests. We also have increasingly technical solutions (Marx et al., 2016) and quality assurance tools (Coecke et al., 2005) to overcome the limitations of the early cell-culture technologies. Stem-cell technologies now make high-quality human cells more broadly available, and bioengineering allows the reproduction of organ architecture and function in cell culture. Such advanced *organotypic* cell models are now often called microphysiological systems. They promise to provide all life sciences, including safety sciences (Andersen et al., 2014; Marx et al., 2016; Smirnova et al., 2018), with more meaningful functional organ models, overcoming many of the shortcomings of traditional cell culture (Pamies and Hartung, 2017) and, thereby, making them more competitive to animal experimentation. Our own development of human *mini-brains* from stem cells (Pamies et al., 2017) may serve as an example for the many models mushrooming as a consequence of stem-cell technologies and advances in bioengineering.

5 Validating Animal Models and Their Alternatives

The ultimate quality control and the basis for replacing an animal method is formal validation of alternative methods (Leist et al., 2012). This started with the creation of the first validation body, the European Centre for the Validation of Alternative Methods (ECVAM) in 1991 (which the author headed between 2002 and 2008). Since then, validation has been internationally harmonized and also required for new animal test methods by the Organisation for Economic Co-operation and Development (OECD) (2005). The validation process was developed for regulatory tests (mainly originating from drug safety testing, but with a focus on their application to cosmetics and industrial chemicals), where safety is at stake, and is not generally considered necessary for other areas of the life sciences. However, the elements and principles of validation are very much advisable to any type of experimental work (i.e., the clear definition of the method—its purpose, execution, and applications—and the assessment of its reproducibility and relevance) and are vital to moving away from animal experiments. Successful examples of validation include testing for skin and eye corrosion and irritation, phototoxicity, skin sensitization, pyrogenicity, and batch testing for several vaccines in international test guidelines from the OECD and different pharmacopoeias. The reader is referred to the websites of validation bodies, such as ECVAM and its US counterpart, the Interagency Coordinating Committee on the Validation of Alternative Methods (ICCVAM); and the independent website, AltTox.org, which keep track of the status of the validation and acceptance of testing methods.

Validation has taught us, first of all, that clear definitions of a test and its purpose are needed. It is astonishing to see how often these are not clearly stated in scientific literature and the whole field of animal research. Second, validation formally addresses reproducibility. While requiring ring trials of a new method is certainly going too far, a more formal reporting on reproducibility (starting with a clear distinction between what was done repeatedly, and what was done in parallel technical replicates only) is an important element of addressing the prevailing reproducibility crisis. The most overlooked element of validation within the life sciences is to formally establish the relevance of a test. This might sound odd to a lay audience, but in science we often produce results in a model system and then uncritically translate them to the system being modeled (usually humans).

Often lacking in our scientific papers are formal assessments of the scientific basis of the new methods (are the relevant mechanisms reflected?) and their interspecies predictivity, as well as a demonstration that the model gives meaningful results with well-known reference compounds. The “cherry-picking” of

the literature backing our results creates enormous bias. A change in scientific paradigm is needed towards evidence-based approaches. Here too, within the preclinical sciences, it is toxicology and the search for alternatives that are spearheading relevant developments, i.e., the creation of evidence-based toxicology (Hoffmann and Hartung, 2006), with systematic reviews of the literature (Stephens et al., 2016).

6 Alternative Technologies in Toxicology as a Roadmap for Basic and Applied Research

Much of what has been written above is centered on *in vitro* methods. *In silico* methods have undergone similar developments making them a central tool in the life sciences and regulatory assessments (Ekins, 2014). Ever-increasing computer-power allows more and more applications of these methods. However, their limitations so far prohibit regulatory use on a large scale (Hartung and Hoffmann, 2009); this seems to result from the fact that most approaches have looked for an exact formula to describe parts of the chemical universe from the structures of the chemicals. This has proven to be difficult owing to the quality problems of the animal input data and the quite small datasets generally available. More recently, however, *in silico* methods have gained ground, especially the very pragmatic area of data-gap filling by read-across. Read-across is based on the principle that similar chemicals have similar toxicological effects; i.e., it suggests taking over the results from similar chemicals with the respective reasoning about similar chemistry, chemico-physical properties, uptake, metabolism, and biological effect. The use of read-across flourished in the context of REACH (Patlewicz et al., 2014), but the extent of its applicability and how to conduct and report it are under debate. This has prompted the development of *Good Read-Across Practices* (Ball et al., 2016) and ideas for a more automated read-across (Hartung, 2016). The latter development also makes use of the emerging large toxicological databases (Luechtefeld et al., 2016). These machine-learning approaches are agnostic to the biological effect studied and are similarly useful in drug discovery. Other *in silico* approaches, which are mushrooming, include modeling from receptor binding to cells, organs, and organisms. In short, the informatics revolution fuels the replacement of animal tests with increasing pace (Ekins, 2014).

Increasingly, *in vitro* and *in silico* methods are combined, forming integrated testing strategies, acknowledging that one method alone does not satisfy all information needs (Hartung et al., 2013; Rovida et al., 2015a). While the idea is rather simple, the systematic composition, optimization, and validation of

such strategies are still in their infancy. Again, the safety sciences are spearheading the concept, also combining it with a more mechanistic approach (Tollefsen et al., 2014); but the needs and opportunities are not very different for other areas of the life sciences. Mechanistic toxicology has been boosted by the recent cataloging of mechanisms as adverse outcome pathways (AOP) (Leist et al., 2017), which have been systematically developed under the umbrella of the OECD and which help the discussion and design of integrated testing strategies, among others. Similarly, modern drug development integrates different testing tools, though this could often benefit from a more formal integration of tests. It is interesting what can be learned from the mass testing of environmental chemicals. Simply said, for tests, 1+1 is more than 2 when well integrated.

In the life sciences, the increases in molecular and mechanistic understanding—as exemplified by the mapping of the human genome—have given rise to mechanistic models throughout experimental medicine (Langley et al., 2015). The new approaches do not simply replace or complement animal tests; they are enabling technologies that outperform the animal-based procedures as soon as sufficient mechanistic understanding shows their physiological relevance. The increasing use of non-animal methods corresponds with this stronger mechanistic emphasis of research: biochemistry and molecular biology have dramatically changed how we understand physiology and disease. It is very difficult to identify a mechanism leading to disease in the whole animal organism, and it is very difficult to test selectively for a certain mechanism employed by a test substance using a complex animal model. An understanding of pathways increasingly allows the modeling of (patho-) physiology as a *systems biology* (systems toxicology) approach (Hartung et al., 2012, 2017, Smirnova et al., 2018). The scientific progress that is demanding more tailored experimental systems has been automatically making animal testing superfluous to needs (Rovida et al., 2015b). Figure 28.1 illustrates these developments.

7 Barriers to Non-animal Methods

The major obstacle for the development of new non-animal models is the prevailing over-reliance on the value of animal-based procedures as an information source in the life sciences. As long as researchers believe that they cannot produce the high-level publications needed to enhance their career without a new gene knock-out mouse, many researchers will choose animal experiments. A transparent and objective assessment of animal research's shortcomings is, therefore, key for opening the scientific community to change. The reproducibility crisis noted in the life sciences is, therefore, a godsend for those

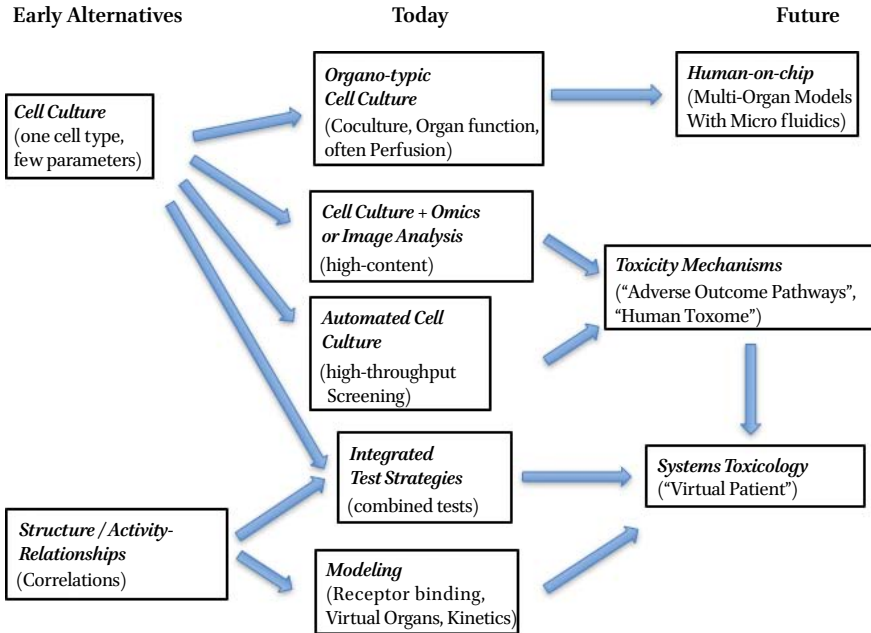

FIGURE 28.1 The technological developments in alternative methods in toxicology (Busquet and Hartung, 2017; reproduced with permission). Technologies listed as *today* refer to the more broadly available new technologies, while those only emerging are listed as *future*.

who want such a discussion about the shortcomings and misdirection of animal tests and models.

For decades, our desire to study the complexity of the human organism and its diseases seemed feasible only through using animals. Increasingly, however, very different complex systems are now used. These new approaches challenge the value of costly and time-consuming animal models and erode the justification for causing animal suffering. *In vitro* and *in silico* tools are cheaper and faster and, thus, can usually be carried out more readily and with greater ease of quality control. With such quality control, sometimes supported by validation, they represent robust methods for data generation. They are simplistic and partial, i.e. only reflecting a small fraction of (patho-) physiology. However, this is overcome by two principal approaches: reproducing complexity in the models (e.g., [multi-] organs on a chip); and combining pieces of information in integrated testing strategies or modeling (e.g., systems biology). Ultimately, all alternative approaches come with limitations too; but compared to animal models, these limitations can be surmounted by combining these new advanced animal-free models. With the ongoing improvements of these technologies and their (combined) use,

we will be able to rely less and less on the evidently unsound animal component in this mix.

8 Concluding Thoughts

Many developments summarized here hint at an upcoming scientific revolution, changing the paradigm and predominance of animal experimentation in the life sciences. In his influential book, *The Structure of Scientific Revolutions* (1962), Thomas Samuel Kuhn (1922–1996) laid out some principles that nurture this expectation (Hartung, 2008). Our current belief system is being shattered by, among other things, the reproducibility crisis. Kuhn (1962) remarked that “normal science [...] often suppresses fundamental novelties because they are necessarily subversive of its basic commitments” (p. 5); a good description of how alternatives have been perceived by many in the scientific establishment. The revolution takes place when “the tradition-shattering complements to the tradition-bound activity of normal science” (p. 6) hit. This is exactly what we observe with accelerated technological opportunities to transition into mechanistic, cellular, and even molecular understanding. The old (animal) model simply does not fully meet the needs of scientific and economic progress; it fails in cost, speed, level of detail of understanding, and human relevance. On top of this, animal experimentation lacks acceptance by an ethically evolving society. So let us embrace the revolution.

Acknowledgment

The input and editing by Martin Stephens are gratefully appreciated. The author is aware that many references are only to his own earlier publications; this is not meant to say that others have not published similar ideas, but these publications fully reference them and thus give the interested reader access.

Conflict of Interest Statement

The author is the Founder of Organome LLC, Baltimore, MD, which aims to make brain organoid technologies from Johns Hopkins University commercially available. He also consults Underwriters Laboratories on computational toxicology, with shares of their respective sales, and consults AstraZeneca on organoid technologies and testing.

References

- Andersen, M., K. Betts, Y. Dragan, S. Fitzpatrick, J.L. Goodman, T. Hartung, J. Himmel-farb, D.E. Ingber, A. Jacobs, R. Kavlock, K. Kolaja, J.L. Stevens, D. Tagle, D.L. Taylor and D. Throckmorton (2014). Developing Microphysiological Systems for Use as Regulatory Tools: Challenges and Opportunities. *Alternatives to Animal Experimentation*, 31, pp. 364–367. [online] Available at: http://www.altex.ch/resources/altex_2014_3_Suppl_Andersen.pdf [Accessed 10 July 2017].
- Arrowsmith, J. (2011a). Trial Watch: Phase II Failures: 2008–2010. *Nature Reviews Drug Discovery*, 10, pp. 328–329.
- Arrowsmith, J. (2011b). Trial Watch: Phase III and Submission Failures: 2007–2010. *Nature Reviews Drug Discovery*, 10, p. 87.
- Arrowsmith, J. (2012). A Decade of Change. *Nature Reviews Drug Discovery*, 11, pp. 17–18.
- Baker, M. (2016). 1,500 Scientists Lift the Lid on Reproducibility. *Nature*, 533, pp. 452–454.
- Ball, N., M.T.D. Cronin, J. Shen, M.D. Adenuga, K. Blackburn, E.D. Booth, M. Bouhifd, E. Donley, L. Egnash, J.J. Freeman, C. Hastings, D.R. Juberg, A. Kleensang, N. Klein-streuer, D. Kroese, A.C. Lee, T. Luechtefeld, A. Maertens, S. Marty, J.M. Naciff, J. Palmer, D. Pamies, M. Penman, A.N. Richarz, D.P. Russo, S.B. Stuard, G. Patlewicz, B. van Ravenzwaay, S. Wu, H. Zhu and T. Hartung (2016). Toward Good Read-Across Practice (GRAP) Guidance. *Alternatives to Animal Experimentation*, 33, pp. 149–166.
- Begley, C.G. and L.M. Ellis (2012). Drug Development: Raise Standards for Preclinical Cancer Research. *Nature*, 483, pp. 531–533.
- Bottini, A.A. and T. Hartung (2009). Food for Thought.... On Economics of Animal Test-ing. *Alternatives to Animal Experimentation*, 26, pp. 3–16.
- Busquet, F. and T. Hartung (2017). The Need for Strategic Development of Safety Sci-ences. *Alternatives to Animal Experimentation*, 34, pp. 3–21.
- Coecke, S., M. Balls, G. Bowe, J. Davis, G. Gstraunthaler, T. Hartung, R. Hay, O.W. Merten, A. Price, L. Schechtman, G. Stacey and W. Stokes (2005). Guidance on Good Cell Culture Practice. *Alternatives to Laboratory Animals*, 33, pp. 261–287.
- Daneshian, M., M.A. Akbarsha, B. Blaauboer, F. Caloni, P. Cosson, R. Curren, A. Gold-berg, F. Gruber, F. Ohl, W. Pfaller, J. van der Valk, P. Vinardell, J. Zurlo, T. Hartung and M. Leist (2011). A Framework Program for the Teaching of Alternative Methods (Replacement, Reduction, Refinement) to Animal Experimentation. *Alternatives to Animal Experimentation*, 28, pp. 341–352.
- Daneshian, M., F. Busquet, T. Hartung and M. Leist (2015). Animal Use for Science in Europe. *Alternatives to Animal Experimentation*, 32, pp. 261–274.
- DiMasi, J.A., H.G. Grabowski, and R.W. Hansen (2016). Innovation in the Pharma-ceutical Industry: New Estimates of R&D Costs. *Journal of Health Economics*, 47, pp. 20–33.

- Ekins, S. (2014). Progress in Computational Toxicology. *Journal of Pharmacological and Toxicological Methods*, 69, pp. 115–140.
- European Parliament (2010). Directive 2010/63/EU of the European Parliament and of the Council of 22 September 2010 on the protection of animals used for scientific purposes. *Official Journal of the European Communities*, L 276, pp. 33–79. [online] Available at: <http://eur-lex.europa.eu/legal-content/EN/TXT/?uri=CELEX%3A32010L0063> [Accessed 18 July 2017].
- Hartung, T. (2008). Towards a New Toxicology – Evolution or Revolution? *Alternatives to Laboratory Animals*, 36, pp. 635–639.
- Hartung, T. (2009a). Toxicology for the Twenty-first Century. *Nature*, 460, pp. 208–212.
- Hartung, T. (2009b). Per Aspirin Ad Astra. *Alternatives to Laboratory Animals*, 37(2), pp. 45–47.
- Hartung, T. (2010a). Comparative Analysis of the Revised Directive 2010/63/EU for the Protection of Laboratory Animals with Its Predecessor 86/609/EEC – a t⁴ Report. *Alternatives to Animal Experimentation*, 27, pp. 285–303.
- Hartung, T. (2010b). Food for Thought... On Alternative Methods for Chemical Safety Testing. *Alternatives to Animal Experimentation*, 27, pp. 3–14.
- Hartung, T. (2013). Look Back in Anger – What Clinical Studies Tell Us About Preclinical Work. *Alternatives to Animal Experimentation*, 30, pp. 75–291.
- Hartung, T. (2016). Making Big Sense from Big Data in Toxicology by Read-across. *Alternatives to Animal Experimentation*, 33, pp. 83–93.
- Hartung, T. (2017a). Evolution of Toxicological Science: The Need for Change. *International Journal of Risk Assessment and Management*, 20, pp. 21–45.
- Hartung, T. (2017b). Opinion Versus Evidence for the Need to Move Away from Animal Testing. *Alternatives to Animal Experimentation*, 34, pp. 193–200.
- Hartung, T. and S. Hoffmann (2009). Food for Thought.... On *In Silico* Methods in Toxicology. *Alternatives to Animal Experimentation*, 26, pp. 155–166.
- Hartung, T. and C. Rovida (2009). Chemical Regulators Have Overreached. *Nature*, 460, pp. 1080–1081.
- Hartung, T., B. Blaauboer and M. Leist (2009). Food for Thought.... On Education in Alternative Methods in Toxicology. *Alternatives to Animal Experimentation*, 26, pp. 255–263.
- Hartung, T., R. FitzGerald, P. Jennings, G. Miriams, M. Peitsch, A. Rostami-Hodjegan, I. Shah, M. Wilks and S. Sturla (2017). Systems Toxicology: Real World Applications and Opportunities. *Chemical Research in Toxicology*, 30, pp. 870–882.
- Hartung, T., T. Luechtefeld, A. Maertens and A. Kleinsang (2013). Integrated Testing Strategies for Safety Assessments. *Alternatives to Animal Experimentation*, 30, pp. 3–18.
- Hartung, T., E. van Vliet, J. Jaworska, L. Bonilla, N. Skinner and R. Thomas (2012). Systems Toxicology. *Alternatives to Animal Experimentation*, 29, pp. 119–128.

- Hoffmann, S. and T. Hartung (2006). Towards an Evidence-based Toxicology. *Human and Experimental Toxicology*, 25, pp. 497–513.
- Kuhn, T. (1962). *The structure of scientific revolutions*. Chicago, IL: University of Chicago Press.
- Langley, G., C.P. Austin, A.K. Balapure, L.S. Birnbaum, J.R. Bucher, J. Fentem, S.C. Fitzpatrick, J.R. Fowle III, R.J. Kavlock, H. Kitano and B.A. Lidbury (2015). Lessons from Toxicology: Developing a 21st Century Paradigm for Medical Research. *Environmental Health Perspectives*, 123(11), p. A268.
- Leist, M., A. Ghallab, R. Graepel, R. Marchan, R. Hassan, S. Hougaard Bennekou, A. Limonciel, M. Vinken, S. Schildknecht, T. Waldmann, E. Danen, B. van Ravenzwaay, H. Kamp, I. Gardner, P. Godoy, F.Y. Bois, A. Braeuning, R. Reif, F. Oesch, D. Drasdo, S. Höhme, M. Schwarz, T. Hartung, T. Braunbeck, J. Beltman, H. Vrieling, F. Sanz, A. Forsby, D. Gadaleta, C. Fisher, J. Kelm, D. Fluri, G. Ecker, B. Zdrzil, A. Terron, P. Jennings, B. van der Burg, S. Dooley, A.H. Meijer, E. Willighagen, M. Martens, C. Evelo, E. Mombelli, O. Taboureau, A. Mantovani, B. Hardy, B. Koch, S. Escher, C. van Thriel, C. Cadenas, D. Kroese, B. van de Water, and J.G. Hengstler (2017). Adverse Outcome Pathways: Opportunities, Limitations and Open Questions. *Archives Toxicology*, 31, pp. 221–229.
- Leist, M., M. Hasiwa, M. Daneshian and T. Hartung (2012). Validation and Quality Control of Replacement Alternatives – Current Status and Future Challenges. *Toxicological Research*, 1, pp. 8–22.
- Luechtefeld, T., A. Maertens, D.P. Russo, C. Rovida, H. Zhu and T. Hartung (2016). Global Analysis of Publicly Available Safety Data for 9,801 Substances Registered Under REACH from 2008–2014. *Alternatives to Animal Experimentation*, 33, pp. 95–109.
- Marx, U., T.B. Andersson, A. Bahinski, M. Beilmann, S. Beken, F.R. Cassee, M. Cirit, M. Daneshian, S. Fitzpatrick, O. Frey, C. Gaertner, C. Giese, L. Griffith, T. Hartung, M.B. Heringa, J. Hoeng, W.H. de Jong, H. Kojima, J. Kuehnl, A. Luch, I. Maschmeyer, D. Sakharov, A.J.A.M. Sips, T. Steger-Hartmann, D.A. Tagle, A. Tonevitsky, T. Tralau, S. Tsyb, A. van de Stolpe, R. Vandebriel, P. Vulto, J. Wang, J. Wiest, M. Rodenburg and A. Roth (2016). Biology-inspired Microphysiological System Approaches to Solve the Prediction Dilemma of Substance Testing Using Animals. *Alternatives to Animal Experimentation*, 33, pp. 272–321.
- Organisation for Economic Co-operation and Development (OECD) (2005). Guidance Document on the Validation and International Acceptance of New or Updated Test Methods for Hazard Assessment. *OECD Series on Testing and Assessment*, 34. [online] Available at: [http://www.oecd.org/officialdocuments/publicdisplaydocumentpdf/?doclanguage=en&cote=env/jm/mono\(2005\)14](http://www.oecd.org/officialdocuments/publicdisplaydocumentpdf/?doclanguage=en&cote=env/jm/mono(2005)14) [Accessed 16 June 2017].
- Pamies, D. and T. Hartung (2017). 21st Century Cell Culture for 21st Century Toxicology. *Chemical Research in Toxicology*, 30, pp. 43–52.

- Pamies, D., P. Barreras, K. Block, G. Makri, A. Kumar, D. Wiersma, L. Smirnova, C. Zang, J. Bressler, K.M. Christian, G. Harris, G.L. Ming, C. Berlinicke, K. Kyro, H. Song, C.A. Pardo, T. Hartung and H.T. Hogberg (2017). A Human Brain Microphysiological System Derived from Induced Pluripotent Stem Cells to Study Neurological Diseases and Toxicity. *Alternatives to Animal Experimentation*, 34(3), pp. 362–367.
- Patlewicz, G., N. Ball, R.A. Becker, K. Blackburn, E. Booth, M. Cronin, D. Kroese, D. Steup, B. van Ravenzwaay and T. Hartung (2014). Read-across Approaches: Misconceptions, Promises and Challenges Ahead. *Alternatives to Animal Experimentation*, 31, pp. 387–396.
- Pound, P. and M.B. Bracken (2014). Is Animal Research Sufficiently Evidence Based to Be a Cornerstone of Biomedical Research? *British Medical Journal*, 348, p. g3387. [online] Available at: <http://doi.org/10.1136/bmj.g3387> [Accessed 10 July 2017].
- Pound, P., S. Ebrahim, P. Sandercock, M.B. Bracken and I. Roberts (2004). Where Is the Evidence That Animal Research Benefits Humans? *British Medical Journal*, 328(7438), pp. 514–517.
- Prinz, F., T. Schlange and K. Asadullah (2011). Believe It or Not: How Much Can We Rely on Published Data on Potential Drug Targets?. *Nature Reviews Drug Discovery*, 10, p. 712 [online] Available at: <https://www.nature.com/articles/nrd3439-c1> [Accessed 10 July 2017].
- Rovida, C., N. Alépée, A.M. Api, D.A. Basketter, F.Y. Bois, F. Caloni, E. Corsini, M. Daneshian, C. Eskes, J. Ezendam, H. Fuchs, P. Hayden, C. Hegele-Hartung, S. Hoffmann, B. Hubesch, M.N. Jacobs, J. Jaworska, A. Kleensang, N. Kleinstreuer, J. Lalko, R. Landsiedel, F. Lebreux, T. Luechtefeld, M. Locatelli, A. Mehling, A. Natsch, J.W. Pitchford, D. Prater, P. Prieto, A. Schepky, G. Schuurmann, L. Smirnova, C. Toole, E. van Vliet, D. Weisensee and T. Hartung (2015a). Integrated Testing Strategies (ITS) for Safety Assessment. *Alternatives to Animal Experimentation*, 32, pp. 171–181.
- Rovida, C., C. Asakura, M. Daneshian, H. Hofman-Huether, M. Leist, L. Meunier, D. Reif, A. Rossi, M. Schmutz, J.P. Valentin, J. Zurlo and T. Hartung (2015b). Toxicity Testing in the 21st century Beyond Environmental Chemicals. *Alternatives to Animal Experimentation*, 32, pp. 25–40.
- Smirnova, L., N. Kleinstreuer, R. Corvi, A. Levchenko, S.C. Fitzpatrick, and T. Hartung (2018). 3S: Systematic, Systemic, and Systems Biology and Toxicology. *Alternatives to Animal Experimentation*, 35, pp. 39–162.
- Stephens, M. and N. Mak (2013). History of the 3Rs in toxicity testing: From Russell and Burch to 21st century toxicology. In: D.G. Allen and M.D. Waters, eds., *Reducing, Refining and Replacing the Use of Animals in Toxicity Testing*. 19th ed. Royal Society of Chemistry. pp. 1–43.

- Stephens, M.L., K. Betts, N.B. Beck, V. Cogliano, K. Dickersin, S. Fitzpatrick, J. Freeman, G. Gray, T. Hartung, J. McPartland, A.A. Rooney, R.W. Scherer, D. Verloo and S. Hoffmann (2016). The Emergence of Systematic Review in Toxicology. *Toxicological Sciences*, 152, pp. 10–16.
- Tollefsen, K.E., S. Scholz, M.T. Cronin, S.W. Edwards, J. de Knecht, K. Crofton, N. Garcia-Reyero, T. Hartung, A. Worth and G. Patlewicz (2014). Applying Adverse Outcome Pathways (AOPs) to Support Integrated Approaches to Testing and Assessment (IATA). *Regulatory Toxicology and Pharmacology*, 70, pp. 629–640.

Afterword: Evidence over Interests

John P. Gluck

Professor Emeritus, University of New Mexico; Research Professor, Kennedy
Institute of Ethics, Georgetown University, United States

jgluck@unm.edu

After years of science education, teaching experience, and research practice, which focused on the use of non-human primates as potential models of human psychological disorders, a young student in my primate behavior class amiably, but insistently, suggested my preparation was incomplete. She asked me to read Peter Singer's book *Animal Liberation*, which had been published two years earlier, in 1975. I had been lecturing in class about the effects of early experience on the rhesus monkey's (*Macaca mulatta*) social and intellectual development, and my descriptions of the invasive research interventions and behavioral consequences encouraged her to make the book suggestion. I said I would try to find the time, but that I was busy. She handed me a fresh new copy of the book saying, "This is for you." She made it clear that she was not loaning me her copy but wanted the book to be part of my professional library. Over the following weeks while describing this event to colleagues, many also involved in animal research, I asked them if they had read Professor Singer's book. While some had heard of it, no one had actually read it. "Why should I do that?" was a common tone of the comments. After all, our experimental standards were quite clear and seemed self-evidently valid. That is, if any interesting and, therefore, valuable research question could not be tested in humans for ethical reasons, then it could be evaluated in animal models. Progress required risk, and progress was urgently needed. This powerful drive to know and understand nature, so as to improve the welfare of human beings, was what the bioethicist Paul Ramsey (1976) called, the *research imperative*, to emphasize its motivational dominance.

In response to the student's questioning looks as we saw one another in class, and out of respect for her serious intention, I did finally read *Animal Liberation*. The chapter titled, *Tools for research or what the public doesn't know it is paying for*, quickly trapped my attention. Three of the assertions of the chapter were: (1) The raw descriptions of the experimental manipulations done to animals revealed a shocking emotional callousness on the part of investigators; (2) The extent of the harms, which the animals were required to absorb, seemed excessive in comparison with the many obvious or even trivial facts discovered; (3) It was estimated that after all the experimental effort and

animal suffering, approximately one quarter of the studies actually made it into the open scientific literature. I thought the number was significantly less than 25%. More personally, a significant part of the chapter raised specific ethical questions about the research of Harry F. Harlow, which also involved studying the effects of socially isolating infant rhesus monkeys from their mothers and peers. Harlow was once one of my central mentors in graduate school and continued to support me by providing monkey subjects and experimental advice. Singer described the laboratory where I was educated, and he sounded morally disgusted. While I mostly rejected the implication, it was clear that the basic assertion of *Animal Liberation* was that our vague and rarely articulated ethical assumptions, when placed under the light of a sophisticated utilitarian ethical analysis, revealed themselves to be simplistic, self-serving, and mostly indifferent to science-generated animal harm and suffering.

As my colleagues and I began to see an increase in the number of pointed questions about the validity and justification of animal models from students, a few scientists, and from the public after 1975, curiosity about the controversy and the issues raised turned to hardened defensiveness and something approaching contempt for the questioners. We bolstered our dismissiveness by making forceful statements about the demands of the research imperative and the extent of human clinical need. We remained blind or just mute about the dangers that can accrue when an imperative becomes an omnipotent and unassailable directive.

More subtle, but perhaps more dangerous, is that there is evidence that many researchers have neglected and continue to neglect the notion that science is not just based on acts of direct perception of nature, followed by the straightforward description of facts. Rather, it is a process strongly influenced by psychological, social, and cultural forces. Ludwik Fleck, a microbiologist who wrote as early as 1935 about how different sides of many scientific controversies evolved into *thought collectives* that demanded loyalty to the beliefs of the collective and disdain for outsiders. Fleck showed that the collectives were capable of shaping *thought styles* that could have the effect of limiting the ability of members to actually understand divergent perspectives and to take alternative research paths. The magisterial work of Thomas Kuhn (1962), in *The Structure of Scientific Revolutions*, which built on Fleck (1935), articulated how, what he termed, "normal science" could actively deny incorporating experimental findings that had the potential to disconfirm entrenched methods and explanations. More recently, historians of science, such as David Wootton (2007) in his book *Bad Medicine: Doctors Doing Harm since Hippocrates*, further elaborate how the tendency of scientists to confer authority to "established" theories and methods have been the central factor in the delay of medical progress, and so it is now with much of the work in animal research.

Animal Experimentation: Working Towards a Paradigm Change illustrates how these crucial cautions about doing science, and the necessity to understand the complex nature of methodological choices, have remained surprisingly weak in encouraging checks on the tribal-like loyalty to the continued use of animal models in the face of contrary evidence. It is as if Claude Bernard's (the father of modern physiology) brash nineteenth century assurance that "experiments on animals are entirely conclusive for the toxicology and hygiene of man" (Hajar, 2011) is in no need of modification. This trust is maintained even in the face of the moral demands left by our increased knowledge of the cognitive and emotional capabilities of the "other", and the scientific understanding of physiological processes taking place below the level of magnification of the common microscope. By the time you, the readers, are at this point in this volume, you have been exposed to an incredible variety of evidence of the empirical failure of animal models to protect humans and to control many diseases and maladies. You have seen the existence of regulatory dysfunction, along with good faith attempts to structure legal systems that confront outmoded, ineffective, and pain-provoking research traditions. You have had a look at parts of the incentive structure of science and its unfortunate facilitation of the *good soldier* keeping in line with traditional, safe expectations in order to produce long vitas that are likely to be short on breakthroughs and revolutionary excursions.

This carefully constructed and edited book needs to be held close by those with brave-thinking hearts. I will place my copy right next to my well-worn edition of *Animal Liberation* given to me many years ago.

References

- Fleck, L. (1935). *Genesis and development of a scientific fact*. Chicago, IL: University of Chicago Press.
- Hajar, R. (2011). Animal Testing and Medicine. *Heart Views: The Official Journal of the Gulf Heart Association*, 12(1), p. 42.
- Kuhn, T. (1962). *The structure of scientific revolutions*. Chicago, IL: University of Chicago Press.
- Ramsey, P. (1976). The Enforcement of Morals: Nontherapeutic Research on Children. *Hastings Center Report*, 6(4), p. 2.
- Singer, P. (1975). *Animal liberation*. New York: Avon Books.
- Wootton, D. (2007). *Bad medicine: Doctors doing harm since Hippocrates*. Oxford, UK: Oxford University Press.

Index

- abnormal behavior 5, 7, 10, 15, 522–524
 stereotypies 7, 522
- abolishment of harmful animal use 27
- academia 79, 163, 244, 250, 265, 653
- Accreditation Council for Graduate Medical Education (ACGME) 556
- ACGME. *See* Accreditation Council for Graduate Medical Education (ACGME)
- ADHD. *See* Attention Deficit Hyperactivity Disorder (ADHD)
- administrative costs 66, 248
- ADR, *see* Adverse drug reactions (ADRS)
- Advanced Trauma Life Support (ATLS) 552, 555–556
- Adverse drug reactions (ADRS) 125, 126, 257, 420, 421, 423, 427, 433
- adverse outcome 367, 613, 615–619, 626
- adverse outcome pathway (AOP) 30, 367, 590, 595, 596, 598, 615–619, 627, 682
- advertising 132–134, 136, 137
- Agricultural Research Service (ARS) 129, 260, 261
- agriculture. *See* animal agriculture
- air bubbles 646
- Alcmaeon of Croton 321
- Alliance of science and research organisations 90
- Allianz der Wissenschaftsorganisationen 90. *See also* Alliance of science and research organisations
- Alternative. *See also* Replacement
- alternative approaches 34, 35, 88, 109, 358, 365, 597, 683
- alternative methods 32–34, 93, 97, 103, 152, 155, 158, 183, 185, 196, 200, 202, 332, 341, 465, 568, 572–578, 587–588, 591–595, 598, 600, 603, 604, 648, 653, 659, 660, 675, 676, 679, 680, 683
- development of 34, 97, 100, 105, 160, 183, 196, 202, 341, 365, 578, 588, 601, 604, 675, 678
- validation of 34, 88, 599, 676, 680
- Alzheimer Disease 480–500
- American College of Surgeons (ACS) 555, 556
- American opposition to animal use in research 286
- amphibian 367, 521, 661–663
- analgesia 13–15, 246, 322, 333
- Anderson, E. 309, 310
- anesthesia 13–15, 179, 217, 234, 246, 321, 322, 333, 453, 559
- anger 294, 298
- animal agriculture 90, 97, 109, 110, 112, 124, 129–132, 135–138, 160, 209, 231, 246, 250, 258–259, 261, 265, 266, 282, 309, 313, 343, 446, 452, 554, 659
- animal agriculture industrial complex 259
- animal agriculture research 258–259
- animal behavior 15, 518–538
- animal bioassays 257
- animal ethics 21, 219, 227, 236, 237, 456, 561, 570, 572
- Animal Ethics Committees (AECs) 21, 227–231, 234–238, 561
- animal experimentation 3, 88, 124, 152, 174, 194, 209, 224, 245, 276, 289, 305, 321, 341, 378, 392, 432, 460, 485, 532, 568, 595, 657, 675, 693
- animal free science 29, 32, 33, 35, 37, 88–96, 98–102, 104, 105, 107, 108, 114, 127, 138, 158, 159, 161, 173, 200, 204, 216, 227, 233, 236, 237, 342, 365, 369, 417, 419, 425–430, 433, 527, 561, 578, 587, 650, 660, 663, 666, 682–684
- animal health 3, 155, 168, 174, 195, 259, 290, 322
- animal laboratory 22, 231, 551–561
- animal law 168, 170, 290–292
- animal method 109, 157, 158, 431, 645, 650, 680
- animal model
- devalidation 95
- failure 23, 26, 73, 248, 401–407
- limitations 204, 324–325, 620, 621
- refinement (*see* Chapter 1) 3–38
- shortcomings 278, 677, 682, 683
- animal protection 80, 96, 155–159, 173, 178, 184, 291, 299

- animal protection law 8, 9, 181, 183, 292, 297, 553. *See also* animal law
 animal protection organization 159, 292, 552, 594, 604, 663
 animal research 3, 73, 89, 124, 151, 169, 203, 209, 234, 244, 275, 289, 305, 321, 341, 378, 392, 425, 443, 480, 553, 568, 605, 657, 675, 691
 animal research community 3, 37, 175, 225, 673
 animal research industry 265. *See also* biomedical industrial complex
 Animal Research Reporting In Vivo Experiments (ARRIVE) guidelines 17, 21, 329–331, 379
 animal rights 66, 89, 90, 113, 153, 178–182, 198, 199, 201, 225, 281, 308, 392, 579
 animal safety test 417, 423, 428, 432, 433, 676, 678
 Animals Scientific Procedures Act (ASPA) 520
 animal testing 11, 32, 33, 35, 91–96, 101, 103, 104, 109, 110, 113, 115, 124, 127, 152, 156–159, 183, 202, 216–218, 245, 246, 257, 258, 295, 297–299, 307, 325, 341, 342, 365, 368–369, 392, 405, 417–433, 465, 486, 487, 570, 587–606, 620, 621, 641–654, 656, 657, 659, 660, 663, 665–668, 675, 676, 678–683
 Animals use
 in applied research 4, 30, 33, 113, 152, 245, 529, 681–682
 in basic research 343, 358, 487
 in education and training 138, 568
 animal welfare 5, 20, 27, 37, 113, 132, 152, 158, 173, 198, 225, 237, 262, 283–284, 333, 452, 520–523
 Animal Welfare Act (AWA) 124, 209, 217, 246, 258, 264, 265, 282–284, 660, 661
 animal welfare law 93, 94, 227. *See also* animal law; Animal Welfare Act
 anthropomorphism 295
 antibiotic(s) 128–131, 139, 259, 261, 262, 424
 antibiotic resistance 128–129, 131, 139, 259, 261, 262
 antibodies 16, 71, 111, 366, 396, 419, 451, 489, 490, 665
 antivivisectionism
 epistemic 198
 ethical 198
 scientific 199
 AOP. *See* adverse outcome pathway (AOP)
 ape 179, 381, 400, 525, 529, 530, 535, 536, 538
 applied research 4, 30, 33, 90, 107, 111–113, 152, 245, 529, 681–682
 aquatic 124, 130, 666
 ARS. *See* Agricultural Research Service (ARS)
 ASPA. *See* Animals Scientific Procedures Act (ASPA)
 aspirin 108, 255, 257, 344, 359–363, 423, 621, 678
 assumption of human-animal similarity 249
 ATLS. *See* Advanced Trauma Life Support (ATLS)
 Attention Deficit Hyperactivity Disorder (ADHD) 380–385
 Australia 137, 183, 225–240, 493
 author guidelines 331
 AWA. *See* Animal Welfare Act (AWA)
 awareness 11, 15, 26, 29, 30, 132, 137, 140, 161, 225, 227, 278, 322, 330, 344, 368, 369, 386, 480, 551, 560, 568, 569, 571, 572, 577, 651, 662, 667, 679
 balance of interests 175, 177, 178, 180
 Balls, M. 13, 37, 178, 422, 449, 456, 465, 593, 659, 662, 666
 ban on patenting animals 93
 barren cages 5, 523
 basal ganglia 376, 523
 Basel Declaration 197, 226
 basic science 24, 30, 35, 36, 71, 75, 79, 89–91, 111, 112, 114, 115, 184, 194, 202, 251, 277, 278, 280, 281, 284, 285, 341–343, 357, 358, 386, 392, 405, 450, 481, 483–485, 487, 491, 492, 499, 500, 529, 595, 596, 603–605, 630, 676
 BB3R. *See* Berlin-Brandenburg research platform (BB3R)
 behavior 5–11, 13, 15, 19, 67, 91, 107, 126, 134, 138, 169, 194, 196, 239, 276, 280, 285, 293, 325, 376, 385, 394, 396, 398, 399, 457, 484, 485, 487, 518–538, 587, 613, 644, 662, 691
 abnormal 5, 7, 10, 15, 521–523
 stereotypies, stereotypic 7–9, 455, 521
 behavior adaptation 293, 376, 521

- behavioral research 276, 280, 285, 518–538
- behaviorism 519
- Bennett, B.T. 196, 657, 658, 664, 668
- Bentham, J. 213, 322
- Berlin-Brandenburg research platform (BB₃R) 98, 99
- Bernard, Claude 199, 614, 693
- best practice 331, 617
- BfR. *See* Bundesinstitut für Risikobewertung (BfR)
- BIA 10–24, 74, 419
- bias 16–21, 25, 26, 29, 133, 161, 178, 235, 252–254, 258, 263, 276, 277, 284, 323, 326–331, 356, 357, 379, 385, 421, 447, 494, 496, 530, 621, 681. *See also* publication bias
- biochip 426, 622
- biological(s) 10, 22, 30, 35, 75, 90, 91, 101, 103, 107, 111, 112, 184, 199, 201, 202, 216, 245, 264, 278, 322–325, 328, 330, 334, 341, 358, 377, 394, 395, 398, 430, 444, 451, 461, 485, 553, 572, 587, 595, 598, 612–618, 621, 623–628, 643, 646, 647, 649, 681
- biological products 35, 90, 111, 112, 184, 341, 430
- biomarkers 92, 425, 491, 492, 628–630
- BioMed₂₁ 30
- biomedical industrial complex (BIC) 247–248
- biomedical industrial eco-system 244
- biomedical knowledge 277
- biomedical research 11, 16, 20, 28–34, 65–81, 99, 140, 154, 161, 170, 197, 199, 202, 226, 237, 238, 245–248, 251, 252, 258, 266, 275, 278, 285, 286, 306, 314, 376–386, 392, 421, 431, 444, 461, 462, 518, 529, 531, 534, 538, 660, 661, 678. *See also* biomedical science
- Biomedical Research for the 21st Century (BioMed₂₁) Collaboration 30. *See also* BioMed₂₁
- biomedical science 33, 34, 36, 66, 72, 328, 401, 575
- bioscience sector 155, 160
- biotransformation 620, 643
- bird 209, 217, 246, 343, 367, 521, 523, 538, 660, 662
- black box warning 420, 620
- blinding 18, 212, 263, 276, 326, 327, 329, 408, 433, 692
- BMBF. *See* Bundesministerium für Bildung und Forschung (BMBF); German Federal Ministry of Education and Research
- body on a chip 622, 628. *See also* human on a chip, disease on a chip, lab on a chip, organ on a chip
- Bovine Corneal Opacity and Permeability assay (BCOP) 663, 666
- bovine spongiform encephalopathy (BSE) 260, 261
- Braithwaite, V. 521, 662
- Brazil 398, 567–579
- Brazilian Network for Humane Education 578
- breeding 7, 12, 22, 71, 97, 130, 195, 229, 247, 264, 333, 341, 343, 369, 443, 446, 453–454, 483, 499, 529, 533–538, 575, 576, 662, 676
- British Union for the Abolition of Vivisection (BUAV) 322. *See also* Cruelty Free International
- BUAV. *See* British Union for the Abolition of Vivisection (BUAV); Cruelty Free International
- Bundesinstitut für Risikobewertung (BfR) 34, 90, 97, 100. *See also* Federal Institute for risk assessment
- Bundesministerium für Bildung und Forschung (BMBF) 31, 32, 35, 98–101, 104, 108
- Burch, R.L. 3, 4, 18, 29, 36, 171, 172, 196, 364, 577, 656–659, 664, 668
- business ethics 209, 214, 218–220
- by-pass protein effect 260
- CAAT. *See* Center for Alternatives to Animal Testing (CAAT)
- cadaver 321, 555, 558, 573–575
- CAMARADES. *See* Collaborative Approach to Meta-Analysis and Review of Animal Data from Experimental Studies (CAMARADES)
- Cambridge Declaration on Consciousness 29
- campaigning 136, 151–164, 198, 314, 322, 342, 365, 367–369, 421, 667

- Canada 133, 175, 333, 334, 369, 420, 556, 561, 651
- cancer 7, 24, 67, 71, 72, 79, 125–127, 135, 160, 176, 245, 249, 251, 253, 254, 257, 276, 277, 343, 357, 362, 378, 392, 401, 419, 423, 424, 447–452, 454, 455, 459, 460, 462–465, 480, 482, 497, 590, 596, 615
- cancer gene panel 277
- captive welfare 8
- captivity 5, 8–11, 499, 518–538, 664
- carcinogenicity research 135, 257, 324, 365, 392
- care 4, 73, 97, 126, 154, 168, 197, 217, 227, 246, 279, 294, 307, 333, 342, 386, 419, 445, 482, 535, 555, 605, 627, 641, 664, 693
- culture of, *see* culture of care
- carnivore 521
- cat 257, 281, 283–286, 343, 357, 363, 367, 381, 423, 519, 552, 555, 556, 575
- cell 16, 75, 91, 194, 216, 234, 245, 278, 357, 377, 398, 419, 444, 485, 573, 588, 612, 641, 658, 679
- cell culture 92, 106, 107, 245, 462, 573, 588, 596, 606, 615, 621, 626, 629, 641–644, 646–649, 659, 664, 665, 679
- cell lineage 646
- Center for Alternatives to Animal Testing (CAAT) 93, 103, 104, 651, 657, 659
- Center for Open Science 20
- Center for Responsible Science (CRS) 430
- Centrum für Ersatzmethoden zum Tierversuch (CERST-NRW) 98, 99
- cephalopod 97, 228, 294, 575, 660, 664, 676
- CERST-NRW. *See* Centrum für Ersatzmethoden zum Tierversuch (CERST-NRW)
- check-off program 136
- chemotherapy 277
- chest tube insertion 555
- chicken 130, 260, 265, 424, 451, 660, 662–664, 666
- chimpanzee 248, 249, 255, 285, 286, 323, 324, 381, 399, 400, 403, 461, 525, 526, 529–536, 538
- China 160, 453, 495
- chronic disease 125–129, 131, 133, 138, 480
- citation analysis 379–381
- Citizen's Initiative 161–163, 169, 170, 194
- class action 96
- classical conditioning 519
- classification 27, 156, 175, 176, 195, 220, 234, 297, 301, 394, 402, 575, 598, 599, 657
- clinical decision making 559
- clinical research 26, 75, 79, 216, 251, 257, 334, 362, 376, 377, 425, 491, 500
- clinical science
- non-translatable 255, 256
- clinical testing 245, 431, 651
- clinical trial 16, 17, 19–21, 23, 24, 26, 35, 72, 74, 75, 200, 203, 215, 235, 245, 248, 252–258, 278, 307, 328–329, 332, 358, 366, 367, 378, 379, 392, 405, 407, 419–422, 424, 426, 429, 430, 449, 451, 459, 465, 486–489, 492, 495, 498, 570, 596, 619, 620, 644, 645, 651
- Clustered Regularly Interspaced Short Palindromic Repeats (CRISPR) 31, 444–451, 453, 456–458, 460, 463–465, 612, 613
- co-culture 103, 623, 627, 628
- cognition 5, 29, 194, 203, 258, 280, 293, 311, 314, 325, 420, 458, 461, 481, 484, 485, 487, 491–496, 518, 521, 523, 525, 527, 529–533, 536, 538, 557, 559, 569, 573, 693
- cognition research 521, 527
- cognitive abilities 518, 521, 529
- cognitive dissonance 311, 314, 569
- Collaborative Approach to Meta-Analysis and Review of Animal Data from Experimental Studies (CAMARADES) 26, 277, 424
- Collins, F. 17, 28, 251, 278, 424, 426, 570
- commodification 135–137, 259, 261, 264, 309
- communication 34, 80, 101, 105, 162, 170, 197, 226, 228, 229, 231–234, 300, 376, 385, 396, 428, 432, 484, 522, 529, 556, 557, 559, 560, 575, 576, 622, 628, 642
- comparative cognition 521, 529, 531–533
- comparative studies 462
- compassion 11–13, 131, 204, 212–216, 285, 286, 298, 568
- complexity science 69, 391, 393, 400
- complex systems 69, 70, 72, 251, 277, 393–400, 403, 405–408, 683
- compromise 7, 8, 157, 199, 249, 254, 291, 293, 325, 427, 492, 494, 524, 534, 538, 649, 675

- computational modelling 196, 200, 266, 307, 400, 401, 425, 426, 527, 605, 613–615, 625, 644, 652, 679
- computer model 196, 200, 266, 307, 400, 401, 425, 426, 527, 605, 644, 652, 679
- Concordat on Openness on Animal Research 226, 232
- confidentiality, confidential 231, 235, 292, 368
- confinement 10, 129, 201, 499. *See also* husbandry
- confirmatory science 249
- Consolidated Standards of Reporting Trials (CONSORT) 17, 328, 329
- CONSORT. *See* Consolidated Standards of Reporting Trials (CONSORT)
- contextualism 298
- cosmetics 32, 89, 93, 102, 103, 109, 115, 156–159, 183, 185, 202, 212, 218, 245, 246, 365–367, 369, 433, 587, 591, 592, 594, 601, 604, 641, 647, 650, 667, 678, 680
- testing 89, 183, 212, 365, 369, 591, 601, 604, 678
- Cosmetics Directive 156, 157, 159, 183. *See also* EU Cosmetics Directive 76/768/EEC
- Cosmetics Regulation. *See* EU Cosmetics Directive 76/768/EEC
- Cosmetic Toiletry and Fragrance Association (CTFA) 103
- cost
- economic 646, 650
 - of failed clinical trials 257
- cost-benefit analysis 198, 236–237, 282. *See also* harm-benefit-analysis (HBA)
- Cottee, Y. 662
- Council of Europe 3, 168, 172, 176, 177
- cow 130, 259–261, 263, 265, 451, 452, 660, 661, 664
- cannibalism 261
- crab 664
- cricothyroidotomy 555, 558
- Crisis Resource Management (CRM), XXII
- CRISPR. *See* Clustered Regularly Interspaced Short Palindromic Repeats (CRISPR)
- critical appraisal of animal studies 24–28
- critical thinking 69, 79–81, 427
- critique of animal experiments 194–204. *See also* political critique
- CRM. *See* Crisis Resource Management (CRM)
- crops 130, 131, 136, 137, 139
- crosstalk 644
- CRS. *See* Center for Responsible Science (CRS)
- Cruelty Free International 212, 292, 322, 358, 457, 594, 603
- Cruelty to Animals Act 152, 171, 322
- crustacean 664
- CTFA. *See* Cosmetic Toiletry and Fragrance Association (CTFA)
- culture of care 4, 11–13
- Czech Republic 154
- dairy 128, 130, 132–138, 259, 260, 452, 495
- DARPA. *See* Defense Advanced Research Projects Agency (DARPA)
- Darwin, C. 77, 244, 280, 377, 532
- data publication 95
- decline on ethical grounds 104
- De Denktank Aanfullende financiering alternatieven voor dierproeven 110
- Defense Advanced Research Projects Agency (DARPA) 103, 109, 643, 644, 647
- deliberate practice 558, 560
- democracy 224, 291, 300
- Denmark 236, 290, 601
- Department of Defense (DoD) 246, 552, 554. *See also* US Department of Defense
- depression 5, 9, 10, 129, 217, 364, 459, 520, 615
- deprivation 8, 217, 297, 519, 522, 523
- Descartes, R. 77, 321
- desensitization 312, 569
- Deutsche Forschungsgemeinschaft (DFG) 90, 98, 108, 194, 196–198
- Deutsches Tierschutzgesetz. *See* German Animal Welfare Act
- Developmental toxicology 107
- DFG. *See* Deutsche Forschungsgemeinschaft (DFG)
- diabetes 9, 24, 125–127, 245, 255, 276, 331, 357, 378, 452, 455, 459, 495, 496
- Diagnostic peritoneal lavage 555
- differentiation 24, 622, 628
- Directive 76/768/EEC. *See* EU Cosmetics Directive 76/768/EEC
- Directive 86/609/EEC 88, 152–155, 158, 159, 173, 591, 603

- Directive 2010/63/EU 3, 8, 10, 11, 27, 34, 35, 37, 88–97, 102, 109, 115, 152, 154–156, 160–162, 170–173, 175, 179, 181, 182, 233, 234, 236, 239, 282, 289–291, 295, 299, 300, 334, 335, 364, 417, 529, 560, 591, 605, 656, 660, 662–665, 668, 676
- Article 36 97, 180
- Article 49 94, 97, 113
- Article 55 93, 179, 529
- discovery research 202
- disease on a chip, *see* body on a chip. *See also* human on a chip, lab on a chip, organ on a chip
- disparity 134, 177, 613
- disposition 22, 179, 296, 309, 310
- distress 4, 9, 13, 14, 18, 22, 26, 28, 37, 93–95, 175, 179, 182, 194–196, 198, 227, 234, 237, 246, 294, 298, 306, 308, 314, 333, 454, 455, 520, 521, 554, 658, 664, 676
- diversity 139, 298, 456
- DoD. *See* Department of Defense (DoD); US Department of Defense
- Doerenkamp-Zbinden Chair of *in-vitro* Toxicology and Biomedicine/ Alternatives to Animal 98, 99
- dog 14, 163, 245, 257, 281, 283–286, 297, 343, 357, 358, 362, 363, 365, 368, 378, 379, 381, 401, 419, 422, 423, 452–453, 456, 483, 499, 519, 520, 552, 554–556, 568, 574, 575, 590, 604, 659
- double muscled beef cattle 263
- Draize eye irritation test 368, 663
- drug
- attrition in clinical trials 258
 - development 24, 29, 31, 68, 79, 258, 391, 403, 406–408, 457, 481, 483, 485–491, 499, 500, 596, 619–623, 630, 645, 677, 678, 682
 - discovery 28, 253, 256, 266, 432, 498, 596, 619, 625, 645, 649, 650, 681
- Dutch Ministry of Economic Affairs 110
- easy care sheep 264–265
- EC 1907/2006 157. *See also* REACH Regulation
- ECEAE. *See* European Coalition to End Animal Experiments (ECEAE)
- ECHA. *See* European Chemicals Agency (ECHA)
- ecological relevance 526
- economic(s) 101, 108, 110, 114, 135, 151, 170, 177, 183, 218, 264, 265, 294, 315, 367, 398, 399, 407, 500, 521, 530, 577, 589, 616, 620, 646, 650, 651, 663, 680, 684
- economic benefits 651
- ECVAM. *See* European Centre for the Validation of Alternative Methods (ECVAM)
- education and training 11, 21, 29, 33–34, 36, 90, 111, 112, 138, 140, 184, 322, 568, 569, 571, 572, 576–578. *See also* training
- effectiveness 18, 19, 21, 23, 27, 32, 67, 73, 88, 89, 124, 125, 127, 129, 132, 133, 140, 153–155, 162, 164, 170, 173, 176, 177, 180, 184, 185, 204, 215, 225, 235, 254–256, 265, 279, 307, 308, 314, 322–325, 330, 335, 357, 391, 405, 406, 417–420, 422–424, 429–431, 457, 465, 482, 486, 487, 492, 553, 556, 558, 560, 568, 619, 651, 679
- efficacy 16, 30–32, 34, 35, 73, 74, 92, 109, 124, 245, 246, 255, 256, 275–286, 322, 324, 327, 328, 332, 334, 335, 342, 358, 391, 392, 407, 418, 421, 423, 424, 430, 459, 461, 486–488, 500, 555, 587, 588, 596, 597, 619, 621
- electrodes 280, 281, 457, 520
- embryos 106, 363, 379, 445, 446, 449, 453, 454, 458, 462, 591, 621, 656, 661–663, 666, 667, 676
- emotion 11, 13, 67, 80, 129, 289, 294–301, 560, 569, 691, 693
- empathy 12, 280, 286, 294, 295, 298, 310, 558, 569
- EMST. *See* Early Management of Severe Trauma (EMST)
- endpoint
- experimental 182
 - humane 13, 18
 - less-inhumane 13
- enrichment. *See* environmental enrichment
- entrepreneurship 652
- environment 5, 72, 94, 127, 151, 171, 195, 211, 228, 244, 278, 290, 306, 325, 359, 392, 418, 518, 558, 568, 587, 614, 641, 663, 682
- environmental enrichment 5, 6, 8, 325, 331, 334
- Environmental Protection Agency (EPA) 94, 102, 103, 246, 429

- environmental refinement 5, 7–9. *See also*
environmental enrichment
- EPA. *See* Environmental Protection Agency
(EPA)
- EPAA. *See* European Partnership for
Alternative Approaches to Animal
Testing (EPAA)
- epistemic injustice 296
- epistemology 194–204, 305, 307, 309,
310, 315
problems 202
- equity investment 650
- Estonia 290
- ethical
conflict 290
consensus 285, 290
evaluation 178, 291
review 228, 232, 282, 289, 292–295, 301,
310, 329, 332, 602, 605
- Ethical Consumer Research Association 32,
667
- Ethical Principles for Medical Research
Involving Human Subjects 197. *see*
also Helsinki Declaration
- ethics 12, 21, 22, 36, 139, 183, 194–204,
209, 214, 218–220, 227–229, 236, 237,
275–286, 290, 292–295, 299, 323, 324,
329, 330, 403, 430, 480–500, 531–534,
537, 561, 569, 570, 572, 578, 595. *See also*
animal ethics
- ethology 194, 518, 520–521, 524, 526–528,
530, 536
- EU Cosmetics Directive 76/768/EEC 183
- EU Cosmetics Product Regulation (EC) No
1223/2009 157
- Eurobarometer 292
- Europe 3, 92, 102–104, 109, 125, 172, 176, 177,
183, 185, 202, 239, 260, 322, 588, 591, 593,
594, 596, 599–601, 603, 604
- European animal welfare and animal
protection laws 290. *See also*
Directive 86/609/EEC, Directive
2010/63/EU
- European Centre for the Validation of
Alternative Methods (ECVAM) 33, 91,
94, 104, 105, 152, 156, 157, 593, 598, 600,
659, 665, 666, 680
- European Chemicals Agency (ECHA) 159,
365, 623
- European Citizen's Initiative 169
- European Coalition to End Animal
Experiments (ECEAE) 154, 158, 368
- European Commission (EC) 4, 11, 12, 21,
27, 32, 33, 88, 93, 94, 102, 105, 113–115,
125, 153–157, 159, 161–163, 168–170,
173, 183, 185, 202, 322, 341, 365, 378,
420, 591, 593, 594, 599, 601, 602, 604,
661, 676
- European Commission department
Directorate-General for
Environment 94
- European Convention on Human
Rights 177
- European Directive on the approximation of
laws, regulations and administrative
provisions of the Member States
regarding the protection of animals
used for experimental and other
scientific purposes. *See* Directive
86/609/EEC
- European Directive on the protection of
animals used for scientific purposes
(Directive 2010/63/EU) 3, 8, 10, 11, 27,
34, 35, 37, 88–98, 102, 109, 115, 151, 152,
154–156, 160–162, 170–173, 175, 179, 181,
182, 233, 234, 236, 239, 282, 289–291,
295, 299, 300, 334, 335, 364, 417, 529,
560, 591, 605, 656, 660, 662–665,
668, 676
- European Ombudsman 159, 162
- European Parliament 4, 8, 14, 15, 27, 31, 32,
88, 93, 95, 97, 109, 113, 152, 155–159, 161,
170, 171, 173, 175, 176, 179, 181–183, 233,
236, 282, 289–291, 297, 334, 364, 417,
418, 529, 560, 575, 591, 600, 603, 605,
656, 660, 662, 664, 668, 676
- European Partnership for Alternative
Approaches to Animal Testing
(EPAA) 109, 159
- European Union, Europe (EU) 3, 10, 88,
92, 102–104, 109, 125, 137, 151, 152, 160,
169, 172, 176, 177, 183, 185, 202, 224, 226,
232–235, 239, 246, 260, 282, 289, 322,
341, 417, 443, 526, 529, 560, 588, 591, 593,
594, 596, 599–601, 603, 604, 656, 659,
665, 675
- European Union Reference Laboratory for
Alternatives to Animal Testing (EURL-
ECVAM) 33, 91, 94, 104, 105, 152, 156,
157, 659, 665, 666

- European Union Seventh Framework Programme 91
- EU-ToxRisk 91, 101, 102, 106, 107, 432
- evaluation committee 289–292, 301
- evidence-based medicine 25, 276
- evolution 29, 69, 70, 72, 77, 79, 106, 151, 152, 172, 174, 184, 199, 219, 220, 249, 260, 263, 277, 280, 285, 322, 376, 391–394, 399–400, 403, 406, 407, 429, 432, 433, 456, 460, 461, 464, 518, 521, 528, 567–579, 681, 684, 692, 693
- Excellence in Editorial Mandatory Policies for Animal Research (EXEMPLAR) Scale 330, 331
- experimental animal 26, 37, 110, 244, 278, 281, 284, 404, 432
- expertise 76, 79, 80, 95, 110, 159, 163, 203, 263, 282, 290–292, 295, 602, 621, 622
- eyes 30, 105, 212, 280, 365, 368, 396, 431, 433, 455, 589, 656, 660, 663, 666, 678–680
- factory farm 128–131, 259, 262, 265, 309
- factory farm-acology 262
- failed clinical trial 256, 257
- fallibilism 298
- false negative 200, 257, 325, 401, 402, 423, 424, 487
drug toxicity 257
- false positive 19, 20, 200, 256, 257, 325, 401, 402, 404, 423, 424, 487
animal model success 256–257
drug toxicity 257
- Farm Animal Welfare Committee 662
- farming. *See* animal agriculture
- fast-food 132, 134
- fat 128, 135, 259, 260, 262, 263, 452, 495
- FBS. *See* fetal bovine serum (FBS)
- FCS. *See* fetal calf serum (FCS)
- FDA. *See* Food and Drug Administration (FDA)
- FDAMA. *See* Food and Drug Administration Modernization Act of 1997 (FDAMA)
- Federal Institute for Risk Assessment 34.
See also Bundesinstitut für Riskobewertung (BfR)
- feed efficiency 259, 262
- fetal bovine serum (FBS) 92, 664, 665
- fetal calf serum (FCS) 664, 665
- fialuridine 419, 426
- fish 130, 171, 209, 228, 246, 281, 343, 367, 446, 521, 529, 538, 659, 661–663
embryo toxicity (FET) test 663, 666
farms 130
- five pillar-program 90, 113
- Fleming, A. 363, 424
- flow stress 642
- FOI. *See* Freedom of Information (FOI)
- Food and Drug Administration (FDA) 19, 29, 73, 94, 102, 125, 139, 246, 254–258, 343, 418, 420, 427, 429–431, 486–489, 619
- Food and Drug Administration Modernization Act of 1997 (FDAMA) 19, 20
- food deprivation 519
- food service 132, 134
- FRAME. *See* Fund for the Replacement of Animals in Medical Experiments (FRAME)
- France 89, 101, 154, 343, 419
- Fraunhofer Institute for Systems and Innovation Research 100
- Freedom of Information (FOI) 229–232, 421, 553
- free-living 293, 518, 520–523, 527
- fruit, plants, vegetables 128, 135–137, 497
- Fund for the Replacement of Animals in Medical Experiments (FRAME) 358, 659
- funding 17, 21, 23, 28, 30–33, 35, 36, 66, 73, 76, 78, 80, 81, 91–92, 97–104, 109, 110, 113, 114, 126, 127, 129, 133–134, 136, 137, 152, 155, 159, 160, 162, 164, 183, 226, 237, 238, 244–247, 249, 258, 261, 262, 265, 266, 277–279, 282, 285, 328, 330–332, 358, 365, 385, 386, 425, 429, 465, 481, 491, 497–499, 527, 578, 592, 595, 601–603, 605, 606, 647, 651, 659, 667, 678
redeployment of 35–36
- gas-liquid interface 647
- gavage 9, 325
- gene 23, 77, 102, 194, 263, 266, 277, 278, 357, 377, 397, 399, 400, 403, 405, 444–453, 455, 457–463, 465, 483–485, 590, 591, 613, 622, 626, 629, 682
- gene-pharming 194
- general principle of animal welfare 173, 174

- general public 67, 73, 76, 78, 105, 531, 660, 675
 genetically modified animals (GM animals) 16, 197, 333, 341, 343, 369, 443–465, 483
 genetic selection 259, 262–264
 genomics 135, 200, 249, 367, 398, 447–449
 German Animal Welfare Act 96, 97, 171, 175, 176, 181
 German Centre for the Protection of Laboratory Animals (Bf3R) 32, 97, 98
 German Federal Ministry of Education and Research, *see* Bundesministerium für Bildung und Forschung (BMBF)
 Germany 3, 12, 31, 89–92, 95, 97–102, 104, 106–109, 113, 154, 289, 291, 292, 294, 295, 343, 530, 553, 570, 601, 651, 679
 Glivec 423
 GM animals. *See* genetically modified animals (GM animals)
 goat 258, 451, 552, 555, 664
 Goldberg, A. 3, 103, 172, 179, 657
 gold standard 140, 199, 401, 402, 418, 427, 593, 649, 677
 Gold Standard Publication Checklist (GSPC) 17, 21, 329
 government 31, 33, 35, 78, 81, 89, 103, 113, 126, 132, 134, 136, 137, 154, 175, 177, 182–184, 211, 226, 229, 231, 232, 234, 235, 237, 238, 244–247, 250, 251, 258, 259, 264–266, 301, 417, 418, 420, 425, 426, 429, 431, 433, 554, 557, 570, 571, 575, 578, 595, 604, 605, 650, 653, 659, 662, 667, 668, 678
 Greek, J. 69, 72, 78, 124, 176, 277, 393, 403, 405
 Greek physicians 321
 Greek, R. 29, 35, 65–81, 124, 127, 176, 178, 199, 204, 236, 321, 323, 391–408, 518
 greenhouse gas 130, 131, 138, 139
 GSPC. *See* Gold Standard Publication Checklist (GSPC)
 Habermas, J. 312
 handling 9, 12, 13, 18, 195, 293, 325, 331, 499, 569, 643
 hand-rear 523
 Hansen, L.A. 69, 72, 78, 275–286, 392, 393, 677
 HARKING 19, 21
 harm-benefit-analysis (HBA) 95, 175, 290, 291, 334, 463
 harmonization 290, 292, 407, 429, 560–561, 594, 599, 600, 616, 619
 harm(s), animal 176, 283, 578, 692
 unnecessary 197
 unjustified 37
 harm(s), human 257, 310
 Hartung, T. 20, 23, 30, 96, 101, 200, 216, 324, 325, 332, 363, 366, 423, 427, 433, 593, 615, 620, 621, 650, 675–684
 hazard assessment 114
 HBA. *See* harm-benefit-analysis (HBA)
 HCI. *See* high content imaging (HCI)
 HCS. *See* high content screening (HCS)
 health 3, 66, 91, 124, 158, 168, 195, 213, 226, 245, 275, 290, 306, 321, 357, 380, 392, 418, 455, 482, 523, 553, 588, 615, 644
 heart disease 79, 125–127, 357, 423, 482, 497, 596
 Helsinki Declaration 181, 183, 197. *See also* Ethical Principles for Medical Research Involving Human Subjects
 hierarchy of the 3Rs 36, 171–174, 184
 high content imaging (HCI) 613
 high content screening (HCS) 612, 613, 615
 high throughput screening (HTS) 426, 615, 621, 644–646, 649, 650, 661
 HIPS. *See* Helmholtz Institute for Pharmaceutical Research Saarland (HIPS)
 HIPSC. *See* human induced pluripotent stem cells (hipsc)
 history 65, 66, 68, 77–79, 110, 151, 152, 172, 184, 194, 196–201, 210, 219, 221, 254, 277, 278, 285, 309, 315, 363, 376, 378, 393, 423, 428, 497, 519, 528, 554, 555, 557, 558, 568, 570–576, 593, 598, 644, 646–650, 676, 692
 Home Office 153, 176, 226, 233, 234, 236, 237, 333, 341, 343, 365, 366, 443, 454, 486, 521, 526, 659, 661, 662
 homeostasis 574, 614, 615, 617, 646
 Honneth, A. 306, 309–311
 Horizon 2020 91, 101
 horse 343, 433, 556, 664
 horseshoe crab 664. *See also* crab
 household products 93, 342, 343, 366, 604
 House of Lords 154, 160

- housing. *See* confinement; husbandry
- HTS. *See* high throughput screening (HTS)
- human 3, 65, 92, 124, 151, 168, 194, 209, 225, 245, 275, 290, 305, 321, 341, 376, 391, 417, 443, 480, 518, 551, 568, 587, 612, 641, 657, 676, 691
- human behavior 518, 520, 522
- human biology-based model 28
- human clinical trial 16, 17, 20, 35, 203, 215, 254, 255, 258, 328–329, 358, 367, 379, 405, 407, 420, 430, 620
- humane education 367, 567–579
- Humane Research Australia 225, 227, 228, 235, 240
- human healthcare 23, 323, 324, 380
- human induced pluripotent stem cells (hiPSC) 612, 627, 628, 649
- human on a chip model 103, 105, 107, 366. *See also* body on a chip, disease on a chip, lab on-a-chip, organ on a chip
- human patient simulator 553
- human primary cells 612, 642, 649
- human-relevant, and
 method 341, 358, 367, 433, 481
 model 35, 342, 460, 498, 668
 science, XXX
 test 430
- husbandry 4–11, 18, 22, 237, 264, 329, 523, 535, 661, 662
- IACUCS. *See* Institutional Animal Care and Use Committees (IACUCS)
- IATA. *See* Integrated Approaches to Testing and Assessment (IATA)
- iatro-epidemics 257
- IC50 646
- ICCVAM. *See* Interagency Coordinating Committee on the Validation of Alternative Methods (ICCVAM)
- ICH. *See* International Council on Harmonisation (ICH)
- inconsistency 22, 81, 174, 231, 298, 324, 356, 357, 363, 494, 620, 664
- incubators 649
- India 160, 171, 181–183, 212, 366, 422, 495, 554, 555, 561
- indispensability 6, 20, 175, 176, 291, 292
- individual differences 377, 525
- in dubio pro animale 174
- induced pluripotent stem cells 366, 462, 612, 628, 649
- industrial farming 129
- inequity aversion in mammals 293
- inhalation toxicology 106
- inhumanity 3, 4, 196
- InnoSysTox 101
- innovation index for replacement methods 112
- Innovative Systems Toxicology for Alternative to Animal Testing. *See* InnoSysTox
- in silico* 32, 196, 216, 266, 366, 367, 377–378, 382, 383, 425, 588, 590, 591, 596, 612–630, 650, 679, 681, 683
- Institutional Animal Care and Use Committees (IACUCS) 73, 282–284, 286
- instrumentalism 279
- instrumentalization 312
- Integrated Approaches to Testing and Assessment (IATA) 92
- integrity 65, 177–182, 184, 297, 299, 301, 333, 557, 623
- intention 109, 160, 169, 201, 215, 216, 226, 247, 259, 262, 275, 296, 297, 308, 310, 322, 329, 344, 393, 429, 537, 571, 691
- Interagency Coordinating Committee on the Validation of Alternative Methods (ICCVAM) 94, 266, 431, 593, 663, 666, 680
- International Council on Harmonisation (ICH) 430, 594
- interpretation 18, 25, 26, 65, 170, 172, 174, 184, 199, 210–212, 228, 291, 365, 492, 613
- intrinsic value 181, 297, 311, 314, 332
- invasive 37, 131, 245, 321, 322, 331, 333, 334, 386, 454, 519–521, 527, 528, 534, 552, 554, 572, 597, 691
- invertebrate 155, 403, 575, 656, 659, 661, 664, 667
- in vitro* 16, 24, 32, 34, 74, 91, 92, 98, 99, 101, 103, 106, 107, 196, 216, 234, 266, 362, 365–367, 377, 382, 383, 419, 423, 425, 426, 429, 430, 432, 450, 463, 573, 588–591, 595–599, 612–630, 641–647, 651, 652, 656, 658, 661, 663–666, 668, 679, 681, 683

- in vivo* 16–18, 34, 91, 196, 234, 329, 331, 362, 379, 425, 426, 450, 462, 588, 590, 612, 615, 620–622, 624–628
- Ipsos MORI 225, 233, 418
- irreproducibility 16, 18, 249–252, 256, 448
- isolated chicken eye (ICE) test 663, 666
- isolated rabbit eye (IRE) test 663
- Israel 101, 175, 183, 212, 366
- Italy 154
- Jenni, K. 309
- Jennings, M. 161, 453, 457, 661, 662
- Kant, I. 309
- Keesler Air Force Base 554
- killing 14, 15, 18, 27, 153, 182, 198, 200, 201, 203, 215, 244, 249, 279, 283, 297, 306, 313, 359, 420, 453, 568, 588, 662, 663
- Klausner, R. 254
- Koëter, H. 110
- Kuhn, T. 602, 684, 692
- labelling 598, 599
- lab on a chip 590, 596, 598. *See also* body on a chip, disease on a chip, human on a chip, organ on a chip
- laboratory 4, 66, 89, 125, 152, 169, 196, 209, 227, 245, 282, 293, 305, 321, 341, 427, 445, 483, 518, 551, 574, 593, 643, 656, 677, 692
- animal. *See* experimental animal
- animal research community. *See* animal research community
- animal science 4, 11, 72, 95, 113, 308, 311, 454
- animal science community 4, 11
- animal welfare 282, 286, 521–524. *See also* welfare
- behavioral experiment 524, 531
- behavioral research 519–520, 528
- enrichment. *See* environmental enrichment
- environment 518, 519, 522–524, 526, 528
- housing 333, 522. *See also* confinement; husbandry
- noise 9, 306, 307, 522, 523
- stress 294
- stressor 523
- technicians 308, 311, 314
- Lackland Air Force Base 553, 554
- Langley, G. 28–30, 36, 74, 424, 485, 486, 587, 596, 617, 682
- lasting harm 28, 182, 237, 520, 521
- law 3, 8–10, 12, 15, 19, 20, 33, 76, 89, 93–97, 136, 152, 155, 157, 159, 162, 168, 170–173, 175, 177–185, 195, 199, 211, 216–217, 220, 226, 227, 229, 231, 232, 245, 253, 258, 266, 282, 284–286, 289–294, 297, 299–301, 313, 365, 399, 417, 443, 464, 527, 529, 536, 553, 569–571, 577, 578, 594, 603, 643, 664, 693
- LD₅₀ 594
- learned helplessness 9, 10, 520
- legislation 3, 4, 29, 34, 78, 134, 154–162, 172, 183, 202, 227, 234, 265, 285, 290, 322, 343, 365, 368, 421, 552, 568, 576, 591, 594, 598–599, 603, 656, 657, 660–662, 664, 675–676, 678
- legislative change 35, 365
- likelihood ratio 422
- limitation 6, 14, 23, 26, 27, 31–33, 74, 75, 96, 104, 128, 155, 160, 161, 172, 179, 180, 199, 200, 202–204, 211, 216, 220, 234, 236, 249, 257, 266, 275, 282, 283, 285, 286, 295, 308, 310–312, 314, 324–325, 331, 335, 356, 357, 364, 368, 377, 396, 429, 448, 452, 453, 457–459, 461, 486, 487, 492, 494, 500, 529, 557, 569, 579, 598, 605, 615, 620–622, 624–627, 642, 657, 664, 668, 676, 677, 679, 681, 686, 692
- limulus amoebocyte lysate (LAL) assay 664
- limulus polyphemus 664
- literature review
 - structured 14, 15
 - systematic (*see* systematic review)
- liver toxicity 612–630
- live tissue training (LTT) 552–553, 560
- lock-in 427
- lorcainide 422
- L'Oréal 592
- low clearance compounds 646
- LTT. *See* live tissue training (LTT)
- Lukács, G. 310
- lung model 106
- Lush Cosmetics 667
- Lush Prize 32, 667, 668
- Lyons, D. 152, 153

- macaque 8, 280, 359, 381, 453, 457, 520, 530
MAD. *See* Mutual Acceptance of Data (MAD)
Mad Cow Disease 259, 265
Madigan Health System 553, 554
magnetic resonance imaging (MRI) 279
Major Depressive Disorder (MDD) 380, 381, 383–385
mammal 15, 71, 293, 377, 392, 400, 403, 423, 613, 656, 659–662
manikin 563
MARC. *See* Meat Animal Research Center (MARC)
marketing 68, 73, 89, 90, 101, 125, 132, 133, 136–139, 160, 183, 185, 212, 215, 217, 245, 256–258, 262, 263, 291, 359, 363, 365, 366, 394, 402, 407, 420, 430, 456, 619–621, 645–647, 650, 651, 653, 654, 676, 678
Marks, J. 36, 660, 666
master plan for an end to animal experiments 90
maternal separation 523
maximum tolerated dose 325
MBM. *See* meat and bone meal (MBM)
MDD. *See* Major Depressive Disorder (MDD)
meat 126, 128, 130–132, 134–138, 259–263, 309, 451, 452, 495
meat and bone meal (MBM) 260, 261
Meat Animal Research Center (MARC) 261–265
Medical Council of India 554
medical education 552, 556, 560, 571, 572
medical research 3, 15, 16, 28, 31, 38, 72, 111, 179, 181, 197, 214, 215, 226, 281, 306, 329, 330, 341, 342, 379, 384, 393, 403, 458, 481, 595, 641
medical simulation 559, 560
medical training 138–139, 552–557, 560, 561, 574
medication 15, 26, 124–127, 131, 138, 139, 486, 557
medicine 23, 68, 89, 127, 184, 194, 235, 244, 276, 292, 322, 341, 385, 391, 417, 446, 486, 553, 572, 594, 613, 682, 692
mega farm 130
memory 278, 481, 484, 485, 519, 521, 530
Menache, A. 69, 78, 127, 178, 403
meta-analysis 25, 26, 277, 279, 323, 379, 424, 494, 496
metabolic signaling 642
metazoan endoparasite 658
methodological quality 26, 200, 325–331, 335
Mexico, XXIII
mice. *See* mouse
microdosing 426, 429, 597
microelectronics 643
microfluidics 103, 216, 622, 627, 628, 647, 648
microfluidic systems 627, 628
micro-liver 426
microphysiological system (MPS) 31, 103, 641, 643–644, 679
microtiter plate 642, 644
military 247, 306, 313, 314, 551–554, 559, 560, 570
miniaturized reproductive tract. *See* repro-on-a-chip
mini pig 365, 659. *See also* pig
money 32, 35, 67, 73, 76, 80, 81, 101, 108, 132, 136, 137, 158, 244–266, 276, 279, 285, 293, 429, 497, 500, 667
money waste 244–266
monitoring 8, 13, 15, 18, 20, 89, 90, 93–95, 112, 114, 115, 228, 234, 238, 246, 301, 308, 456, 521, 572, 578, 589
monkey 93, 247, 257, 281, 358, 362, 363, 378, 381, 399, 419, 422, 452–453, 456–459, 461, 499, 520, 523, 529, 530, 553, 588, 597, 604, 691, 692
moral agency 306, 309–314
moral doubt 289–301
moral injury 305–315
moral status 200, 209–221, 280, 308, 309, 311, 314, 315
moral taboo 313
morbidity 279, 307
morphology 69, 393, 523, 622, 642
mortality 77, 264, 279, 307, 455, 487, 491, 496, 664
mouse 6–9, 13, 14, 22–24, 27, 29, 67, 72, 107, 124, 209, 217, 244–249, 251, 254–258, 266, 277, 278, 281, 284, 326, 343, 357–359, 362, 363, 365, 378, 381, 384, 397, 399, 400, 405, 406, 419, 422, 427, 444–448, 452–456, 460–462, 465, 480, 483–485, 487, 499, 521, 524, 573, 577, 588, 590, 591, 596, 599, 659–661, 666, 682
MPS. *See* microphysiological system (MPS)

- MRI. *See* magnetic resonance imaging (MRI)
- multi-chamber plates 643
- multidisciplinary cooperation 112
- Multilateral Collaboration in Computational Neuroscience 101
- multiple sclerosis 324, 330, 419, 459
- murine local lymph node assay (LLNA) 596, 599, 666
- mus* 381, 660
- Mutual Acceptance of Data (MAD) 599
- myostatin gene 263
- NANN. *See* National Association of Neonatal Nurses (NANN)
- narrative review 323
- NAS. *See* National Academy of Sciences (NAS)
- National Academy of Sciences (NAS) 595
- National Anti-Vivisection Society (NAVS) 33, 246, 251, 322
- National Association of Neonatal Nurses (NANN) 555
- National Center for Computational Toxicology 102
- National Centre for the Replacement, Refinement & Reduction of Animals in Research (NC3Rs) 32, 33, 35
- National competency centers 93, 94
- National Institute of Public Health and Environmental Protection (RIVM) 110
- National Institutes of Health (NIH) 28, 31, 66, 67, 73, 91, 102, 109, 136, 245, 246, 248, 251–253, 262, 275, 278, 285, 358, 367, 419, 424, 426, 429, 497, 498, 530, 647
- National Toxicology Program at the National Institute of Environmental Health Sciences (NIEHS) 102, 246
- NATO. *See* North Atlantic Treaty Organization (NATO)
- natural behavior 10, 518–520, 522–524, 527, 528
- Naval Medical Center Portsmouth 554
- NAVS. *See* National Anti-Vivisection Society (NAVS)
- NCad. *See* Netherlands National Committee for the protection of animals used for scientific purposes (NCad)
- necrosis 642
- negative results 27, 200, 252, 325, 332, 423
- Netherlands 26, 35, 89, 101, 109–114, 179, 290, 341, 433
- Netherlands National Committee for the protection of animals used for scientific purposes (NCad) 35, 89, 90, 96, 109–115, 184, 341, 433
- neurological disease 324, 461
- new drug pipeline 245, 254, 487
- new variant Creutzfeldt-Jakob disease (nvCJD) 259, 261
- NGO. *See* non-governmental organization (NGO)
- NHP. *See* non-human primate (NHP)
- NIH. *See* National Institutes of Health (NIH)
- noise 9, 19, 306, 307, 522, 523
- non-animal method. *See* animal free science
- non-animal model. *See* animal free science
- non-animal research approach 266
- non-animal technology. *See* animal free science
- non-animal test. *See* animal free science
- non-governmental organization (NGO) 31, 67, 301, 657, 668
- non-human primate (NHP) 8, 14, 27, 93, 152, 160, 178, 179, 183, 229, 234, 239, 255, 281, 326, 343, 357, 358, 365, 378, 400, 424, 453, 456, 457, 483, 519, 529–531, 538, 552, 659, 691
- non-invasive 278, 331, 518, 520, 528, 529, 531, 597
- non-technical skills 560
- Non-technical Summaries (NTS) 233–236, 239, 526
- North Atlantic Treaty Organization (NATO) 553, 560
- Norway 10, 33, 366
- Norwegian Animal Research Authority 553
- NTSS. *See* Non-technical Summaries (NTSS)
- numbers of animals used 6, 88, 128, 527, 656, 657
- nutrition 36, 127, 132–136, 138–140, 259, 452, 494
- nvCJD. *See* new variant Creutzfeldt-Jakob disease (nvCJD)
- obesity 9, 24, 125–127, 133, 134, 419, 496
- objectification 309, 569
- OECD. *See* Organisation for Economic Co-operation and Development (OECD)

- ombudsman 159, 162
omics 107, 612–615, 626, 628–630
 1R 197, 667, 668
 opioid 126
 opportunity cost 244, 307
 organ 9, 91, 92, 101–103, 105–107, 109, 115, 138, 194, 196, 199, 216, 324, 332, 343, 364, 366, 367, 377, 419, 425, 426, 428, 451, 459, 462, 493, 555, 596, 613, 615, 617, 622, 624, 627, 641–654, 658, 660, 662, 667, 679, 681, 683
 Organisation for Economic Co-operation and Development (OECD) 92, 159, 367, 407, 589–591, 593–596, 600, 601, 616, 617, 624, 663, 666, 680, 682
 organoid 24, 91, 106, 462, 622, 642, 643, 646, 684
 organ on a chip 92, 101, 102, 106, 115, 138, 216, 366, 426, 596, 641–653. *See also* body on a chip, disease on a chip, human on a chip, lab on a chip
 organs in a plate 643, 645, 649
 outcome assessment 329
 overhead 66, 247, 248, 266
- pain 12–16, 18, 22, 28, 37, 93–97, 154, 174, 175, 179, 182, 196–199, 203, 209, 213, 225, 227, 228, 232, 234, 236, 237, 239, 245, 246, 275, 278–283, 285, 286, 294, 297, 306, 307, 333, 362, 419, 420, 423, 444, 447, 452–454, 459, 464, 499, 520, 521, 528, 554, 569, 571, 590, 622, 658, 659, 661, 662, 664, 665, 676, 693
 PALS. *See* Pediatric Advanced Life Support (PALS)
 paradigm change 34, 35, 89, 90, 95, 109–110, 112, 113, 151, 159, 162–164, 169, 170, 172, 182–184, 200, 201, 209, 239, 284–286, 289, 291, 295, 300, 315, 335, 342, 367, 369, 393, 432, 551, 568, 570, 579, 595, 606, 629, 651–654, 657, 667, 693
 paradigm shift. *See* paradigm change
 patent(s) 93, 106, 245, 247, 257, 647, 678
 patient(s)
 animal 315, 574
 human 24, 28, 305, 307, 324, 333, 334, 408, 430, 433, 553, 557–559
 expectations 38
 safety 368, 433, 560
- PCRM. *See* Physicians Committee for Responsible Medicine (PCRM)
 Pediatric Advanced Life Support (PALS) 555
 peer review 17, 21, 65, 70, 76–81, 249, 253, 260, 261, 427, 491, 650
 Penicillin 257, 344, 359–364, 424
 People for Animal Rights Germany–The Federal Association against Vivisection 90, 113
 People for the Ethical Treatment of Animals (PETA) 32, 159, 368, 552, 553, 555, 556, 663, 666
 perfusion 642, 646
 pericardiocentesis 555
 peristaltic pump 648
 personalized medicine 68, 79, 127, 138, 140, 277, 278, 391, 403, 408, 613, 628
 Persson, T. 153, 155
 PETA. *See* People for the Ethical Treatment of Animals (PETA)
p-hacking 19
 pharmaceutical 12, 19, 23, 29, 30, 73, 92, 94, 98, 99, 103, 138, 139, 160, 215, 224, 244–247, 254, 256, 258, 266, 291, 306, 325, 342, 358, 364, 407, 422, 423, 426, 429, 430, 432, 433, 456, 460, 486, 487, 491, 492, 554, 619, 620, 623, 644, 645, 647, 650, 677
 pharmaceutical industry 73, 92, 139, 244, 254, 256, 358, 423, 487, 619, 620, 644, 647, 677
 Pharmaceutical Research and Manufacturers of America 23, 215, 487
 pharmacodynamics 614, 615, 625, 627
 pharmacokinetics 366, 392, 614, 615, 620, 624, 627
 pharmacology 72, 283, 486, 518, 554, 561, 574, 625
 Pharmacy Council of India 554
 phase-out 35, 89, 90, 101, 110–115, 172, 183, 185, 341, 433, 527
 Philippines 175
 physical
 activity 129, 133, 493, 494, 497
 examination 558
 suffering 307
 Physicians Committee for Responsible Medicine (PCRM) 135, 136, 368, 553–556

- Physiologically Based Pharmacokinetic (PBPK) models 366, 624, 625
- pig 8, 14, 71, 130, 169, 257–260, 262, 343, 357, 362, 363, 368, 381, 451, 452, 459, 521, 552, 554, 555, 569, 590, 602, 661
- pigeon 519, 520
- plant 124–140, 174, 217, 260, 418, 464, 497, 658
- plant based 124–140, 497
- plausibility 97, 289–301
- pluralism 579
- pneumatic 103, 648
- Polish Ministry of National Defense 553
- political critique of animal experiments 194–204
- politics, political 31, 35, 37, 67, 104, 110, 114, 115, 134, 151–164, 169–171, 194–196, 203–204, 218, 285, 293–295, 300, 309, 315, 342, 365, 369, 570, 579, 594, 595, 600, 601, 604–606
- poll 225, 233, 418, 482
- Portugal 290
- pragmatism 297, 298
- precautionary principle 173, 174, 403
- preclinical
 - animal test 421–426
 - biomedical experiments 248
 - research 35, 90, 111, 245, 246, 251, 254, 256, 385, 406, 500
 - science, non-repeatable 249, 256
 - testing 111, 256, 258, 422, 423, 425, 430, 486, 487
 - trials 20, 21, 385
- Preclinical Trials 20, 21
- predator 519, 521, 523
- predictive value 23, 28, 68–74, 76, 78, 79, 178, 391, 393, 394, 399–408, 417, 427, 492
- predictivity 8, 68, 95, 127, 178, 199, 230, 249, 277, 296, 323, 342, 377, 391, 417, 447, 484, 536, 587, 613, 641, 676
- preregistration
 - animal studies 20
 - clinical studies 20, 235–236
 - preclinical studies 20, 235–236
- prescription drugs 124–126, 139, 140
- Principles of Humane Experimental Technique 3, 196, 364, 657
- The Principles of Humane Experimental Technique 3, 196, 364, 657
- production efficiency 259, 261–264, 266
- professionalism 104, 153, 198, 201–203, 220, 227, 283, 284, 297, 313, 332, 433, 556, 557, 559, 561, 569, 572, 575, 578, 691
- professorships for animal-free research
 - methods 92
- project evaluation 21, 27, 95, 97, 156
- proportionality test 174–178
- protein 135, 259–261, 277, 444, 451, 461, 484, 485, 490–492, 575, 590, 596, 623
- proteomics 200
- psychological constructs 518
- psychological suffering 519. *See also* suffering
- publication bias 18, 19, 21, 26, 252–254, 276, 357
- public health 16, 36, 110, 126, 128, 133, 134, 158, 247, 282, 322, 324, 334, 429, 430
- public opinion 73, 153, 154, 162, 239, 240, 281, 365, 378, 392
- puzzle box 519
- pyrogenicity 101, 602, 603, 664, 680
- QSP. *See* quantitative systems pharmacology (QSP)
- quality management 95
- quantitative systems pharmacology (QSP) 625
- rabbit 7, 14, 212, 247, 257, 343, 357, 358, 363, 364, 368, 381, 422, 424, 452, 483, 588–591, 594, 598, 599, 602, 603, 660, 663, 664
- rabbit pyrogen test 664
- randomization 17, 18, 26, 276, 326–328, 380, 381, 405, 493, 495, 558
- rat 5, 8, 10–14, 22, 27, 71, 124, 209, 217, 246, 257, 281, 284, 293, 294, 297, 298, 326, 343, 357, 358, 362–364, 381, 406, 419, 422–424, 427, 464, 483, 519, 521, 523, 589–591, 660, 666, 677
- rat embryotoxicity assay 666
- rat skin transcutaneous electrical resistance (TER) test 666
- REACH. *See* Registration, Evaluation, Authorisation and Restriction of Chemicals (REACH)
- REACH Regulation 433
- read-across 93, 590, 591, 623, 624, 681

- recognition 28, 67, 108, 158, 181, 280, 296–297, 306, 310, 332, 342, 369, 573, 599
- recording chambers 521
- rede de desenvolvimento humano (RedEH) 578, 579
- RedEH. *See* Brazilian Network for Humane Education; rede de desenvolvimento humano (RedEH)
- red meat production efficiency 262
- reduction 3, 72, 89, 124, 158, 168, 196, 218, 227, 265, 279, 290, 315, 327, 342, 396, 430, 456, 493, 551, 558, 577, 588, 612, 657
- refinement and
 - experimental 3, 13–22
 - of experimental design, conduct and reporting 16–22, 33
 - housing 5, 9–10
 - R of ultima ratio 4
- reform proposal 171–180
- registered reports 21
- Registration, Evaluation, Authorisation and Restriction of Chemicals (REACH) 157, 365, 433, 677
- Regulation 433
- Rego, L. 4, 31, 152, 168, 443
- Regulation (EC) No 1223/2009 157
- Regulation (EC) No 1907/2006 157, 592. *See also* REACH
- regulatory acceptance 32, 96, 266, 589–591, 593–595, 599, 600, 649, 666
- regulatory approval 28, 266, 604, 650, 651
- regulatory bodies 21, 22, 407, 593, 594, 603, 620, 644, 663, 666, 667
- regulatory preclinical research 35, 111
- regulatory testing
 - safety testing 112, 246, 341, 418, 427, 588
 - toxicity testing 363, 659
- reification
 - of animals 311, 314
 - of humans 305–315
- relative replacement 658, 661
- reliability 8, 24, 25, 94, 307, 325, 327, 330–332, 335, 524, 595, 601, 625
- Renaissance 321
- rendering 66, 68, 80, 177, 182, 199, 211, 212, 260, 299, 400, 443, 444, 451, 485, 619
- Rennes, France 419
- replacement 3–38, 88–91, 93, 96–100, 102–105, 108, 109, 111–113, 151, 152, 154–160, 169–174, 178, 183–185, 196, 227, 228, 233, 239, 290, 291, 330, 332, 342, 358, 364, 366, 367, 369, 377, 418, 430, 432, 433, 457, 481, 490, 494, 500, 519, 527, 551, 555, 557, 568–572, 574, 575, 577–579, 587–589, 592, 596, 599–602, 605, 649–652, 656–668, 676, 678, 679, 681. *See also* alternative
- replicability 6, 8, 524. *See also* alternative
- reporting
 - bias 18, 20, 21, 26, 235, 326, 356
 - selective 18, 20, 235, 421
- reproducibility crisis 16, 424, 677, 680, 682, 684
- reproductive toxicology 107
- repro-on-a-chip 107
- reptile 217, 661, 662
- research
 - budget 100, 136, 261
 - competition 291
 - confirmatory 19
 - discovery (*see* discovery research)
 - exploratory 19
 - flaws and shortcomings 20, 21
 - non-publishable 252–254
 - quality 379 (*see also* scientific rigor)
- research assessment exercise 328
- Research Initiative R2N–Replace and Reduce 98
- responsibility 10, 11, 15, 25, 35–37, 88, 94, 113, 114, 135, 136, 182, 185, 211, 224, 227, 229, 232, 233, 238, 265, 279, 311, 324, 365, 368, 378, 420, 423, 430, 456, 464, 481, 484, 523, 553, 576, 603
- RETHINK 168–185, 659
- retrospective assessment 21, 27–28, 95, 156, 233–235, 368, 676
- return on investment (ROI) 239, 247, 266, 358
- review process 65, 76, 77, 289–301, 427
- Rice, M.J. 69, 72, 78, 127, 393, 398, 403, 404, 406
- Rijksinstituut voor Volksgezondheid en Milieu Netherlands (RIVM) 110
- risk assessment 30, 34, 97, 100, 101, 112, 114, 431, 432, 616, 625–627, 641
- risk of bias (RoB) 17, 25, 26, 329, 330
- RIVM. *See* Rijksinstituut voor Volksgezondheid en Milieu Netherlands (RIVM)

- road map 89, 90, 113
- ROB. *See* Risk of Bias (ROB)
- robotic equipment 642, 643
- rodent 8, 12, 14, 28, 30, 171, 325, 358, 365, 426, 451, 453, 456–458, 520, 521, 523, 538, 590, 661, 662
- ROI. *See* return on investment (ROI)
- routes of exposure 325
- Royal Society for the Prevention of Cruelty to Animals (RSPCA) 330, 662
- RSPCA. *See* Royal Society for the Prevention of Cruelty to Animals (RSPCA)
- Russell, W.M.S. 3, 4, 18, 29, 36, 171, 172, 196, 197, 364, 577, 656–659, 664, 668
- Safer Medicines Trust 433
- safety of medicines 89, 90, 417, 418, 432
- Saint Bernard of Clairvaux 259
- same-species feeding 260
- sample size 18, 327–329, 344
- saturated fat 135, 495
- scaffold 575, 642
- SCHEER. *See* Scientific Committee on Health Environmental and Emerging Risks (SCHEER)
- science-friendly 298
- scientific collaboration 36–37
- Scientific Committee on Health Environmental and Emerging Risks (SCHEER) 161, 171, 178
- scientific output 109, 521
- scientific progress 30, 110, 162, 300, 433, 678, 682
- scientific rigor 23, 394, 428
- search engine for alternative methods 34
- sentience 77, 153, 161, 170, 171, 181, 198, 200, 203, 280, 285, 290, 300, 402, 403, 499, 535, 570, 656–659, 662, 664
- serum 92, 103, 423, 664, 665, 667
- Set Foundation 98, 100, 101
- SEURAT- 1, 91, 102, 601
- severity assessment 294
- severity classification 297, 301
- shame 297, 314
- Shanks, N. 69, 71, 78, 124, 199, 202, 204, 277, 307, 393, 403–405
- sheep 14, 257, 258, 262, 264–265, 284, 343, 357, 452, 454, 521, 555, 556
- Simulab Corporation 555–557
- simulator 368, 553–560, 573
- Singapore 160, 175
- Singer, P. 213, 214, 217, 218, 308, 691, 692
- skin and
 - corrosion 366, 598, 666
 - irritation 365, 431, 589, 592, 594, 595, 598–600, 602
 - sensitization 365, 367, 590, 595, 599, 600, 602, 617, 666, 680
- Skinner box 519
- SMAFIRA. *See* smart feature-based interactive ranking algorithm (SMAFIRA)
- smart feature-based interactive ranking algorithm (SMAFIRA) 34
- SNAP. *See* Supplemental Nutrition Assistance Program (SNAP)
- social isolation 217, 520
- societal concerns 4, 29, 38
- species differences 18, 23, 107, 332, 356, 357, 363, 425, 443, 444, 465, 497, 593, 596
- speciesism 198, 200, 202, 568, 571
- spheroids 642, 644, 647
- stakeholder 66, 74, 90, 93, 94, 104, 105, 109, 110, 112–115, 135, 154, 157, 162, 163, 170, 209–221, 224, 286, 342, 369, 448, 456, 660
 - theory 209, 210, 216, 220
- standardization 5, 6, 9, 195, 588, 603, 619, 625, 643, 648
- statins 162, 173, 293, 362, 364, 368, 423–425, 486, 495
- statistics 16, 18–20, 25, 31, 76, 79, 130, 195, 199, 216, 228–230, 238, 323, 326–330, 343, 379, 381–385, 422, 429, 443, 454, 482, 496, 521, 652, 662, 676
- stem cells 24, 92, 107, 216, 278, 357, 366, 445, 450, 462, 591, 612, 626, 628, 649, 679
- stereotactic 521
- stereotypy 7–9, 455, 522. *See also* abnormal behavior
- stewardship 279–281
- Stop Vivisection 161–163, 169, 170, 194. *See also* Citizen's Initiative
- strategy 20, 22, 33, 35, 89, 90, 104, 108, 110, 112, 113, 138, 152, 158, 162–164, 170, 171, 173, 201, 202, 227, 236, 237, 239, 254, 313, 314, 342, 362, 368, 429, 431–433, 452, 530, 535, 557, 577, 589, 590, 603, 615, 617, 651–654, 681–683

- stress 7–11, 13, 129, 172, 196, 231, 232, 263, 300, 305, 307, 313, 314, 325, 333, 454, 465, 522, 523, 528, 535, 538, 560, 614, 615, 617, 642, 662
- stressor 5, 8, 10, 305, 307, 325, 333, 518, 523, 614, 616
- stroke 22, 24–26, 125, 126, 133, 255, 276, 324, 357, 402, 406, 424, 425, 482, 495
- The Structure of Scientific Revolutions 684, 692
- subjectivity 11, 237, 308, 310, 314, 327, 399, 454, 569, 590
- subsidies 135–139, 244, 247, 261, 266, 368
- suffering 13, 92, 124, 153, 168, 194, 210, 225, 248, 275, 290, 306, 321, 342, 377, 403, 420, 444, 499, 519, 569, 594, 652, 656, 675, 692
- unnecessary 300, 301
- Supplemental Nutrition Assistance Program (SNAP) 134, 137
- sustainability 127, 130–132, 137, 266, 652
- Sweden 154, 179, 290, 601
- Switzerland 17, 179, 331
- symptoms 125, 139, 255, 297, 385, 405, 483, 487, 491, 492, 558
- SYRCLE. *See* Systematic Review Center for Laboratory Animal Experimentation (SYRCLE)
- systematic review 6, 15, 17, 25–27, 96, 161, 236, 276, 323, 325, 326, 329, 331, 332, 344–358, 362, 369, 379, 429, 494–496, 681
- Systematic Review Center for Laboratory Animal Experimentation (SYRCLE) 6, 26, 27
- system change 90
- systemic models 646
- systems biology 101, 216, 613, 614, 621, 625–627, 682, 683
- systems toxicology 101, 613–615, 630, 682
- Taiwan 183
- Tamoxifen 257, 423
- target 22, 32, 75, 107, 110, 114, 132, 137, 229, 231, 253, 256, 261, 278, 312, 380–384, 419, 445–450, 452, 454, 455, 457, 458, 460, 463–465, 480, 486, 491–493, 524, 527, 604–606, 615–618, 623, 625, 627–629, 644, 650, 665, 678
- taxpayers 35, 109, 136, 244, 245, 247, 248, 254, 261–266, 499
- tax-supported animal research 245
- Taylor, K. 4, 14, 31, 152, 168, 216, 322, 379, 443, 454, 482, 587–606, 647, 666
- technological development 94, 613, 683
- teratogenicity research 324
- testing 3, 65, 88, 124, 151, 170, 194, 209, 227, 244, 281, 289, 306, 322, 341, 381, 391, 417, 448, 486, 521, 569, 587, 615, 641, 656, 675, 691
- Test Methods Regulation, EC 440/2008 600
- TGN₁₄₁₂ 366, 419, 426
- Thailand 181
- theory of mind 521, 525, 526, 529, 530, 532, 536, 537
- Think Tank on Supplementary Financing for Alternatives to Animal Testing 110
- 3D and
- bioprint 108
- cell culture 106, 462, 621, 642, 644, 646
- 3D organotypic cultures 627
- 3Rs
- hierarchy 36, 171–174, 184
- impact 4
- implementation of 27, 159, 237, 239, 331, 577
- Tierschutz-Versuchstierverordnung (Ordinance on the protection of animals used for experimental purposes) 96, 292, 297
- tissues 24, 31, 71, 92, 101–103, 107, 183, 194, 196, 212, 216, 249, 278, 358, 364, 366, 367, 377, 378, 425, 426, 428, 454, 455, 552, 555, 558, 573, 574, 588, 598, 613, 617, 621, 622, 624, 642, 644, 646, 649, 656, 658, 659, 662, 665–667
- tool use 521
- Tox21. *See* Toxicology in the 21st Century (Tox21)
- Toxicity in the 21st century (Tox21) 29, 89, 92, 102, 367, 426, 432, 595, 612–619
- toxicity testing 29, 30, 35, 89, 91, 102, 105, 109–111, 114, 152, 158, 159, 184, 236, 244, 245, 322, 341, 342, 362, 363, 365–367, 417, 418, 421, 423, 428, 432, 433, 587–592, 595, 601–603, 620, 659, 660, 676–680
- toxicodynamics 324, 332, 624
- toxicokinetics 365

- toxicology 29, 72, 89, 157, 200, 266, 306, 323, 342, 424, 486, 588, 612, 667, 676, 693
 Toxicology in the 21st Century (Tox21) 29, 89, 92, 102, 367, 426, 432, 595, 612–619
 training 11, 33, 36, 66, 90, 137, 184, 209, 237, 263, 301, 322, 342, 457, 551, 568, 666, 679. *See also* education and training
 transgenic 29, 195, 239, 278, 365, 453, 456, 483–485, 492, 659
 transition
 management 112–113
 strategy 90, 112–113
 to non-animal research 35, 89, 110, 113, 114
 translatability 10, 22, 199, 424, 460, 489
 crisis 18
 translation 10, 14, 18, 19, 22–25, 31, 73, 75, 90, 101, 102, 111, 112, 124, 125, 151, 180, 199, 245, 252, 254–258, 265, 266, 276, 277, 280, 285, 305, 307, 315, 324, 327, 343, 344, 356, 357, 362, 386, 408, 424–426, 451, 457, 460, 462, 465, 480, 483, 485–487, 489, 499, 620, 621, 652, 657, 680
 translational research 90, 111, 112. *See also* applied research
 translational risk 254
 transparency 19–21, 27, 34, 37, 93, 94, 115, 134, 156, 158, 160, 162, 163, 197, 224–240, 265, 292, 301, 328, 329, 427, 682
 transportation 130, 246, 333
 Trans-species modeling theory (TSMT) 69, 70, 72, 392–394, 408
 trauma 23, 276, 313, 499, 551–553, 555–557, 560
 TraumaMan 555–557
 trauma management 552
 Travis Air Force Base 554
 trial registries 20, 253, 332
 TSMT. *See* Trans-species modeling theory (TSMT)
 twinner beef cattle 263

 UN GHS. *See* United Nations Globally Harmonised System of Classification and Labelling of Chemicals (UN GHS)
 unintended negative consequences 244
 United Kingdom (UK) 3, 26, 32, 33, 36, 89, 126, 130, 152–155, 159, 160, 174, 176, 179, 185, 196, 225, 226, 232–234, 236, 237, 239, 281, 290, 291, 326, 328, 330, 333, 334, 341, 343, 358, 418, 419, 421, 425, 432, 433, 443, 454, 486, 520, 521, 526, 560, 588, 592, 601, 603, 650, 651, 653, 659, 661, 662
 United Nations Globally Harmonised System of Classification and Labelling of Chemicals (UN GHS) 599
 United States of America (USA, US) 16, 28, 29, 31–33, 66, 73, 89, 91, 92, 94, 101, 102, 104, 109, 124–126, 128–134, 136, 137, 160, 168, 171, 176, 209, 212, 217, 219, 244–251, 253, 254, 257–259, 261–265, 275, 276, 278, 279, 282, 285, 286, 326, 330, 366, 418–420, 422, 424, 426, 427, 429, 431, 432, 445, 452, 456, 461, 481, 482, 486, 497, 498, 529, 530, 534, 538, 551–554, 556, 560, 561, 593, 595, 601, 615, 619, 643, 647, 650, 651, 660, 661, 677, 678, 680
 universities 26, 34, 42, 66, 78, 79, 93, 98, 103, 104, 108, 109, 176, 196, 219, 226, 229–232, 247, 248, 254, 260, 261, 283, 312, 314, 328, 366, 367, 392, 489, 491, 500, 521, 529, 530, 555, 571–575, 578, 587, 602, 628, 647–652, 657, 661, 665, 684
 University of Nebraska-Lincoln (UNL) 260–263
 UNL. *See* University of Nebraska-Lincoln (UNL)
 USDA. *See* US Department of Agriculture (USDA)
 US Department of Defense 246, 552, 554
 US Department of Agriculture (USDA) 124, 129–132, 134–136, 209, 246, 258, 260–263, 282, 554, 659, 660
 US National Institutes of Health 28, 245, 248, 647. *See also* National Institutes of Health (NIH)
 utilitarianism 153, 177, 198, 229, 334, 464, 533, 535, 537, 692

 vaccine 32, 35, 67, 90, 111, 112, 184, 245, 246, 248, 249, 255, 259, 266, 306, 341, 378, 379, 406, 424, 489, 538, 587, 588, 644, 659, 664, 678, 680
 validation 30, 32–34, 69, 88, 91, 92, 94–97, 101, 104–106, 114, 152, 155, 157, 162, 170,

- 178, 256, 266, 278, 366, 418, 425, 427,
431, 433, 463, 486, 492, 592, 593, 595,
598–600, 624, 628, 644, 650, 651, 653,
663, 666, 676, 678–681, 683
- validity
 animal model 22, 392, 522
 drug screening 105
 construct 25
 external 6, 25, 276, 524, 526
 internal 25, 524
 lack of 251, 307
 predictive 24, 394
 relative 174, 176
 scientific 25, 70, 334, 343, 368
 toxicity screening 257
- van Dam, M. 90, 109, 110
- variation 5, 6, 10, 16, 25, 405, 524, 525, 575
- vascular network 642
- vegetables 128, 135–137, 497
- venous cutdown 555
- vertebrates 97, 155, 168, 172, 179, 246, 292,
294, 322, 334, 377, 403, 551, 575, 647,
656–658, 660, 662–665, 667
- Vesalius, A. 321
- vivisection 33, 90, 161–163, 169, 170, 194, 199,
201, 227, 228, 275, 276, 283, 285, 286, 322,
571, 661
- Washington University, St. Louis 555
- waste
 animal lives 18, 328, 454
 funding/funds 307
 money 73, 158, 244–266, 405
 resources 16, 36, 643
- welfare. *See also* laboratory animal welfare
 behavioral indicators of 522
 poor 264
 whitewashing 37, 168–185
- WHO. *See* World Health Organization (WHO)
- whole body mannequins 557, 558
- whole food 124, 127, 131, 139, 140
- wild animal 219, 518–528
 behavior 518–528
- wild-caught 519, 522
- wildlife 131, 367, 529, 538
- workplace environment 107, 108
- World Health Organization (WHO) 36, 135,
174, 380, 482, 588, 664
- World Organization for Animal Health 3,
168
- Wyss-Institute for Biologically Inspired
 Engineering, Harvard University 103
- zebrafish 365, 446, 460, 656, 658, 661–663
- Zentrum zum Schutz der Versuchstiere. *See*
 German Centre for the Protection of
 Laboratory Animals (Bf3R)
- Zerhouni, E. 28, 29, 74, 248, 278, 429