

Ecology of Marine Bivalves

An Ecosystem Approach



Second
Edition



Richard F. Dame



CRC Press
Taylor & Francis Group



Ecology of
Marine Bivalves
An Ecosystem Approach
Second Edition



Marine Science Series

The CRC Marine Science Series is dedicated to providing state-of-the-art coverage of important topics in marine biology, marine chemistry, marine geology, and physical oceanography. The series includes volumes that focus on the synthesis of recent advances in marine science.

CRC MARINE SCIENCE SERIES

SERIES EDITOR

Michael J. Kennish, Ph.D.

PUBLISHED TITLES

- Artificial Reef Evaluation with Application to Natural Marine Habitats*, William Seaman, Jr.
- The Biology of Sea Turtles, Volume I*, Peter L. Lutz and John A. Musick
- Chemical Oceanography, Third Edition*, Frank J. Millero
- Coastal Ecosystem Processes*, Daniel M. Alongi
- Coastal Lagoons: Critical Habitats of Environmental Change*, Michael J. Kennish and Hans W. Paerl
- Coastal Pollution: Effects on Living Resources and Humans*, Carl J. Sindermann
- Ecology of Estuaries: Anthropogenic Effects*, Michael J. Kennish
- Ecology of Marine Invertebrate Larvae*, Larry McEdward
- Ecology of Seashores*, George A. Knox
- Environmental Oceanography, Second Edition*, Tom Beer
- Estuarine Indicators*, Stephen A. Bortone
- Estuarine Research, Monitoring, and Resource Protection*, Michael J. Kennish
- Estuary Restoration and Maintenance: The National Estuary Program*, Michael J. Kennish
- Eutrophication Processes in Coastal Systems: Origin and Succession of Plankton Blooms and Effects on Secondary Production in Gulf Coast Estuaries*, Robert J. Livingston
- Handbook of Marine Mineral Deposits*, David S. Cronan
- Handbook for Restoring Tidal Wetlands*, Joy B. Zedler
- Intertidal Deposits: River Mouths, Tidal Flats, and Coastal Lagoons*, Doeke Eisma
- Marine Chemical Ecology*, James B. McClintock and Bill J. Baker
- Ocean Pollution: Effects on Living Resources and Humans*, Carl J. Sindermann
- Physical Oceanographic Processes of the Great Barrier Reef*, Eric Wolanski
- The Physiology of Fishes, Second Edition*, David H. Evans
- Pollution Impacts on Marine Biotic Communities*, Michael J. Kennish
- Practical Handbook of Estuarine and Marine Pollution*, Michael J. Kennish
- Practical Handbook of Marine Science, Third Edition*, Michael J. Kennish
- Restoration of Aquatic Systems*, Robert J. Livingston
- Seagrasses: Monitoring, Ecology, Physiology, and Management*, Stephen A. Bortone
- Trophic Organization in Coastal Systems*, Robert J. Livingston

Ecology of Marine Bivalves

An Ecosystem Approach

Second Edition

Richard F. Dame



CRC Press

Taylor & Francis Group

Boca Raton London New York

CRC Press is an imprint of the
Taylor & Francis Group, an **informa** business

CRC Press
Taylor & Francis Group
6000 Broken Sound Parkway NW, Suite 300
Boca Raton, FL 33487-2742

© 2012 by Taylor & Francis Group, LLC
CRC Press is an imprint of Taylor & Francis Group, an Informa business

No claim to original U.S. Government works

ISBN-13: 9781439839096 (Hbk)

This book contains information obtained from authentic and highly regarded sources. Reasonable efforts have been made to publish reliable data and information, but the author and publisher cannot assume responsibility for the validity of all materials or the consequences of their use. The authors and publishers have attempted to trace the copyright holders of all material reproduced in this publication and apologize to copyright holders if permission to publish in this form has not been obtained. If any copyright material has not been acknowledged please write and let us know so we may rectify in any future reprint.

The Open Access version of this book, available at www.taylorfrancis.com, has been made available under a Creative Commons Attribution-Non Commercial-No Derivatives 4.0 license.

For permission to photocopy or use material electronically from this work, please access www.copyright.com (<http://www.copyright.com/>) or contact the Copyright Clearance Center, Inc. (CCC), 222 Rosewood Drive, Danvers, MA 01923, 978-750-8400. CCC is a not-for-profit organization that provides licenses and registration for a variety of users. For organizations that have been granted a photocopy license by the CCC, a separate system of payment has been arranged.

Trademark Notice: Product or corporate names may be trademarks or registered trademarks, and are used only for identification and explanation without intent to infringe.

Library of Congress Cataloging-in-Publication Data

Dame, Richard F.
Ecology of marine bivalves : an ecosystem approach / Richard F. Dame. -- 2nd ed.
p. cm. -- (Marine science)
"A CRC title."
Includes bibliographical references and index.
ISBN 978-1-4398-3909-6 (hardcover : acid-free paper)
1. Bivalves--Ecology. 2. Marine invertebrates--Ecology. 3. Biotic communities. I.
Title.

QL430.6.D33 2012
594'.4--dc23

2011036561

Visit the Taylor & Francis Web site at
<http://www.taylorandfrancis.com>

and the CRC Press Web site at
<http://www.crcpress.com>

Contents

| | |
|---|----|
| Preface..... | xi |
| Chapter 1 Introduction | 1 |
| Historical/Geological Setting | 1 |
| Ecosystems | 4 |
| Thermodynamics and Ecosystems | 5 |
| Structural Properties | 8 |
| Ecosystem Processes and Biodiversity..... | 11 |
| Feedback | 13 |
| Multiple or Alternate States..... | 14 |
| Scaling | 17 |
| System Types..... | 18 |
| Book Organization..... | 19 |
| References | 19 |
| Chapter 2 Historical Ecology of Bivalves..... | 23 |
| Introduction | 23 |
| Natural Reefs and Human Constructs | 24 |
| Case Study: The Oyster Shell Rings..... | 27 |
| Interpreting Shell Rings through Time | 27 |
| Comparing Past to Present Systems | 32 |
| Clues from History | 37 |
| References | 38 |
| Chapter 3 Physical Environmental Interactions..... | 43 |
| Introduction | 43 |
| Temperature..... | 44 |
| Salinity | 48 |
| Temperature–Salinity and Other Factor Combinations..... | 50 |
| Acidification | 51 |
| Water Flow | 51 |
| Tides..... | 56 |
| Sediments | 57 |
| References | 58 |
| Chapter 4 Organismic Scale Processes..... | 63 |
| Introduction | 63 |
| Feeding | 66 |

| | |
|--|-----|
| Suspension-Feeding | 66 |
| The Bivalve Filter and Pump | 66 |
| Filtration and Particle Quality | 70 |
| Larviphagy..... | 73 |
| Dissolved Organic Matter (DOM)..... | 73 |
| Filtration and Particle Size | 74 |
| Clearance Rate Models..... | 74 |
| Deposit Feeding..... | 78 |
| Microbial Stripping | 79 |
| Cellulase Activity and Detritus Feeding..... | 79 |
| Particle Selection | 79 |
| Proportion of Foods..... | 80 |
| Optimal Foraging for Food in the Sediments | 80 |
| Shipworms..... | 81 |
| Symbiotic Nutrition..... | 82 |
| Photoautotrophic Symbioses | 82 |
| Chemoautotrophic Symbioses..... | 85 |
| Production (P)..... | 88 |
| Production Due to Growth (P_g)..... | 88 |
| Growth Measurement | 89 |
| Shell Growth..... | 89 |
| Longevity..... | 91 |
| Production Due to Reproduction (P_r) | 92 |
| Growth Models | 92 |
| Respiration (R) | 93 |
| Kleiber's Law | 95 |
| Excretion..... | 98 |
| References | 99 |
| | |
| Chapter 5 Population Processes | 109 |
| Introduction | 109 |
| Life Cycle..... | 109 |
| Statistical Measures of Populations..... | 110 |
| Density | 110 |
| Reproduction | 111 |
| Population Growth | 113 |
| Bivalves as Open or Metapopulations..... | 115 |
| Life and Fecundity Tables | 116 |
| Mortality..... | 119 |
| Abiotic Mortality..... | 119 |
| Predation..... | 120 |
| Competition-Induced Mortality..... | 127 |
| Aggregated Distributions..... | 128 |
| Zonation | 130 |
| Diseases and Parasites | 131 |

| | |
|---|-----|
| Population Energy Budgets | 134 |
| References | 136 |
| Chapter 6 Ecosystem Grazing..... | 143 |
| Introduction | 143 |
| Grazing Theory as Applied to Bivalves..... | 144 |
| Conceptualizing Grazing | 145 |
| The Classical Population Dynamics Approach | 145 |
| The Turnover Time/Turnover Rate Approach..... | 148 |
| Turnover Time | 148 |
| Carrying Capacity..... | 148 |
| Water Residence Time | 149 |
| Primary Production Time | 149 |
| Bivalve Clearance Time..... | 149 |
| Methods Used to Estimate System Grazing | 150 |
| Upstream–Downstream Observations | 150 |
| Free-Flow Designs..... | 150 |
| Laboratory Flumes | 151 |
| Field Flumes | 153 |
| Tunnels | 153 |
| Revised List of Bivalve-Dominated Ecosystems Used to | |
| Compare Grazing and Other Characteristics | 157 |
| Chesapeake Bay, Virginia, and Maryland..... | 157 |
| Delaware Bay, Delaware..... | 157 |
| Bay of Marennes–Oléron, France | 157 |
| Narragansett Bay, Rhode Island | 158 |
| North Inlet, South Carolina | 158 |
| Oosterschelde Estuary, The Netherlands | 159 |
| Ria de Arosa, Spain | 159 |
| San Francisco Bay, California | 160 |
| Sylt, Eastern Wadden Sea, Germany | 161 |
| Western Wadden Sea, The Netherlands | 161 |
| Ecosystem Comparisons | 162 |
| A Mini Case Study | 167 |
| References | 169 |
| Chapter 7 Ecosystem Metabolism and Nutrient Cycling..... | 175 |
| Introduction | 175 |
| Methods for Measuring System Metabolism | 176 |
| Chamber Measurements | 176 |
| Free-Flow Measurements | 177 |
| Tunnel Studies | 178 |
| Nutrient Cycling | 178 |
| Theoretical Background | 179 |

| | | |
|------------------|---|------------|
| | Nutrient Cycles..... | 181 |
| | Carbon..... | 181 |
| | Nitrogen..... | 188 |
| | Phosphorus..... | 195 |
| | Silicon..... | 197 |
| | System Nutrient Turnover..... | 198 |
| | Coupling Metabolism and Nutrients..... | 199 |
| | Conclusions..... | 199 |
| | The Case of the Missing Nitrogen..... | 200 |
| | References..... | 202 |
| Chapter 8 | Ecosystem Experiments..... | 207 |
| | Introduction..... | 207 |
| | Models..... | 209 |
| | System Simulation Models..... | 210 |
| | SMOES: Simulation Model Oosterschelde Ecosystem..... | 210 |
| | Model Formulation..... | 210 |
| | Model Analysis..... | 213 |
| | Chesapeake Bay Ecosystem Model and Oysters..... | 220 |
| | Ecosystem Field Experiments..... | 224 |
| | Incidental Ecosystem Scale Experiments..... | 225 |
| | Designed Ecosystem Scale Experiments..... | 227 |
| | Case Study..... | 227 |
| | Comparison of Coastal, Estuarine, and Marine Ecosystems Dominated by Bivalve Suspension- Feeders..... | 230 |
| | References..... | 230 |
| Chapter 9 | Ecosystem Health, Restoration, and Services..... | 235 |
| | Introduction..... | 235 |
| | Ecosystem Services..... | 235 |
| | Bivalves as Components of Ecosystem Health..... | 235 |
| | Bivalves as Monitors..... | 237 |
| | Bivalves as Integrators..... | 239 |
| | Bivalve Responses..... | 240 |
| | Shell Movements..... | 241 |
| | Mortality..... | 242 |
| | Shell and Tissue Growth..... | 243 |
| | Bivalve Scope for Growth (SFG)..... | 243 |
| | Systems Measures..... | 246 |
| | Ecosystem Services..... | 247 |
| | System Valuation..... | 248 |
| | Invasions by Bivalves..... | 249 |

| | |
|---|-----|
| Biodiversity | 249 |
| Biodiversity and Ecosystem Productivity..... | 249 |
| Invasion, Extinction, and Biodiversity..... | 250 |
| A Case Study: The Wadden Sea and the Invasion of | |
| <i>Crassostrea gigas</i> | 252 |
| Biology of <i>Crassostrea gigas</i> | 253 |
| The Spread of <i>Crassostrea gigas</i> | 253 |
| Reef Building..... | 253 |
| Invaders and their Ecosystems..... | 254 |
| Contributors to Successful Environments | 254 |
| Positive Implications of <i>Crassostrea gigas</i> | 255 |
| Climate Change—Possible Effects..... | 255 |
| Conclusion..... | 257 |
| References | 258 |
| Index | 261 |

Preface

The first edition of *Ecology of Marine Bivalves: An Ecosystem Approach* (EMB-AEA) addressed the major goal of providing the scientific community and others of similar interests with an understandable presentation of the ecology of marine bivalve molluscs. However, with the advent of the United Nations Millennium Ecosystem Assessment (MEA) in 2000 and its emphasis for utilizing the ecosystem approach as a standard guideline, I felt it was time to write a second book that would have a broader focus than the first edition.

There are a number of new features in the second edition. At the beginning of each chapter, important terms or concepts are defined. There is a new chapter on shell rings that emphasizes the importance of interaction between disciplines so that we might learn from the past in order to plan for the future. Then, because of the interest in the imminency of global climate change, this edition is more inclusive geographically by utilizing scientific work done on several continents. Finally, there are case studies that exemplify the special nature of that particular site.

1 Introduction

The Bivalvia family of molluscs is highly valued for the ecological processes in which its members are involved. This book focuses on the ecology of the Bivalvia; that is, the study of the interactions of these animals with other organisms as well as with their physical environment in estuarine and coastal marine waters both spatially and temporally. The properties of bivalve-dominated ecosystems will be surveyed and synthesized using ecological thermodynamics, energetics, and complexity as underlying components that mold the work into an integrated presentation. In the time since the first edition in 1996, the ecosystem approach has become more widely accepted by natural resource managers due to the general failure of single species management. The ecosystem or holistic systems approach was also recommended or used in a number of global and regional resource appraisals including the United Nations Millennium Ecosystem Assessment program

(MEA 2005). This acceptance and application of the ecosystem approach has led to a dramatic increase in new and often cross-disciplinary research projects, particularly in the areas of global change, biodiversity, ecosystem function, and environmental restoration. Thus for the second edition a geographically diverse group of case studies will highlight these areas of increased interest, and a definitions box of important terms will be a part of the first page of each chapter.

IMPORTANT TERMS AND CONCEPTS

Classical Laws of Thermodynamics: Describe the direction of heat flow and the availability of energy to do work.

Ecosystem: Any unit that includes all organisms that function together in a given area interacting with the physical environment so that the flow of energy leads to clearly defined biotic structure and cycling of materials between living and nonliving parts.

Holistic: An approach to science where all components in a process are considered to interact with each other.

MEA: Millennium Ecosystem Assessment Program of the United Nations.

Nonequilibrium Thermodynamics: Describes how living systems and some nonliving systems use external sources of energy to exist far from thermodynamic equilibrium.

Rudist: An early form of bivalve that was prominent 500 Ma.

HISTORICAL/GEOLOGICAL SETTING

The first bivalve molluscs appeared in the sea during the Cambrian period about 620 Ma (Ma is a date millions of years before present), and well before organisms had invaded the land (Figure 1.1). Because their shells are made of calcium carbonate,

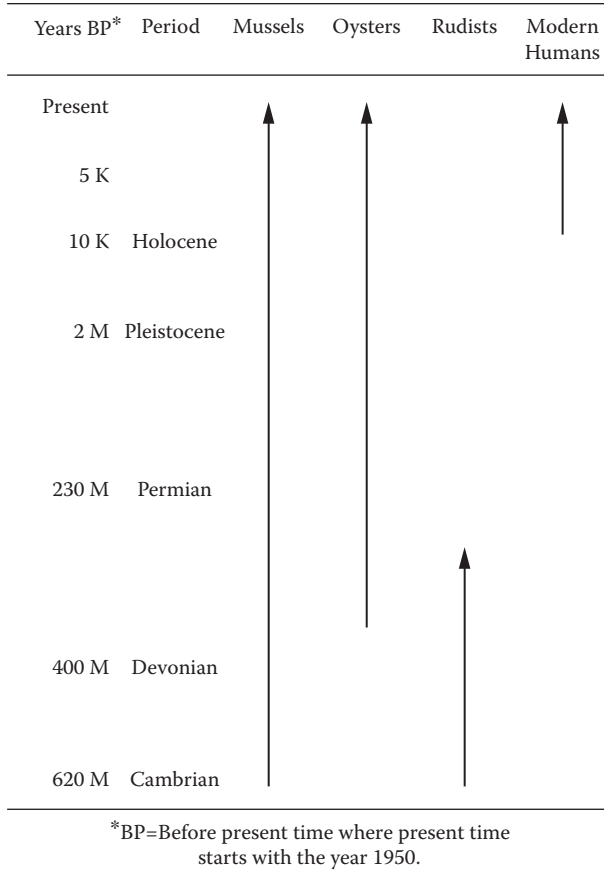

FIGURE 1.1 Timeline.

bivalves were well represented in the fossil record and are often used as paleontological markers. A primitive bivalve, the rudist, appeared about 500 Ma. They were gregarious in nature and were often found in association with corals and other reef-forming organisms (Stenzel 1971). In fact, Kauffman (1993) and Johnson (1995) argued that during the Cretaceous “greenhouse” world, the rudist out-competed the corals and were thought to be a major cause in the decline of reef corals. This controversy, however, was short lived as more comprehensive and detailed studies on the autecology of the rudist (Gili et al. 1995; Wood 1999) showed that rudist were gregarious sediment-dwellers and not carbonate reef builders. Between 620 and 65 Ma the bivalve molluscs, in general, were overshadowed by an unrelated but similarly structured group, the brachiopods or lamp shells. Both groups were suspension-feeders and removed phytoplankton from the water column by means of a ciliary filter mechanism. However, during the Cretaceous/Tertiary (K/T) in 65 Ma, a major mass extinction event occurred, wiping out 95% of the life in the sea including the rudists and most brachiopods. That event is speculated to have been caused by a combination of extraterrestrial impacts, mega-volcanic eruptions, and sea level regressions (Gallagher 1991). The surviving

bivalve molluscs quickly became dominant and remain so today (Yonge 1960). The bivalves' success can be attributed to their metabolic rates being 3 to 10 times higher than those of brachiopods and to a more efficient calcium-carbonate buffering system (Knoll et al. 2007). These physiological and energetic attributes led to bivalves out-competing brachiopods for high productivity habitats and the relegation of brachiopods to the colder, darker, and lower productivity zones of the oceans (Vermeij 1999; Knoll et al. 2007).

The bivalve molluscs are thought to have originated in warm shallow euhaline coastal waters and gradually invaded estuaries and brackish systems, as well as all the reaches of the world ocean. Because the adult forms of the majority of these animals are benthic or bottom dwelling, many different evolutionary adaptations to the benthic habitat have occurred. Most common lifestyles include the following: (1) buried within burrows in unconsolidated soft sediments; (2) attached by byssal threads to pebbles or cemented to shells or rocks; and (3) as semi-mobile members of the epibenthos. Today these adaptations are exemplified by clams, mussels, oysters, and scallops, respectively. In natural shallow water habitats, there are often gradients of sediments from muddy unconsolidated materials to hard substrates that reflect a water dynamics-energy gradient from low to high energy environments, with different species of bivalves zoned accordingly.

Fossil gryph-shaped (gryph = curved or coiled like a reptilian toenail) oysters of the Miocene (2 Ma) are often found associated with corals and other euhaline reef-building forms.

The largest reef-building bivalve known was *Crassostrea gryphoides*, the giant oyster, also known as *Crassostrea gigantissima*. These bivalves, with a reported maximum height of 60 cm, weight of 4.5 kg, and shell thickness of 15 cm, grew rapidly in warm, shallow, brackish waters of the Miocene (Stenzel 1971).

Today dense bivalve reefs and beds are only formed by brackish water species such as *Crassostrea* and *Mytilus*. In contrast to tropical coral reefs, these bivalve assemblages are mainly found in the temperate zone (Hughes 1991). In most cases, as the bivalve shell framework accumulates it eventually becomes unstable and collapses. However, in the southeastern United States, oyster reefs dominated by *C. virginica* reach extensive size and persist for long periods of time (Hughes, 1991). In the last 20 years, the Pacific oyster, *Crassostrea gigas*, has invaded northwestern Europe where it builds reefs with an equivalent complexity to those built by *C. virginica*. In general, bivalve reefs are sinks for particulate material and sources of dissolved inorganic nutrients (Dame et al. 1984; Dame and Dankers 1988). They are the epitome of ecosystem reef builders working on ecosystem hot spots as keystone species.

The earliest attempt at relating living bivalves to their associated organisms and physical environment was by Möbius (1880). In his studies of oyster beds along the Schlesweg-Holstein shore in the Eastern Wadden Sea near Sylt, Germany, and the estuaries of southern England, he noticed that the organisms found on the two sites had numerous things in common. First, the similar species composition of bivalves, crabs, barnacles, bryozoans, starfish, sea urchins, worms, fish, and algae were present. Möbius (1880) speculated that every oyster bed is a collection of organisms that finds everything necessary for its growth and reproduction.

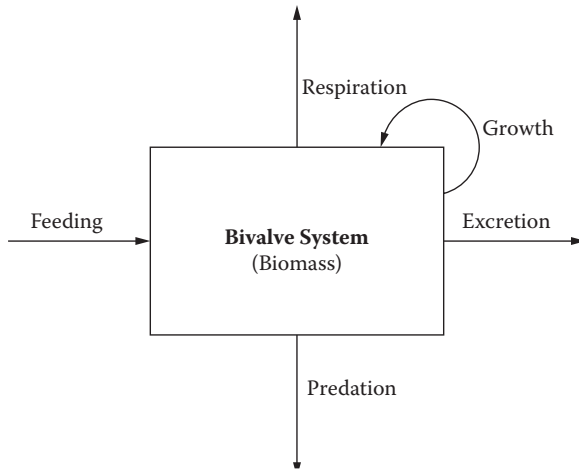

FIGURE 1.2 Ecosystem box diagram showing major functional components. (From Dame, R.F. 1996. *Ecology of Marine Bivalves: An Ecosystem Approach*. Boca Raton, FL: CRC Press.)

Second, these organisms were normally found with similar environmental qualities of food, salinity, temperature, and substrate. He coined the word “bioceonosis” to describe the community of living organisms that is mutually limited by the environment. Möbius also observed that when the external environment changed, so did the composition of the bed. This effective binding of the community of organisms to the vagaries of the environment is a strong predilection toward what today we think of as ecosystems.

ECOSYSTEMS

Ecosystems are organized assemblages of plants and animals in complex interactions with each other and their physical environment (Figure 1.2). While individual species are governed by genetic and physiological processes, their existence in nature is conditioned by the total environment and in turn influences the environment of which they are a part. Because of these complex interdependencies, understanding ecosystems requires a holistic approach where the whole is greater than the sum of its parts. Thus for the purposes of this book, Odum’s (1983) definition for ecosystem will be used:

An ecosystem is any unit that includes all organisms that function together in a given area interacting with the physical environment so that the flow of energy leads to clearly defined biotic structure and cycling of materials between living and nonliving parts.

Another representation (Figure 1.3) shows the open nature of the ecosystem via flows of energy and matter between the system and the external environment. It also separates the organisms into feeding or trophic groups. These groups include the following: primary producers (P) or autotrophs that usually use sunlight as an energy

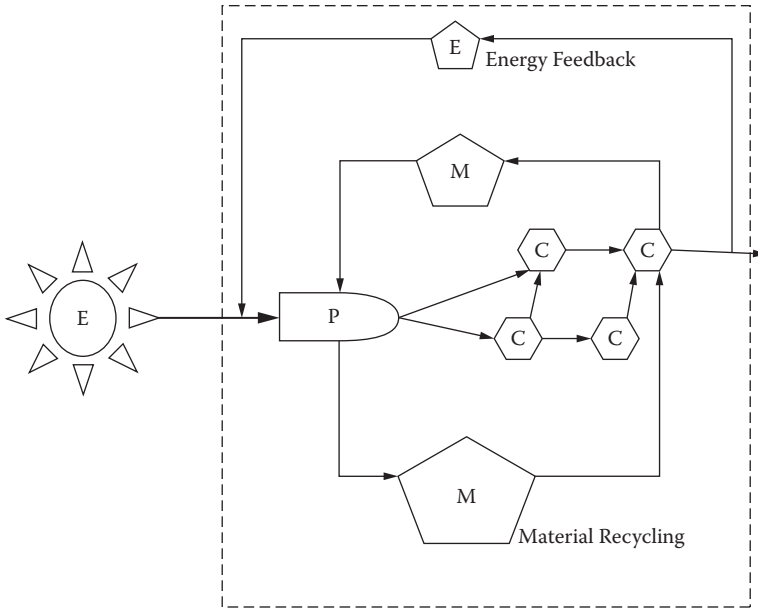

FIGURE 1.3 General ecosystem diagram.

source (E) to convert inorganic material into organic matter (M); heterotrophs or consumers (C) that feed on organic matter; and decomposers that break down complex organic matter into its basic chemical components.

THERMODYNAMICS AND ECOSYSTEMS

Ecological energetics (thermodynamics) is the area of science that deals with the transfers, transformations, and interactions of energy and matter both within and between system components. Classical thermodynamics was an outgrowth of the Industrial Revolution in England during the late 18th and 19th centuries as scientists and industrialists searched for ways to build more efficient machines and be more economically competitive (Snow 1964; Atkins 1984). After years of work, the investigations into the relationships between heat, work, and energy gave rise to two laws or rules that are known as the laws of thermodynamics.

In classical thermodynamics, these laws are used to describe the direction of heat flow and the availability of energy to do work. It is assumed that the system in question is isolated or closed, that there is a measurable quantity of energy in the system, and that the system is near or can reach thermodynamic equilibrium. If the external constraints on the system are allowed to change, the properties of temperature, pressure, or chemical composition will also generally change. The laws of thermodynamics describe these changes and predict the thermodynamic equilibrium state of the system (Morowitz 1970).

The first law, or the Law of Conservation of Energy, states that energy cannot be created or destroyed and that whenever energy is converted from one form to another

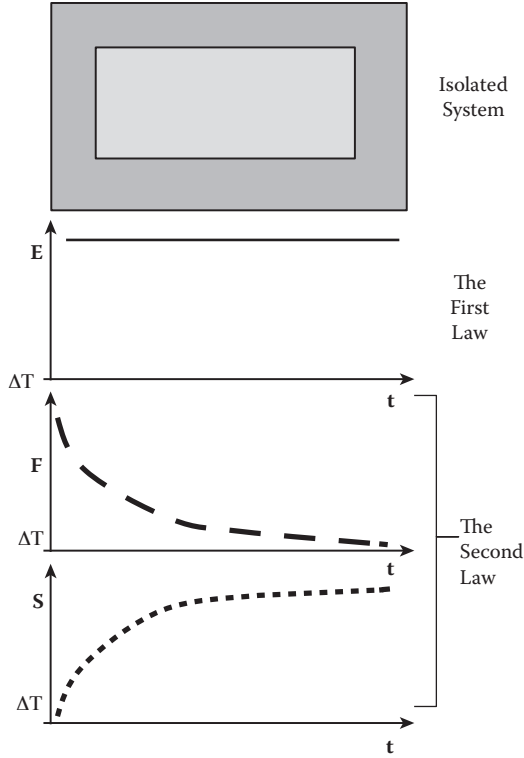

FIGURE 1.4 Classical thermodynamics. (Modified from Chaisson, E.J. 2001. *Cosmic Evolution: The Rise of Complexity in Nature*. Cambridge, MA: Harvard University Press.)

the total quantity of energy in the system remains the same (Figure 1.4). Energy is defined as the ability to do work. The mathematical equivalent is:

$$\Delta E = Q + W \tag{1.1}$$

In Eq. (1.1), ΔE is the change in usable energy; Q is usable heat; and W is work. Basically, the first law of thermodynamics is a no-win situation because the amount of energy in the universe stays the same and you can't get something for nothing (Snow 1964).

The second law or entropy law (Morowitz 1970) maintains that in a closed system the entropy (S) in the system does not decrease and is a measure of the energy that is unavailable due to transformations.

$$\Delta E = T\Delta S - W \tag{1.2}$$

T is the temperature in degrees K , and along with entropy determines the direction of heat flow in or out of the system. It is for that attribute of determining direction of heat flow that this law is sometimes called "times arrow" (Blum 1962). Entropy is defined as the amount of unusable energy that is produced.

Classical thermodynamics works well with most physical systems, but there are major problems when it is applied to organized flow systems like convection cells and to living organisms, as well as ecosystems. The latter systems are open to the flows of energy, matter, and information, and exist far from thermodynamic equilibrium. Ecological systems must be open to energy and material flows in order to build and maintain their far-from-equilibrium, highly complex systems (Figure 1.5). If these ecological systems are closed to energy flows they will deteriorate toward equilibrium and die (Johnson 1995). Also, the understanding of the science supporting the Law of Conservation of Energy is much more developed than that supporting the entropy law, particularly with regard to living systems and the environment (Ulanowicz and Hannon 1987). Thus the rules governing living systems are a stark contrast to those prevailing over the nonliving as so aptly expressed by Schrödinger's (1944) book, *What is Life?* Living systems can only construct their internal order at the expense of a continuous creation of disorder in the external environment through metabolic activity. There are important questions for ecologists to consider: Do complex processes like self-organization that take place within ecosystems give rise to structures such as food webs, and if they do, are the food webs shaped by the interplay of internal interactions, or external

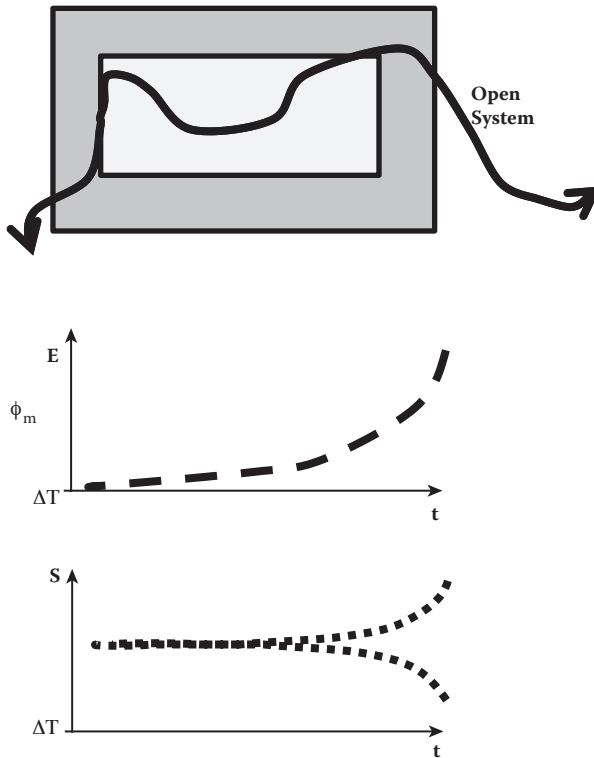

FIGURE 1.5 Open system far from equilibrium thermodynamics. (Modified from Chaisson, E.J. 2001. *Cosmic Evolution: The Rise of Complexity in Nature*. Cambridge, MA: Harvard University Press.)

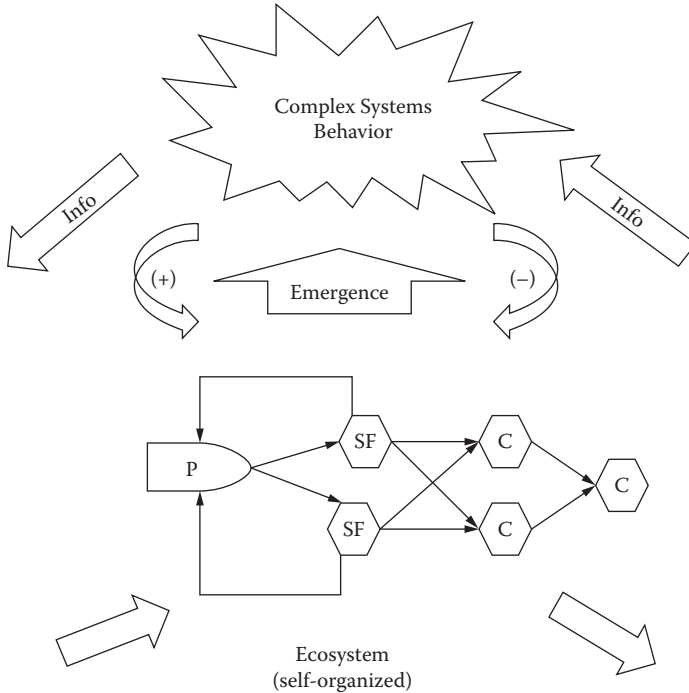

FIGURE 1.6 Ecosystems as complex systems, where P = producer; SF = suspension feeder; C = consumer.

thermodynamic constraints, or a combination of both (Meysman and Bruers 2007)? Until very recently, ecology was satisfied with the default state variables of mass and energy that were generally sufficient for explanations using the conservation law. But with the rise of the second law and nonequilibrium thermodynamics, entropy became a major component in physical systems. However, entropy is still difficult to quantify in living systems. In any case, the application of entropy in ecological studies should be a profitable area of new and unique ecological research.

Structural Properties

Ancient philosophers to modern cosmologists observed that our universe tends toward increasing complexity over time. In general, across scales ranging from nuclear particles to galaxies, complexity increases with time. Fundamentally, more complex structures (Figure 1.6) arise because there are large energy gradients in our universe that allow open nonequilibrium systems to take advantage of the laws of thermodynamics to build evermore complex structures (Chaisson 2001). Also, natural selection results in ecosystems that are organized to maintain high productivity of organic matter and high species diversity (Leigh and Vermeij 2002). In addition, increasingly more efficient predators and herbivores favor faster turnover of system resources (Leigh and Vermeij 2002).

Dense aggregations of benthic suspension-feeding bivalves are common to many shallow water environments. Typically called reefs or beds, these systems often play

such dominant structural and functional roles in ecosystems that they are frequently categorized as “hot spots” or ecosystem engineers (Jones et al. 1994). Reefs and beds of suspension-feeders are thermodynamically open systems that are connected to their external environment by material and energy fluxes that include the processes of feeding, excretion, reproduction, predation, resuspension, and nutrient cycling. Other organisms within these aggregations are connected to the suspension-feeders as well as to each other and include primary producers, grazers, sediment processors, decomposers, and predators (Dame 1976). Thus the bed or reef is a network (Figure 1.6) or subsystem of interconnected and intraconnected organisms or components with different functional attributes within a larger system or ecosystem. The ecosystem is itself composed of a network of interconnected and intraconnected subsystems. It is from the interrelationships between the components within and between organizational scales that behavior or properties emerge.

Bivalves contribute very obvious structures of biomass, skeleton, and burrows to the ecosystem. The shells of bivalves not only provide a platform for these animals, but when taken with the soft body, amount to major components within some ecosystems. These structures also form a system matrix within which habitats are generated for other organisms. This matrix allows an increase in biodiversity as well as leads to increased system complexity and redundancy (Hughes 1991).

The physical environment (the focus of Chapter 3) is also a component of ecosystem structure (see Figure 1.2). Not only can abiotic factors limit the abundance and extent of the biota, but the living components can influence the physical environment. Because bivalve shells are rigid, the flow of water around them can be both microscopically and macroscopically altered. In dense assemblages of bivalves, reefs, beds, and so forth, the accumulated empty and living shells can markedly alter the physical dynamics of water flow over these structures at even greater physical scales, i.e., creek or channel. Generally, the orientation of the individual bivalve within the bed tends to enhance water circulation and turbulence over the system and in turn increases the functional performance of the molluscs (Hughes 1991).

Ecological systems are multiscaled (Table 1.1), and they can be organized vertically or horizontally into embedded or nested layers. Hari and Müller (2000) suggest a classification scheme for hierarchical systems based on the number and type of

TABLE 1.1
Spatial and Temporal Scales Involved in Studying Bivalves

| Process | Spatial Scale | Duration | Frequency |
|----------------------|---------------|------------------|----------------------|
| Physiological | cm–m | Minutes | None–seasonal |
| Predation | 1–10 cm | Minutes–hours | Weeks–months |
| Associations | 1–10 cm | Days | Months–years |
| Disease | cm–km | Days–weeks | |
| Temperature–Salinity | 1–100 km | Days | Months–years |
| Storms | 1–100 km | Days | Months–decades |
| Epidemics | 10–1000 km | Years | Decades–centuries |
| Climate Change | Global | 10–100,000 years | 10,000–100,000 years |

TABLE 1.2
A Comparison of Small, Middle, and Large Number Systems

| Small Number of Components | Middle Number of Components | Large Number of Components |
|-------------------------------|--------------------------------------|----------------------------|
| < 10 ¹⁵ | 10 ¹⁵ to 10 ²⁰ | 10 ²⁰ < |
| Newtonian physics | Ecosystems | Boyle's gas laws |
| Organized | Organized complexity | Unorganized |
| Nonrandom | | Chaotic |
| Excessive order (equilibrium) | Life (nonequilibrium) | Excessive disorder |
| Death | | Too much change |
| Closed system | Open system | Death |
| Low energy flow | High energy flow | |
| Low entropy | Entropy | High entropy |
| High useable energy | Useable energy | Low useable energy |
| Low complexity | High complexity | Low complexity |

Note: Living systems are in the middle.

interacting components in a system (Table 1.2). Small-number systems contain few components, and each component can be described by a single equation. These systems are studied by traditional scientific analysis. Medium-number systems contain an intermediate number of components that interact nonrandomly. These systems cannot be analyzed by traditional methods and often appear to be stochastic. Large-number systems contain so many identical components, interacting randomly, that their statistical properties appear to be deterministic.

Analyzing ecosystems is problematic because there are a large number of linkages that are subject to unexpected occurrences across space and time. Even if that magnitude of information were known, the biological components of an ecosystem are constantly changing as they adapt to a continually varying environment, which makes these systems even more complex and difficult to analyze. In practice, the question being posed dictates the levels or scales that are used. The observer determines the hierarchical levels and defines the system. Some features of hierarchy in an ecological system are stated below from Hari and Müller (2000):

1. The system consists of subsystems that are connected with each other.
2. Subsystems are organizational units for inferior levels and part of a superior level at the same time.
3. Collective and emergent properties occur at each level.
4. Subsystems interact with each other by passing signals.
5. Interactions between subsystems of the same level are not very intense, but there are important interactions between different levels.

6. Superior levels constrain inferior levels by specific rules of signal transfer and filtering.
7. Processes of superior levels operate over large spatial areas and have slow temporal fluctuations, while processes on inferior levels operate on small spatial areas and have high temporal fluctuations.
8. The scale of a level is a feature of its spatial and temporal characteristics.
9. Macroscopic structures constrain the microscopic processes that form them. (Hari and Müller 2000)

Food webs have developed from two different perspectives in ecology. The energetic or process-functional approach was proposed by Lindeman (1942) and focuses on the consumption and dissipation of energy by functional groups (primary producers, consumers, etc.). The food web describes the network of pathways that the energy follows as it is processed by the ecosystem. The population-community school is concerned with the dynamical constraints that result from species interactions (Pimm 1982). This approach recognizes that the openness of marine ecosystems, lack of specialists, long lifespans, and large size changes over the life histories of many species can result in highly connected food webs (Link 2002). The dominant species or functional group that exerts the greatest control over usable resources imposes a cascade of top-down control measures on the rest of the system. At each higher level in the hierarchy, the energy dissipation rate decreases (Johnson 1995) and there is a progression from rapid turnover at the bottom to low turnover at the top. In the intertidal oyster reef or mussel bed, for example (Figure 1.7), oysters or mussels are the dominant species within the dominant functional group (suspension-feeders) (Dame 1976). Thus changes in dominant suspension-feeding bivalve abundance potentially can cause changes elsewhere in the system and make it more likely that these webs may be perturbed beyond historical equilibria as well as shifted to new stable states (Link 2002). Loreau (2005) feels that the two approaches are converging in search of similar patterns, and Link (2002) argues that the sheer complexity of these food webs makes them difficult to predict.

Networks or network models are models built by ecologists to investigate specific questions or scenarios. There are basically two types of network models: those designed to simulate the ecological system, and those that will be analyzed using engineering or system analytical tools. The latter analysis can provide estimates of energy and material flows between the various system components as well as the efficiency with which the energy and materials are transferred, assimilated, and dissipated (Ulanowicz 1986, 1997).

Ecosystem Processes and Biodiversity

Diversity is inherent in all levels of biological organization, from molecules that carry genetic information, to species where natural selection takes place, to ecosystems where organisms interact with each other and their environment. From this perspective, biodiversity is a fundamental property of the structure and function of ecosystems (Ray 1991) and refers to the extent of genetic, taxonomic, and ecological diversity over all temporal and spatial scales (Harper and Hawksworth 1995). Due

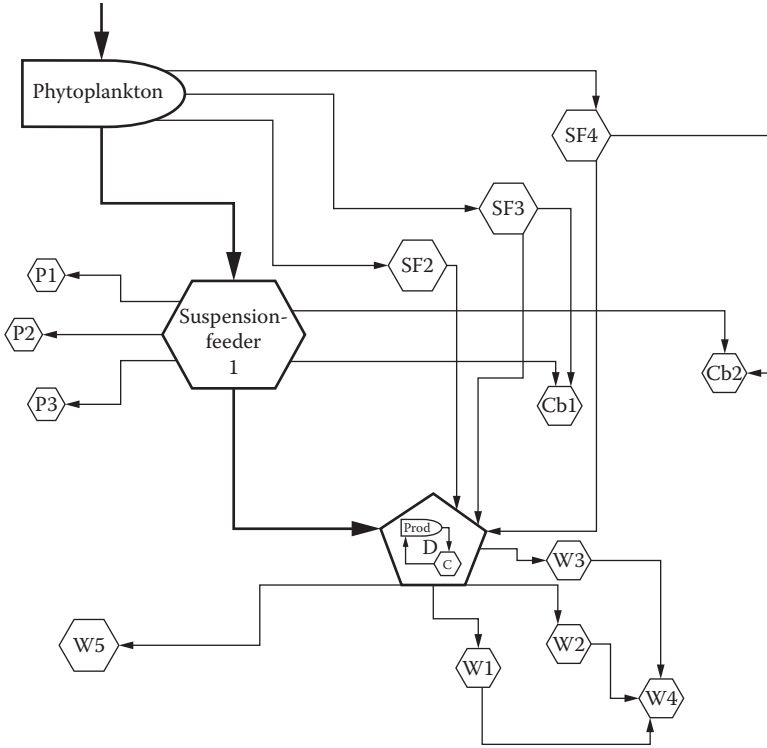

FIGURE 1.7 Food web using H.T. Odum’s “energy symbolic language.” (From Odum, H.T. 1983. *Systems Ecology: An Introduction*. NY: Wiley-Interscience, p. 8.)

mainly to the activities of seashell collectors, a fair amount is known about the species diversity of marine bivalve molluscs through space and time.

From a process-functional perspective, ecosystem processes are the changes in energy and matter over time and space as a result of biological activity. Ecosystem function is a synonym for ecosystem processes, and ecosystem functioning is the sum of all processes that sustain ecosystems. Traditionally, groups of organisms with similar functions, processes, feeding, or trophic levels have been grouped together into functional components. The most common functional groups represented by bivalves are suspension-feeders (filter feeders), deposit feeders, consumers, and herbivores. Each component has inflows and outflows that are represented by specific organismic level processes, e.g., feeding and excretion. As energy and matter are processed and transformed by the organisms, work is done and degraded energy or waste heat is lost from the system. This latter process is known as respiration at both the organismic and system levels. Production or growth is the storage of energy or matter by a given system component. These processes may result in the increase in size of individuals or populations of animals over a unit of time. Predation is the removal of energy and materials by one component feed-

ing on another, usually animals eating animals. The activity of herbivores eating plants or grazing may also be termed predation.

Nutrient cycling is the process of specific nutrients or molecules moving from component to component within the ecosystem (see Figure 1.2). Since matter is finite, atoms are used and reused within the ecosystem, and the rate at which this reuse takes place is an exceedingly important process in ecosystem ecology. By determining nutrient cycling patterns and rates, ecosystems can be compared and important components in the cycling of a particular nutrient within an ecosystem can be identified (Odum 1983). In some ecosystems, bivalves are thought to increase the rate of nutrient cycling because of their elevated abundances and high metabolic rates. However, if the diversity of organisms changes within a system, it is not clear what would happen to the functional attributes of the system in question. Covich et al. (2004) point out the difficulties of investigating the activities of the benthos in shallow waters due to the variability of water flow.

Feedback

Examples of feedback loops are easily seen within bivalve systems. Predator–prey relationships between organisms on the surface of the benthic sediments and infauna are well documented. In addition, feedback resulting from nutrient cycling within bivalve-dominated systems and other components of the estuary are also evident. These types of feedback depend more on the relationships between components, habitats, or patches than the individual organisms. Given the number and variety of feedback pathways in ecological systems, these relationships can extend beyond simple feedback to nonlinear processes. This internal structure of feedback relationships has the property of self-organization that allows this internal structure to interact with and respond to the inner surroundings (Manson 2001).

A second type of feedback involves feedback between internal structure and the external environment. This kind of feedback is exemplified by the development of the physical structure of the intertidal oyster reef (Figure 1.8). It is well known that oyster larvae are gregarious and prefer to settle on adult oysters or clean oyster shell. The oyster larvae even orientate their shells parallel to tidal currents in order to remove suspended particles more efficiently from the currents (Lawrence 1971). Each generation of larvae tends to settle on top of the preceding generation so that the reef grows vertically (Bahr and Lanier 1981). Eventually, the top of the reef encounters the external negative feedback of high temperatures and extended exposure during the summertime, and this causes high oyster mortality on the top of the reef (Bushek, personal communication 2007). Thus the shape of an intertidal oyster reef emerges from the interaction of positive and negative feedbacks. There is no grand master plan, only a few simple rules that govern when, where, and how the larvae settle and how the oysters interact with their physical environment.

The multitude of feedback mechanisms acting in concert within and between systems is also nonlinear in character, meaning the behavior of the system to a forcing parameter may not always give a similar response. In complex systems jargon (Table 1.3), this behavior is often referred to as “surprise.” In a creek scale experiment comparing nutrient fluxes in creeks with oysters to creeks with oysters removed, a seemingly linear experiment, we were surprised to find no differences among the

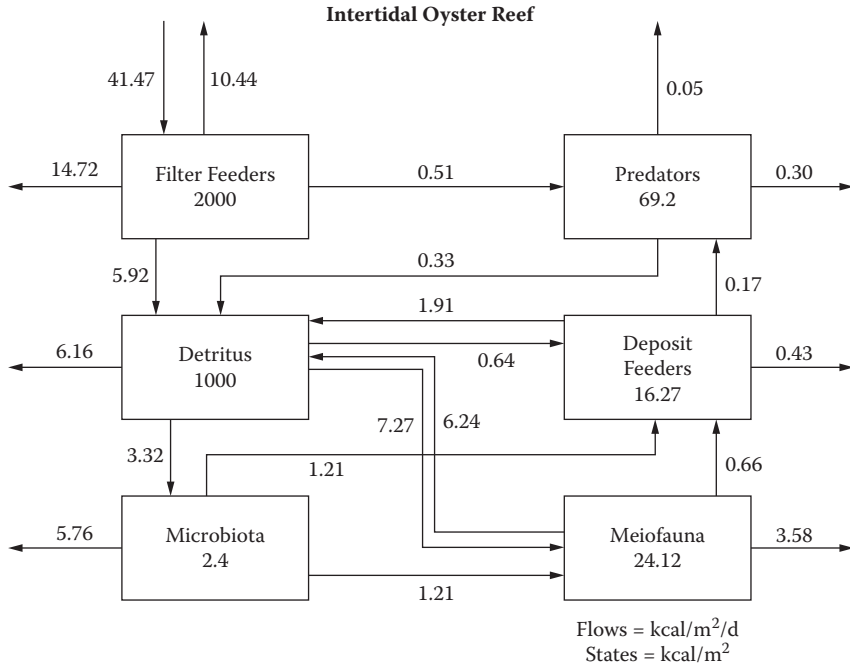

FIGURE 1.8 Intertidal oyster reef. (From Dame, R.F. and Patten, B.C. 1981. Analysis of energy flows in an intertidal oyster reef, *Mar. Ecol. Prog. Ser.* 5:115–124.)

different categories of creeks. Using simple linear spreadsheet models, we predicted less ammonium in creeks with oysters removed (Dame et al. 2002), but can only speculate that the network of feedback mechanisms in the creeks somehow compensated for or reconfigured itself to the removal of the oysters (Dame et al. 2002).

Multiple or Alternate States

Freshwater ecosystems, particularly lakes, appear to exist in alternate states (Scheffer et al. 1993; Dent et al. 2002; Beisner et al. 2003). It is generally thought that internal feedback mechanisms tend to keep the system in a particular state, while small incremental changes in external environmental feedbacks or anthropogenic forcings can result in a rapid change in the system's state (Figure 1.9) by overwhelming internal stabilizing mechanisms (Scheffer et al. 2001; Scheffer and Carpenter 2003). If the new state is stabilized by its own set of internal feedback mechanisms, it may be difficult if not impossible to reverse the state change simply by reversing the external forcing (Dent et al. 2002). There is evidence of such changes in subtidal *C. virginica* reefs in Chesapeake Bay (Newell 1988) and in reefs once dominated by intertidal and subtidal European oysters, *Ostrea edulis*, in Marennes-Oléron, France, and the Wadden Sea bounded mainly by The Netherlands and Germany (Reise et al. 1989; Héral 1993). In the cases where a system state change occurred, the external forcings of overharvesting, pollution, increased suspended sediments, and disease were usually implicated, and reversal of the forcing to achieve the original state was usually

TABLE 1.3
Some Properties of Bivalve-Dominated Complex Systems

| Property | Description | Example | Source |
|--|---|---|------------------------|
| Biodiversity | Biodiversity is variation of life at all levels of biological organization Species diversity is the number of species in an area including their relative abundance Species richness is the number of species per unit area or volume | | Belgrano et al. (2005) |
| Free energy/ Helmholtz free energy (H) | Energy available to do work/energy available to do biological work/the internal energy of a system minus the product of its temperature and its entropy Also known as Helmholtz free energy | | Morowitz (1970) |
| Free energy rate density | Rate at which free energy transits a system of given mass or weight specific metabolic rate (Φ_m) | Organisms to stars (103 to 2 erg s ⁻¹ g ⁻¹) | Chaisson (2001) |
| Open/closed system | Whether energy and matter can enter or leave a system | Living systems are open and dead systems are closed | Schrödinger (1944) |
| Equilibrium/ nonequilibrium | Equilibrium means a state of balance In an equilibrium state, there are no unbalanced driving forces A system that is in equilibrium experiences no changes when it is isolated from its surroundings Living systems are far from thermodynamic equilibrium; dead systems are at equilibrium | Live bivalves | Dame (1976) |
| Nonlinear | Process of multiple components interacting with each other and their environment | Bivalve bed | Manson (2001) |
| Dissipative structures | Structures that produce entropy by using free energy | Individual bivalves, beds | Dame (2005) |

(continued)

TABLE 1.3 (Continued)
Some Properties of Bivalve-Dominated Complex Systems

| Property | Description | Example | Source |
|---|---|---|--|
| Hierarchy | A self-regulating, open system that incorporates all lesser subsystems and is itself part of higher level of systems describes a hierarchy | To understand the bivalve level, the primary producer and secondary consumer levels should be included | Müller (1992) |
| Positive feedback | Process enhancing or self-reinforcing | Bivalve growth | Dame (1972) |
| Negative feedback | Process reducing and dampening | Parasites infecting bivalves | |
| Self-organization and emergence | The process of subsystem components form into new structures via cooperative interactions | The formation of oyster reefs from larvae | Dame (2005) |
| Gradients | The continuous change in magnitude of a process or a variable; they are the consequences of all dissipative, self-organizing processes in open systems | Temperature changes across the boundary of an intertidal mussel bed | Müller (1998) Hari and Müller (2000) |
| Food webs and networks | Interconnected subsystems or components that define the flow of energy and matter through an ecosystem | | Link et al. (2005); Baird and Ulanowicz (1989) |
| Cycles | A closed loop or pathway depicting the reuse of materials | Recycling of N and P in bivalve-dominated systems | Dame et al. (1984) |
| Alternate stable state (phase or regime shifts) | Depending on the strength of the stress, the system stays the same or shifts temporarily or shifts permanently to a new state From an ecosystem perspective, environmental changes drive state changes | Suspension-feeding bivalves may be lost if their ecosystem changes to favor water column suspension-feeders | Newell (1988); Kay (1991) |
| Surprise | Term used to indicate the unpredictability of open, nonlinear, nonequilibrium systems | Nutrient concentrations in creeks with oysters removed | Dame et al. (2002) |
| History | Information stored in the structure of a system | Bivalve shells | Claassen (1998) |
| Scale | Spatial or temporal measure of size or magnitude | Shell height, turnover | Claassen (1998); Odum (1983) |

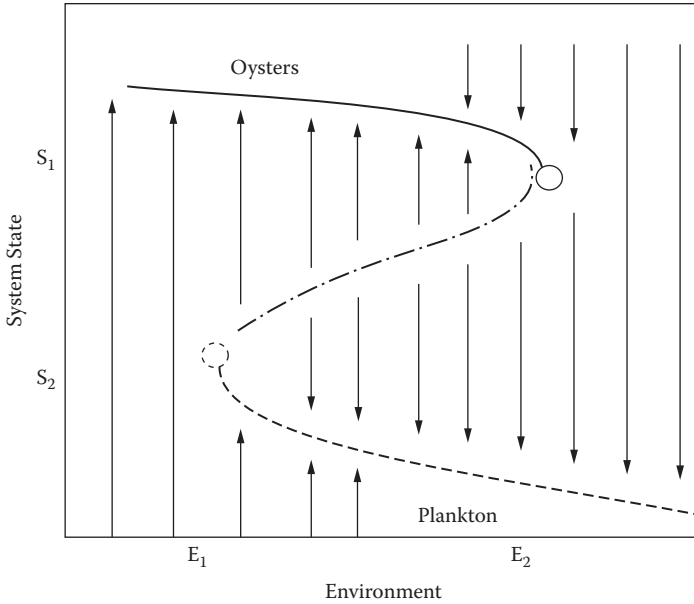

FIGURE 1.9 Change of state diagram. (From Dame, R.F. 2005. Oyster reefs as complex systems. In *The Comparative Roles of Suspension-Feeders in Ecosystems*. Dame, R.F. and Olenin, S., Eds. Dordrecht: Springer, pp. 331–343.)

ineffective. This irreversibility is common in living systems because the extensive feedback networks reconfigure to new conditions, generating a new system that is enhanced by its own feedback network (Beisner et al. 2003).

Scaling

As the mass or size of a system, living or physical, changes, the quantitative relationships between its various structural components and processes must adjust so the system can continue to function (Brown et al. 2000). In organisms, many structural and functional relationships change with size as to remain self-similar. That these self-similar relationships are said to be fractal over a broad range of spatial or temporal scales creates a type of emergent ecological phenomena (Brown et al. 2002). These relationships are generally characterized by simple power functions. The majority of the early work on biological scaling was directed at variation among individuals or allometry. Studies on the metabolism or oxygen consumption of oysters and mussels in relation to temperature and body size fall into this category (Dame 1972a, b; Shumway 1982; Shumway and Koehn 1982; Bayne et al. 1973). At scales greater than the individual (population, assemblage, and ecosystem), ecologists studying suspension-feeders have focused on spatial and temporal variations in system structure. At these scales, fractal geometry has been used to describe the structure and complexity of bivalve associations, particularly mussel beds (Commito and Rusignuolo 2000; Kostylev and Erlandsson 2001; Lawrie and McQuaid 2001; van de Koppel et al. 2005).

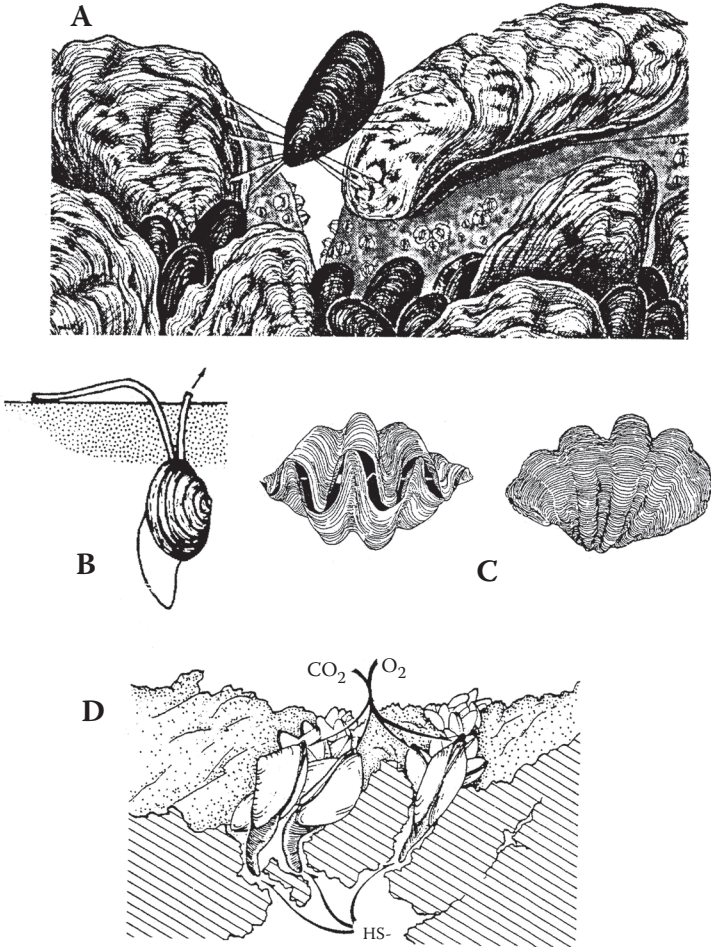

FIGURE 1.10 Trophic groups of some common bivalves. (A) Filter feeders (adapted from Barnes 1974), (B) deposit feeders (adapted from Barnes 1974), (C) photo autotrophic or photosymbiotic mussels (adapted from Fisher 1990). (Barnes, R.D. 1974. *Invertebrate Zoology*. 3rd ed. Philadelphia: Saunders, 870 pp.; Fisher, C.R. 1990. Chemoautotrophic and methanotrophic symbioses in marine invertebrates, *Rev. Aquat. Sci.* 2, 399–436; Lucas, J.S. 1988. Giant clams: Description, distribution, and life history, in Copeland, J.W. and Lucas, J.S., Eds., *Giant Clams in Asia and the Pacific*, Canberra: Australia Center for International Agricultural Research, pp. 21–32.

System Types

A variety of bivalve molluscs are prominent members of many diverse systems (Figure 1.10). These animals have reached greatest abundances in shallow coastal waters and estuaries. In these systems, phytoplankton is consumed from tidal waters sweeping over dense beds of bivalves, mainly clams, cockles, mussels, oysters, and scallops. The dominant bivalves in these systems are adapted to changing

temperatures and salinity, and some are adapted to exposure and wave action in the intertidal zone. Three different lifestyles are prevalent: (1) gregarious, permanently attached forms, oysters; (2) byssally attached and partially mobile, mussels; and (3) bivalves that burrow into semiconsolidated or unconsolidated sediments, clams. Some bivalves have been successful in the extreme environments of the rocky intertidal zone and the sandy beach. In the former, rapid growth and a protective shell are major attributes, while in the latter, rapid burrowing in shifting sediments is important. In the low productivity zones of coral reefs and deep-sea vents, endosymbiotic relationships between bivalves and microbes are keys to success.

BOOK ORGANIZATION

This introduction (Chapter 1) to the ecology of marine and coastal bivalves is presented with elementary discussions of ecological thermodynamics as it applies to living organisms and ecosystems. The succeeding chapters focus on specific aspects of bivalve dominated ecosystems with case study examples. Chapter 2 addresses biological or ecological history from the perspective of learning from the past to succeed in the future. The prehistorical interactions of bivalves, humans, and the environment are introduced with a multidisciplinary approach that concludes with a case study that has the makings of a mystery. Using the ecosystem approach, the interactions of bivalves with the physical environment, particularly temperature, salinity, water motion, suspended particles, and dissolved materials, are presented in Chapter 3. The chapter closes with an examination of the impacts of global environmental change on marine and coastal bivalves. Physical factors often are a major influence on organismic scale rate processes. Thus the controls on the organismic scale feeding, respiration, growth, and reproduction are from an ecosystem perspective in Chapter 4. Population scale processes (Chapter 5) follow, with particular attention being given to growth and mortality in natural and cultivated bivalve species as well as energy and material budgets. In Chapter 6, the process of bivalves as major ecosystem grazers in highly productive coastal and estuarine waters is investigated and compared. The processes of system metabolism and nutrient cycling including system turnover rates are addressed in Chapter 7. The use of ecosystem scale experiments in bivalve dominated systems is examined in Chapter 8. In Chapter 9 the health or lack of health of bivalve-dominated systems is explored as well as the ability of these systems to provide services and be renovated. The final chapter provides a short overview and speculations on the future.

REFERENCES

- Atkins, P.W. 1984. *The Second Law*. New York: W.H. Freeman, 230 pp.
- Bahr, L.M. and Lanier, W.P. 1981. *The Ecology of Intertidal Oyster Reefs of the South Atlantic Coast: A Community Profile*. FWS/OBS-81/15, US Fish and Wildlife Service, 105 pp.
- Baird, D. and Ulanowicz, R. 1989. The seasonal dynamics of the Chesapeake Bay ecosystem. *Ecol. Monogr.*, 59, 329–64.
- Barnes, R.D. 1974. *Invertebrate Zoology*. 3rd ed. Philadelphia: Saunders, 870 pp.

- Bayne, B.L., Thompson, R.J., and Widdows, J. 1973. Some effects of temperature and food on the rate oxygen consumption by *Mytilus edulis* L. In *Effects of Temperature on Ectothermic Organisms*, Wieser, W., Ed. Berlin: Springer-Verlag, pp. 189–93.
- Beisner, B.E., Heydon, D.T., and Cuddington, K. 2003. Alternative stable states in ecology. *Front. Ecol. Environ.*, 1, 376–82.
- Belgrano, A., Scharler, U., Dunne, J., and Ulanowicz, R., Eds. 2005. *Aquatic Food Webs: An Ecosystem Approach*. Oxford, UK: Oxford University Press, 262 pp.
- Blum, H.F. 1962. *Time's Arrow and Evolution*. New York: Harper, 224 pp.
- Brown, J.H., West, G.B., and Enquist, B.J. 2000. Scaling in biology: Patterns and processes, causes and consequences. In *Scaling in Biology*, Brown, J.H. and West, G.B., Eds. Oxford, UK: Oxford University Press, pp. 1–24.
- Brown, J.H., Gupta, V.K., Li, B.-L., Milne, B.T., Restrepo, C., and West, G.B. 2002. The fractal nature of nature: Power laws, ecological complexity and biodiversity. *Phil. Trans. Royal Soc. Lond. B.*, 357, 619–26.
- Chaisson, E.J. 2001. *Cosmic Evolution: The Rise of Complexity in Nature*. Cambridge, MA: Harvard University Press, 275 pp.
- Claassen, C. 1998. *Shells*. Cambridge, UK: Cambridge University Press, 266 pp.
- Commito, J.A. and Rusignuolo, B.R. 2000. Structural complexity in mussel beds: The fractal geometry of surface topography. *J. Exp. Mar. Biol. Ecol.*, 255, 133–52.
- Covich, A.P., Austen, M.C., Barlocher, F., Chauvet, E., Cardinale, B.J., Biles, C.L., Inchausti, P., Dangles, O., Solan, M., Gessner, M.O., Stutzner, B., and Moss, B. 2004. The role of biodiversity in the functioning of freshwater and marine benthic ecosystems. *Bioscience*, 54, 767–75.
- Dame, R.F. 1972a. The ecological energies of growth, respiration and assimilation in the intertidal American oyster, *Crassostrea virginica*. *Mar. Biol.*, 17, 243–50.
- Dame, R.F. 1972b. Comparison of various allometric relationships in intertidal and subtidal American oysters. *Fisheries Bull. US*, 70, 1121–26.
- Dame, R.F. 1976. Energy flow in an intertidal oyster population. *Estuaries Coast. Mar. Sci.*, 4, 243–53.
- Dame, R.F. 1996. *Ecology of Marine Bivalves: An Ecosystem Approach*. Boca Raton, FL: CRC Press.
- Dame, R.F. 2005. Oyster reefs as complex systems. In *The Comparative Roles of Suspension-Feeders in Ecosystems* Dame, R.F. and Olenin, S., Eds. Dordrecht: Springer, pp. 331–43.
- Dame, R.F., Bushek, D., Allen, D.M., Lewitus, A.J., Edwards, D., Koepfler, E.T., and Gregory, L. 2002. Ecosystem response to bivalve density reduction. *Aquatic Ecol.*, 36, 51–65.
- Dame, R.F. and Dankers, N. 1988. Uptake and release of materials by a Wadden Sea mussel bed. *J. Exp. Mar. Biol. Ecol.*, 118, 207–16.
- Dame, R.F. and Patten, B.C. 1981. Analysis of energy flows in an intertidal oyster reef. *Mar. Ecol. Prog. Ser.* 5:115–124.
- Dame, R.F., Zingmark, R., and Haskin, E. 1984. Oyster reefs as processors of estuarine nutrients. *J. Exp. Mar. Biol. Ecol.*, 83, 239–47.
- Dent, C.L., Cumming, G.S., and Carpenter, S.R. 2002. Multiple states in river and lake ecosystems. *Phil. Trans. Royal Soc. Lond. B*, 357, 635–45.
- Fisher, C.R. 1990. Chemoautotrophic and methanotrophic symbioses in marine invertebrates. *Rev. Aquat. Sci.* 2, 399–436.
- Gallagher, W.S. 1991. Selective extinction and survival across the Cretaceous/Tertiary boundary in the northern Atlantic Coastal Plain. *Geology*, 19, 967–70.
- Gili, E., Masse, J.-P., and Skelton, P.W. 1995. Rudists as gregarious sediment-dwellers, not reef-builders, on Cretaceous carbonate platforms. *Paleogeogra., Paleoclimatol., Paleoecol.*, 118, 245–67.

- Hari, S. and Müller, F. 2000. Ecosystems as hierarchical systems. In *Handbook of Ecosystem Theories and Management*, Jørgensen, S.E. and Müller, F., Eds. London: Lewis, pp. 265–80.
- Harper, J.L. and Hawksworth, D.L. 1995. Preface. In *Biodiversity—Measurement and Estimation*, Hawksworth, D.L., Ed. London: Chapman and Hall, pp. 5–12.
- Héral, M. 1993. Why carrying capacity models are useful tools for management of bivalve culture. In *Bivalve Filter Feeders in Estuarine and Coastal Ecosystem Processes*, Dame, R.F., Ed. New York: Springer-Verlag, pp. 455–77.
- Hughes, R.N. 1991. Reefs. In *Fundamentals of Aquatic Ecology*, Barnes, R.S.K. and Mann, K.H., Eds. Oxford, UK: Blackwell Scientific, pp. 213–29.
- Johnson, L. 1995. The far-from-equilibrium ecological hinterlands. In *Complex Ecology: The Part-Whole Relation in Ecosystems*, Patten, B.C. and Jørgensen, S.E., Eds. New Jersey: Prentice Hall, pp. 51–103.
- Jones, C.G., Lawton, J.H., and Shachak, M. 1994. Organisms as ecosystem engineers. *Oikos*, 69, 373–86.
- Kauffman, S.A. 1993. *The Origins of Order: Self-Organization and Selection in Evolution*. New York: Oxford University Press, 734 pp.
- Kay, J.J. 1991. A non-equilibrium thermodynamic framework for discussing ecosystem integrity. *En. Manag.*, 15, 483–95.
- Knoll, A.H., Bambach, R.K., Payne, J.L., Pruss, S., and Fischer, W.W. 2007. Paleophysiology and end-Permian mass extinction. *Earth. Planet. Sci. Letts.*, 256, 295–313.
- Kostylev, V. and Erlandsson, J. 2001. A fractal approach for detecting spatial hierarchy and structure in mussel beds. *Mar. Biol.*, 139, 497–506.
- Lawrence, D.R. 1971. Shell orientation in recent and fossil oyster communities from the Carolinas. *J. Paleo.*, 45, 347–49.
- Lawrie, S.M. and McQuaid, C.D. 2001. Scales of mussel bed complexity: Structure, associated biota and recruitment. *J. Exp. Mar. Biol. Ecol.*, 257, 135–61.
- Leigh, E.G. and Vermeij, G.J. 2002. Does natural selection organize ecosystems for the maintenance of high productivity and diversity? *Phil. Trans. Roy Soc Lond. B*, 357, 709–18.
- Lindeman, R.L. 1942. The trophic dynamic aspect of ecology. *Ecology*, 23, 399–418.
- Link, J.S. 2002. Does food web theory work for marine ecosystems? *Mar. Ecol. Prog. Ser.*, 230, 1–9.
- Link, J.S., Stockhausen, W.E., and Methratta, E.T. 2005. Food-web theory in marine ecosystems. In *Aquatic Food Webs: An Ecosystem Approach*, Belgrano, A., Scharler, U.M., Dunne, J., and Ulanowicz, R.E., Eds. Oxford, UK: Oxford University Press, pp. 98–113.
- Loreau, M. 2005. Current and future perspectives on food webs. In *Aquatic Food Webs: An Ecosystem Approach*, Belgrano, A., Scharler, U.M., Dunne, J., and Ulanowicz, R.E., Eds. Oxford, UK: Oxford University Press, p. v–vi.
- Lucas, J.S. 1988. Giant clams: Description, distribution, and life history, in Copeland, J.W. and Lucas, J.S., Eds., *Giant Clams in Asia and the Pacific*, Canberra: Australia Center for International Agricultural Research, pp. 21–32.
- Manson, S.M. 2001. Simplifying complexity: A review of complexity theory. *Geoforum*, 32, 405–14.
- Menzel, W. 1991. *Estuarine and Marine Bivalve Mollusk Culture*. Boca Raton, FL: CRC Press, 362 pp.
- Meysman, F.J.R. and Bruers, S. 2007. A thermodynamic perspective on food webs: Quantifying entropy production within detrital-based ecosystems. *J. Theor. Biol.*, 249, 124–39.
- Meysman, F.J.R. and Bruers, S. 2009. Ecosystem functioning and maximum entropy production: A quantitative test of hypotheses. *Phil. Trans. R. Soc. B*, 365, 1405–16.
- Möbius, K. 1880. Die Auster und die Austerwirthschaft, Report to the U.S. Commission on Fisheries, pp. 683–751.

- Morowitz, H.J. 1970. *Entropy for Biologists: An Introduction to Thermodynamics*. New York: Academic Press, 195 pp.
- Müller, F. 1992. Hierarchical approaches to ecosystem theory. *Ecol. Model.*, 63, 215–42.
- Müller, F. 1998. Gradients in ecological systems. *Ecol. Model.*, 108, 3–21.
- Newell, R.I.E. 1988. Ecological changes in Chesapeake Bay: Are they the result of overharvesting the American oyster, *Crassostrea virginica*? In *Understanding the Estuary: Advances in Chesapeake Bay Research*, Lynch, M.P. and Krome, E.C., Eds. Solomon's, MD: Chesapeake Bay Research Consortium, pp. 536–46.
- Odum, E.P. 1983. *Basic Ecology*. Philadelphia: Saunders, 603 pp.
- Odum, H.T. 1983. *Systems Ecology: An Introduction*. NY: Wiley-Interscience, p. 8.
- O'Neill, R.V., DeAngelis, D.L., Waide, J.B., and Allen, T.F.H. 1986. *A Hierarchical Concept of Ecosystems*. Princeton, NJ: Princeton University Press, 253 pp.
- Pimm, S.I. 1982. *Food Webs*. Chicago: University of Chicago Press, 219 pp.
- Prigogine, I. 1980. *From Being to Becoming*. San Francisco: W.H. Freeman, 272 pp.
- Ray, G.C. 1991. Coastal zone biodiversity patterns. *Bioscience*, 41, 490–8.
- Reise, K., Herre, E., and Sturm, M. 1989. Historical changes in the benthos of the Wadden Sea around the island of Sylt in the North Sea. *Helgoland Meers*, 43, 417–33.
- Scheffer, M. and Carpenter, S. 2003. Catastrophic regime shifts in ecosystems: Linking theory to observation, *TREE*, 18, 648–56.
- Scheffer, M., Carpenter, S., Foley, J.A., Folke, C., Walker, B. 2001. Catastrophic shifts in ecosystems. *Nature* 413, 591–596.
- Scheffer, M., Hospar, S.H., Meijer, M-L., Moss, B., and Jeppesen, E. 1993. Alternative equilibria in shallow lakes. *TREE*, 8, 275–79.
- Schrödinger, E. 1944. *What is Life?* Cambridge, UK: Cambridge University Press.
- Shumway, S.E. 1982. Oxygen consumption in oysters: An overview. *Mar. Biol. Lett.*, 3, 1–23.
- Shumway, S.E. and Koehn, T.K. 1982. Oxygen consumption in the American oyster *Crassostrea virginica*. *Mar. Ecol. Prog. Ser.*, 9, 59–68.
- Snow, C.P. 1964 (1993 reprint). *The Two Cultures and A Second Look*. Cambridge, UK: Cambridge University Press, 112 pp.
- Stenzel, H.B. 1971. Oysters. In *Treatise on Invertebrate Paleontology, Part N, Mollusca 6, Bivalvia*, Moore, R.C., Ed. Lawrence, KS: Geological Society of America, pp. N593–1051.
- Ulanowicz, R.E. 1986. *Growth and Development: Ecosystem Phenomenology*. Berlin: Springer-Verlag, 203 pp.
- Ulanowicz, R.E. 1997. *Ecology: The Ascendent Perspective*. New York: Columbia University Press, 201 pp.
- Ulanowicz, R.E. and Hannon, B.M. 1987. Life and the production of entropy. *Proc. R. Soc. Lond. B.*, 232, 181–92.
- van de Koppel, J., Riekerk, M., Dankers, N., and Herman, P.M.J. 2005. Scale-dependent feedback and regular spatial patterns in young mussel beds. *Am. Naturalist*, 165, E66–E77.
- Vermeij, G.J. 1999. Inequality and the directionality of history. *Am. Naturalist*, 153(3), 243–53.
- Wood, R. 1999. *Reef Evolution*. Oxford, UK: Oxford University Press, 415 pp.
- Yonge, C.M. 1960. *Oysters*. London: Collins.

2 Historical Ecology of Bivalves

INTRODUCTION

Historical ecology is a relatively new approach to studying the ecology of a variety of organisms, ecosystems, and landscapes. It focuses on the historical relationship between humans and the biosphere (Balée 2006) and essentially promotes the view that (1) wherever humans have been, the natural environment is somehow different or changed; (2) human nature is not programmed genetically; (3) different societies impact ecosystems and landscapes in different ways; and (4) human interactions with ecosystems and landscapes may be studied as a whole. Historical ecology has principles that involve different levels of human-mediated disturbance to natural systems for example, the effect of overharvesting of bivalves on primary producers or phytoplankton. It also is more the product of the social sciences, particularly anthropology, archaeology, and geography, than that of biology, chemistry, and physics. However, ecology and historical ecology are multidisciplinary, and multidisciplinary teams of experts have generally produced more meaningful interpretations of the data. Applied historical ecology can provide the reference conditions of spatial, temporal, and general environmental information to assist in the restoration of past ecosystems and landscapes. The interaction of ecology and historical ecology should prove to be a positive experience to both disciplines as well as our species.

IMPORTANT TERMS AND CONCEPTS

Adaptive governance: The necessity and flexibility to negotiate changes in human–environmental interactions as the environment changes.

Historical ecology: Focuses on the chronological relationships between humans and the biosphere.

RCC: Rapid climate change that may be caused by natural or anthropomorphic factors.

Reverse engineering: The process of taking something apart to determine how it works.

Shell midden: An accumulation of food refuse and other waste byproducts of human activity.

Shell mound: Begins as a refuse pile and often becomes a burial site.

Shell ring: A circular structure built mostly of bivalve shells in the prehistoric high salt marsh.

TABLE 2.1
A Comparison of Species Number or Richness in Living and Prehistoric Assemblages Dominated by Oysters

| Location | Habitat | Dominant Bivalve | Total Species | Source |
|----------------------|---|------------------------------|---------------|---------------------------|
| Delaware Bay, DE | Live/Reef/Subtidal | <i>Crassostrea virginica</i> | 129 | Maurer and Watling (1973) |
| Potomac River, MD | Live/Reef/Subtidal | <i>Crassostrea virginica</i> | 41 | Frey (1946) |
| James River, VA | Live/Reef/Subtidal | <i>Crassostrea virginica</i> | 138 | Larsen (1985) |
| Newport River, NC | Live/ Reef/ Intertidal–Subtidal /Gradient | <i>Crassostrea virginica</i> | 303 | Wells (1961) |
| North Inlet, SC | Live/Reef/Intertidal | <i>Crassostrea virginica</i> | 37 | Dame (1979) |
| Fig Island 1, SC | Prehistoric Shell Ring | <i>Crassostrea virginica</i> | > 45 | Russo (2002) |
| Sapelo Island, GA | Intertidal Rocks | <i>Crassostrea virginica</i> | 42 | Bahr and Lanier (1981) |
| Crystal River, FL | Live/Reef/Intertidal | <i>Crassostrea virginica</i> | 31 | Lehman (1974) |
| Apalachicola Bay, FL | Live/Reef/Subtidal | <i>Crassostrea virginica</i> | 90 | Pearse and Wharton (1938) |

NATURAL REEFS AND HUMAN CONSTRUCTS

Many bivalves occur in natural reefs and in the remnants of human use. Bivalve reefs and beds are structures built by living animals on or in the surface sediments. Reefs generally grow upward away from the bottom sediments and are structural habitats for a diverse community of plants and animals. In a review of oyster reefs in the United States (Table 2.1), the highest species richness (303 species) was found on live intertidal/subtidal bivalve reefs across the broad estuarine gradient of the Newport River, North Carolina (Wells 1961). The lowest species richness (31 species) was reported for live intertidal reefs in Crystal River, Florida (Lehman 1974). These are the most southern reefs of those reported in Table 2.1 and potentially have the greatest exposure to thermal stress.

Bivalve shells also occur in middens, mounds, and shell rings, indicating that humans utilized the soft tissues of these animals for food, and their shells for building material. A partial listing of shell ring material used by humans in a variety of building and construction activities is listed in Table 2.2. Although evidence of hominoid feeding on bivalve tissue is sparse before the Holocene period (10,000 BP), Claassen (1998) reports observations by Lumley (1972) that bivalves had been used by the inhabitants of Terra Amata, France as early as 300,000 BP. In addition, Volman (1978) reported early bivalve shell use in South

TABLE 2.2
A Partial List of Products Derived from Bivalve Shells in Middens

| Agriculture | Building | Commerce |
|----------------|-----------------|------------------|
| Farming | Foundations | Lime |
| Fertilizer | Fill | Oyster spat beds |
| Garden topsoil | Roads | Recreation |
| Golf greens | Parking lots | Jewelry |
| Tennis courts | Sidewalks | Gardens |
| Bird feed | Drainage fields | |
| | Sea walls | |
| | Platforms | |
| | Tombs | |

Source: Adapted from Ceci, L. 1984. Shell midden deposits as coastal resources. *World Arch.*, 16, 62–74; and Claassen, C. 1998. *Shells*. Cambridge, UK: Cambridge University Press.

Africa between 130,000 and 30,000 BP. Moreover, Claassen (1998) indicated similar situations occurring in Gibraltar between 50,000 to 40,000 BP and in China about 13,000 BP. Thus *Homo sapiens* had populated the majority of livable environments on our planet and their interactions with bivalves were evident from the middens that were a product or byproduct of their activities.

Here I use the term midden as derived from the Scandinavian word meaning piles of accumulated material deposited by humans near their dwelling or living space. The more specific terms of shell middens, shell mounds, and shell rings imply that it is mostly bivalve shells with soft body tissues removed that are intentionally deposited near a living space by humans. The accumulating shell is often dispersed in such a way as to increase the structural integrity of the midden. Middens are always found near water and a large source of bivalve shells, and in the coastal zone this usually means shallow or intertidal habitats. Like the earthen mounds that punctuate terrestrial landscapes at approximately the same time, coastal and estuarine shell middens are generally three-dimensional and elevated. Readers should take note that in the source literature the term shell midden can mean gastropod as well as bivalve shell, and the term shellfish includes these molluscs as well as crustaceans.

A number of distinctive midden stages or types can be identified based on the local environment and how the shells are arranged. Fairbridge (1976) offered a detailed scheme for classifying middens. The following examples are an extensively modified adaptation of his work.

1. Stage BK is located on the bank of a tidal river. This type is one of the oldest and simplest.
2. Stage MM describes middens that are in estuaries with salt marsh or mangrove wetlands. Average salinity and tidal range are higher. Primary and secondary production approach a global maximum for density at mid and low latitudes. Oyster rings are found in this category.

3. Stage LS are shell middens that are found on sand-spits or bars where the flow dynamics deposit sand in shallow lagoons or meandering tidal creeks.
4. Stage PL is located on a Pleistocene platform that is composed of older pre-Holocene sediments.

The stages can be envisioned as a sequence of different states or a continuum that exist between the sea and the uplands. These systems gradually are drowned during periods of sea level rise and are exposed when sea level declines. Tidal flows and sea level fluctuations provide energy supplements that make this interface one of the most productive ecological gradients or zones on the planet (Dame et al. 2000).

Shell middens appeared globally during the Holocene as the ice age ended and the rate of sea level rise was slowed (Claassen 1998). It was also an era when humans were starting to change from hunter-gatherers to more sedentary behaviors. Extensive middens have been found in Brazil (Fairbridge 1976), the southeastern United States (Claassen 1998), northeastern United States (Ceci 1984; Lightfoot and Cerrato 1988), Africa (Volman 1978), northern Europe (Dupont et al. 2009), Middle East (Biagi and Nisbet 2006), Southeast Asia (Somadeva and Ranasinghe 2006; Stephens et al. 2008), and Australia (Bird et al. 2002).

As an ecologist who is interested in the holistic systems approach to life on our planet, I am curious how the historical ecology school compares to modern ecology. So I attempted a meta-analysis by looking at a few published papers on prehistoric shell middens (Table 2.3). I used Google and the Web of Science as my search engines. The shell middens had to be dominated by estuarine or marine bivalves. To be selected for the review, the paper also had to be freely available as a download through Coastal Carolina University's library. My goal was to find a comprehensive article for each ocean–continental–climatic interface. I used Bailey (1975) and Fairbridge (1976) as my target standard because they were the only papers that covered all the aspects used in Table 2.3. I examined a number of papers and deemed 19 papers usable.

Two papers, Bailey (1975) and Jerardino (1995), addressed a longstanding problem with computing population density values for prehistoric shell middens using a reverse engineering approach together with archaeological analysis. In archaeological research, density is number or mass per unit volume or area. Density values are determined from the shells and skeletons of various species that make up the shell midden. Usually cores or shovels of midden material are collected in sufficient number to account for the spatial and temporal distribution of the midden material. The cores are subdivided into vertical layers that are analyzed radiometrically or stratigraphically for total midden age. Generally, the oldest material is on the bottom and the youngest is on the top surface of the midden. The dry weight and density of the bivalve shells is determined directly from the samples. The amount of edible soft tissue is calculated using a shell weight to dry soft tissue model built with data from modern bivalves. The dry soft tissue for each individual bivalve in the sample is calculated and the sum of the individual values is total dry soft tissue per sample, where the sample is in either m^2 or m^3 (see Claassen 1998 for details). These spatial estimates can be combined with temporal (radiometric/stratigraphic) observations to generate dry soft tissue production rates.

To understand the functional roles of the prehistoric humans who built the middens, it is essential that the diets of these consumers be accurately assessed. Initially, the assessment polarized into two separate views: the European outlook that bivalves were a minor dietary component for midden dwelling humans, and the American and New Zealand viewpoint that bivalves were a major food source for prehistoric coastal people (Bailey 1975; Jerardino 1995). While some problems with estimating the human diet seem to have abated (Claassen 1998), sediment layer compression and the assumption of a constant deposition of shell midden matrix are still difficult issues that influence temporal scaling (Jerardino 1995). If you are interested in these measurement details and associated problems, I suggest that you see Claassen (1998) and Reitz and Wing (2008).

CASE STUDY: THE OYSTER SHELL RINGS

Oysters are ancient and important benthic components of the intertidal and shallow subtidal bottoms of the rich and productive southeastern U.S. marsh–estuarine ecosystems (Dame et al. 2000). Assemblages of living oysters form open nonequilibrium systems whose many components interact via multiple nonlinear feedback loops that develop emergent and often surprising dissipative structures such as reefs (Dame 2005). In recent decades, ecological research has shown that when these systems are impacted by natural and anthropogenic stresses they often respond by reorganizing into another alternate state (Newell 1988; Dame 2005).

A shift of bivalve-dominated marsh–estuarine ecosystems may have occurred on a regional scale thousands of years ago as evidenced by oyster shell rings in coastal South Carolina, Georgia, and Florida (Figure 2.1). Shell rings are prehistoric ring-like structures (4500 to 3000 BP) built by the coastal Native Americans (Figure 2.2) in the developing and highly productive marsh–estuarine ecosystems on the landward side of southeastern U.S. sea islands (Crook 1992). The rings are 3 to 10 m high (on top of high salt marsh), 20 to 250 m in diameter, and built from billions of oyster shells. Speculation as to the function of the rings ranges from fortifications to cultural monuments to small villages (Saunders 2002). The construction of shell rings is thought to symbolize and signal the conversion of nomadic hunter-gatherers to the more complex social and sedentary structure of coastal fisherfolk and is considered a pivotal stage in the evolution of pre-European contact culture in the United States. However, by 3000 BP the shell rings with their complex social structure were abandoned and the Native Americans are thought to have returned to the more dispersed hunter-gatherer mode (Russo and Heide 2001; Saunders 2002). Thus we might pose the following questions: Was the demise of the shell ring culture at about 3000 BP self-inflicted, or were there external environmental factors involved? Is the explanation stored in the shells that make up the rings?

INTERPRETING SHELL RINGS THROUGH TIME

Investigating living oysters and reefs is a relatively straightforward adventure. However, studying prehistoric oysters requires the addition of geological and archaeological approaches (Claassen 1998; Wood 2000; Reitz and Wing 2008). Because the

TABLE 2.3
Meta-Analysis of the Major Properties of Selected Shell Middens (Global Distribution)

| Site | Climate | System | Date (yr BP) | Midden Type | Density (Ind./m ²) | Midden Size (m ³) | Dominant Bivalve Species | Source | Major Question(s) Addressed |
|---------------------------------|-----------------------|-------------------|--------------|-------------|--------------------------------|-------------------------------|---|---|---|
| USA-Southeast (Fing Island, SC) | Temperate-Subtropical | Estuarine Coastal | 6000–5000 | Ring | 7.0×10^4 | 2.2×10^4 | <i>Crassostrea virginica</i> | Crook (1992, 2007) Saunders (2002) | Overharvesting, rapid climate change |
| USA-Northeast | Temperate-Boreal | Estuarine | 6000–5000 | Shell | NPD | NPD | <i>Crassostrea virginica</i> <i>Mercenaria mercenaria</i> | Carbotte et al. (2004) Ceci (1984) Lighthfoot et al. (1988) | Rapid climate change Deposition of sediments Harvest multiple seasons |
| Canada-Northwest | Temperate | Estuarine Coastal | NA | Shell | $3-4 \times 10^2$ | 1.2×10^3 | NPD | Cannon (2000) | Core method proven accurate |
| California | Temperate | Coastal-Upwelling | 11,200–9000 | Shell | NPD | NPD | <i>Mytilus californianus</i> | Erlanson et al. (2008) | Rapid coastal migrations into North America |
| California SW | Temperate | Coastal-Upwelling | 1100 | Shell | NPD | NPD | <i>Mytilus californianus</i> <i>Chione sp.</i> | Treganza & Cook (1948) Glassow & Wilcoxon (1988) | Shell midden productivity north and south of Point Conception |
| Brazil | Tropical-Subtropical | Estuarine Coastal | 6000 | Shell | $2-3 \times 10^3$ | 1.2×10^5 | <i>Ostrea arborea</i> <i>O. brasiliana</i> <i>Perna perna</i> | Fairbridge (1976) | Overharvesting Sea level rise |

| | | | | | | | | | | |
|--------------|-----------------------|-------------------|-----------|-------|-----------------------|-----------------------|-----|--|-------------------------------|--|
| France | Temperate | Estuarine Coastal | 6100–4800 | Shell | NPD | NPD | NPD | <i>Cerastoderma edule</i> <i>Ruditapes decussatus</i> <i>Ostrea edulis</i> | Dupont et al. (2009) | All resources overexploited |
| France | Temperate | Estuarine | 8000 | Shell | NPD | NPD | NPD | <i>Ostrea edulis</i> <i>Scrobicularia plana</i> | Poirier et al. (2009) | Environmental change from 8000 BP |
| Portugal | Temperate | Estuarine | 6300–5300 | Shell | NPD | NPD | NPD | NPD | van der Schriek et al. (2007) | Sudden appearance of large shell middens throughout Portugal about –6100 |
| Mozambique | Tropical-Subtropical | Coastal Island | NPD | Shell | NPD | NPD | NPD | <i>Anadara antiquate</i> <i>Pinctada nigra</i> <i>Saccostrea cucullata</i> | de Boer et al. (2000) | Comparing recent and abandoned middens to detect human exploitation |
| South Africa | Temperate-Subtropical | Coastal Upwelling | NPD | Shell | NPD | NPD | NPD | <i>Perna perna</i> | Lasiak & Field (1995) | Only macrofauna showed significant effects due to exploitation |
| Australia | Subtropical | Coastal Estuarine | NPD | NPD | 320–570 | Live | NPD | <i>Anadara trapezia</i> <i>Saccostrea commercialis</i> | Catterall & Poiner (1987) | Impact of gathering on bivalves |
| Australia | Subtropical | Coastal Estuarine | 1720 | Shell | 4–9 × 10 ³ | 3.3 × 10 ⁴ | NPD | <i>Saccostrea commercialis</i> | Bailey (1975) | The role of bivalves in the coastal economies |

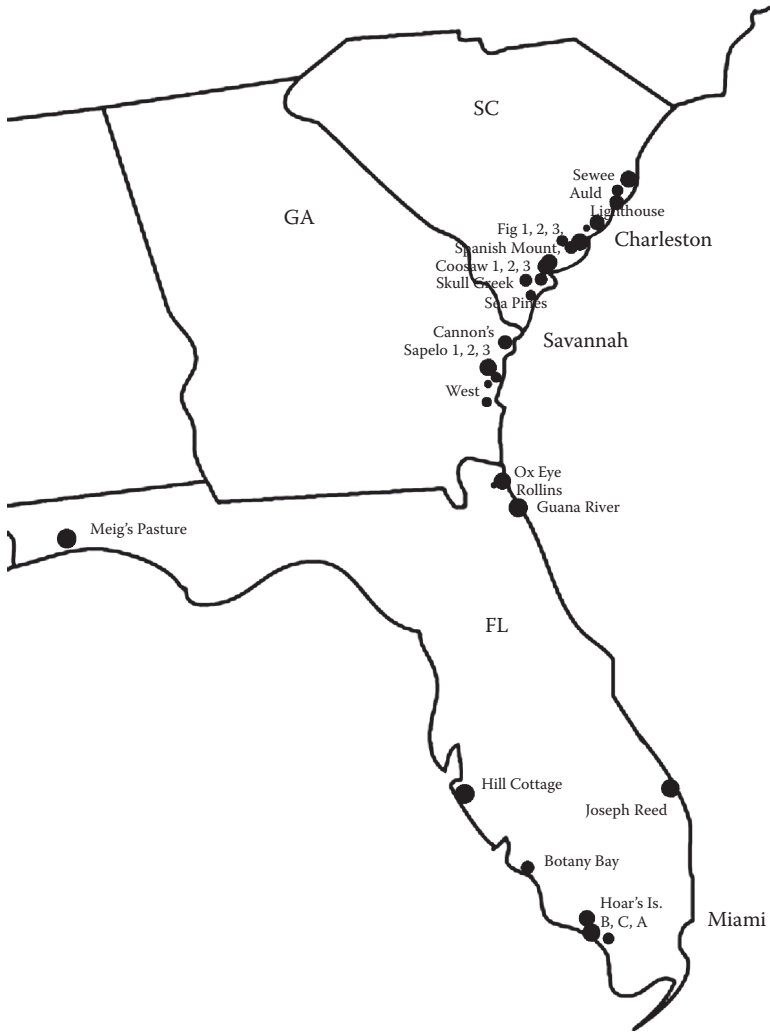

FIGURE 2.1 Map of southeastern United States showing locations of shell rings. (From Russo, M. 2006. *Archaic Shell Rings of the Southeast U.S.: National Historic Landmarks*. Southeastern Archeological Center.)

shells of ancient oysters do not deteriorate quickly in saltwater, modern ecological techniques can be successfully applied to capture the information held in the structure of the shells. The physical and chemical environment surrounding the live cells of the bivalve leaves information in the form of the size and shape of the calcium carbonate crystals that are laid down while the bivalve was alive. As such crystals are not formed in dead bivalves, the layers of shell crystals are the equivalent of the pages in a book or the data on a CD. Reverse engineering is the general term used to describe the process of collecting information about the bivalve at some time in the past.

The size of an individual bivalve is one of its most significant characteristics. In oysters, size is usually measured linearly as shell height (long-axis) and dry tissue

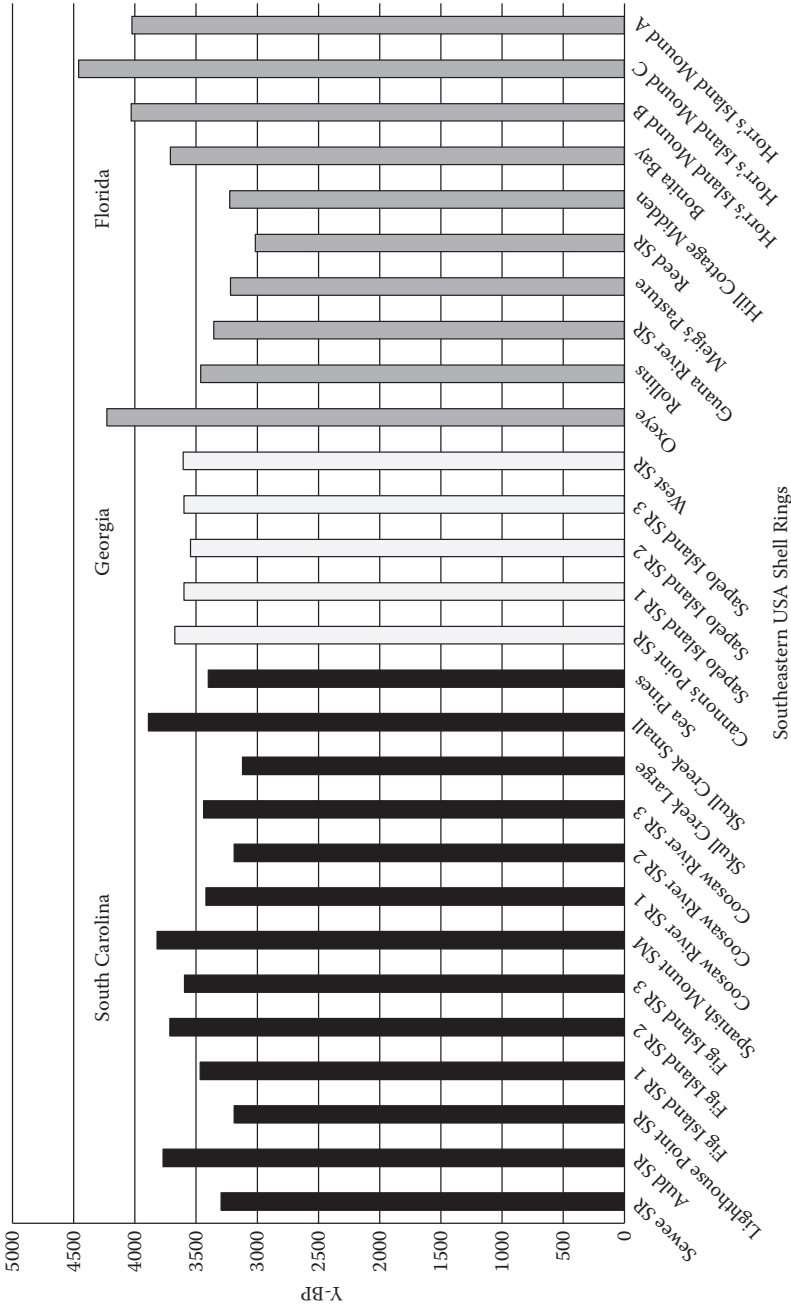

FIGURE 2.2 Radiocarbon dates of southeastern United States shell rings. (From Russo, M. 2006. *Archaic Shell Rings of the Southeast U.S.: National Historic Landmarks*. Southeastern Archeological Center.)

weight (biomass). There are few if any differences in the ecological and archaeological methods. The two measures are related by allometric equations (Dame 1972; Reitz and Wing 2008) that allow the easy conversion from one size parameter to another. The relationship works on prehistoric data just as well as modern data. Size is important because with temperature it governs the magnitude of many organismic physiological rates, for example, growth, filtration, and respiration. Thus if size is known, many functional properties of both living and dead organisms can be nondestructively estimated. Moreover the environmental history stored in the shells when the bivalves were alive can be interpreted.

If the number of oysters of various sizes is known, then population scale estimates of a variety of ecological properties and processes can be calculated. In addition, the potential impact of a population of oysters on a given system can be assessed.

For decades, physiological ecologists have shown that there are allometric ratios that mechanistically describe the scaling relationship between an organism's size and its shape. An allometric relationship means that the ratio of the biomass to the rate is different from unity and nonlinear, while a ratio of 1 between the quantities is said to be isometric and linear. Utilizing power functions, bivalve ecologists have found that shell height (H) in mm is the most useful field measurement for predicting biomass in units of grams dry body ($g\ db$) for bivalve, and in particular for *Crassostrea virginica* (Dame 1972),

$$W_t = -2.38 H^{2.21} \quad (2.1)$$

The allometric equation for the filtration of suspended particles or clearance rate (CR) is a general relationship for estuarine bivalves (Gerritsen et al. 1994) where

$$CR = 0.120 W_t^{0.75} \quad (2.2)$$

and CR is m^3 of water cleared individual⁻¹ d⁻¹ and W_t is $g\ db$. Note that the power exponent 0.75 or $\frac{3}{4}$ is derived from the *Metabolic Theory of Ecology* (Brown et al. 2004). The clearance rate can be scaled up to the size of a population with a spreadsheet model that calculates the rates for each size class of organism and then processes the data to get an estimate of the population clearance rate.

COMPARING PAST TO PRESENT SYSTEMS

Lunz (1938) was one of the first scientists to address the differences in size between modern *C. virginica* found on living intertidal oyster reefs and those found in shell rings and mounds in South Carolina (Table 2.4). It should be noted that measures of statistical variability were not reported. He concluded that modern oysters from polluted locations, i.e., the Ashley River in Charleston, South Carolina, were smaller than those living oysters from an unpolluted site near Sewee, as well as prehistoric oysters from a shell mound and shell ring also near Sewee. Lunz (1938) further speculated that intense fishing pressure might also result in smaller oysters. The largest oyster he found was one from the Sewee shell mound that was about 200 mm

TABLE 2.4
The Influence of the Environment on the Size of Prehistoric and Modern Intertidal *Crassostrea virginica*

| Location | Environment | Category | Size (mm) | Source |
|-----------------------|-------------|----------|-----------|--------------|
| South Carolina | | | | |
| Ashley River | Polluted | Average | 89 | Lunz (1938) |
| Sewee | Pristine | Average | 98 | Lunz (1938) |
| Sewee | Pristine | Largest | 120 | Lunz (1938) |
| Sewee | Shell Ring | Average | 166 | Lunz (1938) |
| Sewee | Shell Ring | Largest | 200 | Lunz (1938) |
| Georgia | | | | |
| Sapelo | Pristine | Singles | 93 | Crook (1992) |
| Sapelo | Pristine | Reef | 107 | Crook (1992) |
| Sapelo | Shell Ring | Largest | 91 | Crook (1992) |

Source: From data compiled by Lunz, G.R. 1938. Comparison between pre-colonial and present-day oysters. *Science*, 87, 367.

in height. Larger *C. virginica* can be found in South Carolina in current times and in pristine environments.

Crook (1992) conducted a specific study at Sapelo Island, Georgia, on *C. virginica* living in various habitats and shells found in the nearby prehistoric shell ring and shell middens (mounds or heaps). Using a statistical test (analysis of variance, or ANOVA), he found no significant difference in the shell heights of any category. However, the widths of the oysters used in the shell ring were significantly greater, and Crook (1992) attributed this finding to faster growth in the oysters on the beds used as shell for the shell ring. He speculated that growth was faster on these source beds because they were being culled by routine harvesting. Thus we can make no general statement as to size difference between prehistoric and modern intertidal oysters of the same species.

Harding et al. (2008) built shell length-at-age relationships for subtidal oysters (*C. virginica*) collected 400 years apart in Chesapeake Bay. Their findings indicated a downward trend in size over time. This trend was attributed to degradation in the environment and changes in oyster biology.

We can address the question of how many oysters with associated species make a modern oyster reef or a prehistoric shell ring. Intertidal oyster reefs are typical of the salt marsh–estuarine systems in the Carolina–Georgia Bight. One such reef that has been studied extensively over the past 40-plus years is in North Inlet estuary, South Carolina (Dame 1976, 1979). The reef is approximately 750 m² with a density of 2200 individuals m⁻² and a biomass of 345 g db m⁻². The average biomass per individual is 0.20 g db individual⁻¹ (Table 2.5). The average individual biomass value is low because oysters of all sizes are included.

The shell rings of the southeastern United States were built by Native Americans using oysters from nearby living beds (Crook 1992). Depending on the state and the

TABLE 2.5
Comparison of a Live North Inlet Oyster Reef to the Fig Island 1 Shell Ring

| Characteristic | North Inlet Live Reef ^a | Fig Island 1 Shell Ring ^b |
|---------------------------|--|--|
| Site area | 750 m ² | 17,427 m ² |
| Site volume | NA | 22,114 m ³ |
| Sample size | 0.25 /m ² | 0.025 m ³ |
| Dominant bivalve species | <i>Crassostrea virginica</i> | <i>Crassostrea virginica</i> |
| Age | Live | 3820 ± 70 BP |
| Density | 2200 /m ² | 69,538/m ³ |
| Biomass | 345 g db/m ² | 56,848 g db/m ³ |
| Total population density | 1.65 × 10 ⁶ | 1.54 × 10 ⁹ |
| Total population biomass | 2.59 × 10 ⁵ | 1.26 × 10 ⁸ |
| Avg. biomass/individual | 0.20 g db | 0.82 g db |
| Clearance rate/individual | 0.04 m ³ /d | 0.10 m ³ /d |
| Total clearance rate | 6.60 × 10 ⁴ m ³ /d | 1.21 × 10 ⁸ m ³ /d |

^a From Dame, R.F. 1996. *The Ecology of Marine Bivalves: An Ecosystems Approach*. Boca Raton, FL: CRC Press.

^b From Saunders, R., ed. 2002. *The Fig Island Ring Complex: Coastal Adaptation and the Question of Ring Function in the Late Archaic*. Report to the South Carolina Department of Archives and History, Columbia, SC.; and Russo, M. 2002. Faunal analysis at Fig Island. In *The Fig Island Ring Complex: Coastal Adaptation and the Question of Ring Function in the Late Archaic*, Saunders, R., ed. Report to the South Carolina Department of Archives and History, Columbia, SC, 141–53.

actual location, many shell ring sites have been by presidential decree (signature) classified as national historical sites by Presidential decree that must be preserved and protected. They have been analyzed by professional scholars from state and federal governments. These analyses are very work intensive as well as expensive, and few have been published. However, this type of data is being made more available over the Internet.

The Fig Island archaeological study (Saunders 2002) is one of the more recently available reports on shell ring sites. At publication, the largest shell ring known was Fig Island 1 (Table 2.5). It is approximately 900 m² and is located in the high salt marsh on the west side of Edisto Island near Charleston, South Carolina. Detailed topographic and stratigraphic maps were constructed for each structure. The Fig Island maps used 5-m intervals across the site and probing for shell depth beneath the rings. The size of a sample is 0.025 m³, and using the MNI (minimum number of individuals per sample) zooarchaeological method (see Reitz and Wing 2008) there are 1370 individual oysters in a sample. The total volume of Fig Island 1 shell ring is 22,114 m³ with an estimated total of 1.2 × 10⁹ individual oyster shells. The high numbers are because these are dead oysters. The shells were accumulated and

compressed over several years. The average dry body weight was 0.82 g db per individual with a projected total biomass of 9.9×10^8 g db (Table 2.5). Assuming only 50% of the oysters were taken from the live reef each year, it would take 1466 years to accumulate the number of shells in the shell ring. However, based on a detailed analysis of the Fig Island site, Sassaman (2004), Russo and Heide (2003), and Saunders (2002) concluded that the shell rings were built in just a few seasons. Such a rapid construction rate would have stripped or severely overfished large areas of the ecosystem of oysters and resulted in a major loss of services, such as fish habitat, water clearance, nutrient recycling, etc. Furthermore, the removal of large quantities of shell from the source oyster reefs would probably have destabilized the structure of the reefs (Powell and Klinck 2007; Mann and Powell 2007).

The individual dry body weight estimates for oysters in the shell rings can be substituted into the allometric equation (Equation 2.2) for clearance rate (CR) to generate potential water clearance capacity lost from the system because the ring oysters have been removed from the living system. For the modern North Inlet reef, summertime CR is about 66,000 m³/d and the lost potential for oysters in the shell ring is 121,000,000 m³/d. The calculated lost clearance capacity for the oysters in the Fig Island 1 shell ring is 5.5 times the volume of the North Inlet ecosystem (Dame 2009) and suggests potential overharvesting by the Fig Island shell ring builders.

The period of time since the most recent ice age is known as the Holocene and dates from about 10,000 BP. Because estuaries are at the interface of the atmosphere, land, and sea, they are frequently impacted by external forces including natural abiotic global climate fluctuations and anthropogenic stresses such as overfishing. These systems responded to these forces by reorganizing or adapting into another alternate stable state. For the coastal region, it was a time of change and increasing ecological complexity.

The abiotic environment of the early Holocene was also changing. Not only was the climate quickly warming, but sea level was also rising as glacial ice melted and the water flowed back into the ocean. With the swiftly rising sea level (30 cm/100 yr [Scott et al. 1995]), intertidal and shallow coastal habitats were constantly changing as they were submerged or forced up-slope. By 6000 BP, the glacial melt along with sea level rise began to gradually slow down (10 cm/100 yr [Scott et al. 1995]) and deltas of accumulated sediment began to appear at the mouths of submerging drainage basins and river valleys. The accumulated sediments in these developing estuaries provided habitat for benthic vascular plants and suspension-feeding bivalves (DePratter and Howard 1981). The addition of these components dramatically increased the nutrient trapping and processing capabilities as well as the complexity of these systems. With the addition of tidal and gravitational water flows as well as subtropical solar energy inputs, these estuarine systems were becoming some of the most productive natural ecosystems on our planet (Dame et al. 2000). The native human population of the coastal southeast appeared to have taken advantage of these resources by harvesting the fauna in these estuaries (Crook 2007).

During the mid-Holocene (4500 BP) mean sea level (MSL) on the South Carolina and Georgia coasts was 1.5 to 2 m lower than modern MSL (DePratter and Howard 1981; Scott et al. 1995). The rich estuarine ecosystems of that period supported complex food webs that included humans. Perhaps the coastal Native Americans took

advantage of the higher productivity of the marsh–estuarine ecosystems to develop a denser more sedentary culture (Figure 2.1). The ecological and socioeconomic complexity of this culture was exemplified by construction of major visible structures, the shell rings.

Changes in climate through time can play a major role in the success of ecological systems. The central paradigm in Holocene paleoclimatology was that the Earth’s climate tended to change gradually in response to slowly changing environmental forcing. However, in the 1990s precision analysis of ice cores revealed that climate could change rapidly and unexpectedly in response to natural environmental stresses (Stanley 2000). These rapid climate changes (RCC) could take place in days to months (Stanley 2000; Overpeck and Webb 2000) and destabilize the system. In the region of the shell rings, the period from 4500 to 3000 BP was subjected to RCC, which in turn drove vertical sea level changes of 2 to 3 m (DePratter and Howard 1981; Overpeck and Webb 2000). Low stands in sea level (Figures 2.2 and 2.3) corresponded to cool, wet conditions and warm, dry environments related to high stands of sea level (Saunders 2002; Crook 2007). Jackson et al. (2001) argued that the collapse or shift of coastal ecosystems to alternate states is caused by anthropogenic forcings, i.e., overfishing,

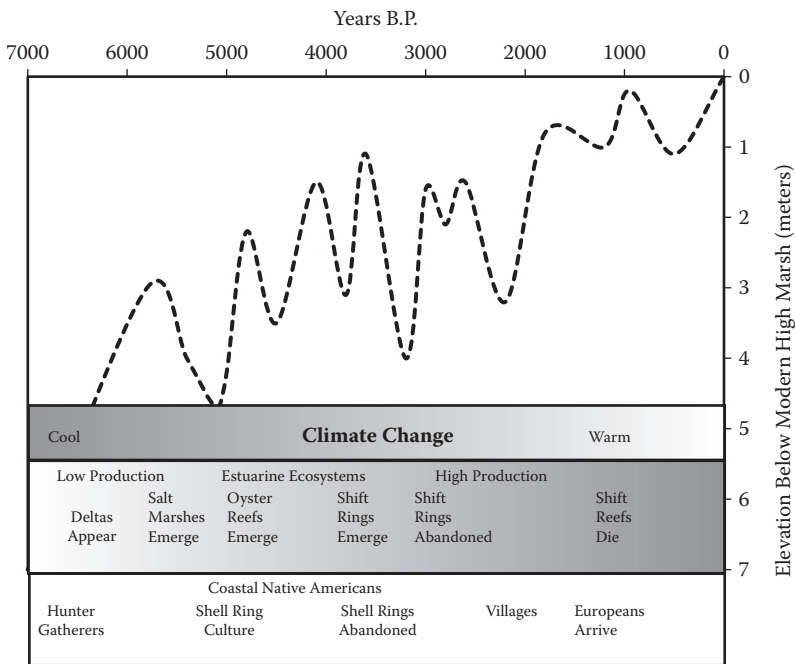

FIGURE 2.3 Brooks curve, SLR, time. (From Brooks, M.J., Stone, P.A., Colquhoun, D.J., and Brown, J.G. 1989. Sea-level change, estuarine development and temporal variability in woodland period subsistence-settlement patterning on the lower coastal plain of South Carolina. In *Studies in South Carolina Archaeology: Essays In Honor of Robert L. Stephenson*, Goodyear, A.C. and Hanson, G.T., Eds. Anthropological Studies #9, Columbia, South Carolina: Occasional papers of the South Carolina Institute of Archaeology and Anthropology, pp. 91–100.)

shell removal, and pollution. Mannino and Thomas (2002) contend that there is compelling evidence that prehistoric human foragers may have overexploited or depleted intertidal shellfish stocks because the organisms in these systems are easily accessible to human foragers. Thus shifts in systems dominated by oysters probably occurred in the prehistoric, rich, marsh–estuarine ecosystems of the southeastern region (Russo and Heide 2001). These systems also seem to be susceptible to natural environmental forcings (Figure 2.3), such as RCC coupled to sea level rise (Carbotte et al. 2004; Mayewski et al. 2004). In this case, rapidly changing sea level disrupts the ability of the estuarine ecosystem to capture suspended organic sediments and results in lower system productivity. It furthermore appears that a combination of anthropogenic and environmental forcings may make a system scale shift more likely (Carbotte et al. 2004). Thus by 3000 BP, the southeastern U.S. shell ring systems were abandoned and the Native Americans who had been associated with them were dispersed (Figure 2.3) and the system shifted to another state, a state without humans.

CLUES FROM HISTORY

Perhaps the Native Americans of the marsh–estuarine systems attempted to take advantage of the rich available resources of the system by constructing a more complex and sedentary phase or state, the shell ring culture. An anthropogenic stress, like the overharvesting of the source oyster population in a short period of time, could have led to a shift of the marsh–estuarine ecosystem from dominance by the shell ring culture people, particularly if oysters were by far the major component in the shell ring culture’s diet (Russo 2002; Russo 2006) and the shell budgets of the reefs became unsustainable (Powell and Klinck 2007; Mann and Powell 2007).

Even though overharvesting seems to be a likely cause in the demise of the shell ring culture, it does not explain the apparent synchrony of the event near 3000 BP. The 3000 BP date is also coincident with a major period of RCC with climate cooling, increased precipitation, and flooding, as well as regressive or falling sea level in the Holocene (Brooks et al. 1989; Scott et al. 1995; Mayewski et al. 2004; Kidder 2006; Figure 2.3). This incident of RCC encompassed the southeastern United States and the Mississippi River valley (Kidder 2006) as well as providing a synchronizing mechanism for phase shifts at the regional to global scales. Cooling periods have also been used to explain the extinction of subtidal oysters in New England about 1500 BP (Sanger and Sanger 1986) and in the Hudson River estuary between 5000 and 4000 BP (Carbotte et al. 2004). In the shell ring area, biological productivity would have declined and oyster mortality due to extended exposure resulting from declining sea level would have increased. Thus overharvesting and RCC could have combined to generate a food shortage for the Native Americans in the shell ring culture. This food shortage might have contributed to the collapse of the shell ring culture as the Native Americans abandoned their shell rings and reverted to the dispersed earlier hunter-gatherer stage. With the Native Americans no longer a major part of the food web, the oysters could again dominate the system and the average individual oyster size should have increased.

The shells of bivalves from individuals to reefs have the potential to provide a great deal of information about their present and past environments. In this exercise,

the examination of prehistoric shell rings with an integrated ecological, archaeological, geological, and global climate change perspective suggests that about 3000 years ago many marsh–estuarine ecosystems in the southeastern United States may have gone through a phase shift that also reflected a change not found in modern systems, the loss of humans and their shell ring culture from the system. A likely scenario was that the Native Americans of the shell ring culture could not adapt to their more complex system when it was stressed by anthropogenic (overharvesting) and natural environmental (RCC) factors. The response of the native human population was to revert back to the less complex hunter-gatherer state. The Native Americans eventually returned to the southeastern marsh–estuarine ecosystems, but the shell ring culture did not. It should also be pointed out that unlike modern humans, the Native Americans of the shell ring era had no influence on climate change. While these results broaden our perspective, caution should be exercised as the further back in time we investigate, the greater the uncertainty. We should always keep in mind that modern humans are an integral part of complex systems whose trajectories may offer many surprises. We should also remember that most ecosystems do not require humans to function properly.

REFERENCES

- Bahr, L.M. and Lanier, W.P. 1981. The ecology of intertidal oyster reefs of the South Atlantic coast: A community profile. U.S. Fish and Wildlife Service, Office of Biological Services, Washington, DC. FWS/OBS-81/15, 105 pp.
- Bailey, G.N. 1975. The role of molluscs in coastal economies: The results of midden analysis in Australia. *J. Arch. Sci.*, 2, 45–62.
- Balée, W. 2006. The research program of historical ecology. *Ann. Rev. Anthro.*, 35(5), 1–24.
- Biagi, P. and Nisbet, R. 2006. The prehistoric fisher-gatherers of the western coast of the Arabian Sea: A case of seasonal sedentarization? *World Arch.*, 38, 220–38.
- Bird, D.W., Richardson, J.L., Veth, P.M., and Barham, A.J. 2002. Explaining shellfish variability in middens on the Meriam Islands, Torres Strait, Australia. *J. Arch. Sci.*, 29, 457–69.
- Brooks, M.J., Stone, P.A., Colquhoun, D.J., and Brown, J.G. 1989. Sea-level change, estuarine development and temporal variability in woodland period subsistence-settlement patterning on the lower coastal plain of South Carolina. In *Studies in South Carolina Archaeology: Essays In Honor of Robert L. Stephenson*, Goodyear, A.C. and Hanson, G.T., Eds. Anthropological Studies #9, Columbia, South Carolina: Occasional papers of the South Carolina Institute of Archaeology and Anthropology, pp. 91–100.
- Brown, J.H., Gillooly, J.F., Allen, A.P., Savage, V.M., and West, G.B. 2004. Towards a metabolic theory of ecology. *Ecology*, 85, 1771–85.
- Cannon, A. 2000. Settlement and sea-levels on the central coast of British Columbia: Evidence from shell midden cores. *Am. Antiq.*, 65(1), 67–77.
- Carbotte, S.M., Bell, R.E., Ryan, W.B.F., McHugh, C., Slagle, A., Nitsche, F., and Rubenstone, J. 2004. Environmental change and oyster colonization within the Hudson River estuary linked to Holocene climate. *Geo-Mar. Lett.*, 24, 212–24.
- Catterall, C.P. and Poiner, I.R. 1987. The potential impact of human gathering on shellfish populations, with reference to some NE Australian intertidal flats. *Oikos*, 50, 114–22.
- Ceci, L. 1984. Shell midden deposits as coastal resources. *World Arch.*, 16, 62–74.
- Claassen C. 1998. *Shells*. Cambridge, UK: Cambridge University Press, 266 pp.
- Crook, M.R. 1992. Oyster sources and their prehistoric use on the Georgia coast. *J. Arch. Sci.*, 19, 396–483.

- Crook, M.R. 2007. Prehistoric pile dwellers within an emergent ecosystem: An archaeological case of hunters and gatherers at the mouth of the Savannah River during the mid-Holocene. *Human Ecol.*, 33, 223–37.
- Dame, R.F. 1972. Comparison of various allometric relationships in intertidal and subtidal American oysters. *Fish. Bull.*, 70, 1121–26.
- Dame, R.F. 1976. Energy flow in an intertidal oyster population. *Estuaries Coast. Mar. Sci.*, 4, 243–53.
- Dame, R.F. 1979. The abundance, diversity and biomass of macro-benthos on North Inlet, South Carolina, intertidal oyster reefs. *Proc. Nat. Shellfish. Assoc.*, 69, 6–10.
- Dame, R.F. 1996. *The Ecology of Marine Bivalves: An Ecosystems Approach*. Boca Raton, FL: CRC Press, 254 pp.
- Dame, R.F. 2005. Oyster reefs as complex systems. In *The Comparative Roles of Suspension-Feeders in Ecosystems*, Dame, R.F. and Olenin, S., Eds. Dordrecht: Kluwer Academic, 331–53.
- Dame, R.F. 2009. Shifting through time: Oysters and shell rings in past and present southeastern estuaries. *J. Shellfish Res.*, 28(3), 425–30.
- Dame, R.F., et. al. 2000. Estuaries of the South Atlantic coast of North America: Their geographical signatures. *Estuaries*, 23, 793–819.
- de Boer, W.F., Pereira, T., and Guissamulo, A. 2000. Comparing recent and abandoned shell middens to detect the impact of human exploitation on the intertidal ecosystem. *Aquat. Ecol.*, 34, 287–97.
- DePratter, C.B. and Howard, J.D. 1981. Evidence for a sea level low stand between 4500 and 2400 B.P. on the southeast coast of the United States. *J. Sed. Petrol.*, 51, 1287–95.
- Dupont, C., Tresset, A., Desse-Berset, N., Gruet, Y., Marchand, G., and Schulting, R. 2009. Harvesting the seashores in the late Mesolithic of Northwestern Europe: A view from Brittany. *J. World Prehist.*, 22, 93–211.
- Erlanson, J.M., Moss, M.L., and Lauriers, M.D. 2008. Life on the edge: Early maritime cultures of the Pacific coast of North America. *Quart. Sci. Rev.*, 27, 2232–45.
- Fairbridge, R.W. 1976. Shellfish-eating pre-ceramic Indians in coastal Brazil. *Science*, 191, 353–59.
- Frey, D.G. 1946. Oyster bars of the Potomac River. *U.S. Fish Wildlife Service Special Scientific Report*, 32, 1–93.
- Gerritsen, J., Holland, A.F., and Irvine, D.E. 1994. Suspension-feeding bivalves and the fate of primary production: An estuarine model applied to Chesapeake Bay. *Estuaries*, 17, 403–16.
- Glassow, M.A. and Wilcoxon, L.R. 1988. Coastal adaptations near Point Conception, California, with particular regard to shellfish exploitation. *Am. Antiq.*, 53, 36–51.
- Harding, J.M., Mann, R., and Southworth, M.J. 2008. Shell length at-age relationships in James River, Virginia oysters (*Crassostrea virginica*) collected four centuries apart. *J. Shellfish Res.*, 27, 1109–15.
- Jackson, J.B.C., et al. 2001. Historical overfishing and the recent collapse of coastal ecosystems. *Science*, 293, 629–38.
- Jerardino, A. 1995. The problem with density values in archaeological analysis: A case study from Tortoise cave, Western Cape, South Africa. *S. Af. Arch. Bull.*, 50, 21–27.
- Kidder, T.R. 2006. Climate change and the Archaic to Woodland transition (3000–2500 cal B.P.) in the Mississippi River Basin. *Am. Antiq.*, 71, 195–231.
- Larsen, P.F. 1985. The benthic macrofauna associated with the oyster reefs of the James River estuary, Virginia, USA. *Int. Rev. Gesamt. Hydrobiol.*, 70, 797–814.
- Lasiak, T.A. and Field, J.G. 1995. Community-level attributes of exploited and non-exploited rocky intertidal macrofaunal assemblages in Transkei. *J. Exp. Mar. Biol. Ecol.*, 185, 33–53.

- Lehman, M.E. 1974. Oyster reefs at Crystal River, Florida and their adaptation to thermal plumes, PhD dissertation, University of Florida, 197 pp.
- Lightfoot, K.G. and Cerrato, R.M. 1988. Prehistoric shellfish exploitation in coastal New York. *J. Field Arch.*, 15,141–49.
- Lumley, H., 1972. A paleolithic camp at Nice. In *Old World Archaeology*, Lamberg-Karlovsky, C., Ed. San Francisco: W.H. Freeman, pp. 33–41.
- Lunz, G.R. 1938. Comparison between pre-colonial and present-day oysters. *Science*, 87, 367.
- Mann, R. and Powell, E.N. 2007. Why oyster restoration goals in the Chesapeake Bay are not and probably cannot be achieved. *J. Shellfish Res.*, 26, 905–17.
- Mannino, M.A. and Thomas, K.D. 2002. Depletion of a resource? The impact of prehistoric human foraging on the intertidal molluscs communities and its significance for human settlement, mobility and dispersal. *World Arch.*, 33(3), 452–74.
- Maurer, D. and Watling, L. 1973. Studies on the oyster community of Delaware: The effects of the estuarine environment on the associated fauna. *Int. Rev. Ges. Hydrobiol.*, 58, 161–201.
- Mayewski, P.A., et al. 2004. Holocene climate variability. *Quat. Res.*, 62, 243–55.
- Newell, R. 1988. Ecological changes in Chesapeake Bay: Are they the result of overharvesting the American oyster, *Crassostrea virginica*? In *Understanding the Estuary: Advances in Chesapeake Bay Research*, Lynch M.P. and Krome, E.C., Eds. Solomon's, MD: Chesapeake Bay Research Consortium, pp. 536–46.
- Overpeck, J. and Webb, R. 2000. Non-glacial rapid climate events: Past and future. *Proc. Nat. Acad. Sci.*, 97, 1334–38.
- Pearse, A.S. and Wharton, G.W. 1938. The oyster leech, *Stylochus inimicus*, associated with oysters on the coasts of Florida. *Ecol. Monogr.*, 8, 605–55.
- Poirier, C., Sauriau, P-G., Chaumillon, E., and Allard, J. 2009. Can molluscan assemblages give insights into Holocene environmental changes other than sea level rise? A case study from a macro-tidal bay (Marennes-Oleron, France). *Palaeogeogra. Palaeoclim. Palaeoecol.*, 280, 105–18.
- Powell, E.N. and Klinck, J.M. 2007. Is oyster shell a sustainable estuarine resource? *J. Shellfish Res.*, 26, 181–94.
- Reitz, E.J. and Wing, E.S. 2008. *Zooarchaeology*, 2nd ed. Cambridge: Cambridge University Press, 533 pp.
- Russo, M. 2002. Faunal analysis at Fig Island. In *The Fig Island Ring Complex: Coastal Adaptation and the Question of Ring Function in the Late Archaic*, Saunders, R., Ed. Report to the South Carolina Department of Archives and History, Columbia, SC, 141–53.
- Russo, M. 2006. *Archaic Shell Rings of the Southeast U.S.: National Historic Landmarks*. Southeastern Archeological Center, Tallahassee, FL: National Park Service.
- Russo, M. and Heide, G. 2001. Shell rings of the southeast. *Antiquity*, 75, 491–92.
- Russo, M. and Heide, G. 2003. Mapping the Sewee shell ring. Report submitted to Francis Marion and Sumter National Forest, USFS.
- Sanger, D. and Sanger, M.J. 1986. Boom or bust on the river: The story of the Damariscotta oyster shell heaps. *Arch. East. North Am.*, 14, 65–78.
- Sassaman, K.E. 2004. Complex-hunter-gatherers in evolution and history: A North American perspective. *J. Arch. Res.*, 12, 227–75.
- Saunders, R., ed. 2002. *The Fig Island Ring Complex: Coastal Adaptation and the Question of Ring Function in the Late Archaic*. Report to the South Carolina Department of Archives and History, Columbia, SC.
- Scott, D.B., Gayes, P.T., and Collins, E.S. 1995. Mid-Holocene precedent for a future rise in sea-level along the Atlantic coast of North America. *J. Coast. Res.*, 11, 615–622.

- Somadeva, R. and Ranasinghe, S. 2006. An excavation of a shell-midden in southern littoral area of Sri Lanka: Some evidence of prehistoric Chenier occupation in the 4th millennium C. *Ancient Asia*, 1, 1–10.
- Stanley, S.M. 2000. The past climate change heats up. *Pro. Nat. Acad. Sci.*, 97, 1319.
- Stephens, M., Matthey, D., Gilbertson, D.D., and Colin, V. M-W. 2008. Shell-gathering from mangroves and the seasonality of the Southeast Asian monsoon using high resolution stable isotopic analysis of the tropical estuarine bivalve (*Geloina erosa*) from the Great Cave of Niah, Sarawak: Methods and reconnaissance of molluscs of early Holocene and modern times. *J. Arch. Sci.*, 35, 2686–97.
- Treganza, A.E. and Cook, S.F. 1948. The quantitative investigation of Aboriginal sites: With physical and archaeological analysis of a single mound. *Am. Antiq.*, 13, 287–97.
- van der Schriek, T., Passmore, D.G., Stevensen, A.C., and Rolao, J. 2007. The palaeogeography of Mesolithic settlement-subsistence and shell midden formation in the Muge valley, lower Tagus Basin, Portugal. *The Holocene*, 17, 369–85.
- Volman, T. 1978. Early archaeological evidence for shellfish collecting. *Science*, 201, 911–13.
- Wells, H.W. 1961. The fauna of oyster beds, with special reference to the salinity factor. *Ecol Monogr.*, 31, 239–66.
- Wood, R. 2000. *Reef Evolution*. Oxford: Oxford University Press, 414 pp.

3 Physical Environmental Interactions

INTRODUCTION

From an ecosystem perspective, the biotic and abiotic components of a given environment are intimately bound together to control and generate the ecological system. In many instances, there is a two-way interaction: The physical environment may control living components, and the biotic environment may control abiotic components.

The existence of an organism in a given environment implies that the organism has succeeded or survived in the presence of all the abiotic and biotic influences that impinge upon it. Any condition or factor that approaches or exceeds the organism's tolerance for that factor is defined as a limiting factor or condition (Odum 1983). Studies on the lower limits of an organism's existence to physical factors were initiated by Liebig (1847) and later formalized into Liebig's "law of the minimum." From Liebig's studies, it was found that the law was strictly applicable only to systems in steady-state, i.e., systems where inflow balances outflow of energy and materials.

In addition, Liebig found that factors or conditions can influence each other, and care must be taken to recognize these potential interactions.

Organisms have a life zone, often called the "biokinetic zone" (Vernberg and Vernberg 1972), where there are both lower (minima) and upper limits for a given factor. This concept was first developed by Shelford (1913) and is generally termed Shelford's "law of tolerance."

Organisms with broad ranges of tolerance to a given condition are termed "eury-" while those with narrow biokinetic zones are called "steno-" (Figure 3.1).

IMPORTANT TERMS AND CONCEPTS

Acidification: The process of decreasing the sea's pH due to CO₂ uptake from the atmosphere.

Biokinetic zone: The life zone where there are both upper and lower limits for a given factor.

Euryhaline: A habitat with a great variation in salt concentration.

Laminar flow: A state where the flow particles move orderly in layers.

Poikilotherm: An animal whose body temperature conforms to the environment.

Reynolds number: A dimensionless number that describes the relative magnitude of inertia and viscous forces in a moving fluid.

Turbulent flow: Fluid flow where the flow particles are irregular or not aligned and characterized by high Reynolds numbers.

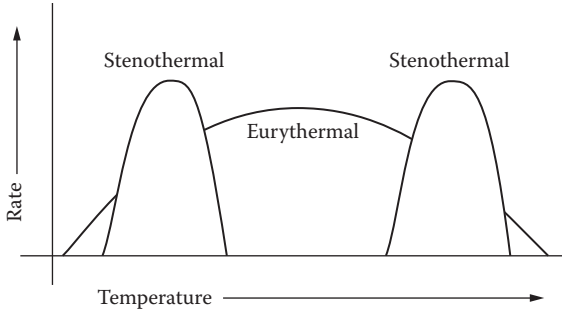

FIGURE 3.1 The generalized influence of temperature on rate processes in stenothermal and eurythermal bivalves. (Adapted from Shelford, V. 1913. *Animal Communities in Temperate America*. Chicago: University of Chicago Press.)

In the remainder of this chapter, the major abiotic environmental factors that influence bivalve molluscs are reviewed. The focus is on the so-called “operationally significant” factors that play a major role on bivalves during their life cycles.

TEMPERATURE

Temperature is a measure of the degree of random motion or kinetic energy in molecules of matter. Temperature not only limits the spatial distribution of bivalves, but also is a major controlling factor in many physiological rate processes, e.g., feeding and growth, that play important roles in many ecosystem level processes. Because bivalve molluscs produce only small amounts of heat during metabolism, they are termed “poikilotherms” or animals whose body temperature conforms to that of the environment. While the majority of marine bivalves live within a temperature range from near -3°C to $+44^{\circ}\text{C}$ (Vernberg and Vernberg 1972), there are creatures that live at the extremes. For example, intertidal oysters like *Crassostrea* may attain body temperatures of 49°C in warm subtropical and tropical climates (Galtsoff 1964). Moreover, *Mytilus* in Canada have been shown to survive temperatures as low as -16°C (Bourget 1983). In addition, coastal and estuarine bivalves tend to be eurythermal, while oceanic forms are typically stenothermal in tolerance (Figure 3.1).

Incident light input per unit area of surface decreases from the equator to the poles due to the curvature of the Earth. This decrease in input energy results in a latitudinal temperature gradient of decreasing temperature with increasing latitude. The gradient in temperature may result in broad geographical zonation of bivalve species. For example, along the Atlantic coast of North America *Mytilus edulis* is common to Cape Hatteras at the southern limit of Virginia and absent south of that location. It is generally believed that the warm water, northward-moving currents (the Gulf Stream), so typical of the western boundaries of oceans, provide a temperature barrier to the distribution and survival of *Mytilus* larvae southward. In contrast, *C. virginica* is a more eurythermal species and is found over a broader latitudinal range both north and south of Cape Hatteras. It is important to note that it is the tolerance of the mobile larval stage or reproductive period that is most sensitive to temperature.

In addition to geographical distribution, physiological rates may vary over a latitudinal gradient. Butler (1953) has shown that for *C. virginica* growth rate of soft body is greatest near the central portion of this species' north–south range, or about the location of Chesapeake Bay (Figure 3.2). North and south of that point growth rate declines. Along the coast of the Gulf of Mexico, Butler speculates that the oysters are near the limit of their geographical distribution. Excluding nongrowth months, Butler's observations suggest that oysters from the warmest areas produce the least amount of biomass per unit time, and all other regions are considered intermediate in growth rate. His data appear to fit the general form of the curve in Figure 3.2.

Butler's findings imply a more general application of perturbation theory and the subsidy–stress gradient approach (Odum et al. 1979). In this application, the input perturbation, temperature, is an energy source and a convex performance curve may simulate the system response (Figure 3.3). For the oyster case, as temperature increases growth rate may increase and then gradually decrease. In addition, the relative variability of observed growth rate will increase as temperature increases. If the perturbation is destructive, as high temperatures are, then performance may be reduced to the point where the species and the community are replaced with more tolerant forms.

In addition to latitudinal temperature gradients, subtropical, temperate, boreal, and arctic coastal water habitats experience seasonal cycles in temperature. Seasonality is caused by the inclination of the Earth as it spins on its axis in relation to the sun. For bivalves, seasonality reaches its greatest extent in temperate and boreal shallow tidal waters where land–sea interactions have their greatest influence on temperature.

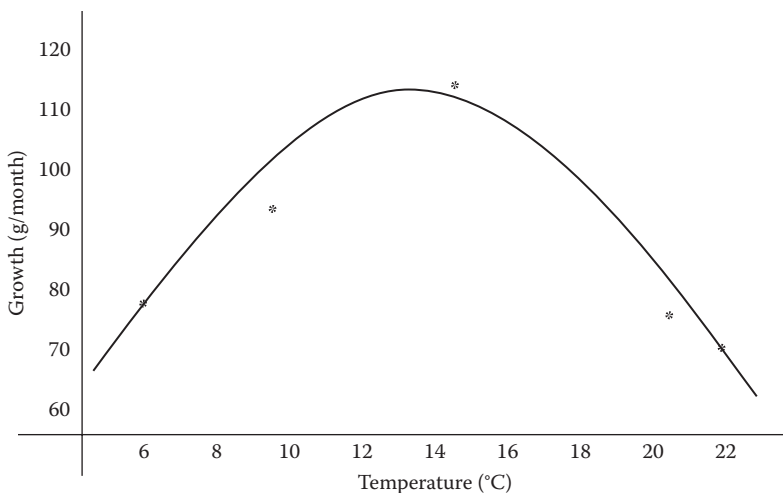

FIGURE 3.2 The influence of environmental temperature on the growth rate of *Crassostrea virginica* along a latitudinal gradient. (Adapted from Butler, P.A. 1953. Oyster growth as affected by latitudinal temperature gradients. *Commer. Fish. Rev.*, 15, 7–12, modified from Dame, R.F. 1996. *Ecology of Marine Bivalves: An Ecosystem Approach*. Boca Raton, FL: CRC Press.).

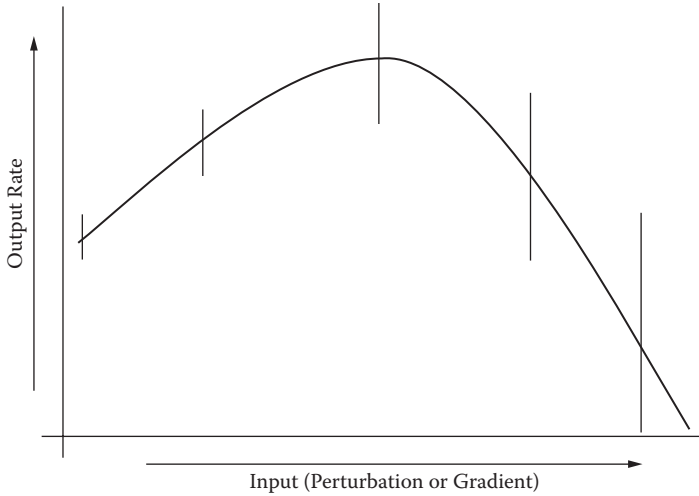

FIGURE 3.3 The general form of the subsidy–stress gradient approach and its similarity to oyster growth across a latitudinal gradient. (Modified from Odum, E.P., Finn, J.T., and Franz, E.H. 1979. Perturbation theory and the subsidy-stress gradient. *Bioscience*, 29, 349–52.)

Because organisms experience quite different temperature regimes depending on the time of year, they are essentially thermally acclimated to the different conditions in different seasons. Thermal acclimation is defined (Crisp and Ritz 1967) as any nongenetic adjustment by an organism in direct response to a change in a single factor in the environment. Many physiological rates, i.e., growth, respiration, feeding, excretion, and so forth, respond to thermal acclimation. In the case of intertidal oysters (Dame 1972), *C. virginica*, respiration is significantly different at different acclimation temperatures (Figure 3.4). Thus an organism can be seasonally acclimated to a temperature regime and be exposed to a variety of temperatures during a tidal or daily cycle. Physiological ecologists have approached this situation by acclimating organisms to a series of temperatures and then observing physiological rates over a range of temperatures for a given acclimation temperature. Initially, only a single environmental factor and a specific physiological rate were observed, but now balanced energy budgets are developed for a target species (Kuenzler 1961; Dame 1972) and integrated into population level estimates.

Decadal scale oscillations in the Earth's climate lead to fluctuations in the temperature regimes of many marine and estuarine ecosystems. These variations in many marine ecosystems include the following factors: changes in the timing of reproduction, reproductive success, recruitment, growth, mortality and geographic distribution. Ectothermic animals are adapted to and depend upon the maintenance of the characteristic temperature or thermal window of their natural environment (Pörtner 2002). Thus thermal tolerance windows differ between species depending on the range of environmental temperature. An overview of thermal tolerance ranges of tropical, temperate, and polar bivalves, compiled by Peck and Conway (2000),

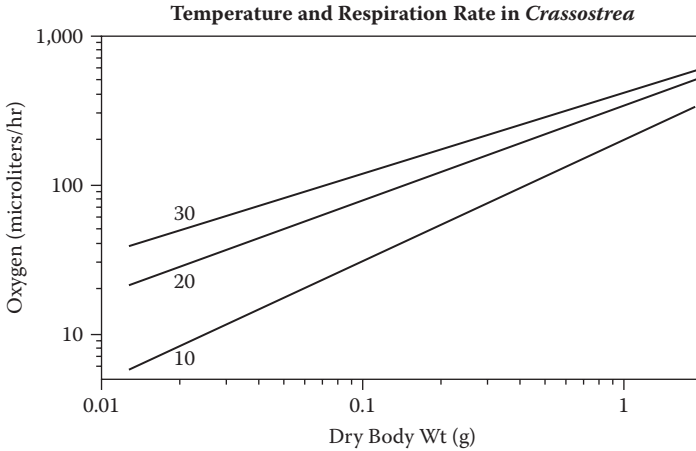

FIGURE 3.4 The influence of temperature on the respiration rates of intertidal American oysters, *Crassostrea virginica*. (Adapted from Dame, R.F. 1972. The ecological energies of growth, respiration and assimilation in the intertidal American oyster, *Crassostrea virginica*. *Mar. Biol.*, 17, 243–50.)

suggests that tolerance windows are wider in the tropical and temperate species than in polar bivalves (Figure 3.5).

This figure indicates that adaptation to temperatures below about 8°C leads to a narrowing of the tolerance window and strongly suggests that life in the cold is a severe challenge to the organism. The organism is forced to specialize in living at low temperatures. Eurytherms, however, tolerate wider temperature fluctuations and in the temperate zone are able to shift tolerance windows between summer and winter temperature regimes (Pörtner 2002). These tolerance data generally support the climate variability hypothesis that in variable temperate climates poikilothermic animals have wide thermal tolerance windows as compared to tropical climates where they have small thermal tolerance windows (Stevens 1989). Recently, this hypothesis gained additional support from a study that estimated the thermal tolerance windows with the lethal thermal limits of tropical and temperate bivalves (Compton et al. 2007).

The combined effects of complex environmental variables on the integrated physiological response of the organism as a whole continues to develop. This multidimensional approach, often called “response-surface analysis” (Alderdice 1972), has been applied to a number of bivalves including *Mytilus* (Widdows 1978; Bayne and Scullard 1978) and *Ostrea* (Buxton et al. 1981). In the case of *Ostrea* (Buxton et al. 1981), multiple linear regression analysis was used to obtain polynomial expressions for assimilated ration as a function of acclimation temperature and exposure temperature as well as respiration of the general form (Equation 3.1),

$$Y = a + bX_1 + b_2X_2 \quad (3.1)$$

and these relationships generated a three-dimensional response surface.

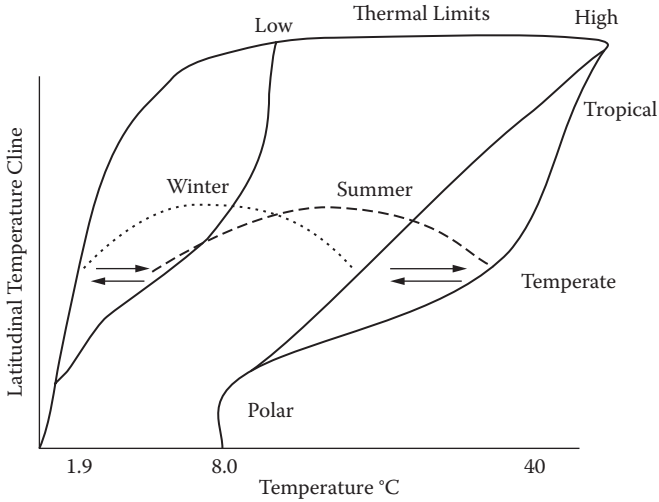

FIGURE 3.5 A conceptual model of the thermal tolerance ranges of tropical, temperate, and polar bivalves. (Modified from Peck, L.S. and Conway, L.Z. 2000. The myth of metabolic cold adaptation: Oxygen consumption in stenothermal Antarctic bivalves. In *Evolutionary Biology of the Bivalvia, Special Publication 177*, Taylor, H.E. and Crame, J.A., Eds. Geological Society: London, pp. 441–50.)

As discussed in the case study on shell rings (Chapter 2), global climate change (GCC) is one of the most pressing environmental issues facing our species and, more often than not, GCC is expressed as a change in temperature. GCC is usually defined as the statistical distribution of weather ranging from decades to millions of years (Taylor 1999). The root cause of GCC can be anthropomorphic like influencing a change in the concentrations of greenhouse gasses, or a natural physical event like a meteor colliding with the Earth or cycling of solar input energy. The time scales for these environmental changes can vary from decades to millions of years.

The shells of bivalves can play an important part in the determination and interpretation of past environments. The environmental information is stored when calcium carbonate crystals are formed in the construction of the bivalve shell.

In summary, temperature is a major physical factor that limits the physical extent of bivalves both latitudinally and vertically. This abiotic parameter also influences ecosystems by controlling the rates of functional processes, such as survival, growth, feeding, and excretion. As temperature is seasonal in all but equatorial and deep sea habitats, this factor induces a considerable amount of temporal variation on bivalves and their ecosystems.

SALINITY

While temperature is generally recognized as the principal factor at large biogeographic scales, salinity is an important determining factor in the distribution of coastal and estuarine bivalves and is influential on many physiological rates. Salinity

may affect the structural and functional properties of animals through changes in (1) total osmotic concentration; (2) relative proportions of solutes; (3) coefficients of adsorption and saturation of dissolved gases; and (4) density and viscosity (Kinne 1964). Although salt concentrations or salinities are fairly constant in the oceans at about 35‰, in coastal and estuarine regions salinity varies along a gradient from freshwater in landward areas to full marine salinity. Depending on the geographical location, salinity may vary seasonally due to seasonal river input and freshwater runoff and precipitation. Bivalve molluscs are found at all salinities including freshwater and hypersaline areas typical of tropical zones.

Because estuarine and coastal species are not uniformly distributed across these salinity gradients, numerous schemes have been developed to describe the observed distributions (Bulger et al. 1993). The Remane and Schlieper (1971) scheme has been criticized because its database came from the Baltic Sea and probably incorporates a temperature gradient as well as a salinity gradient. However, the latter scheme was documented by Khlebovich (1969) to describe the principle of critical salinity. This principle states that there is a salinity barrier between 5‰ and 8‰. Poikiloosmotic organisms can survive above this barrier, but hyperosmotic regulation is required below the barrier. Thus this scheme is physiologically based.

The most well-known scheme is the Venice system (Anonymous 1959). The Venice system was constructed from the experiences of the scientists of the day and has no reported objective criteria. The Bulger scheme supports the Venice system, but is based on field data and principal component analysis. The Bulger scheme divides the salinity gradient into the following overlapping zones: 0–4, 2–14, 11–18, 16–27, and 24–marine ‰.

At the system or community level, Wells' (1961) study of the fauna of oyster beds along a salinity gradient clearly demonstrates the influences of salt concentrations. Utilizing a series of nine stations along a 10-mile stretch of the Newport River estuary in North Carolina, Wells found a consistent decline in animal species in the oyster beds from more than 60 species at the most saline station to less than 10 species at the most upstream site with salinities less than 10‰. Wells supported his field observations with a laboratory examination of low salinity tolerance by the 20 most common animal species found on these beds, including the bivalves *Crassostrea*, *Mercenaria*, *Geukensia*, *Brachidontes*, and *Chione*. A comparison of salinity death points and distribution along the salinity gradient resulted in a more or less similar ranking for the bivalves and all but two of the other animals. From these results, Wells concluded that a great majority of the species on the oyster bed are limited in their upstream distribution or penetration by salinity.

Salinity also influences many of the major rate processes in bivalves, although laboratory and field studies do not always appear to agree (Bayne et al. 1976). Typically, the respiration rates of euryhaline bivalves are similar when measured at their field-ambient salinities (Remane and Schlieper 1971), but major differences occur when there is an acclimation period. Some of this discrepancy may be due to the necessity for a much longer acclimation period for salinity as opposed to the normal 2-week period for temperature acclimation (Bayne et al. 1976). Changes in environmental salinity may disrupt the steady-state balance between the input and

output of cellular water and salts (Hawkins and Bayne 1992). Most bivalves respond immediately to changes in their environment by closing their shells and isolating themselves from the external salinity environment. This isolation helps to reduce the rate of associated changes in cell volume and allows isoosmotic intracellular regulation to commence (Hawkins and Bayne 1992). Thus following a sudden change in salinity, physiological rates of feeding and respiration are depressed, but gradually the animal regains normal function.

As with temperature, salinity can vary along a spatial gradient, particularly in coastal regions. Temporal variation may also occur due to precipitation and land water runoff, but these variations are not as obvious as those noted for temperature. Like temperature, salinity limits the distribution of bivalves and can control the basic physiological rates that translate to functional processes in ecosystems.

TEMPERATURE–SALINITY AND OTHER FACTOR COMBINATIONS

From the preceding discussion, it is evident that temperature and salinity are significant abiotic factors that have major influences on biological processes. These two factors are often correlated in various ways. Temperature can modify the effects of salinity and enlarge, narrow, or shift the salinity range of an individual, and vice versa (Kinne 1964).

The larvae and adults of bivalves are two distinct morphological and physiological organisms that occupy very different ecological environments (Lough 1974). Because of their coastal and estuarine water column environment, the larvae of most coastal bivalves experience great variations in temperature and salinity during their life stage. Using the response surface approach of Alderdice (1972), Lough (1974) compared the survival and growth of the early and late stage larvae of *C. virginica*, *M. mercenaria*, and *Mulinia lateralis* to the combined influences of temperature and salinity. Although the three species are euryhaline as adults, their larvae have a comparatively narrow salinity range. The observed progressive change in temperature–salinity tolerance with age or time approaches the range tolerated by the adults. Maximum predicted growth occurred at higher temperatures and somewhat higher salinities than those for maximum survival in all three species. Late larval survival and growth appear to be maximized to take advantage of the complex environment the larvae experience on approaching settlement. As bivalves move from one ecosystem to another during their larval stage, it is important that those interested in the whole system be aware of this spatial transition and the role continuously varying abiotic factors may play.

The adult stage of most euryhaline bivalves is usually sessile or semisessile, and the animals must experience many potentially lethal or deleterious abiotic environmental stresses. Not only do temperature and salinity vary, but oxygen and other related chemical parameters may also impact on bivalve survival and physiological rates. For example, Shumway and Koehn (1982) show the effect of declining oxygen tension on the respiration of *C. virginica* adults at different temperatures and salinities, also using the response surface technique. Regulation of respiration in declining oxygen tension decreases with decreasing salinity and increasing temperature. Maximum respiration occurs at moderate salinity and 30°C at all oxygen tensions. In

the case of *C. virginica*, this bivalve appears to have a rather “elastic” or “euryplastic” (Alderdice 1972) physiological ecology that allows it to utilize available oxygen over a broad range of temperature–salinity–oxygen combinations without falling into anaerobiosis. In other words, these oysters are well adapted to life in their constantly varying environment.

The interaction of the two factors, temperature and salinity, with various bivalve processes can often describe the potential habitat of a given animal. It is also clear that because of the great differences in the benthic vs. the water column the adult bivalve responses to the physical parameters of temperature and salinity are different from those of the larvae of the same species. These life history differences allow bivalves to exploit and exist in different ecosystems and thus increase their chance of survival and influence.

ACIDIFICATION

Human activities are responsible for increasing the atmospheric concentration of carbon dioxide 30%–40% in the last 200 years. This increase of CO₂ along with increases of the other greenhouse gases are thought to be the main cause of the current episode of global climate change or global warming. The “evil twin” of global warming is ocean acidification (Pelejero et al. 2010).

It is understood that about one-third of the anthropogenic carbon dioxide was absorbed by the oceans and coastal waters, and it is also thought that this carbon dioxide has reduced the pH of the world oceans by 1–2 tenths of pH units. The additional carbon dioxide has also significantly disrupted the carbonate buffer system in the seas (Orr et al. 2005; Miller et al. 2009). There is widespread concern that if these additions continue key marine organisms—such as bivalves and corals—will not be able to maintain their calcium carbonate skeletons (Orr et al. 2005; Berge et al. 2006). In fact, one of the first global estimates of oyster reef losses to acidification was 85%.

The chemical system that is being destabilized by the addition of atmospheric CO₂ to the oceans is commonly called the calcium carbonate–carbon dioxide buffer system (see Chapter 4). This buffer system normally stabilizes the pH (or acidity) of the world’s oceans. The continued increase of anthropogenic CO₂ in the atmosphere disrupts the following reaction (Orr et al. 2005):



The excess CO₂ in the sea water has now reached the point where there is a measurable rise in pH and a measurable dissolving of calcium carbonate that results in a measurable decrease in the growth of bivalve larvae (Miller et al. 2009) and adults (Berge et al. 2006). The problem is greatest in coastal and estuarine waters.

WATER FLOW

The interaction of moving water with bivalves has only recently been recognized as an important phenomenon. Most water flow is created by currents, usually tidal or

wind driven, but on open shores or in shallow open bays water flow can also be generated by wave action. Suspension-feeding bivalves require sufficient water motion to bring in new supplies of suspended food and take away waste. In contrast, deposit-feeding bivalves require low water flow to allow the accumulation of deposited seston as a food resource. In this view, the flowing water provides an energy subsidy that allows sessile bivalves to utilize a particular habitat far beyond the ability of the adjacent water column to provide food. If suspension-feeding bivalves accumulate in large numbers, the structures created by their beds can greatly alter the flow environment and in turn allow bivalves to play a role in the hydrodynamics and development of certain systems.

Bivalve larvae must deal with the same flow dynamics as adults, but with very different strategies. For the larvae, flowing water delivers them to preferred surfaces, but also dislodges them (see Koehl 2007 for a detailed review).

From an ecological perspective, there are two fundamental flow regimes, laminar and turbulent flow. In laminar flow all the fluid particles move more or less parallel to each other in smooth paths, and this motion is the same at both low and high scale flow. Turbulent flow is very different, with the fluid particles moving in a highly irregular manner even if the fluid as a whole is traveling in a single direction. The transition point between the two flow regimes is often abrupt and is also where biological processes are of major importance (Vogle 1981).

The removal of momentum from a moving fluid by a body, i.e., a bivalve, is known as drag. Because living systems are not uniform objects, drag is difficult to predict for them. As it turns out, the Reynolds number (Re) is a valuable descriptor of not only drag, but also other aspects of fluids interacting with solids. The Re is a scaling parameter that spans the spatial scales of living systems from molecules to ecosystems. Its role is sometimes comparable to that of the surface-to-volume ratio in physiology (Vogel 1981). Early studies showed that increasing fluid speed, increasing the size of the object in the flow, increasing the density of the fluid, and decreasing the viscosity of the fluid could shift a flow from laminar to turbulent. This combination of parameters derives the dimensionless Re

$$Re = IU/\nu \quad (3.3)$$

where I is the size of the object, U is the velocity of the fluid, and ν the kinematic viscosity that is the ratio of the dynamic viscosity and density. The drag coefficient, C_D , describes the behavior of drag and is a function of the Re .

Because most adult bivalves live on the bottom, it is water velocity near the bottom that is usually most ecologically important to these organisms. As water flows over the bottom, it is subject to frictional drag with the bottom that dissipates energy (momentum) in the flow and slows down the current. Therefore at the interface between the current and the bottom, the velocity of the water is zero or near zero. The frictional effects of the bottom are transferred within the flow by molecular and turbulent mixing. Thus there is a velocity gradient from near zero at the bottom to some distance above where the current is not significantly influenced by the bottom. This gradient is called the boundary layer (Figure 3.6). The boundary layer may be either turbulent or laminar. A laminar boundary layer is a region with very little

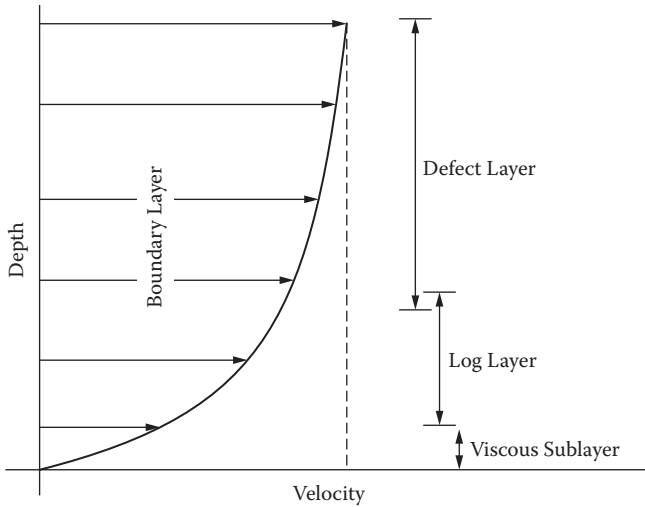

FIGURE 3.6 A generalized diagram showing the influence of depth and water velocity on the different components of the boundary layer. (Adapted from Vogle, S. 1981. *Life in Moving Fluids: The Physical Biology of Flow*. Boston: Willard Grant Press.)

exchange with the surrounding layers of water and often becomes depleted of nutrients and food while accumulating waste materials. Laminar boundary layers are usually found at low water velocities, and turbulent layers are found at higher water velocities. Bottom roughness can enhance turbulent boundary layer formation and thus increase mixing within the current.

Using flumes and acoustic Doppler flow sensors, ecologists have recently begun to catalog the flow patterns of macrobenthic organisms in a manner similar to meteorological wind shadows (Friedrichs and Graf 2009). These patterns are the responses of the water flows to the organisms. In general, the organisms reduce local environmental water flows, and that results in Reynolds number separation of 4000 and 20,000. The benthos benefit from flow modifications with increased food particle, gas exchange, and spawning residence times.

In gradually varying flow regimes typical of uneven bottoms and changing water currents, the boundary layer can be divided into three layers (Frechette et al. 1993). Nearest the bottom is the viscous sublayer (Figure 3.6) where velocity varies linearly with height above the bottom. This layer is continuous and well defined over relatively smooth bottoms, but becomes discontinuous over rougher surfaces like mussel beds and oyster reefs. Under the latter conditions, the flow is said to be rough-turbulent and transport is largely determined by turbulent mixing processes. The next layer is the log layer where velocity varies logarithmically with distance above the bottom. The outermost layer is known as the defect layer and flow behavior here is largely independent of bottom roughness.

Bivalves may respond to flowing water by orienting their shells to reduce drag and thus increase stability and increase the availability of food and removal of waste. There are two ways to describe the interactions of adult bivalves and flowing water:

passive and active. A passive bivalve is unable to move or reposition its body in response, but it can interact with a flow environment by pumping or not pumping water, as well as exhibiting different patterns of shell growth. In sessile bivalves, it is well known that *C. virginica* living in high flow environments have elongated shells while those in low flow conditions have more rounded shells (Kauffman 1971). This observation implies a cause and effect relationship between water flow and structural morphology. The shell surface of many sessile bivalves is often rough with either uniform or nonuniform protuberances. This surface roughness may be an example of the “dimple” or “golf ball” phenomena described by Vogel (1981), where surface roughness induces the stability of an object in a current. From a slightly different perspective, Lawrence (1971) found that individual or isolated *C. virginica* in South Carolina showed little orientation to tidal currents, while densely packed or clustered animals on reefs oriented their planes of commissure parallel to water flow. He also found that fossil beds of *Crassostrea gigantissima* in North Carolina likewise oriented parallel to tidal flow.

An active response describes the ability of a bivalve to reorientate or move its entire body, for example, a mussel. Not only do surface dwelling bivalves orient to the flow, but siphonate infaunal bivalves do also. Vincent et al. (1988) noted that *Mya arenaria* usually orients normal to the axis of tidal flow over the clam flats. This orientation suggests that the preferred alignment minimizes the mixing of exhaled and inhaled water, thus optimizing suspension-feeding and reducing refiltration. From a system perspective, not only do bivalves respond to the boundary layer flow, but they also may also influence the boundary layer by pumping jets and siphon behavior (Monismith et al. 1980). From flume studies, Monismith et al. (1980) showed that a significant portion of excurrent water could be refiltered depending on the boundary layer velocity profile, velocity of the excurrent water and siphon height, orientation, and size. With nonsiphonate epifaunal mussels only, the roughness generated by the shells appeared to influence turbulent mixing, and mussel pumping was not a necessary consideration to explain the observed velocity profiles (Frechette et al. 1993).

In surface-dwelling byssate and nonbyssate mobile bivalves, the animal tends to respond to a current by orienting the inhalant portion into the current and the exhalant area downstream. In addition, shell shape appears to influence the channeling of water across the bivalve from inhalant to exhalant areas. Evidence from flume experiments (Wildish et al. 1984, 1993) has clearly shown that forced orientation of the exhalant area of scallops into the current resulted in reduced growth and food uptake.

Many scallops have developed jet propulsion or swimming as means of predator avoidance. This phenomenon is an adaptation of shell morphology and internal structure into an integrated behavior for survival. In this behavior, the bivalve not only utilizes the current, but because of its shell shape and jet propulsion generates lift and becomes an object moving through a fluid rather than just responding to the moving fluid (for more on this topic, see Wildish and Kristmanson 1993; Dadswell and Weihs 1990; Morton 1980).

At a higher scale of organization, Grave (1905) hypothesized that oyster reefs build out from the shore toward the central channel. Later work by Keck et al. (1973) linked oyster reef development to tidal creek development. These workers found that reefs are often associated with large creek meanders where higher current velocities

on the concave side of the bend result in areas of scour. The sediments of this zone tend to be firm and swept free of soft mud and slime that are unsuitable for spat settlement. The convex side of the meander is an area of lower current velocities and a depositional zone for finer sediments and, thus generally unsuitable for settlement and oyster survival. Once the reef has been established on the concave portion of the meander, the higher water velocities provide more food and carry away feces and pseudofeces. A study by Dame et al. (1987) found that on a South Carolina oyster reef there was sufficient sediment deposition to cause burial within several tidal cycles. However, in this system maximum ebb tide water velocities over the reef were always adequate to resuspend the accumulated materials.

In addition to structural effects, many functional processes are influenced by water movement. One of the most well studied of these relationships is the role of current speed on bivalve growth. In this process, it is assumed that the bivalves, particularly dense populations, reduce the concentration of suspended food in the overlying boundary layer. Initially it was thought that the depletion of food from the boundary layer was a simple function of reduction in current speed (Wildish and Kristmanson 1984), and that this reduction in available food led to reduced growth. Later studies by Frechette et al. (1993) indicated that vertical mixing also plays a role. Depletion of the boundary layer can be alleviated by wave action or currents, but resuspension itself does not appear to positively affect the growth of mussels (Frechette and Grant 1991). Thus it is appropriate that field observations of mussel beds of different sizes show higher mussel growth along the leading edges and reduced growth along the direction of flow and in the central portions of beds (Newell 1990).

Waves are another form of water flow that influences bivalves. On rocky shores, many bivalves attach themselves to the substrate either through cementation or byssal threads. Although bivalves in these environments benefit from the seston produced by the wave-generated turbulent flows, there is some evidence (Harger 1971) that bivalves facing the direct ocean waves are not as large as those protected by boulders. These observations suggest that energy for growth may be diverted into repairing injuries sustained from more powerful waves.

The role of wave energy in enhancing intertidal productivity has been examined along the northeastern Pacific by Leigh et al. (1987). These authors found that on shores with more wave energy productivity was higher. As intertidal organisms cannot transform wave energy into biochemical energy nor harness wave energy, the real question is how does this energy enhance productivity. Apparently, primary production is enhanced through numerous mechanisms: (1) increased primary production results in more food for animals like bivalves; (2) increased turbulence constantly renews the seston in the area of the bivalves, thus providing more food availability; and (3) wave action can protect residents of the intertidal zone by knocking away their enemies or preventing them from feeding.

Bivalves living in current- and wave-dominated environments are the beneficiaries of increased food availability and waste removal, and these are essentially energy subsidies beyond normal solar inputs to ecosystems. Thus in these environments it is very common to find large populations of bivalves that probably play major roles in the functioning of their respective ecosystems.

The farming of bivalve suspension-feeders is or is becoming a major industry, and sophisticated models are being developed and used to help maximize production and sustainability of bivalve resources. These efforts often merge ecology with applied physics or mathematics. This situation is particularly true with water flow and bivalve aquaculture.

For example, Stevens et al. (2008) examine the issues relating to the design and mechanics of long line shellfish structures in relation to the deeper offshore marine environment as compared to shallower nearshore or estuarine or coastal systems (Stevens et al. 2008). The target species is the mussel *Perna canaliculus* and the country is New Zealand. The focus in this study was determining the maximum potential of physical forces on the long line fishing structure and could the structure withstand those forces. The second focus is the reverse perspective or the impact of the cultivated bivalves and the necessary gear of the long line farm on water flow passing through the farmed area. The major source of mechanical forces in the offshore system is waves and these forces are commonly estimated by the Morison Equation (Morison et al. 1950).

From an ecological/ecosystems perspective, waves are the largest source of energy in this type of aquaculture and as much as 75% of that energy is dissipated as the waves and water flow through the farm. The mussels take food and oxygen from the water and release particulate and dissolved waste into currents. I would think that the greatest dangers to the system would be storms (weather) and eutrophication; however, both of these can be planned for the engineering and operation of these systems. Clearly, the involvement of engineers and physical scientists as well as the traditional biologists and ecologists would be a major positive aspect for this type of project.

TIDES

At the land–sea interface, tides have the potential to produce major effects on systems dominated by bivalves. The zone between the high and low tide marks is called the intertidal or littoral zone. Organisms in this zone are subject to exposure as the tide drops and submergence as the tide rises. During exposure, inhabitants are faced with increased temperature variability and increased desiccation. During submergence, temperature extremes are minimized and there is no desiccation, but in open areas wave action can come into play by dislodging individuals or predators.

Although the rise and fall of the tides tracks a smooth curve, zonation in the intertidal region is often attributed to tides. If a series of tidal curves is plotted a series of distinct breaks is evident, and these breaks are thought to be related to the boundaries between zones. From Figure 3.7, showing maximum time of continuous submergence for various tide levels along the California coast, certain points or critical tide levels (Doty 1946) reflect sharp increases in exposure to air. These levels have been invoked to explain intertidal zonation. Support for the critical tide level explanation for zonation has been well-accepted, most likely because of the great variations in topography from place to place in the intertidal zone. Other mainly biological factors certainly play a role in intertidal zonation and these are discussed in Chapter 4.

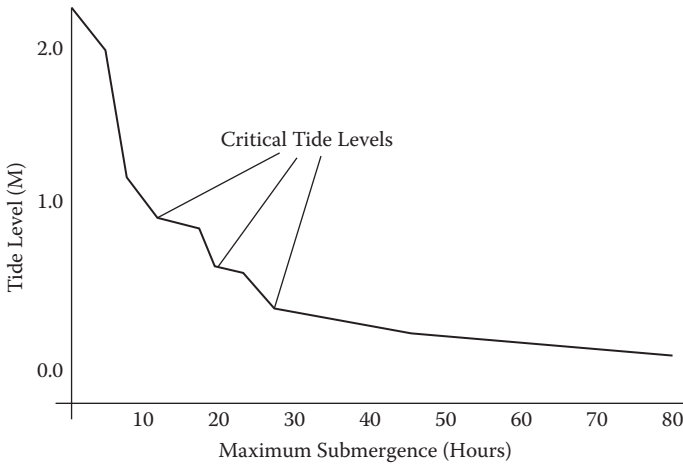

FIGURE 3.7 A diagram of critical tidal exposure levels along the California coast. (Redrawn after Doty, M.S. 1946. Critical tide factors that are correlated with the vertical distribution of marine algae and other organisms along the Pacific coast. *Ecology*, 27, 315–28.)

At an ecosystem scale, tides allow the exchange of water between coastal environments. Thus water molecules within coastal systems are constantly being replaced by other water molecules from either land runoff or the sea.

The time it takes for all the molecules of water in a water mass to be replaced is called the turnover time. The time the average water molecule stays within a system is termed the residence time. Turnover times range from hours to months, depending on tidal fluxes, land water inputs, and volume of the system. Short turnover times in the order of hours are typical of low volume systems or systems that go dry at low tide, while long turnover times are found in large volume seas and bays. The longer the turnover time the more time bivalves have to interact with the water volume. However, the biomass of bivalves now becomes an important factor in determining influence. High bivalve densities can offset the tidal dominance of rapid turnover times and lead to control of material turnover rates by these animals (Dame et al. 1992).

In summary, tides can influence the spatial distribution of bivalves in coastal environments. Tides along with coastal geomorphology can determine the turnover time of coastal water volumes, and bivalve biomass can in some cases override the influence of tides in material transport.

SEDIMENTS

Sediment composition is another physical parameter that seems to play a role in the spatial distribution of bivalves. Particle size, as categorized into sand, silt, and clay, is used to describe sediments. Often zones of low energy or little water flow are dominated by finer sediments while areas of high energy are composed of coarser sediments like sand. Since sediments and water flow are correlated, gradients of sediments are often found, particularly in coastal waters and in the intertidal zone. Generally, deposit-feeding bivalves are prevalent in finer sediments, and

filter-feeding bivalves are common to coarser sediments (Rhoads and Young 1970). Although some of this bivalve spatial variation is due to local hydrodynamics and food availability, some is due to the specific species ability to live on the surface of changing sediments or burrow into the sediments. Because sediments are often in particle size gradients, it is not unexpected to find identifiable zones inhabited by different communities of bivalves in intertidal sands and muds (Peterson 1991).

It has long been known that benthic suspension feeders and deposit feeders exhibit reciprocal spatial distributions. In environments where one type of bivalve is abundant and diverse, the other is reduced. Rhoads and Young (1970) found that deposit feeders, especially bivalves, intensively rework surface sediments and produce the following changes: (1) an uncompacted sediment consisting of fecal pellets and reworked material of semiconsolidated mud; (2) a surface of biogenic sand-size particles of low bulk density; and (3) sediments of high water content. These biological modifications of the sediment affect the physical stability of the bottom by increasing interface roughness and lowering critical erosion velocity. This physical instability of the surface sediments is proposed to be stressful to suspension-feeding benthos (bivalves) by: (1) clogging filtering structures; (2) resuspending and burying newly settled larvae; and (3) discouraging the settlement of suspension-feeding larvae. Unstable sediments also do not provide a suitable substrate for sessile filter-feeding bivalves to attach to. Rhoads and Young (1970) further argue that this explanation is limited to areas of high primary production where food is not limiting to bivalve filter feeders. As noted earlier, Wildish and Kristmanson (1993) have observed that, in detailed velocity profile studies of similar habitats, it is the availability of food for benthic suspension-feeders in the benthic boundary layer that may be limiting their success. The size and composition of the benthic boundary layer are a result of current velocity, bottom composition, and biotic interactions.

REFERENCES

- Alderdice, D.F. 1972. Responses of marine poikilotherms to environmental factors acting in concert. In *Marine Ecology*, Kinne, O., Ed. London: Wiley, pp. 1659–722.
- Anonymous. 1959. Symposium on the classification of brackish waters, Venice, 8–14, 1958. *Arch. Oceanograf. Limnol.*, 11 (Suppl.).
- Bayne, B.L. and Scullard, C. 1978. Rates of oxygen consumption by *Thais (Nucella) lapillus*. *J. Exp. Mar. Biol. Ecol.*, 32, 97–111.
- Bayne, B.L., Thompson, R.J., and Widdows, J. 1976. Physiology I. In *Marine Mussels: Their Ecology and Physiology*, Bayne, B.L. Ed. New York: Cambridge University Press, pp. 121–206.
- Berge, J.A., Bjerkeng, B., Pettersen, O., Schaanning, M.T., and Øxnevad, S. 2006. Effects of increased sea water concentrations of CO₂ on growth of the bivalve *Mytilus edulis* L. *Chemosphere*, 62, 681–87.
- Bourget, E. 1983. Seasonal variations of cold tolerance in intertidal mollusks and their relation to environmental conditions in the St. Lawrence Estuary. *Can. J. Zool.*, 61, 1193–201.
- Bulger, A.J., Hayden, B.P., Monaco, M.E., Nelson, D.M., and McCormick-Ray, M.G. 1993. Biologically-based estuarine salinity zones derived from a multivariate analysis. *Estuaries*, 16, 311–22.
- Butler, P.A. 1953. Oyster growth as affected by latitudinal temperature gradients. *Commer. Fish. Rev.*, 15, 7–12.

- Buxton, C.D., Newell, R.C., and Field, J.G. 1981. Response-surface analysis of the combined effects of exposure and acclimation temperatures on filtration, oxygen consumption and scope for growth in the oyster *Ostrea edulis*. *Mar. Ecol. Prog. Ser.*, 6, 73–82.
- Compton, T.J., Rijkenberg, M.J.A., Drent, J., and Piersma, T. 2007. Thermal tolerance ranges and climate variability: A comparison between bivalves from differing climates. *J. Exp. Mar. Biol. Ecol.*, 352, 200–11.
- Crisp, D.J. and Ritz, D.A. 1967. Temperature acclimation in barnacles. *J. Exp. Mar. Biol. Ecol.*, 1, 236–56.
- Dadswell, M.J. and Weihs, D. 1990. Size related hydrodynamic characteristics of the giant scallop, *Placopecten magellanicus*. *Can. J. Zool.*, 68, 778–85.
- Dame, R.F. 1972. The ecological energies of growth, respiration and assimilation in the intertidal American oyster, *Crassostrea virginica*. *Mar. Biol.*, 17, 243–50.
- Dame, R.F. 1987. The net flux of inorganic matter by an intertidal oyster reef. *Cont. Shelf Res.*, 7, 1421–24.
- Dame, R.F. 1996. *Ecology of Marine Bivalves: An Ecosystem Approach*. Boca Raton, FL: CRC Press.
- Dame, R.F., Spurrier, J.D., and Zingmark, R.G. 1992. In situ metabolism of an oyster reef. *J. Exp. Mar. Biol. Ecol.*, 164, 147–59.
- Doty, M.S. 1946. Critical tide factors that are correlated with the vertical distribution of marine algae and other organisms along the Pacific coast. *Ecology*, 27, 315–28.
- Frechette, M. and Grant, J. 1991. An in situ estimation of the effect of wind-driven resuspension on the growth of the mussel, *Mytilus edulis*. *J. Exp. Mar. Biol. Ecol.*, 148, 201–13.
- Frechette, M., Lefaivre, D., and Butman, C.A. 1993. Bivalve feeding and the benthic boundary layer. In *Bivalve Filter Feeders in Coastal and Estuarine Ecosystem Processes*, Dame, R.F., Ed. Heidelberg: Springer-Verlag, pp. 325–69.
- Friedrich, M. and Graf, G. 2009. Characteristic flow patterns generated by macrozoobenthic structures. *J. Mar. Sys.*, 75, 348–59.
- Galtsoff, P.S. 1964. The American oyster *Crassostrea virginica* (Gmelin). *U.S. Fish Wildlf. Serv. Fish. Bull.*, 64, 1–480.
- Grave, C. 1905. Investigations for the promotion of the oyster industry of North Carolina. *Rep. U.S. Fish Comm.*, 1903, 247–341.
- Harger, J.R.E. 1971. The effect of wave impact on some aspects of the biology of sea mussels. *Veliger*, 12, 401–14.
- Hawkins, A.J.S. and Bayne, B.L. 1992. Physiological interrelations, and the regulation of production. In *The Mussel Mytilus: Ecology, Physiology, Genetics and Culture*, Gosling, E., Ed. Amsterdam: Elsevier, pp. 171–222.
- Kauffman, E.G. 1971. Form, function, and evolution. In *Treatise on Invertebrate Paleontology, Part N, Mollusca 6, Bivalvia*, Moore, R.C., Ed. Lawrence, KS: Geological Society of America, N129–N210.
- Keck, R., Maurer, D., and Watling, L. 1973. Tidal stream development and its effect on the distribution of the American oyster. *Hydrobiology*, 42, 369–79.
- Khlebovich, V.V. 1969. Aspects of animal evolution related to critical salinity and internal state. *Mar. Biol.*, 2, 338–45.
- Kinne, O. 1964. The effects of temperature and salinity on marine and brackish water animals, II. Salinity and temperature salinity combinations. *Annu. Rev. Oceanogr. Mar. Biol.*, 2, 281–339.
- Koehl, M.A.R. 2007. Mini review: Hydrodynamics of settlement into fouling communities. *Biofouling*, 23, 5, 357–68.
- Kuenzler, E.J. 1961. Structure and energy flow of a mussel population in a Georgia salt marsh. *Limnol. Oceanogr.*, 6, 191–204.
- Lawrence, D.R. 1971. Shell orientation in recent and fossil oyster communities from the Carolinas. *J. Paleontol.*, 45, 347–49.

- Leigh, E.G., Paine, R.T., Quinn, J.F., and Suchanek, T.H. 1987. Wave energy and intertidal productivity. *Proc. Natl. Acad. Sci. U.S.A.*, 84, 1314–18.
- Liebig, J. 1847. *Chemistry in Its Applications to Agriculture and Physiology*. London: Taylor and Wilson, 240 pp.
- Lough, R.G. 1974. A reevaluation of the combined effects of temperature and salinity on survival and growth of bivalve larvae using response surface techniques. *Fish. Bull.*, 73, 86–94.
- Miller, A.W., Reynolds, A.C., Sobrino, C., and Riedel. 2009. Shellfish face uncertain future in high CO₂ world: Influence of acidification on oyster larvae calcification and growth in estuaries. *PLoS One*, 4, 5, 1–8.
- Monismith, S.G., Koseff, J.R., Thompson, J.K., O’Riordan, C.A., and Nepf, H.M. 1980. A study of model bivalve siphonal currents. *Limnol. Oceanogr.*, 35, 680–96.
- Morison, J.R., O’Brien, M.P., Johnson, J.W., and Schaaf, S.A. 1950. The forces exerted by surface waves on piles. *Petrol. Transac. AIME*, 189, 149–57.
- Morton, B. 1980. Swimming in *Amusium pleuronectes*. *J. Zool. Lond.*, 190, 375–404.
- Newell, C.R. 1990. The effects of mussel (*Mytilus edulis*) position in seeded bottom patches on growth at subtidal lease sites in Maine. *J. Shellfish Res.*, 9, 113–18.
- Odum, E.P. 1983. *Basic Ecology*. Philadelphia: Saunders, 613 pp.
- Odum, E.P., Finn, J.T., and Franz, E.H. 1979. Perturbation theory and the subsidy-stress gradient. *Bioscience*, 29, 349–52.
- Orr, J.C., Fabry, V.J. Aumont, O., Bopp, L., Doney, S.C., Feely, R.A., Gnanadesikan, A., Gruber, N., Ishida, A., Joos, F., Key, R.M., Lindsay, K., Maier-Reimer, E., Matear, R., Monfray, P., Mouchet, A., Najjar, R.G., Plattner, G-K, Rodgers, K.B., Sabine, C.L., Sarmiento, J.K., Schlitzer, R., Slater, R.D., Totterdell, I.J., Weirig, M-F., and Yamanaka, A. 2005. Anthropogenic ocean acidification over the twenty-first century and its impact on calcifying organisms. *Nature*, 437, 681–86.
- Peck, L.S. and Conway, L.Z. 2000. The myth of metabolic cold adaptation: Oxygen consumption in stenothermal Antarctic bivalves. In *Evolutionary Biology of the Bivalvia, Special Publication 177*, Taylor, H.E. and Crame, J.A., Eds. Geological Society: London, pp. 441–50.
- Pelejero, C., Calvo, E. and Hoegh-Guldberg, O. 2010. Paleo-perspectives on ocean acidification. *Trends in Ecology and Evolution* (in press).
- Peterson, C.H. 1991. Intertidal zonation of marine invertebrates in sand and mud, *Am. Sci.*, 79, 236–49.
- Pörtner, H.O. 2002. Climate variations and the physiological basis of temperature dependent biogeography: Systemic to molecular hierarchy of thermal tolerance in animals. *Comparative Biochemistry and Physiology Part A*, 132, 739–61.
- Remane, A. and Schlieper, C. 1971. *Biology of Brackish Water*. New York: Wiley-Interscience, 372 pp.
- Rhoads, D.C. and Young, D.K. 1970. The influence of deposit-feeding organisms on sediment stability and community trophic structure. *J. Mar. Res.*, 28, 150–78.
- Shelford, V. 1913. *Animal Communities in Temperate America*. Chicago: University of Chicago Press, 368 pp.
- Shumway, S.E. and Koehn, R.K. 1982. Oxygen consumption in the American oyster *Crassostrea virginica*. *Mar. Ecol. Prog. Ser.*, 9, 59–68.
- Stevens, C., Plew, D., Hartstein, N., and Fredriksson, D. 2008. The physics of open water shellfish aquaculture. *Aquacult. Eng.*, 38, 145–60.
- Stevens, G.C. 1989. The latitudinal gradient in geographical range: How so many species coexist in the tropics. *Am. Naturalist.*, 133, 240–56.
- Taylor, K. 1999. Rapid climate change. *Am. Sci.*, 87, 4, 320–27.
- Vernberg, F.J. and Vernberg, W.B. 1972. *Environmental Physiology of Marine Animals*. New York: Springer-Verlag, 346 pp.

- Vincent, B., Desrosiers, G., and Gratton, Y. 1988. Orientation of the infaunal bivalve *Mya arenaria* L. in relation to local current direction on a tidal flat. *J. Exp. Mar. Biol. Ecol.*, 124, 205–14.
- Vogle, S. 1981. *Life in Moving Fluids: The Physical Biology of Flow*. Boston: Willard Grant Press, 352 pp.
- Wells, H.W. 1961. The fauna of oyster beds, with special reference to the salinity factor. *Ecol. Monogr.*, 31, 239–66.
- Widdows, J. 1978. Combined effects of body size, food concentration and season on the physiology of *Mytilus edulis*. *J. Mar. Biol. Assoc. U.K.*, 58, 109–24.
- Wildish, D.J. and Kristmanson, D.D. 1984. Importance to mussels of the benthic boundary layer. *Can. J. Fish. Aquat. Sci.*, 41, 1618–25.
- Wildish, D.J. and Kristmanson, D.D. 1993. Hydrodynamic control of bivalve filter feeders: A conceptual view. In *Bivalve Filter Feeders in Coastal and Estuarine Ecosystem Processes*, Dame, R.F., Ed. Heidelberg: Springer-Verlag, pp. 299–324.

4 Organismic Scale Processes

INTRODUCTION

Organismic rate processes, e.g., feeding, respiration, excretion, and growth, are often fundamental to examining the structural and functional roles of bivalves at the population and ecosystem scales. Traditionally, these organismic rate processes have been summed, equivalent to scaling up, to yield population and ecosystem estimates. Frequently, these processes have been grouped together or integrated into ratios, either indices or budgets, in an effort to provide a deeper understanding of the underlying physiological or ecological processes.

In a more ecological perspective, the energy or material budget so typical of Bayne and Newell (1983), Crisp (1984), and Griffiths and Griffiths (1987) has

been utilized to further understand the various energy and material-processing relationships. As introduced in Chapter 1, classical thermodynamics deals with closed systems at or near thermodynamic equilibrium. The first law of thermodynamics is concerned with energy and is well studied. However, the second law is concerned with entropy and has many research possibilities.

Examples of living systems are individual organisms, populations, ecosystems, and our planet Earth. The energy budget applies the laws of thermodynamics to living systems. These systems are open to the inflow and outflow of energy and matter, which are used to build structures and keep the system far from equilibrium state as well as produce entropy (see Chapter 1). Thus it is assumed that for energy or material,

IMPORTANT TERMS AND DEFINITIONS

Chemoautotrophic: Organisms that derive their primary source of energy from inorganic chemicals.

Clearance rate (CR): The rate that particles are removed from the system.

Energy budget: A method to account for the energy in a system according to the first law of thermodynamics.

Entropy: What remains after energy has done work.

Larviphagy: Bivalve adults feeding on their own larvae.

$$\text{Input} = \text{Output} \quad (4.1)$$

and that these terms can be expanded to

$$C = P + R + F + U \quad (4.2)$$

where C is the energy or material content of the food consumed; P is that quantity produced as tissues or gametes; R is that lost as metabolic heat or gas; F is the quantity lost as feces; and U is the amount lost from excreted urine and mucus. Production can be further divided,

$$P = P_g + P_r \quad (4.3)$$

where P_g is the energy or material concentrated in new tissues and P_r is the energy lost as reproductive material. Assimilation is defined as the amount of energy or material consumed (C) that is utilized by the organism. A can be calculated as

$$A = C - (F + U) = P + R \quad (4.4)$$

The concept of “scope for growth” (SFG) is defined as the difference between the energy of the food the animal consumes (gains) and all the other utilizations and losses (Warren and Davis 1967) and is readily derived from energy or material budgets. Such indirect estimates have been applied to economically important bivalves (Table 4.1) including *Mytilus edulis* (Widdows and Bayne 1971), *Crassostrea virginica* (Dame 1972), and *Ostrea edulis* (Buxton et al. 1981), as well as bivalves common to stressful environments like *Arctica islandica* (Begum et al. 2010). These and other studies on bivalves indicate that the capacity of bivalves to regulate the various components of the energy budget by acclimation may enhance their ability to maintain a positive scope for growth.

Results from such studies also suggest that outside the limits of acclimatory adjustment, energy balance considerations may limit the bivalve’s existence to a particular ecological niche or context (Buxton et al. 1981). Thus the physiological term assimilation (A) is expressed in units of energy per time per mass and in some disciplines denoted by the symbol Φ_m . This term is known to physicists as the power density, to geologists as the specific radiant flux, to biologists as the specific metabolic rate, and to engineers as the power-to-mass ratio. Chaisson (2001) prefers the more informational free energy rate density, and the thermodynamics scientific community uses the term maximum entropy production (Kleidon et al. 2010). The various definitions lend support to the interdisciplinary application of the concept in the natural sciences.

In this chapter, bivalve physiological rate processes are examined and related to various integrative measures, including budgets. This approach will facilitate an understanding of how estimates of ecosystem level rates are achieved through scaling up from organismic rate measurements and how the methods used to make organismic scale rate estimates, particularly clearance rates, developed through time. Finally, I encourage those interested in energy budgets to take a close look at the Begum et al. (2010) paper and see the extension of the standard energy budget to a calcium carbonate budget and a lifetime energy budget.

TABLE 4.1
The Major Components (Rates) for Selected Bivalve Suspension-Feeder Energy Budgets

| Species | Climate | CR (liter h ⁻¹ g ⁻¹) | R (mO ₂ h ⁻¹ g ⁻¹) | EN (ugNH ₃ h ⁻¹ g ⁻¹) | SFG (Joules h ⁻¹ g ⁻¹) | Source |
|----------------------------------|-----------|--|---|--|--|-----------------------------|
| <i>Arca zebra</i> | Tropical | 3.13 | 0.31 | - | 9.81 | Widdows et al. (1990) |
| <i>Hippopus hippopus</i> | Tropical | 0.52 | 0.11 | - | 7.21 | Klump and Griffiths (1994) |
| <i>Perna perna</i> | Tropical | 2.55 | 0.41 | 24.4 | - | Van Erkom Griffiths. (1992) |
| <i>Pinctada marfartitfera</i> | Tropical | 11.5 | 1.04 | 81.4 | 35.8 | Yukihira et al. (1998) |
| <i>Pinctada maxima</i> | Tropical | 11.5 | 0.86 | 72.8 | 39.7 | Yukihira et al. (1998) |
| <i>Tridacna crocea</i> | Tropical | 0.58 | 0.61 | - | 19.4 | Klump and Griffiths (1994) |
| <i>Tridacna gigas</i> | Tropical | 3.68 | 1.06 | - | 45.5 | Klump and Griffiths (1994) |
| <i>Tridacna squamosa</i> | Tropical | 0.32 | 0.48 | - | 11.1 | Klump and Griffiths (1994) |
| <i>Aulacomya ateer</i> | Temperate | 1.39 | 0.21 | - | 7.12 | Griffiths and King (1979) |
| <i>Chlamys opercularis</i> | Temperate | 3.23 | 0.23 | - | - | McLusky (1973) |
| <i>Choromytilus meidionalis</i> | Temperate | 3.49 | 0.58 | 73.1 | - | Van Erkom et al. (1992) |
| <i>Crassostrea gigas</i> | Temperate | 3.65 | 0.54 | - | 38.01 | Barille et al. (1997) |
| <i>Crassostrea virginica</i> | Temperate | 2.55 | 0.24 | 45.1 | - | Hartwell et al. (1991) |
| <i>Mercenaria mercenaria</i> | Temperate | 2.61 | - | 54.1 | - | Coughlan and Ansell (1964) |
| <i>Mytilus californiensis</i> | Temperate | 1.61 | 0.54 | 23.9 | 12.6 | Bayne Griffiths. (1976) |
| <i>Mytilus chilensis</i> | Temperate | 1.55 | 0.34 | 23.3 | 10.1 | Navarro and Winter (1982) |
| <i>Mytilus edulis</i> | Temperate | 2.55 | 0.51 | 11.4 | 62.3 | Bayne et al. (1989) |
| <i>Mytilus galloprovincialis</i> | Temperate | 6.46 | 0.36 | 8.2 | 34.5 | Widdows and Johnson (1988) |
| <i>Rangia cuneata</i> | Temperate | 0.56 | 0.16 | - | - | Hartwell et al. (1991) |
| <i>Saccostrea glomerata</i> | Temperate | 2.30 | 0.75 | 10.0 | 40.1 | Bayne and Svensson (2006) |
| <i>Arctica islandica</i> | Polar | 5.61 | 0.35 | - | - | Begum et al. (2010) |

FEEDING

From an ecosystem perspective, feeding is the input of energy and materials into the bivalve. A number of quite different feeding mechanisms have evolved in the bivalves. Suspension-feeding is one mechanism that allows the bivalve to remove suspended microscopic particulate materials from the water column. Bivalve suspension-feeders pump or process water through a structural internal filter that usually retains particles irrespective of their food quality. Deposit feeding is typical of infaunal bivalves living in soft sediments. In this type of feeding, particles on the surface or within the substrate, i.e., deposits, rather than suspended sediments are collected by the bivalve and utilized as food. More specialized in their feeding mechanisms are boring bivalves and bivalves with symbiotic algae or bacteria in their tissues.

SUSPENSION-FEEDING

As noted earlier, bivalves evolved in shallow coastal seas where there was an abundance of suspended particulate material, usually dominated by phytoplankton. Because most bivalve suspension-feeders are sessile or semisessile as adults, these animals must pump and filter volumes of water considerably greater than that immediately adjacent to their habitat in order to consume sufficient phytoplankton to survive. The pumping and filtering mechanism used by bivalves has been a point of biological interest for a considerable time, and an understanding of the structure and function of this mechanism is crucial to understanding the types of observations made and translated from the organismic level to the ecosystem level.

THE BIVALVE FILTER AND PUMP

The process of bivalve suspension-feeding is the result of the combined action of three types of cilia on the gill filaments (Figure 4.1). I shall discuss one type of cilia. The lateral cilia are the main water movers and beat with a meta-chronal wave that assures a minimum distance between the cilia in order to maintain maximum water movement (Sleigh and Aiello 1972). As the water is moved or pumped through the gills, potential food particles are retained by the latero-frontal cirri in a number of ways. The particles may be sieved, intercepted, and impact with the gill through inertia, motile particle motion, or gravitational deposition. Except for sieving, all of these potential ways of particle interception allow for the trapping of particles smaller than the spaces between the cirri of the filter. In addition, particles are carried along in free suspension or caught up in mucus and transported by the frontal cilia in mucus trains or strings toward the labial palps and mouth (Jørgensen 1990; Ward et al. 1993). At the labial palps, particles are sorted either to be transported to the mouth or rejected as pseudofeces. For an excellent detailed description of the mechanisms and physiology of feeding by larval and adult *Crassostrea virginica* see Newell and Langdon (1996).

Although I have presented the bivalve filter as a more mechanical device, Jørgensen (1990) has argued in a controversial fashion that it is a fluid mechanical filter where the complex patterns of laminar currents at the interfilament canals transfer particles

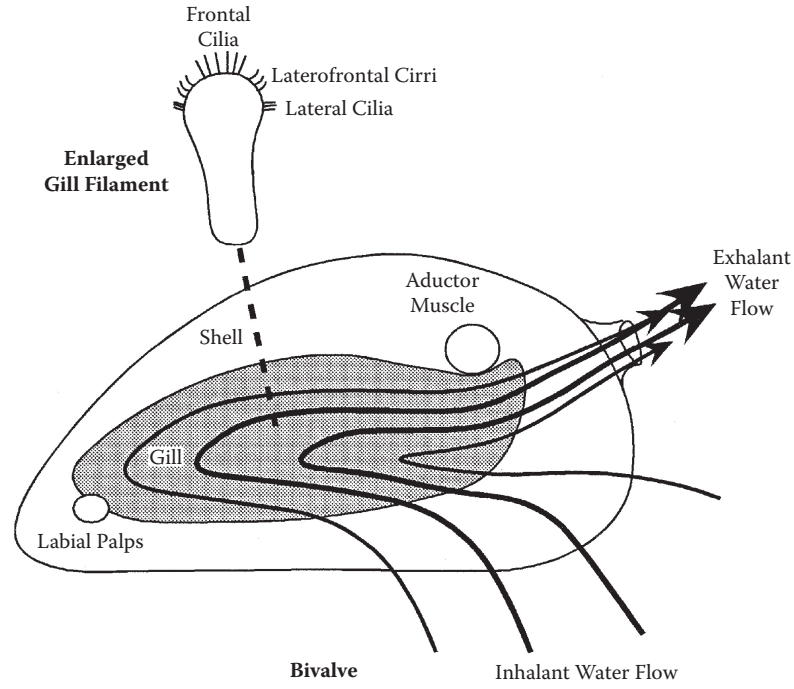

FIGURE 4.1 Water currents passing through the typical bivalve shell cavity, with a cross-sectional view of a gill filament showing the different types of cilia. (Modified from Dame, R.F. 1976. Energy flow in an intertidal oyster population. *Estuarine Coast. Mar. Sci.*, 4, 243–53.)

across streamlines from throughflowing currents to surface currents. *In situ* observations using a fiber optic probe (endoscope) indicate that both mechanical and hydrodynamic filtration mechanisms appear to function in bivalves (Ward et al. 1993) and that these two mechanisms are not mutually exclusive. These authors also directly confirmed that mucus is important in the normal feeding of bivalves. In their study, *Mytilus edulis* used mucus strings on the ventral grooves of the gill filaments, *Placopecten magellanicus* mainly used a hydrodynamic slurry in the dorsal tracts, and *Crassostrea virginica* utilized both mechanisms (Ward et al. 1994). These scientists speculate that the two mechanisms are efficient under different environmental conditions.

The regulation of bivalve filtration rates has also been a contentious issue in recent years. One school of thought (Jørgensen et al. 1986; Jørgensen 1990) maintains that the bivalve filter pump is basically controlled by the physical properties of the filter pump and the water that flows through the system. Jørgensen and his colleagues argue that variations in pumping rate in bivalves in response to temperature can be explained by changes in kinematic viscosity of the flowing water. They base this contention on the correlation between viscosity and filtration rate. Their views do not explain how the pump responds to environmental variation.

The physiological school led by Bayne argues that body size, temperature, physiological condition, and suspended particulate material quantity and quality are

important in explaining the variability of bivalve filtration rates. As the filtration rate shows an acute response to changes in temperature, the temperature is most likely a major and fundamental controlling factor on metabolism in poikilotherms (Kinne 1964). Willows (1992) suggests that a general explanation, based on temperature dependence of metabolism, is an underlying cause for filtration rate variability. This view is supported by many studies on the physiological acclimation of filtration rate to temperature (Widdows and Bayne 1971; Widdows 1976). As with temperature controls, the rapid and compensatory decline in filtration rate in response to increased particulate loading is also attributed to physiological processes (Widdows 1976). Thus a physiological explanation of filtration rates in bivalves seems to be more persuasive.

However, another controversy was in the making for the physiological-ecologists interested in measuring clearance rates (CR) by bivalve suspension-feeders. Hans Ulrik Riisgård (2001) published a provocative review paper that comprehensively discussed the advantages and disadvantages of a number of different organismic scale methodologies and noted the reliability of the data that was obtained from them (Table 4.1). The ensuing arguments were formally published as “Comments” in *Marine Ecology Progress Series* between 2001 and 2004. The debate concluded with comments by Bayne (2004) and Riisgård (2004) that presented positive statements regarding the efforts of Petersen et al. (2004) to resolve most of the conflict by conducting and publishing a study on the intercalibration of methods used to measure organismic scale bivalve filtration rates (Table 4.2).

Filgueira et al. (2006) presented an experimental chamber, a mesocosm system, and a validation protocol for using the flow-through chamber method to measure clearance rate. The procedure was made up of a preliminary analysis of the fluid dynamics within the chamber and a statistical analysis of the clearance rate measurement of the targeted bivalve at different water inflows. This method allowed the performance of the chamber for each flow to be identified. The performance of the chamber for all the flows studied was also modeled simultaneously by means of the Ivlev exponential curve. The protocol, applied to an individual cylindrical experimental chamber (ICEC), established that ICEC complied with all the requirements for clearance rate measurement using the flow-through chamber method. As required by the size and shape of the targeted species, a number of different ICEC were designed and constructed. After validation of the ICEC, the performance of these chambers was evaluated *in situ* and in the laboratory. As no statistically significant differences were found between the experimental systems, they were considered validated for making clearance rate measurements using the flow-through chamber method.

The great diversity in methods for measuring clearance rate on the organismic scale and then using these data to scale up to the ecosystem scale raises an important question: Is it necessary to continue to make organismic scale measurements? Why not just measure at the ecosystem scale?

TABLE 4.2
Some Bivalves with Chemoautotrophic Symbionts

| Species | Visual EM | Enzymes | $\delta^{13}\text{C}(\%)$ | $^{\circ}\text{S}$ |
|------------------------------------|-----------|---------------|---------------------------|--------------------|
| Lucinidae | | | | |
| <i>Anodontia philippiana</i> | + | Ru | | |
| <i>Codakia costata</i> | + | Ru | | |
| <i>Codakia orbiculata</i> | | Ru, As, R | -23.2 to -28.3 | |
| <i>Codakia orbiculata</i> | | Ru | | |
| <i>Linga pennsylvanica</i> | | Ru | | |
| <i>Loripes lucinalis</i> | + | Ru, Ar, As | | |
| <i>Lucina nassula</i> | | Ru | -23.0 | |
| <i>Lucina radians</i> | | Ru | | |
| <i>Lucinella divaricata</i> | + | Ru, Ar, As | | |
| <i>Lucinoma aequizonata</i> | + | Ru, As, R | | + |
| <i>Lucinoma annulata</i> | + | | | |
| <i>Lucinoma atlantis</i> | | | -31.2 to -33.0 | |
| <i>Lucinoma borealis</i> | + | Ru, Ar | -24.1 to -29 | + |
| <i>Myrtea spinifera</i> | + | Ru, Ar, As | -23.1 to -24.2 | + |
| <i>Parvilucina multilineata</i> | + | Ru | | |
| <i>Parvilucina tenuisculpta</i> | + | Ru, As | | + |
| <i>Pseudomiltha floridana</i> | + | Ru, Ar | | + |
| Solemyidae | | | | |
| <i>Solemya reidi</i> | + | Ru, As, Ar, R | -30 | + |
| <i>Solemya velesiana</i> | + | | | |
| <i>Solemya velum</i> | + | Ru | -30.9 to -33.9 | |
| Thyasiridae | | | | |
| <i>Thyasira equalis</i> | + | Ru | | |
| <i>Thyasira flexuosa</i> | + | Ru, Ar, As | -29.3 | + |
| <i>Thyasira gouldi</i> | + | | -32 | |
| <i>Thyasira sarsi</i> | + | Ru, Ar, As | -28.2 to -31 | + |
| Vesicomylidae | | | | |
| <i>Calyptogena elongata</i> | + | | | + |
| <i>Calyptogena laubieri</i> | + | | | + |
| <i>Calyptogena magnifica</i> | + | Ru, As | -32.1 to -51.6 | + |
| <i>Calyptogena phaeseoliformis</i> | + | | -37.8 to -40.1 | + |
| <i>Calyptogena ponderosa</i> | + | | -31.2 to -39.1 | + |
| <i>Vesicomya cordata</i> | + | Ru, As | -39.8 | |
| <i>Vesicomya gigas</i> | + | Ru, As | | |
| Mytilidae | | | | |
| <i>Bathymodiolus thermophilus</i> | + | Ru, As | -30.5 to -37.1 | |

Note: Ar = APS reductase, As = ATP sulfurylase, R = ribulose 5' kinase, Ru = ribulose biphosphate carboxylase/oxygenase, $^{\circ}\text{S}$ = elemental sulfur in gills.

Source: From Fisher, C.R. 1990. Chemoautotrophic and methanotrophic symbioses in marine invertebrates. *Rev. Aquat. Sci.*, 2, 399-436.

FILTRATION AND PARTICLE QUALITY

In natural ecosystems, suspension-feeding bivalves pump water containing a variety of particles of differing qualitative food values. It is common for suspended inorganic particles of little or no food value to be present in much higher concentrations than phytoplankton and other organic particles. The high concentrations of inorganic particles essentially reduce the food value of the total suspended particulate material. If bivalve suspension-feeders could qualitatively select particles they could offset the inorganic seston dilution effect. While some research (Winter 1978) asserts that suspension-feeding bivalves have no qualitative particle selection ability, other longstanding evidence from bivalve stomach contents shows that the particles in the gut are not in the same proportions as those in the adjacent water column (Grave 1916; Morse 1944).

In a series of observations, Kiørboe and Møhlenberg (1981) showed that the efficiency of selection varied from almost nil to 15%, depending on species (Figure 4.2). The efficiency of selection was clearly related to palp size, but not gill type or turbidity in the respective bivalve's environment. Additional studies by Shumway et al. (1985) concluded that not only are the palps selective, but the gills and stomach may also play a role in particle selection. Other work by Kiørboe et al. (1981) found that sorting did not commence until a minimum concentration or threshold value of suspended inorganic particulate material had been reached. This threshold appears to occur when the concentration of suspended matter exceeds the capacity for ingestion of material retained by the filter. This threshold also appears to be the point at which mucus secretion increases and thus entangles particles to be ejected as pseudofeces (Jørgensen 1990). In *Mytilus edulis*, this threshold value was 1 mg/l of suspended material (Kiørboe et al. 1981). In the same vein, Newell and Langdon (1996) have argued that once sufficient particles are retained on the gill to saturate the gut's capacity to process them, one of two things must happen: (1) the clearance rate must decline, or (2) excess particles must be rejected as pseudofeces. The latter process is a more advantageous mechanism because the gut can be filled with nutritious particles for the least amount of energy.

Particle size and quality also play a role in filtration and feeding. Particles that are too large are not utilized as food (rejected as pseudofeces) and particles that are too small may pass through the filter. In addition, particles may have different nutritional values depending on size. For example, bacterial cells are much higher in numerical concentration than phytoplankton cells in most coastal systems, but bacteria are not as good a source of carbon as phytoplankton (Newell and Field 1983).

Generally, algae are the main source of nutrition for bivalve suspension-feeders, but in coastal habitats, bacteria, detritus, and nano-zooplankton may also make contributions (Langdon and Newell 1990). Several stable isotope studies have shown that both oysters, *Crassostrea virginica*, and marsh mussels, *Geukensia demissa*, utilize *Spartina* (marsh grass) detritus and phytoplankton (Peterson et al. 1985; Kreeger et al. 1988; Langdon and Newell 1990). The bivalves have more detrital carbon in their bodies when they are close to the marsh and more phytoplankton carbon when they are close to the sea. These studies suggest that the consumption and assimilation of particles is related to particle abundance and that detrital carbon is assimilated into bivalve

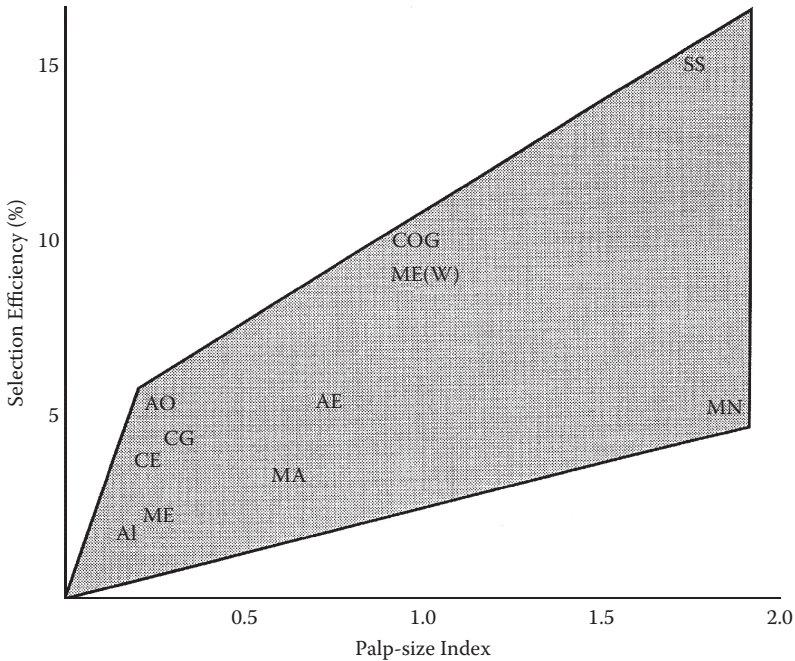

FIGURE 4.2 The relationship of selection efficiency (as determined from the ratio of relative chl *a* concentration in the inhalant water to the same concentration in the pseudofeces) to the palp-size index (palp area relative to clearance) in bivalves. AE = *Acanthocardia echinata*; AI = *Arctica islandica*; AO = *Aequipecten opercularis*; CE = *Cerastoderma edule*; CG = *Crassostrea gigas*; COG = *Corbula gibba*; MA = *Mya arenaria*; ME = *Mytilus edulis*; ME(W) = *Mytilus edulis* (Wadden Sea); MN = *Musculus niger*; SS = *Spisula subtruncata*. (Adapted from Kiørboe, T. and Møhlenberg, F. 1981. Particle selection in suspension-feeding bivalves. *Mar. Ecol. Prog. Ser.*, 5, 291–6.)

tissue. Stable isotope studies are useful because they provide an integrated measure of the contribution of foods of different isotopic signatures to consumers, but they provide little information on the physiology and behavior of the animal regarding feeding. Other studies, using radioactively labeled *Spartina alterniflora* carbon that had been ground into small particles and fed to bivalves, indicate only a very low absorption (2% to 3%) of ^{14}C in *Crassostrea* (Crosby et al. 1989) and *Geukensia* (Kreeger et al. 1988). Based on these estimates, this form of detrital carbon provides only 0.7% and 8.6%, respectively, of the metabolic requirements for the two bivalve species. When the cellulose assimilation efficiencies of intertidal and subtidal marsh mussels are compared, the intertidal bivalves have a higher efficiency. This higher assimilation efficiency has been attributed to prolonged gut residence time for the intertidal form (Kreeger et al. 1988) and supports the suggestion of Bayne et al. (1988) that intertidal suspension-feeding bivalves may physiologically compensate for reduced feeding periods by increasing gut residence time. Not all detrital carbon is as refractory as *Spartina lignocellulose*; thus one might expect a greater percentage of celulosic material being utilized by bivalves in systems with sea grasses or macroalgae. For example, Stuart et

al. (1982) investigated the absorption of kelp detritus by the ribbed mussel *Aulacomya after*. They found that kelp detritus was absorbed with an efficiency of about 50% while kelp bacteria were absorbed with an efficiency of about 70%. These findings suggest that kelp debris may represent an important source of carbon for suspension-feeders in and adjacent to kelp beds.

Bacteria may also provide, both directly and indirectly, nutrition to suspension-feeding bivalves. Bacteria can be utilized as food by adult bivalves. Zobell and Landon (1937) and Zobell and Feltham (1938) fed *Mytilus californianus* an exclusive diet of bacteria for 9 months. After that time, the bacteria-fed mussels showed a weight gain of 12.4%, while the unfed controls lost 16.3% of their original body weight. Prieur (1981) examined the digestive tract of *M. edulis* and found partially digested bacterial cells throughout the gut, and undamaged cells were found in the hind gut 3 h after feeding. Prieur (1981) also showed that the bacteria could divide several times during their passage through the gut, so that the yield of bacteria in the feces could be considerably in excess of the biomass of the bacteria ingested as food. The uptake of several species of bacteria labeled with radioactive tritiated thymidine by *M. edulis* was investigated by Birbeck and McHenry (1982). They concluded that *Mytilus* could select for bacteria if it were capable of lysing and discriminating between bacterial polymers in order to reject DNA. Seiderer et al. (1984) examined the crystalline style of *Choromytilus meridionalis* in a kelp bed environment and found that this digestive structure contained bacteriolytic enzymes capable of lysing a majority of the free-living suspended bacteria in the surrounding water column. They also observed that style enzymatic activity was highest when bacteria were the predominant exploitable food resource. As the bacteria in this environment have a high carbon:nitrogen ratio (3.7:1), bacteria are a potentially significant source of nitrogen for these mussels. Studies from Chesapeake Bay indicate that *Crassostrea virginica* and *Geukensia demissa* were able to filter free, unattached bacteria with an efficiency of 5% and 15.8%, respectively (Kreeger et al. 1988). The latter value is similar to that estimated by Wright et al. (1982) for marsh mussels in a New England estuary. Using Crosby's (1987) 57% assimilation efficiency for bacterial carbon, Langdon and Newell (1990) estimated that unattached, free bacteria could contribute 3.4% and 25.8% to the metabolic carbon requirements of oysters and marsh mussels, respectively. Thus bacteria in free suspension appear to make a much larger contribution to the carbon budget of mussels and to the nitrogen budgets of bivalves in general.

Suspended organic detritus often has bacteria attached or associated with it, and these bacteria not only are involved in the decomposition of the detrital carbon, but are also assimilating dissolved organic carbon released from the detritus. The bivalve filter can remove the larger organic detritus particles with the attached bacterial cells. Crosby (1987) and Crosby and Newell (1990) have shown in laboratory experiments that *C. virginica* can assimilate radioactively tagged cellulolytic bacteria and cellulose detrital complex with an efficiency of 10.3%. This efficiency is almost four times the efficiency with which oysters assimilated ¹⁴C-labeled cellulose alone. Langdon and Newell (1990) have extended these estimates to summer field conditions in Chesapeake Bay and estimated that attached bacteria could contribute 2.1% of the metabolic carbon requirements of subtidal oysters and 5.2% of the requirements of intertidal marsh mussels. They caution that the actual contribution of attached bacteria is probably even

smaller, as the total carbon requirement of bivalves is generally about 33% greater than the metabolic requirement (Bayne and Newell 1983).

Langdon and Newell (1990) have argued that nano-zooplankton may be a more important means of transferring detrital carbon through the decomposer community to suspension-feeders. These zooplankters feed primarily on bacteria and because they are 2 μm to 20 μm in diameter they can be more efficiently retained on the bivalve gill than the much smaller bacteria. Thus nano-zooplankton may be an important link in the transfer of nutrients from bacteria to bivalves (Sherr et al. 1990). Langdon and Newell (1990) have estimated that nano-zooplankton could contribute 15% and 37% to the summer metabolic carbon requirements of oysters and mussels, respectively, at their study site in Chesapeake Bay.

LARVIPHAGY

It is well known that shallow water benthic bivalves like *M. edulis* can pump up to 70 liters of water per day from which they filter particles as large as 110 μm . Davenport et al. (2000) found that the adult mussels filtered mesozooplankton that included their own larvae as well as the larvae of other species. The larvae are killed and become food or are expelled in mucus-coated pseudofeces. Further work by this group (Lehane and Davenport 2004) found that adult mussels ingested and fully digested about 90% of the bivalve larvae offered. This larviphagy by bivalves is evident on all larval stages and a major cause of bivalve larval mortality. Recent comparative studies on the introduced Pacific oyster *C. gigas*, *M. edulis*, and *C. edule* found that the filtration rates (probability of being removed from the water column) of the oyster larvae were roughly 50% lower than the rates of the native species. This suggests that *C. gigas* larvae can somehow reduce their filtration risk (Troost et al. 2008; see Chapter 9).

DISSOLVED ORGANIC MATTER (DOM)

Dissolved organic matter (DOM) has long been hypothesized to play an important role in the nutrition of aquatic animals (Putter 1909). Because most DOM can be extremely complex and difficult to characterize, studies of bivalve uptake of DOM have focused on relatively simple dissolved free amino acids (DFAA). Bivalve filter feeders pump large quantities of water and thus are exposed to sufficient quantities of DFAA to make them a potentially significant source of nutrition. Marine bivalve suspension-feeders, including *Mytilus*, *Geukensia*, *Rangia*, *Cerastoderma*, *Mya*, *Ostrea*, and *Bankia*, have been observed to have the ability to transport DFAA (Wright 1982). Uptake of DFAA appears to take place on the surface tissues of the gills, and the system is capable of providing a net input of amino acid from submicromolar concentrations in the surrounding water column. Wright (1982) and Stephens (1982) have calculated that this pathway can supply reduced carbon at rates as high as 60% of the oxidative requirements of the bivalves. The utilization of exogenous amino acids as a nutritional source was challenged by Wright (1985), who contended these DFAA were only taken up for use in osmoregulation. Later studies by Rice and Stephens (1987) with radiochemical analysis found that as many as 10 different

amino acids are taken up from the water column and that these DFAA are distributed rapidly into the internal tissues of *Crassostrea gigas* and *Mytilus edulis*. All of the preceding findings are from laboratory observations and caution should be taken in applying them to the field. Newell (personal communication) has pointed out that natural marine or estuarine bacteria, rather than the cultured bacteria used above, most likely can take up DFAA more efficiently than bivalves. Field studies need to be undertaken on the uptake of DFAA by bivalves *in situ*.

FILTRATION AND PARTICLE SIZE

Early studies of particle retention (percent removal) by bivalves showed that particles below 1 μm to 2 μm were usually passed through the animal, while particles larger than 3 μm were normally retained at a higher percentage (see Jørgensen 1966 and 1990, for reviews). Jørgensen (1966) further speculated that the sharp size limit between retainable and nonretainable particles is an indication that it is particle size and therefore the pore size of the filter that is a major factor regulating retention. Atkins (1938) measured the distance between the adjacent cilia on the latero-frontal cirri on a gill filament in *Crassostrea virginica* to vary between 1.5 μm and 3.7 μm . This range coincides with the inflection point in the observations by Haven and Morales-Alamo (1970), also on *C. virginica*. In a comparative study of filtration by *Mytilus edulis*, *Geukensia demissa*, and *Mya arenaria*, Wright et al. (1982) found that only *Geukensia* was capable of efficiently filtering bacteria. Measurements of the distance between laterofrontal cilia in *Mytilus* and *Geukensia* revealed closer spacing and more overlap of cilia in *Geukensia*. Thus it appears that the distance between the latero-frontal cilia is one of the determinants of the smallest size particles that can be completely retained on the bivalve filter and allow bivalves like *Geukensia* to utilize smaller cells like bacteria.

Later studies by Jørgensen (synthesized in 1990) and others have shown that although particle size and filter sieve size are important, other properties including water flow within the bivalve can regulate particle capture. Ancient bivalves probably used cilia to generate respiratory water current to clean the gills of particles retained in this process (Yonge 1947). In such systems, mucus was used to bind particles and transport them along rejection pathways. The currents produced by the gill cilia are laminar and, in conjunction with the gill wall, act to prevent particles from contacting the wall and escaping the current (Jørgensen 1990). In addition to the particle sieve size of the gill, mucus binding and the hydrodynamics of laminar water flow across the gill play a role in the capture and retention of particles. Consequently, the structural and functional features of bivalves as well as the dynamics of water flow act in concert to regulate filtration.

CLEARANCE RATE MODELS

Filtration or clearance rate (CR) is defined as the volume of water completely cleared of particles per unit of time (Bayne et al. 1976). Clearance or filtration rate should not be confused with pumping or ventilation rate, which is the volume of water

flowing through the gills per unit of time. The two rates are the same if all particles are removed by the bivalve suspension feeder's gills, i.e., 100% retention efficiency (Bayne et al. 1976). In reality, the filtration rate is usually less than the pumping rate particularly as particle size declines below 2 μm .

In practice, feeding rates have been estimated both directly and indirectly. Direct methods usually involve the interception and measurement of the inhalant and exhaling currents of the bivalve (Coughlan 1969). In this approach, the concentration of the particles is determined and multiplied by the water flow to estimate material fluxes. Therefore, the pumping rate (PR) is

$$\text{PR} = (F_i \times C_i) - (F_o \times C_o) \quad (4.5)$$

where F_i and F_o are the input and output flows, and C_i and C_o are the input and output concentrations. This direct approach to estimating pumping rate is difficult to use and is almost always carried out in the laboratory.

Indirect methods emphasize the rate of removal of particles by a bivalve from a known volume of suspension (Coughlan 1969). The calculated rate is a function of the feeding current and retentivity and is termed the filtration rate. Initially, researchers used a static chamber or container whose volume did not change (Coughlan 1969). At least four assumptions are fundamental to calculating the filtration rates in static systems:

1. The reduction in concentration of particles is due to filtration by the animal and gravitational settling.
2. The animal's pumping rate is constant through time.
3. Particle retention is 100% efficient; alternatively, a known constant percentage is retained.
4. The test suspension is homogenous through time.

If all the assumptions hold, the calculated rate is the pumping rate (Coughlan 1969).

Suspension-feeding bivalves continuously remove particles from the known water volume and dilute the suspension. If the filtration rate remains constant, the concentration in the chamber will decline exponentially. Clearance can be described by a general relationship

$$C_t = \exp^{(mn/M + a) t} \quad (4.6)$$

where C is the concentration at time t ; M is the volume of the suspension; n is the number of animals; m is the filtration rate of a single animal; and a is the rate particles settle out of suspension. Solving for m this relationship becomes

$$m = M/n[(\log_e C_0 - \log_e C_t) - a/t] \quad (4.7)$$

Coughlan (1969) has shown that the above relationship is equivalent to no less than six previously published clearance equations utilizing different notation. Coughlan also

provides a simple graphical method to determine filtration rate in static systems when the sampling interval and the ratio of initial and observed concentrations are known.

The static chamber exponential filtration rate model has been mathematically evaluated by Williams (1982). Williams found that the exponential model is a sufficient description of pumping rate only when filtration efficiencies are 100%. As noted earlier (Haven and Morales-Alamo 1970; Vahl 1972; Møhlenberg and Riisgård 1978; Palmer and Williams 1980), filtration efficiency in bivalves declines for smaller particles, particularly those below 3 μm to 4 μm . These observations suggest that forms of particle capture other than sieving may be involved in bivalve suspension-feeding (Williams 1982). Rubenstein and Koehl (1977) theorize that particles too small to be retained at 100% efficiency are captured by direct interception, inertial impaction, or random collision with cilia on the bivalve filter. Such filtration of small particles, termed aerosol filtration, theoretically should result in a complex or double exponential decline in cell concentration that does not easily translate into filtering or pumping rates (Williams 1982). It is also very difficult to measure.

The static chamber method of determining filtration rate has evolved in recent years to include automatic maintenance of particle concentration. This approach allows the estimation of filtration rate from the number of particles added to the volume (Winter 1969, 1970, 1973). This closed chamber system can produce variable results because as the experiments progress oxygen concentrations decline and metabolic waste increases. As with the static chamber estimates of filtration rate, Williams (1982) has shown that the change in the proportion of 100% efficiently filtered cells to those less efficiently filtered produces an artifact in the filtration rate estimate—an artifact not related to the physiology of the bivalve, but to the physical size of the cells the bivalve is feeding on. Today, clearance rate is defined as the volume of water cleared of particles large enough to be retained with maximum efficiency (usually 2 μm to 3 μm). In such cases, the Coulter counter is set to count only particles larger than this size range. In this case, small particles do not interfere with the measurement of clearance rate.

With the advent of automatic particle counters that allow much more rapid and accurate determinations of particle concentrations, flow-through filter feeding systems have become feasible. These systems allow longer time frame measurements, steady-state concentration of particles, and potential experimental manipulations. In addition, they maintain oxygen concentrations, avoid metabolic waste build up, and can be adapted to field conditions.

Size is most often modeled as an allometric relationship of the general power function

$$\text{CR} = \alpha W^\beta \quad (4.8)$$

where W is the dry weight of the soft body and α and β are the intercept and exponent, respectively. The values for β usually vary between 0.67 and 1.00, indicating a proportionality between surface area and body weight (Winter 1978). As an alternative to weight, shell length is often substituted, but such linear measures are usually considered less accurate than weight measures (Dame 1972; Winter 1978). It should also be noted that models built from animals feeding on a single type of

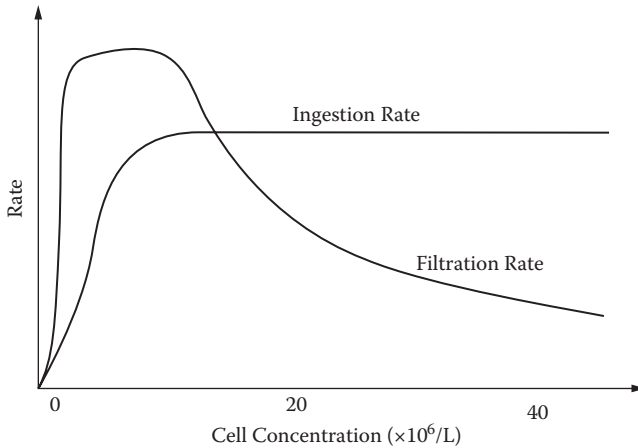

FIGURE 4.3 A generalized representation of clearance rate and ingestion rate as a function of suspended cell concentration. (Redrawn after Winter, J.E. 1978. A review on the knowledge of suspension-feeding in lamellibranchiate bivalves, with special reference to artificial aquaculture systems. *Aquaculture*, 13, 1–33.)

particle, monoculture of phytoplankton, or inert suspended material, overestimate filtration when compared to models developed from bivalves feeding on a variety of suspended particles (Doering and Oviatt 1986). These authors offer one of the few examples of combining temperature and size to estimate filtration rate. Their model is

$$CR = [(L^{b1})(T^{b2})]/a \quad (4.9)$$

where L is length and T is temperature in °C. By adding temperature to their model, Doering and Oviatt (1986) increased the amount of variation explained by about 25%.

In general, clearance rate decreases as suspended particle concentrations increase (see Winter 1978, for review). Such observations imply that bivalves regulate the amount of water from which particles are removed in relation to food concentration. Winter (1978) provides a schematic representation of the relationships between food concentration and filtration rate (Figure 4.3). In this scheme, as food concentration rises from some threshold value, filtration rate increases rapidly and stays constant until a maximum of food is ingested. As soon as this maximum ingestion rate is reached, the filtration rate decreases continuously while food ingestion remains constant. This pattern remains unchanged until the adequate food concentration is reached after which pseudofeces production begins. At still higher food concentrations, however, filtration and ingestion rates are drastically reduced. These relationships will vary according to particle size with smaller particles needing higher concentrations to be equivalent to larger particles.

The ingestion rate of particles by bivalves is also a function of body size, temperature, and food concentration. As long as pseudofeces are not produced, the amount of food ingested is equal to the amount of food cleared or filtered (Winter 1978).

This level of particle concentration is important in aquaculture and is known as the “pseudofeces-free cell density.” This concentration appears to be very close or equal to the optimum food concentration because of the low energy demand for filtration and the high filtration efficiency of algal cells (Winter 1978).

Willows (1992) developed a functional model of the feeding behavior and physiology of filter-feeding bivalves. This model assumes that the net rate of energy gain from the available food sources is maximized. The model is different from previous empirical and physical models in that it optimizes for feeding mainly through physiological adaptation to variations in food quality.

DEPOSIT FEEDING

Deposit-feeding bivalves generally inhabit muddy low energy environments while suspension-feeders are more commonly associated with coarser sediments in more energetic environments dominated by tidal and wave-induced currents. Compared with suspension-feeding bivalves that pump large quantities of water and filter this water for small quantities of suspended particulate food, deposit-feeding bivalves not only pump water, but also remove large quantities of deposited sediments from the surrounding benthic environment in order to gain a relatively low percentage of quality organic material. Deposit-feeding bivalves meet most of their nutritional needs from the organic portion of the sediments they ingest. Some bivalve deposit feeders can switch back and forth from suspension-feeding to deposit-feeding or feed in both modes simultaneously depending on the conditions in their environment. Thus the classification of a bivalve’s status as a deposit feeder may be relative.

Bivalve deposit feeders use the same pumping mechanism as is used by bivalve suspension-feeders to move water through the animal. Unlike the surface-dwelling filter feeders, many, but not all, deposit-feeding bivalves have lengthy incurrent and excurrent siphon tubes that insure the continuity of flow from the benthic–pelagic interface to the animal buried in relatively unconsolidated muddy sediments. For example, in the clam *Scrobicularia* the inhalant siphon extends and moves across the sediment surface during low tide sucking up surface particles, but retracts during high tide to avoid predation by fish and crabs (Hughes 1969). In the more primitive bivalves, e.g., *Nucula*, *Solemya*, and *Yoldia*, there is little siphonal development and the animal moves through the muddy sediments ingesting sediments through the incurrent opening. For example, the file clam, *Yoldia*, uses its siphons for water flux but not feeding. Instead, it uses two grooved tentacle-like appendages to feed. The cilia on these grooves move particles to the clam’s mouth (Levinton 1982).

Because the food quality or organic content of sediments is very low, deposit-feeding bivalves have developed two approaches to feeding: bulk feeding and sorting. In bulk feeding, large volumes of sediments are processed through the digestive tract in order to gain a small amount of nutrition. Bivalve deposit feeders typically sort particles before they are ingested into the mouth and reject the majority of the particles as pseudofeces (Lopez and Levinton 1987). While there are probably no completely nonselective deposit-feeding bivalves, the process of sorting quality food particles from the great mass of poor quality particles results in a lower feeding rate and, in turn, a longer residence time for the food in the gut. As noted earlier for

suspension-feeders, a longer gut residence time enables the digestion of the more refractory organic compounds common to the benthic environment. Thus deposit-feeding bivalves can process up to 20 times their body weight in sediments per hour with as much as 90% of these sediments egested as pseudofeces (Lopez and Levinton 1987).

As deposit feeders feed on the sediments, a number of fundamental questions arise. What are the sources of deposit-feeding bivalve nutrition? Which components of the sediments are more important as food sources? In this mixture of particles, how does the bivalve separate quality food from poor food?

MICROBIAL STRIPPING

Studies by Newell (1965) first touted the importance of microbes as food for deposit-feeding bivalves. He concluded that *Macoma balthica* ingested both organic material and microbes, but only digested the microbes. This process is referred to as "microbial stripping." Newell (1965) further suggested that the egested organic particles were recolonized by microbes after egestion. These particles could again be ingested and stripped of microbes, thus making the deposit feeder a major component of a decomposition feedback loop in the sediments.

CELLULASE ACTIVITY AND DETRITUS FEEDING

Although the microbial stripping idea focused on the microorganisms as food, it left unclear the role of organic matter as a food source. One approach to examining the role of organic matter as food for bivalve deposit feeders was to determine if the animals produced cellulase enzymes in their gut. In a survey of bivalve species, Crosby and Reid (1971) found that in both suspension-feeding and deposit-feeding bivalves, cellulolytic activity generally corresponds to the level of cellulose in the food. In the typically deposit-feeding genera investigated, *Yoldia* and *Macoma*, cellulolytic activity was comparatively low. Crosby and Reid (1971) suggested suspension-feeding bivalves have higher cellulase activities than deposit feeders because suspended food includes dinoflagellates that have a cellulose cell wall. Thus if cellulose is not a general food for deposit-feeding bivalves, microbes must be.

PARTICLE SELECTION

In deposit-feeding bivalves, the initial selection of particles occurs with the location and movement of the incurrent siphon or with palp tentacles. *Yoldia*, for example, can use its tentacles to reject up to 95% of the sediment collected (Bender and Davis 1984). As with suspension-feeding bivalves, deposit-feeding bivalves can also use the size of their filter to select particles. Both tentacles and filters appear to select for finer particles rather than larger particles and this process favors increased particle surface area and microbes. In addition to these selective mechanisms, many tellinid bivalves, e.g., *Macoma* and *Scrobicularia*, have complex stomachs capable of sorting and retaining smaller and less dense particles as opposed to larger particles (Hylleberg and Gallucci 1975). Some of these bivalves may also be adapted for

stripping microbes from the ingested particles (Lopez and Levinton 1987). Finally, in some deposit-feeding bivalves, the bacteria in the stomach are able to alter the composition of the organic matter in the stomach. This observation led Hylleberg and Gallucci (1975) to suggest that in *Macoma nasuta* the stomach may be compared to a chemostat, where dilution rate and multiplication rate of bacteria are balanced, yielding a net nutrition gain to the bivalve.

PROPORTION OF FOODS

Like strictly suspension-feeding bivalves, deposit-feeding bivalves remove phytoplankton, microzooplankton, organic and inorganic particles, and microbes, including bacteria, fungi, and microalgae, from the sediments and surrounding waters. They also probably absorb dissolved organic materials in much the same manner as their suspension-feeding relatives.

The determination of the relative proportions of the various food sources for deposit-feeding bivalves is a major problem (Lopez and Levinton 1987). Some success has been found in combining the ^{14}C -formaldehyde technique of Lopez and Crenshaw (1982) with the ^{14}C : ^{31}Cr method of Calow and Fletcher (1972) to estimate the absorption of organic materials. As each of the major food resources for deposit-feeding bivalves has a different stable isotope ratio, the use of multiple stable isotope analysis to determine sources of materials and trophic status may also have utility in these endeavors (Peterson et al. 1985).

OPTIMAL FORAGING FOR FOOD IN THE SEDIMENTS

The concept of optimal foraging is probably so important to the survival of bivalves that extant forms may be living close to their preferred optima (Hughes 1980). As bivalve deposit feeders are not very motile, their foraging strategies are mainly a function of ingestive and digestive processes (Taghon and Jumars 1984). Thus foraging models (Figure 4.4) for these organisms stress ingestion and time dependent absorptions of food. Because of the fine particle nature of the sediments, particle selection is better modeled stochastically (Jumars et al. 1982) and the range of food value is broad, varying from bacteria and digestible plant debris to undigestible materials. As microbial organisms and organic matter are inversely correlated with sediment grain sizes (Yamamoto and Lopez 1985), it is expected that a model of optimal ingestion will predict selection for fine particles (Taghon and Jumars 1984). Microbial feeding with the concurrent production of feces (fecal pellets) may actually stimulate microbial growth through maintenance of logarithmic growth of the microbe populations via grazing and by enriching the sediments with nutrients as they pass through the gut. As a bivalve increases its feeding rate, more food reaches the gut, but gut passage time and digestion rate decrease. This balance of digestion and food reaching the gut sets up an optimal feeding rate that should increase with increasing food quality. Alternatively, Calow (1975) has argued that as food quality decreases, gut residence time should increase to allow increased digestion. Although these strategies seem at odds with each other, if the gut length is longer for bivalves

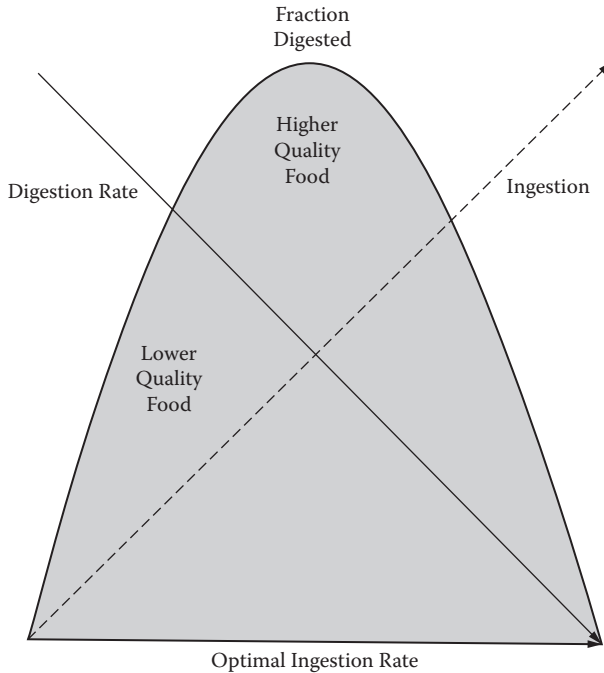

FIGURE 4.4 The hypothetical relationships between optimal ingestion rate, increasing ingestion, decreasing digestion, and food quality in deposit feeding bivalves. (Redrawn after Lopez, G.R. and Levinton, J.S. 1987. Ecology of deposit-feeding animals in marine sediments. *Q. Rev. Biol.*, 62, 235–60.)

feeding on poorer quality foods, then the ingestion rate need not change. This latter strategy is observed in deep sea bivalves (Allen and Sanders 1966).

SHIPWORMS

Shipworm is the common term for some bivalve species in the genera *Bankia*, *Lyrodus*, *Martesia*, and *Teredo*. These organisms are specialists at boring into wood and are commonly called shipworms. Because these bivalves eventually destroy their habitat, they have developed a number of adaptations that enhance their success in their transient environment. These include (1) a shell that is an effective rasping tool, (2) a fast growth rate to take advantage of the transient nature of their habitat, (3) early maturation of gonads, (4) high fecundity, (5) incubation of larvae, (6) protandry, and (7) enzymes for cellulose breakdown (Morton 1978).

While all shipworms maintain their ability to suspension-feed, it is the development of what appears to be a step-wise process of utilizing cellulose derived from wood that has allowed these bivalves to exploit their special habitat in the marine environment. First the shell rasps a tunnel into a piece of wood; then the wood particles are taken into the mantle cavity, and through a selective sorting mechanism the small fragments are swallowed; in the esophagus, the organ of Deshayes with its

symbiotic bacteria secretes cellulytic enzymes; in the Teredinidae, the stomach further sorts the wood particles and additional cellulytic enzymes are produced; finally, the products of lignocellulose decomposition are absorbed by the digestive diverticula and digestion continues intracellularly. Thus, as is typical of other bivalves, digestion is a two-step process with an extracellular digestive sequence and an intracellular sequence (Morton 1978).

Although a similar mucous-producing organ is found in other molluscs, the organ of Deshayes is unique to the shipworm bivalves. It not only produces digestive enzymes that aid in the processing of cellulose, but it may be the only case to date in the animal kingdom of nitrogen-fixing bacteria in pure culture in a particular organ (Waterbury et al. 1983).

In summary, shipworm bivalves can play a major part in the decomposition of woody materials in the sea. During the process of adaptation to this role, they may have developed a truly unique symbiotic relationship with nitrogen fixing bacteria.

SYMBIOTIC NUTRITION

There are two fundamentally different types of autotrophic symbioses between bivalves and microbes. In one type, the relationship is between a small number of tropical bivalve species found in coral reef environments and the dinoflagellates, *Symbiodinium* (= *Gymnodinium*) *microadriaticum*, also known as zooxanthellae. These autotrophic symbioses are driven by solar energy mediated by photosynthesis (Yonge 1936).

The second type of symbiosis is between a variety of bivalves and bacteria living in the bivalves' tissues. In these chemoautotrophic relationships, the bacteria are chemotrophic, obtaining energy from chemical sources; lithotrophic, because their energy source is inorganic; and autotrophic, because their source of cellular carbon is inorganic (Fisher 1990). As some of these bacteria utilize methane as an energy source and because their cellular carbon source can be organic, these forms are called methanotrophic. While the first bivalves exhibiting chemotrophic symbioses were found around deep sea hydrothermal vents, a great variety of bivalves from mainly anaerobic sulfide-rich environments have now been observed to exhibit chemoautotrophic and methanotrophic symbioses.

PHOTOAUTOTROPHIC SYMBIOSES

Members of the tropical giant clam family, *Tridacnidae* (*Tridacna gigas*, *T. maxima*, *T. derasa*, *T. squamosa*, *T. crocea*, *Hippopus hippopus*, and *H. porcelains*) as well as the heart cockle, *Corculum cardissa*, have symbiotic relationships with the zooxanthellae. Almost all of these bivalves are associated with coral reefs where the same species of zooxanthellae is symbiotic with many massive reef building (hermatypic) corals. As with the massive deposition of coral matrices composed of calcium carbonate, the bivalves containing zooxanthellae have a tendency to massive calcium carbonate shells. One species, *T. gigas*, is known as the giant clam and has been reported to exceed 1.2 m in length and 250 kg in weight (Yonge 1936), making it the largest living bivalve. Only certain extinct species of rudist exceed the tridacnids in

size, and they also may have had symbiotic zooxanthellae in their tropical/coral reef habitat (Kauffman and Sohl 1974).

Early observations on these large coral reef bivalves quickly focused on the absence of sufficient planktonic food to support their metabolism (Yonge 1936). Furthermore, these bivalves appeared to absorb dissolved inorganic compounds. Various microscopic studies showed that unicellular zooxanthellae were living in the hemal sinuses of the hypertrophied siphon of these bivalves or what is commonly referred to as the "mantle tissue" in tridacnids (Yonge 1936) and to a lesser extent in the other organs (Goreau et al. 1973).

Unlike corals where zooxanthellae are within the cells of the corals, these algae are found intercellularly in the bivalves, which means the larval bivalves must be infected by the zooxanthellae for the symbioses to take place. This uptake of zooxanthellae from the environment apparently occurs in the veliger stage of the clam's development (Fitt and Trench 1981).

When submerged, tridacnid clams gape and extrude their mantle folds. This action exposes the zooxanthellae in these tissues to sunlight and permits photosynthesis to take place in the zooxanthellae. Although the clams may receive some nutrition from digesting zooxanthellae, most of the metabolic gain from the symbiosis is believed to be derived from released photosynthates (Goreau et al. 1973; Trench et al. 1981), specifically glycerol and alanine (Muscatine 1967).

Both the zooxanthellae and the bivalve benefit from their relationship. The algae are sheltered, nourished with dissolved inorganic nutrients and exposed to sunlight by their host. In turn, the clam has a ready source of inorganic and organic nutrients that are usually in low concentration in reef waters (Yonge 1936). Further, the uptake kinetics of inorganic compounds by this symbiosis seems to provide the capacity to take immediate advantage of spikes or surges in limiting nutrients (e.g., ammonium), much the same as has been shown in corals (Wilkerson and Trench 1986).

The bivalve host can rapidly incorporate carbohydrates produced by the zooxanthellae into its metabolic processes (Goreau et al. 1973). However, these carbohydrates are neither a source of nitrogen nor a source of protein to the bivalves. To gain these food components, the bivalve must filter phytoplankton and microzooplankton from the surrounding water. The dependence on normal sources of bivalve nutrition (plankton) in the tridacnids is evidenced by the presence of feeding gills, selective palps, and an elaborate digestive system (Yonge 1975). Because of the symbiosis exhibited between zooxanthellae and tridacnid clams, a number of studies have focused on the role of the zooxanthellae in the bivalve host's nutrition. Early studies (for reviews see Goreau et al. 1973, and Fankboner and Reid 1990) contended that zooxanthellae were captured by amoebocytic blood cells with digestion occurring in the blood stream and indigestible products being removed by the kidneys. Light and electron microscope studies by Trench et al. (1981) found no evidence for zooxanthellae in blood amoebocytes. These authors also found no support for tridacnids digesting their symbionts and the undigested components collecting in the kidneys. In fact, the deposits in the kidneys were found to be mineral phosphorus. Using radioactively labeled carbon dioxide ($^{14}\text{CO}_2$), Goreau et al. (1973) were able to clearly show that uptake of label by the zooxanthellae and the eventual transmission of the labeled products via the blood to the rest of the bivalve. Thus it appears that it is the

photosynthetic products of the zooxanthellae that are utilized for food instead of the zooxanthellae themselves.

Tridacnids expose their zooxanthellae-containing mantle tissues only during the day and are nocturnally inactive (Reid et al. 1984). This observation also focuses on the importance of the zooxanthellae symbionts as a source of nutrition because the great majority of plankton in coral reef waters is usually only over the reef during night while the zooxanthellae require exposure to light.

Light plays a major role in the nutrition of tridacnid bivalves because of the light-limited nature of zooxanthellae. In essence, we must look at these clams as if they are primary producers rather than herbivores. Studies of oxygen uptake and release in *Tridacna maxima* (Trench et al. 1981) show that these bivalves are adapted to strong light intensities typical of shallow coral reef environments and show no signs of photoinhibition. By comparing light-driven evolution of oxygen (production [P] + respiration [R] = net production [NP]) to dark uptake of oxygen (respiration), Fisher et al. (1985) clearly showed P:R ratios greater than 1.0. At lower light intensities, smaller clams have higher P:R ratios probably because more of their zooxanthellae are exposed to higher light intensities while in larger clams, the thicker shells and bodies shade a sizable proportion of the zooxanthellae.

Trench et al. (1981) estimated the relative contribution of zooxanthellae photosynthesis to respiratory carbon demand by the clam *T. maxima*. They utilized direct observations of respiration, net photosynthesis, and the proportion of net carbon translocated from zooxanthellae to the clam following Porter's model (1980)

$$\%C = [(P_{\text{net clam, 12h day}})(0.37PQ^{-1} + (R_{\text{clam, 12h night}})(0.375RQ))(95\%)(40Y)/(R_{\text{clam, 12h night}})(0.375RQ)(2)(95\%)] \quad (4.10)$$

where %C is carbon assimilated, P is production, PQ is photosynthetic quotient, R is respiration, and RQ is respiration quotient. From this model that only requires oxygen concentration observations, estimates of zooxanthellae contribution to clam respiratory carbon needs on sunny days were 77% to 84% and on cloudy days 62% to 63%. Thus the photosynthetic carbon produced by the zooxanthellae may provide over half of the respiratory carbon requirements of these tridacnid clams. These authors stress, however, that due to the many assumptions made in the models, these estimates should not be considered definitive.

In more recent studies, Klumpp et al. (1992) and Hawkins and Klumpp (1995) found that giant clams deposit proportionally more carbon into their tissues relative to that respired than completely heterotrophic bivalves. Furthermore, small clams depended more on suspension-feeding (65%) for carbon needs, while large clams only acquire 34% of their carbon from this source—these statistics support the notion that with the development of clams from settlement to adult the symbionts also develop and become a major component in the clam's nutrition.

Another aspect of nutrition in this photoautotrophic symbiosis is that of the source and recycling of inorganic nutrients. In a series of studies, Fitt et al. (1993) and Belda et al. (1993) determined that nonsymbiotic larvae and young clams with few zooxanthellae release ammonium; large clams deplete ammonium and nitrate from sea water. Clams grown in elevated concentration of ammonium and phosphate showed

an increase in the concentration of these elements in tissues of both the clam and the algae. Stoichiometric analysis revealed that the clams probably regulate the availability of phosphorus to the zooxanthellae. Using ^{15}N -ammonium, Hawkins and Klumpp (1995) found there was a net uptake of ammonium from sea water that was modulated by nutritional history, light history, ammonium concentration, and possible biological rhythmicity. Zooxanthellae also assimilated nitrogen excreted by host tissues. Most of the nitrogen released by the zooxanthellae was incorporated into the host tissues with no significant loss from the clam. They concluded that the photoautotrophic symbiosis of the giant clam confers a nutritional advantage over nonsymbiotic bivalves because this symbiotic relationship tightly recycles limiting nutrients in a nutrient-poor environment.

Thus tridacnid clams are nutritional opportunists in a nutrient-poor environment because they employ the following methods of feeding. They eat suspended particles including diatoms, crustaceans, and zooxanthellae released from heat-stressed corals; they take up dissolved organic matter; and they incorporate photosynthates released by the zooxanthellae (Fankboner and Reid 1990). In doing so, they reflect essentially the same nutritional diversity as the dominant corals in their ecosystem.

CHEMOAUTOTROPHIC SYMBIOSES

Chemoautotrophic symbioses are widespread in marine bivalve molluscs (Fisher 1990). Both chemoautotrophic and methanotrophic symbionts have been clearly demonstrated in numerous species of bivalves (Table 4.3). While the behavioral, physiological, and morphological adaptations to their symbionts vary among the different families of bivalves, there are many similarities. Unlike the photoautotrophic symbionts, most of the chemoautotrophic symbionts are intracellular, with the Thyasiridae an exception. The various bacterial symbionts appear to be associated with bacteriocyctic cells and are often located in cellular vacuoles. These associations are found in a wide range of habitats, usually at the interface between aerobic and anaerobic environments. The successful bivalve symbioses appear to bridge this interface with numerous and often unique adaptations.

As the chemoautotrophic symbionts are relatively small (prokaryotic in size), a variety of methods have been used to demonstrate their existence. These approaches include electron microscopical identification, level of enzymatic activity, presence of lipopolysaccharide, stable isotopic ratios, presence of elemental sulfur, unique physiological adaptations, and the anatomy and habitat of the host (Fisher 1990). Enzymatic studies focus on the presence and activity of specific enzyme systems responsible for chemosynthesis. The enzymes of interest are:

1. Ribulose-1,5-bisphosphate carboxylase-oxygenase (RuBPC/O), which catalyzes the first reaction in the Calvin Benson Cycle.
2. Adenosine-5'-phosphosulfate (APS) reductase, which catalyzes the reaction of AMP and sulfite.
3. Adenosine triphosphate (ATP) sulfurylase, which catalyzes the reversible reaction of adenosine-phosphosulfate and pyrophosphate to yield ATP and sulfate.

Table 4.3
Summary Comparison of Organismic Scale Bivalve Clearance Rate Measurement Methods

| Method | Configuration | Flow | Advantages | Disadvantages | First to Use |
|----------------|---|--------|--|-----------------------------------|--------------------------------|
| Direct | Separate chambers | no | Uses standard mussel Good for physiological studies | Pressure problems | Moore (1910) |
| Flow through | Geometrically matched | yes | Constant algae concentration | Flow must be above critical | Haven and Morales-Alamo (1970) |
| Suction | Water through tubes | no(?) | Animals undisturbed | Geometry difficult | Møhlenberg and Riisgård (1978) |
| Clearance | Indirect | yes | Reliable | Concentration declines over time | Fox et al. (1937) |
| Photo-aquarium | Auto-recording | yes | Continuous | High speed recirculation | Møhlenberg and Riisgård (1978) |
| Steady state | Filtration from algae removed | yes | Long-term experiments | Needs mixing | Hildreth and Crisp (1976) |
| Replacement | Complete water replacement | no (?) | Natural position | Behavior abnormal | Coughlan and Ansell (1964) |
| Hermiston | Thermal flow sensor | yes | NA | Sensitive | Foster-Smith (1976) |
| Biodeposit | Clearance = ratio of egested/ conc. inorganics in water | yes | Works well in field and with oysters | Possible under-estimation of rate | Hawkins et al. (1996) |
| Impeller | Mechanical | yes | NA | May not precisely measure rate | Jones et al. (1992) |
| Video | Microscopic video recording with image analysis | NA | NA | May be overly complicated | Nielsen et al. (1993) |
| Scaling | Variable size chambers | yes | Scaling, adaptable to lab and field | Complicated | Filgueira et al. (2006) |
| InEx | Pairwise simultaneous sampling of inhaled and exhaled water | yes | Direct and non-intrusive | Scaling | Yahel et al. (2005) |

4. Sulfate adenyl transferase, in the same reaction as ATP sulfurylase, which yields ADP instead.
5. Rhodanase, which catalyzes the splitting of thiosulfate into sulfite and sulfur.
6. Sulfide oxidase, which catalyzes the first step in the oxidation of hydrogen sulfide.
7. Nitrate reductase, which catalyzes the reduction of nitrate to nitrite.
8. Nitrate reductase, which catalyzes the reduction of nitrite to ammonia (see Fisher [1990] for a more detailed discussion).

Another group of tools in the ecologist's arsenal for identifying chemoautotrophic symbioses is the stable isotope ratios of carbon, nitrogen, and sulfur. Long known for their utility in determining the food source and web structure of ecological systems, these isotopic ratios are also useful in identifying chemoautotrophic symbioses. The sources of carbon, nitrogen, and sulfur elements for the various energy-generating reactions are quite different from those in nonsymbiotic bivalves. While the individual isotopic ratios of carbon ($\delta^{13}\text{C}$), nitrogen ($\delta^{15}\text{N}$), and sulfur ($\delta^{34}\text{S}$) can give evidence for food sources, and carbon and nitrogen isotopes can reflect trophic level, it is the broad range and use of multiple isotopic ratios that provides the most useful information both in symbiotic studies as well as in ecosystem level analyses.

Of the several chemoautotrophic species in the Mytilidae, *Bathymodiolus thermophilus*, the deep sea hydrothermal vent mussel, is the best studied (Fisher 1990; Kenk and Wilson 1985). These mussels have been found in a wide range of environmental conditions in the area of the hydrothermal vents, and this distribution has been attributed to their ability to obtain nutrition from symbioses (Fisher 1990), suspension-feeding (Le Pennec and Prieur 1984), and dissolved organic material (Fiala-Medioni et al. 1986). Stable isotope ratios of mussels taken near the Rose Garden hydrothermal vent site on the Galapagos rift support the suggestion that multiple sources of nutrition are important to these animals (Fisher 1990).

The family Solemyidae was initially an enigma to science because it is composed of relatively large prosobranch bivalves with reduced or absent digestive tract and feeding abilities (Reid 1980). All members of this family are now thought to contain chemoautotrophic symbionts. Further, these shallow water estuarine clams typically make deep burrows in organically rich sediments that penetrate both oxidized and reduced sediment layers. Dense populations of *Solemya reidi* are found in sites polluted from paper mill effluent and sewage sludge deposits that are high in reduced sulfides. Despite their symbiotic nature and their lack of a gut, these clams reach a size of up to 5 cm.

The Thyasiridae are closely related to the Lucinidae, but they are notable in that their symbiotic bacteria are extracellular. The extracellular nature of the symbionts has been interpreted as indicating an early stage in the development of chemoautotrophic symbioses in this group compared to those groups with intracellular symbionts (Fisher 1990).

Vesicomysids have been found in a variety of middepth to deep sea sulfide-containing habitats, including hydrothermal vents, subduction zones, saline seeps,

hydrocarbon seeps, and deep sea reducing sediments. Some species of these clams may burrow through the sediments, while others are epifaunal. The vent clam *Calymene magnifica* is one of the better studied of these chemoautotrophs. Here again it is evident that the clam utilizes the interface between the oxidized and reduced environments to the best advantage of the symbiosis. These epifaunal clams of the hydrothermal vents orient their bodies such that the foot is exposed to warm reducing vent waters rich in hydrogen sulfide, while cooler overlaying water high in oxygen is pumped through the clam.

Thus a small number of bacterial species have succeeded in forming an endosymbiotic relationship with marine bivalves. As the bacteria are mainly sulfide oxidizers, these microbes benefit from the dependable interface (Reid and Brand 1986) the bivalve provides between the aerobic sediment surface and water column and the anaerobic environments of reducing sediments and hydrothermal vent environments. The bivalves benefit from an additional source of food or energy, and this feature may allow them to exist in environments they might otherwise be unable to inhabit. Very recently there was a report of symbiotic nitrogen fixer bacteria in tropical corals.

PRODUCTION (P)

Production is defined as the accretion of somatic tissues or gametes and has been extensively studied in bivalves (Hawkins and Bayne 1992). Production includes not only material and energy stored as new tissues and represented as growth of the individual (P_g), but also material that goes into gametes (P_r). Hawkins and Bayne (1992) have stated that production is controlled by the interaction between endogenous processes that pertain to the organism and exogenous factors from the external environment. Exogenous influences include quality and quantity of food, temperature, and salinity, and have been discussed elsewhere in this text. The major endogenous factors are body size, physiological status, and genotype. These internal influences determine maximal capacity for production.

PRODUCTION DUE TO GROWTH (P_G)

Growth is one of the most-used measures of an organism's vitality in a given environment. In bivalves, the animal's size is directly related to its age, and this cumulative increase in biomass with respect to time is termed "absolute growth," while the percentage increase in biomass per unit time is "relative growth" (Seed 1976).

As growth represents changes in bivalve size, it is most often measured as shell length, weight, and volume. There may be complications in just measuring single shell parameters, as shell growth may be different from soft body growth due to environmental factors or variations in the reproductive cycle of the bivalve. It is the soft body that carries out the living processes of the animal, not the shell. Thus allometric relationships are often developed between shell parameters and body weight in order to nondestructively estimate soft body biomass on living bivalves (Dame 1972).

Growth Measurement

Some methods used to assess growth in bivalves are following size changes in marked individuals, tracking size frequency distributions, measuring shell growth rings in relation to biomass, and observing radioactive tracer uptake. To determine seasonal growth rates as well as the influence of size and local environmental conditions, marked bivalves are often kept in wire cages at a particular depth or intertidal elevation. The cages partially protect the bivalve from predation and make them easier to retrieve than individual animals. Generally, cages do not influence growth, but Harger (1970) found that mussels kept in intertidal cages grew faster than those not in cages, possibly because wave action was reduced within the cages.

Following a particular cohort by measuring size frequency distribution through time is a common technique among population ecologists (see Chapter 5). In this method, a given year class is followed, and the change in the average size of the mode is equivalent to average growth. This method only works well in bivalve species with a very narrow reproductive or recruitment period (Craig and Oertel 1966). If the recruitment period is extended, i.e., *Crassostrea virginica* (Dame 1972), or growth rates are variable, i.e., *Mytilus* (Seed 1976), then the method has limited application.

Shell growth lines are defined as abrupt or repetitive changes in the character of accreting bivalve tissue (Dillon and Clark 1980) and, depending on the circumstances, may be a postmortem indicator of growth. These lines are evident in some bivalves when they experience well-defined seasonal conditions, particularly suspended periods of shell growth (Seed 1976). Such periods are usually associated with extremes of temperature, wave action, or reproductive periods. Bivalves from environments with uniform conditions generally do not exhibit rings, and line formation is variable both between habitats and within a habitat. Thus care should be taken to check the reliability of rings in each locality. In general, the live-collected shells of bivalves contain the geochemical history or record of temperature and salinity, so records of prehistoric conditions can be obtained from fossil shells (Surge et al. 2003).

SHELL GROWTH

Growth of shell is quite different from growth of somatic and reproductive tissues. The bivalve shell is composed of both an organic matrix and crystals of calcium carbonate (CaCO_3). There are three major aspects of shell growth and formation: (1) the role of metabolism in CaCO_3 formation and the synthesis of the organic matrix; (2) secretion of shell components by the mantle; and (3) CaCO_3 crystal growth (Wilbur 1964; Wilbur and Saleuddin 1983).

As CaCO_3 and CO_2 are both components of the calcium carbonate–carbon dioxide buffer system so prevalent in sea water, changes in the concentrations of any component in this buffer system influence the amount of the other components (also see acidification in Chapter 3).

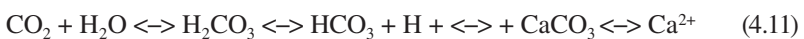

Alkaline conditions will drive this buffer system to the right with an increase in CaCO_3 , assuming sufficient calcium ions are present, while an increasing acidity will drive the system to the left with the dissolving of CaCO_3 and eventual production of CO_2 . The CO_2 concentration within the bivalve's tissues can also be a function of intermediary metabolism, and combined with the buffer system potentially controls shell crystal formation (Wilbur 1964). The amount of calcium deposited in the shell is also a function of the calcium concentration in the surrounding water and time of submergence (see acidification of the oceans due to global change in Chapter 3). Early studies of intertidal bivalves clearly supported the above processes in that the longer the animal is submerged the greater the calcium uptake, and consequently shell growth is higher (Rao 1953; Baird and Drinnan 1956).

The organic matrix is secreted in insoluble form by the mantle and deposited as a layer on the inner shell surface. The matrix is proteinaceous and is the substrate upon which CaCO_3 crystals initiate and grow.

While measuring shell growth by weight in water (Havinga 1928; Andrews 1961) or by linear measures is straightforward, determining the organic matrix component of the shell, a relatively small component of growth, as a percentage of total weight is difficult. Although small in mass, in terms of calories or organic carbon, the organic matrix may be an important component of growth. The two most common ways of estimating the biomass of the organic matrix are through careful ashing in a furnace or acid dissolution of shell followed by weighing the remaining dried organic material (Dame 1972; Price et al. 1970).

In addition to seasonal and reproductive shell growth rings that are visually external, microscopic growth increments or lines ranging from 1 to 100 μm thick are discernible within bivalve shells (Rhoads and Pannella 1970; Lutz and Rhoads 1980). These deposition increments are laid down during each 24-hour period of physiological activity (House and Farrow 1968; Clark 1968; Clark 1974). It is generally accepted that many, if not all, microgrowth increments in bivalve shells are a reflection of variations in the relative proportions of organic material and calcium carbonate (Lutz and Rhoads 1980). In many bivalves, these growth lines appear to be correlated with the tides and the fact that the valves are open during submergence and closed during exposure. To explain these lines, Lutz and Rhoads (1977) proposed that differences in organic concentrations in the various regions of the shell were simply residues left behind as a result of dissolution of shell material during periods of anaerobiosis. Subsequent studies have supported their hypothesis (Gordon and Carriker 1978; Lutz and Rhoads 1980). Microgrowth increments have been documented in five temporal categories: (1) semidiurnal and diurnal, (2) fortnightly, (3) monthly, (4) annual, and (5) semiperiodic or random events (Lutz and Rhoads 1980; Surge et al. 2003). These microscopic lines provide information about environmental and physiological conditions of individual animals from both current and past environments (Table 4.4). Thus the bivalve shell may be considered a long-term continuous environmental recorder.

To summarize, shell growth is a function of calcium availability in water and therefore of the amount of water pumped across the bivalve's tissues, the pH of the bivalve's internal system, the intermediary metabolism of the animal, and the environmental temperature that controls the rates of most of these processes. Although

TABLE 4.4
Physiological and Environmental Events Recorded in Molluscan Growth Patterns

| Events | Characteristics | Time and Place | Ecological Application |
|-------------------|---|--|----------------------------------|
| Circadian rhythms | Dark and light shell layers | Daily | Physiology |
| Spawning | Sudden depositional break | Variable by species and place | Reproductive period and duration |
| Winter | Gradual reduction in deposition rate | Shallow water at mid- and high latitudes | Climate, latitude, and geography |
| Summer | Thickest daily increment | – | Climate, latitude, and geography |
| Tides | Regular recurrent patterns with 15- to 30-d cycle | Intertidal and shallow water | Sea level change |
| Storms | Sudden depositional break with rapid recovery | Storm frequency | Weather |

Source: From Rhoads, D.C. and Pannella, G. 1970. The use of molluscan shell growth patterns in ecology and paleoecology. *Lethaia*, 3, 143–161.

shell size is related to soft body tissue mass, it is not a direct measure of body size, because some of the controlling factors are different. Further, as discussed in Chapter 3, the pH of coastal and estuarine environments is being influenced by the changing concentration of CO₂ in the atmosphere. The resulting acidification will dissolve the shells of both live and dead bivalves as well as become an additional source of mortality for larval and adult bivalves. Thus in Chapter 5, the dynamics of living populations as well as accumulated deposits of bivalve shell is examined.

LONGEVITY

The age of a number of bivalve species can be determined from the age rings laid down every year in the shell (Philipp and Abele 2009). The ocean quahog, *Arctica islandica*, has a reported maximum lifespan of 374 years in polar waters (Schöne et al. 2005). Extremely long-lived bivalves share two common life-history features. The first is an extremely slow and seemingly indeterminate growth. The second is the late onset of reproduction that continues into old age without a postreproductive stage (Abele et al. 2009). Bivalves are promising models for age research because their tissues allow very clear distinctions between internal and environmental factors that control the rate of senescence in cells and tissues (Philipp and Abele 2009). Consistent with the pleiotropic theory of aging, *A. islandica* seems to trade slow growth and late onset of reproduction for a very efficient autophagic potential that

mitigates oxidative damage accumulation and supports long lifetime (Strahl et al. 2007).

PRODUCTION DUE TO REPRODUCTION (P_r)

In addition to the energy and materials bivalves allocate to shell and body growth, they place considerable amounts of production into gonadal tissues (P_r). These tissues develop into gametes that are lost from the individual during spawning. Consequently, there is a cyclical storage and loss of reproductive products that is controlled by endogenous and exogenous factors.

The following methods are used to estimate the amount of production allocated to reproduction. For instance, the amount of P_r can be directly estimated by inducing the bivalve to spawn in the laboratory and then counting or weighing the gametes released. In an indirect method, P_r can be estimated from allometric relationships relating weight loss due to spawning to body weight or shell size (Bayne and Worrall 1980). A less accurate method is to estimate the proportion of gonad lost from the proportion of spatfall in a given time period (Dame 1976).

The proportion of production devoted to reproduction is low in young bivalves, but gradually increases to a dominant proportion in adults. In the largest mussels, reproductive tissues may account for more than 50% of the soft body weight, and P_r may be > 90% of total production (P) (Seed and Suchanek 1992; Thompson 1979). Bivalves may “conservatively” utilize nutrient reserves to buffer gametogenesis from environmental changes (Hawkins et al. 1985). These reserves may come from somatic tissues. Generally, gametogenesis is “opportunistic,” being supported by feeding alone (Hawkins et al. 1985).

The condition index for bivalves relates the proportion of the shell cavity that is occupied by soft body tissue. Such indices have been used to follow seasonal change in gross nutrient reserves or meat quality, as well as to monitor various pollutants (see Chapter 8) and diseases (Crosby and Gale 1990). In a comparison of various methods of determining the condition index, Crosby and Gale (1990) concluded that the gravimetric formulation

$$\text{Condition Index} = \left[\frac{\text{dry soft tissue wt(g)}}{1000/\text{internal shell cavity capacity(g)}} \right] \quad (4.12)$$

has less measuring errors, lower coefficients of variation, is the easiest and fastest to use, and is most meaningful as an index of current bivalve nutritive status and recent stress. These investigators stress the need for further investigations into the seasonal and age-dependent relationships between tissue/shell components and gravimetric condition indices in order to gain new insights into bivalve energetics.

GROWTH MODELS

Numerous models have been developed to describe the growth of individual organisms. The most useful models are those in which the components and constants have biological meaning, and a few of these will be reviewed here.

The simplest formulation is the monomolecular model

$$l_t = L_\infty (1 - e^{-kt}) \quad (4.13)$$

where l_t is the size at time t ; L_∞ is the maximum size; and k is a constant representing the rate at which maximum size is approached. In this model there is no inflection point, and growth rate declines linearly with increasing size. Maximum size can be determined from observed data or from a Walford plot (Walford 1946)

$$l_t = bL_t + 1 + a \quad (4.14)$$

where this linear relationship intercepts the no-size-change line is an estimate of maximum size. This function is often used to represent the later portions of life (Richards 1959).

The autocatalytic or logistic model

$$l_t = L_\infty / (1 - e^{-kt}) \quad (4.15)$$

produces a symmetrical or s-shaped curve about an inflection point. Its relative growth rate declines linearly with increasing size. This model has been used as a convenient empirical curve (Richards 1959).

The Gompertz model

$$\log l_t = \log L_\infty [1 - e^{-kt}] \quad (4.16)$$

resembles the logistic model, but is asymmetrical. Linear relations exist between its relative growth rate and $\log l$ and between $\log l$ and time.

The von Bertalanffy model (Bertalanffy 1957; also see the Bauer model in Brauckmann 1997)

$$l_t = L_\infty [1 - e^{-k(t - t_0)}] \quad (4.17)$$

in its general form includes all of the preceding models. This model has been favored by biologists because of this generality and its derivation from allometric and metabolic relationships with biological meaning (Figure 4.5).

RESPIRATION (R)

At the ecosystem level, respiration represents a measure of the energetic cost of supporting a given bivalve. Respiration is a unique component of the energy budget because it is entirely a loss term, and in nonequilibrium thermodynamics it can be used as a first estimate of entropy. The matter associated with respiration is recycled as CO_2 and water and energy is lost as waste heat to the environment. At the level of the organism, respiration represents all the work a bivalve must perform in order to survive. Finally, respiration is the most thoroughly and precisely measured process

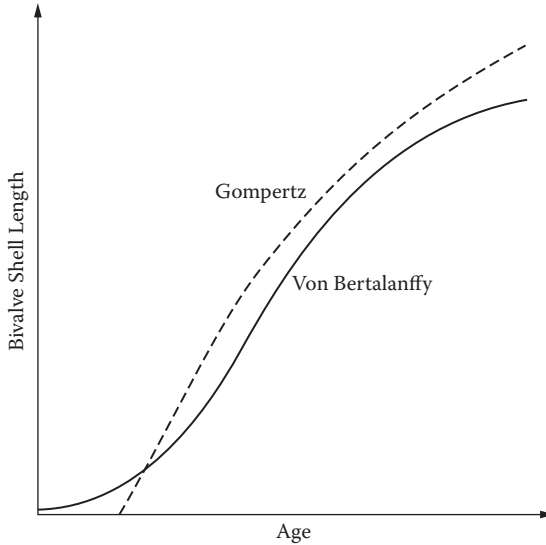

FIGURE 4.5 A generalized comparison of the Gompertz and von Bertalanffy growth curves in bivalves. (Modified from Dame, R.F. 1976. Energy flow in an intertidal oyster population. *Estuarine. Coast. Mar. Sci.*, 4, 243–53 and Dame, R.F. 1996. *Ecology of Marine Bivalves: An Ecosystem Approach*. Boca Raton, FL: CRC Press, 254 pp.)

in the energy budget. Because of this, there is an extensive body of knowledge and theory explaining respiration.

In bivalves, respiratory gas exchange between the water and the animal occurs primarily at the gill. The bivalve gill has a high surface area due to the folding of the tissues or demibranchs, and this feature increases the ability of the animal to exchange gases with the atmosphere. The demibranchs are also well supplied with blood vessels and this characteristic ensures the rapid movement of gases into and out of the bivalve. Last, large volumes of water are pumped or moved by the cilia on the gill. This action provides a constant renewal of water within the bivalve so that fresh water with higher oxygen levels is constantly provided and stale waters with higher waste gas concentrations are constantly flushed from the animal. Thus in addition to being the main feeding organ of filter feeders, the gill is also the main respiratory organ.

Aerobic respiration involves the utilization of organic carbon compounds as sources of matter and energy. In its most fundamental form:



Estimates of metabolism usually focus on the measurement of changes in one of the components of the preceding relationship. In actuality, oxygen concentration is the most commonly measured estimator although carbon dioxide and heat are also used. Once one component of the metabolic equation is known, the others can be calculated. If the organic carbon source is unknown or varying, then measurement of both oxygen and carbon dioxide allows the computation of the respiratory quotient (RQ) and thus an estimate of the type of carbon compounds being metabolized.

KLEIBER'S LAW

Kleiber's Law is named after animal physiologist Max Kleiber, a Swiss-trained member of the Animal Husbandry Department of the University of California at Davis. He was first known for his large chamber experiments investigating the energy metabolism of farm animals. From these studies he concluded that the body weight raised to the 3/4 power (0.75) was the most reliable basis for predicting the basal metabolic rate (BMR) in animals. His book *The Fire of Life* (Kleiber 1961) is considered a landmark in animal physiological ecology (Figure 4.6).

This law is the result of the merging of physics and geometry of animal circulatory systems. Young animals (small) respired or used more oxygen per unit weight than older (larger) animals of the same species. Thus oxygen consumption is directly related to the size of the bivalve by the allometric power function β

$$R = \alpha W^\beta \quad (4.19)$$

where R is oxygen uptake, W is the body weight of the bivalve, α is the intercept, and β is the slope. Surveys of respiration-to-weight relationships for many different animals, including bivalves (Hemmingsen 1960), found that the coefficient β is about 0.75. In bivalves, estimates of β may vary from 0.5 to 1.0, but Bayne et al. (1976) note that deviations from $\beta = 0.75$ are often attributed to a narrow size range in the observed animals. Kruger (1960) recommends a size range of 1:50 from smallest to largest individuals to provide reliable estimates of α and β .

Peters (1983) has made a number of points concerning the oxygen consumption to size relationship. First, the apparent constancy of the slope ($\beta = 0$) shows that the proportionality is unaffected by size. Second, the positive value of β means larger animals respire at higher rates than smaller individuals. Third, as $\beta < 1$ the metabolic rate rises more slowly than body size. Finally, the data are scattered, which suggests the relationship should not be interpreted as deterministic.

As metabolism is the summed energetic cost of an organism's life processes, the relationship between size and respiration should be reflected in other biological relationships. Thus the power function, $\beta = 3/4$, is often successful in describing scaling for other rates. This parallelism is called the principle of similitude (Thompson 1961). Although the surface law and dimensional analysis are most often given as the explanation for this allometric relationship, each has its problems (see Peters 1983) and there is no consensus.

Because most adult bivalves are relatively sessile in their benthic habitats, many of these animals are exposed to anaerobic as well as aerobic conditions. Hence bivalves are defined as facultative anaerobes, i.e., they can live aerobically or anaerobically, but preferentially use oxygen for respiration because of its higher efficiency in producing energy during intermediary metabolism (Zwaan and Mathieu 1992). Anaerobic conditions can occur in bivalves when they seal their valves during exposure at low tide or when their external environment has reduced oxygen concentration. In some cases, hydrothermal vents and some sediments, the bivalves live at the interface between aerobic and anaerobic environments and through the presence of symbiotic bacteria utilize inorganic compounds as energy sources. Some of these

Kleiber's Law

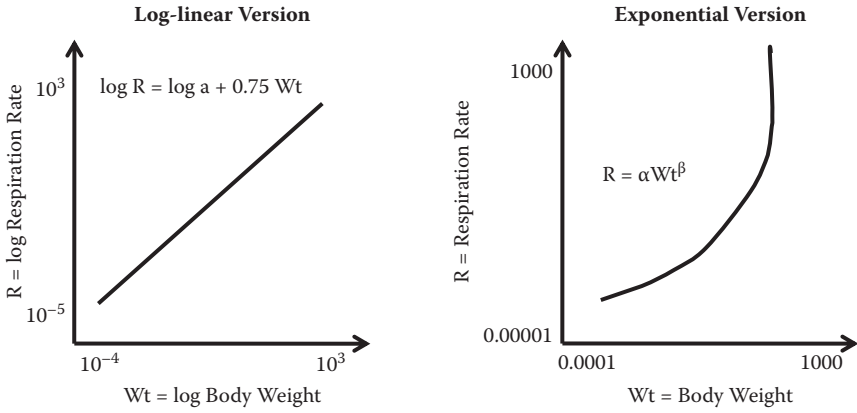

(a)

**Weight Specific Rate
(Energy Flow Density)**

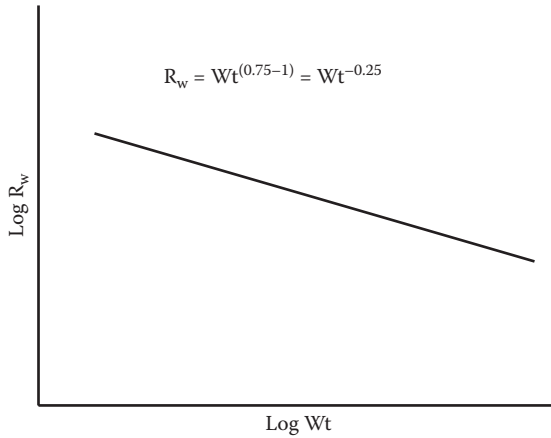

(b)

FIGURE 4.6 Kleiber's Law. (a) Log-linear version; (b) exponential version. (Modified from Dame, R.F. 1976. Energy flow in an intertidal oyster population. *Estuarine Coast. Mar. Sci.*, 4, 243–53 and Dame, R.F. 1996. *Ecology of Marine Bivalves: An Ecosystem Approach*. Boca Raton, FL: CRC Press, 254 pp.)

compounds, i.e., H_2S , are effective poisons to aerobic respiration by inhibiting cytochrome function and blocking O_2 uptake by hemoglobin.

Anaerobic metabolism is a normal part of the production of energy by metazoans. However, energy production through anaerobic metabolism is somewhat lower than through aerobic metabolism. In adult bivalves lacking red blood cells, the animal can switch between aerobic and anaerobic metabolism, depending on oxygen

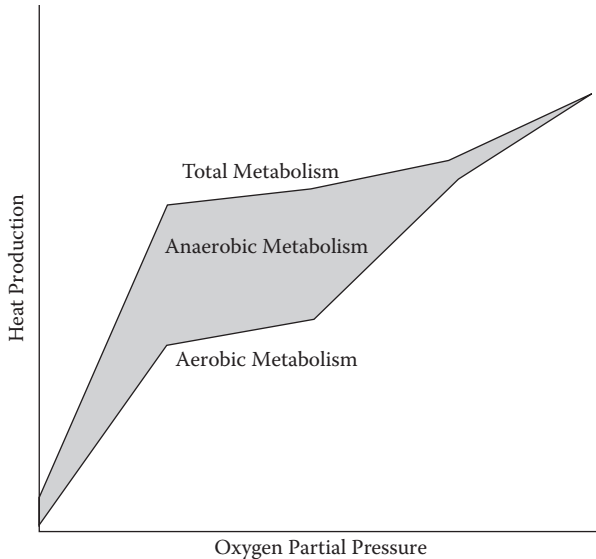

FIGURE 4.7 The general relationship between heat production, oxygen partial pressure, and aerobic, anaerobic, and total metabolism in bivalves. (Modified from Dame, R.F. 1976. Energy flow in an intertidal oyster population. *Estuarine Coast. Mar. Sci.*, 4, 243–53 and Dame, R.F. 1996. *Ecology of Marine Bivalves: An Ecosystem Approach*. Boca Raton, FL: CRC Press, 254 pp.)

concentrations in the environment (Mangum and Van Winkle 1973). There is an ecological advantage to switching to anaerobic metabolism. Anaerobic metabolism is reduced and this reduction lowers total metabolic activity and energy demand. In intertidal bivalves, feeding stops during low tide exposure; therefore, the carbon sources for metabolism are reduced and lower metabolism (anaerobic) is favored. Reduced metabolism and anaerobiosis during winter months are thought to be important factors in freezing temperature survival in *Geukensia* (Aarset 1982). In this case, anaerobic metabolism end products may act as antifreeze or cryoprotectant (Loomis et al. 1988).

While the determination of aerobic respiration through oxygen uptake is well known and developed, determination of anaerobic metabolism and total metabolism (aerobic + anaerobic) are less so. Anaerobic metabolism is often estimated indirectly by measuring anaerobic metabolic end products. Total metabolism (Figure 4.7) can be estimated by summing aerobic and anaerobic estimates or by directly measuring total heat production with a calorimeter (Shick et al. 1983). The heat production method was first used on invertebrates by Gnaiger (1977) and later applied to aerobic bivalves by Hammen (1979) and anaerobic bivalves by Hammen (1980) and Pamatmat (1979). The indirect approach to estimating anaerobic metabolism from end products in bivalves was led by Zwaan (1977) and others. Originally, it was thought that the direct production method produced a greater estimate of metabolism than could be accounted for by endproducts (Gnaiger 1980). However, later studies (Shick et al. 1983) showed that individual organism variability was large enough

to explain the discrepancy. Thus the indirect and direct methods of determining metabolism are comparable.

As noted earlier, oxygen consumption increases with bivalve size according to the power law ($b = 0.7$). The relationship between anaerobic heat production rate and bivalve body size is different with a $b = 1.0$ (Pamatmat 1979). In general, anaerobic metabolism for intertidal mussels is about 7.5% of aerobic metabolism (Pamatmat 1979).

EXCRETION

Marine bivalves produce excretory waste products as a result of incomplete digestion and metabolism. Thus various forms of carbon, nitrogen, phosphorus, and silicon can be found in the waste of bivalves. Three of these components, nitrogen, phosphorus, and silicon, are often limiting in marine environments and, for this reason, it is important that the flows and processes involving these constituents be understood (see Chapter 6).

While metabolic degradation of organic compounds takes place in all living tissues, the excretion of the end products of metabolism usually takes place via the kidneys and across tissue surfaces, particularly the gills. Both of these locations have high surface-to-volume ratios that allow maximum exchange across their surfaces. It has long been thought that filtration of the blood occurs in the pericardial coelom of bivalves, and the products of this filtration flow to the kidney where secretion and reabsorption take place (Martin and Harrison 1964).

Bivalve molluscs excrete nitrogen as a major end product of protein and nucleic acid metabolism. In studies using incubation chambers, ammonium is the major excretory product with urea, uric acid, purines, and free amino acids (FAA) in lesser amounts (Hammen 1980). However, recent studies using high performance liquid chromatography (HPLC), a technique that directly measures the net fluxes of metabolites during a single passage of natural sea water over a bivalve's gill, have shown that ammonia is the only nitrogenous waste product excreted by some bivalves (Hawkins and Bayne 1992).

Incubation techniques indicate that ammonia is the most common nitrogenous excretory product, varying from 37% to 78% of total nitrogen excreted by bivalves (Table 4.5). Some of the ammonia produced within the bivalves' tissues may be utilized to synthesize organic products, but there is always a surplus that is excreted to the external environment. It is unclear at this time whether the FAAs observed in incubation studies are the actual products of bivalves or other heterotrophs in the water of the chamber. At the ecosystem level of investigation, FAAs are often referred to as DON, or dissolved organic nitrogen.

Bayne et al. (1976) noted that the rates of nitrogen excretion are extremely variable, and this variability is probably due to marked seasonal changes in nutrient storage and utilization of reserves. There is evidence that organism size and feeding status together with environmental temperature, salinity, and exposure to air can all influence the rate of nitrogen excretion.

As with oxygen consumption, nitrogen excretion increases with bivalve size according to the following equation:

$$N = \alpha W^\beta \quad (4.20)$$

TABLE 4.5
Relative Percent of Total Nitrogen of Specific Excretion Products by Selected Marine Bivalves

| Species | %N | | | | Source |
|---------------------------------|-----------------|------|-------|-----------|---------------------------|
| | NH ₄ | Urea | FAA | Uric Acid | |
| <i>Crassostrea virginica</i> | 68 | 8 | 21 | 3 | Hammen (1980a & b) |
| <i>Donax serra</i> | 77 | 2 | 21 | – | Cockcroft (1990) |
| <i>Donax sordidus</i> | 78 | 1 | 22 | – | Cockcroft (1990) |
| <i>Mercenaria mercenaria</i> | 66 | – | 30 | 4 | Hammen (1980a & b) |
| <i>Geukensia demissus</i> | 64 | – | 36 | – | Hammen (1980a & b) |
| <i>Mytilus edulis</i> | 67–41 | 4 | 55 | – | Bayne and Scullard (1977) |
| <i>Mytilus galoprovincialis</i> | 58–37 | – | 42–63 | – | Bayne and Scullard (1977) |
| <i>Solemya velum</i> | 70 | – | 27 | 3 | Hammen (1980a & b) |
| <i>Tagelus plebius</i> | 50 | – | 31 | 19 | Hammen (1980a & b) |
| <i>Teredo navalis</i> | 55 | – | 10 | 35 | Hammen (1980a & b) |

where N is the rate of nitrogen excretion, W is the weight of the body, and α and β are coefficients (Hammen 1980). Normally, during starvation bivalves metabolize stored glycogen, but as these reserves are used up they are forced to increase protein catabolism as a source of energy (Bayne et al. 1976). In *Mytilus edulis*, ammonia excretion rises with temperature, but there is no acclimation (Bayne and Scullard 1977). Numerous investigators (see Bayne et al. 1976) have found that the rate of ammonia excretion increases as salinity decreases. These observations are supported by a review by Griffiths and Griffiths (1987) that found that the coefficients of the excretion–size relationship are strongly influenced by size, temperature, salinity, and exposure.

In their role as individual organisms, bivalves have been and are major components of most marine ecosystems because they can process large quantities of quality material and energy that they transform into complex structures and maximize entropy, while distancing themselves from thermodynamic equilibrium.

REFERENCES

- Aarset, A.V. 1982. Freezing tolerance in intertidal invertebrates. *Comp. Biochem. Physiol.*, 73A, 571–80.
- Abele, D., Brey, T., and Philipp, E. 2009. Bivalve models of aging and the determination of molluscan lifespans. *Exp. Gerontology*, 44, 307–15.
- Allen, J.A. and Sanders, H.L. 1966. Adaptations to abyssal life as shown by the bivalve *Abra profundorum*. *Deep Sea Res.*, 13, 1175–84.
- Andrews, J.D. 1961. Measurement of shell growth in oysters by weighing in water. *Proc. Natl. Shellfish. Assoc. Add.*, 52:6583.

- Atkins, D. 1938. On the ciliary mechanisms and interrelationships of lamellibranchs. VII. Laterofrontal cilia of the gill filaments and their phylogenetic value. *Q. J. Microsc. Sci.*, 80, 345–436.
- Baird, R.H. and Drinnan, R.E. 1956. The ratio of shell to meat in *Mytilus* as a function of tidal exposure to air. *J. Cons. Int. Explor. Mer*, 22, 329–36.
- Barille, L., Prou, J., Heral, M., and Razet, D. 1997. Effects of high natural seston concentrations on the feeding, selection and absorption of the oyster, *Crassostrea gigas*. *J. Exp. Mar. Biol. Ecol.*, 212, 149–72.
- Bayne, B.L., 2004. Comparisons of measurements of clearance rates in bivalve molluscs. *Mar. Ecol. Prog. Ser.*, 276, 305–6.
- Bayne, B.L., Bayne, C.J., Carefoot, T.C., and Thompson, R.J. 1976. The physiological ecology of *Mytilus californianus*, Conrad, 2 metabolism and energy balance. *Oecologia*, 22, 211–28.
- Bayne, B.L., Hawkins, A.J.S., and Navarro, E. 1988. Feeding and digestion in suspension-feeding bivalve molluscs: The relevance of physiological compensations. *Am. Zool.*, 28, 147–59.
- Bayne, B.L., Hawkins, A.J.S., Navarro, E., and Inglesias, I.P. 1989. Effects of seston concentration on feeding, digestion, and growth in the mussel *Mytilus edulis*. *Mar. Ecol. Prog. Ser.*, 55, 47–54.
- Bayne, B.L. and Newell, R.C. 1983. Physiological energetics of marine molluscs. In *The Mollusca*, Vol. 4, Saleuddin, A.S.M. and Wilbur, K.M., Eds. New York: Academic Press, pp. 407–515.
- Bayne, B.L. and Scullard, C. 1977. Rates of nitrogen excretion by species of *Mytilus*. *J. Mar. Biol. Assoc. U.K.*, 57, 355–69.
- Bayne, B.L. and Svensson, S. 2006. Seasonal variability in feeding behavior, metabolic rates, and carbon and nitrogen balances in the Sydney oyster, *Saccostrea glomerata* (Gould). *J. Exp. Mar. Biol. Ecol.*, 332, 12–26.
- Bayne, B.L., Thompson, R.J., and Widdows, J. 1976. Physiology I. In *Marine Mussels: Their Ecology and Physiology*, Bayne, B.L., Ed. New York: Cambridge University Press, pp. 121–206.
- Bayne, B.L. and Worrall, C.M. 1980. Growth and production of mussels (*Mytilus edulis*) from two populations. *Mar. Ecol. Prog. Ser.*, 3, 317–28.
- Begum, S., Basova, L., Heilmayer, O., Philipp, E.R., Abele, D., and Brey, T. 2010. Growth and energy budget models of the bivalve *Arctica islandica* at six different sites in the Northeast Atlantic Realm. *J. Shellfish Res.*, 29(1), 107–15.
- Belda, C.A., Lucas, J.S., and Yellowlees, D. 1993. Nutrient limitation in the giant clam–zooxanthellae symbiosis: Effects of nutrient supplements on growth of the symbiotic partners. *Mar. Biol.*, 117, 655–64.
- Bender, K. and Davis, W.R. 1984. The effects of feeding by *Yoldia limatula* on bioturbation. *Ophelia*, 23, 91–100.
- Bertalanffy, L. von. 1957. Quantitative laws in metabolism and growth. *Q. Rev. Biol.*, 32, 215–31.
- Birkbeck, T.H. and McHenry, J.G. 1982. Degradation of bacteria by *Mytilus edulis*. *Mar. Biol.*, 72, 7–15.
- Brauckmann, S. 1997. The organism and the open system: Ervin Bauer and Ludwig von Bertalanffy. *Ann. N.Y. Acad. Sci.*, 901, 291–300.
- Buxton, C.D., Newell, R.C., and Field, J.G. 1981. Response-surface analysis of the combined effects of exposure and acclimation temperatures on filtration, oxygen consumption and scope for growth in the oyster *Ostrea edulis*. *Mar. Ecol. Prog. Ser.*, 6, 73–82.
- Calow, P. 1975. The feeding strategies of two freshwater gastropods, *Ancylus fluviatilis* and *Planorbis contortus*, with a comparison of field and laboratory estimates of food absorption rate. *Oecologia*, 20, 51–63.

- Calow, P. and Fletcher, C.R. 1972. A new radiotracer technique involving ^{14}C and ^{51}Cr for estimating the assimilation efficiency of aquatic primary producers. *Oecologia*, 9, 155–70.
- Chaisson, E.J. 2001. *Cosmic Evolution: The Rise of Complexity in Nature*. Cambridge, MA: Harvard University Press, 275 pp.
- Clark, G.R. 1968. Mollusc shell: Daily growth lines. *Science*, 161, 800–3.
- Clark, G.R. 1974. Growth lines in invertebrate skeletons, *Annu. Rev. Earth Planet. Sci.*, 2, 77–99.
- Cockcroft, A.C. 1990. Nitrogen excretion by the surf zone bivalves *Donax serra* and *D. Sordidus*. *Mar. Ecol. Prog. Ser.*, 60, 57–65.
- Coughlan, J. 1969. The estimation of filtering rate from the clearance of suspensions. *Mar. Biol.*, 2, 356–58.
- Coughlan, J. and Ansell, A.D. 1964. A direct method for determining the pumping rate of siphonate bivalves. *J. du Council. Int. Explor Mer*, 29, 205–13.
- Craig, G.Y. and Oertel, G. 1966. Deterministic model of living and fossil populations of animals. *Q. J. Geol. Soc. Lond.*, 122, 315–55.
- Crisp, D.J. 1984. Energy flow measurements. In *Methods for the Study of Marine Benthos, IBP Handbook 16*, Holme, N.A. and McIntyre, A.D., Eds. Oxford: Blackwell Scientific, pp. 285–369.
- Crosby, M.P. 1987. *Utilization of Detrital Complexes by the Oyster Crassostrea virginica (Gmelin)*, PhD thesis, College Park, MD: University of Maryland.
- Crosby, M.P. and Gale, L.D. 1990. A review and evaluation of bivalve condition index methodologies with a suggested standard method. *J. Shellfish Res.*, 9, 233–37.
- Crosby, M.P., Langdon, C.J., and Newell, R.I.E. 1989. Importance of refractory plant material to the carbon budget of the oyster *Crassostrea virginica*. *Mar. Biol.*, 100, 343–52.
- Crosby, M.P. and Newell, R.I.E. 1990. Bacterial mediation in the utilization of carbon and nitrogen from detrital complexes by *Crassostrea virginica*. *Limnol. Oceanogr.*, 35, 625–39.
- Crosby, N.D. and Reid, R.G.B. 1971. Relationships between food, phylogeny, and cellulose digestion in the bivalvia. *Can. J. Zool.*, 49, 617–22.
- Dame, R.F. 1972. The ecological energies of growth, respiration and assimilation in the intertidal American oyster, *Crassostrea virginica*. *Mar. Biol.*, 17, 243–50.
- Dame, R.F. 1976. Energy flow in an intertidal oyster population. *Estuarine Coast. Mar. Sci.*, 4, 243–53.
- Dame, R.F. 1996. *Ecology of Marine Bivalves: An Ecosystem Approach*. Boca Raton, FL: CRC Press, 254 pp.
- Davenport, J., Rowan, J., Smith, W., and Packer, M. 2000. Mussels *Mytilus edulis*: Significant consumers and destroyers of mesozooplankton. *Mar. Ecol. Prog. Ser.*, 198, 131–37.
- Dillon, J.F. and Clark, G.R. 1980. Growth-line analysis as a test for contemporaneity in populations. In *Skeletal Growth of Aquatic Organisms*, Rhoads, D.C. and Lutz, R.A., Eds. New York: Plenum Press, pp. 395–415.
- Doering, P.H. and Oviatt, D.A. 1986. Application of filtration rate models to field populations of bivalves: An assessment using experimental mesocosms. *Mar. Ecol. Prog. Ser.*, 31, 265–75.
- Fankboner, P.V. and Reid, R.G.B. 1990. Nutrition in giant clams (*Tridacnidae*). In *The Bivalvia—Proceedings of a Memorial Symposium. in Honour of Sir Charles Maurice Yonge, Edinburgh, 1986*. Morton, B., Ed. Hong Kong: Hong Kong University Press, 195–209.
- Fiala-Medioni, A., Alayse, A.M., and Cachet, G. 1986. Evidence of *in situ* uptake and incorporation of bicarbonate and amino acids by the hydrothermal vent mussel. *J. Exp. Mar. Biol. Ecol.*, 96, 191–98.

- Filgueira, R., Labarta, U., and Fernandez-Reiriz, M.J. 2006. Flow-through chamber method for clearance rate measurements in bivalves: Design and validation of individual chambers and mesocosm. *Limnol. Ocean. Methods*, 4, 284–92.
- Fisher, C.R. 1990. Chemoautotrophic and methanotrophic symbioses in marine invertebrates. *Rev. Aquat. Sci.*, 2, 399–436.
- Fisher, C.R., Fitt, W.K., and Trench, R.K. 1985. Photosynthesis and respiration in *Tridacna gigas* as a function of irradiance and size. *Biol. Bull.*, 169, 230–45.
- Fitt, W.K., Rees, T.A.V., Braley, R.D., Lucas, J.S., and Yellowlees, D. 1993. Nitrogen flux in giant clams: Size-dependency and relationship to zooxanthellae density and clam biomass in the uptake of dissolved inorganic nitrogen. *Mar. Biol.*, 117, 381–86.
- Fitt, W.K. and Trench, R.K. 1981. Spawning, development, and acquisition of zooxanthellae by *Tridacna squamosa*. *Biol. Bull.*, 161, 213–35.
- Foster-Smith, R.L. 1976. Some mechanisms for the control of pumping activity in bivalves. *Mar. Behav. Physiol.*, 4, 41–60.
- Fox, D., Sverdrup, H.U., and Cunningham, J.P. 1937. The rate of water propulsion by the California mussel. *Biol. Bull.*, 72, 417–38.
- Gnaiger, E. 1977. Thermodynamic considerations of invertebrate anoxybiosis. In *Applications of Calorimetry in Life Sciences*, Lamprecht, I. and Schaarschmidt, B., Eds. Berlin: Walter de Gruyter, 281–303.
- Gnaiger, E. 1980. Energetics of invertebrate anoxybiosis: Direct calorimetry in aquatic oligochaetes. *FEBS Letts.*, 112, 239–42.
- Gordon, J. and Carriker, M.R. 1978. Growth lines in bivalve mollusk: Subdaily patterns and dissolution of the shell. *Science*, 202, 519–21.
- Goreau, T.F., Goreau, N.I., and Yonge, C.M. 1973. On the utilization of photosynthetic products from zooxanthellae and of a dissolved amino acid in *Tridacna maxima*. *J. Zool. Lond.*, 169, 417–54.
- Grave, C. 1916. The process of feeding in the oyster. *Science*, 44, 178–81.
- Griffiths, C.L. and Griffiths, R.J. 1987. Bivalvia. In *Animal Energetics*, Pandian, T.J. and Vernberg, F.J., Eds. New York: Academic Press, pp. 1–88.
- Griffiths, C.L. and King, J.A. 1979. Some relationships between size, food availability and energy balance in the ribbed mussel *Aulacomya ater*. *Mar. Biol.*, 51, 141–49.
- Hammen, C.S. 1979. Metabolic rates of marine bivalve molluscs determined by calorimetry. *Comp. Biochem. Physiol.*, 62A, 955–59.
- Hammen, C.S. 1980a. Total energy metabolism of marine bivalve mollusks in anaerobic and aerobic states. *Comp. Biochem. Physiol.*, 67A, 617–21.
- Hammen, C.S. 1980b. *Marine Invertebrates: Comparative Physiology*. Hanover, NH: University Press of New England, 127 pp.
- Harger, J.R.E. 1970. The effect of wave impact on some aspects of the biology of sea mussels. *Veliger*, 12, 401–14.
- Hartwell, S., Wright, D., Takars, R., and Hocutt, C. 1991. Relative respiration and feeding rates of oyster and brackish water clams in variously contaminated waters. *Mar. Pollut. Bull.*, 22, 191–97.
- Haven, D.S. and Morales-Alamo, R. 1970. Filtration of particles from suspension by the American oyster *Crassostrea virginica*. *Biol. Bull.*, 139, 248–64.
- Havinga, B. 1928. The daily rate of growth of oysters during summer. *J. Cons.*, 3, 231–45.
- Hawkins, A.J.S. and Bayne, B.L. 1992. Physiological interrelations, and the regulation of production. In *The Mussel Mytilus: Ecology, Physiology, Genetics and Culture*, Gosling, E., Ed. Amsterdam: Elsevier, pp. 171–222.
- Hawkins, A.J.S. and Klumpp, D.W. 1995. Nutrition of the giant clam *Tridacna gigas* (L.). II. Relative contributions of filter-feeding and ammonium-nitrogen acquired and recycled by symbiotic alga toward total nitrogen requirements for tissue growth and metabolism. *J. Exp. Mar. Biol. Ecol.*, 190, 263–90.

- Hawkins, A.J.S., Salkeld, P.N., Bayne, B.L., Gnaiger, E., and Lowe, D.M. 1985. Feeding and resource allocation of the mussel *Mytilus edulis*: Evidence for time-averaged optimization. *Mar. Ecol. Prog. Ser.*, 20, 273–87.
- Hawkins, A.J.S., Smith, R.F.M., Bayne, B.L., and Heral, M. 1996. Novel observations underlying the fast growth of suspension-feeding shellfish in turbid environments: *Mytilus edulis*. *Mar. Ecol. Prog. Ser.*, 131, 179–90.
- Hemmingsen, A.M. 1960. Energy metabolism as related to body size and respiratory surfaces and its evolution. *Rep. Steno. Mem. Hosp.*, 4, 7–58.
- Hildreth, D.I. and Crisp, D.J. 1976. A corrected formula for calculation of filtration rate of bivalve molluscs in an experimental flowing system. *J. Mar. Biol. Assoc. U.K.*, 56, 111–20.
- House, M.R. and Farrow, G.E. 1968. Daily growth banding in the shell of the cockle *Cardium edule*. *Nature*, 219, 1384–86.
- Hughes, R.N. 1969. A study of feeding in *Scrobicularia plana*. *J. Mar. Biol. Assoc. U.K.*, 49, 805–23.
- Hughes, R.N. 1980. Optimal foraging in the marine context. *Oceanogr. Mar. Biol. Annu. Rev.*, 18, 423–81.
- Hylleberg, J. and Gallucci, V. 1975. Selectivity in feeding by the deposit bivalve *Macoma nasuta*. *Mar. Biol.*, 32, 167–78.
- Jones, H.D., Richards, O.G., and Southern, T.A. 1992. Gill dimensions, water pumping rate and body size in the mussel *Mytilus edulis* L. *J. Exp. Mar. Biol. Ecol.*, 155, 213–37.
- Jørgensen, C.B. 1966. *Biology of Suspension Feeding*. Oxford: Pergamon Press, 357 pp.
- Jørgensen, C.B. 1990. *Bivalve Filter Feeding: Hydrodynamics, Bioenergetics, Physiology, and Ecology*. Fredensborg, Denmark: Olsen and Olsen, 140 pp.
- Jørgensen, C.B., Larsen, P.S., Møhlenberg, F., and Riisgård, H.U. 1986. The bivalve pump. *Mar. Ecol. Prog. Ser.*, 34, 69–77.
- Jumars, P., Self, R.F.L., and Nowell, A.R.M. 1982. Mechanics of particle selection by tentaculate deposit-feeders. *J. Exp. Mar. Biol. Ecol.*, 64, 47–70.
- Kauffman, E.G. and Sohl, N.F. 1974. Structure and evolution of Cretaceous Rudist frameworks. *Verh. Naturforsch. Ges.*, 84, 399–467.
- Kenk, V.C. and Wilson, B.R. 1985. A new mussel (*Bivalvia, Mytilidae*) from hydrothermal vents in the Galapagos Rift zone. *Malacologia*, 26, 253–77.
- Kinne, O. 1964. The effects of temperature and salinity on marine and brackish-water animals. II. Salinity and temperature-salinity combinations. *Oceanogr. Mar. Biol. Annu. Rev.*, 2, 281–339.
- Kjørboe, T. and Møhlenberg, F. 1981. Particle selection in suspension-feeding bivalves. *Mar. Ecol. Prog. Ser.*, 5, 291–6.
- Kjørboe, T., Møhlenberg, F., and Nøhr, O. 1981. Effect of suspended bottom material on growth and energetics in *Mytilus edulis*. *Mar. Biol.*, 61, 283–88.
- Kleiber, M. 1961. *The Fire of Life*. New York: Wiley.
- Kleidon, A., Malhi, Y., and Cox, P.M. 2010. Maximum entropy production in environmental and ecological systems. *Phil. Trans. R. Soc. B*, 365, 1297–302.
- Klumpp, D.W., Bayne, B.L., and Hawkins, A.J.S. 1992. Nutrition in the giant clam *Tridacna gigas* (L.). I. Contribution of filter feeding and photosynthates to respiration and growth. *J. Exp. Mar. Biol. Ecol.*, 155, 105–22.
- Klumpp, D.W., and Griffiths, C.L. 1994. Contributions of phototrophic and heterotrophic nutrition to the metabolic and growth requirements of four species of giant clams (Tridacnidae). *Mar. Ecol. Prog. Ser.*, 115, 103–15.
- Kreeger, D.A., Langdon, C.J., and Newell, R.I.E. 1988. Utilization of refractory cellulosic carbon derived from *Spartina alterniflora* by the ribbed mussel *Geukensia demissa*. *Mar. Ecol. Prog. Ser.*, 42, 171–79.

- Kruger, F. 1960. Zur Frage der Grossenabhangigkeit des Sauerstoff verbrachs von *Mytilus edulis*. *Helgo. Wiss. Meeresunters.*, 7, 125–48.
- Langdon, C.J. and Newell, R.I.E. 1990. Utilization of detritus and bacteria as food sources by two bivalve suspension-feeders, the oyster *Crassostrea virginica* and the mussel *Geukensia demissa*. *Mar. Ecol. Prog. Ser.*, 58, 299–310.
- Lehane, C. and Davenport, J. 2004. Ingestion of bivalve larvae by *Mytilus edulis*: Experimental and field demonstrations of larviphagy in farmed blue mussels. *Mar. Biol.*, 145, 101–7.
- Le Pennec, M. and Prieur, D. 1984. Observations sur la nutrition d'un *Mytilidae* d'un site hydrothermal actif de la dorsale du Pacifique Oriental. *C.R. Acad. Sci. Paris Ser. III*, 298, 493–500.
- Levinton, J.S. 1982. *Marine Ecology*. Englewood Cliffs, NJ: Prentice Hall, 526 pp.
- Loomis, S.H., Carpenter, J.F., and Crowe, J.H. 1988. Identification of strombine and taurine as cryoprotectants in the intertidal bivalve *Mytilus edulis*. *Biochim. Biophys. Acta*, 943, 113–18.
- Lopez, G.R. and Crenshaw, M.A. 1982. Radiolabelling of sedimentary organic matter with ¹⁴C-formaldehyde: Preliminary evaluation of a new technique for use in deposit-feeding studies. *Mar. Ecol. Prog. Ser.*, 8, 283–89.
- Lopez, G.R. and Levinton, J.S. 1987. Ecology of deposit-feeding animals in marine sediments. *Q. Rev. Biol.*, 62, 235–60.
- Lutz, R.A. and Rhoads, D.C. 1977. Anaerobiosis and a theory of growth line formation. *Science*, 198, 1222–27.
- Lutz, R.A. and Rhoads, D.C. 1980. Growth patterns within the molluscan shell. In *Skeletal Growth of Aquatic Organisms*, Rhoads, D.C. and Lutz, R.A., Eds. New York: Plenum Press, pp. 203–54.
- Mangum, C. and Van Winkle, W. 1973. Responses of aquatic invertebrates to declining oxygen conditions. *Am. Zool.*, 13, 529–41.
- Martin, A.W. and Harrison, F.M. 1964. Excretion. In *Physiology of Mollusca*, Wilbur, K.M. and Yonge, C.M., Eds. New York: Academic Press, pp. 353–86.
- McLusky, D.S. 1973. The effect of temperature on the oxygen consumption and filtration rate of *Chlamys (Aequipecten) perculans*. *Ophelia*, 10, 114–54.
- Møhlenberg, F. and Riisgård, H.U. 1978. Efficiency of particle retention in 13 species of suspension feeding bivalves. *Ophelia*, 17, 238–46.
- Moore, H.F. 1910. Volumetric studies of the food and feeding of oysters. *Bull. U.S. Bure. Fish.*, 27, 1297–308.
- Morse, D.C. 1944. Some observations on the food and feeding of oysters in Chesapeake Bay. *Proc. Natl. Shellfish Assoc.*, 55, 17–19.
- Morton, B. 1978. Feeding and digestion in shipworms. *Oceanogr. Mar. Biol. Annu. Rev.*, 16, 107–44.
- Muscatine, L. 1967. Glycerol excretion by symbiotic algae from corals and *Tridacna* and its control by the host. *Science*, 156, 516–19.
- Navarro, J.M. and Winter, J.E. 1982. Ingestion rate, assimilation efficiency and energy balance in *Mytilus chilensis* in relation to body size and different algal concentrations. *Mar. Biol.*, 67, 255–66.
- Newell, R.C. 1965. The role of detritus in the nutrition of two marine deposit feeders, the prosobranch *Hydrobia ulvae* and the bivalve *Macoma balthica*. *Proc. Zool. Soc. Lond.*, 144, 25–45.
- Newell, R.C. and Field, J.G. 1983. The contribution of bacteria and detritus to carbon and nitrogen flow in a benthic community. *Mar. Biol. Lett.*, 4, 23–36.
- Newell, R.I.E. and Langdon, C.J. 1996. Mechanisms and physiology of larval and adult feeding. In *The Eastern Oyster, Crassostrea virginica*, Eble, A., Kennedy, V.S., and Newell, R.I.E., Eds. Maryland: Maryland Sea Grant Publications, pp. 185–229.

- Nielson, N.F., Larsen, P.S., Riisgård, H.U., and Jørgensen, C.B. 1993. Fluid motion and particle retention in the gill of *Mytilus edulis*. Video recordings and numerical modelling. *Mar. Biol.*, 116, 61–71.
- Palmer, R. and Williams, L.G. 1980. Effect of particle concentration on filtration efficiency of the Bay Scallop *Argopecten irradians* and the oyster *Crassostrea virginica*. *Ophelia*, 19, 163–74.
- Pamatmat, M.M. 1979. Anaerobic heat production of bivalves (*Polymesoda caroliniana* and *Modiolus demissus*) in relation to temperature, body size, and duration of anoxia. *Mar. Biol.*, 53, 223–29.
- Peters, R.H. 1983. *The Ecological Implications of Body Size*. New York: Cambridge University Press, 329 pp.
- Petersen, J.K. 2004. Method for measurement of bivalve clearance rate—Hope for common understanding. *Mar. Ecol. Prog. Ser.*, 276, 309–10.
- Petersen, J.K., Bougrier, S., Smaal, A.C., Garen, P., Robert, S., Larsen, J.E.N., and Brummelhuus, E. 2004. Intercalibration of mussel *Mytilus edulis* clearance rate measurements. *Mar. Ecol. Prog. Ser.*, 267, 187–94.
- Peterson, B.J., Howarth, R.W., and Garritt, R.H. 1985. Multiple stable isotopes used to trace the flow of organic matter in estuarine food webs. *Science*, 227, 1361–63.
- Philipp, E.E.R. and Abele, D. 2009. Masters of longevity: Lessons from long-lived bivalves—A mini-review. *Gerontology*, 56, 55–65.
- Porter, J.W. 1980. Primary productivity in the sea, reef corals *in situ*. *Brookhaven Symp. Biol.*, 31, 403–10.
- Price, T.J., Ghayer, G.W., LaCroix, M.W., and Roberts, T.G. 1970. The organic content of shells, tissues and pallial fluid of some estuarine molluscs and its ecological implication. *Annu. Rep. Beaufort Fish. Lab.*, 186–90.
- Priour, D. 1981. Experimental studies of trophic relationships between marine bacteria and bivalve molluscs, *Kieler Meeresforsch. Sonderh.*, 5, 376–83.
- Putter, A. 1909. *Die Ernährung der Wassertiere and der Stoffhaushalt der Gewässer*. Jena: Fisher.
- Rao, K.P. 1953. Shell weight as a function of intertidal height in a littoral population of pelecypods. *Experientia*, 9, 465–68.
- Reid, R.G.B. 1980. Aspects of the biology of a gutless species of *Solemya* (Bivalvia: Protobranchia). *Can. J. Zool.*, 58, 386–93.
- Reid, R.G.B. and Brand, D.G. 1986. Sulfide-oxidizing symbiosis in Lucinaceans: Implications for bivalve evolution. *Veliger*, 29, 3–24.
- Reid, R.G.B., Fankboner, P.V., and Brand, D.G. 1984. Studies on the physiology of the giant clam *Tridacna gigas*. I. Feeding and digestion. *Comp. Biochem. Physiol.*, 78A, 95–101.
- Rhoads, D.C. and Pannella, G. 1970. The use of molluscan shell growth patterns in ecology and paleoecology. *Lethaia*, 3, 143–61.
- Rice, M.A. and Stephens, G.C. 1987. Uptake and internal distribution of exogenously supplied amino acids in the Pacific oyster *Crassostrea gigas*. *Aquaculture*, 66, 19–31.
- Richards, F.J. 1959. A flexible growth function for empirical use. *J. Exp. Bot.*, 10, 290–300.
- Riisgård, H.U. 2001. On measurement of filtration rates in bivalves—The stony road to reliable data: Review and interpretation. *Mar. Ecol. Prog. Ser.*, 211, 175–291.
- Riisgård, H.U. 2004. Intercalibration of methods for measurement of bivalve filtration rates—A turning point. *Mar. Ecol. Prog. Ser.*, 276, 307–8.
- Rubenstein, D.I. and Koehl, M.A.R. 1977. The mechanisms of filter feeding: Some theoretical considerations. *Am. Nat.*, 111, 981–94.
- Schöne, B.R., Fiebig, J., Pfeiffer, M., Gless, R., Hickson, J., Johnson, A., Dreyer, W., Oshmann, W. 2005. Climate records from a bivalve Methuselah (*Arctica icelandica*; Iceland). *Paleogeogra., Paleoclimatol., Paleoecol.*, 228, 130–48.

- Seed, R. 1976. Ecology. In *Marine Mussels: Their Ecology and Physiology*, Bayne, B.L., Ed. New York: Cambridge University Press, pp. 13–65.
- Seed, R. and Suchanek, T.H. 1992. Population and community ecology of *Mytilus*. In *The Mussel Mytilus: Ecology, Physiology, Genetics and Culture*, Gosling, E., Ed. Amsterdam: Elsevier, pp. 87–169.
- Seiderer, L.J., Davis, C.L., Robb, F.T., and Newell, R.C. 1984. Utilisation of bacteria as nitrogen resource by kelp-bed mussel *Choromytilus meridionalis*. *Mar. Ecol. Prog. Ser.*, 15, 109–16.
- Sherr, E.B., Sherr, B.F., Fallon, R.D., and Newell, S.Y. 1990. Small aloricate ciliates as a major component of the marine heterotrophic nanoplankton. *Limnol. Oceanogr.*, 37, 177–84.
- Shick, J.M., Zwaan, A. de, and Bont, A.M. de. 1983. Anoxic metabolic rate in the mussel *Mytilus edulis* estimated by simultaneous direct calorimetry and biochemical analysis. *Physiol. Zool.*, 56, 56–63.
- Shumway, S.E., Cucci, R.C., Newell, R.C., and Yentsch, C.M. 1985. Particle selection, ingestion, and absorption in filter-feeding bivalves. *J. Exp. Mar. Biol. Ecol.*, 91, 77–92.
- Sleigh, M.A. and Aiello, E. 1972. The movement of water by cilia. *Acta Protozool.*, 11, 265–77.
- Stephens, G.C. 1982. Recent progress in the study of “Die Ernährung der Wassertiere und der Stoffhaushalt der Gewässer.” *Am. Zool.*, 22, 611–19.
- Strahl, J., Philipp, E., Brey, T., Broeg, K., and Abele, D. 2007. Physiological aging in the Icelandic population of the ocean quahog *Arctica islandica*. *Aquatic Bio.*, 1, 77–83.
- Stuart, V., Field, J.G., and Newell, R.C. 1982. Evidence for absorption of kelp detritus by mussel *Aulacomya ater* using a new ⁵¹Cr-labeled microsphere technique. *Mar. Ecol. Prog. Ser.*, 9, 263–71.
- Surge, D.M., Lohmann, K.C., and Goodfriend, G.A. 2003. Reconstructing estuarine conditions: Oyster shells as recorders of environmental change, Southwest Florida. *Estuaries Coast. Shelf Sci.*, 57, 737–56.
- Taghon, G.L. and Jumars, P.A. 1984. Variable ingestion rate and its role in optimal foraging behavior of marine deposit feeders. *Ecology*, 65, 549–58.
- Thompson, D.W. 1961. *On Growth and Form*. New York: Cambridge University Press.
- Thompson, R.J. 1979. Fecundity and reproductive effort of the blue mussel (*Mytilus edulis*), the sea urchin (*Strongylocentrotus droebachiensis*) and the snow crab (*Chionectes opal*) from populations in Nova Scotia and Newfoundland. *J. Fish. Res. Board Can.*, 36, 955–64.
- Trench, R.K., Wethey, D.S., and Porter, J.W. 1981. Observations on the symbiosis with zooxanthellae among the Tridacnidae. *Biol. Bull.*, 161, 180–98.
- Troost, K., Kamermans, P., and Wolff, W.J. 2008. Larviphagy in native and an introduced oyster. *J. Sea Res.*, 60, 157–63.
- Vahl, O. 1972. Efficiency of particle retention in *Mytilus edulis*. *Ophelia*, 10, 17–25.
- van Erkom Schurink, C. and Griffiths, C.L. 1992. Physiological energetics of four South African mussel species in relation to body size, ration and temperature. *Comp. Biochem. Physiol.*, 101A, 779–89.
- Walford, L.A. 1946. A new graphic method of describing the growth of animals. *Biol. Bull.*, 90, 141–47.
- Ward, J.E., MacDonald, B.A., Thompson, R.J., and Beninger, P.G. 1993. Mechanisms of suspension feeding in bivalves: Resolution of current controversies by means of endoscopy. *Limnol. Oceanogr.*, 38, 265–72.
- Ward, J.E., Newell, R.I.E., Thompson, R.J., and MacDonald, B.A. 1994. *In vivo* studies of suspension-feeding processes in the Eastern oyster, *Crassostrea virginica* (Gmelin). *Biol. Bull.*, 186, 221–40.
- Warren, C.E. and Davis, G.E. 1967. Laboratory studies on the feeding bioenergetics and growth of fish. In *The Biological Basis of Freshwater Fish Production*, Gerking, S.D., Ed. Oxford: Blackwell Scientific, pp. 175–214.

- Waterbury, J.B., Turner, R.D., and Calloway, C.B. 1983. A cellulolytic nitrogen-fixing bacterium cultured from the gland of *Deshayes* in shipworms. *Science*, 221, 1401–3.
- Widdows, J. 1976. Physiological adaptation of *Mytilus edulis* to cyclic temperatures. *J. Comp. Physiol.*, 105, 115–28.
- Widdows, J. and Bayne, B.L. 1971. Temperature acclimation of *Mytilus edulis* with reference to its energy budget. *J. Mar. Biol. Assoc. U.K.*, 51, 827–43.
- Widdows, J. and Johnson, D. 1988. Physiological energetics of *Mytilus edulis*: Scope for growth. *Mar. Ecol. Prog. Ser.*, 46, 113–21.
- Wilbur, K.M. 1964. Shell formation and regeneration. In *Physiology of Mollusca*, Wilbur, K.M. and Yonge, C.M., Eds. New York: Academic Press, pp. 243–82.
- Wilbur, K.M. and Saleuddin, S.M. 1983. Shell formation. In *The Mollusca, Vol. 4, Physiology, Part 1*, Saleuddin, S.M. and Wilbur, K.M., Eds. New York: Academic Press, pp. 236–87.
- Wilkerson, F.P. and Trench, R.K. 1986. Uptake of dissolved inorganic nitrogen by the symbiotic clam *Tridacna gigas* and the coral *Acropora*. *Mar. Biol.*, 93, 237–46.
- Williams, L.G. 1982. Mathematical analysis of the effects of particle retention efficiency on determination of filtration rate. *Mar. Biol.*, 66, 171–77.
- Willows, R.I. 1992. Optimal digestive investments: A model for filter feeders experiencing variable diets. *Limnol. Oceanogr.*, 37, 829–47.
- Winter, J.E. 1969. Über den Einfluss der Nahrungskonzentration und anderer Faktoren auf Filtrierleistung und Muscheln *Arctica islandica* und *Modiolus modiolus*. *Mar. Biol.*, 4, 87–135.
- Winter, J.E. 1970. Filter feeding and food utilization in *Arctica islandica* and *Modiolus modiolus* at different food concentrations. In *Marine Food Chains*, Steele, J.H., Ed. Edinburgh: Oliver and Boyd, pp. 196–206.
- Winter, J.E. 1973. The filtration rate of *Mytilus edulis* and its dependence on algal concentration measured by a continuous automatic recording apparatus. *Mar. Biol.*, 22, 317–28.
- Winter, J.E. 1978. A review on the knowledge of suspension-feeding in lamellibranchiate bivalves, with special reference to artificial aquaculture systems. *Aquaculture*, 13, 1–33.
- Wright, R.T., Coffin, R.B., Ersing, C.P., and Pearson, D. 1982. Field and laboratory measurements of bivalve filtration of natural marine bacterioplankton. *Limnol. Oceanogr.*, 27, 91–98.
- Wright, S.H. 1982. A nutritional role for amino acid transport in filter-feeding marine invertebrates. *Am. Zool.*, 22, 621–34.
- Wright, S.H. 1985. Mechanism and physiological role of epidermal amino acid transport in marine bivalves. In *Comparative Physiology and Biochemistry: Current Topics and Trends, Vol. B, Transport, Iono- and Osmoregulation*, Gilles, R. and Gilles-Bailien, M., Eds. Berlin: Springer-Verlag, pp. 292–302.
- Yahel, G., Marie, D. and Genin, A. 2005. InEx—A direct *in situ* method to measure filtration rates, nutrition, and metabolism of active suspension-feeders. *Limn. Oceanogr. Meth.*, 3, 46–58.
- Yamamoto, N. and Lopez, G. 1985. Bacterial abundance in relation to surface area and organic content of marine sediments. *J. Exp. Mar. Biol. Ecol.*, 90, 209–20.
- Yonge, C.M. 1936. Mode of life, feeding, digestion and symbiosis with zooxanthellae in the Tridacnidae. *Sci. Rep. Gr. Barrier Reef Exped. Br. Mus.*, 1, 283–321.
- Yonge, C.M. 1947. The pallial organs in the aspidobranch Gastropoda and their evolution throughout the Mollusca. *Phil. Trans. Roy. Soc. Lond. Ser. B*, 232, 443–518.
- Yonge, C.M. 1975. Giant clams. *Sci. Am.*, 23, 96–105.
- Yukihira, H., Klumpp, D.W., and Lucas, J.S. 1998. Effects of body size on suspension feeding and energy budgets of the pearl oysters *Pinctada margaritifera* and *P. maxima*. *Mar. Ecol. Prog. Ser.*, 170, 119–30.

- Zobell, C.E. and Landon, W.A. 1937. Bacterial nutrition of the California mussel. *Proc. Soc. Exp. Biol. Med.*, 36, 607–9.
- Zobell, C.E. and Feltham, C.B. 1938. Bacteria as food for certain marine invertebrates. *J. Mar. Res.*, 1, 312–27.
- Zwaan, A. de. 1977. Anaerobic energy metabolism in bivalve molluscs. *Annu. Rev. Oceanogr. Mar. Biol.*, 15, 103–87.
- Zwaan, A. de. and Mathieu, M. 1992. Cellular biochemistry and endocrinology. In: *The Mussel Mytilus: Ecology, Physiology, Genetics and Culture*, Gosling, E. (Ed.), Amsterdam: Elsevier, pp. 233–308.

5 Population Processes

INTRODUCTION

A group of organisms of the same species living in the same area is termed a population. Each population has a number of characteristics that can be categorized as biological or group attributes. Biological attributes are characteristics the population shares with its component organisms. Life history or cycle is most often given as a biological attribute because a population grows, differentiates, and maintains itself just like individual organisms. Group attributes are common only to the population and include birth rate (natality), death rate (mortality), and age structure. These group attributes are unique to the population and only have meaning to a population of organisms (Odum 1983). These population or group attributes reflect the ecology of a species and can provide information on the spatial and temporal aspects of the environment (Cerrato 1980).

In this chapter, the demography of bivalve populations will be presented by examining life tables of specific bivalves and by exploring a number of population processes, i.e., growth, recruitment, and mortality for a variety of species. As all of these processes influence the production of bivalves, understanding them is vital to determining the role of these animals in ecosystems.

LIFE CYCLE

The life cycle of bivalve molluscs begins with fertilization of eggs, usually in the water surrounding the adults. Gametes are typically shed within the shell cavity and swept out on the exhalant currents generated by pumping. In contrast, some bivalves brood their eggs with fertilization occurring in the mantle cavity. Here again the bivalve water pump is important in bringing in the sperm for fertilization. In shipworms, brooding occurs in the suprabranchial cavity, and in the oyster, *Ostrea*, within the gills (Barnes 1974).

IMPORTANT TERMS AND CONCEPTS

Age structure: The distribution of different aged organisms in a population.

Birth rate: The production of new organisms per unit time.

Death rate: Describes the number of organisms dying per unit time.

Density: The number of individuals or biomass per unit space.

Group attributes: Characteristics the population shares with its component organisms. They are common only to the population.

Life cycle: A series of stages an organism or population passes through during its lifetime.

The eggs of bivalves develop into free-swimming trochophore and then veliger larvae. In some marine bivalves, the veliger stage may last as long as several months. In others, it is only a few days. In brooders, the veliger larvae are released after a specific period (8 days in *Ostrea edulis*). The larval stage is planktonic and subject to very high mortality. At metamorphosis, the larvae settle out of the plankton and the bivalve spends its remaining life as a member of the benthos. Consequently, the life cycle of a marine bivalve can be separated into two very distinct stages: the planktonic presettlement–larval period and the postsettlement juvenile–adult period. The presettlement period is important for dispersal of the species while the juvenile–adult period is important for reproduction. The two stages are spatially and temporally separated for most of their existence, and that reduces the chances of adult-induced mortality on the larvae through adult filter feeding.

The population dynamic of the presettlement stage is poorly studied probably because of its short duration and the greater logistical complications of sampling plankton. Thus most studies of bivalve population dynamics focus on the postsettlement stage and particularly on shallow-water, commercially valuable species.

STATISTICAL MEASURES OF POPULATIONS

Postsettlement bivalves are excellent subjects for population studies because their shells provide a long-lasting record of the organism's life and, through statistical compilation, the dynamics (demography) of a given population. The shell is an easily observed and identified characteristic of a bivalve species and collections of living animals can yield accurate estimates of population density (Cerrato 1980). In some cases, shells from ancient deposits can also be used to determine the densities and other properties of past populations of bivalves (Rhoads et al. 1982; Powell et al. 1984). Through shell growth rings, the growth rate and age of individual bivalves can be assessed. This information can be compiled to determine age structure for a specific population. In some cases, the shell records telltale clues as to the causes of mortality. Not all population parameters can be determined from the shell. Fecundity requires the analysis of living bivalves while incidences of disease and parasitism may require direct observation of living tissues.

DENSITY

Often the simplest population attributes to determine are density and abundance. Generally, density refers to the population size at a given time, i.e., number of individuals per unit area, while abundance implies a dynamic (changing) aspect to the population, i.e., number per unit area per unit time. Because the individuals in a population vary physiologically and genetically and respond differently to the environment, it is usually more meaningful to focus on the population at a level of resolution greater than simple density.

Density observations on a population are easily arranged into nonoverlapping groups or classes that divide the life span or size range of the organism. The class frequencies for the data are found by summing the number of individuals in each

class. The class frequency data may appear as a table or more often as a histogram with classes (size or age) plotted versus frequency (Figure 5.1). In bivalves, age is often used in these plots, as growth or age can be determined from rings on the shell. If small size class intervals are used in constructing the histogram, variations in growth within a year or recruitment class can be resolved (Cerrato 1980).

Most temperate and boreal shallow water bivalves are seasonally programmed with distinct spawning periods. With frequent sampling, these spawning periods will be reflected in the size frequency histograms as a pulse of new individuals at the smallest size class. Normally, the smaller size or year classes make up the numerical majority of the population while the older and larger classes are only a small portion of the total population size. If additional samples are taken through time, these samples will show recruitment pulses migrating across successive size frequency plots. This movement across the frequency plots is caused by the growth of individuals within the population and offers a way of computing modal or average growth for a size class. Mortality will also cause the pulse to decrease in height or shrink and it too can be estimated from the size frequency plot (see Figure 5.1).

For long-lived species, multiple pulses are often discernible in the size frequency histogram, and each pulse represents an age class or year class in the population. It is also common for an age class or pulse to have a roughly normal distribution and to overlap adjacent age classes. There are a number of graphical and statistical methods (Walford 1946; Cassie 1954; Sheldon 1965; Cerrato 1980; Basson et al. 1988) that can be used to separate the overlapping age classes. Thus the size frequency histogram contains valuable information about the population in question over and above simple measures of density.

REPRODUCTION

The process of reproduction is the generation of new individuals that have the potential to become members of the population. Reproduction is integrated into the bivalve's life cycle and is one of the few instances where the planktonic gamete and larval stages are linked to the postsettlement juvenile and adult stages. There are a number of terms that are often used and confused when discussing reproduction in bivalves at the population level, and they need to be specifically defined (after Krebs 1978).

The reproductive output in many bivalves can represent a major proportion of total population production and can be a significant energy input to the water column. Most bivalves are

BIVALVE REPRODUCTIVE TERMINOLOGY

Fecundity: The potential capability of an organism to produce reproductive units.

Fertility: The actual capability for an organism to produce offspring.

Natality or birth rate: The rate of production of new individuals by a population.

Recruitment: The successful colonization of the bottom by bivalves and implies the passage of time with survival and postsettlement mortality (Seed and Suchanek 1992).

Reproductive output: The amount of gametes released into the environment.

Settlement: The process by which individual bivalve larvae come into contact with and attach to the bottom (usually permanently).

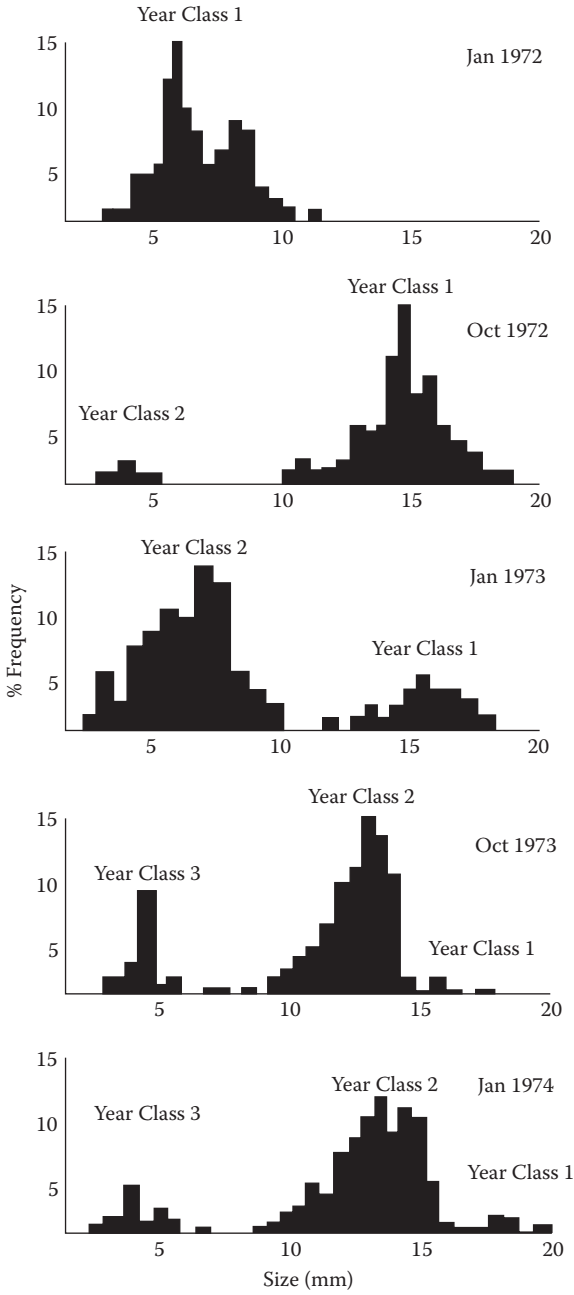

FIGURE 5.1 Size-frequency distributions of the cockle *Cerastoderma* in Ireland. (Adapted from Seed, R. and Brown, R.A. 1975; in Dame, R.F., 1996.)

TABLE 5.1
Bivalve Reproductive Effort in Relation to Total Production (%)

| Species | Reproductive Effort (%) | Source |
|----------------------------------|-------------------------|--------------------------------|
| <i>Aulacomya ater</i> | 63 | Griffiths and Griffiths (1987) |
| <i>Chione cancellata</i> | 50 | Moore and Lopez (1969) |
| <i>Choromytilus meridionalis</i> | 73 | Griffiths (1981) |
| <i>Crassostrea gigas</i> | 98 | Bernard (1974) |
| <i>Crassostrea virginica</i> | 16 | Dame (1976) |
| <i>Dosinia elegans</i> | 47 | Moore and Lopez (1970) |
| <i>Geukensia demissa</i> | 17 | Kuenzler (1961) |
| <i>Lyrodus pedicellatus</i> | 47 | Gallager et al. (1981) |
| <i>Mercenaria mercenaria</i> | 46 | Hibbert (1977) |
| <i>Ostrea edulis</i> | 47 | Rodhouse (1978) |
| <i>Patinopectin yessoensis</i> | 3–38 | Fuji and Hashizume (1974) |
| <i>Perna perna</i> | 16 | Berry (1978) |
| <i>Scrobicularia plana</i> | 24–52 | Hughes (1970) |
| <i>Tellina tenuis</i> | 9–62 | Trevallion (1971) |

Source: From Dame, R.F. 1996. *Ecology of Marine Bivalves: An Ecosystems Approach*. Boca Raton, FL: CRC Press, 254 pp.

iteroparous (multiple breeding in a lifetime) and their reproductive output varies according to size or age, with smaller individuals putting proportionally more effort into somatic growth and older individuals putting more effort into reproduction (Bayne 1976). Therefore, younger individuals as a group may contribute as many or more offspring because their numbers are usually much greater than those of larger individuals in the population. This change in reproductive output with age appears to be the rule not only for energy and carbon, but also for nitrogen (Rodhouse et al. 1984). Reproductive output or gamete production in most bivalves seems to follow the planktotrophic strategy (Vance 1973; Bayne 1976) that is characterized by high fecundity and high metabolic cost.

A cursory survey of estimated bivalve reproductive effort as a proportion of total production is shown in Table 5.1. Reproductive effort is highly variable both within and among species. While most low values can be related to young populations, those values for *Crassostrea* and *Geukensia* are for mature populations. However, these populations are in the mid- to upper intertidal zone in the subtropical U.S. marsh–estuarine ecosystems where stress due to exposure may detract energy from reproductive effort. Changes in year-to-year environmental conditions may also explain variations in population reproductive effort in *Tellina*, *Choromytilus*, and *Perna*.

POPULATION GROWTH

The size of a population in terms of numbers is a function of the inputs and outputs to that population.

The major inputs or additions to the population are the births of new individuals (B) and immigration (I), while the major losses or outputs are death (D) and emigration (E). The size or density of the population is Nt . The change in population size (ΔN) per unit change in time (Δt) can be represented by:

$$\Delta N/\Delta t = B + I - (D + E) \quad (5.1)$$

From an ecosystem perspective, it is probably more meaningful to represent these parameters as biomass in units of energy or grams of material, i.e., carbon, nitrogen, or phosphorus (Valiela 1984).

When a population exists in a favorable environment with no limitations due to space, food, predation, or environment, the specific growth rate (growth rate per individual) of the population is constant and maximal for the specific conditions. This growth rate is specific for a particular population age structure, as found in a size class histogram, and is a size index of population growth (Odum 1983). This growth is represented by r , a coefficient in the exponential growth model

$$dN/dt = rN \quad (5.2)$$

and where

$$r = dN(Ndt) \quad (5.3)$$

or when integrated

$$N_t = N_0 e^{rt} \quad (5.4)$$

where N_t is the population size at some later time t , N_0 is the population size at the initial time, e is the exponential constant, and r is the growth coefficient. Taking the natural logarithm of the preceding equation,

$$\ln N_t = \ln N_0 + rt \quad (5.5)$$

and

$$r = (\ln N_t - \ln N_0)/t \quad (5.6)$$

The index r is, then, the difference between the instantaneous specific birth (natality) rate b and the instantaneous death (mortality) rate d . When emigration and immigration are small or nonexistent, as is the case with most bivalves, then they can be ignored and

$$r = b - d \quad (5.7)$$

This form of r is called the intrinsic rate of natural increase, or r_{max} , and is dependent on a stable and stationary population age structure (Table 5.2). These values indicate at what age a larva will establish a successful colony and are shown in Figure 5.2 for *Mya*. As r increases, the importance of older age categories increases with regard to reproductive value and is largely due to increasing reproductive rate in older clams. Thus r can be used to generate additional information from the data compiled in a life or fecundity table.

BIVALVES AS OPEN OR METAPOPOPULATIONS

As the spatial scale for considering a population increases, the population dynamics are less affected by movements (immigration and emigration) and become increasingly dominated by the interactions of birth and death rates discussed above (McGrorty and Goss-Custard 1991). With organisms that have a great potential for dispersal, e.g., marine bivalve larvae, enormous geographical areas must be considered in order to achieve the birth rate and death rate control of population dynamics. This requirement is usually impractical. Instead of this closed or entire population approach, the combined population properties of many local groups (patches, sub-populations, etc.) or metapopulations can be utilized and depend not only on the interaction between groups (Roughgarden et al. 1985) but also within group processes

TABLE 5.2
Life and Fecundity Table Definitions and Calculations (modified from Dame 1996)

| Property | Definition | Observation or Calculation |
|----------|--|--|
| X | Age interval | Age or size class data from histogram of live or dead shells |
| n_x | Number of individuals at start of age interval | — |
| l_x | Proportion of individuals surviving to start age interval | Usually adjusted to a cohort of 1000 for age interval 1 |
| d_x | Number of individuals dying during an age interval | $l_x + l_{x+1}$ |
| q_x | Rate of mortality during an age interval | d_x/l_x |
| L_x | Average number of individuals alive during an age interval | $[l_x + l_{x+1}]/2$ |
| T_x | Number of individual time units left in a population at the start of an age interval | \sum_x^{∞} |
| e_x | Average life expectancy for an age interval | T_x/l_x |
| m_x | Age-specific fecundity (number of larvae spawned) | Estimated from oocyte production or plankton |
| V_x | Expected number of offspring | $l_x m_x$ |

Source: From Dame, R.F. 1996. *Ecology of Marine Bivalves: An Ecosystem Approach*. Boca Raton, FL: CRC Press, 254 pp.

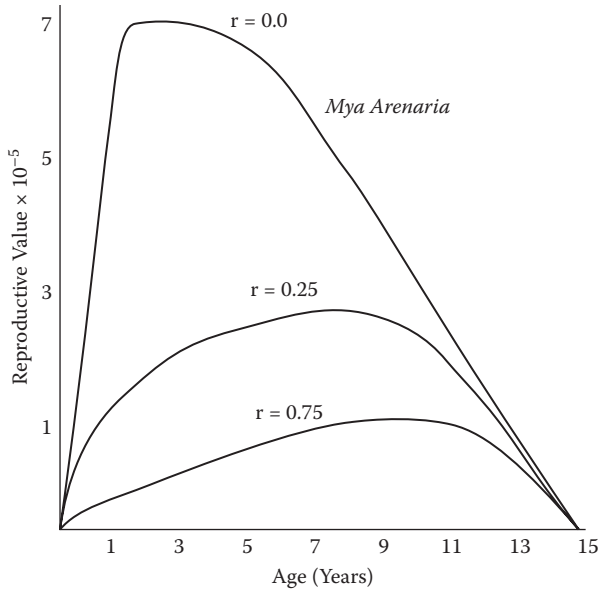

FIGURE 5.2 The relationship between reproductive value and age for *Mya arenaria*. (Adapted from Brousseau, D.J. 1978; in Dame, R.F., 1996.)

of density-dependent mortality, self-thinning, density-limited growth, and density-dependent emigration (McGrorty and Goss-Custard 1991). With this approach, the distribution, size, and density of the metapopulation may be regulated or limited by the supply of larvae from the plankton rather than by local fecundity (McGrorty et al. 1990). In a field study of the population dynamics of *Mytilus edulis* in the Exe estuary, England, McGrorty et al. (1990) and McGrorty and Goss-Custard (1991) found that annual variations in spat fall over the entire estuary were related closely to the densities of adults on the different beds. They further found that the main environmental gradient along with the population dynamics of mussels in this surveyed estuary was exposure time. Mortality regulation during the first year resulted in a pronounced stability of the total population.

LIFE AND FECUNDITY TABLES

The age-specific statistical characteristics of mortality, survivorship, and life expectancy are generally represented in columnar form in a life table. Because the size of a population may change as a function of births and deaths of individuals, the life table provides an organized method for determining these properties.

The life table is made up of rows and columns of both observed and calculated information on a population. The rows usually represent the age or year classes while the columns denote various population properties. Definitions and calculations for the columns are given in Table 5.2.

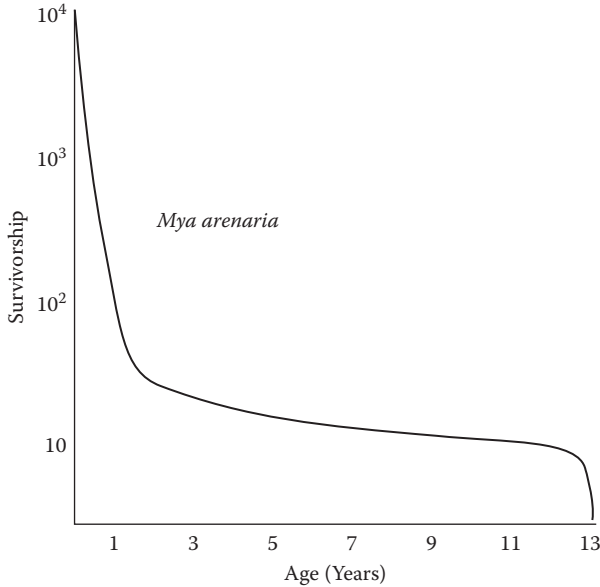

FIGURE 5.3 A survivorship curve for the clam *Mya arenaria* at Gloucester, MA. (Adapted from Brousseau, D.J. 1978. in Dame, R.F., 1996.)

While the number of individuals alive at a particular time (n_x) is directly observed, mortality can be obtained from age of death observations by computing the decline in the numbers of individuals in an age class through time and by directly monitoring the death rate of marked individuals (Cerrato 1980). It is normal to analyze mortality by focusing on one property, l_x , the survivorship. Usually the log of survivorship is plotted as a function of age (x). Although there are several standard survivorship curve forms, Kurten (1964) has pointed out that when the complete life cycle of a species is considered, the shape of the survivorship curve is sigmoidal with high mortality in both young and old age classes (Figure 5.3).

A classical example of a bivalve life table is given in Table 5.3. In the Pismo clam, *Tivela stultorum*, the numbers of observed living clams in a given age interval are adjusted to an initial cohort of 1000 juvenile clams. Of this initial cohort, 550 clams die during the first age interval (d_x) and can be expressed as a mortality rate (q_x) of 550/1000 or 0.550. The average number of clams alive during the age interval (L_x) is 723 or $(1000 + 450)/2$. Summing the L_x column from the bottom yields the T_x value, and dividing this by l_x gives the life expectancy in years (e_x) for each age interval. The data show that young (0 to 2)- and older (4 to 8)-age interval clams die more rapidly than middle-aged clams. Life expectancy is highest for 1- to 3-year-old clams. These observations are typical for invertebrate populations that do not brood or protect their young and experience high mortality after settlement.

An excellent example of a life table with fertility computations for a marine bivalve, *Mya arenaria*, is given by Brousseau (1978) and is described in Table 5.4. The data in this table are presented differently than those in Table 5.3 in that the

TABLE 5.3
Life Table for *Tivela stultorum*, the Pismo Clam

| Age X (years) | l_x | d_x | q_x | L_x | T_x | e_x (years) |
|------------------|-------|-------|-------|-------|-------|---------------|
| 0–1 | 1000 | 550 | 550 | 723 | 1569 | 1.57 |
| 1–2 | 450 | 202 | 449 | 349 | 844 | 1.87 |
| 2–3 | 248 | 72 | 290 | 212 | 495 | 1.99 |
| 3–4 | 176 | 60 | 341 | 146 | 283 | 1.60 |
| 4–5 | 116 | 60 | 517 | 86 | 137 | 1.18 |
| 5–6 | 56 | 38 | 678 | 37 | 51 | 0.90 |
| 6–7 | 18 | 13 | 722 | 11.5 | 14 | 0.75 |
| 7–8 | 5 | 5 | 1000 | 2.5 | 2.5 | 0.50 |

Source: From Dame, R.F. 1996. *Ecology of Marine Bivalves: An Ecosystem Approach*. Boca Raton, FL: CRC Press, 254 pp.

TABLE 5.4
***Mya arenaria* Life and Fecundity Table**

| Size Class (mm) | Age x (years) | l_x | L_x | e_x (years) | q_x | m_x |
|--------------------|------------------|-------|-------|------------------|-------|--------|
| 2.0–4.9 | 0.143 | 0.557 | – | 0.769 | 0.885 | – |
| 5.0–9.9 | 0.286 | 0.662 | 0.610 | 1.820 | 0.675 | – |
| 10.0–14.9 | 0.428 | 0.800 | 0.731 | 3.562 | 0.400 | – |
| 15.0–19.9 | 0.571 | 0.800 | 0.800 | 4.602 | 0.400 | – |
| 20.0–24.9 | 0.714 | 0.834 | 0.817 | 6.336 | 0.333 | – |
| 25.0–29.9 | 0.857 | 0.900 | 0.867 | 8.248 | 0.199 | – |
| 30.0–34.9 | 1.000 | 0.968 | 0.934 | 9.178 | 0.062 | – |
| 35.0–39.9 | 1.333 | 0.978 | 0.973 | 8.758 | 0.045 | – |
| 40.0–44.9 | 1.667 | 0.963 | 0.971 | 8.143 | 0.075 | 7,379 |
| 45.0–49.9 | 2.000 | 0.966 | 0.965 | 7.758 | 0.066 | 13,589 |
| 50.0–54.9 | 2.333 | 0.973 | 0.970 | 7.268 | 0.055 | – |
| 55.0–59.9 | 2.666 | 0.962 | 0.968 | 6.665 | 0.078 | 18,835 |
| 60.0–64.9 | 3.000 | 0.952 | 0.957 | 6.186 | 0.098 | 33,605 |
| 65.0–69.9 | 4.000 | 0.949 | 0.951 | 5.794 | 0.101 | 36,624 |
| 70.0–74.9 | 5.000 | 0.969 | 0.959 | 5.386 | 0.059 | 46,034 |
| 75.0–79.9 | 6.000 | 0.984 | 0.977 | 4.690 | 0.031 | 56,986 |
| 80.0–84.9 | 7.000+ | 0.911 | 0.948 | 3.830 | 0.176 | 72,125 |

Source: From Dame, R.F. 1996. *Ecology of Marine Bivalves: An Ecosystem Approach*. Boca Raton, FL: CRC Press, 254 pp.

proportion of clams surviving (l_x) is used rather than observed numbers and the first three year classes were subdivided. This life table (Table 5.4) shows that *Mya* reaches maximum life expectancy at 30 mm length or about an age of 1 year. Mortality as described by survivorship is highest for larvae and very old size classes (Figure 5.3). This survivorship curve form is sigmoidal as suggested by Kurten (1964), and supports Murphy's (1968) theory that long life and iteroparity are favored under conditions where spawning or settlement success are highly variable. Using histological analysis, Brousseau (1978) also was able to compute age-specific fecundity. This property increased with size and age from 40 mm and 1.7 years with a fecundity of 7399 and to a maximum age and size with a fecundity of 72,125 or an order of magnitude higher than the younger clams. Using her estimates of l_x and m_x , Brousseau (1978) was able to compute a very high intrinsic rate of natural increase (r_{max}) of 4.74 for this clam population. This enormous potential for increase is completely offset by high larval mortality, i.e., in the order of 0.001% to 0.0001% of larvae spawned eventually settled (Brousseau 1978).

As we have seen in the size frequency histograms, new recruits to the bivalve population show up as pulses of individuals in the smallest size or year classes. Powell et al. (1984) have shown that, if the sample frequency is too long, the abundance of newly settled recruits will not be estimated accurately. This response is because most juvenile bivalves recruited to the benthic population may settle, live, and die between sampling periods and thus not be included in the size or age frequency histogram. These authors found that by sampling the shells of bivalves in the sediments adjacent to the live population, they could construct the death assemblage of the population. Input into the short-term death assemblage occurs in pulses and these pulses gradually decay as a result of taphonomic processes that destroy the individual shells. If larval settlement produces pulses of juveniles, if pulse decay rates are low, and if the half-lives of the decaying pulses are known, then the size of the original settlement can be determined from the death assemblage. From this analysis, Powell et al. (1984) determined that larval settlement is consistently underestimated by as much as 90% from living population data on bivalves.

MORTALITY

As noted earlier, the height of the age size class histograms in postsettlement bivalves decreases in size as mortality reduces population size. Mortality is also explicit in the plot of survivorship versus time. Mortality in bivalves is caused by abiotic factors, predation, disease, and competition, as well as human harvest for food or other products.

ABIOTIC MORTALITY

As discussed in Chapter 3, physical factors limit the existence of a bivalve to a given environment or niche. For bivalves, the most important of these abiotic mortality agents are temperature, aerial exposure, salinity, oxygen concentration, siltation, and waves. Depending on the latitude and coastal morphology, many of these factors

may vary seasonally and thus result in seasonal mortality effects. In addition, many physical factors may act in concert with other factors to cause mortality. At the extreme, catastrophic environmental events, e.g., storms or widespread anoxia, may lead to mass mortality in bivalve populations.

Temperature can be a major cause of mortality in the intertidal zone. Summer extremes of high temperature during daytime low tide exposure can lead to extensive mortalities, particularly in subtropical and tropical populations of oysters (Dame 1976) and mussels (Suchanek 1978; Tsuchiya 1983), while extreme cold and icing conditions can do likewise in northern temperate and boreal bivalve populations (Suchanek 1986). Strong waves associated with storms can dislodge intertidal bivalves resulting in mortality. Such conditions may also bring large floating debris, i.e., logs that batter, crush, and dislodge bivalves in rocky shallow and intertidal environments (Dayton 1971; Lubchenco and Menge 1978; Suchanek 1986). In unconsolidated sedimentary environments, shifting of particles, burial, erosion, and direct movement of bivalves by currents and waves can also cause patchiness.

Anaerobic conditions are common to shallow bays and estuaries with poor circulation. Although some bivalves, e.g., oysters, can close their valves and resist anaerobic conditions for weeks, others (e.g., mussels) may suffer immediate mass mortality. For example, in the Dutch Oosterschelde estuary, large populations of mussels are cultivated. If the storm surge barrier separating the estuary from the North Sea is closed, water circulation is greatly reduced, and the large population of mussels may rapidly drive the system to an anaerobic state and result in mass mortalities of mussels.

PREDATION

Often the most important cause of mortality in bivalve populations is predation. Predation can be defined as (a) the process that occurs when one organism kills another for food; (b) when individuals of one species eat living individuals of another; (c) a process by which one population benefits at the expense of another; or (d) any ecological process in which energy and matter flow from one species to another (Taylor 1984). For our purposes, predation is a direct interaction between different species populations.

In bivalve-dominated systems, the most common predators are gastropods, starfish, crabs, fish, birds, and mammals. Rather than be controlled by a specific predator, most sessile and slow-moving bivalves are usually preyed upon by suites or guilds of predators (Seed 1993). Many bivalve predators are only effective on certain size classes of prey, usually the smaller sizes, and at specific seasons of the annual cycle. Methods of predation range from defeating the defenses of the bivalve shell by small invertebrates and some birds, to crushing or breaking the shells by crabs, fish, and mammals, to the swallowing of the whole bivalve by birds. Most of our information on the predation of bivalves comes from intertidal and shallow water environments and is usually focused on economically important species. Those interested in a detailed review of the influence of invertebrate predators on bivalves should see Seed (1993) and of birds, Meire (1993).

Because bivalve larvae live in a different habitat, they suffer predation from an entirely different group of predators than do the benthic adult stages. The most commonly reported bivalve larval predators are ctenophores and jellyfish. In the bays along the Atlantic coast of North America, for example, the ctenophore *Mnemiopsis leidyi* has been deduced to be a major planktonic predator of oyster larvae as the ctenophore's density is inversely related to that of the oyster larvae (Kremmer 1979). Curiously, this ctenophore is also preyed upon by the sea nettle, *Chrysaora quinquecirrha*, which is also a major predator of oyster larvae in Chesapeake Bay (Cargo and Shultz 1967).

In addition to these truly planktonic predators, benthic adult bivalve filter feeders may also ingest bivalve larvae (Korringa 1949). Although the idea that there is a significant interaction between established adult bivalve filter feeders and their settling larvae has been strongly questioned by Black and Peterson (1988), field manipulation studies with dense populations of the cockle, *Cerastoderma edule*, suggest that adult-larval interactions play an important role in this species population dynamics (Andre and Rosenberg 1991; Andre et al. 1993). Studies by Möller (1986) suggested that plots with high densities of *Mya arenaria* had fewer settled juveniles of *M. arenaria* and *C. edule* than control plots with low densities of *M. arenaria*. Andre and Rosenberg (1991) concluded that the settlement of bivalve larvae may be reduced by up to 40% in the presence of adult *C. edule* and *M. arenaria*. In a follow-up study using an experimental flume, Andre et al. (1993) determined that adult *C. edule* reduced the settlement of *C. edule* larvae by 33% in an area immediately surrounding individual adults. They also found that over dense beds of these cockles, as many as 75% of the observed larvae were inhaled by adults. These authors concluded that for *C. edule* beds, the reduction in larval settlement was small to moderate at the scale of the individual adult, but that inhalation of settling larvae by the populations of resident filter-feeding bivalves may cause a significant decrease in settlement on a larger scale (10 m to 1000 m). Thus when spatial and temporal scaling are taken into account, it appears that dense populations of adult bivalve filter feeders can be and are a major cause of mortality for settling larvae.

Compared to the predation of planktonic larvae, the predation of postsettlement bivalves is better studied because of the accessibility of the prey. The predators range in size from small flatworms to mammals. The following is a short synopsis of bivalve predators. For a more detailed view see Seed (1993) and Meire (1993).

The flatworm, *Stylochus ellipticus*, is an important predator of newly settled oysters on the Atlantic coast of North America (Loosanoff 1956; Webster and Medford 1959). *Stylochus* appears to enter the oyster spat through the slightly opened valves where it then eats the soft body tissues. Although this flatworm seems to prefer barnacles, it will switch to oysters when they are abundant. Similar findings have been reported for *Stylochus mediterraneus* in mussels (Galleni et al. 1977).

Gastropod molluscs are common predators of bivalves. The majority of gastropod predators drill holes in the bivalve shell by a combination of mechanical (radula) and chemical means. These predators are often opportunistic, switching between prey species of bivalve or other phyla, e.g., barnacles, depending on prey availability and ease of successful attack. These predators also seem to favor younger or thinner-shelled bivalves over older or thicker-shelled prey (Seed 1993). While most

gastropod predation studies focus on temperate, economically important bivalve species, i.e., clams, mussels, and oysters (Galtsoff 1964; Seed 1992, 1993), studies of the cultivated tropical clam, *Tridacna maxima*, in the Cook Islands of the Pacific also reflect high gastropod predation on the smaller size classes (< 10 cm) when the shell of *T. maxima* is thinner (Sims and Howard 1988). Thus with increasing size and age, the thickening bivalve shell reduces the effectiveness of the gastropod predator. In essence, a size refuge is formed in the bivalve population for the very size classes that contribute the most to population production and reproduction.

Most crustacean predators are highly mobile and capable of searching for prey over large distances, even during a single tidal cycle (Seed 1993). They can feed on bivalves in both epibenthic and infaunal habitats as well as change food sources depending on availability. These decapods, mainly crabs and lobsters, use their specialized claws (chelae) or their mandibles to break the bivalve shell. Most decapod predators use more than one method to penetrate the bivalve shell. Lau (1987) and Seed (1993) have summarized these techniques in Table 5.5.

An illustrative example of decapod predation on bivalves was reported by Rhoads et al. (1982) for mussels inhabiting the deep sea hydrothermal vents along the Galapagos Rift in the Pacific Ocean. These investigators deduced that marks and damage to mussel shells from this area were the result of predation by the crab *Bathogrea thermydron*. Because the effectiveness of this predator declines as the mussels approach 2.0 cm in length, this mussel generates its own size refuge from predation by rapidly growing beyond the size preferred by the crab. As with most bivalves, the larger individuals have stronger shells and are more resistant to decapod predation.

Handling time is probably not limiting in the hydrothermal vent crab–mussel system, but in intertidal areas mobile decapod predators probably minimize handling

TABLE 5.5
Decapod Methods for Penetrating a Bivalve Shell

| Method | Handling Time | Prey Size | Structural Investment |
|--------------------|----------------|--------------|-----------------------|
| Swallowing whole | Short | Small | Low |
| Chipping–biting | Moderate | Medium | Low |
| Wedging | Short–moderate | Medium | Low |
| Prying | Moderate | Medium | Low |
| Crushing | Short | Medium–large | High |
| Chipping–peeling | Long | Medium–large | Moderate |
| Boring | Long | Medium | Moderate |
| Tubercular peeling | Long | Medium–large | Moderate |
| Shearing | Short | Medium | Moderate |

Sources: From Lau, C.J. 1987. Feeding behaviour of the Hawaiian slipper lobster, *Scyllarides squammosus*, with a review of decapod crustacean feeding tactics on molluscan prey. *Bull. Mar. Sci.*, 41, 378–91; Seed, R. 1993. Invertebrate predators and their role in structuring coastal and estuarine populations of filter feeding bivalves. In *Bivalve Filter Feeders in Estuarine and Coastal Ecosystem Processes*, Dame, R., Ed. Heidelberg: Springer-Verlag, pp. 149–95.

time rather than maximize food energy (Hughes and Seed 1981; Boulding 1984; Cresswell and McClay 1990). It is not uncommon for bivalve beds, mussels, and oysters to form in the intertidal zone where predators have limited foraging time and therefore become ineffective at reducing prey population size (Paine 1976). In contrast, Robles (1987) found that the major predator of mussels in the intertidal zone on the southern California rocky shore was the spiny lobster, *Panulirus interruptus*. This predator prefers mussels and moves rapidly into the upper intertidal zone as the tide rises, where it feeds voraciously and selectively on concentrations of mussels. Not unexpectedly, intertidal mussel beds are not found in this area.

In some areas, starfish are thought to be the most effective predators of bivalve populations. These predators feed both extra- and intra-orally and can attach to several bivalves at once (Paine 1974). Starfish, such as *Astropecten* and *Luidia*, that have short or inflexible arms, typically swallow their prey whole. Digestion occurs in the stomach and undigested shells are cast out through the mouth. Starfish with more flexible arms, for example *Asterias*, commonly evert their stomachs and gradually engulf the prey. In many cases, these starfish use their arms to hold the starfish next to the bivalve or to increase the gap between the bivalve shells and force their everted stomach through the shell gape into the bivalve where extra-oral digestion begins. There are reports of mussels bound with wire being consumed by *Pisaster ochraceus* in this manner in just a few hours (Feder 1955).

Predator-prey studies of the starfish-bivalve interaction are numerous and extensive because of the ease of observation in the rocky intertidal zone. These studies are part of the foundation of our understanding of the causes of rocky intertidal zonation and provide additional evidence of size and spatial refugia in bivalve populations.

As with other equivalent-sized predators, starfish appear to show size preferences for bivalve prey. For example, *Asterias vulgaris* appears to favor small mussels, while *Pisaster ochraceus* feeding on *Mytilus californianus* may take all sizes but favor smaller sizes (Paine 1976). As noted for other predators, predator preference for smaller size classes of bivalves leads to a size refuge for large bivalves and is favored by high bivalve growth rates (Paine 1974, 1976).

Spatial refugia are commonly found in rocky intertidal zone bivalve populations experiencing starfish predation. In most of these cases, the starfish prey heavily on bivalves in the lower portions of the intertidal zone and down into the subtidal zone. The middle portions of the intertidal zone become a refuge because starfish predation is less effective there. This reduced predation effectiveness is thought to be due to the decreased time available for foraging and increased time of exposure to desiccation stress higher in the intertidal zone. Thus in many temperate rocky intertidal zone habitats, bands of bivalves, mussels, and oysters may be found that are limited by physical stress at their upper distribution and predation at their lower limit in the intertidal zone (Menge 1992).

In some subtidal environments, starfish may also control the occurrence of bivalves. Himmelman and Dutil (1991) found that in the Gulf of St. Lawrence the lower limit of dense subtidal beds of *Mytilus edulis* was controlled by the starfishes *Asterias vulgaris* and *Leptasterias polaris*. At greater depths, *Leptasterias* appears to use its tube feet to dig out other species of large infaunal bivalves.

The most mobile and ubiquitous predators in the marine environment are the fishes. However, few studies have focused on the predation of bivalves by fishes. Of the cartilaginous fishes, only the rays are reported to prey on bivalves. Along the Atlantic coast of North America, the cow-nosed ray, *Rhinoptera bonasus*, is reported to feed not only on clams and other bivalves in soft sediment, but also on adult oysters (Smith and Merriner 1978).

Although much more numerous than cartilaginous fishes, little is known about bivalve predation by boney fishes. From the mid-Atlantic to Gulf coasts of North America, the black drum, *Pogonias cromis*, is known to feed on postsettlement oysters (Galtsoff 1964). Schools of this fish invade oyster reefs where they use their powerful pharyngeal teeth to crush shells and devour the bivalve. In the rocky intertidal habitats of New England, the cunner, *Tautoglabrus adspersus*, is a major predator on *Mytilus* (Olla et al. 1975). The importance of this labrid fish in structuring intertidal communities has been touted to be at least as great as that of the snail *Thais lapillus* (Edwards et al. 1982). Likewise, two labrids, the rock wrasse (*Halichoeres semisinctus*) and the sheeps head (*Semicossyphus pulcher*), are thought to be significant consumers of rocky intertidal mussels on Southern California shores (Robles 1987).

Fish are a major cause of a sublethal form of predation known as siphon nipping, where portions of the exposed siphon are regularly eaten by fishes and occasionally by birds. For a variety of clams, these losses may significantly reduce clam growth (Coen and Heck 1991). Thus sublethal predation of siphon tissue can be a major food source for fishes (Trevallion et al. 1970; DeVlas 1979, 1985; Peterson and Quammen 1982). For example, in Rhoad River estuary of Chesapeake Bay, the sciaenid fish, *Leiostomus xanthurus*, and the sole, *Trinectes maculatus*, nipped large numbers of *Macoma balthica* siphons as a major source of food (Haines et al. 1990).

Coastal waters are important feeding areas for many species of birds. Although some birds confine their bivalve predation to rocky intertidal areas, i.e., turnstones and sandpipers, others such as ducks focus on soft bottoms. Still others are found in most shallow water and intertidal habitats, i.e., waders and gulls (Marsh 1986; Meire 1993). Birds have essentially three methods of feeding on bivalves: (1) they may swallow the shell whole; (2) they may remove the flesh from the shell; or (3) they may rob the prey from another bird (Meire 1993). If the shell is swallowed whole, it is crushed in the bird's gizzard and the shell fragments are regurgitated as pellets or defecated. When the flesh is removed, as is the case with oystercatchers, the bill is stabbed between the gaping valves or the shell is hammered until it breaks. Once the bill breaches the shell, the adductor muscle is cut and the valves are pried apart by opening the bill inside the shell. Birds with chisel-shaped bills are mainly stabbers and those with blunt bills are hammerers. Some birds, e.g., gulls and crows, may use another unique method to remove the flesh. The prey is taken from the intertidal habitat and after the bird reaches a suitable altitude the bivalve is repeatedly dropped onto a hard surface until the shell breaks (Meire 1993).

Meire (1993) has synthesized the role of birds in bivalve predation on shallow and intertidal sediments. He identifies a number of bivalve characteristics that should enhance survival in these habitats: (1) a high growth rate allows the bivalve to grow into a size refuge; (2) for infauna bivalves, increasing burial depth reduces the probability of being preyed upon and thus provides a spatial refuge; and (3) a high

reproductive rate assures that the bivalve population will recruit more individuals than will be preyed upon by birds.

In rocky intertidal habitats in Oregon, Marsh (1986) showed that surfbirds (*Aphriza virgata*), gulls (*Larus glaucescens*), and black oystercatchers (*Haematopus bachmani*) acting in concert decreased the density of mussels. The intensity of this predation was a function of mussel density and substrate relief where mussels on vertical walls were unavailable to the birds. Marsh (1986) concluded that a multiple predator assemblage can be effective because its members are active in different microhabitats or prey on different size mussels.

Birds can interact with other predators to structure the populations of intertidal bivalves. Sanchez-Salazar et al. (1987) and Griffiths (1990) found that the shore crab, *Carcinus maenas*, and oystercatchers, *Haematopus ostralegus*, could control the size and distribution of cockles, *Cerastoderma edule*, in the intertidal zone. Cockles settled at relatively low densities throughout the intertidal zone with those at higher elevations growing more slowly. Although space was not limiting, the shore crabs fed voraciously on small cockles low on the shore and oystercatchers ate large cockles high on the shore. The resulting distribution of cockles was spat and a few large cockles near the low tide mark and small bivalves higher in the intertidal zone (Figures 5.4 and 5.5).

In shallow water areas, flocks of birds can decimate natural and cultivated bivalve populations. In Olympia Bay of Puget Sound, Washington, several species of ducks

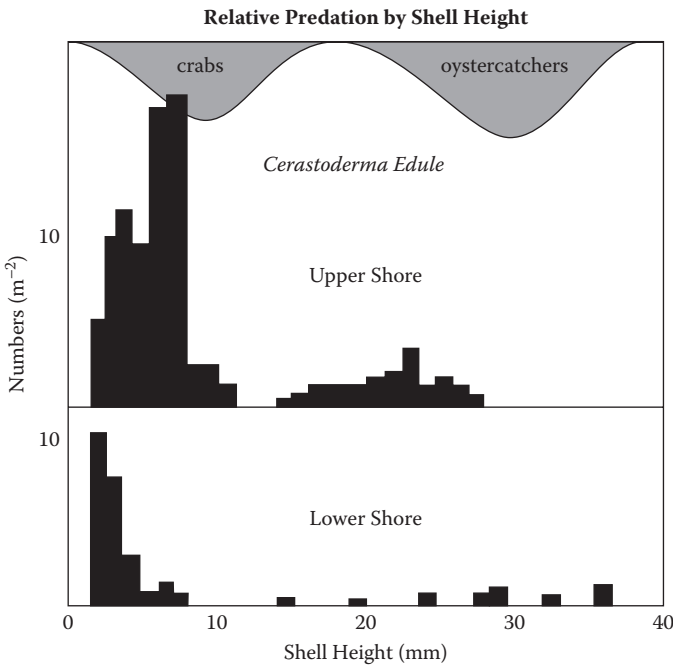

FIGURE 5.4 The spatial variation in the predation of cockles by crabs and oystercatchers. (Adapted from Griffiths, C.L. 1990; in Dame, R.F. 1996.)

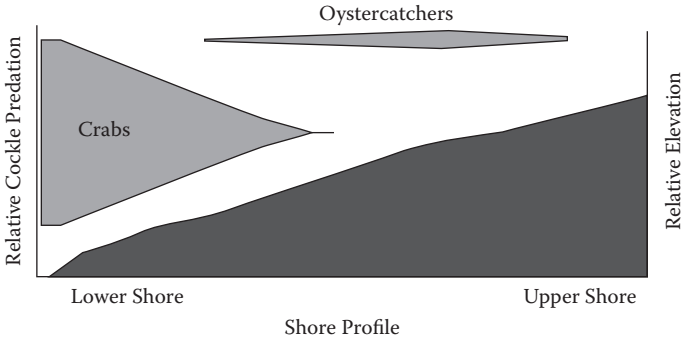

FIGURE 5.5 The relative predation intensity of crabs and oystercatchers on cockles across an intertidal gradient. (Adapted from Griffiths, C.L. 1990; in Dame, R.F. 1996.)

utilized oysters as a major food source and as a result severely damaged the oyster industry (Galtsoff 1964). In Europe and the British Isles, immense flocks of eider ducks (*Somateria*) and oystercatchers (*Haematopus*) can produce heavy bivalve mortalities in wave-protected environments. In Holland, Craeymeersch et al. (1986) reports that available mussel production appears to be the limiting factor on overwintering oystercatchers, and Meire and Eryvynck (1986) have estimated that these birds may consume almost half of the annual mussel production.

Marine mammals are primarily observed at the sea surface, but their feeding activities normally occur underwater beyond the view of observers (Oliver et al. 1983). Of the marine mammals only a few, sea otters, bearded seals, and walrus, prey on bivalve communities and have been studied in any detail.

With the decline in the fur trade, sea otter populations have gradually been re-established both artificially and naturally in the cold-temperate nearshore waters of the North Pacific Ocean from Hokkaido to the California peninsula (Van Blaricom 1988). With this re-establishment, the role of sea otters in benthic predation and ecosystem dynamics has come under close scrutiny.

Sea otters forage on a large variety of the benthos of rocky and soft-sediment systems. Prey are dislodged from rocks or dug from the sediments by the forepaws and carried to the surface where they are eaten. The shells of bivalves are typically cracked with rocks or other hard objects and then consumed (Riedman and Estes 1988). Their diet is quite broad and depends on the abundance of prey.

On rocky shores, sea otters have been reported to prey on both subtidal and intertidal mussel populations, occasionally creating gaps in the mussel-dominated zone. Because of the impact of their predation on rocky intertidal communities, sea otters have been called “keystone” predators. Although sea otters are not size selective in the mussels taken from the rocks, they are selective in the mussels they consume. Those not consumed are cast off into deep water where mortality is thought to be total. Mussels do not attain a refuge in size from sea otter predation (Van Blaricom 1988).

In soft bottom areas, sea otters feed on three distinct groups: epifauna, shallow-burrowing infauna, and deep-burrowing infauna. Of the 30 species of prey recorded

in these habitats, most were clams (Kvitek and Oliver 1988; Kvitek et al. 1988). Only the deep-burrowing clams seem to have spatial refuge from the sea otters, since the otters must excavate large amounts of sediment at depth to capture these prey (Kvitek et al. 1988). Because rocky habitats are like small islands in a sea of sediment, sea otters may depend on the prey in soft-bottom habitats as much as or more than those on the rocky shore (Kvitek and Oliver 1988).

The largest predator of bivalves is the walrus, *Odobenus rosmarus*. These large consumers are common and conspicuous components of the marine mammal fauna inhabiting the Arctic and subarctic waters of the Northern Hemisphere. Walruses are the most abundant bottom-feeding marine mammal and are particularly abundant in the Bering and Chukchi Seas where well over 200,000 feed upon the bivalve communities found on the Beringian platform (Oliver et al. 1983). Walruses excavate bivalves from soft sediments by sucking and expelling water and by movements of the snout and vibrissae (the tusks are not used in feeding). This feeding process produces pits and furrows in the soft sediment that can be analyzed by scuba divers (Oliver et al. 1985). Once the bivalves are out of the sediments and before consumption, the soft parts are removed by suction from between the shells, and the unbroken shells are discarded to the sea floor (Oliver et al. 1983). In different parts of their range, walruses compete with bearded seals and sea otters for bivalves, but little is known of these relationships (Oliver et al. 1983; Oliver et al. 1985). Because of their abundance and large size, walruses disrupt large areas of the soft sediment bivalve community. Most of the bivalves consumed have a generation time of about 3 years. Therefore, it has been hypothesized that the walrus population may decline or crash because the prey population cannot regenerate fast enough to sustain the walruses. Since these large bivalve predators are seldom hunted by humans, time should answer this classical predator-prey cycle question (Oliver et al. 1985).

Many other predators have been reported for bivalve populations. Sea turtles and octopi are predators of *Tridacnid* clams in the South Pacific (Copland and Lucas 1988). Diamondback terrapins (Hurd et al. 1979) and sea urchins (Seed 1992) are thought to prey on *Mytilus* in different environments. Without a doubt, there are many, some probably significant, bivalve predators that we have missed in this review. Bivalves are a significant food resource to a great variety of marine organisms.

COMPETITION-INDUCED MORTALITY

As discussed earlier, postsettlement bivalves can and do remove the planktonic larvae of their own and other species from the water column. While this form of adult feeding and larval mortality appears incidental, it is also self-serving to the adult because it removes a potential competitor for food, space, and other resources. More directly, along the West Coast of North America, *Mytilus californianus* competes with and dominates *Mytilus edulis*, setting the lower limits of *M. edulis* in exposed rocky intertidal habitats (Suchanek 1978, 1986). Harger (1972) has proposed that *M. californianus* crushes *M. edulis*. However, Suchanek (1978) has argued to the contrary, and there is no consensus on this idea. In soft sediments, competitive exclusion in space is rare although competition for food probably exists (Peterson 1991).

AGGREGATED DISTRIBUTIONS

Many bivalves, e.g., oysters, mussels, clams, cockles, etc., form dense assemblages or populations, and these are often called beds or, in the most extreme case, reefs. A reef is defined as an elevated ridge or block of material that may be derived from the skeletal material of organisms, geological substrates, or man-made structures (Hughes 1991). These structures influence local topographic complexity on a large scale and in so doing influence hydrographic conditions and provide numerous microhabitats for a variety of organisms. Thus reefs are associated with an increase in biodiversity or species richness when compared to the adjacent environment. While both mussels and oysters form extensive layers of shell on the bottom of estuaries, these layers tend to become unstable upon reaching a critical thickness and collapse as a result of currents and waves (Seed 1969). In the southeastern United States, the shells of *Crassostrea virginica* can accumulate and form extensive reefs that range from tens to thousands of meters in length (Stenzel 1971; Dame 1976).

In New England, the mussel *Geukensia demissa* forms dense bands on the edge of *Spartina alterniflora* salt marsh in the mid-intertidal zone. Bertness and Grosholz (1985) found that the effects of conspecifics on the success of individual mussels included reduced growth rates and reduced fecundity. Smaller mussels were affected by crowding more than larger mussels. In contrast, the mortality agents of sediment suffocation, winter ice dislodgment, and predation were all reduced by group living. These investigators suggest that both hard substrates and soft sediment aggregations of mussels directly affect the most critical variables limiting their populations, i.e., space and sediment stability.

The reduction in population density by competitively induced losses of individuals within a cohort is known as self-thinning or density-dependent disappearance (Hughes and Griffiths 1988). Accordingly, when space is used fully and surviving individuals are still able to grow, the area occupied per individual must be inversely proportional to population density. As weight is proportional to the cube of length, and area occupied by an individual is proportional to the square of its length, this scaling ratio accounts for the exponent, $3/2$. These authors were able to show that for the mussel *Choromytilus meridionalis* deviations from this exponent could be accounted for by allometric growth and multilayered packing. Allometric growth is a factor because mussels change their shape as they grow and mature, and layering causes deviations because the mussels in each layer inhibit each other's growth. Thus self-thinning appears to be a fundamental property of dense mussel populations.

At a somewhat different spatial scale, the distribution of clumps of large and small oysters on oyster reefs in the Copano Bay-Aransas Bay area along the Texas coast were investigated by Powell et al. (1987). They found that small-scale spatial variation (about 40 cm) in small oysters (< 2 cm) was patchily distributed, while large oysters (> 5 cm) were less contagiously distributed. Negative spatial autocorrelation was restricted to adjacent clumps < 12 cm apart. Thus as the oyster populations aged, their association changed from gregarious (positive) to negative. These investigators speculate that mortality produced by predation and disease, modulated by competition for food, allowed large oysters to affect the survivorship of oysters in adjacent clumps. In these small-scale changes in spatial distribution, beds of bivalves have many of the ecological advantages of clonal style living, good spatial competition

with other species, and reduced mortality from both physical and biological agents. The benefits of this lifestyle are greater than the costs of solitary existence.

The dominant bivalves in reefs and beds provide a vertical aspect to the three-dimensional nature of these communities. This structure provides numerous microhabitats for both motile species and other sessile forms (Dean 1981). On intertidal oyster reefs in South Carolina, Dame (1979) found 37 species of macroinvertebrates and this value compares favorably with 42 species found by Bahr and Lanier (1981) on oyster rocks in Georgia. Most of the species in these systems are heterotrophic and are dominated functionally by suspension-feeders, deposit feeders, and predators. In nearby North Carolina, Wells (1961) found 303 species on both intertidal and subtidal oyster reefs along a salinity gradient in the Newport River estuary.

Similar efforts on mussel beds (Lintas and Seed 1994; Seed 1996) have shown that like oyster reefs, mussel communities on rocky shores are typically dominated by a few very abundant macroinvertebrate species. These investigators found that *Mytilus edulis* beds on rocky wave-exposed shores in North Wales could be stratified into three layers, each dominated by a single species. A population of foraminiferan dominated the sediments of the bottom layer. Barnacles were only found on the outer surface of the mussel shells. Finally, the brooding bivalve, *Lasaea rubra*, was only found in the matrix of shell and byssal threads in the middle layer. Thus these systems are diverse in macroinvertebrates and are not simple monospecific stands of bivalves.

Following the ideas of island biogeography (MacArthur and Wilson 1967), the number of species in a community increases with the size of the island because environmental heterogeneity increases with island size. Recent studies by Tsuchiya and Nishihira (1985, 1986) investigated these species-area relationships for patches of *M. edulis* ranging in size from 0.4 cm² to 521.3 cm². They found that with increasing patch size and species richness, the number of individuals of associated animals increased but decreased per unit patch size. Large individuals of some species were only found on the larger patches. In the larger patches, the edges of the patch supported a different environment from the central part. The amounts of sediments, shell fragments, and byssal threads were greater in the periphery and central part of adult mussel patches than in young and old mussel patches. Total organic matter increased with the age of the patch. Species richness was higher in older patches, and species diversity was higher in adult mussel patches. These findings were, in general, supported by the studies of Lintas and Seed (1994) and Seed (1996) on mussel beds and patches in North Wales. These authors further speculated that small-scale spatial variations exhibited by the fauna associated with *M. edulis* appear to be related to aerial and tidal exposure, mussel density, and the amount of accumulated sediment as well as patch size. Although these investigators focused mainly on the biotic aspects of *Mytilus* islands, they recognize the importance of the interactions between system structure and the physical environment in temporal and spatial development. These observations also show that comparisons of bivalve communities based on samples collected at single points in space and time need to be interpreted with caution (Seed 1996).

ZONATION

The intertidal zone is characterized by vertical gradients in both physical and biotic factors that control populations and communities dominated by bivalves. On rocky coastlines throughout the world, bivalves, particularly mussels in the family *Mytilidae*, have the ability to dominate portions of the intertidal zone. In addition to being eurytopic, with abilities to withstand extremes of physical factors, i.e., temperature, salinity, desiccation, and oxygen tension, the members of this family develop byssal attachment threads that allow them to exploit hard substrates and dominate rocky habitats (Suchane 1986). These mussels often form dense bands of animals that occupy intertidal space, particularly in temperate regions (Seed and Suchanek 1992). The majority of *Mytilidae* can also survive in the subtidal zone.

Numerous studies (see Seed and Suchanek 1992) have shown that the upper limit of mussel bands on rocky intertidal environments is controlled by physical factors while the lower limit is usually controlled by predation and competition. These general observations support those of Connell (1961, 1972) on intertidal barnacles and the speculation that such zonation control was applicable to other intertidal forms.

Peterson (1991) has argued persuasively that zonation of bivalves and other invertebrates also occurs in intertidal sediments. These environments are typically sand and mud flats that are often quite extensive in shallow coastal systems. As in the rocky intertidal zone, gradients of physical factors lead to gradients of physiological processes. The dominant factors are exposure to air, light, temperature, and wave action. Thus higher elevations are more rigorous, and only a few species can tolerate these stresses. Predation is frequently evidenced by rapidly moving fishes, crabs, and birds, as well as terrestrial predators. In contrast to the rocky intertidal zone where competition for space can lead to sharp boundaries between zones, competitive exclusion is rare in these soft sediment systems. The greatly reduced competition for space and the indirect effects of competition for food lead to more gradual zonation dominated by physical effects (Black and Peterson 1988).

Intertidal oyster reefs and mussel beds are usually found in creeks and channels surrounded by soft sediment environments. Mussel and oyster beds are exposed to the same gradients of physical factors as dense populations of bivalves in the rocky intertidal zone and less dense populations in mud and sand flats. As the beds grow vertically, the effects of the physical environment, particularly exposure and temperature at their upper limits, can become acute. These systems appear to suffer predation from rapidly moving birds, crabs, and fish as well as sluggish forms of gastropods and fungi. There is strong competition for space that is modulated by mussels and oysters growing on top of each other and thus increasing the vertical dimension of their communities. This increase in system structure in the form of more microhabitats leads to a moderation in competitive exclusion and the existence of other bivalves in significant numbers, i.e., *Brachidontes* mussels on oyster reefs. Oysters, in general, when compared to other bivalve species, appear to build reefs with the highest relief. Among the oysters, intertidal *Crassostrea virginica* is, generally, thought to have the largest and highest reefs. Thus it follows that when *C. virgi-*

nica is in a pristine marsh-estuarine system, it is one of the key components in one of the most productive natural ecosystems on our planet (Dame 2009).

In Europe, *Crassostrea gigas* is the invasive species that seems to adapt to the environment the quickest. The case study at the end of Chapter 9 gives more detail on this.

DISEASES AND PARASITES

The healthy state of a bivalve mollusc entails normal structural and functional status where the animal can successfully accommodate the typical ecological conditions as they influence growth, development, reproduction, survival, and competition (Kinne 1980). Disease is the deviation or reduction (negative deviation) from the healthy state of the living animal. There is a gradient from the healthy to the diseased state.

A disease is demonstrable when the disease-causing agent surpasses certain critical levels. Critical levels can be identified by (1) an increase in the number of given disease carrying agents per host bivalve; (2) an increase in the agent's virulence or destructive potential; (3) the concomitant activities of several agents of different taxa; (4) a decrease in host resistance; and (5) changes in the quantitative relationship between host and agent (Kinne 1980).

Although diseases can be restricted to an individual bivalve, this book will focus on those that are transmitted from one individual to another, i.e., infectious, communicable, and contagious diseases. Four types of disease can be identified: (1) endemics (enzootics) are diseases that are characteristic of a host population in a certain area; (2) epidemics (epizootics) are temporary mass outbreaks of a communicable disease; (3) pandemics (panzootics) are temporary mass outbreaks of a communicable disease over a wide geographic area; and (4) sporadic (ecdemic) diseases are more or less atypical of the area concerned (Kinne 1980).

Diseases have a number of different causes that include the following: (1) circumstances internal; (2) nutritional disorders; (3) effects of abiotic physical factors and pollutants; (4) physical injuries; (5) agents or coexisting organisms; and (6) combinations of the preceding five causes. This text will focus on the biotic diseases or agents, including viruses, bacteria, fungi, protozoans, mesozoans, and metazoans.

In 1983, Kinne declared that more is known about the diseases of bivalves than of the diseases of all other marine invertebrates combined. Because of the voluminous amount of published literature on marine bivalve diseases, it is impossible to do the topic justice in this short space. However, those interested in detailed accounts are encouraged to see Kinne (1980 and 1983), Sparks (1985), Sinderman (1990), and Perkins (1993) for comprehensive reviews of bivalve diseases.

Many viruses have been described for marine bivalves (Sinderman 1990). Few have been adequately characterized and then only with histopathology and ultrastructure morphology. The major problem with viral diseases in shellfish is the demonstration of causal relationships between the virus and the observed pathology. A number of different viral types have been observed in commercially abundant bivalves including herpes virus, reovirus, papovavirus, icosahedral virus, iridovirus, retrovirus, and papillomavirus. Each virus appears to invade a specific tissue with infections found in digestive glands, gonads, gills, palps, and connective tissues. Of

these viruses, an epidemic (epizootic) of iridovirus that causes gill disease in *Crassostrea angulata* resulted in the loss of this species to cultivation along the coast of France in the 1960s and 1970s (Sinderman 1990; Perkins 1993).

Bacterial (prokaryotes) diseases of bivalves appear to be important in the pre-settlement stages and are, for the most part, unimportant in adults because of the well-developed defense mechanisms of phagocytosis and encapsulation common in postsettlement bivalves. Successful bivalve bacterial agents appear to be able to avoid or escape these defenses. By far the most important disease-causing bacterium for bivalves is *Vibrio* that can be deadly to developing larvae (Sinderman 1990; Perkins 1993).

The fungi (Eumycota) are poorly represented in the litany of disease-causing agents of bivalves. The major observed fungal agent is an aquatic phycomycetes that attacks the shell of adult bivalves and is known as “shell disease” or *maladie du pied*. This fungus, *Ostracoblabe implexa*, has been reported to cause mass mortality in both natural and cultivated stocks of European oysters, and has been recognized as a major cause of the extinction of European oysters. In this disease, the shell in the area of the muscle attachment was attacked. Eventually, the muscle became detached and death followed (Sinderman 1990; Perkins 1993).

The protozoans (Protista) are probably the most common cause of epizootic outbreaks that result in mass mortalities in populations of economically important bivalves. Although protozoan infections have been reported in many bivalves including mussels, clams, and shipworms, it is in the oysters where they have been most extensively studied. The most notable of the many protozoan diseases are dermo, caused by a member of the phylum Apicomplexa, *Perkinsus marinus*, and MSX caused by *Haplosporidium nelsoni* of the phylum Ascetospora (Sparks 1985; Sinderman 1990). Dermo is characterized by emaciation of the digestive gland in oysters. Adult oysters appear to be most susceptible after spawning, and mortality increases with age and size (Lauckner 1983). MSX also attacks and emaciates oysters, and both diseases have limits imposed by salinity and temperature. Both of these protozoans have caused epidemics in natural and cultivated oyster populations along the Gulf and Atlantic coasts of North America to the extent that oyster harvests in these areas are but a fraction of previous yields. Although protozoan epidemics are reported worldwide, it is thought that these massive population mortalities have always existed. Their spread has been helped by experimental plantings of oysters from other regions. As is the case for most disease, dense populations typical of cultivated plots and growout facilities are most susceptible to disease transmission.

Parasitic worms, trematodes, cestodes, and nematodes can reduce growth and fecundity within bivalves and may in some cases cause death (Lauckner 1983; Sinderman 1990). Polychaete annelid worms of the genus *Polydora* (mud or blister worms) can invade oysters, mussels, and scallops where the death of these organisms occurs in cases of severe infection. The larvae of *Polydora* settle on the exterior of bivalves where they proceed to make burrows at the edge of the valves. The worm accumulates mud around itself and the bivalve responds by secreting shell to cover the mud–worm complex. Bivalves heavily infested by *Polydora* are usually of poor condition and weak (Galtsoff 1964; Skeel 1979). Some bivalves may die as

a consequence of *Polydora* infestation, but most are weakened both physiologically (condition) and structurally (perforated shells) and thus are more susceptible to other forms of predation. In a study of *Polydora ciliata* infestations of *Mytilus edulis*, Ambariyanto and Seed (1991) found that there was a higher incidence of these parasites in larger mussels and that heavily infested mussels were more vulnerable to predation by shore crabs. These investigators also found that *P. ciliata* infestations were highest at the mouth of the estuary and declined along a gradient up the estuary. Unlike other parasites of bivalves, these shell-borers showed no systematic variation with tidal elevation.

Using Taylor's (1984) general definition of predation, the small pyramidellid gastropods can be considered predators or parasites. Such a gastropod, *Boonea impressa*, is a common member of *Crassostrea virginica* dominated oyster reefs in the southern United States. This gastropod feeds, as do other pyramidellids, by attaching to the soft tissues of the bivalve with a sucker. Then it pierces the tissues with a buccal stylet and sucks the body fluids of the prey (Fretter and Graham 1949; Allen 1958). Small *Boonea* may be a direct cause of oyster spat mortality (White et al. 1988) while the valve movements, filtration rate, and growth rate of larger bivalves are affected by the parasite (Ward and Langdon 1986). Using an energy flow model, White et al. (1988) determined that these snails appear to have less impact on populations of large oysters, and because of *Boonea*'s patchy distribution, its impact could not be uniform. Further work by this group showed that *Boonea* can be a vector for the transmission of dermo disease since individuals migrate between oysters.

Parasitic crustaceans that are common in bivalves often destroy the gonads, influence nutrient adsorption, and modify or inhibit gill function (Sinderman 1990). A number of species of the parasitic copepod *Mytilicolas* infect the digestive track of different bivalves including mussels, oysters, and clams. The well-known pea crab, *Pinnotheres ostreum*, inhabits the mantle cavity of *Crassostrea virginica*, and other pinnotherids parasitize scallops and mussels. Developing pea crabs invade the bivalve where the crabs mature to sexually dimorphic forms of relatively large females and tiny males. Originally, these crustaceans were thought not to harm the bivalve (Galtsoff 1964), but the current belief is that pea crabs interfere with growth by eroding the gills (Kruczynski 1972; Bierbaum and Ferson 1986; Bierbaum and Shumway 1988). In oysters, it is thought that pea crabs may influence sex ratio in favor of male bivalves (Awati and Rai 1931; Christensen and McDermott 1958), and this ratio change could have population effects. Although pea crabs are usually categorized as parasites or pests, using the more general definition of predation, they can and do reduce the productivity of bivalves at both the individual and population levels.

Disease is an important ecological factor. At the individual level, disease can affect the rates and efficiencies of metabolic processes including growth, filtration, respiration, and reproduction. It may change the timing of the life cycle and the capacities for regulation and adaptation of the host bivalve to stress. Disease may also change the structural morphology of not only the soft body parts, but also the shell. Ultimately disease reduces the life span of the organism and its success in its environment.

At the population level, epidemics can change population structure and reduce population size. Population distribution and abundance can be influenced both spatially and temporally and population reproduction is often reduced. If critical levels are reached, entire populations may go extinct.

From an ecosystem perspective, epidemic diseases will directly influence the functional status of the host bivalve and indirectly radiate to the rest of the system through the food web. The loss of an entire functional component to disease, i.e., suspension-feeders, can change the entire ecosystem.

POPULATION ENERGY BUDGETS

As is presented in Chapter 3, Organismic Level Processes, the components of an organism's energy budget can be determined by examining the feeding, respiration, excretion, fecal production, growth, and reproduction of bivalves of different sizes. These values can be scaled-up to population patches or entire populations by taking into account natality and mortality patterns and integrating estimates of population density usually in the form of the age or size histograms described earlier.

Population energy budgets are usually used to compare different populations or the same population in different years. These budgets are acutely sensitive to changes in size and age composition as well as changing environmental conditions (Griffiths and Griffiths 1987). In spite of the difficulties raised earlier, it is still worthwhile to compare the energy budgets of different bivalve populations (Table 5.6).

From Table 5.6, it is obvious that denser populations consume more energy than less dense populations. Most bivalve populations put less than 10% of their intake into growth and slightly more than 10% of their intake into growth and reproduction combined. Most consumption goes into respiration and waste. The production to biomass ratio (P/B) is an estimate of the turnover of energy in the population. The P/B ratio averages to 1.2, but this ratio is very sensitive to size distribution, with small, fast-growing size classes having higher P/B ratios and older size classes having smaller ratios (Griffiths and King 1979).

There are few generalities regarding bivalve population energy budgets. Although they give a much more detailed view of the functional aspects of a given bivalve population, each population should be considered a unique case. When the informational need is apparent and the resources are available, then population specific energy budgets should be constructed. Try to measure all of the components independently. Just remember this now obscure incident. When the energy budget of a coastal system was built it was about 45% out of balance, so the already distinguished scientists printed one word next to number, outwelling.

TABLE 5.6
Population Energy Budgets for Various Bivalve Species, Expressed as a Percentage of Consumption (C)

| Species | C (kJ m ⁻² year ⁻¹) | P _g (%) | P _r | R (%) | F + U (%) | P/B ratio | Source |
|----------------------------------|--|-----------------------|----------------|----------|--------------|--------------|---------------------------|
| <i>Aulacomya ater</i> | 27 | 3.4 | 5.8 | 49.3 | 41.5 | 1.30 | Griffiths and King (1979) |
| <i>Cardium edule</i> | 3,622 | 2.8 | — | 57.2 | 40.0 | — | Loo and Rosenberg (1989) |
| <i>Chlamys islandica</i> | 55,711 | 1.0 | 0.4 | 3.6 | 94.2 | 0.76 | Vahl (1981) |
| <i>Choromytilus meridionalis</i> | 831,890 | 1.6 | 4.8 | 10.4 | 83.2 | 2.91 | Griffiths (1981) |
| <i>Crassostrea gigas</i> | 10,140 | 0.4 | 20.7 | 20.7 | 63.7 | — | Bernard (1974) |
| <i>Crassostrea virginica</i> | 8,811 | 17.7 | 3.4 | 28.9 | 50.0 | 2.00 | Dame (1976) |
| <i>Geukensia demissa</i> | 468 | 12.4 | 2.5 | 34.8 | 50.0 | 0.28 | Kuenzler (1961) |
| <i>Lyrodus pedicellatus</i> | — | 9.0 | 4.3 | 19.8 | 66.7 | — | Gallager et al. (1981) |
| <i>Mercenaria mercenaria</i> | 5,400 | 5.6 | 4.7 | 18.7 | 71.1 | 0.39 | Hibbert (1977) |
| <i>Mya arenaria</i> | 545 | 6.8 | — | 53.2 | 40.2 | — | Loo and Rosenberg (1989) |
| <i>Mytilus edulis</i> | — | 8.9 | 4.8 | 25.8 | 60.4 | — | Bayne and Newell (1983) |
| <i>Ostrea edulis</i> | 468 | 6.4 | 5.5 | 29.0 | 59.1 | — | Rodhouse (1978) |
| <i>Patinopecten yessoensis</i> | — | 22.7 | 4.3 | 43.6 | 29.4 | — | Fuji and Hashizume (1974) |
| <i>Scrobicularia plana</i> | 2,315 | 6.6 | 6.2 | 48.0 | 39.3 | — | Hughes (1970) |
| <i>Tellina tenuis</i> | 703 | 1.2 | 0.9 | 7.9 | 90 | — | Trevallion (1971) |

Note: C = Consumption; P_g = production as growth; P_r = production as reproduction; and F + U = feces and urine (excreted waste).

Source: From Dame, R.F. 1996. *Ecology of Marine Bivalves: An Ecosystem Approach*. Boca Raton, FL: CRC Press, 254 pp.

REFERENCES

- Allen, J. 1958. Feeding habits of two species of *Odostomia*. *Nautilus*, 72, 11–15.
- Ambariyanto, R. and Seed, R. 1991. The infestation of *Mytilus edulis* Linnaeus by *Polydora ciliata* (Johnston) in the Conway estuary, North Wales. *J. Moll. Stud.*, 57, 413–24.
- Andre, C. and Rosenberg, R. 1991. Adult–larval interactions in the suspension feeding bivalves *Cerastoderma edule* and *Mya arenaria*. *Mar. Ecol. Prog. Ser.*, 71, 227–34.
- Andre, C., Jonsson, P.R., and Lindegarth, M. 1993. Predation on settling bivalve larvae by benthic suspension in feeders: The role of hydrodynamics and larval behaviour. *Mar. Ecol. Prog. Ser.*, 97, 183–92.
- Awati, P.R. and Rai, H.S. 1931. *Ostrea cucullata* (the Bombay oyster). *Indian Zool. Mem.*, 3, 1–107.
- Bahr, L.M. and Lanier, W.P. 1981. The ecology of intertidal oyster reefs of the South Atlantic coast: A community profile. FWS/OBS-81/15, U.S. Fish and Wildlife Service, 105 pp.
- Barnes, R.D. 1974. *Invertebrate Zoology*, 3rd ed. Philadelphia: Saunders, 870 pp.
- Basson, M., Rosenberg, A.A., and Beddington, J.R. 1988. The accuracy and reliability of two new methods for estimating growth parameters from length-frequency data *J. Cons. Int. Explor. Mer.*, 44, 277–85.
- Bayne, B.L. 1976. Aspects of reproduction in bivalve molluscs. In *Estuarine Processes, Vol. 1, Uses, Stresses and Adaptation to the Estuary*, Wiley, M., Ed. New York: Academic Press, pp. 432–48.
- Bayne, B.L. and Newell, R.C. 1983. Physiological energetics of marine molluscs. In *The Biology of Molluscs: Physiology*, Wilbur, K.M. and Saleuddin, A.S.M., Eds. New York: Academic Press, pp. 407–515.
- Bernard, F.R. 1974. Annual biodeposition and gross energy budget of mature Pacific oysters *Crassostrea gigas*. *J. Fish. Res. Board Can.*, 31, 185–90.
- Berry, P.F. 1978. Reproduction, growth and production in the mussel, *Perna perna* (Linnaeus), on the east coast of South Africa. *Invest. Rep. Oceanogr. Res. Inst. Durban*, 48, 1–28.
- Bertness, M.D. and Grosholz, E. 1985. Population dynamics of the ribbed mussel, *Geukensia demissa*: The costs and benefits of an aggregated distribution. *Oecologia*, 67, 192–204.
- Bierbaum, R.M. and Ferson, S. 1986. Do symbiotic pea crabs decrease growth rate in mussels? *Biol. Bull.*, 170, 51–61.
- Bierbaum, R.M. and Shumway, S. 1988. Filtration and oxygen consumption in mussels, *Mytilus edulis*, with and without pea crabs, *Pinnotheres maculatus*. *Estuaries*, 11, 264–71.
- Black, R. and Peterson, C.H. 1988. Absence of preemption and interference competition for space between large suspension-feeding bivalves and smaller infaunal macroinvertebrates. *J. Exp. Mar. Biol. Ecol.*, 120, 183–98.
- Boulding, E.G. 1984. Crab-resistant features of shells of burrowing bivalves: Decreasing vulnerability by increasing handling time. *J. Exp. Mar. Biol. Ecol.*, 76, 201–23.
- Brousseau, D.J. 1978. Population dynamics of the soft-shell clam *Mya arenaria*. *Mar. Biol.*, 50, 63–71.
- Cargo, D.G. and Shultz, L.P. 1967. Further observations on the biology of the sea nettle and jellyfishes in Chesapeake Bay. *Chesapeake Sci.*, 8, 209–20.
- Cassie, R.M. 1954. Some uses of probability paper in the analysis of size frequency distributions. *Aust. J. Mar. Freshw. Res.*, 5, 513–22.
- Cerrato, R.M. 1980. Demographic analysis of bivalve populations. In *Skeletal Growth of Aquatic Organisms*, Rhoads, D.C. and Lutz, R.A., Eds. New York: Plenum Press, pp. 417–68.
- Christensen, A.M. and McDermott, J.J. 1958. Life-history and biology of the oyster crab, *Pinnotheres ostreum* (Say). *Biol. Bull.*, 114, 146–79.

- Coen, L.D. and Heck, K.L. 1991. The interacting effects of siphon nipping and habitat on bivalve (*Mercenaria mercenaria* L.) growth in a subtropical seagrass (*Halodule wrightii* Aschers) meadow. *J. Exp. Mar. Biol. Ecol.*, 145, 1–13.
- Connell, J.H. 1961. Effects of competition, predation by *Thais lapillus*, and other factors on natural populations of the barnacle *Balanus balanoides*. *Ecol. Monogr.*, 31, 61–104.
- Connell, J.H. 1972. Community interactions on marine rocky intertidal shores. *Annu. Rev. Ecol. Syst.*, 3, 169–92.
- Copland, J.W. and Lucas, J.S. 1988. *Giant Clams in Asia and the Pacific*. Canberra: Australian Center for International Agricultural Research, 274 pp.
- Craeymeersch, J.A., Herman, P.M.J. and Meire, P.M. 1986. Secondary production of an intertidal mussel (*Mytilus edulis* L.) population in the Eastern Scheldt. *Hydrobiologia*, 133, 107–15.
- Cresswell, P.D. and McClay, C.L. 1990. Handling times, prey size and species selection by *Cancer novaezelandiae* feeding on molluscan prey. *J. Exp. Mar. Biol. Ecol.*, 140, 13–29.
- Dame, R.F. 1976. Energy flow in an intertidal oyster population. *Estuarine Coastal Mar. Sci.*, 4, 243–53.
- Dame, R.F. 1979. The abundance, diversity and biomass of macrobenthos on North Inlet, South Carolina, intertidal oyster reefs. *Proc. Natl. Shellfish Assoc.*, 69, 6–10.
- Dame, R.F. 1996. *The Ecology of Marine Bivalves: An Ecosystems Approach*. Boca Raton, FL: CRC Press, 254 pp.
- Dame, R.F. 2009. Shifting through time: Oysters and shell rings in past and present southeastern estuaries. *J. Shellfish Res.* 28(3), 425–430.
- Dayton, P.K. 1971. Competition, disturbance, and community organization: The provision and subsequent utilization of space in a rocky intertidal community. *Ecol. Monogr.*, 41, 351–89.
- Dean, T.A. 1981. Structural aspects of sessile invertebrates as organizing forces in an estuarine fouling community. *J. Exp. Mar. Biol. Ecol.*, 53, 163–80.
- DeVlas, J. 1979. Annual food intake by plaice and flounder in a tidal flat area in the Dutch Wadden Sea, with special reference to consumption of regenerating parts of macrobenthic prey. *Neth. J. Sea Res.*, 13, 117–53.
- DeVlas, J. 1985. Secondary production by siphon regeneration in a tidal flat population of *Macoma balthica*. *Neth. J. Sea Res.*, 19, 147–64.
- Edwards, D.C., Conover, D.O., and Sutter, F. 1982. Mobile predators and the structure of marine intertidal communities. *Ecology*, 63, 1175–80.
- Feder, H.M. 1955. On the methods used by the starfish *Pisaster ochraceus* in opening three types of bivalve molluscs. *Ecology*, 36, 764–67.
- Fisher, R.A. 1958. *The Genetical Theory of Natural Selection*. New York: Dover, 291 pp.
- Fretter, V. and Graham, A. 1949. The structure and mode of life of the Pyramidellidae, parasitic opisthobranch. *J. Mar. Biol. Assoc. U.K.*, 28, 493–532.
- Fuji, A. and Hashizume, M. 1974. Energy budget for a Japanese common scallop, *Patinopecten yessoensis* (Jay), in Mutsu Bay. *Bull. Fac. Fish. Hokkaido Univ.*, 25, 7–19.
- Gallager, S.M., Turner, R.D., and Berg, C.J. 1987. Physiological aspects of wood consumption, growth, and reproduction in the shipworm *Lyrodus pedicellatus* Quatrefages (Bivalvia: Teredinidae). *J. Exp. Mar. Biol. Ecol.*, 52, 63–77.
- Galleni, L., Ferro, E., Salghetti, V., Tongiorgi, P., and Salvadego, P. 1977. Ulteriori osservazioni sulla predazione di *Stylochus mediterraneus* sui Mytili e suo orientamento chemiotattico. *Atti IX Congr. Soc. Ital. Biol. Mar. Lacco Ameno d'Ischia*, pp. 259–61.
- Galtsoff, P.S. 1964. The American oyster *Crassostrea virginica* Gmelin. *Fish. Bull.*, 64, 1–480.

- Griffiths, C.L. 1990. Spatial gradients in predation pressure and their influence on the dynamics of two littoral bivalve populations. In *The Bivalvia—Proceedings of a Memorial Symposium in Honour of Sir Charles Maurice Yonge, Edinburgh, 1986*, Morton, B., Ed. Hong Kong: Hong Kong University Press, pp. 321–32.
- Griffiths, C.L. and Griffiths, R.J. 1987. Bivalvia. In *Animal Energetics, Vol. 2, Bivalvia through Reptilia*, Pandian, T.J. and Vernberg, F.J., Eds. New York: Academic Press, pp. 1–88.
- Griffiths, C.L. and King, J.A. 1979. Energy expended on growth and gonad output in the ribbed mussel *Aulacomya ater*. *Mar. Biol.*, 53, 217–22.
- Griffiths, R.J. 1981. Production and energy flow in relation to age and shore level in the bivalve *Choromytilus meridionalis*. *Estuarine Coastal Mar. Sci.*, 12, 101–18.
- Haines, A.H., Haddon, A.M., and Wiechert, L.A. 1990. Guild structure and foraging impact of blue crabs and epibenthic fish in a sub-estuary of Chesapeake Bay. *Mar. Ecol. Prog. Ser.*, 67, 105–26.
- Harger, J.R.E. 1972. Competitive co-existence: Maintenance of interacting associations of the sea mussels *Mytilus edulis* and *Mytilus californianus*. *Veliger*, 14, 387–410.
- Hibbert, C.J. 1977. Energy relations of the bivalve *Mercenaria mercenaria* on an intertidal mudflat. *Mar. Biol.*, 44, 77–84.
- Himmelman, J.H. and Dutil, C. 1991. Distribution, population structure and feeding of subtidal seastars in the northern Gulf of St. Lawrence. *Mar. Ecol. Prog. Ser.*, 76, 61–72.
- Hughes, R.N. 1970. An energy budget for a tidal-flat population of the bivalve *Scrobicularia plana* (Da Costa). *J. Anim. Ecol.*, 39, 357–81.
- Hughes, R.N. 1991. Reefs. In *Fundamentals of Aquatic Ecology, 2nd ed.*, Barnes, R.S.K. and Mann, K.H., Eds. Oxford: Blackwell Scientific, pp. 213–29.
- Hughes, R.N. and Griffiths, C.L. 1988. Self-thinning and mussels: The geometry of packing. *Am. Nat.*, 132, 484–91.
- Hughes, R.N. and Seed, R. 1981. Size selection of mussels by the blue crab *Callinectes sapidus*: Energy maximizer or time minimizer? *Mar. Ecol. Prog. Ser.*, 6, 83–89.
- Hurd, L.E., Smedes, G.W., and Dean, T.A. 1979. An ecological study of a natural population of diamondback terrapins (*Malaclemys t. terrapin*) in a Delaware salt marsh. *Estuaries*, 2, 28–33.
- Kinne, O. 1980. Diseases of marine animals: General aspects. In *Diseases of Marine Animals, Vol. 1*, Kinne, O., Ed. New York: Wiley, pp. 13–74.
- Kinne, O., Ed., 1983. *Diseases of Marine Animals, Vol. 2*. Helgoland: Biologische Anstalt, 961 pp.
- Korringa, P. 1949. *Crepidula fornicata* as an oyster-pest. *J. Cons. Perm. Int. Explor. Mer., Rapp. P.-V. Reun.*, 128, 55–59.
- Krebs, C.H. 1978. *Ecology: The Experimental Analysis of Distribution and Abundance, 2nd ed.*, New York: Harper and Row, 678 pp.
- Kremmer, P. 1979. Predation by the ctenophore *Mnemiopsis leidyi* in Narragansett Bay, Rhode Island. *Estuaries*, 2, 97–105.
- Kruczynski, W.L. 1972. Distribution and abundance of *Pinnotheres maculatus* Say in Bogue Sound, North Carolina. *Biol. Bull.*, 145, 482–91.
- Kuenzler, E.J. 1961. Structure and energy flow of a mussel population in a Georgia salt marsh. *Limnol. Oceanogr.*, 6, 191–204.
- Kurten, B. 1964. Population structure in paleoecology. In *Approaches to Paleocology*, Imbrie, J. and Newell, N., Eds. New York: Wiley, pp. 91–106.
- Kvitek, R.G., Fukayama, A.K., Anderson, B.S., and Grimm, B.K. 1988. Sea otter foraging on deep-burrowing bivalves in a California coastal lagoon. *Mar. Biol.*, 98, 157–67.
- Kvitek, R.G. and Oliver, J.S. 1988. Sea otter foraging habits and effects on prey populations and communities in soft-bottom environments. In *The Community Ecology of Sea Otters*, Van Blaricom, G.R. and Estes, J.A., Eds. New York: Springer-Verlag, pp. 22–47.

- Lau, C.J. 1987. Feeding behaviour of the Hawaiian slipper lobster, *Scyllarides squammosus*, with a review of decapod crustacean feeding tactics on molluscan prey. *Bull. Mar. Sci.*, 41, 378–91.
- Lauckner, G. 1983. Diseases of mollusca: Bivalvia. *Diseases of Marine Animals*, Vol. 2, Kinne, O., Ed. Hamburg: Biologische Anstalt Helgoland, pp. 477–984.
- Lintas, C. and Seed, R. 1994. Spatial variation in the fauna associated with *Mytilus edulis* on a wave-exposed rocky shore. *J. Moll. Stud.*, 60, 165–74.
- Loo, L.-O. and Rosenberg, R. 1989. Bivalve suspension-feeding dynamics and benthic-pelagic coupling in an eutrophicated marine bay. *J. Exp. Mar. Biol. Ecol.*, 130, 253–76.
- Loosanoff, V.L. 1956. Two obscure oyster enemies in New England waters. *Science*, 123, 1119–20.
- Lubchenco, J. and Menge, B.A. 1978. Community development and persistence in a low rocky intertidal zone. *Ecol. Monogr.*, 48, 67–94.
- MacArthur, R.H. and Wilson, E.O. 1967. *The Theory of Island Biogeography*. Princeton, NJ: Princeton University Press, 203 pp.
- Marsh, C.P. 1986. Rocky intertidal community organization: The impact of avian predators on mussel recruitment. *Ecology*, 67, 771–86.
- McGrorty, S., Clarke, R.T., Reading, C.J., and Goss-Custard, J.D. 1990. Population dynamics of the mussel *Mytilus edulis*: Density changes and regulation of the population in the Exe estuary, Devon. *Mar. Ecol. Prog. Ser.*, 67, 157–69.
- McGrorty, S. and Goss-Custard, J.D. 1991. Population dynamics of the mussel *Mytilus edulis*: Spatial variations in age-class densities of an intertidal estuarine population along environmental gradients. *Mar. Ecol. Prog. Ser.*, 73, 191–202.
- Meire, P. 1993. The impact of bird predation on marine and estuarine bivalve populations: A selective review of patterns and underlying causes. In *Bivalve Filter Feeders in Estuarine and Coastal Ecosystem Processes*, Dame, R.F., Ed. Heidelberg: Springer-Verlag, pp. 197–244.
- Meire, P.M. and Ervynck, A. 1986. Are oystercatchers (*Haematopus ostralegus*) selecting the most profitable mussels (*Mytilus edulis*)? *Anim. Behav.*, 34, 1427–35.
- Menge, B.A. 1992. Community regulation: Under what conditions are bottom-up factors important on rocky shores? *Ecology*, 73, 755–65.
- Möller, P. 1986. Physical factors and biological interactions regulating infauna in shallow boreal areas. *Mar. Ecol. Prog. Ser.*, 30, 33–47.
- Moore, H.B. and Lopez, N.N. 1969. The ecology of *Chione cancellata*. *Bull. Mar. Sci.*, 19, 131–48.
- Moore, H.B. and Lopez, N.N. 1970. A contribution to the ecology of the Lamellibranch *Dosinia elegans*. *Bull. Mar. Sci.*, 20, 980–86.
- Murphy, G.I. 1968. Pattern in life history and the environment. *Am. Nat.*, 102, 391–403.
- Odum, E.P. 1983. *Basic Ecology*. Philadelphia: Saunders, 613 pp.
- Oliver, J.S., Kvitek, R.G., and Slattery, P.N. 1985. Walrus disturbance: Scavenging habits and recolonization of the Bering Sea benthos. *J. Exp. Mar. Biol. Ecol.*, 91, 233–46.
- Oliver, J.S., Slattery, P.N., O'Connor, E.F., and Lowry, L.F. 1983. Walrus, *Odobenus rosmarus*, feeding in the Bering Sea: A benthic perspective. *Fish. Bull.*, 81, 501–12.
- Olla, B.L., Bejda, A.J., and Martin, A.D. 1975. Activity movements, and feeding behavior of the cunner, *Tautoglabrus adspersus*, and comparison of habits with young tautog, *Tautoga onitis*, off Long Island, New York. *Fish. Bull.*, 73, 895–900.
- Paine, R.T. 1974. Intertidal community structure: Experimental studies on the relationship between a dominant competitor and its principal predator. *Oecologia*, 14, 93–120.
- Paine, R.T. 1976. Size-limited predation: An observational and experimental approach with the *Mytilus-Pisaster* interaction. *Ecology*, 57, 858–73.
- Perkins, F.O. 1993. Infectious diseases of molluscs. In *Pathobiology of Marine and Estuarine Organisms*, Couch, J.A. and Fournie, J.W., Eds. Boca Raton, FL: CRC Press, 255–87.

- Peterson, C.H. 1991. Intertidal zonation of marine invertebrates in sand and mud. *Am. Sci.*, 70, 236–49.
- Peterson, C.H. and Quammen, M.L. 1982. Siphon nipping: Its importance to small fishes and its impact on growth of the bivalve *Protothaca staminea* (Conrad). *J. Exp. Mar. Biol. Ecol.*, 63, 249–68.
- Powell, E.N., Cummins, H., Stanton, R.J., and Staff, G. 1984. Estimation of the size of molluscan larval settlement using the death assemblage. *Estuarine Coast. Shelf Sci.*, 18, 367–84.
- Powell, E.N., White, M.E., Wilson, E.A., and Ray, S.M. 1987. Small-scale spatial distribution of oysters (*Crassostrea virginica*) on oyster reefs. *Bull. Mar. Sci.*, 41, 835–55.
- Rhoads, D.C., Lutz, R.A., Cerrato, R.M., and Revelas, E.C. 1982. Growth and predation activity at deep-sea hydrothermal vents along the Galapagos Rift. *J. Mar. Res.*, 40, 503–16.
- Riedman, M.L. and Estes, J.A. 1988. A review of the history, distribution and foraging ecology of sea otters. In *The Community Ecology of Sea Otters*, Van Blaricom, G.R. and Estes, J.A., Eds. New York: Springer-Verlag, pp. 4–21.
- Robles, C. 1987. Predator foraging characteristics and prey population structure on a sheltered shore. *Ecology*, 69, 1502–14.
- Rodhouse, P.G. 1978. Energy transformations by the oyster *Ostrea edulis* L. in a temperate estuary. *J. Exp. Mar. Biol. Ecol.*, 34, 1–22.
- Rodhouse, P.G., Roden, C.M., Hensey, M.P., and Ryan, T.H. 1984. Resource allocation in *Mytilus edulis* on the shore and in suspended culture. *Mar. Biol.*, 84, 27–34.
- Roughgarden, J., Iwasa, Y., and Baxter, C. 1985. Demographic theory for an open marine population with space-limited recruitment. *Ecology*, 66, 54–67.
- Sanchez-Salazar, M.E., Griffiths, C.L., and Seed, R. 1987. The interactive roles of predation and tidal elevation in structuring populations of the edible cockle, *Cerastoderma edule*. *Estuarine Coastal Shelf Sci.*, 25, 245–60.
- Seed, R. 1969. The ecology of *Mytilus edulis* L. (Lamellibranchiata) on exposed rocky shores. 2. Growth and mortality. *Oecologia*, 3, 317–50.
- Seed, R. 1992. Crabs as predators of marine bivalve molluscs. In *Proc. 1st Int. Conf. Marine Biol. Hong Kong and Southern China*, Morton, B., Ed. Hong Kong: Hong Kong University Press.
- Seed, R. 1993. Invertebrate predators and their role in structuring coastal and estuarine populations of filter feeding bivalves. In *Bivalve Filter Feeders in Estuarine and Coastal Ecosystem Processes*, Dame, R., Ed. Heidelberg: Springer-Verlag, pp. 149–95.
- Seed, R. 1996. Patterns of biodiversity in the macro-invertebrate fauna associated with mussel patches on rocky shores. *J. Mar. Biol. Assoc. U.K.*, 76, 203–10.
- Seed, R. and Brown, R.A. 1975. The influence of reproductive cycle, growth, and mortality on population structure in *Modiolus modiolus* (L.), *Cerastoderma edule* (L.) and *Mytilus edulis* L. (Mollusca: Bivalvia). *Proc. 9th Eur. Mar. Biol. Symp.*, pp. 257–74.
- Seed, R. and Suchanek, T.H. 1992. Population and community ecology of *Mytilus*. In *The Mussel Mytilus: Ecology, Physiology, Genetics and Culture*, Gosling, E., Ed. New York: Elsevier, pp. 87–169.
- Sheldon, R.W. 1965. Fossil communities with multi-modal size-frequency distributions. *Nature*, 206, 1336–38.
- Sims, N.A. and Howard, N. T. 1988. Indigenous tridacnid clam populations and the introduction of *Tridacna derasa* in the Cook Islands. In *Giant Clams in Asia and the Pacific*, Copland, J.W. and Lucas, J.S., Eds. Canberra: Australian Center for International Agricultural Research, pp. 34–40.
- Sinderman, C.J. 1990. *Principal Diseases of Marine Fish and Shellfish, 2nd ed., Vol. 2*. N.Y. Academic Press, 521 pp.
- Skeel, M.E. 1979. Shell-boring worms (Spionidae: Polychaeta) infecting cultivated bivalve molluscs in Australia. *Proc. World Maricult. Soc.*, 10, 529–33.

- Smith, J.W. and Merriner, J.V. 1978. *Biology and Identification of Rays in the Chesapeake Bay, No. 20* Gloucester Point, VA: VIMS Educational Services, 22 pp.
- Sparks, A.K. 1985. *Synopsis of Invertebrate Pathology Exclusive of Insects*. New York: Elsevier, 521 pp.
- Stenzel, H.B. 1971. Oysters. In *Treatise on Invertebrate Paleontology, Part N, Mollusca 6, Bivalvia*. Moore, R.C., Ed. Lawrence, KS: Geological Society of America, pp. N954–N1224.
- Suchanek, T.H. 1978. The ecology of *Mytilus edulis* L. in exposed rocky intertidal communities. *J. Exp. Mar. Biol. Ecol.*, 76, 105–20.
- Suchanek, T.H. 1986. Mussels and their role in structuring rocky shore communities. In *The Ecology of Rocky Coasts*, Moore, P.G. and Seed, R., Eds. Sevenoaks, U.K.: Hodder and Stoughton, pp. 70–96.
- Taylor, R.J. 1984. *Predation*. New York: Chapman and Hall, 166 pp.
- Trevallion, A. 1971. Studies on *Tellina tenuis* (Da Costa). III. Aspects of general biology and energy flow. *J. Exp. Mar. Biol. Ecol.*, 7, 95–122.
- Trevallion, A., Edwards, R.R.C., and Steele, J.H. 1970. Dynamics of a benthic bivalve. In *Marine Food Chains*, Steele, J.H., Ed. University of California Press, pp. 285–95.
- Tsuchiya, M. 1983. Mass mortality in a population of the mussel *Mytilus edulis* L. caused by high temperature on rocky shores. *J. Exp. Mar. Biol. Ecol.*, 66, 101–11.
- Tsuchiya, M. and Nishihira, M. 1985. Islands of *Mytilus* as habitat for small intertidal animals: Effect of island size on community structure. *Mar. Ecol. Prog. Ser.*, 25, 71–81.
- Tsuchiya, M. and Nishihira, M. 1986. Islands of *Mytilus* as habitat for small intertidal animals: Effect of *Mytilus* age structure on the species composition of the associated fauna and community organization. *Mar. Ecol. Prog. Ser.*, 31, 171–78.
- Vahl, O. 1981. Energy transformations by the Iceland scallop, *Chlamys islandica*, from 70°N. II. The population energy budget. *J. Exp. Mar. Biol. Ecol.*, 53, 297–303.
- Valiela, I. 1984. *Marine Ecological Processes*. New York: Springer-Verlag, 546 pp.
- Van Blaricom, G.R. 1988. Effects of foraging by sea otters on mussel-dominated intertidal communities. In *The Community Ecology of Sea Otters*, Van Blaricom, G.R. and Estes, J.A., Eds. New York: Springer-Verlag, pp. 48–91.
- Vance, R.R. 1973. On reproductive strategies in marine benthic invertebrates. *Am. Nat.*, 107, 339–52.
- Walford, L.V. 1946. A new graphic method of describing the growth of animals. *Biol. Bull.*, 30, 453–67.
- Ward, J.E. and Langdon, C.J. 1986. Effects of the ectoparasitic *Boonea* (= *Odostomia*) *impressa* (Say) (Gastropoda: Pyramidellidae) on growth rate, filtration rate, and valve movements of the host *Crassostrea virginica* (Gmelin). *J. Exp. Mar. Biol. Ecol.*, 99, 163–80.
- Webster, J.R. and Medford, R.Z. 1959. Flatworm distribution and associated oyster mortality in Chesapeake Bay. *Proc. Natl. Shellfish Assoc.*, 50, 85–9.
- Wells, H.W. 1961. The fauna of oyster beds, with special reference to the salinity factor. *Ecol. Monogr.*, 31, 241–66.
- White, M.E., Powell, E.N., and Ray, S.M. 1988. Effect of parasitism by the Pyramidellid Gastropod *Boonea impressa* on the net productivity of oysters (*Crassostrea virginica*). *Estuarine Coastal Shelf Sci.*, 26, 359–77.

6 Ecosystem Grazing

INTRODUCTION

We now know that the Earth's living components regulate numerous fluxes of energy and matter. In coastal and estuarine ecosystems with dense populations or subsystems of bivalves, these organisms often represent a major functional component that consumes large quantities of primary producers and strongly couples the benthic and water column habitats to each other. In these systems, bivalves graze on phytoplankton in the water column, benthic microflora, "resuspended" benthic algae, detritus, or all of the above. They also can remove some of their potential food competitors, the microzooplankton that also includes their own larvae. Thus the role of the bivalves in moving energy and materials through and within their ecosystems is prominent. When measured at local scales, these rates are usually called ecosystem processes. Ecosystem properties are attributes of the biotic assemblage in terms of the number and types of organisms. The combination of processes, properties, and their maintenance represent ecosystem functioning (Reiss et al. 2009), but to avoid confusion, I agree with Norberg and Comming (2008) and advocate using the term "ecosystem processes."

Early accounts of the food of bivalve suspension-feeders were the result of gut content analyses of commercially important species. For example, McCrady (1874) reported that the gut contents of *Crassostrea virginica* included diatoms and algal spores; Lotsy (1893) found similar foods in the guts of clams and ribbed mussels. These observations supported the argument of Möbius (1880) that oyster reefs and mussel beds were assemblages of interacting organisms, with the suspension-feeders

IMPORTANT TERMS AND CONCEPTS

- Complex systems:** Produce unexpected dynamics because of nonlinear interactions among components.
- Ecological restoration:** The process of assisting in the recovery of damaged ecosystems.
- Ecosystem functions:** Attributes of an ecosystem that help to keep its component parts running together.
- Ecosystem processes:** Defined or described in terms of delivery, movement, or loss of energy or materials to an ecosystem.
- Ecosystem services:** Processes that are beneficial to humans.
- Estuarine ecosystems:** Coastal bodies of water where seawater meets and mixes with freshwater from land and ground runoff.
- Feedback:** An output signal that controls the future magnitude of a flow.
- Resilience:** The amount of disturbance a system can absorb while still remaining within the same state or domain of attraction.

providing the major source of input to the system. Later studies by Morse (1944) noted that the food species might be different in different seasons. The first possible system consequences of suspension-feeding were speculated upon by Damas (1935) as reported by Lund (1957) and involved self-silting by the cockle (*Cardium=Cerastoderma edule*). It was not until the extensive study of Verwey (1952) on the cockle (*C. edule*) and the mussel (*Mytilus edulis*) in the Dutch Wadden Sea that the potential effects of bivalve suspension-feeders on an entire ecosystem were addressed.

GRAZING THEORY AS APPLIED TO BIVALVES

Grazing is a system level process that directly connects the herbivores, in this case the suspension-feeding bivalves, to the food source or primary producers. This process directly reduces the standing crop of the primary producers through consumption and results in nutrition to the bivalves while changing the community or population structure of the algae. Grazing control on the primary producers is often depicted as a top-down process generated by herbivores higher up the food chain (Sternner 1986). In contrast, nutrient or resource enrichment or limitation and competition are termed bottom-up control of phytoplankton (Tilman 1976; Sommer 1989). Both bottom-up and top-down controls probably take place at the same time with each contributing to feedback loop construction.

As grazing intensity by herbivores on primary producers increases, three potential consequences have been observed (Hilbert et al. 1981). First, there may be a direct linear decrease in the primary producers and primary production; second, there may be a lag period and then a linear decrease; and third, primary production may actually increase and then drop off (Figure 6.1). The third alternative is known as the “grazing optimization hypothesis” and was first proposed by McNaughton (1979) for terrestrial plant–herbivore interactions. In aquatic systems, the herbivore-mediated removal of algal cells may be compensated for or stimulated by (1) an increase in light in the water column; (2) the cropping of larger and thus older cells in a population leading to a higher logarithmic growth rate; (3) biodiversity shifts to faster growing phytoplankton species; (4) higher nutrient recycling rates; and (5) microalgae growth rates that may also be stimulated by increased nutrient availability due to reduced storage of nutrients in algae biomass (Prins et al. 1995). The first three of these potential mechanisms are directly the result of grazing while the others are indirect effects eventually elicited by nutrient enrichment or feedback. Because of this mixing of direct and indirect effects, as well as the top-down versus bottom-up aspects of phytoplankton population regulation, most of the studies concerning these ideas have taken place in controlled experiments, i.e., microcosms and mesocosms.

Remember, positive feedbacks are signal reinforcing or action increasing, and negative feedbacks are action or process reducing. It is not unusual for a positive and a negative feedback to be paired. The feedbacks listed in Table 6.1. include both effects from ecosystem level processes on the physiology and growth of the individual bivalve, and potential feedback mechanisms as a result of bivalve activity that affect phytoplankton biomass and primary productivity or the quality of the main food source, phytoplankton. The negative feedbacks on phytoplankton biomass by

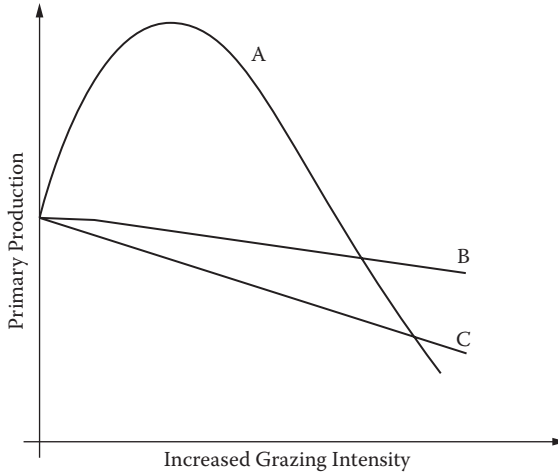

FIGURE 6.1 Hypothetical influence of grazing intensity on primary production. A = grazing optimization; B = linear decrease; C = time lag followed by linear decrease. (Adapted from Hilbert, D.W., Swift, D.M., Detline, J.K., and Dyer, M.I. Relative growth rates and the grazing optimization hypothesis. *Oecologia* 51, 14–18.)

grazing may be partly counteracted by positive feedbacks on phytoplankton growth rates, and this mechanism can have a significant impact on the carrying capacity of an ecosystem. The positive and negative feedbacks or feedback loops potentially stabilize the productivity of the system, and increase the functional and structural sustainability of ecosystems.

CONCEPTUALIZING GRAZING

THE CLASSICAL POPULATION DYNAMICS APPROACH

Officer et al. (1982) used data from South San Francisco Bay to develop a model of bivalve suspension-feeding as a potential eutrophication control mechanism in shallow coastal bays. These authors recognized that numerous factors had, up to that time, been investigated as controls on the quantity and quality of phytoplankton. Some of these controls were light, temperature, turbidity, self-shading, nutrient concentrations, trace elements, initial seed population, phytoplankton motility, and sinking as well as zooplankton grazing and hydrodynamic effects. In South Bay, Cloern (1982) was able to discount the preceding factors as major controlling influences and suggested that benthic suspension-feeders may be the major control mechanism on phytoplankton

$$dC_m / dt = k_m - \sum_{n=1}^N k_{mn}c_n - k_n c_m + k_h c_{m0} \quad (6.1)$$

where c_m = concentration of any constituent of the system; N = total number of constituents or dependent variables; c_{m0} = influent constituent concentration to the

TABLE 6.1
A Summary of Important Feedbacks in Suspension-Feeder-Dominated Ecosystems

| Process Involved | Direct Effect | Consequences |
|--|---|---|
| Filtration (local scale) | Local depletion of food | Bivalve growth reduction |
| Blooming of harmful/inedible algae | Reduced filtration | Reduced top-down control of algae blooms |
| Blooming of harmful algae | Changes in physiological rates | Bivalve growth reduced |
| Biodeposition | Retention of nutrients | Changes in stoichiometry of pelagic inorganic nutrient pool |
| Mineralization of biodeposits | Release of inorganic nutrients to water column | Increase of pelagic inorganic nutrient pool |
| Filtration (system scale) A | Reduced storage of nutrients in algae biomass | Increase of pelagic inorganic nutrient pool |
| Filtration B | Top-down control of phytoplankton biomass | Reduced bottom-up effect of nutrient loading on phytoplankton |
| Filtration C | Exclusion of slow-growing phytoplankton species | Change in phytoplankton composition |
| Filtration D | Increased mortality of zooplankton | Change in trophic structure of pelagic food web |
| Change in phytoplankton composition | Change in primary production | Change in carrying capacity |
| Change in inorganic nutrient pool | Change in primary production | Change in carrying capacity |
| Change in primary limitation phytoplankton | Change in carrying capacity | Change in nutrient growth |

Source: From Prins, T.C., Smaal, A.C., and Dame, R.F. 1998. A review of the feedbacks between bivalve grazing and ecosystem processes. *Aqua. Ecol.*, 31, 349–259.

system; t = time; k_m = net internal production rate of the constituent over natural decay, respiration, or sinking out of the system; k_{mn} = rate coefficients for uptake of cm by other constituents c_n and k_h = reciprocal to the hydrodynamic residence time (water turnover time). When considering the relationship between the phytoplankton and the filter-feeding benthos, the equations reduce to the Lotka-Volterra predator-prey equations. The equations for this purpose are

$$dP/dt = k_p P - 24 \times 10^{-3} (F/h)(BP) \quad (6.2)$$

$$dB/dt = k_b B + 24 \times 10^{-6} \alpha \beta_1 \beta_2 FPB \quad (6.3)$$

where P = phytoplankton population in μg chlorophyll l^{-1} ; B = benthic filter-feeding population in grams total weight m^{-2} ; $k_p = 1/\tau_p$ = plankton growth rate, d^{-1} ; $kb = 1/\tau_b$ = benthic mortality rate, d^{-1} ; h = water depth in meters; F = specific filtration rate for

a given benthic animal, $l \text{ h}^{-1} \text{ g}$ total weight of animal⁻¹; α = conversion coefficient, plankton nitrogen: plankton chlorophyll by weight; β_1 = benthic population feeding efficiency, food intake: filtering intake; β_2 = conversion coefficient, total weight of benthic animal: nitrogen weight of animal (Officer et al. 1982).

The first relationship of this pair of equations expresses the continuity relation that the time rate of increase of phytoplankton in a column of water is equal to the rate of production of plankton through photosynthesis in the column minus the rate removal through benthic suspension-feeding. The second equation expresses the continuity relation that the time rate of increase of the benthic population is equal to the rate of increase of the population through plankton feeding minus the rate decrease of the population through mortality. Values for the various components of the equations are from various sources and are given by Officer et al. (1982). For constant coefficients, the solutions for the pair of equations will oscillate about average values for P and B determined by

$$P = kb/\alpha\beta_1\beta_2F \times 10^6/24 \quad (6.4)$$

and

$$B = k_p h/F \times 10^3/24 \quad (6.5)$$

For the South Bay, $P = 4 \mu\text{g}$ chlorophyll l^{-1} and $B = 140 \text{ g m}^{-2}$. Thus, in a shallow water system, the model predicts that a benthic suspension-feeding community of a few hundred g m^{-2} will act as a control on the phytoplankton population, and phytoplankton concentrations will be a few $\mu\text{g chl l}^{-1}$.

The time necessary for the benthic suspension-feeders to filter the available water or clearance time (τ_f) is given by

$$\tau_f = h/FB \times 10^3/24 \quad (6.6)$$

and is approximately 1 d for the South Bay example. The time coefficient for the phytoplankton growth (τ_p) is given by

$$\tau_p = 1/k_p = \tau_f \quad (6.7)$$

Therefore, the two coefficients should be equivalent if the suspension-feeding benthos are to control the phytoplankton.

From this stage, Officer et al. (1982) concluded that for the benthic suspension-feeding system to control the phytoplankton, the following situations should exist: (1) water depths must be shallow; (2) nutrients must be abundant; (3) there must be no limitation of phytoplankton due to light, temperature, or turbidity; (4) poor hydrodynamic exchange of the water mass (long water mass turnover time) is required; and (5) there must be a dense benthic suspension-feeding community of small animals.

The Officer et al. (1982) model is a population interaction relationship that includes some environmental constraints. However, because of its use of the functional groups

of suspension-feeders and phytoplankton, it can also be considered a process–functional relationship. The advantage of this simplified modeling approach is that the state of the system can be expressed as a function of a few readily interpretable parameters. Nevertheless, the Officer et al. (1982) model uses the Lotka-Volterra system of equations, and these are difficult to apply to the concept of stability, hard to measure in the field, and lack spatial and temporal variability (Herman 1993). The Officer et al. (1982) conclusion that bivalve control of phytoplankton is only effective in shallow waters depends on the assumption that primary production is independent of water depth and cannot apply to light-limited primary production (Herman 1993). In spite of these problems, the Officer et al. (1982) model does provide a starting point and does raise the issues surrounding the concept of bivalve grazing controlling phytoplankton in some systems.

THE TURNOVER TIME/TURNOVER RATE APPROACH

Because of the value of their bivalve inhabitants, many coastal and estuarine systems have been studied and compared. The professional literature base in this area of study is rapidly becoming interdisciplinary and global in scope as well as size. This audience is less scientifically and technically aware. To address this situation, for example, I suggest the equivalent of the back of an envelope or napkin approach. Use the familiar turnover time/turnover rate comparative approach as a first or early step in the analysis of energy and material flows in natural beds and reefs of bivalves as well as bivalves under intense cultivation.

Turnover Time

Turnover time is the amount of time that a particle spends in a given system (Odum 1983). The measurement varies directly with the amount of substance that is present in the system. The term is common in science, technology, and medicine. A generic form of the relationship is τ (residence time) is equal to V (the capacity of a system to hold a substance) divided by q (the rate of flow of the substance into the system); that is,

$$\tau = V/q \quad (6.8)$$

In ecology, residence time is often called turnover time or replacement time, but the meaning is the same. Where τ is used as the variable for turnover time, V is the capacity of the system, and q is the flow into or out of the system. The system is as simple or as complex as you define it to be.

The following discussion links the simplicity of residence time to the concept of carrying capacity and directly follows from Dame (1996) and Dame and Prins (1998). These two papers define and show that the carrying capacity of marine suspension feeding bivalves in estuarine and coastal ecosystems has major implications for their culture as well as the structure and function of their ecosystems.

Carrying Capacity

As the biomass of bivalves living in an ecosystem increases, the matter and energy necessary to maintain these components increases proportionally at a greater rate.

Although increases in bivalve biomass and system complexity are often associated with increases in quality and stability, these benefits are normally offset or diminished by increases in the costs of removing disorder, i.e., entropy, and are usually represented by respiration. As more and more living biomass is accumulated, the proportion of primary production that is available for further growth in bivalve biomass declines. When bivalve biomass ceases to increase, the system is said to have reached maximum carrying capacity (Odum 1983). Experience shows that the optimum carrying capacity sustainable over long periods of time is lower, perhaps lower by as much as 50% of the theoretical maximum (Odum 1983). Thus I define bivalve carrying capacity as the total biomass supported by a given ecosystem as a function of the water residence time, primary production time, and bivalve clearance time of the system.

WATER RESIDENCE TIME

Water residence time (RT) is the theoretical time it takes for volume or mass of water within a basin to be replaced with water from outside the system. The water flow from outside the system, also sometimes known as advection, enters as ocean currents, tidal exchange, rainfall, surface water runoff from the surrounding landscape, groundwater input, or river flow. In general, the smaller the basin was, the shorter the residence time of its water mass. Coastal systems are strongly influenced by river flows that were often seasonal. In large estuarine systems, the residence time of water varies depending on the location within the system. Thus although water residence time is an ecosystem scale parameter, it varies greatly depending on the season and location. In most of the systems described here, salinities were seldom very low and tidal exchange dominated freshwater flux (Dame and Prins 1998).

PRIMARY PRODUCTION TIME

In this discussion, primary production time (PPT) is defined as the ratio of yearly averages of phytoplankton biomass (B) to phytoplankton primary production (P) within the particular ecosystem. Primary production time or B/P describes the time it takes for primary production within the system to replace the standing crop biomass of phytoplankton within the system. This measure is analogous to the organismic-population measure known as phytoplankton doubling time, but PPT is an ecosystem scale parameter. Primary production time is influenced by import and export of phytoplankton and seasonal variations in light and nutrients.

BIVALVE CLEARANCE TIME

The time that is theoretically needed for the total bivalve suspension-feeder biomass within an ecosystem to filter particles from a volume of water equivalent to the total volume is termed as the bivalve clearance time (CT). This turnover time is a function of the biomass of the bivalves and seasonal influences of particulate concentrations, seston quality and temperature on the filtration rate of the bivalves (Dame and Prins 1998).

It is generally believed that bivalve suspension-feeders can and do pump large volumes of water by which they are also thought to control coastal plankton (Dame 1996). However, several investigators have argued that most of the suspension-feeding rates were determined on a few animals in small chambers so that the data had to be scaled up to be used at the scale of beds or reefs. With up-scaling, the data became highly variable and potentially unreliable. However, their argument was only valid for half of the sites, as the BEST Tunnel system that operates on the scale of a small community was used at North Inlet, the Western Wadden Sea, Oosterschelde and Marennes-Oléron, while a flume was used at Sylt (Dame and Prins 1998).

METHODS USED TO ESTIMATE SYSTEM GRAZING

The first estimates of bivalve suspension-feeder grazing were simply scaled up from observations made on individuals or small groups of animals in closed systems or jars (see Chapter 3). These methods were limited because they did not take into account the structural effects of aggregations of bivalves nor did they include the role of varying water velocities and food concentrations so typical of natural systems. They did, on the other hand, allow the computation of energy and material budgets. However, from a thermodynamic perspective, the measurements were made in a closed system that is accumulating entropy and approaching equilibrium or death.

UPSTREAM–DOWNSTREAM OBSERVATIONS

As most dense populations of bivalves occur in flowing water environments, methods developed for these systems eventually were adopted or formed the basis for new approaches to estimating grazing by bivalves. Most of these methods involved some application of the upstream–downstream approach to estimating changes in material concentrations and fluxes.

FREE-FLOW DESIGNS

The upstream–downstream method was applied first to a coral reef by Sargent and Austin (1949) and from an ecosystem perspective by Odum and Odum (1955). In this method, sample stations were selected along a stream of water so that the stream was sampled before and after it passed over a system. It was assumed that the water mass was not influenced in any major way by influxes adjacent to the stream; the flowing water exhibited continuity. In addition to sampling material concentrations, water velocity was measured and cross-sectional water fluxes were computed. The water fluxes were multiplied by the material concentrations to provide material flux estimates both upstream and downstream. If the upstream material fluxes were higher than the downstream fluxes, the system was assumed to have taken up this constituent. If the upstream material fluxes were lower than the downstream fluxes, then the system was thought to be releasing materials into the water. The upstream–downstream method, as discussed above, has several advantages: It does not require the removal or disturbance of the benthos; it includes all components of the benthic, water column, and sediment systems; and environmental conditions are unaffected

by the measurements. The most frequent problems with this approach include the following: the lack of water mass continuity; insufficient biomass in the benthic system to produce a measurable response; and, although it is possible to make repeated measurements, there can be no true replication (see Odum et al. 1959, for an extensive discussion).

The upstream–downstream approach was first applied to a mussel bed by Nixon et al. (1971) to estimate the metabolism of the system through differences in oxygen fluxes. Unlike grazing studies, this project had to contend with the exchange of oxygen with the atmosphere. This study also recognized the role of water flow, i.e., current speed, in influencing the metabolism of a benthic system.

Wright et al. (1982) estimated the grazing of *Mytilus edulis* under natural conditions in the Essex Estuary of Massachusetts. Using the classical upstream–downstream design, they assessed changes in bacterial and phytoplankton populations as the flooding tide swept across a mussel bed. Water samples were taken every 5 min by sampling the upstream water and releasing an orange as a “drogue.” When the drogue reached the other side of the bed its passage time was noted and a downstream water sample was taken. Clearance was calculated from these observations using the relationship developed by Jørgensen (1943)

$$r = 1/t \ln (C_u / C_d) V \quad (6.9)$$

where r is clearance; t is the time for the water to pass across the 46.5 m bed; V is the water occupying a 1-m wide path across the bed; C_u is the plankton concentration upstream; and C_d is the concentration downstream. Observations by Wright et al. (1982) plainly show that phytoplankton are removed as they pass across the mussel bed, but bacteria are not. Their field estimates of grazing were 10 times their laboratory estimates derived from individual mussels and demonstrate scaling issues.

Studies on coastal and estuarine benthic systems (Wildish 1977; Warwick and Uncles 1980; Wildish and Peer 1983) developed the idea that current speed influenced the growth of bivalves through the combined effects of food limitation near the bottom and renewal of food-depleted water by the flow regime. Fréchette et al. (1993) have argued that this paradigm is flawed because it only explains the effects of current speed on growth through correlative means and does not include the mechanistic aspects of current speed and related hydrodynamic characteristics of the environment. They are particularly concerned because the benthic boundary layer, a universal feature of shallow water flows, is not taken into account.

LABORATORY FLUMES

Laboratory flumes are flow tanks designed to examine processes occurring in steady (constant flow) one-dimensional open-channel flows. In general, the dynamical similarity between laboratory flume and field boundary-layer flows is accomplished by matching four dimensionless flow ratios: the Reynolds number, the Froude number, the Strouhal number, and the Euler number (see Nowell and Jumars 1987; Fréchette et al. 1993). When dealing with sedentary living bivalve beds interacting with the flowing water both passively (structural roughness) and actively (pumping and

filtering water), the use of flumes is tricky and essentially becomes a fluid dynamic engineering exercise. With bivalve beds, large flumes are required to provide (1) one-dimensional flow, (2) fully developed flow (boundary layer reaches the surface), and (3) fully developed turbulent flow. The effects of the bed on phytoplankton concentrations and the effects of this food supply on bivalve feeding and growth rates requires the bivalves cover a major portion of the flume in the along-channel direction. As a rule of thumb, Fréchette et al. (1993) recommend a flume at least 50 cm wide by 10 cm deep by about 10 m long.

In the Fréchette et al. (1989) study, consumption of phytoplankton by the mussel bed was estimated from the uptake of fluorescence by mussels in a flow-through chamber and scaled up to total bed consumption by multiplying the weight-specific uptake of fluorescence times the size class biomass of mussels in the bed. Fluorescence consumption was found to be correlated to fluorescence F as computed in the horizontal advection and vertical diffusion model.

Using this combination of flow-through filtration chamber and gradient models as well as under typical flow and roughness conditions, the Fréchette model predicts a significant decrease in phytoplankton concentration in the water over the mussel bed. Vertical gradients are stronger than horizontal gradients, and they are steepest close to the bed. Uptake of phytoplankton by the mussel bed results in a gradual decrease in phytoplankton concentrations downstream. Mussel bed consumption rate at the center of the bed increases almost linearly with increasing velocity, and it also increases with increasing bed roughness. Increasing height of mussel intake above the bottom also increases consumption. This attribute supports the formation of mussel hummocks to increase food consumption, presumably with enhanced growth.

The Fréchette et al. (1989) model has been supported by several very graphical experiments using a 17-m laboratory flume (Butman et al. 1994). Not only did this upstream–downstream experimental design allow a multitude of vertical and horizontal water sampling points for phytoplankton (fluorescence) concentrations, but velocity was extensively measured with a two-axis forward-scatter laser Doppler velocimeter, also known as a two-component laser Doppler anemometer (LDA). Their observations show significant enhancement of turbulent stress due to mussel bed roughness and provide further evidence of horizontal and vertical depletion of the food supply to the mussel bed. Fréchette et al. (1993) have argued that pump jets from mussels do not influence the boundary flow to any great extent.

Epifaunal bivalves are not the only animals to interact with the benthic boundary layer. Infaunal siphonate bivalves may also influence the near-bottom flow (Monismith et al. 1990; Koseff et al. 1993), both by their physical structure and biotic pumping. Using a laboratory flume with model clams, an LDA and laser-induced fluorescence (LIF) system, this group has investigated the role of pumping jets and siphon behavior of infaunal clams on near-bottom flow. It appears that a significant proportion of excurrent water could be refiltered, depending on boundary layer velocity and excurrent water velocity, as well as siphon height, orientation, and size. They also showed that the interaction of bivalve siphon currents with the overlying turbulent boundary layer flow results in the formation of concentration boundary layers over dense populations of clams (O'Riordan et al. 1993). Clam feeding within

a bed appears to benefit by increasing siphon height and decreasing pumping speed as velocity increases.

FIELD FLUMES

Field flumes offer a straightforward method to directly measure grazing as well as other material fluxes by dense beds of bivalves. These structures offer several advantages (Fréchette et al. 1993): (1) the benthic community and system are not disturbed; (2) fluxes are computed for a large area of the system, not just an individual or a few individuals; (3) the effects of changing flow can be directly observed; (4) general environmental conditions are not constrained; and (5) flow is simplified or channelized by the walls of the flume. However, these authors further caution that flumes should (1) not interfere with the natural benthic boundary layer; (2) be aligned with the current flow; and (3) be of a size and configuration so as to avoid wall or edge effects.

The only successful field flume I am aware of is the Sylt flume (Asmus et al. 1990). This flume was constructed across an intertidal bed of mussels (*Mytilus edulis*) in the Eastern Wadden Sea near the island of Sylt, Germany. The flume was oriented along the axis of the main tidal currents, and water entering and leaving the flume had little direct contact with other mussels. A wooden support structure was anchored upon the mussel bed. The flume was 20 m long, 2 m wide, and 2 m high. Platforms were constructed above high water at each end of the flume to hold scientists and instruments. The wooden superstructure of the flume remained permanently in place during the summer sampling period. During sampling, polyethylene sheeting was attached to the wooden frame along each side to form a channel. To prevent leakage underneath the wall of the flume, the plastic sheeting was sealed to the bottom with a heavy iron chain. Thus a 40 m² area of mussel bed with more than 140,000 mussels was channelized, and lateral currents were prevented. The tidal range in this location was 1.8 m and the mussels were submerged 8 h to 10 h on each tide. Water velocity was measured using plastic drift bags filled with freshwater or seawater. The transient time of the drift bags through the flume was an estimate of water flow. This drift bag method of water flow through the flume was calibrated against direct current estimates using an induction flow meter, and the two sets of measurements were found to be in close correspondence (Asmus et al. 1990). In spite of its structural size, this flume met the requirements laid out by Fréchette et al. (1993) for incorporating the benthic boundary layer flows. The flume's size can create disadvantages. Because it is constructed of heavy wood, it can float, be carried away by extra high tides and crushed by tidal ice.

TUNNELS

Tunnels can be described as flumes with a top and have been utilized in high tidal range and water flux environments. The original tunnel for bivalve research was developed by Dame et al. (1984) to investigate the fluxes of materials between the water column and intertidal oyster reefs. The tunnel was the culmination of a series of efforts to measure these material fluxes in a high tidal flow environment at North

Inlet, South Carolina. This group's initial efforts focused on a free-flow upstream–downstream design within a tidal creek that had dense populations of oysters. That effort failed to show significant differences in material fluxes across the oyster beds in question, probably due to a lack of continuity in the water mass from upstream to downstream. Next, a flume, very similar in size and configuration to the Sylt flume, was constructed across an oyster reef in the same area as before. Again, there was difficulty in determining significant differences in the material fluxes across the reef, and it was thought that the volume of water passing through the flume was sufficiently large to dilute the materials of interest. It was at this point that these investigators became aware of Rogers' (1979) study of a coral reef using a tunnel and following an upstream–downstream approach pioneered by Odum and Odum (1955) and Nixon et al. (1971). The Rogers (1979) tunnel was used to measure the productivity of a coral reef, but it did offer a way to ensure continuity of water flow and reduce the influences of dilution.

With the preceding knowledge, the North Inlet group constructed a portable 10-m long plastic tunnel that was installed over an oyster reef (Dame et al. 1984). The tunnel (benthic ecosystem tunnel—BEST) was made of eight formed Plexiglass plates, and each section was joined in the field with neoprene strips. On the first tunnels, neoprene was also used to seal the tunnel to the bottom. Later versions of the tunnel were adapted to rest on permanently installed steel rails (Prins and Smaal 1994). BEST was 0.8 m wide and had a cross-sectional area of 0.225 m². It covered 7.9 m² of bottom and had a nonflow volume of 1.74 m³.

As it was impossible to take continuous multiple water velocity measurements within the tunnel, Kjerfve and Dame (unpublished; also see Prins 1996) conducted a detailed study of the water flow dynamics within the tunnel while it was deployed over an oyster reef and mussel beds. Using an induction flow meter (Marsh-McBirney 201 with an accuracy of ± 10 cm/s) on a mobile mount, flow across the entire cross-section and length of the tunnel was observed, and it was determined that total cross-sectional water flux was strongly related to water flow measured at a single point in the center of the tunnel. Later dye studies on a similar tunnel in the Netherlands showed that vertical mixing (turbulent flow) was observed at all water velocities > 1 cm s⁻¹ (Binsbergen, unpublished; Prins 1996).

Material concentrations were determined from water samples taken simultaneously from 0.5 m within each end of the tunnel and, as there was continuity of water flow through BEST, the mass fluxes across each end of the tunnel were calculated by multiplying the water flux by the incoming and outgoing material concentrations. The net flux of a particular constituent was the difference between incoming and outgoing mass fluxes. If the net flux had a positive value, material uptake occurred as the water passed through the tunnel and over the bivalves. If the net flux was negative, material had been released. Since the incoming water had not been within the tunnel, it was considered to be a control or untreated sample while the outgoing water sample was considered to be an experimental or treated sample. The input and output water samples were compared statistically using paired t-test to examine for significant differences. Later studies used a tunnel with no suspension-feeders present as a parallel control (Asmus et al. 1992). It was assumed that the tunnel had no effect on the biogeochemistry of the sampling site.

In the only comparison of material flux techniques to date, the Dutch tunnel group and the Sylt flume group compared these two measurement systems simultaneously (Asmus et al. 1992). In general, the tunnel measurements were indicative of the minimum material flux, were more flexible in installation including time requirements, and could be used in deep waters. To avoid trapping and sedimentation effects, tunnels must be adapted to the specific current regime. Flumes can only be used in shallow waters with stable current regimes. These investigators concluded that the inferences concerning the ecological role of mussel beds are not likely to be different whether tunnels or flumes are used.

At the ecosystem level, it is not clear whether benthic bivalve suspension-feeders compete with zooplankton grazers for the phytoplankton resource or, as some mesocosm studies have shown, the bivalves actually filter out the zooplankton, particularly microzooplankton (Horsted et al. 1988; Riemann et al. 1988; 1990; Prins et al. 1995) and eliminate their competition.

Smaal and Prins (1993) suggest that the impact of bivalve suspension-feeders extends to various scales. These scales are the level of the bivalve bed, the estuary or bay, and the land-ocean interface. In those systems with low bivalve biomass-to-water volume ratios, i.e., current Chesapeake Bay, Delaware Bay, and Narragansett Bay, the residence time of the water mass is less than that of the potential clearance time and thus bivalve influences are probably limited to the level of the bed or community.

Systems with higher bivalve biomass to water volume ratios cleared larger volumes of water in less time than the water mass turned over (Smaal and Prins 1993). In these systems, i.e., Oosterschelde, Western Wadden Sea, Marennes-Oléron, etc., bivalve control of phytoplankton biomass is much more likely at the level of the bay or estuary when dry body bivalve biomass was in the range of 2 g m^{-3} to 8 g m^{-3} , water mass residence times were long (sometimes called slow systems), and filtration pressure was high.

Phytoplankton biomass in short residence time systems (fast systems) could still be controlled by bivalves if their biomass:volume ratio is high, $> 8 \text{ g m}^{-3}$, as in North Inlet and Sylt. Thus some fast systems function more like feedlots with food being imported from the adjacent ocean to support high heterotrophic activity within their shallow tidal creeks and flats. Herman, as reported in Heip et al. (1995), has found that there is a very good inverse relationship between volume-specific biomass of bivalves and water mass residence time. Herman further speculates that food-limitation for system-wide bivalves may be a general property.

The observations presented in Tables 6.2 and 6.5 show that any model or conceptualization of the role of bivalve filtration in coastal waters should account for several things: system water mass residence time, phytoplankton primary production or replacement time, as well as particle or bivalve clearance rates or clearance time by the great majority of filtering organisms.

The relationship between water mass residence time and system clearance time by bivalves is only one aspect of the regulation of the water column by suspension-feeders.

The amount and rate of the production of organic carbon by phytoplankton and how effectively that carbon is removed by bivalves is another aspect (Smaal and Prins 1993). A list of bivalve dominated ecosystems extensively adapted from Smaal and Prins (1993) is discussed below.

TABLE 6.2
System Physical Structure

| System | Area (km ²) | Depth (m) | Volume V (10 ⁶ m ³) | Tidal Range (m) | Residence Time RT (d) | Advection | Source |
|----------------------------|----------------------------|--------------|---|--------------------|--------------------------|----------------|-------------------------|
| Sylt | 5.6 | 1.3 | 7.25 | 2.0 | 0.5 | Tides | Asmus et al. (1990) |
| North Inlet | 8.8 | 2.5 | 22 | 1.7 | 1.0 | Tides | Dame et al. (1980) |
| Marennes-Oléron | 135.7 | 5.0 | 675 | 3.0 | 7.1 | Tides & wind | Héral et al. (1988) |
| South San Francisco Bay | 490. | 5.1 | 2500 | 1.7 | 11.1 | Rivers | Cloern (1992) |
| Narragansett Bay | 328 | 8.3 | 2724 | 1.2 | 26.0 | Rivers & tides | Pilson (1985) |
| Oosterschelda | 351 | 7.8 | 2740 | 3.0 | 40.0 | Rivers & tides | Smaal et al. (1986) |
| Western Wadden Sea | 1386 | 2.9 | 4020 | 2.5 | 10.0 | Runoff & tides | Dame et al. (1991) |
| Ria de Arosa | 228 | 19 | 4335 | | 23.0 | Ocean | Tenore et al. (1982) |
| Delaware Bay | 1942 | 10 | 19,410 | 1.5 | 97.0 | Rivers | Biggs and Howell (1984) |
| Chesapeake Bay | 11,500 | 7 | 27,300 | 0.7 | 22.0 | Rivers | Newell (1988) |

Note: Specific sources listed for each estuarine and coastal ecosystem.

Source: Modified from Dame, R.F. and Prins, T.C. 1998. Bivalve carrying capacity in coastal ecosystems. *Aq. Ecol.*, 31, 409-421.

REVISED LIST OF BIVALVE-DOMINATED ECOSYSTEMS USED TO COMPARE GRAZING AND OTHER CHARACTERISTICS

CHESAPEAKE BAY, VIRGINIA, AND MARYLAND

Chesapeake Bay is the largest estuarine water body in the United States (11,500 km²) and is located on the central Atlantic coast. With an average depth of 7 m, a water volume of 27.3×10^9 m³, and a residence time of 22 days, the bay is extensively used for fisheries, recreation, and waste disposal.

Historically, the bay was the primary commercial source of the Eastern oyster, *Crassostrea virginica*, but over the past century, and particularly in the time period from 1970 to present, declining water quality, disease, and overharvesting have led to the precipitous reduction of this fishery (Newell 1988; Ulanowicz and Tuttle 1992).

Concurrent with the decline of the oyster population, numerous bivalve species have invaded the bay, e.g., *Rangia cuneata* and *Corbicula fluminea* (Newell, personal communication). In an interesting modeling exercise, Gerritsen et al. (1994) have shown that these invaders and other suspension-feeding bivalves including *Macoma* spp., *Mulinia lateralis*, *Mya arenaria*, and *Tagelus plebeius* are capable of removing up to 50% of the annual phytoplankton primary production in the upper Chesapeake Bay. They contend that rehabilitating the oyster populations may not change the water quality in the bay, because these bivalves will only be capable of filtering the water in the shallow zones.

DELAWARE BAY, DELAWARE

Delaware Bay is located in the mid-Atlantic region of the United States, with a surface area of 1942 km² and a water volume of 19.4×10^9 m³. The bay has large areas of open water fringed with flats and marshes. Both planktonic and benthic biomass are considered low relative to other estuarine systems (Biggs and Howell 1984). The major suspension-feeders in the bay are zooplankton dominated by *Acartia tonsa*, *Temora longicornus*, *Centrophages hatamus*, and *Pseudocalanus minutus*. Biggs and Howell (1984) estimated that these zooplankton can filter the entire bay volume in 77 days or about 3 to 5 times a year. The dominant bivalve suspension-feeder is *Crassostrea virginica*, but, as in Chesapeake Bay, populations of this organism have been severely depleted over the past century due to overfishing and disease (Maurer et al. 1971). Current populations of bivalves are so low that it would take 3.5 years for them to filter the water mass in Delaware Bay or about 10 times longer than the physical residence time of water in the bay. Consequently, in this bay bivalves probably do not have as much influence on the phytoplankton populations as do the zooplankton (Taylor and Bushet 2008).

BAY OF MARENNES-OLÉRON, FRANCE

The Bay of Marennes-Oléron is a highly variable shallow water body along the western Atlantic coast of France. The bay is 135.7 km² with a water volume of 675×10^6 m³. Marennes-Oléron is the major European area for oyster (*Crassostrea gigas*) cultivation. Mussels (*Mytilus edulis*) are also cultivated on a lesser scale. From 1960

to 1969, growth and production of bivalves declined rapidly, due to overexploitation of the food resources, and culminated in an epidemic of iridovirus that wiped out the *C. angulata* population. Current populations of *C. gigas* were introduced, but overstocking again occurred (Héral et al. 1988; Bacher 1989; Héral 1993). Calculations by Smaal and Prins (1993) show that the bivalves can filter the water volume within the bay in about 2.7 days, while the residence time of the water is about 7.1 days. This system is unique in that it is one of the few documented occurrences of overstocking with bivalve suspension-feeders on two different occasions with different species.

NARRAGANSETT BAY, RHODE ISLAND

Narragansett Bay is located along the coast of Rhode Island, with an area of about 265 km². This bay has been the focus of ecological studies for many years and is one of the first systems to be simulated with a comprehensive ecosystem-oriented computer model (Kremer and Nixon 1978). Although the bay is dominated by plankton processes, large widespread populations of the hard clam, *Mercenaria mercenaria*, dominate the benthic communities. In the Kremer and Nixon (1978) formulations, clams consume via filtration 29% of the net primary production in the bay and zooplankton consume 79%. Using these authors' data, the water volume of the bay is approximately 2.4×10^9 m³ with a tidal prism of 310×10^6 m³. The residence time of the bay water volume is 27 days. The clam populations in the bay can potentially filter 15% of each tidal prism or the entire bay volume in 25 days. Thus Narragansett Bay offers an example of a coastal system where bivalve grazing probably does not dominate ecosystem processes, but appears to be balanced with planktonic grazing processes.

NORTH INLET, SOUTH CAROLINA

North Inlet is located on the northeast coast of South Carolina and is dominated by extensive salt marshes, tidal creeks, and dense populations of intertidal oysters, *Crassostrea virginica*. The system is about 32 km² in area and has a volume of 22×10^9 m³. It has a major connection to the Atlantic Ocean and several minor connections to an adjacent estuary, Winyah Bay. An ecosystem scale study concluded that filtration by oysters strongly coupled the benthic and water column subsystems (Dame et al. 1980, 1986). In this system, concentrations of phytoplankton measured by Chl *a*, phytoplankton plasma volume, and total biomass as estimated by ATP consistently showed high values at high tide and rapidly declining values as the tide ebbs (Chrzanowski et al. 1979). Concurrent analysis of suspended sediments indicated an organic fraction that behaved similarly to ATP and Chl *a* except on spring tides.

Both settling and zooplankton consumption were discounted as major explanations of North Inlet ecosystem consumption of phytoplankton (Dame et al. 1980). Rough estimates of total oyster filtration in North Inlet showed that this component of the ecosystem was capable of pumping 1.5×10^7 m³ per tide of a total tidal prism of 2.2×10^7 m³. Thus the dense oyster reefs in North Inlet are capable of influencing the suspended particulate environment on a relatively short time scale, the time of a single tidal cycle.

OOSTERSCHELDE ESTUARY, THE NETHERLANDS

The Oosterschelde (Eastern Scheldt) estuary is located on the southwest coast of the Netherlands and is part of the Dutch delta system where the Rhine River exits to the North Sea. The water volume of the estuary is about $2.7 \times 10^9 \text{ m}^3$ and has a residence time of 20 to 135 days depending on physical conditions and distance from the North Sea (i.e., faster turnover closer to the North Sea). The estuary is an international wetland, including sand and mud flats, cultivating large populations of mussels and cockles, feeding large numbers of migratory waterfowl, and further comprising deep channels, artificial rocky shores, and salt marshes. The system is unique because it is the site of one of the most significant engineering projects of the 20th century, the storm surge barrier with its associated hydrotechnical works. As a result of the barrier-induced changes in the Eastern Scheldt, this system has been extensively studied and is synthesized by Nienhuis and Smaal (1994).

The dominant food chain in the Eastern Scheldt consists of phytoplankton, bivalve suspension-feeders, wading birds, and human harvesters. The phytoplankton and suspension-feeder components were similar both before and after the structural changes to the estuary. Smaal et al. (1986) first estimated the effects of bivalve grazing on this system. Later, using the BEST tunnel technique, Dame et al. (1991) estimated that the mussels within the Eastern Scheldt can clear the water column of phytoplankton in about 5 days or in considerably less time than the water mass turns over. This high system clearance rate implies the control of the phytoplankton populations by the dense populations of bivalve suspension-feeders. In addition, Herman and Scholten (1990) have shown that this effective top-down control by grazing can keep phytoplankton biomass low and stabilizes the ecosystem as long as the primary producers do not escape suspension-feeder control by shifts to species that are not or are less efficiently filtered, like macrophytes or very small cells (Riemann et al. 1988).

RIA DE AROSA, SPAIN

The Ria de Arosa is an ocean-dominated bay along Spain's northwest Atlantic coast. The Arosa is the largest of several bays (230 km^2) and supports the intensive raft culture of *Mytilus edulis*. Compared to the other systems reviewed here, the Arosa is unique because of the intermittent upwelling of nutrient-rich deep Atlantic Ocean water into the bay. This enrichment supports high water column primary production that in turn supports the culture of mussels (Tenore et al. 1982). Mainly due to the huge volume of organic sediments produced beneath the mussel rafts, Rias with intensive mussel culture have quite different benthic environments than those without aquaculture. Smaal and Prins (1993) combined the data of Tenore et al. (1982), Navarro et al. (1991), and Perez Camacho et al. (1991) to generate estimates of the filtration capacity of *Mytilus* in the Ria de Arosa. Their calculations showed that the mussels could filter or clear the Arosa in 12.4 days or in about half the time the water remained in the system.

SAN FRANCISCO BAY, CALIFORNIA

San Francisco Bay is a large estuarine system on the central coast of California. The bay is divided into two hydrologically distinct arms: the northern bay, a typical riverine estuary that receives fresh water from the large Sacramento–San Joaquin river system; and the southern bay, a lagoon-type estuary where fresh water is limited to local runoff sewage effluent and the influx of northern bay water during very high frequency fresh-water inflows during winter (Thompson and Nichols 1988). The bay has a surface area of approximately 1240 km² with an average depth of 2 m (including mud flats) or 6 m (excluding mud flats) and a residence time of 11.1 days to several months in summer.

San Francisco Bay has experienced numerous changes in its bivalve populations and biodiversity since the Europeans arrived in the mid-1800s. Initially, the bay was dominated by populations of *Ostrea lurida*, *Mytilus edulis*, and *Macoma nasuta*. The Europeans did not like the taste of *O. lurida* and imported *Crassostrea virginica* from the East Coast of the United States. Other bivalves were incidentally imported, including *Mya arenaria*, *Geukensia demissa*, *Tapes philippinarum*, and *Musculista senhousia*. Gradually, the *O. lurida* populations declined, probably because increased suspended sediment loads reduced settlement success. The Asian clam, *Corbula amurensis*, invaded in the 1980s and because it is tolerant of all salinities, depths, and substrate types, it has achieved dominance everywhere in the estuary (Nichols and Pamatmat 1988).

As part of a continuing series of studies, Cloern (1982) reported on the regulation of the phytoplankton biomass in South San Francisco Bay. Using a one-dimensional dispersion model (1-D) with spatial (transects) and temporal (seasonal) observations of many variables including Chl a concentration, the net rate of phytoplankton population growth was estimated. The model estimates showed little relationship to the observed phytoplankton population dynamics in the South Bay. Cloern (1982) evaluated his model and concluded that none of the assumptions inherent in the calculation of the specific growth rate of phytoplankton were grossly violated. He also found that zooplankton grazing and physical transport from the system were of insufficient magnitude to explain the discrepancies. Cloern (1982) noted that benthic invertebrates are abundant in South San Francisco Bay and that the suspension-feeding bivalves, *Musculus senhousia*, *Tapes japonica*, and *Gemma gemma*, were common. He estimated that these three bivalves could potentially filter 7.2 to 10.8 m³ m⁻² d⁻¹ in a portion of the South Bay averaging only 6 m deep and thus filter a volume equivalent to 1.2 to 1.8 times the South Bay volume each day. Cloern (1982) also noted that as the South Bay occasionally stratifies, the benthos are separated effectively from the surface waters and removed from grazing control. Thus stratification allows potential bloom conditions for the phytoplankton.

Later studies by Doering and Oviatt (1986) criticized Cloern's (1982) estimates of the filtration capabilities of the bivalves in South Bay. They noted that in their controlled studies Cloern's filtration rate method yielded estimates an order of magnitude above actual observations. Doering and Oviatt (1986) attribute these differences to the use of filtration rates determined in the laboratory using monocultures of phytoplankton. In spite of these differences, they agree that bivalve suspension-feeders can represent important control mechanisms on phytoplankton populations.

Benthic-Pelagic coupling in coastal and estuarine ecosystems has generally focused on phytoplankton being consumed by bivalve suspension-feeders. However, the invasion of *Corbula amurensis* into San Francisco Bay shifted the attention of the ecological community to other suspended particles. So in addition to standard phytoplankton, a just-completed study by Greene et al. (submitted) has found strong evidence that microphytoplankton and microzooplankton are being consumed. Greene et al. (submitted) believe there is a good chance that the conditions are right for large-scale changes in food web dynamics similar to those reported by Petersen et al. (2008) and Higgins and Vander Zanden (2010).

SYLT, EASTERN WADDEN SEA, GERMANY

The island of Sylt lies in the eastern part of the North Sea and provides protection from ocean waves and winds to the Eastern Wadden Sea. On the northern lee side of Sylt lies the bay of Königshafen, which is a shallow intertidal flat area interlaced with tidal channels. Extensive intertidal mussel beds of *Mytilus edulis* occur at the low tide mark. The biology and ecology of these flats have been extensively studied and are summarized by Reise (1985). More recent work by Asmus (1987), Asmus et al. (1990), and Asmus and Asmus (1991) focused on the role of the suspension-feeders in interacting with the water column in the Königshafen ecosystem. Using a 20 m long flume, the Asmus group was able to determine filtration rates for mussel beds as a whole. Phytoplankton biomass was reduced 37% between the inflow and outflow of the flume (Asmus and Asmus 1991). The entire range of phytoplankton cells from 4 μm to several hundred μm was reduced by the filtering action of the bed. There was a significant positive correlation between both concentration and uptake of phytoplankton by the mussel bed. From their data (Asmus et al. 1990), the mussels appear to be able to clear the water volume of the system in about 2.1 days, while the water volume itself turns over every tide because this system is mainly intertidal. Thus the mussel beds filter somewhere between 25% and 50% of the water in the ecosystem on each tide.

WESTERN WADDEN SEA, THE NETHERLANDS

The Western Wadden Sea is located in northern Holland and is separated from the North Sea by the islands of Texel, Vlieland, and Terschelling. Water exchanges between the North Sea and the Wadden Sea through inlets between North Holland and Texel, Texel and Vlieland, and Vlieland and Terschelling. Freshwater enters the sea via runoff from the adjacent mainland. The Western Wadden Sea has a volume of about $4 \times 10^9 \text{ m}^3$ with a residence time of 5 to 15 days depending on climatic conditions. There are extensive intertidal flats interlaced with creeks and beds of bivalve suspension-feeders, mussels and cockles, are abundant.

Verwey's (1952) study was based on the premise that the Wadden Sea was inhabited by large numbers of animals and that as the tidal flats within this system were changing rapidly, it was important to know what role these animals played in the formation of or the change in the tidal flats. With a truly ecosystem approach, Verwey (1952) described the ecology of the cockles and mussels in the Western Wadden Sea.

He included their preferred habitat, the role of the physical environment in controlling their feeding, the potential foods available in the water column, and the materials as well as algae within their guts. He then scaled up from the filtration rates and shell formation rates of individual bivalves to estimate the total amount of material potentially removed from the water column that would be available to restructure the tidal flats within the Wadden Sea. This amount, 250×10^6 kg (dw) per year, is far greater than that available within the Wadden Sea and suggests that material must be imported from the North Sea. Later observations by Jonge and Postma (1974) and Van der Eijk (1979) showed that chlorophyll and primary production were remarkably low in areas of extensive mussel culture and that this apparent result of bivalve grazing was greatest during the summer when mussel growth was highest. It is interesting to note that while the bivalves in Verwey's (1952) study were commercially cultivated and harvested species, he asked a strictly ecosystem oriented question: How do the animals interact with their environment? The answer requires the synthesis of information from the fields of biology, ecology, and sedimentary geology.

During the latter portion of the 1980s, Dame and Dankers (1988) and Dame et al. (1991) investigated the exchange of materials between the intertidal mussel beds and the water column. These investigators used a 10-m long Plexiglas tunnel, BEST, to directly estimate the exchange rates of mussel beds holistically. Chlorophyll *a* was used as an estimator of phytoplankton. Using fishery statistics and other data, Dame et al. (1991) scaled up their mussel bed exchange rates to the entire Western Wadden Sea system. They estimated that the mussel beds in the Western Wadden Sea could clear or filter the phytoplankton in about 20 days. The residence time of the water mass in the Wadden ranges from 5 to 15 days and is comparable to the system clearance rate for chlorophyll. From these calculations, it appears that mussels may control phytoplankton within this system, but this control is probably dependent on seasonal conditions and location.

ECOSYSTEM COMPARISONS

The systems range in area from 5.6 to 11,500 km² with total water volumes varying between 7.2 and $27,300 \times 10^6$ m³. The majority of these systems are mesotidal and water mass residence times vary from 0.5 to 97 days. These systems vary from subtropical to north temperate in climate and experience distinctive seasonal fluctuations in physical and biological factors (Tables 6.2, 6.3, 6.4, and 6.5).

The main source of materials and energy to support large populations of bivalves in coastal systems comes from phytoplankton. The observed primary producer standing crops, primary production, and turnover times for the system of interest are given in Table 6.3. Average Chl *a* concentrations vary from 2.6 to 22.0 mg m⁻³. Water mass is less than that of the potential clearance time and thus bivalve influences are probably limited to the level of the bed or community.

Systems with higher bivalve biomass to water volume ratios cleared larger volumes of water in less time than the water mass turned over (Smaal and Prins 1993). In these systems, i.e., Oosterschelde, Western Wadden Sea, Marennes-Oléron, etc., bivalve control of phytoplankton biomass was much more likely at the level of the bay or estuary when dry body bivalve biomass was in the range of 2 to 8 g m⁻³ and water mass residence times were long (sometimes called slow systems).

TABLE 6.3
Phytoplankton Parameters and Primary Production Turnover Time

| System | Average Annual Concentration Chl <i>a</i> (mg m ⁻³) | Total Phytoplankton Biomass B _p (10 ⁶ gC) | Primary Production Particulate (gC m ⁻² Y ⁻¹) | System Primary Production P (10 ⁶ gC d ⁻¹) | Primary Production Turnover Time Bp/P(d) | Cell Doubling Time | Data Time Period | Source |
|-------------------------|---|---|--|---|--|--------------------|------------------|----------------------------------|
| Sylt | (3) | 0.7 | 61 | 0.9 | 0.78 | 1 | Growing season | Asmus et al. (1990) |
| North Inlet | 7.0 | 5.1 | 259 | 6.2 | 0.82 | — | Annual avg. | Dame et al. (1980) |
| Marennes-Oléron | 4.0–22.0 | 222.8 | 60 | 22.2 | 10.0 | — | Time series | Raillard et al. (1993) |
| South San Francisco Bay | 2.6 | 216.0 | 146 | 196.0 | 1.10 | 1 | Summer | Cloern et al. (1982) |
| Narragansett Bay | 3.0 | 408.0 | 270 | 243.0 | 1.68 | — | Annual avg. | Nixon (per. com.); Pilson (1985) |
| Oosterschelde | 7.5 | 616.5 | 208 | 200.0 | 3.08 | — | Growing season | Smaal and Prins (1993) |
| Western Wadden Sea | 8.0 | 964.0 | 262 | 994.0 | 0.97 | 1–2.5 | Growing season | Cadée (1986) |
| Ria de Arosa | 16 | 109.6 | 277 | 172.7 | 0.63 | — | Annual avg. | Tenore et al. (1982) |
| Delaware Bay | 9.9 | 5768.0 | 146 | 777.0 | 7.40 | 1.8–12 | Growing season | Harding et al. (1986) |
| Chesapeake Bay | 6.9 | 5651.0 | 191 | 6006.0 | 0.94 | 0.8–4.3 | Growing season | Harding et al. (1986) |

Source: Modified from Dame, R.F. and Prins, T.C. 1998. Bivalve carrying capacity in coastal ecosystems. *Aq. Ecol.*, 31, 409–421.

TABLE 6.4
Bivalve Grazer Parameters and Clearance Time

| System | Bivalve | Total Biomass B_{sf} (10^6 g) | B_{sf}/V g m^{-3} | Bivalve Clearance Time CT (d) | CT/RT | Sources |
|-------------------------|------------------------------|--|--------------------------|-------------------------------------|-------|-------------------------|
| Sylt | <i>Mytilus, Cerastoderma</i> | 86 | 11.6 | 4.0 | 8.00 | Asmus et al. (2010) |
| North Inlet | <i>Crassostrea</i> | 338 | 15.4 | 0.7 | 0.70 | Dame et al. (1980) |
| Marennes-Oléron | <i>Crassostrea, Mytilus</i> | 2850 | 4.2 | 2.7 | 0.38 | Bacher (1989) |
| South San Francisco Bay | Various | 6255 | 2.5 | (0.7) | 0.06 | Cloern (1982) |
| Narragansett Bay | <i>Mercenaria, Mytilus</i> | (1267) | (0.5) | 25 | 0.93 | Kremer and Nixon (1978) |
| Oosterschelde | <i>Mytilus, Cerastoderma</i> | 8509 | 3.1 | 3.7 | 0.09 | Smaal et al. (1986) |
| Western Wadden Sea | <i>Mytilus</i> | 14,700 | 3.7 | 5.8 | 0.58 | Dame et al. (1991) |
| Ria de Arosa | <i>Mytilus</i> | 6900 | 1.6 | 12.4 | 0.54 | Tenore et al. (1982) |
| Delaware Bay | <i>Crassostrea</i> | (178) | (0.009) | 1278 | 13.17 | Biggs and Howell (1994) |
| Chesapeake Bay | <i>Crassostrea</i> | 1900 | 0.07 | 325 | 14.78 | Newell (1988) |

Source: Modified from Dame, R.F. and Prins, T.C. 1998. Bivalve carrying capacity in coastal ecosystems. *Aq. Ecol.*, 31, 409–421.

TABLE 6.5
A Comparative Listing of Turnovers by Location and Type

| System | Water Mass Residence Time RT (d) | Primary Production Time B _p /P (d) | Bivalve Clearance Time CT (d) |
|-------------------------------|--|---|-------------------------------------|
| Sylt (SY) | 0.5 | 0.78 | 4.0 |
| North Inlet (NI) | 1.0 | 0.82 | 0.7 |
| Marennes-Oléron (MO) | 7.1 | 10.00 | 2.7 |
| South San Francisco Bay (SSF) | 11.1 | 1.10 | 0.7 |
| Narragansett Bay (NB) | 26.0 | 1.68 | 25.0 |
| Oosterschelde (OO) | 40.0 | 3.08 | 3.7 |
| Western Wadden Sea (WW) | 10.0 | 0.97 | 5.8 |
| Ria de Arosa (RA) | 23.0 | 0.63 | 12.4 |
| Delaware Bay (DB) | 97.0 | 7.40 | 1278 |
| Chesapeake Bay (CB) | 22.0 | 0.94 | 325 |

Source: Modified from Dame, R.F. and Prins, T.C. 1998. Bivalve carrying capacity in coastal ecosystems. *Aq. Ecol.*, 31, 409–421.

Phytoplankton biomass in short residence time systems (fast systems) could still be controlled by bivalves if their biomass:volume ratio is high, $> 8 \text{ g m}^{-3}$, as in North Inlet and Sylt. Thus some fast systems function more like feedlots, with food being imported from the adjacent ocean to support high heterotrophic activity within their shallow tidal creeks and flats. Herman, as reported in Heip et al. (1995), has found that there is a very good inverse relationship between volume-specific biomass of bivalve suspension-feeders and water mass residence time. Herman further speculates that food-limitation for systemwide bivalve suspension-feeders may be a general property.

It is evident from the observations presented in Tables 6.2, 6.3, 6.4, and 6.5 that any model or conceptualization of the role of bivalve filtration in coastal waters should account for system water mass residence time, phytoplankton primary production or replacement time, and particle clearance rates or clearance time by the great majority of filtering organisms. These aspects should be fundamental components in any model of bivalve suspension-feeder dominated ecosystems as they represent the physical environment (water residence time, Table 6.2), the primary producers (replacement time, Table 6.3), and the grazers (clearance time, Table 6.4). (See also Figure 6.2 in conjunction with above tables adapted from Smaal and Prins 1993).

Herman proposed a simple model that includes these relationships (Heip et al. 1995). In Herman's model the rate of change of phytoplankton biomass per m^3 of water is described by

$$dP/dt = P(\mu - m) - P(CI_{ff})(B_{ff}) - P/RT + P_e/RT \quad (6.10)$$

where

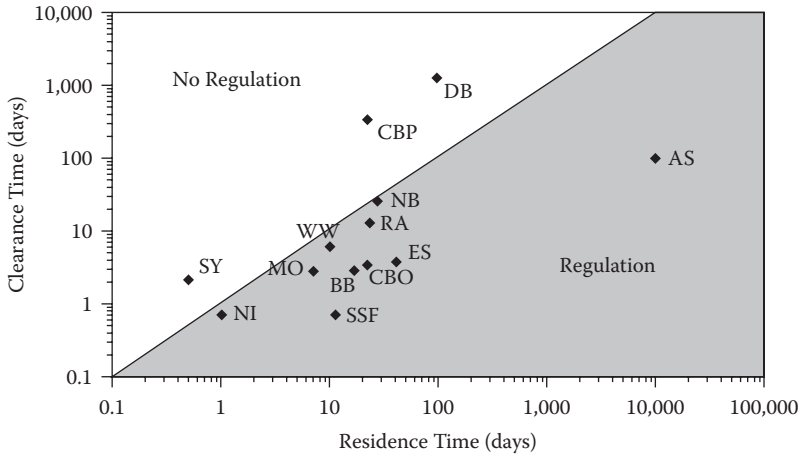

FIGURE 6.2 Regulation as determined by turnover rates. (Modified from Smaal, A.C. and Prins, T.C. 1993. The uptake of organic matter and the release of inorganic nutrients by bivalve suspension feeder beds. In *Bivalve Filter Feeders in Estuarine and Coastal Ecosystem Processes*, Dame, R.F., Ed. Heidelberg: Springer-Verlag, pp. 273–98.)

P = phytoplankton biomass (g m^{-3})

μ = growth rate of phytoplankton (day^{-1})

m = death rate of phytoplankton, resulting from causes other than grazing by bivalve suspension feeders (day^{-1})

Cl_{ff} = biomass-specific clearance rate of bivalve suspension feeders ($\text{m}^3 \text{g}^{-1} \text{d}^{-1}$)

B_{ff} = biomass of bivalve suspension feeders (g m^{-3})

RT = water mass residence time (days)

P_e = phytoplankton concentration in advected water (g m^{-3})

As discussed earlier, Chesapeake Bay of the past was heavily dominated by benthic bivalve suspension-feeders, but through overharvesting, disease, and changes in the surrounding landscape this system has changed to a planktonic one (Newell 1988). The switching from benthic–pelagic coupling to a planktonic system is but one way bivalves have been involved in changing the nature of a coastal system. In Ria de Arosa (Tenore et al. 1982) and Marennes–Oléron (Héral et al. 1988), we find the reverse case, where the artificial culture of dense populations of bivalves has moved these systems toward dominance by benthic bivalve suspension-feeders. From an ecosystem perspective, it would be interesting to know if such a phase shift can occur naturally, and if it does what the system advantages and disadvantages are. I suggest that pelagic planktonic grazing and benthic bivalve suspension-feeding are simply redundant components in the processing of consuming suspended particulate material in coastal waters. However, when conditions favor benthic suspension-feeders, i.e., shallow flowing water, sufficient substrate, and adequate phytoplankton food supply, benthic bivalve suspension-feeders probably will dominate because their food chains are shorter, they take advantage of tidal energy subsidies to receive

their food, and their longer life spans with greater stored biomass stabilizes a given ecosystem over longer time periods with a greater variety of environmental cycles.

From the comparison of ecosystems with major populations of bivalve suspension-feeders, each system is unique in many ways. The focus on turnover times as defining parameters of bivalve suspension-feeder carrying capacity strongly couples the major abiotic and biotic components in a straightforward way. The use of turnover times also allows a general comparison of a broad variety of coastal and estuarine ecosystems. From an ecosystem perspective, these systems range from fast (short turnaround time) to slow (long turnover times). Fast systems are generally smaller with denser populations of bivalves (Carpenter and Turner 2001).

The use of turnover times also introduces the mechanistic approach to dealing with living complex systems in a practical yet simple manner. However, the complex aspects of dense assemblages of both natural and artificial suspension-feeding bivalves begs for the inclusion of more components to the puzzle along with more and better quality data. All of which means a commitment of more financial resources. There is the potential to make some additional progress by utilizing Ecopath (Christensen et al. 2000). Ecopath is a steady-state mass balance model that can be thought of as being generic. Unless you are an ecological modeler, I would advise that at this stage you should seek out a new team member who has previous experience in modeling estuarine and coastal marine systems.

A MINI CASE STUDY

Over the past century, the natural resources of our planet suffered as a result of some well-known fundamental human failings. I believe that our species' greatest weakness is our inability to control our use of nature's resources and services in a sustainable manner. Closely aligned with this first problem is our species' failure to recognize the fundamental truth that we need nature much more than nature needs us.

As a part of the United Nations Millennium Ecosystem Assessment (MEA) for the year 2000, a census of all living creatures on our planet was conducted. The UN recognized that in conducting the MEA it was also becoming involved in the largest biodiversity study to date. With the size and complexity of the systems known, the UN announced that the ecological side of the MEA would be conducted with an ecosystems approach (MEA 2003). It was initially thought that the epitome of ecosystem engineers, the oyster, had suffered a worldwide population collapse due to habitat destruction and overfishing (Schulte et al. 2009). However, field studies (Table 6.6) on several suspension-feeding bivalves in the late 20th and early 21st centuries indicated that restoration of native oyster reefs might be possible (Bartol et al. 1999; Lenihan 1999; Nestlerode et al. 2007).

An oyster reef begins with oyster larvae searching out a clean, hard spot to attach then glue themselves to the substrate. Oyster larvae will attach to just about any hard surface, but they generally prefer the shells of their own species (also known as gregarious behavior). Assuming the appropriate environmental conditions exist, the larvae initiate processes that not only increase the productivity and energy flow of the oyster reef system but also dramatically increase the reef's complexity. For example (Table 6.6.), *C. virginica* forms a veneer of young oysters in the interstitial

TABLE 6.6**A Preliminary List of Biotic and Physical Properties of Restored and Unrestored *Crassostrea virginica* Reefs**

| Property | Restored | Unrestored | Comments |
|----------------------------------|--|---|--|
| Settlement substrate | Hard, high settlement, low deposition | Soft, low settlement, high deposition | Resuspension (>15 cm s ⁻¹) |
| Accretion | Oyster shell | Other | Species specific |
| Interstitial veneer | 3-D | 2-D | Increased complexity |
| Interstitial space ample refugia | Oysters escape predation | Predation high | Increased biodiversity |
| Parasites | Resisted | Unresisted | |
| Interstitial water flow | 5× | – | Increased energy efficiency |
| Interstitial habitat | Diversity high | Diversity low | Biodiversity enhanced |
| Mounding with vertical relief | High relief implies high water quality | Low relief implies lower water flow and quality | |
| Sanctuary and no take status | No fishing, high density and growth | Fishery depleted | Biodiversity enhanced |

Source: From Lenihan, H.S. 1999. Physical-biological coupling on oyster reefs: How habitat structure influences individual performance. *Ecol. Monographs*, 69(3), 251–275.

spaces at the base of the emerging reef. As the reef develops, the veneer provides a substrate for the settlement of more oyster larvae as well as other invertebrate and fish larvae. The accumulation of larvae on the veneer provides a vertical axis to the two-dimensional (2-D) veneer so that the reef is now a three dimensional (3-D) object that is dramatically increasing its habitat space. The 3-D reef structure has a much denser and more complex distribution of individual oysters, which means the reef is pumping and filtering much more water. Essentially, the oysters transform their normally 2-D by constructing a vertical relief environment into a 3-D structure that rises off the mud flats to provide structure that contains a high density of randomly shaped spaces where fish and invertebrate larvae can hide or forage (Nestlode et al. 2007). This reef building process gradually develops new surfaces for even more structural development where invertebrate and fish larvae can hide. More importantly, the increase in oyster numbers and decrease in average individual size produces a large increase in water pumped as well as metabolic efficiency, all of which positively influences the health of the oysters. In essence, the reef has become a much larger and efficient pump as well as a good example of positive feedback.

The decline of native oyster populations has been attributed to overfishing and habitat destruction (Jackson 2001). As major ecosystem engineers, these animals influenced many important processes including nutrient cycling, water filtration, habitat structure, biodiversity, food web dynamics, and eutrophication (Dame 1996; Jackson 2001). In the United States, the publicity focused on the Eastern oyster,

Crassostrea virginica, and the collapse of the Chesapeake Bay estuarine ecosystem. The phase or state of the system was the one dominated by suspension-feeding benthic bivalves. Newell (1988) argued that the new state of Chesapeake Bay would be dominated by the plankton and nekton of the water column. In spite of expensive oyster restoration programs and trial introductions of other oyster species, most efforts were unsuccessful. *Crassostrea virginica*'s inability to resist two diseases (MSX: *Haplosporidium nelsoni* and Dermo: *Perkinsus marinus*) seemed to be a major factor in its failure. From a different perspective, there have been a number of reports of populations overcoming disease when living near ideal conditions with protected or sanctuary status (Lenihan 1999).

Schulte et al. (2009) reported the successful restoration of a native metapopulation of *C. virginica* in the Great Wicomico Estuary of lower Chesapeake Bay. The 35.5 ha site is a permanent sanctuary. In this study, the single most important factor in reef success was vertical relief above the channel bottom. The density of oysters on high relief reefs is also high and is probably due to optimal water flow over the reef and equivalent healthier physiological condition of oysters on high relief reefs. Optimal flow maximizes growth and survival and minimizes the influence of disease and sedimentation (Schulte et al. 2009).

Another factor was the availability of shell to accrete in a natural reef building situation. Shell accretion is indicative of the high relief reefs and the vertical growth as well as the architecture they exhibit. The future availability of shell for reef building may be a major problem because of increasing estuarine and coastal acidification. Coastal and estuarine acidification is caused by increased CO₂ in the atmosphere dissolving into these waters. As the CO₂ is taken up by the coastal waters the normal water chemistry buffers the pH maintaining a basic system, but as the buffer system becomes overloaded the system gradually becomes acidic. In the acidic mode, the oyster shells begin to dissolve.

In researching Schulte et al. (2009), I was struck by how many of the positive factors or processes that are targets of oyster reef restoration are common to the intertidal oyster reefs of the southeastern United States and part of the richest natural ecosystems on our planet.

REFERENCES

- Asmus, H. 1987. Secondary production of an intertidal mussel bed community related to its storage and turnover compartments. *Mar. Ecol. Prog. Ser.*, 39, 251–66.
- Asmus, H., Asmus, R.M., Prins, T.C., Dankers, N., Frances, G., Maass, B., and Reise, K. 1992. Benthic-pelagic flux rates on mussel beds: Tunnel and tidal flume methodology compared. *Helgol. Wiss. Meeresunters.*, 46, 341–61.
- Asmus, H., Asmus, R.M., and Reise, K. 1990. Exchange processes in an intertidal mussel bed: A Sylt-flume study in the Wadden Sea. *Ber. Biol. Anst. Helgol.*, 6, 1–79.
- Asmus, R.M. and Asmus, H. 1991. Mussel beds: Limiting or promoting phytoplankton? *J. Exp. Mar. Biol. Ecol.*, 148, 215–32.
- Bacher, C. 1989. Capacité trophique du bassin de Marennes-Oléron: Couplage d'un modèle de transport particulaire et d'un modèle de croissance de l'huître *Crassostrea gigas*. *Aquat. Living Resour.*, 2, 199–214.
- Barnes, R.D. 1974. *Invertebrate Zoology*. Philadelphia: Saunders. 870 pp.

- Bartol, I.K., Mann, R. and Luckenbach, M. 1999. Growth and mortality of oysters (*Crassostrea virginica*) on the constructed intertidal reefs: Effects of tidal height and substrate level. *J. Exp. Mar. Biol. Ecol.*, 237, 157–84.
- Biggs, R.B. and Howell, B.A. 1984. The estuary as a sediment trap: Alternate approaches to estimating filter efficiency. In *The Estuary as a Filter*, Kenney, V.S., Ed. New York: Academic Press, 107–29.
- Butman, C.A., Fréchette, M., Geyer, W.R., and Starczak, V.R. 1994. Flume experiments on food supply to the blue mussel *Mytilus edulis* L. as a function of boundary-layer flow. *Limnol. Oceanogr.*, 39, 1755–68.
- Cadée, G.C. 1986. Recurrent and changing seasonal patterns in phytoplankton of the western-most inlet of the Dutch Wadden Sea from 1969–1985. *Mar. Biol.*, 93, 281–89.
- Carpenter, S.R. and Turner, M.G. 2001. Hares and tortoises: Interactions of fast and slow variables in ecosystems. *Ecosystems*, 3, 495–97.
- Christensen, W., Walters, C.J., and Pauly, D. 2000. *Ecopath with ECOSIM: A User's Guide*. Vancouver, Canada: Fisheries Centre, University of British Columbia, 130 pp.
- Chrzanowski, T., Stevenson, H., and Kjerfve, B. 1979. Adenosine 5' triphosphate flux through the North Inlet marsh system. *App. Environ. Microbiol.*, 37, 841–8.
- Cloern, J.E. 1982. Does the benthos control phytoplankton biomass in South San Francisco Bay? *Mar. Ecol. Prog. Ser.*, 9, 191–202.
- Damas, D. 1935. Le rôle des organismes dans la formation des vases marines. *Ann. Soc. Geol. Belg.*, 58, 143–52.
- Dame, R.F. 1996. *Ecology of Marine Bivalves: An Ecosystem Approach*. Boca Raton, Florida: CRC Press, 254 pp.
- Dame, R.F., Chrzanowski, T., Bildstein, K., Kjerfve, B., McKellar, H., Nelson, D., Spurrier, J., Stancyk, S., Stevenson, H., Vernberg, J., and Zingmark, R. 1986. The outwelling hypothesis and North Inlet, South Carolina. *Mar. Ecol. Prog. Ser.*, 33, 217–29.
- Dame, R.F. and Dankers, N. 1988. Uptake and release of materials by a Wadden Sea mussel bed. *J. Exp. Mar. Biol. Ecol.*, 118, 207–16.
- Dame, R.F., Dankers, N., Prins, T. Jongsma, H., and Smaal, A. 1991. The influence of mussel beds on nutrients in the Western Wadden Sea and Eastern Scheldt estuaries. *Estuaries*, 14, 130–38.
- Dame, R.F. and Prins, T.C. 1998. Bivalve carrying capacity in coastal ecosystems. *Aq. Ecol.*, 31, 409–21.
- Dame, R.F., Zingmark, R.G., and Haskin, E. 1984. Oyster reefs as processors of estuarine materials. *J. Exp. Mar. Biol. Ecol.*, 83, 239–47.
- Dame, R.F., Zingmark, R.G., Stevenson, H., and Nelson, D. 1980. Suspension-feeding coupling between the water column and benthic systems. In *Estuarine Perspectives*, Kennedy, V.S., Ed. NY: Academic Press, pp. 521–26.
- Doering, P.H. and Oviatt, C.A. 1986. Application of filtration rate models to field populations of bivalves: An assessment using experimental mesocosms. *Mar. Ecol. Prog. Ser.*, 31, 265–75.
- Fisher, C.R. 1990. Chemoautotrophic and methantrophic symbioses in marine invertebrates. *Rev. Aquatic Sci.* 2: 399–436.
- Fréchette, M., Butman, C.A., and Geyer, W.R. 1989. The importance of boundary-layer flows in supplying phytoplankton to the benthic suspension feeder *Mytilus edulis*. *Limnol. Oceanogr.*, 34, 19–36.
- Fréchette, M., Lefavre, D., and Butman, C.A. 1993. Bivalve feeding and the benthic boundary layer. In *Bivalve Filter Feeders in Estuarine and Coastal Ecosystem Processes*, Dame, R.F., Ed. Heidelberg: Springer-Verlag, pp. 325–69.

- Gerritsen, J., Holland, A.F., and Irvine, D.E. 1994. Suspension-feeding bivalves and the fate of primary production: An estuarine model applied to Chesapeake Bay. *Estuaries*, 17, 403–16.
- Greene, V.E., Sullivan, L.J., Thompson, J.K., and Kimmerer, Wim J. In press. Grazing impact of the invasive clam *Corbula amurensis* on the microplankton assemblage of the northern San Francisco Estuary. *Mar. Ecol. Prog. Ser.*
- Harding, L.W., Meeson, B.W., and Fisher, T.R. 1986. Phytoplankton production in two east coast estuaries: photosynthesis-light functions and patterns of carbon assimilation in Chesapeake and Delaware Bays. *Estuarine Coast. Shelf Sci.*, 23, 773–806.
- Heip, C.H.R., Goosen, N.K., Herman, P.M.J., Kromkamp, J., Middelburg, J., and Soetaert, K. 1995. Production and consumption of biological particles in temperate tidal estuaries. *Oceanogr. Mar. Biol. Annu. Rev.*, 33, 1–149.
- Héral, M. 1993. Why carrying capacity models are useful tools for management of bivalve culture. In *Bivalve Filter Feeders in Estuarine and Coastal Ecosystem Processes*, Dame, R.F., Ed. Heidelberg: Springer-Verlag, pp. 455–77.
- Héral, M., Deslous-Paoli, J.-M., and Prou, J. 1988. Approche de la capacité trophique d'un écosystème conchylicole. *J. Cons. Int. Explor. Mer*, Cm 1988/K, 22 pp.
- Herman, P.M.J. 1993. A set of models to investigate the role of benthic suspension feeders in estuarine ecosystems. In *Bivalve Filter Feeders in Estuarine and Coastal Ecosystem Processes*, Dame, R.F., Ed. Heidelberg: Springer-Verlag, pp. 421–54.
- Herman, P.M.J. and Scholten, H. 1990. Can suspension-feeders stabilise estuarine ecosystems? In *Trophic Relationships in the Marine Environment*, Barnes, M. and Gibson, R.N., Eds. Aberdeen: Aberdeen University Press, pp. 104–16.
- Higgins, S.N. and Vander Zanden, M.J. 2010. What a difference a species makes: A meta-analysis of dreissenid mussel impacts on freshwater ecosystems. *Ecol. Monogr.*, 80, 2, 179–96.
- Hilbert, D.W., Swift, D.M., Detling, J.K., and Dyer, M.I. 1981. Relative growth rates and the grazing optimization hypothesis. *Oecologia*, 51, 14–18.
- Horsted, S.J., Nielsen, T.G., Tiemann, B., Pock-Steen, J., and Bjørnsen, P.K. 1988. Regulation of zooplankton by suspension feeding bivalves and fish in estuarine enclosures. *Mar. Ecol. Prog. Ser.*, 48, 217–24.
- Jackson, J.B.C., Kirby, M.X., Berger, W.H., Bjørndal, K.A., et al. 2001. Historical overfishing and the recent collapse of coastal ecosystems. *Science*, 293, 629–38.
- Jonge, V.N. de and Postma, H. 1974. Phosphorus compounds in the Dutch Wadden Sea. *Neth. J. Sea Res.*, 8, 139–53.
- Jørgensen, C.B. 1943. On the water transport through the gills of bivalves. *Acta Physiol. Scand.*, 5, 297–304.
- Koseff, J.R., Holen, J.K., Monismith, S.G., and Cloern, J.E. 1993. Coupled effect of vertical mixing and benthic grazing on phytoplankton populations in shallow, turbid estuaries. *J. Mar. Res.*, 1–26.
- Kremer, J. and Nixon, S. 1978. *A Coastal Marine Ecosystem*. New York: Springer-Verlag, 217 pp.
- Lenihan, H.S. 1999. Physical-biological coupling on oyster reefs: How habitat structure influences individual performance. *Ecol. Monographs*, 69(3), 251–75.
- Lotsy, J.P. 1893. The food of the oyster, clam, and ribbed mussel. *Rep. U.S. Comm. Fish and Fisheries*, 19, 375–86.
- Lucas, J.S. 1988. Giant clams: Description, distribution, and life history. In Copland, J.W. and Lucas, J.S., Eds., *Giant Clams in Asia and the Pacific*. Australian Center for International Agricultural Research, Canberra, 21–32.
- Lund, E.J. 1957. A quantitative study of clearance of a turbid medium and feeding by the oyster. *Publ. Inst. Mar. Sci. Texas*, 4, 296–312.

- Maurer, D., Watling, L. and Keck, R. 1971. The Delaware oyster industry: A reality? *Trans. Am. Fish. Soc.*, 100, 101–11.
- McCrary, J. 1874. Observations on the food and reproductive organs of *Ostrea virginica*, with some account of *Bucephalus cuculus* nov. sp. *Proc. Boston Soc. Nat. Hist.*, 16, 170–92.
- McNaughton, S.J. 1979. Grazing as an optimization process: Grass-ungulate relationships in Serengeti. *Am. Nat.*, 113, 691–703.
- Millennium Ecosystem Assessment (MEA). 2003. *Ecosystems and Human Well-Being*. Washington, DC: Island Press, 137 pp.
- Möbius, K. 1880. Die Auster und die Austerwirthschaft. *Rep. U.S. Comm. Fish.*, 683–751.
- Monismith, S.G., Koseff, J.R., Thompson, J.K. O’Riordan, C.A., and Nepf, H.M. 1990. A study of model bivalve siphonal currents. *Limnol. Oceanogr.*, 35, 680–96.
- Morse, D.C. 1944. Some observations on the food and feeding of oysters in Chesapeake Bay. *Proc. Natl. Shellfish Assoc.*, 55, 17–19.
- Navarro, E., Ingelsias, J.I.P., Perez Camacho, A., Labarta, U., and Beiras, R. 1991. The physiological energetics of mussels (*Mytilus galloprovincialis*) from different cultivation rafts in Ria de Arosa (Galicia, N.W. Spain). *Aquaculture*, 94, 177–96.
- Nestlerode, J.A., Luckenbach, M.W. and O’Beirn, F.X. 2007. Settlement and survival of the oyster *Crassostrea virginica* on created oyster reef habitats in Chesapeake Bay. *Restor. Ecol.*, 15, 2, 273–83.
- Newell, R.I.E. 1988. Ecological changes in Chesapeake Bay: Are they the result of overharvesting the American oyster, *Crassostrea virginica*? In *Understanding the Estuary: Advances in Chesapeake Bay Research*, Lynch, M.P. and Krome, E.C., Eds. Solomon’s, Maryland: Chesapeake Research Consortium, pp. 536–46.
- Nichols, F.H. and Pamatmat, M. 1988. The ecology of the soft-bottom benthos of San Francisco Bay: A community profile. *USF&WS Biol. Rep.*, 85(7.19).
- Nienhuis, P.H. and Smaal, A.C. 1994. *The Oosterschelde Estuary: A Case Study of a Changing Ecosystem* (reprinted from *Hydrobiologia* 282/283). Dordrecht Kluwer, 597 pp.
- Nixon, S.W., Oviatt, C.A., Rogers, C., and Taylor, K. 1971. Mass metabolism of a mussel bed. *Oecologia*, 8, 1–30.
- Norberg, J. and Cumming, G.S. 2008. *Complexity Theory for a Sustainable Future*. New York: Columbia University Press, 315 pp.
- Nowell, A.R.M. and Jumars, P.A. 1987. Flumes: Theoretical and experimental considerations for simulation of benthic environments. *Oceanogr. Mar. Biol. Annu. Rev.*, 25, 91–112.
- Odum, E.P. 1983. *Basic Ecology*. Philadelphia: Saunders, 613 pp.
- Odum, H.T., Burkholder, P.R., and Rivero, J. 1959. Measurements of productivity of turtle grassflats, reefs and the Bahia Fosfrescente of southern Puerto Rico. *Publ. Inst. Mar. Sci.*, 6, 159–71.
- Odum, H.T. and Odum, E.P. 1955. Trophic structure and productivity of a windward coral reef community on Eniwetok atoll. *Ecol. Monogr.*, 25, 381–411.
- Officer, C.B., Smayda, T.J., and Mann, R. 1982. Benthic suspension-feeding: A natural eutrophication control. *Mar. Ecol. Prog. Ser.*, 9, 203–10.
- O’Riordan, C.A., Monismith, S.G., and Koseff, J.R. 1993. An experimental study of concentration boundary layer formation over bivalve assemblages. *Limnol. Oceanogr.*, 38, 1712–29.
- Perez Camacho, A., Gonzalez, R., and Fuentes, J. 1991. Mussel culture in Galicia (N.W. Spain). *Aquaculture*, 92, 263–78.
- Petersen, J.K., Hansen, J.W., Laurensen, M.B., Clausen, P., Cartensen, J., and Conlay, D.J. 2008. Regime shift in a coastal marine ecosystem. *Ecol. Appl.*, 18, 2, 497–510.
- Pilson, M.Q. 1985. On the residence time of water in Narragansett Bay. *Estuaries*, 8, 2–14.

- Prins, T.C. 1996. *Bivalve Grazing, Nutrient Cycling and Phytoplankton Dynamics in an Estuarine Ecosystem*. PhD dissertation. Wageningen, the Netherlands: University of Wageningen, 173 pp.
- Prins, T.C., Escaravage, V., Smaal, A.C., and Peeters, J.C.H. 1995. Nutrient cycling and phytoplankton dynamics in relation to mussel grazing in a mesocosm experiment. *Ophelia*, 41, 289–315.
- Prins, T.C. and Smaal, A.C. 1994. The role of the blue mussel *Mytilus edulis* in the cycling of nutrients in the Oosterschelde estuary. In *The Oosterschelde Estuary: A Case Study of a Changing Ecosystem*, Nienhuis, P.H. and Smaal, A.C., Eds. Dordrecht: Kluwer, pp. 413–29.
- Prins, T.C., Smaal, A.C., and Dame, R.F. 1998. A review of the feedbacks between bivalve grazing and ecosystem processes. *Aqua. Ecol.*, 31, 349–59.
- Raillard, O., Deslous-Paoli, J-M., Héral, M., and Razet, D. 1993. Modelling growth and feeding of the Japanese oyster *Crassostrea gigas* in Marennes-Oléron Bay (France). *Ocean. Acta*, 16, 73–82.
- Reise, K. 1985. *Tidal Flat Ecology—An Experimental Approach to Species Interactions*. Heidelberg: Springer-Verlag, 191 pp.
- Reiss, J., Bridle, J.R., Montoya, J.M., and Woodward, G. 2009. Emerging horizons in biodiversity and ecosystem functioning research. *Trends in Ecol. Evol.*, 24, 505–14.
- Riemann, B., Nielsen, T.G., Horsted, S.J., Bjørnsen, P.K., and Pock-Steen. 1988. Regulation of phytoplankton biomass in estuarine enclosures. *Mar. Ecol. Prog. Ser.*, 48, 205–15.
- Riemann, B., Sørensen, H.M., Bjørnsen, P.K., Horsted, S.J., Jensen, L.M., Nielsen, T.C., and Søndergaard, M. 1990. Carbon budgets of the microbial food web in estuarine enclosures. *Mar. Ecol. Prog. Ser.*, 65, 159–70.
- Rogers, C.S. 1979. The productivity of San Cristobal reef in Puerto Rico. *Limnol. Oceanogr.*, 24, 342–49.
- Sargent, M.C. and Austin, T.S. 1949. Organic productivity of an atoll. *Trans. Am. Geophys. Union*, 30, 245–49.
- Schulte, D.M., Burke, R.P., and Lipcius, R.N. 2009. Unprecedented restoration of a native oyster metapopulation. *Science*, 325, 1124–28.
- Smaal, A.C. and Prins, T.C. 1993. The uptake of organic matter and the release of inorganic nutrients by bivalve suspension feeder beds. In *Bivalve Filter Feeders in Estuarine and Coastal Ecosystem Processes*, Dame, R.F., Ed. Heidelberg: Springer-Verlag, pp. 273–98.
- Smaal, A.C., Verhagen, J.H.G., Coosen, J., and Haas, H.A. 1986. Interactions between seston quantity and quality and benthic suspension feeders in the Oosterschelde, the Netherlands. *Ophelia*, 26, 385–99.
- Sommer, U. 1989. Nutrient status and nutrient competition of phytoplankton in a shallow hypertrophic lake. *Limnol. Oceanogr.*, 34, 1162–73.
- Sterner, R.W. 1986. Herbivores' direct and indirect effects on algal populations. *Science*, 231, 606–7.
- Taylor, J. and Bushek, D. 2008. Intertidal oyster reefs can persist and function on a temperate North American Atlantic estuary. *Mar. Ecol. Prog. Ser.* 361, 301–306.
- Tenore, K.R., Boyer, L.F., Cal, R.M., Corral, J, Garcia-Fernandez, C., Gonzalez, N., Gonzalez-Gurriaran, E., Hanson, R.B., Iglesias, J., Krom, M., Lopez-Jamar, E., McClain, J., Pamatmat, M.M., Perez, A., Rhoads, D.C., de Santiago, G., Tiején, J., Westrich, J., and Windom, H.L. 1982. Coastal upwelling in the Rias Bajas, NW Spain: Contrasting the benthic regimes of the Rias de Arosa and de Muros. *J. Mar. Res.*, 40, 701–72.
- Tilman, D. 1976. Ecological competition between algae: Experimental confirmation of resource based competition theory. *Science*, 192, 463–65.

- Thompson, J.K. and Nichols, F.H. 1988. Food availability controls seasonal cycle of growth in *Macoma balthica* (L.) in San Francisco Bay, California. *J. Exp. Mar. Biol. Ecol.*, 116, 43–61.
- Ulanowicz, R.E. and Tuttle, J.H. 1992. The trophic consequences of oyster stock rehabilitation in Chesapeake Bay. *Estuaries*, 15, 257–65.
- Van der Eijk, M. 1979. The Dutch Wadden Sea. In *Marine Production Mechanisms*. Cambridge, U.K.: Cambridge University Press, pp. 197–228.
- Verwey, J. 1952. On the ecology of distribution of cockel and mussel in the Dutch Wadden Sea, their role in sedimentation and the source of their food supply. *Arch. Neerl. Zool.*, 10, 172–239.
- Warwick, R.M. and Uncles, R.J. 1980. Distribution of benthic macrofauna associations in the Bristol Channel in relation to tidal stress. *Mar. Ecol. Prog., Ser.*, 3, 97–103.
- Wildish, D.J. 1977. Factors controlling marine and estuarine sublittoral macrofauna. *Helgol. Wiss. Meeresunters.*, 30, 445–54.
- Wildish, D.J. and Peer, D. 1983. Tidal current speed and production of benthic macrofauna in the lower Bay of Fundy. *Can. J. Fish. Aquat. Sci.*, 40(Suppl. 1), 309–21.
- Wright, R.T., Coffin, R.B., Ersing, C.P., and Pearson, C.P. 1982. Field and laboratory measurements of bivalve filtration of natural marine bacterioplankton, *Limnol. Oceanogr.*, 27, 91–98.

7 Ecosystem Metabolism and Nutrient Cycling

INTRODUCTION

One of the most important and time-proven measures of functional activity in ecological systems is the metabolic rate. System metabolism or metabolic rate is the sum of system respiration, primary production, and external exchanges. The rate of system metabolism is one of the few readily measurable emergent or holistic properties of ecosystems and allows systems to be categorized as autotrophic (net producer) or heterotrophic (net consumer) systems. In each case, the historical perspective for research in an area is presented along with the theoretical background (Hopkinson and Smith 2004). Methodologies are reviewed and examples utilizing bivalves are provided.

IMPORTANT TERMS AND CONCEPTS

Denitrification: The process of converting nitrate eventually to N_2 gas.

Diurnal curve: A plot of oxygen concentration versus time of day (24 hr).

Mineralization: The conversion of organic nitrogen to inorganic nitrogen.

Net metabolism: Defined as the difference between gross primary production (GPP) and respiration (R).

Respiratory quotient (RQ): Reflects if an environment is aerobic (>1) or anaerobic (<1).

The use of whole-stream (system) approach to estimate system metabolism was first advocated by Odum (1956) and Odum and Hoskin (1958) for streams and estuaries, respectively. As with organisms, ecosystem metabolism can be estimated from temporal changes in the concentration of metabolic gases (O_2 and CO_2), and this approach has been utilized for many types of aquatic ecosystems (Kemp and Boynton 1980; Kenney et al. 1988; Marzolf et al. 1994).

The character of system metabolism is often dominated by subsystems within the ecosystem (Marzolf et al. 1994). In estuarine and coastal waters, beds of bivalve suspension-feeders (mussels, oysters, clams, etc.) may play a dominant role in the total metabolism of these systems. In the case of mussel and oyster beds, it is the high density of bivalve biomass that has been found to take up large quantities of O_2 (Nixon et al. 1971; Dankers et al. 1989; Dame et al. 1992) and has allowed these beds to dominate well-mixed tidal systems. In other reduced-flow systems, stratification of the water column allows benthic bivalves to regulate the heterotrophic nature of bottom waters (Cloern 1982; Alpine and Cloern 1992; Cloern 2001).

METHODS FOR MEASURING SYSTEM METABOLISM

As with individual organisms (Chapter 4), the major components of system metabolism, photosynthesis, and respiration can be estimated by the uptake and release of isotopic tracers for systems isolated in chambers (Chapter 6) or temporal changes in the concentrations of metabolic gases *in situ* or in microcosms or mesocosms. The rates of photosynthesis and respiration are usually separated by measuring gas concentrations *in situ* over a 24-hour period (diurnal curves) or by using light and dark chambers (Odum 1956). The light component represents the sum of photosynthesis and respiration while the dark component characterizes respiration. Subtracting the dark component from the light observations gives an estimate of photosynthesis. Both quiet water and flowing water upstream–downstream (see Chapter 6) time series of dissolved oxygen concentrations have found general acceptance in determining system metabolism.

In flowing waters, typical of bivalve-dominated environments, chambers reduce the realism of system metabolic measurements because mixing is reduced and the portion of the system observed is constrained (Kemp and Boynton 1980; Kemp et al. 1997). The use of time series of oxygen concentrations to estimate system metabolism is based on the understanding that (1) during the day both benthic plants and phytoplankton release oxygen into the water column as a result of photosynthesis; (2) oxygen is taken from the water by organismic respiration and sometimes chemical oxygen demand; (3) there is an exchange of oxygen with the atmosphere in a direction depending on the saturation gradient; and (4) there may be an influx of oxygen in ground water and surface drainage (Odum 1956). The advantages of these methods are that the benthos remains undisturbed, all components of the system are included, and environmental conditions, i.e., water velocity, light, temperature, etc., are unaffected by the measurements. Disadvantages that are often encountered include: no true replication, confounded observations due to lateral flow, and corrections for air–water exchange of oxygen (Marzolf et al. 1994).

CHAMBER MEASUREMENTS

A variety of investigators have utilized the chamber approach to obtain estimates of bivalve-dominated system metabolism. The role of clams in system metabolism was the focus of Murphy and Kremer (1985) and Doering et al. (1987), oyster community metabolism was investigated by Bahr (1976), and the influence of oyster biomass on benthic metabolism was examined by Boucher and Boucher-Rodoni (1988) and Boucher-Rodoni and Boucher (1990). In Colorado Lagoon, Long Beach, California, Murphy and Kremer (1985) used *in situ* opaque and clear hemispherical chambers (43 liters) to measure aerobic respiration and chemical oxygen demand of the benthic environment dominated by the introduced clam *Mercenaria mercenaria*. These researchers extrapolated their chamber results to the entire lagoon (5.6 ha) and found that although microbial processes generally have been credited with being the most important component of benthic consumer communities, *Mercenaria* accounted for more than 50% of the oxygen uptake within the system.

In a more realistic approach, Doering et al. (1987) used experimental mesocosms (13 m³) to examine the effect of the hard clam *Mercenaria mercenaria* on the exchange of oxygen and carbon dioxide as well as inorganic nutrients across the sediment–water interface. The entire benthic component of the mesocosm was covered with a clear chamber (320 liters) to follow material concentrations over time. The presence of clams at moderate densities increased the exchange of oxygen across the sediment–water interface and confirmed the observations of Murphy and Kremer (1985). Paradoxically, carbon dioxide production was not significantly different in chambers with and without clams. The investigators speculated that the lack of effect on carbon dioxide production may have been due to small sample size.

In studies by Doering et al. (1987), the respiratory quotient (CO₂:O₂) ranged from 0.26 to 3.29, but exhibited no treatment effect. The benthic respiratory quotient (RQ) is a combined index of aerobic and anaerobic respiration, and chemical oxidation of reduced products of anaerobic respiration. An RQ of 1.0 suggests that decomposition is mainly aerobic, or that reduced products of anaerobiosis are quickly oxidized chemically. A value greater than 1.0 implies that anaerobic production of CO₂ predominates over aerobic and chemical consumption of O₂. Thus reduced products must either accumulate in the sediments or be exported from them (Hargrave and Phillips 1981). Although the RQ values in their study varied over an order of magnitude, indicating that aerobic and anaerobic respiration and chemical oxygen demand were not in balance in the short term, the long-term average RQ was about 1.0 and implies that these processes are roughly in balance on an annual basis (Doering et al. 1987).

Oxygen consumption by an intertidal oyster reef in Georgia was estimated by Bahr (1976) using samples incubated in plastic tubs. A layer of paraffin oil was used to seal the chambers from the atmosphere, and stratification was reduced through hand stirring. Oxygen consumption varied seasonally from 6 to 50 g m⁻² day⁻¹ with oysters, *Crassostrea virginica*, accounting for about 48% of the total uptake. No effort was made to partition the photosynthetic component.

In a series of studies, Boucher and Boucher-Rodoni (1988) and Boucher-Rodoni and Boucher (1990) investigated the respiratory metabolism of oyster beds in the Bay of Morlaix, North Brittany, France. Oxygen flux at the sediment–water interface was estimated *in situ* using hemispherical plastic chambers (40 to 50 l) with closed water circulation. Oysters, *Crassostrea gigas*, accounted for 26% of the annual oxygen uptake, and increasing oyster biomass increased oxygen uptake. These researchers also noted that oyster biomass influenced the coupling between oxygen consumption and inorganic nitrogen release, and the presence of oysters stabilized nitrogen release.

FREE-FLOW MEASUREMENTS

Nixon et al. (1971) was one of the first groups to have successfully measured the metabolism of a bivalve system using the upstream–downstream free-flow technique in shallow coastal waters. Part of their success can be attributed to the location of the mussel bed they studied. It was located across the narrow, bottleneck opening that connects Bissel's Cove and the West Passage of Narragansett Bay, Rhode Island. The bed was completely exposed at low tide and was covered by flowing water at various

depths on the ebbing and flooding tides. Oxygen concentrations were measured upstream and downstream of the bed using the Winkler method. Current velocities were estimated using drift bottles and dye along a transect between the upstream and downstream sample points. All estimates were made during the summer under daylight conditions. However, so photosynthesis was not estimated. Since diffusion to or from the atmosphere could influence oxygen concentrations in the water, a diffusion constant (reaeration constant) was derived from the equations of Edwards and Owen (1964) as checked by the floating dome method of Copeland and Duffer (1964). These investigators found that oxygen uptake was $0.2 \text{ g m}^{-2} \text{ h}^{-1}$ in quiet water and rose to $2.7 \text{ g m}^{-2} \text{ h}^{-1}$ in currents over 10 cm s^{-1} . Nixon et al. (1971) argued that the hyperbolic response of mussel bed oxygen consumption with response to increasing water velocity was indicative of the energy subsidy of the current serving as a limiting factor on community metabolism. Subsequent studies on experimental mussel beds with controlled water flow at velocities below 10 cm s^{-1} (Dankers et al. 1989) support the Nixon et al. (1971) interpretation for low flow conditions.

TUNNEL STUDIES

The BEST tunnel approach (see Chapter 6) has been used to investigate the *in situ* metabolism of intertidal mussel beds in the Dutch Wadden Sea and oyster reefs in North Inlet, South Carolina (Dankers et al. 1989; Dame et al. 1992). Both studies utilized the diurnal approach to give estimates of day and night oxygen fluxes. The Dutch study also included an experimental flume design with constant water velocities and continuous upstream–downstream oxygen concentration monitoring with corrections for atmospheric exchanges. The mussel bed studies focused only on the summer season, and oxygen uptake rates of 1.2 to $3.9 \text{ g m}^{-2} \text{ h}^{-1}$ were observed (Dankers et al. 1989). The oyster reef investigations were uniformly distributed over the annual cycle and found a range of rates from a release of $1.5 \text{ g m}^{-2} \text{ h}^{-1}$ in winter to an uptake of $4.0 \text{ g m}^{-2} \text{ h}^{-1}$ in summer (Dame et al. 1992). The release of oxygen by the oyster reef in winter was attributed to the large growths of macroalgae on the beds and the reduced metabolism of the animals due to cold temperatures.

A summary of the system metabolism by a number of bivalve-dominated communities is provided in Table 7.1. Only the flux of oxygen per unit area is given because some reports did not provide bivalve biomass estimates. In general, systems with denser populations of bivalves have higher fluxes of oxygen and thus higher metabolism. As would be expected, rates are lower at lower temperatures in colder seasons, and production of oxygen can be observed when algal blooms occur on these beds.

NUTRIENT CYCLING

Bivalve molluscs not only remove materials from the water column or benthic–water interface, but, as a result of feeding and metabolism, they generate both particulate and dissolved materials that have an influence on benthic and pelagic habitats. Therefore, specific high quality organic constituents in the form of plankton, detritus, and amino acids are consumed as food, processed, deposited as feces or pseudofeces,

TABLE 7.1
Some Observed Oxygen Fluxes in Bivalve-Dominated Marine Systems

| System | Oxygen Flux ($\text{mg m}^{-2} \text{h}^{-1}$) | | | |
|------------------------------|--|--------|--------|-----------------------------------|
| | Location | Min. | Max. | Source |
| <i>Crassostrea gigas</i> | France | 1 | 160 | Boucher and Boucher-Rodoni (1988) |
| <i>Crassostrea virginica</i> | Georgia | 6,000 | 50,000 | Bahr (1976) |
| <i>Crassostrea virginica</i> | South Carolina | -1,500 | 4,000 | Dame et al. (1992) |
| <i>Crassostrea virginica</i> | Texas | 500 | | Collier (1959) |
| <i>Mercenaria mercenaria</i> | California | -40 | 800 | Murphy and Kremer (1985) |
| <i>Mercenaria mercenaria</i> | Rhode Island | 1,830 | | Doering et al. (1987) |
| <i>Mytilus edulis</i> | Rhode Island | 200 | 2,700 | Nixon et al. (1971) |
| <i>Mytilus edulis</i> | The Netherlands | 1,200 | 3,900 | Dankers et al. (1989) |
| <i>Nearshore Benthos</i> | Georgia | 51 | 141 | Hopkinson (1985) |

or excreted as fundamental nutrients to the water column where they can be utilized by the plankton. Because bivalves often form dense assemblages or communities of organisms in shallow ecosystems, these animals may play an important role in the cycling of nutrients within these systems. In this section, the function of bivalves in nutrient cycling will be addressed. Specifically, the role these organisms play in the translocation, transformation, and remineralization of essential nutrients as well as their part in feedback loops involving these elements will be examined.

THEORETICAL BACKGROUND

Early studies by Liebig (1840) indicated that biologically essential elements (bioelements or nutrients) could limit the production of organisms. At the level of the ecosystem, rather than a single limiting bioelement, it is often more complex interactions of elements that are limiting. The flux or cycling of essential materials is necessary for the continuity and stability of any living system and often provides a good indicator of metabolic activity and energy pathways through food webs. Consequently, the study of nutrient cycling is a major strategy in the analysis of ecosystems (Pomeroy 1970). There are a number of aspects to nutrient cycling including: (1) nutrient limitation of primary production; (2) recycling of nutrients and the mechanisms of recycling; (3) chemical complexity; and (4) stoichiometry (DeAngelis 1992). Nutrient limitation of primary production is common in all ecosystems and may be compensated for by internal recycling. In addition, the degree of system openness, as determined by the imports and exports of nutrients and when compared to the quantities of elements being recycled, is an important property at the ecosystem level. The cycle of each element is different from all others in its specifics, and some, like nitrogen, are very complex involving a number of different compounds. Finally, chemical stoichiometry relates to the proportions of various elements, usually C, H, O, N, P, and S, in a substance. These proportions are quite regular within groups of

organisms and generally mean that one or more of these elements will be kept in short enough supply in the pool of available nutrients in an ecosystem to be limiting (DeAngelis 1992).

Initially, the role of macroconsumers in total ecosystem function was viewed from the context of energy flow. Kitchell et al. (1979) showed that large animals, e.g., bivalves, can influence nutrient cycling through physical and chemical processes not directly reflected by energy flow. Kitchell et al. (1979) summarize these processes into two general mechanisms of influence: translocation and transformation. In systems dominated by bivalve suspension-feeders, nutrients are moved from the water column to the benthos and back mainly through the pumping action of the animals. These translocated or retained nutrients can be distributed in ways that influence the total production rates of the system as a whole. Bivalves may also transform nutrients by changing their chemical complexity and by changing the particle size distribution in the water column. Normally, particulate organic matter is consumed and dissolved inorganic materials are released as a part of bivalve metabolic processes. In addition, some bivalves may filter different portions of the suspended particulate size spectrum, and this may also change material surface area-to-volume relationships. Finally, small particles in the water column are aggregated into the bodies of benthic bivalves and the relatively large size particles of their feces and pseudofeces.

A closer examination of nutrient cycling in ecosystems dominated by bivalves (Figure 7.1) indicates two basic types of feedback: negative and positive. Grazing or the consumption of primary producers by bivalves can be considered part of a predator-prey system where the bivalves benefit from eating the primary producers while the primary producers are reduced through consumption. As one component benefits and the other is negatively affected, this direct effect is referred to as negative feedback or deviation-counteracting. There is a general consensus in ecology that negative feedback regulation occurs to the degree that it normally keeps populations and communities from going completely out of control although it may not always be strong enough to prevent sizable fluctuations (DeAngelis et al. 1986).

The strong coupling of benthic filter-feeding bivalves to phytoplankton in the water column via grazing (Chapter 6) is a negative feedback loop in the consumer-producer (predator-prey) mode. Such negative feedbacks should have a stabilizing influence on their ecosystems because they counteract deviations in the functional attributes

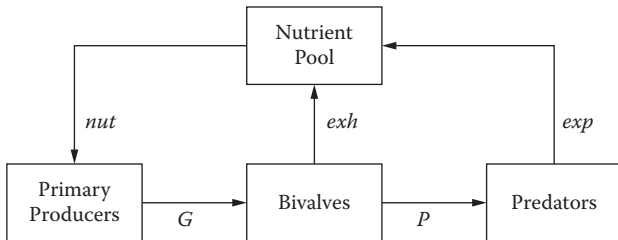

FIGURE 7.1 A simple diagram of nutrient cycling in bivalve-dominated systems. G = grazing; P = predation; exh = excretion by bivalves; exp = excretion by predators; nut = nutrient uptake by primary producers. (Redrawn from DeAngelis, D.L., Post, W.M., and Travis, C.C. 1986. *Positive Feedback in Natural Systems*. Berlin: Springer-Verlag, 290 pp.)

of the system. Bivalve suspension-feeders may be especially stabilizing because (1) they are permanently in the ecosystem; (2) their filtration rates do not level off with increasing food availability; and (3) their biomass turns over at a low rate (Herman and Scholten 1990). Unlike predator–prey cycles in the plankton, the permanent presence of long-lived bivalves ensures that no time lags, a characteristic of negative feedback loops, occur between the appearance of food and the grazing activity of the animals. The bivalves are always waiting to feed, slowly starving during the winter, and immediately grazing when primary production starts in the spring. The absence of a time lag may ensure that the phytoplankton cannot reach a level where effective grazing control becomes impossible (Herman and Scholten 1990).

Positive feedback is an indirect effect in bivalve systems where they utilize the nutrients in the primary producers, and in turn the primary producers use the nutrients excreted by the bivalves. In essence, the bivalves are gardening their food resource, the phytoplankton. Both components benefit, but systems may respond to this feedback by reinforcing the change or effect in the direction of the deviation. Positive feedback amplifies changes and may result in boom or bust scenarios. DeAngelis et al. (1986) have made four generalizations about positive feedback: (1) the very existence of a positive feedback loop increases the complexity of the system through the network of nutrient flows and connections; (2) the positive feedback loop accelerates change within the system, i.e., bivalves short-circuit the food web turning over nutrients more rapidly and making them available to the plankton for more production; (3) this type of feedback typically exhibits threshold effects where the mode of behavior of the system suddenly changes; and (4) systems that have major positive feedback loops may be fragile and the collapse or loss of one of the components may destroy the feedback loop, i.e., if the bivalve or the plankton components are lost from the system then the feedback loop and its features may be lost. Fragility may not always be a problem in bivalve systems as there are often redundant pathways and components, i.e., multiple bivalve and plankton species (redundant), that protect the system from collapse.

NUTRIENT CYCLES

In this section, nutrient cycling in bivalve-dominated systems will be discussed for specific elements. In the case of carbon and nitrogen, there are atmospheric (gaseous) forms that make these cycles more open. In phosphorous and silicon, the cycles are more closed because they do not have an important gaseous form.

CARBON

Both inorganic and organic carbon are processed and stored by marine bivalves. Inorganic carbon is found in substantial amounts in the sea compared to the atmosphere and the land. Much of this carbon is present as dissolved inorganic carbon and forms a complex equilibrium reaction that buffers the pH of seawater (Valiela 1984). One component of this buffer system is calcium carbonate in the form of crystals in bivalve shells and structural components of other organisms, e.g., corals. In some groups, e.g., giant clams, their symbiotic relationship to zooxanthellae leads to the

control of the carbonate buffer system within the clam and to an enhanced ability to lay down calcium carbonate crystals.

Photosynthetically active organisms can rapidly take up dissolved inorganic carbon and produce organic carbon that bivalves can utilize as food. This aerobic processing of organic carbon in marine systems with a significant bivalve component will be the focus of our discussions.

In many studies of the role of bivalves, energy flow and carbon cycling are used more or less synonymously (Baird and Milne 1981; Dame and Patten 1981). In the energy flow description of these systems, different forms of inputs and outputs, i.e., light energy, tidal energy, respiration, fecal production, etc., may not be distinguished. The oyster reef that I studied is a good example of this approach to carbon cycling (Figure 7.2). Oyster reefs have long been recognized as communities of organisms interacting with themselves and with their estuarine environments. These systems influence estuaries both physically, by removing suspended particulate material and changing current patterns, and biologically, by removing phytoplankton and producing large quantities of oyster biomass. In addition, the structure of the reef provides habitats for many sedentary and mobile organisms. The oyster reef as conceived by Dame and Patten (1981) has six major components: suspension-feeders, detritus, microbiota, meiofauna, deposit feeders, and predators. Their conceptualization is

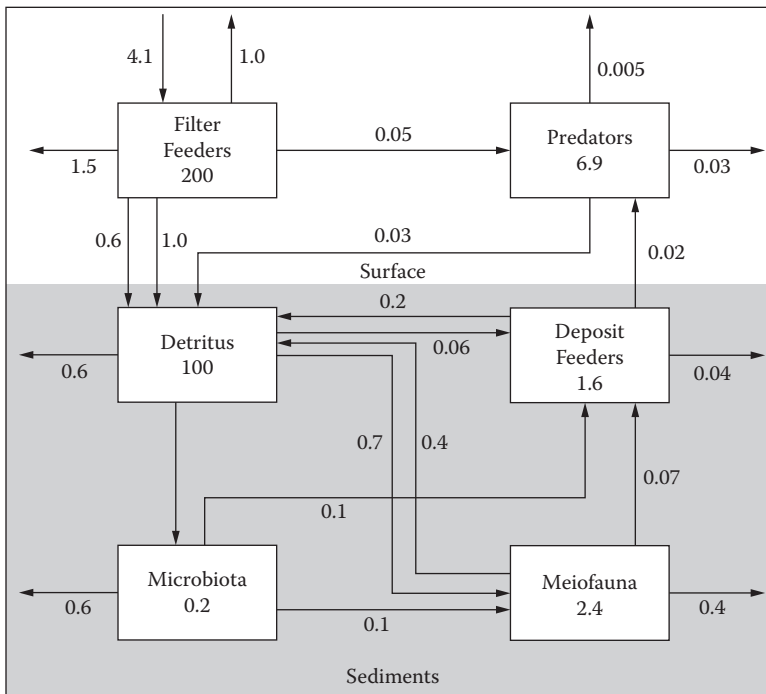

FIGURE 7.2 Carbon flow through an intertidal oyster reef in South Carolina. Flow = gC m⁻² d⁻¹; states = gC m⁻². (Adapted from Dame, R.F. and Patten, B.C. 1981. Analysis of energy flows in an intertidal oyster reef. *Mar. Ecol. Prog. Ser.*, 5, 115–24.)

for an intertidal oyster reef in South Carolina with an average annual water temperature of 20°C. For simplicity and as supported by more than 20 years of observations on the North Inlet, South Carolina system, their oyster reef is assumed to be at steady state (inputs = outputs). As in natural reefs, the epibenthic portions of the reef are dominated by the suspension-feeders, in this case *Crassostrea virginica* and *Brachidontes exustus*, and the rest of the system is sedimentary.

On the basis of my calculations, this oyster reef consumes $4.2 \text{ gC m}^{-2} \text{ d}^{-1}$ or about $1514 \text{ gC m}^{-2} \text{ year}^{-1}$ making it one of the most heterotrophic natural systems known. The suspension-feeders couple the reef to the water column, and this connection allows them to function both as grazers of phytoplankton and as suspended particulate detritus feeders. As there is little evidence that the suspension-feeders in the oyster reef utilize detritus as a food source, it is assumed that they simply deposit this material, and it can then be utilized by other organisms in the reef.

In this synthesis, the oyster reef is strongly heterotrophic with food and waste carried in or taken away by the tides. Carbon deposited by the suspension-feeders is processed by a subsystem of organisms living in the sediments. An analysis of the carbon flows within the system shows the separation of the suspension-feeders from the rest of the system because there are no carbon feedbacks to the suspension-feeders from the rest of the system. Although there are numerous feedback pathways in the sediment portions of the system, only 11% of the material entering the reef is recycled with the remaining amount fluxing through the surface components of suspension-feeders, detritus, and predators. In the analysis of the model, the suspension-feeders clearly controlled the system, but the predators, mainly mud crabs, also exerted control over the detritus, microbiota, and meiofauna components.

My conceptualization of carbon flow through an intertidal oyster reef was built from the bottom up using physiological and population data (see Chapters 4 and 5) on constituent organisms. Later studies by Dame et al. (1989) used portable plastic tunnels to determine the input and output fluxes of the various forms of carbon, nitrogen, and phosphorus to an intertidal oyster reef in North Inlet. This group deployed the tunnel over a living oyster reef every 10.2 days (33 tidal cycles) over a single year and, using regression estimation techniques, computed an annual carbon uptake of $1200 \text{ gC m}^{-2} \text{ year}^{-1}$, a value that is reasonably close to that estimated by Dame and Patten (1981) of $1514 \text{ gC m}^{-2} \text{ year}^{-1}$. In the tunnel study, the oyster reef was considered to be a black box, and the fluxes of particulate organic carbon (POC) and dissolved organic carbon (DOC) were observed. POC was taken up by the oyster reef on 95% of the observed flooding tides and released on 63% of the ebbing tides. The POC fluxes were probably the net result of both biofiltration and the physical processes of sedimentation and resuspension on the oyster reef. The DOC component was released on 63% of both flooding and ebbing tides. This constituent can be taken up by suspension-feeders as a nutritional subsidy in the form of amino acids (Manahan et al. 1982; Stephens 1982; Wright 1982) and can be excreted as urea, amino acids, and uric acid (Hammen et al. 1966). In addition, other organisms on the reef, such as bacteria and algae, can take up and release DOC (Valiela 1984), and increased water velocities may increase the release of DOC from benthic systems (Boynton et al. 1981).

In conclusion, the Dame and Patten (1981) carbon flow description of the oyster reef was confirmed by the black box–tunnel field measurements (Dame et al. 1989).

These systems are highly heterotrophic and filter large quantities of POC from the water column and release DOC back to the surrounding environment. As generalized by Kitchell et al. (1979), oyster reefs translocate and transform large quantities of carbon in estuaries and can be considered high-speed estuarine processors.

At a slightly higher level of complexity, but still historically early in carbon budget descriptions, Warwick et al. (1979) developed a carbon flow model of a mud flat in the Lynher Estuary, Cornwall, U.K. Their initial conceptualization was developed from steady-state carbon budgets for major groups including: diatoms, meiofauna, deposit feeders, suspension-feeders, and worms driven by external variables of particulate carbon, bacteria, phytoplankton, fish, and birds (Figure 7.3). From a bivalve perspective, their model is unique because it includes both suspension-feeding bivalves and deposit-feeding bivalves. The suspension-feeders were dominated

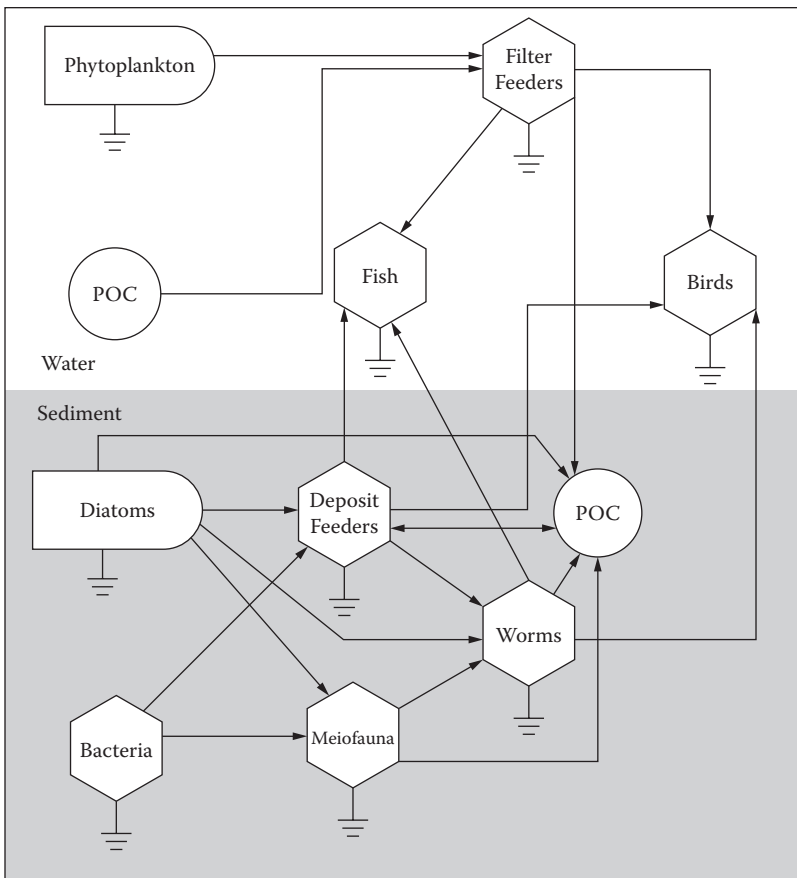

FIGURE 7.3 A conceptual model of carbon flow in Lynher mud-flat system in Scotland showing the dual role of suspension-feeding and deposit-feeding bivalves. (Adapted from Warwick, R.M., Joint, I.R., and Radford, P.J. 1979. Secondary production of the benthos in an estuarine environment. In *Ecological Processes in Coastal Environments*, Jefferies, R.L. and Davy, A.J., Eds. Oxford: Blackwell Scientific, pp. 429–50.)

by *Mya* and *Cardium* = *Cerastoderma*, while the deposit feeders were represented by *Macoma* and *Scrobicularia*. The steady-state model highlighted the lack of information about meiofauna and small annelids in particular. The steady-state version of the model was further developed into a dynamic simulation model that realistically mimicked the deposit feeders. As with the steady-state model, this version also reflected the lack of good data on the kinetics of feeding by meiofauna and macrofauna especially in relation to food concentrations and assimilation rates. As with the preceding carbon flow representations, there were no positive feedback loops and only tacit negative feedbacks were present.

A steady-state carbon flow model was constructed for the Ythan Estuary in Scotland by Baird and Milne (1981). This model also included both suspension-feeding and deposit-feeding bivalves represented by *Mytilus edulis* and *Macoma balthica*. *M. edulis* appears to consume a major portion of the phytoplankton produced in the system although a significant amount is exported to the sea. *M. balthica* is thought to utilize benthic diatoms as well as particulate organic matter from macrophytes. The production of macrofauna appears to be at least twice that of predator demand and partially explains increases in bird populations. As with the Warwick et al. (1979) study, meiofauna need further investigation in this system. Although it is not clearly shown, this model is the first attempt to include inorganic nutrients and their recycling in a system dominated by bivalves.

Killary Harbour is one of the principal areas in Ireland for the intensive suspended cultivation of mussels. Rodhouse and Roden (1987) developed a carbon flow model for this system emphasizing the roles of natural shore mussel populations, raft cultured mussels, and herbivorous zooplankton (Figure 7.4). This synthesis focused on the potential roles of the various suspension-feeding components and whether one or the other was enhanced. The study recognized that the water column within the estuary produced insufficient phytoplankton to support the size of the suspension-feeder populations and that phytoplankton must be imported from outside the inlet. In their conceptualization, Rodhouse and Roden (1987) assumed that increasing mussel raft production would decrease the zooplankton component of the estuary.

Ulanowicz and his colleagues have developed a series of carbon flow models for Chesapeake Bay that include oysters and bivalves as major components (Baird and Ulanowicz 1989; Baird et al. 1991; Ulanowicz and Tuttle 1992). Their original conceptualization of carbon flow in Chesapeake Bay (Baird and Ulanowicz 1989) was composed of 36 components that they thought were significant. These components included water column and benthic primary producers, decomposers, oysters and other suspension-feeders, deposit feeders, numerous different fishes, and predators. An aggregated form of this model was subsequently developed that had 13 components (Figure 7.5) and was used to address specific questions about the role of oysters within the Chesapeake Bay ecosystem (Ulanowicz and Tuttle 1992).

The Ulanowicz and Tuttle (1992) depiction of carbon flow through the Chesapeake Bay ecosystem is similar to that of Dame and Patten (1981) for an oyster reef in that the suspension-feeders (oysters) receive no feedback flows. This approach has also been used for systems dominated by mussels feeding mainly on phytoplankton (Baird and Milne 1981; Rodhouse et al. 1981).

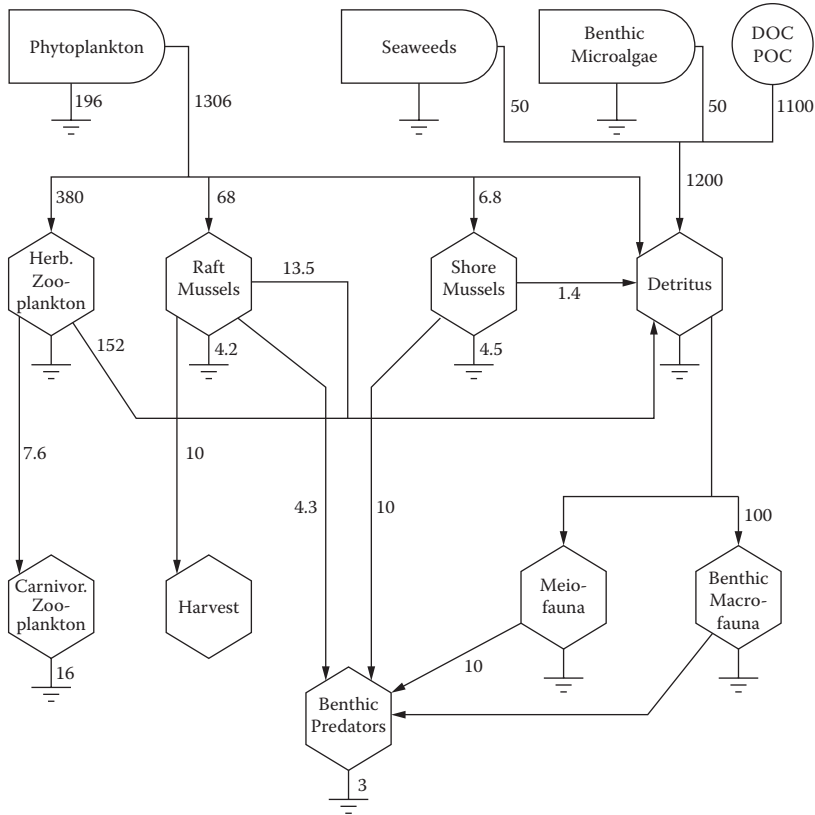

FIGURE 7.4 A carbon flux model of Killary Harbour, Ireland, showing the interrelationships of pelagic zooplankton, raft mussels, and shore mussels, the major grazers, in the system. Units in tons C per year. (Adapted from Rodhouse, P.G. and Roden, C.M. 1987. Carbon budget for a coastal inlet in relation to intensive cultivation of suspension-feeding bivalve molluscs. *Mar. Ecol. Prog. Ser.*, 36, 225–36.)

In controlled mesocosm experiments (Chapter 8) that were designed to simulate conditions in shallow unstratified coastal waters, e.g., Narragansett Bay, Doering et al. (1986) examined the effects of the clam, *Mercenaria mercenaria*, on carbon cycling. In their studies, these authors used radioactively labeled carbon, ^{14}C , to examine systems with and without clams. They found that chambers with clams had greater system production, sedimentation of particulate carbon, and benthic remineralization. The presence of *Mercenaria* did not change the standing stock of phytoplankton, but the possible positive feedback of remineralized nutrients may have offset the negative effects of grazing. These authors point out that the residence time of water in systems subjected to bivalve filtering could determine the importance of these feedbacks. They further suggested that the effects of suspension-feeders on system function vary with density and that the variations are not only quantitative, but qualitative.

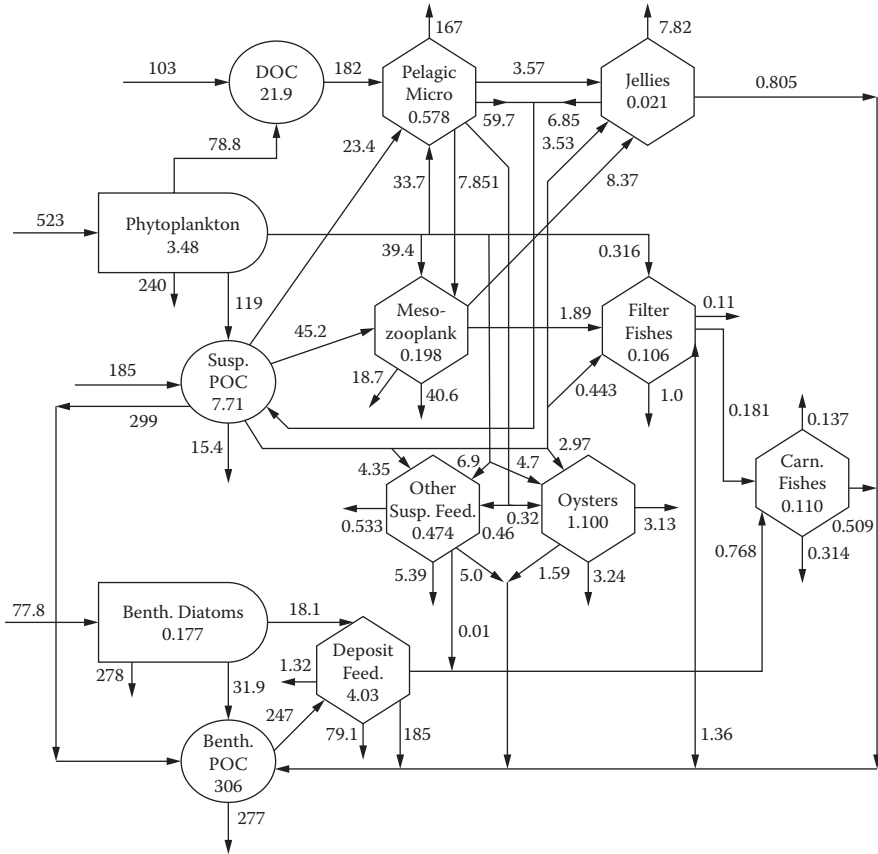

FIGURE 7.5 Carbon flow through Chesapeake Bay. Flows = $\text{gC m}^{-2} \text{ year}^{-1}$; states = gC m^{-2} . (Adapted from Ulanowicz, R.E. and Tuttle, J.H. 1992. The trophic consequences of oyster stock rehabilitation in Chesapeake Bay. *Estuaries*, 15, 298–306.)

However, Newell and Field (1983) described carbon flow for a kelp bed system with a significant component of filter feeding mussels, *Aulacomya ater*, that were potentially consuming 9% of their carbon input in the form of bacteria generated from the decomposition of kelp detritus (Figures 7.6a and 7.6b). This positive feedback of carbon via the decomposer loop and back to the bivalve suspension-feeders may be more common to mussel-dominated systems, as Wright et al. (1982) have shown that mussels can filter and consume smaller (bacteria size) particles than oysters. On the basis of the available information, carbon flow in oyster-dominated systems does not appear to have any clearly identifiable positive feedback flows.

To summarize, the role of bivalves in carbon cycling can be important when large amounts of organic carbon are being processed. In shallow low flow systems, it is probable that removing oxygen from the water and releasing carbon dioxide in return are not only going to influence environmental conditions but will also set up potential positive feedbacks between the bivalves and other primary producers. The

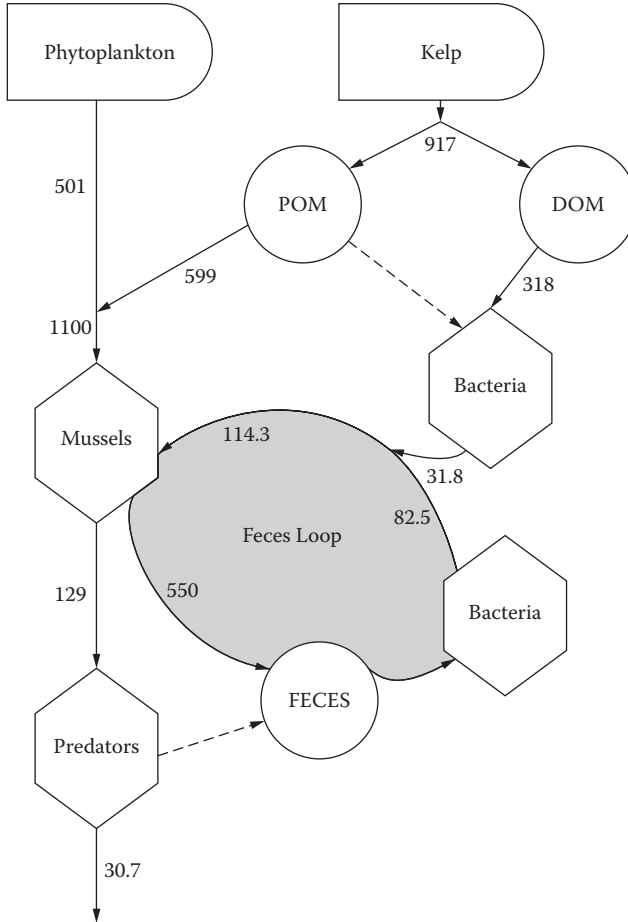

FIGURE 7.6a Carbon flow and cycling through a kelp bed community off South Africa. Flows = $\text{gC m}^{-2} \text{ year}^{-1}$. (Adapted from Newell, R.C. and Field, J.G. 1983. The contribution of bacteria and detritus to carbon and nitrogen flow in a benthic community. *Mar. Biol. Lett.*, 4, 23–36.)

clearly defined negative feedback loops in conjunction with positive feedback loops will probably lead to more stable ecosystems when bivalves are present.

NITROGEN

Nitrogen is an element that undergoes numerous transformations in addition to state changes as it cycles through the environment. After carbon, nitrogen may be the most important element to living organisms, especially those that live in marine and coastal environments where nitrogen may be a limiting factor (Sprent 1987). Compared to carbon that has only one inorganic form, nitrogen has several that play important roles in environments where bivalves may be dominant components. It

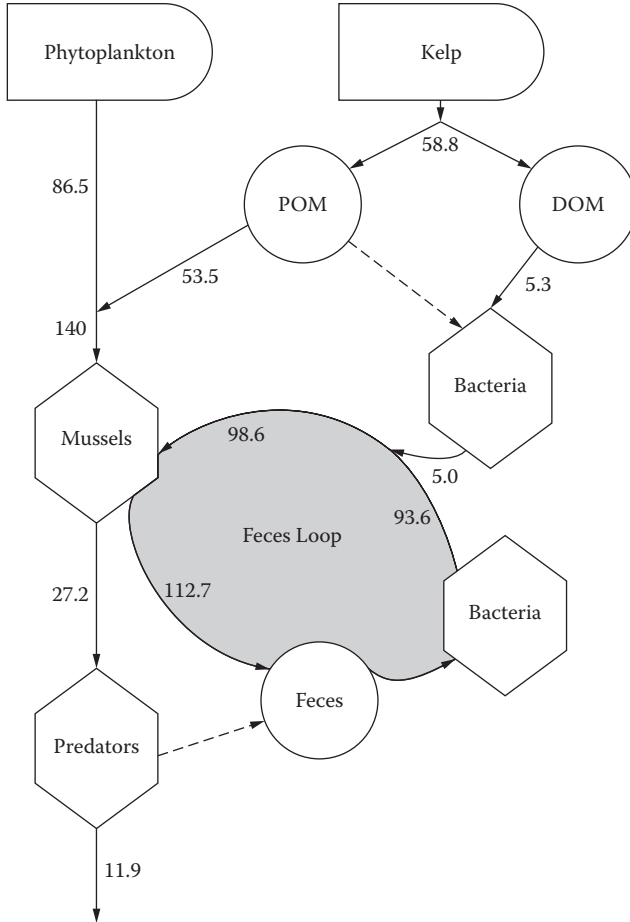

FIGURE 7.6b Nitrogen flow and cycling through a kelp bed community off South Africa. Flow = $\text{gN m}^{-2} \text{ year}^{-1}$. (Adapted from Newell, R.C. and Field, J.G. 1983. The contribution of bacteria and detritus to carbon and nitrogen flow in a benthic community. *Mar. Biol. Lett.*, 4, 23–36.)

is probably this diversity of forms and states that has retarded the development of nitrogen budgets for ecosystems in general and coastal systems in particular (Nixon and Pilson, 1983). Thus it is not surprising that observation of nitrogen processing by bivalves in general is incomplete for most systems studied.

In many systems, input of new nitrogen, i.e., nitrogen from fixation, is not sufficient to support the needs of primary production. In these cases, particulate organic nitrogen is recycled by the release of inorganic nitrogen by heterotrophic consumers, e.g., oysters. Usually this inorganic nitrogen is ammonium and often this form of nitrogen is preferentially taken up by phytoplankton. Bivalves may also release dissolved organic nitrogen in the form of amino acids and urea (Hammen et al. 1966) that can also be used by phytoplankton (McCarthy 1980). Thus in the nitrogen cycle

in coastal waters, benthic bivalves can short-circuit pelagic nutrient processing and rapidly recycle nitrogen. The nitrogen feedback loop between the bivalves and the phytoplankton is positive because both the phytoplankton and the bivalves benefit from the process.

Several studies have focused on the role of mussels from different environments in the processing of nitrogen. In the Baltic Sea adjacent to Askö, Sweden, Kautsky and Wallentinus (1980) determined the fluxes of nitrogen from a *Mytilus*–red algae community utilizing *in situ* plastic bags. Their observations showed that nutrient release by the mussels greatly exceeded demand by the benthic algae, which may explain why the algae reach maximum growth after nutrient concentrations in the surrounding water column are depleted by the spring phytoplankton bloom. These investigators further speculate that the removal of phytoplankton by the mussels also positively influences the growth of the red algae by increasing light availability to the benthos.

For the Askö system, the mussels produce by recycling several orders of magnitude greater nutrients than can be accounted for from land runoff. Because of the magnitude of particle removal by the mussels, Kautsky and Evans (1987) conducted *in situ* studies on the production of feces and pseudofeces by *Mytilus edulis* in the Askö area. They found that the concentrations of carbon and nitrogen in the *Mytilus* biodeposits were higher than that of sediments deposited through natural physical means in the same area. Thus these investigators concluded that mussels remove and initiate the sedimentation of small suspended particles of high organic content that would otherwise stay suspended in the water column. They argue that *Mytilus* occupies an important position as a connecting link between the pelagic and benthic components of the coastal ecosystem by increasing sedimentation by as much as 10% and enhancing the recycling of nutrients to the primary producers in both the pelagic and benthic habitats. In essence, the mussels strengthen the coupling between the benthos and the water column.

In a very different environment, Jordan and Valiela (1982) investigated the nitrogen budget of the ribbed mussel, *Geukensia demissa*, and its significance in nitrogen flow in a New England salt marsh. Working initially at the population level, they developed a nitrogen budget for the marsh mussel (Figure 7.7). Of the nitrogen filtered from the water column by the mussel population, slightly less than half was deposited as feces and pseudofeces. Of the nitrogen absorbed, 55% was excreted as ammonia. At the level of the entire marsh–estuarine ecosystem (Figure 7.8), the mussels filtered 1.8 times the particulate nitrogen exported from the salt marsh by tidal flushing. On the basis of these comparisons, the marsh mussels released more ammonia into the system than any other group of organisms. Thus marsh mussels increase retention of nitrogen within the marsh by filtering particulate nitrogen from the water column, depositing it as biodeposits, and storing it as long-lived mussel biomass. As nitrogen limits productivity in this marsh, increased retention and remineralization of nitrogen by marsh mussels may ultimately enhance the productivity of the salt marsh. Indeed, an experimental study by Bertness (1984) in a similar New England salt marsh showed that *Spartina alterniflora* grass with large clumps of marsh mussels had primary production higher than grass without mussels. Bertness (1984) found that the sediments surrounding the mussels had higher concentrations

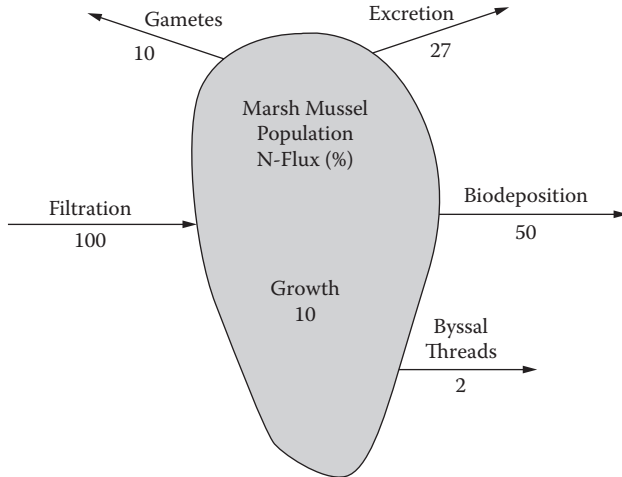

FIGURE 7.7 The relative percentage nitrogen flux in a population of the marsh mussel, *Geukensia demissa* in a New England salt marsh. (Data from Jordan, T.E. and Valiela, I. 1982. A nitrogen budget of the ribbed mussel, *Geukensia demissa*, and its significance in nitrogen flow in a New England salt marsh. *Limnol. Oceanogr.*, 27, 75–90.)

of inorganic nitrogen and attributed this fact to mussel excretion and feces production. Thus the nitrogen retained in the system may go to another form of plant other than phytoplankton and not to water column microalgae that would complete a direct positive feedback loop. However, it is possible that the positive feedback to the mussels from increased *Spartina* growth may result in a better structural habitat for the marsh mussels.

The first direct evidence that bivalve suspension-feeders could influence nitrogen fluxes at the ecosystem level came from Nixon et al. (1976). In their study of the Bissel Cove salt marsh embayment in Narragansett Bay, a bed of *Mytilus* was observed to excrete 4 to 5 mM ammonia $m^{-2} h^{-1}$ at 15°C. These authors hypothesized that blue mussels in this system import large quantities of suspended particulate nitrogen, and export large amounts of ammonia to the adjacent offshore water.

It was not until the application of portable plastic tunnels (Dame et al. 1984) and domes (Boucher and Boucher-Rondoni 1988) that *in situ* measurements of nitrogen uptakes and releases were conducted on bivalve systems. A major objective of each of these studies was to observe the material fluxes across bivalve beds in as realistic a manner as possible.

The initial tunnel work was conducted on intertidal oyster reefs, *Crassostrea virginica*, in North Inlet, South Carolina, and is described in Chapter 5. The simultaneous fluxes of various forms of nitrogen were measured every 10.2 days for a year (Table 7.2). A striking observation of this study was the considerable variation in material fluxes from one observed tidal cycle to the next. This variability was attributed to tide-to-tide differences in ebb and flood velocity patterns. In addition to the general net flux pattern of uptake of particulates and release of dissolved materials, the observed fluxes were almost always an order of magnitude greater than

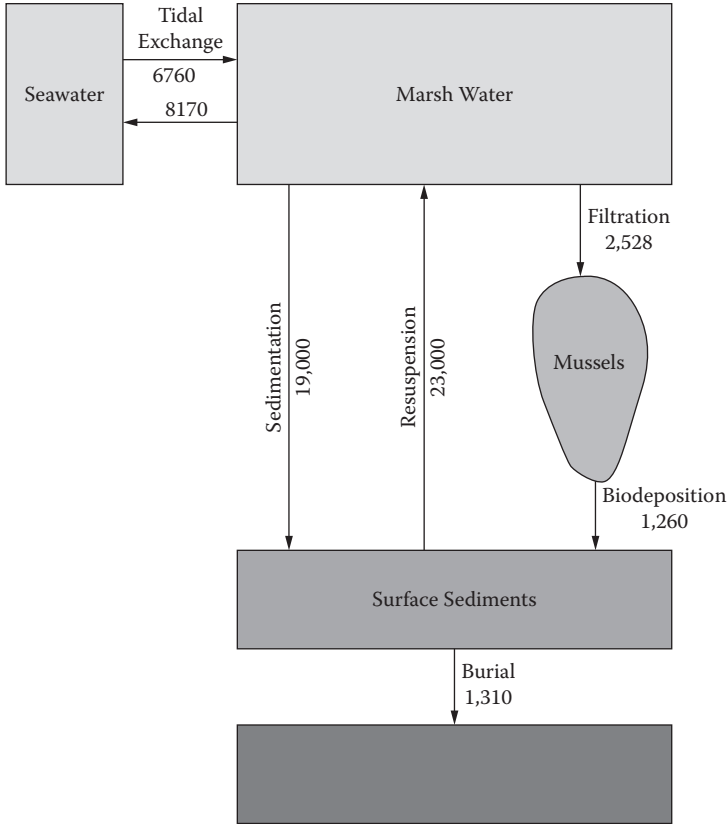

FIGURE 7.8 Nitrogen flux in Great Sippewissett salt marsh, depicting the importance of marsh mussels in the ecosystem. (Adapted from Jordan, T.E. and Valiela, I. 1982. A nitrogen budget of the ribbed mussel, *Geukensia demissa*, and its significance in nitrogen flow in a New England salt marsh. *Limnol. Oceanogr.*, 27, 75–90.)

scaled-up estimates from laboratory data. This latter finding supports the argument that more nutrient processing is also taking place both in the adjacent sediments and by other organisms in the reef community. The high flux rates observed in this study strongly suggest a major role for oysters in ecosystems where they are abundant. When scaled-up to the marsh–estuarine basin, the oyster reefs are by comparison the largest and only significant source of ammonium within this part of the North Inlet system (Dame et al. 1991b). In North Inlet, the turnover time for ammonium as calculated from oyster reef release is about half that of the water mass residence time. This relationship implies that the oyster reefs are controlling ammonium concentrations in North Inlet.

In the large tidal range estuaries of North Brittany, France, Boucher and Boucher-Rodoni (1988) and Boucher-Rodoni and Boucher (1990) investigated the role of the oyster, *Crassostrea gigas*, in nutrient fluxes. Using relatively low densities of oysters in domes, they found that the oysters contributed about 15% to 40% of the

TABLE 7.2
Yearly Nitrogen and Phosphorus Budgets for an Intertidal Oyster Reef in North Inlet, South Carolina

| Constituent | Flood Tide | Ebb Tide | Net |
|----------------------------|------------|----------|-------|
| Total dissolved nitrogen | -116* | 91 | -25 |
| Ammonium | -58* | -67* | -125* |
| Nitrite + nitrate | 0.3 | -1.3 | -1.0 |
| Dissolved organic nitrogen | -136* | 263* | 127 |
| Particulate nitrogen | 472* | -250 | 222 |
| Total nitrogen | 275* | -86 | 189 |
| Orthophosphate | 1.4 | -9.1 | -7.7 |
| Particulate phosphate | 156* | -86 | 70 |
| Total phosphorus | 136* | -38* | 98* |

Note: Units in $\text{gN m}^{-2} \text{ year}^{-1}$ or $\text{gP m}^{-2} \text{ year}^{-1}$; * = significant at 5% level; + = uptake (no sign indicated); - = release.

Source: After Dame, R.F., Spurrier, J.D., and Wolaver, T.G. 1989. Carbon, nitrogen and phosphorus processing by an oyster reef. *Mar. Ecol. Prog. Ser.*, 54, 249-56.

ammonium and urea within the chambers. They also noted that the actual material fluxes due to the oysters were always greater than potential estimates. In these dome studies, some nitrate production was observed and these researchers suggested that this indicated occasional nitrification, i.e., the transformation of ammonia to nitrate.

The nitrogen excreted by bivalves and released by organically enriched adjacent sediments can have a major influence on the microalgae in bivalve culture facilities (Robert et al. 1982; Maestrini et al. 1986). These researchers found that the microalgae seem to have adapted to the high concentrations of ammonium, nitrate, and organic nitrogen in these culture ponds. Normally high concentrations of ammonium inhibit the uptake of other nitrogen sources by algae, but the threshold of ammonium inhibition is much higher in these pond algae than in pelagic or neritic species, allowing them to assimilate other sources of nitrogen simultaneously with ammonium.

A number of studies dealing with the intensive cultivation of mussels and oysters have shed more light on the role of bivalves in the processing of nitrogen in the sediments (Robert et al. 1982; Kaspar et al. 1985; Feuillet-Girard et al. 1988). In all of these studies, the sediments in bivalve culture areas or ponds were compared to areas without bivalve culture. In early studies on the pond culture of *Crassostrea gigas* in the Marennes-Oléron area of France, culture ponds with oysters had very high concentrations of dissolved nitrogen compared to ponds without oysters. In addition, there was higher microalgae production in the ponds with oysters. Subsequent studies in Marennes-Oléron Bay found that the sediments in oyster cultivation areas accumulated six times as much nitrogen as those without adjacent oysters. The fluxes of nitrogen from the sediments were higher in cultivation zones than noncultivation zones. These authors concluded that oyster cultivation induces nitrogen fixation in the sediments

above noncultivated levels. In their concept of nitrogen cycling in the oyster culture areas of Marennes-Oléron Bay, Feuillet-Girard et al. (1988) concluded that oysters accounted for about 50% of the nitrogen reaching the sediments from the water column, but the influence of the oysters on dissolved nitrogen concentrations was minimal.

In addition to increasing nitrogen fluxes to the sediments, the enriched biosediments near bivalve culture plots also influence a number of biogeochemical processes in the sediments. Kaspar et al. (1985) compared the effects of the culture of the green-lipped mussel, *Perna canaliculus*, on the nitrogen cycle in Marlborough Sound, New Zealand. The nitrogen cycle for the mussel farm is described in Figure 7.9. As in the French studies, they found that the organic nitrogen pool in the

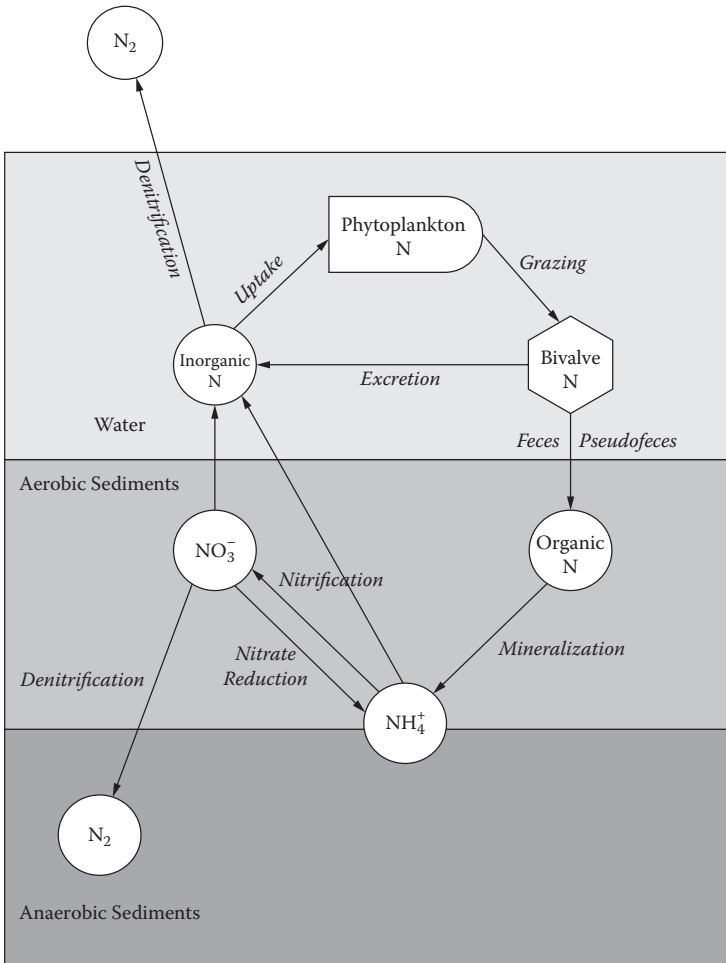

FIGURE 7.9 The nitrogen cycle in a bivalve suspension-feeder-dominated system. (From Kaspar, H.F., Gillespie, P.A., Boyer, I.C., and MacKenzie, A.L. 1985. Effects of mussel aquaculture on the nitrogen cycle and benthic communities in Kenepuru Sound, Marlborough Sounds, New Zealand. *Mar. Biol.*, 85, 127–36.)

sediments beneath the mussel farm was larger than at a reference site. The nitrate and nitrite pools were similar in the sediments at both sites, and the ammonium pool was about twice as high in the culture sediments as in the reference sediments. As in other studies, the mussels and the mussel farm are envisioned as a large filter that forms fast-sedimenting pellets from planktonic particles that accumulate as organic nitrogen in the sediments. The larger ammonium pool of the mussel farm sediments was attributed to higher ion-exchange capacity of the sediments due to the increased organic matter content. Thus the mussel-induced increased sedimentation directly stimulated the remineralization of organic nitrogen in the sediments. These authors also speculate that by producing organically enriched sediments, the mussels are indirectly stimulating denitrification in the deeper anaerobic sediments, i.e., the conversion of nitrate to nitrogen gas. Denitrification by anaerobic sediments adjacent to bivalve communities has been argued by some (Roger Newell, personal communication) as a way of removing nitrogen from extensively nutrient-loaded or -polluted estuaries. Kaspar et al. (1985) also point out that in addition to increasing nitrogen turnover in the system, mussels that are harvested are a nonreturned sink of nitrogen that may lead to system nitrogen depletion and limitation. To summarize, (1) bivalves enhance the movement of organic nitrogen to the sediments where it decomposes; (2) decomposition in the aerobic surface sediments yields ammonium and nitrate/nitrite through mineralization and nitrification, respectively; (3) in the deeper anaerobic sediments the process of denitrification may convert nitrate into nitrogen gas.

In order to directly assess the role of oyster reefs on nutrient cycling in a group of tidal creeks, Dame and Libes (1993) developed a design to experimentally manipulate these systems. In their experiment, nutrient concentrations in creeks with oysters were compared to creeks with oysters removed using a BACI (before-after-control-impact) design (Underwood 1994). The amount of oyster biomass to water volume in each creek was standardized to that of the North Inlet system (3.8 g m^{-3}) and the bank-full volume of each creek was determined by hypsometric characterization. After a before-manipulation calibration run of 1 month, oysters were removed from half of the creeks, and the daily concentrations of nutrients were monitored for 2 months. With regard to total nitrogen, ammonium, and phosphorus and total dissolved phosphorus, concentrations were found to be significantly higher in creeks with oysters when compared to creeks without oysters. These data support the previous suggestions that dense populations of bivalves can and do influence the amounts and types of nitrogen in tidal waters. In addition, this preliminary study supports the idea that bivalves may play a major role in material cycling in these systems.

PHOSPHORUS

Phosphorus is one of the essential elements in living organisms and plays a fundamental role in the metabolic processes of energy transfer both in respiration and photosynthesis. In marine environments, phosphorus is found in living organisms, in the water column as dissolved inorganic phosphorus (usually orthophosphate), as

dissolved organic phosphorus, and particulate phosphorus. In sediments, particularly anaerobic sediments, the chemistry of phosphorus can be complicated (Valiela 1984).

The first studies of phosphorus and marine bivalves used the radioactive isotope of phosphorus (^{32}P) to determine uptake and utilization (Ronkin 1950; Pomeroy and Haskin 1954). The earliest evidence that bivalve suspension-feeders could play an important role in mineral cycling at the ecosystem level came from Kuenzler's (1961) study of the phosphorus budget of the salt marsh mussel in Georgia. Kuenzler concluded that although these bivalves moved about 1% as much energy as bacteria in the salt marsh system, they are probably more important as remineralizers than consumers as a result of their high rates of filtration and deposition.

Only a few studies have focused on the role of oysters in processing phosphorus at the ecosystem level. Sornin et al. (1986) examined the role of intensively cultured *Crassostrea gigas* in the phosphorus cycle in Marennes-Oléron Bay of France. These investigators found that oysters removed about 50% of both total and assimilable phosphorus from the water column of the bay, with most being deposited in the sediments. As earlier described, Dame et al. (1989) determined the phosphorus budget for an intertidal oyster reef, *Crassostrea virginica*, in South Carolina (Table 7.2). There was a significant uptake of total phosphorus with most of that being particulate. Only 8% of the total phosphorus uptake on the South Carolina reef was released as orthophosphate as compared to 3% by the less dense community in Marennes-Oléron Bay. The expected N:P Redfield ratio is 16, and for the South Carolina reef the ratio for the uptake fluxes is about 2. Consequently, the oyster reef appears to be taking up proportionally more phosphorus than nitrogen or carbon (Dame et al. 1989). Thus in the oyster-dominated systems studied to date, these animals seem to remove considerably more phosphorus from estuarine waters than would be expected. Oyster reefs may be significant components in retaining phosphorus—a constituent that, unlike nitrogen and carbon, has no gaseous state and can only enter the estuary via land runoff or import from the coastal ocean.

Asmus et al. (1995) examined the exchange of phosphorus between a mussel bed and the tidal waters of Königshafen Bay near Sylt in the Eastern Wadden Sea (see Chapter 5 for a detailed description). Using the Sylt flume, these investigators concluded that the mussel bed increased the flux of phosphorus both in the release of dissolved inorganic phosphorus and in uptake of particulate phosphorus. They noted that differences in the phosphorus fluxes from bed to bed could be attributed to the environmental characteristics of a given community. Low phosphate release rates from coastal sediments have been attributed to the buffering capacity of the sediments (Pomeroy et al. 1965; Hinga 1990) caused by the adsorption-desorption equilibrium of phosphate interacting with ferrioxihydroxides in interstitial water (Sundby et al. 1992). When the sediments are anoxic, phosphate is released in great amounts due to a stronger reducing environment (Patrick and Khalid 1974; Balzer et al. 1983). Dense mussel bed coverage tends to lead to highly anoxic sediments because of decomposition processes in the organically enriched sediments (Asmus et al. 1995). These same investigators were able to show experimentally that beds with large macroalgae populations released less phosphate than beds with no macroalgae (Asmus et al. 1990). Therefore, young or cultured beds with relatively little macroal-

gae cycle their phosphorus back into the water column, while mature natural beds store phosphorus in macroalgal biomass.

SILICON

Silicon (Si) and silica (SiO_2) can be limiting nutrients in systems dominated by diatoms. While most animals and algae have a minimal need for silicon, silica forms the ridged cell wall or frustule of diatoms and may account for half of the cell's mass. Most silica is thought to originate from the dissolution of rocks and enters the ocean via rivers. Because it is readily taken up by diatoms and converted into skeletal material, silica sedimentates easily and accumulates in marine deposits. Silica can be recycled by animal metabolism and by release from anoxic sediments. As the demand for silicon by diatoms is high, in those systems dominated by diatoms it may become a limiting nutrient, particularly in the absence of recycling (Libes 1992).

Silicon can be taken up by bivalves in the process of feeding on and metabolizing diatoms as a food source with the subsequent excretion of silicate or silicic acid (H_4SiO_4) by the animals and the associated sediments (Asmus et al. 1990). Although poorly represented in the literature, there have been a few investigations of bivalves and bivalve beds as sources and sinks of silicon (Asmus 1986; Doering et al. 1987; Dame et al. 1991a; Prins and Smaal 1994). These studies indicate a relatively high release of silicate from bivalve beds. For example, Prins and Smaal (1994) reported on the estimated uptake of particulate organic silicon and measured the release of silicate by mussel beds in the Oosterschelde estuary (Table 7.3). Silicate release rates were lower than biogenic silicon uptakes in April and June 1987, when high phytoplankton concentrations caused a high uptake of biogenic silicon. High silicate release was observed in the night tidal cycle of June 1987, and by comparison implies that diatoms are rapidly taken up during the day and remineralized during the evening. High silicate release in the fall probably resulted from the increased rate of dissolution of silicate at higher water temperatures. In addition, concurrent direct

TABLE 7.3
A Silicon Budget for Mussel Beds in the Oosterschelde Estuary

| Month | Particulate Organic Silica Uptake ($\text{mmol m}^{-2} \text{h}^{-1}$) | Silicate Release ($\text{mmol m}^{-2} \text{h}^{-1}$) |
|-----------|--|---|
| April | $2.32 \pm 0.23^{***}$ | $1.11 \pm 0.27^{***}$ |
| June 1987 | $3.63 \pm 0.68^{***}$ | $3.20 \pm 1.21^{**}$ |
| June 1988 | $0.56 \pm 0.12^{***}$ | $0.80 \pm 0.50_{\text{ns}}$ |
| September | $0.15 \pm 0.02^{***}$ | $3.27 \pm 1.45^*$ |

Note: A t-test was used to estimate if the fluxes were significantly different from 0.

Source: After Prins, T.C. and Smaal, A.C. 1994. The role of the blue mussel *Mytilus edulis* in the cycling of nutrients in the Oosterschelde estuary (The Netherlands). In *The Oosterschelde Estuary (The Netherlands): A Case Study of a Changing Ecosystem*, Nienhuis, P.H. and Smaal, A.C., eds. Dordrecht: Kluwer, pp. 413–29.

measurements of individual bivalve excretion of silicate were below detection limits and suggest that the majority of the silicate release came from the sediments. Thus it appears that almost all of the biogenic silicon filtered from the water will be deposited and then mineralized in the sediments that will be returned to the water column (Prins and Smaal 1994).

SYSTEM NUTRIENT TURNOVER

The concept of turnover is defined as the ratio of throughput to content (Odum 1983). Turnover is often expressed as a rate fraction or as a unit of time that is the reciprocal of the rate fraction. The turnover rate is the fraction of the total amount of a substance in a system that is released or that enters in a given length of time. Turnover time is the reciprocal of the turnover rate and represents the time required to replace or remove a quantity of material equal to the amount of that material in the system. The residence time is similar to the turnover time and refers to the time a given material remains within the system. With regard to bivalve-dominated systems, a comparison of nutrient turnover times to water mass turnover times can, as we saw in Chapter 6 with grazing, give an indication of the potential for bivalves to regulate the cycling of a particular nutrient.

To date, the concept of nutrient turnover as influenced by bivalves has been applied to ammonium in three ecosystems: North Inlet in South Carolina (Dame et al. 1989), and the Western Wadden Sea and Oosterschelde in The Netherlands (Dame et al. 1991b). In Table 7.4, the turnover times of ammonium and water residence times are compared for the three systems. Ammonium turnover times were determined from total bivalve uptake and release rates in relation to the average total amount of ammonium within the system. Nutrient turnover times are a function of the biomass of bivalves per unit water volume, the material concentrations in the water column, and other environmental factors including temperature and water velocity. Shorter turnover times relative to water mass turnover time imply a greater influence by the bivalves. The systems

TABLE 7.4
Turnover Time of Ammonium Derived from Bivalve Release Rates in
Three Different Estuarine Ecosystems and Compared to Water
Residence Time in the Same Systems

| System | Bivalve Biomass (g m ⁻³) | Ammonium Release Rate (gN g ⁻¹ h ⁻¹ × 10 ⁻⁵) | Ammonium Turnover Time (Days) | Water Residence Time (Days) |
|---------------|--|--|-------------------------------------|-----------------------------------|
| North Inlet | 3.8 | -3.8 | 0.5 | 1 |
| Wadden Sea | 3.7 | -7.4 | 18.0 | 10 |
| Oosterschelde | 3.7 | -9.5 | 21.0 | 40 |

Source: From Dame, R.F., et al. 1991b. Annual material processing by a salt marsh-estuarine basin in South Carolina, USA. *Mar. Ecol. Prog. Ser.*, 72, 153-66.

represented span the range from a short water mass residence time estuary, North Inlet, to moderate residence time systems in The Netherlands. Ammonium turnover times are about half the water mass residence times in North Inlet and the Oosterschelde, but about double the residence time in the Western Wadden Sea. Thus it is probable that bivalves are more likely to influence nutrient cycling in the prior systems rather than the latter (Smaal and Prins 1993). These conclusions have been further supported by the field experiments of Dame and Libes (1993) and the modeling efforts of Herman and Scholten (1990).

COUPLING METABOLISM AND NUTRIENTS

Bivalves couple the benthic habitat to the water column and in the process of catabolizing organic compounds not only take up oxygen, but release inorganic nutrients including ammonium and dissolved inorganic phosphate. From the perspective of the animal, the ratio of atoms of oxygen consumed to nitrogen released can be used as an index of a bivalve's rate of catabolism and the composition of its food (Bayne 1976). In the case of nitrogen, the major release product of bivalves is ammonium (see Chapter 3). If the amino acids produced by catabolism are deaminated and the ammonia is excreted while the carbon components of the amino acids are completely oxidized, the theoretical minimum for the ratio of O:N is 7, signifying protein catabolism. Higher values for the O:N ratio indicate increased catabolism of carbohydrate or lipid (Bayne 1976; Mayzaud and Conover 1988). As bivalve systems are mostly composed of animals, it is possible that the O:N ratio may have some meaning at this higher level of ecological organization (Dame et al. 1992). Boucher and Boucher-Rodoni (1988) reported an O:N ratio for *Crassostrea gigas* of 21:1 and the surrounding sediments of 34:1. Dame et al. (1992) found that on intertidal *Crassostrea virginica* reefs during the winter the ratio was about 30:1. Both studies suggest that carbohydrate and lipid are the main organic compounds being metabolized. As these oyster reef systems contain animals, plants, microbes, and nonbiological chemical processes, these ratios provide only a relative indication of food utilization (Dame et al. 1992).

CONCLUSIONS

In coastal ecosystems with dense populations of bivalves, these animals remove large quantities of suspended particulate organic materials and remineralize them into forms that are readily utilized by phytoplankton (Figure 7.10). The remineralization process is amplified in reef systems in that feces and pseudofeces enrich the sediments surrounding the bivalves, and the microorganisms in these sediments effectively double the remineralization rates to the reef. These processes effectively short-circuit the typical pelagic food web and move carbon, nitrogen, and phosphorus through these ecosystems at much faster rates. As a consequence of these material flows, both negative and positive feedback loops are established (Table 7.5) that potentially increase the productivity and stability of estuarine ecosystems. In essence, dense beds or reefs of bivalves increase the functional and structural sustainability of their ecosystems.

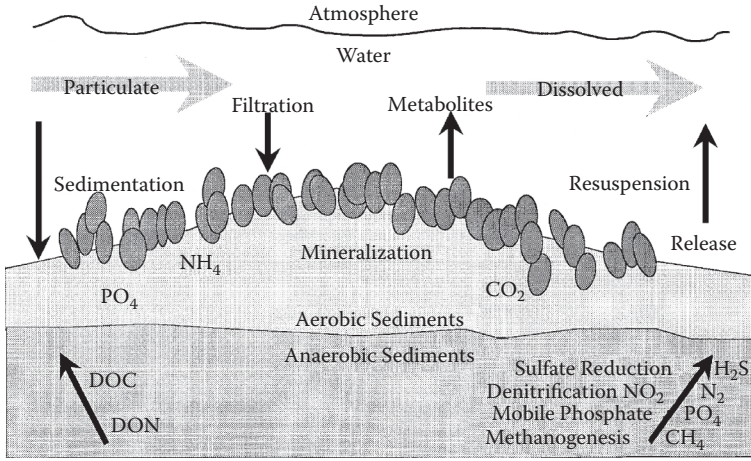

FIGURE 7.10 A graphical summary of nutrient processes in and around dense systems of bivalves. (Adapted from Dame, R.F. 1993. The role of bivalve suspension-feeder material fluxes in estuarine ecosystems. In *Bivalve Suspension-Feeders in Estuarine and Coastal Ecosystem Processes*, Dame, R.F., Ed. Heidelberg: Springer-Verlag, pp. 245–69.)

TABLE 7.5
A Summary of System Nutrient Cycling Control by Oyster Reefs

| Nutrient | Feedback Loop | |
|------------|---------------|--------|
| | (+) | (-) |
| Carbon | No | Direct |
| Nitrogen | Direct | Direct |
| Phosphorus | (no) | Direct |

Source: Adapted from Dame, R.F. 1993. The role of bivalve suspension-feeder material fluxes in estuarine ecosystems. In *Bivalve Suspension-Feeders in Estuarine and Coastal Ecosystem Processes*, Dame, R.F., Ed. Heidelberg: Springer-Verlag, pp. 245–69.

THE CASE OF THE MISSING NITROGEN

Over the past century, our understanding of the importance of estuaries and other shallow coastal bodies of water has been in a continual state of change. Initially, these extremely productive systems were viewed as unlimited resources for the exclusive use of *Homo sapiens*. By mid-century, ecologists in Europe and North America were sounding the dire warnings of rising pollution and declining fisheries. The basic message was clear: Humans and their actions are tightly coupled to the environment. The theories of science and technology were also rapidly advancing into the areas of complex systems and nonequilibrium thermodynamics. Our planet’s pre-eminent

systems' engineers were about to appear in a learn-as-you-go situation. Chesapeake Bay is a good example of the preceding and is the setting for a short narrative.

During the past half century, large investments were made in the study of Chesapeake Bay from a systems perspective. The decline of the oyster resources in the bay and how they were connected to other natural resources, including nutrients, were of particular interest. As is the case in many estuaries, Chesapeake Bay receives nutrient inputs from sewage treatment plants, septic tanks, agricultural runoff, and the atmosphere. These extra inputs of mainly N and P can cause changes in the magnitude and location of phytoplankton biomass and primary production within the bay. They also may enhance harmful algae blooms. The extra biomass generated by the fertilization of plants can cause eutrophication. Central to all these activities is a viable population of bivalve suspension-feeders that remove the particulate N and P from the water column and transfer it to the bottom (see Newell et al. 2005, for details). In a laboratory study, Newell's group incubated sediment from cores taken from beneath oyster farms and compared them to sediments taken from oyster-free areas. The sediments were analyzed for the standard forms of N and P. Because there was some evidence that the addition of a rich carbon source might increase denitrification flux out of the sediment, Newell et al. (2005) also compared sediment cores with and without carbon enrichment for denitrification. The results of Newell's laboratory experiments supported the contention that oysters enhanced denitrification.

However, there are lingering questions. Has the role of denitrification in aquatic systems been overemphasized (Burgin and Hamilton 2007)? Moreover are our analytical methods for measuring denitrification (Groffman et al. 2006) up to the tasks?

Between 2008–2010, a research group teaming scientists from Virginia Tech and Virginia Commonwealth University was contracted for a project to quantify the three paths of N_2 (biomass, burial, and denitrification) out of actively working oyster farms on Chesapeake Bay (Higgins et al. in press). I was the external faculty member on Ms. Higgins' graduate committee.

The 2-year-long study was conducted at three different oyster culture farms: Spencer's Creek, Ophelia, Virginia; St. Jerome Creek, Ridge, Maryland; and St. Thomas Creek, Hollywood, Maryland.

The goals of this study were as follows: (1) to determine if oyster biodeposition enhances net losses of N (as N_2 gas) from the estuarine ecosystem by increasing the rates of denitrification and anammox in the sediments of commercial-scale oyster culture farms in Chesapeake Bay; (2) to determine the amount and significance of N and P burial in the sediments below the oyster farms; and (3) to estimate the total N and P that can leave the oyster farms as oyster biomass.

Biomass was defined as total N in soft body and shell. Burial referred to the gradual accumulation of once suspended particles (assumed to be feces and pseudofeces). Denitrification was measured by two methods: the membrane inlet mass spectrometry (MIMS) process and the $\delta^{15}N$ stable isotope enrichment procedure. The two approaches generated equivalent denitrification rates.

The lessons learned were as follows:

1. A simple yet accurate method is now available for estimating the amount of nutrients removed via harvesting aquacultured oysters.
2. The project illustrated that aquacultured oysters have a much lower total nutrient content than was previously postulated.
3. The project illustrated that although laboratory studies can artificially increase rates of denitrification, under the current physicochemical conditions of waters and sediments in Chesapeake Bay, the bay ecosystem has an inherent denitrification threshold that is not enhanced by oyster biodeposition.
4. The strain of Eastern oyster used does not have a significant effect on the amounts of nutrients that are incorporated per gram of tissue or shell.
5. Much of the nutrient content of biodeposits is returned to the water. However, depending on site-specific characteristics, such as sediment accumulation rate, turnover time, and nutrient burial, the potential to exceed the amounts harvested through biosequestration is possible.

REFERENCES

- Alpine, S.E. and Cloern, J.E. 1992. Trophic interactions and direct physical effects control phytoplankton biomass and production in an estuary. *Limnol. Oceanogr.*, 37, 946–55.
- Asmus, H., Asmus, R.M., and Reise, K. 1990. Exchange processes in an intertidal mussel bed: A Sylt-flume study in the Wadden Sea. *Ber. Biol. Anst. Helgol.*, 6, 1–79.
- Asmus, H., Asmus, R.M., and Zubillaga, G.F. 1995. Do mussel beds intensify the phosphorus exchange between sediment and tidal waters? *Ophelia*, 41, 37–55.
- Asmus, R. 1986. Nutrient flux in short-term enclosures of intertidal sand communities. *Ophelia*, 26, 1–18.
- Bahr, L.M. 1976. Energetic aspects of the intertidal oyster reef community at Sapelo Island, Georgia (USA). *Ecology*, 57, 121–31.
- Baird, D., McGlade, J.M., and Ulanowicz, R.E. 1991. The comparative ecology of six marine ecosystems. *Phil. Trans. R. Soc. Lond. Ser. B*, 333, 15–29.
- Baird, D. and Milne, H. 1981. Energy flow in the Ythan estuary, Aberdeenshire, Scotland. *Estuarine Coastal Shelf Sci.*, 13, 455–72.
- Baird, D. and Ulanowicz, R.E. 1989. A seasonal dynamics of the Chesapeake Bay ecosystem. *Ecol. Monogr.*, 59, 329–64.
- Balzer, W., Grasshoff, K., Dieckmann, P., Haardt, H., and Petersohn, U. 1983. Redox-turnover at the sediment/water interface studied in a large bell jar system. *Oceanolog. Acta*, 6, 337–44.
- Bayne, B.L. 1976. *Marine Mussels: Their Ecology and Physiology*. Cambridge, UK: Cambridge University Press, 506 pp.
- Bertness, M.D. 1984. Ribbed mussels and *Spartina alterniflora* production in a New England salt marsh. *Ecology*, 65, 1794–1807.
- Boucher, G. and Boucher-Rodoni, R. 1988. *In situ* measurement of respiratory metabolism and nitrogen fluxes at the interface of oyster beds. *Mar. Ecol. Prog. Ser.*, 44, 229–38.
- Boucher-Rodoni, R. and Boucher, G. 1990. *In situ* study of the effect of oyster biomass on benthic metabolic exchange rates. *Hydrobiologia*, 206, 115–23.

- Boynton, W.R., Kemp, W.M., Osborne, C.G., Kaumeyer, K.R., and Jenkins, M.C. 1981. Influence of water circulation rate on *in situ* measurements of benthic community respiration. *Mar. Biol.*, 65, 185–90.
- Burgin, A.J. and Hamilton, S.K. 2007. Have we overemphasized the role of denitrification in aquatic ecosystems? A review of nitrate removal pathways. *Front. Ecol. Environ.*, 5, 89–96.
- Cloern, J.E. 1982. Does the benthos control phytoplankton biomass in South San Francisco Bay? *Mar. Ecol. Prog. Ser.*, 9, 191–202.
- Cloern, J.E. 2001. Our evolving conceptual model of the coastal eutrophication problem. *Mar. Ecol. Prog. Ser.*, 210, 223–53.
- Collier, A. 1959. Some observations on the respiration of the American oyster *Crassostrea virginica* (Gmelin). *Publ. Inst. Mar. Sci. Univ. Texas*, 6, 92–108.
- Copeland, B.J. and Duffer, W.R. 1964. Use of a clear plastic dome to measure gaseous diffusion rates in natural waters. *Limnol. Oceanogr.*, 9, 494–9.
- Dame, R.F. 1993. The role of bivalve suspension-feeder material fluxes in estuarine ecosystems. In *Bivalve Suspension-Feeders in Estuarine and Coastal Ecosystem Processes*, Dame, R.F., Ed. Heidelberg: Springer-Verlag, pp. 245–69.
- Dame, R.F., Dankers, N., Prins, T., Jongsma, H., and Smaal, A. 1991a. The influence of mussel beds on nutrients in the Western Wadden Sea and Eastern Scheldt estuaries. *Estuaries*, 14, 130–8.
- Dame, R.F. and Libes, S.L. 1993. Oyster reefs and nutrient retention in tidal creeks. *J. Exp. Mar. Biol. Ecol.*, 171, 251–58.
- Dame, R.F. and Patten, B.C. 1981. Analysis of energy flows in an intertidal oyster reef. *Mar. Ecol. Prog. Ser.*, 5, 115–24.
- Dame, R.F., Spurrier, J.D., Williams, T.M., Kjerfve, B., Zingmark, R.G., Wolaver, T.G., Chrzanowski, T.H., McKellar, H.N., and Vernberg, F.J. 1991b. Annual material processing by a salt marsh-estuarine basin in South Carolina, USA. *Mar. Ecol. Prog. Ser.*, 72, 153–66.
- Dame, R.F., Spurrier, J.D., and Wolaver, T.G. 1989. Carbon, nitrogen and phosphorus processing by an oyster reef. *Mar. Ecol. Prog. Ser.*, 54, 249–56.
- Dame, R.F., Spurrier, J.D., and Zingmark, R.G. 1992. *In situ* metabolism of an oyster reef. *J. Exp. Mar. Biol. Ecol.*, 164, 147–59.
- Dame, R.F., Zingmark, R.G., and Haskin, E. 1984. Oyster reefs as processors of estuarine materials. *J. Exp. Mar. Biol. Ecol.*, 83, 239–47.
- Dankers, N., Dame, R.F., and Kersting, K. 1989. The oxygen consumption of mussel beds in the Dutch Wadden Sea. *Scient. Mar.*, 53, 473–76.
- DeAngelis, D.L. 1992. *Dynamics of Nutrient Cycling and Food Webs*. London: Chapman and Hall, 270 pp.
- DeAngelis, D.L., Post, W.M., and Travis, C.C. 1986. *Positive Feedback in Natural Systems*. Berlin: Springer-Verlag, 290 pp.
- Doering, P.H., Kelly, J.R., Oviatt, C.A., and Sowers, T. 1987. Effect of the hard clam *Mercenaria mercenaria* on benthic fluxes of inorganic nutrients and gases. *Mar. Biol.*, 94, 377–83.
- Doering, P.H., Oviatt, C.A., and Kelly, J.R. 1986. The effects of the filter-feeding clam *Mercenaria mercenaria* on carbon cycling in experimental marine mesocosms. *J. Mar. Res.*, 44, 839–61.
- Edwards, R.W. and Owens, M. 1964. The oxygen balance of streams. In *Ecology and Industrial Society*, Goodman, G.J., Edwards, R.W., and Lambert, J.M., Eds. New York: Wiley, pp. 149–72.
- Feuillet-Girard, M., Heral, M., Sornin, J.-M., Deslous-Paoli, J.-M., Robert, J.-M., Mornet, F., and Razet, D. 1988. Nitrogenous compounds in the water column and at the sediment–water interface in the estuarine bay Marennes-Oléron: Influence of oyster farming. *Aquat. Living Resour.*, 1, 251–65.

- Groffman, P.M., Altabet, M.A., Bohlke, J.K., Butterbach-Bahl, K., David, M.B., Firestone, M.K., Giblin, A.E., Kana, T.M., Nielsen, L.P., and Voytek, M.A. 2006. Methods for measuring denitrification: Diverse approaches to a difficult problem. *Ecol. Appl.*, 6, 2091–2122.
- Hammen, C.S., Miller, H.F., and Geer, W.H. 1966. Nitrogen excretion of *Crassostrea virginica*. *Comp. Biochem. Physiol.*, 17, 1199–1200.
- Hargrave, B.T. and Phillips, G.A. 1981. Annual *in situ* carbon dioxide and oxygen flux across a subtidal marine sediment. *Estuarine Coastal Shelf Sci.*, 12, 725–37.
- Herman, P.M.J. and Scholten, H. 1990. Can suspension-feeders stabilise estuarine ecosystems? In *Trophic Relationships in the Marine Environment*, Barnes, M. and Gibson, R.N., Eds. Aberdeen: Aberdeen University Press, pp. 104–16.
- Higgins, C.B., Tobias, C., Piehler, M.F., Smyth, A., and Brown, B.L. 2010. Impact of native oyster aquaculture biodeposition on denitrification and anammox rates in estuarine sediments in Chesapeake Bay, USA, in press.
- Hinga, K.R. 1990. Alteration of phosphorus dynamics during experimental eutrophication of enclosed marine ecosystems. *Mar. Poll. Bull.*, 21, 275–80.
- Hopkinson, C.S. 1985. Shallow-water benthic and pelagic metabolism: Evidence of heterotrophy in the nearshore Georgia Bight. *Mar. Biol.*, 87, 19–32.
- Hopkinson, C.S. and Smith, E.M. 2004. Estuarine respiration: An overview of benthic, pelagic and whole system respiration. In *Respiration in Aquatic Ecosystems*, Del Giorgio, P.A. and Williams, B., Eds. Oxford: Oxford University Press, pp. 132–46.
- Jordan, T.E. and Valiela, I. 1982. A nitrogen budget of the ribbed mussel, *Geukensia demissa*, and its significance in nitrogen flow in a New England salt marsh. *Limnol. Oceanogr.*, 27, 75–90.
- Kaspar, H.F., Gillespie, P.A., Boyer, I.C., and MacKenzie, A.L. 1985. Effects of mussel aquaculture on the nitrogen cycle and benthic communities in Kenepuru Sound, Marlborough Sounds, New Zealand. *Mar. Biol.*, 85, 127–36.
- Kautsky, N. and Evans, S. 1987. Role of biodeposition by *Mytilus edulis* in the circulation of matter and nutrients in a Baltic coastal ecosystem. *Mar. Ecol. Prog. Ser.*, 38, 201–12.
- Kautsky, N. and Wallentinus, I. 1980. Nutrient release from a Baltic *Mytilus*-red algae community and its role in benthic and pelagic productivity. *Ophelia*, (Suppl.) 1, 17–30.
- Kemp, W.M., and Boynton, W.R. 1980. Influence of biological and physical processes on dissolved oxygen dynamics in an estuarine system: Implications for measurement of community metabolism. *Estuarine Coastal Mar. Sci.*, 11, 407–31.
- Kemp, W.M., Smith, E.M., DiPasquale, M.M., and Boynton, W.R. 1997. Organic carbon balance and net ecosystem metabolism in Chesapeake Bay. *Mar. Ecol., Prog. Ser.*, 150, 229–48.
- Kenney, B.E., Litaker, W., Duke, C.S., and Ramus, J. 1988. Community oxygen metabolism in a shallow tidal estuary. *Estuarine Coastal Shelf Sci.*, 27, 33–43.
- Kitchell, J.F., O'Neill, R.V., Webb, D., Gallepp, G.W., Bartell, S.M., Koonce, J.F., and Ausmus, B.S. 1979. Consumer regulation of nutrient cycling. *Bioscience*, 29, 28–34.
- Kuenzler, E.J. 1961. Phosphorus budget of a mussel population in a Georgia salt marsh. *Limnol. Oceanogr.*, 6, 400–15.
- Libes, S.M. 1992. *An Introduction to Marine Biogeochemistry*. New York: Wiley, 734 pp.
- Liebig, J. 1840. *Chemistry in Its Application to Agriculture and Physiology*. London: Taylor and Walton, 401 pp.
- Maestrini, S.Y., Robert, J.-M., Lefley, J.W., and Collos, Y. 1986. Ammonium thresholds for simultaneous uptake of ammonium and nitrate by oyster-pond algae. *J. Exp. Mar. Biol. Ecol.*, 102, 75–98.
- Manahan, D.T., Wright, S.H., Stephens, G.C., and Rice, M.A. 1982. Transport of dissolved amino acids by the mussel *Mytilus edulis*: Demonstration of net uptake from natural seawater. *Science*, 215, 1253–55.

- Marzolf, E.R., Mulholland, P.J., and Steinman, A.D. 1994. Improvements to the diurnal upstream-downstream dissolved oxygen change technique for determining whole-stream metabolism in small streams. *Can. J. Fish. Aquat. Sci.*, 51, 1591-99.
- Mayzaud, P. and Conover, R. 1988. O:N atomic ratio as a tool to describe zooplankton metabolism. *Mar. Ecol. Prog. Ser.*, 45, 289-302.
- McCarthy, J.J. 1980. Nitrogen. In *The Physiological Ecology of Phytoplankton*, Morris, I., Ed. Berkeley: University of California Press, pp. 191-234.
- Murphy, R.C. and Kremer, J.N. 1985. Bivalve contribution to benthic metabolism in a California lagoon. *Estuaries*, 8, 330-41.
- Newell, R.C. and Field, J.G. 1983. The contribution of bacteria and detritus to carbon and nitrogen flow in a benthic community. *Mar. Biol. Lett.*, 4, 23-36.
- Newell, R.I.E., Fisher, T.R., Holyoke, R.R., and Cornwell, J.C. 2005. Influence of Eastern oysters on nitrogen and phosphorus regeneration in Chesapeake Bay, USA. In *The Comparative Roles of Suspension-Feeders in Ecosystems*, Dame, R.F. and Olenin, S., Eds. The Netherlands: Springer, pp. 93-120.
- Nixon, S.W., Oviatt, C.A., Garber, J., and Lee, V. 1976. Diel metabolism and nutrient dynamics in a salt marsh embayment. *Ecology*, 57, 740-50.
- Nixon, S.W., Oviatt, C.A., Rogers, C., and Taylor, K. 1971. Mass and metabolism of a mussel bed. *Oecologia*, 8, 21-30.
- Nixon, S.W. and Pilson, M.E.Q. 1983. Nitrogen in estuarine and coastal marine ecosystems. In *Nitrogen in the Marine Environment*, Carpenter, E.J. and Capone, D.G., Eds. New York: Academic Press, pp. 565-648.
- Odum, E.P. 1983. *Basic Ecology*. Philadelphia: Saunders, 613 pp.
- Odum, H.T. 1956. Primary production in flowing waters. *Limnol. Oceanogr.*, 1, 102-17.
- Odum, H.T. and Hoskin, C.M. 1958. Comparative studies of the metabolism of marine waters. *Publ. Inst. Mar. Sci. Texas*, 5, 16-48.
- Patrick, W.H. and Khalid, R.A. 1974. Phosphate release and sorption by soils and sediments: Effect of aerobic and anaerobic conditions. *Science*, 186, 53-56.
- Pomeroy, L.R. 1970. The strategy of mineral cycling. *Annu. Rev. Ecol. Syst.*, 1, 171-90.
- Pomeroy, L.R. and Haskin, H.H. 1954. The uptake and utilization of phosphate ions from sea water by the American oyster, *Crassostrea virginica* (Gmel.). *Biol. Bull.*, 107, 123-29.
- Pomeroy, L.R., Smith, E.E., and Grant, C.M. 1965. The exchange of phosphate between estuarine water and sediments. *Limnol. Oceanogr.*, 10, 167-72.
- Prins, T.C. and Smaal, A.C. 1994. The role of the blue mussel *Mytilus edulis* in the cycling of nutrients in the Oosterschelde estuary (The Netherlands). In *The Oosterschelde Estuary (The Netherlands): A Case Study of a Changing Ecosystem*, Nienhuis, P.H. and Smaal, A.C., Eds. Dordrecht: Kluwer, pp. 413-29.
- Robert, J.M., Maestrini, S.Y., Heral, M., and Zanette, Y. 1982. Production des micro-algues des claires ostreicoles en relation avec l'azote ornique dissous excrete par les huitres. *Oceanol. Acta*, 1989, 389-95.
- Rodhouse, P.G., Ottway, B., and Burnell, G.M. 1981. Bivalve production and food chain efficiency in an experimental nursery system. *J. Mar. Biol. Assoc. U.K.*, 61, 243-56.
- Rodhouse, P.G. and Roden, C.M. 1987. Carbon budget for a coastal inlet in relation to intensive cultivation of suspension-feeding bivalve molluscs. *Mar. Ecol. Prog. Ser.*, 36, 225-36.
- Ronkin, R.R. 1950. The uptake of radioactive phosphate by the excised gill of the mussel, *Mytilus edulis*. *J. Cell. Comp. Physiol.*, 35, 241-60.
- Smaal, A.C. and Prins, T.C. 1993. The uptake of organic matter and the release of inorganic nutrients by bivalve suspension feeder beds. In *Bivalve Suspension-Feeders in Estuarine and Coastal Ecosystem Processes*, Dame, R.F., Ed. Heidelberg: Springer-Verlag, pp. 273-98.

- Sornin, J.-M., Feuillet, M., Héral, M., and Fardeau, J.-C. 1986. Influence des cultures d'huîtres *Crassostrea gigas* sur le cycle du phosphore en zone intertidale: Role de la biodeposition. *Oceanol. Acta*, 9, 313–22.
- Sprent, J.I. 1987. *The Ecology of the Nitrogen Cycle*. NY: Cambridge University Press, 151 pp.
- Stephens, G.C. 1982. Recent progress in the study of Die Ernährung der Wassertiere und der Stoffhaushalt der Gewässer. *Am. Zool.*, 22, 611–19.
- Sundby, B., Gobeil, C., Silberberg, N., and Mucci, A. 1992. The phosphorus cycle in coastal marine sediments. *Limnol. Oceanogr.*, 37, 1129–45.
- Ulanowicz, R.E. and Tuttle, J.H. 1992. The trophic consequences of oyster stock rehabilitation in Chesapeake Bay. *Estuaries*, 15, 298–306.
- Underwood, A.J. 1994. On beyond BACI: Sampling designs that might reliably detect environmental disturbances. *Ecol. Appl.*, 4, 3–15.
- Valiela, I. 1984. *Marine Ecological Processes*. New York: Springer-Verlag, 546 pp.
- Warwick, R.M., Joint, I.R., and Radford, P.J. 1979. Secondary production of the benthos in an estuarine environment. In *Ecological Processes in Coastal Environments*, Jefferies, R.L. and Davy, A.J., Eds. Oxford: Blackwell Scientific, pp. 429–50.
- Wright, R.T., Coffin, R.B., Ersing, C.P., and Pearson, D. 1982. Field and laboratory measurements of bivalve filtration of natural marine bacterioplankton. *Limnol. Oceanogr.*, 27, 91–8.
- Wright, S.H. 1982. A nutritional role for amino acid transport in filter feeding marine invertebrates. *Am. Zool.*, 22, 621–34.

8 Ecosystem Experiments

INTRODUCTION

Ecosystems in which bivalves play important roles are complex. For example, bacterial and decomposer components living in the sediments adjacent to bivalves may require anaerobic conditions. Phytoplankton in the water column grazed for food may drift long distances in the currents while functioning on much shorter time scales than the bivalves. Finally, the bivalves themselves may play significant roles as major benthic–pelagic coupling mechanisms. To address ecosystem scale questions, ecologists have traditionally utilized a number of experimental approaches (Table 8.1) that incorporate increasing system complexity. These approaches are system level computer simulation models, living models or microcosm and mesocosms, as well as full-scale ecosystem field manipulations (Table 8.1). Thus there is a scaling up from simplifications of the real system that depends on the purpose of the research and is representative of the state of knowledge at the conception of the model to direct observations of real systems and their undisturbed behavior over years to decades.

Historically, most ecological studies consisted of making observations and then conceiving mentally probable explanations for the observations. Hairston (1989) calls these explanations or conclusions “weak inference,” because there are frequently alternative explanations, and there is little assurance as to which conclusion is correct. He further argues that manipulative experiments provide a preferable alternative, because planning experiments require at least an implied prediction. Ecosystem level computer simulation models usually offer more scientific rigor than direct interpretations of observations. The development of mathematical hypothesis to explain processes and mechanisms in specific systems can result in predictions and force their makers and users to think more clearly. Unfortunately, such models may only explain the obvious and, more important, incorporate assumptions that are difficult to justify (Hairston 1989). If, however, these models are well conceived and

IMPORTANT TERMS AND CONCEPTS

APLZ: The average number of compartments through which a given inflow passes.

BACI: Before-After-Control-Impact design used in field manipulation studies.

Global change (GC): Focuses on comparing ecosystems at global scales.

Mesocosm: A modest or middle-size experimental environmental chamber.

Recycling efficiency (RE): The proportion of material absorbed during processing.

Throughflow: The matter or energy that passes through a component.

Total system throughflow (TST): The sum of the unnormalized throughflows.

TABLE 8.1
Experimental Approaches Used in Bivalve Research, with Relative Estimates of Temporal and Spatial Scales As Well As Ecological Complexity

| Approach | Organizational Level | Temporal Scale | Spatial Scale | Processes | Ecological Complexity |
|-------------------------|----------------------------|--------------------|---------------|--|-----------------------|
| Endoscope | Organism | Seconds to Minutes | mm | Filtration | Low |
| Jar | Organism | Minutes to Hours | cm | Respiration Filtration Excretion | Low |
| Microcosm | Organisms | Hours | cm | Respiration Filtration Excretion | Moderate |
| Exclusion cages | Populations to Communities | Months to Years | m | Predation Competition | High |
| Lab flume | Population | Hours | m | Grazing | Moderate |
| Field flume and tunnels | Populations to Ecosystems | Hours | m | Grazing Nutrients Metabolism | Moderate to High |
| Simulation models | Populations to Ecosystems | Days to Years | m to km | Multiple | Moderate |
| Mesocosm | Simple System | Days to Years | m | Multiple | Moderate + |
| Incidental experiments | Ecosystem | Months to Years | km | Multiple | High |
| Designed experiments | Ecosystem | Months to Years | km | Multiple | High |

Source: Adapted from Porter, E.T. 1999. Physical and biological scaling of benthic-plagic coupling in experimental ecosystem studies. PhD dissertation, College Park, University of Maryland, pp. 312.

validated, they have the potential to provide an experimental platform for systems too large and complex to directly manipulate (Herman and Scholten 1990).

Intermediate to the more or less completely controlled mathematically based ecosystem models and minimally controlled field experiments are the laboratory or field chambers also known as microcosm or mesocosms. In these experimental ecosystems, most environmental variables are controlled or at least vary in a systematic manner, and a single variable is manipulated to address a specific question. In addition, these chambers are replicated to show repeatability and provide statistical rigor. Because the chambers themselves are smaller and less dynamic than a real ecosystem, there are often complications and unrealistic findings. Other potential problems include pseudoreplication, edge effects, changing controls, and stratification (Hairston 1989).

Unlike the preceding approaches to ecological experiments, with field manipulation experiments, it is not possible to exercise control over most of the variables in the system. In this approach, the variable of interest is manipulated in a set way while the other variables fluctuate independent of the experiment (Hairston 1989).

Ecosystem level field experiments have come into great favor in recent years because many of the important features of ecosystems are at large temporal and spatial scales. In estuaries with dense assemblages of bivalves, for example, water dynamics, biogeochemical processes, global change, and predation are difficult to reproduce in chambers and not sufficiently understood to describe in mathematical simulation models. Often these field experiments are not easily replicated because of spatial and temporal constraints and, ultimately, costs (Carpenter et al. 1995).

In this chapter, chambers and field manipulations will be addressed with particular attention to those systems dominated by marine bivalves. With regard to bivalve-dominated ecosystems, these approaches are not self-exclusionary and there is often a blending of two or more of these techniques in the search for knowledge. This approach is often useful in making global comparisons.

MODELS

Models are simplified versions of the real world. In science as elsewhere, informal models may be graphical as is a diagram, picture, or a painting, or verbal as a description of a process or cycle. These types of models are often useful to present a concept in its most basic form. Many informal ecological models are transformed into formal models with statistical or mathematical representations that allow quantitative predictions of the processes and states within the modeled system. These models formally relate ecological interactions, both biological and physical, through specific mathematical relationships. In addition to simulation modeling, steady-state (budget) models are often analyzed using the engineering–economic techniques of flow and network analyses. This latter approach provides a systems level view of material cycling, flow structure and connections, as well as system development. It also allows the direct comparison of very different ecosystems through the use of unitless indices.

Computer simulations of models have become a normal part of the modeling process. A computer simulation model allows the researcher to make predictions of potential outcomes of the model and to experiment with the various parameters and components of the model in ways that would be inappropriate in a natural system. Also, the development of the model usually provides a summary or accounting of what is known about the system of interest and provides the ecologist with information on areas needing new or better information.

The development of models often begins with the construction of a conceptual diagram, flow chart, or box model, many of which have been used throughout this book. At this level of development, there are four basic components of the model: (1) forcing functions or properties outside of the system of note that drive, regulate, or control the system; (2) state variables or components that describe what we see in the model, i.e., populations, trophic levels, etc.; (3) flows of materials or energy between the various components often depicted as arrows; and (4) interaction functions that formalize how interactions modify, amplify, or control flows (Odum 1983). Every good model will describe the space or boundaries of the system, the important subsystems in the larger system, and the time interval of interest in the model. Once a simulation model is built, it must be validated by comparing the model outcomes to independent observations of the real system. If these observations do not confirm

the simulation of the model, then the investigator must re-examine or re-evaluate the model for the validity of the relationships or assumptions applied or for the appropriateness of the data utilized. The modeling process is a clear application of the scientific method. For detailed information on ecosystem model building, readers are directed to Hall and Day (1977), Halfon (1979), Platt et al. (1981), Odum (1983), Ulanowicz and Platt (1985), and Hannon and Ruth (1994).

There are many more models that depict various aspects of bivalves and their relationships to the environment than space permits for review. Some of these models are emerging, e.g., Grant et al. (1993, 1995, and 2007), Emerson et al. (1994), and Hatcher et al. (1994), who are developing physiological-based models linked to water flow dynamics. Other models are controversial, e.g., Powell et al. (1992, 1994) and Hofman et al. (1992, 1994, 1995), who have developed a budget model for oysters that is linked to a detailed hydrodynamic numerical model.

SYSTEM SIMULATION MODELS

SMOES: Simulation Model Oosterschelde Ecosystem

Since 1979, the Oosterschelde estuary (Eastern Scheldt) of The Netherlands has been extensively modified by the building of a storm-surge barrier in the mouth of the estuary and two large auxiliary compartment dams in the upper portions of the system. As a consequence of this engineering marvel, the regional human population has been protected from North Sea storms, and because of reduced tidal exchange and river input the estuary now behaves as a tidal bay. The system is characterized by high production rates, tight benthic-pelagic coupling, and a high degree of biological control between components. Because the engineering changes to the Oosterschelde system would result in profound changes in the extant habitats and many of the management options taken would influence the complex interactions by which the components of the aquatic ecosystem depend on each other, simulation modeling was chosen as an essential tool for predicting the consequences of these management choices on the structure and function of the ecosystem (Herman 1994). The goal of the SMOES model was to provide a quantitative summary of the scientific observations and to provide a tool for analysis and prediction of the ecosystem's responses to the engineered manipulations (Klepper et al. 1994). SMOES describes the main carbon and nutrient flows with a spatial scale of 10 km to 20 km and a temporal scale of approximately one day. For a more detailed documentation of SMOES, see Klepper (1989).

MODEL FORMULATION

SMOES simulates 11 state variables: diatoms, other algae, zooplankton, silicate, inorganic nitrogen, silicon detritus, carbon detritus, benthic diatoms, salinity, refractory detritus, and oxygen. The food web for the system is given in Figure 8.1; note that suspension feeders are a forcing function and not a state variable (Klepper 1989). Spatially the ecosystem is divided into four boxes, each with a tidal excursion of 10 km to 15 km (Figure 8.2). Model structure is the same for each box, but morphological parameters such as depth, surface area, etc., are compartment dependent. The

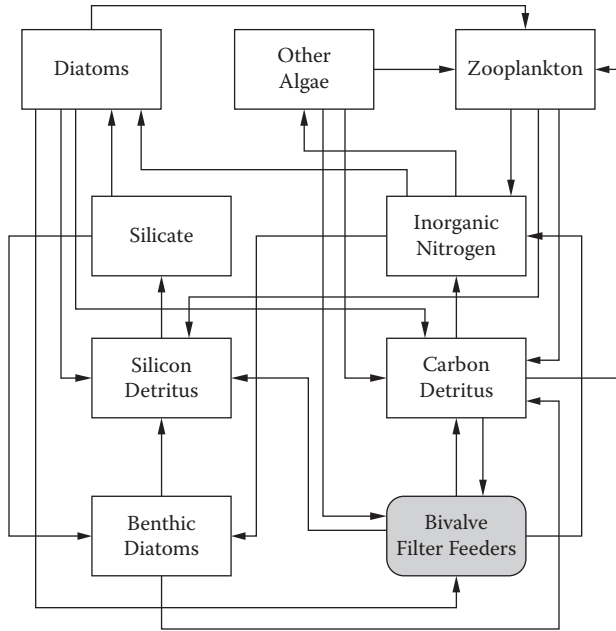

FIGURE 8.1 Conceptual model of the SMOES simulation of the Oosterschelde estuary, The Netherlands. (Redrawn from Klepper, O. 1989. *A Model of Carbon Flows in Relation to Macrobenthic Food Supply in the Oosterschelde Estuary* (S.W. Netherlands). PhD thesis. Wageningen, The Netherlands: Wageningen Agricultural University.)

simulation consists of formulating the rate of change in every state variable as a result of the state of the system itself and of time-dependent external conditions, e.g., light intensity, temperature, nutrient fluxes, and state variable concentrations in the adjacent North Sea. After calculating all the rates of change for a given time increment, the new state of the system is calculated and then moves ahead one time step (Klepper et al. 1994)

The water transport submodel (Klepper et al. 1994) makes the assumptions that: (1) the bivalve suspension-feeders have a fixed position in the moving water mass and (2) these animals only feed from the compartment in which they reside at mid-tide. The first assumption has been examined in detail by Klepper (1989) and found to be acceptable. The second is well within the spatial resolution of the model. As dispersive transport dominates advective transport in the Oosterschelde, the transport of dissolved materials was modeled according to a “forward time centered space” approximation to the advection–dispersion model (Ruardij and Baretta 1989) and is described in detail by Klepper et al. (1994). Particulate transport is modeled similarly to that of dissolved substances, but account is made for particles that settle out of suspension or are resuspended during a tidal cycle (Klepper et al. 1994).

The major biological submodels are those of phytoplankton, microphytobenthos, zooplankton, macrobenthos, and mineralization. The details of these submodels are presented in Klepper (1989) and Klepper et al. (1994) and their formulations are described in Tables 8.2a and 8.2b.

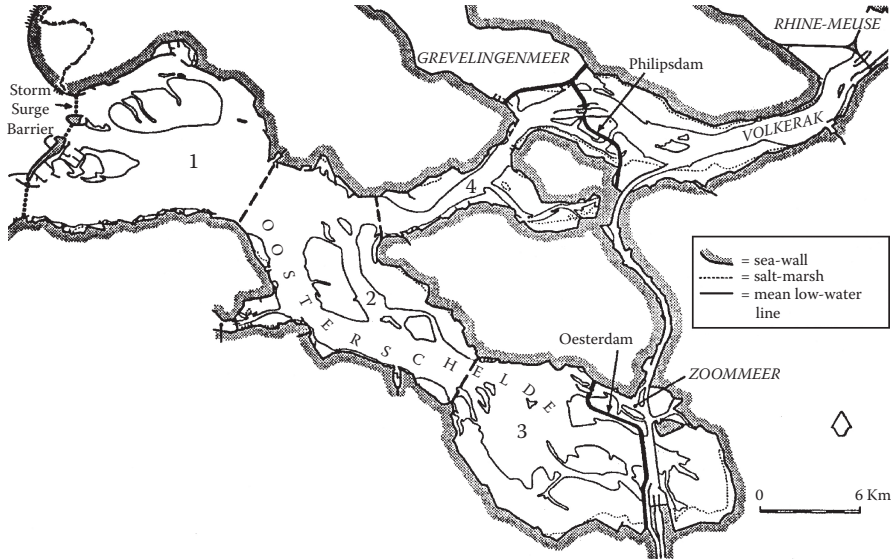

FIGURE 8.2 SMOES locational map showing location of the simulation grid. (Redrawn from Klepper, O. 1989. A Model of Carbon Flows in Relation to Macrobenthic Food Supply in the Oosterschelde Estuary (S.W. Netherlands). PhD thesis. Wageningen, The Netherlands: Wageningen Agricultural University.)

The phytoplankton model describes photosynthesis and primary production as a function of light intensity and dynamic processes. There are two unique aspects to the phytoplankton model. First, photosynthesis is based on a physiological model and is assumed to take place in phytoplanktonic units in three states: resting, active, and inactive. Second, there are two different phytoplankton groups in the Oosterschelde: diatoms and nondiatoms. Each of these aspects is taken into account in the modeling process. The microphytobenthos is modeled in a similar fashion (Klepper 1989).

The zooplankton are defined as both holoplankton and meroplanktonic larvae, and the model takes both into account. The main objective of this component is its influence in grazing the phytoplankton and follows the approaches of DiToro et al. (1971) and Kremer and Nixon (1978).

The macrobenthos is composed of two groups: the deposit feeders (grazing bottom algae and detritus) and the suspension-feeders (feeding on detritus and phytoplankton). The deposit feeders are dominated by meiofauna (nematodes and harpacticoid copepods), surface deposit feeders (the snail *Hydrobia*), and infaunal deposit feeders (particularly the worm *Arenicola*). The dominant suspension-feeders are cockles (*Cerastoderma*), mussels (*Mytilus*), and fouling organisms on the rocky substrate introduced in the engineering process. As the mussels are all cultivated and the cockles are heavily managed as a fishery, the biomass of these groups is used to empirically drive the model (Klepper et al. 1994).

Two nutrient processes are modeled; the decomposition of detritus or mineralization and the process of denitrification in the sediments by the microphytobenthos.

TABLE 8.2a
Equations Representing the Biological Submodels in the
SMOES Simulation

| Phytoplankton and Microphytobenthos | |
|--|--|
| Photosynthesis | $P = I/aI^2 + bI + c$ |
| Integrated gross production | $P_g = D_1 P_{\max} F_1$ |
| Maximum production (temp) | $P_{\max} = P_{\max 10} \exp((T - 10)T_{\text{coef}})$ |
| Nutrient limitation | $F_n(C) = C/(K_s + C)$ |
| Chlorophyll content | $\text{Chl} = D_1 F_n / 1.341_0$ |
| Chlorophyll:carbon | $\text{Chl:C} = \text{Chl}_{\max} F_n (I - F_1)^{0.6}$ |
| Respiration | $R_p = R_o + (1 - p_v)(P_g - R_o)$ |
| Excretion | $E = E_{\max}(1 - F_n)P_g$ |
| Zooplankton | |
| Ingestion | $R_i = R_{\max} \min\{1, F/F_{\text{lim}}\}$ |
| Mortality | $Z_{\text{mort}} = mqqB$ |
| Macrobenthos | |
| Deposit feeder ingestion | $G = c_T B_g (B_p + B_d)$ |
| Filter feeder clearance | $CR = f_T g_s a W^b$ |
| Assimilation efficiency | $AE = AE_{\max} \text{POM}_q / (\text{POM}_q + 0.15)$ |
| Respiration | $R_b = f_T p W^q$ |
| Pseudofeces | $\text{PSF} = CR_{\max} \{0, (S - S_{\text{psf}})\}$ |
| Nutrient Processes | |
| Mineralization | $M = k(T) \cdot \text{DET}$ |
| Denitrification | $\text{DC} = \text{NC} C r_{10} f(T)[N/K_m + N]$ |

MODEL ANALYSIS

The comparison between actual observed data and the simulated output of the SMOES model is described in the analysis of uncertainty (Klepper et al. 1994) and the calibration efforts of Scholten and van der Tol (1994). Inconsistencies between the model and the observed data can result from several causes (Herman 1994):

1. The model formulations may be a poor representation of reality.
2. A number of model parameters are assumed to be constant and are in reality variable.
3. Model inputs are only approximately known and lead to model uncertainty.

After analyzing SMOES, Klepper et al. (1994) concluded that the weakest parameters or parts of the model were processes that had not been well studied in the project. These weaknesses included: microbiological processes, algal respiration, zooplankton food limitation and loss processes, carbon-to-chlorophyll ratio, transport of algae and detrital silicon, assimilation efficiency of cockles, and gas exchange with the atmosphere.

TABLE 8.2b
Definitions of Parameters Used in SMOES Simulation Equations

| Parameter | Definition |
|--------------------|--|
| a | Coefficient |
| AE | Assimilation efficiency of macrobenthos |
| AE _{max} | Maximum assimilation efficiency of macrobenthos |
| b | Coefficient |
| B | Biomass of zooplankton |
| B _d | Benthic labile detritus |
| B _g | Biomass of benthic deposit feeder |
| B _p | Biomass of phytobenthos |
| c | Coefficient |
| C | Bottom labile detritus concentration |
| Chl | Chlorophyll <i>a</i> content |
| Chl:C | Chlorophyll to carbon ratio |
| Chl _{max} | Maximum chlorophyll <i>a</i> content |
| CR | Clearance rate of filter feeders |
| CR _{max} | Maximum clearance rate of filter feeders |
| C _T | Deposit feeder temperature-dependent ingestion coefficient |
| D ₁ | Day length |
| Dc | Denitrification rate in carbon units |
| DET | Detritus concentration |
| E | Phytoplankton excretion rate |
| E _{max} | Maximal phytoplankton excretion as a fraction of gross production |
| F | Zooplankton food concentration |
| F ₁ | Phytoplankton dimensionless reduction function |
| F _{lim} | Zooplankton threshold food concentration |
| F _n | Phytoplankton nutrient limitation function |
| f _T | Macrobenthic exponential temperature function |
| G | Deposit feeder ingestion rate |
| g _s | Negative exponential function of suspended sediments |
| I | Light intensity |
| I _o | Light intensity at water surface |
| K _m | Denitrification half-saturation coefficient |
| K _s | Nutrient limitation half-saturation concentration |
| k(T) | Mineralization rate as a function of temperature |
| M | Mineralization |
| mqq | Proportionality constant for zooplankton mortality |
| N | Inorganic nitrogen concentration |
| NC | Nitrogen consumption per unit of carbon consumption |
| P | Photosynthesis |
| p | Respiration coefficient |
| P _g | Daily integrated gross primary production per unit volume per unit biomass |
| P _{max} | Maximum primary production |

(continued)

TABLE 8.2b (continued)
Definitions of Parameters Used in SMOES Simulation Equations

| Parameter | Definition |
|---------------|--|
| $P_{\max t}$ | Maximum primary production as a function of temperature |
| $P_{\max 10}$ | Maximum primary production at 10°C |
| p_V | Production value, the amount of biomass produced per unit of primary production |
| POM_q | Fraction of organic matter in macrobenthos food |
| PSF | Pseudofeces production |
| q | Respiration exponential coefficient |
| R | Macrobenthic respiration |
| $R_{\max t}$ | Zooplankton temperature dependent maximum daily ration |
| R_o | Phytoplankton maintenance respiration |
| R_p | Phytoplankton respiration |
| R_t | Zooplankton temperature dependent ingestion per unit biomass |
| r_{10} | Relative denitrification rate at 10°C and saturated dissolved inorganic nitrogen |
| S | Suspended matter concentration |
| S_{psf} | Threshold concentration for pseudofeces production |
| T | Temperature in °C |
| T_{coef} | Temperature coefficient |
| W | Filter feeder dry body weight |

The issue of model validation is addressed in detail by Scholten and van der Tol (1994). These workers use the Schelsinger et al. (1979) definition for validation: substantiation that a computer simulation model within its domain of use possesses a satisfactory range of accuracy consistent with the intended application of the model. More generally stated by Herman (1994), a model is valid if it accurately predicts system behavior under the scenarios for which it was constructed. In order to validate SMOES, this group compared the adequacy of the model simulation runs (are all field data falling within the model's uncertainty limits?) and the reliability of these simulations (how good is the average fit between the model and the data?) (Herman 1994). Depending on the rigor with which one holds to these definitions of validity, SMOES is as valid or invalid as most other ecosystem level models (Scholten and van der Tol 1994).

With particular interest to the major bivalve groups in the Oosterschelde, Herman and Scholten (1990) used the prestorm surge barrier version of SMOES to examine the relationship between the suspension-feeding bivalves and the phytoplankton. By varying the biomass of the bivalves and the input of nutrients to the ecosystem, they were able to investigate the influence of these changes on phytoplankton biomass. They found that bivalve suspension-feeders could stabilize the phytoplankton under changing nutrient inputs. Suspension-feeder grazing regulated the phytoplankton at high nutrient levels and nutrient concentrations regulated at low levels. At low nutrient levels, the recycling of nutrients via suspension-feeder grazing was essential

to maintaining phytoplankton primary production. These authors also found that although these results were consistent with the field data and poststorm-surge barrier simulations, they could not be obtained using the prebarrier version of the model to generate a postbarrier prediction. The differences between real observations and the simulated predictions may be the result of compensating errors within the models (Herman 1994). Regardless of its failings, during the mid-1990s the SMOES model was the most complicated and extensively analyzed simulation model in which bivalves played a major role at the ecosystem level.

In Chapter 7, the flow of carbon through an intertidal oyster reef was introduced, and this conceptualization can also be rendered as an energy flow model for the oyster reef system (Dame and Patten 1981). The data for the intertidal oyster reef was collected, synthesized, and developed by Dame and Stevens (unpublished) and is one of the most used data sets for testing system-oriented theories. In addition to providing an accounting of the standing crops and flows of energy in the oyster reef, these authors applied a number of analytical techniques to the model that provided further insights into the processes operating within this community. These techniques are from the realm of systems analysis and are derived from the input–output theory of economics as applied to ecosystems (Hannon 1973). This approach has the advantage of revealing the structure of the system by demonstrating with energy or matter flows the direct and indirect dependence of each state variable or component upon the others. Hannon's initial adaptations have been expanded in succeeding years by Finn (1976, 1980), Patten et al. (1976), and Ulanowicz (1986) into a set of formal theories on the analysis of flows within ecosystems. The oyster reef model will be used as an introduction to flow analysis in a system dominated by bivalves.

Energy flow in the oyster reef system is shown in Figure 8.3. Detailed definitions for the standing crops (boxes) in kcal m^{-2} and flows (arrows) in $\text{kcal m}^{-2} \text{d}^{-1}$ are given in the same publication. In the oyster reef system, causality is transmitted by conservative energy flows and at times by nonconservative information flows or at least flows that are similar to information controls. Input–output flow analysis permits the tracing of relationships within the system. Thus the use of this analysis allows the investigator to describe the internal flow structure of the system. This structure can show how much energy is flowing through the system versus how much is cycling within the system. In this particular case, energy cycling means that some potential energy is not utilized on its first pass through a given component and can be used on a subsequent pass through the system. In flow analysis, the initial procedure is to normalize in turn one unit of output from each component in the reef system. Back calculation from an output determines the source flows necessary to produce a given unit of output. These source flows are specific for each unit of outflow and are often called input environments (Figure 8.4). This figure gives the input flow environment necessary to generate one unit of outflow from the predators in the oyster reef model. The values within the compartments are the throughflows required to generate the unit of outflow; numbers associated with arrows represent causal flows such as feeding or respiration. The sum of the input or output flows to a given component defines the throughflow value (T_{ii}).

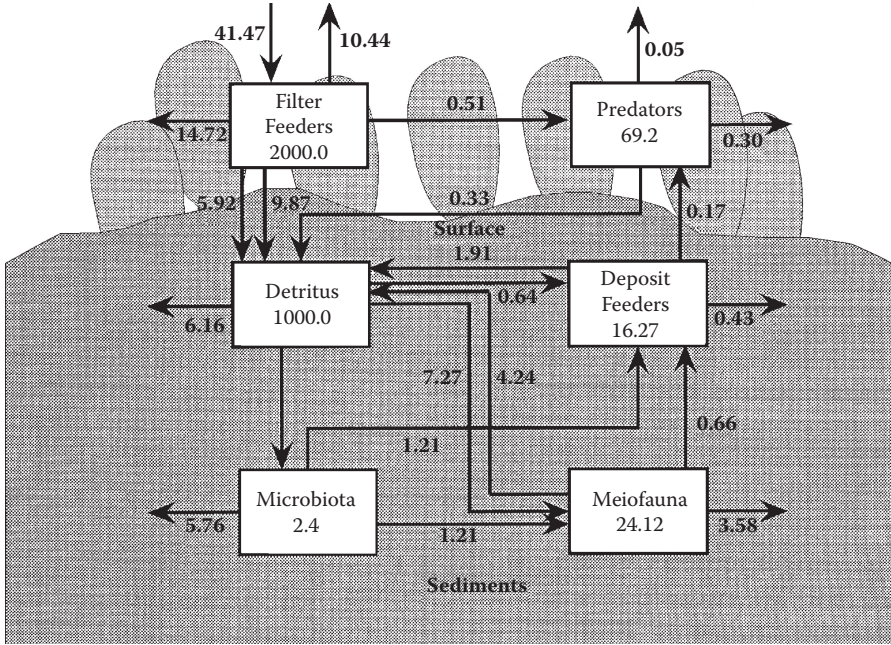

FIGURE 8.3 Intertidal oyster reef energy flow model. Flows are in kcal m⁻² d⁻¹ and states are in kcal m⁻². (Data from Dame, R.F. and Patten, B.C. 1981. Analysis of energy flow in an intertidal oyster reef. *Mar. Ecol. Prog. Ser.*, 5, 115–24.)

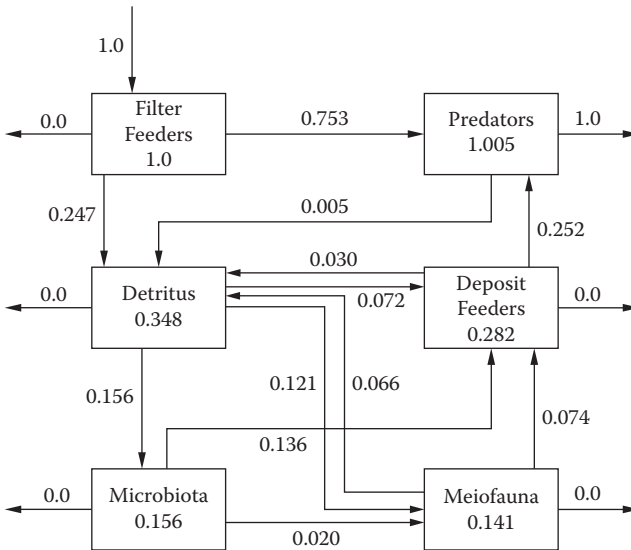

FIGURE 8.4 Intertidal oyster reef model **input environments**. (Data from Dame and Patten 1981.)

An example of output environments for the oyster reef model is described in Figure 8.5. In this case, one unit of input into the filter feeders generates the throughflows and outputs shown (Figure 8.5). The case shown is the only real output environment for this model as there is only one inflow of energy into the system and that is to the filter feeders. Imaginary output environments can be computed for the other components, and these are necessary to calculate other flow analysis measures (Dame and Patten 1981).

At steady-state there are a number of characteristics of flow analysis. They are pathlength, cycling efficiency, and cycling index. Each of these measures is useful in comparing the structure and functional traits of different ecosystems.

Total system throughflow (TST) is the sum of the unnormalized throughflows, and for the oyster model this is 85.58 kcal m⁻² d⁻¹. Because the oyster reef model conforms to laws of thermodynamics, throughflow observed for each component declines as energy moves through the system (Table 8.3).

Average pathlength of an inflow (APLZ) is defined as the average number of compartments through which a given inflow passes (Finn 1976). Thus for the oyster reef model, 1 unit of energy enters the filter feeders and has a pathlength of 1.0 (Figure 8.2). Only 39% of this input moves on to other components, while the remaining 61% leaves the system as respiration and egestion. Of that energy that moves on, 39% will have a pathlength of at least 2.0 and 24% will have a pathlength of 3.0. The result is an average pathlength of an inflow of 2.02. The average pathlength of a unit of outflow (APLY) from a given compartment is derived similarly to APLZ (Table 8.3).

In the oyster reef model, all energy does not move directly or straight through the system; some energy cycles. Energy cycling does not mean energy is degraded more

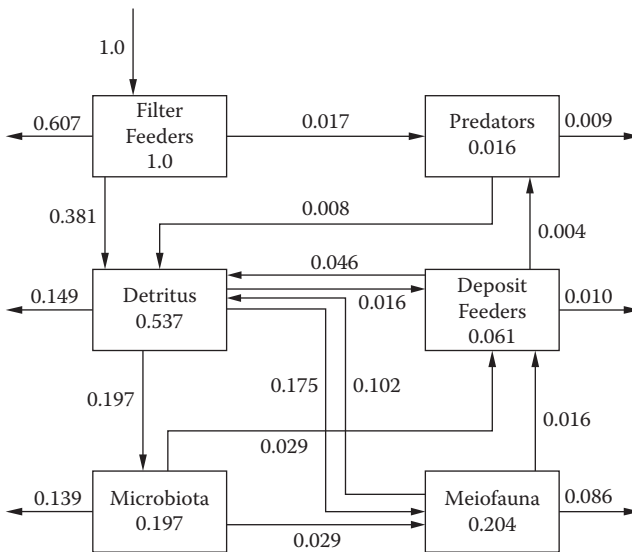

FIGURE 8.5 Intertidal oyster reef model **output environments**. (Data from Dame, R.F. and Stevens, S. 1981. Unpublished.)

TABLE 8.3
Flow Analysis Measures for the Oyster Reef Model

| Measure | Suspension- Feeders | Detritus | Micro- biota | Meio- fauna | Deposit Feeders | Predators |
|--|------------------------|----------|-----------------|----------------|--------------------|-----------|
| Throughflow | 41.47 | 22.27 | 8.17 | 8.48 | 2.51 | 0.69 |
| Average pathlength of unit input | 2.02 | 2.59 | 1.84 | 2.54 | 3.12 | 2.23 |
| Average pathlength of unit output | 1.00 | 2.93 | 3.93 | 4.07 | 4.71 | 2.93 |
| % Total system throughflow as inflow | 100.00 | — | — | — | — | — |
| % Total system throughflow as outflow | 30.10 | 21.66 | 27.10 | 17.45 | 2.43 | 1.26 |
| Recycling efficiency | 0 | 0.28 | 0.09 | 0.23 | 0.11 | 0.01 |

Source: From Dame, R.F. and Patten, B.C. 1981. Analysis of energy flow in an intertidal oyster reef. *Mar. Ecol. Prog. Ser.*, 5, 115–24.

than once, but that some potential energy is not utilized on its first pass through a component and a small proportion of that energy may be recycled back to a component it has already passed through. Energy cycling is particularly common in the sediments where deposit-feeding organisms are constantly ingesting and egesting partially decomposed material. Thus in the oyster reef model, cycling pathways are depicted among the deposited detritus, microbiota, meiofauna, deposit feeders, and predators (Figure 8.3).

A recycling efficiency (RE) may be calculated for a given component by subtracting 1.0 unit of flow from the throughflow for that particular component in the outflow environment for that component ($T_{ii} - 1.0$) and dividing by the same throughflow (T_{ii}). The REs for the oyster reef model are given in Table 8.3.

From the preceding, it is implied that total system throughflow (TST) is composed of a cycled (TST_c) and a noncycled or straight (TST_s) portion. By multiplying the appropriate recycling efficiency (RE) in Table 8.3 by the throughflow for a given component, the portion of throughflow due to cycling can be calculated. Summing the cycling portions yields total system throughflow that cycles (TST_c), and by subtraction, the energy that moves directly through the system (TST_s). In the case of the oyster reef model, total system throughflow that cycles is $9.21 \text{ kcal m}^{-2} \text{ d}^{-1}$. A dimensionless cycling index (CI) may also be calculated by dividing cycled throughflow (TST_c) by total system throughflow (TST). For the oyster reef system, this index is 0.11 (Dame and Patten 1981). Therefore, 89% of the energy entering the system flows directly through the system and 11% is recycled and most of this is in the sediment portions of the model.

The analysis of the flow structure of the oyster reef model shows the separation of the filter feeder compartment from the rest of the system because there are no feedback energy flows to the filter feeders from other components in the system. Visual analysis of the structure of the flows in the sediment portion of the model

reveals numerous feedback loops that can influence the processes there (Dame and Patten 1981). This portion of the model is where 11% of the energy is recycled and is supported by the elevated (relative) RE for the detritus, microbiota, meiofauna, and deposit feeder components.

CHESAPEAKE BAY ECOSYSTEM MODEL AND OYSTERS

The initial carbon flow model of the Chesapeake Bay ecosystem was developed by Baird and Ulanowicz (1989). This model focused on the carbon budgets and exchanges of the 36 most important components in the mesohaline portion of the bay and examined these interactions in a seasonal perspective.

Ulanowicz and his colleagues have subjected the Chesapeake Bay carbon model to flow analysis, using similar measures to those utilized on the oyster reef model and have developed new and unique network (flow) analysis tools that further elucidate the structure of this system (Ulanowicz 1986; Baird and Ulanowicz 1989; Baird et al. 1991; Wulff and Ulanowicz 1989). One of these tools is very graphical, the Lindeman Spine. In this analysis the energy flow networks are mapped into simplified trophic aggregations and depicted with their associated routes of recycling. Trophic efficiencies are also given as percentages within the boxes and are defined as that fraction of the total carbon in a trophic level that is transmitted to the next higher trophic level. Respiration and exports from each level are also shown (Figure 8.6). In the 36-compartment version of the Chesapeake Bay carbon model, the trophic chain is eight levels long, and oysters reside within level II. Using an aggregated 15-compartment version of the Chesapeake Bay carbon model, Baird et al. (1991) calculated an APLY of 3.61 and CI of 29.7.

During the 1980s, Ulanowicz (1980, 1986) developed additional measures of a system's flow or network analysis that he argued showed the degree of network development. As discussed by Baird et al. (1991), the measures were an elaboration of specific information theory concepts. Ulanowicz (1986) contended that the amount of species richness and the extent of trophic specificity (the lack of trophic niche and overlap) are embodied in the average mutual information of the flow connections. To have high network mutual information, a system should have many species or functional groups of comparable size that are unambiguously connected with each other. That is, each component exchanges matter or energy with only a very few other compartments. Ulanowicz (1980) scaled the mutual information of

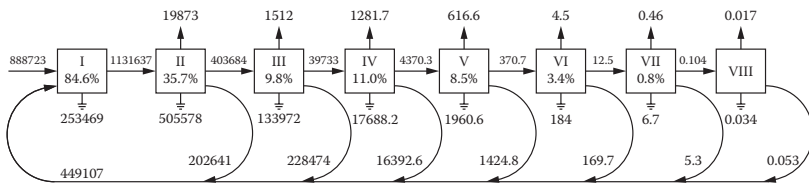

FIGURE 8.6 The trophic chain or Lindeman spine for the Chesapeake Bay carbon model; flows in $\text{mgC m}^{-2} \text{ year}^{-1}$. (Adapted from Baird, D. and Ulanowicz, R.E. 1989. A seasonal dynamics of the Chesapeake Bay ecosystem. *Ecol. Monogr.*, 59, 329–64.)

the network of flows by its activity or TST, and named the resulting measure system ascendancy (A). Ascendancy represents the combined attributes of system size and trophic organization (see Ulanowicz 1986, for a detailed development of this theory).

Briefly, Ulanowicz (1986) quantifies the diversity of pathways in a flow network (food web) as follows:

$$C = -k \sum Q_i \log Q_i \quad (8.1)$$

where C is the capacity of the system and a quantification of the diversity of pathways in the flow network, Q_i is the ratio of the quantity of material or energy flowing through a given compartment to the total system throughflow, and k is an arbitrary constant. Note the similarity of this relationship to the Shannon-Weaver information index for species diversity:

$$H = -k \sum p_i \log p_i \quad (8.2)$$

Because C does not quantify the size or relationship between compartments, k has been equated to total system throughflow (T_i) and the probability of flow between any two components (f_{ij}). The result is a measure described by Ulanowicz (1986) as network ascendancy (A) and formulated as:

$$A = T \sum \sum f_{kj} Q_k \log [f_{kj} / (\sum f_y Q_i)] \quad (8.3)$$

Network ascendancy (A) has both size and network properties, and capacity or system development capacity (C) is the upper limit of (A). Thus the degree of system development is the fraction of possible organization that is actually realized, i.e., $A:C$. The actual values for ascendancy, capacity, and their ratio are relative to comparisons with other systems, but the current situation in Chesapeake Bay produces values intermediate to other systems studied (Baird et al. 1991). From their analyses of the Chesapeake Bay model, Baird and Ulanowicz (1989) concluded that under the present circumstances oysters are not central players in the trophic dynamics of this system.

However, Newell (1988) raised the proposition that oysters once were and can once again become key agents in the structuring of Chesapeake Bay's ecosystem. Accordingly, Ulanowicz and Tuttle (1992) aggregated the original 36-compartment model of Baird and Ulanowicz (1989) into a 13-compartment carbon balance model as shown in Figure 8.7. This dynamic model renders the current circumstances in Chesapeake Bay and was designed to explicitly address the trophic consequences of increasing oyster stocks (biomass). Ulanowicz and Tuttle (1992) reasoned that oysters in the bay had been overharvested and that by reducing the exploitation rate of oysters only food availability to the oysters and not oyster larval recruitment would be influenced. The results of this simulation of the Chesapeake Bay carbon model under the preceding conditions are shown in Figure 8.7. The flows and states represented by Figure 8.7 are for a 23% reduction in the exploitation rate of oysters. The most obvious result of this change was an increase in oyster biomass of 150% over their original values. The extinction of the "other benthic suspension-feeders" compartment is considered to be the result of a false assumption concerning competition.

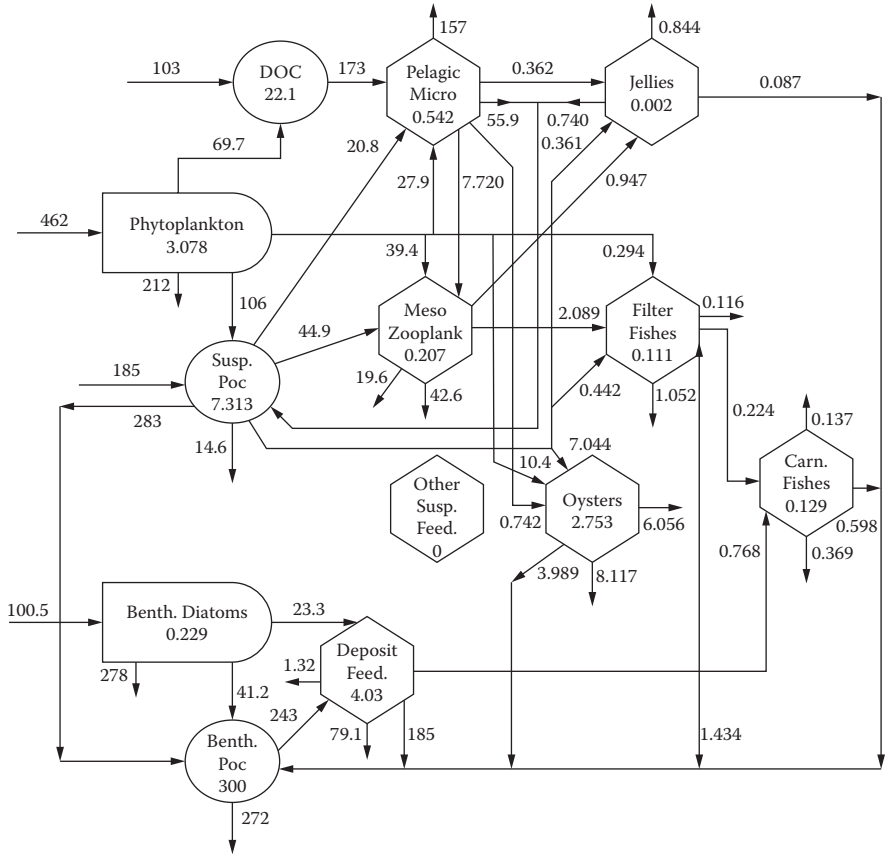

FIGURE 8.7 The Chesapeake Bay carbon simulation model assuming reduced oyster stock exploitation. Flows in $\text{gC m}^{-2} \text{ year}^{-1}$ and states in gC m^{-2} . (Adapted from Ulanowicz, R.E. and Tuttle, J.H. 1992. The trophic consequences of oyster stock rehabilitation in Chesapeake Bay. *Estuaries*, 15, 298–306.)

A comparison of the current situation with the hypothesized oyster rehabilitation case is given in Table 8.4. The model predicts that increasing oyster abundances will decrease phytoplankton productivity as well as stocks of pelagic microbes, ctenophores, medusae, and particulate organic carbon. Field data from the vicinity of oyster raft aquaculture plots in the same area of Chesapeake Bay support the model's predictions of phytoplankton productivity, bacterioplankton, and labile organic carbon. Ulanowicz and Tuttle (1992) argue that restoring oyster beds or introducing raft culture represents a potentially significant addition to the goal of mitigating eutrophication through reduction of nutrient inputs.

The Scientific Committee on Ocean Research (SCOR) has defined experimental ecosystems as physically confined, self-maintaining, multitrophic systems with a duration time exceeding the generation time of the penultimate trophic level present,

TABLE 8.4
Percentage Changes in the Standing Crops of the
Compartments in Figure 7.5 That Are Introduced by a
23% Reduction in the Rate of Oyster Exploitation per
Unit Biomass as Shown in Figure 8.6

| Compartment (State) | Percentage Change |
|----------------------------|-------------------|
| Increases | |
| Oysters | +150.2 |
| Benthic diatoms | +29.1 |
| Carnivorous fishes | +17.5 |
| Filter feeding fishes | +5.2 |
| Mesozooplankton | +4.8 |
| DOC | +1.3 |
| Decreases | |
| Gelatinous zooplankton | -89.2 |
| Phytoplankton | -11.5 |
| Pelagic microbes | -6.2 |
| Suspended POC and bacteria | -5.2 |
| Sediment POC and bacteria | -1.8 |

Source: Adapted from Ulanowicz, R.E. and Tuttle, J.H. 1992. The trophic consequences of oyster stock rehabilitation in Chesapeake Bay. *Estuaries*, 15, 298–306.

and of a size sufficient to enable pertinent sampling and measurements to be made without seriously influencing the structure and dynamics of the system (Lalli 1990). In the case of bivalves, self-maintaining means that their food is generated within the experimental ecosystem itself, in contrast to an aquarium where food is provided from outside the system (Pilson 1990). From a practical standpoint, these systems are also classified according to size as:

- Microcosms 1 m^3
- Mesocosms 1 m_3 to 10_3 m_3
- Macrocosms $>10_3 \text{ m}_3$

The temporal and spatial requirements of these systems are tightly coupled with larger volumes or areas required for larger organisms or processes that require longer time spans or generation times (Figure 8.8). The use of such experimental ecosystems is firmly linked to the natural environment, laboratory work, and models. In contrast to computer simulation models, these mini-ecosystems are often

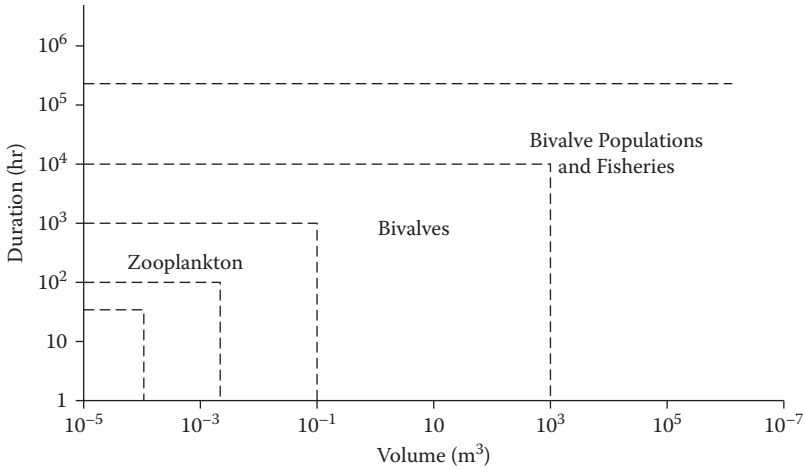

FIGURE 8.8 Spatial and temporal scales for experimental ecosystems emphasizing bivalves. (From Dame, R.F. 1996. *Ecology of Marine Bivalves: An Ecosystem Approach*. Boca Raton: FL CRC Press.)

referred to as living models and find great utility in studying systems and processes that are difficult to observe in nature or where there is a need to examine human influences on systems without endangering the natural system, i.e., pollution and global change questions.

Although numerous bivalve studies have used chambers to measure various parameters, these chambers are often not self-sustaining because they are expensive to build as well as maintain. Therefore they will not be considered separately in this work.

ECOSYSTEM FIELD EXPERIMENTS

Ecosystem scale experiments on real systems are the most realistic, yet the most difficult to conduct with the specific control of environmental parameters. For bivalves, these experiments have their genesis in the use of bell jars or chambers in the field (Zeitschel and Davies 1978), domes (Boucher and Boucher-Rodoni 1988), and tunnels (Dame et al. 1984) to elicit direct measurements of material fluxes between the bivalves and their community and the water column. From a different perspective, population and community ecologists have used various devices to exclude predators or competitors from portions of benthic communities dominated by bivalves in order to investigate the roles of predation and competition in community structure (Connell 1972, 1975; Menge 1976; Paine 1977). While these approaches have allowed the estimation of processes at the level of a population or community, they are not able to definitively answer questions on an ecosystem scale, and since they are discussed in previous chapters they will not be examined further. Instead, unintentional or incidental and designed ecosystem scale manipulation studies will be examined.

INCIDENTAL ECOSYSTEM SCALE EXPERIMENTS

Incidental ecosystem scale experiments are the result of some sort of activity that influences ecological processes at the scale of the entire ecosystem. For bivalve-dominated systems, the most common example of this type of experiment is intensive cultivation and harvest of these animals and the ecosystem changes that occur as a result of this activity. Specifically (Table 8.5), mussel culture in New Zealand changes the sediments and the nitrogen budget of the system (Kaspar et al. 1985); mussel culture in the Rias of Spain changes the sediment fauna and plankton (Tenore et al. 1982); oyster culture changed the carbon budget for Killary Harbor (Rodhouse and Roden 1987); oyster culture and overharvesting resulted in the loss of a cultured bivalve species and carbon budget changes in Marennes-Oléron (Héral 1993); and overharvesting and nutrient runoff resulted in a switch from a benthic-dominated to a pelagic-dominated system in Chesapeake Bay (Newell 1988). The intentional and unintentional (invasions) introduction of bivalve species and their subsequent population explosions in the San Francisco Bay has resulted in major ecosystem level changes (Cloern 1982; Nichols 1985; Carlton et al. 1990; Nichols et al. 1990; Alpine and Cloern 1992; Kimmerer et al. 1994). The major engineering changes to the Oosterschelde and the adjacent delta works in The Netherlands has had only a small influence on the role of bivalve-dominated ecosystem processes (Nienhuis and Smaal 1994). All of these cases have been examined previously in Chapters 5 and 6. Because Chesapeake Bay has been the focus of a long-term change and is the subject of ongoing studies across the range of ecosystem scale, it will be revisited here.

As a fishery, oysters, *Crassostrea virginica*, reached peak production in Chesapeake Bay in 1884. As recently as 1992, the production had declined to about 2% of the maximum production (Rothschild et al. 1994). These authors attribute the decline in oysters to habitat destruction and overfishing, and others have also implicated the additional effects of declining water quality as a result of pollution and increasing incidents of disease (Newell 1988). Some of the major ecological effects of the oyster fishery's decline on the bay were already obvious, i.e., uneaten and dead phytoplankton causing increased bacterial abundance and anoxic water conditions in the 1930s (Rothschild et al. 1994). Newell (1988), as discussed earlier, has argued that the decline in the oysters has led to the increase in planktonic suspension-feeding organisms with their attendant pelagic food web. He further argued that increasing the oyster population in the bay through management and aquaculture could significantly improve water quality and allow the system to revert to its benthic-dominated state. Newell's ideas were explored by Ulanowicz and Tuttle (1992) through the use of a simulation model (Figure 8.7) and through a preliminary and rough ecosystem level field experiment. The experiment compared the areas in the Bay with oyster aquaculture plots to adjacent areas without such plots. They found that phytoplankton standing stocks in culture plots were about half those in uncultivated areas. Even though this experiment was of short duration and limited spatial scope, Ulanowicz and Tuttle (1992) felt it supported the potential increased filtration effects to be seen if oyster populations in the bay were rehabilitated. However, just adding or increasing oysters to the present system may not switch it back to its original state. Gerritsen et al. (1994) calculated the capacity of benthic bivalves to filter the phytoplankton in

TABLE 8.5
Direct and Incidental Ecosystem Manipulations That Result in Changes to Bivalve-Mediated Processes

| Ecosystem | Bivalve | System Change | Process or Structure Changed | Ref. |
|--------------------------------|--|---|--|---|
| Chesapeake Bay, U.S. | <i>Crassostrea virginica</i> | Overharvesting | Switch from benthic to pelagic food webs | Newell 1988 |
| Kenepunu Sound, New Zealand | <i>Perna canaliculus</i> | Intense cultivation | Higher nitrogen concentrations in sediments, more intense nitrogen cycling | Kaspar et al. 1988 |
| Killary Harbour, Ireland | <i>Mytilus edulis</i> | Intense cultivation | Switch from pelagic to benthic bivalve filter-feeding system | Rodhouse and Roden 1987 |
| Marennes-Oléron, France | <i>Crassostrea angulata</i> <i>Crassostrea gigas</i> <i>Mytilus edulis</i> | Overcultivation | Low growth, epidemics, extinction | Héral 1993 |
| Oosterschelde, The Netherlands | <i>Cerastoderma edule</i> <i>Mytilus edulis</i> | Storm surge barrier constructed | No change | Nienhuis and Smaal 1994 |
| Ria De Arosa, Spain | <i>Mytilus edulis</i> | Intense cultivation | Organically enriched sediments, high sediment biodiversity | Tenore et al. 1982 |
| San Francisco Bay, U.S. | <i>Various bivalves</i> | Drought and high salinity, species invasion | Intense grazing of phytoplankton and zooplankton | Cloern 1982; Alpine and Cloern 1992; Nichols 1985; Kimmerer et al. 1994 |
| North Inlet, U.S. | <i>Crassostrea virginica</i> | Oysters removed experimentally (Summer) | Nutrient concentrations reduced in water | Dame and Libes 1993 |
| North Inlet, U.S. | <i>Crassostrea virginica</i> | Oysters removed experimentally (1-year) | Nutrient concentrations reduced in water | Dame et al. 2002 |

Source: From Dame, R.F. 1996. Ecology of Marine Bivalves: An Ecosystem Approach. Boca Raton: FL CRC Press.

the bay, using the dominant species as of 1988. These species were *Corbicula fluminea*, *Macoma* spp., *Mulinia lateralis*, *Mya arenaria*, *Rangia cuneata*, and *Tagelus plebeius*. Notice that oysters are not listed. Using a probabilistic model of bivalve suspension-feeding, these investigators found that bivalves could consume more than 50% of annual primary production in the shallow freshwater and oligohaline reaches of upper Chesapeake Bay and the Potomac River. In the deeper mesohaline portions, the model estimated that these bivalves could only consume about 10% of the primary production. As a result of their calculations, Gerritsen et al. (1994) argued that just adding oysters to the bay would only have a limited effect in improving water quality, as they are mainly influencing the shallow portions of the bay. Their study raises another ecological issue that is not discussed by any of these authors. Have the currently dominant bivalve filter feeders in Chesapeake Bay always been there at their current densities or have they risen to prominence as the oysters declined? Is this a case of functional redundancy with the bay? As with all experiments, planned and otherwise, new and interesting questions arise from them.

DESIGNED ECOSYSTEM SCALE EXPERIMENTS

Designed experiments on aquatic ecosystems can be traced to the forested watershed studies of Likens et al. (1970) and the whole-lake experiments of Schindler (1990) as well as Carpenter and Kitchel (1993). In each of these large studies, major trophic components were manipulated and the ensuing changes on the ecosystem were monitored.

CASE STUDY

All ecosystems generate products as a result of their participation in a variety of ecosystem processes. In economic terms, they provide goods and services that are often essential to the Earth and beneficial to humans (Daily 1997; Dame et al. 2002) or in other words, ecosystem services are the benefits that humans derive from ecosystems (Palmer and Filoso 2009). Many of these products are without cost to the recipients and we must wisely manage them in a sustainable context. As coastal and estuarine systems are among the most productive ecological systems on our planet and we are the dominant life form, it is in our best interest to protect the products and processes that are suffering the ever-increasing impacts of over harvesting, nutrient loading, and unexpected global climate changes. Bivalve fisheries are a visible example of this problem (Dame 1996).

Bivalve-dominated systems have been extensively studied and that attribute has led to the development of broad databases that lend themselves to more holistic or ecosystem management approaches. In an ecosystem management approach, physical and biological components are considered in an integrated manner. Larkin (1996) has argued that the three essential components of ecosystem management are as follows: (1) sustainable yield of products, both goods and services; (2) maintenance of natural biodiversity in order to sustain ecosystem structure and function; and (3) protection from the effects of pollution and habitat degradation. He

also cautions that these components must be reconciled with the economic and social factors.

Intertidal oyster reefs are prominent and intensely bivalve components of the marsh estuarine ecosystems of the southeastern Atlantic coast of North America. North Inlet is a pristine system that has been the focus of a number of fundamental ecological studies. Results from some of these investigations have demonstrated that oyster reefs can influence productivity and biodiversity in marsh-estuarine systems by (1) providing three-dimensional structures that increase habitat heterogeneity and supply space to support diverse assemblages of benthic and nektonic organisms (Wells 1961); (2) modifying tidal creek morphology and hydrodynamics by structurally altering creeks and increasing water residence times (Keck et al. 1973); and (3) converting large amounts of particulate material from the water column into large quantities of inorganic and organic nutrients via filtration and subsequent excretion (Dame 1993, 1996). The interpretation of ecosystem scale experiments requires that two questions need to be answered: (1) did the manipulated ecosystem change following the manipulation? and (2) did the manipulation cause the change? (Frost et al. 1988). These questions can be answered by randomized, replicated designs (Hurlbert 1984; Frost et al. 1988) and with less statistical power by other techniques such as intervention analysis (Carpenter et al. 1989).

The BACI (before-after-control-impact) experimental design of Stewart-Oaten et al. (1986) assumes that observations are made on a potential site for some time before intervention or manipulation, and also on another site with similar characteristics. It is not necessary that the two sites match perfectly with respect to the distributions of the ecological parameters measured. After the intervention is applied to the randomly chosen experimental site, the change in mean value for any given parameter there is compared to any concomitant (natural) change at the untreated control site. This difference, referred to as the effect of the manipulation, may be immediate or gradual; it may also be either lasting or temporary. Underwood (1994) expanded upon the BACI idea by introducing multiple control sites and treating these as random effects in a multifactor mixed model analysis of variance.

If there are significant time-treatment interactions, then a staircase approach should be considered (Walters et al. 1988). In this less statistically powerful method, the manipulation, i.e., removal of oysters from a creek, is assumed to result in different effects, depending on the season of the removal. Thus the design must stage the removals to the seasons, with each removal compared to a control or unmanipulated system.

As ecosystem scale manipulation experiments are expensive to replicate a clearer time line, it is often the case (see "Incidental Ecosystem Scale Experiments" above) that only one manipulated system and one reference system is available. In this case, Carpenter et al. (1989) have developed RIA (random intervention analysis) as a method to determine if nonrandom change has occurred in a manipulated ecosystem.

The projects that were described by Dame and Libes (1993) and Dame et al. (2002) were called LINKS by students and faculty who were involved. LINKS grew out of a couple of large projects known as CREEK and Outwelling. All of these projects took place at the Baruch Marine Field Laboratory on North Inlet, South Carolina. Most of the research support came from the National Science Foundation (NSF) although the summer pilot study (Dame and Libes 1993) was supported by an

award from the state of South Carolina. The participants were students and faculty from Coastal Carolina University and the University of South Carolina.

The pilot study took place in the summer of 1989 with a preincident time period of June 1–30 and after incident time period of July 1–August 30. Water samples were taken every other tidal cycle from each of the six experimental creeks. On June 30 all of the oysters were removed from three experimental creeks. After the removal of the oysters from three creeks all the reactive inorganic chemicals concentrations were significantly higher in creeks with oysters. There was no significant difference in Chl *a* concentrations. The findings suggest that there is a positive feedback loop that enhances nutrient retention in the creeks with oysters. The study also demonstrated that ecosystem scale field experiments can be undertaken in the highly complex tidal creek system.

Using the results of the summer season pilot study, a much more comprehensive study was designed and conducted from 1996 to 1998 (Dame et al. 2002). The full-scale study used the BACI statistical guidelines outlined above in a series of manipulation experiments in North Inlet that included the removal of oysters from four of a set of eight creeks and the monitoring of ecosystem level changes over a 1-year postmanipulation period. The scientific team investigated the following ecosystem processes: top-down and bottom-up control of plankton, the nutrient dynamics of the tidal creek food web, nekton biodiversity, total system metabolism and productivity, and the physical dynamics of water exchange.

The findings of this expanded study were interesting. Creeks with oysters removed had slightly higher somatic growth (less competition for food) and greater larval recruitment (less chance of being eaten by adult suspension-feeders). These data suggested that creeks with oysters present were near or below carrying capacity.

Nekton biomass in the summer in the experimental tidal creeks was often greater than oyster biomass. Also, our calculations indicate that oysters do not produce enough ammonium to satisfy phytoplankton productivity, but nekton, water column remineralization, and sediments can account for most of the ammonium deficit. Finally, microflagellates, which are a preferred food for the oysters, dominated the phytoplankton during the summer growing season and diatoms dominated the colder months. The timing of the change in phase of the phytoplankton dominance appeared to mirror the seasonal arrival and departure times of the nekton in the tidal creeks. Herman et al. (1999) have speculated the dense beds and reefs of suspension-feeding bivalves may induce strong positive feedback linkages that may invoke alternate stable states. Further, positive feedback is typically fragile and exhibits threshold effects. This phase shift and collapse of a positive feedback mechanism may explain why natural suspension-feeder systems are so slow to return to their initial state.

Although individual findings may seem inconsequential, they each played a role in a natural complex nonlinear system we know as the oyster reef and further illuminated how bivalve reefs are one of the greatest processors of matter and energy in the natural world.

COMPARISON OF COASTAL, ESTUARINE, AND MARINE ECOSYSTEMS DOMINATED BY BIVALVE SUSPENSION-FEEDERS

The number of ecosystem scale field experiments involving marine bivalves is relatively few and this aspect is probably due to the expense involved in comprehensive monitoring and experimental replication. The incidental and designed studies have supported with simulations and mesocosms the lower scale investigations of nutrient cycling and grazing, but have also pointed out important areas of exploration that are not easily simulated, i.e., species invasions and biodiversity. The future begs for more comprehensive ecosystem scale studies that integrate computer simulations, mesocosms, and field manipulations to provide a clearer understanding of the ecosystem role of bivalves.

REFERENCES

- Alpine, S.E. and Cloern, J.E. 1992. Trophic interactions and direct physical effects control phytoplankton biomass and production in an estuary. *Limnol. Oceanogr.*, 37, 946–55.
- Baird, D., McGlade, J.M., and Ulanowicz, R.E. 1991. The comparative ecology of six marine ecosystems. *Phil. Trans. R. Soc. Lond. Ser. B*, 333, 15–29.
- Baird, D. and Ulanowicz, R.E. 1989. A seasonal dynamics of the Chesapeake Bay ecosystem. *Ecol. Monogr.*, 59, 329–64.
- Boucher, G. and Boucher-Rodoni, R. 1988. In situ measurement of respiratory metabolism and nitrogen fluxes at the interface of oyster beds. *Mar. Ecol. Prog. Ser.*, 44, 229–38.
- Carlton, J.T., Thompson, J.K., Schemel, L.E., and Nichols, F.H. 1990. Remarkable invasion of San Francisco Bay, California, USA by the Asian clam *Potamocorbula amurensis*. I. Introduction and dispersal. *Mar. Ecol. Prog. Ser.*, 66, 81–94.
- Carpenter, S.R., Chisholm, S.W., Krebs, C.J., Schindler, D.W., and Wright, R.F. 1995. Ecosystem experiments. *Science*, 269, 324–27.
- Carpenter, S.R., Frost, T.M., Heisey, D., and Kratz, T.K. 1989. Randomized intervention analysis and the interpretation of whole-ecosystem experiments. *Ecology*, 70, 1142–152.
- Carpenter, S.R. and Kitchell, J.F. 1993. *The Trophic Cascade in Lakes*. New York: Cambridge University Press.
- Cloern, J.E. 1982. Does the benthos control phytoplankton biomass in South San Francisco Bay? *Mar. Ecol. Prog. Ser.*, 9, 191–202.
- Connell, J.H. 1972. Community interactions on marine rocky intertidal shores. *Annu. Rev. Ecol. Sys.*, 3, 169–92.
- Connell, J.H. 1975. Some mechanisms producing structure in natural communities: A model and evidence from field experiments. In *Ecology and Evolution of Communities*, Cody, M.L. and Diamond, J.M., Eds. Cambridge, MA: Belknap/Harvard University Press, pp. 460–90.
- Daily, G.C. 1997. *Nature's Services: Societal Dependence on Natural Ecosystems*. Washington, DC: Island Press.
- Dame, R.F. 1993. *Bivalve Filter-Feeders in Estuarine and Coastal Ecosystem Processes*. Heidelberg: Springer-Verlag.
- Dame, R.F. 1996. *Ecology of Marine Bivalves: An Ecosystem Approach*. Boca Raton: FL CRC Press.
- Dame, R.F., Bushek, D., Allen, D., Lewitus, A., Edwards, D., Koepfler, E., and Gregory, L. 2002. Ecosystem response to bivalve density reduction: Management implications. *Aq. Ecol.*, 36, 51–65.

- Dame, R.F. and Libes, S.L. 1993. Oyster reefs and nutrient retention in tidal creeks. *J. Exp. Mar. Biol. Ecol.*, 171, 251–58.
- Dame, R.F. and Patten, B.C. 1981. Analysis of energy flow in an intertidal oyster reef. *Mar. Ecol. Prog. Ser.*, 5, 115–24.
- Dame, R.F., Zingmark, R.G., and Haskin, E. 1984. Oyster reefs as processors of estuarine materials. *J. Exp. Mar. Biol. Ecol.*, 83, 239–47.
- DiToro, D.M., O'Connor, D.J., and Thomann, R.V. 1971. A dynamic model of the phytoplankton in the Sacramento–San Joaquin delta. *Adv. Chem. Ser.* 106, 131–180.
- Emerson, C.W., Grant, J., Mallet, A., and Carver, C. 1994. Growth and survival of sea scallops *Placopecten magellanicus*: Effects of culture depth. *Mar. Ecol. Prog. Ser.*, 108, 119–32.
- Finn, J.T. 1976. Measures of ecosystem structure and function derived from the analysis of flows. *J. Theor. Biol.*, 56, 363–80.
- Finn, J.T. and Leschine, T.M. 1980. Does salt marsh fertilization enhance shellfish production? An application of flow analysis. *Env. Manag.*, 4, 193–203.
- Frost, T.M., DeAngelis, D.L., Bartell, S.M., Hall, D.J., and Hurlbert, S.H. 1988. Scale in the design and interpretation of aquatic community research. In *Complex Interaction in Lake Communities*, Carpenter, S.R., Ed. New York: Springer-Verlag, pp. 229–60.
- Gerritsen, J., Holland, A.F., and Irvine, D.E. 1994. Suspension-feeding bivalves and the fate of primary production: An estuarine model applied to Chesapeake Bay. *Estuaries*, 17, 403–16.
- Grant, J., Bugden, G., Horne, E., Archambault, M.-C., and Carreau, M. 2007. Remote sensing of particle depletion by coastal suspension-feeders. *Can. J. Fish. Aquat. Sci.*, 64, 387–90.
- Grant, J., Dowd, M., Thompson, K., Emerson, C., and Hatcher, A. 1993. Perspectives on field studies and related biological models of bivalve growth and carrying capacity. In *Bivalve Filter Feeders and Marine Ecosystem Processes*, Dame, R.F., Ed. Heidelberg: Springer-Verlag, pp. 371–420.
- Grant, J., Hatcher, A., Scott, D.B., Pockington, P., Schafer, C.T., and Winters, G.V. 1995. A multidisciplinary approach to evaluating impacts of shellfish aquaculture on benthic communities. *Estuaries*, 18, 124–44.
- Hairston Sr., N.G., 1989. *Ecological Experiments: Purpose, Design, and Execution*. New York: Cambridge University Press.
- Halfon, E. 1979. *Theoretical Systems Ecology*. New York: Academic Press.
- Hall, C. and Day, J. 1977. *Ecosystem Modeling in Theory and Practice*. New York: Wiley.
- Hannon, B. 1973. The structure of ecosystems. *J. Theor. Biol.*, 41, 535–46.
- Hannon, B. and Ruth, M. 1994. *Dynamic Modeling*. NY: Springer-Verlag 248 pp.
- Hatcher, A., Grant, J., and Schofield, B. 1994. Effects of suspended mussel culture (*Mytilus* spp.) on sedimentation, benthic respiration and sediment nutrient dynamics in a coastal bay. *Mar. Ecol. Prog. Ser.*, 115, 219–35.
- Héral, M. 1993. Why carrying capacity models are useful tools for management of bivalve molluscs culture. In *Bivalve Filter Feeders in Estuarine and Coastal Ecosystem Processes*, Dame, R.F., Ed. Heidelberg: Springer-Verlag, pp. 453–77.
- Herman, P.M.J. 1994. The analysis of a dynamic simulation model for the Oosterschelde ecosystem—A summary. In *The Oosterschelde Estuary (The Netherlands): A Case Study of a Changing Ecosystem*, Nienhuis, P.H. and Smaal, A.C., Eds. Dordrecht: Kluwer, pp. 431–36.
- Herman, P.M.J., Middleburg, J.J., Van de Koppel, J., and Heip, C.H.R. 1999. Ecology of estuarine macrobenthos. *Adv. Ecol. Res.*, 29, 195–240.
- Herman, P.M.J. and Scholten, H. 1990. Can suspension-feeders stabilise estuarine ecosystems? In *Trophic Relationships in the Marine Environment*, Barnes, M. and Gibson, R.N., Eds. Aberdeen: Aberdeen University Press, pp. 104–16.
- Hofmann, E.E., Klinck, J.M., Powell, E.N., Boyles, S., and Ellis, M. 1994. Modelling oyster populations. II. Adult size and reproductive effort. *J. Shellfish Res.*, 13, 165–82.

- Hofmann, E.E., Powell, E.N., Klinck, J.M., and Saunders, G. 1995. Modelling diseased oyster populations. I. Modelling Perkinsus marinus infections in oysters. *J. Shellfish Res.*, 14, 121–51.
- Hofmann, E.E., Powell, E.N., Klinck, J.M., and Wilson, E.A. 1992. Modelling oyster populations. III. Critical feeding periods, growth and reproduction. *J. Shellfish Res.*, 11, 399–416.
- Hurlbert, S.J. 1984. Pseudoreplication and the design of ecological field experiments. *Ecol. Monogr.*, 54, 187–211.
- Kaspar, H.F., Gillespie, P.A., Boyer, I.C., and MacKenzie, A.L. 1985. Effects of mussel aquaculture on the nitrogen cycle and benthic communities in Kenepuru Sound, Marlborough Sounds, New Zealand. *Mar. Biol.*, 85, 127–36.
- Keck, R., Maurer, D. and Watling, L. 1973. Tidal stream development and its effect on the distribution of the American oyster. *Hydrobiology*, 42, 369–79.
- Kimmerer, W.J., Gartside, E., and Orsi, J.J. 1994. Predation by an introduced clam as the likely cause of substantial declines in zooplankton of San Francisco Bay. *Mar. Ecol. Prog. Ser.*, 113, 81–93.
- Klepper, O. 1989. *A Model of Carbon Flows in Relation to Macrobenthic Food Supply in the Oosterschelde Estuary (S.W. Netherlands)*. PhD thesis. Wageningen, The Netherlands: Wageningen Agricultural University.
- Klepper, O., van der Tol, M.W.M., Scholten, H., and Herman, P.M.J. 1994. SMOES: A simulation model for the Oosterschelde ecosystem. I. Description and uncertainty analysis. In *The Oosterschelde Estuary (The Netherlands): A Case Study of a Changing Ecosystem*, Nienhuis, P.H. and Smaal, A.C., Eds. Dordrecht: Kluwer, pp. 437–51.
- Kremer, J.N. and Nixon, S.W. 1978. *A Coastal Marine Ecosystem—Simulation and Analysis*. New York: Springer-Verlag.
- Lalli, C.M. 1990. Introduction. In *Enclosed Experimental Marine Ecosystems: A Review and Recommendations, Coastal and Estuarine Studies 37*, Lalli, C.M., Ed. New York: Springer-Verlag, pp. 1–6.
- Larkin, P.A. 1996. Concepts and issues in marine ecosystem management. *Rev. Fish. Biol. Fisheries*, 6, 139–64.
- Likens, G.E., Borman, F.H., Johnson, N.M., Fisher, D.W., and Pierce, R.S. 1970. Effects of cutting and herbicide treatment on nutrient budgets in Hubbard Brook watershed-ecosystem. *Ecol. Monogr.*, 40, 23–47.
- Menge, B.A. 1976. Organization of the New England rocky intertidal community: Role of predation, competition, and environmental heterogeneity. *Ecol. Monogr.*, 46, 355–93.
- Newell, R.I.E. 1988. Ecological changes in Chesapeake Bay: Are they the result of overharvesting the American oyster, *Crassostrea virginica*? In *Understanding the Estuary: Advances in Chesapeake Bay Research*, Lynch, M.P. and Krome, E.C., Eds. Solomon's, MD: Chesapeake Research Consortium, pp. 536–46.
- Nichols, F.H. 1985. Increased benthic grazing: An alternative explanation for low phytoplankton biomass in northern San Francisco Bay during the 1976–1977 drought. *Estuarine Coastal Shelf Sci.*, 21, 379–88.
- Nichols, F.H., Thompson, J.K., and Schemel, L.E. 1990. Remarkable invasion of San Francisco Bay (California, USA) by the Asian clam *Potamocorbula amurensis*. II. Displacement of a former community. *Mar. Ecol. Prog. Ser.*, 66, 95–101.
- Nienhuis, P.H. and Smaal, A.C. 1994. *The Oosterschelde Estuary: A Case Study of a Changing Ecosystem*, reprinted from *Hydrobiologia* 282/283. Dordrecht: Kluwer.
- Odum, E.P. 1983. *Basic Ecology*. Philadelphia: Saunders.
- Odum, H.T. 1983. *Systems Ecology*. New York: Wiley.
- Paine, R.T. 1977. Controlled manipulations in the marine intertidal zone and their contributions to ecological theory. In *The Changing Scenes in Natural Sciences, 1776–1976*. Philadelphia: Acad. Nat. Sci., Spec. Pub., 12, pp. 245–70.

- Palmer, M.A. and Filoso, S. 2009. Restoration of ecosystem services for environmental markets. *Science*, 325, 575–80.
- Patten, B.C., Bosserman, R.W., Finn, J.T., and Cale, W.G. 1976. Propagation of cause in ecosystems. In *System Analysis and Simulation in Ecology*, Vol. 4, Patten, B.C., Ed. New York: Academic Press, pp. 457–579.
- Pilson, M.E.Q. 1990. Application of mesocosms for solving problems in pollution research. In *Enclosed Experimental Marine Ecosystems: A Review and Recommendations*, Coastal and Estuarine Studies 37, Lalli, C.M., Ed. New York: Springer-Verlag, pp. 155–68.
- Platt, T., Mann, K.H., and Ulanowicz, R.E. 1981. *Mathematical Models in Biological Oceanography*. Paris: UNESCO Press.
- Powell, E.N., Hofmann, E.E., Klinck, J.M., and Ray, S.M. 1992. Modeling oyster populations. I. A commentary on filtration rate. Is faster always better? *J. Shellfish Res.*, 11, 387–98.
- Porter, E.T. 1999. Physical and biological scaling of benthic-plagic coupling in experimental ecosystem studies. PhD dissertation, College Park, University of Maryland, pp. 312.
- Powell, E.N., Klinck, J.M., Hofmann, E.E., and Ray, S.M. 1994. Modeling oyster populations. IV. Rates of mortality, population crashes, and management. *Fish. Bull.*, 92, 347–73.
- Riemann, B., Nielsen, T.G., Horsted, S.J., Bjørnsen, P.K., and Pock-Steen, J. 1988. Regulation of phytoplankton biomass in estuarine enclosures. *Mar. Ecol. Prog. Ser.*, 48, 205–15.
- Riemann, B., Sørensen, M., Bjørnsen, P., Horsted, S., Jensen, L., Nielsen, T., and Søndergaard, M. 1990. Carbon budgets of the microbial food web in estuarine enclosures. *Mar. Ecol. Prog. Ser.*, 65, 159–70.
- Rodhouse, P.G. and Roden, C.M. 1987. Carbon budget for a coastal inlet in relation to intensive cultivation of suspension-feeding bivalve molluscs. *Mar. Ecol. Prog. Ser.*, 36, 225–36.
- Rothschild, B.J., Ault, J.S., Gouletquer, P., and Héral, M. 1994. Decline of the Chesapeake Bay oyster populations: A century of habitat destruction and overfishing. *Mar. Ecol. Prog. Ser.*, 111, 29–39.
- Ruardij, P. and Baretta, J.W. 1989. The construction of the transport submodel. In *Tidal Flat Estuaries*, Baretta, J. and Ruardij, P., Eds. Berlin: Springer-Verlag, pp. 65–76.
- Schlesinger, S.R.E., Crosbie, R.E., Gagne, R.E., Innis, G.S., Lalwani, C.S., Lich, J., Sylvester, R.J., Wright, R.D., Kheir, N., and Bartos, D. 1979. Terminology for model credibility. *Simulation*, 32, 103–4.
- Schindler, D.W. 1990. Experimental perturbations of whole lakes as tests of hypotheses concerning ecosystem structure and function. *Oikos*, 56, 25–41.
- Scholten, H. and van der Tol, M.W.M. 1994. SMOES: A simulation model for the Oosterschelde ecosystem. II. Calibration and validation. In *The Oosterschelde Estuary (The Netherlands): A Case Study of a Changing Ecosystem*, Nienhuis, P.H. and Smaal, A.C., Eds. Dordrecht: Kluwer, pp. 453–74.
- Stewart-Oaten, A., Murdoch, W.M., and Parker, K.R. 1986. Environmental impact assessment: “Pseudoreplication” in time? *Ecology*, 67, 929–40.
- Tenore, K.R., Boyer, L.F., Cal, R.M., Corral, J., Garcia-Fernandez, C., Gonzalez, N., Gonzalez-Gurriaran, E., Hanson, R.B., Iglesias, J., Krom, M., Lopez-Jamar, E., McClain, J., Pamatmat, M.M., Perez, A., Rhoads, D.C., de Santiago, G., Tiejn, J., Westrich, J., and Windom, H.L. 1982. Coastal upwelling in the Rias Bajas, NW Spain: Contrasting the benthic regimes of the Rias de Arosa and de Muros. *J. Mar. Res.*, 40, 701–72.
- Ulanowicz, R.E. 1980. A hypothesis on the development of natural communities. *J. Theor. Biol.*, 85, 233–45.
- Ulanowicz, R.E. 1986. *Growth and Development: Ecosystems Phenomenology*. New York: Springer-Verlag.
- Ulanowicz, R.E. and Platt, T. 1985. Ecosystem theory for biological oceanography. *Can. Bull. Fish. Aquat. Sci.*, 213, 1–260.
- Ulanowicz, R.E. and Tuttle, J.H. 1992. The trophic consequences of oyster stock rehabilitation in Chesapeake Bay. *Estuaries*, 15, 298–306.

- Underwood, A.J. 1994. On beyond BACI: Sampling designs that might reliably detect environmental disturbances. *Ecol. Appl.*, 4, 3–15.
- Walters, C.J., Collie, J., and Webb, T. 1988. Experimental designs for estimating transient responses to management disturbances. *Can. J. Fish. Aquat. Sci.*, 45, 530–38.
- Wells, H.W. 1961. The fauna of oyster beds with special reference to the salinity factor. *Ecol. Monogr.*, 31, 239–66.
- Wulff, F. and Ulanowicz, R.E. 1989. A comparative anatomy of the Baltic Sea and Chesapeake Bay ecosystems. In *Network Analysis in Marine Ecology*, Field, J.G., Wulff, F., and Mann, K.H., Eds. New York: Springer-Verlag, pp. 232–56.
- Zeitschel, B. and Davies, J.M. 1978. Benthic growth chambers. *Rapp. P.V. Reun. Cons. Int. Explor. Mer.*, 173, 31–42.

9 Ecosystem Health, Restoration, and Services

INTRODUCTION

In previous chapters, it is shown that ecosystems are open, nonlinear, complex systems that exist in the natural world at the interface of the sea, air, and land. In this area, also called the Coastal Transition Zone (CTZ), there are assemblages of bivalves that consume more energy and produce more entropy than most other living systems. With the United Nation's Millennium Ecosystem Assessment (MEA) of life on our planet targeted for the year 2000, interests turned to investigations of the role ecosystems dominated by nonhumans played in processes critical to human sustainability and systems health.

ECOSYSTEM SERVICES

E.P. Odum (1983) defined an ecosystem as the bonding of living organisms and their nonliving environment inseparably to each other, or as presented by

MEA: An ecosystem is a dynamic complex of living organisms and a nonliving environment interacting as a functional unit (MEA 2009). Because these definitions are very similar, either version can be used in describing an ecosystem.

BIVALVES AS COMPONENTS OF ECOSYSTEM HEALTH

Ecosystem health may be defined in terms of characteristics applicable to any complex system. Costanza (1992) states that sustainability is a function of activity, organization, and resilience. Thus an ecosystem is healthy and free from distress if it is stable and sustainable—that is, if it is active and maintains its organization and

IMPORTANT TERMS AND CONCEPTS

Indigenous: A species within its natural range.

Interstitial space: Small, three-dimensional space that together with spat, adults, and shell fragments are a major source of biodiversity.

Introduced: A species is introduced specifically by human activities.

Invasion: A nonindigenous species moved out of its range by both human activities and natural range expansion.

Invasive species: A nonindigenous species that becomes successfully established.

MEA: Millennium Ecosystem Assessment of the United Nations.

Seascape ecology: The submerged equivalent of landscape ecology in the coastal zone.

Veneer: A flat layer of oyster spat that forms the top of an oyster reef.

autonomy over time and is resilient to stress. In this definition, it is implied that the ecosystem is sustainable and can maintain its structure and function over time.

As each ecosystem is unique, defining ecosystem health is a dynamic process that requires: (1) the identification of important indicators of health, i.e., metabolism, nutrient flux, primary production, etc.; (2) the categorizing of important endpoints of health, i.e., composites of indicators, species, and systems; and (3) the identification of a healthy state incorporating our values and overall system performances (Costanza 1992).

The concept of ecosystem health applies the model of human or animal medicine to the practice of “ecological medicine.” The assessment of health in medicine is as follows:

1. Identify the symptoms
2. Identify and measure the vital signs
3. Make a provisional diagnosis
4. Conduct tests to verify the diagnosis
5. Make a prognosis
6. Prescribe a treatment

While the model is applicable to ecosystems, ecologists do not have a compendium of known diseases or stresses with associated symptoms and signs. They have, however, begun to categorize system level stresses and record their effects (symptoms) on the ecosystem (Costanza 1992). Table 9.1 provides an early attempt at presenting these characteristics for bivalve-dominated systems. As more observations are added

TABLE 9.1
Characteristic Responses (Symptoms) of Bivalve-Domination of Ecosystem to Stress

| Stress | Nutrients | Primary Production | Size Distribution | Species Diversity | System Retrogression |
|-----------------------------------|-----------|--------------------|-------------------|-------------------|----------------------|
| Harvesting of renewable resources | – | – | – | – | + |
| Nutrient loading | + | + | – | – | + |
| Physical restructuring | * | * | – | – | + |
| Introduction of species | + | + | * | – | + |
| Extreme natural events | * | * | – | – | + |

Note: Signs (+ or –) indicate the direction of change compared with normal functioning of relatively unstressed systems. (*) Response not observed as yet.

Source: From Rapport, D.J., Regier, H.A., and Hutchinson, T.C. 1985. Ecosystem behavior under stress. *Am. Nat.*, 125, 617–40.

to this compendium, the next step is to develop quick diagnostic tests that will enable the ecologists to detect stress early (before ecosystem retrogression) and recommend remedial action.

If the database of symptoms and appropriate diagnostic tools for assessing ecosystem health are lacking, Costanza (1992) recommends network analysis and simulation modeling as stopgap approaches. Network measures, like ascendancy, estimate how many different species there are in an ecosystem and how these species are organized. Simulation modeling allows the prediction of ecosystem responses to various management alternatives and to natural environmental changes.

BIVALVES AS MONITORS

For almost a century, marine environmental monitoring focused on abiotic parameters like temperature, salinity, currents, and nutrients. With the advent of an awareness that pollutants (those things that cause a biological effect) and contaminants (discharges, etc., to the environment of materials in excess of normal concentrations) could affect mankind and the environment (Widdows and Donkin 1992), monitoring efforts were refocused on the detection of anthropogenic materials in order to obtain information on distribution, transport mechanisms, and the fates of these materials. Initially, analytical techniques had to be perfected, but eventually these problems were overcome and routine abiotic monitoring became widespread. However, the discrete sampling of natural waters followed by chemical analysis is considered inadequate for three reasons (Baldwin and Kramer 1994):

1. It fails to identify contaminants which are not included in the routine analysis but which may nonetheless occur.
2. It does not necessarily relate directly to the impact that measured chemicals have on the biota and ecosystem.
3. It may fail to identify sporadic contamination of the ecosystem.

In order to gain more information, continuous monitoring and biological monitoring have been developed. A number of attributes of bivalves have led to their use as “monitors,” “sentinels,” or “indicators” of environmental stress (Widdows and Donkin 1992; Smaal and Widdows 1994):

1. Bivalves are dominant members of coastal and estuarine systems and have wide geographical distributions.
2. These animals are sedentary and serve as integrators of contamination in a specific area.
3. They are relatively tolerant of (but not insensitive to) a wide range of environmental conditions.
4. Suspension-feeding bivalves pump large volumes of water and concentrate many chemicals by several orders of magnitude over concentrations in seawater.
5. Concentrations of contaminants in bivalve tissues provide an assessment of biological availability.

6. Bivalves have a very low level of activity for those enzyme systems capable of metabolizing organic contaminants.
7. Commercially important bivalve populations are relatively stable.
8. Bivalves can be readily transplanted and maintained in specific sites.
9. Several bivalves are commercially important as seafood, and their chemical contamination is of interest to public health.
10. Bivalves have several behavioral and physiological responses to stress that are easily and quickly measured.

With so many advantages, it is not surprising that bivalves have been successfully used as short-term and long-term monitors (Table 9.2) of environmental stress in coastal and estuarine waters.

TABLE 9.2
Temporal Scales of Various Bivalve Monitoring Approaches for Assessing Ecosystem Health

| Organizational Level | Process | Measurement | Stress Response | Temporal Scale |
|----------------------|---------------|--|------------------------------|----------------|
| Organism | Behavioral | Shell movement | Gaping, overextended closure | sec–min |
| Organism | Physiological | Growth | Reduced | weeks–years |
| Organism | Physiological | Condition index | Decrease | days–weeks |
| Organism | Physiological | Anaerobic metabolism | Increase | min–hours |
| Organism | Physiological | Pollutant or contaminant concentration | Increase in shell or tissue | weeks–years |
| Organism–population | Physiological | Reproduction | Decrease | weeks–years |
| Organism–population | Infection | Parasitism or disease | Increase | days |
| Organism–population | Toxicological | Mortality | Death | days |
| Organism–population | Metabolic | Scope for growth | Decrease | days–months |
| Community | Metabolic | Production: respiration | Decrease or increase | days–years |
| Ecosystem | Metabolic | Production: respiration | Decrease or increase | hours–years |
| Ecosystem | Connectivity | Ascendancy | Decrease | months–years |

Source: From Dame, R.F. et al. 2000. Estuaries of the South Atlantic coast of North America: Their geographical signatures. *Estuaries*, 23,(6), 793–819.

BIVALVES AS INTEGRATORS

The direct assessment of chemical pollution is difficult because pollutant concentrations in seawater are often so low that chemical preconcentration of samples is necessary before analysis. In other words, the concentration of pollutants is often below detection limits. As a result, clean and exacting water sample collections and handling techniques must be employed. In addition, the inherent variability of pollutant concentrations in seawater due to temporal and spatial variability in sources and removal processes require frequent sampling to assess mean or time-averaged levels (Pitts and Wallace 1994). As an alternative, chemical concentrations in various bivalve tissues (soft and hard) are often used as indicators of ambient water chemistry. Because of their feeding processes, these organisms can concentrate many chemical species by orders of magnitude over seawater concentrations. Furthermore, pollutant levels in specific tissues provide an indication of bioavailability (Pitts and Wallace 1994). For these and previously listed reasons, bivalves have been used as monitors of chemical contamination in coastal waters, particularly in areas receiving waste discharged from point sources such as municipal waste treatment plants or nonpoint sources such as stormwater runoff.

There is strong experimental evidence supporting the use of living bivalves as biomonitors. Numerous laboratory experiments with controlled concentrations and exposures (Cunningham and Tripp 1975; Fisher and Teyssie 1986; etc.), as well as field transplant experiments of oysters and mussels between high and low concentration areas (Roesijadi et al. 1984; Martin 1985; etc.) have demonstrated the accumulation of pollutants in bivalves. The degree to which inorganic and organic contaminants are accumulated by bivalves depends on both abiotic physiochemical properties, and biotic factors such as pumping activity, growth, biochemical composition, reproductive condition, and metabolism. All of these various factors influence the rates of the dynamic processes concerned with uptake deposition and depuration that together determine the degree of bioaccumulation (Widdows and Donkin 1992).

As early as 1976, the United States initiated the "Mussel Watch Monitoring Program" as a means to monitor pollution in coastal waters using mussels and oysters (Goldberg et al. 1978). Similar programs were developed in the U.K., France, Canada, Australia, Japan, Taiwan, India, South Africa, and the Soviet republics. In these early efforts, bivalve body tissues were analyzed for four classes of pollutants: trace metals, chlorinated hydrocarbons, petroleum hydrocarbons, and radionuclides (Goldberg et al. 1978, 1983). The primary motivation of these observations was to protect human health by estimating exposure via the diet back to humans and protect valuable living resources (Widdows and Donkin 1992).

The early version of Mussel Watch in the United States was eventually superseded by the National Status and Trends (NS&T) Mussel Watch Project in 1986. This project annually samples more than 100 sites along the Atlantic, Gulf, and Pacific coasts of the United States. *Mytilus edulis* is the sampled species from Maine to Delaware Bay; *Crassostrea virginica* from Delaware Bay through the Gulf of Mexico; and the mussels *M. edulis* and *Mytilus californianus* along the West Coast. The chemicals that are analyzed include DDT and its metabolites (6), chlorinated pesticides other than DDT (9), polychlorinated biphenyls (18 congeners), polycyclic

aromatic hydrocarbons (24), and the major elements aluminum, iron, and manganese, as well as trace elements (11). Except for the major elements, all are possible contaminants in the sense that their concentrations in the environment have been altered by human activities (O'Connor et al. 1994). The project operates sporadically, but usually produces good long-term data.

In monitoring programs over wide geographic ranges, several bivalve species may be used, but species intercomparability can be a problem. For example, oysters and mussels are not equal in their ability to concentrate chemicals. When the two bivalves are compared at the same site, the trace elements of silver, copper, and zinc are highly enriched by oysters while chromium and lead are higher in mussels (O'Connor et al. 1994). No strong species effect was found for organic compounds or other elements. Similar species, i.e., *M. edulis* and *M. californianus*, concentrated chemicals similarly. In order to offset physiological effects within a bivalve species, samples are taken on a set size range, at the same site, and in the winter prior to the spawning season.

Pitts and Wallace (1994) have shown that in addition to the concentration of trace elements in the soft body tissues of bivalves, analysis of such elements in the bivalve shell is also feasible. Using the clam *Mya arenaria*, these investigators found that there was a strong correlation between lead in the shell and lead that was dissolved in seawater. Their method required few samples ($n = 5 - 10$) and could be done on individual annual growth layers (see Chapter 3). Thus the shell analysis technique offered not only current estimates of lead in a given coastal environment, but also estimated lead concentrations from the recent and ancient past.

Generally, the mussel watch-type programs have not only quantified the degree of contamination, but they have identified unexpected contamination hot spots (Widdows and Donkin 1992). Thus bivalves as sentinel organisms have proved to be useful tools in identifying variations in chemical contamination between sites and have contributed to an understanding of trends in coastal contamination (Widdows and Donkin 1992).

BIVALVE RESPONSES

Widdows and Donkin (1992) have argued that pollution implies a biological effect while contamination is a physical–chemical phenomenon. Therefore, they contend that the assessment of pollution and environmental quality must ultimately be in terms of biological measurements, preferably in concert with appropriate measurements of chemical contaminants.

Appropriate biological observations for assessing and monitoring environmental quality should meet most of the following criteria (Widdows and Donkin 1992):

1. They should be sensitive to actual environmental levels of pollutants, and have a response from optimal to lethal conditions.
2. They should reflect a quantitative and predictable relationship with toxic contaminants.
3. They should have a relatively short response time so that pollution impacts can be detected in their incipient stages.

4. The technique should be applicable to both laboratory and field studies in order to associate laboratory-based concentration–response relationships to field measurements of spatial and temporal changes in environmental quality.
5. They should not only provide an integrated response to the total pollutant load, but should also provide insight into the underlying cause and the mechanism of toxicity.
6. The biological response should have ecological relevance and be shown to reflect deleterious effects on fundamental physiological parameters of the individual that translate to the level of the population and the system.

Some responses of bivalves that have been used to measure the effects of contaminants and the effects of environmental pollution are shell movement, mortality, shell growth, tissue growth, and scope for growth.

SHELL MOVEMENTS

In a time perspective, most biological approaches to monitoring focus on the past occurrence of pollutants over weeks or longer time spans. If an immediate warning of a pollution event is needed, then some sort of continually monitored biological response must be considered. These “biological early warning systems” (BEWS) provide a rapid warning of the occurrence of contaminants at concentrations that could be immediate threats to living systems. These systems are a combination of an automated continuous biological monitor serving as a sensing element and coupled to an electrical, optical, or mechanical sensing element that transfers the information to a monitoring computer. They usually measure a physiological or behavioral response of the organism (Baldwin and Kramer 1994).

A number of physiological responses by bivalves have been tested in the laboratory for their suitability to detect environmental change (Akberali and Trueman 1985). A few that seem promising for use in BEWS systems are heartbeat, respiration, filtration, pumping rate, and shell or valve closure (Baldwin and Kramer 1994). Of these responses only shell closure has, to date, led to a practical BEWS technique. Closure of the valves is a typical example of an escape or avoidance behavior response as bivalves normally have their shells open for feeding and respiration. Numerous studies have shown that bivalves close their shells under both natural and anthropogenic stress, and this closure may last for an extended period of time. Certain other stresses, particularly pollutants such as chlorine and organic solvents, cause a dramatic increase in valve movement activity (Kramer et al. 1989).

A BEWS has been developed using the valve movement response in blue mussels. This system is commercially known as the Musselmonitor (Kramer et al. 1989). The mussel monitor is designed to operate *in situ* and is contained in a waterproof housing. Valve movement is detected with a high frequency electromagnetic induction system. The electronic sensor consists of two small coils glued to opposite shell halves of the mussel. One coil acts as the transmitter generating a magnetic field while the other coil functions as a receiver. Across the width of the individual bivalve, a linear response is obtained. The system is normally deployed with eight

mussels, and each mussel is individually monitored to discriminate individual mussel behavior and improve the reliability of alarm detection. Valve movement likewise allows the detection of animal death or low battery power. This system also permits optimization for maximum sensitivity and minimum false alarms (Baldwin and Kramer 1994). As the system is operating *in situ*, handling of the mussel is minimized. Moreover, the system has been deployed for more than 3 months without replacement of the mussels. Suspension-feeding bivalves are considered best for use in the mussel monitor because they are in maximum contact with the water column. *Mytilus edulis* and *Ostrea* sp. have been used in temperate estuarine situations, while the green mussel, *Perna viridis*, offers possibilities in tropical areas (Baldwin and Kramer 1994).

BEWS are thought to be best used when a relatively steep gradient in pollution concentration is to be detected. In marine conditions, dilution may be a factor, and in estuarine systems, salinity may interfere with the measurements. It is thought BEWS should be useful for effluent monitoring near industrial effluent lines, offshore discharges, aquaculture sites, and intake water for public aquaria and marinas (Baldwin and Kramer 1994).

MORTALITY

In the laboratory, the most common measure of acute toxicity to chemical contaminants is the 96 h LC₅₀ test, which determines the toxicant concentration resulting in a 50% lethal response over a period of 96 hours exposure. This approach works well with larval bivalves (populations), but leads to false estimates of tolerance in adult bivalves because they usually close their valves and thus isolate themselves from extreme environmental conditions for long periods of time. Also, it takes a long time for adult bivalve mortality effects to overcome extensive body reserves, but long-term lethal effects can be predicted from measurements of negative energy balance or scope for growth (Widdows and Donkin 1992). The mortality approach is seldom advocated because it lacks the sensitivity either to protect the environment by adequately screening toxic materials prior to release, or to identify pollutant effects in all but the most extreme and acute environmental pollution events.

A more promising approach is the resistance of bivalves to aerial exposure (Eertman and de Zwann 1994). Some bivalves, like mussels, when acclimated to subtidal conditions are unable to consume enough oxygen when suddenly exposed to air. Thus aerial exposure of these bivalves, like exposure to environmental anoxia, will gradually result in their tissues becoming anoxic and in their metabolic processes switching from aerobic to anaerobic. In those species that are able to consume oxygen during aerial exposure, anoxia tolerance can be determined by exposing these bivalves to anoxic seawater.

Numerous studies (see Eertman and de Zwaan 1994) indicate that natural or anthropogenic factors that reduce anoxia tolerance will lead to higher mortality or reduced fitness in bivalves. Such factors are stress indicators according to Bayne's (1980) definition. Anoxic survival is consequently a stress index where the damage caused by environmental factors is expressed as a reduced capability to

resist environmental change in the form of blocked supply of oxygen. This stress is evaluated from mortality data. The method is simple and inexpensive, with general applicability potential to coastal monitoring programs.

SHELL AND TISSUE GROWTH

The rate of growth is a basic measure of the physiological fitness of an organism and, to a certain extent, a population. For this reason, growth has frequently been used as a measure of pollution effects and environmental quality. In bivalves, growth is often difficult to measure in a quantifiable way because (1) production due to reproduction (gametes) is lost from the animal and extremely difficult to determine directly, (2) weight changes are difficult to measure because of shells and trapped water within shells, (3) there is no tight coupling between shell growth and that of soft tissues and gonads, and (4) it is difficult to separate nutrition and sublethal toxicant effects in field measurements of growth (Widdows and Donkin 1992). The end result of these problems is that natural environmental variability in growth can mask sublethal effects of pollutants.

The preceding concerns are less of a problem when bivalve larvae are the organisms selected. As they are followed in laboratory controlled conditions for short time periods, growth measurements are usually combined with mortality estimates (Calabrese et al. 1977; Widdows 1991).

BIVALVE SCOPE FOR GROWTH (SFG)

The growth process in bivalves can be disrupted by changes in environmental quality and stress. As noted earlier, scope for growth (SFG) is an integrated physiological parameter that reflects the balance between the processes of energy acquisition (feeding and absorption) and energy expenditure (metabolism and excretion). This determination of the energy available for growth is estimated by an energy budget rather than by the direct measurement of growth itself, and has proven to be particularly effective in assessing the biological effects of pollution (Widdows and Johnson 1988; Smaal and Widdows 1994). The SFG approach provides not only an instantaneous estimate of the energy status of the animal, but also supplies insight into the underlying physiological components that effect changes in the growth rate. In addition, there is supporting evidence that there is agreement between indirect growth estimates using energy budgets and direct methods measuring tissue and shell growth (Riisgård and Randløv 1981), and observations of production utilizing detailed population analysis (Gilfillan and Vandermenlen 1978; Bayne and Worrall 1980; Grant and Cranford 1991).

Scope for growth can be defined by the energy-budget equation

$$C = P + R + E + F \quad (9.1)$$

and

$$P = A - (R + E) \quad (9.2)$$

where C is consumption, P is total production (shell, tissues, gametes), R is respiration, E is excretion, F is fecal energy, and A is assimilated or absorbed energy. When production is estimated by the difference between assimilation and respiration plus excretion it is called scope for growth (Warren and Davis 1967). When scope for growth is estimated under well-defined conditions, it provides an integration of the various physiological parameters involved and a discrimination between natural and anthropogenic stress (Figure 9.1).

The advantages of using the scope for growth estimate on bivalves in marine ecosystems as an environmental quality monitoring technique are according to Smaal and Widdows (1994):

1. SFG provides a sensitive, quantitative, and integrated stress response over a wide range of conditions.
2. A decline in growth has ecological relevance and is readily interpretable as a deleterious effect.

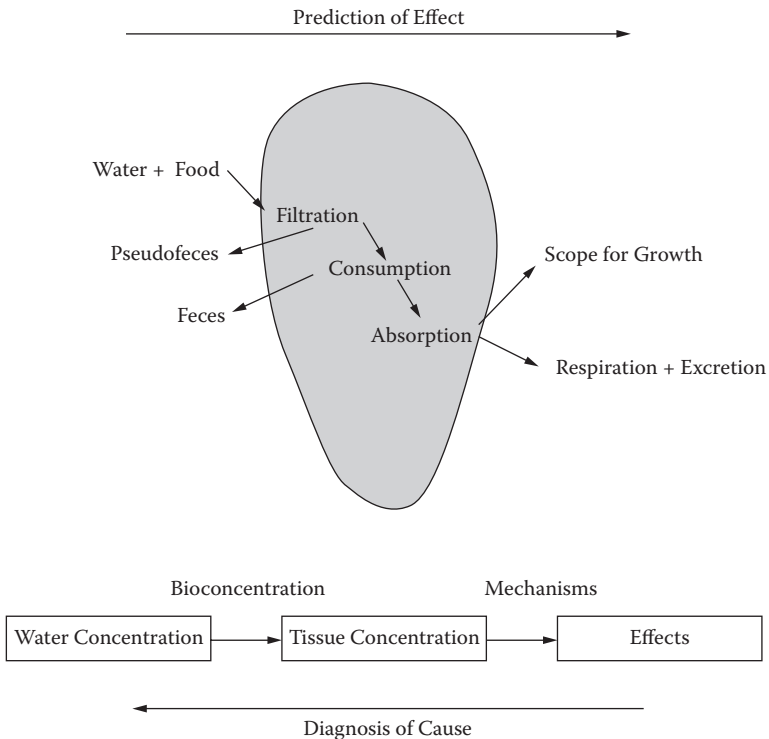

FIGURE 9.1 Bivalve scope for growth as part of the original energy budget with an ecotoxicology framework. (Adapted from Widdows, J. and Donkin, P. 1992. Mussels and environmental contaminants: Bioaccumulation and physiological aspects. In *The Mussel Mytilus: Ecology, Physiology, Genetics and Culture*, Gosling, E., Ed. Amsterdam: Elsevier, pp. 383–424.)

3. SFG is an early warning indicator of cellular and metabolic responses at the individual level, which allows detection of responses to environmental change prior to measurable effects on the growth, reproduction, or survival of the individual.
4. SFG represents an instantaneous estimate of growth potential, which can be applied rapidly and cost effectively both in the laboratory and under field situations.

The disadvantages of the SFG approach include initial equipment costs and a need for a higher level of training and expertise for the personnel involved. For a discussion of specific techniques for using SFG on bivalves, see Smaal and Widdows (1994).

A number of both natural and anthropogenic factors influence the estimation of scope for growth in bivalves. The physiological rates of feeding, respiration, and excretion all increase with increasing body size in an allometric manner (see Chapter 4). Reproductive condition can influence SFG as respiration and excretion rates are higher when gonads are fully developed (Smaal and Widdows 1994). Hence the spawning period should be avoided in SFG measurements. Genetic differences have only a slight influence on SFG, but parasites can reduce filtration rates and growth rates. Laboratory conditions can affect the SFG of bivalves when these conditions exceed the adaptive capacity of field-acclimatized animals. For this reason, laboratory conditions should be close to ambient field conditions (Smaal and Widdows 1994).

SFG in bivalves can be influenced directly, as an acute response to chemical contaminants in water and sediment (Smaal and Widdows 1994), or after chronic exposure and long-term accumulation of pollutants (Widdows and Donkin 1992). Numerous field studies show that SFG varies significantly in mussels collected along estuarine or pollution gradients. In other words, there is lower SFG with higher pollution. Those interested in details of various contaminants and their influence on bivalve SFG may see Smaal and Widdows (1994).

The scope for growth approach for quantifying the biological effects of pollutants has several important attributes (Widdows and Johnson 1988) as seen in the following list:

1. It demonstrates sensitivity to environmentally realistic levels of pollution.
2. It reflects a quantitative and predictable relation with the concentrations of toxicants in the bivalve body tissues.
3. It represents a general response to the total pollution stimulus in a given system.
4. Bivalve feeding and growth responses are readily interpretable in terms of significant negative effects at the level of the organism and the population.

At present it appears difficult to extrapolate SFG to the health of the ecosystem because of the variability and inconsistencies of the data involving feeding and growth.

SYSTEMS MEASURES

Bivalves can be integral and important components in marine and estuarine ecosystems. While these animals are good monitors of pollution and stress in ecosystems, the transition from their organismic and population status as indicators of environmental quality to signs of ecosystem health is at best vague because these indicators do not reflect the complexity of ecosystems. Costanza (1992) has argued that there is a progression from directly measured indicators of a component's status through endpoints that are composites of these indicators, to measures of system values including performance and health. While indicators are directly measured tangible observations of generally high precision, values are difficult to determine, highly comprehensive, and relevant. As we have shown, there are a number of bivalve processes that are good indicators of environmental quality, and in some systems bivalve populations and their associated communities are important enough to be considered endpoints. However, the final step to values of overall system health, the most integrative step, has yet to be accomplished.

To meet the goal of a practical definition of ecosystem health, Costanza (1992) believes that the concept of ecosystem health should include a combined measure of the system (Table 9.3). These measures include (1) resilience, the ability to maintain its structure and patterns of behavior in the face of disturbance; (2) balance, the proper equilibrium between system components; (3) organization, diversity, and complexity; and (4) vigor, system metabolism, or scope for growth—the difference between the energy required for system maintenance and the energy available to the system for all purposes (P/R). Other considerations include a comprehensive description of the system, a weighing of factors to compare and aggregate the different components, and a hierarchical presentation to account for the interdependence of various time and space scales.

TABLE 9.3
Potential Components of an Ecosystem Health Index as Envisioned by Costanza (1992)

| System Health Component | Related Concept | Related Measures | Method |
|-------------------------|--|------------------------------|------------------|
| Vigor | Function productivity throughput | GPP, NPP, P/R, metabolism | Measurement |
| Organization | Structure biodiversity | Diversity index | Network analysis |
| Resilience | Disturbance | Scope for growth | Simulation |
| Combinations | Connectivity Complexity | Ascendancy | Simulation |

Source: From Costanza, R. 1992. Toward an operational definition of ecosystem health. In *Ecosystem Health: New Goals for Environmental Management*, Costanza, R., Norton, B.G., and Haskell, B.D., Eds. Washington, DC: Island Press, pp. 239–256.

Thus Costanza (1992) proposed a preliminary index of overall system health:

$$HI = V \cdot O \cdot R \quad (9.3)$$

where HI = system health index, and also indicates sustainability; V = system vigor; O = system organization; and R = system resilience. In Table 9.3 the probable methods of determining the various components of HI are listed.

ECOSYSTEM SERVICES

Ecosystems are functional. In other words, they accomplish goals in terms of producing goods and services. Using a nutrient cycle as an example, we know that the nitrogen cycle involves innumerable individual organisms and species that are dynamically coupled to control parameters that are continuously responding to weather and climatic drivers. This example is the reality of a true complex system. It contains components, moves energy and matter into and out of its space, and interacts with components.

Ecosystem services are the conditions and processes through which natural ecosystems, and the species that make them up, sustain and fulfill human life; or the fundamental life-support services provided by natural ecosystems without which human civilization would cease to thrive (Daily 1997). To make it clear, humanity can at best only approximately duplicate a few ecosystem services and then only at huge costs.

Palmer and Filoso (2009) emphasize that measuring an ecological process is not the same as measuring an ecosystem service. The former is based on accepted scientific methodology that tells how the ecosystem is performing; the latter is based on the yield of a final product or service. The ecosystem approach is a strategy for the integrated management of land, water, and living resources that promotes conservation and sustainable use in an equitable way (Beaumont et al. 2007). Assessing ecological processes and resources in terms of the goods and services they provide translates the complexity of the environment into a series of functions that can be more readily understood by policymakers and nonscientists. Describing the environment in this manner also enables a true understanding of what exactly is being gained or lost when exploitation or development takes place (Beaumont et al. 2007).

The Nature Conservancy in 2009 estimated that 85% of the maximum global amount of oyster reefs had been lost due to anthropogenic impacts (Beck et al. 2009).^{*} However, the same or similar restoration programs that were being developed for ecosystem services could be implemented to rebuild and restore oyster reefs and mussel beds worldwide. Further, such an expanded program adds expertise and provides more opportunities for interaction idea generation (Beck et al. 2009; Boström et al. 2011).

Beds of bivalve molluscs generally provide ecosystem services in four areas: cultural, provisional, regulating, and supportive. Cultural services include recreational and tourism oriented activities as well as historical and educational experiences.

^{*} Author's note: The 85% loss should be verified independently.

Provisional products include fisheries, fertilizers and jewelry. Regulating activities are represented by water quality maintenance, shoreline protection, and sediment trapping. Supportive services include nutrient cycling, biodiversity, and habitat construction (Table 9.4).

SYSTEM VALUATION

Historically, the value of ecosystem services apparently has been overlooked by humans until something critical or drastic occurs. Such events disrupt water and material cycles that in turn interact with weather and climate to corrupt the present status quo. For example, the 2 to 5 year cycle of El Niño/La Niña changes the environment for a relatively short time.

For many ecologists, valuation of ecosystem services may be unnecessary or even inappropriate. *Homo sapiens* is one species among millions and this will not alter the fact that ecosystems will continue to operate in some fashion regardless of human activities (Limburg et al. 2002). The concept that one species is in charge and is managing the ecosystem makes little sense. The ecological system is invaluable because its continued stable operation is essential for human survival (Limberg et al. 2002).

The critical interactions between humans and the environment are not determined by societal value systems but those derived from ecological systems. It is the ecosystem's rules that count, rather than humanity's self-centered concept of its place in the universe. *Homo sapiens* is the species in danger because it is the species that is undermining the ability of the biosphere to maintain the essential flows of ecosystem goods and services (Limberg et al. 2002).

TABLE 9.4
Ecosystem Services and Functional Processes Attributable to Marine Bivalves

| Ecosystem Services | General Type | Direct/Indirect | Ecosystem Function | Example |
|--------------------|---|---------------------|--|---|
| Provisioning | Fishing | Direct | Energy and matter | Seafood, aquaculture, fertilizer, jewelry |
| Supportive | Nutrient cycling, habitats, biodiversity | Direct and indirect | Storage, internal cycling | Nitrogen fixation |
| Regulating | Shoreline protection, water quality maintenance | Direct and indirect | Storage and retention of water | Water management |
| Cultural | Recreation and tourism | Direct and indirect | Providing opportunities for recreation | Ecotourism |

Source: From Beaumont, N.J. et al. 2007. Identification, definition, and qualification of goods and services provided by marine biodiversity: Implications for ecosystem approach. *Mar. Poll. Bull.* 54: 253–265.

INVASIONS BY BIVALVES

The invasion of estuarine and marine habitats by nonindigenous species (NIS) of invertebrates is a common event. Bivalves are one of the most common NIS. However, strong prejudices are thought to have biased the data set. The absence of reliable experimental data does not speak well for the research community.

There are at least two hypotheses that deal with the response of the local bivalves to invaders. The Data Bias hypothesis, for example, examines the data set for observed patterns of marine invasions. Experience tells us that there are probably at least three patterns in each of the data sets. The first patterns are derived from the “by-catch” data. The quality of systematic and biogeographic data is usually very unevenly distributed, thus resulting in difficulties. For more on this topic see Ruiz et al. (2000).

Using the ecological medicine model described in the introduction of this chapter, bivalves can and currently do play an important role in the determination and maintenance of ecosystem health in many coastal ecosystems. Because these animals are proven integrative monitors, they are commonly used as indicators of numerous symptoms of system stress and may be important components in determining the vital signs of some ecosystems. From the early warning of system problems, bivalves can be instrumental in developing provisional diagnoses and providing reliable test subjects to verify these diagnoses. After a treatment program is initiated, bivalves can be important monitors of its effectiveness. These bivalves are also often major components of their ecosystems. Therefore, they and their systems will play a prominent role in the development of ecosystem health indices and values not only in coastal and estuarine systems, but for ecosystems in general.

BIODIVERSITY

Biodiversity is the variety of life at all levels of organization from genes to ecosystems and from ecosystems to landscapes or seascapes (Pittman et al. 2011). Biologists tend to focus biodiversity studies on the number of species in an ecosystem. The rapid spatial and temporal expansion of our species on our planet has led to dramatic increases in species extinctions and to much lower biodiversity. These changes have raised numerous concerns that the functional stability of the planet’s ecosystems are in danger and the major source or sources of some essential ecosystem services or processes could be lost.

BIODIVERSITY AND ECOSYSTEM PRODUCTIVITY

Vitousek and Hooper (1993) have proposed three qualitatively different potential relationships between biodiversity and an ecosystem process (Figure 9.2). The linear relationship (1) suggests that each species added to or removed from an ecosystem would have the same impact on an ecosystem as any other species. The flat relationship (3) means that after one, two, or some small number of species are present additional species would have no effect on an ecosystem process. Vitousek and Hooper (1993) hypothesize that the most likely response would be a saturating or asymptotic

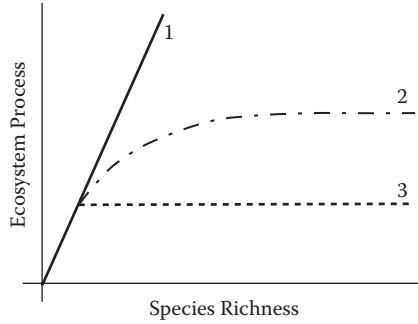

FIGURE 9.2 Hypothetical plots of species richness versus ecosystem process. (From Vitousek, P.M. and Hooper, D.U. 1992. Biological diversity and terrestrial ecosystem biogeochemistry. In *Biodiversity and Ecosystem Function*, Schulze, E.D. and Mooney, H.A., Eds. Berlin: Springer-Verlag, pp. 3–14.)

curve (2), because each added species shares an increasingly greater proportion of its product with existing species and thus does less to diversify the functioning of the ecosystem than the initial species.

INVASION, EXTINCTION, AND BIODIVERSITY

The ecological community is concerned about what happens to an ecosystem that is invaded by a non-native species. Gurevitch and Padilla (2004) believe that invasions of non-native species are a major cause of species extinctions (Table 9.5). Moreover, Lamoreux et al. (2003) state that extinctions not only change biological communities, but they also lead to declines in biodiversity.

From a different perspective, Byrnes et al. (2007) report on the impact of invasions and extinctions in reshaping coastal marine food webs. These investigators examined data from the Wadden Sea in Europe, San Francisco Bay in California, and The Gulf of the Farallones in Australia. They found that the combined effect of species loss was due to human-caused extinction. The species gain resulted from both intentional and accidental introductions that were changing the trophic structure of food webs in these systems. Specifically, most extinctions took place with high trophic level animals and most invasions were by species at lower trophic levels (deposit feeders and suspension-feeders). The opposing changes altered the shape of the marine food webs. A shorter, squatter structure dominated by suspension-feeders replaced a trophic pyramid that was capped by a diverse array of predators and consumers (Byrnes et al. 2007).

Most of the preceding statements are generally true, but starting in the late 1990's a number of new studies were initiated in both the United States and northern Europe that would increase our understanding of the way bivalve-dominated estuarine ecosystems functioned. In each area, the studies tended to focus on one large estuary: Chesapeake Bay in the United States and the Wadden Sea in northern Europe. These ecosystems have different properties. However, if we look at them from a functional view point, there are more similarities than differences.

TABLE 9.5
Extinction Vulnerability Characteristics

| Characteristic | High | Low |
|-------------------------------|----------------|----------------|
| Population Turnover | | |
| Longevity | Long | Short |
| Growth rate | Slow | Fast |
| Natural mortality rate | Low | High |
| Reproduction | | |
| Effort | Low | High |
| Frequency | Continuous | Seasonal |
| Sexual maturity | Old or large | Young or small |
| Sex change | Protandry | No |
| Spawning | Synchronized | Other |
| Allee effects | Strong | Weak |
| Recovery Capacity | | |
| Fragment regeneration | Does not occur | Occurs |
| Dispersal | Short | Long |
| Competitive ability | Poor | Good |
| Competitive | Poor | Good |
| Colonizing | Poor | Good |
| Adult mobility | Low | High |
| Range and Distribution | | |
| Horizontal dispersal | Nearshore | Offshore |
| Vertical depth range | Narrow | Broad |
| Geographic range | Small | Large |
| Patchiness of population | High | Low |
| Habitat specificity | High | Low |
| Habitat vulnerability | High | Low |
| Common or Rare | Rare | Abundant |

Source: From Troost, K. 2010. Causes and effects of a highly successful marine invasion: Case-study of the introduced Pacific oyster *Crassostrea gigas* in continental NW European estuaries. *J. Sea Res.*, 64, 145–65.

In other words, their dominant organisms are suspension-feeding bivalves. For example, the subtidal Eastern oyster, *Crassostrea virginica*, was the initial dominant suspension-feeding bivalve in Chesapeake Bay. The flat oyster, *Ostrea edulis* and the mussel, *Mytilus edulis*, were the dominant suspension-feeding bivalves in the Wadden Sea. During the past few decades, each ecosystem was losing or lost one or more dominant suspension-feeding species. For instance, Chesapeake Bay was having trouble sustaining *C. virginica* while in the Wadden Sea the flat oyster, *O. edulis*, went extinct.

For more than a century, oyster research in the United States focused on the environment in Chesapeake Bay and the decline of the Eastern oyster, *Crassostrea virginica*, in mainly subtidal beds. Although the early colonists reported seeing extensive oyster beds breaking the surface waters of the bay, the oysters of these beds were easily stripped and almost impossible to restore to their former glory because each oyster farmer had his own unique experience with overharvesting. Many oyster farmers claimed that the intertidal oysters were not worth harvesting. Moreover, they believed that the oysters were on the verge of extinction. But times change and a new wave of oyster biologists came to the bay with different experiences. Some of these scientists argued that in South Carolina and Georgia the intertidal oyster reefs were among the most productive ecosystems in the world (Dame 1976; Crook 1992). The southeastern United States also had a different way of looking at the ecology of oysters. It was called “the ecosystem approach.” These scientists contended that oysters were actively integrated into the system as a whole. Therefore, these oysters were major factors influencing the structure and function of the system rather than being isolated components in it. After years of declining oyster production, the scientists studying Chesapeake Bay began to question the dogma of the past generation. For example, why were the intertidal oysters surviving while the subtidal ones were dying? Studies showed that *C. virginica* preferred to settle on *C. virginica* shells and in the process cemented their spat to shell fragments and living oysters. This flat, hard surface is the foundation or base that is often complemented with a veneer or top layer. Not only is the structure becoming stronger and three-dimensional, but the size of the average individual bivalve is changing according to the ratio of surface area to volume ratio of 0.75. This means that the average newly settled bivalve will pump more water in less time. Thus the oysters formed into a very strong and stiff three-dimensional structure, creating the first stage of reef construction. As the structures got higher, the water flushed the interstitial spaces more quickly, which made more food available to the newly settled oysters (Bartol et al. 1999). Soniat et al. (2004) showed that the increased water circulation caused by enhanced vertical relief also promoted oyster survival and the formation of a resident fish habitat. Results from other investigations indicated there were at least two separate scales that should be taken into account: small or interstitial size and large or mound size assemblages (Nesterode et al. 2007). Finally, Powers et al. (2009) found that “no harvest” sanctuary areas, places where there is no interaction between humans and the environment, facilitated oyster growth.

A CASE STUDY: THE WADDEN SEA AND THE INVASION OF *CRASSOSTREA GIGAS*

Until the 1940s and 1950s, the dominant oyster species in northwest Europe was the European flat oyster, *Ostrea edulis*. A number of circumstances led to the decimation and finally the extinction of this oyster; first, overharvesting of the oysters, then several hard winters followed by the mixing of brood stocks with foreign strains, and finally the introduction of the parasite *Boromia ostreae* (Troost 2010). Thus the

opportunity arose to find a replacement that would fill the functional niche that *O. edulis* had occupied.

BIOLOGY OF *CRASSOSTREA GIGAS*

The genus *Crassostrea* is composed of oysters that attach to hard substrates including each other by secreting a form of cement that allows them to build three-dimensional reefs. *C. gigas* is often referred to as the Pacific or Japanese or giant oyster, because these common names explain their place of origin and describe their size.

In Europe the life cycle of *C. gigas* is initiated with spawning in mid-summer when temperatures are highest. The pelagic or dispersal stage lasts about 3 weeks after which the larvae seek out a hard substrate such as oyster shells or rocks on which to settle. Then the larvae cement their lower cupped valve to the substrate (Troost 2010).

THE SPREAD OF *CRASSOSTREA GIGAS*

Initially, *C. gigas* was not seriously considered as a replacement for *O. edulis* because it was thought that the cool waters around northwestern Europe would be too stressful for its physiology. However, it was brought in for research purposes from the Sakhalin Islands, Russia. The oysters were released as spat in a cooling water basin of a power and desalinization plant on the island of Texel that lies between the North Sea on the west and the Wadden Sea on the east in North Holland, The Netherlands. After their initial introduction in The Netherlands in 1964, *C. gigas* was also introduced in Belgium (1969), Germany (1971), Denmark (1972), Sweden (1973), and Norway (1979). It turns out that the Pacific oyster's favorite settlement substrate in northwestern Europe are the shells of the mussel, *Mytilus edulis*, that live in the mid-intertidal zone (Troost 2010).

REEF BUILDING

In the Wadden Sea, beds solely occupied by mussels form a flexible meshwork with individual bivalves connected by attachable/detachable byssal threads. *M. edulis* essentially constructs or creates a three-dimensional, flexible structure as multiple individuals connect and disconnect their shells by byssal threads. Because the sediments and fluids can pass through the mesh, the mussels can more efficiently flush the pore waters underneath the bed. Moreover, the individual mussels are vertically mobile and are less likely to be buried. The interaction of *M. edulis* and *C. gigas* creates rigid reef-like structures (Markert et al. 2010). The macrofaunal system associated with this "hybrid" reef shows increased species richness, biomass, and diversity (Markert et al. 2010; Troost 2010). All of these factors support the argument that this new form of reef is a more complex system. In North America, *C. virginica* prefers to build a third type of bivalve reef, a reef built mostly of *C. virginica* shell. The shells of *C. virginica* are thicker and heavier than other species of *Crassostrea*, which suggests that *C. virginica* constructs the strongest bivalve reefs.

INVADERS AND THEIR ECOSYSTEMS

An invasive species refers to nonindigenous species that manage to establish successfully and has a certain impact on its receiving ecosystem. There are definite characteristics that determine whether a species is invasive and its habitat can be invaded. These stages include the following:

1. Colonization of the receiving ecosystem
2. Establishment in the receiving habitat
3. Natural range expansion after establishment

CONTRIBUTORS TO SUCCESSFUL ENVIRONMENTS

There are several contributing factors for the successful adaptation of *C. gigas* in the Wadden Sea (Table 9.6). These traits include (1) a lack of natural enemies; (2) “ecosystem engineering”; (3) adaptability to new surroundings; and (4) dispersibility.

First, there are natural predators. Birds such as herring gulls (*Larus argentatus*) and oyster catchers (*Haematopus ostralegus*), shore crabs (*Carcinus maenas*),

TABLE 9.6
Characteristics Generally Attributed to Successful Invader Species

| Stage | Trait |
|-------------------------|---|
| Colonization | R-Selected Life History Strategy Rapid growth Rapid sexual maturation High fecundity Generalists Ability to colonize wide range of habitat types Broad diet Tolerance to wide range of environmental conditions Gregarious behavior Genetic variability and phenotype plasticity Ability to recolonize after population crash |
| Establishment | Lack of natural enemies Ecosystem engineering Association with humans Repeated introductions Genetic variability and phenotype plasticity Competitiveness |
| Natural range expansion | Traits of successful colonist (see above) Dispensability |

Source: From Troost, K. 2010. Causes and effects of a highly successful marine invasion: Case-study of the introduced Pacific oyster *Crassostrea gigas* in continental NW European estuaries. *J. Sea Res.*, 64, 145–65.

starfish (*Asterias rubens*), and the fungus *Ostreas implexa* are among the organisms that feed on or attack the oysters. However, none of these predators seem to be causing high mortality rates (Troost 2010).

Secondly, *C. gigas* is sometimes referred to as an “ecosystem engineer” because of its ability to build strong, three-dimensional reefs. These structures provide shelter against extreme environmental conditions such as heat and desiccation, a refuge from predators such as birds and crabs, and reduction in the ratio of predator–prey encounters. In addition, the roughness of the reefs helps increase the food flux toward the bivalves and reduces refiltration of already filtered seawater. Finally, the reefs provide the hard substrate and surface necessary for spat settlement.

A third factor is *C. gigas*’ ability to adapt to new environments. In terms of survival, growth, and reproductive effort, *C. gigas* is very flexible in the morphology of its feeding programs and in the limits of its thermal tolerance.

Finally, *C. gigas*’ ability to survive is related to its capabilities to colonize and disperse. There are certain traits attributed to successful colonizers. These traits include fast growth rates, rapid sexual maturation, and a high fecundity. *C. gigas* appears to fulfill most of these characteristics. For example, in 2 years at Sylt, Germany, it can reach a length (long axis) of 80 mm. Then, in regard to its ability to reproduce, it may produce more than 50 million eggs per spawning. Its eggs are small and have a lower energy content resulting in a longer duration of the pelagic larval phase. This trait enables it to have a wider dispersal range and the capability of spreading rapidly.

POSITIVE IMPLICATIONS OF *CRASSOSTREA GIGAS*

There are many reasons why *C. gigas* may have a positive influence on the ecosystems of the Wadden Sea. For instance, in its mature reef form *C. gigas* may prevent further erosion on the intertidal flats. As the oyster reefs grow larger, they will likely protect the higher trophic rated pinnacle consumers and that can potentially change the food webs of shallow tidal streams. In addition, the sediments will be enriched by organic waste deposited by animals. Basically, the Wadden Sea has the potential to grow into a large energy and nutrient trap driven by billions of hand sized water pumps. Furthermore, the Wadden Sea ecosystem may restore habitat diversity and biodiversity because the fishermen don’t want to tear their nets on the oyster shells. Finally, *C. gigas* and *M. edulis* may coexist with *M. edulis* growing on the bottom between *C. gigas* reefs.

CLIMATE CHANGE—POSSIBLE EFFECTS

Although it is impossible to state with absolute accuracy the outcomes of global change, there are some factors that need to be taken into account (Table 9.7). First, global warming could increase spatfall success of *C. gigas* in the summer and the survival of its spat the following winter leading to increased metabolic rates in its population (Table 9.8). Conversely, the warming trend could decrease the frequency of severe winters so that benthic invertebrate predators would forage on the bivalve spat causing a decline in the population size of the native bivalves. Another effect could be that the combination of global warming and reduced nutrient loads would

TABLE 9.7

Filtration Rates for Selected Northwestern European Bivalve Suspension Feeders

| Species | Location- Temperature Range (°C) | Weight Specific Filtration Rate (L h ⁻¹ g ⁻¹ dbw) | Reference |
|--------------------------|--|---|-------------|
| <i>Mytilus edulis</i> | Wadden Sea (5-25) | 9.2 | Troost 2010 |
| <i>Crassostrea gigas</i> | Wadden Sea (5-25) | 2.0-5.9 | Troost 2010 |
| <i>Cardium edule</i> | Wadden Sea (5-25) | 0.7-7.4 | Troost 2010 |

Source: Adapted from Troost, K. 2010. Causes and effects of a highly successful marine invasion: Case-study of the introduced Pacific oyster *Crassostrea gigas* in continental NW European estuaries. *J. Sea Res.*, 64, 145–65.

TABLE 9.8

Habitat Parameters for Selected Bivalves

| Habitat Parameters | <i>Crassostrea virginica</i> | <i>Crassostrea gigas</i> | <i>Mytilus edulis</i> | <i>Cerastoderma edule</i> |
|-----------------------|---|--------------------------------|---|--|
| Tidal range | Mid-intertidal to subtidal | Low intertidal to subtidal | Mid-intertidal to subtidal | High intertidal to shallow subtidal |
| Sediment | Sandy mud and attachment to any hard surface | Attachment to hard surfaces | Attachment to hard and filamental surfaces | Sand, soft mud, and gravel |
| Salinity | Estuarine to full marine | Estuarine to full marine | Estuarine to full marine | Estuarine to full marine |
| Burrowing depth | | | | < 5 cm |
| Exposure | Exposed to sheltered | Semi-exposed to sheltered | Exposed to sheltered | Semi-exposed to sheltered |

Source: Adapted from Troost, K. 2010. Causes and effects of a highly successful marine invasion: Case-study of the introduced Pacific oyster *Crassostrea gigas* in continental NW European estuaries. *J. Sea Res.*, 64, 145–65.

lead to a reduction in the biomass of the phytoplankton, which would severely impact the carrying capacity of bivalve suspension-feeders.

Troost (2010) concludes that for the time being the invasive species, *C. gigas*, has had more beneficial than negative results in the northwestern waters of Europe. For instance, *C. gigas* seems to have at least partially filled the niche left by the extinction of *O. edulis*. It also seems to compete with native bivalves but only marginally. Furthermore, *C. gigas*' role as a reef builder may compensate for habitat and biodiversity loss in estuarine environments caused by human activities over the past

decades. These oyster reefs may in the future play an important role in capturing sediment and protecting tidal flats from erosion resulting from sea level rise.

CONCLUSION

In this book, I have tried to build a bridge connecting the past to the present. I have covered a variety of bivalves that inhabit estuarine systems throughout the world. However, in my concluding thoughts, I find myself focusing on the reef-building bivalves for two reasons. The first reason is that the majority of my research has dealt with *Crassostrea virginica*. The second reason is that, in my opinion, the reef builders are the agents of change in the estuarine movement.

For almost 500 million years, bivalve mollusks have been successful participants in building the structure and the function of our coastal waters. They are the dominant members of the shallow coastal and estuarine ecosystems because they possess several outstanding characteristics.

First and foremost, they are survivors. They have withstood numerous cycles of climate change; they have lived through the impact of extraterrestrial objects such as comets and asteroids; and they have outcompeted the bivalve phylum, *Brachapodia*, driving it into a deeper, less productive habitat.

Their survivorship may also be attributed to their functions of filtration, growth, reproduction, and reef building. Bivalves, as we noted earlier, filter the surrounding water, obtaining nutrients that promote both growth and reproduction. The larvae that are spawned seek out hard substrates that have the same or similar chemical components. Because bivalves are gregarious, searching for their own kind, and because they have the ability to cement themselves onto similar organisms, they can build reefs. Reefs, in turn, protect bivalves from the mud and the predators that dwell therein. Moreover, reefs are valuable because they help structure the creeks and waterflow that bring nutrients in and wash waste away.

Now as never before we have the tools and the technology to help us build on foundations laid in the past so that we can understand and monitor the conditions of the present in order to protect the future of our estuaries: the nurseries of our ocean life. There are several questions in my mind as I close this book; I share them with you now. Perhaps some will show that I remain ever interested in estuarine research. Perhaps others will lead to discussions and ideas that will inspire more interdisciplinary research to tackle the environmental problems that plague our planet.

1. Will the rapid increase in stock (population) size of *Crassostrea gigas* in NW Netherlands coupled with large populations of native bivalves saturate the carrying capacities of some estuaries? What could be done to resolve such a situation?
2. Will *Crassostrea gigas* eventually replace *Mytilus edulis*?
3. Why does the genus *Crassostrea* seem to be so successful, and what managerial things can we do to ensure that it remains successful?
4. What attributes make bivalves environmentally valuable, and how do we maintain a balance between using them without depleting them?
5. What would make a “No-Take Zone” work?

6. How will global climate change affect bivalves and their food sources in particular and ecosystems in general?
7. Assuming it is possible to genetically engineer water flux by bivalves, how would it help in coastal management?
8. Do bivalves offer a possibility to perform first aid for estuaries?
9. How does acidification affect bivalves: Which ones are the most affected? Which are the least affected? Why?

REFERENCES

- Akberali, H.B. and Treuman, E.R. 1985. Effects of environmental stress on marine bivalve molluscs. *Adv. Mar. Biol.*, 22, 102–99.
- Baldwin, I.G. and Kramer, K.J.M. 1994. Biological early warning systems (BEWS). In *Biomonitoring of Coastal Waters and Estuaries*, Kramer, K.J.M., Ed. Boca Raton, FL: CRC Press, pp. 1–28.
- Bartol, I.K., Mann, R., and Luckenbach, M. 1999. Growth and mortality of oysters (*Crassostrea virginica*) on constructed intertidal reefs: Effects of tidal height and substrate level. *J. Exp. Mar. Biol. Ecol.*, 237, 157–84.
- Bayne, B.L. 1980. Physiological measurements of stress, *Rapp. P.-V. Reun. Cons. Int. Explor. Mer.*, 179, 56–61.
- Bayne, B.L. and Worrall, C.M. 1980. Growth and production of mussels (*Mytilus edulis*) from two populations. *Mar. Ecol. Prog. Ser.*, 3, 317–28.
- Beaumont, N.J., et al. 2007. Identification, definition and quantification of goods and services provided by marine biodiversity: Implications for the ecosystem approach. *Mar. Poll. Bull.*, 54, 253–65.
- Beck, M.B., et al. 2009. *Shellfish Reefs at Risk: A Global Analysis of Problems and Solutions*. Arlington, VA: The Nature Conservancy.
- Boström, C., Pittman, S.J., Simenstad, C., and Kneib, R.T. 2011. Seascape ecology of coastal biogenic habitats: Advances, gaps and challenges. *Mar. Ecol. Prog. Ser.*, 427, 191–217.
- Byrnes, J.E., Reynolds, P.L., and Stachowicz, J.J. 2007. Invasions and extinctions reshape coastal marine food web. *PLS ONE*.
- Calabrese, A., MacInnes, J.R., Nelson, D.A., and Miller, J.E. 1977. Survival and growth of bivalve larvae under heavy-metal stress. *Mar. Biol.*, 41, 179–84.
- Costanza, R. 1992. Toward an operational definition of ecosystem health. In *Ecosystem Health: New Goals for Environmental Management*, Costanza, R., Norton, B.G., and Haskell, B.D., Eds. Washington, DC: Island Press, pp. 239–56.
- Costanza, R., Norton, B.G., and Haskell, B.D., Eds. 1992. *Ecosystem Health: New Goals for Environmental Management*. Washington, DC: Island Press, 269 pp.
- Crook, M.R. 1992. Oyster sources and their prehistoric use on the Georgia coast. *J. Arch. Sci.*, 19, 483–396.
- Cunningham, P.A. and Tripp, M.R. 1975. Factors affecting the accumulation and removal of mercury from tissues of the American oyster *Crassostrea virginica*. *Mar. Biol.*, 31, 311–19.
- Daily, G.C., ed. 1997. *Nature's Services: Societal Dependence on Natural Ecosystems*. Washington, DC: Island Press, 392 pp.
- Dame, R.F. 2005. Oyster reefs as complex systems. In *The Comparative Roles of Suspension-Feeders in Ecosystems*, Dame, R.F. and Olenin, S. Eds. Dordrecht: Springer, pp. 331–43.
- Dame, R.F. 1976. Energy flow in an intertidal oyster population. *Estuarine Coastal Mar. Sci.*, 4, 243–53.

- Dame, R.F., Alber, M., Allen, D., Mallin, M., Montague, C., Lewitus, A., Chalmers, A., Gardner, R., Gilman, C., Kjerfve, B., Pinckney, J., and Smith, N. 2000. Estuaries of the South Atlantic coast of North America: Their geographical signatures. *Estuaries*, 23,(6), 793–819.
- Eertman, R.H.M. and de Zwaan, A. 1994. Survival of the fittest: Resistance of mussels to aerial exposure. In *Biomonitoring of Coastal Waters and Estuaries*, Kramer, K.J.M., Ed. Boca Raton, FL: CRC Press, pp. 269–84.
- Fisher, N.S. and Teyssie, J.-L. 1986. Influence of food composition on biokinetics and tissue distribution of zinc and americium in mussels. *Mar. Ecol. Prog. Ser.*, 28:197–207.
- Gilfillan, E.S. and Vandermenlen, J.H. 1978. Alterations in growth and physiology of soft shell clams, *Mya arenaria*: Chronically oiled with Bunker C from Chedabucto Bay, Nova Scotia, 1970–1976. *J. Fish. Res. Board Can.*, 35, 630–36.
- Goldberg, E.D., Bowen, V.T., Farrington, J.W., Harvey, G., Martin, J., Parker, P.L., Risebrough, R.W., Robertson, W., Schneider, E., and Gamble, E. 1978. The Mussel Watch. *Environ. Conser.*, 5, 101–25.
- Goldberg, E.D., Koide, M., Hodge, V., Flegal, A.R., and Martin, J. 1983. U.S. Mussel Watch: 1977–1978 results on trace metals and radionuclides. *Estuarine Coastal Shelf Sci.*, 16, 69–93.
- Grant, J. and Cranford, P.J. 1991. Carbon and nitrogen scope for growth as a function of diet in the sea scallop, *Placopecten magellanicus*. *J. Mar. Biol. Assoc. U.K.*, 71, 437–50.
- Gurevitch, J. and Padilla, D.K. 2004. Are invasive species a major cause of extinctions? *TREE*, 19 (9), 470–4.
- Kramer, K.J.M., Jenner, H.A., and de Zwart, D. 1989. The valve movement response of mussels: A tool in biological monitoring. *Hydrobiologia*, 188/189, 433–43.
- Lamoreux, J., et al. 2003. Value of the IUCN Red List. *TREE*, 18(5), 214–15.
- Limburg, K.E., O'Neill, R.V., Costanza, R., and Farbar, S., 2002. Complex systems and valuation. *Ecol. Econ.*, 41, 409–20.
- Markert, A., Wehrmann, A., and Kroncke, I. 2010. Recently established *Crassostrea*-reefs versus native *Mytilus* beds: Differences in ecosystem engineering affects the macrofaunal communities (Wadden Sea of Lower Saxony, Southern German Bight). *Biol. Invasions*, 12, 15–32.
- Martin, M. 1985. State Mussel Watch: Toxics surveillance in California. *Mar. Pollut. Bull.*, 16, 140–6.
- Millennium Ecosystem Assessment. 2005. *Ecosystems and Human Well-Being: Synthesis*. Washington, DC: Island Press, 137 pp.
- Nestlerode, J.A., Luckenbach, M.W., and O'Beirn, F.X. 2007. Settlement and survival of the oyster *Crassostrea virginica* on created oyster reef habitats in Chesapeake Bay. *Rest. Ecol.*, 15, 273–83.
- O'Connor, T.P., Cantillo, A.Y., and Lauenstein, G.G. 1994. Monitoring of temporal trends in chemical contamination by the NOAA National Status and Trends Mussels Watch project. In *Biomonitoring of Coastal Waters and Estuaries*, Kramer, K.J.M., Ed. Boca Raton, FL: CRC Press, pp. 29–50.
- Odum, E.P. 1983. *Basic Ecology*. Philadelphia: CBS College Publishing, 613 pp.
- Palmer, M.A. and Filoso, S. 2009. Restoration of ecosystem services for environmental markets. *Science*, 325, 575–6.
- Pittman, S., Kneib, R., and Simenstad, C.A. 2011. Practicing coastal seascape ecology. *Mar. Ecol. Prog. Ser.*, 427, 187–90.
- Pitts, L.C. and Wallace, G.T. 1994. Lead deposition in the shell of the bivalve, *Mya arenaria*: An indicator of dissolved lead in seawater. *Estuarine Coastal Shelf Sci.*, 39, 93–104.
- Powers, S.P., Peterson, C.H., Grabowski, J.H., and Lenihan, H.S. 2009. Success of constructed oyster reefs in no-harvest sanctuaries: Implications for restoration. *Mar. Ecol. Prog. Ser.*, 389, 159–70.

- Rapport, D.J., Regier, H.A., and Hutchinson, T.C. 1985. Ecosystem behavior under stress. *Am. Nat.*, 125, 617–40.
- Riisgård, H.U. and Randløv, A. 1981. Energy budgets, growth and filtration rates in *Mytilus edulis* at different algae concentrations. *Mar. Biol.*, 61, 227–34.
- Roesijadi, G., Young, J.S., Drum, A.S., and Gurtisen, J.M. 1984. Behavior of trace metals in *Mytilus edulis* during a reciprocal transplant field experiment. *Mar. Ecol. Prog. Ser.*, 15, 155–70.
- Ruesink, J.L., Feist, B.E., Harvey, C.J., Hong, J.S., Trimble, A.C., and Wisheart, L.M. 2006. Changes in productivity associated with four introduced species: Ecosystem transformation of a 'pristine' estuary. *Mar. Ecol. Prog. Ser.*, 311, 203–15.
- Ruiz, G.M., Fofonoff, P.W., Carlton, J.T., Wonham, M.J., and Hines, A.H. 2000. Invasion of coastal marine communities in North America: Apparent patterns, processes, and biases. *Annu. Rev. Ecol. Syst.*, 31, 481–531.
- Smaal, A.C. and Widdows, J. 1994. The scope for growth of bivalves as an integrated response parameter in biological monitoring. In *Biomonitoring of Coastal Waters and Estuaries*, Kramer, K.J.M., Ed. Boca Raton, FL: CRC Press, pp. 247–67.
- Soniat, T.M., Finelli, C.M., and Ruiz, J.T. 2004. Vertical structure and predator refuge mediate oyster reef development and community dynamics. *J. Exp. Mar. Biol. Ecol.*, 310, 163–82.
- Troost, K. 2010. Causes and effects of a highly successful marine invasion: Case-study of the introduced Pacific oyster *Crassostrea gigas* in continental NW European estuaries. *J. Sea Res.*, 64, 145–65.
- Vitousek, P.M. and Hooper, D.U. 1992. Biological diversity and terrestrial ecosystem biogeochemistry. In *Biodiversity and Ecosystem Function*, Schulze, E.D. and Mooney, H.A., Eds. Berlin: Springer-Verlag, pp. 3–14.
- Warren, C.E. and Davis, G.E. 1967. Laboratory studies on the feeding bioenergetics and growth in fish. In *The Biological Basis of Freshwater Fish Production*, Gerking, S.C., Ed. Oxford: Blackwell Scientific, pp. 175–214.
- Widdows, J. 1991. Physiological ecology of mussel larvae. *Aquaculture*, 94, 147–64.
- Widdows, J. and Donkin, P. 1992. Mussels and environmental contaminants: Bioaccumulation and physiological aspects. In *The Mussel Mytilus: Ecology, Physiology, Genetics and Culture*, Gosling, E., Ed. Amsterdam: Elsevier, pp. 383–424.
- Widdows, J. and Johnson, D. 1988. Physiological energetics of *Mytilus edulis*: Scope for growth. *Mar. Ecol. Prog. Ser.*, 46, 113–21.

Index

A

Abiotic mortality, 119
Acanthocardia echinata, 71
Acartia tonsa, 157
Acidification, definition of, 43
Adaptive governance, definition of, 23
Aequipecten opercularis, 71
Aerosol filtration, 76
Age structure, definition of, 109
Amino acids
 deaminated, 199
 dissolved free, 73
 free, 98
Ammonium inhibition, threshold of, 193
Anadara
 antiquate, 29
 trapezia, 29
Anaerobic metabolism, energy production
 through, 96
Anodonta philippiana, 69
Aphriza virgata, 125
APLZ, *see* Average pathlength of inflow
Arca zebra, 65
Arctica islandica, 64, 65, 71, 91
Arenicola, 212
Assimilation, definition of, 64
Asterias, 123
Asterias vulgaris, 123
Astropecten, 123
Aulacomya ater, 113, 135, 187
Average pathlength of inflow (APLZ), 207, 218

B

BACI design, *see* Before-after-control-impact design
Bacteria
 attachment to suspended organic detritus, 72
 endosymbiotic relationship with marine bivalves, 88
 as exploitable food resource, 72
 zooplankton feeding on, 73
Bankia, 73, 81
Basal metabolic rate (BMR), 95
Bathogrea thermydron, 122
Bathymodiolus thermophilus, 69, 87
Before-after-control-impact (BACI) design, 195, 207, 228

Benthic algae, resuspended, 143
Benthic-pelagic coupling, 161, 166
BEST Tunnel system, 150, 154
BEWS, *see* Biological early warning systems
Biodiversity, 249–252
 ecosystem productivity and, 249–250
 invasion, extinction, and biodiversity, 250–252
Biokinetic zone, 43
Biological early warning systems (BEWS), 241
Birds, methods of feeding on bivalves, 124
Birth rate, definition of, 109
Bivalves
 aerial exposure of, 242
 anaerobic conditions, 95
 birds feeding on, 124
 deposit-feeding, prevalence, 57
 -dominated complex systems, properties of, 15–16
 filter, 66
 filtration rates
 regulation of, 67
 variability of, 68
 form of water flow influencing, 55
 gut passage time, 80
 ingestion rate of particles, 77
 longevity, 91
 molluscs
 first appearance of, 1
 origination, 1
 populations, most effective predators of, 123
 reproductive terminology, 111
 shell, decapod methods for penetrating, 122
 spatial and temporal scales involved in studying, 9
 trophic groups of, 18
Bivalves, introduction to, 1–22
 bivalve molluscs, first appearance of, 1
 book organization, 19
 change of state diagram, 17
 classical laws of thermodynamics, 1
 complex systems, ecosystems as, 8
 controversy, 2
 ecological processes, 1
 ecosystems, 4–19
 biodiversity, 11–13
 feedback, 13–14
 multiple or alternate states, 14–17
 scaling, 17

- structural properties, 8–11
 - system types, 18–19
 - thermodynamics, 5–19
 - entropy law, 6
 - food webs
 - development, 11
 - energy symbolic language, 12
 - fossil record, 2
 - general ecosystem diagram, 5
 - heat flow, 6
 - historical/geological setting, 1–4
 - holistic, definition of, 1
 - intertidal oyster reef, 14
 - Law of Conservation of Energy, 5
 - lifestyles, 3
 - MEA, 1
 - network models, 11
 - nonequilibrium thermodynamics, 1
 - phytoplankton consumption, 18
 - population–community school, 11
 - predation, definition of, 12
 - properties of bivalve-dominated complex systems, 15–16
 - rudist, definition of, 1
 - rules governing living systems, 7
 - small, middle, and large number systems, 10
 - spatial and temporal scales involved in studying bivalves, 9
 - subtidal reefs, 14
 - surprise behavior, 13
 - times arrow, 6
 - trophic groups of common bivalves, 18
 - universe, energy gradients in, 8
- Black box–tunnel field measurements, 183
- BMR, *see* Basal metabolic rate
- Boonea impressa*, 133
- Boromia ostreae*, 252
- Brachidontes*, 49
- Brachidontes exustus*, 183
- Brooks curve, 36
- Bulger scheme, 49
- C**
- Calcium, deposition in shell, 90
- Calcium carbonate
 - carbon dioxide buffer system, 51
 - coral matrices composed of, 82
 - crystals, 30
- Calvin Benson Cycle, 85
- Calyptogena*
 - elongata*, 69
 - laubieri*, 69
 - magnifica*, 69, 88
 - phaeseoliformis*, 69
 - ponderosa*, 69
- Carbohydrates, bivalve incorporation of, 83
- Carbon dioxide production, 177
- Carcinus maenas*, 125, 254
- Cardium edule*, 135, 256
- Cellulose assimilation efficiencies, 71
- Centrophages hatamius*, 157
- Cerastoderma*, 73, 112, 212
- Cerastoderma edule*, 121, 125, 29, 71, 144
- Change of state diagram, 17
- Chemical oxygen demand, 176
- Chemoautotrophic, definition of, 63
- Chemoautotrophic symbioses, 85–99
 - excretion, 98–99
 - growth measurement, 89
 - growth models, 92–93
 - Kleiber’s law, 95–98
 - longevity, 91–92
 - production due to growth, 88–89
 - production due to reproduction, 92
 - respiration, 93–94
 - shell growth, 89–91
- Chione*, 49
 - cancellata*, 113
 - sp., 28
- Chlamys*
 - islandica*, 135
 - opercularis*, 65
- Chlorophyll, 162
- Choromytilus meridionalis*, 65, 72, 113, 128, 135
- Chrysaora quinquecirrha*, 121
- CI, *see* Cycling index
- Classical laws of thermodynamics, 1
- Clearance rate (CR), 32, 35
 - controversy in measuring, 68
 - decreasing, 77
 - definition of, 63, 74
- Coastal Transition Zone (CTZ), 235
- Codakia*
 - costata*, 69
 - orbicularis*, 69
 - orbiculata*, 69
- Competition-induced mortality, 127
- Complex systems, definition of, 143
- Condition index, 92
- Corbicula fluminea*, 157, 227
- Corbula*
 - amurensis*, 160
 - gibba*, 71
- Corculum cardissa*, 82
- Coulter counter, 76
- CR, *see* Clearance rate
- Crassostrea*, 49, 164
 - angulata*, 132, 226
 - gigantissima*, 3, 54
 - gigas*, 3, 65, 71, 113, 135, 157, 177, 179, 192, 193, 196, 199, 226, 253, 255, 257
 - gryphoides*, 3

- virginica*, 3, 14, 24, 28, 32, 33, 44, 50, 64, 65, 66, 72, 74, 89, 99, 113, 128, 130, 133, 135, 143, 157, 158, 160, 169, 177, 179, 183, 191, 196, 199, 225, 226, 239, 251, 252, 253
- CREEK project, 228
- CTZ, *see* Coastal Transition Zone
- Cultural services, 247
- Cycling index (CI), 219
- D**
- Data Bias hypothesis, 249
- DDT, 239
- Death rate, definition of, 109
- Denitrification, definition of, 175
- Density, definition of, 109
- Deposit feeding, 78–81
 - cellulase activity and detritus feeding, 79
 - environment, 78
 - microbial stripping, 79
 - optimal foraging for food in sediments, 80–81
 - particle selection, 79–80
 - prevalence, 57
 - proportion of foods, 80
 - surface particles in, 66
- DFAA, *see* Dissolved free amino acids
- Disease
 - causing agent, 131
 - as ecological factor, 133
- Dissolved free amino acids (DFAA), 73
- Dissolved organic carbon (DOC), 183
- Dissolved organic matter (DOM), 73
- Dissolved organic nitrogen (DON), 98
- Diurnal curve, definition of, 175
- DOC, *see* Dissolved organic carbon
- DOM, *see* Dissolved organic matter
- DON, *see* Dissolved organic nitrogen
- Donax*
 - serra*, 99
 - sordidus*, 99
- Doppler flow sensors, 53
- Dosinia elegans*, 113
- E**
- Earth's climate, decadal scale oscillations in, 46
- Ecological restoration, definition of, 143
- Ecopath model, 167
- Ecosystem(s), 4–19
 - analysis, 10
 - biodiversity, 11–13
 - box diagram, 4
 - definition of, 1
 - engineering, 9, 254
 - feedback, 13–14
 - functions, definition of, 143
 - marsh-estuarine, 27
 - mini-, 223
 - multiple or alternate states, 14–17
 - processes, definition of, 143
 - scale experiments, 224–227
 - designed experiments, 227
 - incidental experiments, 225–227
 - scaling, 17
 - self-organization within, 7
 - services, 247–249
 - definition of, 143
 - invasions by bivalves, 249
 - system valuation, 248
 - stress, 236
 - structural properties, 8–11
 - system types, 18–19
 - thermodynamics, 5–19
- Ecosystem experiments, 207–234
 - APLZ, definition of, 207
 - average pathlength of an inflow, 218
 - bivalve-dominated ecosystems, 209
 - case study, 227–230
 - comparison of coastal, estuarine, and marine ecosystems dominated by bivalve suspension-feeders, 230
- CREEK project, 228
- cycling index, 219
- ecosystem scale experiments, 224–227
 - designed experiments, 227
 - incidental experiments, 225–227
- energy flow, oyster reef system, 216
- field manipulation experiments, 208
- forward time centered space, 211
- global change, 207
- information theory concepts, 220
- LINKS project, 228
- mathematical hypothesis, 207
- mesocosm, definition of, 207
- mini-ecosystems, 223
- model analysis, 213–224
 - average pathlength of inflow, 218
 - Chesapeake Bay ecosystem model and oysters, 220–224
 - energy flow, 216
 - inconsistencies, 213
 - model validation, 215
 - recycling efficiency, 219
 - total system throughflow, 218, 219
- models, 209–210
 - development, 209
 - formulation, 210–212
 - SMOES, 210
 - system simulation models, 210
- network ascendancy, 221
- pelagic food web, 225
- photosynthesis, model describing, 212

- random intervention analysis, 228
- recycling efficiency, 207, 219
- Shannon-Weaver information index for
 - species diversity, 221
- steady-state (budget) models, 209
- throughflow, definition of, 207
- total system throughflow, 207, 218
- trophic efficiencies, 220
- water transport submodel, 211
- weak inference, 207
- Ecosystem grazing, 143–174
 - benthic-pelagic coupling, 161, 166
 - BEST Tunnel system, 150, 154
 - biomass to water volume ratios, 162
 - chlorophyll, 162
 - complex systems, definition of, 143
 - conceptualizing grazing, 145–150
 - bivalve clearance time, 149–150
 - carrying capacity, 148–149
 - classical population dynamics approach, 145–148
 - primary production time, 149
 - turnover time, 148
 - turnover time/turnover rate approach, 148–149
 - water residence time, 149
 - ecological restoration, definition of, 143
 - Ecopath model, 167
 - ecosystem comparisons, 162–169
 - bivalve grazer parameters and clearance time, 164
 - comparative listing of turnovers by location and type, 165
 - mini case study, 167–169
 - phytoplankton parameters and primary production turnover time, 163
 - ecosystem functions, definition of, 143
 - ecosystem oriented question, 162
 - ecosystem processes, definition of, 143
 - ecosystem services, definition of, 143
 - estuarine ecosystems, definition of, 143
 - feedback, definition of, 143
 - food chain, dominant, 159
 - food-depleted water, renewal of, 151
 - free-flow designs, 150–151
 - Froude number, 151
 - grazing optimization hypothesis, 144
 - grazing theory as applied to bivalves, 144–145
 - herbivore-mediated removal of algal cells, 144
 - laboratory flumes, 151–156
 - field flumes, 153
 - tunnels, 153–156
 - laser Doppler anemometer, 152
 - Lotka-Volterra predator–prey equations, 146
 - methods used to estimate system grazing, 150
 - nutrient cycling, 168
 - phytoplankton growth, time coefficient, 147
 - resilience, definition of, 143
 - resuspended benthic algae, 143
 - revised list of bivalve-dominated ecosystems
 - used to compare grazing and other characteristics, 157–162
 - Bay of Marennes-Oléron, France, 157–158
 - Chesapeake Bay, Virginia, and Maryland, 157
 - Delaware Bay, Delaware, 157
 - Narragansett Bay, Rhode Island, 158
 - North Inlet, South Carolina, 158
 - Oosterschelde Estuary, The Netherlands, 159
 - Ria de Arosa, Spain, 159
 - San Francisco Bay, California, 160–161
 - Sylt, Eastern Wadden Sea, Germany, 161
 - Western Wadden Sea, The Netherlands, 161–162
- Reynolds number, 151
- Strouhal number, 151
- suspension-feeding bivalves, grazing, 144
- system physical structure, 156
- turnover time, 148
- upstream–downstream observations, 150–151
- zooplankton grazing, 145
- Ecosystem health, restoration, and services, 235–260
 - bioaccumulation, 239
 - biodiversity, 249–252
 - ecosystem productivity and, 249–250
 - invasion, extinction, and biodiversity, 250–252
 - biological early warning systems, 241
 - bivalve responses, 240–245
 - bivalve scope for growth, 243–245
 - mortality, 242–243
 - shell movements, 241–242
 - shell and tissue growth, 243
 - bivalves as components of ecosystem health, 235–237
 - bivalves as integrators, 239–240
 - bivalves as monitors, 237–238
 - case study (Wadden Sea and invasion of *Crassostrea gigas*), 252–257
 - biology of *Crassostrea gigas*, 253
 - climate change, 255–257
 - contributors to successful environments, 254–255
 - invaders and their ecosystems, 254
 - positive implications of *Crassostrea gigas*, 255
 - reef building, 253
 - coastal contamination, trend sin, 240
 - cultural services, 247

- Data Bias hypothesis, 249
 - DDT, 239
 - ecosystem approach, 252
 - ecosystem engineering, 254
 - ecosystem health, practical definition of, 246
 - ecosystem services, 235, 247–249
 - invasions by bivalves, 249
 - system valuation, 248
 - energy-budget equation, 243
 - hybrid reef, 253
 - indigenous, definition of, 235
 - interstitial space, definition of, 235
 - introduced, definition of, 235
 - invasion, definition of, 235
 - invasive species, definition of, 235
 - mussel watch-type programs, 239, 240
 - network measures, 237
 - nitrogen cycle, weather and, 247
 - seascape ecology, definition of, 235
 - supportive services, 248
 - systems measures, 246–247
 - temporal scales of bivalve monitoring
 - approaches for assessing ecosystem health, 238
 - veneer, definition of, 235
 - Ecosystem metabolism and nutrient cycling, 175–206
 - amino acids, deaminated, 199
 - ammonium inhibition, threshold of, 193
 - ammonium turnover times, 198
 - anoxic sediments, 196
 - black box–tunnel field measurements, 183
 - carbon cycling, energy flow and, 182
 - carbon dioxide production, 177
 - chamber measurements, 176–177
 - chemical oxygen demand, 176
 - denitrification, 175, 201
 - dissolved organic carbon, 183
 - diurnal curve, 175
 - feedbacks, importance of, 186
 - free-flow measurements, 177–178
 - internal recycling, 179
 - methods for measuring system metabolism, 176
 - mineralization, 175
 - missing nitrogen, 200–202
 - negative feedback regulation, 180
 - net metabolism, 175
 - nutrient cycling, 178–199
 - carbon, 181–188
 - coupling metabolism and nutrients, 199
 - nitrogen, 188–195
 - nutrient cycles, 181
 - phosphorus, 195–197
 - silicon, 197–198
 - system nutrient turnover, 198–199
 - theoretical background, 179–181
 - particulate organic carbon, 183
 - particulate organic matter, consumption of, 180
 - photosynthesis, estimate of, 176
 - positive feedback, 181
 - pseudofeces, 190
 - radioactive isotope of phosphorus, 196
 - reaeration constant, 178
 - respiratory quotient, 175
 - sediments, ion-exchange capacity of, 195
 - system metabolism, 175
 - time series of oxygen concentrations, 176
 - tunnel studies, 178
 - Energy
 - budget, 64
 - definition of, 63
 - equation, 243
 - respiration and, 93
 - flow
 - carbon cycling and, 182
 - oyster reef system, 216
 - population energy budgets, 134
 - production, anaerobic metabolism and, 96
 - solar input, 48
 - source, methane as, 82
 - symbolic language, 12
 - wave, 55, 56
 - Entropy
 - definition of, 63
 - law, 6
 - Environmental interactions, *see* Physical environmental interactions
 - Estuarine ecosystems, definition of, 143
 - Euryhaline, definition of, 43
 - Extinction, 134
- F**
- FAA, *see* Free amino acids
 - Feedback
 - definition of, 143
 - importance of, 186
 - loops, examples of, 13
 - mechanisms, 13
 - Field flumes, 153
 - Fig Island archaeological study, 34
 - Filter-feeding bivalves, 58
 - Filtration rate, 75
 - First law of thermodynamics, 63
 - Food webs
 - development, 11
 - energy symbolic language, 12
 - pelagic food, 225
 - Forward time centered space, 211
 - Free amino acids (FAA), 98
 - Froude number, 151

G

- Gametogenesis, 92
- GC, *see* Global change
- GCC, *see* Global climate change
- Gemma gemma*, 160
- Geukensia*, 49, 73
- Geukensia demissa*, 74, 99, 113, 128, 135, 160, 190
- Global change (GC), 207
- Global climate change (GCC), 49
- Global warming, evil twin of, 51
- Golf ball phenomena, 54
- Gompertz model, 93
- Grazing optimization hypothesis, 144
- Group attributes, definition of, 109

H

- Haematopus*, 126
 - bachmani*, 125
 - ostralegus*, 125, 254
- Halichoeres semisinctus*, 124
- Haplosporidium nelsoni*, 132, 169
- High performance liquid chromatography (HPLC), 98
- Hippopus*
 - hippopus*, 65, 82
 - porcelains*, 82
- Historical ecology, 23–41
 - adaptive governance, definition of, 23
 - Brooks curve, 36
 - calcium carbonate crystals, 30
 - case study (oyster shell rings), 27
 - clues from history, 37–38
 - comparing past to present systems, 32–37
 - comparison of species number or richness
 - in living and prehistoric assemblages dominated by oysters, 24
 - cooling periods, 37
 - definition of, 23
 - dry body weight estimates, 35
 - edible soft tissue, 26
 - Fig Island archaeological study, 34
 - historical ecology, definition of, 23
 - Holocene, abiotic environment of, 35
 - interpreting shell rings through time, 27–32
 - intertidal oyster reefs, 33
 - marsh-estuarine ecosystems, 27
 - midden stages, 25
 - Native Americans, 38
 - natural environmental forcings, 37
 - natural reefs and human constructs, 24–27
 - population density values (shell middens), 26
 - population scale estimates, 32
 - products derived from bivalve shells in middens, 25

- radiocarbon dates of southeastern United States shell rings, 31
- rapid climate change, 23
- reference conditions, 23
- reverse engineering, definition of, 23
- shell midden, definition of, 23
- shell mound, 23
- shell ring, definition of, 23
- Holistic, definition of, 1
- Homo sapiens*, 25, 200, 248
- HPLC, *see* High performance liquid chromatography
- Hydrobia*, 212

I

- ICEC, *see* Individual cylindrical experimental chamber
- Indigenous, definition of, 235
- Individual cylindrical experimental chamber (ICEC), 68
- Interstitial space, definition of, 235
- Intertidal oyster reef, 14, 33
- Introduced, definition of, 235
- Invasion, definition of, 235
- Invasive species, definition of, 235
- Isotopic ratios, chemoautotrophic symbiosis, 87

J

- Jet propulsion (scallops), 54

K

- Keystone predators, 126
- Kleiber's Law, 95–98

L

- Laboratory flumes, 151–156
 - field flumes, 153
 - tunnels, 153–156
- Laminar flow, definition of, 43
- Larus*
 - argentatus*, 254
 - glaucescens*, 125
- Larviphagy, 73–78
 - clearance rate models, 74–78
 - definition of, 63
 - dissolved organic matter, 73–74
 - filtration and particle size, 74
- Lasaea rubra*, 129
- Laser Doppler anemometer (LDA) 152
- Laser-induced fluorescence (LIF) system, 152
- Law of Conservation of Energy, 5
- Law of the minimum (Liebig's), 43
- Law of tolerance (Shelford's), 43

- LDA, *see* Laser Doppler anemometer
Leiostomous xanthurus, 124
Leptasterias polaris, 123
 Life cycle, definition of, 109
 LIF system, *see* Laser-induced fluorescence system
Linga pennsylvanica, 69
 LINKS project, 228
Loripes lucinalis, 69
 Lotka-Volterra predator–prey equations, 146
Lucina
 nassula, 69
 radians, 69
Lucinella divaricata, 69
Lucinoma
 aequizonata, 69
 annulata, 69
 atlantis, 69
 borealis, 69
Luidia, 123
Lyrodus, 81
Lyrodus pedicellatus, 113, 135
- M**
- Macoma*
 balthica, 79, 124, 185
 nasuta, 80, 160
 spp., 157, 227
 Marine bivalves, *see* Bivalves
Martesia, 81
 MEA, *see* United Nations Millennium Ecosystem Assessment
 Mean sea level (MSL), 35
 Membrane inlet mass spectrometry (MIMS) process, 201
Mercenaria, 49
Mercenaria mercenaria, 28, 50, 65, 99, 113, 135, 176, 177, 179, 186
 Mesocosm, definition of, 207
 Metabolism, total, 97
 Microzooplankton, filtered, 83
 MIMS process, *see* Membrane inlet mass spectrometry process
 Mineralization, definition of, 175
 Minimum number of individuals per sample (MNI), 34
Mnemiopsis leidyi, 121
 MNI, *see* Minimum number of individuals per sample
 Model
 autocatalytic, 93
 Chesapeake Bay, 220
 development, 209
 Ecopath, 167
 exponential growth, 114
 Gompertz, 93
 growth, 92
 logistic, 93
 network, 11
 SMOES, 210
 static chamber exponential filtration rate, 76
 von Bertalanffy, 93
 MSL, *see* Mean sea level
Mulinia lateralis, 50, 157, 227
Musculista senhousia, 160
Musculus
 niger, 71
 senhousia, 160
 Musselmonitor, 241
 Mussel Watch Monitoring Program, 239
Mya, 73
Mya arenaria, 54, 71, 74, 117, 118, 121, 135, 157, 160, 227, 240
Myrtea spinifera, 69
Mytilus, 3, 47, 72, 164, 212
 californianus, 65, 72, 28, 123, 127, 239
 chilensis, 65
 edulis, 44, 64, 65, 67, 71, 72, 99, 116, 123, 127, 129, 135, 153, 157, 159, 160, 161, 179, 190, 226, 251, 253, 255, 256
 galioprovincialis, 65
- N**
- Native Americans, 38
 Net metabolism, definition of, 175
 Network models, 11
 Nitrogen
 cycle, weather and, 247
 most common excretory product, 98
 zooanthellae-assimilated, 85
 Nonequilibrium thermodynamics, 1
Nucula, 78
 Nutrient cycling, 178–199
 carbon, 181–188
 coupling metabolism and nutrients, 199
 nitrogen, 188–195
 nutrient cycles, 181
 phosphorus, 195–197
 silicon, 197–198
 system nutrient turnover, 198–199
 theoretical background, 179–181
 Nutrient reserves, conservative use of, 92
 Nutrition, symbiotic, 82–85
 carbohydrate incorporation, 83
 energy source, methane as, 85
 inorganic nutrients, 84
 photoautotrophic symbioses, 82–85
- O**
- Ocean acidification, 51
Odobenus rosmarus, 127

- Organismic scale processes, 63–108
- absolute growth, 88
 - acidification, 91
 - aerosol filtration, 76
 - ammonia, 98
 - anaerobic conditions, 95
 - anaerobic metabolism, energy production through, 96
 - assimilation, definition of, 64
 - autocatalytic model, 93
 - bacteria
 - attachment to suspended organic detritus, 72
 - endosymbiotic relationship with marine bivalves, 88
 - basal metabolic rate, 95
 - bivalve filtration rates
 - regulation of, 67
 - variability of, 68
 - calcium carbonate, coral matrices composed of, 82
 - Calvin Benson Cycle, 85
 - cellulose assimilation efficiencies, 71
 - chemoautotrophic, definition of, 63
 - chemoautotrophic symbioses, 85–99
 - excretion, 98–99
 - growth measurement, 89
 - growth models, 92–93
 - Kleiber's Law, 95–98
 - longevity, 91–92
 - production due to growth, 88–89
 - production due to reproduction, 92
 - respiration, 93–94
 - shell growth, 89–91
 - clearance rate
 - controversy in measuring, 68
 - definition of, 63
 - clearance relationship, 75
 - condition index, 92
 - deposit feeding, 78–81
 - cellulase activity and detritus feeding, 79
 - microbial stripping, 79
 - optimal foraging for food in sediments, 80–81
 - particle selection, 79–80
 - proportion of foods, 80
 - surface particles in, 66
 - dissolved free amino acids, 73
 - dissolved organic nitrogen, 98
 - energy budget, 63, 64
 - energy source, methane as, 82
 - entropy, definition of, 63
 - feeding, 66
 - filtration efficiency, 76
 - filtration rate, 75
 - first law of thermodynamics, 63
 - flowing water, kinematic viscosity of, 67
 - free amino acids, 98
 - gametogenesis, 92
 - Gompertz model, 93
 - gut passage time, 80
 - high performance liquid chromatography, 98
 - individual cylindrical experimental chamber, 68
 - ingestion rate of particles, 77
 - isotopic ratios, 87
 - laminar water flow, hydrodynamics of, 74
 - larviphagy, 73–78
 - clearance rate models, 74–78
 - definition of, 63
 - dissolved organic matter, 73–74
 - filtration and particle size, 74
 - logistic model, 93
 - mantle tissue, 83
 - metabolic carbon requirements, 72
 - metabolism, estimates of, 94
 - mucus-producing organ, 82
 - photoautotrophic symbiosis, nutrition in, 84
 - photosynthetic quotient, 84
 - physiological school, 67
 - power-to-mass ratio, 64
 - pseudofeces-free cell density, 78
 - pumping rate, 75
 - relative growth, 88
 - respiratory gas exchange, 94
 - respiratory quotient, 94
 - sediments, organic content of, 78
 - shell growth lines, definition of, 89
 - shell growth rings, 90
 - shell microgrowth increments, 90
 - shipworms, 81–82
 - static chamber exponential filtration rate model, 76
 - suspension-feeders, removal of particulate materials by, 66
 - suspension-feeding, 66–73
 - bivalve filter and pump, 66–69
 - filtration and particle quality, 70–73
 - symbiotic nutrition, 82–85
 - carbohydrate incorporation, 83
 - energy source, methane as, 85
 - inorganic nutrients, 84
 - photoautotrophic symbioses, 82–85
 - tide exposure, 97
 - total metabolism, 97
 - von Bertalanffy model, 93
 - Walford plot, 93
 - wood cellulose, 81
- Ostracoblabe implexa*, 132
- Ostrea*, 47, 73, 109, 242
- arborea*, 28
 - brasiliiana*, 28
 - edulis*, 14, 29, 64, 110, 113, 135, 251, 253
 - lurida*, 160

Ostrea implexa, 255

Oxygen consumption

nitrogen excretion and, 98

studies, 17

P

Panulirus interruptus, 123

Parasitic worms, 132

Particulate organic carbon (POC), 183

Parvilucina

multilineata, 69

tenuisculpta, 69

Patinopecten yessoensis, 113, 135

Perkinsus marinus, 132, 169

Perna

canaliculus, 56, 194, 226

perna, 28, 29, 65, 113

viridis, 242

Perturbation theory, 45

Photoautotrophic symbiosis, nutrition in, 84

Photosynthesis

estimate of, 176

model describing, 212

Photosynthetic quotient, 84

Physical environmental interactions, 43–61

acidification, 43, 51

biokinetic zone, 43

boundary layer, 52

Bulger scheme, 49

calcium carbonate–carbon dioxide buffer system, 51

curvature of Earth, 44

defect layer, 53

Doppler flow sensors, 53

drag coefficient, 52

euryhaline, definition of, 43

filter-feeding bivalves, 58

flume experiments, 54

frictional drag, 52

fundamental flow regimes, 52

global climate change, 49

golf ball phenomena, 54

input energy, decrease in, 44

laminar flow, definition of, 43

law of the minimum (Liebig's), 43

law of tolerance (Shelford's), 43

log layer, 53

ocean acidification, 51

perturbation theory, 45

poikiliosmotic organisms, 49

poikilotherm, definition of, 43

respiration rates, 47

response-surface analysis, 47

Reynolds number, definition of, 43

salinity, 48–50

scallops, jet propulsion of, 54

seasonality, 45

sediments, 57–58

solar input energy, 48

suspension-feeders, farming of, 56

suspension-feeding bivalves, water motion requirement, 52

temperature, 44–48

temperature–salinity and other factor combinations, 50–51

temperature–salinity tolerance, 50

thermal acclimation, definition of, 46

thermal tolerance windows, 46

tides, 56–57

tolerance data, 47

turbulent flow, definition of, 43

turnover times, 57

Venice system, 49

water flow, 51–56

water movement, 55

wave energy, 55, 56

Phytoplankton

consumption, shallow coastal waters, 18

drifting of, 207

filtered, 83

form of nitrogen taken up by, 189

growth, time coefficient, 147

model describing photosynthesis, 212

motility, 145

population regulation, 144

primary production, 155

Pinctada

marfaritifera, 65

maxima, 65

nigra, 29

Pinnotheres ostreum, 133

Pisaster ochraceus, 123

POC, *see* Particulate organic carbon

Pogonias cromis, 124

Poikiliosmotic organisms, 49

Poikilotherm, definition of, 43

Polydora, 132

Polydora ciliata, 133

Population density values (shell middens), 26

Population–community school, 11

Population processes, 109–141

abiotic mortality, 119–120

age-specific fecundity, computation of, 119

age structure, 109

aggregated distributions, 128–129

anaerobic conditions, 120

biological attributes, 109

birth rate, 109, 115

bivalves as open or metapopulations, 115–116

clonal style living, 128

competition-induced mortality, 127

death rate, 109

density, 109, 110–111

- diseases and parasites, 131–134
 ecological factor, disease as, 133
 exponential growth model, 114
 extinction, 134
 gastropods, 120
 group attributes, 109
 growth coefficient, 114
 instantaneous death, 114
 keystone predators, 126
 larval settlement, underestimated, 119
 life cycle, 109–110
 life expectancy, 117
 life and fecundity tables, 116–119
 mortality, 114, 119
 multiple pulses, 111
 natality, 114
 negative spatial autocorrelation, 128
 parasitic worms, 132
 population density, reduction in, 128
 population energy budgets, 134
 population growth, 113–115
 predation, 120–127
 predator–prey cycle question, 127
 predators, opportunistic, 121
 presettlement period, 110
 reproduction, 111–113
 sea otters, feeding groups, 126
 shell disease, 132
 spawning periods, 111
 statistical measures of populations, 110
 topographic complexity, structures
 influencing, 128
 viruses, 131
 zonation, 130–131
 PPT, *see* Primary production time
 PR, *see* Pumping rate
 Predation, 120–127
 definition of, 12
 Lotka-Volterra predator–prey equations, 146
 role of birds in, 124
 Predator(s)
 keystone, 126
 opportunistic, 121
 –prey cycle question, 127
 Primary production time (PPT), 149
Pseudocalanus minutus, 157
 Pseudofeces-free cell density, 78
Pseudomiltha floridana, 69
 Pumping rate (PR), 75
- R**
- Random intervention analysis (RIA), 228
Rangia, 73
Rangia cuneata, 65, 157, 227
 Rapid climate change (RCC)
 definition of, 23
 periods, 36
 RCC, *see* Rapid climate change
 RE, *see* Recycling efficiency
 Recycling efficiency (RE), 207, 219
 Reefs, dominant bivalves in, 129
 Resilience, definition of, 143
 Respiratory quotient (RQ), 94, 175
 Response-surface analysis, 47
 Reverse engineering, definition of, 23
 Reynolds number, 43, 151
Rhinoptera bonasus, 124
 RIA, *see* Random intervention analysis
 RQ, *see* Respiratory quotient
 Rudist, definition of, 1
Ruditapes decussatus, 29
- S**
- Saccostrea*
 commercialis, 29
 cucullata, 29
 glomerata, 65
 Scientific Committee on Ocean Research
 (SCOR), 222
 Scope for growth (SFG), 64
 SCOR, *see* Scientific Committee on Ocean
 Research
Scrobicularia, 78
Scrobicularia plana, 29, 113, 135
 Seascape ecology, definition of, 235
 Seasonality, 45
 Sediments
 anoxic, 196
 composition, 57
 fluxes of nitrogen from, 193
 ion-exchange capacity of, 195
 optimal foraging for food in, 80–81
 organic content of, 78
Semicossyphus pulcher, 124
 SFG, *see* Scope for growth
 Shannon-Weaver information index for species
 diversity, 221
 Shell
 disease, 132
 growth lines, definition of, 89
 growth rings, population measurement and,
 110
 midden, definition of, 23
 mound, 23
 ring, definition of, 23
 Shipworms, 81–82
 Silicon uptake, 197
 SMOES model, 210
 Solar input energy, 48
Solemya, 78

- reidi*, 69, 87
 - velesiana*, 69
 - velum*, 69, 99
 - Somateria*, 126
 - Spartina alterniflora*, 71, 128, 190
 - Spisula subtruncata*, 71
 - Static chamber exponential filtration rate model, 76
 - Strouhal number, 151
 - Stylochus*
 - ellipticus*, 121
 - mediterraneus*, 121
 - Suspension-feeders, 66–73
 - aggregations of, 8
 - bivalve filter and pump, 66–69
 - cellulase activity, 79
 - comparison of coastal, estuarine, and marine ecosystems dominated by, 230
 - environments of, 78
 - farming of, 56
 - feedbacks, 146
 - filtration and particle quality, 70–73
 - food-limitation for, 165
 - grazing, 144, 215
 - removal of particulate materials by, 66
 - stress, 58
 - system, nitrogen cycle in, 194
 - water motion requirement, 52
 - Symbiodinium microadriaticum*, 82
 - Symbiotic nutrition, 82–85
 - carbohydrate incorporation, 83
 - energy source, methane as, 85
 - inorganic nutrients, 84
 - photoautotrophic symbioses, 82–85
- T**
- Tagelus plebeius*, 157, 227
 - Tapes*
 - japoonica*, 160
 - philippanarum*, 160
 - Tellina tenuis*, 113, 135
 - Temora longicornus*, 157
 - Temperature, definition of, 44
 - Teredo*, 81
 - Teredo navalis*, 99
 - Thermal acclimation, definition of, 46
 - Thermal tolerance windows, 46
 - Throughflow, definition of, 207
 - Thyasira*
 - equalis*, 69
 - flexuosa*, 69
 - gouldi*, 69
 - sarsi*, 69
- Tides
- coastal geomorphology, 57
 - zonation, 56
- Tivela stultorum*, 117, 118
- Total system throughflow (TST), 207, 218, 219
- Tridacna*
 - crocea*, 65, 82
 - derasa*, 82
 - gigas*, 65, 82
 - maxima*, 82, 84, 122
 - squamosa*, 65, 82
- Trinectes maculatus*, 124
- TST, *see* Total system throughflow
- Turbulent flow, definition of, 43

U

- United Nations Millennium Ecosystem Assessment (MEA), 1, 167, 235

V

- Veneer, definition of, 235
- Venice system, 49
- Vesicomya*
 - cordata*, 69
 - gigas*, 69
- Vibrio*, 132
- Viruses, 131
- von Bertalanffy model, 93

W

- Walford plot, 93
- Water residence time, 149
- Water transport submodel, 211
- Wood cellulose, 81

Y

- Yoldia*, 78, 79

Z

- Zooanthellae
 - assimilated nitrogen, 85
 - bivalves containing, 82
- Zooplankters, feeding of on bacteria, 73
- Zooplankton grazing, 145, 155

