

DE GRUYTER

# PARTITIVE DETERMINERS, PARTITIVE PRONOUNS AND PARTITIVE CASE

*Edited by Petra Sleeman and  
Giuliana Giusti*

LA LINGUISTISCHE ARBEITEN

DE  
G

## **Partitive Determiners, Partitive Pronouns and Partitive Case**

# Linguistische Arbeiten



Edited by  
Klaus von Heusinger, Agnes Jäger,  
Gereon Müller, Ingo Plag,  
Elisabeth Stark and Richard Wiese

**Volume 580**

# Partitive Determiners, Partitive Pronouns and Partitive Case



Edited by  
Petra Sleeman and Giuliana Giusti

**DE GRUYTER**

The Open Access publication of this volume was made possible by the Netherlands Organization for Scientific Research NWO.

ISBN 978-3-11-073729-5  
e-ISBN (PDF) 978-3-11-073222-1  
e-ISBN (EPUB) 978-3-11-073229-0  
ISSN 0344-6727  
DOI <https://doi.org/10.1515/9783110732221>



This work is licensed under the Creative Commons Attribution 4.0 International License. For details go to <http://creativecommons.org/licenses/by/4.0/>.

**Library of Congress Control Number: 2021943073**

**Bibliographic information published by the Deutsche Nationalbibliothek**

The Deutsche Nationalbibliothek lists this publication in the Deutsche Nationalbibliografie; detailed bibliographic data are available on the Internet at <http://dnb.dnb.de>.

© 2021 with the authors, editing © 2021 Petra Sleeman and Giuliana Giusti, published by Walter de Gruyter GmbH, Berlin/Boston  
The book is published open access at [www.degruyter.com](http://www.degruyter.com).

Typesetting: Integra Software Services Pvt. Ltd.  
Printing and binding: CPI books GmbH, Leck

[www.degruyter.com](http://www.degruyter.com)

# Preface

The basis of this volume is the 1<sup>st</sup> PARTE Workshop entitled *Partitive Determiners and Partitive Case*, which took place at Ca' Foscari University of Venice on November 13-14, 2017. Most of the papers that were selected for this volume have been presented at that workshop.

PARTE (PARTitivity in European languages) is a network of 11 research teams of theoretical linguists, dialectologists, sociolinguists, typologists, historical linguists and applied linguists at the University of Amsterdam, Meertens Institute, University of Zurich, Ca' Foscari University of Venice, University of Pavia, Károli Gáspár University (Budapest), Christian-Albrecht-University of Kiel, University of Leipzig, Goethe University Frankfurt, CNRS in Bayonne, and University of Turku. The project is funded by NWO (the Netherlands Organization for Scientific Research) and co-funded by the Universities of Zurich, Venice, Budapest and Pavia and is aimed at bringing together ongoing research on partitivity by the 11 partners together.

For the conception and preparation of this volume, we would especially like to thank the invited speakers of the workshop, Anne Carlier and Urtzi Etxeberria, to have kindly accepted to publish their papers in this volume. Both papers form valuable contributions to the volume and significantly deepen our understanding of partitivity. We are also very grateful to the other authors of the volume for sharing their excellent research on partitivity. The papers were separately peer-reviewed by contributors to the volume and by other PARTE members. We thank the reviewers for their time and their valuable comments on the papers. We are also very grateful to Klaus von Heusinger and Elisabeth Stark, series editors of *Linguistische Arbeiten*, for their critical comments on an earlier version of this volume.

We especially thank the Netherlands Organization for Scientific Research NWO for financially supporting the PARTE network (Grant 236-70-007) and for a grant which made the Open Access publication of this volume possible (Grant 36.201.023).

Amsterdam / Venice

October 20, 2021

Petra Sleeman & Giuliana Giusti



# Contents

## Preface — V

Giuliana Giusti & Petra Sleeman

**Introduction: Partitive elements in the languages of Europe.**

**An advancement in the understanding of a multifaceted phenomenon — 1**

## Part I: Setting the diagnostics for partitivity in Romance languages

Giuliana Giusti

**Partitivity in Italian.**

**A protocol approach to a multifaceted phenomenon — 33**

Anne Carlier

***Du/des*-NPs in French.**

**A comparison with bare nouns in English and Spanish — 77**

## Part II: The diachrony of partitivity

Ilja A. Seržant

**Diachronic typology of partitives — 111**

Silvia Luraghi & Giovanna Albonico

**The partitive article in Old Italian.**

**Early stages in the grammaticalization of the Italian partitive article — 169**

## Part III: The acquisition of partitivity

Petra Sleeman & Tabea Ihsane

**The L2 acquisition of the partitive pronoun *en* in French by L1 speakers of German and the role of the L1 — 205**

Sanne Berends, Petra Sleeman, Aafke Hulk & Jeannette Schaeffer

**The L2 acquisition of the referential semantics of Dutch partitive pronoun ER constructions — 237**



## Part IV: **The syntax-semantics correlations of case in partitivity**

Klaus von Heusinger & Jaklin Kornfilt

**Turkish partitive constructions and (non-)exhaustivity — 263**

Tuomas Huomo

**Longitudinal or transverse?**

**How the unbounded quantity expressed by the Finnish partitive case relates to time — 295**

Urtzi Etxeberria

**The partitive marker in Basque, and its relation to bare nouns and the definite article — 319**

**Index — 357**

Giuliana Giusti & Petra Sleeman

# Introduction: Partitive elements in the languages of Europe

An advancement in the understanding of a multifaceted  
phenomenon

## 1 Introduction

Partitivity is a linguistic notion that is used to denote diverse phenomena, including but not limited to those presented in (1)-(7) below.<sup>1</sup>

In the **proper partitive** construction (1), a subset of three indefinite books is picked out of a larger definite set of books. In the **pseudo-partitive** construction (2) the quantity of a substance (wine) is measured by the quantity noun *glass* and no larger set of the quantity is introduced in the discourse (Koptjevskaja-Tamm 2001; Tănase-Dogaru 2017):

(1) *three of her books*

(2) *a glass of wine*

---

<sup>1</sup> As will be clear from this overview chapter, the adjective ‘partitive’ and the noun ‘partitivity’ can denote complex constructions referring to an indefinite part of a definite set, as in (1) and (6); but also to the indefinite quantified part of an understood superset (5); or even just to an existentially quantified nominal (with no relation to a superset), as in (2), (3) or (7). It may also denote an indefinite referent, as in (4) (in this case the notions of partition and quantification are not involved, despite the ‘partitive’ morphology, which is realized as a case-marker or a preposition). In this latter case, partitivity or quantification may have been present at previous stages of the language but is absent in synchrony. This wealth of similar forms with different although contiguous interpretations gives rise to wide variation across related languages and interesting parallels across unrelated languages, that are treated in competing analyses. This inevitably results in terminological inconsistencies that cannot be solved, as they are often related to different traditional grammars as well as different theoretical points of view (see Section 3). A caveat is therefore at stake before attempting to understand this complex phenomenon. Despite the ongoing discussion and collaborations across the authors of this volume, which is the result of the PARTE network, terminological consistency is not always possible and is not an aim of the project.

---

**Note:** This introductory chapter has benefited from the remarks and suggestions of several of the authors of this volume.

Partitivity in a broader sense may refer to **quantified expressions** (which may imply that the indefinite set is picked out of a larger set previously introduced into the discourse), as in (3). It may also refer to nominal expressions introduced by overt **indefinite determiners** found with mass and plural count nouns in French (and Italian), such as *du/des* in (4), that are apparently formed by the partitive preposition *de/di* inflected for the definite article and are traditionally named ‘partitive articles’ (cf. Dobrovie-Sorin and Beyssade 2004; Carlier 2007; Ihsane 2008). The interpretation of these determiners is partially similar to null (or absent) indefinite determiners in many other languages, as shown by the English glosses.

(3) *I have read three books.*

- (4) a. *Marie a bu du vin.* (French)  
 Mary has drunk PART.DET.M.SG wine  
 ‘Mary drank (some) wine.’
- b. *Marie a bu des apéritifs.* (French)  
 Mary has drunk PART.DET.PL aperitifs  
 ‘Mary drank (some) aperitifs.’

There are **partitive pronouns** that resume the nominal expression denoting the superset in ‘partitive’ constructions, such as the Dutch weak pronoun *er* in (5a), which requires the presence of the quantifier in Netherlandic Standard Dutch, or the clitic *ne* in Italian (5b) (and *en* in French). Note that *ne/en* can appear without the quantifier, resuming a determinerless indefinite expression, often called ‘bare noun’:

- (5) a. *Ik heb er drie.* (Dutch)  
 I have PART.WK three
- b. *Ne ho (tre).* (Italian)  
 PART.CL have.PRS.1SG (three)  
 ‘I have three (of them).’

Note that *er* in (5a) does not imply reference to a definite superset. The basic structure of (5a) should therefore be totally similar to the quantified expression *drie boeken* (‘three books’) equivalent to (3), not to (1), whose equivalent is *drie van haar boeken* (‘three of her books’). In (5b) *ne* can resume a determinerless indefinite nominal. Thus, the basic structure can be *tre libri* (‘three books’), but it could also be just a bare noun *libri* (‘books’), with an indefinite interpretation. It is controversial whether these clitic pronouns can resume the definite superset. This would be suggested by the fact that these pronouns have oblique

case morphology and can resume genitive and locative prepositional phrases, a property that is shared by the prepositional phrase denoting the superset in partitive constructions (henceforth called the partitive PP).

In richly inflected languages, ablative and genitive **case** related to partitivity is expectedly found on nominal expressions, as in Turkish and Lithuanian:

- (6) a. *Meyve-ler-den üç elma(-yı) ye-di-m.* (Turkish)  
 fruit-PL-ABL three apple(-ACC) eat-PST-1SG  
 ‘I ate three apples of the fruits.’ (von Heusinger & Kornfilt 2021, this volume)
- b. *Mačiau (keletą) jo kolegų.* (Lithuanian)  
 see.PST.1SG (some.ACC) his colleagues.GEN  
 ‘I saw (some of) his colleagues.’ (Seržant 2021, this volume)

Finally, there are richly inflected languages, notably Finno-Ugric languages and Basque, which mark partitivity in the broad-sense with a dedicated case:

- (7) a. *Kissa jo-i (paljon/vähän) maito-a.* (Finnish)  
 cat.NOM drink-PST.3SG much / little milk-PART  
 ‘The cat drank a lot of / a little milk.’ (Thomas 2003)
- b. *Anek ez du garagardo-rik edan.* (Basque)  
 Ane.ERG NO AUX beer-PART drink  
 ‘Ane has not drunk beer.’ (Etxeberria, this volume)

As shown by the glosses, the nominals marked with partitive case in (7) have the interpretation of weak indefinites.

The phenomena above present many similarities, among which the notion of indefinite quantity, which is an ingredient of partitive and pseudo-partitive constructions and which is the main property of partitive determiners, partitive pronouns and partitive case. The study of partitivity therefore intersects with the study of (in)definiteness, which is an elusive notion itself (cf. Brasoveanu & Farkas 2016), expressed by very different markers (including zero marking even in languages with articles, as noted for English above), taking many different semantic and pragmatic interpretations (specificity, presupposition of existence, free choice), and notoriously interacting with clausal features such as polarity, modality, aspect, and quantification.

Although the interest in the concept of partitivity has continuously increased in the last decades and has given rise to considerable advances in research, partially represented in the considerations made so far (cf. Luraghi & Huomo (eds.) 2014; Falco & Zamparelli (eds.) 2019; Ihsane & Stark (eds.) 2020; Ihsane (ed.) 2021; Westveer 2021), the fine-grained morpho-syntactic and semantic

variation displayed by partitive elements across European languages is far from being well-described, let alone well-understood. There are two main obstacles to this: on the one hand, theoretical linguistics and typological linguistics are fragmented in different methodological approaches that hinder the full sharing of cross-theoretic advances; on the other hand, partitive elements have been analyzed in restricted linguistic environments, which would benefit from a broader perspective. The aim of the PARTE project, from which this volume stems, is precisely to bring together linguists of different theoretical approaches using different methodologies to address this notion in its many facets.

The volume wants to address the three core notions of partitivity, namely partitive structures, partitive determiners and partitive pronouns (including partitive case) in different languages, language families and language types, from different perspectives. The volume also aims to reflect on the many different terms used in different frameworks and hypotheses to name the same phenomenon and, vice versa on the ambiguously used term ‘partitivity’ to name very different phenomena.

The rest of this section provides an introduction to the major empirical phenomena observed by previous literature and the questions raised therein. Section 2 provides an overview of how the chapters of this volume contribute to answering some of these questions. Section 3 provides a terminological guide.

## 1.1 Cross-linguistic variation

While proper partitive (1) and pseudo-partitive (2) constructions are present in very many (possibly all) languages, partitive determiners, pronouns, and case are only present in restricted groups of languages, belonging to different language families. This is not to deny that the functions of these three types of elements cannot be identified in most (possibly all) languages, but to observe that in many languages these functions are associated to zero morphemes, that is zero determiners, unmarked case, or nominal ellipsis (occurring in the presence of a quantifier). The investigation of partitivity is therefore interesting and promising in both the intra-genealogical micro-parametric perspective (across languages belonging to the same language family) and the extra-genealogical macro-parametric perspective across languages that belong to different language families and language types. The former allows us to detect the microvariation that characterizes given markers. The latter allows us to test general properties across apparently very different markers.

This section sets the properties of the partitivity markers treated in the volume into a wider picture of the phenomena involved. In a micro-comparative perspective, we present the properties of partitive determiners, partitive pronouns and

partitive case in Romance and Germanic. In the macro-comparative perspective, we review recurrent properties of partitive case(s) in Balto-Slavic, Finnish or Basque that are also found on partitive determiners and partitive pronouns in the other language types.

In the Romance family, the partitive determiner (4) is limited to Gallo-Romance varieties (French, northern Italian dialects and Standard Italian, Gascon, Provençal). Portuguese, Spanish, Catalan and Romanian have another type of overt indefinite determiner competing with bare nominals, related to the plural form of the indefinite article (Port. *uns*, Cat. *uns*, Sp. *unos*, Rom. *niște* (nominative-accusative) and *unor* (dative-genitive)). There are some interesting differences in interpretation between Italian *dei* and French *des*: both can have ambiguous scope in intensional and negative contexts, but while the former can be the object of telic predicates (and for some Italian speakers only of telic predicates, cf. Cardinaletti & Giusti 2016; Giusti 2021), the latter can only appear with atelic predicates (cf. de Swart 2006; Carlier 2021, this volume, and the references in Section 1.4 below):

- (8) a. *Maria ha raccolto delle fragole* (Italian)  
 Mary has picked PART.DET.PL strawberries  
*in un'ora / %per un'ora.*  
 in an hour / for an hour  
 'Mary picked some strawberries in an hour.'  
 %'Mary has been picking strawberries for an hour.'
- b. *Marie a cueilli des fraises* (French)  
 Mary has picked PART.DET.PL strawberries  
*pendant des heures \*en une heure.*  
 for PART.DET.PL hours / in an hour  
 'Mary has been picking strawberries for an hour.'  
 '\*Mary picked strawberries in an hour.'

The most urgent step in this regard is to pin down the contexts that detect “core” indefiniteness and the other types of indefinites (cf. Gianollo 2018) to test the partitive article in different Romance varieties.

The partitive clitic *en/ne* (5b) is more extended across Romance languages than the partitive determiner, being also found in Catalan, Romansh, Occitan, Sardinian, and central and southern Italian dialects (Bossong 2016: 63). If a relation is to be hypothesized between the two markers, it is therefore an implicational one where the presence of the partitive pronoun is the condition for the presence of the partitive determiner. At the background of this issue is the notion of (partitive) case in languages in which case morphology is absent on nouns but present on pronouns. Not much literature has addressed this issue.

All Romance languages express partitivity and pseudo-partitivity with the genitive preposition *de/di*, as represented by Catalan (9), except Romanian, where *de* is limited to pseudo-partitives, and the locative preposition *dintre* appears with partitives, as shown in (10) (cf. Tănase-Dogaru 2008, 2017):

- (9) a. *molts dels meus amics* (Catalan)  
 many.M.PL of-the.M.PL my.M.PL friend.M.PL  
 ‘many of my friends’  
 b. *una tassa de cafè*  
 a cup of coffee
- (10) a. *mulți dintre / \*de copiii mei* (Romanian)  
 many.M.PL of-among / of friend.M.PL-the.M.PL my.M.PL  
 ‘many of my friends’  
*o ceașcă de cafea*  
 a cup of coffee

Note that *de* in all Romance languages has preserved (to varying degrees) the original locative/relative/ablative function of Latin *de* (‘from’) and the same holds for the clitic pronoun *en/ne*, which can have a locative function (12), besides a partitive function (5b) and a genitive function (13):

- (11) a. *Elle est de Venise.* (French)  
 ‘She is from Venice.’  
 b. *Sono di Amsterdam.* (Italian)  
 ‘I am from Amsterdam.’
- (12) a. *Ils en sortent.* (French)  
 they OBL.CL come-out.  
 ‘They come out of it.’  
 b. *Ne usciremo presto.* (Italian)  
 OBL.CL come-out. FUT.1P.PL soon  
 ‘We’ll soon be out of it.’
- (13) a. *J’en demanderai le prix.* (French)  
 I GEN.CL ask.FUT.1P.SG the price  
 ‘I will ask its price.’  
 b. *Ne conosco le virtù.* (Italian)  
 GEN.CL know.PRS.1P.SG the virtues  
 ‘I know his/her/its/their virtues.’

A locative preposition with partitive interpretation alternating with *de/di* is also found in Romance languages other than Romanian, such as Italian *tra/fra* ('out of'), which has a wider use than the genitive *di* (cf. Cardinaletti & Giusti 2006, 2017, Giusti 2021, this volume) and is clearly related to the ablative case found in other languages, as in Turkish (6a) above.

In the microparametric perspective, many questions arise as to the synchronic relation between partitive forms on determiners and pronouns. Can the partitive determiner be unified with the preposition merged with the definite article introducing the superset in a partitive construction occurring with quantifiers (as attempted by Milner 1978; Chierchia 1998; Zamparelli 2008)? If not, what is the category of the partitive determiner? Is it the same category as the partitive pronoun? What are the properties responsible for the variation found in the distribution of partitive determiners and partitive pronouns across the Romance languages that display such elements? What are the properties that have triggered the new formation of such elements from the common Latin ingredients? Has the development of the partitive determiner in Italian an independent line or is it due to contact with French and Northern-Italian Gallo-Romance? A comparative perspective with continental Germanic may help us set such questions in a broader scenario.

Continental Germanic languages display a different pattern than English, cf. (1)-(2) and the glosses of (4)-(5) above. Let us take German, a language that has preserved genitive case. In Standard German, the part-whole relation can be expressed by genitive case or by the genitive / locative preposition *von*, assigning dative to its complement, as in (14):

- (14) a. *Ich habe drei ihrer Bücher gelesen.*  
 I have three her.GEN books read  
 b. *Ich habe drei von ihren Büchern gelesen.*  
 I have three of/from her.DAT books.DAT read  
 'I read three of her books.'  
 c. *Ich habe drei davon gelesen.*  
 I have three there-of read  
 'I read three of those.'

Neither marker appears in the pseudo-partitive relation, which is instead realized with the juxtaposition of a bare noun to the quantity noun (15a). As in English, indefiniteness is realized by bare nouns (15b). Overt partitive determiners are not present. The pronominalization of a PP denoting the definite superset appearing with a null quantifier is possible with the weak pronoun *da* procliticized onto the preposition *von* in (15c):



- (15) a. *Marie hat ein Glass Wein getrunken.*  
 ‘Mary drank a glass [of] wine.’  
 b. *Marie hat Wein getrunken.*  
 ‘Mary drank wine.’  
 c. *Marie hat von dem Wein / \*des Weins / davon getrunken.*  
 Marie has of-the wine / the.GEN wine.GEN / there-of drunk  
 intended reading: ‘Marie has drunk some (of the wine).’

Partitive determiners are however found in non-standard Germanic varieties and appear to be strictly related to the genitive case that is found in previous stages with a partitive function (cf. Glaser 1992, 1993; Strobel & Glaser 2021 and Section 1.2 below). Döhmer’s (2017: 120–121, 2018) data on Luxembourgish show that genitive determiners with a partitive interpretation appear with quantifiers (16a) as well as on indefinite nominals (16b), in which use they are in complementary distribution with the null determiner (16c), which is used with an indefinite interpretation. Strobel & Glaser (2021) confirm similar cases in Walliser and Valser German dialects (16d), with the interesting possibility of few “out of the blue” indefinites with a partitive determiner, equivalent to “*Do we still have apples?*” in the context of a grocery list, but not to “*These are no roses, they are tulips*” in the context of a flower shop.

- (16) a. *An ech kéint nach 100 där Beispiller nennen.*  
 and I could more 100 the.GEN.PL examples mention  
 ‘And I could mention 100 more of these examples.’  
 b. *Mir hunn all Dag där Beispiller.*  
 we have all day the.GEN.PL examples  
 ‘Every day we have (some) of these examples.’  
 c. *Gitt Beispiller!*  
 ‘Give examples!’  
 d. *Welleder nu deru/deschi Steina/Boone/Epfla?*  
 want.you still the.GEN.PL stones/beans/apples  
 ‘Would you like (some) more of these /such stones / beans / apples?’

Apart from these cases, they note that the genitive forms usually have an additional “sort-of” interpretation, as in all cases of (16). In this interpretation, they covary with the newly formed *von+art* construction, which is also present in Southern Rhine Franconian and Dutch.

As a matter of fact, not only does Dutch display the partitive (quantitative) pronoun *er* in (5a) above, it also has a construction that resembles the use of the partitive determiner in Romance: the *van die*-construction (de Hoop, van den

Wyngaerd & Zwart 1990). This construction, which contains a demonstrative, is however limited to the “sort-of” interpretation, which is possible but is not the core interpretation of the partitive determiner in Romance. Generally, the construction is used with a modifier and can figure as an object of a transitive verb (17a), or with an existential verb (17b) and in presentational constructions (17c):

- (17) a. *Hij heeft altijd van dat vieze haar.*  
 he has always of that dirty hair  
 ‘He always has (that) dirty hair.’
- b. *Er zijn van die mensen die altijd tevreden zijn.*  
 there are of those people that always satisfied are  
 ‘There are people that are always satisfied.’
- c. *Er liepen van die vreemde mensen op straat.*  
 There walked of those strange people on street  
 ‘There were such strange people walking on the street.’

The loss of genitive case and the new formation with the semi-lexical preposition *von/van* appear to be the two extremes of a system in which zero morphology represents an intermediate stage and a strong competitor. Note that these *van/von* determiners have the “quality” interpretation which is also present in French and Italian when the partitive determiner is formed by a demonstrative, which Le Bruyn (2007) calls bare partitives (translations are ours):

- (18) a. *Je n’ ai pas vu de ces bonhommes.* (French)  
 I NEG.CL have NEG seen of these little-men  
 ‘I never saw this type of guys.’
- b. *Non abbiamo di questi libri.* (Italian)  
 NEG have.PRS.1PL of these books  
 ‘We don’t have this type of books.’

As regards pronominal forms, Strobel (2012) shows that genitive weak pronouns are resilient in West Central German and East Franconian, as a pronominal partitive anaphor binding the quantitative complement of a quantifier, as in (19a), or a bare indefinite, as in (19b) (competing with different new formations, including the more general Germanic null pronoun, but also the use of the indefinite determiner *ein* ‘one’ and the interrogative determiner *welch-*, ‘which’):

- (19) a. *(Geschwister)? Ich habe (ere) fünf.* (Central Hessian)  
 Siblings? I have PART.WK five.’ (SyHD Pt\_E3\_B\_Aug\_11: Q20)

- b. *Mer hu ach Melch. Willst du ere?* (Central Hessian)  
 we have also milk want you PART.WK (SyHD E2\_Jun\_11: Q22)  
 ‘We have milk, too. Would you like some?’

As for partitive case, in Balto-Slavic, partitive genitive is related to negation, as in (20a-b) and to quantifiers, as in (20c):

- (20) a. *W parku nie ma fontanny.* (Polish)  
 in park.LOC NEG have fountain.GEN  
 ‘There is no fountain in the park.’ (Miestamo 2014)
- b. *Jonas ne-per-skaitė laišk-o.* (Lithuanian)  
 Jonas NEG-PRV-read.PST.3SG letter-GEN  
 ‘Jonas did not read the letter.’ (Arkadiev 2016)
- c. *pjatj star-yx gorod-ov* (Russian)  
 five.NOM/ACC old-GEN.PL town-M.GEN.PL  
 ‘five old towns’ (Stepanov & Stateva 2018)

In Finnish, partitive case appears with unbounded predicates (21a), with quantifiers (21b) and in the scope of negation (21c).

- (21) a. *Poika sö-i omen-i-a.* (Finnish)  
 boy.NOM eat-PST.3SG apple-PL-PART  
 ‘The boy was eating apples.’ (Thomas 2003: 24)
- b. *Kissa jo-i paljon / vähän maito-a.*  
 cat.NOM drink-PST.3SG much / little milk-PAR  
 ‘The cat drank a lot of / a little milk.’ (Thomas 2003: 41)
- c. *He ei-vät syö liha-a.*  
 they.NOM NEG-3PL eat meat-PART  
 ‘They don’t eat meat.’ (Thomas 2003: 45)

The quantifier condition is notably independent of unboundedness, as shown by the contrast in (22). In (22a), the quantifier is marked for partitive because it is in the complement of an unbounded predicate and assigns partitive to the nominal expression it quantifies over. In (22b), there is no partitive case on the quantifier in the complement of a bounded predicate, but partitive case is still assigned by the quantifier to the noun (cf. Thomas 2003):<sup>2</sup>

<sup>2</sup> Parallel to the partitive genitive in Russian, the number of the quantified noun depends on the selectional properties of the quantifier. Note that two Finnish quantifiers with roughly the same

- (22) a. *Koira sö-i kahta luu-ta.* (Finnish)  
 dog.NOM eat-PAST.3SG two.PART bone-PART  
 ‘The dog was eating two bones.’  
 b. *Koira sö-i kaksi luu-ta.*  
 dog.NOM eat-PST.3SG two bone-PART  
 ‘The dog ate two bones.’

Besides Balto-Slavic (and Finno-Ugric/Uralic languages (Tamm 2014)), a designated partitive case is also found in Basque. In the Basque examples (23) it interacts with modality (23a) and clause type (23b):

- (23) a. *Beharbada entzungo dut albiste on-ik.* (Basque)  
 perhaps hear.FUT AUX news good-PART  
 ‘Perhaps I will hear good news.’  
 b. *Goxoki-rik nahi al duzu?* (Basque)  
 candy-PART want QUEST AUX  
 ‘Do you want any candy?’ (Etxeberria 2021, this volume)

Since partitivity in the broad sense can be expressed in different ways, the question arises as to whether cognate forms in cognate languages have the same interpretation and/or the same formal properties. Given the great variability in interpretation and distribution of these forms even in neighboring dialects (cf. Cardinaletti & Giusti 2018, 2020 for Italian dialects and regional informal Italian), the expected answer is no. But then a more articulate question must be asked as to whether we can find constants in the attested variation. In order to start answering this question we must first establish the repertory of syntactic and semantic variation for each possible form, and the properties that it shares with homonymous non-partitive markers (such as ablative/genitive case or prepositions), as is attempted in Giusti’s, Carlier’s and Etxeberria’s contributions (2021, this volume).

In the macro-comparative perspective, there are at least two properties worth noting. First of all, partitive markers are generally restricted to internal argument

---

meaning such as *paljon* and *monta* display a different form of the noun (Thomas 2003; Csirmaz 2012):

- (i) *Kissa sö-i paljon hiir-i-ä.*  
 cat.NOM ate many mouse-PL-PART  
 (ii) *Kissa sö-i monta hiir-tä.*  
 cat.NOM ate many mouse-SG-PART  
 ‘The cat ate many mice.’

positions, such as direct object or subject of unaccusative predicates, and alternate with the structural case attributed to them (e.g., nominative/accusative in Finnish or Italian, absolutive in Basque). In many respects, partitive case is a type of DOM (differential object marking), which marks affected/specific/definite/salient referents as opposed to unaffected/non-specific/indefinite/unknown referents marked by partitivity or not marked at all (cf. Witzlack-Makarevich & Seržant 2018). This holds for richly inflected languages such as Turkic, Finno-Ugric, Balto-Slavic and Basque, but also for poorly inflected languages such as Romance and partially Germanic, irrespective of whether they have an article. These properties are recurrently noted in most contributions to this volume.

Many contributions also account for another recurrent property; namely, the fact that partitivity presents coexisting patterns that build a complex system of partitive markers. Some of these markers specialize for different interpretations (e.g., the part-whole relation, the measure interpretation of pseudo-partitivity, the indefinite quantity interpretation of existential quantifiers, and indefinite reference), some overlap with one another, providing an intricate pattern of variability and optionality. This gives rise to diatopic and diachronic variation. In this respect, again, the question arises as to whether it is possible to find recurrent paths of grammaticalization (Luraghi & Kittilä 2014), or partitivity cycles, i.e., recurrent diachronic developments by which a former proper partitive (a true-partitive construction in Seržant's terms) turns into a generalized partitive and then into a partitive determiner (Seržant 2021, this volume).

## 1.2 The diachrony of partitive determiners, pronouns and case

French and Italian provide a privileged field of study of the development of partitive determiners. Such a construction was already present in Latin (cf. Luraghi 2012). Carlier (2007) claims that in Old French the partitive determiner is formed by two concurring changes: the loss of case morphology that is at the base of a higher use of prepositions (in this case *de* becomes the marker of genitive case and grammaticalizes as an indefinite determiner) and the loss of plural morphology, which makes it necessary for the definite article to grammaticalize, losing its definite interpretation in the partitive determiner. This diachronic development was accompanied by an extension of the contexts in which partitives could be used. From direct objects, the use was extended first to subjects of existential verbs, then to subjects of unaccusative verbs, unergative verbs and transitive verbs, and to complements of prepositions (Carlier & Lamiroy 2014).

Partitive determiners are attested in Old Spanish and Portuguese but disappeared in later stages of these languages. With the Old Spanish example (24)

from the second half of the 13<sup>th</sup> century, Luraghi (2012) shows that the partitive construction was allowed with unaccusatives by that time, and had therefore set some steps already on the diachronic cline presented in the previous paragraph for French and Italian:

- (24) *Et salieron a él de los omnes buenos.* (Old Spanish)  
 and come.PST.3PL to him of the men good  
 ‘And some good men came to him.’  
 (Alfonso X el Sabio, Primera Crónica general, 1260–1284)

According to Luraghi, a similar path of development also took place in the case of Finnish, partitive case being allowed on subjects with existential verbs, and, more recently, also on subjects of unaccusative verbs. Although partitive case in Finnish has different interpretive properties than French and Italian partitive determiners, it also clearly expresses indefiniteness, as in (25), (cf. also Section 1.4 below):

- (25) *Löysin voita.* (Finnish)  
 find.PST.1SG butter.PART  
 ‘I found some butter.’ (Huumo 2010)

The partitive pronoun follows a similar path. In both Romance and Germanic, its original meaning is that of a referential superset: ‘from there’, ‘thereof’, ‘of them’, ‘their’ (Badía i Margarit 1947; Bech 1952). The Romance partitive clitic derives from the oblique weak form INDE (‘from there’), as is often the case with genuine partitives. It was lost in Spanish and Portuguese, just like the partitive determiner (Gerards 2020). With the omission of the quantifier, an indefinite reading similar to the partitive determiner reading was created, as in the French example (26b):

- (26) a. *Tu connais ces livres? Oui, j'en ai lu trois.* (French)  
 you know these books? Yes, I PART.CL have read three.  
 ‘Do you know these books? Yes, I read three of them.’  
 b. *Vous voulez du café? Non, j'en ai encore.*  
 You want PART.DET.M.SG coffee? No, I PART.CL have still.  
 ‘Do you want coffee? No, I still have some.’

In Germanic, it is a residual genitive pronoun (5a), (19), parallel to the genitive determiners in (16). Strobel (2017), Strobel & Glaser (2021) show that these genitive forms expressing partitivity and indefiniteness are abundantly present in Old and Middle High German (27)–(28) and residual in Early New High German (29):

- (27) a. *joh brast in thar **thes** win-es*  
 also was-lacking them there the.GEN.M wine-GEN.M  
 ‘and they also lacked wine’ (OHG, O. 2.8.11)
- b. *nam er tho selbo thaz brot [...] gibot thaz sie-s azin*  
 took he then himself the bread[...] demanded that they-it.GEN ate.SBJV  
 ‘then he took the bread and demanded that they should eat it/some’  
 (OHG, O. 4.10.9)
- (28) a. *Wand ich noch **ein-er salb-en-** hân die dâ*  
 because I still a-GEN.F ointment-GEN.F have that there  
*Feimorgân machte.*  
 Feimorgân made  
 ‘Because I still have some ointment made by Feimorgân.’ (MHG, Iw. 3423)
- b. *und **dez** gap im nieman*  
 and this.GEN gave him nobody  
 ‘and nobody gave him any [pigfeet]’  
 (MHG, Sermons, 13th c., Grieshaber 1848, 78)
- (29) a. *iss **des** brot-s*  
 eat the.GEN bread-GEN  
 ‘Eat (some) bread’ (ENHG Luther, OT, Ruth 2.14)
- b. *darmit das holtz, ob im **des** zufluß,*  
 with-this the wood if him this.GEN towards-flowed  
*aus dem wasser gezogen werd*  
 out-of the water pulled was  
 ‘so that he could pull the wood flowing towards him out of the water’  
 (ENHG, ms. 1475, Lexer 1862, 250)

The diachronic dimension is crucial to capture the relation between the expression of partitivity and the expression of indefiniteness, thereby providing the ground to hypothesize the notion of partitive cycle. Seržant’s contribution (2021, this volume) discusses in a typological perspective recurrent patterns of change from adverbial (ablative) partitives to selected quantificational partitives (and pseudo-partitives) to generalized partitives (without the quantifier), which are the base of the formation of partitive determiners and dedicated partitive pronouns and partitive case. Luraghi and Albonico’s contribution (2021, this volume) gives an overview of the rare attestations of this development from Old Italian to modern Italian and argues that the “bare” partitive construction is independent of the formation of the partitive determiner in modern Italian.

### 1.3 The acquisition of partitivity in bilingualism and L2/L3

If the broad notion of partitivity is a linguistic universal that is realized by corresponding forms in human language, we would expect a rather direct transfer from one language to another. If we are in fact dealing with different types of phenomena, we expect greater variation of bilingual or L2–L3 acquisition from speakers who do not have partitive elements in their L1.

Research on the second language acquisition of partitive elements has shown that their acquisition is most problematic for learners who do not have the partitive element in their first language (L1), although it may also present some problems for learners who do have the partitive element in their L1. Studies for article-less languages as L1 are, a.o., Runić (2012), who studied the use of the Italian articles by Serbo-Croatian students. Runić showed, among other things, that the Serbo-Croatian learners overgeneralized the use of the definite article in contexts where a partitive determiner or a null determiner should be used in Italian. Example (30) was produced by an L2 student of Italian at the B2 level of the Common European Framework of Reference. For all definite determiners used by the student a null determiner (or a partitive determiner in other cases) would appear in the target language:

- (30) *Le numerose opere sono nate a causa dei sentimenti del*  
 the numerous works are born because of-the feelings of-the  
*genere.* (L2 Italian)  
 sort

*Sono piene delle emozioni che suscitano le riflessioni sui rapporti*  
 are.3PL full of-the emotions that arouse the thoughts on-the relations  
*esistenti nella nostra vita. [. . .] Abbiamo speso i giudizi molto*  
 existing in-the our life. [. . .] have.1PL often the judgements very  
*soggettivi quando si tratta dell'atteggiamento di un amico.*  
 subjective when REF [it]-handles of-the attitude of a friend

‘Many works were born because of this kind of feelings. They are full of emotions that arise from thoughts about existing relations in our life. We often have very subjective judgements when the attitude of a friend is concerned.’

Studies on the acquisition of partitive pronouns by learners with L1s without a partitive pronoun are Wust (2009) in a dictogloss task, for the use of the French partitive clitic *en* by L1 English learners of French as an L2, and Perpiñan (2017), who studied the use of the Catalan partitive clitic *en* by Catalan-Spanish bilinguals by means of an Acceptability Judgement Task and an Oral Production Task. Wust



shows that low and intermediate L1 English learners of L2 French did not yet use partitive *en*. Perpiñan shows that the omission of the partitive clitic in the Acceptability Judgement Task was significantly more accepted by the Spanish-dominant bilinguals than by the balanced bilinguals, who in turn accepted the omission significantly more than the Catalan-dominant bilinguals. In the Oral Production Task, the Catalan-dominant speakers produced the partitive clitic significantly more than the two other groups. An example of the omission of the partitive clitic is given in (31):

- (31) *La Maria menja carn? No menja mai.* (L2 Catalan)  
 the Maria eats meat? not eats.3SG never  
 ‘Does Mary eat meat? No, she never eats it.’  
 Expected Response: *No en menja mai.*

Sleeman & Ihsane (2017) show that L1 (Netherlandic Standard) Dutch learners of L2 French had most problems with the contexts in which the use of the partitive pronoun in French and Dutch differs. These were especially contexts in which in French a noun phrase introduced by a partitive determiner or negative *de* is replaced by the partitive clitic *en*. In a Grammaticality Judgement Task, most (advanced) Dutch learners of L2 French accepted the ungrammatical definite pronoun *le* in (32a), which they transferred from their L1, *het* in (32b):

- (32) a. *Tu ne bois jamais de vin?*  
 you NEG.CL drink never DE wine?  
*Non, je n' en /\*le bois jamais.*  
 No, I NEG.CL PART.CL./ACC.CL drink never  
 b. *Drink je nooit wijn? Nee, ik drink \*er/het nooit.*  
 drink you never wine? no, I drink PART.WK/ACC.WK never  
 ‘Do you never drink wine? No, I never drink it.’

Recall that Dutch *er* is a weak pronoun, not a clitic, and cannot resume a bare indefinite in Netherlandic Standard Dutch, as noted in (5a) above.

Ehala (2012) conducted a quantitative study of Estonian object marking, including the use of partitive case, by L2 learners with Russian as their L1. In Russian, the direct object is usually in the accusative case, but in negative clauses, it may be in the genitive case. In Estonian, the direct object can be marked with the partitive, genitive, or nominative case, but the partitive case is the most used. The data show that informants negatively transferred Russian features to Estonian L2, but that there was also positive transfer. The author does not explain all errors in this way. It is argued that some non-target forms may also be due to

patterns that are productive in the L2, such as universal cognitive preferences and analogical extension of error patterns.

Some studies compare groups of learners with different L1s or different types of bilingualism. A study that was already mentioned is Perpiñan (2017) on the acceptance and production of the Catalan partitive pronoun *en* by adult Spanish-dominant, Catalan-dominant and balanced bilinguals. Soto-Corominas (2019) shows that different types of bilingual children (Spanish-dominant, Catalan-dominant, or balanced) display different behavior not only in the production of *en* in Catalan, but also in the non-target production of it in Spanish. According to Soto-Corominas, the Spanish-dominant bilingual children lag behind in the acquisition of the partitive clitic with respect to the Catalan-dominant bilinguals in contexts that require partitive *en* in Catalan, while Catalan-dominant bilingual children often recycle the Catalan clitic in Spanish. Tarrés & Bel (2017) studied the production of the Catalan partitive pronoun *en* by L1 French and L1 Portuguese learners of Catalan. Their results suggest a facilitative effect of French, which possesses a partitive pronoun, but not of Portuguese, which does not have one. Spoelman (2011) investigated the use of partitive case in L2 Finnish by L1 Estonian, German, and Dutch learners on the basis of the *International Corpus of Learner Finnish*. She showed that, since the use of partitive case is largely similar in Finnish and Estonian, the Estonian learners made significantly fewer partitivity errors than the German and Dutch learners. Some specific error patterns were attributable to subtle L1–L2 differences between Estonian and Finnish.

Most of these studies focus on the absence in the L1 and the presence in the L2 of a feature. Some of these studies investigate the acquisition of subtle differences if both the L1 and the L2 possess the partitivity marker. An interesting question is whether positive transfer is possible not only when the partitivity marker is used in the same way in the L1 and the L2 in all, most or some of the contexts, but also when the L1 does not have the same type of partitivity marker and can express partitivity in the relevant contexts in another way. This question will be answered in Sleeman & Ihsane's and Berends, Sleeman, Hulk & Schaeffer's contributions (2021, this volume).

## 1.4 The semantic implications of partitive constructions

For partitive constructions introduced by a quantifier, as in the example *three of her books* illustrated in (1) – see, among others, Hoeksema (1996), Zamparelli (1998) and Cardinaletti & Giusti (2006, 2017) – Jackendoff (1977) formulated the Partitive Constraint, which states that the presence of a definite determiner in the complement has to be respected:

- (33) a. *\*many of all books*  
 b. *\*two of a lot of books*  
 c. *many of the books*  
 d. *two of these books*

Ladusaw (1982) argued that in partitive constructions such as in (33d) the superset ‘these books’ cannot contain less than two elements. The number of elements in the subset can be equal or smaller to the number of elements in the superset. On the opposite side, Barker (1998) argued that partitive constructions can only express proper partitivity, which means that the number of elements in the superset must be higher than in the subset. Marty (2019) defends Ladusaw’s view arguing that proper partitivity is the result of a presuppositional implicature, due to the competition with non-partitive alternatives, as in (34):

- (34) a. *Three of John’s lawyers.*  
 b. *John’s three lawyers.*

However, while the interpretation of (34a) is that of three indefinite individuals out of a definite group of individuals, the interpretation of (34b) is that of three definite individuals and no superset is involved. The two constructions therefore do not truly compete for the same interpretation.

Partitivity in a broader sense may refer to nominal expressions introduced by overt indefinite determiners, as in the case of mass and plural nouns in French (and Italian) exemplified in (4) above. As also mentioned in Section 1.2, Carlier (2007) claims that the ‘partitive article’ in modern French is fully grammaticalized into an indefinite determiner: the form *de* is not a preposition and the definite article has no definite meaning (e.g. it interacts with scope, negation, and aspect). Cardinaletti & Giusti (2016) support the same claim, against Chierchia (1998) and Zamparelli (2008), showing that the definite article cannot be attributed a kind-referring interpretation.<sup>3</sup>

As for the fact that the plural indefinite determiner in French can only appear with atelic predicates, as illustrated in (8), Ihsane (2005) proposes that *de* is itself an aspectual functional head, thereby accounting for the unbounded aspect in sentences such as (8b).

When combined with sentential negation, *de* in French is used without the definite article. In that case, it can only get a narrow scope interpretation.

---

<sup>3</sup> Cf. Giusti (2021, this volume) for a detailed argumentation of this.

- (35) a. *Nous n' avons pas de sucre.*  
 we NEG.CL have NEG DE sugar  
 'We do not have sugar.'
- b. *Jean n' a pas acheté de pommes.*  
 Jean NEG.CL has NEG bought DE apples  
 'John has not bought apples.'

In this respect *de* in (35) contrasts with noun phrases introduced by a definite determiner as in (36a), which can take wide scope over negation, as observed above with reference to Cardinaletti & Giusti (2016). It also contrasts with the use of the partitive determiner *des* in contrastive contexts, such as (36b), in which the intension rather than the quantity is negated:

- (36) a. *Nous n' avons pas mangé le pain.*  
 we NEG.CL have NEG eaten the bread  
 intended reading: 'There is bread and we have not eaten it.'
- b. *Jean n' a pas acheté des pommes, mais des bananes.*  
 Jean NEG.CL has NEG bought PART.DET apples, but PART.DET bananas.  
 'Jean has not bought apples, but bananas.'

In a macroparametric perspective the question arises if semantic or morphological distinctions such as those presented in this section can also be made by means of case distinctions. For Turkish, Enç (1991) claims that the sentence in (37a) can have either of the two continuations, which only differ in the accusative case morpheme appearing on the object DP in (37b), which is missing in (37c). The difference in interpretation is that only (37b) can refer to two girls that are part of the children mentioned in the context sentence (37a):<sup>4</sup>

- (37) a. *Oda-m-a birkaç çocuk gir-di.*  
 room-1.SG-DAT several child enter-PST  
 'Several children entered my room.'
- b. *İki kız-ı tanı-yor-du-m.*  
 two girl-ACC know-PROG-PST-1.SG  
 'I knew two girls.'

---

<sup>4</sup> The translations of the examples in (37) and (38) are Enç's. The glosses have been taken from Kornfilt and von Heusinger (2021, this volume).

- c. *İki kız tanıyor-du-m.*  
 two girl know-PROG-PST-1.SG  
 ‘I knew two girls.’

Enç proposes that accusative objects are specific and semantically interpreted as partitives. Enç further observes that Turkish has two ways to express the superset, with genitive case or ablative case, as in (38):

- (38) a. *Ali kadın-lar-ın iki-sin-i tanıyor-du.*  
 Ali woman-PL-GEN two-3.SG-ACC know-PROG-PST.3.SG  
 b. *Ali kadın-lar-dan iki-sin-i tanıyor-du.*  
 Ali woman-PL-ABL two-3.SG-ACC know-PROG-PST.3.SG  
 ‘Ali knew two of the women.’

In both sentences (38), the accusative marker *-i* is obligatory. This leads Enç to attribute to the accusative marker an interpretation of specificity (capacity to refer to a previously introduced referent) and partitivity (the ‘part’ interpretation in a ‘part-whole’ construction). Many authors (cf. Kornfilt 1997; von Heusinger & Kornfilt 2005 a.o.) claim that Differential Object Marking in Turkish, parallel to what happens in other languages, conveys a specificity interpretation. Öztürk (2005) even claims that the accusative marker conveys definiteness and exhaustivity. But these notions are in turn cover terms for different types of reference, as argued by von Heusinger (2019) and von Heusinger & Kornfilt (2021, this volume). According to von Heusinger & Kornfilt, Enç’s claim about the Turkish accusative marker expressing specificity is (probably) correct, but not for the reasons that Enç refers to (i.e., the partitivity of overt accusative in (38)); instead, they appeal to a formal morpho-syntactic constraint, which predicts the obligatoriness of overt accusative in such examples, and which is independent from partitivity. This is further discussed by the authors (von Heusinger & Kornfilt 2021, this volume).

Finnish is a language in which the use of partitive case shows many resemblances with the use of the partitive determiner in French. As already observed in (21)-(22) above, it is used both on indefinite mass nouns and indefinite plural nouns signaling an unbounded quantity; it may depend on the unbounded aspect of the verb (Kiparsky 1998); it is also used on indefinite nouns combined with clausal negation (Huumo 2021, this volume).

As regards Basque partitive case, historically, it could be licensed by negative polarity items (de Rijk 1972; Etxeberria 2021, this volume), just like *de* in French (32a) can be licensed by negation:

- (39) *Beretzat ez zegoen beste gizon-ik inor.* (Agirre, Kresala, 190)  
 for her/him NEG AUX other man-PART anybody  
 ‘For her/him, there was no other man.’

The clear parallel between partitive case on nouns, pronouns and determiners, with partitive determiners that have the form of a prepositional case marker, calls for a unified analysis. More research is needed to determine in which contexts case is exactly used and what its exact semantic contribution is in these languages. Does accusative case in Turkish distinguish a proper partitive reading from partitive tout court (Marty 2019) or vice versa? What is the relation between unbounded quantity and unbounded aspect in Finnish? How did the relation between partitive case and negation develop in modern Basque? The contributions by Kornfilt & Von Heusinger, Huumo, and Etxeberria help to answer these questions.

## 2 Overview of the volume

This volume collects several of the papers presented at the first workshop of the PARTE Network, held at Ca’ Foscari University of Venice on November 13–14, 2017. It focuses on Partitive Determiners, Partitive Pronouns and Partitive Case in European languages, their emergence and spread in diachrony, their acquisition by L2 speakers, and their syntax and interpretation in a cross-theoretical typological perspective. It is structured in nine chapters grouped in four parts: each part presents a different perspective to approach partitive determiners, partitive pronouns and partitive case.

Part I aims at setting general diagnostics to distinguish partitive determiners, pronouns and case from proper partitive constructions and pseudo-partitive constructions on the one hand and the zero marker for indefinites on the other hand. In Chapter 1, Giuliana Giusti presents a number of diagnostics that apply to Italian to distinguish partitive determiners from partitive pronouns and to distinguish both categories from the partitive PPs that refer to the definite superset in a partitive construction. The proposal is set in what Giusti calls a “protocol approach”, which organizes language properties into a taxonomic system that allows the comparison of different languages/varieties or different constructions in the same language. In Chapter 2, Anne Carlier observes differences and similarities between the French partitive determiner and the zero marker with plural count nouns and singular mass nouns in Spanish and English. She also brings into the discussion the indefinite article that appears with singular count nouns

in the three languages. The result is a protocol-like presentation of the environments that detect semantic and pragmatic functions of the partitive determiner.

Part II presents two complementary perspectives in the study of language change: the typological macro-comparative and the language-internal micro-comparative perspective. In Chapter 3, Ilja Seržant addresses the issue of diachronic change from the typological perspective, resting on a convenience sample of partitive expressions in 138 languages, from 46 families, covering the six macro-areas in the World, with a bias for Eurasia (48%), in line with the focus of the PARTE project on European languages. Seržant claims that partitive expressions encoded by adpositional strategies are unstable cross-linguistically and tend to first develop into pseudo-partitives and then in “generalized” partitives. In Chapter 4, Luraghi & Albonico provide a language-internal perspective of the still scarcely documented development of the partitive determiner in (Old) Italian. On the basis of a corpus search, Luraghi & Albonico claim that not only did Old Italian display the “faded partitive” (like (18) above), in which *di* occurs with all sorts of determiners and has the interpretation of “things of this type”, it also displayed the partitive determiner, in which *di* only combines with the definite article and at this stage was ambiguous between a specific and a non-specific interpretation. According to the authors, this shows that it is not correct to derive the partitive determiner from the faded partitive.

Part III deals with the second language acquisition of partitive pronouns in Romance and Germanic, which represent the only surfacing of partitive case in these languages. The two chapters complement each other in the different populations studied and resemble each other in the method used: a Grammaticality Judgement Task. In both chapters the question is raised what the role is of transfer from the L1 to the L2, but in a property-by-property approach and not in a whole-sale approach. In Chapter 5, Sleeman & Ihsane provide a case in the acquisition of the partitive pronoun *en* in L2 French by German L1 speakers. After a fine-grained comparison of French and German noun ellipsis constructions, Sleeman & Ihsane investigate if there can be positive transfer in cases in which in French the noun ellipsis construction requires the use of *en* and in cases in which the anaphoric pronoun *welch-* is used in German (see Section 1.1). In Chapter 6, Berends, Sleeman, Hulk & Schaeffer study the acquisition of the partitive pronoun *er* in L2 Dutch by L1 speakers of French and English and take a similar approach as the one taken in Chapter 5: a property-by-property approach, focusing on [±presupposition] contexts. The authors show that both L1 French and L1 English learners significantly discriminate between grammatical [-presupposition] and ungrammatical [+presupposition] constructions in Dutch, which they attribute to transfer of a distinction that is made in other constructions in the L1 languages.

Part IV is dedicated to the syntax-semantics correlations between case and aspect and information structure on the one hand, and case and negation on the other hand, in three non-Indo-European languages. Chapter 7, by Tuomas Huomo, addresses the relation between case, (un)boundedness and time – consecutive events or a simultaneous event – in Finnish. It is shown how longitudinal and transverse quantities are expressed by Finnish S and O arguments in the partitive vs. nominative/accusative, and how they contribute to the aspectual meaning of the clause. Chapter 8, by Klaus van Heusinger and Jaklin Kornfilt, investigates the contribution of accusative case on the subset in a partitive construction as in (1) in Turkish to the interpretation of the construction. Based on an experimental study, the authors argue against the view that accusative case marks exhaustivity, i.e., expresses non-proper partitivity (see Section 1.4). They claim instead that accusative case marks specificity. In Chapter 9, Urtzi Etxeberria studies the development of partitive case into a partitive determiner in Basque. The author argues that the partitive determiner is the negative form of the existential interpretation of the Basque definite article [-a(k)] and the partitive determiner is analyzed as a super weak Polarity Item and licensed in non-veridical contexts.

### 3 A terminological note

This section provides a handy guide in the intricate and often inconsistent terminology used to refer to the many different types of partitive items.

**Proper partitive constructions** or **true partitives** are synonymous terms to refer to the complex structures in (1) or in (40), which refer to the part-whole relation between an indefinite subset and a definite superset. Note that in (40a) the structure is headed by a quantifier, while in (40b) it is headed by a measure noun:

- (40) a. *many of the girls I know*  
 b. *a cup of the tea you prepared, a bunch of the flowers you picked*

**Pseudo-partitive constructions** are instantiated by measure nouns (not quantifiers) which quantify over an indefinite mass or plurality:

- (41) a. *a cup of tea*  
 b. *a bunch of flowers*

**The partitive PP** is the prepositional phrase denoting the superset in a partitive construction. Richly inflected languages do not have the preposition but case



marking. According to Cardinaletti & Giusti (2006, 2017) the partitive PP that occurs in a true partitive construction is selected by the quantifier and displays structural case. The quantifier sets a requirement of lexical identity between the (often elided) indefinite nominal and the nominal in the definite superset:

- (42) a. *many (girls) of the girls who were at the party*  
 b. *\*these (girls) of the girls/children who were at the party*  
 c. *\*many girls of the children who were at the party*

This does not hold for circumstantial partitive PPs, such as the one introduced by *out of* in (43), which may cooccur with any type of nominal and do not show any logical restriction (Sleeman & Ihsane 2016):

- (43) a. *these girls out of the children who were at the party*  
 b. *many girls out of the children who were at the party*

**Implicit partitives, quantitative constructions, or simple quantifier phrases** are quantified nominal expressions that do not display an overt partitive superset. Since the superset may be recovered from the discourse, as in (44b), they are assigned by some authors an optional partitive interpretation:

- (44) a. *some / many / three girls*  
 b. *There were nice boys at the party. I had already met three.*

By some authors, they are assimilated to pseudo-partitives.

**Generalized partitives**, according to Seržant (2021, this volume), are “headless partitives” derived from the generalized drop of the quantifier in a true-partitive constructions. They are different from quantitative constructions (implicit expressions in Seržant’s term) in that they still refer to the full part-whole relation, as in Lithuanian:

- (45) *Mačiau (kaletą) jo kolegų.*  
 see.PST.1SG (some.ACC) 3SG.GEN colleague.GEN(=PART).PL  
 ‘I saw some of his colleagues’.

**Faded partitives** (de Hoop 2003) or **bare partitives** (Le Bruyn 2007) have the form of a partitive PP in direct object position, parallel to the generalized partitives, but unlike these they do not convey the part-whole relation. Instead, they convey the ‘sort-of’ or ‘you-know’ meaning, as illustrated by example (46), taken from De Hoop (2003). They have a demonstrative and not a definite article:

- (46) *Els at van die smerige bonbons.*  
 Els ate of those filthy bonbons  
 ‘Els ate of those filthy bonbons (you know).’

The **partitive determiner** or **partitive article** introduces an indefinite nominal expression. It is a property of Gallo-Romance languages and it is formally made of the preposition *di*, which is claimed by many (a.o. Carlier 2007; Ihsane 2008; Cardinaletti & Giusti 2016 and references therein) to have grammaticalized into a determiner, and the definite article, which does not contribute definite interpretation:

- (47) a. *J’ai vu des filles.* (French)  
 b. *Ho visto delle ragazze.* (Italian)  
 ‘I saw (some) girls.’

**Bare nominals** or **bare nouns** are weak indefinites with no determiner in languages which have an article (e.g., Romance and Germanic languages). In Germanic they can also refer to a kind, while in Romance kind-reference is realized by the definite article, notably in subject and object position. Thus, while the object of *love* can refer to a kind, the object of *eat* cannot and is expressed with a bare noun in Spanish (Laca 1990) and with the partitive determiner in French (Anscombe 1996), which does not have bare nouns in any position. In Italian bare nouns in the indefinite object of generic sentences alternate with the definite article, which does not refer to a kind but is simply indefinite, as proven by the comparison with the other three languages (cf. Giusti 2021):

- (48) a. *Monkeys love bananas.*  
 b. *Los monos aman las bananas.* (Spanish)  
 c. *Les singes aiment les bananes.* (French)  
 d. *Le scimmie amano le banane.* (Italian)
- (49) a. *Monkeys don’t eat bananas.*  
 b. *Los monos non comen bananas.* (Spanish)  
 c. *Les singes ne mangent pas des bananes.* (French)  
 d. *Le scimmie non mangiano (le) banane.* (Italian)

**Partitive pronouns**, also named **quantitative pronouns**, resume indefinite nominal expressions. They resume a bare noun (as in Italian) or the nominal constituent of a quantitative construction (as in Italian and Dutch), as already exemplified in (5) above. In French, in which weak indefinites are introduced by a partitive determiner, the quantitative clitic resumes such weak indefinites:

- (50) a. *J'ai mangé des cerises.* (French)  
 I have eaten PART.DET.PL cherries.  
 'I ate cherries'
- b. *J'en ai mangé.*  
 I PART.CL have eaten  
 'I ate some'

## References

- Agirre, Txomin. 1906. *Kresala*. Durango: Florentino Elosu-ren echean.
- Anscombre, Jean-Claude. 1996. Partitif et localisation temporelle. *Langue française* 109. 80–103.
- Arkadiev, Peter. 2016. Long-distance genitive of negation in Lithuanian. In Axel Holvoet & Nicole Nau. (eds.), *Argument Realization in Baltic*, 37–81. Amsterdam: Benjamins.
- Badia Margarit, Antonio M. 1947. Los complementos pronominalo-adverbiales derivados de IBI e INDE en la península ibérica. (= *Anejos de la Revista de Filología Española* 38). Madrid: Consejo Superior de Investigaciones Científicas.
- Barker, Chris. 1998. Partitives, double genitives, and anti-uniqueness. *Natural Language and Linguistic Theory* 16(4). 679–717.
- Bech, Gunnar. 1952. Über das niederländische Adverbialpronomen *er*. *Travaux du Cercle Linguistique de Copenhague* 8. 5–32. Copenhagen: Nordisk Sprog- of Kulturforlag.
- Berends, Sanne, Petra Sleeman, Aafke Hulk & Jeannette Schaeffer. 2021, this volume. The L2 acquisition of the referential semantics of Dutch partitive pronoun ER constructions. In Petra Sleeman & Giuliana Giusti (eds.) *Partitive determiners, partitive pronouns and partitive case* (Linguistische Arbeiten 580). Berlin: de Gruyter.
- Bossong, Georg. 2016. Classification. In Adam Ledgeway & Martin Maiden (eds.), *The Oxford guide to the Romance languages*, 63–72. Oxford: Oxford University Press.
- Brasoveanu, Adrian & Donka D. Farkas. 2016. Indefinites. In Maria Aloni & Paul Dekker (eds.), *The Cambridge handbook of formal semantics*, 238–266. Cambridge: Cambridge University Press.
- Cardinaletti, Anna & Giuliana Giusti. 2006. The syntax of quantified phrases and quantitative clitics. In: Martin Everaert & Henk van Riemsdijk (eds.), *The Blackwell companion to syntax*, vol. V, 23–93. Oxford: Blackwell.
- Cardinaletti, Anna & Giuliana Giusti. 2016. The syntax of the Italian indefinite determiner *dei*. *Lingua* 181. 58–80.
- Cardinaletti, Anna & Giuliana Giusti. 2017. Quantified expressions and quantitative clitics. In Martin Everaert & Henk van Riemsdijk (eds.), *The Wiley Blackwell companion to syntax*, 2nd edn., 1–61. Hoboken, NJ: Wiley Blackwell.
- Cardinaletti, Anna & Giuliana Giusti. 2018. Indefinite determiners: Variation and optionality in Italo-Romance. In Diego Pescarini & Roberta D'Alessandro (eds.), *Advances in Italian dialectology: Sketches of Italo-Romance grammars*, 135–161. Amsterdam: Brill.
- Cardinaletti, Anna & Giuliana Giusti. 2020. Indefinite determiners in informal Italian: A preliminary analysis. In Tabea Ihsane & Elisabeth Stark (eds.), *Shades of partitivity: Formal and areal properties*. Special issue of *Linguistics* 58(3). 679–712.

- Carlier, Anne 2007. From preposition to article: The grammaticalization of the French partitive. *Studies in Language* 31. 1–49.
- Carlier, Anne. 2021, this volume. *Du/Des* NPs in French: a comparison with bare nouns in English and Spanish. In Petra Sleeman & Giuliana Giusti (eds.), *Partitive determiners, partitive pronouns and partitive case* (Linguistische Arbeiten 580). Berlin: de Gruyter.
- Carlier, Anne & Béatrice Lamiroy. 2014. The grammaticalization of the prepositional partitive in Romance. In Silvia Luraghi & Tuomas Huomo (eds.), *Partitive cases and related categories*, 477–523. Berlin: Mouton De Gruyter.
- Chierchia, Gennaro. 1998. Partitives, reference to kinds and semantic variation. In Aaron Lawson (ed.), *Proceedings of Semantics and Linguistic Theory (SALT)*, vol. VII, 73–98. Ithaca NY: CLC Publications.
- Csirmaz, Aniko. 2012. The case of divisible phase: Licensing partitive case in Finnish. *Syntax* 15(3). 215–252.
- Dobrovie-Sorin, Carmen & Claire Beyssade. 2004. *Définir les indéfinis*. Paris: CNRS Éditions.
- Döhmer, Caroline E. 2017. *Aspekte der luxemburgischen Syntax*. University of Luxembourg dissertation.
- Döhmer, Caroline E. 2018. A new perspective on the Luxembourgish genitive. In Tanja Ackermann, Horst J. Simon & Christian Zimmer (eds.), *Germanic genitives* (Studies in Language Companion 193), 15–36. Amsterdam: John Benjamins.
- Ehala, Martin. 2012. Transfer, hybridization and analogy in L2 usage: The case of Estonian object marking. *International Journal of Bilingualism* 16(1). 159–174.
- Enç, Murvet. 1991. The semantics of specificity. *Linguistic Inquiry* 22(1). 1–25.
- Etxeberria, Urtzi. 2021, this volume. The partitive marker in Basque and its relation to bare nouns and the definite article. In Petra Sleeman & Giuliana Giusti (eds.) *Partitive determiners, partitive pronouns and partitive case* (Linguistische Arbeiten 580). Berlin: de Gruyter.
- Falco, Michelangelo & Roberto Zamparelli (eds.) 2019. Special collection: Partitives. *Glossa*. <https://www.glossa-journal.org/collections/special/partitives/>
- Gerards, David P. 2020. *Bare partitives in Old Spanish and Old Portuguese*. University of Zurich dissertation.
- Gianollo, Chiara. 2018. *Indefinites between Latin and Romance* (Oxford Studies in Diachronic and Historical Linguistics 33). Oxford: Oxford University Press.
- Giusti, Giuliana. 2021. A protocol for indefinite determiners in Italian and Italo-Romance. In Tabea Ihsane (ed.), *Disentangling bare nouns and nominals introduced by a partitive article* (Syntax & Semantics 43), 262–300. Amsterdam: Brill.
- Giusti, Giuliana. 2021, this volume. Partitivity in Italian: A protocol approach to a multifaceted phenomenon. In Petra Sleeman & Giuliana Giusti (eds.), *Partitive determiners, partitive pronouns and partitive case* (Linguistische Arbeiten 580). Berlin: de Gruyter.
- Glaser, Elvira. 1992. Umbau partitiver Strukturen in der Geschichte des Deutschen. *Sprachwissenschaft* 17(2). 113–132.
- Glaser, Elvira. 1993. Syntaktische Strategien zum Ausdruck von Indefinitheit und Partitivität im Deutschen (Standardsprache und Dialekt). In Werner Abraham & Josef Bayer (eds.), *Dialektsyntax*, 99–116. Opladen: Westdeutscher Verlag.
- Heusinger, Klaus von. 2019. Indefinites and specificity. In Barbara Abbott & Janet Gundel (eds.), *Oxford handbook of reference*, 146–167. Oxford: Oxford University Press.
- Heusinger, Klaus von & Jaklin Kornfilt. 2005. The case of the direct object in Turkish: Semantics, syntax and morphology. *Turkic Languages* 9. 3–44.

- Heusinger, Klaus von & Jaklin Kornfilt. 2021, this volume. Turkish partitive constructions and (non-)exhaustivity. In Petra Sleeman & Giuliana Giusti (eds.), *Partitive determiners, partitive pronouns and partitive case* (Linguistische Arbeiten 580). Berlin: de Gruyter.
- Hoeksema, Jacob. 1996. Introduction. In Jacob Hoeksema (ed.), *Partitives: Studies on the syntax and semantics of Partitivity and related constructions*, 1–24. Berlin: Mouton de Gruyter.
- Hoop, Helen de. 2003. Partitivity. In Lisa Cheng & Rint Sybesma (eds.), *The second Glot International state-of-the-article book*, 179–212. Berlin: Mouton de Gruyter.
- Hoop, Helen de, Guido van den Wyngaerd & Jan-Wouter Zwart. 1990. Syntaxis en semantiek van de *van die*-constructie. *Gramma, Tijdschrift voor Taalkunde* 14. 81–106.
- Huomo, Tuomas. 2010. Nominal aspect, quantity, and time: The case of the Finnish object. *Journal of Linguistics* 46(1). 83–125.
- Huomo, Tuomas. 2021, this volume. Longitudinal or transverse? How the unbounded quantity expressed by the Finnish partitive case relates to time. In Petra Sleeman & Giuliana Giusti (eds.), *Partitive determiners, partitive pronouns and partitive case* (Linguistische Arbeiten 580). Berlin: de Gruyter.
- Ihsane, Tabea. 2005. On the structure of French DU/DES ‘of the’ constituents. *GG@G (Generative Grammar in Geneva)* 4. 195–225.
- Ihsane, Tabea. 2008. *The layered DP. Form and meaning of French indefinites*. Amsterdam: John Benjamins.
- Ihsane, Tabea (ed.). 2021. *Disentangling bare nouns and nominals introduced by a partitive article* (Syntax & Semantics 43). Amsterdam: Brill.
- Ihsane, Tabea & Elisabeth Stark (eds.). 2020. *Shades of partitivity: Formal and areal properties*. Special issue of *Linguistics* 58(3).
- Jackendoff, Ray. 1977. *X'-Syntax: A study of Phrase Structure*. Cambridge, MA: MIT Press.
- Kiparsky, Paul. 1998. Partitive case and aspect. In Miriam Butt & Wilhelm Geuder (eds.), *The projection of arguments: Lexical and compositional factors*, 265–307. Stanford, CA: CSLI.
- Koptjevskaja-Tamm, Maria. 2001. “A piece of the cake” and “a cup of tea”: partitive and pseudo-partitive nominal constructions in the Circum-Baltic languages. In Östen Dahl & Maria Koptjevskaja-Tamm (eds.), *The Circum-Baltic languages. Volume 2: Grammar and Typology*, 523–568. Amsterdam: John Benjamins.
- Kornfilt, Jaklin. 1997. *Turkish*. London: Routledge.
- Laca, Brenda. 1990. Generic object: Some more pieces of the puzzle. *Lingua* 81(1). 25–46.
- Ladusaw, William A. 1982. Semantic constraints on the English partitive construction. *Proceedings of West Coast Conference on Formal Linguistics* 1, 231–242. Stanford: Cascadilla Press.
- Le Bruyn, Bert. 2007. The partitive article *dei* in Italian. *Linguistics in the Netherlands* 2007, 138–149.
- Luraghi, Silvia. 2012. Partitives and differential marking of core arguments: A crosslinguistic survey. Unpublished manuscript, University of Pavia.
- Luraghi, Silvia & Giovanna Albonico. 2021, this volume. The partitive article in Old Italian. Early stages in the grammaticalization of the Italian partitive article. In Petra Sleeman & Giuliana Giusti (eds.), *Partitive determiners, partitive pronouns and partitive case* (Linguistische Arbeiten 580). Berlin: de Gruyter.
- Luraghi, Silvia & Tuomas Huomo (eds.). 2014. *Partitive cases and related categories*. Berlin: Mouton de Gruyter.

- Luraghi, Silvia & Seppo Kittilä. 2014. Typology and diachrony of partitive case markers. In Silvia Luraghi & Tuomas Huomo (eds.), *Partitive cases and related categories*, 17–62. Berlin: Mouton de Gruyter.
- Marty, Paul. 2019. On the source of proper partitivity. In M. Teresa Espinal, Elena Castroviejo, Manuel Leonetti, Louise McNally & Cristina Real-Puigdollers (eds.), *Proceedings of Sinn und Bedeutung 23(2)*, 143–160.
- Miestamo, Matti. 2014. Partitives and negation: A cross-linguistic survey. In Silvia Luraghi & Tuomas Huomo (eds.), *Partitive cases and related categories*, 63–86. Berlin: Mouton de Gruyter.
- Milner, Jean-Claude. 1978. *De la syntaxe à l'interprétation : Quantités, insultes, exclamations*. Paris: Seuil.
- Öztürk, Balkız. 2005. *Case, referentiality and phrase structure*. Amsterdam: John Benjamins.
- Perpiñan, Silvia. 2017. Catalan-Spanish bilingualism continuum. *Linguistic approaches to bilingualism* 7(5). 477–513.
- Rijk, Rudolf P.G. de. 1972. *Studies in Basque syntax: Relative clauses*. Cambridge, MA: MIT dissertation. <https://dspace.mit.edu/handle/1721.1/12980>
- Runić, Marija. 2012. L'uso dell'articolo italiano in apprendenti di madrelingua serbo-croata. In Silvana Ferreri (ed.), *Linguistica educativa: Atti del XLIV Congresso internazionale di studi della Società di linguistica italiana (SLI). Viterbo, 27–29 settembre 2010* (Pubblicazioni della Società linguistica italiana 55), 395–407. Roma: Bulzoni.
- Seržant, Ilja. 2015. Independent partitive as a Circum-Baltic isogloss. *Journal of Language Contact* 8. 341–418.
- Seržant, Ilja. 2021, this volume. Diachronic typology of partitives. In Petra Sleeman & Giuliana Giusti (eds.), *Partitive determiners, Partitive pronouns and partitive case* (Linguistische Arbeiten 580). Berlin: de Gruyter.
- Sleeman, Petra & Tabea Ihsane. 2016. Gender mismatches in partitive constructions with superlatives in French. *Glossa* 1(1): 35. 1–25. <https://doi.org/10.5334/gjgl.137>
- Sleeman, Petra & Tabea Ihsane. 2017. The L2 acquisition of the French quantitative pronoun *en* by L1 learners of Dutch. Vulnerable domains and cross-linguistic influence. In Elma Blom, Jeannette Schaeffer & Leonie Cornips (eds.), *Cross-linguistic influence in bilingualism. In Honor of Aafke Hulk*, 303–330. Amsterdam: John Benjamins.
- Sleeman, Petra & Tabea Ihsane. 2021, this volume. The L2 acquisition of the partitive pronoun *en* in French by L1 speakers of German and the role of the L1. In Petra Sleeman & Giuliana Giusti (eds.), *Partitive determiners, Partitive pronouns and partitive case* (Linguistische Arbeiten 580). Berlin: de Gruyter.
- Soto-Corominas, Adriana. 2019. Acquisition of quantified partitivity in Catalan-Spanish bilingualism. Influence from child-level and language-level factors. *Linguistic Approaches to Bilingualism*. (online-first articles) <https://doi.org/10.1075/lab.19016.sot>
- Spoelman, Marianne. 2011. The use of partitive predicatives by Estonian learners of Finnish at different levels of L2 proficiency. *Lähivõrdlusi. Lähivertailuja* 21. 280–304.
- Stepanov, Arthur & Penka Stateva. 2018. Countability, agreement and the loss of the dual in Russian. *Linguistics* 54. 779–821.
- Strobel, Thomas. 2012. On the areal and syntactic distribution of indefinite-partitive pronouns in German: Methodological advances and empirical results within the project Syntax of Hessian Dialects (SyHD). In Xosé Afonso, Álvarez Pérez, Ernestina Carrilho, & Catarina Magro (eds.), *Proceedings of the International Symposium on Limits and Areas in Dialectology*, 405–430.

- Strobel, Thomas. 2017. *Pronominale Partitivität: Arealität und Mikrovariation einer morphosyntaktischen Variable in den Varietäten des Deutschen*. University of Frankfurt dissertation.
- Strobel, Thomas & Elvira Glaser. 2021. The rise and fall of partitive markers in some Germanic varieties. In Tabea Ihsane (ed.), *Disentangling bare nouns and nominals introduced by a partitive article* (Syntax & Semantics 43), 17–53. Amsterdam: Brill.
- Swart, Henriette de. 2006. Aspectual implications of the semantics of plural indefinites. In Svetlana Vogeleer & Liliane Tasmowski (eds.), *Non-definiteness and plurality*, 161–189. Amsterdam: Benjamins.
- Tamm, Anne. 2014. The partitive concept versus linguistic partitives: from abstract concepts to evidentiality in the Uralic languages. In Silvia Luraghi & Tuomas Huomo (eds.), *Partitive cases and related categories*, 89–152. Berlin: Mouton de Gruyter.
- Tănase-Dogaru, Mihaela. 2008. Pseudo-partitives and (silent) classifiers in Romanian. In Sylvia Blaho, Camlia Constantinescu & Erik Schoorlemmer (eds.), *Proceedings of ConSOLE XV*, 295–320.
- Tănase-Dogaru, Mihaela. 2017. Partitive constructions. In Martin Everaert & Henk van Riemsdijk (eds.), *The Wiley Blackwell companion to syntax*, 2<sup>nd</sup> edn. Hoboken, NJ: Wiley Blackwell.
- Tarrés, Mònica & Aurora Bel. 2017. Optionality in sequential bilingualism. Production of Catalan adverbial clitics by children of different L1s. Paper presented at 2017 IASCL Conference.
- Thomas, Rose. 2003. *The Partitive in Finnish and its relation to the weak quantifiers*. University of Westminster dissertation.
- Westveer, Thom. 2021. *Gender mismatches in partitive constructions in French and German: How society shapes language*. Amsterdam: LOT.
- Witzlach-Makarevich, Alena & Ilja Seržant. 2018. Differential argument marking: Patterns of variation. In Alena Witzlach-Makarevich & Ilja Seržant (eds.), *Diachrony of differential argument marking* (Studies in Diversity Linguistics 19), 1–40. Berlin: Language Science Press.
- Wust, Valerie. 2009. A la recherche des clitiques perdus: The dictogloss as a measure of the comprehension of *y* and *en* by L2 learners of French. *The Canadian Modern Language Review* 65(3). 471–499.
- Zamparelli, Roberto. 1998. A theory of kinds, partitives, and *of/z* possessives. In Artemis Alexiadou & Chris Wilder (eds.), *Possessors, predicates and movement in the Determiner Phrase*, 259–301. Amsterdam: John Benjamins.
- Zamparelli, Roberto. 2008. *Dei ex machina*: a note on plural/mass indefinite determiners. *Studia Linguistica* 63(3). 301–327.

---

**Part I: Setting the diagnostics for partitivity  
in Romance languages**





Giuliana Giusti

# Partitivity in Italian

A protocol approach to a multifaceted phenomenon

This paper claims that “partitive” is a cover term for at least four types of syntactic constructions and provides diagnostics to distinguish among (i) partitive structures instantiated by a quantifier selecting two arguments: an indefinite nominal expression and a “partitive PP” (cf. Cardinaletti & Giusti 2017) (ii) quantitative structures instantiated by a quantifier just selecting the indefinite nominal expression; (iii) the so-called “partitive article” (*di+art* in Italian), which is an indefinite determiner for mass and plural count nouns; (iv) the partitive clitic *ne*, which only resumes a bare indefinite nominal expression. The paper presents the diagnostics in the “protocol” fashion, a theory-neutral methodology to present and organize data, encompassing the incommunicability across different approaches. The diagnostics highlight properties that distinguish the four categories from one another and set them in comparison with other categories, such as genitive and oblique PPs; accusative, genitive and oblique clitics and null subject pronouns; circumstantial partitive PPs; bare nouns and pseudo-partitives. This is done in a one-language perspective, focussing on Italian with a close eye on what has been claimed for French, the only other language to display the four phenomena.

## 1 Introduction

### 1.1 The controversial notion of partitivity

The term “partitive” is often used as a cover-term to refer to what I claim here to be four different phenomena.<sup>1</sup> I concentrate on Italian, but the argument is predicted to hold more generally in languages displaying forms and constructions such as the four nominal expressions in square brackets in the following examples:

---

<sup>1</sup> Preliminary versions of this paper have been presented in an invited seminar at the Amsterdam Center for Language and Communication on May 25, 2018, and at the PARTE Workshop in Venice. I thank the audiences and an anonymous reviewer for comments and constructive criticism. I also thank Laura Brugè, Anna Cardinaletti, Petra Sleeman and Klaus von Heusinger for precious comments on previous drafts. Needless to say, all remaining mistakes are my own fault.

- (1) a. [Alcune delle ragazze] sono arrivate.  
 ‘Some of the girls arrived.’  
 b. [Alcune ragazze] sono arrivate.  
 ‘Some girls arrived.’  
 c. [Delle ragazze] sono arrivate.  
 of-the girls are arrived  
 ‘Girls arrived.’  
 d. [Ne] sono arrivate (alcune).  
 CL.PART are arrived some  
 ‘Some arrived.’

In (1a), the subject is the prototypical example of a “partitive construction” with a quantifier *alcune* (‘some’) picking an indefinite quantity of indefinite individuals out of a definite set of individuals of the same kind (‘girls’). The (genitive) preposition *di* (‘of’) merges with a definite article *le* (art.F.PL) obtaining *delle*, to express the definite set out of which the partition is operated.<sup>2</sup> In (1b), the subject is a quantified nominal expression without a partitive complement. The interpretation is of an indefinite quantity of girls, with no partition of a definite set. In (1c), the subject is apparently introduced by the same *di*+art form introducing the definite set in (1a), but its interpretation is neither of partition nor of definiteness. Instead, it is indefinite as in (1b) but, unlike (1b), it is not quantified. Finally, in (1d), we observe the possibility to substitute the indefinite subject with the clitic *ne*. The quantifier *alcune* (‘some’) is optional here. This suggests that *ne* is extracted from the internal argument position (direct object or postverbal subject of unaccusative verb, as in this case) even when the quantifier is not present.<sup>3</sup>

---

**2** I will call the *di*-constituent “partitive PP”, as it is usually called in current literature for languages that express the superset with a prepositional phrase. Nothing in the label P prevents us from assuming that *di* is a case-marker and is therefore semantically and functionally equivalent to partitive case, which is also realized as genitive or ablative across languages, as observed in Giusti & Sleeman (2021, this volume), Seržant (2021, this volume), von Heusinger & Kornfilt (2021, this volume), and Huumo (2021, this volume). In this perspective, it is not surprising to consider the whole partitive PP as “definite”, assuming that the preposition *di* is a case marker in the highest head of the nominal expression.

**3** I am not claiming that the four constructions exhaust the notion of “partitivity” in a cross-linguistic perspective or even in Italian. The four cases in (1) are just the most prominent in Italian and therefore the most urgent to be discussed in a language-internal perspective. I only briefly touch upon partitives and pseudo-partitives arising with semi-lexical quantity nouns (‘a glass of wine, a liter of wine’), which are treated for comparative purposes in section 2.1, protocol (16), and section 3.1 protocol (66). I disregard other constructions like ‘that treasure of a woman’ or ‘wine of good quality’ which, in my opinion, are not to be unified with partitives, *pace* Corver

A unified analysis of the four types of nominal expressions in (1) is legitimated by the features that are apparently common to some of the constructions and could, by transitivity, be extended to all. The fact that *ne* can, in other contexts, resume a genitive possessor or a genitive argument of a verb (as will be discussed later) may suggest that the *ne* in (1d) is a prepositional clitic that resumes a partitive PP, such as the one we find in (1a). The fact that *di+art* introduces partitive PPs and indefinite expressions may suggest that the partitive determiner in (1c) is in the complement of a hidden quantifier thereby unifying (1c) with (1a). The hidden quantifier hypothesis could further unify (1c) with (1a-b)). Finally, the indefinite interpretation of the nominal expressions in (1b) and (1c) may suggest the assumption of a hidden quantifier even for bare indefinite nominals, which are resumed by *ne* in (1d). These possibilities are summarized in (2):

- (2) a. genitive morphology on the partitive PP (1a) and on the clitic *ne* (1d),  
 b. formal identity (*di+art*) of the inflected preposition in the partitive construction in (1a) and the partitive determiner in (1c),  
 c. occurrence of the same class of existential quantifiers in (1a), (1b), and (1d),  
 d. indefinite interpretation of the nominal expressions in (1a-c) and of the clitic in (1d).

There are, however, crucial differences among the four constructions in (1) and notable parallels that each of them has with non-partitive constructions, which must be accounted for.

## 1.2 Aims and structure of the paper

The aim of this paper is to pin down in a systematic way differences and similarities across the structures in (1) and propose diagnostics to distinguish them from one another and put them in comparison with other constructions. This will be done using a descriptive methodology informed by the advances of formal linguistics, which I call Protocol Linguistics for reasons that will be made clear below.

---

(1998) and much work following him. I also disregard possessive partitives or double genitives such as “a friend of Mary’s” which are one of the main points in Barker’s (1998) paper but are not present in Italian and would therefore take us afar from the focus of this paper.

The paper is structured as follows. The rest of this section introduces the protocol methodology. Section 2 overviews previous literature proposing unification of two or more of the structures in (1) and presents diagnostics to evaluate alternative analyses. Section 3 provides an overview of the diagnostics in basic and dislocated positions. Section 3.1 presents the selectional restrictions on partitives, indefinites and pseudo-partitives also distinguishing between selected and circumstantial partitives. Section 3.2 discusses the categorial status of partitives and indefinites making use of the different distribution and forms of resumptive clitics in dislocated positions. Section 4 draws the conclusions.

Before starting the discussion, a terminological caveat is in order. I use the term **nominal expression** (abbreviated as **NomExpr**), to abstract away from the NP/DP diatribe. I call complex structures such as *alcune delle ragazze* ('some of the girls') in (1a) **partitive constructions** and less complex structures with a NomExpr preceded by a quantifier such as *alcune ragazze* ('some girls') in (1b) **quantitative constructions**. *Delle ragazze* in (1c) is an **indefinite NomExpr**, introduced by the **partitive determiner**<sup>4</sup> *delle* (also labelled as *di+art*), to be distinguished from the preposition bundled with a definite article in the **partitive PP** belonging to the partitive construction in (1a). The clitic *ne* in (1d) is labelled **partitive ne**<sup>5</sup> to be distinguished from **genitive ne** in the complement of nouns (whether functional or lexical) and **oblique ne** in the complement of verbs.<sup>6</sup> An indefinite NomExpr with no overt determiner is called **bare NomExpr**.

---

<sup>4</sup> I use the term “partitive determiner” or “*di+art*” as equivalent to “partitive article”, which is also very common in the literature. This is to remain agnostic as to the category of this element, which is analyzed in Cardinaletti & Giusti (2015, 2016, 2020) as an indefinite determiner (*di*) in SpecDP combining with concord morphology in D (the article). In this perspective neither portion of *di+art* is a true article. However, nothing hinges on this here.

<sup>5</sup> In much literature, among which Cardinaletti & Giusti (2006, 2017) partitive *ne* is called quantitative *ne* because it is claimed to resume the indefinite expression in the quantitative construction. The term partitive here is used for the sake of homogeneity with the other papers of the volume but it is also useful to distinguish *ne* which resumes a bare NomExpr, that can appear in a quantitative construction but can also appear independently of insertion of a quantifier.

<sup>6</sup> I am claiming here that no genuine partitive clitic exists in the narrow sense of a clitic resuming the *di*-PP in a partitive construction. The term partitive *ne* is therefore used to refer to the case assigned to the indefinite nominal in a quantitative construction and to the clitic that resumes it. The correlation of partitive case with indefiniteness, is discussed at length by Carlier (2021, this volume), Huumo (2021, this volume) Etxeberria (2021, this volume) and by Giusti and Sleeman (2021, this volume).

### 1.3 The protocol methodology

Achievements in linguistics are often ignored by applied fields such as language teaching, language therapy, and language policies. It is also true that researchers of different theoretical persuasions find it difficult to share their results and build on reciprocal advances. The generalized incommunicability is due to the highly abstract theoretical assumptions and specialized terminological tools, which are not shared by different theoretical frameworks and specializations. This is particularly unfortunate in the view that different subfields (syntax, semantics, morphology, phonology, discourse, etc.) and approaches (historical, typological, functional, generative, optimality, etc.) raise different research questions, whose answers would altogether bring about a better understanding of language as a human capacity. We therefore need a sound methodology, free of those theoretical biases that hinder the collaboration among linguists, to overcome this stalemate situation and build on current theoretical advances.

Such a methodology should allow us to formulate research questions, design questionnaires and experiments, and present the results in a format accessible to linguists of different persuasions as well as non-linguists, avoiding unnecessary technicalities but crucially without renouncing depth of insight. What can such a methodology consist of? It cannot be another theory, in addition to the ones already available; nor can it be an a-theoretical or anti-theoretical approach. It needs to individuate good practices, which are currently in use and organize research in a “protocol” fashion. In science, a protocol is an established procedure, which applies in the same way with the same tools in different but comparable situations. It is therefore set to ensure comparability in the collection, organization, and presentation of data avoiding disturbances.

What is a good protocol for linguistic data collection and presentation? General linguistics is used to systematizing linguistic features in tables that display a  $[\pm]$  value for the crossing point of two different indicators. Table charts showing the interaction of two dimensions of indicators are a simple and shared methodology.

The protocol methodology applied in the last years to different empirical environments (cf. Giusti 2011, Giusti & Zegrean 2015, Di Caro & Giusti 2015, Giusti 2021) wants to go one step further and set a methodology to design appropriate table-charts for given research questions. In the streamline of the search for parameters or implicational universals of language, the features of the protocol can be organized in clusters of properties that contribute to characterize a given construction and distinguish it from the other.

After having established the relevant clusters of features for the relevant phenomena in the studied language(s), we are ready to produce a simple table-chart

intersecting the features with the studied constructions in one or more languages. To give a provisional example of a protocol, let us organize the observations that justify the unification of the four constructions under the umbrella-term “Partitivity in Italian”. In protocol (3), the horizontal axis lists the constructions in (1) above, the vertical axis lists the interpretive properties of the constructions and the observed formal identity with “genitive” morphology. The [+] value stands for mandatory presence of the feature; the [-] value stands for mandatory absence; the [+/-] value stands for presence or absence according to different contexts; [0] indicates that the intersection is irrelevant, as is the case in (3c) for the interpretation of the article in quantitative constructions and with partitive clitics, given that there is no article in these cases:

(3)	Partitivity in Italian	Partitive construction (1a)	Quantitative construction (1b)	NomExpr with a partitive determiner (1c)	Partitive clitic (1d)
a.	quantified interpretation	+	+	-	+/-
b.	part-whole interpretation	+	-	-	-
c.	definite interpretation of the article	+	0	-	0
d.	genitive-like morphology	+	-	+	+

Protocol (3) states that the partitive construction (1a) has a quantified part-whole interpretation, marked with [+] in (3a-b), it contains a definite NomExpr in the partitive *di*-PP which has apparent genitive morphology, as indicated by [+] in (3c-d). The quantitative construction (1b) is quantified but does not have the part-whole interpretation, as indicated by [+] in (3a) and [-] in (3b). Since in Italian the NomExpr in the quantitative construction never displays the preposition *di*, it receives a [-] as regards genitive morphology in (3d). The indefinite NomExpr introduced by a partitive determiner (1c) is not quantified and does not have a part-whole interpretation, nor does it have definite interpretation; thus, it is marked with [-] in (3a-c). The determiner formed with *di* can be considered as displaying genitive morphology. This is marked with [+] in (3d). Partitive *ne* (1d) may resume the indefinite argument of the quantifier and is marked with [+/-] in (3a), but cannot resume the partitive PP (as will be argued in section 2.2), nor can it have definite interpretation. This is marked with [-] in (3b). Its genitive form is uncontroversial and is marked with [+] in (3d).

Unification of the four constructions would imply arguing that the differences in values in (3) are only apparent. This may come to mind if we consider French,

where the indefinite complement of the quantifier *beaucoup* ('much / many') is introduced by the preposition *de* (4a-b) thereby supporting unification of genitive morphology in the four cases. Milner's (1978) seminal work on these constructions unifies the quantitative constructions in (4b-b') proposing a covert counterpart of *de* in (4b'). It also unifies nominal expressions with partitive determiners (4c) and quantitative constructions proposing a covert quantifier selecting the partitive determiner. Finally, partitive *en* in (4d) can pronominalize the nominal part of a quantitative construction or an indefinite NomExpr if the quantifier is not expressed:

- (4) a. J'ai vu beaucoup/plusieurs des filles.  
       'I've seen many of the girls.'
- b. J' ai vu beaucoup de filles.  
       I have seen much of girls'
- b' J' ai vu plusieurs filles.  
       have seen many girls.  
       'I saw many girls'
- c. J' ai vu des filles.  
       I have seen of-the girls  
       'I saw girls.'
- d. J' en ai vu (beaucoup/plusieurs).  
       I CL.PART have seen many  
       'I saw many of them.'

Further arguments for unification would be the possibility for an indefinite NomExpr with a partitive determiner and partitive *en* to refer to a previously introduced referent, thereby having the same referential property as the partitive PP (which is mandatorily definite). The dislocated NomExpr in (5a) can be interpreted as either referential (*deux des livres de Zola* 'two of Zola's books') or non-referential (equivalent to *deux livres de Zola* 'two books by Zola'), as shown by the translation. The second sentence in (5b) can either mean that they killed five of the ten lions seized on Tuesday (referential interpretation), or that they killed five more lions (non-referential interpretation):

- (5) a. Des livres de Zola, j'en ai lu deux.  
       of-the books by Zola, I CL.PART have read two.  
       'I read two (of the) books by Zola'



- b. Ils ont attrapé dix lions mardi;  
 they have caught ten lions [on] Tuesday;  
 mercredi, ils en ont tué cinq.  
 [on] Wednesday they CL.PART have killed five  
 ‘They caught ten lions on Tuesday; on Wednesday they killed five more  
 lions/ five of them.’

Protocol (6) summarizes the similarities that may suggest unification in French making use of covert categories and extends them to Italian by assuming more covert categories. The value [(c)overt] means that the item can be overt or covert:

(6)	Partitivity in Italian and French	Partitive construction	Quantitative construction	NomExpr with partitive determiner	Partitive clitic
a. Quantifier	Italian	+	+	+	+
	French	overt	overt	covert	(c)overt
b. Preposition	Italian	+	+	+	+
	French	overt	covert	overt	overt
c. Genitive morphology	Italian	+	+	+	+
	French	overt	covert	overt	overt
d. Definite interpretation		+	-	-/+	-/+

In (6a), a covert quantifier is assumed in the NomExpr with the partitive determiner; this is consequently extended to the partitive clitic, which is now analyzed as occurring with an overt or covert quantifier. In (6b), the unification of *de* as a preposition in partitive and quantitative constructions (overtly with *beaucoup* in (4b), covertly with *plusieurs* in (4b') and in indefinite nominal expressions also unifies partitive determiners with partitive clitics and prepositional clitics. In (6c), the genitive morphology realized by *di/de* and *ne/en* is unified in the four constructions, assuming *di/de* to be covert in quantitative constructions in Italian, and overt or covert in French according to the quantifier. Even the interpretive properties in (6d) would be at least partially unified: the possibility reported in (5) of referential interpretation for the dislocated NomExpr with partitive determiners resumed by *ne* softens two out of three [-] values in (3c) to variable values [-/+ ] in (6d). In the rest of the paper, I will argue against the unification envisaged in protocol (6).

The literature on these phenomena is copious and the proposals so diverse that it is impossible to do justice to them here. As far as I know, no piece of work has ever attempted a full unification of the four structures, as represented in (6). Researchers working on different languages and theoretical frameworks usually only focus on part of the empirical environments represented in (1). This is mainly due to the fact that while partitive PPs and quantitative constructions with quantifiers are present in many languages, partitive clitics and partitive determiners are quite restricted.<sup>7</sup> The point here is that while most authors emphasize the similarities and aim to accommodate the differences in a unified frame,<sup>8</sup> this work aims to show that these phenomena are radically different from one another in the synchrony<sup>9</sup> and treats them in comparison with other properties of the language.

---

7 As observed by Giusti and Sleeman (2021, this volume), partitive determiners are limited to French, Italian and non-standard Gallo-Romance varieties (cf. Gerards & Stark 2021 on Franco-Provençal). I am unaware of other languages that have a genitive preposition combined with a definite article introducing indefinite nominal expressions. The Dutch *van die* construction is no exception to this, if Le Bruyn (2007) is correct in proposing that *van* ('of') is a preposition and *die* is not an article ('the') but a demonstrative ('those').

Across Indo-European languages, partitive clitics are present in French, Italian and Catalan (a subset of Romance) but also in Slavic (cf. Toman 1986 for Czech) while partitive weak pronouns are present in Germanic (Strobel & Glaser 2021 and the many papers on Duch *er*, among which Berends et al. 2021, this volume). Genitive morphology or case alternations related to indefiniteness is found in Finno-Ugric (cf. Huumo, 2021, this volume), Turkic (cf. von Heusinger & Kornfilt, 2021, this volume) and Basque (cf. Etxeberria, 2021, this volume). I am unaware whether all these languages distinguish between quantitative and partitive constructions. The picture is further complicated by the observation that there are different types of partitive constructions (cf. Giusti & Sleeman, 2021, this volume and Falco & Zamparelli 2019 for a general overview, Seržant 2021, this volume for a diachronic typology, and section 3.1.1 of this paper for Italian). It is therefore very difficult to decide what categories and constructions are relevant to crosslinguistic comparison.

8 This is the spirit of more recent literature. For example, Zamparelli (2000), Dobrovie-Sorin & Beyssade (2004), Ihsane (2008), and Dobrovie-Sorin (2021) derive different interpretations proposing different levels of structural complexity but maintain that the most complex nominal expression is equivalent to referential DPs. These authors assume that ambiguous items such as quantifiers, the functional element *di* and the article it combines with are merged lower than D and can be moved upwards to intermediate heads reaching the level of D at most. Unification of partitive and quantitative constructions and the partitive clitic in Ibero-Romance is proposed by Martí i Girbau (1999, 2010) who claims that a quantifier selects a single complement which can be definite (partitive) or indefinite (quantitative); and both can be resumed by the clitic *en/ne*. Indefinite *des/du* is unified with quantitative and partitive by Bosveld de Smet (1998, 2004) for French. The list cannot be exhaustive.

9 It is important to distinguish the diachronic analysis, which derives the partitive determiner from a proper partitive construction, from the newly formed partitive determiner with proper characteristics even in neighboring languages; cf. Carlier (2021, this volume), Carlier (2007),

It will do so by providing protocols to diagnose differences and similarities that each of the four constructions has with other constructions of the language. The comparative dimension here is not across languages but across categories and constructions. The diagnostics provided here can be the ground for the design of data collection in future research to validate the data presented here, detect variability across speakers and across varieties. Gallo-Romance varieties in this respect are the most relevant, since they are the only ones that productively display the four phenomena.

## 2 Three environments of possible unification

Chierchia (1997) and Zamparelli (2008) propose a unified analysis of partitive, quantitative and indefinite nominal expressions introduced by *dei* along the following rationale: (i) The partitive construction is made of a quantifier in D, a null NP filled by a covert [PART] feature and a partitive PP. (ii) The quantitative construction is simpler and only has the quantifier in D and an overt NP. (iii) The indefinite NomExpr with *dei* is derived by moving the low D into P and then the complex head P+D from the downstairs partitive PP to N, adjoining it to [PART], and then moving the whole [[PART]+*delle*] to the higher D. The status of the clitic *ne* is taken to resume the upper NP in (1a-b). For this reason, *ne* cannot be extracted from (7c), where the content of the upper NP has been moved to D. The three structures in (7) are my own simplification. (7a) corresponds to (1a); (7b) to (1b) and (7c) to (1c):

- (7) a. [<sub>DP</sub> [<sub>D</sub> *alcune*]] [<sub>NP</sub> [<sub>N</sub> PART] [<sub>PP</sub> [<sub>P</sub> *delle*] [<sub>DP</sub> [<sub>D</sub> *te*] [<sub>NP</sub> [<sub>N</sub> *ragazze*]]]]]]]  
 b. [<sub>DP</sub> [<sub>D</sub> *alcune*]] [<sub>NP</sub> [<sub>N</sub> *ragazze*]]  
 c. [<sub>DP</sub> [<sub>D</sub> PART+*delle*] [<sub>NP</sub> [<sub>N</sub> PART+*delle*] [<sub>PP</sub> [<sub>P</sub> *delle*] [<sub>DP</sub> [<sub>D</sub> *te*] [<sub>NP</sub> [<sub>N</sub> *ragazze*]]]]]]]]]

Three separate hypotheses are needed in the unification in (7); each of them has (at least) an alternative in a framework in which indefinite nominal expressions are of category DP (Cardinaletti & Giusti 2015, 2016), while quantified constructions are of category QP, as in Cardinaletti & Giusti (2006, 2017):

---

Carlier & Lamiroy (2014) for French, Stark (2002), Luraghi & Albonico (2021, this volume), for Old Italian.

- (8) a. [<sub>QP</sub> [<sub>Q</sub> alcune [<sub>DP</sub> pro]] [<sub>PP</sub> de- [<sub>DP</sub> le [<sub>NP</sub> ragazze]]]]] (1a)  
 b. [<sub>DP</sub> alcune [<sub>DP</sub> 0 [<sub>NP</sub> ragazze]]] (1b)  
 c. [<sub>DP</sub> de- [<sub>D</sub> le] [<sub>NP</sub> ragazze]] (1c)

The unifying assumptions are formulated in (9i-iii.a) and the alternatives in (9i-iii.b):

- (9) Three independent hypotheses
- i.a. The partitive PP is unified with the indefinite NP complement of D.
  - i.b. Alternatively, the partitive PP and the indefinite DP are different arguments of Q.
  - ii.a. *Ne* is ambiguous between the partitive and the quantitative interpretation.
  - ii.b. Alternatively, *ne* resumes the indefinite NomExpr in a quantitative construction.
  - iii.a. The partitive determiner is derived from the PP by movement.
  - iii.b. Alternatively, the partitive determiner is an independent indefinite determiner.

In principle, each hypothesis in (9) could coexist with any other except its direct alternative. Therefore, the exclusion of one alternative, *per se*, gives no clue as to which hypothesis should be favoured in the other pairs.

The hypothesis that functional projections can split in separate hierarchical projections (Rizzi 1997 for the clause, Giusti 1996 for its early application to the nominal structure) is the base of Zamparelli's (2000) and Ihsane's (2008) proposals to analyze different types of indefinites as having a common structural core and being different as to the presence or absence of the highest projections. A common feature of the two approaches is that they split the DP in three projections, each realizing a different discourse feature / triggering a different interpretation: referential > quantitative > predicative. Determiners that are ambiguous across two or all three interpretations, such as existential quantifiers, singular *un* ('a/one') and partitive determiners are taken to start from the lowest possible position and move stepwise to higher ones. This has a consequence on the analysis of the clitic *ne*, which is analyzed as being structurally less rich than accusative clitics, thereby deriving its non-referential interpretation. I consider these as unified analyses.

On the opposite side, Cardinaletti & Giusti (1992, 2006, 2017) distinguish across quantifiers of different classes, one of which selects an indefinite NomExpr (the only one to be resumed by *ne*) and an optional partitive PP (with a definite NomExpr). Furthermore, Cardinaletti & Giusti (2015, 2016, 2020) claim that indefinite nominal expressions are DPs that can have overt or non-overt determiners according to the

case they are assigned. A bare NomExpr is assigned partitive case, can only occur in internal argument position, and is resumed by *ne*. An indefinite NomExpr introduced by a partive determiner can be in any position and receive case accordingly: when dislocated from object position, it is resumed by an accusative clitic; when in subject position it is resumed by a null subject pronoun. For this reason, it cannot be assumed to receive partitive case (since arguments can only bear one case).

The rest of section 2 pins down some empirical facts to evaluate the alternatives spelled out in (9) and organize them in three protocols: (i) different partitive complements, (ii) different categories of *ne*; (iii) different categories of *di+art*. For reasons of space, I only refer to seminal works and do not mention the large debate stemming from them.

## 2.1 The two complements of Q

As early as Jackendoff (1968), generative approaches attempt a unification of partitive expressions occurring with quantity nouns (qNs) and quantifiers (Qs), like those in (10), making use of deletion-transformations. According to this line of reasoning, (10c) is derived from (10b) by deleting *of*. Lack of article in (10c) is related to the possibility in English to express indefiniteness with a null determiner, as is also possible in the partitive complement of the quantity noun in (10a):

- (10) a. a / the group of (the) men  
 b. three of \*(the) men  
 c. (the) three (\*the) men

Jackendoff (1968) must postulate a restriction to a single definite determiner either preceding or following the quantifier to account for the ungrammaticality of *\*the three of the men*. This is an unmotivated difference with qNs, which freely admit a determiner before and after them, as in *the group of the men*, cf. section 3.1.2 below.

Against the unified proposal, Selkirk (1977) for English, Milner (1978) for French, Belletti (1979) and Rizzi (1979) for Italian claim that the partitive PP in (10b) is different from the NomExpr occurring with a quantifier in the quantitative construction (10c).

Belletti observes that *five books* simply refers to five individuals, while *five of the books* also implies the existence of more than five individuals. This is the core of the partitive construction (Barker 1998) and should hold crosslinguistically. Note that this is not the case of the PP complement of qNs such as *group*. Belletti also observes that in Italian, it is impossible to extract a possessor PP from a par-

titive construction (11a), while this is possible from a quantitative construction (11b). Furthermore, Italian allows extraction from a definite NomExpr (11c). Thus, in (11b) extraction is not blocked by the definiteness of the partitive PP but by its prepositional nature<sup>10</sup> This is a good argument against the assumption of a covert preposition *di* in quantitative constructions:

- (11) a. \*Di chi hai letto molti [<sub>PP</sub> dei libri [<sub>PP</sub> di chi]]  
 of whom have-you read many of-the books  
 b. Di chi hai letto molti [<sub>NomExpr</sub> libri [<sub>PP</sub> di chi]]  
 of whom have-you read many books  
 ‘Whose books did you read?’  
 c. Di chi hai letto tutti [<sub>NomExpr</sub> i libri [<sub>PP</sub> di chi]]  
 of whom have-you read all the books  
 ‘By whom did you read all books?’

Rizzi (1979) observes that a singular quantifier such as *un(o)* in (12a) agrees in number with its nominal complement while the partitive PP is plural (12b):

- (12) a. un libro / \*un libri  
 one book / one books  
 b. uno dei libri / \*uno del libro  
 one-of-the books / \*one-of-the book’

Rizzi also observes that the elided form *un* (‘a/one’), as well as other singular quantifiers such as *ogni* (‘each’) and *qualche* (‘some’) can only occur in a quantitative construction (13a) and not with a partitive PP (13b). The presence of the PP is only allowed with a strong (pronominal) form of the quantifier (13c), suggesting the presence of a null category (a bare NomExpr in our terms) between the quantifier and the PP:

- (13) a. un / ogni / qualche libro  
 a / each / some book  
 b. \*un / \*ogni / \*qualche dei libri  
 c. uno / ognuno / qualcuno dei libri  
 one / each / some of-the books

---

<sup>10</sup> If we take prepositions to be case markers, we could say that in Italian it is impossible to extract from oblique NomExpr. In this perspective, postverbal nominative, accusative, and partitive are direct cases from which it is possible to extract.

The data in (11)-(13) favour hypothesis (9i.b) over (9i.a), as stated in (14):

- (14) The partitive PP and the bare NomExpr occurring with Q cannot be reduced to a single category.

Note that qNs always have a PP complement in Italian. This PP is different from both the partitive PP occurring with Q in partitive constructions and the NomExpr occurring with Q in quantitative constructions. In fact, the PP complement of qNs can be definite or indefinite (15a). Extraction from qNs (15b) show that if the PP embeds an indefinite DP, it has the properties of the indefinite NomExpr in the complement of Q, which does not imply the part-whole relation and allows extraction (cf. (11b) above); if it embeds a definite DP, it has the properties of the partitive PP, which conveys the part-whole interpretation and disallows extraction (cf. (11a) above):

- (15) a. un gruppo di ragazze / delle ragazze della mia classe  
 ‘a group of girls / of the girls of my class’  
 b. Di quale classe conosci un gruppo di ragazze/\*delle ragazze  
 [di quale classe]?  
 ‘Of which class do you know a group of girls/\*of the girls?’

Also note that unlike Q in (11), which agrees for gender with the NonExpr independently of the presence or absence of a preposition, qN has a morphological gender of its own (*gruppo* in (15) is masculine even if it refers to a plurality of girls).

The protocol in (16) summarizes the features to distinguish the partitive PP and the bare NomExpr in the quantitative construction. It also shows that the PP complement of a qN is different from both and needs to be treated separately:

(16)	‘Partitive’ complements of Q and qNs	Partitive PP in partitive constructions	Indefinite NomExpr in quantitative constructions	PP complement of qN
a.	The NomExpr can be definite	+	-	+
b.	The NomExpr can be indefinite	-	+	+
c.	The construction implies a larger set	+	-	+/-
d.	<i>Wh</i> -extraction of a possessor PP	-	+	+/-
e.	Number agreement between Q/qN and the NomExpr	-	+	-
f.	Gender agreement between the Q/qN and the NomExpr	+	+	-

## 2.2 The category of *ne*

Let us now evaluate the competing hypotheses (9ii.a-b) regarding the possible unification of the clitic pronoun (French *en*, Italian *ne*) with the partitive PP or the indefinite NomExpr complement of a Q. In this perspective, a comparison with genitive *ne* is relevant.

Milner (1978:51) notes that partitive *en* cannot be extracted out of a definite NomExpr, while genitive *en* can. The same holds for Italian. In the second sentence of the pair in (17a), *ne* resumes the indefinite complement of the quantifier; the ungrammaticality of the second sentence in (17b) suggests that *ne* cannot resume an NP when D is filled by a definite article. This also holds when a cardinal is present, suggesting a dual nature of the cardinal (as a quantifier and as an adjective, cf. Cardinaletti & Giusti 2006, 2017):

- (17) a. Ho letto due libri. → Ne ho letti due [ne].  
           'I read two books' → CL.PART I-have read.M.PL two  
       b. Ho letto i due libri. → \*Ne ho letti i due [ne].  
           'I read the two books' → CL.PART I-have read.M.PL the two

The sentences in (18) show that genitive *ne*, unlike partitive *ne*, can be extracted out of a definite or indefinite NomExpr:

- (18) a. Conosco (le) tre versioni di questo capitolo.  
           I-know (the) three versions of this chapter  
       b. Ne conosco (le) tre versioni [ne].  
           CL.GEN I-know (the) three versions

Establishing that partitive *ne* is different from genitive *ne* slightly favours (9ii.b) over (9ii.a) under the consideration that both genitives and partitives are prepositional.

Boivin (1999, 2005) provides one piece of evidence, for French, against the assumption that partitive *en* is the partitive PP, even if in some cases it is translated as “of them” in English. The same type of evidence holds in Italian. In (19), adapted from Boivin (2005), there is no definite set of books to which *ne* could refer; therefore, *ne* could only refer to the indefinite NomExpr in the complement of the quantifier:

- (19) Maria ha comprato tre libri alla Coop  
       Maria has bought three books at-the Coop  
       e Piero ne ha comprati due da B&N.  
       and Piero CL.PART has bought.M.PL two at B&N's



Sentence (19), however, is only evidence for the possibility of *ne* to refer to an indefinite entity previously introduced but is still compatible with (9ii.a), which proposes that *ne* has ambiguous quantitative or partitive status.

Cardinaletti & Giusti (1992) observe that quantitative *ne* in Italian behaves like a direct object clitic and is different from prepositional clitics in that it triggers past participle agreement, while prepositional clitics do not, cf. (20a) with (20b-c):<sup>11</sup>

- (20) a. Ne ho letti/\*o due [ne] (di libri).  
 CL.PART I-have bought.M.PL two (of books.M.PL)  
 'Books, I read two.'
- b. Ne ho parlato/\*parlati [ne] ieri (di libri).  
 CL.PART I-have spoken.(\*M.PL) yesterday (of books.M.PL)  
 'I talked about books, yesterday.'
- c. Ne ho letto/\*i due versioni [ne] (di questi libri).  
 CL.PART I-have read.(\*M.PL) two versions (of-these books.M.PL)  
 'Of these books, I read two versions.'

Cardinaletti & Giusti unify partitive *ne* with direct object clitics (which trigger past participle agreement and are nominal expressions) and genitive and oblique *ne* with prepositional clitics (which do not trigger agreement and are of category PP).

Both partitive *ne* and accusative clitics can extract out of a quantifier. The crucial difference is that universal quantifiers select a definite NomExpr to which they transfer the accusative case assigned by the verb in (21a). Existential quantifiers absorb accusative and assign partitive case to the indefinite NomExpr in (21b):

- (21) a. Ho letto tutti i libri. → Li ho letti tutti [ti]  
 'I read all the books' → CL.ACC.M.PL I-have read.M.PL all.M.PL
- b. Ho letto molti libri. → Ne ho letti molti [ne].  
 'I read many books' → CL.PART I-have read.M.PL many.M.PL

The same holds for postverbal subjects of unaccusative verbs, with the crucial difference that partitive *ne* is parallel to *pro*, since Italian is a null subject language. The null subject *pro* has referential interpretation and can be the complement of a

<sup>11</sup> Agreeing past participles have the following endings: *-o* (M.SG), *-a* (F.SG), *-i* (M.PL), *-e* (F.PL) and are glossed consequently. Non-agreeing past participles have the ending *-o* which is not to be considered as masculine singular but as lack of gender agreement. For this reason, I will not gloss it at all.

universal quantifier in (22), while the indefinite pronoun selected by *molti* in (23) must be realized as partitive *ne*:<sup>12</sup>

- (22) a. Sono arrivati tutti i libri.  
are arrived.M.PL all the books.M.PL  
'All books arrived.'
- b. Sono arrivati tutti [pro].  
are arrived.M.PL all.M.PL  
'All arrived.'
- (23) a. Sono arrivati molti libri.  
are arrived.M.PL many.M.PL books.M.PL  
'Many books arrived.'
- b. Ne sono arrivati molti [ne].  
CL.PART are arrived.M.PL many.M.PL  
'Many arrived.'

Note that extraction of a direct object or subject pronoun, whether overt (*li/ne*) or covert (*pro*), triggers past participle agreement in (21)-(23). The facts are reversed with indirect objects (24) and oblique complements of the verb (25):

- (24) a. Ho parlato a Maria.  
I-have talked to Maria  
'I talked to Maria.'
- b. Le ho parlato/\*a [le].  
CL.DAT.F.SG I-have spoken/F.SG  
'I talked to her.'

---

**12** In (22)-(23), the [-animate] noun “books” excludes the possibility of a [+human] arbitrary *pro* interpretation (cf. Rizzi 1986), which according to Cardinaletti & Giusti (1992, 2006, 2017) allows for a null bare NomExpr in the complement of Q in any grammatical function:

- (i) a. Ho visto molti [pro].  
I-have seen many.M.PL  
'I saw many [people].'
- b. \*Ho letto molti.M.PL [pro].  
I-have read many
- (ii) Sono arrivati molti [pro]  
are arrived.M.PL many.M.PL  
'Many [people] arrived.'

- (25) a. Ho parlato di Maria  
I-have talked of Maria  
'I talked about Maria.'
- b. Ne ho parlato/\*a [ne].  
CL.GEN I-have spoken/F.SG  
'I talked about her.'

Partitive *ne* (26b) can resume an indefinite NomExpr (bare or introduced by the partitive determiner) with narrow scope reading, such as (*delle*) *lettere* in (26a):<sup>13</sup>

- (26) a. Non ho scritto (delle) lettere.  
NEG I-have written (of-the) letters.F.PL  
'I didn't write (some) letters.'
- b. Non ne ho scritte [ne].  
NEG CL.PART I-have written.F.PL  
'I didn't write any.'

Note that the indefinite NomExpr with the partitive determiner in (26a) may have wide scope ('there are some letters that I did not write'). But *ne* in (26b) can only have narrow scope.

Finally, Belletti notes that partitive *ne* must cooccur with the partitive PP in relative clauses (27a-b), while genitive *ne* cannot cooccur with the oblique PP selected by the verb (27c):

- (27) a. Questi libri, di cui ne ho letti molti [ne] [di cui],  
these books.M.PL of which CL.PART I-have read.M.PL many.M.PL  
sono in programma.  
are in syllabus
- b. \*Questi libri, di cui ho letto molti [di cui], sono in programma.  
these books.M.PL of which I-have read many.M.PL are in syllabus  
'These books, of which I read many, are on the syllabus.'
- c. Questi libri, di cui (\*ne) ho parlato, sono  
these books.M.PL of which CL.GEN I-have talked are  
in programma.  
in syllabus  
'These books, which I talked about, are on the syllabus.'

**13** Note that unlike French, in Italian indefinite nominal expressions in the scope of negation are not introduced by the bare preposition *di*, cf. French *Je n'ai pas écrit de lettres* (lit.: I NEG have NEG written of letters, 'I wrote no letters'). There is therefore no reason to hypothesize that the clitic that resumes the bare indefinite is of category PP.

The data in (20)-(27) favor hypothesis (9ii.b) over (9ii.a). As regards the category of partitive *ne*, we can formulate the empirical generalization in (28):

- (28) Partitive *ne* is like a direct object clitic, a null subject pronoun, and a bare NomExpr, and unlike a prepositional clitic, such as genitive *ne* or oblique *ne*.

The features to diagnose the three different types of *ne* in Italian are given in protocol (29):

(29)	Partitive vs prepositional <i>ne</i>	Partitive <i>ne</i>	Genitive <i>ne</i>	Oblique <i>ne</i>
a.	Can extract out of a definite NomExpr	–	+	0
b.	Triggers past participle agreement	+	–	–
c.	Covaries with accusative clitics	+	–	–
d.	Covaries with null subjects	+	–	–
e.	Can cooccur with a <i>di</i> -PP	+	–	–

In (29a) we contrast (17b) with (18b), which are both extraction out of a NomExpr. Extraction of the genitive selected by a verb is irrelevant to the point. In (29b) we contrast partitive *ne* (20a) that requires past participle agreement with genitive and oblique *ne* (20b-c), which excludes it, on a par with other prepositional clitics (24/25b). (29c) puts together the past participle agreement of partitive *ne* (21b) with accusative clitics (21a). (29d) draws parallels between partitive *ne* in post-verbal subject positions (23b) and null subject pronouns in the complement of a universal quantifier (22b). (29e) contrasts the co-occurrence of partitive *ne* with a partitive PP introducing a relative clause (27a-b) with other prepositional clitics (and their counterpart PP introducing a relative clause (27c).

The diagnostics in (29) support the hypothesis that partitive *ne* is of the same category as direct object clitics and null subjects. Following Cardinaletti & Giusti (2006, 2017), I take it to be an indefinite NomExpr assigned partitive case by the quantifier that embeds it or by an external operator in the clause (Belletti 1988, Dobrovie-Sorin & Beyssade 2004). Note that discrimination among the “partitive” constructions analyzed here allows unification of partitive *ne* with accusative clitics and subject *pros* and of genitive *ne* with oblique clitics. Such a unification would not be possible in an analysis that unifies partitive *ne* with genitive *ne* in the name of a generalization of genitive PPs and partitive PPs.

### 2.3 The category of the partitive determiner

The partitive determiner in (1c) is homophonous with the preposition *di* ‘of’ merged with a definite article. It contributes a quantity interpretation and occurs with mass nouns and plural count nouns. It is therefore tempting to unify it with the partitive PP that occurs with quantifiers and claim that the quantifier may be null, as proposed by Milner (1978) for French, and represented in (30) for Italian, where the first translation corresponds to the sentence without the quantifier and the second to the sentence with the quantifier:

- (30) a. Ho mangiato (molta) della carne.  
 I-have eaten (much) of-the meat  
 ‘I ate meat.’ / ‘I ate a lot of the meat.’
- b. Ho letto (molti) dei libri.  
 I-have read (many) of-the books  
 ‘I read books.’ / ‘I read many of the books.’

The unification hypothesis under the category PP is at first sight supported by the observation that the definite article in (30) may be replaced by a demonstrative. However, as Kupferman (1979) notes for French and we observe here for Italian, this only holds for the object of verbs that have a “fragmentative” interpretation, such as *mangiare* (‘eat’) in (31a). With other verbs, the bare partitive formed with a demonstrative (without an overt quantifier) can only have the “sort-of” interpretation, as in (31b):<sup>14</sup>

- (31) a. Ho mangiato (molta) di questa carne.  
 I-have eaten (much) of this meat  
 ‘I ate some of this meat.’ / ‘I ate a lot of this meat.’
- b. Ho letto #(molti) di questi libri.  
 I-have read (many) of these books  
 ‘I read I read books of this sort.’ / ‘I read many of these books.’

This observation led Kupferman (1979) and much work after him (cf. Ihsane 2008 for an overview) to propose that fragmentative verbs have a PP complement.

---

<sup>14</sup> Also cf. the discussion of (78) below. This type of partitives that may occur with demonstratives and other determiners are also called “faded partitives” by de Hoop (2003) and bare partitive by Le Bruyn (2007). See the terminological section of Giusti & Sleeman (2021, this volume) and the internal references therein.

Thus, the prepositional form of the bare partitive with a demonstrative is not to be unified with the partitive determiner. In this hypothesis, the partitive determiner introduces an indefinite NomExpr and not a quantified one.

Furthermore, while the partitive determiner conveys indefinite interpretation, as shown by the glosses of (30)-(31), the partitives formed with a demonstrative may have genuine partitive interpretation, which is detectable in the plural object of fragmentative verbs. Thus, while (32a) simply means ‘I ate an indefinite number of biscuits’, (32b) can either mean that I ate parts of these biscuits leaving the biscuits partially uneaten or that I have eaten biscuits of this sort; but it cannot mean that I ate an indefinite number of these biscuits:

- (32) a. Ho mangiato dei biscotti.  
 I-have eaten of-the biscuits  
 ‘I ate (some) biscuits.’
- b. Ho mangiato di questi biscotti.  
 I-have eaten of these biscuits  
 ‘I ate parts of these biscuits.’ / ‘I ate biscuits of this sort.’

Therefore, only for the fragmentative interpretation of (32b) would it be legitimate to hypothesize the presence of a covert classifier noun [part], which induces the partitive interpretation. *Vice versa*, the lack of partitivity in the indefinite interpretation of (32a) and in the sort-of interpretation of (32b) suggests the absence of such a covert element.

Another crucial semantic difference between partitive determiners and partitive PPs is the interpretation of the article. The article is not interpreted as definite in (33a), where *di+art* has ambiguous scope properties like the indefinite article in (33b). The opposite case is provided by the quantifier in (33c), which induces wide scope, regardless of the presence or absence of the partitive PP. Note that a bare NomExpr cannot have scope over negation (33d):

- (33) a. Non ho mangiato dei biscotti.  $\neg E / E \neg$   
 NEG I-have eaten of-the biscuits  
 ‘I didn’t eat any biscuits / I didn’t eat some biscuits.’
- b. Non ho mangiato un biscotto.  $\neg E / E \neg$   
 NEG I-have eaten a biscuit  
 ‘I didn’t eat any biscuit / I didn’t eat a [certain] biscuit.’
- c. Non ho mangiato alcuni (dei) biscotti.  $*\neg E / E \neg$   
 NEG I-have eaten some (of-the) biscuits  
 ‘There are some biscuits I did not eat.’

- d. Non ho mangiato biscotti. -E / \*E-  
 NEG I-have eaten biscuits  
 'I did not eat biscuits.'

In the attempt to rescue Chierchia's (1997) analysis that derives (33a) from (33c), Zamparelli (2008) suggests that the definite article in the partitive determiner in (33c) does not refer to a definite individual (as it does in (33a)) but to the kind. This is in principle plausible given that in all Romance languages, generic interpretation is expressed by the definite article. Zamparelli's proposal is however contradicted by two facts, brought about by Cardinaletti & Giusti (2016). The first is the possibility of a partitive determiner with measure nouns, as in (34a), but not in true partitive constructions, as in (34b). Note that measure nouns generally require a specification of quantity, which can be provided by an indefinite article or a cardinal (34c); they also allow the "small quantity" interpretation provided by the partitive determiner in (34a) or the quantifier *alcuni* in (34b). What is totally unallowed is a true partitive construction in (34b):

- (34) a. Ho comprato ?(dei) chili di quei biscotti.<sup>15</sup>  
 I-have bought (of-the) kilos of those biscuits  
 'I bought (some) kilos of those biscuits.'
- b. Ho comprato alcuni (\*dei) chili di quei biscotti.  
 I-have bought some (of-the) kilos of those biscuits  
 'I bought some kilos of those biscuits.'
- c. Ho comprato un chilo / tre chili di quei biscotti.  
 'I bought a kilo / three kilos of those biscuits.'

The almost mandatory presence of *dei* with measure nouns is unexpected if the definite article refers to the kind, given that it is implausible to suppose that measures are kinds. This is confirmed by the fact that measure nouns in the plural are ungrammatical as subject of predicates such as *be widespread* that ensure kind interpretation, as in (35):

- (35) a. \*I chili sono diffusi in tutta Europa.  
 the kilos are widespread in all Europe  
 intended reading: 'The kilo is commonly used throughout Europe'

<sup>15</sup> The noun *chili* can be the head of a bare nominal only if it is focalized (*Ho comprato CHILI di quei biscotti* 'I bought TONS of these biscuits'). For this reason, lack of *dei* is indicated as marginal in (34a), which has no emphasis on *chili* ('kilos')

- b. ?\*I chili hanno soppiantato le libbre.  
 the kilos have replaced the pounds  
 intended reading: ‘The kilo replaced the pound.’

Thus, the perfect grammaticality of the partitive determiner contrasted with the impossibility of the kind-referring article with measure nouns contradicts Zamparelli’s (2008) attempt to rescue Chierchia’s (1997) unification of a NomExpr introduced by a partitive determiner with the partitive PP.

Extraction of the *wh*-PP *di quali studenti* ‘of which students’ sets the partitive determiner *dei* (36c) apart from the partitive P+art *dei* (36a) and on a par with quantifier *alcuni* (36b) and the indefinite singular article *un* (36d). Extraction from a bare NomExpr is marginal, while it is possible if the NomExpr is introduced by a definite article (36e):

- (36) a. \*Di quali studenti hai corretto alcuni dei compiti [di quali studenti]?  
 ‘Of which students did you check some of the tests?’  
 b. Di quali studenti hai corretto alcuni compiti [di quali studenti]?  
 ‘Of which students did you check some tests?’  
 c. Di quali studenti hai corretto dei compiti [di quali studenti]?  
 of which students did you check of-the tests (same as (34b))  
 d. Di quali studenti hai corretto un compito [di quali studenti]?  
 ‘Of which students did you check a test?’  
 e. Di quali studenti hai corretto ?(i) compiti [di quali studenti]?  
 ‘Of which students did you check (the) tests.’

The data discussed in this section favor hypothesis (9iii.b) over (9iii.a). The category of the partitive determiner cannot be unified with the partitive PP or with the quantitative QP, as stated in (37):

- (37) In Italian, the partitive determiner *di*+art is the plural/mass counterpart of the indefinite article *un*. It is different from the partitive P *di* bundled with a definite article. It is also different from the quantifier *alcuni* selecting a bare NomExpr.

The features to diagnose the category of the partitive determiner in Italian are given in protocol (38), which highlights the differences from both partitive constructions and existential quantifiers on the one hand, and bare nouns on the other hand, and the similarities with the singular indefinite determiner:



(38)

	Different types of <i>di+art</i> in Italian vs. existential quantifiers or bare nominals	Partitive PP <i>di+art</i>	<i>Alcuni</i> in quantitative construction	Indefinite <i>di+art</i>	Indefinite article	Null determiner in bare NomExpr
a.	The article can be replaced by a demonstrative	+	0	-	0	0
b.	induces part-whole interpretation	+	-	-	-	-
c.	can have scope over NEG	+	+	+	+	-
d.	can have scope below NEG	-	-	+	+	+
e.	the article refers to kind	-	0	-	0	0
f.	can embed a measure noun	-	+	+	+	+/-
g.	allows <i>wh</i> -extraction	-	+	+	+	-

## 2.4 Interim conclusions

Section 2 has provided three protocols to discriminate between the two sets of possible hypotheses spelled out in (9). I have shown that the unification hypotheses in (9i-iii.a) cannot be maintained. The partitive PP selected by a quantifier is not the same complement of Q as the mandatory indefinite NomExpr (9i.b); clitic *ne* is nominal and not prepositional (9ii.b); and the partitive determiner is not a quantifier, nor can it be derived from the partitive PP in syntax (9iii.b). The anti-unification hypotheses predict that these three elements behave differently from one another in certain syntactic environments. This is the topic of the next section.

## 3 Relevant syntactic environments

This section singles out the syntactic properties of partitive and genitive PPs that allow us to diagnose prepositional vs nominal status. The clause internal argument position distinguishes the dependency relation between the quantity item (when present) and the part of structure that provides the lexical content. The dislocated position distinguishes objects (which require a resumptive clitic) and subjects (which are resumed by null *pro*) from oblique arguments (which have optional resumption) and circumstantial adjuncts (which are not resumed at all).

### 3.1 Selection

Since predicates select the category of their arguments, the predicate-argument dependency is an important diagnostic to determine the category of a constituent. This subsection is divided into two parts. In 3.1.1 I distinguish partitive PPs selected by a quantifier and introduced by the functional preposition *di* from circumstantial partitive PPs introduced by the lexical preposition *tra* (also cf. Cardinaletti & Giusti 2006, 2017). In 3.1.2, I distinguish these partitive *di*-PPs from three different types of genitive *di*-PPs selected by lexical verbs, lexical nouns, and semi-lexical (measure) nouns, respectively. As anticipated in fn. 2 above, I consider P as an extended projection of the NomExpr and therefore attribute the interpretive properties of DP (theta-role, referential interpretation, definiteness, etc.) to the whole PP which contains it.

#### 3.1.1 Two types of partitive PPs

In the discussion of (31) above, I reported Kupferman's (1979) observation that fragmentative verbs may select a *di*-PP with partitive interpretation, unlike other transitive verbs selecting a direct object. I adopted Kupferman's conclusion that it is a property of these verbs in their fragmentative interpretation to select a PP and not a generalized property of Italian to substitute an indefinite NomExpr with a PP embedding a definite NomExpr.

As anticipated in (8) above, according to Cardinaletti & Giusti (1992, 2006, 2017), partitive *di*-PPs are optional arguments of a subclass of existential Qs that also select a bare NomExpr providing the restriction. This is projected in a structure parallel to the one of ditransitive predicates. Notably, the partitive PP is never the internal argument of Q, unlike what we observed with the complement of qNs in (10) and (15) above.

As in (8), for the sake of simplicity, I keep the structure of QP to a minimum, merging the internal argument of Q under Q' and the partitive PP under QP. In (39a), the bare NomExpr *ragazze* ('girls') is the internal argument (direct complement) of Q, the PP is the second argument, and requires a preposition because it is not assigned case by Q. Note that universal quantifiers only select a definite NomExpr (39b). A demonstrative or definite article is a functional projection of N and does not have selectional properties. For this reason, it cannot occur with a partitive PP (39c):<sup>16</sup>

---

<sup>16</sup> Indefinite and definite nominal expressions are indicated as DP in (39)-(42) for convenience, but the reasoning also holds if we assume determiners to be modifiers of N and nominal expres-

- (39) a. [<sub>QP</sub> [<sub>Q'</sub> molte / alcune / tre [<sub>DP</sub> ragazze]] [<sub>PP</sub> delle ragazze che conosco]]  
           many / some / three girls           of-the girls       that I-know  
 b. [<sub>QP</sub> [<sub>Q'</sub> tutte [<sub>DP</sub> le ragazze]] [<sub>PP</sub> \*delle ragazze che conosco]]  
           all    the girls                   of-the girls       that I-know  
 c. [<sub>DP</sub> [<sub>D'</sub> queste / le [<sub>NP</sub> ragazze]] [<sub>PP</sub> \*delle ragazze che conosco]]  
           these / the girls                   of-the girls       that I-know

The selectional relation between the quantifier and the partitive PP is confirmed by the observation that the intension of the two arguments of Q (the indefinite DP and the PP) must be lexically identical (Giusti 1991). In syntactic terms, this results in the identity of the lexical head N in the two arguments. Thus, although it would make perfect sense to pick some pupils out of a set of girls (40a), or pick some strawberries out of a set of fruits (40b), the partitive PP is ungrammatical:

- (40) a. [<sub>QP</sub> [<sub>Q'</sub> molte / alcune / tre [<sub>DP</sub> alunne]] [<sub>PP</sub> \*delle ragazze che conosco]]  
           many / some / three pupil.F.PL of-the girls       that I-know  
 b. [<sub>QP</sub> [<sub>Q'</sub> molte / alcune / tre [<sub>DP</sub> fragole]] [<sub>PP</sub> \*dei frutti che ho preso]]  
           many / some / three strawberries of-the fruits that I-have taken

Furthermore, the ungrammaticality of the partitive PP in (39b-c) cannot be motivated by logical incompatibility of the part-whole relation with universal quantification or deixis, as shown by the possibility of a circumstantial PP introduced by *tra/fra* ('out-of') in (41) rescuing (40) and in (42) rescuing (39b-c):

- (41) a. [<sub>QP</sub> [<sub>Q'</sub> molte / alcune / tre [<sub>DP</sub> alunne]] [<sub>PP</sub> tra/fra le ragazze che conosco]]  
           many / some / three pupil.F.PL out-of the girls       that I-know  
 b. [<sub>QP</sub> [<sub>Q'</sub> molte / alcune / tre [<sub>DP</sub> fragole]] [<sub>PP</sub> tra/fra i frutti che ho preso]]  
           many / some / three strawberries out-of the fruits that I-have taken
- (42) a. [<sub>QP</sub> [<sub>Q'</sub> tutte [<sub>DP</sub> le ragazze]] [<sub>PP</sub> tra/fra le ragazze che conosco]]  
           all    the girls                   out-of the girls       that I-know  
 b. [<sub>DP</sub> [<sub>D'</sub> queste [<sub>NP</sub> ragazze]] [<sub>PP</sub> tra/fra le ragazze che conosco]]  
           these    girls                   out-of the girls       that I-know

Furthermore, as noted by Barker (1998), partitive PPs are generally definite. This holds of both the selected *di*-PP and the circumstantial *tra*-PP:

---

sions to be of category NP. The category NP in (39c) is of a different nature. DP is a full nominal object, a phase in the sense of Chomsky (2001). NP is a portion of it.

- (43) a. molte / alcune / tre di \*(queste) ragazze  
           many / some / three of \*(these) girls  
       b. tutte tra \*(queste) ragazze  
           all out-of \*(these) girls

However, while the selected partitive PP cannot be universally quantified (44a), the circumstantial partitive PP can (44b):

- (44) a. molte / alcune / tre delle /\*di tutte le ragazze che conosco  
           many / some / three of-the / \*of all the girls that I-know  
       b. queste tra (tutte) le ragazze che conosco  
           these out-of (all) the girls that I-know.'

Finally, note that the circumstantial partitive PP cannot substitute the partitive PP selected by fragmentative verbs, cf. (31a) and (32b), repeated here in (45):

- (45) a. Ho mangiato di questa carne / di questi biscotti. (cf. (31a))  
           I-have eaten of this meat / of these biscuits  
           'I ate some of this meat / of these biscuits.'  
       b. \*Ho mangiato tra questa carne / tra questi biscotti. (cf. (32b))  
           I-have eaten out-of this meat / out-of these biscuits

From the discussion in (39)-(45), we can formulate the generalization in (46):

- (46) In Italian, there are two types of partitive PPs: a circumstantial PP introduced by the preposition *tra/fra* and a selected PP (the second argument of Q) introduced by the functional preposition *di*. Only the former is compatible with a universal quantifier that requires a definite referential NomExpr.

The diagnostics for the two different partitive PPs are given in protocol (47).

(47)	Partitive PPs	Selected partitive <i>di</i> -PP	Circumstantial partitive <i>tra</i> -PP
a.	identity of intension (lexical N)	+	-
b.	must be definite	+	+
c.	can be (universally) quantified	-	+
d.	can be selected by consumption predicates	+	-
e.	can be adjoined to any NomExpr	-	+

In (47a) we report on the data in (40)-(43). In (47b) I represent the parallel between (43a) and (43b). In (47c) I summarize the contrast in (44) and in (47d) the contrast in (45). Finally, in (47e) I report the contrast in (44)-(43).

### 3.1.2 Genitive PPs

We know that *di* is the most frequent functional preposition in Italian (Rizzi 1988). It can also express the theme of verbs of speaking (48a) and the stimulus of psych-verbs (48b):

- (48) a. Ho parlato a Maria di alcune delle mie studenti.  
 ‘I talked to Maria about some of my students.’  
 b. Mi preoccupo di alcune delle mie studenti.  
 ‘I worry about some of my students.’

The oblique argument of a verb can freely extract as a *wh*-constituent (49) and as a clitic. In this case the form is oblique *ne* (50):

- (49) a. Di chi hai parlato a Maria [~~di chi~~]?  
 ‘Who did you talk to Maria about?’  
 b. Di chi ti preoccupi [~~di chi~~]?  
 ‘Who do you worry about?’  
 (50) a. Ne ho parlato a Maria [~~ne~~].  
 ‘I talked to Maria about them.’  
 b. Me ne preoccupo [~~ne~~].  
 ‘I worry about them.’

The preposition *di* is also the whole-purpose preposition that instantiates the R-relation between a noun and its argument(s) (cf. Higginbotham 1985, 1987), expressed by genitive case in many languages. Like *of* in English, it can express any relation with the noun. Cinque (1980, 2014) shows that it is the only PP that can extract out of a NomExpr, cf. (51b) vs. (51c), thereby suggesting that it is the only constituent to be a genuine argument of the noun receiving structural case (examples are mine):

- (51) a. Ho sentito il discorso di Fortunato Ladu ai pastori sardi.  
 I-have heard the speech of F.L to the Sardinian shepherds  
 ‘I heard Fortunato Ladu’s speech to the Sardinian shepherds.’

- b. Di chi hai sentito il discorso [di chi] ai pastori sardi?  
 of whom you-have heard the speech to the Sardinian shepherds  
 ‘whose speech to the Sardinian shepherds did you hear?’
- c. \*A chi hai sentito il discorso di Fortunato Ladu [a chi]?  
 to whom you-have heard the speech of Fortunato Ladu

Cinque shows that if there are two *di*-PPs, only the highest one (the external argument) can extract, displaying a ‘relativized minimality’ effect (cf. Rizzi 1990). In (52a-c), only the agent can extract, as shown by the grammaticality of (52b) and the ungrammaticality of (52c). But if the theme is the only genitive present, it can freely extract, as shown by the contrast between (52c) and (52d):

- (52) a. Ha documentato la conquista di Cesare della Gallia  
 (s)he-has documented the conquest of Caesar of-the Gaul.  
 ‘(S)he documented Caesar’s conquest of Gaul.’
- b. Di chi ha documentato la conquista [di chi] della Gallia?  
 of whom (s)he-has documented the conquest of-the Gaul  
 ‘Whose conquest of Gaul did (s)he document?’
- c. \*Di che regione ha documentato la conquista  
 of which region (s)he-has documented the conquest  
 di Cesare [di che regione]?  
 of Caesar
- d. Di che regione ha documentato la conquista [di che regione]?  
 ‘Of which region did (s)he-has document the conquest?’

The same hierarchy is observed with pronominal possessors. Only the highest argument can turn into a pronominal or a possessive adjective, as shown in (53b):

- (53) a. Ha documentato la sua/loro conquista [sua/loro] della Gallia  
 ‘(S)he documented his/their conquest of Gaul.’
- b. \*Ha documentato la sua/loro conquista di Cesare [sua/loro]?  
 (s)he-has documented the its/their conquest of Caesar

Extraction of *ne* out of a NomExpr is marginally possible, with the same hierarchical restrictions, allowing the internal argument to extract only in the absence of the external argument (54b):

- (54) a. ?Ne ha documentato la conquista [ne] della Gallia. (*ne* = *di Cesare*)  
 ‘(S)he documented his conquest of Gaul.’

- b. ?Ne ha documentato la conquista (\*di Cesare) [nɛ]. (*ne* = *della Gallia*)  
 ‘(S)he documented its conquest (\*of Caesar).’

Unlike the NomExpr in a partitive PP, which is always definite and cannot be quantified (cf. (43)-(44)), the complement of a lexical N can have any interpretive value: referential (51)-(53), quantificational (55a),<sup>17</sup> or kind-referring (55b). When it is indefinite, the conditions for a bare NomExpr are restricted, as in (55c-d):

- (55) a. il compito di ogni studente / di molti studenti / di uno degli studenti  
 ‘the test of every student / of many students / of one of the students’  
 b. i doveri dell’insegnante / degli insegnanti  
 ‘the duties of the teacher / of the teachers’  
 c. la cartella di \*(certi) studenti / di uno studente / ??di degli studenti<sup>18</sup>  
 ‘the schoolbag of (certain) students / of a student / of some students’  
 d. C’erano (delle) cartelle di studenti appoggiate per terra.  
 ‘There were schoolbags of students lying on the floor.’

Let us now go back to measure nouns and other semi-functional nouns (qNs) selecting a genitive PP and giving rise to pseudo-partitive constructions (Czirmaz & Stavrou 2017, Tănase-Dogaru 2017). Unlike the partitive PP selected by a quantifier, which can only be definite and cannot be quantified, the partitive complement of a collective noun such as *gruppo* (‘group’) can be definite or indefinite (56a) and existentially quantified (56b) but not universally quantified (56c):

- (56) a. un gruppo di studenti / di questi studenti / degli studenti  
 a group of students / of these students / of-the students  
 b. un gruppo di ?molti / tre / ?alcuni studenti  
 a group of many / three / some students  
 c. \*un gruppo di tutti gli studenti  
 a group of all the students

<sup>17</sup> Notably, the singular definite article in (55a) does not necessarily convey a definite referential interpretation on the possessed NomExpr. The interpretation of the genitive possessor is independent from the interpretation of the possessum but the interpretation of the possessum depends on the interpretation of the possessor (cf. Giusti 2002, 2015 for an analysis).

<sup>18</sup> The three examples in (55c) present three different types of indefinite possessor. *Certi studenti* can be interpreted either as specific ‘certain students I have in mind’ or as ‘non-specific students of a certain type of students I have in mind’, cf. Giusti (2021). *Uno studente* ‘a student’ can be specific or non-specific. In either case, the whole NomExpr inherits the specificity feature of the possessor. *Di degli studenti* (‘of some students’) is marginal (probably due to an incompatibility of the preposition *di* and the partitive determiner *di*+art, which diachronically derives from it) but not ungrammatical.

Container nouns such as *scatola* only allow for cardinal numbers (57b) but not quantifiers. Measure nouns such as *kilo* do not allow for any quantification (58b-c):

- (57) a. una scatola di biscotti / di questi biscotti/  
 a box of biscuits / of these biscuits/  
 dei biscotti che ho preparato  
 of-the biscuits that I-have prepared
- b. una scatola di venti / \*molti / \*alcuni biscotti  
 a box of twenty / \*many / \*some biscuits
- c. \*una scatola di tutti i biscotti  
 a box of all the biscuits
- (58) a. un chilo di mele / di queste mele / delle mele che sono in frigorifero  
 a kilo of apples / of these apples / of-the apples that are in [the] fridge
- b. \*un chilo di molte / quattro / alcune mele  
 a kilo of many / four / some apples
- c. \*un chilo di tutte le mele  
 a kilo of all the apples

Collective and container nouns can be preceded by a definite or indefinite determiner (59) like lexical nouns (60a) and unlike quantifiers (60b):<sup>19</sup>

- (59) a. il gruppo dei miei studenti  
 ‘the group of my students’
- b. questa scatola di biscotti  
 ‘this box of biscuits’
- (60) a. la rappresentante dei miei studenti  
 ‘the delegate of my students’
- b. (\*i/\*questi) molti dei miei studenti  
 (the/these) many of-the my students

Unlike the complement of lexical Ns (61), the complement of semi-lexical nouns cannot be substituted by a possessive adjective. In (62a-b), the collective noun *gruppo* ‘group’

<sup>19</sup> Some quantifiers may appear after a definite article or a demonstrative, but in this case, they cannot select the partitive PP. Giusti (1991) and Cardinaletti & Giusti (2006, 2017) argue that they are (quantity) adjectives and, like all prenominal adjectives in Italian, do not select NP.



and the container noun *scatola* ‘box’ can be modified by a possessive only in the relational reading triggered by the lexical counterpart of the nouns, not in the partitive reading, which is relevant to our discussion. In (62c), the measure noun ‘kilos’ gives straight ungrammatical results because it does not have a lexical counterpart:

- (61) a. il suo aroma [suo = del caffè]  
           ‘its aroma’ [its = of the coffee]  
       b. la loro aula [loro = degli studenti]  
           ‘their classroom’ [their = of the students]
- (62) a. il loro gruppo [loro = #degli studenti /\*di studenti]  
           ‘their group’ [their = of the students]  
       b. la loro scatola [loro = #dei biscotti /\*di biscotti]  
           ‘their box’ [their = of biscuits]  
       c. \*tre suoi chili [suoi = \*del caffè / \*di caffè]  
           three its kilos [its = of the coffee]

Semi-lexical nouns freely allow *wh*-extraction of their PP complement:

- (63) a. Di quali studenti hai contattato un gruppo [di quali studenti]?  
           ‘Of which students did you contact a group?’  
       b. Di quali biscotti hai comprato una scatola [di quali biscotti]?  
           ‘Of which biscuits did you buy a box?’  
       c. Di che mele hai comprato tre chili [di che mele]?  
           ‘Of what apples did you buy three kilos?’

They also freely allow *ne*-cliticization of the genitive PP (64), unlike lexical nouns, which display restrictions on genitive *ne* (cf. (54)) and only partially like the bare NomExpr complement of a quantifier (*viz.* the DP in (41a)):<sup>20</sup>

<sup>20</sup> In (64) *ne* is not glossed as CL.PART because it does not behave like partitive *ne* with respect to past participle agreement. Rather it behaves like genitive *ne*, in not requiring past participle agreement. It is however not exactly like genitive *ne*, which totally disallows agreement on the past participle. Here we observe a hierarchy of acceptability of agreement from almost ungrammatical to almost grammatical (64c). For this reason, it is not glossed as CL.GEN either.

Note the hierarchy of acceptability of agreement on the past participle. The more lexical the noun is, the less mandatory is the agreement for gender and number on the past participle, as shown by the different grammaticality judgements in (64). For reasons of space, I will not discuss this property here, which appears to distinguish different classes of semi-lexical/functional nouns.

- (64) a. Ne ho contattato/\*contattati un gruppo. [ne = di studenti]  
 CL I-have contacted/(?\*M.PL) a group? [CL = of student.M.PL]  
 b. Ne ho comprato/??comprati una scatola. [ne = di biscotti]  
 CL I-have bought/(??M.PL) a.F.SG box.F.SG [CL = of bicuit.M.PL]  
 c. Ne ho comprato /?comprate tre chili [ne = di mele]  
 CL I-have bought.(?F.PL) three kilo.M.PL [CL = of apple.F.PL]

From the discussion in (48)-(64), we can formulate the generalizations in (65):

- (65) In Italian, there are three types of genitive PPs, all introduced by the functional preposition *di*: (i) the complement of V, which receives a thematic role; (ii) the argument of N (subject or object), which is interpreted as having a relation with the possessum; (iii) the complement of semi-lexical Ns, which is interpreted as quantitative (indefinite) or partitive (definite).

The protocol to diagnose the three types of genitive PPs is given in (66):

(66)	Genitive <i>di</i> -PPs	Genitive <i>di</i> -PP selected by a lexical V	Genitive <i>di</i> -PP selected by a lexical N	Genitive <i>di</i> -PP selected by a semi-lexical N
a.	can be definite	+	+	+
b.	can be indefinite	+	-	+
c.	can be existentially quantified	+	+	+/-
d.	can be universally quantified	+	+	-
e.	can be resumed by a possessive pronoun or adjective	-	+	-
f.	can <i>wh</i> -extract	+	+	+
g.	can cliticize as <i>ne</i> <sup>21</sup>	+	+	+

### 3.2 Dislocation with resumptive clitics

Italian displays pragmatically marked structures with topic arguments in clause-initial and clause-final positions. The occurrence and form of the resumptive clitic is a diagnostic for case, category and function of the displaced constituent. This

<sup>21</sup> For the status of *ne* cf. protocol (29) above.

subsection provides the features to diagnose partitive PPs, genitive PPs, indefinite nominal expressions introduced by a partitive determiner, and bare nominal expressions.

First, note that while direct objects must be resumed by a clitic (67b) (cf. Cinque 1990), indirect objects need not (67c) and, according to normative grammar, they should not, as indicated by the % diacritic:

- (67) a. Ho dato questo libro a mia sorella.  
           'I gave this book to my sister'  
       b. Questo libro,       \*(l')           ho   dato a mia sorella.  
           this book.M.SG   CL.ACC.M.SG I-have given to my   sister  
       c. A mia sorella,   (%le)           ho   dato questo libro.  
           to my sister.F.SG CL.DAT.F.SG I-have given this   book

Furthermore, as noted in (20)-(25) above, while object clitics (e.g. *li* ('them') in (68a)) trigger past participle agreement, oblique clitics (e.g. *le* ('to-her') in (68b)) do not:

- (68) a. Questi libri,       li           ho   regalati/\*o a mia sorella.  
           these book.M.PL   CL.ACC.M.PL I-have given/\*(.M.PL) to my sister  
       b. A mia sorella,   (%le)           ho   regalato/\*a questi libri.  
           to my sister.F.SG CL.DAT.F.SG I-have given(\*.F.SG) these books

As in (67) above, the accusative clitic is mandatory in (68a), while the dative clitic is optional in (68b) and sanctioned by normative grammar to the extent that some speakers judge it ungrammatical.

Partitive PPs of either type are not resumed by clitics. This can be argued in two steps. First, observe that when the *tra*-PP has locative interpretation (69a) it can be resumed by the locative clitic *ci* but not by *ne*. When it has partitive interpretation (69b), it cannot be resumed by any clitic:

- (69) a. Tra   questi libri, (%ci / \*ne)   ho   trovato tre romanzi.  
           among these books CL.LOC/CL.GEN have found three novels  
           'I found found three novels among these books.'  
       b. Tra   questi libri, (\*ci / \*ne)   ho   letto tre romanzi.  
           out-of these books CL.LOC/CL.PART I-have read three novels  
           'I read three novels out of these books.'

When the *di*-PP is the genitive complement of a verb (70a), it may be resumed by genitive *ne*, with the usual proviso of normative grammar, like other oblique

complements of verbs. When it has partitive interpretation (70b), it cannot be resumed by a genitive clitic, which does not trigger past participle agreement:<sup>22</sup>

- (70) a. Dei libri di Morante, (%ne/\*ci) ho parlato spesso.  
of-the books by Morante CL.GEN/CL.LOC I-have talked often  
‘I often spoke of Morante’s books.’  
b. \*Dei libri di Morante, (ne/ci) ho letto tre.  
of-the books by Morante CL.GEN/CL.LOC I-have read three  
intended reading: ‘I read three of Morante’s books.’

The second step is to observe that the presence of partitive *ne* in quantitative constructions is mandatory in (71), on a par with the presence of the accusative clitic in (67b) and (68a). Crucially, the clitic triggers past participle agreement with the internal object of a quantifier, which can be plural (71a) or singular (71b), while the partitive PP is always plural (cf. (13c) above):

- (71) a. Di lettere, ne ho lette (due/molte).  
of letter.F.PL CL.PART I-have read.F.PL (two/many.F.PL)  
b. Di lettere/Di lettera, ne ho letta \*(una).  
of letter.F.PL/SG CL.PART I-have read.F.SG one.F.SG.  
c. Di lettere, ne ho lette (\*una).  
of letter.F.PL CL.PART I-have read F.PL one.F.SG  
‘Letters, I read two / many / one.’

In (71b), singular *ne* cannot resume a singular count noun unless the quantifier is overt. This makes *ne* parallel to a bare NomExpr which can occur without a quantifier only with plural count or mass nouns. Contrasting (71b) with (71c), we observe that the past participle does not agree with the dislocated NomExpr but with the internal object position. For this reason, in (71c), the plural past participle is incompatible with a singular quantifier.

The number mismatch between the dislocated plural indefinite and the basic position in (71b) thus shows that partitive *ne* does not resume a partitive PP but an indefinite NomExpr. This is further confirmed by its mandatory occurrence, not only in dislocated constructions (72a) but also in *wh*-interrogatives (72b), relative

<sup>22</sup> The ungrammaticality of (70b) is due to the uninflected form of the past participle, which ensures that we are dealing with an oblique clitic and not a partitive one. In (72), we will come back to this.

clauses (72c), and fronted focuses (72d), as noted by Belletti (1979) and reported in (27) above:

- (72) a. Dei libri che mi hai dato, ne ho letti molti.  
 of-the books that me you-have given CL.PART I-have read.M.PL many.M.PL  
 ‘Of the books you gave me, I read many.’
- b. Di quali libri, ne hai letti molti?  
 of which books CL.PART you-have read.M.PL many.M.PL?  
 ‘Of which books did you read many?’
- c. Questi libri, di cui ne ho letti molti, sono buoni.  
 these books of which CL.PART I-have read.M.PL many.M.PL are good  
 ‘These books, of which I read many, are good.’
- d. Di questi LIBRI, ne ho letti molti, non di quelli!  
 of these BOOKS CL.PART I-have read.M.PL many M.PL not of those  
 ‘Of these BOOKS I read many, not of those!’

Given that *wh*- and focus fronting never allow for a resumptive clitic, the occurrence of *ne* in (72) is strong evidence that it does not resume the fronted partitive PP but has an independent life of its own.

Let us now turn to the behaviour of indefinite nominal expressions introduced by the partitive determiner *di+art*, which I argued to be DPs and not PPs. This is confirmed by the fact that they must be resumed by an accusative clitic (73a), minimally differing from bare nominal expressions, which are resumed by partitive *ne* (73b):

- (73) a. Dei libri, \*(li) ho letti;  
 of-the book.M.PL CL.ACC.M.PL I-have read.M.PL;  
 degli altri, \*(li) devo ancora leggere.  
 of-the others.M.PL CL.ACC.M.PL I-must still read  
 ‘Some books I read; others I must still read.’
- b. Libri, \*(ne) ho letti;  
 book.M.PL CL.PART I-have read.M.PL;  
 riviste, non \*(ne) ho lette.  
 journal.F.PL NEG CL.PART I-have read.F.PL  
 ‘I read books, not journals.’

The different form of the clitic can be straightforwardly captured by the proposal that a bare NomExpr is assigned partitive case, while an indefinite NomExpr introduced by *di+art* is assigned accusative case.

As Belletti (1988) observes, partitive case is only found in structurally governed positions, such as the direct object of transitive verbs (73b) and the postverbal subject of unaccusative verbs (74), but not in the preverbal subject of unergative verbs (75):

- (74) Libri, ieri, \*(ne) sono arrivati.  
 books.M.PL yesterday CL.PART are arrived.M.PL  
 ‘Yesterday, some books arrived.’
- (75) \*Libri, (ne) hanno deluso il pubblico.  
 books CL.PART have disappointed the public  
 intended reading: ‘Some books disappointed the public.’

A null pronoun can appear in a quantitative construction in preverbal subject position. In this case, there is no contrast between the preverbal subject of the unaccusative *arrivare* in (76a) and unergative *deludere* (76b):

- (76) a. (Libri,) [molti *pro*] sono arrivati ieri.  
 ‘Many books arrived yesterday.’  
 b. (Libri,) [molti *pro*] hanno deluso il pubblico.  
 ‘Many books disappointed the public.’

However, a NomExpr introduced by a partitive determiner behaves like a referential NomExpr in being resumed by (nominative) *pro* with no quantifier:

- (77) a. Dei libri, ieri, [pro] sono arrivati per posta.  
 some books.M.PL yesterday are arrived.M.PL through mail  
 ‘Yesterday, some books arrived with the mail.’  
 b. Dei libri, ieri, [pro] hanno deluso il pubblico.  
 some books yesterday have disappointed the public  
 ‘Yesterday, some books disappointed the public.’

Finally, dislocation can disambiguate the constituent *di*+DEM+NP in (78a), which can be an indefinite NomExpr with the interpretation of ‘N of this type’, which is resumed by partitive *ne* triggering past participle agreement (78b) or a PP selected by the verb (‘write about these letters’), which is resumed by genitive *ne* triggering no agreement (78c). Note that unlike what has been observed for the partitive determiner in (73a), *di*+DEM+NP cannot be resumed by an accusative clitic (78d):

- (78) a. Non ho mai scritto di queste lettere.  
 NEG I-have ever written of these letters  
 'I never wrote letters of this type / 'I never wrote about these letters'
- b. Di queste lettere, non ne ho mai scritte.  
 of these letters.F.PL NEG CL.PART I-have ever written.F.PL  
 'I never wrote letters of this type.'
- c. Di queste lettere, non ne ho mai scritto.  
 of these letters.F.PL NEG CL.GEN I-have ever written  
 'I never wrote about these letters.'
- d. \*Di queste lettere, non le ho mai scritte.  
 of these letters.F.PL NEG CL.ACC I-have ever written.F.PL

From the discussion of (67)-(78), we formulate the generalizations in (79)-(81):

- (79) Dislocation can distinguish direct objects, which must be resumed by a clitic, from oblique objects, which can but need not be resumed by a clitic, and from circumstantials, which cannot be resumed by a clitic.
- (80) Partitive PPs behave like circumstantials, oblique genitives behave like other oblique arguments (e.g. locatives); the indefinite complements of quantifiers behave like nominal arguments in object or subject position.
- (81) The partitive determiner is different from the bare partitive *di*+DEM+NP construction in that the former is resumed by an accusative clitic, while the latter is resumed by partitive *ne*.

The diagnostics created by dislocated structures are given in protocol (82).<sup>23</sup>

<sup>23</sup> Recall that 0 stands for irrelevant feature, [(+)] stands for optional, [+/-] stands for present or absent in different contexts. In (82d) [+/-] captures the need of an overt Q in subject position (76).

(82)	Resumptive strategies	Oblique PP	Partitive <i>tra</i> PP	Partitive <i>di</i> PP	Definite NomExpr	Indefinite <i>di</i> +art NomExpr	Indefinite bare NomExpr
a.	clitic pronoun in left dislocation, including prepositional <i>ne</i>	(+)	-	-	-	+	+
b.	partitive <i>ne</i>	-	-	-	-	-	+
c.	accusative <i>lo/la/li/le</i>	0	0	0	+	+	-
d.	nominative <i>pro</i>	0	0	0	+	+	+/-

## 4 Conclusions

In this paper, I have argued against the unification of any of the structures in (1), repeated here as (83):

- (83) a. *Alcune delle ragazze sono arrivate.*  
 ‘Some of the girls arrived.’  
 b. *Alcune ragazze sono arrivate.*  
 ‘Some girls arrived.’  
 c. *Delle ragazze sono arrivate.*  
 of-the girls are arrived  
 ‘Girls arrived.’  
 d. *Ne sono arrivate (alcune).*  
 CL.PART are arrived.F.PL some.F.PL  
 ‘Some arrived.’

I have done so by applying a meta-theoretical approach that I named Protocol Linguistics, which provided us with diagnostics regarding constituency, categorial status, and syntactic distribution.

In section 2, I have evaluated three pairs of alternative hypotheses and have reached the following conclusions. Protocol (16) has shown that the partitive PP and the indefinite complement of a quantifier cannot be unified for semantic and morpho-syntactic reasons. Protocol (29) has shown that the clitic form *ne* is ambiguous between partitive *ne*, which behaves like a direct argument (object or subject), and prepositional *ne*, which can unify oblique arguments of V and



genitive arguments of N. Protocol (38) has set the partitive determiner *di+art* on a par with the indefinite singular determiner *un(a)* and apart from the existential quantifier *alcune* ('some'), the partitive preposition inflected for a definite article, and the null determiner that can be hypothesized to occur in a bare NomExpr.

In section 3, I have discussed two types of dependencies: selectional environments and dislocation structures. Protocol (47) has diagnosed two different partitive PPs: one is the second argument of a Q or the first argument of a fragmentation V, the other is a circumstantial PP that can be adjoined to different types of Nominal Expressions but not to VPs. Protocol (66) has compared different types of genitive PPs: the complements of a lexical V, of a lexical N, or of a semi-lexical Ns (measure nouns or group nouns, which we called qNs), showing that they are three different types of constituents. Finally, protocol (82) has distinguished the different partitive constituents studied in this paper by means of independent properties of left dislocated constructions in Italian: obligatory / possible / impossible presence of a resumptive clitic and has compared *ne* with other clitic pronouns, confirming the hypothesis that partitive *ne* is parallel to accusative clitics and null subject nouns and different from genitive *ne*, which behaves like oblique clitics.

In the discussion, I have relied on a wealth of observations done in previous literature on both Italian and French. These two languages and the non-standard varieties that represent a continuum in the Gallo-Romance area are a privileged area of study because, as far as I know, they are the only languages in which the four different types of partitives appear and are fully productive. In the perspective of this work, this is not surprising if the four constructions are not manifestations of one and the same phenomenon. Thus, presence or absence of a partitive clitic in a language is independent from the presence or absence of genitive morphology in the complement of quantifiers and / or presence or absence of a partitive determiner. The different properties of partitive clitics and partitive determiners should be studied in the cross-linguistic perspective as independent from one another and, importantly, as independent from the notion of true partitivity.

## References

- Barker, Christopher. 1998. Partitives, double genitives and anti-uniqueness. *Natural Language and Linguistic Theory* 16. 679–717.
- Belletti, Adriana. 1979. Sintagmi nominali quantificati e strutture dislocate a sinistra. *Annali della Scuola Normale Superiore. Classe di Lettere e Filosofia, serie III, IX, 4*. 1525–1568.
- Belletti, Adriana. 1988. The case of unaccusatives. *Linguistic Inquiry* 19(1). 1–34.
- Belletti, Adriana & Luigi Rizzi. 1981. The syntax of *ne*: some theoretical implications. *The Linguistic Review* 1. 117–154.

- Berends, Sanne, Petra Sleeman, Aafke Hulk & Jeannette Schaeffer. 2021, this volume. The L2 acquisition of the referential semantics of Dutch partitive pronoun ER. In Petra Sleeman & Giuliana Giusti (eds.), *Partitive determiners, partitive pronouns and partitive case* (Linguistische Arbeiten 580). Berlin: de Gruyter.
- Boivin, Marie-Claude. 1999. Case feature checking and its consequences: Evidence from *en*-cliticization in French. In Jean-Marc Authier, Barbara Bullock & Lisa Reed (eds.), *Formal perspectives on Romance linguistics*, 39–56. Amsterdam: John Benjamins.
- Boivin, Marie-Claude. 2005. Case theory, DP movement, and interpretation: A new approach to the distribution of French subnominal clitic *en*. *Natural Language and Linguistic Theory* 23. 543–593.
- Bosveld-de Smet, Leonie M. 1998. *On mass and plural quantification. The case of French des/du-NP's*. Groningen: University of Groningen dissertation.
- Bosveld-de Smet, Leonie M. 2004. Towards a uniform characterization of noun phrases with *des* or *du*. In Francis Corblin & Henriëtte de Swart (eds.), *Handbook of French semantics*, 41–54. Stanford, CA: CSLI Publications.
- Cardinaletti, Anna. 1998. On the deficient/strong opposition in possessive systems. In Artemis Alexiadou & Chris Wilder (eds.), *Possessors, predicates and movement in the determiner phrase*, 17–53. Amsterdam: John Benjamins.
- Cardinaletti, Anna & Giuliana Giusti. 1992. Partitive *ne* and the QP-hypothesis. In Elisabetta Fava (ed.), *Proceedings of the XVII meeting of Generative Grammar 1991*, 121–141. Torino: Rosenberg & Sellier.
- Cardinaletti, Anna & Giuliana Giusti. 2006. The syntax of quantified phrases and quantitative clitics. In Martin Everaert & Henk van Riemsdijk (eds.), *The Blackwell companion to syntax*, vol 5, 23–94. Oxford: Blackwell.
- Cardinaletti, Anna & Giuliana Giusti. 2015. Cartography and optional feature realization in the nominal expression. In Ur Shlonsky (ed.), *Beyond functional sequence* (The Cartography of Syntactic Structures 10), 151–172. Oxford: OUP.
- Cardinaletti, Anna & Giuliana Giusti. 2016. The syntax of the Italian determiner *dei*. *Lingua* 181. 58–80.
- Cardinaletti, Anna & Giuliana Giusti. 2017. Quantified expressions and quantitative clitics. In Martin Everaert & Henk C. van Riemsdijk (eds.), *The Wiley Blackwell companion to syntax*, 2nd edn. Hoboken, NJ: Wiley Blackwell. DOI: 10.1002/9781118358733.wbsyncom063.
- Cardinaletti, Anna & Giuliana Giusti. 2020. *Indefinite determiners in informal Italian: A preliminary analysis*. *Linguistics* 58(3). 679–712.
- Carlier, Anne. 2007. From preposition to article. *Studies in Language* 31(1). 1–49.
- Carlier, Anne. 2021, this volume. *Du/Des-NPs in French: a comparison with bare nouns in English and Spanish*. In Petra Sleeman & Giuliana Giusti (eds.), *Partitive determiners, partitive pronouns and partitive case* (Linguistische Arbeiten 580). Berlin: de Gruyter.
- Carlier, Anne & Béatrice Lamiroy. 2014. The Romance partitive. In Tuomas Huomo & Silvia Luraghi (eds.), *Partitive cases and related categories*, 477–518. Berlin: de Gruyter.
- Chierchia, Gennaro. 1997. Partitives, referents to kinds and semantic variation. In Aaron Lawson (ed.), *SALT VII*, 73–98. Ithaca, NY: Cornell University.
- Cinque, Guglielmo. 1980. On extraction from NP in Italian. *Journal of Italian Linguistics* 5. 47–99.
- Cinque, Guglielmo. 1990. *Types of A-bar dependencies*. Cambridge, Mass: MIT Press.
- Cinque, Guglielmo. 2014. *Extraction from DP in Italian revisited*. In Enoch O. Aboh, M. Teresa Guasti & Ian Roberts (eds.), *Locality*, 86–103. Oxford: OUP.

- Corver, Norbert. 1998. Predicate movement in pseudopartitive constructions. In Artemis Alexiadou & Chris Wilder (eds.), *Possessors, predicates and movement in the determiner phrase*, 215–257. Amsterdam: John Benjamins.
- Czirmaz, Anikó & Melita Stavrou. 2017. Measure phrases and semi-lexical nouns. In Martin Everaert & Henk C. van Riemsdijk (eds.), *The Wiley Blackwell companion to syntax*, 2nd edn. Hoboken, NJ: Wiley Blackwell. DOI: 10.1002/9781118358733.wbsyncom058.
- Di Caro, Vincenzo N. & Giuliana Giusti. 2015. A protocol for the inflected construction in Sicilian dialects. *Annali di Ca' Foscari. Serie Occidentale* 49, 293–322.
- Dobrovie-Sorin, Carmen. 2021. Negation, *des*-indefinites in French and bare nouns across languages. In Tabea Ihsane (ed.), *Disentangling bare nouns and nominals introduced by a partitive article* (Syntax & Semantics 43), 187–261. Amsterdam: Brill.
- Dobrovie-Sorin, Carmen & Claire Beyssade. 2004. *Définir les indéfinis*. Paris: CNRS Editions.
- Etxeberrya, Urtzi. 2021, this volume. The partitive marker in Basque and its relation to bare nouns and the definite article. In Petra Sleeman & Giuliana Giusti (eds.), *Partitive determiners, partitive pronouns and partitive case* (Linguistische Arbeiten 580). Berlin: de Gruyter.
- Falco, Michelangelo & Roberto Zamparelli. 2019. Partitives and partitivity. *Glossa: A Journal of General Linguistics*, 4(1). 111. DOI: <http://doi.org/10.5334/gjgl.642>.
- Gerards, David P. & Elisabeth Stark. 2021. 'Partitive Articles' in Aosta Valley Francoprovençal—Old questions and new data. In Tabea Ihsane (ed.), *Disentangling bare nouns and nominals introduced by a partitive article* (Syntax & Semantics 43), 105–139. Amsterdam: Brill.
- Giusti, Giuliana. 1991. The categorial status of quantified nominals. *Linguistische Berichte* 136, 438–452.
- Giusti, Giuliana. 1996. Is there a FocusP and a TopicP in the noun phrase structure? *University of Venice Working Papers in Linguistics* 6, 105–128.
- Giusti, Giuliana. 2002. The functional structure of noun phrases: A bare phrase structure approach. In Guglielmo Cinque (ed.), *Functional structure in DP and IP* (The Cartography of Syntactic Structures 1), 54–90. Oxford: OUP.
- Giusti, Giuliana. 2011. Structural protocols for linguistic awareness enhancing language identity. Research project at CRSSH. University of Cambridge, October–December 2011. <http://www.crassh.cam.ac.uk/people/profile/giuliana-giusti>
- Giusti, Giuliana. 2015. *Nominal syntax at the interfaces. A comparative analysis of languages with articles*. Newcastle upon Tyne: Cambridge Scholars Publishing.
- Giusti, Giuliana. 2021. A protocol for indefinite determiners in Italo-Romance. In Tabea Ihsane (ed.), *Disentangling bare nouns and nominals introduced by a partitive article* (Syntax & Semantics 43), 262–300. Amsterdam: Brill.
- Giusti, Giuliana & Petra Sleeman. 2021, this volume. Partitive elements in the languages of Europe. An advancement in the understanding of a multifaceted phenomenon. In Petra Sleeman & Giuliana Giusti (eds.), *Partitive determiners, partitive pronouns and partitive case* (Linguistische Arbeiten 580). Berlin: de Gruyter.
- Giusti, Giuliana & Iulia Zegrean. 2015. *Syntactic protocols to enhance inclusive cultural identity. A case study on Istro-Romanian clausal structure*. *Quaderni di Linguistica e Studi Orientali* 1, 117–138.
- Heusinger von, Klaus & Jaklin Kornfilt. 2021, this volume. Turkish partitive constructions and (non-)exhaustivity. In Petra Sleeman & Giuliana Giusti (eds.), *Partitive determiners, partitive pronouns and partitive case* (Linguistische Arbeiten 580). Berlin: de Gruyter.

- Higginbotham, James. 1985. On semantics. *Linguistic Inquiry* 16. 547–594.
- Higginbotham, James. 1987. The autonomy of syntax and semantics. In Jay L. Garfield (ed.), *Modularity in knowledge representation and natural languages understandings*, 119–131. Cambridge, Mass.: MIT Press.
- De Hoop, Helen. 2003. Partitivity. In Lisa Cheng & Rint Sybesma (eds.), *The second Glot International state-of-the-article book*, 179–212. Berlin: de Gruyter.
- Huumo, Tuomas. 2021, this volume. Longitudinal or transverse? How the unbounded quantity expressed by the Finnish partitive case relates to time. In Petra Sleeman & Giuliana Giusti (eds.), *Partitive determiners, partitive pronouns and partitive case* (Linguistische Arbeiten 580). Berlin: de Gruyter.
- Ihsane, Tabea. 2008. *The layered DP. Form and meaning of French indefinites*. Amsterdam: John Benjamins.
- Ihsane, Tabea. 2013. *En* pronominalization in French and the structure of nominal expressions. *Syntax* 16(3). 217–249.
- Jackendoff, Ray S. 1968. Quantifiers in English. *Foundations of Language* 4. 422–442.
- Kupferman, Lucien. 1979. Réflexions sur la partition: les groupes nominaux partitifs et la relativisation. *Langue française* 122. 30–51.
- Le Bruyn, Bert. 2007. Which van die dingen? *Uil-OTS yearbook 2006*: 93–112. Utrecht: Utrecht Institute of Linguistics OTS.
- Luraghi, Silvia & Giovanna Albonico. 2021, this volume. The partitive article in old Italian. Early stages in the grammaticalization of the Italian partitive article. In Petra Sleeman & Giuliana Giusti (eds.), *Partitive determiners, partitive pronouns and partitive case* (Linguistische Arbeiten 580). Berlin: de Gruyter.
- Martí-Girbau, Núria. 1999. Towards a unitary analysis of partitive and quantitative constructions. *Oxford University Working Papers in Linguistics, Philology & Phonetics* 4. 84–10
- Martí i Girbau, Núria. 2010. *The syntax of partitives*. Barcelona: Universitat Autònoma de Barcelona dissertation.
- Milner, Jean-Claude. 1978. *De la syntaxe à l'interprétation*. Paris: Seuil.
- Rizzi, Luigi. 1979. Teoria della traccia e processi fonosintattici. *Rivista di Grammatica Generativa* 4(1–2). 165–181.
- Rizzi, Luigi. 1986. Null objects in Italian and the theory of *pro*. *Linguistic Inquiry* 17. 501–558.
- Rizzi, Luigi. 1988. Il sintagma preposizionale. In Lorenzo Renzi & Giampaolo Salvi (eds.), *Grande grammatica italiana di consultazione*, Bologna: Il Mulino.
- Rizzi, Luigi. 1990. *Relativized minimality*. Cambridge, Mass: MIT Press.
- Rizzi, Luigi. 1997. The fine structure of the left periphery. In Lilliane Haegeman (ed.), *Elements of grammar*, 281–337. Dordrecht: Kluwer.
- Selkirk, Elisabeth. 1977. Some remarks on noun phrase structure. In Peter W. Culicover, Thomas Wasow & Adrian Akmajian (eds.), *Formal syntax*, 285–325. London: Academic Press.
- Seržant, Ilja. 2021, this volume. Diachronic typology of partitives. In Petra Sleeman & Giuliana Giusti (eds.), *Partitive determiners, partitive pronouns and partitive case* (Linguistische Arbeiten 580). Berlin: de Gruyter.
- Stark, Elisabeth. 2002. Indefiniteness and specificity in Old Italian texts. *Journal of Semantics* 19(3). 315–332.
- Strobel, Thomas & Elvira Glaser. 2021. The rise and fall of partitive markers in some Germanic varieties. In Tabea Ihsane (ed.), *Disentangling bare nouns and nominals introduced by a partitive article* (Syntax & Semantics 43), 17–53. Amsterdam: Brill.

- Tănase-Dogaru, Mihaela. 2017. Partitive constructions. In Martin Everaert & Henk C. van Riemsdijk (eds.), *The Wiley Blackwell companion to syntax*, 2nd edn. Hoboken, NJ: Wiley Blackwell. DOI: 10.1002/9781118358733.wbsyncom017.
- Toman, Jindřich. 1986. Cliticization from NPs in Czech and comparable phenomena in French and Italian. In Hagit Borer (ed.), *The syntax of pronominal clitics*, 123–145. Orlando, FL: Academic Press.
- Zamparelli, Roberto. 2000. *Layers in the determiner phrase*. New York: Garland.
- Zamparelli, Roberto. 2008. *Dei ex-machina*: a note on plural/mass indefinite determiners. *Studia Linguistica* 63(3). 301–327.

Anne Carlier

# *Du/des*-NPs in French

## A comparison with bare nouns in English and Spanish

Like English bare NPs, French *du/des*-NPs combine the features of indefiniteness and non-singularity (e.g. *de l'eau* ‘water’, *des pommes* ‘apples’). Because of this similarity, the hypotheses accounting for the fact that bare nouns do not establish a stable discourse referent (the kind-denoting, the property-denoting and the narrow-scope indefinite hypothesis) are assumed to be equally valid for *du/des*-NPs.

On the basis of systematic comparison between French *du/des*-NPs and Spanish bare NPs, the present paper refutes this assumption. A distinction is made between the ability to establish a referent and the ability to specify the referent’s spatial boundaries. With respect to the former feature, unlike Spanish bare NPs and like the indefinite singular *un*-NP, *du/des*-NPs can introduce a stable discourse referent. As a consequence, *du/des*-NPs can serve as an antecedent for an anaphoric pronoun or zero anaphor in the case of subject deletion, they can have wide-scope with respect to an intensional predicate or negation, and they are not restricted to internal argument positions and may be topical. However, contrary to the indefinite singular *un*-NP, which conceives its referent as spatially bounded, *du/des*-NPs do not specify the spatial limits of their referent, whether this referent is composed of individuals (*des*) or not (*du*). Therefore, like Spanish bare NPs, they do not induce telic aspect and they do not interact with quantifiers. The only quantitative indication they convey, by virtue of their partitive origin, is that their referent does not reach the limits of the category, but always represents a part of it.

## 1 Introduction

### 1.1 Bare plural nouns in English and in Romance: Kind-referring vs property-referring

In his influential paper on the bare plural in English, Carlson (1977) argues that, in comparison with the indefinite singular NP, bare plurals have atypical referential properties, pointing to the fact that they do not readily establish a stable discourse

---

**Note:** This text has benefited from the comments of the editors and an anonymous reviewer. Many thanks to them!

referent. His solution consists in analyzing the existential use of the bare plural (1a) by aligning it with the generic use (1b), arguing that bare NPs invariably are kind-referring and that the difference between the existential and the generic use is not due to the ambiguity of the NP itself but rather to the context: whereas a stage-level predicate selects the existential interpretation of the bare plural, an individual-level or property-denoting predicate selects its generic interpretation:

- (1) ENGLISH  
 a. *Dogs* are barking.  
 b. *Dogs* bark.

Dobrovie-Sorin & Laca (2003) convincingly show that bare nouns in several Romance languages, viz. Spanish, Italian and Romanian, do not have the same properties as bare plural nouns in English: they do not occur freely in preverbal subject position in their existential uses and they are strongly constrained in generic interpretation, as evidenced by the fact that the Spanish examples corresponding to the English examples in (1) are both ungrammatical:

- (2) SPANISH  
 a. \**Perros* están ladrando.  
 b. \**Perros* ladran.

Moreover, unlike English bare plural nouns, they are excluded with a predicate concerning the species as a whole (3).

- (3) a. ENGLISH: *Whales* are nearly extinct.  
 b. SPANISH: \**Ballenas* están casi extintas.

As pointed out by Dobrovie-Sorin & Laca (2003), Brazilian Portuguese does however allow the same patterns as English (cf. Ionin, Montrul & Santos 2011 for a detailed account).

- (4) BRAZILIAN PORTUGUESE  
 a. *Cães* ladravam na montanha.  
    ‘*Dogs* barked on the mountain.’  
 b. *Baleias* são mamíferos.  
    ‘*Whales* are mammals.’

Dobrovie-Sorin & Laca (2003) conclude that the kind-referring hypothesis is not tenable for bare plurals in Romance languages such as Spanish, Italian and Romanian. While maintaining a unitary analysis accounting for the atypical refer-

ential properties of bare plurals in these Romance languages, they put forward a hypothesis that consists in assigning them an even weaker referential force: they propose to align the existential use of the bare plural nouns with their predicative use, illustrated by (5), and argue on this basis that plural bare nouns are invariably property-referring. This hypothesis enables them to account, among other features, for the fact that certain argument positions (cf. ex. 2) are not accessible to them.

(5) SPANISH

Brutus y Rex son *perros*.

‘Brutus and Rex are *dogs*.’

More recently, Dobrovie-Sorin (2009) proposes a revised hypothesis for Romance bare plurals and returns to a more referential conception of bare plurals. Romance bare plurals are defined as weak indefinites, which are necessarily VP-internal and have invariably narrow scope and whose denotation consists of a sum of individuals.

The purpose of this study is not to assess the different hypotheses proposed for the analysis of bare nouns in English or in Romance languages, but rather to examine whether these hypotheses account for the referential properties of *du/des*-NPs in French.

## 1.2 French *du/des*-NPs and bare plurals

Over the course of its history, French has developed a specific article for indefinite non-singular reference, the so-called ‘partitive’ article. This article, which is a contraction of *de* ‘from/of’ and the definite article, expanded progressively to different contexts, at the expense of zero determination, to the extent that the use of bare common nouns has become very exceptional in Modern French. The development of the partitive article leads to the following article paradigm:

**Table 1:** The paradigm of articles in Modern French in historical perspective.

	+ Singular	- Singular (plural count & uncount nouns) <sup>1</sup>
+ Definite	Definite article <i>le</i> < Weakened demonstrative	Definite article <i>le</i> < Weakened demonstrative
- Definite	Indefinite article <i>un</i> < Weakened unity numeral	Indefinite article < <i>de</i> + DEF.ART

<sup>1</sup> The term “uncount noun” is to be understood as a hypernym regrouping mass and abstract nouns, as illustrated in example (6).



Given the structural position of the partitive article within the paradigm of articles, it seems plausible to assume that *du/des*-NPs have the same referential properties as bare plural nouns or bare uncount nouns, without an opposition between singular and plural. The following equivalences seem to confirm this hypothesis:

- (6) a. ENGLISH  
 I bought **a** lamb /  $\emptyset$  lambs /  $\emptyset$  lamb.  
 I feel  $\emptyset$  sympathy for him.
- b. SPANISH  
 Compré **un** cordero /  $\emptyset$  corderos /  $\emptyset$  cordero.  
 Siento  $\emptyset$  simpatía por él.
- c. FRENCH  
 J'ai acheté **un** agneau / **des** agneaux / **de** l'agneau.  
 J'éprouve **de la** sympathie pour lui.

Dobrovie-Sorin & Laca (2003: 258) argue indeed that the partitive article is the almost perfect counterpart of bare nouns in other Romance languages. However, following Galmiche (1986) and Bosveld-de Smet (1998) (cf. also Ihsane 2008), they highlight a marked use of *des*, which has a properly partitive meaning, presupposing a contextually defined partition set.

- (7) FRENCH
- a. **Des** élèves étaient malades.  
 '(Some) students were sick.'
- b. **Des** verres sont vides / ébréchés.  
 '(Some) glasses are empty / chipped.'
- c. **Des** tomates sont vertes.  
 '(Some) tomatoes are green.'
- d. **Des** basquetteurs sont petits.  
 '(Some) basketball players are short.'
- e. **Des** lettres ne sont pas arrivées.  
 '(Some) letters did not arrive.'
- f. **Des** enfants tambourinaient sur leurs tables, tandis que d'autres criaient à tue-tête.  
 'Children were drumming on their tables, while others were shouting at the top of their lungs.'

Kleiber (1988) even mentions a case of *du* combined with a mass noun, with the same partitive meaning:

## (8) FRENCH

Dans ce champ, **du** maïs était pollué.

'In this field, (some) corn was polluted.'

As pointed out by Bosveld-de Smet (1998: 16), the partitive reading relies on the availability of a contextually defined set, e.g. the students of my class for (7a) or the tomatoes in the basket for (7c), and the ability of the verbal predicate to isolate a subset of individuals or substance with respect to this set by associating the subset of individuals with an unexpected state of affairs, e.g. being sick for a subset of the students in my class, or being green rather than having the expected color of red for a subset of the tomatoes in the basket. This verbal predicate can be an individual-level property (e.g., *être petit* 'be short'), a temporary state (e.g. *être malade/ vide* 'be sick/empty') or a negated predicate (7e). The partitive reading of *des*, consisting in isolating a subset within a contextually defined set, can also be favored according to Dobrovie-Sorin & Laca (2003: 259) by the mention of a contrast set evoked by *d'autres* 'others', even if an indefinite reading of *des enfants* is not excluded in (7f).

Dobrovie-Sorin & Laca (2003: 258) establish a clear distinction between this partitive use of *du/des* and the indefinite use: because the partitive use of *du/des* presupposes a contextually defined set, it has wide scope with respect to negation (7e) and is not subject to the constraint with respect to subject position. The alleged parallelism between the French partitive article, on the one hand, and bare plural and uncount nouns in Romance, on the other hand, only concerns its indefinite use.

In this paper, this parallelism between indefinite *du/des* and bare plural and uncount nouns, viz. either mass or abstract nouns (6), will be called into question, on the basis of a comparative analysis. Section §2.1 will deal with the constraint specific to bare plurals and bare uncount nouns in Spanish, regarding the preverbal subject position, and examine whether this constraint applies to French *du/des*-NPs. With respect to bare plural and uncount nouns, I will leave for a future research whether the hypotheses are valid for other Romance languages. Sections §§2.2, 2.3 & 2.4 will be devoted to the features of bare nouns in English and in Spanish, related to scope, aspect and anaphora, and investigate whether these features are shared by French *du/des*-NPs. In order to avoid basing my argumentation on artificial examples, at the borderline of acceptability, I will use French authentic data as much as possible. Examples are extracted from the database *Frantext* ([www.frantext.fr](http://www.frantext.fr)), which corresponds dominantly to a literary register.

## 2 Analysis

### 2.1 Prenominal subject position

As has been illustrated by the example (2), bare nouns in Spanish cannot freely be used as a preverbal subject.

- (2) SPANISH
- a. \**Perros* están ladrando.
  - b. \**Perros* ladran.  
'Dogs are barking/bark.'

This constraint on the distribution of bare nouns in Spanish has been formulated more precisely by Suñer (1982: 209) under the name of “Naked Noun Constraint”:

An unmodified common noun in the preverbal position cannot be the surface subject of a sentence under conditions of normal stress and intonation.

The relevant examples, taken from Dobrovie-Sorin & Laca (2003: 271), are given in (9).

- (9) SPANISH
- a. \**Ratones* salieron del armario.  
'*Mice* came out of the closet.'
  - b. Salieron *ratones* del armario.  
'There were *mice* coming out of the closet.'
  - c. *Ratones asquerosos* salieron del armario.  
'*Disgusting mice* came out of the closet.'
  - d. *RATONES* salieron del armario.  
'*MICE* came out of the closet.'
  - e. *Ratones* salieron del armario, pero *arañas* no.  
'*Mice* came out of the closet, but no spiders.'

The “Naked Noun Constraint” combines syntactic constraints (unmodified bare nouns are licensed in subject position of unaccusative verbs when the subject follows the verb (9a-b-c)) and constraints linked to information structure of the sentence (even in preverbal subject position, bare nouns are licensed when their referent is assigned narrow focus by prosodic prominence (9d) or contrastive focus (9e) but not when it is unmarked and tends to be associated with the status of topic (9a)). The question arises as to whether similar constraints, relating

to syntax and information structure, determine the distribution of the French partitive article.

As to the syntactic constraint, the empirical data show that French *du/des*-NPs in their existential reading are possible in preverbal subject position, not only with unaccusative verbs (10)-(11) or verb constructions (12), but also with transitive verbs (13)-(15). Syntactic constraints therefore appear to be less strong for *du/des*-NPs in French than for bare nouns in Spanish.

FRENCH

- (10) **Des** paquets arrivaient sans arrêt. (Ch. Akerman)  
 ‘Packets were arriving all the time.’
- (11) **Du** carburant manquait aux stations (Perec)  
 ‘Fuel was lacking at the stations.’
- (12) **Des** chambres furent mises à leur disposition (J. Verne)  
 ‘Rooms were made available to them.’
- (13) **Des** enfants sonnaient les cloches. (M. Déon)  
 ‘Children were ringing the bells.’
- (14) **Du** sang teignit le sac. (R. Char)  
 ‘Blood tinted the bag.’
- (15) **Nous** prenions conscience que l’exploitation familiale représentait, en fait, une formule par laquelle, dans des cas, **des** enfants n’accédaient même pas au certificat d’études, où **des** femmes et **des** gosses servaient de main-d’œuvre à tout faire, où **des** couples, écrasés de fatigue, ne s’adressaient plus la parole. En termes clairs, **des** hommes et **des** femmes gâchaient leur vie pour maintenir intacte une structure sociale considérée, a priori, comme une panacée. (M. Debatisse)  
 ‘We realized that family farming was, in fact, a formula whereby, in some cases, *children* were even not given the possibility to obtain the school completion certificate, *women and children* were used as handymen, *couples*, crushed by fatigue, no longer spoke to each other. In short, *men and women* were wasting their lives to keep intact a social structure considered, a priori, as a panacea.’

With respect to information structure, the same examples show that there is no requirement of narrow focus, or contrastive focus in order to license *du/des* in pre-

verbal subject position. The examples (10) to (15) all exemplify wide focus, which means that the whole sentence is presented as new information. It could be argued that this difference between *du/des*-NPs in French, on the one hand, and bare nouns in Spanish, on the other, is due to a difference in constituent order: while Spanish allows the subject to be postponed to the verb in the case of wide scope (Lahousse & Lamiroy 2012), this is not the case in French, where constituent order is determined more by the syntactic function than by the information structure (Dobrovie-Sorin & Laca 2003: 273). Consequently, French *du/des* preverbal subjects are more easily accepted than bare nouns as a preverbal subject in Spanish, since preverbal subject position is less readily associated with topic status in French than in Spanish.

However, in the following examples, the French *des*-NP is even used in sentences where the preverbal subject can be analyzed as a topic, in both specific (16)-(17) and generic reading (18)-(19).

#### FRENCH

- (16) Je suis revenu ce matin. Il était huit heures. On dansait encore. Des marchandes commençaient à apparaître en papillotes sur la porte de leur magasin. **Des boutiques** n'étaient pas ouvertes. Les étalages étaient encore couverts de serge verte. (Goncourt)  
 'I came back this morning. It was eight o'clock. They were still dancing. Merchants began to appear with hair curlers on the door of their store. *Shops* were not open. The displays were still covered with green serge.'
- (17) **Des peuples**, comme les romains, dont la vie nationale ne fut qu'une longue injustice féroce organisée, ont triomphé, des siècles durant. (P. Bourget)  
 '*Nations*, such as the Romans, whose national life was nothing more than a long and fiercely organized injustice, triumphed for centuries.'
- (18) **Des témoignages divergents** ne s'excluent pas. (Rudler)  
 '*Divergent testimonies* do not exclude each other.'
- (19) **Des jumeaux vrais** ne sont qu'un seul être dont la monstruosité est d'occuper deux places différentes dans l'espace. (M. Fournier)  
 '*Identical twins* are only one being whose monstrosity is to occupy two different places in space.'

Note that *du/des*, albeit a topic in (16) to (19), is used in its indefinite meaning. Hence, this configuration is not restricted to *du/des*-NPs with a partitive reading, illustrated by the examples (7) and (8). On the contrary, a targeted search to retrieve occurrences of properly partitive *du/des*-NPs in preverbal subject posi-

tion and with a topical referent gives barely results, confirming the native speaker's intuition that the examples given in (7) and (8), fabricated by linguists, are unnatural. An example of the partitive use of *des* in subject position is provided by the following example, where *des feuilles*, isolating a subset with respect to the entire chestnut trees' foliage, is a contrastive topic opposed to *d'autres* 'others'.

## (20) FRENCH

Les marronniers se sont garnis de bourgeons achetés chez le confiseur.

**Des feuilles** sont fraîches comme de petites langues ; d'autres ont un air vieillot, ridées, comme des fronts de nouveau-nés ; mais les branches des plus hauts arbres sont encore fines comme des cheveux. (J. Renard)

'The chestnut trees have garnished themselves with buds bought from the confectioner. *Some leaves* are as fresh as little tongues; others look old-fashioned, wrinkled, like foreheads of newborns; but the branches of the tallest trees are still as thin as hair.'

These observations are at odds with the findings of Dobrovie-Sorin & Laca (2003) on two points:

- *Du/des* in their partitive meaning are barely attested in preverbal subject position.
- Conversely, *du/des* in their indefinite meaning occur in preverbal subject position with a variety of verbs, even when their referent has the status of sentence topic.

Nevertheless, it should be acknowledged that *du/des*-NPs are subject to constraints in preverbal subject position: on the one hand, they do not occur as a subject in canonical generic sentences, a point that will be discussed in §3.2;

## (21) FRENCH

a. \***Des baleines** sont des mammifères.

b. \***Des baleines** sont presque éteintes.

'Whales are mammals. / Whales are almost extinct.'

c. \***Du mercure** est toxique.

'Mercury is toxic.'

on the other hand, they require specific types of predicates in their existential use. The latter constraint is at least in part related to their status as an indefinite article and is equally observed for indefinite singular *un*-NPs. Although the detailed analysis of these constraints is beyond the scope of this paper, it may be noted that the verbal predicate should provide a referential anchorage, which minimally consists of a spatial location:

## FRENCH

- (22) a. ??**Un** *homme* est blond.  
 ‘A man is blond.’  
 b. ??**Du** *sucre* est en morceaux.  
 ‘Sugar is in cubes.’
- (23) a. **Un** *homme* était là, sur le seuil.  
 ‘A man was there, on the threshold.’  
 b. **De l’herbe** était là, sous mes pieds.  
 ‘There was grass under my feet.’

The fact that French indefinite *du/des*-NPs, unlike Spanish bare nouns, are not necessarily VP-internal, but can occur as a preverbal subject with a variety of verbs, even when this subject is topical, shows that an analysis in terms of property-denoting is not appropriate. In the following sections, it will be further examined whether French *du/des*-NPs exhibit the referential properties that have been ascribed to bare nouns in both English and Spanish. These properties concern their relative scope with respect to intensional predicates, negation and quantification (§2.2), their interactions with telicity (§2.3) and finally their ability to serve as an antecedent for a referential anaphoric expression (§2.4).

## 2.2 Wide vs narrow scope readings

In order to study the scope properties of bare plural nouns in English, Carlson (1977) takes as a starting point the well-known ambiguity of the singular indefinite NP induced by the intensional predicate ‘wish’.

- (24) a. Minnie wishes to talk to *a young psychiatrist*.

The first reading can be glossed as ‘there is a specific young psychiatrist that Minnie wants to talk to’, whereas according to the second reading Minnie will be satisfied if she can talk to any young psychiatrist. The specific reading is also called “wide-scope reading”, because it is formalized by an existential operator outside the scope of the intensional predicate ‘wish’ (‘there is a young psychiatrist and Minnie wishes to talk to her’), while the non-specific reading will be modeled by an existential operator with narrow scope, i.e., embedded within the scope of the verb ‘wish’. Carlson observes that this ambiguity does not appear in the same context with a bare plural: the bare plural has only the narrow-scope or non-specific reading.

- (24) b. Minnie wishes to talk to *young psychiatrists*.

Dobrovie-Sorin & Laca (2003: 240) confirm this analysis for bare plurals in Spanish by providing formal evidence: in (25a) the opposition between wide-scope or specific reading and narrow-scope or non-specific reading of *un libro* is marked by an alternation between indicative and subjunctive mood in the relative clause, whereas in (25b), the bare plural allows only the subjunctive mood in the relative clause, and hence a non-specific or narrow-scope reading.

(25) SPANISH

- a. María quiere *un libro* que describe<sub>INDIC</sub>/describe<sub>SUBJ</sub> la conquista de México.  
 b. María quiere *libros* que \*describen<sub>INDIC</sub>/describan<sub>SUBJ</sub> la conquista de México.  
 ‘Maria wants a book/books that describe(s) the conquest of Mexico.’

Contrary to the English and Spanish bare plurals, the French *des*-NP is compatible with a wide-scope or specific reading in intensional contexts. Witness the following example, where the context makes clear that President Giscard d’Estaing had some specific individuals in mind.<sup>2</sup>

(26) FRENCH

«Giscard veut parler à **des intellectuels de gauche**. Edgar et moi donnons un déjeuner à l’Hôtel de Lassay. Il a suggéré, entre autres noms, le vôtre.»

Je reste sans voix.

Pétrie de l’antagonisme pouvoir-opposition cher aux Français, je me vois mal trinquant à table avec le champion de la droite. La tradition républicaine, après les têtes coupées, exige la non-communication absolue entre les deux clans. (G. Halimi)

“Giscard wants to talk to *left-wing intellectuals*. Edgar and I are having lunch at the Hotel de Lassay. He suggested, among other names, yours.”

I am speechless.

Filled with the power-opposition antagonism dear to the French, I see myself as having a hard time toasting at the table with the champion of the right. The republican tradition, after the heads cut off, requires absolute non-communication between the two clans.’

<sup>2</sup> Note that this wide-scope reading of indefinite *des* is different from the properly partitive use of *des*, which presupposes a partition set defined in context and requires a verbal predication that isolates a subset of individuals within the partition set. With respect to example (26), the context provides no evidence of an available list of names of left-wing intellectuals, from which Giscard, right-wing president, makes his choice.



This possibility of a wide-scope reading suggests that the *des*-NP has a greater referential strength than bare plurals in Spanish as well as in English.

Carlson (1977: 418) next shows how the singular indefinite NP and the bare plural behave differently with respect to negation. Regarding the argument in (27), he considers that its conclusion can have either a contradictory reading or a non-contradictory reading

(27) ENGLISH

- a. *A cat* is in this room  
*A cat* is in the next room

---

Therefore: *A cat* is in the room and *a cat* is not in the room

These two readings can be respectively glossed as follows:

- ‘there is a cat in this room and it is not the case that there is a cat in this room’  
or put differently: ‘there is a cat in this room and there isn’t a cat in this room’;
- ‘there is cat in this room and there is a cat not in this room’.

In the former reading of *a cat* in the negative sentence, the existential quantifier is within the scope of negation and hence has narrow scope, which yields the non-specific interpretation ‘no cat’, whereas in the latter case it has wide scope. In contrast, the same example with a bare plural noun has only the contradictory reading of the conclusion ‘cats are in the room and there aren’t cats in the room’, which corresponds to the narrow-scope or non-specific reading of the bare plural:

(27) ENGLISH

- b. *Cats* are in this room  
*Cats* are in the next room

---

Therefore: *Cats* are in the room and *cats* are not in the room

As noted by Dobrovie-Sorin & Laca (2003: 240–241), the Spanish data are similar: in contrast to (28a), (28b) is necessarily interpreted as contradictory.

(28) Spanish

- a. Llegó *una carta* y no llegó *una carta*.  
‘A letter arrived and a letter didn’t arrive.’
- b. Llegaron *cartas* y no llegaron *cartas*.  
‘Letters arrived and letters didn’t arrive.’

Here again, the French *des*-NP does not pattern with the English and Spanish bare plural (cf. Cardinaletti & Giusti 2016; Giusti 2021, this volume, for a similar observation on *dei* in Italian). The example (29) shows that a narrow-scope or non-specific reading of the *des*-NP in preverbal subject position with respect to negation is possible.

(29) FRENCH

Je ne suis pas le fils d'un mandarin, hélas! **Des perles** ne boutonnèrent point les devants de mes chemises.

'I am not the son of a Mandarin, alas! *Pearls* did not button the front of my shirts.' (R. Crevel)

However, a wide-scope or specific reading is more frequent:

FRENCH

(30) **Des Juifs** ne voulaient pas sortir de leurs maisons. Ils ont été tués sur place.  
(F. Milewski)

'Some Jews did not want to leave their homes. They were killed on the spot.'

(30') **Des Juifs** ne voulaient pas sortir de leurs maisons et des Juifs acceptaient de quitter leurs maisons.

'Some Jews did not want to leave their homes and some Jews agreed to leave their homes.'

(31) L'inquiétude rampe et s'infiltré. **Des boutiques** n'ont pas ouvert. **D'autres**, qui avaient ouvert, ferment. (M. Déon)

'Worry crawls and infiltrates. *Some shops* have not opened. Others, which had opened, are closing.'

(31') **Des boutiques** n'ont pas ouvert et des boutiques ont ouvert.

'Some shops have not opened and some shops have opened.'

In (30), the *des*-NP is not in the scope of the negation, which means that (30') can be asserted without contradiction. (31) shows more explicitly that the *des*-NP refers to a set of individuals for which the predication is valid but is not incompatible with the existence of a complementary set for which the predication is not valid, which is confirmed by the fact that (31') is not contradictory.

A final case studied by Carlson in relation to the scope restrictions of bare plurals concerns quantifiers.

- (32) a. All workshop participants have read *a book on statistics*.  
 b. All workshop participants have read *books of statistics*.
- (33) a. Tous les participants du workshop ont lu *un livre de statistique*.  
 b. Tous les participants du workshop ont lu *des livres de statistique*.

In (32a) as well as in (33a), the indefinite singular NP is ambiguous between a wide-scope or specific reading ‘there is a book on statistics which has been read by all workshop participants’ and a narrow-scope or non-specific reading ‘every participant read a book but not necessarily the same particular book’ or put differently, there can be as many books as there are participants. In real discourse, this ambiguity is normally resolved, as shown by the following examples, with a narrow-scope or non-specific reading for the indefinite singular NP in (34) while a wide-scope or specific reading is plausible for the indefinite singular NPs at the beginning of the example (35), as evidenced by *C’était pourtant un homme charmant*. Crucial, however, is the fact that the indefinite singular NP as such allows the two readings.

- (34) Tous les matins on ramasse *un colibri mort* dans la cage. (A. Daudet)  
 ‘Every morning we pick up *a dead hummingbird* from the cage.’
- (35) Pendant des mois, tous les soirs *une splendide Hispano* m’attend à la sortie du Jockey, dans laquelle *un chauffeur impassible* doit me conduire au Claridge. . . pour souper avec *un ministre plénipotentiaire d’Amérique du Sud*. . . immensément riche. Tous les soirs *un appartement* est rempli de fleurs, *un délicieux souper* se prépare, et. . . tous les soirs j’envoie *une amie* qui a moins de . . . scrupules que moi. **C’était pourtant un homme charmant**, et que j’aurais pu aimer, peut-être, s’il n’y avait pas eu tout ce fric ! Pouah ! Faire ça pour de l’argent ! (A. Prin)  
 ‘For months, every evening *a splendid Hispano* awaits me at the Jockey’s exit, in which *an impassive driver* must drive me to the Claridge. . . for dinner with *a plenipotentiary minister from South America*. . . immensely rich. Every evening *an apartment* is filled with flowers, *a delicious dinner* is prepared, and. . . every night I send *a friend* who has less ... scruples than me. **He was a charming man**, and whom I could have loved, maybe, if there had not been all that money! Ugh! Doing this for money!’

This is not the case for the bare plural in the English example (32b): only the narrow-scope or non-specific reading is available. The sentence cannot be understood as ‘there is some set of books on statistics which has been read by

all workshop participants'. With respect to the French example (33b), contrary to what we have observed for intensional predicates and negation, the *des*-NP only allows the narrow-scope or non-specific reading: *des livres* cannot refer to one and the same set of books read by all participants.

In sum, *des*-NPs seem to have hybrid scope properties: whereas bare plurals in English and in Spanish do not have wide-scope readings with respect to intensional predicates such as 'want', negation and quantifiers, *des*-NPs can have a wide-scope reading in the first two contexts, but not in relation to quantifiers. This apparently contradictory result will be examined in a broader context in §3.

### 2.3 Telic vs atelic aspect

It is well known (Dowty 1991; Krifka 1992; Tenny 1994; Jackendoff 1996) that the referential properties of the NP in direct object position of certain transitive verbs (36) or in the subject position of certain unaccusative verbs (37) can have an impact on verbal aspect: an indefinite singular NP may have the effect of placing a boundary on the process expressed by the verb, while bare nouns – whether plural bare nouns or mass nouns – do not induce a boundary. This distinction between telic and atelic aspect according to the opposition between singular indefinite NP and bare noun is evidenced by the compatibility with aspectual adjuncts introduced by *in* combined to a noun denoting a time unit in the former case, and introduced by *for* in the latter case.

- (36) a. Mary ate **an** *apple* in one minute / \*for one minute.  
 b. Marie ate *apples* \*in one minute / for five minutes.  
 c. Marie drank *coffee* /\*in one hour / for one hour.
- (37) a. **An** *ambulance* arrived in five minutes /\*for five minutes.  
 b. *Ambulances* arrived \*in five minutes / for two hours.

Expectedly, the Spanish bare nouns exhibit the same interaction with aspect.

- (38) a. María se comió **una** *manzana* en un minuto / \*por un minuto.  
 b. Marie comió *manzanas* \*en un minuto / durante cinco minutos.  
 c. Marie bebió *café* \*en una hora / durante una hora.
- (39) a. **Una** *ambulancia* llegó en cinco minutos /\*durante cinco minutos.  
 b. Llegaron *ambulancias* \*en cinco minutos/ durante dos horas.

In contrast to what we have observed with regard to scope phenomena (§2.2), French *du/des*-NPs are similar to English and Spanish bare nouns with respect to aspect, insofar as they induce atelicity:<sup>3</sup>

- (40) a. Marie a mangé **une** pomme en une minute / \*pendant une minute.  
 b. Marie a mangé **des** pommes \*en une minute / pendant cinq minutes.  
 c. Marie a bu **du** café \*en une heure / pendant une heure.
- (41) a. **Une** ambulance est arrivée dans cinq minutes / \*pendant cinq minutes.  
 b. **Des** ambulances sont arrivées \*en cinq minutes / pendant deux heures.

Other aspectual tests (cf. Carlson 1977: 422) confirm this parallelism between bare nouns in English and Spanish, on the one hand, and *du/des*-NPs in French, on the other: unlike examples (42/43/44a), which reflect a strange situation, examples (42/43/44b) are natural because the process is carried out on an unbounded object.

- (42) a. John killed **a** fly repeatedly last night.  
 b. John killed *flies* repeatedly last night.
- (43) a. Juan mató **a una** mosca repetidamente anoche.  
 b. Juan mató *moscas* repetidamente anoche.
- (44) a. Jean a tué **une** mouche à plusieurs reprises hier soir.  
 b. Jean a tué **des** mouches à plusieurs reprises hier soir.

## 2.4 Pronominal anaphora and referential identity

The examples (45) and (46), translated from Laca (2000: 901), illustrate two possible types of relationships between the 3<sup>rd</sup> person anaphoric pronoun and its antecedent:

- (45) A man fell in the river, he was drunk.
- (46) Peter has read *many political novels* but Mary finds them boring.

---

<sup>3</sup> The French *du/des* article is in this respect different from the Italian partitive article, cf. Giusti & Sleeman 2021, this volume.

In the example (45), the pronoun *he* takes up the referent of its antecedent. In the example (46), Mary's appreciation does not relate exactly to the political novels that Peter read, but rather to political novels in general. Hence, the pronoun *them* does not establish a referential identity relationship with the antecedent, but relying on the nominal description conveyed by the antecedent, it refers to entities of the same type.<sup>4</sup> In this section, I will focus on antecedents that correspond to a bare noun in English and Spanish or to a *du/des*-NP in French, and examine whether the anaphoric relationship between a pronoun and this antecedent involves referential identity, as in (45), or only sortal identity, *i.e.* refers to entities of the same type, like in (46).

As has been shown in § 2.2, a sentence such as (47a), containing a singular indefinite NP in an intensional context, presents a scope ambiguity between a wide-scope or specific reading and a narrow-scope or non-specific reading of the singular indefinite NP. Carlson (1977: 425) points out that this ambiguity can however be resolved by pronominalization.

(47) English

- a. Peter was looking for *a book on the mosques of Iran*.
- b. Peter was looking for *a book on the mosques of Iran* and finally found it.
- c. Peter was looking for *a book on the mosques of Iran* and finally found one.

Example (47b), containing the anaphoric pronoun *it* in a subsequent clause, corresponds to the wide-scope or specific reading: 'there is a specific book on the mosques of Iran that Peter was seeking', whereas (47c), containing the proform *one*, rather suggests a narrow-scope or non-specific meaning 'Peter was looking for a book on the mosques of Iran without having anyone specific title in mind', but it does not rule out a wide-scope or specific reading 'although initially looking for a specific book on the mosques of Iran, Peter eventually found another one'.

It would however be erroneous to suggest a correlation between a specific or wide scope reading of the antecedent and the presence of a 3<sup>rd</sup> person anaphoric pronoun in a subsequent clause. In particular, although bare plural antecedents can never take a wide-scope or specific reading in an intensional context, they can be anaphorized by a 3<sup>rd</sup> person pronoun, as illustrated by (47b).

(47) d. Peter was looking for *books on the mosques of Iran* and finally found them.

---

<sup>4</sup> The absence of a referential identity between the pronoun and the antecedent is corroborated by the fact that the plural pronoun *them* is perfectly compatible with a singular antecedent (Klaus von Heusinger, p.c.):

Peter has read *a political novel*, but Mary finds them boring.

(47d) does not suggest that the books on Iranian mosques Peter eventually found were identical to the ones he was originally looking for, which means that *them* associated to a bare plural antecedent does not correspond to an anaphora with referential identity.

More generally, even outside an intensional context, with a bare noun as an antecedent, the third personal pronouns *it*, *him* or *them* do not require a strict referential identity with the antecedent. Witness the following examples, quoted from Carlson (1977: 426): while the same referent is referred to by the antecedent and anaphoric pronoun in (48a), this need not be the case in (48b-c).

- (48) a. Harriet caught *a rabbit* yesterday, and Ozzie caught it today.  
 b. Harriet caught *rabbits* yesterday, and Ozzie caught them today.  
 c. Dad drank *beer* slowly, and I drank it fast.

The following example from Laca (2000: 902) shows that the Spanish bare plural has exactly the same characteristics with respect to the pronominal anaphor: the anaphoric pronoun *las* in (49a) does not suggest that the spoons seen by Mary are the same as those seen by Peter (an interpretation that would be obtained in the presence of a determiner like *tres* ‘three’ or *unos* ‘some’ (49b), cf. Laca 2000: 902)).

(49) SPANISH

- a. Pedro ha visto *cucharas* en la cocina, y María las ha visto también en la dispensa.  
 b. Pedro ha visto ***tres/unas*** *cucharas* en la cocina, y María las ha visto también en la dispensa.  
 ‘Peter has seen spoons (three/some spoons) in the kitchen, and Maria has also seen them in the pantry.’

The French *des*-NP does not function in the same way as the English or Spanish bare plural with respect to pronominal anaphor, but is on the contrary similar to the singular indefinite NP. In an intensional context, *des*-NP is subject to the same scope ambiguity as the singular indefinite NP (cf. §2.2). Likewise, this ambiguity can be resolved by pronominalization: *les* requires referential identity with the anaphoric expression and, hence, induces a specific or wide-scope reading (50), while the genitive pronoun *en* does not require and even excludes referential identity and therefore does not yield a specific or wide-scope reading (51) (cf. Ihsane 2013). This referential identity constraint associated with the anaphoric pronoun *le/les* is respected at least when the referent of the antecedent is a concrete rather than an abstract entity (52).

## FRENCH

- (50) Est allé à plusieurs reprises sous le feu de l'ennemi chercher **des blessés** entre les tranchées françaises et allemandes et les a ramenés. (H. Bordeaux)  
 'Went several times under enemy fire to seek some wounded persons between the French and German trenches and brought them back.'
- (51) Puis il chercha **des timbres**, mais il n'en trouva pas. (J.-P. Manchette)  
 'Then he looked for *stamps*, but he didn't find any.'
- (52) Tu cherches **des raisons** qui te convaincraient que tu finiras un jour par être heureuse, mais tu ne les trouves point. (C. Juliet)  
 'You are looking for *reasons* that would convince you that you will one day end up being happy, but you don't find them.'

Outside of an intensional context, the contrast between Spanish bare nouns and French *du/des*-NPs is even more salient: in contrast to *las* in the Spanish example (47a), the pronoun *les* in the French example (53) necessarily involves referential identity, *viz.* 'the spoons seen by Mary are the same as those seen by Peter'. This means that the French *des*-NP in (53) establishes a discourse referent, which is taken up by the pronoun *les*, whereas the Spanish bare plural in (49a) fails to do so.<sup>5</sup>

## (53) FRENCH

Pierre a vu **des cuillères** dans la cuisine et Maria les a vues aussi dans le garde-manger.  
 'Peter has seen spoons in the kitchen, and Maria has also seen them in the pantry.'

A related issue addressed by Carlson (1977: 426) concerns the difference between bare nouns and indefinite singular NPs in coordinate structures with subject deletion. In the case of an indefinite singular NP introduced by *a*, subject deletion

<sup>5</sup> The impact of the availability of a genitive pronoun in certain Romance languages and language varieties (e.g. *ne* in Italian, *en* in French) but not in others (e.g. Spanish, Portuguese) on the referential properties of the 3<sup>rd</sup> person pronoun deserves further investigation. In this perspective, the case of Catalan, which has no partitive article, but does have a genitive pronoun, is particularly interesting. As is shown by the Catalan translation of example (49b) (thanks to Anna Pineda!), the genitive pronoun *en/n'* excludes referential identity with *culleres*, whereas the 3<sup>rd</sup> person pronoun *les* requires referential identity with the antecedent.

El Pere ha vist <i>culleres</i> a la cuina	i la Maria també <u>n'</u> ha vist al rebost. [-referential identity]
	i la Maria també <u>les</u> ha vist al rebost [+referential identity]



yields identity of reference. Witness (54b), where subject deletion results in the strange assertion that the same building will collapse tomorrow and perish in the flames the day after in two different places. The same sentence with a bare plural as a subject (54b) is not liable to this constraint of strict referential identity and does not evoke an unusual state of affairs.

## ENGLISH

- (54) a. *A building* will collapse in Berlin tomorrow, and *a building* will burn down in Boston the day after.  
 b. *A building* will collapse *in* Berlin tomorrow, and *\_* will burn down in Boston the day after.
- (55) a. *Buildings* will collapse in *Berlin* tomorrow, and *buildings* will burn in Boston the day after.  
 b. *Buildings* will collapse in Berlin tomorrow, and *\_* will burn in Boston the day after.

Discussing subject deletion in coordinated constructions in Spanish, Laca (2000: 902) makes similar observations: she argues that, in contrast with (56/57a), (56/57b) do not require that the same individuals are concerned by the predication.

## SPANISH

- (56) a. En esta ciudad nacieron y murieron **tres** *hombres célebres*.  
 b. En esta ciudad nacieron y murieron *hombres célebres*.  
 ‘**(Three)** *Famous men* were born and died in this city.’
- (57) a. Entran y salen **varias** *mujeres*.  
 ‘**Several** *women* come and go.’  
 b. Entran y salen *mujeres* entre dos compras o entre dos embotellamientos de coches. (M. Vázquez Montalbán)  
 ‘*Women* go in and out between two purchases or between two car jams.’

Moreover, she shows that this lack of referential identity constraint is equally verified with bare mass nouns: it is patently not the same portion of oil that is concerned by events that occur in different places and at different times.

## (58) SPANISH

- En 1945 surgió *petróleo* en Chiapas y un año después volvió a surgir en Yucatán.  
 ‘In 1945, *oil* emerged in Chiapas and a year later emerged again in Yucatan.’

Once again, French *du/des*-NPs do not pattern with the bare nouns in English and Spanish, as is shown by the following examples:

FRENCH

- (59) a. **Un** *voyageur* descendit et **un** *voyageur* monta.  
 b. **Un** *voyageur* descendit et \_ monta.
- (60) a. **Des** *voyageurs* descendirent et *des voyageurs* montèrent  
 b. **Des** *voyageurs* descendirent et \_ montèrent. (A. Lubin)  
 ‘A traveler/Travelers came down and \_ came up.’
- (61) Un peu plus loin, les rangs s’écartent d’eux-mêmes pour ne point bousculer un cheval blessé. [...] **Du** *sang* coule jusqu’au sabot et \_ tache la poussière de la route. (M. Genevoix)  
 ‘A little further on, the ranks move away from themselves so as not to overwhelm an injured horse. (Some) *blood* flows to the hoof and \_ stains the dust of the road.’

As in the case of the NP introduced by the singular indefinite article *un* (59b), there is a referential identity constraint between the *des*-NP (58b) or *du*-NP (60), on the one hand, and the deleted subject, on the other. As a consequence, the French example (60b), which assumes that the same individuals are involved in the two events mentioned by the coordinated predicates, is not equivalent to the Spanish example (57b). Similarly, the French example (62), unlike the Spanish example in (56b), asserts that the same individuals are involved in the events of being born and dying at one and the same place specified in the context.

(62) FRENCH

Il y a des Péruviens qui vivent à Cerro de Pasco, 4 360 m d’altitude : plus de 4 km au-dessus de l’océan, au-dessus de toute vie normale. [. . .] **Des** *enfants* naissent là, et \_ meurent vraisemblablement, à plus de 4 km au-dessus du niveau de la mer.  
 ‘There are Peruvians living in Cerro de Pasco, 4,360 m above sea level: more than 4 km above the ocean, above all normal life. . . . *Children* are born there, and probably die, more than 4 km above sea level.’

### 3 Results and discussion

Table 2 gives an overview of the referential properties of the French *du/des*-NPs in the several examined contexts in Section 2, in comparison with bare plural and uncount nouns in English as well as in Spanish, on the one hand, and with the NP introduced by indefinite singular article, on the other hand.

**Table 2:** Comparison of *du/des*-NPs with bare nouns and indefinite singular NPs in English and Spanish.

	Indef. sg. NPs	<i>du/des</i> -NPs	Bare nouns	
			ENGL.	SPANISH
Preverbal subject	✓	✓	✓	✗
Wide Scope – Intensional Predicate	✓	✓		✗
Wide Scope – Negation	✓	✓		✗
Wide Scope – Quantifier	✓	✗		✗
Telic Aspect	✓	✗		✗
Anaphora and referential identity	✓	✓		✗

It is shown that French *du/des*-NPs are in several aspects distinct from English as well as from Spanish bare nouns, and share more properties with indefinite singular NPs. However, they resemble English and Spanish bare nouns in two ways: first, when used as a direct object of a transitive verb or as a subject of an unaccusative verb, they do not induce telic aspect, and, second, they do not interact with quantifiers.

#### 3.1 The semantic features of *du/des* in synchrony

With respect to verbal aspect, the fact that determination has an impact on telicity has been analyzed in terms of a transfer of the spatial properties of the internal direct argument (i.e. the direct object of certain transitive verbs or the subject of certain unaccusative verbs) on the internal temporal structure of the verbal predicate (Krifka 1992): (63a) is telic because the boundaries of the object are specified by a quantifying expression *a glass of*, whereas (63b) is atelic because bare nouns do not convey any indication of quantitative boundaries.

- (63) a. Peter is drinking *a glass of wine*.  
 b. Peter is drinking *wine*.

As Jackendoff (1996: 307) points out, bare nouns do however not necessarily refer to an unbounded or limitless entity – *wine* in (63b) refers to a limited amount of wine that is consumed –, but the boundaries of their referent are left unspecified.

It has been shown in § 2.3 that *du/des*-NPs are similar to bare nouns in this respect: they do not convey any quantitative indication as to boundaries of their referent and hence *du/des* cannot be analyzed as quantifiers.<sup>6</sup> As to *un*-NPs, although *un* as an indefinite article is not in itself a quantifier (cf. Heim 1982), it conceives its referent as quantitatively bounded. *Un* bears the grammatical feature of singular, and combines with count nouns, which convey intrinsically an individuation principle allowing to distinguish individual instances. When *un* combines with a count noun, it gives the instruction to delineate a single referent in accordance with the individuation principle, which amounts to a quantitative delimitation. The resulting contrast between *du/des*-NPs and the indefinite singular *un*-NP for telicity is illustrated in (40).

(40) FRENCH

- a. Marie a mangé **une** pomme en une minute / \*pendant une minute.
- b. Marie a mangé **des** pommes \*en une minute / pendant cinq minutes.
- c. Marie a bu **du** café \*en une heure / pendant une heure.

Interestingly, the fact that French *du/des* are void of quantificational content accounts for another feature equally shared with bare nouns in English and Spanish: they do not interact with quantifiers, which explains why *des* cannot take wide scope with respect to *tous* in (33b). In contrast, although *un* is not intrinsically a quantifier, the indefinite singular *un*-NP presents its referent as quantitatively bounded and, hence, can have either wide or narrow scope with respect to a quantifier, i.e. ‘one and the same book’ or ‘one book for each participant, without these books being identical’ in (33a).

(33) FRENCH

- a. Tous les participants du workshop ont lu **un** livre de statistique.
- b. Tous les participants du workshop ont lu **des** livres de statistique.  
‘All workshop participants have read **a** book/books on statistics’

The non-quantificational nature of *du/des*-NPs can be evidenced by the possibility of adverbial quantification. As has been shown by Laca (2000: 900), bare

---

<sup>6</sup> For a more detailed argumentation, cf. Carlier (2007) on the French partitive article as well as Cardinaletti & Giusti (2016) on the Italian partitive article.

plurals in Spanish, equally void of quantificational context, are compatible with adverbial expressions such as *en masa* ‘in mass’, *en [gran/pequeña] cantidad* ‘in (big/small) quantity’, *por miles* ‘by millions’, *in exceso* ‘in excess’, quantifying the relationship between the predicate and its internal direct argument (64a), whereas quantified NPs do not allow these adverbials (64b) since this would result in a double quantification.

## (64) SPANISH

- a. Emigraron *técnicos* por miles.
- b. \*Emigraron *muchos técnicos* por miles.  
‘Technicians / \*A lot of technicians emigrated by thousands.’

Similarly, *du/des*-NPs used as a direct object of transitive verbs or as a subject of an unaccusative verbal predicate do allow adverbial quantification, showing that they are not quantifying expressions.

## (65) FRENCH

- a. mon potager me donne *des légumes* en quantité (G. Sénac de Meillhan)  
lit.: ‘my vegetable garden gives me *vegetables* in quantity’
- b. Tout le long du trottoir, *des tonneaux de bière* sont alignés par centaines. (B. Auroy)  
lit.: ‘All along the sidewalk, *barrels of beer* are lined up by hundreds.’
- c. J’ai reçu *des lettres* en masse, aujourd’hui. (J.-P. Sartre)  
lit.: ‘I received *letters* in mass today.’
- d. Vous aurez *du bois mort* en quantité. (J. Verne)  
lit.: ‘You will have *dead wood* in quantity.’

With respect to the other properties examined in §2, *du* and *des* are similar to *un*: they are able to introduce a discourse referent that can be outside the scope of an intensional predicate or negation, and this discourse referent will serve as an antecedent for an anaphoric pronoun or for zero anaphor in the case of subject deletion. It is also this greater referential strength that explains why *du/des*-NPs, unlike bare plurals in Spanish, are not restricted to internal argument positions and can have the status of topic.

In a contrastive perspective, this hybrid profile with respect to its referential properties sets the French *du/des* article apart from the English indefinite determiner *some*. As pointed out by Reinhart (1997: 372), the indefinite determiner *some* can have wide or narrow scope with respect to any of the contexts mentioned in Table 2, including quantifiers, whereas *du/des* do not allow wide scope with respect to quantifiers: in contrast with (33b), (66) can mean either that there

is a specific book that all women have read (wide scope), or that all women have read a specific book, without these books being identical (narrow scope).

- (66) ENGLISH  
Every lady read **some** book.

### 3.2 The semantic features of *du/des* in diachrony

There is a long-lasting tradition dating back to J.-C. Scaliger (1540), which analyzes the partitive *de* as part of a quantifying expression: since French quantifiers such as *beaucoup* ‘a lot’, *peu* ‘a little’, *assez* ‘enough’, *trop* ‘too much’ require *de* in order to be used in nominal quantification,

- (67) FRENCH  
 a. Il a assez travaillé. ‘He has worked enough.’  
 b. Il a assez **de** travail. ‘He has enough work.’

it is hypothesized that the presence of *de* in the partitive can be accounted for by a silent or deleted quantifier, associated to the semantic feature of quantitative unboundedness.

- (68) Q            *de* Ø N'    >    Ø *de* DEF.ART N'  
beaucoup **de**    *bière* >    **de** *la*    *bière*  
 ‘a lot            of            beer >            of    the            beer

The deleted quantifier hypothesis is adopted for the Modern French partitive article by Milner (1978: 37) and for the Old French partitive construction by Foulet (1930).<sup>7</sup> However, the phenomena studied in this paper do not support an analysis of the partitive article in terms of quantification.<sup>8</sup>

The historical data suggest another possible line of analysis that does not involve the notion of quantification. The sentence in (69) presents an example of the Old French partitive construction, which is the precursor of the partitive article.

<sup>7</sup> Cf. also Zribi-Hertz (1996). For Italian, see Chierchia (1997) and Zamparelli (2008), cited by Giusti (2021, this volume).

<sup>8</sup> For a more detailed argumentation against a unified account of *de/di* as part of the article, on the one hand, and *de/di* in quantifier constructions, on the other, see Carlier (2007) and Carlier & Melis (2007) for French, and Cardinaletti & Giusti (2016), Giusti (2021, this volume) for Italian.

(69) OLD FRENCH (Chrétien de Troyes, *Erec*, 3170)

Le gastel et le vin lor baille, .i. fromage lor pere et taille. Cil mangierent qui fain avoient,

et **del** vin volantiers bevoient  
and of.the-M.SG wine readily drink-PST.3PL

‘He brings them the cake and the wine, he prepares and cuts a cheese. They ate, since they were hungry, and they drank readily *some of the wine*.’

(70) OLD FRENCH (*Enéas*, v. 3549)

A son escorz menjot **lo** pain,  
in his-M.SG lap eat-PST.3SG the-ACC.M.SG bread  
a molt grant trait bevoit **le** vin.  
by very big gulp drink-PST.3SG the-M.SG wine

‘In his lap he ate the bread and he drank by enormous gulps *the wine*.’

*Del vin* in (69) illustrates the typical features of the medieval partitive construction:

- there is an existential presupposition of a referent which is defined in the context, i.e. the carafe of wine that was just brought to the table;
- in comparison with *le vin* in (70), *de* in *del vin* in example (69) indicates that this referent is not wholly but only in part affected by the verbal process, without quantitatively specifying the portion concerned.

*De* behaves at this stage as a genitive case-marker, albeit an atypical one: it does not establish a relationship with an external element – nominal or verbal –, but it conveys the feature of partition, whose conditions of use can be compared with those of the partitive case in Finnish, or the genitive case in Homeric Greek and in Lithuanian (Humbert 1960; Väänänen 1981; Karlsson 1983; Serbat 1996; Carlier 2007; Luraghi & Kittilä 2014; as well as Seržant 2021, this volume).

In Middle French, the partitive undergoes a sudden rise in frequency (cf. Carlier 2007 for statistical data), showing its grammaticalization into an article. From a syntagmatic viewpoint, it expands at the expense of zero marking in combination with plural count nouns and uncount nouns, initially only mass nouns and, later, also abstract nouns. On the paradigmatic level, it integrates into the paradigm of articles, represented in Table 1 (rementioned below for convenience), and, as a corollary, undergoes a readjustment of its semantic features (cf. Lehmann 2002: 120), which is represented in Table 3.

**Table 1:** The paradigm of articles in Modern French in a historical perspective.

	+ Singular	- Singular (plural count & uncount nouns)
+ Definite	Weakened demonstrative <i>le</i>	Weakened demonstrative <i>le</i>
- Definite	Weakened unity numeral <i>un</i>	<i>de</i> + DEF.ART

**Table 3:** The semantic shift from the Old French partitive construction to the partitive article.

PARTITIVE CONSTRUCTION	PARTITIVE ARTICLE	Binary parameters of the article paradigm
Existential presupposition of a contextually defined referent	---	
Extraction of quantitatively unspecified subset of this referent	Quantitatively unspecified Indefinite	- Singular - Definite

- The feature of partition or extraction and the associated feature of the existential presupposition of referent are backgrounded because they do not create a binary contrast with respect to other elements of the paradigm.
- The feature of quantitative underspecification is maintained, since it creates a binary opposition with the indefinite singular article *un*.
- The feature of indefiniteness, which allows the partitive article to enter into a binary opposition with the definite article, is acquired by pragmatic inference (Traugott & Dasher 2012): a referent corresponding to an unspecified quantity is necessarily not univocally identifiable by the addressee.

This diachronic analysis offers a straightforward account of the fact that the partitive article is void of quantificational content, since the feature of quantificational underspecification is inherited from the Old French partitive construction. *Du/des*-NPs are similar in this respect to plural and uncount bare NPs. However, in this process, where *du/des*-NPs replace bare NPs, the partitive article does not entirely lose the features coming from its partitive origin, a phenomenon termed ‘persistence’ (Hopper & Traugott 1993).

- On the one hand, because of its partitive origin, *du/des* convey the instruction that their referent does not encompass the category as a whole and therefore, they do not replace the generic Old French  $\emptyset$ -NPs. Hence, they are not used in Modern French canonical generic sentences (Carlier 2000);



- (71) a. OLD FRENCH  
*Coral* est une pierre ki creist en la mer altresi cum arbre. (*Lapidaire*, p. 103)  
 ‘*Coral* is a stone that grows in the sea just like a tree.’
- b. MODERN FRENCH  
***Le/\*Du coral*** est une pierre qui croît dans la mer de la même façon qu’un arbre.
- (72) a. OLD FRENCH  
 Voir me dit ma mere, ma dame, / Qui me dit que *deiable* sont / Plus esfraee chose do mont.  
 ‘She was right, my mother, my lady, when she told me that *devils* are the scariest thing in the world.’
- b. MODERN FRENCH  
***Les/\*Des diables*** sont la chose la plus effroyable du monde.  
 ‘*Devils* are the scariest thing in the world.’

- On the other hand, similarly to the partitive construction, which owes its referential strength to the existential presupposition of the partition set, the partitive articles *du/des* are endowed with a referential strength that bare nouns are lacking. They are able to introduce a discourse referent, and therefore they can have a wide-scope interpretation with respect to an intensional predicate or in relation to negation, they have access to the external argument position of the verbal predicate and, in the case of an anaphoric relationship, this anaphoric relationship goes along with referential identity between the antecedent and the 3<sup>rd</sup> personal pronoun.

By the latter feature, *du/des*-NPs are similar to the indefinite singular *un*-NP. However, they differ from *un*-NPs as to how they conceive and delineate their referent: *un* combined with a count noun conceives its referent as a single individual, *des* in combination with a count noun builds its referent as a set of individuals whose size is not specified, and *du* does not provide any formatting to its referent. Witness the following example, where the absence of formatting motivates the quantitative precision in the apposition.

- (73) MODERN FRENCH  
***Du sang*** jaillit, *un jet mince*, de cette boule de plumes, et aspergea quelques assistants. (M. Van der Meersch)  
 ‘*Blood* gushed out of this ball of feathers, a thin stream, and sprinkled some of the assistants.’

In order to account for the hybrid profile of *du/des*-NPs, displayed in Table 2 above, it is important to distinguish between the ability to introduce a discourse referent, which is a feature of indefinites, and characterizes *un* as well as *du* and *des*, on the one hand, and the spatial configuration and delimitation as indicated by the different articles, on the other. However, it is plausible that there is some interaction between these two features: because of the specific way according to which each of the three articles format the referent, either as a single individual, or as a quantitative unspecified set of individuals, or without any formatting, *un* confers a higher degree of referential autonomy to its referent than *des*, which in turn grants more referential autonomy to its referent than *du*. It would be interesting to investigate empirically whether this gradience as to referential autonomy is reflected for instance in the degree of propensity to take a wide-scope reading in relation to intensional predicates as well as in the ease of accessing the preverbal subject position with a variety of verbal predicates.

Beyond these differences, the fact remains that partitive articles are fundamentally indefinites, on a par with the indefinite article *un*. Noteworthy, this proximity accounts for the fact that *des* is compatible with a generic interpretation under the same conditions as the article *un*, provided that the predicate bares on a referent conceived as a set of individual entities (Carlier 2000).

(74) MODERN FRENCH

*des langues parentes* sont en réalité une seule et même langue modifiée de manières diverses au cours du temps. (A. Meillet)

'parent languages are in fact one and the same language modified in different ways over time.'

## 4 Conclusion

In order to account for the fact that bare plural nouns in their existential reading do not establish a stable referent in English as well as in several Romance languages, among which Spanish, three major hypotheses have been put forward, varying as to the degree of referentiality attributed to them: bare plurals have been analysed as property-denoting (Dobrovie-Sorin & Laca 2003; Dobrovie-Sorin & Beyssade 2004), as kind-denoting (Carlson 1977), and as weak indefinites having systematically narrow-scope (Dobrovie-Sorin 2009).

Given that French *du/des*-NPs occupy the same structural position in the paradigm of articles as bare plural count nouns and uncount nouns, it may seem plausible to assume that they have the same referential properties. This

assumption, supported by Dobrovie & Laca (2003), does however not stand up to a detailed examination and, therefore, none of the three hypotheses with respect to bare plurals is appropriate to account for the referential properties of *du/des*-NPs. The present study has shown that it is necessary to distinguish between the ability to establish a referent, on the one hand, and the ability to specify the referent's spatial boundaries, on the other. With respect to the former feature, it has been shown that *du/des*-NPs, unlike bare nouns and similarly to the indefinite singular *un*-NP, can introduce a stable discourse referent, which can serve as an antecedent for an anaphoric pronoun or for zero anaphor in the case of subject deletion. This ability to introduce a discourse referent also explains why they can have wide-scope interpretation with respect to an intensional predicate or negation. Finally, the referential strength of *du/des*-NPs explains why they are not – unlike bare plurals in Spanish – restricted to internal argument positions and can have the status of topic. In this regard, *du/des*-NPs are similar to the indefinite singular *un*-NP. However, contrary to the indefinite singular *un*-NP, which refers to one single individual and, hence, conceives its referent as spatially delineated, *du/des*-NPs do not specify the spatial limits of their referent, whether this referent presents an internal division into individual members (*des*) or not (*du*). Therefore, just like Spanish bare NPs, they do not induce telic aspect and they do not interact with quantifiers. The only quantitative indication they convey, by virtue of their partitive origin, is that their referent does not reach the limits of the category, but always represents a part of it.

It may be tempting to consider *du/des*-NPs as equivalent to indefinite NPs introduced by determiners such as *some* in English, because both show scope ambiguity with respect to intensional predicates and negation. However, the fact that *du/des*-NPs do not set quantitative boundaries to their referent entails that, unlike NPs introduced by *some*, they cannot take a wide scope with respect to quantifiers.

## References

- Bosveld-de Smet, Leonie M. 1998. *On mass and plural quantification. The case of French des/du-NP's*. University of Groningen dissertation.
- Cardinaletti, Anna & Giuliana Giusti. 2016. The syntax of the Italian indefinite determiner *dei*. *Lingua* 181. 58–80.
- Carlier, Anne. 2000. Les articles *du* et *des* en synchronie et en diachronie: une analyse de leur résistance à l'interprétation générique. *Revue romane* 35. 177–206.
- Carlier, Anne. 2007. From preposition to article: The grammaticalization of the French partitive. *Studies in Language* 31. 1–49.

- Carlier Anne & Ludi Melis. 2006. L'article partitif et les expressions quantifiantes contiennent-ils le même *de*? In Georges Kleiber, Catherine Schnedecker, Anne Theissen (eds.), *La relation partie-tout*, 449–464, Leuven: Peeters.
- Carlson, Greg. 1977. A unified analysis of the English bare plural. *Linguistics and Philosophy* 1. 413–457.
- Chierchia, Gennaro. 1997. Partitives, referents to kinds and semantic variation. In Aaron Lawson (ed.), *SALT VII*, 73–98, Ithaca, NY: Cornell University.
- Dobrovie-Sorin, Carmen. 2009. Existential bare plurals: From properties back to entities. *Lingua* 119. 296–313.
- Dobrovie-Sorin, Carmen & Brenda Laca. 2003. Les noms sans déterminant dans les langues romanes. In Danièle Godard (ed.), *Les langues romanes. Problèmes de la phrase simple*, 235–281. Paris: Editions du CNRS.
- Dobrovie-Sorin, Carmen & Claire Beyssade. 2004. *Définir les indéfinis*. Paris: Editions du CNRS.
- Dowty, David R. 1991. Thematic proto-roles and argument. *Language* 67(3). 547–561.
- Foulet, Lucien. 1930<sup>3</sup> [1919<sup>1</sup>]. *Petite syntaxe de l'ancien français*. Paris: Champion.
- Galmiche, Michel. 1986. Note sur les noms de masse et le partitif. *Langue française* 72. 40–53.
- Giusti, Giuliana. 2021, this volume. Partitivity in Italian. A protocol approach to a multifaceted phenomenon. In Petra Sleeman & Giuliana Giusti (eds.), *Partitive determiners, partitive pronouns and partitive case* (Linguistische Arbeiten 580). Berlin: de Gruyter.
- Giusti, Giuliana & Petra Sleeman. 2021, this volume. Partitive elements in the languages of Europe. An advancement in the understanding of a multifaceted phenomenon. In Petra Sleeman & Giuliana Giusti (eds.), *Partitive determiners, partitive pronouns and partitive case* (Linguistische Arbeiten 580). Berlin: de Gruyter.
- Heim, Irene 1982. *The semantics of indefinite and definite noun phrases*. Amherst: University of Massachusetts dissertation.
- Hopper, Paul J. & Elizabeth C. Traugott. 1993. *Grammaticalization*. Cambridge: Cambridge University Press.
- Humbert, Jean. 1960<sup>3</sup>. *Syntaxe grecque*. Paris: Klincksieck.
- Ihsane, Tabea. 2008. *The layered DP. Form and meaning of French indefinites*. Amsterdam: John Benjamins.
- Ihsane, Tabea. 2013. *EN pronominalization in French and the structure of nominal expressions*. *Syntax* 16. 217–249.
- Ionin, Tania, Silvina Montrul & Héléde Santos. 2011. An experimental investigation of the expression of genericity in English, Spanish and Brazilian Portuguese. *Lingua* 121(5). 963–85.
- Jackendoff, Ray. 1996. The proper treatment of measuring out, telicity, and perhaps even quantification in English. *Natural Language and Linguistic Theory* 14(2). 305–354.
- Karlsson, Fred. 1983. *Finnish Grammar*. Porvoo, Helsinki, Juva: Werner Söderström Osakeyhtiö.
- Kleiber, Georges. 1988. L'opposition massif/comptable et les adjectifs. In Jean David & Georges Kleiber (eds.), *Termes massifs et termes comptables*, 267–292. Paris: Klincksieck.
- Krifka, Manfred. 1992. Thematic relations as links between nominal reference and temporal constitution. In Ivan Sag & Anna Szabolcsi (eds.), *Lexical matters*, 29–53. Chicago: Chicago University Press.
- Laca, Brenda. 1999. Presencia y ausencia de determinante. In Ignacio Bosque & Violeta Demonte (eds.), *Gramática descriptiva de la lengua española*. Madrid: Espasa Calpe.
- Lahousse, Karen & Béatrice Lamiroy. 2012. Word order in French, Spanish and Italian: A grammaticalization account. *Folia Linguistica* 46(2). 387–415.

- Lehmann Christian. 2002<sup>3</sup> [1982<sup>1</sup>]. *Thoughts on grammaticalization*. München, Newcastle: Lincom.
- Luraghi, Silvia & Seppo Kittilä. 2014. Typology and diachrony of partitive case markers. In Silvia Luraghi & Tuomas Huomo (eds.), *Partitive cases and related categories*, 17–62. Berlin: De Gruyter.
- Milner, Jean-Claude. 1978. *De la syntaxe à l'interprétation: quantités, insultes, exclamations*. Paris: Seuil.
- Reinhart, Tanya. 1997. Quantifier scope: How labor is divided between QR and choice functions. *Linguistics and Philosophy* 20(4). 335–97.
- Scaliger, Julius-Caesar. 1540. *De causis linguae latinae*. Lyon: S. Gryphium.
- Serbat, Guy. 1996. *Grammaire fondamentale du latin*. Volume VI(1): *L'emploi des cas en latin: nominatif, vocatif, accusatif, génitif, datif*. Louvain: Peeters.
- Seržant, Ilja. 2021, this volume. Diachronic typology of partitives. In Petra Sleeman & Giuliana Giusti (eds.), *Partitive determiners, partitive pronouns and partitive case* (Linguistische Arbeiten 580). Berlin: de Gruyter.
- Suñer, Margarita. 1982. *Syntax and semantics of Spanish presentational sentence-types*. Washington: Georgetown University Press.
- Tenny, Carol T. 1994. *Aspectual roles and the syntax-semantics interface*. Dordrecht: Kluwer.
- Traugott, Elizabeth C. & Richard B. Dasher. 2002. *Regularity in semantic change*. Cambridge: Cambridge University Press.
- Väänänen, Veikko. 1981. La préposition latine *de* et le génitif. In Veikko Väänänen, *Recherches et créations latino-romanes*. Naples: Bibliopolis.
- Zamparelli, Roberto. 2008. *Dei* ex-machina: a note on plural/mass indefinite determiners. *Studia Linguistica* 63(3). 301–327.
- Zribi-Hertz, Anne. 2006. Pour une analyse unitaire de DE *partitif*. In Francis Corblin, Sylvie Ferrando & Lucien Kupferman (eds.), *Indéfini et prédication*, 141–154. Paris: PUPS.



## **Part II: The diachrony of partitivity**



Ilja A. Seržant

# Diachronic typology of partitives

The present paper investigates diachronic developments that partitives undergo over the course of time. First, it is shown that true-partitives (part-whole-relation partitives) encoded by adpositional strategies are not stable cross-linguistically and tend to develop into pseudo-partitives, which are defined as constructions that encode simple quantification but retain the morphology of true-partitives. Secondly, the frequency bias towards indefiniteness drives the emergence of *generalized partitives* – partitives with no explicit realization of the subset referent. Generalized partitives tend to undergo a closer relationship with the verb. Moreover, generalized partitives may develop into markers (co-)expressing such predicate-level functions as aspectuality (the delimitative meaning) and discontinuous predicate negation, as well as hypothetical events, as well as develop into differential object markers.

## 1 Introduction

Cross-linguistically, partitives are found to interact with a variety of grammatical domains ranging from argument-level to clause-level categories such as negation, aspectuality, or hypothetical events. On the argument level, partitives pertain to the domain of indefiniteness and low discourse potential and sometimes even develop into indefinite determiners (as in French or Italian). Moreover, partitives may be coded in different ways: with dedicated partitive pronouns (such as French *en*), with adpositions involving different metaphors such as possession, or spatial metaphors such as separation or location. Finally, there are many languages that do not have special means of marking partitives; instead, these languages employ a mere juxtaposition of an indefinite quantifier with a definite expression (Seržant, *forthc.*).

The aim of this paper is to identify cross-linguistically recurrent diachronic pathways in the development of partitives. Since most of the linguistic evidence on partitives does not offer any diachronic data, the diachronic evidence will

---

**Acknowledgments:** I cordially thank HH for help with access to materials. Without this archive this work would not have been possible. Søren Wichmann helped me a lot with finding the data in this archive. I furthermore thank Nicole Hober, Kurt Malcher, Bastian Persohn, the editors of the volume Giuliana Giusti and Petra Sleeman, and the series editor Klaus von Heusinger, as well as an anonymous reviewer. All disclaimers apply.



be based on some of the few in-depth studies of diachrony of partitives (*inter alia*, Carlier & Lamiroy 2014; Seržant 2015b) as well as on intra-genealogical and extra-genealogical variation of co-expression patterns. Here, typological evidence rests on the database comprising a convenience sample of 138 languages with a total of 171 entries (some languages have multiple options for encoding partitivity) from 46 families ranging across all six macroareas (Eurasia, Australia, Africa, Oceania, and both Americas) (Seržant 2020).

I proceed as follows. Section §2 lays out the conceptual and terminological apparatus, explaining related notions such as *true-partitives* (§2.1), *partitives* (§2.2), *implicit expressions* (§2.3), *pseudo-partitives* (§2.4), and *generalized partitives* (§2.5). Section §3 presents the database for the typological background. Sections §§4–8 are structured chronologically and detail the mechanisms of various changes that partitives undergo. Thus, section §4 illustrates various morphological sources for partitives across languages. Section §5 details the emergence of generalized partitives that is driven by the frequency bias towards indefiniteness (§5.1) via ellipsis to conventionalization (§5.2) and across syntactic macroroles (§5.3). Section §6 discusses the development from true-partitives into pseudo-partitives (§6.1) and the partitivity cycle related to this development (§6.2). Section §7 discusses the change from pseudo-partitives into indefinite-determiner NPs and, then, into unmarked NPs. Finally, Section §8 discusses the emergence of the predicate-level functions of partitives: intensional and hypothetical predicates (§8.1), discontinuous predicate negation (§8.2), and aspectuality (§8.3). Section §9 summarizes the results and provides conclusions.

## 2 Conceptual and terminological apparatus: *True-partitives, implicit expressions, pseudo-partitives, and generalized partitives*

The term *partitives* has been used in a broad variety of meanings in the literature and may refer to a set of categories that are not always straightforwardly interrelated. For this reason, in what follows, I first lay out the terminological apparatus adopted in this paper (see for more details Seržant *forthc.*).

Unfortunately, there is a lot of confusion with regard to the term *partitive* in the literature. For example, some scholars take this notion to include *meronymics*, that is, parts of a whole that do not belong to the same kind of things such as *a hand* as a part of a body or *a leaf* as a part of a tree, while others – including myself – work only with partitives in which both, the part and the whole, belong

to the same kind, as, for example, in English *some of our students*, where both referents *some* and *our students* belong to the same kind *students*.

Other researchers refer to any kind of expression in the language X that may be translated with a partitive in a language Y – and that is sometimes arbitrarily taken as the gold standard – as partitive as well. For example, the German expression in (1) is also sometimes considered to be a partitive because its English counterpart employs a partitive-like construction with the preposition *of*:

- (1) German  
*ein Glas Wasser*  
 INDEF glass water  
 ‘a glass of water’

I refrain from extending language-specific definitions onto other languages. Instead, in what follows, I try to give definitions that do not depend on language-particular properties and may thus be applied more objectively for the analysis of the diachronic (and synchronic) variation of partitives across languages.

## 2.1 True-partitives

Consider the following example:

- (2) *some of our students*

In (2), the *true-partitive relation* obtains (cf., *inter alia*, Enç 1991; von Heusinger 2002: 261–262; Koptjevskaja-Tamm 2001), that is, there is a subset denoted by the pronominal quantifier *some* and the superset encoded by the NP *our students*. In addition, there is a marker *of* – an adposition in this case – that signals the relation of inclusion of the subset in the superset. Both referents, the subset and the superset, refer to entities of the same kind (*students*). The meaning of (2) can be said to render proportional quantity.

The true-partitive relation may also hold between portions of a substance such as *tea* in (3):

- (3) *a cup of the tea you just made for me*

In this example, there is also a sub-portion and the super-portion of the same kind of substance, and there is an inclusion relation between the two, fully parallel to (2) above.

In what follows, I refer to both subsets and sub-portions as *subsets* and to both supersets and super-portions as *supersets* for the sake of simplicity.

## 2.2 Partitives

I define *partitive constructions* or, in short, *partitives* as grammatical means that can encode the true-partitive relation. The ability to encode the true-partitive relation is definitional in my approach. Those grammatical items that cannot encode the true-partitive relation at all – such as (1) – are not considered partitives in this paper.

(4) Definition of partitives (Seržant, forthc.)

*Partitives are grammatical constructions that may be used to encode the true-partitive relation without relying on contextual inferences. Partitive obligatory encode (i) a quantifier and (ii) the restrictor. Partitives are often encoded by (iii) a special marker or lexically.*

Contextual inferences are understood in the narrow sense, excluding the anaphora resolution. Thus, partitive pronouns such as *er* in Dutch *encode* – and not simply implicate – the reference to the superset. Moreover, many pronouns may also be used deictically and, on this reading, partitive pronouns should be able to occur in out-of-the-blue contexts with the true-partitive relation.

The definition in (4) is concededly very broad and it subsumes under partitives everything that is capable of encoding the true-partitive relation without contextual support. Moreover, I employ *partitives* as an umbrella term for different subtypes to be explained immediately below in §2.2–§2.6 and summarized in Table 1 below. Crucially, the definition in (4) excludes any grammatical or lexical items that cannot themselves encode the true-partitive relation without contextual support, even if they may have functional, semantic, or distributional affinities with partitives otherwise.

Importantly, the definition in (4) does allow for partitives to be polyfunctional categories:

(5) A corollary (Seržant, forthc.)

*In addition to encoding the true-partitive relation, partitive constructions may also have other (diachronically) related functions.*

### 2.3 Implicit expressions of a true-partitive relation

The definition in (4) also excludes an *implicit expression of a true-partitive relation* (cf. “implicit partitives” in von Heusinger & Kornfilt 2017; or “covert partitives” in de Hoop 2003: 207; “implicit expressions” in Seržant, *forthc.*), i.e. quantifiers, numerals, and other expressions that may occur in a context in which the partitive interpretation given the context is likely (henceforth *implicit expressions*). While acknowledging the tradition to subsume these under partitives as well, I refrain here from doing so for the following reasons.

Consider example (6b). Here, the quantifiers *some*, *three*, or *a few flowers* do not contain the reference to the superset (the restrictor *flowers* only refers to the kind):

- (6) a. *There are flowers in the garden.*  
 b. *Bring me **some / three / a few flowers**.*

The superset can be identified as *the flowers in the garden* only once the first sentence in (6a) is also provided.

Indeed, it would be counter-intuitive to say that *three* is a grammatical expression to encode the true-partitive relation in English; nor *some* or *a few* encode the true-partitive relation in English.<sup>1</sup> A typical property of implicit expressions is that they do not encode the reference to the superset (*the flowers in the garden*) even in a reduced (pronominal) form but only an optional reference to the kind (*flowers*). Moreover, (6b) uttered in an out-of-the-blue context is not likely to be interpreted as designating a true-partitive relation. Implicit expressions themselves do not encode the true-partitive relation and need contextual support to yield this meaning.

In contrast to English *some*, *davon* ‘thereof’ is a partitive in German:

- (7) German (p.k.)  
 a. *Es gibt Blumen im Garten.*  
    ‘There are flowers in the garden.’  
 b. *Bring mir fünf davon.*  
    bring me five thereof  
    ‘Bring me five of them.’

---

<sup>1</sup> Alternatively, these may be considered as being ambiguous by having two lexical variants in English: the stressed partitive variant and the unstressed non-partitive one (cf. *stressed indefinites* in Hoeksema 1996: 2).

German *davon* does encode the superset which is resolved either anaphorically, as in (7b), or deictically (if (7b) is uttered out of the blue by pointing with a finger to some items). Having said this, indefinite pronouns such as English *some* may come functionally very close to a partitive. For example, the German pronoun *welche* ‘some’ (not the homonymous interrogative) may indeed be considered to be a partitive, as it patterns very much like *davon* (Glaser 1992).

To summarize, in order to analyse an expression as a partitive and not as an implicit expression, two conditions have to be met: (i) there must be an example in which this expression encodes the true-partitive relation without contextual inferences and (ii) the reference to the superset must be encoded in this example, either deictically, anaphorically, or with a full NP.

Finally, some languages have dedicated lexical partitives that can be used to encode the true-partitive relation without contextual inferences and thus do adhere to the definition in (4). For example, Cora (Uto-Aztecan; Mexico) has dedicated true-partitive quantifiers, cf. *héiwa* ‘many (non-partitive)’ vs. *mwi’iká-ka* ‘many.of-ACC (partitive)’ (Casad 1984: 265); Haida (isolate) has dedicated, lexical partitive quantifiers such as *t’ij* ‘some of’ (Enrico 2003: 771, *passim*).

## 2.4 Pseudo-partitives

For a true-partitive relation to obtain, the Partitivity Constraint must hold. This constraint requires the superset (super-portion) to be a definite specific (non-generic and non-property-denoting/predicate), non-distributional, discursively accessible set (cf., *inter alia*, de Hoop 2003: 186 following Westerståhl 1985; Jackendoff 1977; Barwise & Cooper 1981; Ladusaw 1982; Dowty & Brodie 1984; Ionin *et al.* 2006; Reed 1989).<sup>2</sup> For example, while (8) is formally very much similar to (3), repeated as (9) for convenience, it does not denote the true-partitive relation:

(8) *A cup of tea*

(9) *A cup of the tea you just made for me*

---

<sup>2</sup> There are exceptions to this which have been widely discussed in the semantics literature on partitives, e.g. *that book could belong to one of three people*, where *three people* is indefinite (de Hoop 2003: 183), and various attempts have been made to provide an account for them (cf., *inter alia*, Ladusaw 1982; de Hoop 1997). Moreover, certain definite NPs are nevertheless excluded from occurring as a superset, such as those headed by *both* or, in many instances, *all*.

The utterance in (8) is not a relation at all because it does not involve two referents but only one; hence, no relation can obtain. It is just a quantity or a measure phrase. At the same time, its formal properties are very much similar to the expression of a true-partitive relation in (9): (8) also involves a quantifier (*A cup*) and another NP embedded under the same preposition (*of*). It is since Selkirk (1977) that expressions of this type have been identified as *pseudo-partitive* constructions and delineated from the superficially homonymous true-partitives (*proper partitives* in this volume, see Giusti & Sleeman 2021, this volume) such as in (3).

(10) Definition of pseudo-partitives (Seržant, forthc.)

*A pseudo-partitive construction (abbreviated: a pseudo-partitive) is a partitive construction with no specific superset in the restrictor.*

While true-partitivity is about proportional quantification, pseudo-partitives denote *plain quantification* such as amounts (e.g. *a group of people*) or quantities (*the majority of people*) of particular kinds (*people*);<sup>3</sup> pseudo-partitives are sometimes referred to as *quantitative partitives* (e.g. Ihsane 2013). Thus, pseudo-partitives do not encode a relation between two referents but rather just one referent that is quantified or measured. Semantically pseudo-partitives pattern with simple measure or quantifier phrases such as *many people* in English or *eine Gruppe Touristen* (lit. ‘a group tourists’) ‘a group of tourists’ in German and tend to reduce their original syntactic structure of one NP embedded into the other NP towards just one NP (cf. Selkirk 1977 on English).

Note that there is a tradition of extending the notion of pseudo-partitives to include any kind of measure phrases, including those that have nothing to do with partitives in the respective language. For example, *Glas Wein* (lit. ‘glass wine’) ‘glass of wine’ in German is a pseudo-partitive according to some researchers (e.g. de Hoop 2003: 192; Koptjevskaja-Tamm 2001, 2009), while it is not a pseudo-partitive in this framework. Crucially, such a conceptual extension unnecessarily overgeneralizes the original term of Selkirk (1977), making it synonymous with the more transparent term *measure phrase* or *quantity phrase*, for that matter. Moreover, this conceptual extension also produces confusion in languages like English in which *a glass of wine* can no longer be terminologically distinguished from German *Glas Wein* ‘glass of wine’, which, crucially, does not contain any partitive marker and is a different syntactic construction.

Selkirk (1977) made the important discovery that *a glass of wine* in English – although morphologically similar to the expression of the true-partitive relation

---

<sup>3</sup> Pseudo-partitives may be subdivided into further subclasses (Koptjevskaja-Tamm 2001).

in English (with its head and dependent NPs) – is syntactically (and semantically) a single NP. Thus, the term *pseudo-partitive* is justified for English *a glass of wine* because it is indeed a seeming, that is pseudo, partitive. By contrast, the German *Glas Wein* is straightforwardly analysable as one NP and has no structural, semantic, or morphological affinity to true-partitives in German whatsoever. The latter are encoded by means of the preposition *von* ‘from’. Its only relation to partitivity is based on the fact that *Glas Wein* maybe translated with a partitive-like expression in some other languages such as English. An argument *ad absurdum* here may be then that *much wine* in English should also be an instance of pseudo-partitives because it is translated with a partitive-like expression into Russian (with the genitive originally carrying the partitive function) or Basque (with the partitive case) and corresponds to the pseudo-partitive *a lot of wine* in English. Thus, I suggest that the extension of the term *pseudo-partitives* into a purely semantic term is rather ill-advised. Such an extension is also problematic for the description of the diachronic process by which true-partitives first only alternate with, and then develop into, pseudo-partitives and then into simple quantifier phrases like *many people* (see §6). To summarize:

- (11) A corollary of definitions (4) and (10) (Seržant, forthc.)  
*Pseudo-partitives are only found if they exploit the grammatical means that, at the same time, may also be used to encode the true-partitive relation in the language.*

Note that pseudo-partitives tend to syntactically deviate from true-partitives. Thus, for English, Selkirk (1977) puts forward syntactic tests which show that there is also a difference in the syntactic structure between true-partitives and pseudo-partitives such as the possibility of extraction of the head NP with true-partitives but not with pseudo-partitives (see also de Hoop 2003 for a similar argument on Dutch).

## 2.5 Generalized partitives

Partitives – both true-partitive and pseudo-partitive constructions – tend to drop the indefinite pronominal quantifier (often in the head position), especially in languages that generally tend to drop indefinite pronouns, such as in Lithuanian (Indo-European). Contrast (12a) with the explicit indefinite pronominal quantifier *keletą* against (12b) with quantifier drop:

- (12) Lithuanian (Indo-European; p. k.)
- a. *Mačiau keletą jo kolegų.*  
 see.PST.1SG **some.ACC** 3SG.GEN colleague.GEN(=PART).PL  
 ‘I saw **some** of his colleagues.’
- b. *Mačiau jo kolegų.*  
 see.PST.1SG 3SG.GEN colleague.GEN(=PART).PL  
 ‘I saw [**some**] of his colleagues.’

What is originally an occasional drop of the indefinite quantifier is generalized in many languages and the elliptical construction becomes conventional. In effect, the resulting, “headless” partitives undergo developments not undergone by their “headed” pendants and thus turn into a category in its own rights. Therefore, I refer to partitives such as in (12b) as *generalized partitives*.<sup>4</sup>

Generalized true-partitives are not to be confused with implicit expressions (§2.3), which only implicate the superset based on the discourse. Generalized partitives, by contrast, encode both the superset and the subset quantifier, and the latter is inherently ‘some’ or ‘any’. In Section §5 below, I detail the development of generalized partitives and explain the conditioning factors.

## 2.6 Summarizing the ontology of partitives

I summarize the different subtypes of partitives in Table 1:

**Table 1:** Ontology of partitives.

	PARTITIVES	
	encoding only the true-partitive relation	encoding the true-partitive relation and pseudo-partitives
<i>generalized partitives</i>	<i>only the restrictor expression is explicit, while the quantifier is understood as ‘some/any’</i>	
<i>headed partitives</i>	<i>the quantifier &amp; the restrictor expressions are explicit</i>	

<sup>4</sup> Sometimes these partitives are referred to as *independent partitives* (Seržant 2014a, 2014b, 2015a, 2015b). This term is problematic because generalized partitives are not always syntactically truly independent. For example, they tend to enter the case frame of different types of predicates, such as negated or intensional predicates (see below §§8.1–8.2).



### 3 The data

In this paper, I primarily rely on a few in-depth studies on the diachrony of partitives in different languages. In addition, I employ a database on partitives in order to establish typologically valid co-expression patterns that may be interpreted diachronically. The entire database, published in Seržant (2020), rests on a convenience sample of partitive expressions covering 138 languages, 171 entries from 46 families and all six macroareas, see Figure 1. The sample is biased towards Eurasia (48% of the entries, 82/171).

The data were collected from grammars that have sections devoted to partitives and, in a few cases, by searching for the relevant examples in the grammars (if they lacked such a section or if the section was not informative enough).

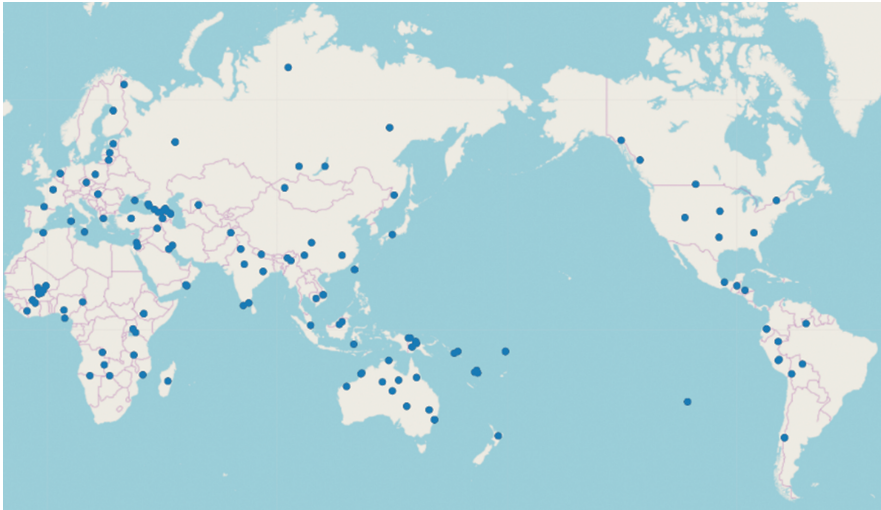

**Figure 1:** Languages of the database.

Not all examples that were translated with the English partitive (*out*) of were taken into account. For example, *the two of us*, *both of them* (often just rendering the respective dual forms), *none of us*, and *all of us* were not taken into account. The motivation behind this decision was to exclude examples that seem to be partitives solely due to the restrictions on numeral and quantifier modifiers in English and may thus only be a translational phenomenon. Furthermore, in order to exclude implicit expressions such as *some flowers* in (6) (with the partitive meaning produced by contextual inferences), only examples with the supersets explicitly marked as definite (pronouns, demonstratives, etc.) were taken into account.

## 4 Emergence of partitives

This section provides an overview over the provenance of the morphological markers that may be employed for forming a partitive. Partitive markers vary along the following two variables: the strategy and the type (Seržant, *forthc.*), as is schematized in Table 2:

**Table 2:** Coding variation of partitives (Seržant, *forthc.*).

Type	Strategies				
NP-internal	Possessive	Separative	Locative	Unmarked	other
NP-external, particle	Possessive	Separative	Locative	Unmarked	other

The marking *strategy* concerns the semantic relation the partitive marker is historically based on: the *separative* strategy (13), the *locative* strategy (14), the *possessive* strategy (15), and the *zero* strategy, which is formed by adjoining the indefinite subset quantifier to the definite superset expression (16) (see Koptjevskaja-Tamm 2001, 2009; Luraghi and Kittilä 2014: 55).

- (13) Tyvan (Turkic; Russia; Anderson & Harrison 1999: 16)

*šay-dan ižer men*  
 tea-**ABL(=PART)** drink-P/F 1SG  
 ‘I’ll drink some (of the) tea.’

- (14) Oko (Atlantic-Congo; Nigeria; Atoyebi 2010: 132)

*òpɔ́rɛ égbén ábɛ íbè yò úbó*  
 one children DEF.PL **LOC(=PART)** go house  
 ‘One of the children went home.’  
 (Lit. One inside/among the children went home.)

- (15) Lavukaleve (isolate; Solomon islands; Terrill 2003: 95)

*Aka ma-fan e*  
 then 3PL.**POSS(=PART)**-some 1PL.EXCL  
*fī e-tau vo-foi-re*  
 1PL.EX.POSS-hand.PL 3PL.OBJ-hold-NF 3SG.N.FOC  
 ‘Then some of us held our hands. . .’

Some languages may simply leave the true-partitive relation morphologically unmarked and employ mere bare juxtaposition in which the indefinite (subset) quantifier and the definite restrictor NP are juxtaposed:

- (16) Mapudungun (Araucanian; Chile; Smeets 2008: 136)

*kiñe-ke ñi pu wenüy*  
 some-DISTR POSS.1SG PL friend  
 ‘some of my friends’

The variable *type* is about the syntactic host: the partitive marker may occur NP-internally, e.g. as an adposition e.g. in (13) above, or NP-externally, as a partitive particle (including both partitive pronouns and quantifiers), which generally tend to cliticize onto the verb as in (17) and (18). The variable *strategy* and the variable *type* are orthogonal to each other.

In (17), the dedicated third-person partitive pronoun ‘of it/this/them’ cliticizes to the verb:

- (17) Itzaj (Mayan; Guatemala; Hofling & Tesucún 2000: 251)

*Yan in-jan-t-ik-i'ij?*  
 OBLIG 1SG.A-eat-TRN-IIS-PART  
 ‘Do I have to eat some of this?’

In (18), the marker *á* is somewhat different in that it is not a pronoun itself but rather a dedicated partitive quantifier (‘some of’) while the superset is left unexpressed (but has to be understood):

- (18) Hdi (Afroasiatic, Chadic; Africa; Frajzyngier 2001: 264)

*ndâ-’á-ndâ*  
 swallow-PART-swallow  
 ‘he swallowed some of (them)’

Finally, the NP-external type *particle* consists of two subtypes: the partitive pronoun (cf. English ‘of them/of it’) and the partitive quantifier (‘some of/any of’). While these two subtypes are distinct, it is not easy to differentiate between the two in many examples. It is only for this reason that I lump these two subtypes into one type.

#### 4.1 Emergence of the separative, locative, possessive, and other strategies

The separative, locative, and possessive strategies are predominantly based on adpositions (or case affixes), except for the possessive strategy, which may also be based on possessive indexes as in (15) above.

The most frequent source of partitive markers is spatial adpositions. Partitives relying on the separative strategy develop from the spatial relation of *separation* of the Figure from the Ground (Koptjevskaja-Tamm 2001, 2009). This is demonstrably the case in languages such as Russian (partitives based on *iz* ‘from’), Latvian (*no* ‘from’), Finnic languages (partitives based on the elative and partitive cases), Turkic languages (partitives based on the ablative case), or Semitic languages (partitives based on the ablative preposition *min*). Even for those languages for which there is no good diachronic evidence at disposal, the co-expression of partitivity and separation is most likely to have originated from the spatial meaning of separation because spatial meanings are usually the original ones, while abstract meanings – such as partitivity – are historically secondary.

For some languages, there is a threefold co-expression pattern: possession, partitivity and separation, such as the French preposition *de* or Dutch *van*. Again, given that spatial meanings are the least abstract ones, they are most probably also the original ones. This assumption is supported by those languages for which there is diachronic evidence at our disposal. For example, in case of the preposition *de* (from Latin *dē*) in Romance languages, the co-expression of separation and partitivity is found already in late Latin, while the possession meaning developed later (cf. Carlier & Lamiroy 2014: 480–481).

While the separative strategy is largely uniform in its spatial source despite minor distinctions, such as *from among* vs. *from inside*, the locative strategy is diachronically more diverse. First, in some languages, it is historically based on the concept of *among/between*. This is, for example, the case in Togo Kan (Dogon). In this language, the postposition *kénè* ‘among’ may be used as a partitive marker as well (Heath 2015: 150, §8.2.12). The second subtype is based on the spatial concept of containment (‘inside’), such as in Koyra Chiini or Koyraboro (both from the Songhay family). Finally, other locative relations to the Ground are found. Thus, German marginally employs the spatial concept of closure ‘at’ with the preposition *an*:

(19) German (WWW<sup>5</sup>)

*Lass Deinen Mann doch mal **am** Fisch probieren*  
 let your husband PRT PRT **at.DEF.DAT.SG(=PART)** fish taste  
*und beurteilen, ob’s salzig ist*  
 and judge whether=it salty is  
 ‘Let your husband taste **the fish** and tell whether it is salty.’

5 <http://www.gesundehunde.com/forum/archive/index.php/t-87252.html>

Some languages may employ several of these subtypes. For example, Jamsay (Dogon) marks the superset NP with either *bèrê*: ‘in’ or with *gǎnn* ‘between’ without any clear meaning difference (Heath 2008: 471).

In Seržant (forthc.), I have argued that the different strategies are areally biased. Thus, languages of Eurasia prefer the separative strategy while the locative strategy seems to be more dominant in languages of Africa. The zero strategy is primarily found in languages of Oceania.

## 4.2 Emergence of NP-external, particle-marked partitives: Partitive pronouns and partitive quantifiers

Partitive pronouns typically stem from pronominal spatial demonstratives or third-person pronouns that sometimes also incorporate a particular spatial affix or an adposition. For example, the clitic partitive pronoun *-i'ij* in Itzá (Mayan) is homophonous with the locative demonstrative pronoun *-i'ij* ‘there’ (Hofling & Tesucún 2000: 304, 306) and is, therefore, likely to historically descend from it (the locative strategy).

A number of Bantu languages employ clitic locative indexes for marking partitives (Persohn 2017; Persohn & Devos 2017). Thus, Luvale (Bantu) employs the location index *ku-* (class 17) as is found in (20) (Persohn & Devos 2017: 4). Its partitive use is demonstrated in (21):

- (20) Luvale (Bantu; Horton 1949: 50)  
*Ali ku-zuvo yasakananga ku-ze.*  
 be.3SG 17-house of\_so\_and\_so 17-yonder  
 ‘He is at that house there.’

- (21) Luvale (Bantu; Persohn & Devos 2017: 22)  
*eji ku-ly-anga ku-ku-lya c-ami*  
 AUX 15-eat-HAB 17(=PART)-15-food 15-POSS.1SG  
 ‘He eats of my food.’

The location indexes in the partitive meaning are attached on the top of the noun with its lexical classifier (*ku-*, class 15 for ‘food’ in (22)). Historically, the partitives in Bantu typically derive from the so-called second series of demonstratives or referential demonstratives of these locative classes, which typically have anaphoric uses such as ‘there’ plus additional information that the locative class provides (e.g. *in-landmark* or *from-landmark*) (Persohn, p.c.). The situation found in Luvale is found in many other Bantu languages, which employ the locative

indexes for marking different types of partitives (cf. the overview in Persohn 2017, Persohn & Devos 2017).

Another example of a partitive particle (pronoun) is the partitive pronoun *en* in French, *ne* in Italian, or *nde* in Sardinian stems from the separative deictic *indē* ‘from there’ in Latin, which is also originally a demonstrative pronoun employed in the separative strategy. The spatial, separative meaning thereof is still retained in French (22):

(22) French (Giusti & Sleeman 2021, this volume)

*Ils en sortent.*  
 3PL PART/DEM come-out  
 ‘They come out of it.’

By contrast, the partitive pronoun *er* in Dutch stems from the old genitive form of the third-person pronoun (Old Dutch *iro* ‘of them’) (Philippa et al. 2003), representing the possessive strategy. The same holds for the different partitive pronouns found in German dialects such as *ərə* (cf. Standard German *ihrer* ‘3PL.GEN’), *sñ* (*seiner* ‘3SG.M/N.GEN’) and *əs* (*dessen* ‘DEM.M/N.GEN.SG’), which all originally stem from genitive forms but after the loss of the adverbial and adnominal genitive in German dialects were no longer realized as such (Glaser 1992: 124).

While partitive pronouns discussed above are only possible in the third person, a few languages allow partitive pronouns in all persons. Thus, the partitive pronouns in Eibela (Bosavi; Papua New-Guinea) – 1PL *ni:je:*, 2PL *gi:je:*, 3PL animate *i:je:* – inflect for all three persons (Aiton 2016: 117). These pronouns evidently derive from the plural personal pronouns and their forms are analysable as plural pronouns with the affix *-je:* which is homonymous with the locative marker and thus most probably stems from it: 1<sup>st</sup> *ni:je:* from *ni:-je:* 1PL-PART, 2<sup>nd</sup> *gi:je:* from *gi:-je:* 2PL-PART, 3<sup>rd</sup> animate *i:je:* from *i:-je:* 3PL-PART.

Another frequent source of the partitive particles is the pronominal use of indefinite existential quantifiers such as English *some* or *one*. This is the case in a number of Oceanic languages such as Boumaa Fijian with the partitive marker *soo*, Avava (*tuut ier*) and many other Oceanic languages (cf. Budd 2014: 534–535) or possibly with the class 18 bound verbal partitive particles in some Bantu languages such as *=mo* ‘one, some’ in Nyakyusa (Persohn 2017: 161). The German indefinite pronoun *welche* (and its dialectal variants) seems also to undergo the development towards a partitive pronoun (cf. Glaser 1992; Strobel 2017; Sleeman & Ihsane 2021, this volume).<sup>6</sup>

<sup>6</sup> Thus, in contrast to, for example, English *some* or German *einige*, it has abandoned its attributive use found in Early Modern German and some Low German dialects (Glaser 1992: 126).

This second source of partitive markers is very different from the spatial demonstratives and personal pronouns in terms of definiteness of the source. Spatial demonstratives and personal pronouns are inherently definite while existential quantifiers such as *some* or *one* are inherently indefinite. The grammaticalization path is also very different. While partitive quantifiers develop from the quantifier slot of the partitive construction and often have the meaning ‘some of’, demonstratives and pronouns develop from the restrictor slot of the partitive construction and have the meaning ‘of them/of it’.

### 4.3 Emergence of dedicated partitives

Adpositions and cases used to encode partitivity may sometimes develop into dedicated partitives, that is, lose their original – e.g. spatial – meaning, retaining only those meanings that are related to partitivity. For example, this is the case with the partitive case of the Finnic languages, which no longer attest the original separative meaning. The original ablative meaning has been lost in this branch of Finno-Ugric (except for some residual adverbs, cf. Koptjevskaja-Tamm 2001).

The development into a dedicated partitive marker is found in 9% (9/95<sup>7</sup>) of the languages in my sample. Moreover, while the possessive strategy never seems to develop into a dedicated partitive, the separative strategy gives rise to dedicated partitives most frequently while losing its original spatial meaning, see Table 3:

**Table 3:** Dedicated partitivity markers.

Separative	Locative	Possessive
17%	4%	0%

For example, in addition to Finnic languages, a dedicated partitive case stemming from an ablative is found in Kryz (Nakh-Daghestanian). Here, the subrelative case came to be used exclusively for partitivity-related functions, while its spatial meaning has been taken over by a new postposition (Authier 2009: 82):

<sup>7</sup> Unclear strategies as well as unmarked partitives have been excluded here, thus reducing the total number of partitives under consideration to 95.

- (23) Kryz (Nakh-Daghestanian; Russia; Authier 2009: 190)  
*zi-va-z vardavlat.ci-kar vuts'-ru-zin*  
 1SG-2SG-DAT wealth.F-SUBEL(=PART) give-EVT.F-1SG  
 'I will give you my fortune.'

In Archi and in Khwarshi (Nakh-Daghestanian), the dedicated partitive case stems from an earlier inter-relative (Kibrik 1977: 174; Khalilova 2009). In northern Siberian Turkic languages such as Yakut and Tofa, there is a dedicated partitive case marker in *-DA*. Its spatial origin is not entirely clear. It is often assumed to descend from a locative case of Proto-Turkic (see Ubrjatova et al. 1982: 134; Nevskaya 2017: 278). However, the same case has been used to denote the source of motion (in addition to the locative meanings) in Old Turkic as well, cf. *tengri-de* /sky-*DA*/ 'in the sky, from the sky' (Ubrjatova 1982: 134, Nevskaya 2017: 279; Erdal 2004). Other Turkic languages have renewed the marking of partitivity by the ablative case that is, however, not etymologically related to the old case in *-DA*.

#### 4.4 Expansion of partitives along lexical classes of verbs

There is much overlap in semantic classes of verbs that are early attested with partitives in different languages. Thus, partitives tend to occur with consumption verbs such as 'to eat' or 'to drink' and not, say, with destruction verbs such as 'to kill', at an early stage of development. These – and possibly some other – verbs represent the lexical core of partitive constructions and, accordingly, are the first ones to be used with partitive objects. For example, there is evidence that the ablative case of Proto-Finnic – to develop into the partitive case in modern Finnic – was used with consumption verbs on its partitive function. Larsson (1983) suggests that the Mordvin (partitive) ablative reflects the general Proto-Volgaic stage, which further developed in the Finnic subbranch (also Kiparsky 1997). Yet, Mordvin primarily attests consumption verbs – 'to eat', 'to drink' – along with some other verbs with the ablative case on the direct object used in the partitive function (Itkonen, 1972: 170; Larsson, 1983: 125ff.; Kiparsky 1998).

Similarly, the generalized partitive genitive in ancient Indo-European languages such as Ancient Greek or Vedic Sanskrit (*inter alia*, Schwyzler and Debrunner 1950; Kuryłowicz 1964: 184; Dahl 2014: 422–424) is most frequently attested with consumption verbs.

Likewise, Carlier & Lamiroy (2014: 485, 493) also find that the generalized-partitive use of *de* in late medieval Romance languages (e.g. in Old French) first spreads to objects of consumption verbs as 'to drink' or 'to eat' as well as to transfer verbs such as 'to give'.



Likewise, consumption verbs such as ‘to eat’ or ‘to drink’ as well as transfer verbs such as ‘to take’ are also those verbs where generalized partitives persist longer if the entire category is being gradually lost in the language. For example, the partitive genitive in contemporary modern Russian is a recessive category and yet it is mostly found with these verbs. Carlier & Lamiroy (2014: 502) report the same phenomenon for Spanish, which has almost entirely lost the partitive use of *del* found in Old Spanish.

The reason for this special role of consumption verbs is their semantics. These verbs cross-linguistically tend to demote or leave out their objects most frequently (Malchukov 2015: 105–106; Næss 2017: 127; Seržant et al., *forthc.*). Thus, in a typological study of transitivity, Malchukov (2015: 105–106) and Seržant et al. (*forthc.*) find that ‘eat’ is one of the most frequent verbs that demote their object, e.g. via an antipassive or just in terms of A-preserving lability.

## 5 From headed to generalized partitives

This section deals with the loss of the explicit expression of the (subset) quantifier and with the generalization of the indefinite interpretation thereof. Thus, in Lithuanian, the subset quantifier is frequently left unexpressed; contrast (24a) with (24b):

(24) Lithuanian (Baltic, Indo-European)

- a. *Mačiau keletą jo kolegų.*  
 see.PST.1SG **some**.ACC 3SG.GEN colleague.GEN(=PART).PL  
 ‘I saw **some** of his colleagues.’
- b. *Mačiau Ø jo kolegų.*  
 see.PST.1SG 3SG.GEN colleague.GEN(=PART).PL  
 ‘I saw [**some**] of his colleagues.’

I refer to partitive expressions that generalize the indefinite meaning of the subset quantifier, leaving it for this reason unexpressed as in (24b), as *generalized partitives*.

In what follows (§§5.1–5.3), I sketch the development from headed into generalized partitives and the motivations for it.

## 5.1 Frequency bias of the subset quantifier

A true-partitive expression requires two referents in order to be properly interpreted: the subset and the superset (§2.1). While the latter must be definite and familiar, the former can be either definite or indefinite. Examples with the definite subsets are primarily confined to superlative constructions that often build on partitives (cf. English *He is **the best among them***) but sometimes also include predicative, focal subsets and some other minor types as in (25) below (see also Table 4 below):

(25) Russian (Slavic, Indo-European)

*Vsego na ekzamen prišlo 28 studentov.*

'28 students came to the exam altogether.'

*Iz nix tol'ko ja smog sdat' ekzamen.*

from 3PL.GEN only 1SG.NOM be\_able.PST pass.INF exam.ACC

'Out of them, only I was able to pass the exam.'

However, in the vast majority of cases, the subset quantifier tends to be indefinite in and across languages. The tendency is so strong that most of the grammars consulted in this study do not even provide examples of partitives with definite subsets. To corroborate this observation with corpus data, a small corpus survey has been carried out on the basis of the oral subcorpus of the Russian National Corpus. I have annotated the first 300 hits of the expression *iz nix* [lit.] 'from them', which tends to predominantly occur in the true-partitive construction in Russian (Table 4). Among the 300 hits, 277 instances were indeed true-partitive expressions, with both definite and indefinite subsets:

**Table 4:** The relative frequency of the definite vs. indefinite subsets to the superset *iz nix* 'from them' in the Russian National Corpus ([www.ruscorpora.ru](http://www.ruscorpora.ru)), the oral subcorpus.

	INDEFINITE				DEFINITE		
	quantifier <sup>8</sup>	one, any <sup>9</sup>	interrog. <sup>10</sup>	numeral	no one <sup>11</sup>	superlative	other
	115	80	28	21	18	11	4
Total	262 (95%)					15 (5%)	

<sup>8</sup> Including: *nekotorye* 'some', *kakie-to* 'some', *neskol'ko* 'some', *každyj* 'each', *mnogie* 'many'.

<sup>9</sup> Including: *odin* 'one', *ljuboj* 'any', *kakoj-to* 'any', *kto-to* 'a person', *drugie* 'others'.

<sup>10</sup> Including: *skol'ko* 'how many', *kotoryj* 'which', *kto* 'who', *kogo* 'whom'.

<sup>11</sup> Including: *nikto* 'no one', *ni odin* 'not any one'.

The figures in Table 4 show that partitives are heavily biased towards indefiniteness of the subset with ca. 95% ( $p < 0.001$ ,  $\chi^2$ ). Accordingly, many languages exploit this strong frequency asymmetry and implement a more efficient coding by creating reduced forms of the subset quantifier. Given its overwhelming frequency, the indefinite subset is the expected default. It thus does not need as elaborate a coding as definite subsets, which are the unexpected option (form-frequency correspondance in Haspelmath 2008a, 2008b, 2008c).

There are two ways in which languages respond to this frequency asymmetry: the (subset) quantifier is either mentioned by a reduced-coding device or is left unexpressed. In Syer (Atlantic-Congo), the indefinite quantifier morpheme may also encode the true-partitive relation (Dombrowsky-Hahn 2015: 299). For example, in (26), the partitive is conveyed by the indefiniteness suffix that is attached to the definite NP ‘our women’ with no partitive marker:

- (26) Syer (Atlantic-Congo; Dombrowsky-Hahn 2015: 299)  
*mè wò čě-plàà sò nìwuru.*  
 CONS our woman-INDEF marry even  
 ‘... and even married some of our women.’

Most frequently, however, the indefinite subset quantifier is simply left unexpressed. Thus, in Lithuanian, the subset quantifier is frequently left unexpressed: see (24b), repeated here as (27) for convenience:

- (27) Lithuanian (Indo-European; p. k.)  
*Mačiau ∅ jo kolegų.*  
 see.PST.1SG 3SG.GEN colleague.GEN=PART.PL  
 ‘I saw [some] of his colleagues.’

Notably, the omission of the indefinite quantifier in the subset position may occur very early in the development of a partitive. For example, the new partitive marker *dē* ‘from’ of Vulgate Bible Latin may already be used without the quantifier:

- (28) Late Latin, approx. 4th c. (*Ezechiel 39,17*; Carlier & Lamiroy 2014: 480)  
*Et sic de pane illo edat.*  
 and thus from bread.ABL.SG DEM.ABL.SG eat.SUBJ.3SG  
 ‘And so let him eat of that bread.’

The conditions on leaving out the quantifier may vary cross-linguistically and may also depend on whether indefinite pronominal referents generally have to be

coded in particular syntactic slots at all (cf. the subject indefinite *man* in German) or may simply be left unexpressed.

Partitive pronouns may also develop into generalized partitives. For example, partitive pronouns in Eibela (Bosavi; Papua New-Guinea) 1<sup>st</sup> *ni:je:*, 2<sup>nd</sup> *gi:je:*, 3<sup>rd</sup> animate *i:je:* (Aiton 2016: 117) have generalized the indefinite quantifier ‘some’:

(29) Eibela (Bosavi; Papua New-Guinea; Aiton 2016:119)

*nɛ:na: i:je: o:-mɛ:na:*  
 1DU 3.PART shoot-FUT.1  
 ‘We two will shoot **some of them.**’

Here too, the pronoun itself provides the referent of the restrictor while the quantifier is understood as indefinite ‘some’ or ‘any’.

Cross-linguistically, the development of generalized partitives is a very frequent phenomenon that is found in many languages. Thus, 45% (52/115) of all adpositional partitives in my database allow for leaving the quantifier unexpressed.

Generalized partitives are distinct from partitives not only in the non-expression of the quantifier but they also gradually develop into a category that is functionally and structurally distinct from headed partitives. For example, the generalized partitive of Finnish (marked by the partitive case) very often codes functions such as discontinuous negation or aspectuality that cannot be encoded by the partitive with an explicit quantifier (unless the latter is itself a generalized partitive).

## 5.2 Morphosyntactic traces of the subset quantifier

At an initial stage, the dropped indefinite quantifier may leave behind traces in the morphosyntax of the hosting clause, and the partitive construction may show properties of ellipsis (*pro* in formal terms). For example, the generalized partitive encoded by the genitive (the possessive strategy) in ancient Indo-European languages such as Ancient Greek, Avestan or Old Russian shows a number of behavioural properties – to be abandoned in the later stages – that are very much reminiscent of an ellipsis rather than of a conventionalized zero (Seržant 2012, 2015b).

Thus, the generalized partitive genitive of Ancient Greek is not restricted syntactically as to which syntactic position it may occur in. It can replace any NP of the clause including non-argumental accusatives (so-called *accusativus graecus*) or datives despite its genitive case-marking (Seržant 2012). It can, furthermore, be coordinated with otherwise-case-marked NPs, including lexical cases. For example, the partitive-genitive-marked NP may be coordinated with

non-structural NPs such as the instrumental-marked object in Old Russian, consider (30):

- (30) Old Russian (Georgios Monachos' Chronicle)  
*vl(d)č(s)tvovaľb Asourieju i Persidoju*  
 govern.PST.M.SG Assyria.INS.SG and Persia.INS.SG  
*i pročixb stranb*  
 and other.GEN(=PART).PL country.GEN(=PART).PL  
*souštixb na vbstocě*  
 be.PARTC.GEN(=PART).PL on East  
 'He ruled over **Assyria and Persia and [some] of the other countries** in the East.'

Furthermore, the number value of the unexpressed quantifier may also be cross-indexed on the verb. This is found in Ancient Greek and Avestan along the schema in Table 5:

**Table 5:** Cross-indexing generalized partitives on the verb.

The value of the implicit subset	'[one] of the mortals'	'[some] of the philosophers'
The value of the verbal index	Singular	Plural

- (31) Ancient Greek (Eur. *Her.* 976–977; Seržant 2015b: 140)  
*ouk ésti thnētôn hóstis exairésetai*  
 NEG be.3SG mortal.GEN(=PART).PL REL.NOM.SG rescue.FUT.3SG  
 lit. 'there is no(t a single) mortal who would rescue (him)'
- (32) Ancient Greek (Arist. *Hist. Anim.* 513a; Seržant 2015b: 141)  
*Eisì dè kai tôn perì fúsin*  
 be.PRS.3PL PRT and DET.GEN(=PART).PL about nature  
 'There **are [some]** of the nature philosophers . . .'

Accordingly, I adopt the following stages in the development of generalized partitives established in Seržant (2015b: 148) on the basis of comparison of the partitive genitive in some ancient Indo-European languages with – etymologically the same – partitive genitive in modern Indo-European languages:

- (33) Intermediate stages in the emergence of generalized partitives (Seržant 2015: 148)  
*Explicit subset quantifier > elliptical, implicit quantifier with traces in morphosyntax > no traces of the quantifier*

Garifuna (Arawakan) patterns very much with Ancient Greek when it comes to the partitive in the subject position and its cross-indexing on the verb. Here, the logical number and person values of the implicit quantifier are cross-indexed on the verb (Barchas-Lichtenstein 2012: 189; Seržant 2015: 138–139), cf. (33):

- (34) Garifuna (Awakan; South America; Barchas-Lichtenstein 2012: 189)  
*Éibagua-tiyan wá-dagiya.*  
 run-T3**PL** P1**PL-FROM(=PART)**  
 ‘[Some] of us ran.’

In (34), the number of the left-out quantifier ‘some’ is plural and the person value is third person while the restrictor is first person. It is these values that are cross-indexed on the verb.

There are more languages like that. These languages too attest the properties of ellipsis rather than of a conventionalized zero when the generalized partitive is in the subject position, cf. the plural index on the verb in Armenian (35) and Jibbali (36):

- (35) Modern Eastern Armenian (Indo-European; Dum-Tragut 2009: 313)  
*R<sup>o</sup>adio-y-ov heřarjak-v-um ēin Hovhannes*  
 radio-INS broadcast-PASS-PTCP.PRS AUX.PST.**3PL** Hovhannes  
*T<sup>u</sup>manyān-i patmvack<sup>1</sup>-ner-ic’.*  
 T<sup>u</sup>manyān-DAT story-**PL-ABL(=PART)**  
 ‘Some of Hovhannes T<sup>u</sup>manyān’s stories were broadcasted on the radio.’

- (36) Jibbali (Afroasiatic, Semitic; Oman; Hofstede 1998: 42)  
*mən é-γó d<sup>c</sup>ɔd yəzír iḳbért*  
**from(=PART)** DEF-people still.3M.SG/C.PL visit.IMPF.**3M.PL** DEF.tomb  
 ‘some people still visit a (saint’s) tomb’

Eventually, morphosyntactic traces of the implicit quantifier are often lost. The non-expression of the indefinite quantifier is conventionalized and generalized partitives start their own life as an independent category. The verb assumes the default, non-agreeing form. This final stage of (33) is found, for example, in

Standard Russian or Lithuanian. In these languages, the generalized-partitive subject always occurs with the singular (neuter) index of the verb regardless the logical value of the referent. Moreover, the generalized partitive in these languages cannot occur in slots other than direct objects and intransitive subjects of some verbs (Seržant 2014a, 2014b, 2015a).

### 5.3 Expansion of generalized partitives across syntactic macroroles

Generalized partitives are inherently indefinite, which is why they are most likely to occur as objects due to the well-known frequency association of syntactic roles with (in)definiteness: while direct objects are often indefinite, transitive subjects are typically definite (Comrie 1981: 128; DuBois 1987; Croft 1988). It is due to this tendency that transitive subjects are very unlikely to be coded by generalized partitives while direct objects are perfectly compatible with them.

The category of the intransitive subject, in turn, is intermediate, and there are intransitive predicates – typically existential or presentational predicates – that often occur with an indefinite argument. Accordingly, it is precisely these intransitive subjects that are often coded by generalized partitives; in fact, it is the default encoding of the subject of an existential predicate in languages such as Lithuanian or Finnish (Moravcsik 1978; Larsson 1983: 142–144; Sands and Campbell 2001: 256; Seržant 2013: 336–337, 2015a: 359; Huumo 2021, this volume). In (37), I suggest that generalized partitives expand from direct objects to transitive subjects through the subjects of intransitive, existential predicates:

- (37) Expansion of generalized partitives across grammatical roles<sup>12</sup>  
 (i) *direct objects only* > (ii) + *existential, inactive subjects* > (iii) + *some transitive subjects*

Stage (ii) is the most frequently attested one among generalized partitives, for example, in Lithuanian and North Russian (Seržant 2014a, 2014b), Latgalian (Nau 2014), Ancient Greek (Nachmanson 1942), Sanskrit and Avestan (Dahl 2014: 439). The expansion of the partitive marker *del*-Noun in Old French also proceeded from direct objects to intransitive subjects and then to transitive subjects, thus documenting the entire cline in (37) (Carlier & Lamiroy 2014: 494–495).

As argued above, stage (iii) is extremely rare because transitive subjects are the least compatible with the inherent indefiniteness of generalized partitives. Stage (iii) is marginally found in colloquial Finnish (Huumo 2018) but not, for instance, in the closely related Estonian. Armenian may have partitive-ablative

intransitive subjects and direct objects (Dum-Tragut 2009: 313) but not transitive subjects, thus documenting stage (ii) in (37).

The cline in (37) might also apply to partitive pronouns/quantifiers. Thus, the partitive pronoun *en* in French cannot occur in the transitive-subject and the intransitive subject slot unless there is an adnominal modifier (Lagae 2001: 46), thus, documenting stage (i) in (37). By contrast, the partitive prefix/clitic *ʔaʔ-/aa-* in Tlingit (Athabaskan-Eyak-Tlingit) can replace both the subject and the object prefixes (Leer 1991: 123–124), analogically the partitive pronouns in Eibela (Bosavi) (Aiton 2016: 117). Thus, both languages might represent stage (iii) with their partitive pronouns.

Finally, the rare occurrence of partitives in non-structural, oblique positions might be related to the general tendency across languages to overtly mark oblique relations while readily allowing for efficiency-driven zeros in the structural positions (cf. Comrie 1989: 128). Since partitives often do not encode semantic relations to other constituents of their clause, it seems that the pressure for overt marking of an oblique relation is the reason for restricting partitives to structural positions only (cf. Kornfilt 1996: 131 on Turkish).

## 6 From true-partitives to pseudo-partitives: The partitivity cycle

Above (4), I have defined partitives as grammatical constructions that may encode the true-partitive relation, which involves a proportion of two sets or two portions. The *true-partitive relation* is different from *plain quantification* as in *much wine, a lot of water, a glass of wine*, and so forth, which only involves one set or one portion and, hence, no proportion and no relation between any two sets is available. Yet, partitives frequently undergo the extension of their function from encoding the true-partitive relation only to the ability to encode plain quantification as well. This semantic extension is frequently found with both headed and generalized partitives. This development paves the way for new, argument-level functions (differential-object marking and indefiniteness markers, §7) and clause-level functions pertaining to aspectuality or negation with generalized partitives (§8). Before I turn to these new functions of generalized partitives, I first describe the semantic extension of partitives from the true-partitive relation only to include the denotation of plain quantification as well (§6.1) and the cyclic emergence of partitive markers (§6.2).



## 6.1 Expansion from encoding only the true-partitive relation to encoding plain quantification as well

Partitives, which originally encode true-partitive relation only, often extend their function to include plain quantification. In the latter case, the partitive is pseudo-partitive, see the definition thereof in (10) above (term introduced in Selkirk 1977). Thus, the partitive construction marked by *of* in English can have two different functions: encoding of the true-partitive relation (38) and encoding of the plain quantification (39):

(38) *Yesterday I had a cup of the tea that I made for you.*

(39) *Yesterday I had a cup of tea.*

Historically, the extension from (38) to (39) proceeds via gradual violation of the Partitivity Constraint. Recall that pseudo-partitives are partitive constructions with no discursively restricted superset (§2.4, cf. the definition in (10) and (11)). The latter is replaced by a kind-referring expression such as *tea* in (39), which is not a set. With a kind-referring expression, neither the complement nor the superset can be meaningfully defined in terms of sets. To summarize, even though (39) formally coincides with (38), it is semantically very different from it.

What superficially may look like just loosening selectional input restrictions on the restrictor to include kind-referring expressions thus produces a category that is semantically no longer conceivable in terms of the true-partitive relation between two sets/portions: for example, the concept of *proportion* between the subset and the superset is no longer available with pseudo-partitives. Proportion is replaced by the concept of a more abstract relation, namely, the one between a kind of objects and a quantity of its instantiations. I suggest that the development of pseudo-partitives and the abandonment of the Partitivity Constraint proceeds diachronically along the following stages:

(40) Demise of the Partitivity Constraint<sup>12</sup>

- (i) *discursively defined supersets only* > (ii) + (*discursively*) *defined types* > (iii) + *kinds*

---

<sup>12</sup> '+' means 'in addition to' because very often the original meaning is not entirely lost and can still be encoded by the given expression in a limited number of contexts.

Accordingly, the developments in (40) lead to new functions and properties of the partitives that undergo them:

- (41) Different types of partitives resulting from the demise of the Partitivity Constraint (38)<sup>12</sup>  
 (i) *true-partitives* > (ii) + *faded partitives* > (iii) + *pseudo-partitives*

The constructed examples in (42) illustrate the three stages (i)–(iii) in both (40) and (41):

- (42) a. *Yesterday, I had a cup of the tea that you bought for me.*  
 b. *Yesterday, I had a cup of the tea that you always buy for me.*  
 c. *Yesterday, I had a cup of tea.*

In (42a), the relative clause denoting a particular, referential event disambiguates the embedded NP *the tea* as a particular amount of *tea* that qualifies it to be a superset (the super-portion). As a result, the whole expression in (42a) is a true-partitive. In (42b), however, there is a generic event in the relative clause that blocks the referential interpretation of the definite article of *tea*. The head NP is interpreted, accordingly, as referring to the kind specified by the relative clause and not as a particular amount of *tea*. Consequently, it cannot be interpreted as a super-portion, or portion at all, and the whole expression is no longer a true-partitive. Still, there is a contrast between (42b) and (42c) in that the former has a definite, familiarity-based sub-kind of tea (*the tea that you always buy for me*), while the latter is even less informative, containing just the bare kind *tea*. The partitives with a familiarity-based definite kind in the restrictor position as in (42b) have been called *faded partitives* in de Hoop (2003):

- (43) Dutch (de Hoop 2003: 193)  
*Els at van die smerige bonbons*  
 Els ate of those filthy bonbons  
 ‘Els ate some of those filthy bonbons (“you know”).’

The *you-know*-meaning highlighted in (43) is referred to as *faded partitive* in de Hoop (2003: 193). ‘Those filthy bonbons’ refer to a kind that is assumed to be familiar to the hearer, featuring stage (41.ii).

Faded partitives represent a transitional stage towards pseudo-partitives, which do not impose any familiarity requirement on the restrictor at all. Diachronically, the difference between (41.i) and (41.ii) – crucial for the development of the pseudo-partitive function – boils down to the ambiguous interpretation of defi-

niteness of the embedded NP: a definite NP may highlight either the familiarity of the referent or the familiarity of the referent's kind. The latter is found in (41.ii) and, as has been suggested in Koptjevskaja-Tamm (2009: 341), it is precisely this ambiguous nature of definite expressions that creates bridging contexts towards pseudo-partitivity (cf. also Carlier & Lamiroy 2014: 486).

The second step of the development from (41.ii) to (41.iii) is the entire abandonment of the Partitivity Constraint. The restrictor NP may now also include generic and kind-referring expressions with no familiarity at all, as in:

- (44) Ossetic (Indo-European; Bagaev 1965: 156)  
*Nartxor-æj æryssadtoj dyuuæ tonnæjy*  
 maize-**ABL(=PART).SG** ground two tonnes  
 'They ground two tons of maize.'

The development into pseudo-partitives makes the partitive construction more compatible with less individuated objects such as 'maize' (44) or 'peppercorns' (45) that typically do not occur individually, whereas true-partitives seem to pattern better with more individuated referents, such as human beings (Carlier & Lamiroy 2014: 486).

- (45) Old French (translation of Albertus Magnus, *De falconibus*, BNF fr. 2003, 15th c.; Carlier & Lamiroy 2014: 486)  
*Pren des grains de poyvre.*  
 take.IMPV.2SG PART.DEF.PL grain.PL of pepper  
 'Take some peppercorns.'

Different languages show different progress on the cline in (40). For example, English attests all three steps (i)–(iii) of the cline in (40), as illustrated by the examples in (42). The development (40.i–iii) is also well documented for the partitive marker *de* in Romance languages in which it originally, i.e. in Latin, Old French, Old Spanish, and Old Italian, only encoded the true-partitive relation (Carlier & Lamiroy 2014).

By contrast, the Dutch preposition *van* covers only the first two steps (i)–(ii) of (40): definite supersets and definite, familiar kinds. The same holds for the following languages and their partitive markers: German *von*, Imonda *-ia-nèi* (Border), Itzaj *-i'ij* (Mayan), Boumaa Fijian *soo*, Avava *tuut ier*, and many other Oceanic languages (cf. Hofling & Tesucún 2000: 251; Budd 2014: 534–535).

Cross-linguistically, the co-expression of the true-partitive relation and plain quantification with partitives is very frequent. Thus, 53% (61/116) of all partitives in the database that are based on the strategies other than the zero strat-

egy allow for the meaning of plain quantification as well and may thus pattern as pseudo-partitives. From this it follows that partitives encoding only the true-partitive relation are quite unstable diachronically and tend to drift towards plain quantification. Indeed, old partitives tend to be increasingly associated with the pseudo-partitive use, while the true-partitive relation requires new markers (*partitivity cycle*, §6.2). The frequency of co-expression does not predict the direction of change itself, of course. However, there is diachronic evidence for precisely this direction of change with partitives based on the adpositional strategies (the locative, separative, and possessive strategy, including possessive indexes) and partitive pronouns.<sup>13</sup> I illustrate this in the next section.

## 6.2 Partitivity cycle

A number of languages attest a renewal of partitives, which I refer to as the *partitivity cycle* (in analogy to the famous Jespersen's cycle of negation). When a partitive is frequently used as a pseudo-partitive, that is, at stage (40.iii), often there is already a new partitive construction that only encodes the true-partitive relation. During this emergent stage, different markers may be employed interchangeably and only later is just one marker conventionalized as the new partitive marker. For example, Latin employed the old Indo-European, possessive strategy to encode partitives (with the genitive case). In parallel, late Latin has developed new partitive constructions based on the separative strategy with the prepositions: *ex*, *dē*, *a(b)*, all denoting 'from'. Later Romance languages conventionalized only *de* (from *dē*). Similarly, Ancient Greek developed, in addition to the ancient possessive strategy, the separative strategy marked by prepositions *apó* 'from' or *ek(s)* 'from' (Nachmanson 1942), while only *apó* is conventionalized in Modern Greek. Likewise, German and Dutch developed the separative strategy with the preposition *von* and *van*, respectively, while the original possessive strategy (the genitive case) – still attested in earlier German (Glaser 1992: 120) – is on the verge of disappearance. Slavic languages have conventionalized distinct separative prepositions, as in Russian *iz* 'from' vs. Serbian *od* 'from', when replacing the old possessive strategy. Similarly, Baltic languages, with Lithuanian *iš* 'from' vs. Latvian *no* 'from', developed new partitive constructions that can only express the

---

<sup>13</sup> By contrast, partitive quantifiers and unmarked partitives are inherently and originally ambiguous between pseudo-partitives and true-partitives.

true-partitive relation.<sup>14</sup> Finnish and Saami employ the relative case (a more recent separative strategy) for the true-partitive relation instead of the older (separative) strategy with the partitive case (originally ablative) (Alho 1992; Itkonen 1972: 181). Many modern Turkic languages introduced the new strategy of encoding partitivity – namely with the ablative case – while losing the older partitive case in *-DA*. The latter is attested only in northern Siberian Turkic languages such as Yakut or Tofa, as well as in Old Turkic (Ubrjatova 1982: 134; Nevskaya 2017: 278; Erdal 2004). The partitive case in *-(r)ik* in Basque can no longer encode the true-partitive relation at all, residing in the domains typical of pseudo-partitives such as negation, hypothetical events (conditionals), or with some quantifiers (cf. López 2014; Etxeberria 2021, this volume).

Recall that the emergence of new partitive markers is subject to macro-areal pressures. In Seržant (forthc.), I have argued that, for example, Eurasia is heavily biased for the separative strategy, which is not the case in Africa or Oceania.

## 7 From generalized pseudo-partitives to indefiniteness markers and unmarked NPs

Concomitantly to the semantic change in (40), partitives undergo the syntactic change from two constituents into one NP. A partitive construction encoding the true-partitive relation maximally consists of two NPs corresponding to the subset and the superset referent, respectively. Thus, *some of our students* consists of NP1 *some* and NP2 *our students*, and the two NPs are linked by the preposition *of*.<sup>15</sup>

The gradual development towards a single NP construction involves reductional changes in the internal syntactic organization (Selkirk 1977; De Hoop 2003). The development into a single NP proceeds along the following steps:

- (46) Reduction of the syntactic structure along with the development into generalized partitive and then into pseudo-partitive in (40) and (41)  
 (i) *[NP1] adposition [NP2]* > (ii) *adposition [NP1]* > (iii) *determiner [NP]* > (iv) *∅ [NP]*

<sup>14</sup> It is possible that this intragenetic variation in modern Slavic and modern Baltic stems from optionality in the earlier language layers similar to the variation among the three separative prepositions found in Latin.

<sup>15</sup> NP2 is also frequently syntactically embedded under NP1, but this is less relevant here (see Seržant, forthc., for an overview).

Observe that the development from (46.i) to (46.ii) also involves the emergence of the generalized-partitive construction in which the quantifier is generalized as ‘some’ or ‘any’ and is therefore left out, unexpressed.

The reduction of the syntactic structure in (46.i–iv) is well-documented in a number of languages. For example, faded partitives based on *van* in Dutch come close to (46.iii). Faded partitives, such as *van die smerige bonbons* in (43) above, no longer syntactically pattern as prepositional phrases but rather as simple NPs with regard to a number of syntactic tests such as extraction, for example (de Hoop 2003: 193).

A well-documented case is the development of the preposition *dē* from Latin into an indefinite plural/mass-noun determiner in modern French or Italian (Carlier & Lamiroy 2014; Cardinaletti & Giusti 2015). The original state of (46.i) is found in the following example:

- (47) Latin, 1st c. BC (Cicero, *Mil.* 24,65)  
*si quis de nostris hominibus*  
 if any **DE** our.ABL people.ABL  
 ‘if any of our men’

The development of *dē* into generalized partitive, as in (46.ii), is found in the following example from Late Latin:

- (48) Late Latin, approx. 4th c. AD (*Ezechiel* 39,17; Carlier & Lamiroy 2014: 480)  
*Et sic de pane illo edat.*  
 and thus **DE** bread.ABL.SG dem.ABL.SG eat.SUBJ.3SG  
 ‘And so let him eat of that bread.’

Finally, already in Old French as well as in modern Italian and French, the adposition *dē*, turned *de*, developed into a modifying quantifier or a determiner (46.iii). For example, it can now co-occur with prepositions that themselves do not govern it:

- (49) Old French, 16th c. (translation of Albertus Magnus, *De falconibus*; Carlier & Lamiroy 2014: 487)  
*Et le lendemain le faut tresbien*  
 and DET following\_day 3SG.ACC.M must.PRS.3SG very\_well  
*oindre avecques du savon.*  
 rub.INF **with** **DE**.DEF.M.SG soap  
 ‘And the following day, you have to rub him very well with soap.’

Another property of (46.iii) is its ability to trigger verbal agreement from the subject position – something that is atypical for NPs headed by oblique adpositions and rather normal for NPs with modifiers or determiners:

(50) French

*Des hommes sont venus*  
**DE.DEF.PL** man.**PL** AUX.**3PL** come.PARTC.PST.**PL**  
 ‘Some men arrived.’

Thus, Gallo-Romance varieties attest the development from (46.i) to (46.iii) but not to (46.iv), at which stage the former partitive marker becomes a residual morpheme with no particular meaning.

A parallel development is found in some North Russian dialects (Indo-European), Veps (Uralic) (Lytkin et al. 1975: 108; Koptjevskaja-Tamm & Wälchli 2001: 658; Seržant 2015a: 396, 2015b) and very rarely in Finnish (considered mostly ungrammatical, T. Huumo, p.c.). In these languages too, the partitives may denote plain quantification and occur as generalized partitives (stage (46.ii)). Moreover, generalized partitives in the subject position may be indexed on the verb according to the number value of the (former) restrictor (i.e. NP2 in (46)). In contrast with French, however, cross-indexing is found only occasionally and is not at all obligatorily:

(51) North Russian (Trubinskij in Seržant 2014b: 311)

*k jim vsegda ljudej na-begut*  
 to them always people.**GEN(=PART).PL** many-run.**3PL**  
 ‘So many people run to them (that there is no place for an apple to fall).’

(52) Sujsar’ North Russian (Markova in Seržant 2014b: 311)

*Tut-to medvedej byvajut, tol’ko malo*  
 here-PRT bear. **GEN(=PART).PL** occur.**3PL** only few  
 ‘There are bears, but only few.’

(53) Sujsar’ North Russian (Markova in Seržant 2014: 311)

*A kto rabotal pokrepče, tak ix byli*  
 but who worked stronger, CONJ **3PL.GEN(=PART)** be.PST.PL  
 ‘As regards those who worked harder, there were (some) of them.’

- (54) Veps (Uralic; Lytkin et al. 1975: 108)  
*endę kikat pidelibad mořźmīd'*  
 earlier married.woman.PART.PL carry.PST.3PL cap.ACC.PL  
 'Earlier married woman used to wear caps.'

Thus, it can be said that the partitive NP in these languages behaves just as an indefinite nominative (plural) NP, which means that the partitive (genitive) case-marking is no longer perceived as a case, which is stage (46.iii).

Note that similar to the development of generalized pseudo-partitives into quantifiers and determiners in (46), headed pseudo-partitives may also undergo the same development by which the quantifying NP turns into a modifying quantifier that does not block cross-indexing of the restrictor; consider English:

- (55) a. *A group of students was present there*  
 b. *A group of students were present there*

The original construction is (55a) in which the subset nominal (*a group*) is cross-indexed on the verb. By contrast, the development of *a group* into a quantifier makes the whole construction semantically and syntactically a single NP, very much like *some students*. Accordingly, in (55b), it is the former restrictor that provides the number value that is cross-indexed on the verb.

Finally, in some languages, the partitive marker, turned indefinite determiner, entirely loses its original semantics, yielding an unmarked pattern with no particular meaning (stage (46.iv)). Stage (46.iv) is found in some languages in which quantifier phrases have to be marked by an oblique marker that is originally the partitive marker. This is most prominently known from Slavic, Finnic, and Baltic languages, as for example in Russian:

- (56) Russian (p.k.)  
*pjat' stolov*  
 five table.GEN.PL  
 'five tables'

Here, the numeral phrase has been formed by the genitive case on the kind-referring NP 'tables'. Likewise, some existential quantifiers like *neskol'ko* 'some' also require the genitive marking on the dependent noun:



- (57) Russian (p.k.)  
*neskol'ko stolov*  
 some table.GEN.PL  
 'some tables'

The presence of the genitive – originally the partitive genitive – is obligatory and does not indicate definiteness or indefiniteness. Finally, the differential, animate-object marking of Slavic languages goes back to the genitive-under-negation, which, in turn, stems from the partitive genitive, as described in §8.2 below (Klenin 1983; Krys'ko 1994, 1997, 2006).

Parallel examples are found in Wolaytta (Na-Te-Omoti; Lamberti & Sottile 1997: 216), Central Moroccan (Afroasiatic), and Ossetic (Indo-European):

- (58) Central Moroccan or Rif Berber (Kossmann 2000: 108, 160)  
*tlata n twrar*  
 three GEN hill  
 'three hills'
- (59) Ossetic (Indo-European; Arys-Djanaïéva 2004: 107)  
*Fondz xædzar-y*  
 five house-GEN.SG  
 'five houses'

A similar situation is found in Finnic languages. Here too, some numeral and quantifier phrases require the partitive case on the noun, which, however, does not contribute any meaning.

Moreover, there is a trend in some Finnic languages to expand the partitive marking to all direct objects in terms of the default object marking. For example, the frequencies of the partitive case in the same parallel text in Estonian and Finnish are very different, with Estonian having many more partitives than Finnish (Lees 2004: 2). Accordingly, Estonian now strongly prefers partitive marking of pronominal objects in the singular of the first and second person as well as of the reflexive pronoun regardless of the semantics (including the totality contexts). What is more, the partitive marking even became obligatory in the plural across the board, even in the contexts of totality and definiteness with no negation or intensionality in the clause (L. Lindström, p.c.; Lees 2004: 1). Contrast the accusative with a noun in (60) with the partitive case on the personal pronoun in (61) in the same sentence:

(60) Estonian (Uralic; L. Lindström, p.c.)<sup>16</sup>

*Ma pesin lapse / ta puhtaks*  
 I wash.PST.1SG child.ACC.SG / 3SG.ACC clean.TR  
 ‘I washed **the child/(him/her)** clean.’

While singular indistinguishably allows for both options, plurals take only the partitive case (Liina Lindström, p.c.):

(61) Estonian (Uralic; L. Lindström, p.c.)

*Ma pesin \*teie / teid puhtaks*  
 I wash.PST.1SG \*2PL.ACC / 2PL.PART clean.TR  
 ‘I washed **you (pl)** clean.’

Thus, the partitive marking has achieved stage (46.iv) with plural pronouns in Estonian.

Similarly, to various degrees the partitive became the only direct-object marking option in other South Finnic languages as well: Livonian (Kont 1963: 103–106; Tveite 2004: 38–39), Votic (only rarely can accusative plural forms be found) (Markus & Rozhanskiy 2011: 230). The default partitive is also found in the North Finnic Ingrian (Rozhanskiy, p.c.), and even Saami (e.g. in the eastern Saami branch in Russia), which has generalized the former partitive plural as the only direct-object plural marker, that is, as an accusative (Itkonen 1972: 178). Finally, on the lexical level, many verbs in Estonian have generalized the partitive marking of their direct objects (Tamm 2006); the same is also true for Russian or Lithuanian (Seržant 2014a, 2014b) and many other languages.

## 8 Generalized partitives developing the meanings related to intensionality, negation, and aspect

In some languages, generalized partitives interact with such predicate-level domains as verbal quantification and, thus, aspectuality (§8.3). Independently from this, and often earlier, generalized partitives may co-express predicate nega-

---

<sup>16</sup> Note that the accusative case is syncretic with the possessive genitive case in the singular and with the nominative case in the plural in Finnic languages. Thus, there is no dedicated, unambiguous accusative case in Estonian.

tion (§8.2) and intensionality (§8.1). Drawing on Larjavaara (1991), I adopt the chronology of these functions (cf. also Seržant 2015a: 358) shown in Figure 2:

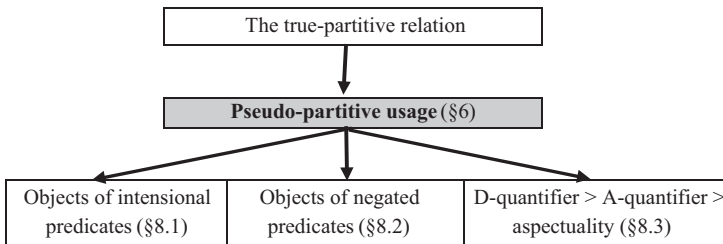

**Figure 2:** The relative chronology of negation, intensionality, and aspectuality.

## 8.1 Generalized partitives with intensional and hypothetical predicates

Intensional verbs allow for two interpretations of their objects: a specific or transparent meaning (the speaker has a particular referent in mind as the object) and an opaque, non-referential meaning, i.e. with no existential presupposition (Quine 1960: §32; Zimmermann 1993), property-denoting reading (Borschev et al. 2007; see also Neidle 1988: 31; Partee 2008).<sup>17</sup> For example, the English verb *to seek for* does not require its object to exist, as one can seek for magic items or a new planet, whereas under normal circumstances other verbs require their objects to exist (e.g. *to look at*, *to destroy*). Note that the correlation between partitives and hypothetical events is not accidental. It has been observed in the literature that hypothetical events (e.g. irrealis) may be encoded by different kinds of object demotion devices such as antipassive, for example (Givón 2001: 168).

In more archaic Indo-European languages, the partitive (genitive) was able to take over this function. Subsequently, partitives were lexicalized as the only object marking available with some of these predicates. For example, the Lithuanian verb *ieškoti* ‘to seek’ (Ambrasas, ed., 2006: 486, cf. also Endzelins 1951: 558 on earlier Latvian) or the verb *iskati* ‘to seek’ in Old and dialectal Russian require the genitive marking of the object, which goes back to the originally partitive (genitive) marking.

<sup>17</sup> Intensional meanings are concepts and are opposed to extensional meanings, which have referents; they should not be confused with *intentional* contexts (Cruse 2000: 21).

Hypothetical events are very much similar to intensional contexts in that neither require their object to exist. For example, grammatical categories such as modality (62), the future tense (63), imperative mood (64), or purpose constructions (65) denote events that are non-referential and hypothetical and thus do not impose existential requirement on the direct objects (Seržant 2014a: 290–293, 2014b: 298–301):

- (62) Lithuanian (Indo-European; Ambrazas, ed., 2006: 486; Seržant 2014a: 290)  
*Noriu stal-o su keturi-omis kėd-ėmis*  
 want.PRS.1SG table-**GEN(=PART)**.SG with four-INS.PL.F chair-INS.PL  
 ‘I want (to have) a table with four chairs.’
- (63) Lithuanian (Indo-European; Seržant 2014a: 290)  
*Važiuosiu egl-ės pirkti*  
 drive.FUT.1SG Christmas\_tree-**GEN(=PART)**.SG buy-INF  
 ‘I will go (to a marketplace) to buy a Christmas tree.’
- (64) North Russian (Indo-European; Mansikka in Seržant 2014b: 299)  
*Prinesite okutki*  
 bring.PFV.IPV.2PL blanket-**GEN(=PART)**.SG  
 ‘Bring the blanket!’
- (65) North Russian (Indo-European; Mansikka in Seržant 2014b: 298)  
*Pošla golovy poloskat’*  
 go.PST.F.SG head-**GEN(=PART)**.SG wash.IPFV-INF  
 ‘She went to wash (her) head’.

Similarly to the examples from Lithuanian and North Russian above, in a number of Finnic languages such as Finnish, Karelian, Ingrian, and Veps the partitive case is the default object marking with imperatives, embedded purpose clauses typically controlled by some motion verbs, modal verbs such as ‘want’ or ‘try’, future auxiliaries such as ‘to be going to’ (Larsson 1983: 84–85, 92–93, 103–104).

Likewise, the partitive case (-*DA*) of Yakut and Tofa (Turkic, Siberian) is only used with imperatives (Ubrjatova et al. 1982: 134), and, in Dolgan, with intended events as well (‘I will tell you a story (PART)’ (Ubrjatova 1985: 117). Furthermore, the partitive prefix *ni-* in Cherokee (Iroquoian) may denote hypothetical events rendered by English ‘almost’ (*I almost forgot . . .*) (Montgomery-Anderson 2008: 313). Similarly, the partitive verbal clitic *-te* in Apma “is often exploited to underline the uncertainty of hypothetical situations, desires, requests and attempts,” such as in irrealis expressions of intention or prospect (Schneider 2010: 167):

(66) Apma (Austronesian; Vanuatu; Schneider 2010: 167)

*Ani na=n      veb=te      nge teweb.*

but 1SG=IRR talk=**PART** just a.little.bit

‘But I’ll just talk a little bit.’

## 8.2 Generalized partitives under predicate negation

The use of partitives under predicate negation is not entirely typologically uncommon (pace Koptjevskaja-Tamm & Wälchli 2001: 729; Miestamo 2014: 67). Thus, 14% of marked partitives in my database (18/128) show some interaction between partitives and predicate negation. Most of these languages cluster in two geographical areas: Europe and Vanuatu.

Thus, a number of languages in Europe employ discontinuous negation markers that are – or historically go back to – partitives: French, modern Finnic languages, Welsh, Polish, Old Russian, and Lithuanian. However, ancient Indo-European languages (such as Ancient Greek or Latin) do not show any indication of obligatoriness. The discontinuous-negation function of the partitive is therefore historically secondary in modern Indo-European languages.

Likewise, the ablative case (Proto-Volgaic *\*-ta*) found in the Volgaic branch of Uralic must have first developed partitive functions and only later acquired the discontinuous-negation function as the comparative evidence suggests (Kiparsky 1997). Thus, in the Mordvin subbranch of Volgaic, one predominantly finds pseudo-partitive functions of the ablative (*-də/-tə* in Moksha) but no interaction with predicate negation, which is likely to be the original state of affairs in Proto-Volgaic. By contrast, most languages of the Finnic subbranch of Volgaic do require the partitive marking of the object under predicate negation in terms of a discontinuous negation marker.

The partitive preposition *o* was also obligatory with definite objects under negation in Middle Welsh (Borsley et al. 2007: 312). The same seems to be true for Old Russian as well, where, however, the accusative started penetrating into negative contexts very early.

Outside of Europe, the obligatoriness of partitives under negation is found in a number of languages of Vanuatu (Austronesian). For example, the partitive particle, turned clitic, is obligatory with transitive verbs with non-generic objects in Paamese (Crowley 1982: 147), Lewo, Lamén, South-East Ambrym, Atchin (Early 1994: 81, 84–86, 89), with prohibitives in Apma (Schneider 2010: 127), in Raga (Vari-Bogiri 2011: 149), in Araki (François 2002: 68), and in some other languages of Vanuatu:

- (67) Paamese (Austronesian; Oceania; Crowley 1982: 145)

*Ro-longe-\*(tei) inau*  
 3SG.NEG-hear-\*(PART) 1SG  
 ‘He didn’t hear me.’

Compare the following example from Rapa Nui, in which the genitive preposition seems to be motivated by the negation as well:

- (68) Rapa Nui (Austronesian; Kievet 2017: 254)

*Kai toe tā’ana o te ika, o te ’ura,*  
 NEG.PFV remain POSS.3SG.A GEN DET fish GEN DET lobster  
*o te kō’iro.*  
 GEN DET conger\_eel  
 ‘There was no fish, lobster, or conger eel left for her.’

The partitive prefix *ni-* is used as a discontinuous negation marker in conjunction with the negation marker *-v̄vna* in nominalized subordinate predicates in Cherokee:

- (69) Cherokee (Iroquoian; USA; Montgomery-Anderson 2008: 315)

*ni-uu-yóosiisk-v̄vna a-ali-stáyvvhvska*  
 PART-3-hungry.NEG.NMLZ 3A-MID-fix.a.meal.PRS  
 ‘He’s eating while he’s not hungry.’

Thakali requires genitive marking on intransitive subjects and direct objects if the predicate is negated (Georg 1996: 83–84):

- (70) Marphatan Thakali (Sino-Tibetan, Bodic; Georg 1996: 84)

*ña-se su-e a mrañ ju.*  
 1SG-ERG INDEF-GEN NEG see AUX  
 ‘I haven’t seen anyone.’

Diachronically, negation markers have the tendency to be doubled (and then renewed) by expressions whose original function is emphatic (Jespersen’s cycle, cf. van der Auwera 2009). The full Jespersen’s cycle specifically with partitives is found in Welsh, where the earlier negation marker *dim* ‘none’ fused with the partitive preposition *o* to yield the new negation marker *mo* already by the 17th c. (Borsley et al. 2007: 312).

Kuryłowicz (1971) was perhaps the first to propose an explanation for languages such as Polish that require the partitive marking on the object under

predicate negation. He suggested that the original function of the partitive here was emphasis. The indefiniteness meaning yielded by the partitive produced a stronger claim than what would actually be sufficient in the context. Consider the sentences in (71):

- (71) *Have you seen the dog with black paws here?*  
 a. *No, I haven't seen that dog here.*  
 b. *No, I haven't seen any dog here.*

(71b) is a stronger statement than (71a) in that it entails the latter but not vice versa. This is due to the reverse entailments under negation: the weaker the reference, the stronger the statement. If both options are available in the language, the stronger option is typically emphatic in that it provides more information than is actually requested. Indeed, the partitive marking of the object under predicate negation yields emphasis in Ancient Greek:

- (72) Ancient Greek (*Aristophanes*, *Vesp.* 352)  
*panta pephraktai k=ouk estin opēs*  
 all.NOM.PL.N seal.PERF.3SG and=NEG be.3SG hole.GEN(=PART).SG  
 ‘Everything is sealed fast; and there is no (single) **hole** (that even a gnat could get through).’

The partitive genitive is by no means obligatory here. Moreover, it does not quantify over the referent of its NP ‘hole’ such as \*‘some of the hole/some hole’. The partitive marking yields the emphatic effect: ‘there is not a single instance of a hole there’, that is, ‘there is no hole whatsoever/there aren’t any holes here’.

The initial stage at which partitives still feature emphasis is also attested outside of ancient Indo-European languages. Many Bantu languages employ class 16 or 17 partitive (=locative) indexes in marking negation (Devos & van der Auwera 2013; Persohn & Devos 2017: 20). For example, the partitive (=locative) particle =*khwo* in Luhya (Bantu) “serves to reinforce negation” (Persohn & Devos 2017: 20).

The partitive-locative preposition *m* in Ancient Egyptian also adds emphasis to the negation (Winand 2015: 539–540). Likewise, the partitive particle *tuur* of Avava (Austronesian) conveys the emphatic meaning ‘at all’ when used with the predicate negation (Crowley 2006: 79). Example (73) illustrates the partitive particle =*te* in Apma that conveys an emphatic meaning in negated transitive sentences in Apma but is obligatory with the existential *bibi* ‘to be’ (Schneider 2010: 127, 168–169; cf. also Crowley 1982: 141 on Paamese; Budd 2014: 555–556):

(73) Apma (Austronesian; Vanuatu; Schneider 2010: 169)

‘What did you kill yesterday?’

- a. *Na=t=ba*            *ih bamte*            *abma=nga.*  
 1SG=PFV=NEG.1    hit make.die            something=NEG.2  
 ‘I don’t kill things.’
- b. *Na=t=ba*            *ih bamte=te*            *abma=nga.*  
 1SG=PFV=NEG.1    hit make.die=**PART**    something=NEG.2  
 ‘I didn’t kill anything.’

I summarize:

(74) Emergence of negation markers from partitives

(i) *partitive induces emphasis* (‘at all’, ‘(not) a single’, ‘any’) > (ii) *partitive is obligatory* > (iii) *the former partitive is the only negation marker*

The full development (74.i–iii) is found, for example, in the Modern Welsh negation marker *mo*, which etymologically contains the partitive marker *o*. Most languages discussed above are at stage (74.i) or (74.ii).

### 8.3 Generalized partitives and emergence of aspectual meanings

Consider the following examples from North Russian and Finnish:

(75) North Russian (Indo-European; Malyševa in Seržant 2015a: 388)

*Ja otvorju dverej*  
 1SG open.FUT.1SG door.GEN(=**PART**).PL  
 ‘I will [**somewhat/partly**] open the door(s).’

(76) Finnish (Finnic, Uralic; Kiparsky 1998)

*Hän avasi ikkunaa*  
 3SG.NOM opened window.**PART**  
 a. ‘(S)he opened the window [**for a while/partly/somewhat**].’  
 b. ‘(S)he was opening the window.’

Both partitives are pseudo-partitives in that they reside on the formal means of partitives but do not encode the true-partitive relation. Instead, they encode plain quantification but with the quantifier quantifying the event and not the referent of the hosting NP: in both examples, the partitive marking encodes the quanti-



fier ‘some(what)’ that quantifies the event and not the host NPs ‘door’ (72) and ‘window’ (73) which are affected holistically throughout the process of opening. This quantifier induces the *delimitative* interpretation of the event (see Sasse 2002; Mehlig 2006 for the term) that is sometimes referred to as “partial completion” (cf. Schneider 2010: 167) in both languages, cf. (75) and (76a), while the progressive meaning (76b) is solely available in Finnish. The delimitative meaning ‘some(what) / a little bit / for a while’ in these examples is typologically the meaning that is most consistently found with aspectually-relevant partitives cross-linguistically.

In some languages, like Finnish (76b), the meaning may even be broader to include also other kinds of non-culminating events such as progressives. For Finnish, it can be said that the partitive encodes actionality (and not aspect in the strict sense of, e.g., Smith 1997), i.e. non-culmination of the event encoded by the verb phrase with the object either bounded (delimitative) or unbounded (progressive). By contrast, the meaning induced by the partitive in North Russian, Russian and Lithuanian is narrower: it is only compatible with the delimitative subtype of non-culminating events, while, e.g., the progressive meaning is ungrammatical (Seržant 2014b: 285; 2015a: 386).

Approximately 10% (13/128) of the marked partitives in my sample develop functions pertaining to the domain of aspectuality. Notably, only those languages in my sample that allow for the pseudo-partitive meaning allow for the interaction with aspectuality. This suggests that the diachronic development of aspectuality-relevant functions presupposes the development of partitives into pseudo-partitives:

(77) The development of aspectuality-relevant functions<sup>12</sup>

(i) *the true-partitive relation* > (ii) + *plain quantification* > (iii) + *aspectuality*

The diachronic mechanism for the development of aspectuality-relevant functions involves a very frequent development. A(dverb)-quantifiers most frequently develop from former D(eterminer) quantifiers (Keenan & Paperno 2012: 948; cf. also Budd 2014: 554–555),<sup>18</sup> cf. the English quantifier *a lot*:

(78) D-quantifier >> A-quantifier  
*He bought a lot of flowers.* >> *He has been buying flowers a lot.*

<sup>18</sup> A-quantifier is shortened from A(dverb)-quantifier, i.e. a quantifier that quantifies predicates and patterns morphosyntactically as an adverb, while D(eterminer)-quantifier is a quantifier that quantifies nominal expressions and forms constituency with them (cf. Löbner 1985; Partee 1995).

In the same way, generalized pseudo-partitives which denote indefinite quantity ('some' or 'any') may also undergo the same development by which its D-quantifier 'some' extends to an A-quantifier 'somewhat'.

Note that, in contrast to generalized partitives in North Russian (75) or Finnish (76), the quantifier *a lot* in English changed its linear position in the clause to clause-final, when extending its semantic scope from D-quantification to A-quantification. A change in linear position is less likely with adpositions and case inflection because these are more strongly morphologically integrated into the host NP. In this sense, the development found in North Russian or Finnish is only unusual in that the new A-quantifier is still morphologically integrated within the object NP, while the very semantic extension of a D-quantifier into an A-quantifier is a frequent development cross-linguistically (Keenan & Paperno 2012: 948).

Accordingly, NP-external partitive markers such as a partitive pronoun or a quantifier are more likely to undergo this development (78) because pronouns and quantifiers usually stem from independent words and, therefore, have more positional flexibility at least to begin with. This seems to be the reason for why partitives encoded by adpositions or case inflection within an NP are much less prone to developing aspectuality-related functions than partitive pronouns or quantifiers, cf. Table 6:

**Table 6:** Different strategies vs. aspectuality-related functions.

	locative	separative	possessive	particles (pronouns/quantifiers)
<b>aspectually relevant</b>	0%	9%	<b>13%</b>	<b>33%</b>
Irrelevant	100%	91%	<b>88%</b>	<b>67%</b>

Indeed, partitive pronouns and quantifiers very often move closer to the verb complex in different languages, not only in French (the partitive pronoun *en*), but also in a number of Austronesian languages of Vanuatu and Micronesia (Budd 2014). For example, the partitive quantifier *tuut* 'some' in Avava is found in its original, postnominal modifier position (79) and in the new, postverbal position (80) (Budd 2014: 553–556), cf.:

(79) Avava (Austronesian; Vanuatu; Budd 2014: 553)

*Komat-yan mwiniel i moroko-n tuut ier*  
 1PL.EXC.R-eat taro INS rib-3SG **some/PART** PL  
 'We ate the taro with some of its ribs.'

- (80) *I-yan tuut emer ki*  
 3SG.R-eat **PART** eel DEM  
 ‘He ate some of the eel.’

Many other languages of Vanuatu developed aspectuality-related functions, e.g. Apma, Araki, Bierebo, Erromanga, Lewo, and other languages (Early 1994; Budd 2014: 544–545; Schneider 2010: 167–170).<sup>19</sup> Rapa Nui has a verbal degree modifier *'apa* ‘somewhat, kind of’, cf. (81), which precedes the verb root and stems itself from a noun meaning ‘part, portion, piece’ (Kieviet 2017: 340).

- (81) Rapa Nui (Austronesian; Kieviet 2017: 340)  
*Ko 'apa ora 'iti 'ā a au.*  
 PRF **PART** live little CONT DET 1SG  
 ‘I am somewhat recovered.’

Although it is attached to the verb root it may still quantify the object:

- (82) Rapa Nui (Austronesian; Kieviet 2017: 340)  
*Ko 'apa rova'a mai 'ā te me'e pāreherehe matā.*  
 PRF **PART** obtain hither CONT DET thing piece obsidian  
 ‘We obtained a few pieces of obsidian.’

Furthermore, a number of Bantu languages developed aspectuality-related functions of partitives which are also related to the meaning of ‘somewhat’. Similarly to aspectually-relevant partitives in languages of Vanuatu, in the Bantu language Ruund, the partitive indexes (the locative strategy, the NP-external type) *-p* and *-kù* are partitive markers that may either scope over the object NP, inducing the meaning ‘some of’ (83), or over the predicate (84) while morphologically they attach to the verb (Nash 1992: 971–972; Persohn & Devos 2017: 17):

- (83) Ruund (Bantu; Nash 1992: 972)  
*ku-ma-landâ-p māsatu*  
 INF-6(=PL)-buy-16(=PART) three  
 ‘to buy three of them’

<sup>19</sup> In Apma and Araki, the perfective marker is also homonymous with the partitive marker. If this is not an accident, this is reminiscent of the partitive genitive in Russian and, to some extent in Lithuanian, which typically occurs with the perfective viewpoint only (Seržant 2014a, 2014b).

(84) Ruund (Bantu; Nash 1992: 971)

*ku-mw-iimikà-p*

INF-1-stop-16(=PART)

'to stop him for a while'

Nearly any accomplishment and even some achievement verbs (such as *to shoot*) interact with generalized partitives in Finnish and other Finnic languages. While the pattern we observe in North Russian or in Finnish in (75) and (76) above is very advanced, other languages attest a more modest degree of semantic extension of the partitive. In other languages, for example in Avava (Austronesian), Standard Russian or in Lithuanian (both Indo-European), the generalized partitive affects the aspectual interpretation of only a small subset of accomplishment verbs confined to incremental-theme verbs such as *to eat* or *to drink*. Somewhat unfamiliar in this context is the English conative construction with *at* (Levin 1993: 6), sometimes with *on* (Levin 1993: 43), which is also based on an incremental-theme verb with a locative marker that induces the meaning of partitivity:

(85) a. *Margaret cut the bread.*

b. *Margaret cut at the bread.*

c. *The mouse nibbled on the bread.*

Incremental-theme verbs establish the isomorphic relation between the quantity of the object and the quantity of the event. They represent a natural bridge between the quantity of the object and the quantity of the verb and are, therefore, in general, natural targets to interact with quantification of the object, including partitives. Incremental-theme verbs are thus diachronically the first predicates that allow for event quantification by partitives (Kiparsky 1998). Accordingly, I suggest the following cline in the development of aspectuality-relevant functions of partitives:

(86) The expansion of partitive quantification in the clause in stages<sup>12</sup>

(i) *NP quantification only* > (ii) *+incremental NP and VP quantification* > (iii) *+VP quantification only*

Furthermore, in addition to the delimitative and non-culminating meanings, partitives sometimes also develop the cessative meaning ('trying to'). This meaning is frequently found in Finnic languages but also elsewhere. Consider the following example from Lewo (87b) in which the partitive marker *re* may not only quantify the object referent (87a) but also the predicate:

- (87) Lewo (Austronesian; Oceania; Early 1994: 81)

*Ne-suña na sineun sape na-kan re kumpui.*

1SG-stayed now 1SG.wanted COMP 1SG-eat **PART** pork

a. 'After a while I wanted to eat a bit of pork.'

b. 'After a while I wanted to **try** eating some pork.'

This cessative meaning is semantically very close to the aspectual, delimitative meaning 'somewhat, a little bit' in that a try often implies a small portion of the event, cf. English *I tried to eat pork* vs. *I ate pork a little bit*.

Finally, the aspectual function of delimitation is often employed for pragmatic purposes such as politeness. This has been reported for Polish (Holvoet 1991: 110), Lithuanian, Belarusian, Russian dialects (Indo-European; Seržant 2015a: 389–390), Finnic languages (Uralic; Larsson 1983), Hidatsa (Siouan; Park 2012: 481), a number of Bantu languages (Persohn & Devos 2017; Halme-Berneking 2017: 147) such as Few (Gunnink 2018: 132, 274) or Bemba:

- (88) Bemba (Bantu; Persohn & Devos 2017: 19)

*m-pél-é-ní=kó*

OBJ1SG-give-IMP-PL=**17LOC(=PART)**

'Give (you all) me, please!'

Here, the pragmatic function of politeness certainly draws on the more basic aspectual function of delimitation, i.e. literally 'give me for a while/a little bit'. The delimitative function softens the request.

## 8.4 Summarizing the additional meanings of generalized partitives

Above I have demonstrated the mechanisms by which partitives encoding the true-partitive relation develop additional functions: intensionality and hypothetical events (§8.1), affinity to predicate negation (§8.2), and to the aspectuality interpretation of the event (§8.3). Crucially, given that all languages that attest any kind of interaction with negation and/or aspectuality allow for encoding plain quantification (pseudo-partitive) as well, I conclude that these additional functions presuppose the development of the pseudo-partitive use:

- (89) Development of predicate-level functions of partitives
- <sup>12</sup>

*true-partitive* > + *pseudo-partitive* > + *affinity to predicate negation* /  
+ *aspectual interpretation of the event*

The cline in (86) is supported by the quantitative evidence from the database in Table 7:

**Table 7:** The frequency of related meanings in the database.<sup>20</sup>

The true-partitive relation	Plain quantification	Negation	Aspectuality
100%	53% (61/116)	14% (16/117)	12% (14/116)

Note that not only are there many more partitives that may pattern as pseudo-partitives (encoding plain quantification) but also that all partitives that have negation and/or aspectuality-related functions are found as pseudo-partitives as well (but not vice versa).

Furthermore, the assumption that the development of the pseudo-partitive use by a partitive is the precondition for the negation and aspectuality functions receives additional support. In some languages, quantifiers like ‘some’ or ‘a few’ may also become obligatory under negation, while not attesting the true-partitive relation. For example, the verbal markers *-xo* ‘some’ in Saamia or *-po* ‘a bit’ in Ndali and Nyakyusa (Atlantic-Congo; Botne et al. 2006: 79–80; Botne 2008: 91ff), *-tei* ‘a bit’ in Paamese (Austronesian; Crowley 1982: 144) are used as verb-incorporated quantifiers ‘some’ or ‘a bit’ and do not attest examples of the true-partitive relation as far as I can tell from the grammars. At the same time, these markers interact with clause negation and/or aspectuality. This evidence supports the claim that the meaning of plain quantification is the prerequisite of negation and aspectuality-related functions and not the original, true-partitive relation.

## 9 Conclusions

The most frequent development that partitive expressions undergo is the development of the pseudo-partitive usage, resulting from the demise of the Partitivity Constraint, along cline (41) repeated here for convenience as (90) (Koptjevskaja-Tamm 2009: 341; Carlier & Lamiroy 2014: 486; Seržant, *forthc.*):

- (90) Functional change resulting from the demise of the Partitivity Constraint<sup>12</sup>  
 (a) *true-partitives* > (b) *+faded partitives* > (c) *+pseudo-partitives*

<sup>20</sup> Note that partitives encoded by the zero strategy are excluded from these counts.

Thus, the co-expression of the true-partitive relation and of plain quantification by the same partitive construction cross-linguistically is the most frequent co-expression pattern in the domain of partitives: 53% (61/116) of all non-zero strategies to encode the true-partitive relation in my sample allow for the plain-quantification meaning as well. The frequency of co-expression does not entail, of course, the direction of change itself. However, I have presented diachronic evidence in favour of the change from partitives expressing the true-partitive relation only into pseudo-partitives. Thus, I claim that (90) is true for all partitives that stem from an adpositional strategy, that is, the locative, separative, and possessive strategies, including possessive indexes. Moreover, along with the semantic extension in (90), there is also the development towards reduction of the syntactic structure as in (46), repeated in (91) for convenience:

- (91) Reduction of the syntactic structure along with the development into generalized partitive and then into pseudo-partitive  
 (i)  $[NP1]$  adposition  $[NP2]$  > (ii) adposition  $[NP1]$  > (iii) determiner  $[NP]$  > (iv)  $\emptyset$   $[NP]$

This indicates that partitives that are only capable of expressing the true-partitive relation are not semantically and syntactically stable cross-linguistically. Indeed, languages for which there is a historical record attest recurrent renewals of partitives.

By contrast, existential quantifiers sometimes undergo the reverse change: from encoding only plain quantification into a marker of the true-partitive relation. For example, it can be said that English does have a partitive quantifier that developed out of an existential, indefinite quantifier, namely, stressed *SOME* (as opposed to the unstressed *s'm*). However, the situation is not entirely clear, since it might be an effect of the stress which creates alternatives (Klaus von Heusinger, p.c.).

Furthermore, while the true-partitive relation requires two referents – the subset and the superset referent – many languages develop generalized partitive constructions that only consist of a single NP. The motivation behind this is the strong frequency bias of true-partitives towards indefiniteness (of the subset quantifier). This frequency bias leads to a more efficient coding, which, in turn, allows speakers to minimize their production effort with no concomitant information loss. In other words, if the meaning of the subset quantifier is always indefinite existential, there is no need to encode the quantifier since this meaning will be understood anyway. The conventionalization of quantifier drop proceeds along the following steps in (33), repeated here as (92) for convenience:

- (92) Intermediate stages in the emergence of generalized partitives (Seržant 2015: 148)  
*explicit quantifier > elliptical, implicit subset with traces in morphosyntax > no traces of the quantifier*

As a consequence, generalized partitives often develop away from the respective partitives with an explicit quantifier. For example, generalized partitives may enter the domain of argument marking of the verb, such as in terms of differential argument marking (cf. Witzlack-Makarevich & Seržant 2018: 15–16) along the cline in (37), repeated here as (93) for convenience:

- (93) Expansion of generalized pseudo-partitives across grammatical roles<sup>12</sup>  
 (i) *direct objects only* > (ii) + *existential, inactive subjects* > (iii) + *some transitive subjects*

Once generalized partitives develop the ability to express plain quantification and thus pattern as generalized pseudo-partitives, they may start interacting with the predicate in such domains as aspectuality, negation or intensional and hypothetical predication and may be conventionalized as markers (co-)expressing particular functions in these domains. For example, partitives often take part in Jespersen's cycle by developing into discontinuous predicate negation or double negation markers (e.g. in Lithuanian, Polish, Estonian, Paamese, Lewo, Lamem, Raga, or Cherokee).

Likewise, generalized pseudo-partitives may enter the domain of aspectuality. For example, Finnic languages – unlike many European languages (cf. English *to eat* vs. *to eat up*) – do not have means to morphologically distinguish between non-culminating and culminating accomplishments. The partitive case-marking of the object may be employed for this purpose here: a predicate with a partitive-case-marked direct object is always non-culminating. I have argued – building on Kiparsky (1998) – that the expansion of partitives in this domain typically runs along the scale in (86) (repeated as (94) for convenience):

- (94) The expansion of partitive quantification in the clause in stages<sup>12</sup>  
 (i) *NP quantification only* > (ii) +*NP and VP quantification* > (iii) +*VP quantification only*

Crucially, in order to develop aspectuality or negation-related functions, generalized partitives must first undergo the development into pseudo-partitives.



## References

- Aiton, Grant. 2014. Grammatical relations and information structure in Eibela: a typological perspective. *Language and Linguistics in Melanesia* 32(2). 1–25.
- Aiton, Grant. 2016. *Grammatical relations and information structure in Eibela: A typological perspective*. Townsville: James Cook University doctoral dissertation.
- Alho, Irja H. 1992. Distinguishing kind and set in Finnish. *Studies in the Linguistic Science* 22(1). 1–14.
- Ambrazas, Vytautas (ed.). 2006. *Dabartinės lietuvių kalbos gramatika* [A grammar of Modern Lithuanian]. Vilnius: Lietuvių kalbos institutas.
- Anderson, Gregory D. & David K. Harrison. 1999. *Tyvan* (Languages of the World/Materials 257). München: Lincom.
- Arys-Djanaïéva, Lora. 2004. *Parlons Ossète* (Collection Parlons). Paris: L'Harmattan.
- Atoyebi, Joseph Dele. 2010. *A reference grammar of Oko: A West Benue-Congo language of North-Central Nigeria* (Grammatical Analysis of Africans Languages 37). Köln: Rüdiger Köppe.
- Authier, Gilles. 2009. *Grammaire kryz: Langue caucasique d'Azerbaïdjan, dialecte d'Alik*. Paris: Peeters.
- Auwers, Johan van der. 2009. The Jespersen Cycles. In Elly van Gelderen (ed.), *Cyclical change*, 35–71. Amsterdam: Benjamins.
- Bagaev, N. K. 1965. *Sovremennyj osetinskij jazyk*. Ordžonikidze: Severo-osetinskoe knižnoe izdatel'stvo.
- Barchas-Lichtenstein, Jena. 2012. Garifuna Quantification. In Edward L. Keenan & Denis Paperno (eds.), *Handbook of quantifiers in natural language*, 165–226. Dordrecht: Springer.
- Barwise, Jon & Robin Cooper. 1981. Generalized quantifiers and natural language. *Linguistics and Philosophy* 4. 159–219.
- Borschev, Vladimir, Elena V. Paducheva, Barbara H. Partee, Yakov G. Testelefs & Igor Yanovich. 2007. Russian genitives, non-referentiality, and the property-type hypothesis. In Andrei Antonenko, John F. Bailyn & Christina Y. Bethin (eds.), *Formal approaches to Slavic linguistics: The Stony Brook Meeting 2007* (FASL 16). Ann Arbor: Michigan Slavic Publishers.
- Borsley, Robert D., Maggie Tallerman & David Willis. 2007. *The syntax of Welsh* (Cambridge Syntax Guides). Cambridge: Cambridge University Press.
- Botne, Robert, Ochwada Hannington & Michael R. Marlo. 2006. *A grammatical sketch of the Lusaamia verb* (Grammatikalisches Analysen afrikanischer Sprachen 30). Köln: Rüdiger Köppe.
- Botne, Robert. 2008. *A grammatical sketch of Chindali: Malawian variety* (Lightning Rod Press Series 2). Philadelphia: American Philosophical Society.
- Budd, Peter. 2014. Partitives in Oceanic languages. In Silvia Luraghi & Tuomas Huomo (eds.), *Partitive cases and related categories* (Empirical Approaches to Language Typology 54), 523–562. Berlin & Boston: De Gruyter Mouton.
- Cardinaletti, Anna & Giuliana Giusti. 2015. Cartography and optional feature realization in the nominal expression, beyond functional sequence. In Guglielmo Cinque & Luigi Rizzi (eds.), *The cartography of syntactic structures*, vol. 10, 151–172. Oxford UK & New York: Oxford University Press.

- Carlier, Anne & Béatrice Lamiroy. 2014. The grammaticalization of the prepositional partitive in Romance. In Silvia Luraghi & Tuomas Huomo (eds.), *Partitive cases and related categories* (Empirical Approaches to Language Typology 54), 477–522. Berlin & Boston: De Gruyter Mouton.
- Casad, Eugene H. 1984. Cora. In Ronald W. Langacker (ed.), *Studies in Uto-Aztecan grammar 4: Southern Uto-Aztecan grammatical sketches*, 153–459. Dallas: Summer Institute of Linguistics and the University of Texas at Arlington.
- Comrie, Bernard. 1981. *Language universals and linguistic typology: Syntax and morphology*. Chicago: University of Chicago Press.
- Comrie, Bernard. 1989. Some general properties of reference-tracking systems. In Doug Arnold, Martin Atkinson, Jacques Durand, Claire Grover & Louisa Sadler (eds.), *Essays on grammatical theory and universal grammar*, 37–51. Oxford: Clarendon.
- Croft, William. 1988. Agreement vs. case marking and direct objects. In Michael Barlow & Charles A. Ferguson (eds.), *Agreement in natural language: Approaches, theories, descriptions*. Stanford: CSLI.
- Crowley, Terry. 1982. *The Paamese language of Vanuatu* (Pacific Linguistics, Series B 87). Canberra: Research School of Pacific and Asian Studies. Australian National University.
- Cruse, Alan. 2000. *Meaning in language: An introduction to semantics and pragmatics*. Oxford: Oxford University Press.
- Dahl, Eystein. 2014. Partitive subjects and objects in Indo-Iranian and beyond. In Silvia Luraghi & Tuomas Huomo (eds.), *Partitive cases and related categories* (Empirical Approaches to Language Typology 54), 417–442. Berlin & Boston: De Gruyter Mouton.
- Dombrowsky-Hahn, Klaudia. 2015. *A grammar of Syer (Western Karaboro, Senufo): Phonology, morphology, argument realization* (Gur Monographs 12). Köln: Rüdiger Köppe.
- Dowty, David & Belinda Brodie. 1984. The semantics of “floated” quantifiers in a transformationless grammar. *Proceedings of the West Coast Conference on Formal Linguistics* 3. 75–90. CSLI Publications.
- Du Bois, John. 1987. The discourse basis of ergativity. *Language* 63. 805–852.
- Dum-Tragut, Jasmine. 2009. *Armenian: Modern Eastern Armenian*. Amsterdam: John Benjamins.
- Early, Robert J. 1994. *A grammar of Lewo, Vanuatu*. Canberra: Australian National University dissertation.
- Enç, Murvet. 1991. The semantics of specificity. *Linguistic Inquiry* 22(1). 1–25.
- Endzelīns, Jānis. 1951. *Latviešu valodas gramatika* [Grammar of the Latvian language]. Riga: Latvijas valsts izdevniecība.
- Enrico, John. 2003. *Haida syntax* (Studies in the Anthropology of North American Indians). 2 vols. Lincoln: University of Nebraska Press.
- Erdal, Marcel. 2004. *A grammar of Old Turkic*. Leiden & Boston: Brill.
- Etxeberria, Urtzi. 2021, this volume. The partitive marker in Basque and its relation to bare nouns and the definite article. In Petra Sleeman & Giuliana Giusti (eds.), *Partitive determiners, partitive pronouns and partitive case* (Linguistische Arbeiten 580). Berlin: de Gruyter.
- Frajzyngier, Zygmunt. 2002. *A grammar of Hdi* (Mouton Grammar Library 21). Berlin & New York: Mouton de Gruyter.
- François, Alexandre. 2002. *Araki: A disappearing language of Vanuatu* (Pacific Linguistics 522). Canberra: Research School of Pacific and Asian Studies. Australian National University.
- Georg, Stefan. 1996. *Marphatan Thakali: Untersuchungen zur Sprache des Dorfes Marpha im Oberen Kāli-Ganṇḍaki-Tal/Nepal* (LINCOM Studies in Asian Linguistics 02). München: Lincom.

- Giusti, Giuliana & Petra Sleeman. 2021, this volume. Partitive elements in the languages of Europe. An advancement in the understanding of a multifaceted phenomenon. In Petra Sleeman & Giuliana Giusti (eds.), *Partitive determiners, partitive pronouns and partitive case* (Linguistische Arbeiten 580). Berlin: de Gruyter.
- Givón, Talmy. 2001. *Syntax*, vol. 2. Amsterdam & Philadelphia: John Benjamins.
- Glaser, Elvira. 1992. Umbau partitiver Strukturen in der Geschichte des Deutschen. *Sprachwissenschaft* 17(2). 113–132.
- Gunnink, Hilde. 2018. *A grammar of Fwe: A Bantu language of Zambia and Namibia*. Ghent: University of Ghent dissertation.
- Halme-Bernecking, Riikka. 2017. Oshikwanyama locative enclitics (and their non-locative functions). *Africana Linguistica* 23. 137–150.
- Haspelmath, Martin. 2008a. Frequency vs. iconicity in explaining grammatical asymmetries. *Cognitive Linguistics* 19(1). 1–33.
- Haspelmath, Martin. 2008b. Creating economical patterns in language change. In Jeff Good (ed.), *Linguistic universals and language change*, 185–214. Oxford: Oxford University Press.
- Haspelmath, Martin. 2008c. A frequentist explanation of some universals of reflexive marking. *Linguistic Discovery* 6(1). 40–63.
- Haspelmath, Martin. 2011. On S, A, P, T, and R as comparative concepts for alignment typology. *Linguistic Typology* 15(3). 535–567.
- Heath, Jeffrey. 2008. *A grammar of Jamsay* (Mouton Grammar Library 45). Berlin: Mouton de Gruyter.
- Heath, Jeffrey. 2015. *A grammar of Togo Kan (Dogon language Family, Mali)*. University of Michigan. Draft Ms, July 2015.
- Heusinger, Klaus von. 2002. Specificity and definiteness in sentence and discourse structure. *Journal of Semantics* 19(3). 245–274.
- Heusinger, Klaus von & Jaklin Kornfilt. 2017. Partitivity and case marking in Turkish and related languages. *Glossa* 2(1). 1–40.
- Hill, Jane H. & Kenneth C. Hill. 1986. *Speaking Mexicano: Dynamics of syncretic language in Central Mexico*. Tucson, AZ: University of Arizona Press.
- Hober, Nicole. forthcoming. On the intrusion of the Spanish preposition *de* into the languages of Mexico. *Journal of Language Contact*.
- Hoeksema, Jacob. 1996. Introduction. In Jacob Hoeksema (ed.), *Partitives: Studies on the syntax and semantics of partitive and related constructions* (Groningen-Amsterdam Studies in Semantics 14), 2–24. Berlin & New York: Mouton de Gruyter.
- Hofling, Charles Andrew & Félix Fernando Tesucún. 2000. *Itzaj Maya grammar*. Salt Lake City: University of Utah Press.
- Hofstede, Antje Ida. 1998. *Syntax of Jibbāli*. Manchester: University of Manchester doctoral dissertation.
- Holvoet, Axel. 1991. *Transitivity and clause structure in Polish: A study in case marking*. Warszawa: Slawistyczny Ośrodek Wydawniczy.
- Hoop, Helen de. 1997. A semantic reanalysis of the partitive constraint. *Lingua* 103(2/3). 151–174.
- Hoop, Helen de. 2003. Partitivity. In Lisa Cheng & Rint Sybesma (eds.), *The second Glot international state-of-the-article book*. Berlin & New York: Mouton De Gruyter.
- Horton, A. E. 1949. *A grammar of Luvale*. Johannesburg: Witwatersrand University Press.
- Huumo, Tuomas. 2018. The partitive A: On uses of the Finnish partitive subject in transitive clauses. In Ilja A. Seržant & Alena Witzlack-Makarevich (eds.), *Diachrony of differential*

- argument marking* (Studies in Diversity Linguistics), 383–411. Berlin: Language Science Press.
- Huumo, Tuomas. 2021, this volume. Longitudinal or transverse? How the unbounded quantity expressed by the Finnish partitive case relates to time. In Petra Sleeman & Giuliana Giusti (eds.), *Partitive determiners, partitive pronouns and partitive case* (Linguistische Arbeiten 580). Berlin: de Gruyter.
- Ihsane, Tabea. 2013. EN pronominalisation in French and the structure of nominal expressions. *Syntax* 16(3). 217–249.
- Ionin, Tania, Ora Matushansky & Eddy G. Ruys. 2006. Parts of speech: Towards a unified semantics for partitives. In Christopher Davis, Amy Rose Deal & Youri Zabbal (eds.), *Proceedings of NELS 36*, 357–370. Amherst: University of Massachusetts.
- Itkonen, E. 1972. Über das Objekt in den finnisch-wolgaischen Sprachen. *Finnisch-ugrische Forschungen* 39. 153–213.
- Jackendoff, Ray. 1977. *X-bar syntax: A study of phrase structure*. Cambridge, MA: MIT Press.
- Keenan, Edward L. & Denis Paperno. 2012. Overview. In Edward L. Keenan & Denis Paperno (eds.), *Handbook of quantifiers in natural language*, 941–950. Dordrecht: Springer.
- Khalilova, Zaira. 2009. *A grammar of Khwarshi*. Leiden: Rijksuniversiteit te Leiden doctoral dissertation.
- Kibrik, Aleksandr E. 1977. *Arčinskij jazyk: Teksty i slovari* (Publikacii otdelenija strukturnoj i prikladnoj lingvistiki 14). Moscow: Izdatel'stvo Moskovskogo Universiteta.
- Kieviet, Paulus. 2017. *A grammar of Rapa Nui*. Berlin: Language Science Press.
- Kiparsky, Paul. 1998. Partitive case and aspect. In Miriam Butt & Wilhem Geuder (eds.), *The projection of arguments: Lexical and compositional factors* (CSLI Lecture Notes 83), 265–307. Stanford: CSLI Publications.
- Klenin, Emily. 1983. *Animacy in Russian: A new interpretation*. Columbus, Ohio: Slavica Publishers, Inc.
- Kont, Karl. 1963. *Käändsõnaline objekt läänemeresoome keeltes*. Keele ja kirjanduse instituudi uurimused IX. Tallinn: Eesti NSV Teaduste Akad.
- Koptjevskaja-Tamm, Maria. 2001. A piece of the cake and a cup of tea: Partitive and pseudo-partitive nominal constructions in the Circum-Baltic languages. In Östen Dahl & Maria Koptjevskaja-Tamm (eds.), *The Circum-Baltic languages: Typology and contact*, vol. 2: *Grammar and typology* (Studies in Language Companion Series), 523–568. Amsterdam & Philadelphia: John Benjamins.
- Koptjevskaja-Tamm, Maria. 2009. “A lot of grammar with a good portion of lexicon”: towards a typology of partitive and pseudopartitive nominal constructions. In Johannes Helmbrecht, Yoko Nishina, Yong-Min Shin, Stavros Skopeteas & Elisabeth Verhoeven (eds.), *Form and function in language research: Papers in honour of Christian Lehmann*, 329–346. Berlin & New York: Mouton de Gruyter.
- Koptjevskaja-Tamm, Maria & Bernhard Wälchli. 2001. The Circum-Baltic languages: An areal-typological approach. In Östen Dahl & Maria Koptjevskaja-Tamm (eds.), *The Circum-Baltic languages: Typology and contact*, vol. 2: *Grammar and typology* (Studies in Language Companion Series), 615–750. Amsterdam & Philadelphia: John Benjamins.
- Kornfilt, Jaklin. 1996. Naked partitive phrases in Turkish. In Jacob Hoeksema (ed.), *Partitives: Studies on the syntax and semantics of partitive and related construction*, 107–142. Berlin & New York: Mouton de Gruyter.
- Kossmann, Maarten G. 2000. *Esquisse grammaticale du rifain oriental* (Publ. de la SELAF, Société des Etudes Linguistiques et Anthropologiques de France 387). Leuven: Peeters.

- Krys'ko, Vadim B. 1994. *Razvitie kategorii oduševlennosti v istorii russkogo jazyka*. Moskva: Lyceum.
- Krys'ko, Vadim B. 1997. *Istoričeskij sintaksis russkogo jazyka. Ob"ekt i perechodnost'*. Moskva: Azbukovnik.
- Krys'ko, Vadim B. 2006. *Istoričeskij sintaksis russkogo jazyka. Ob"ekt i perechodnost'*. 2-e izdanje, ispravlennoe i dopolnennoe. Moskva: Azbukovnik.
- Kuryłowicz, Jerzy. 1964. *The inflectional categories of Indo-European*. Heidelberg: Carl Winter Universitätsverlag.
- Kuryłowicz, Jerzy. 1971. Słowiański genitivus po negacii. In Stanisław Urbańczyk (ed.), *Sesja naukowa międzynarodowej komisji budowy gramatycznej języków słowiańskich: w Krakowie w dniach 3–5 grudnia 1969*, 11–14. Wrocław: Zakład Narodowy im. Ossolińskich.
- Ladusaw, William A. 1982. Semantic constraints on the English partitive construction. In Daniel P. Flickinger, Marlys Macken & Nancy Wiegand (eds.), *Proceedings of the First West Coast Conference on Formal Linguistics (WCCFL 1)*, 231–242. Stanford, CA: Stanford Linguistics Association.
- Lagae, Véronique. 2001. Le pronom *en*: des compléments adnominaux aux syntagmes quantificateurs. *Travaux de Linguistique* 2001/1-2 (42–43), 43–57.
- Lamberti, Marcello & Roberto Sottile. 1997. *The Wolaytta language* (Studia Linguarum Africae Orientalis 6). Köln: Rüdiger Köppe.
- Larjavaara, Matti. 1991. Aspektuaalisen objektin synty [The origin of the aspectual object]. *Virittäjä* 95. 372–408.
- Larsson, Lars-Gunnar. 1983. *Studien zum Partitivgebrauch in den ostseefinnischen Sprachen* (Acta Universitatis Upsaliensis 15). Uppsala: Borgströms Tryckeri AB.
- Leer, Jeffrey A. 1991. *The schetic categories of the Tlingit verb*. Chicago, Ill.: University of Chicago doctoral dissertation.
- Lees, Aet. 2004. Partitive-accusative alternations in Balto-Finnic languages. In Christo Moskovsky (ed.), *Proceedings of the 2003 Conference of the Australian Linguistics Society*.
- Levin, Beth. 1993. *English verb classes and alternations: A preliminary investigation*. Chicago: University of Chicago Press.
- Löbner, Sebastian. 1985. Natürlichsprachliche Quantoren: Zur Verallgemeinerung des Begriffs der Quantifikation. *Studium Linguistik* 17/18. 79–113.
- López, Borja Ariztimuño. 2014. The origin of the Basque partitive. In Silvia Luraghi & Tuomas Huomo (eds.), *Partitive cases and related categories* (Empirical Approaches to Language Typology 54), 323–346. Berlin & Boston: De Gruyter Mouton.
- Luraghi, Silvia & Seppo Kittilä. 2014. Typology and diachrony of partitive case markers. In Silvia Luraghi & Tuomas Huomo (eds.), *Partitive cases and related categories*. (Empirical Approaches to Language Typology, 54), 17–62. Berlin & Boston: De Gruyter Mouton.
- Lytkin, Vasilij Il'ič & Klara Jevgen'evna Majtinskaja. 1975. *Osnovy finno-ugorskogo jazykoznanija: Pribaltijsko-finskie, saamskie i mordovskie jazyki*. Moscow: Nauka.
- Malchukov, Andrej. 2015. Valency classes and alternations: parameters of variation. In Andrej Malchukov & Bernard Comrie (eds.), *Valency classes in the world's languages*, vols. 1–2, 73–130. Berlin & Boston: De Gruyter Mouton.
- Markus, E. B. & F. I. Rožanskij. 2011. *Sovremennyy vodskij jazyk: Teksty i grammatičeskij očerk*. tom II. St. Petersburg: Nestor-Istorija.
- Mehlig, Hans Robert [Melig, Chans Robert]. 2006. Glagol'nyj vid i vtoričnaja gomogenizacija oboznačaejmoj situacii: K upotrebleniju delimitivnogo sposoba dejstvija v russkom

- jazyke. In Volkmar Lehmann (ed.), *Glagol'nyj vid i leksikografija: Semantika i struktura slavjanskogo vida* 4, 235–276. München: Otto Sagner.
- Miestamo, Matti. 2014. Partitives and negation: a cross-linguistic survey. In Silvia Luraghi & Tuomas Huomo (eds.), *Partitive cases and related categories* (Empirical Approaches to Language Typology 54), 63–86. Berlin & Boston: De Gruyter Mouton.
- Montgomery-Anderson, Brad. 2008. *A reference grammar of Oklahoma Cherokee*. Lawrence, KS: University of Kansas dissertation.
- Moravcsik, Edith A. 1978. On the distribution of ergative and accusative patterns. *Lingua* 45(1). 233–279.
- Nachmanson, Ernst. 1942. *Partitives Subjekt im Griechischen*. Göteborg: Wettergren & Kerbers.
- Næss, Åshild. 2007. *Prototypical transitivity* (Typological Studies in Language 72). Amsterdam & Philadelphia: John Benjamins.
- Nau, Nicole. 2014. Differential object marking in Latgalian. In Axel Holvoet & Nicole Nau (eds.), *Grammatical relations and their non-canonical encoding in Baltic* (Valency, Argument Realization and Grammatical Relations in Baltic 1), 207–255. Amsterdam & Philadelphia: John Benjamins.
- Neidle, Carol. 1988. *The role of case in Russian syntax* (Studies in Natural Language and Linguistic Theory 10). Dordrecht: Kluwer.
- Nevskaya, Irina. 2017. Innovations and archaisms in Siberian Turkic spatial case paradigms: A Transeurasian historical and areal perspective. In Martine Robbeets & Walter Bisang (eds.), *Paradigm change in the Transeurasian languages and beyond* (Studies in Language Companion Series 161), 257–286. Amsterdam: John Benjamins.
- Park, Indrek. 2012. *A grammar of Hidatsa*. Bloomington: Indiana University doctoral dissertation.
- Partee, Barbara H. 1995. Quantificational structures and compositionality. In Emmon Bach, Eloise Jelinek, Angelika Kratzer & Barbara H. Partee (eds.), *Quantification in natural languages*, 541–601. Dordrecht: Kluwer Academic Publishers.
- Partee, Barbara H. 2008. Negation, intensionality, and aspect: Interaction with NP semantics. In Susan Rothstein (ed.), *Theoretical and crosslinguistic approaches to the semantics of aspect* (Linguistik Aktuell/ Linguistics Today 110), 291–317. Amsterdam: John Benjamins.
- Persohn, Bastian. 2017. Locative and extra-locative clitics in Nyakyusa, *Africana Linguistica* 23. 151–165.
- Persohn, Bastian & Maud Devos. 2017. Post-final locatives in Bantu: Axes of variation and non-locative functions. *Africana Linguistica* 23. 3–46.
- Philippa, Marlies, Frans Debrabandere, Arend Quak, Tanneke Schoonheim & Noline van der Sijs. 2003. *Etymologisch woordenboek van het Nederlands*, deel 1. Amsterdam: Amsterdam University Press. <http://etymologiebank.nl>
- Quine, Willard Van Orman. 1960. *Word and object*. Cambridge MA: The MIT Press.
- Reed, A. M. 1989. Discourse groups and semantic groups. In Joyce Powers & Kenneth de Jong (eds.), *Proceedings of the 5th Eastern States Conference on Linguistics* (ESCOL'88), 416–427. Columbus, Ohio: Ohio State University Press.
- Sands, Krishna & Lyle Campbell. 2001. Non-canonical subjects and objects in Finnish. In Alexandra Y. Aikhenvald, Robert M.W. Dixon & Masayuki Onishi (eds.), *Non-canonical marking of subjects and objects*. Amsterdam: John Benjamins.
- Sasse, Hans-Jürgen. 2002. Recent activity in the theory of aspect: Accomplishments, achievements, or just non-progressive state? *Linguistic Typology* 6. 199–271.

- Selkirk, Elisabeth O. 1977. Some remarks on noun phrase structure. In Peter W. Culicover, Thomas Wasow & Adrian Akmajian (eds.), *Formal Syntax: Proceedings of the 1976 MSSB-UC Irvine Conference on the Formal Syntax of Natural Language, June 9–11, 1976, Newport Beach, California*, 285–316. New York: Academic Press.
- Schneider, Cynthia. 2010. *A grammar of Abma: A language of Pentecost island, Vanuatu*. Canberra: Pacific Linguistics.
- Schwyzler, Eduard & Albert Debrunner. 1950. *Griechische Grammatik: Auf der Grundlage von Karl Brugmanns Griechische Grammatik. Zweiter Band: Syntax und syntaktische Stilistik*. Vervollständigt und herausgegeben von Albert Debrunner. München: C. H. Beck'sche Verlagsbuchhandlung.
- Seržant, Ilja A. 2012. Morphosyntactic properties of the partitive genitive in Ancient Greek. *Indogermanische Forschungen* 117. 187–204.
- Seržant, Ilja A. 2013. The diachronic typology of non-canonical subjects. In Ilja A. Seržant & Leonid Kulikov (eds.), *The diachrony of non-canonical subjects* (SLCS 140), 313–360. Amsterdam & Philadelphia: John Benjamins.
- Seržant, Ilja A. 2014a. Denotational properties of the independent partitive genitive in Lithuanian. In Axel Holvoet & Nicole Nau (eds.), *Grammatical relations and their non-canonical encoding in Baltic* (Valency, Argument Realization and Grammatical Relations in Baltic 1), 257–299. Amsterdam & Philadelphia: John Benjamins.
- Seržant, Ilja A. 2014b. The independent partitive genitive in North Russian. In Ilja A. Seržant & Björn Wiemer (eds.), *Contemporary approaches to dialectology: The area of North, Northwest Russian and Belarusian vernaculars* (Slavica Bergensia 13), 270–329. Bergen: John Grieg AS.
- Seržant, Ilja A. 2015a. Independent partitive as a Circum-Baltic isogloss. *Journal of Language Contact* 8. 341–418.
- Seržant, Ilja A. 2015b. An approach to syntactic reconstruction. In Carlotta Vitti (ed.), *Perspectives on historical syntax*, 117–154. Amsterdam & Philadelphia: John Benjamins.
- Seržant, Ilja A. 2020. Dataset for the paper “Typology of partitives”, *Linguistics*. [Data set]. Zenodo. <https://doi.org/10.5281/zenodo.4277624>
- Seržant, Ilja A. forthcoming. Typology of partitives. *Linguistics*. ahead-of-print.
- Seržant, Ilja A., Katarzyna Janic, Darja Dermaku & Oneg Ben Dror. forthcoming. Typology of coding patterns and frequency effects of antipassives. *Studies in Language*. aop.
- Sleeman, Petra & Tabea Ihsane. 2021. this volume. The L2 acquisition of the partitive pronoun *en* in French by L1 speakers of German and the role of the L1. In Petra Sleeman & Giuliana Giusti (eds.), *Partitive determiners, Partitive pronouns and partitive case* (Linguistische Arbeiten 580). Berlin: de Gruyter.
- Smeets, Ineke. 2008. *A grammar of Mapuche* (Mouton Grammar Library 41.) Berlin: Mouton de Gruyter.
- Smith, Carlotta. 1997. *The parameter of aspect (Second edition)* (Studies in Linguistics and Philosophy 43). Berlin: Springer.
- Strobel, Thomas & Elvira Glaser. 2019. The rise and fall of partitive markers in some Germanic varieties. In Tabea Ihsane (ed.), *Disentangling bare nouns and nominals introduced by a partitive article*, 17–53. Leiden: Brill.
- Tamm, Anne. 2006. Estonian transitive verbs and object case. In Miriam Butt & Tracy Holloway King (eds.), *Proceedings of the LFG06 Conference*, 484–504. University of Konstanz: CSLI Publications. <http://csli-publications.stanford.edu/>



- Terrill, Angela. 2003. *A grammar of Lavukaleve* (Mouton Grammar Library 30.) Berlin & Boston: Mouton de Gruyter.
- Tveite, Tor. 2004. *The case of the object in Livonian: A corpus based study*. Helsinki: University of Helsinki MA thesis.
- Ubrjatova, Elizaveta Ivanovna. 1985. *Jazyk noril'skich dolgan*. Novosibirsk: Nauka.
- Ubrjatova, Elizaveta I., L.N. Charitonov & N.E. Petrov. 1982. *Grammatika sovremennogo jakutskogo literaturnogo jazyka: Fonetika i morfologija*. Moscow: Izdatel'stvo Nauka.
- Vari-Bogiri, Hannah. 2011. *Phonology and morpho-syntax of Raga, Vanuatu*. Port Vila: University of the South Pacific doctoral dissertation.
- Westerståhl, Dag. 1985. Determiners and context sets. In Alice ter Meulen & Johan van Benthem (eds.), *Generalized quantifiers in natural language*, 45–71. Dordrecht: Foris.
- Winand, Jean. 2015. The oblique expression of the object in Ancient Egyptian. In Eitan Grossman, Martin Haspelmath & Tonio Sebastian Richter (eds.), *Egyptian-Coptic linguistics in typological perspective*, 533–560. Berlin & Munich & Boston: De Gruyter Mouton.
- Witzlack-Makarevich, Alena & Ilja A. Seržant. 2017. Differential argument marking: Patterns of variation. In Ilja A. Seržant & Alena Witzlack-Makarevich (eds.), *Diachrony of differential argument marking* (Studies in Diversity Linguistics), 1–40. Berlin: Language Science Press. <http://langsci-press.org/>
- Zimmermann, Thomas Ede. 1993. On the proper treatment of opacity in certain verbs. *Natural Language Semantics* 1. 149–179.





Silvia Luraghi & Giovanna Albonico

# The partitive article in Old Italian

Early stages in the grammaticalization of the Italian partitive article

Two different constructions of Old Italian have been connected to the Modern Italian partitive article: the construction formed by the preposition *di* followed by a noun without a definite article and the construction featuring the same preposition followed by the definite article and a noun. The latter construction shows the same formation as the partitive article in Modern Italian. In this paper we survey the function of the two constructions in Old Italian and show how they relate to the Modern Italian partitive article. In particular, we argue that the occurrence of the construction containing a noun without the definite article was limited to certain specific contexts, while the construction with the definite article, contrary to common assumptions, did not only occur within the partitive nominal construction, but also extended to the coding of indefiniteness, and could occur not only with direct objects but occasionally even with subjects. This distribution provides compelling evidence for the conclusion that the construction formed by *di* plus the definite article in Old Italian had already started undergoing grammaticalization in the direction of the Modern Italian partitive article.

## 1 Introduction

In Modern Italian, the partitive article, though routinely used by a large number of speakers, remains in a fuzzy area of the standard language, as witnessed by the fact that even scholarly descriptions often clash with data from actual usage. The reason for this may partly lie in its somewhat limited diatopic distribution, its relatively restricted use in the written register, and possibly in the fact that until at least the 1960s it has been stigmatized in part of the country as a non-standard feature deriving from French influence. With such a problematic synchronic situation, it is no wonder that historical descriptions often do not seem especially compelling. Such a scenario calls for a new assessment of the origin and the distribution of the partitive article in Old Italian, which we intend to present in this paper, by discussing the onset of the grammaticalization process that led to the emergence of the partitive article as it is used in Italian nowadays.

The paper is organized as follows. In Section 2 we provide a brief description of the use of the partitive article in Modern Italian based on a limited corpus study. As in other, better studied, Romance varieties, the Italian partitive article originated from partitive nominal constructions, or PNCs. The latter construction indicates an indefinite part extracted from a definite whole: as defined in Giusti & Sleeman (2021, this volume), partitive constructions “refer to the part-whole relation between an indefinite subset and a definite superset.”<sup>1</sup> Partitive articles, on the other hand, introduce “an indefinite nominal expression” (Giusti & Sleeman 2021, this volume). In other words, while PNCs presuppose a definite set, there is no such presupposition with partitive articles. In Section 3, we provide some historical background, and briefly show how the development started out from Late Latin PNCs attested in the New Testament. Section 4 focuses on some common assumptions concerning Old Italian, and then proceeds with the illustration of our study based on Old Italian texts, and discuss the methodology and the results concerning two constructions: *di* followed by a noun with the definite article and *di* followed by a noun without a definite article. In Section 5 we discuss the diatopic distribution of the data included in our corpus. Section 6 contains the conclusion.

## 2 The partitive article in Modern Italian

The Modern Italian partitive article is nowadays part of the article system. It functions as a partitive article with uncountable nouns, and as a plural indefinite with count nouns, as shown in (1) and (2) and summarized in Table 1.<sup>2</sup>

- (1) *A pranzo ho mangiato del formaggio.*  
 at lunch eat:PRF.1SG PAR.ART.SG.M cheese(M):SG  
 ‘I ate (some) cheese for lunch.’

<sup>1</sup> For a standard definition of partitive nominal constructions see also Koptjevskaja-Tamm (2001: 527), who defines PNCs as “noun phrases consisting of two nominals, one of which is a quantifier”, that “involve a presupposed set of items referred to by one of the nominals (‘that good tea’, ‘Mary’s books’); and the quantifier indicates a subset which is selected from it,” as in ‘a cup of that good tea’.

<sup>2</sup> The abbreviations in the glosses follow the Leipzig glossing rules when available, integrated by the additional abbreviations in Luraghi & Huumo (2014: vii–xi). With long quotations, we only glossed the part which is relevant for our discussion.

- (2) *Ieri sono venuti dei ragazzi*  
 yesterday come:PRF.3PL PAR.ART.PL.M boy(M):PL.M  
 ‘Some boys came yesterday.’

**Table 1:** Italian articles.

	singular count	mass	abstract	plural count
Definite	<i>mangio il panino</i>	<i>mangio il pane</i>	<i>ammiro il coraggio</i>	<i>mangio i panini</i>
Indefinite	<i>mangio un panino</i>			<i>mangio dei panini</i>
Partitive		<i>mangio del pane</i>	<i>ci vuole del coraggio</i>	

Table 1 shows the system of Italian articles based on Renzi (1991) and Grandi (2010). In Italian, contrary to French, the partitive article is not obligatory (on the differences between Italian and French see also Giusti (2021, this volume) and Carlier (2021, this volume)). In cases in which it is omitted, indefiniteness is expressed by the bare noun especially in the case of mass nouns as in (3), while plural count tend to occur with a quantifier such as *alcuni* as in (4), cf. Korzen (1996: ii).

- (3) *A pranzo ho mangiato formaggio.*  
 at lunch eat:PRF.1SG cheese  
 ‘I ate (some) cheese for lunch.’
- (4) *Ieri sono venuti alcuni ragazzi*  
 yesterday come:PRF.3PL some.PL boy.PL  
 ‘Some boys came yesterday.’

Moreover, being in free alternation with the bare noun and indefinite quantifiers, the partitive article is generally less widespread than the indefinite article.<sup>3</sup>

Luraghi (2017) carried out a corpus study based on a portion of the *Corpus e Lessico di Frequenza dell’Italiano Scritto* (CoLFIS) comprising 3,798,275 tokens from three sub-corpora, including newspapers (1.836.119 tokens from *Il Corriere Della Sera*, *Repubblica*, *La Stampa*), periodicals (1.306.653 tokens from 12 different thematic sections, e.g. sport, travel, general information, etc.) and books (655.503 from 13 different genres). She found 2,604 occurrences of the partitive article. A sample containing the first 1,447 occurrences yields the results shown in Table 2.

<sup>3</sup> Due to the wide range of diatopic and diaphasic variation, in-depth descriptions of conditions on the alternation partitive pronoun/bare noun are not available. See the discussion in Stark (2006: 136–141).

**Table 2:** Distribution of partitive articles in Standard Italian.

	ABSTRACT DO	CONCRETE DO	SUBJECT	PREDICATE NOUN	PP/ADVERBIAL
PL. INDEF.	534	401	112	130	98
UNCOUNTABLE	83	57	25	–	7

Table 2 shows the distribution of partitive article in different syntactic functions. As one can see, the vast majority of occurrences function as direct object, and plural indefinite count nouns largely outnumber singular mass and abstract nouns.

Partitive subjects are mostly plural indefinites, and tend to occur with existential verbs or other intransitive verbs, as shown in Tables 3 and 4.

**Table 3:** Distribution of partitive subjects across verb types.

Verb type	137
existential predicates	58
intransitive (unaccuative)	39
passive	16
middle reflexive	13
transitive	7
unergative	4

Table 3 shows the distribution of partitive subjects across verb types in Modern Italian. As remarked above, partitive subjects often occur with existential predicates and other intransitives, passive or middle reflexives, but in a limited number of cases they can also occur with transitive and unergative verbs.

The preverbal position is infrequent for NPs with partitive articles, in particular with uncountable nouns. In Table 4 we show the results of a corpus (Albonico 2018) based on the sections of periodicals and daily newspapers in CoLFIS (3,142,772 tokens).

**Table 4:** Position of subjects with partitive articles.

	postverbal	preverbal	total
Plural indefinite subjects-introduced by <i>degli, dei, delle</i>	104	7	111
Uncountable indefinite subjects introduced by <i>del, dello, della</i>	15	0	15

Out of a total of 971 occurrences of NPs with partitive articles in different syntactic functions, Albonico (2018) found 126 subjects. Out of these total occurrences, as shown in Table 4, 111 contain plural indefinite nouns, placed in post-verbal position in the vast majority of cases (104/7). Occurrences with the singular forms of the partitive article introducing an uncountable NP were only 15, and none of these instances was in preverbal position. Notably, this distribution does not depend on a syntactic restriction, but rather on discourse factors, as indefinite referents are typically new, and tend to occur post-verbally. Subjects, in their turn, tend to refer to referents already introduced in discourse and identifiable both for the speaker and for the hearer, and are typically definite. Hence, indefinite subjects are per se infrequent. A random internet search shows that some occurrences are available, as in (5).

- (5) *Addirittura una volta è scoppiato, nel senso che **del liquido** è uscito fuori  
dal barattolo, bello alto e incredibilmente chiuso col coperchio.*  
from+the jar  
'Once it even blew up, meaning that some liquid leaked out of the jar, which was quite big and closed with a lid.'

The Modern Italian partitive article features *di* followed by the definite article agreeing in gender and number with the nouns it determines, and formally corresponds to a structure already attested in Old Italian, as we will show in Section 4, see sentences (19) and (18). Notably, in this construction, the status of *di* is that of a morpheme which acquires its meaning in connection with the definite article: the whole construction, but not its sub-components, indicates indefiniteness.

Diachronically, the partitive article originated from PNCs, codifying the part-whole relation,<sup>4</sup> as in English *I drank some of the wine from that bottle* (see Koptjevskaja-Tamm 2001 and below, example (11)). The Italian PNC, in its turn, combined the Late Latin partitive construction featuring the preposition *de* with the definite article, that did not exist in Latin (see Section 3). The newly created partitive article started out in direct object position, but soon spread to indefinite post-verbal subjects, as argued in Carlier & Lamiroy (2014: 506–514). The current distribution still reflects the diachronic development.

---

<sup>4</sup> We follow the description of the steps in the diachronic development of partitive articles in the Romance languages in Carlier & Lamiroy (2014); for a more general perspective of the Romance developments in a typological framework see Luraghi & Kittilä (2014: 49–60).

Carlier (2007: 3) describes the transcategorization process by which at a certain moment in the history of French the partitive article split away from the PNC, following three steps (quoted from Carlier 2007: 26):

- i. The notion of partition set fades away.
- ii. The notion of a non-specified quantity remains.
- iii. The partitive article acquires the new property of marking indefiniteness.

Carlier further points out that “this new property is not determined by the real world properties of the referent, but it is discourse-oriented: it indicates to the hearer that the referent is not uniquely identifiable for him.”

The fact that the preposition *de* originally part of the PNC underwent transcategorization is indicated, among other things, by its distribution, which no longer matches the distribution of proper prepositions. As shown in Table 2, Modern Italian *di*, when occurring as sub-morpheme in the partitive article, can co-occur with other proper prepositions, and indeed it does so in a sizable number of the occurrences. In the corpus analyzed in Luraghi (2017), 105 occurrences out of 1,447 contain PPs and adverbials, as shown in Table 2. Out of these, 17 are adverbials of the type shown in (6).

- (6) *Sta*                      *lí*                      *delle*                      *ore*  
 stand.PRS.3SG      there                      PAR                      hour.PL  
 ‘S/he stands there for hours.’

PPs include the occurrences shown in Table 5.

**Table 5:** Occurrences of partitive articles with proper prepositions.

PREPOSITION	NUMBER OF OCCURRENCES
<i>con</i>	46
<i>a</i>	29
<i>per</i>	6
<i>su</i>	4
<i>in</i>	3

Notably, according to Renzi (1991: 378), the partitive article still has a limited usage with primary prepositions, as it cannot occur with *da* ‘from’, *in* ‘in’ and *di* ‘of’. Now, while it is true that one does not normally use <sup>??</sup>*di del* or *di dei* (but note that even in French one does not find *\*de du*), *in* does occur with the partitive article, as shown in Table 5. Even occurrences of *da* are available, and example (7) shows that the latter preposition occurred in this construction already in Manzoni’s *Promessi Sposi* (see further Luraghi & Kittilä 2014; Carlier & Lamiroy 2014).

- (7) *Il viandante che fosse incontrato da de'*  
 the passerby who meet:SBJV.IMPF.PASS.3SG by PAR  
*contadini fuor della strada maestra*  
 peasants outside of+the road main  
 'The passerby who should be encountered by some peasants outside the main road.' (Manzoni, *I promessi sposi*)

In spite of not being obligatory as its French counterparts, the Modern Italian partitive article is not subject to lexical restrictions. In particular, beside mass nouns it is also frequently used with abstract nouns, as in (8) and (9).<sup>5</sup>

- (8) *Fin quando la guerra verrà considerata un male*  
 until when ART.SG war will.be considered an evil  
*avrà sempre del fascino.*  
 have.FUT.3SG always PAR fascination  
 'As long as war is regarded as wicked, it will always have its fascination.'
- (9) *Qual è la ricetta per un matrimonio felice? Charlton: Ci vuole della tolleranza,*  
 one.needs PAR tolerance  
*della comprensione, della flessibilità e un marito fantastico. Si dà il caso*  
 PAR understanding PAR flexibility and a husband fantastic  
*che io riunisca tutte queste qualità.*  
 (Interview with Charlton Eston, CoLFIS periodicals)  
 'What is the recipe for a happy marriage? Charlton: You need PAR tolerance, PAR understanding, PAR flexibility, and a fantastic husband. It is the case that I have all these qualities.'

<sup>5</sup> According to Stark (2007: 50), abstract nouns cannot occur with partitive articles in Modern Italian. She mentions as an ungrammatical structure the phrase *della pazienza*. A random internet search shows that even the noun *pazienza* can occur with the partitive article, as shown in the following example.

*Ha avuto della pazienza Domenico Marciano nella*  
 have:PRF.3SG PAR patience Domenico Marciano in+the  
*ricerca e ha avuto molta perizia nella ricostruzione*  
 research and have:PRF.3SG much care in+the reconstruction  
*di 500 anni di relazioni*  
 of 500 years of relations

'Domenico Marciano has been patient in research and careful in the reconstruction of a 500 years' relation' (*Cinquecento anni di storia: le relazioni tra l'Italia e le Filippine*, by D. Marcianò, from P. Crupi's Introduction).



In example (8), the direct object is an abstract noun, *fascino*, and takes the partitive article. In (9) three abstract nouns *tolleranza*, *comprensione*, *flessibilità* feature the partitive article and are coordinated with an indefinite count noun *un marito*. They occur in a sentence with the impersonal verb *ci vuole* ‘one needs’.

The construction containing an NP with a partitive article in Modern Italian remains homophonous with another construction in which *di* retains its original status of preposition, and the same was also true in Old Italian. Let us consider the occurrences in (10). Here, the complex *del* ‘of the’ contains the preposition *di*, which indicates adnominal dependency, and the definite article *il*, both in the Modern Italian (10a) and in the Old Italian (10b) examples. Similarly, after a quantifying expression the preposition indicates dependency from the quantifier as in (11). In such cases, we find PNCs, in which a quantity is singled out from a pre-established whole. Again, the Modern Italian construction in (11a) matches the corresponding Old Italian one in (11b).

- (10) a. *La macchina del professore.*  
 the car of+DEF.ART.SG.M professor  
 ‘The professor’s car.’
- b. *non per amor del flore ma per amor*  
 not for love of+DEF.ART.SG.M flower but for love  
*del frutto;*  
 of+DEF.ART.SG.M fruit  
 ‘Not for love of the flower but for love of the fruit.’  
 (*Proverbia que dicitur*, XII u.q. venez.)<sup>6</sup>
- (11) a. *Ho invitato alcuni dei ragazzi.*  
 invite:PRF.1SG some PAR boy:PL  
 ‘I invited some of the boys.’
- b. *per sapere se alcuna delle parti è vera o falsa*  
 for know if any of+DEF.ART.PL.F part is true or false  
 ‘In order to know if any of the parts is true or false.’  
 (Brunetto Latini, *Rettorica* 84.7)

The Modern Italian partitive article does not have the same distribution in all diatopic varieties of regional Italian: in particular, it is less used in Central and

<sup>6</sup> For the regional origin of Old Italian texts we kept the abbreviations used in TLIO <http://tlio.oivi.cnr.it/TLIO/>.

Southern Italy than in the Northern part of the country.<sup>7</sup> This skewed distribution, along with its possible omission in a large part of contexts, shows that the Modern Italian partitive article is not yet as fully grammaticalized as its French counterpart and, as we will argue in Section 5, reflects the distribution that the partitive article already showed at its onset in Old Italian.

### 3 Late Latin partitive constructions

The construction that gave rise to partitive articles in the Romance languages is a PNC already attested in Late Latin, which could be used as direct object, as shown in examples (12)-(14) from the New Testament. The data surveyed in this Section is discussed in Luraghi (2013).

- (12) *dicit*            *eis*            *Iesus*            *adferte*            *de*  
 say:PRS.3SG    3.DAT.PL    Jesus:NOM    bring:IMPER.PRS.3PL    from  
*piscibus*        *quos*            *prendidistis*            *nunc.*  
 fish:ABL.PL    REL.ACC.PL    catch:PRF.2PL            now  
 ‘Jesus said to them, ‘Bring some of the fish that you have just caught!’  
 (John 21.10)

- (13) *et misit*            *ad agricolas*            *in tempore*            *servum*            *ut ab*  
 and send:PF.3SG    to    peasant:ACC.PL    in time:ABL    servant:ACC    for from  
*agricolis*            *acciperet*            *de fructu vineae*  
 peasant:ABL.PL            collect:SBJV.IMPF.3SG    from fruit:ABL vineyard:GEN  
 ‘At harvest time he sent a servant to the tenants to collect from them some  
 of the fruit of the vineyard.’ (Mark 12.2)

- (14) *et ipse*            *in nobis*            *quoniam*            *de*            *Spiritu*  
 and    3SG.NOM    in    1PL.ABL            because    from    spirit:ABL  
*suo*            *dedit*            *nobis*  
 POSS.3SG.ABL    give:PRF.3SG    1PL.DAT  
 ‘[We know that we live in him] and he in us, because he has given us of  
 his Spirit.’ (1 John 4.13)

<sup>7</sup> See Cardinaletti & Giusti (2018) with data collected from AIS, and Cardinaletti & Giusti (2020), which contains the results from a survey carried out with questionnaires covering speakers from 15 of the 20 regions of Italy.

The type of PNC exemplified in (12)-(14) did not occur in Classical Latin. At that time PNCs consisted of genitive NPs, or of PPs with the preposition *ex* ‘out of’ (or, only occasionally, *de* ‘from’), always preceded by a quantifier or an indefinite pronoun, as shown in (15) and (16).<sup>8</sup>

(15) *unus ex captivis, . . . , inquit*  
 one.NOM out.of prisoner.ABL.PL say.prs.3sg  
 ‘one of the prisoners said’ (Caes. *G.* 6.35.8)

(16) *illa pars epistulae tuae minime*  
 DEM.NOM.F part(F).NOM letter(F).GEN POSS.2SG.GEN.F minimally  
*fuit necessaria*  
 be.PRF.3SG necessary.NOM.F  
 ‘That part of your letter was not at all necessary.’ (Cic. *Att.* 1.17.5)

In the New Testament, the partitive constructions introduced by *de* are not preceded by any quantifier, and they are always used in order to translate the Greek prepositions *ek* or *apó* (see Luraghi 2013).<sup>9</sup>

From examples (12)-(14) it appears that a variety of different types of noun could already occur referring to a specific whole in the Late Latin PNC: in (12) we find a plural count noun, while (13) contains a collective noun and (14) an abstract noun. These constructions always have a true partitive meaning, as the *de* phrase indicates a specified referent, a part of which is affected by the action described by the predicate; they do not have a possible indefinite interpretation, as grammaticalized partitives can have. This is also shown by the fact that they

---

<sup>8</sup> The partitive use of the genitive well attested in several ancient and modern Indo-European languages (see Luraghi & Kittilä 2014 for an overview, Luraghi 2003: 61–62 and Conti & Luraghi 2014 on Ancient Greek, Dahl 2014 on Indo-Iranian languages, Paykin 2014 and Daniel 2014 on Russian among many others) was marginal in Latin, and the often quoted occurrence of the partitive genitive *aquae* in Cato shown below remains virtually isolated.

*Farinam in mortarium indito; aquae paulatim addto*  
 flour:ACC in mortar:ACC pour:IMP.FUT.3SG water:GEN little.by.little add.IMP. 3SG  
 ‘Pour flour in the mortar; add (some) water little by little’ (Cato, *Agr.* 74; see Väänänen 1981).

<sup>9</sup> In Late Latin the genitive started being replaced by prepositional phrases with *de* plus ablative, leading to Romance prepositions including French *de* and Italian *di*. See Väänänen (1981a: 113–114, 1981b) and Gianollo (2012). That the Latin construction is not simply a calque of Greek is shown by the fact that it belongs to this wider process of replacement, and that it marks the onset of the development of partitive articles. These have no parallels in Greek, even though the genitive in partitive constructions was largely replaced by PPs with *apó* see Mertyris (2014).

appear always with particular types of determiners or modifiers that identify the specific referent: the relative clause *quos prendidistis nunc* ‘that you have just caught’ in (12), the genitive NP *vineae* ‘of the vineyard’ in (13), and the possessive *suo* ‘his’ in (14). As we will show in Section 4.3, this is also a feature of the Old Italian construction formed by *di* followed by a bare noun, in which, too, a determiner or a modifier typically occurs.

As has been observed by Kittilä & Luraghi (2014), *de piscibus* in (12) means ‘some of those specific fish that you have caught’, and could not possibly mean ‘some (indefinite) fish’, as Italian *dei pesci* or French *des poissons* normally mean. The use of the Latin preposition *de* in the Latin examples is connected with both constructions attested in Old Italian that will be surveyed in Section 4, that is, the one featuring *di* without the definite article (Section 4.3), and the one in which *di* combines with the definite article (Section 4.4). Crucially, however, it never has a possible indefinite reading. Only later, in some specific contexts and inside certain Romance varieties, did the preposition start merging with the definite article, undergo transcategorization as argued in Section 2, and eventually the whole construction shifted to an indefinite reading. We can then assume that there is continuity between the Late Latin partitive construction discussed here and the partitive construction with the definite article that starts to convey an indefinite meaning in Old Italian, to which we now turn.

## 4 The partitive article in Old Italian

In this Section, we discuss the data from Old Italian, and describe the construction that points to the emergence of the partitive article. We take as our starting point in Section 4.1 the description in Renzi (2010). After having described our methodology in Section 4.2, we discuss the occurrences in which *di* is followed by a bare noun functioning as direct object (Section 4.3), and then proceed to discussing occurrences that feature *di* combining with the definite article (Section 4.4).

### 4.1 The partitive article in Old Italian: Shared wisdom

According to Renzi (2010: 346), “In Old Italian the partitive article of Modern Italian instantiated in the type: *ho visto dei bambini* [I saw some children], *per la strada giocavano dei bambini* [some children were playing in the street] does not

exist . . . The partitive meaning is expressed by quantifiers (possibly not overtly realized) followed by *di* + NP,”<sup>10</sup> as in example (17), also quoted by Renzi.

- (17) *Tesoro volgarizzato* vol. 4 libro 9: 381–382  
*dire dinanzi a loro di grandi parole e*  
 tell:INF in\_front at 3PL.OBL of big:PL word:PL and  
***graziose***  
 pleasant:PL  
 ‘Tell them (some) high-sounding and pleasant words.’

Renzi (2010) states further that “the combination of *di* + definite article . . . represents a definite set from which an indefinite quantity is extracted . . . Such phrases, differently from Modern Italian, occur always and only in direct object position.”<sup>11</sup> In other words, the combination *di* + definite article, according to Renzi, always only instantiates a PNC. As evidence for his claim, Renzi mentions example (18) (but see the discussion below); another occurrence is example (19).

- (18) Chiaro Davanzati, *Rime*, son. 89 v. 11; mid-13th century  
*Ma sempre si procaccia de l' onore.*  
 but always REFL seek:PRS.3SG of DEF.ART.SG.M honor  
 ‘But he always seeks (some) honor.’
- (19) Ugucione da Lodi, *Libro XIII*, mid-13th century  
*Ela mançà del pomo qe li*  
 she eat: PST.3SG of+DEF.ART.SG.M apple REL 3SG.DAT  
*de' un serpente.*  
 give: PST.3SG a snake  
 ‘She ate (some of) the apple that a snake gave her.’

According to Renzi (2010), within constructions such as (18) and (19), the partitive reading is available because a null quantifier occurs, on which the element introduced by *di* depends.

<sup>10</sup> “In it. ant. non esiste l'articolo partitivo dell'it. mod. rappresentato dal tipo: *ho visto dei bambini, per la strada giocavano dei bambini* . . . Il senso della partitività è espresso da quantificatori (eventualmente non espressi) seguiti da *di* + SN.”

<sup>11</sup> “. . . la combinazione *di* + Art. def. . . rappresenta un insieme definito dal quale viene estratta una quantità indefinita . . . Questi sintagmi, diversamente che in it. mod., appaiono sempre e solo nella posizione di oggetto diretto.”

Leaving aside the assumption of a null quantifier, which necessarily depends on one's wider theoretical persuasions, Renzi's analysis holds for the phrase *del pomo* '(some) of the apple' in (19), in which the relative clause specifies the whole from which a part is taken, hence the interpretation as PNC. However, the same analysis appears to be much less compelling in the case of abstract nouns, as in (18), in which *de l'onore* '(some) honor' does not support the partition reading (see further Mula 2017: 470). Indeed, the phrase *de l'onore* does not seem to refer to a pre-established whole, and rather appears to have the same partitive/indefinite meaning as the corresponding Modern Italian *dell'onore* (*cerca di ottenere dell'onore/onore*).

In order to test Renzi's (2010) claims, which constitute the most recent description of Old Italian, in Sections 4.3 and 4.4 we consider both constructions, and discuss the data briefly surveyed in this Section, along with the data extracted through our own corpus research from the Old Italian OVI corpus. We thus intend to pinpoint the onset and earliest stages of the grammaticalization of the Italian partitive article.

## 4.2 Methodology and goals of the analysis

Our study is based on occurrences extracted from the most representative database of Early Italian: the OVI corpus. This resource has been developed by the Italian National Research Center (CNR). The corpus consists of 2335 texts prior to 1375, representing the whole collection of early Italian texts made accessible by the *Opera del Vocabolario Italiano* (Italian Dictionary Institution). The corpus is periodically updated and consisted of around 29.208.359 tokens when updated on 31 August 2020. It can be accessed at the link:

[http://gattoweb.oivi.cnr.it/\(S\(50yvze55udnhcw45bk4jqh1\)\)/CatForm01.aspx](http://gattoweb.oivi.cnr.it/(S(50yvze55udnhcw45bk4jqh1))/CatForm01.aspx) (last accessed on 25 April 2021).

The corpus can be searched by word forms, and only partially by lemmas. Thanks to this resource, we have been able to consider the very early phase of written Italian for what concerns the development of the partitive article, and also had the possibility of observing texts from different geographical areas.

Unfortunately, the lemma search could not be implemented for our type of query. Hence, we searched the corpus by forms, and looked for all occurrences of *di*, and for all occurrences consisting of *di* plus various possible forms of the definite article. Out of the occurrences resulting from this search, we selected only those in which *di* is used to introduce an argument of a verb, the direct object or the subject. In particular we kept distinct such constructions from constructions in which *di* indicates nominal dependency (notably, this latter function covers

most occurrences). The same operation was needed with the forms composed by *di* plus the definite article. We tried to gather a number of sentences large enough to examine in detail the distribution and the functions of the mentioned structures, so that, in spite of the yet infrequent occurrence of the construction, which was starting to emerge at the time of the texts we surveyed, we are able to base our considerations on a quantitative analysis.

We examined every different form in association to specific elements of the context; for example, looking for elements in object position, we selected only occurrences in which the construction appeared after a verb. In this way we reduced the number of contexts that we had to examine and were able to search the entire corpus. We selected in total 167 occurrences, that we summarize in Table 6. The percentage column indicates the percentage of constructions with definite article over the total, and the percentages in which *di* plus definite article can have an indefinite reading with specific types of noun and in the total occurrences with definite article.

**Table 6:** Occurrences of *di* introducing a verbal argument.

<b>Total 167</b>	<b>No definite article</b>	<b>With definite article</b>		<b>%</b>
	<b>9 (7 with <i>fare</i>)</b>	<b>158</b>		<b>94.6</b>
		Partitive	Possible indefinite	
Abstract nouns		10	8	44.4
Mass Nouns		75	23	25.5
Plural count		20	20	50
Possible subjects			2 (abstract)	
<b>Total</b>		<b>105</b>	<b>53</b>	<b>33.5</b>

It is worth noting that with this kind of search we have included also subjects located in postverbal position. Preverbal subjects introduced by *di* and the definite article were searched in a similar way, selecting only constructions in preverbal position. With the construction featuring *di* without the definite article, reducing the number of occurrences by selecting only those in postverbal position did not yield reliable results, because *di* could also be used to indicate dependency between two verbal forms. For this reason, we searched more specifically for the occurrences in which *di* was followed by a noun or by an adjective, including determiners and quantifiers.

After the extraction we proceeded to the analysis of the contexts we extracted with our search. We considered separately *di* when followed by a noun without a definite article and when combined with the definite article, in order to analyze the two different constructions based on Renzi's (2010) claims discussed in Section 4.1. More specifically we wanted to understand if the functions of the partitive article

of Modern Italian were, at least partially, already present in Old Italian and if the construction from which the modern partitive article originates (*di*+definite article) already conveyed at least occasionally the same indefinite meaning.

### 4.3 The construction *di* noun without a definite article

The construction formed by *di* followed by a noun that does not have a definite article is infrequent (9 out of 167 occurrences) and appears only in specific contexts, characterized by the occurrence of a given predicate or a specific noun phrase structure. In the sample we analyzed this construction frequently (4 out of 9 occurrences) co-occurs with a demonstrative such as *questo* ‘this’ or *quello* ‘that’ or with a quantifier, as shown in Section 4.3.1. We also found several (7 out of 9) occurrences with attributive modifiers and the verb *fare* ‘do, make’ that we discuss in Section 4.3.2.

The fact that in Old Italian the construction that contains *di* plus noun without a definite article was limited to particular collocational contexts, as we will argue, seems to rule out the possibility of continuity between this construction and the Modern Italian partitive article. The occasional similarity in the meaning of *di* in such constructions and the modern partitive article, highlighted by Renzi (2010), is not supported by our findings from the OVI corpus, as in most occurrences we found that the construction featuring *di* plus a noun without the definite article does not seem to be semantically equivalent to the Modern Italian partitive article. In addition, even its development seems to remain separate from the development of the partitive article.

#### 4.3.1 Constructions in which *di* does not combine with the definite article

In most occurrences in which the noun that follows *di* does not have a definite article, the noun still takes a demonstrative or a quantifier. In the sentence in (20), the noun phrase in direct object position contains *di* followed by the proximal demonstrative *questi* ‘these’.

- (20) Pistole di Seneca, XIV m. (fior.): 51  
*Che abbiām noi a fare di questi bagni caldi, per*  
do:INF of DEM.PL bath:PL hot:PL for  
*diseccare, e sottigliare il corpo?*  
dry:INF and slim\_up:INF DEF.ART.SG.M body:SG  
‘Why should we take such hot baths, in order to dry and slim up our body?’



In passages such as (20), the occurrence of *di* entails a shift in the meaning of the demonstrative. The expression *di questi* means ‘of this kind’, and specifies an object that has particular properties and characteristics implied in the previous discourse or in the context. The construction with *di* and the distal demonstrative *quello* ‘that’ has a similar meaning. When the demonstrative occurs, the feature of indefiniteness does not concern the reference of the noun phrase: rather, it characterizes its type.

The same construction also occurs with plural NPs that contain a quantifier between *di* and the noun, as in (21).

- (21) Bind. d. Scelto (ed. Gozzi), a. 1322 (sen.): c. 530  
*E’ lo’ dice di molte belle*  
 1SG.NOM 3PL.OBL tell: PRS.3SG of many:PL.F beautiful:PL.F  
*parole.*  
 word(F):PL  
 ‘He tells them many beautiful words.’

In example (21), the occurrence of *di* does not seem to be the trigger for an indefinite interpretation of the direct object. In Old Italian common verbs like *dire* ‘say’ or *fare* ‘do’ are attested both in this construction, and in the parallel construction that does not contain *di* (*dice molte belle parole*), without relevant changes in their meaning.

A demonstrative may also follow *di* with the generic noun *cose* ‘things’, as in (22).

- (22) Stat. fior., 1310/13: c. 44  
*E cotali che facessono di quelle cose . . .*  
 and DEM.PL REL do:SBJV.IMPF.3PL of DEM.PL.F thing(F):PL  
 ‘And those who would do such things, . . .’

In (22) the noun phrase in direct object position is indefinite and has a very vague reference, as indicated both by the generic noun *cose* ‘things’ and the expression *di quelle* ‘of such type’. This kind of construction can occasionally be linked to another element of the discourse or to some element from the wider external context. However, it is most often followed by a suspension of the discourse, as in (22), pointing to the difficulty of describing otherwise the referents involved in the situation. Notably, in Modern Standard Italian this construction still occurs with a generic meaning; an example is sentence (23), extracted through a random internet search.

- (23) *Ho 73 anni e mai ho visto*  
 have:PRS.1SG 73 year:PL and never see:PRF.3SG  
**di queste cose.**  
 of DEM.PL.F thing(F):PL  
 ‘I am 73 years old and I have never seen such things.’

Example (23) shows that the construction containing *di* followed by a noun preceded by a demonstrative is attested also in Modern Italian, with the same meaning as it already had in Old Italian, hence it cannot be taken as representing a stage in the grammaticalization of the partitive article.

#### 4.3.2 The construction ‘fare di’

A similar construction features the verb *fare* ‘do, make’ followed by *di* and a plural bare noun, usually accompanied by an attribute. It generally co-occurs with the generic noun *cose* ‘things’, as in (22), but often without a demonstrative. An example is (24).

- (24) Brunetto Latini, *Rettorica*, c. 1260–61 (fior.) p. 32  
*Et nota che arditi sono di due maniere:*  
*l’ una che pigliano a ffare di grandi*  
 DEF.ART.SG.F one:SG.F REL take:PRS.3SG to do:INF of great:PL.F  
**cose** con *provedimento di ragione, e questi sono savi;. . .*  
 deed(F):PL  
 ‘And pay attention to the fact that they are bold in two ways: in the first case they start doing (some) great deeds, reasoning about what they do, and those are wise.’

In example (24) the direct object exhibits an indefinite meaning similar to the meaning of the Modern Italian partitive article, but a comparison is hampered by the lexically restricted use of the Old Italian construction. Example (25) shows that other nouns are also attested within the same construction, even though in this specific case the expression seems to take an idiomatic meaning.

- (25) Bind. d. Scelto (ed. Gorra), a. 1322 (sen.): c.279  
*Che le fanno di gran beffe per loro dolci parole.*  
 REL 3PL.OBL make:PRS.3PL of big joke:PL  
 ‘Who mock them much, because of their sweet words.’

In (25), the expression *fare di gran beffe* has the meaning ‘mock’, a meaning that remains in the Modern Italian idiom *farsi beffe*, which, notably, does not feature either *di* or the partitive article. Hence, even in the case of the construction with *fare*, one cannot assume continuity in the development toward the Modern Italian partitive article.<sup>12</sup>

#### 4.4 The construction *di* plus definite article

The construction constituted by *di* plus the definite article already occurred in Old Italian, and, based on the data we extracted, was much more frequent than the construction without a definite article, as shown in Table 6, with 158 occurrences out of 167. According to Renzi (2010) this construction was restricted to the direct object position and always necessarily referred to an indefinite part extracted from a definite whole, that is, it only occurred within PNCs.

It is worth recalling that in Old Italian *di* combined with the definite article also introduced adnominal modifiers, as we have shown in example (10b). For this reason, the first step in our analysis consisted in identifying the occurrences in which the construction introduced a verbal argument and separating them from adnominal constructions. We then divided the sentences we found on the basis of the nature of the noun introduced by *di* plus definite article, and looked at the extent of their presence in the corpus, either with a partitive or with an indefinite meaning.

In our discussion of the data, we start with sentences in which the definite article is singular and occurs with abstract nouns (Section 4.4.1) and, to a larger

<sup>12</sup> Another type of construction in which a verb argument is preceded by *di* in Old Italian occurs with verbs of hitting and fighting, also discussed in *LEI* s.v. Notably, such occurrences feature a different semantics, as shown in the following example.

*Se ti piacesse che tua mano none colpisse di*  
 if 2SG.OBL like:SBJV.IMPF.3SG that your hand neither hit:SBJV.IMPF.3SG of  
*spada né lanciasse dardo,*  
 sword nor throw:SBJV.IMPF.3SG arrow

*credo che tua rinomea no ne sarebbe né fratta né rotta . . .*

‘Even if you wouldn’t like your hand to hit with a sword or throw arrows, I believe that your reputation wouldn’t get ruined for this.’ *Fatti di Cesare*, XIII ex. (sen.).

The function of the NP introduced by *di* is instrumental. Syntactically, this can be considered an argument of the verb or perhaps an adjunct, but it is certainly not a direct object, as are the occurrences in examples (20)-(25). The NP introduced by *di* indicates the means with which the action is performed, and does not entail any of the meanings connected with partitivity or indefiniteness.

extent, mass nouns (Section 4.4.2). We then discuss occurrences of *di* combining with the definite article with plural count nouns (Section 4.4.3). In all three groups, we did in fact find occurrences in which *di* plus definite article introduces a PNC, and actually indicates an indefinite part extracted from a definite whole. However, as we will argue, another type of occurrences also emerged from our data, in which an indefinite reading is likely. In such occurrences the ‘part of a whole’ reading does not fit in the context in which it appears, as no whole from which the indefinite part could be extracted seems to be identifiable.

Contrary to common assumptions, we also found a limited number of occurrences in which the construction *di* plus definite article functions as subject. We discuss them in Section 4.4.4.

#### 4.4.1 Abstract nouns

In Old Italian, the construction featuring *di* followed by the singular definite article may occur with abstract nouns, even though the majority of the occurrences (98 out of 158) show concrete (mass) nouns. The partition meaning is occasionally available, as we show in Section 4.4.1.1. However, as we argue in Section 4.4.1.2, most frequently identifying the whole from which a quantity is extracted is difficult if not impossible.

##### 4.4.1.1 Partitive reading

Example (26) contains a direct object introduced by *di* followed by the singular definite article and an abstract noun *allegrezza* ‘happiness’.

(26) Giovanni Colombini, a. 1367 (sen.): 49

<i>fa</i> =		<i>lla</i>		<i>sentire</i>		<i>dell'</i>
make:IMPER.PRS.2SG=		3SG.ACC.F		feel:INF		of+DEF.ART.SG.F
<i>allegrezza,</i>		<i>che ebbe</i>		<i>la</i>		<i>sua</i>
happiness(F):SG	REL	have:PST.3SG		DEF.ART.SG.F		POSS.3SG.SG.F
<i>santissima</i>		<i>Madre.</i>				
holy:SUPL.SG.F		mother(F):SG				
'Let her feel some of the happiness that her holy mother felt.'						

In (26), the direct object *dell'allegrezza* is modified by means of a relative clause that supports the partitive meaning, specifying the whole from which the object is extracted, that is, “the (greater) happiness felt by her holy mother”. Hence, this occurrence must be taken as a PNC.

#### 4.4.1.2 Possible indefinite reading

When an abstract noun appears within a construction formed by *di* plus definite article, an indefinite reading is available in 44.4% of the occurrences. Indeed, in occurrences such as (18), discussed in Section 4.1, it is difficult if not impossible to identify a pre-established whole from which the mentioned element is extracted, that is, a contextually defined partition set, and the same holds for (27), discussed below. In such occurrences, the meaning of the construction comes close to the indefiniteness meaning conveyed by the partitive article in Modern Italian.

(27) Pistole di Seneca, XIV m. (fior.): 38.27

<i>Anticamente le</i>	<i>genti</i>	<i>andavano</i>	<i>cercando</i>
anciently	DEF.ART.PL.F	people:PL	go:IMPF.3PL
<i>dell'</i>	<i>amistà,</i>	<i>ora</i>	<i>cercano</i>
di+DEF.ART.SG.F	friendship(F):SG	now	look_for: PRS.3PL
<i>guadagno.</i>			
profit:SG			

'In ancient times people looked for (some) friendship, now they look for profit.'

In example (27), the direct object introduced by *di* and the definite article, *dell'amistà* 'friendship', is parallel to another object consisting of a bare noun *guadagno* 'profit'. Both objects are indefinite. Interestingly, both means are also used to express indefiniteness in Modern Italian, as we showed in Section 2. For what concerns the NP *dell'amistà*, it does not seem possible to find the reference and not even a hint to a pre-established definite whole: hence, the occurrence requires an indefinite, rather than a partitive reading. Another similar occurrence that also shows the parallelism between a bare noun and an abstract noun introduced by *di* and the definite article is (28).

(28) Ottimo, Inf., a. 1334 (fior.)

<i>Potrebbe essere in due modi: l'uno</i>	<i>pervanagloria, (...); l'altro</i>
it_could be	in two ways: the one for pride; the other
<i>per guadagnare della</i>	<i>lusinga, e indirizzare altri</i>
to earn	of+def.ART.SG.F
<i>a mal fine (...);</i>	flattery and address others
to bad end.	

'It could be in two different ways: either for pride or to obtain some flattery and make other people end up badly.'

In (28) the abstract NP *della lusinga* 'some flattery' is parallel to the bare noun *vana-gloria* 'pride'; even in this situation a partitive reading does not fit with the context.

Comparing the situation described in (27) and (28) with example (18) quoted in Section 4, one can remark that the interpretation of the object is similar. In (18), the construction featuring *di* and the definite article also supports the same indefinite meaning of the corresponding construction in Modern Italian, that is, the partitive article. The Old Italian occurrences show the onset of the process that led the partitive construction with indefinite nouns to shift to an indefinite meaning, and the complex *di* plus definite article to undergo transcategorization and become a partitive article, as it is in Modern Italian.

#### 4.4.2 Mass nouns

Mass nouns constitute the largest group of nouns that occur with *di* followed by the singular definite article. This construction in Old Italian may have two different meanings when occurring as direct object. In the first place, reference can be made to a well-defined whole from which a quantity is extracted and the presence of the *di* plus definite article is interpreted as mean of expression of the partition meaning. In other words, we may have PNCs, as we argue in Section 4.4.2.1. This first type of construction is more conservative and corresponds to an early stage of grammaticalization, as it reflects a similar use of the Latin PNC with *de* described in Section 3. With some other occurrences, on the other hand, no pre-established definite whole can be identified, and the reading is indefinite as in Modern Italian, as we show in Section 4.4.2.2. In both cases, verbs of transfer ('give') and consumption ('eat') are frequent.

##### 4.4.2.1 Partitive reading

With mass nouns introduced by *di* plus definite article the partition reading is rather widespread in Old Italian (74.5 % of the occurrences). Examples (29) and (30) show reference to a definite whole that does not allow any doubt about the partition meaning expressed by the NP introduced by *di* plus definite article, hence its nature of PNC.

- (29) Giordano da Pisa, Quar. fior., 1306 (pis./fior.): 52  
*questo panno si perde', levandone tu un pelo, e egli intenderebbe*  
 and he wish:COND.PRS.3SG  
*che sse ne perdesse del capitale*  
 that REFL PAR get lost:SBJV.IMPF.3SG of+DEF.ART.SG.M amount(M)  
*de' denari che costò.*  
 of+DEF.ART.PL money:PL REL cost:PST.3SG  
 'This tissue lost (value) because you took away a thread from it, and he wishes that (something) is subtracted from the amount of money that it was paid.'

(30) Fatti di Cesare, XIII ex. (sen.): Luc. L.3, c.9

*et àvi uno arbolo che chi*  
 and have:PRS.3SG INDEF.ART.SG.M tree(M):SG REL who  
*mangia del frutto non può*  
 eat:PRS.3SG of+DEF.ART.SG.M fruit(M):SG NEG can:PRS.3SG  
*morire.*  
 die:INF  
 ‘There is a tree – whoever eats (some of) its fruit cannot die.’

In example (29) the direct object *del capitale* is specified through the following noun phrase that refers to the whole amount of money that was paid, from which an indefinite part was subtracted. It is worth noting that the partition meaning is anticipated by the partitive particle *ne* that refers to the pre-existing whole amount of money.

In example (30) the pre-existing whole is anticipated, and functions as head of the relative clause that contains the partitive construction: “there is a (specific) tree”. Then, the main characteristic of the tree is specified. This characterization concerns a part of the whole, that is, “its fruit”, expressed by the direct object and introduced by *di* plus definite article. In this case, too, we have to do with a PNC, expressing the partition meaning. The indefinite quantity is indicated by the word *frutto* ‘fruit’ that, in this context, most likely does not refer to a single unit (a piece of fruit) but to all the fruit generated by the tree, conceptualized as a mass. It is important to note that, even if one takes *frutto* as referring to a single fruit of this specific tree, the mass reading is still available, as shown in (19), that we have already discussed in Section 4.1. In (19) the verb ‘eat’ takes as direct object the phrase *del pomo qe li de’ un serpente*, referring to an indefinite part/quantity of an apple that was given to her by a snake.

#### 4.4.2.2 Possible indefinite reading

In 25.5% of the occurrences with mass nouns, the construction *di* plus definite article does not support an interpretation as PNC, but rather indicates indefiniteness, as does the Modern Italian partitive article. Examples (31) and (32) contain mass nouns in direct object position introduced by *del/della* that points toward a partitive/indefinite reading, as they refer to an indefinite quantity of a substance without reference to the whole from which this quantity is extracted.

- (31) Elucidario, XIV in. (mil.): L.1, 91

*Tu vorisse ke fisse dado*  
 2SG.NOM want:SBJV.IMPF.2SG that give:SBJV.PSTPF.3SG

**del pan se tu avise fame,**  
 PAR bread:SG if you be\_hungry:SBJV.PSTPF.2SG

**del vin on de l' aqua**  
 of+DEF.ART.SG.M wine:SG or PAR water:SG

**se tu avisse sede e in cossi de le altre nesesitate.**  
 if 2SG.NOM be\_thirsty:SBJV.PSTPF.2SG

‘You would want to be given bread if you’re hungry, wine or water if you’re thirsty, and similarly for other needs.’

- (32)
- Quando fui desto innanzi la dimane,*
- 
- when be: PST.1SG awake before DEF.ART.SG.F next\_day

*pianger senti' fra 'l sonno i*  
 cry:INF hear:PST.1SG in DEF.ART.SG.M sleep:SG DEF.ART.PL.M

*miei figliuoli / ch'eran con meco, e dimandar*  
 POS:1SG.PL.M son(M):PL REL be:IMPF.3PL with me and ask\_for:INF

**del pane.**  
 PAR bread:SG

‘Before the dawn, I awoke and heard my sons, who were there with me, cry from their troubled sleep, asking for bread.’

As one can note from examples (31) and (32) *di* plus definite article constructions featuring mass nouns and supporting an indefinite reading often refer to food (*pane* ‘bread’) or drinks (*aqua* ‘water’, *vino* ‘wine’). In such occurrences, the mass is mentioned with no possible reference to a pre-established whole; hence, one must assume that the reference is indefinite. In (31), the direct objects occur within a desiderative sentence and the reference is intensional (non-specific and non-referential). We find a similar situation in the following sentence (32), as no actual referent is indicated by the noun phrase *del pane* ‘some bread’: indeed, Ugolino, who’s telling his story to Dante in this passage, was being starved to death in his cell with his children, and there was no food around that could constitute the pre-established whole presupposed by a PNC. As in (31), the reference is indefinite and non-specific, as the verb ‘ask for’ does not require having a specific referent as its direct object.



### 4.4.3 Plural count nouns

The construction formed by *di* plus definite article may introduce plural count nouns. Similar to the construction with abstract and mass nouns, in Old Italian this construction can have either a partitive meaning and instantiate the PNC, as we show in Section 4.4.3.1, or an indefinite meaning, as argued in Section 4.4.3.2. Remarkably, the partitive reading is as widespread as the indefinite reading (see Table 6). For what concerns the partitive reading, it appears that the reference to a specific set of elements that includes the direct object introduced by *di* plus definite article could be indicated with various linguistic means, such as, for example, the occurrence of a possessive element or the introduction of a restrictive relative clause with a specifying function.

#### 4.4.3.1 Partitive reading

In (33) we show an occurrence that could only be interpreted as featuring a PNC in direct object position, introduced by the article *delle*.

- (33) Brunetto Latini, *Rettorica* 109.17, c. 1260–61 (fior.)  
*s' elli scampassero e pervenissero a porto che*  
*elli offerrebboro delle loro cose*  
 they offer:COND.PRS.3PL of+DEF.ART.PL.F POSS.3PL belonging(F):PL  
*a quello deo che là fosse.*  
 to DEM.SG.M god(M):SG REL there be:SBJV.IMPF.3sg  
 'If they were rescued and reached the shore, they would offer some of  
 their belongings to the god they found there.'

In example (33) the direct object phrase, introduced by the construction *di* plus definite article, also contains the possessive adjective *loro* 'their'. This possessive element refers to a precise pre-existing whole, someone's belongings, from which some are said to be extracted. The possessive has the function of indicating reference to a pre-established whole: the set of elements possessed by/related to a certain person or group of persons. Such possessives occur in our sample in association to the PNC, not only with plural count nouns but also with mass nouns. Another linguistic means to obtain the reference to a whole consists of a relative clause as in (34).

(34) Milione, XIV in. (tosco.)

*Li due fratelli li donarono delle gioie*  
 the two brother:PL 3SG.DAT donate.PST.3PL of+DEF.ART.PL.F jewels(F)  
*ch' egli aveano in gran quantità, e Barca re*  
 that 3PL.NOM have: IMPF.3PL in big amount, and Barca king  
*le prese volentieri (...).*  
 3PL.F.OBL take:PST.3SG gladly  
 'The two brothers gave him a part of the jewels that they possessed in large quantities, and Barca the king gladly took them (...).'

In (34), however, reference seems to be less specific than in (33); the NP in object position identifies a part of a referent, "their jewels", which is indicated through an indefinite expression concerning its quantity.

#### 4.4.3.2 Possible indefinite reading

Example (35) shows that plural count nouns, within the construction formed by *di* combined with the definite article, could be read as indefinite, in cases in which a definite, pre-established whole is not identifiable and its existence cannot be assumed.

(35) Fr. da Barberino, Regg., 1318–20 (tosco.)

*Ancora, perché 'l marito volentieri / Mangiava le cipolle, / Sì ll' avvezzò a voler di quelle, / Ché dandogli il denaio / Al tempo di ciriegie / O di castangie o fichi primaticci, /*  
*Andava a conperar delle cipolle.*  
 go:IMPF.3SG to buy:INF PAR onion:PL  
 'Because her husband liked onions, she got him used to eating onions so, that, when he gave her money, in the season of cherries or chestnuts or figs, she went to buy (some) onions.'

The occurrence of sentences such (35) shows that the indefinite reading was also available with plural count nouns already in Old Italian for the construction that we are discussing. In particular, in sentence (35) the noun that appears within the construction was already introduced by a definite NP *volentieri mangiava le cipolle*, with a generic meaning and non-referentially. The same noun is used again in direct object position, but this time to introduce a new indefinite referent, in the same way as one can use the plural of the partitive article in Modern Italian. Example (36) also contains a direct object that expresses an indefinite meaning.

(36) Stat. pis., a. 1327

*Le persone di Villa di Chiesa sono povere persone*  
 the people of Villa di Chiesa are poor people  
*stenuti in Castello di Castro, dirrebbino delle cose*  
 kept in Castello di Castro dire:COND.PRS.3PL PAR thing.PL  
*et per povertà et per non stare non vere.*  
 and for poverty and to not stay not true:PL  
 ‘The people from Villa di Chiesa are poor people and because of their  
 poverty and in order to avoid to be imprisoned in Castello di Castro they  
 would say false things.’

In the expression *dire delle cose* ‘tell some things’ that occurs in (36) the verb is followed by the generic noun *cose* that makes the indefinite expression even vaguer. This example is interesting if compared with constructions formed by the object introduced by *di* plus a bare noun. We have shown in (22) and (24) that the expression *fare di cose* was used in Old Tuscan with an indefinite meaning as well as *dire di cose*. The sentence in (36) shows that the expression with the definite article was also used in Old Tuscan with the same distribution; the two constructions were basically variants with the same indefinite meaning.

#### 4.4.4 Possible subjects

Renzi (2010) claims that in Old Italian the construction featuring *di* followed by the definite article can only occur as direct object. This is certainly the more widespread situation but, in our sample, we also found a limited number of occurrences in which *di* plus definite article functions as subject, attesting that the construction can occasionally, even if rarely, occur in subject position too. The scarcity of examples is not surprising, since even in Modern Italian the appearance of the partitive article in subject position is much less frequent than in direct object position, as we showed in Section 2 (see Table 2).

Let us now consider examples (37) and (38).

(37) Ubertino del Bianco d’Arezzo, mid-13th century: 2/p. 237

*No=l sai dire empio tanto né mortale,*  
 NEG=3SG.ACC know:IND.PRS.2SG say:INF bad:SG.M ADV NEG evil:SG.M  
***che del ben non vi sia,***  
 that:CNSV of+DEF.ART.SG.M good:SG NEG there be:SUBJV.PRS.3SG  
 ‘You cannot say anything (about me) so bad and evil that does not contain  
 something good (lit.: that there’s not some good).’

(38) Pietro da Bescapè, 1274 (Iomb.):

*El'è fata tenevre cum è fata la raxa; / No vol veder*  
NEG want:PRS.3SG see:INF

*del ben insir fora de caxa.*  
of+DEF.ART.SG.M good:SG go\_out:INF out of house:SG

'She grew as hard as pitch, she doesn't want to see any goods get out of (her)home.'<sup>13</sup>

Both in (37) and in (38) the NP introduced by the *di* plus definite article occupies the subject position within a subordinate clause, and in both occurrences we find the same noun *ben*, which however has a different meaning in the first and in the second occurrence. Indeed, in (37) *ben* is an abstract noun, meaning 'something good' (as opposed to evil), while in (38) the same noun has the concrete meaning of 'goods', 'belongings'.

It is also worth noting that in (37) *del ben* is the subject of an existential clause, within a presentative construction, that is, the typical construction by means of which new referents are introduced into the discourse. This is also the type of context that favors the extension of partitive indefinites to subject position, as has been argued extensively with respect to the Finnish partitive (see e.g. Huumo 2003), and remains the most frequent type of clause for the occurrence of partitive subjects in Modern Italian, see Section 2, Table 2.

The occurrence of the construction *di* plus definite article in subject position with an indefinite reading attests to a somewhat advanced degree of grammaticalization at the time of the texts surveyed in our study.

## 5 Diatopic distribution of the constructions

We have already mentioned the fact that at the present time the indefinite partitive article in Italian has not reached the stage of obligatoriness as its Modern French counterpart, not only because it is almost always possible to omit it, but also because its use has a particular diatopic distribution. Speakers from the Northern part of the country tend to judge it as acceptable and to use this kind of article

<sup>13</sup> It must be noted that *del ben* can be considered the object of *veder*; in any case, it also functions as subject of *insir*.

in every context, while speakers from Central and Southern Italy often replace it with quantifiers or use bare nouns.<sup>14</sup>

If we look at the diatopic distribution of the Old Italian texts surveyed in our study, we can observe that constructions introduced by the preposition *di* in direct object or subject position mostly occur in texts coming from Tuscany.<sup>15</sup> This fact is not surprising because the documents from this area are the most consistent group of Old Italian material, stored in the OVI corpus. What is quite interesting, instead, is the presence, besides the Tuscan occurrences, of a significant number of examples from Northern Italian documents, in particular coming from Lombardy. Such occurrences attest to an early diatopic distribution of the constructions examined that is still reflected in Modern Italian.

Even more interesting is to take a closer look at the diatopic distribution of the two different constructions we examined, with or without the definite article combining with *di*. If we consider the construction formed by *di* and a noun without a definite article, possibly preceded by a modifier, it clearly emerges from our data that its occurrence is restricted to texts from Tuscany, and in particular to those coming from Florence and Siena. The use of this construction is therefore restricted not only for what concerns the linguistic context, but also geographically. The construction formed by *di* followed by the definite article has a different diatopic distribution, as occurrences are available from both Northern Italy and Tuscany. The remarkable fact in this distribution is that the Northern Italian occurrences of this latter construction typically show original and ‘advanced’ features: for the occurrences from this area the indefinite reading is frequently available, and the construction also occurs in subject position.

Some remarks concerning the distribution of the partitive article in Modern Italian dialects are in order here.<sup>16</sup> In general, the distribution in the Italian

---

**14** More precisely, the partitive article is most widespread among speakers from the North-Western regions of Italy (Piedmont, Liguria and Lombardy) and from Emilia Romagna, as shown in Cardinaletti & Giusti (2020).

**15** The corpus includes all texts written before 1375 belonging to all Italian varieties, except Sardinian, Ladin and Friulan texts and texts written in non-Italian varieties, even if they have been written in Italy.

**16** An explanation is in order here concerning the use of the terms ‘dialect’ and ‘regional Italian variety’. What is commonly referred to as ‘Italian dialects’ is not regional varieties of Italian: these are instead always indicated with the latter term. As remarked in Maiden & Parry (1997: 2) “The often used term ‘Italian dialects’ may create the false impression that the dialects are varieties of the standard Italian language. In fact, the Italian language represents the continuation of one of the dialects (a Florentine variety of Tuscan) which achieved na-

dialectal varieties reflects the distribution that we have already described for Standard Italian (and its regional varieties); however, in the Northwest of the country, especially in Turinese but partly also in other Piedmontese varieties (see Cerruti 2020), *di* occurs with bare nouns to express the same indefinite meaning of the Modern Italian partitive article, as shown in (39) and (40).

(39) *Cata*                    *d*    *carn!*  
 buy:IMPER.2SG    PAR    meet  
 ‘Buy some meet!’

(40) *Cata*                    *d*    *agolòt!*  
 buy:IMPER.2SG    PAR    ravioli  
 ‘Buy (some) ravioli!’

As we do not have texts in Old Italian from this part of the country in the OVI corpus, we cannot speculate on the connection between the Modern Piedmontese construction and the Old Italian one.<sup>17</sup> One can however point out that the extent to which the construction containing *di* with a singular or plural bare noun in Modern Piedmontese can express indefiniteness appears to be wider than what we have observed in the Old Italian corpus, as it is not limited to specific verbs, or specific types of NPs (with determiners, quantifiers or attributive adjectives). Notably, the areas in which *di* indicates indefiniteness with bare nouns borders with Franco-Romance varieties, Provençal and Franco-Provençal, which also use *di* with bare nouns as partitive. Example (41) is usually considered Provençal (see Bonato 2004: 180; note also that this occurrence contains a negation, a context that favors the occurrence of the partitive in Franco-Romance).

---

tional and international prestige from the fourteenth century onwards as a literary language and later (principally in the twentieth century) as a spoken language.” As the authors argue, Italian dialects are “‘sisters’ of Italian, locally divergent developments of the Latin originally spoken in Italy.” In this framework, Standard Italian must be regarded as “the continuation of one of the dialects (a Florentine variety of Tuscan) which achieved national and international prestige.”

<sup>17</sup> The reason for this is that the earliest texts from this area date back to a later time than the limit chosen in OVI for Old Italian, that is, 1375. Earlier texts, such as the *Sermoni Subalpini* quoted in example (41), are commonly considered as attestations of Provençal, a Gallo-Romance variety not included in OVI. For a different view on the language represented in this text, see Miola (2017).

- (41) *So                    compaignun   no   bevrà           d'*  
 POSS.3SG.SG.M   comrade(M)   NEG   drink:FUT.3SG   PA  
*aiva                clara*  
 water(F):SG   clear:SG.F  
 'His comrade will not drink clear water.'  
 (Sermoni subalpini, 12th/13th century, VIII, 156);

In Modern Tuscan varieties, too, *di* can occur with a partitive meaning with bare nouns, but in this function it is especially used in NPs that contain attributive adjectives, see Rohlf (1968), Renzi (1997: 163–164), and largely reflects the use of *di* with bare nouns in Old Italian as we described in Section 4.3.

The distribution described above points toward a continuity between the Old Italian construction featuring *di* and the indefinite article, which can also be observed from the diatopic point of view, while the construction featuring *di* plus a noun without a definite article appears to also have been geographically restricted. The partitive article of Modern Italian appears to have originated out of the PNC with *di* plus definite article, and the onset of the shift of this construction toward the expression of indefiniteness had already started at the time of the texts in our corpus. The Old Italian construction *di* plus bare noun has not been replaced by the construction containing the definite article. Rather, it was a different construction, with specific collocational restrictions and typical of Old Tuscan, which has partly been carried on in the Modern Tuscan vernaculars.

## 6 Conclusion

In this paper, we discussed the early development of the Italian partitive article, which nowadays conveys an indefinite meaning and originated from PNCs. Our study shows that the indefinite meaning started to emerge quite early in Old Italian. Indefinite NPs preceded by *di* and the definite article already occurred in the 12th–13th century Italian, and the indefinite meaning seems to have gradually emerged by the 14th century. In the corpus we analyzed, the indefinite meaning appears to be available in about one third of the occurrences (33.5%, see Table 6).

Considering the construction containing *di* followed by the definite article in Old Italian, in Table 6 we were able to show that the indefinite reading is more easily available in some specific contexts, in particular with plural count nouns (50%) and with abstract nouns (44.4%), while it was less frequently available with mass nouns (25.5%). In the case of abstract nouns, the explanation for this can be found in a tendency of abstract nouns to lose the partition meaning and consequently

acquire an indefinite meaning more easily than concrete nouns. Indeed, abstract nouns do not easily occur in constructions in which reference is made to a part of a pre-established, identifiable whole, and occurrences that call for such an interpretation are infrequent in our corpus.

Most occurrences we analyzed as indicating indefiniteness show *di* plus definite article with direct object NPs, but we also found a limited number of occurrences in which the same construction appears with subjects, especially in presentative clauses.

Our corpus also showed that the construction featuring *di* without a definite article is infrequent (5.4% of the occurrences), and is not semantically equivalent to the Modern Italian partitive article and that its development remains separate from the development of the partitive article. The use of this structure is largely connected with certain characteristics of specific NPs and specific verbs, hence it is limited to some particular collocations.

Finally, based on the diatopic distribution of the two constructions examined, we argued that the use of the construction featuring *di* followed by a noun without the definite article was also geographically restricted. In our sample, indeed, this construction is limited to Tuscan texts, in particular those from Siena and Florence. The construction formed by *di* combined with the definite article has a wider diatopic distribution, as occurrences are available from both Northern Italy and Tuscany. Notably, in occurrences from Northern Italian texts the indefinite reading is more frequently available, and is even possible in subject position.

## References

- AIS = Jaberg, Karl & Jakob Jud. 1928–1940. *Sach- und Sprachatlas Italiens und der Südschweiz*. Zofingen: Ringier
- Albonico, Giovanna. 2018. *Indefinite articles in Italian*. Paper presented at the 51th SLE Conference: 29 August – 1st September 2018, University of Tallinn. Workshop 11: Preverbal indefinite subjects.
- Bonato, Massimo. 2004. Partitivo e articolo indeterminativo plurale nel piemontese parlato contemporaneo, *Rivista Italiana di Dialettologia* 28. 175–196.
- Cardinaletti, Anna & Giuliana Giusti. 2018. Indefinite determiners. Variation and optionality in Italo-Romance. In Roberta D'Alessandro & Diego Pescarini (eds.), *Advances in Italian dialectology. Sketches of Italo-Romance grammars*. Amsterdam: Brill.
- Cardinaletti, Anna & Giuliana Giusti. 2020. Indefinite determiners in informal Italian. A preliminary analysis. In Tabea Ihsane & Elisabeth Stark (eds.), *Shades of Partitivity: formal and areal properties*. Special Issue in *Linguistics* 58(3). 679–712.



- Carlier, Anne. 2007. From preposition to article: The grammaticalization of the French partitive. *Studies in Language* 31. 1–49.
- Carlier, Anne. 2021, this volume. *Du/Des* NPs in French: a comparison with bare nouns in English and Spanish. In Petra Sleeman & Giuliana Giusti (eds.), *Partitive determiners, partitive pronouns and partitive case* (Linguistische Arbeiten 580). Berlin/Boston: Mouton De Gruyter.
- Carlier, Anne & Béatrice Lamiroy. 2014. The grammaticalization of the prepositional partitive in Romance. In Silvia Luraghi & Tuomas Huomo (eds.), *Partitive cases and related categories*, 477–519. Berlin/Boston: Mouton De Gruyter.
- Cerruti, Massimo Simone. 2020. Partitive determiners in Piedmontese: A case of language variation and change in a contact setting. In Tabea Ihsane & Elisabeth Stark (eds.), *Shades of partitivity: formal and areal properties*. Special Issue in *Linguistics* 58(3). 651–677.
- Conti, Luz & Silvia Luraghi. 2014. The Ancient Greek partitive genitive in typological perspective. In Silvia Luraghi & Tuomas Huomo (eds.), *Partitive cases and related categories*, 443–476. Berlin/Boston: Mouton De Gruyter.
- Dahl, Eystein. 2014. Partitive subjects and objects in Indo-Iranian and beyond. In Silvia Luraghi & Tuomas Huomo (eds.), *Partitive cases and related categories*, 417–442. Berlin/Boston: Mouton De Gruyter.
- Daniel, Michael. 2014. The second genitive in Russian. In Silvia Luraghi & Tuomas Huomo (eds.), *Partitive cases and related categories*, 347–378. Berlin/Boston: Mouton De Gruyter.
- Gianollo, Chiara. 2012. Prepositional genitives in Romance and the issue of parallel development. In Charlotte Galves, Sonia Cyrino, Ruth Lopes, Filomena Sandalo & Juanito Avelar (eds.) *Parameter theory and linguistic change*, 281–303. Oxford: Oxford University Press.
- Giusti, Giuliana. 2021, this volume. Partitivity in Italian: A protocol approach to a multifaceted phenomenon. In Petra Sleeman & Giuliana Giusti (eds.), *Partitive determiners, partitive pronouns and partitive case* (Linguistische Arbeiten 580). Berlin/Boston: Mouton De Gruyter.
- Giusti, Giuliana & Petra Sleeman. 2021, this volume. Partitive elements in the languages of Europe. An advancement in the understanding of a multifaceted phenomenon. In Petra Sleeman & Giuliana Giusti (eds.), *Partitive determiners, partitive pronouns and partitive case* (Linguistische Arbeiten 580). Berlin/Boston: Mouton De Gruyter.
- Grandi, Nicola. 2010. Articolo. *Enciclopedia dell'italiano*. Available at: [http://www.treccani.it/enciclopedia/articolo\\_\(Enciclopedia\\_dell'Italiano\)/](http://www.treccani.it/enciclopedia/articolo_(Enciclopedia_dell'Italiano)/)
- Huomo, Tuomas. 2003. Incremental existence: The world according to the Finnish existential sentence. *Linguistics* 41(3). 461–493.
- Koptjevskaja-Tamm, Maria. 2001. 'A piece of the cake' and 'a cup of tea'. In Östen Dahl & Maria Koptjevskaja-Tamm (eds.), *Circum-Baltic languages*. Vol. 2: *Grammar and Typology*, 523–568. Amsterdam /Philadelphia: John Benjamins.
- Korzen, Iørn 1996. *L'articolo italiano tra concetto ed entità: vol. I and II*. Copenhagen: Museum Tusulanum Press.
- LEI = *Lessico etimologico italiano*. 1979. Wiesbaden: Reichert.
- Luraghi, Silvia. 2003. *On the meaning of cases and prepositions*. Amsterdam/Philadelphia: John Benjamins.
- Luraghi, Silvia. 2013. Partitivi nel latino biblico. *Studi italiani di linguistica teorica e applicata* 42(1). 41–60.
- Luraghi, Silvia. 2017. *The distribution of the Italian partitive article*. Paper presented at the 50th SLE Conference: 10–13 September 2017, University of Zürich. Workshop Nr. 3: *Bare nouns vs. Partitive articles: disentangling functions*.

- Luraghi Silvia & Tuomas Huomo (eds.). 2014. *Partitive cases and related categories*. Berlin/Boston: Mouton De Gruyter.
- Luraghi, Silvia & Seppo Kittilä. 2014. The typology and diachrony of partitives. In Silvia Luraghi & Tuomas Huomo (eds.), *Partitive cases and related categories*, 17–62. Berlin/Boston: Mouton De Gruyter.
- Maiden, Martin & Mair Parry. 1997. *The dialects of Italy*. London/New York: Routledge.
- Mertyris, Dionysios. 2014. *The loss of the genitive in Greek: a diachronic and dialectological analysis*. PhD dissertation, La Trobe University.
- Miola, Emanuele. 2017. The position of Piedmontese on the Romance grammaticalization cline. *Folia Linguistica* 51(1). 133–167.
- Mula, Patrik. 2017. *Trésor de la langue italienne: l'italien ancien par les textes*. Saint-Denis: Connaissances et Savoires.
- OVI = *Opera del Vocabolario Italiano*. Available at: <http://www.ovi.cnr.it/index.php/it/>
- Paykin, Katia. 2014. The Russian partitive and verbal aspect. In Silvia Luraghi & Tuomas Huomo (eds.), *Partitive cases and related categories* 379–397. Berlin/Boston: Mouton De Gruyter.
- Renzi, Lorenzo 1991. L'articolo. In Lorenzo Renzi, Giampaolo Salvi & Anna Cardinaletti (eds.), *Grande grammatica italiana di consultazione*, Vol. I. Bologna: Il Mulino, 357–423.
- Renzi, Lorenzo. 1997. The structure of the noun phrase. In Martin Maiden & Mair Parry (eds.), *The dialects of Italy*, 162–170. London: Routledge.
- Renzi, Lorenzo. 2010. L'articolo. In Giampaolo Salvi & Lorenzo Renzi (eds.) *Grammatica dell'italiano antico*, vol. 1, 297–398. Bologna: Il Mulino.
- Rohlf, Gerhard. 1968. *Grammatica storica della lingua italiana e dei suoi dialetti*. Vol. 2 *Morfologia*. Torino: Einaudi.
- Stark, Elisabeth. 2007. Gender, number, and indefinite articles: About the 'typological inconsistency' of Italian. In Elisabeth Stark, Elisabeth Leiss & Werner Abraham (eds.), *Nominal determination: Typology, context constraints, and historical emergence*, 49–71. Amsterdam/Philadelphia: John Benjamins.
- Väänänen, Veikko. 1981a. Introduction au latin vulgaire. 3rd edn. Paris: Klincksieck.
- Väänänen, Veikko. 1981b. La préposition latine *de* et le génitif. In Veikko Väänänen, *Recherches et créations latino-romanes*. Naples: Bibliopolis.





## **Part III: The acquisition of partitivity**



Petra Sleeman & Tabea Ihsane

# The L2 acquisition of the partitive pronoun *en* in French by L1 speakers of German and the role of the L1

Whereas French does have a partitive pronoun (also called quantitative pronoun), standard German does not have one. By means of a Grammaticality Judgment Task it is investigated how advanced German learners of L2 French judge the use of the partitive pronoun or its absence in various contexts. The main goal of the paper is to investigate what role the L1 plays in the acquisition of the use of the partitive pronoun in French. Three different scenarios are explored, namely, the hypotheses i) of poor performance in all contexts, ii) of poor performance only in contexts in which French uses a partitive pronoun, and iii) of poor performance only in contexts where positive transfer from similar constructions in German is not possible. Our results support the third scenario, showing that the possibility of positive transfer should be understood in a broader way. At the same time our results show which contexts are vulnerable and which ones seems to be easier to learn in L2 acquisition of French by German L1 speakers.

## 1 Introduction

The partitive pronoun (also called *quantitative* pronoun) is a pronoun that is used in combination with an indefinite noun phrase in object position that does not

---

**Notes:** This paper has benefited from the help and advice of many people. We thank the participants for filling in the tests. We thank the reviewers of this paper for their valuable comments. A special thanks goes to series editor Klaus von Heusinger for his critical remarks and useful suggestions. We are grateful to Thomas Strobel and Elvira Glaser for answering our questions about the use of *welch* in modern German, to Gabrielle Hess, Liliane Klaey, Thom Westveer, and Richard Zimmerman for their help with the translation of the German test sentences and to Elisabeth Stark for checking the German test. Possible errors are ours. The second author also thanks the URPP *Language and Space* at the University of Zurich and the *Swiss National Science foundation* for financial support.

contain an overt noun.<sup>1</sup> The partitive pronoun can be found both in Romance (e.g. in French, Italian, Catalan as a clitic) and in Germanic languages (e.g. in Dutch, some German dialects).

(1) *Ne ho comprato uno.* ITALIAN  
 PART.CL I.have bought one  
 ‘I bought one.’

(2) *Ik heb er een gekocht.* DUTCH  
 I have PART.WK one bought  
 ‘I have bought one.’

The Romance partitive pronoun has as its origin the Latin adverbial pronoun *inde* ‘from there’, which was lost in several Romance languages, such as Spanish and Portuguese (see, e.g., Badia i Margarit 1947; Martins 2014; Gerards 2020). The partitive pronoun in Dutch and some German dialects derives from the genitive 3rd person plural form *iro* ‘of them, their’ (Bech 1952; Philippa, Debrabandere & Quak 2004). Since the partitive pronoun does not exist in all Romance and Germanic languages, what interests us to know is how the use of the partitive pronoun in a second language is acquired by learners who do not have one in their L1. We will study the acquisition of French as an L2 by native speakers of German.

In French, the partitive pronoun is used in a variety of contexts, such as in combination with a quantifier, as in (3), comparable to (1)-(2), where German does not use a partitive pronoun, as shown in (4).

(3) *J'en ai acheté un.* FRENCH  
 I PART.CL have bought one  
 ‘I have bought one.’

---

<sup>1</sup> The labels “partitive pronoun” and “quantitative pronoun” are both misnomers as the examples discussed in the paper show: these pronouns can be used in various contexts which do not necessarily contain a quantity or have a partitive interpretation. In conformance with the title of this volume (Sleeman & Giusti 2021, this volume), we use the term *partitive pronoun* in this paper (Sleeman & Ihsane 2020). See also the introduction to this volume (Giusti & Sleeman 2021, this volume) for further details on the various types of partitive elements and the terminology used in the volume and Giusti’s article in this volume (Giusti 2021, this volume), in which she discusses Italian *ne*, which is also labelled “quantitative clitic” in the literature.

(4) *Ich habe einen (davon) gekauft.*

GERMAN

I have one.M.SG. of.them bought  
‘I bought one (of them).’

There are also restrictions on the use of the partitive pronoun in other, comparable contexts, for instance in nounless constituents containing a definite article and an adjective (cf. Section 2.1). In such contexts, the partitive pronoun is absent in French, as it is in German. Our main goal is to find out what the role of the L1 is in the learning process when the L1 does not have a partitive pronoun.

The influence of one language on another in situations of language acquisition is called *transfer* (e.g., Lado 1957; Schwartz & Sprouse 1994, 1996; Odlin 1989). If the mother tongue has a property also present in the L2, there may be positive transfer, i.e. the mother tongue may help the acquisition of the property in the L2. If the mother tongue does not have a property present in the L2, there may be negative transfer, i.e. it may hinder the acquisition of the property in the L2. Transfer has often been studied in these conditions: wholesale presence or absence of a phenomenon. However, it may also be the case that a phenomenon is absent in both languages in one context but is present in the L2 only in another context: for example, as mentioned above, the partitive pronoun is absent in definite noun phrases containing an adjective both in French and German, but present with a nounless indefinite noun phrase introduced by a quantifier in French, in contrast to German (recall (3) vs. (4)). This raises the question whether there may also be property-by-property transfer depending on the context. Transfer (positive or negative) in the acquisition of a property *as a whole* and transfer *in some contexts only* thus represent two different scenarios. A third one is the possibility for cues in an L1 to help the learner to learn in which contexts a phenomenon occurs, despite the absence of this phenomenon in the L1.

In this paper, by means of a Grammaticality Judgment Task submitted to (Swiss) German L1 learners of French L2, these three scenarios will be investigated.<sup>2</sup> First, does the absence of a partitive pronoun in German L1 lead the L2 learners to perform poorly in all contexts, i.e. with or without a partitive pronoun? Or, second, do the learners perform poorly only on sentences in which L1 speakers of French accept a partitive pronoun, but do they score equally well as the native speakers of French on sentences in which no pronoun is used in both languages? Or, third, do they perform like the French native speakers in all contexts in which there may be positive influence from German in some way, even if German does not have a partitive pronoun? To be able to evaluate the judgments of the L2

---

<sup>2</sup> Our experiment was carried out at the University of Zurich in Switzerland.



learners on French, we also tested the judgments of a group of native speakers of (Swiss) French by means of the same Grammaticality Judgment Task as the one that was filled in by the L2 learners. In order to evaluate the influence of German L1, we also submitted a Grammaticality Judgment Task in German to the L2 learners, with sentences comparable to the French sentences.

The paper is organized as follows. In Section 2, we present the French partitive pronoun constructions that will be investigated and their German equivalents. In Section 3, we discuss the notion of transfer based on the literature and we present some previous research on the L2 acquisition of the partitive pronoun in relation to the notion of transfer. In Section 4, we will formulate our research question and hypotheses and our methodology. Our results will be presented in Section 5, followed by the discussion in Section 6. Section 7 concludes the paper.

## 2 Partitive pronoun constructions in French and their equivalents in German

In the introduction we showed that the French partitive pronoun *en* is used in combination with a nounless NP in object position that is introduced by a quantifier. In Section 2.1, we present the other contexts in which *en* is used. How German behaves in comparable contexts will be shown in Section 2.2.

### 2.1 Partitive pronoun constructions in French

In the introduction, we saw that partitive pronouns may be used in combination with a nounless NP introduced by a quantifier. In French, the partitive pronoun *en* can also be combined with indefinite noun phrases that are not introduced by a quantifier. The contexts in which *en* is used are presented and exemplified in Table 1. These contexts are all indefinite nounless noun phrases in object position. We present both the context with a noun and the context with *en* instead of a noun.<sup>3</sup>

---

<sup>3</sup> In contexts (ii)-(v) it is not possible to simply leave out the noun in the English translation, as in context (i), or to replace it by *one*, as in context (vi). Therefore, we use the noun in the translation of the contexts with *en*. This will also be done in context (vii).

**Table 1:** Contexts in which *en* is used.

<i>Context</i>	<i>With a noun</i>	<i>With EN<sup>4</sup></i>
(i) NP introduced by a quantifier	<i>Ils ont lu trois livres.</i> they have read three books 'They have read three books.'	<i>Ils en ont lu trois.</i> they PART.CL have read three 'They have read three.'
(ii) Mass NP	<i>Jean a acheté du lait.</i> Jean has bought PART.DET milk 'Jean has bought milk.'	<i>Jean en a acheté.</i> Jean PART.CL has bought 'Jean has bought milk.'
(iii) Negated mass NP	<i>Je ne bois pas de café.</i> I NEG drink NEG of coffee 'I do not drink coffee.'	<i>Je n' en bois pas.</i> I NEG PART.CL drink NEG 'I do not drink coffee.'
(iv) Non-referential plural NP	<i>Elle cherche des noix.</i> she looks.for PART.DET nuts 'She is looking for nuts.'	<i>Elle en cherche.</i> she PART.CL looks.for 'She is looking for nuts.'
(v) Negated indefinite plural NP	<i>Je ne prends pas de photos.</i> I NEG take NEG of pictures 'I do not take pictures.'	<i>Je n' en prends pas.</i> I NEG PART.CL take NEG 'I do not take pictures.'
(vi) Indefinite NP containing an adjective	<i>Il choisit un vélo noir.</i> he chooses a bike black 'He chooses a black bike.'	<i>Il en choisit un noir.</i> he PART.CL chooses a black 'He chooses a black one.'

Milner (1978) distinguishes two different interpretations for *en* in both of the contexts (i) and (vi). He calls these the quantitative and the partitive interpretation, respectively. In the partitive interpretation, the nounless NP is a subset of a delimited superset in the context, see also Berends et al. (2021, this volume):

(5) *De ces livres, ils en ont lu trois.*  
of these books they PART.CL have read three  
'Of these books, they have read three.'

(6) *De ces beaux vélos, il en choisit un noir.*  
of these beautiful bikes he PART.CL chooses a black  
'Of these beautiful bikes, he chooses a black one.'

*En* has a quantitative interpretation if the elided noun has a kind reading:

<sup>4</sup> In the questionnaire that we used in our test, all the test items, including the ones described in Tables 2–4, are introduced by a short situation in parentheses providing an antecedent to the pronoun (see Section 4.2.2).

- (7) *Ils voulaient lire des livres ; ils en ont lu trois.*  
 they wanted to.read PART.DET.PL books they PART.CL have read three  
 ‘They wanted to read books; they have read three.’
- (8) *Il voulait avoir un vélo, il en a choisi un noir.*  
 he wanted to.have a bike, he PART.CL has chosen a black  
 ‘He wanted to have a bike; he has chosen a black one.’

*En* cannot be used with any NP in object position. In Table 2 contexts are presented in which *en* cannot be used. In (vii) the noun phrase is introduced by *des*, just as in (iv). But whereas in context (iv) with a non-referential NP *en* can be used, with the referential NP in context (vii), the definite plural pronoun *les* must be used instead of *en* (see Ihsane 2013 for a theoretical analysis of the distinction between referential and non-referential noun phrases, supported by the two different types of pronoun). Since *en* can only be used in combination with indefinite noun phrases, its combination with a definite noun phrase containing an adjective, i.e. context (viii), the definite counterpart of the noun phrase in (vi), is ungrammatical. The definite nounless NP has to be used without *en*.

**Table 2:** Contexts in which *en* cannot be used.

<i>Context</i>	<i>With a noun</i>	<i>With en</i>
(vii) Referential plural NP	<i>Je vois des enfants.</i> I see PART.DET.PL children <i>Ce sont Jean et Marie.</i> These are Jean and Marie ‘I see children. They are Jean and Marie.’	* <i>J’en vois.</i> I PART.CL see ‘I see children.’  <i>Je les vois.</i> I them see ‘I see them.’
(viii) Definite NP containing an adjective	<i>Il choisit le vélo noir.</i> he chooses the bike black ‘He chooses the black bike.’	* <i>Il en choisit le noir.</i> he PART.CL chooses the black ‘He chooses the black one.’  <i>Il choisit le noir.</i> he chooses the black ‘He chooses the black one.’

## 2.2 Equivalents of the partitive pronoun constructions in German

Standard German does not have a partitive pronoun comparable to *en*. Recall that the core function of the partitive pronoun is its use in combination with

a nounless NP introduced by a quantifier in object position, shown in context (i). As illustrated in (4), in this case German uses a bare quantifier, without the support of a pronoun.

Glaser (1992) observes, however, that since rather recently, standard German uses the pronoun *welch* in an indefinite interpretation, viz. in an anaphoric function referring to a mass noun or an indefinite plural noun, indicating an unspecified quantity, as in (9) and (10), taken from Glaser (1993):<sup>5</sup>

(9) *Wir haben kein Salz mehr, könntest du welches mitnehmen?*  
 we have no salt left could you WELCHES take  
 ‘We do not have salt anymore, could you bring salt?’

(10) *Wenn sie neue Kartoffeln suchen, wir haben welche.*  
 if you new potatoes look.for we have WELCHE  
 ‘If you are looking for new potatoes, we have new potatoes.’

Glaser (1993) observes that in this indefinite-partitive interpretation, *welch* resembles the French partitive pronoun *en* or the Italian *ne*, although the use of *welch* only partially overlaps with the use of *en* and *ne*, viz. only in the indefinite interpretation (i.e. without the specification of a quantity). *Welch* can however not have a properly partitive interpretation, i.e. specifying a quantified subset, in contrast to *en* in French, as illustrated in (5). The above discussion implies that *welch* cannot be used in context (i), since it contains a quantifier, but that it could be used in contexts (ii)-(v) illustrated in Table 1.

Strobel (2017) states that *welch* cannot be used either in combination with an elliptical noun phrase containing an adjective.<sup>6</sup> This would mean that it differs from *en* in that it cannot be used in context (vi), Table 1. It cannot be used in context (viii), Table 2, either, also because this is a definite context. French *en* cannot be used in this context either, as observed in Section 2.1.<sup>7</sup>

Glaser and Strobel do not discuss the distinction between non-referential (context (iv) in Table 1) and referential (context (vii) in Table 2) indefinite plural NPs.

5 There is no equivalent of *welch* in English. Therefore, we use a noun in the translation of the examples with *welch*, including those in Tables 3 and 4.

6 Exemplified by . . . *könntest du (\*welches) gutes kaufen?* lit.: could you (\*WELCHES) good buy? (intended: could you buy good salt?) referring to *Salz* in (9) and . . . *wir haben (\*welche) neue* ‘lit.: we have (\*WELCHE) new (intended: we have new potatoes)’ referring to *Kartoffeln* in (10).

7 Glaser (2008) and Strobel (2017) observe that in some German dialects, there are several other variants of the indefinite-partitive pronoun, viz. *(d)(ə)r(ə)*, *s(ə)n*, and *əs*, and some innovations:  $\emptyset$  and *ein*.

Sleeman & Ihsane (2020) show that native speakers of German tend to accept *welch* in non-referential contexts (94%), but much less so in referential contexts (33%).

The (indefinite, nounless) contexts in which *welch* can be used are presented and exemplified in Table 3. Both the context with *welch* and the preceding context, in the dialogue, with a noun are presented.<sup>8,9</sup>

**Table 3:** Contexts in which *welch* can be used.

(ii) Mass NP	<i>Kind: "Könntest du bitte Brot kaufen?"</i> 'Child: Could you buy bread, please?'	<i>Mutter: "Nein, wir haben noch welches."</i> 'Mother: No, we still have bread.'
(iii) Negated mass NP	<i>Ann: "Trinken Sie keinen Wein?"</i> 'Ann: Don't you drink wine?'	<i>Lucie: "Nein, ich trinke nie welchen."</i> 'Lucie: No, I never drink wine.'
(iv) Non-referential plural NP	<i>Eric: "Ich sehe Kinder auf dem Schulhof spielen. Es sind Sara, Paul und Jessica."</i> 'Eric: I see children playing in the schoolyard. They are Sara, Paul and Jessica.'	<i>Sie sagen: "Ich sehe auch welche, aber ich sehe nicht Sara, Paul und Jessica."</i> 'You say: I also see children, but I do not see Sara, Paul and Jessica.'
(v) Negated indefinite plural NP	<i>"Liest du niemals Kriminalromane?"</i> 'Do you never read thrillers?'	<i>"Nein, ich lese nie welche."</i> 'No, I never read thrillers.'

**8** A reviewer observes that *en* in French stands for at least the two constructions below in German (cf. the discussion of (5)):

(i) *Peter hat Zucker gekauft.*

'Peter has bought sugar.'

*Ich habe davon (welchen) genommen.*

I have of.it some/a.little taken

'I have taken some from it.'

(ii) *Peter sucht Zucker.*

'Peter is looking for sugar.'

*Ich habe ihm \*davon welchen gegeben.*

I have to.him of.it some/a.little given

'I have given some to him.'

*En* may replace a PP containing a delimited discourse familiar set/DP and correspond to *davon* 'of.it', not to *welch* 'some/a.little', as in (i); *en* may also replace a noun or NP and correspond to *welch*, as in (ii), in which case *davon* is ungrammatical. We thank the reviewer for this remark and the examples which show that in German *davon* and *welch* can co-occur as in (i), unlike the partitive *en* and the quantitative *en* in French.

**9** In the negative contexts (iii) and (v) we used another type of negation in our German test than in our French test, which will be motivated in Section 4.2.2.

In Table 4, contexts are presented in which *welch* cannot be used. We present both the context with a noun and the context without a noun.

**Table 4:** Contexts in which *welch* cannot be used.

(i) NP introduced by a quantifier	<i>Ich werde einige Museen besuchen.</i> 'I will visit some museums.'	<i>Ich werde einige besuchen.</i> 'I will visit some.'
(vi) Indefinite NP containing an adjective	<i>Tristan hat einen kleinen Bären im Zoo gesehen.</i> 'Tristan has seen a little bear in the zoo.'	<i>Paul hat einen großen im Zoo gesehen.</i> 'Paul has seen a big one in the zoo.'
(vii) Referential plural NP	<i>Eric: "Ich sehe Kinder auf dem Schulhofspielen. Es sind Sara, Paul und Jessica."</i> 'Eric: I see children playing in the schoolyard. They are Sara, Paul and Jessica.'	<i>Sie sagen: "Ich sehe sie auch."</i> 'You say: I also see them.'
(viii) Definite NP containing an adjective	<i>Marie hat im Laden den roten Ballon gekauft.</i> 'Marie has bought the red balloon in the shop.'	<i>Peter hat im Laden den blauen gekauft.</i> 'Peter has bought the blue one in the shop.'

Strobel (2016), on the basis of an observation made by Glaser (1992), judges the similarity between German *welch* and French *en* only a superficial one, because French *en* is part of a partitive system, whereas modern standard German does not have a comparable partitive system anymore. Although the two systems differ, and *welch* is not a partitive pronoun as *en* is, there is a partial overlap with respect to the contexts in which both can be used, namely, contexts (ii)-(v). One of the goals of this paper is to investigate if a kind of transfer from German L1 into French L2 is therefore possible. In the next section we discuss the notion of transfer.

### 3 Transfer and the role of transfer in the acquisition of the partitive pronoun

The notion of transfer has been used since Lado (1957), in a behaviorist context, and is still one of the major concepts of second language acquisition. To be able to investigate if there could be transfer from L1 German in the case of the acquisition of the partitive pronoun in L2 French, we first discuss the notion of transfer in

Section 3.1. In Section 3.2, we present previous studies that also investigate the L2 acquisition of the partitive pronoun in relation to transfer from the L1.<sup>10</sup>

### 3.1 Transfer

Odlin (1989) defines the notion of transfer as follows:

Transfer is the influence resulting from the similarities and differences between the target language and any other language that has been previously (and perhaps imperfectly) acquired. (Odlin 1989: 27)

According to this definition transfer can be positive (if there are similarities between the languages) or negative (if the languages differ). Furthermore, the definition suggests that there can be transfer from the L1 onto the L2, but also, e.g., from the L2 onto the L3.

Although in the behaviorist view the notion of transfer played an important role, in later theories this was not always the case. A very influential theoretical view in the generative perspective is Schwartz & Sprouse (1994, 1996). Their Full Access/Full Transfer theory states that the initial state of L2 acquisition is the final state of L1 acquisition, which is transferred onto the L2. Thanks to full access to Universal Grammar (UG), the L2 learner is capable of resetting the parameters set for the L1 into the values of the L2. According to Pienemann, Di Biase, Kawaguchi & Håkansson (2005), however, there can only be transfer from the L1 if an L1 structure can be parsed by the L2 learner, which means that the L2 learner has to be rather advanced. On this view, the final state of the L1 is not necessarily the initial state of the L2. Besides research on L2 acquisition, some of which we will discuss below, research on L3 acquisition has shown that in the initial state of L3 acquisition there is predominantly transfer from the L1 (Na Ranong & Leung 2009; Jin 2009; Hermas 2010; Stadt, Hulk & Sleeman 2018), although it becomes less influential in later stages of the learning process. Therefore, in this paper, we start from the assumption that transfer does play a role from the start of L2 acquisition and may continue to play a role. What interests us is what exactly can be transferred. We present three scenarios.

(A) In studies of transfer, what is often studied is transfer of a linguistic phenomenon, or, in UG research, the resetting of a parameter. Japanese, for instance, does not have articles. Therefore, it is predicted that Japanese learners of

---

<sup>10</sup> Besides the notion “transfer”, the notion of cross-linguistic influence has been used in the literature. In this paper we use the former concept.

English as an L2 will leave out the article in cases where it is used in English and will not be able to make a distinction between definite and indefinite articles (Zobl 1984), at least in the initial stages of L2 acquisition. If an L1 does not have null subjects, such as English, it is predicted that, at least in the initial stages, but possibly also still at a near-native level, the L2 learners will use an overt pronoun in cases where a null pronoun is used in the L1, such as in topic continuity contexts in Spanish (see, e.g., Montrul & Rodríguez Louro 2006) or Italian (see, e.g., Belletti, Bennati & Sorace 2007). Rothman (2007) reports an underproduction of overt subjects in Spanish L2 in contrastive contexts, which suggests that the L1 English learners leave out the pronoun in L2 Spanish where they use it in English. Rothman attributes the overuse of overt subjects in other studies and the underproduction of overt subjects in his study to L2 insensitivity to discourse-pragmatic constraints concerning null subjects. This knowledge is missing in English, which is not a null subject language. Therefore, transfer is not possible.

- (B) Zobl (1984) noted that the L2 acquisition of articles in English is delayed if the L1 does not have them, which means that there is an underproduction of articles in contexts where they should be used, as a result of negative transfer. There are also contexts, however, in which English does not use an article. These are, e.g., indefinite mass nouns or proper names. Will Japanese or Chinese learners of L2 English be more accurate on the omission of the article in contexts where no article is required than in contexts where it is required? This is what was found by Master (1987).
- (C) A third point with respect to the question “what may be transferred?” is if learners may rely on other cues in their language, which may help them to learn a distinction. Japanese does not have articles, but it does have demonstrative pre-modifiers. May deictic pronominal modifiers expressed by *sono* ‘that’ (Fukui 1995) help the L2 learner to learn the definite-indefinite distinction in English? This is suggested, a.o., by Kaku (2006). Just like English, Dutch does not have null subjects. Van Kampen & Pinto (2007) show, however, that in Dutch a distinction is made between weak pronouns and demonstrative pronouns corresponding to the null subject versus overt subject pronoun distinction in Italian. Pinto (2018) suggests that this indirect knowledge may help the Dutch learner to make the distinction in Italian L2.



### 3.2 The role of transfer in the L2 acquisition of the partitive pronoun

The research that has been done on the L2 acquisition of the partitive pronoun in French is, to the best of our knowledge, limited.

Wust (2009), using a dictogloss task, shows that in her study not a single low or intermediate L1 English learner of French as an L2 used the partitive pronoun, suggesting that it is acquired late by speakers of English, which does not have a partitive pronoun.

Sleeman & Ihsane (2017) used a Grammaticality Judgment Task to test the knowledge of the use of the partitive pronoun (called ‘quantitative pronoun’ in this work) in French of Dutch Bachelor and Master students, studying French at university level.<sup>11</sup> Their test contained various contexts, comparable to the contexts (i)-(viii) presented in Section 2.1. In contrast to English and German, Dutch does possess a partitive pronoun, more commonly called ‘quantitative pronoun’ in the literature on Dutch (Berends et al., 2021, this volume), as illustrated in (2), although, in standard Dutch, it can only be used in context (i). One of Sleeman & Ihsane’s aims was to investigate if, even at an advanced level of study, there is positive transfer in contexts where the partitive pronoun is present or absent both in Dutch and in French or negative transfer in contexts in which the use of the partitive pronoun differs, as in scenario B presented in Section 3.1. For this goal they submitted a French and a Dutch version of the Grammaticality Judgment Task to the students. In their results they found support for the hypothesis that there is negative transfer in cases in which the use of the partitive pronoun in Dutch and in French differs: in all contexts the L2 French results differed significantly from the L1 Dutch results. They found partial support for the hypothesis that there is positive transfer in cases in which the use of the partitive pronoun in Dutch and in French does not differ, although the support becomes more evident if the results of the two groups of L2 learners are separated: the Master students were more positively influenced by the L1 than the Bachelor students.

While Dutch has a partitive pronoun, German does not have one. In the present paper we investigate the L2 acquisition of the use of the partitive pronoun in French by L1 German learners.

---

<sup>11</sup> Before starting their study of French at university, the students had already learned French during six years in secondary education, where they reached the B1/B2 level of the Common European Framework of Reference.

## 4 Research question, hypotheses and methodology

The discussion of the notion of transfer in Section 3.1 leads to three alternative hypotheses, which we present in Section 4.1. The methodology that we used for this paper follows in Section 4.2.

### 4.1 Research question and hypotheses

The goal of this paper is to investigate how L1 speakers of a language that does not have a partitive pronoun, in this case German, acquire the use of the partitive pronoun in L2 French. We are particularly interested in the role of transfer. Our Research Question is therefore: what is the role of transfer in the L2 acquisition of the partitive pronoun in French by learners who do not have a partitive pronoun in their L1, German? Based on the discussion of the notion of transfer in Section 3.1, we formulate three alternative hypotheses in this section.

In Section 3.1 we discussed the L2 acquisition of null subjects by learners who do not have a null subject in their L1. We mentioned that according to Rothman (2007) overproduction or underproduction of overt subjects in the L2 may be due to the absence of relevant discourse-pragmatic distinctions in the L1. This means that in scenario A presented in Section 3.1 transfer is not possible. Since German does not have a partitive pronoun, whereas French has one, this leads to hypothesis 1:

Hypothesis 1: L2 learners of French with German as their L1 will differ significantly from L1 speakers of French both in contexts where the partitive pronoun is required in French and in contexts where the partitive pronoun is not used in French or they will perform at chance.

Under scenario B presented in Section 3.1, there is negative transfer, but also positive transfer in other contexts. For the acquisition of the partitive pronoun, this can be formulated as hypothesis 2:

Hypothesis 2: L2 learners of French with German as their L1 will differ significantly from L1 speakers of French in contexts where the partitive pronoun is required in French, but not in contexts where the partitive pronoun is not used in French.

In Section 3.1 we also discussed the possibility of getting positive influence from the L1 if the L1 does not have a phenomenon but makes the relevant distinctions for the acquisition of the phenomenon in the L2 in another way. Hypothesis 3 is based on scenario C:

Hypothesis 3: In contexts in which L1 German and L1 French have similar constructions, there may be positive influence from the L1 German. In contexts in which the two languages differ, there may be negative influence.

Similar contexts are contexts where German uses *welch* and French *en* (contexts (ii)-(v) in Tables 1 and 3), contexts where a definite pronoun is used (context (vii) in Tables 2 and 4) and where no pronoun, that is  $\emptyset$ , is used (context (viii) in Tables 2 and 4). Contexts in which the two languages differ are context (i) with a quantifier and context (vi) with an indefinite determiner and an adjective (see Tables 1 and 4).

This is an exploratory study. We have formulated three alternative hypotheses, and we will evaluate them in the light of our results.

## 4.2 Methodology

### 4.2.1 Participants

We tested 33 native speakers of German studying French as their L2 at the University of Zurich in Switzerland. They were all doing their second semester at university and had studied French for eight years on average in secondary education.<sup>12</sup> The expected proficiency in French of the students when they reach university in Zurich corresponds to the level B2 of the Common European Framework of Reference for Languages. 14 participants were left out for different reasons, for instance because they were bilingual French-German, had lived in a French speaking area for a long period, or had not fully completed the questionnaire. Our study therefore includes 19 L1 German students learning French as their L2 (age range: 18–29). 17 indicated that their mother tongue is Swiss German (dialect), and two did not give any information about the variety of German they speak. All

---

<sup>12</sup> The classical training before university comprises 8–9 years of French (secondary school and high school). There were 4 students who reported having studied French for fewer years (2 students studied French for 7 years, 1 for 5,5 years and one for 4,5 years).



‘Context: Designating a salad bowl in the middle of the table.’

*Markiere nur eine Option:*

‘mark only one option’

- Richtig  
‘correct’
- Nicht richtig  
‘not correct’

There were several variants of the test items in the questionnaire, with different targets. In a variant of example (11) above, for instance, the students had to evaluate a sentence with a definite pronoun as in (12), which is incorrect in the given context. For (12), the context and the information in square brackets were the same as in (11).

- (12) *Non, je ne la veux pas.*  
no I NEG it want NEG  
‘No, I don’t want it’.

The participants thus had to judge both grammatical and ungrammatical sentences, according to our judgments. They took the test in class as an offline task and had until the end of the class to complete it, i.e. 45 minutes at most.

The German test items were generally comparable to the French ones. However, since German does not have a counterpart of *en*, some of the test items did not contain a corresponding overt element. This was the case of context (i) with a quantifier and context (vi) with an indefinite article and an adjective (see Table 4). Otherwise, we used *welch* in the constructions in which we expected this element to be accepted (see Table 3), that is, contexts (ii)-(v): mass NPs, negated NPs (singular and plural) and non-referential plural indefinites. The variants of the test items with *welch* contained a definite pronoun as in (12) above. For context (vii) with a referential plural indefinite, we used the expected definite pronoun in the examples but also tested the acceptance of *welch*. Furthermore, in all the contexts in which we tested *welch*, i.e. (ii)-(v) and (vii), we added a third option, the use of an NP instead of a pronoun, as in (13), which is possible in German (and in Dutch from which the German questionnaire was adapted) and which will not be part of the analysis.

- (13) [Context: Isabelle:  
*Haben Sie sich Zucker von Ihrem Nachbarn geliehen?*  
have you yourself sugar of your neighbour borrowed  
‘Did you borrow sugar from your neighbour?’

Mélanie: *Ja, er hat mir Zucker geliehen.*  
 yes he has me sugar lent  
 ‘Yes, he has lent me sugar.’

For each negative context (singular and plural), we also added two test items with a negative determiner *kein* ‘no’ as in (14), but which will not be part of the analysis. *Welch* does not combine with the negation *nicht* ‘not’, but *kein* is used instead. In our questionnaire, we used *nie* ‘never’ as a negation because *nicht welch* ‘not *welch*’ is ungrammatical.

(14) [Context: Louis: *Haben sie kein Geld?*]  
 have you no money  
 ‘Don’t you have money?’

Sara: *Nein, ich habe keins.*  
 no I have none  
 ‘No, I don’t have any.’

As for context (viii), with a definite article and an adjective, the German test items did not contain a pronoun, on a par with the French ones.

The questionnaire also contained test items for the distinction between a quantitative and a partitive interpretation, which will not be analyzed here (but see Sleeman & Ihsane 2017 for French and Sleeman & Ihsane 2020 for German).

Of the questionnaire we used the following test items for the analysis:<sup>14</sup>

- |                  |              |   |
|------------------|--------------|---|
| (i) Quantif      | 3 test items | (with Ø)  |
| (ii) Mass        | 6 test items | (3 with <i>welch</i> ; 3 with a definite pronoun) |
| (iii) Neg sg     | 6 test items | (3 with <i>welch</i> ; 3 with a definite pronoun) |
| (iv) Non-ref     | 6 test items | (3 with <i>welch</i> ; 3 with a definite pronoun) |
| (v) Neg pl       | 6 test items | (3 with <i>welch</i> ; 3 with a definite pronoun) |
| (vi) Indef + adj | 3 test items | (with Ø)  |
| (vii) Refer      | 6 test items | (3 with <i>welch</i> ; 3 with a definite pronoun) |
| (viii) Def + adj | 3 test items | (with Ø)  |

As for the native speakers of French, they filled in the French part of the Grammaticality Judgment Task taken by the L1 German participants, that is, the

<sup>14</sup> In the next sections, we will at times use the following short labels to refer to the eight contexts described in Section 2.1: (i) *quantif*, (ii) *mass*, (iii) *neg sg*, (iv) *non-ref*, (v) *neg pl*, (vi) *indef + adj*, (vii) *refer*, and (viii) *def + adj*.

same 92 questions. Some of the native speakers of French took the test as an online task.<sup>15</sup>

We calculated the percentages of acceptance for the test items that we presented in Section 2 as correct and for the test items that we presented as incorrect. However, for the German part, we had no incorrect sentences for the contexts in which German does not have an overt counterpart to *en*, namely contexts (i) with a quantifier, (vi) with an indefinite article + adjective, and (viii) with a definite article + adjective.

## 5 Results

To understand the role of the L1 in the acquisition of the uses of *en* in French, we compared the percentages of acceptance for i) French L1 versus German L1, ii) French L1 versus French L2, and iii) French L2 versus German L1. Examining French L1 versus German L1 allowed us to see how native speakers react in the eight contexts under study and to identify any difference. The comparison between French L1 and French L2 enabled us to test our three hypotheses. Finally, we compared French L2 and German L1 to determine the influence of German L1 on French L2 and to further check our Hypothesis 3. For the first two comparisons, i) and ii), we performed a Mann-Whitney U test, whereas for comparison iii) we performed a Wilcoxon test. The results are reported in the figures presented in the following subsections.

### 5.1 French L1 and German L1

First, we present the results of the native speakers. Figure 1 represents the correct sentences and Figure 2 the incorrect sentences. In Figure 1, we left out contexts (i) with a quantifier and (vi) with an indefinite article + adjective because the French test items and the German ones are not directly comparable since German does not have a counterpart to *en* in these contexts. In Figure 2, we left out the contexts for which we had no ungrammatical test items in German, i.e. contexts (i) with

---

<sup>15</sup> Our questionnaire contained some more contexts than contexts (i)-(viii). For this study, we only analyzed contexts (i)-(viii), but not with an NP or *kein*. For German, there was no ungrammatical variant of contexts (i), (vi) and (viii). For French we analyzed the judgments on 48 sentences and for German the judgments on 39 sentences.

a quantifier, (vi) with an indefinite article + adjective, and (viii) with a definite article + adjective.

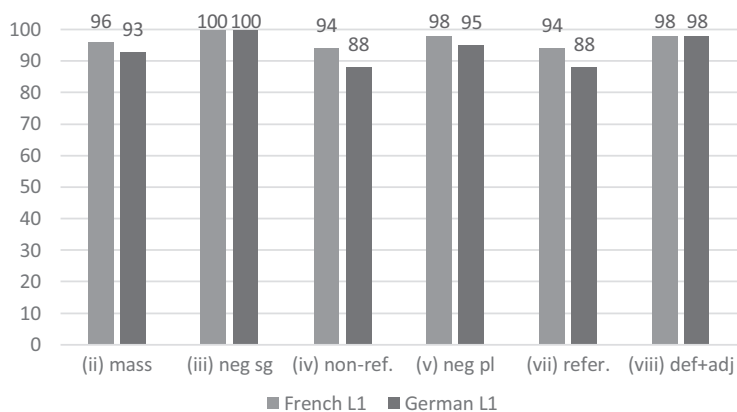

**Figure 1:** French L1 versus German L1, correct sentences.

Overall, Figure 1 shows that all the native speakers scored as expected in the contexts illustrated in at least 88% of the cases. More precisely, the French L1 accepted *en* in at least 94% of the cases in contexts (ii)-(v) and rejected it in contexts (vii) and (viii) (see also Fig. 2); in context (vii) with referential plural indefinites, they accepted the definite pronoun in 94% of the cases and in context (viii) with a definite article + adjective, they accepted the absence of *en* in 98% of the cases. In addition, French L1 accepted *en* in 100% of the cases in context (i) with a quantifier and in 98% of the cases in context (vi) with an indefinite article + adjective, not included in Figure 1. The German L1 accepted *welch* in at least 88% of the cases in contexts (ii)-(v) and the definite pronoun in 88% of the cases in context (vii) with a referential plural indefinite. In context (viii), with a definite article + adjective, the test items without a pronoun were accepted in 98% of the cases. In addition, German L1 accepted “quantifier + Ø” (context i) in 79% of the cases, and “indefinite article + adjective + Ø” (context vi) in 86% of the cases, not included in Figure 1.

These results seem to confirm the description in Section 2.2, namely, that *welch* is possible in contexts (ii)-(v). The fact that *welch* was not accepted in context (vii), with referential plural indefinites (see also Fig. 2), suggests that the relevant distinction in the acceptance or non-acceptance of *welch* is the notion of referentiality: indeed, all the contexts in which *welch* was accepted are non-referential, like the ones in which *en* is used (Ihsane 2013 for French). This supports the conclusions in Sleeman & Ihsane (2020) where we proposed that *welch* replaces non-referential



constituents, labelled -Ref(erentiality) Phrase, but not referential ones, labelled +Ref(erentiality) Phrase.

Let us now turn to Figure 2, for incorrect sentences. We first report the results of the native speakers of French, and then, the ones of the native speakers of German.

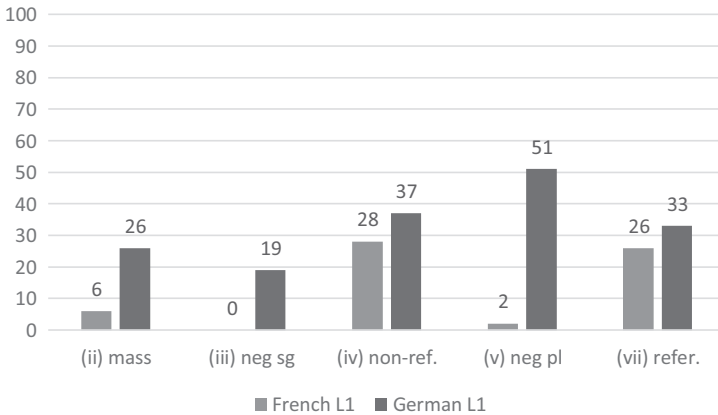

**Figure 2:** French L1 versus German L1, incorrect sentences.

In the incorrect sentences, the definite pronoun was accepted by the French L1 in 6% of the cases in context (ii) with a mass noun, in 0% of the cases in context (iii) with a negated singular indefinite and in 2% of the cases in context (v) with a negated plural indefinite, as expected. In addition, the omission of *en* was never accepted in context (i), with a quantifier, and *en* was always rejected in context (viii), with a definite article + adjective, two constructions not included in Figure 2, since German does not have an overt counterpart to *en*. The results for context (iv), with non-referential plural indefinites, and context (vii), with referential plural indefinites, are not as sharp: French L1 speakers accepted the definite pronoun in 28% of the cases and *en* in 26% of the cases, respectively. This shows that the notion of referentiality is difficult for native speakers of French, and especially confusing in incorrect sentences. As for context (vi), which is not included in the figure, with an indefinite article + adjective, it seems that for some speakers these constructions are acceptable without the pronoun *en* (28% of acceptance). This may be the influence of oral French, where the omission of *en* is more accepted.

The results for the German L1 speakers are more contrasted. The speakers accepted the definite pronoun in 26%, 19%, 37%, and 51% of the cases in different contexts, namely contexts (ii) with a mass noun, (iii) with a negated singular indefinite, (iv) with a non-referential plural indefinite and (v) with a

negated plural indefinite, respectively. Furthermore, they accepted *welch* in 33% of the cases in context (vii), with a referential plural indefinite, which shows that the notion of referentiality is difficult for native speakers of German as well, especially in the incorrect sentences.<sup>16</sup> It may also be the case that the test items for these contexts were not sufficiently clear or that the participants did not pay enough attention to the information in brackets whose purpose was precisely to avoid any confusion. For the remaining constructions, i.e. (i) with a quantifier, (vi) with an indefinite article + adjective, and (viii) with a definite article + adjective, we did not have any incorrect test items for German.

A statistical analysis of the comparison between French L1 and German L1 is provided in Table 5.<sup>17</sup>

**Table 5:** Comparison of acceptance French L1 and German L1.

	correct				incorrect			
	French L1	German L1	U-score	p-value	French L1	German L1	U-score	p-value
(ii) mass	96%	93%	162	0,645	6%	26%	87	0,003
(iii) neg sg	100%	100%	171	1,000	0%	19%	117	0,011
(iv) non-ref.	94%	88%	151,5	0,409	28%	37%	141,5	0,339
(v) neg pl	98%	95%	153,5	0,323	2%	51%	23,5	<0,001
(vii) refer.	94%	88%	144	0,272	26%	33%	153	0,561
(viii) def adj	98%	98%	170,5	0,969	0%			

The comparison between the results of the native speakers of French and those of the native speakers of German shows that, for the correct sentences, there are no significant differences.

Comparing French L1 and German L1 on the incorrect sentences, we can observe that there are three contexts with significant differences: contexts (ii) with a mass noun, (iii) with a negated singular indefinite, and (v) with a negated

<sup>16</sup> According to a reviewer, this could be because an existential inference can always be made from a definite expression. Indeed, in Sleeman & Ihsane (2020: 795), we observe that some native speakers of German accept *welch* with referential noun phrases, as in the filler below:

(i) [*Sophie sieht die Kinder spielen.*] – *Sophie sieht **welche** spielen.*  
 '[Sophie sees the children playing.] – Sophie sees children play.'

<sup>17</sup> In our tables, the terms *correct* and *incorrect* indicate our expectations. However, as the results for context (v) with negative plurals, for instance, show (i.e. 51%), our expectations were not always met.

plural indefinite. For the contexts with non-referential plural indefinites (iv) and with referential indefinites (vii), there are no significant differences between French L1 and German L1.

## 5.2 French L1 and French L2

The next figures illustrate the comparison between French L1 and French L2. The results for the correct sentences are illustrated in Figure 3 and the ones for incorrect sentences in Figure 4.

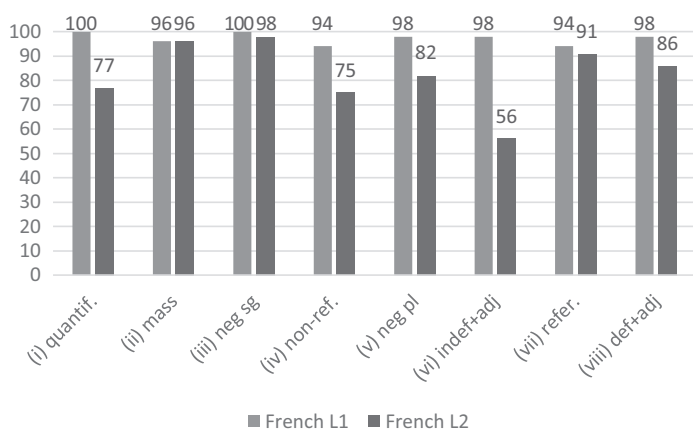

**Figure 3:** French L1 versus French L2, correct sentences.

The results for French L1, both in correct and incorrect sentences, have been discussed in relation to Figures 1 and 2. For French L2, we can observe that for contexts (ii) with a mass noun, (iii) with a negated singular indefinite, (v) with a negated plural indefinite, (vii) with a referential plural indefinite and (viii) with a definite article + adjective, the correct test items were accepted in at least 82% of the cases. This means that *en* was accepted by the learners in contexts (ii), (iii) and (v), that the definite pronoun was accepted in context (vii) and that the sentences without a pronoun were accepted in (viii). For the other contexts, the percentages were slightly lower: *en* was accepted in 77% of the cases in context (i) with a quantifier, in 75% of the cases in context (iv) with a non-referential plural indefinite and in 56% of the cases in context (vi) with an indefinite article + adjective.

The results for the incorrect sentences are presented in Figure 4.

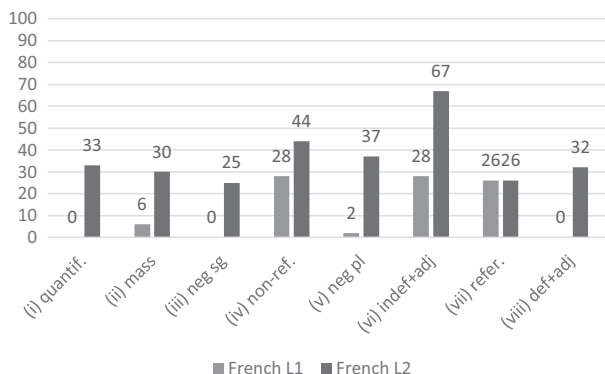

**Figure 4:** French L1 versus French L2, incorrect sentences.

As Figure 4 shows, all the incorrect sentences are accepted by the learners in at least 25% of the cases. For most contexts, the percentages are between 25% and 37%; however, for contexts (iv) with a non-referential plural indefinite and (vi) with an indefinite article + adjective, the percentages are higher: 44% and 67%, respectively. The fact that the participants are first year Bachelor students may explain these results. Furthermore, ungrammatical items are generally more difficult to identify and to evaluate compared to grammatical ones. Although the learners are more uncertain with incorrect sentences, this also holds for the L1 speakers of French, who accept incorrect sentences in 26–28% of the cases in three contexts, (iv) with a non-referential plural indefinite, (vi) with an indefinite article + adjective and (vii) with a referential plural indefinite.

Table 6 provides the statistical analysis of the comparison between the results for French L1 and French L2.

**Table 6:** Comparison of acceptance French L1 and French L2.

	correct				incorrect			
	French L1	French L2	U-score	p-value	French L1	French L2	U-score	p-value
(i) quantif	100%	77%	72	<0,001	0%	33%	36	<0,001
(ii) mass	96%	96%	170	0,955	6%	30%	87	0,003
(iii) neg sg	100%	98%	162	0,330	0%	25%	99	0,002
(iv) non-ref.	94%	75%	114	0,035	28%	44%	125	0,122
(v) neg pl	98%	82%	134,5	0,084	2%	37%	69,5	<0,001
(vi) indef + adj	98%	56%	68,5	<0,001	28%	67%	72,5	0,002
(vii) refer.	94%	91%	154	0,482	26%	26%	169	0,948
(viii) def + adj	98%	86%	125,5	0,043	0%	32%	90	0,001

As for the correct sentences, the comparison between French L1 and French L2 shows significantly different results for contexts (i) with a quantifier and (vi) with an indefinite article + adjective. In addition, there are two results that are less clearly significant: for context (iv) with non-referential plural indefinites and context (viii) with a definite article + adjective. In contexts (ii), (iii), (v) and (vii), there are no significant differences. How these results can be interpreted is discussed in Section 6.

For the incorrect sentences, significant differences between French L1 and French L2 can be observed in all contexts except (iv) and (vii): with non-referential indefinites and with referential indefinites. This confirms our earlier remark in relation to Figures 1 and 2 and suggests that the difference between these contexts is not clear for both the native speakers of French and the learners, especially in incorrect sentences.

### 5.3 French L2 and German L1

Finally, let us consider the comparison between French L2 and German L1, starting with the results for correct sentences (Figure 5), before turning to the results for incorrect sentences (Figure 6). In Figure 5, as in Figure 1, contexts (i) and (vi) were left out and in Figure 6, as in Figure 2, contexts (i), (vi) and (viii) were left out for the reasons explained earlier (i.e. dubious comparison and absence of data, respectively).

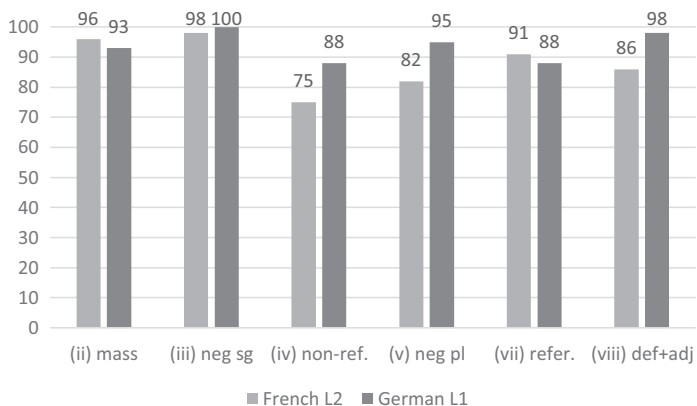
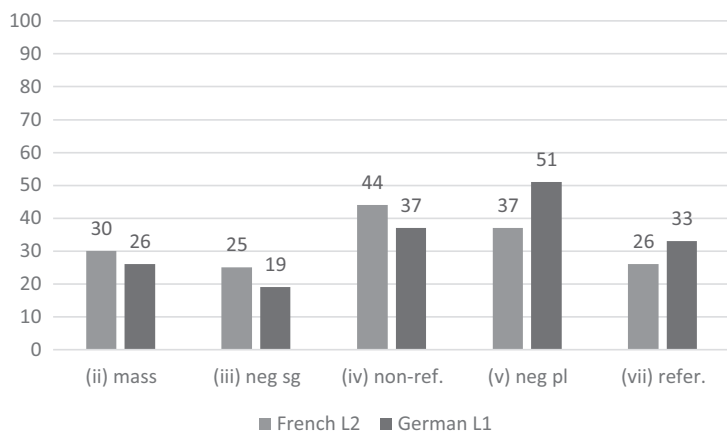

**Figure 5:** French L2 versus German L1, correct sentences.

The results for French L2, for correct and incorrect sentences, have been discussed in relation to Figures 3 and 4, and the ones for German L1 in relation to Figures 1 and 2. Figure 5 shows that learners accept the sentences both in German L1 and

in French L2 in at least 82% of the cases. There is one percentage that is slightly lower, though: for French L2 in context (iv) with non-referential plural indefinites, it is 75%.

Let us now turn to the incorrect sentences, presented in Figure 6.



**Figure 6:** French L2 versus German L1, incorrect sentences.

As can be observed in Figure 6, the percentages of acceptance vary between 25% and 44% for French L2 and between 19% and 51% for German L1. This means that in both varieties the participants accept, to some extent, the definite pronoun in contexts where it is not expected, i.e. (ii), (iii), (iv) and (v). Furthermore, where the definite pronoun is expected, i.e. in context (vii), *en* is accepted in French L2 and *welch* is accepted in German L1, to some extent.

The statistical analysis of the comparison between German L1 and French L2 is reported in Table 7.

**Table 7:** Comparison of acceptance French L2 and German L1.

	correct				incorrect			
	French L2	German L1	Z-score	p-value	French L2	German L1	Z-score	p-value
(ii) mass	96%	93%	-0,707	0,480	30%	26%	-0,504	0,614
(iii) neg sg	98%	100%	-1,000	0,317	25%	19%	-0,722	0,470
(iv) non-ref.	75%	88%	-1,588	0,112	44%	37%	-0,924	0,356
(v) neg pl	82%	95%	-1,265	0,206	37%	51%	-1,456	0,145
(vii) refer.	91%	88%	-0,535	0,593	26%	33%	-1,190	0,234
(viii) def + adj	86%	98%	-1,933	0,053	32%			

Table 7 shows that, in the correct sentences, there are no significant differences between French L2 and German L1. The result for context (viii), with a definite article + adjective, shows a marginally non-significant difference. In the incorrect sentences, there are no significant differences either.

Whether these results support one of the hypotheses formulated in Section 4.1 is discussed in the next section.

## 6 Discussion

In this study, we are testing three hypotheses based on the fact that German, in contrast to French, does not have a partitive pronoun (Section 4.1). According to Hypothesis 1, German L1 speakers learning French as their L2 will differ significantly from L1 French speakers, both in contexts where *en* is required in French and in contexts where *en* is not used, or they will perform at chance. According to Hypothesis 2, the French L2 learners will differ significantly from the native speakers of French in contexts where *en* is required in French but not in contexts where *en* is not used. Finally, according to Hypothesis 3, there may be positive influence from L1 German in contexts in which L1 German and L1 French have similar constructions and negative influence in contexts in which these languages differ.

For Hypothesis 1 to be supported, there should be significant differences between French L1 and French L2 in all the contexts studied here, namely contexts (i)-(viii) described in Section 2.1, or the learners should perform at chance. As seen in the discussion of Figures 3 and 4 and Table 6 in the previous section, this is not the case. For correct sentences, only two out of the eight contexts show significant differences between French L1 and French L2 speakers: context (i) with a quantifier and context (vi) with an indefinite article + adjective. In four contexts, the differences are not significant: (ii) with a mass noun, (iii) with a negated singular indefinite, (v) with a negated plural indefinite and (vii) with a referential plural indefinite. As for contexts (iv) and (viii) with, respectively, a non-referential plural indefinite and a definite article + adjective, the results are marginally significant. Even if the latter are interpreted as significant, since they are at the limit of 0,05, only half of the contexts show significant differences between French L1 and French L2. In addition, in the contexts without significant differences, the learners do not perform at chance, as they accept the sentences in at least 82% of the cases. This rather shows a “mastering” level. In the contexts with a significant difference, the percentages are also above chance (assuming that at chance means 50%): in context (i) with a quantifier, the items are accepted

in 77% of the cases, in context (iv) with a non-referential plural indefinite in 75% of the cases, and in context (vi) with an indefinite article + adjective in 56% of the cases. All the above elements show that Hypothesis 1 is not confirmed for the correct sentences.

Regarding the incorrect sentences, there are significant differences in six contexts, namely (i), (ii), (iii), (v), (vi), and (viii); however, we also find two exceptions, namely contexts (iv) with a non-referential plural indefinite and (vii) with a referential plural indefinite, which falsifies Hypothesis 1. Furthermore, in most of the contexts the learners perform above chance. This confirms that this hypothesis has to be rejected.

To evaluate Hypothesis 2, the contexts in which *en* is required, i.e. (i)-(vi), and the ones in which *en* is impossible, i.e. (vii)-(viii), have to be distinguished: if this hypothesis is correct, there should be significant differences between French L1 and French L2 only in the former contexts, not in the latter. For correct sentences, two significant differences for French L1 and French L2 concern contexts in which *en* is required: (i) with a quantifier and (vi) with an indefinite article + adjective. In addition, one context is marginally significant, context (iv) with non-referential plural indefinites. However, there are also two contexts requiring *en* with no significant differences, that is, (ii) with a mass noun, (iii) with a negated singular indefinite, and (v) with a negated plural indefinite. In other words, not all of the contexts requiring *en*, (i)-(vi), show significant differences between French 1 and French L2. As for contexts (vii) and (viii), there is a non-significant difference for context (vii), as predicted, but the difference for context (viii) is marginally significant.

For incorrect sentences, there is a significant difference for all the contexts in which *en* is required, except for context (iv) with a non-referential plural indefinite. In addition, there is a significant difference for one of the two contexts in which *en* is impossible, namely (viii) with a definite article + adjective. The fact that there is one non-significant difference among the contexts in which *en* is required and one significant difference among the contexts in which *en* is impossible is problematic for Hypothesis 2. On the basis of both the correct and the incorrect sentences, our results therefore prevent us from concluding that this hypothesis is correct.

Let us now turn to Hypothesis 3 and see if it fares better. To evaluate this hypothesis, we need to examine, on the one hand, the contexts that are similar in German and French, and, on the other hand, the ones that are different. We saw in the previous section that contexts (i) and (vi) are not similar in the two languages because German does not have an overt counterpart to *en* in these contexts. As for the other contexts, the comparison between French L1 and German L1 confirms that they can be considered alike in the two languages. Indeed, according to



Figure 1 for correct sentences, there were no significant differences for the contexts (ii)-(v) and (vii)-(viii) and the participants accepted the examples in at least 88% of the cases (cf. Table 5).

To determine whether there is transfer from the L1 (see Section 3.1), we will focus first on the comparison between German L1 and French L2 (cf. Section 5.3). If there is positive transfer from L1, there should be no significant differences in the contexts that are similar in the two languages (i.e. (ii)-(v) and (vii)-(viii)). Since we have no statistical results for contexts (i) and (vi), we cannot establish if there is possible negative transfer on the basis of the comparison between German L1 and French L2.

For correct sentences, none of the results in contexts (ii)-(v) and (vii)-(viii) show significant differences, apart from the result for context (viii) with a definite article + adjective, i.e.  $p = 0,053$ , which is marginally significant (cf. Table 7). This can be explained as follows: in contexts (ii)-(v), *en* is used in French where German has *welch*, in context (vii) with a referential plural indefinite, French has a definite pronoun like German, and in context (viii) with a definite article + adjective, it has no pronoun, like German, since *en* is ungrammatical. The results therefore suggest positive transfer from the L1 in contexts (ii)-(v) and (vii)-(viii). For our study, what is particularly interesting is that the use of *welch* in the German contexts (ii)-(v) seems to facilitate the learning of *en* in those contexts. For the incorrect sentences, there were no significant differences either for contexts (ii)-(v) and (vii), which strengthens our conclusion on positive transfer. As for context (viii) with a definite article + adjective, we did not have any ungrammatical test items, just as for contexts (i) with a quantifier and (vi) with an indefinite article + adjective.

After having established on the basis of the comparison between German L1 and French L2 that there may be at least positive influence from German L1, we evaluate Hypothesis 3 by looking again at the comparison between French L1 and French L2. If there is positive transfer from L1, there should be no significant differences in the contexts that are similar in the two languages (i.e. (ii)-(v) and (vii)-(viii)). If there is negative transfer, there should be significant differences in the contexts that are different (i.e. (i) and (vi)).

We first look at the contexts (i) and (vi). In contexts (i), with a quantifier, and (vi), with an indefinite article + adjective, the L2 learners differed significantly from the native speakers of French, both in correct and incorrect sentences, see Table 6. Since these constructions are different in the two languages, this suggests that there is negative transfer from the L1 German. In other words, the absence of a pronoun (i.e. *welch*) in these two contexts in German, in contrast to French which has *en* in these constructions, negatively influenced the students in their learning process. The fact that contexts (i) and (vi) are the only ones for which there are clearly significant differences in both types of sentences (correct and incorrect) strengthens this conclusion.

If there is positive transfer, there should be non-significant differences between French L1 and L2 in contexts (ii)-(v) and (vii)-(viii). For the “similar” contexts, we found a non-significant difference for context (vii), with referential plural indefinites, as expected, both in the correct and in the incorrect sentences. Both German L1 and French L1 use a definite pronoun in this context. Within some other “similar” categories, namely contexts (ii) with a mass noun, (iii) with a negated singular indefinite, and (v) with a negated plural indefinite, in which German uses *welch* and French *en*, we found a non-significant difference for the correct sentences, as expected, but a significant difference for the incorrect sentences, in which the definite pronoun was used instead of *en*. This result can be explained if we consider that in the L1 German results the definite pronoun was also accepted to some degree in these contexts. We did not find a significant difference for context (iv) with non-referential plural indefinites between French L1 and French L2 in the incorrect sentences, but this can be explained by the surprisingly high acceptance of the definite pronoun in L1 French in this context. In the correct non-referential plural context, there was a slightly significant, non-expected, difference between French L1 and L2. Because of their resemblance to the referential contexts, the non-referential contexts were difficult to judge, especially for the L2 learners. For the “similar” context (viii), definite article + adjective, we found an unexpected significant difference in the incorrect sentences, which was, however, counterbalanced by an only marginally significant difference in the “correct” counterpart.

Although some explanations that we have given for the results may also be used to strengthen Hypothesis 2 (or Hypothesis 1), the difference between Hypothesis 2 and Hypothesis 3 is that with Hypothesis 3 we can attribute the significant differences in the incorrect contexts, i.e. contexts (ii) with mass nouns, (iii) with negated singular indefinites, and (v) with negated plural indefinites, to the acceptance of the definite pronoun in *welch* contexts in German L1.

In conclusion, our discussion shows that Hypothesis 3 is borne out: there is clear positive transfer in the constructions that are similar in both languages, and negative transfer in the ones in which they differ. This means that the existence of an element like *welch* in German, which is similar to *en* in some aspects (although also different in others), helps the L2 speakers in their learning of the uses of *en*. A similar conclusion is drawn by Berends et al. (2021, this volume) for the L2 acquisition of the Dutch partitive pronoun *er* by L1 English and French learners.

## 7 Conclusion

The analysis of possible transfer strategies from a language that does not have a partitive pronoun, German, to a language that has one, French, has enabled us to sharpen our insight into the notion of transfer. While keeping the traditional distinction between positive transfer based on similarities and negative transfer based on differences, we have argued that there may be positive transfer even if German does not have a partitive pronoun, and that this positive transfer does not only concern constructions in which French does not use *en* (no pronoun or a definite pronoun), but also constructions in which German uses the indefinite anaphoric pronoun *welch*.

The distinction between non-referential NPs and referential NPs was not easy to make in both languages. It may be that this was caused by the design of our test sentences, which in a future study could be improved.

## References

- Badía i Margarit, Antoni M. 1947. *Les complements pronominals-adverbials derivades de ibi e inde en la península ibérica*, Madrid. Consejo Superior de Investigaciones Científicas (Revista de Filología Española, Annex XXXVIII).
- Badía i Margarit, Antoni M. 1951. *Gramàtica històrica catalana*. Barcelona: Noguer.
- Bech, Gunnar. 1952. Über das niederländische Adverbialpronomen *er*. Kopenhagen: Nordisk Sprog- of Kulturforlag [etc.]. *Travaux du Cercle Linguistique de Copenhague* 8.
- Belletti, Adriana, Elisa Bennati & Antonella Sorace. 2007. Theoretical and developmental issues in the syntax of subjects: Evidence from near-native Italian. *Natural Language and Linguistic Theory* 25. 657–689.
- Berends, Sanne, Petra Sleeman, Aafke Hulk & Jeannette Schaeffer. 2021, this volume. The L2 acquisition of the referential semantics of Dutch partitive pronoun ER. In Petra Sleeman & Giuliana Giusti (eds.), *Partitive determiners, partitive pronouns and partitive case* (Linguistische Arbeiten 580). Berlin: De Gruyter.
- Fukui, Naoki. 1995. The Principles and Parameters approach: A comparative syntax of English and Japanese. In Masayoshi Shibatani & Theodora Bynon (eds.), *Approaches to language typology*, 327–372. Oxford: Clarendon Press.
- Gerards, David Paul. 2020. Bare partitives in Old Spanish and Old Portuguese. University of Zurich dissertation.
- Giusti, Giuliana. 2021, this volume. Partitivity in Italian. In Petra Sleeman & Giuliana Giusti (eds.), *Partitive determiners, partitive pronouns and partitive case* (Linguistische Arbeiten 580). Berlin: De Gruyter.
- Giusti, Giuliana & Petra Sleeman. 2021, this volume. Partitive elements in the languages of Europe. An advancement in the understanding of a multifaceted phenomenon. In Petra Sleeman & Giuliana Giusti (eds.), *Partitive determiners, partitive pronouns and partitive case* (Linguistische Arbeiten 580). Berlin: De Gruyter.

- Glaser, Elvira. 1992. Umbau partitiver Strukturen in der Geschichte des Deutschen. *Sprachwissenschaft* 17(2). 113–132.
- Glaser, Elvira. 1993. Syntaktische Strategien zum Ausdruck von Indefinitheit und Partitivität im Deutschen (Standardsprache und Dialekt). In Werner Abraham & Josef Bayer (eds.), *Dialektsyntax*, 99–116. Opladen: Westdeutscher Verlag.
- Glaser, Elvira. 2008. Syntaktische Raumbilder. In Peter Ernst & Franz Patocka (eds.), *Dialektgeographie der Zukunft*, 85–111. Stuttgart: Steiner.
- Hermas, Abdelkader. 2010. Language acquisition as computational resetting: Verb movement in L3 initial state. *International Journal of Multilingualism* 7. 343–362.
- Ihsane, Tabea. 2013. *EN* pronominalisation in French and the structure of nominal expressions. *Syntax* 16(3). 217–249.
- Jin, Fufen. 2009. Third language acquisition of Norwegian objects: Interlanguage transfer or L1 influence? In Yan-kit Ingrid Leung (ed.), *Third language acquisition and Universal Grammar*, 44–161. Clevedon: Multilingual Matters.
- Kaku, Keiko. 2006. Second language learners' use of English articles: A case study of native speakers of Japanese. *Ottawa Papers in Linguistics* 34. 63–74.
- Kampen, Jacqueline van & Manuela Pinto. 2007. Germanic and Romance discourse devices in acquisition. In Sergio Baauw, Jacqueline van Kampen & Manuela Pinto (eds.), *The acquisition of Romance languages: Selected papers of the Romance Turn II 2006*. LOT Occasional series 8, 73–96. Utrecht: LOT.
- Lado, Robert. 1957. *Linguistics across cultures*. Ann Arbor: University of Michigan Press.
- Martins, Ana Maria. 2014. Syntactic change in Portuguese and Spanish: divergent and parallel patterns of linguistic splitting. In Patrícia Amaral & Ana Maria Carvalho (eds.), *Portuguese-Spanish interfaces: Diachrony, synchrony, and contact*, 35–64. Amsterdam: John Benjamins.
- Master, Peter. 1987. A cross-linguistic interlanguage analysis of the acquisition of the English article system. Los Angeles: University of California dissertation.
- Milner, Jean-Claude. 1978. *De la syntaxe à l'interprétation: quantités, insultes, exclamations*. Paris: Seuil.
- Montrul, Silvina & Celeste Rodríguez Louro. 2006. Beyond the syntax of the Null Subject Parameter: A look at the discourse-pragmatic distribution of null and overt subjects by L2 learners of Spanish. In Linda Escobar & Vincent Torrens (eds.), *The acquisition of syntax in Romance languages*, 400–418. Amsterdam: John Benjamins.
- Na Ranong, Sirirat & Yan-kit Ingrid Leung. 2009. Null objects in L1 Thai-L2 English-L3 Chinese: An empiricist take on a theoretical problem. In Yan-kit Ingrid Leung (ed.), *Third language acquisition and Universal Grammar*, 162–191. Clevedon: Multilingual Matters.
- Odlin, Terence. 1989. *Language transfer: Cross-linguistic influence in language learning*. Cambridge: Cambridge University Press.
- Philippa, Marlies, Frans Debrabandere & Arend Quak. 2004. *Etymologisch handboek van het Nederlands*, part 1, A-Ezelsbrug. Amsterdam: Amsterdam University Press.
- Pienemann, Manfred, Bruno Di Biase, Satomi Kawaguchi & Gisela Håkansson. 2005. Processing constraints on L1 transfer. In Judith Kroll & Annette de Groot (eds.), *Handbook of bilingualism. Psycholinguistic approaches*, 128–153. Oxford: Oxford University Press.
- Pinto, Manuela. 2018. L'italiano L2 e le regole che non si insegnano a scuola. *Incontri* 33(1). 42–55. [www.rivista-incontri.nl/articles/abstract/10.18352/incontri.10234](http://www.rivista-incontri.nl/articles/abstract/10.18352/incontri.10234)
- Rothman, Jason. 2007. Pragmatic solutions for syntactic problems: Understanding some L2 syntactic errors in terms of discourse-pragmatic deficits. In Sergio Baauw, Frank

- Drijkoningen & Manuela Pinto (eds.), *Romance languages and linguistic theory 2005*, 299–320. Amsterdam: John Benjamins.
- Schwartz, Bonnie & Rex Sprouse. 1994. Word order and nominative case in non-native language acquisition: a longitudinal study of (L1 Turkish) German interlanguage. In Teun Hoekstra & Bonnie D. Schwartz (eds.), *Language acquisition studies in generative grammar*, 317–368. Amsterdam: John Benjamins.
- Schwartz, Bonnie & Rex Sprouse. 1996. L2 cognitive states and the full transfer/full access model. *Second Language Research* 12. 40–72.
- Sleeman, Petra & Giuliana Giusti (eds.). 2021, this volume. *Partitive determiners, partitive pronouns and partitive case* (Linguistische Arbeiten 580). Berlin: De Gruyter.
- Sleeman, Petra & Tabea Ihsane. 2017. The L2 acquisition of the French quantitative pronoun *en* by L1 learners of Dutch. Vulnerable domains and cross-linguistic influence. In Elma Blom, Jeannette Schaeffer & Leonie Cornips (eds.), *Cross-linguistic influence of bilingualism. In honor of Aafke Hulk*, 303–330. Amsterdam: John Benjamins.
- Sleeman, Petra & Tabea Ihsane. 2020. Convergence and divergence in the expression of partitivity in French, Dutch, and German. *Linguistics* 58(3). 767–804.
- Stadt, Rosalinde, Aafke Hulk & Petra Sleeman. 2018. The influence of L1 Dutch and L2 English on L3 French: A longitudinal study. *Journal of the European Second Language Association* 2(1). 63–71. DOI: <http://doi.org/10.22599/jesla.42>.
- Strobel, Thomas. 2016. Die syntaktische Variable ‘pronominale Partitivität’ in den Deutschen Dialekten. In Alexandra N. Lenz & Franz Patocka (eds.), *Syntaktische Variation: Areallinguistische Perspektiven*, 151–197. Vienna: Wiener Arbeiten zur Linguistik.
- Strobel, Thomas. 2017. Pronominale Partitivität. Arealität und Mikrovariation einer morpho-syntaktischen Variable in den Varietäten des Deutschen. Frankfurt: Goethe University dissertation.
- Wust, Valerie. 2009. A la recherche des clitiques perdus: The dictogloss as a measure of the comprehension of *y* and *en* by L2 learners of French. *The Canadian Modern Language Review* 65(3). 471–499.
- Zobl, Helmut. 1984. Cross-language generalizations and the contrastive dimension of the interlanguage hypothesis. In Alan Davies, Clive Cripser & Anthony P.R. Howatt (eds.), *Interlanguage*, 79–97. Edinburgh: Edinburgh University Press.

Sanne Berends, Petra Sleeman, Aafke Hulk & Jeannette Schaeffer

# The L2 acquisition of the referential semantics of Dutch partitive pronoun ER constructions

Studies of second-language acquisition have repeatedly addressed the role of the home language (L1) in the acquisition of the second language (L2). In these studies, the acquisition of syntactic properties has often prevailed over the acquisition of semantic properties (Gass 1984; Meisel 1997; Ionin & Montrul 2010). In this article, we examine L2 learners' ability to acquire certain semantic properties of the Dutch partitive pronoun construction. To do this, we identified two home languages that represent familiarity (French) and non-familiarity (English) with a partitive pronoun. Examining the behaviour of partitive constructions, we argue that there is variation in the representations of partitive constructions in all languages involved. We argue that Dutch has a partitive pronoun (ER) – also referred to as a 'quantitative' pronoun – that encodes the property [non-presupposition], French has a partitive pronoun (EN) that encodes the properties [non-presupposition / presupposition], whereas in English no partitive pronoun exists. We then investigate the role that the home language properties play in the L2 acquisition of semantic properties associated with Dutch partitive pronoun constructions. We present Grammaticality Judgement Task (GJT) data that reveal that signs of semantic influence of L1 are visible in the L2.

## 1 Introduction

For many years, the role of the first language and its relationship to a second one has been an important issue in the field of second language acquisition. As a result, it is well documented that the home language plays a central role in learning a second language in multiple linguistic subdomains (Odlin 2003;

---

**Notes:** The research for this paper was part of Sanne Berends' PhD project Acquiring Dutch quantitative ER (Berends 2019), which was supervised by Aafke Hulk, Petra Sleeman & Jeannette Schaeffer and carried out at the Amsterdam Center for Language and Communication (AACL) of the University of Amsterdam. We thank the reviewers of this paper for their valuable comments.

Isurin 2005; Hattori & Iverson 2009). The present study, however, focuses on L2 learners' ability to acquire semantic properties of a Dutch construction that has hardly been investigated before: the Dutch partitive pronoun construction, also often referred to as the quantitative pronoun construction.

A partitive pronoun construction in Dutch occurs when the NP is elided in the quantificational discourse. In object position, merely omitting the noun results in an ungrammatical sentence, see (1a); insertion of the partitive pronoun (ER) is required, see (1b).

- (1) a. *Marie bakt koekjes.* → *\*Zij eet drie.*  
 Mary bakes biscuits she eats three  
 'Mary bakes biscuits.' 'She eats three.'
- b. *Marie bakt koekjes.* → *Zij eet er drie.*  
 Mary bakes biscuits she eats ER three  
 'Mary bakes biscuits.' 'She eats three.'

The presence of the Dutch partitive pronoun ER is subject to semantic constraints on the quantifier. The semantic constraint included in this study is [presuppositionality], tested with the [+/-definite] and [+/-strong] distinctions of the quantifier. Both properties presuppose either existence or non-existence: the property [+definite] of the quantifier determines the existence of a specific referent in the preceding discourse, whereas the property [-definite] of the quantifier determines the non-existence of a specific referent in the preceding discourse (Strawson 1950; Barwise & Cooper 1981); the property [-strong] determines the non-existence of other potential referents besides the one that is referred to, whereas the property [+strong] determines the existence of other potential referents besides the one that is referred to, meaning a larger set (De Jong 1983; De Hoop 1992). Thus, [presuppositionality] can be considered the overarching characteristic that is converted into two properties: the [+/-definite] and the [+/-strong] distinction of the quantifier.

The Dutch partitive pronoun ER encodes the properties [-definite] and [-strong] and can only appear in sentences in which the quantifier encodes the same properties. Thus, when the referential properties of ER and those of the quantifier match, the elicitation of ER results in grammatical sentences, as in (2a) and (2b), whereas when the properties of ER and those of the quantifier clash, the elicitation of ER results in ungrammatical sentences, as in (3a) and (3b) (Haeseryn et al. 1997).

- (2) a. *Zij bakt er een heleboel.*  
 she bakes ER a lot  
 ‘She bakes a lot.’  
 b. *Zij bakt er enkele.*  
 she bakes ER some  
 ‘She bakes some.’
- (3) a. *\*Zij bakt er de helft.*  
 she bakes ER the half  
 ‘She bakes half of them.’  
 b. *\*Zij bakt er sommige.*  
 she bakes ER some  
 ‘She bakes some of them.’

To examine L2 learners’ ability to acquire these Dutch semantic constraints, we included two L1 languages in our study: French, which features a partitive pronoun (EN) whose use shows (partial) overlap with Dutch ER, and English, which does not feature a partitive pronoun.<sup>1</sup> The similarities and differences in the discourse situations with partitive pronouns between these L1 languages and Dutch make this construction an ideal test ground for second language acquisition research.

Our starting point is the Transfer Hypothesis, which claims that overlap between the L1 and the L2 facilitates the acquisition of the L2. An initial step to test this hypothesis was taken by Berends, Schaeffer & Sleeman (2017) with respect to the L2 acquisition of the syntactic properties of partitive ER. In contrast, the semantic properties constitute a relatively new territory (but see a preliminary study by Sleeman & Ihsane 2017, on the L2 acquisition of French EN). In this innovative and exploratory study we pose the following general question: Is successful acquisition of the semantics of L2 Dutch partitive pronoun ER constructions influenced by properties of the corresponding partitive constructions in L1 French versus L1 English?

This study is organised as follows. Section 2 outlines the linguistic background of this study: the similarities and differences among the three languages, and the existing literature on the acquisition of Dutch partitive ER. We also present the research question, together with the hypothesis and corresponding

---

<sup>1</sup> Although formally Dutch ER is a pronoun and French EN is a clitic, this syntactic difference has no consequence for its semantic properties and therefore falls outside the scope of this study. For an elaboration on syntactic differences between Dutch ER and French EN we refer the reader to Berends, Hulk & Sleeman (2016) and Berends, Schaeffer & Sleeman (2017).



general predictions. Section 3 presents the methodology of the study, including specific predictions. Section 4 presents the results and Section 5 discusses the results. Section 6 concludes this study.

## 2 Background

In the introduction we briefly mentioned that the occurrence of ER is constrained by the semantic property [non-presuppositionality]. We show this in more detail in Section 2.1. Then, to come to predictions about L2 learners' abilities, we explain in Sections 2.2 and 2.3 how French and English partitive discourses relate to Dutch. In Section 2.4 we will discuss relevant previous studies that have focused on the L1 and L2 acquisition of partitive pronouns.

### 2.1 Dutch (non-)presuppositional discourse

We have seen in (2) and (3) that since ER encodes [non-presuppositionality] properties, it cannot be combined with a quantifier that encodes [presuppositionality] properties. That is, the indefinite quantifier *een heleboel* 'a lot' in (2a) and the weak quantifier *enkele* 'some' do not presuppose the existence of (another/specific) set, while the definite quantifier *de helft* 'half of them' and the strong quantifier *sommige* 'some of them' imply the existence of *another half* and *some more of them*. Hence, these properties presuppose the existence of a larger set than the subset that is referred to, which makes the sentences carry a partitive interpretation.

The important difference between non-presuppositional and presuppositional quantifiers clarifies the grammaticality of the sentences in (2) and the ungrammaticality of those in (3). Nonetheless, Dutch has another pronoun that is partitive: ERvan. If the partitive pronoun ER in (3a/b) is replaced by the partitive pronoun ERvan, the sentences become grammatical, see (4):<sup>2</sup>

- (4) a. \**Zij bakt ER de helft/sommige*  
 b. *Zij bakt ER de helft/sommige [PP<sub>ec</sub> van]*

<sup>2</sup> In (4b), ec, empty category, indicates the original position of ER, before movement of ER. This movement is not compulsory: The sentence *Zij bakt de helft ERvan / sommige ERvan* is also grammatical.

In (4a) the sentence is ungrammatical because the definite quantifier *de helft* ‘the half’ and the strong quantifier *sommige* ‘some of them’ carry presuppositional properties, while the pronoun ER carries a non-presuppositional property. In contrast, the pronoun ERvan in (4b) has a presuppositional property and therefore agrees with the properties of the quantifiers, thereby resulting in a grammatical sentence.

Henceforth, in the interpretation of (4a), ER refers to a non-specific set that expresses a **kind-denoting noun** (e.g., biscuits), whereas in the interpretation of (4b), the elided noun phrase refers to a subset of a presupposed **specific set** (e.g., those biscuits, the ten biscuits, the small biscuits) (De Hoop, Vanden Wyngaerd & Zwart 1990; Oosterhof 2005). In both readings there is reference to an antecedent in the discourse. This distinction between a non-presuppositional and a presuppositional interpretation becomes more visible when introductory sentences are added, see (5).

(5) a. non-presuppositional

*Zij houdt van koekjes. Zij bakt er een heleboel/enkele.*  
 she likes of biscuits she bakes ER a lot /some  
 ‘She likes biscuits. She bakes a lot/some.’

b. presuppositional

*Zij koopt tien koekjes. Zij eet ER de helft/sommige [van<sub>ec</sub>]*  
 she buys ten biscuits she eats ER the half/some of  
 ‘She buys ten biscuits. She eats half of them / some of them.’

In (5a) no specific presupposed set is given; rather, only the kind-denoting noun – biscuits – is mentioned. This leads to a non-presuppositional interpretation with the partitive pronoun ER. In (5b) a specific presupposed set is given – ten biscuits – which leads to a presuppositional interpretation with the partitive pronoun ERvan.

## 2.2 French (non-)presuppositional discourse

French has a partitive pronoun too. This means that in French, as well, quantificational discourses in which the NP is elided require the insertion of the partitive pronoun, EN. A very important difference with Dutch is that at first glance French EN does not seem to be constrained by a presuppositionality constraint on the

quantifier, as shown in (6), the French parallels to (5a) and (5b), in which the antecedent is still ‘biscuits’.

- (6) a. non-presuppositional  
*Elle en a fait un grand nombre/quelques-uns.*  
 she EN has made a large number/some  
 ‘She baked a lot/some.’
- b. presuppositional  
*Elle en a fait la moitié/certains.*  
 she EN has made the half /some  
 ‘She baked half/some.’

Both (6a) and (6b) are grammatical sentences. This raises the question as to whether French EN possesses different semantic properties as compared to Dutch ER. This is indeed the case: French partitive EN encodes both non-presuppositional properties and presuppositional properties. This means that EN is an equivalent not only of Dutch ER, but also of Dutch ER<sub>van</sub>. This makes EN polysemous between the non-presuppositional interpretation and the presuppositional interpretation (Milner 1978; Hulk 1982). As a result of this polyfunctionality, the French surface structures in (6) do not immediately force a non-presuppositional or presuppositional interpretation. Nevertheless, the interpretative distinction is undeniably present below the surface of these sentences. To illustrate this, we add right-dislocated phrases after an intonational pause in (7).

- (7) a. non-presuppositional  
*Elle en a fait un grand nombre/quelques-uns, de biscuits.*  
 she EN has made a large number/some of biscuits  
 ‘She baked a lot/some (biscuits).’
- b. presuppositional  
*Elle en a fait la moitié/certains, de ces dix biscuits.*  
 she EN has made the half /some of these ten biscuits  
 ‘She baked half/some, of these ten biscuits.’

In (7a) we added a **kind-denoting noun** (*de biscuits*, ‘biscuits’), which renders a non-presuppositional interpretation, whereas in (7b) we added a **specific set** (*ces dix biscuits*, ‘these ten biscuits’), which results in a presuppositional interpretation.<sup>3</sup>

<sup>3</sup> The non-presuppositional or presuppositional interpretation of EN sometimes follows from lexical properties of the verb in the preceding discourse. In the French sentences *Hier ils ont*

To summarise, we conclude that Dutch ER evokes a non-presuppositional interpretation and ERvan evokes a presuppositional interpretation, while in French, EN can evoke either a non-presuppositional or a presuppositional interpretation, depending on the context. We summarise this in Table 1.

**Table 1:** Non-presuppositional and presuppositional interpretations in Dutch and French.

	indefinite/weak quantifier = non-presuppositional interpretation	definite/strong quantifier = presuppositional interpretation
Dutch	ER	ERvan
French	EN	EN

### 2.3 English (non-)presuppositional discourse

Unlike Dutch and French, English does not have a linguistic marker that expresses partitivity pronominally. To distinguish between a non-presuppositional interpretation and a presuppositional interpretation in English, the prepositional phrase *PP of them* can be used, see (8).

- (8) a. <biscuits> She bakes a lot/a few in the oven.  
 b. <biscuits> She bakes half [<sub>PP</sub> of them] / some [<sub>PP</sub> of them] in the oven.

The PP in (8b) implies the existence of *another half* and *some more of them*. Hence, the presuppositional properties of the quantifier determine the existence of a bigger set than the subset that is referred to. This part-whole relation always results in a partitive interpretation (Radden & Dirven 2007). Despite the clear partitive interpretation of sentence (8b), sentence (8a) does not necessarily result in a presuppositional interpretation. It depends on the context whether the quantifier

---

*tué beaucoup de lions. Aujourd'hui ils EN ont tué quelques-uns* 'Yesterday they killed many lions. Today they killed some', the verb *tuer* 'to kill' in the second sentence, automatically receives a non-presuppositional interpretation because the consequence of this verb in the first sentence is irreversible: It is impossible to kill the same living thing a second time. In contrast, in the sentence *Hier ils ont attrapé six lions. Aujourd'hui ils EN ont tué la moitié/certains* 'Yesterday they captured six lions. Today they killed half/some of them', the verb *tuer* 'to kill', yields a presuppositional interpretation because killing is most naturally interpreted as an action performed on the lions that had been *attrapés* 'captured' (Milner 1978).

refers to a specific presupposed set or to a kind-denoting noun. To illustrate this, we add left-dislocated phrases; see (9a-b).

- (9) a. non-presuppositional As for biscuits (as opposed to muffins), I have put a few in the oven.  
 b. presuppositional As for those biscuits (you decorated), I have put a few in the oven.

In summary, according to the literature, the Dutch pronoun ER is used with indefinite or weak quantifiers to yield a non-presuppositional interpretation, whereas the pronoun ERvan is used with definite or strong quantifiers to yield a presuppositional interpretation. In French, the pronoun EN can be interpreted in either a non-presuppositional or a presuppositional manner determined by the type of quantifier or context. In English, an overt partitive pronoun is absent altogether, but the discourse containing the elided noun can refer to either a kind (non-presuppositional interpretation) or to a specific/presupposed subset (presuppositional interpretation). Thus, the non-presuppositional and presuppositional interpretations are expressed differently in all three languages, with English having no relevant pronouns, French having one relevant pronoun (EN), and Dutch having two relevant pronouns (ER and ERvan).

## 2.4 Previous studies on L1/L2 acquisition of partitive pronouns

A limited number of studies have focused on the L1 and L2 acquisition of partitive pronouns. We will discuss these in order to describe our current understanding and how this study attempts to add to our knowledge regarding the (L2) acquisition of the Dutch partitive pronoun ER.

Almost none of the previous acquisition studies that addressed the Dutch partitive pronoun ER focused on the acquisition of semantic properties, but instead they focused on the L1 emergence of the pronoun or on the L2 acquisition of its syntactic properties. The only study that did look at the acquisition of semantic properties did not focus on Dutch ER but on L2 French EN.

Production of the partitive pronoun in early Dutch child language has been found to appear relatively late. This holds not only intra-linguistically when compared to the emergence of either regular nominal ellipsis (Sleeman & Hulk 2013) or other homophonous types of ER (Van Dijk & Coopmans 2013; Berends, Hulk & Sleeman 2016), but also cross-linguistically when compared to the emergence of

its French counterpart EN (Gavarró et al. 2011; Van Hout et al. 2011; Berends, Hulk & Sleeman 2016).

One study has been specifically devoted to the L2 acquisition of partitive pronoun ER syntax (Berends, Schaeffer & Sleeman 2017). Berends et al. examined the cross-linguistic effect of (semantically similar but) syntactically different L1 sentence constructions on L2 acquisition. They did this on the basis of the Transfer Hypothesis, which states that the influence of L1 on L2 is enhanced when similar linguistic elements are present in both the native and the target language (also known as positive transfer), but that a difference between L1 and L2 will create difficulties in learning the target language (also known as negative transfer). As a testing method, a Grammaticality Judgement Task (GJT) was used in three different conditions – ‘presence of ER’, ‘position of ER’, ‘ER with an adjective’ – on three different groups: adult L1 French speakers (N=25), adult L1 English speakers (N=25), and adult L1 Dutch speakers (N=25) as a control group. The results show that the predictions anticipating negative transfer were all borne out, but that predictions anticipating positive transfer were not.

A study by Sleeman & Ihsane (2017) focused, among other things, on the L2 acquisition of semantic properties of the French partitive pronoun EN by L1 speakers of Dutch. The investigators started out with hypotheses similar to the ones in our previous and current study: positive transfer is expected in constructions that are similar in L1 and L2, and negative transfer is expected in constructions that are different in L1 and L2. One of the findings of this study strengthens the conclusion from the syntactically oriented Berends, Schaeffer & Sleeman (2017) study, namely an L1 with different properties may hinder L2 acquisition. However, Sleeman & Ihsane (2017) also found (partial) evidence (Sleeman & Ihsane 2021, this volume) that strengthens the idea that shared properties between L1 and L2 facilitate L2 acquisition, which was less convincingly supported by Berends, Schaeffer & Sleeman (2017).

## 2.5 Research question, hypothesis and general predictions

The research question of this study is: Is successful acquisition of L2 Dutch partitive pronoun ER constructions influenced by the expression of properties of L1 partitive constructions? Following the Transfer Hypothesis, we predict that similar properties facilitate L2 acquisition (positive transfer), while different properties hinder L2 acquisition (negative transfer).

## 3 Method

In this section we explain the specifics of the study. In Section 3.1 we will describe in detail the characteristics of the participants who took part in our experiment. Then in Section 3.2 we will describe what tasks they underwent. Subsequently we will tell more about the procedure and the analyses in, respectively, Section 3.3 and Section 3.4. In Section 3.5 we will formulate specific predictions.

### 3.1 Participants

The experiment described in this paper was conducted with two experimental groups: adult native speakers of French and adult native speakers of English. Both groups had reached an advanced level of Dutch as an L2. Advanced being B2 or higher, according to the Common European Framework of Reference (CEFR). We purposely looked for advanced speakers of L2 Dutch since the acquisition of ER has proven to be rather complex and late in previous (L1) studies and we did not want participants to have insufficient (subconscious) knowledge regarding this pronoun. An L1 Dutch speaking group was added as a control group. All three groups were recruited in and around the cities of Amsterdam, The Hague, and Groningen through advertisements posted in several educational institutes, publishing companies, supermarkets, and social media websites, as well as through networks of relatives and friends. All participants were financially compensated. The experiment was carried out with 81 participants. All participants consented to take part. The data obtained from six participants were excluded from analysis because these individuals had either an auditory impairment or an insufficient command of Dutch. The final sample, after exclusions, included 75 adults. These were equally divided over the three language groups: L1 French (N=25), L1 English (N=25), and L1 Dutch (N=25).

### 3.2 Materials

All groups of participants took part in the same battery of tests consisting of three tasks: a questionnaire specifically designed for this study; a Dutch proficiency task, the Test of Dutch Vocabulary (TDV); and a Grammaticality Judgement Task (GJT). The latter task is considered the core linguistic task for this experimental study. The design of the experiment was approved by the Ethical Committee of the University of Amsterdam.

Through the questionnaire we collected (i) general information about the participant, such as age, gender, highest level of education, and current occupation; (ii) linguistic information about the use of, exposure to, and knowledge about the participants' native language and potential other languages; and (iii) a self-assessment proficiency task, which in addition to the TDV was administered before the actual experiment started in order to ensure a minimum level of proficiency in Dutch.

We used the TDV as one of the measures of language proficiency in Dutch in order to ensure that the L1 French and the L1 English groups had acquired the minimum level of proficiency in Dutch that we requested: >B2 according to the CEFR. The TDV is a standardized, computer-administered, receptive multiple-choice test that measures passive knowledge of vocabulary. Target vocabulary words (N=60) were presented in a carrier sentence from which the meaning of the target word could not be deduced. Participants had five options to choose from: four potential synonyms and the fifth option being 'I really don't know'. The target words were selected on the basis of frequency information from CELEX (Baayen et al. 1995), and they gradually decreased in frequency. We administered this task in E-Prime so that accuracy on each trial was automatically recorded.

Through a computer-based GJT specifically designed for this study, we measured the participants' judgement skills regarding the semantic characteristic [presuppositionality] of Dutch partitive ER constructions by manipulating the presuppositionality properties of the quantifiers. All of the pre-recorded audio sentence pairs were constructed with the partitive pronoun ER; no test sentences without ER were included in this study. For each of the four quantifiers there were five test sentences, based on successful items from a pilot study. Since the combination of a presuppositional quantifier and ER is not allowed according to the literature, this means that there were ten ungrammatical test sentences. All of the twenty sentence pairs started with an appropriate preamble sentence that carried the antecedent and a certain quantity. It was followed by the target sentence, such as the ones in (10).

- (10) a. ER [non-presuppositional] quantifier  
*Vrijdag heb jij er een heleboel / enkele geplukt.*  
 Friday have you ER a lot / some picked  
 'Friday you picked a lot.'
- b. ER [\*presuppositional] quantifier  
 \**Vrijdag heb jij er de helft / sommige geplukt.*  
 Friday have you ER the half / some picked  
 'Friday you picked half of them.'



In addition to the 20 experimental sentences, 12 pre-recorded sentence pairs that were structurally similar to the experimental items were added as distractor items. These were either correctly or erroneously modified with respect to the conjugation of the verb (N=6) or with respect to verb-second word order (N=6). The total of 32 sentence pairs were divided into two experimental versions.

### 3.3 Procedure

The participants were tested individually in a quiet room. They sat in front of a 15.6" computer screen and made use of a keyboard to indicate their judgements. This was done with a 5-point Likert scale with '1' indicating sentences that the participants thought native speakers of Dutch would never say and '5' indicating sentences that the participants thought native speakers of Dutch would produce. The subsequent sentence pair was initiated automatically after a judgement was given. Before participants began evaluating actual test sentences, two unrelated practice trials with feedback were presented, one being grammatically correct and one being erroneous. The experimenter initiated these practice trials by pressing the space bar. Only if participants would have answered both practice trials incorrectly, we would not have proceeded with the experimental items. All of our participants gave a satisfying response to at least one of the practice trials. The test was programmed and run via E-Prime in order to automatically record response accuracy. Visual stimuli were not provided, only audio recordings.

### 3.4 Statistical analysis

All the data gathered in this study were coded and entered into the software programme R (R Core Team 2016) to run statistical analyses on. The two semantic properties, [+/-definite] and [+/-strong] of the quantifier, were taken together and encapsulated in the denominator [presuppositionality]. The variables from the questionnaire entered into the model against which the Grammaticality Judgement Task scores were compared are: L1, L2, gender, age, years of exposure to L2 Dutch, percentage of L1 exposure, percentage of L2 exposure on a weekly basis, highest degree obtained, acquisition method (formal or informal learning), and Test of Dutch Vocabulary scores. The Test of Dutch Vocabulary resulted in an individual score, theoretically lying between 0 and 60. For each correct answer one point was given, and the test contained a total of sixty items. The answers to the Grammaticality Judgement Task varied on a 1 to 5-point scale.

### 3.5 Predictions

The Transfer Hypothesis that states that similar properties facilitate L2 acquisition, while different properties hinder L2 acquisition, leads to a number of predictions regarding the experiment described above. We will specify these predictions below, starting with the general group predictions for all three language groups included, followed by the within-group and between-group predictions.

#### 3.5.1 General group predictions

L1 Dutch speakers are expected to accept sentences with ER and a non-presuppositional quantifier and reject sentences with ER and a presuppositional quantifier (cf. De Jong 1983). French learners of L2 Dutch are expected to accept both these types of sentences because French has a single pronoun (EN) for both the non-presuppositional and the presuppositional interpretation. Lastly, English learners of L2 Dutch are expected to guess (score at chance level) because there is no partitive pronoun in English. This leads to predictions 1 and 2:

	L1 Dutch	L1 French	L1 English
1. ER with non-presupp. quantifier	accept	accept	guess
2. ER with presuppositional quantifier	reject	accept	guess

An accepted cut-off point for acceptance is a score above 80% (e.g., Muftah & Wong 2011; Muftah & Rafik-Galea 2013; Spinner & Jung 2017). From this number we set the cut-off point for rejection at a score below 20%, and the chance level between 40% and 60%.

Since we have two predictions per language group, for grammatical and ungrammatical sentences, we also are able to construct within-group predictions.

#### 3.5.2 Within-group predictions

In the general group predictions we made a distinction between grammatical and ungrammatical sentences, allowing us to predict that L1 Dutch speakers will be sensitive to the semantic properties of partitive ER constructions, whereas L1 French and L1 English speakers of Dutch will not. Thus, we predict that L1 Dutch speakers will make a clear distinction between the grammatical non-presuppositional experimental items and the ungrammatical presuppositional experimental items, unlike L1 French learners of Dutch and L1 English learners of Dutch, who, accord-

ing to our Transfer Hypothesis, will not make this distinction, as laid out in predictions 3–5:

3. The L1 Dutch group will make a significant distinction between the grammatical and the ungrammatical test items.
4. The L1 French group will not make a significant distinction between the grammatical and the ungrammatical test items.
5. The L1 English group will not make a significant distinction between the grammatical and the ungrammatical test items.

Besides within-group predictions, we also formulate between-group predictions that shed light on how the different experimental groups should interact with each other.

### 3.5.3 Between-group predictions

We predict to find significant differences between the L1 French group and the L1 Dutch group in the ungrammatical presuppositional experimental items because, contrary to Dutch ER, French EN is allowed in sentences with presuppositional quantifiers. We also predict that we will not find a significant difference between the L1 French group and the L1 Dutch group in the grammatical non-presuppositional experimental items because the two languages act similarly. Moreover, we predict that we will find significant differences between the L1 English group and the L1 Dutch group in both the grammatical non-presuppositional items and the ungrammatical presuppositional items because we expect the L1 Dutch group to convincingly either accept or reject the sentences, and the L1 English group to guess due to the non-existence of a partitive pronoun in the home language. Lastly, we predict that we will find significant differences in the comparisons between the L1 French and the L1 English group, because we expect the L1 French group to convincingly accept the sentences, and the L1 English group to guess. This is described in predictions 6–8:

6. The L1 French group and the L1 Dutch group will accept the grammatical non-presuppositional experimental items equally often, while the L1 French group will accept the ungrammatical presuppositional items significantly more often than the L1 Dutch group.
7. The L1 English group will reject sentences in the grammatical non-presuppositional experimental items and accept ungrammatical presuppositional experimental items significantly more often than the L1 Dutch group.

8. Comparisons between L1 French and L1 English speakers will lead to significant differences in both conditions. The L1 French speakers will accept both the grammatical and the ungrammatical sentences significantly more often than the L1 English speakers.

## 4 Results

In subsection 4.1 we reflect shortly on the general outcomes of the questionnaire and the Dutch proficiency task (TDV). In subsection 4.2 we present a graph that visually represents the average acceptance rates per language group on partitive ER sentences modified with respect to [presuppositionality]. This graph will allow us to either confirm or reject the general group predictions and the between-group predictions. In subsection 4.3 we present a table that also represents the average acceptance rates per language group on partitive ER sentences that are modified by [presuppositionality], allowing us to answer the within-group predictions.

### 4.1 Questionnaire and TDV

In this subsection, we first reflect on the general outcome of the questionnaire and the TDV. The L1 French and L1 English learners of Dutch do not reveal influential inequalities relating to gender, age, years of exposure, highest degree obtained, method of acquisition, percentage of exposure to L2, or TDV score. The non-significant comparison of TDV scores,  $p > .05$ , means that both groups are equally proficient in Dutch. Nevertheless, we controlled for proficiency in all of the given p-values in the results below by including the TDV scores in our model. In the following two subsections, the linear regression models reveal the between-group and within-group differences.

### 4.2 General group results and between-group results

Figure 1 presents the average response rate in the two conditions: ER with a [non-presupposition] quantifier and ER with a [\*presupposition] quantifier, as illustrated in (10a-b). The Y-axis represents acceptance rate.

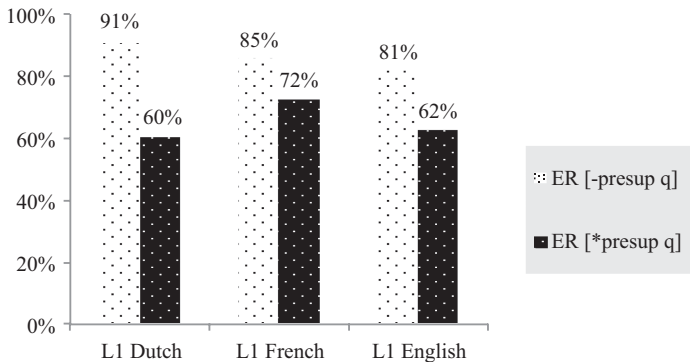

**Figure 1:** Judgement scores in percentages per language group in the grammatical [non-presup.] and the ungrammatical [\*presup.] condition.

### ER [non-presupposition]

Figure 1 shows that both the native Dutch controls and the two groups of L2 Dutch learners accepted sentences with ER and a [non-presupposition] quantifier, with an acceptability rate of higher than 80%:  $M = 91\%$  for native Dutch;  $M = 85\%$  and  $M = 81\%$ , respectively, for the L1 French group and the L1 English group. As a result, after controlling for language proficiency, none of the three separate linear regression models reveals a significant outcome: L1 Dutch – L1 French, ( $t(146) = -0.779$ ,  $p = 0.44$ ); L1 Dutch – L1 English, ( $t(146) = 1.099$ ,  $p = 0.27$ ); L1 French – L1 English, ( $t(146) = 0.418$ ,  $p = 0.68$ ).<sup>4</sup>

### ER [\*presupposition]

For sentences with ER and a [\*presupposition] quantifier, none of the three experimental groups convincingly accepted or rejected them, with  $M = 60\%$  for native Dutch,  $M = 72\%$  for L1 French, and  $M = 62\%$  for L1 English. The three separate linear regression models reveal one significant outcome: L1 Dutch – L1 French, ( $t(146) = 2.34$ ,  $p = 0.021^*$ ). The other groups do not differ significantly from each other, L1 Dutch – L1 English, ( $t(146) = 0.739$ ,  $p = 0.461$ ); L1 French – L1 English, ( $t(146) = 1.516$ ,  $p = 0.132$ ). This means that the only difference we find in the ungrammatical sentences is between the native Dutch group and the L1 French group, with the former rejecting ungrammatical sentences significantly more often than the latter.

<sup>4</sup> We said at the beginning of this section that we included proficiency in our model in order to prevent it from leading to false significant findings. If we leave out this variable, the difference between L1 Dutch and L1 English is significant in grammatical sentences that include ER and a [non-presupposition] quantifier: ( $t(146) = 2.524$ ,  $p = 0.0127$ ). Nevertheless, we know that this difference is based on a difference in proficiency.

### 4.3 Within-group results

Table 2 provides the average acceptance rates per language group on the sentences that include ER with [non-presupposition/\*presupposition] quantifiers.

**Table 2:** Within-group comparisons on sentences modified by [non-presup / \*presup.].

Average acceptance rate per language group			
	Grammatical [non-presupposition]	Ungrammatical [*presupposition]	<i>p</i> -value
DU	4.62 (SD 0.52)	3.39 (SD 1.20)	0.000204 ***
FR	4.40 (SD 0.74)	3.88 (SD 1.02)	3.90e-05 ***
EN	4.23 (SD 0.98)	3.49 (SD 1.10)	0.00514 **

All language groups have significantly higher rates of acceptance on sentences in which partitive ER combines with a [non-presupposition] quantifier than on sentences in which partitive ER combines with a [\*presupposition] quantifier.

## 5 Discussion

The hypothesis that similar relevant properties facilitate L2 acquisition, while different relevant properties hinder L2 acquisition, led to a number of predictions. In this section we will discuss these predictions, starting with the general predictions, followed by the within-group and between-group predictions.

- (1) The first general prediction was about the grammatical sentences in which ER appears with a [non-presupposition] quantifier. We predicted that the L1 Dutch speakers would accept these sentences (cf. De Jong 1983), just like the L1 French learners, who have EN in their home language, which does not distinguish between the presuppositional and non-presuppositional interpretations. The English learners are expected to guess (score at chance level); since there is no partitive pronoun in English, they presumably have no idea about any semantic constraints partitive ER is bound to. The results in Figure 1 indicated that all groups accepted the grammatical sentences at a level above 80%, an accepted cut-off point for native/near-native-like level of acquisition (e.g. Muneera & Wong 2011; Muneera & Rafik-Galea 2013; Spinner & Jung 2017), confirming our expectations regarding the L1 Dutch (91%) and L1 French (85%) groups. However, the L1 English learners of Dutch also accept this type of sentence (81%), whereas we predicted them to score at chance level, set between 40%

and 60%. To summarise, we might say that for the grammatical sentences, positive transfer has been found for the L1 French group, but negative transfer has not been found for the L1 English group.<sup>5</sup> Prediction 1 is thus borne out for the L1 Dutch and L1 the French group, but not for the L1 English group.

- (2) The second general prediction was about the ungrammatical sentences in which ER appears with a [\*presupposition] quantifier. We predicted that the L1 Dutch speakers would reject sentences with ER and a [\*presupposition] quantifier (cf. De Jong 1983), that the L1 French group would accept these sentences as a result of the presence of EN in their home language and the possibility of interpreting EN in a presuppositional and non-presuppositional manner, and that the L1 English group would score at chance level due to the non-existence of a partitive pronoun in that language. Figure 1 shows that the L1 Dutch speakers do not convincingly reject this type of sentences but instead have an average acceptance rate of 60%, which is above the 20% cut-off point. We did not find an important difference between the L1 Dutch speakers or between the test sentences with respect to the scores. This off-target response rating had not been anticipated and disproves our prediction for the L1 Dutch group. Nonetheless, the uncertainty that the native speakers of Dutch seem to be having about the presence of partitive ER does not appear out of thin air: it relates to a finding in the Berends, Schaeffer & Sleeman (2017) paper, in which the L1 Dutch control group did not unanimously judge the sentences in which ER appeared with an adjective as incorrect, but instead they scored at chance. Thus, a Dutch sentence like *\*Ik heb er vijf rode geplukt*, ‘I have picked five red ones’, is considered correct in 56% of all instances. We might therefore hint that ungrammatical sentences with ER – at least in theory ungrammatical –, seem to cause more confusion than grammatical sentences with ER. For French learners of L1 Dutch we predicted that they would accept these sentences as a result of the presence of EN in their home language and the possibility of interpreting EN either in a non-presuppositional or a presuppositional way. Although they did not convincingly (72%) accept this ungrammatical type of sentence with a [\*presupposition] quantifier – we take 80% to be the cut-off point, meaning that the prediction is not borne out – the difference with the L1 Dutch group is significant, meaning that the French learners of L2 Dutch accept these sentences significantly more frequently than the native speakers of Dutch, which may suggest a slight transfer effect. We will come back to between-group comparisons in predictions 6–8. We predicted that the L1

---

<sup>5</sup> We are aware of the idea that positive transfer is not automatically obtained when no significant differences are found.

English learners of Dutch would guess at this type of sentence. This was not confirmed, given the average acceptance rate of 62%, while the chance level is set between 40% and 60%. Nonetheless, a strong tendency can be detected towards chance level. Prediction 2 is not borne out for the L1 Dutch group, almost borne out for the L1 French group, and slightly, if not completely, borne out for the L1 English group.

The previous two general predictions were about group performance, and we have seen that those that predicted ‘acceptance’ were more easily met than those that predicted ‘rejection’ or ‘guessing’. In the following three predictions we made assumptions concerning whether the various language groups would be sensitive to the semantic differences between sentences with ER and a [non-presupposition] quantifier and sentences with ER and a [\*presupposition] quantifier.

- (3) The third prediction anticipated that the L1 Dutch group would be sensitive to the semantic differences between grammatical sentences with ER and ungrammatical sentences with ER. As shown in Table 2, the semantically correct sentences were accepted significantly more often in comparison with the semantically incorrect sentences. With 5 being the maximum level of acceptance, the L1 Dutch group reached 4.62 for the grammatical sentences and 3.39 for the ungrammatical sentences. This difference is highly significant, with  $p < .001$ . Thus, we found evidence that the native speakers of Dutch were sensitive to the semantic properties of quantifiers and how partitive ER relates to those properties. Prediction 3 is borne out.
- (4) In the fourth prediction we predicted that the L1 French group would not be sensitive to the semantic value of the quantifier. Thus, L1 French learners of Dutch were not expected to make a clear distinction in their responses between the grammatical [non-presupposition] condition and the ungrammatical [\*presupposition] condition. The average rates of acceptance for the L1 French group lie at 4.40 for grammatical sentences and at 3.88 for ungrammatical sentences, as can be seen in Table 2. This difference is highly significant, with  $p < .001$ , perhaps because an acceptance rate of 72% is lower than expected for the ungrammatical [\*presupposition] condition. Since the L1 French group does significantly discriminate between the two conditions, prediction 4 is not borne out.
- (5) The fifth prediction anticipated that the L1 English speakers would not be sensitive to the semantic differences between sentences with ER and a [non-presupposition] quantifier and sentences with ER and a [\*presupposition] quantifier, because they have no partitive pronoun. Instead, we expected them to accept the grammatical and ungrammatical sentences equally as bad or as good, at chance level. Nevertheless, with an average acceptance



rate of 4.23 for the grammatical sentences and 3.49 for the ungrammatical sentences, they do significantly discriminate between the two conditions,  $p < .01$ , perhaps because an acceptance rate of 81% is higher than expected for the grammatical [non-presupposition] condition. This significant difference means that prediction 5 is not borne out.

The third to fifth predictions were within-group predictions that concerned the sensitivity of the various language groups to the semantic differences between sentences with ER and a [non-presupposition] quantifier and sentences with ER and a [\*presupposition] quantifier. Although we only expected the L1 Dutch group to be sensitive to this difference, it turned out that in fact all three language groups were. In the following three predictions we take a look at the between-group results. The outcomes will tell us how the different language groups relate to each other and hopefully give an answer to our two hypotheses that positive transfer is expected in constructions that are similar in L1 and L2 and negative transfer is expected in constructions that are different in L1 and L2.

- (6) The sixth prediction anticipated not finding a significant difference between L1 Dutch and L1 French with regard to the grammatical [non-presupposition] condition – as a consequence of the two languages behaving similarly on a semantic level – but anticipated finding a significant difference in the ungrammatical [\*presupposition] condition, because contrary to Dutch ER, French EN is allowed in sentences with presuppositional quantifiers. Figure 1 and Table 2 show that the Dutch native speakers accepted the grammatical [non-presupposition] sentences in 91% of all cases, or equivalently, gave an average score of 4.62 on a 5-point Likert scale, while the French learners of Dutch accepted the sentences in 85% of all cases, or equivalently, gave an average score of 4.40. These results are similar and do not differ from each other, exactly as we predicted. Regarding the ungrammatical [\*presupposition] sentences, the Dutch native speakers accepted the sentences in 60% of all cases, or equivalently, gave an average score of 3.39, while the French learners of Dutch accepted the sentences in 72% of all cases, or equivalently, gave an average score of 3.88. This difference is significant ( $p < .05$ ), meaning that the L1 French group accepted the ungrammatical sentences significantly more than the L1 Dutch group. This makes prediction 6 borne out for both conditions.
- (7) In the seventh prediction we predicted that the L1 English group would reject sentences belonging to the grammatical [non-presupposition] condition significantly more often than the L1 Dutch group and that they would accept sentences belonging to the ungrammatical [\*presupposition] condition significantly more often than the L1 Dutch group. Figure 1 and Table 2 show that the Dutch native speakers accepted the grammatical [non-presupposition] sentences in 91% of all cases, giving them an average score of 4.62 on a 5-point

Likert scale, while the English learners of Dutch accepted the sentences in 81% of all cases, giving them an average score of 4.23. Despite the L1 Dutch group accepting these grammatical sentences at ceiling level, the L1 English group also accepted these sentences. Thus, the L1 Dutch group performed as we expected, but the L1 English group approved of sentences that we assumed they would reject more often (at chance level). As a result, the two language groups do not differ significantly from each other:  $p > .05$  in the grammatical sentences. In the ungrammatical [\*presupposition] sentences, the Dutch native speakers accepted 60% of all cases (thus rejected 40%), resulting in an average score of 3.39 on a 5-point Likert scale, while the English learners of Dutch accepted the sentences in 62% of all cases (thus rejected 38%), with an average score of 3.49. Thus, the L1 Dutch group did not reject these sentences as often as we expected them to, while the L1 English group scored nearly at chance level like we did expect. Therefore, these numbers are too close together to reveal a real difference between them:  $p > .05$ . This means that prediction 7 is not borne out for any condition.

- (8) In the eighth prediction we predicted that the comparisons between L1 French and L1 English speakers would lead to significant differences in both conditions. The two languages have different properties regarding partitive constructions, so we predicted that the L1 French group would accept the Dutch sentences in both conditions and that the L1 English group would score at chance level in both conditions. Nonetheless, neither in the grammatical [non-presupposition] condition,  $p > .05$ , nor in the ungrammatical [\*presupposition] condition,  $p > .05$ , did we find a significant difference between the two languages. This is in line with the results from the syntactic paper in which, despite different predictions for both groups per condition, the L1 French group and the L1 English group never differed significantly from each other.

These last, unforeseen outcomes that the two language groups did not differ significantly from each other could mean that both the L1 French and the L1 English groups have acquired the L1 property [non-presuppositionality/\*presuppositionality] rather well and that they map this property to L2 Dutch partitive ER correspondingly. Possibly they subconsciously know how to differentiate between the non-presuppositional and the presuppositional interpretation in Dutch, because of the distinctions they make in their L1: the L1 French group features EN that is polyfunctional between the non-presuppositional and the presuppositional interpretation – with the interpretative distinction being undeniably present below the surface –, while the L1 English group makes a direct comparison with the ‘some’ versus ‘some of them’ distinction from their home language. This idea expresses itself by the fact that both groups make a significant distinction

between the Dutch grammatical and ungrammatical sentences with partitive pronoun constructions, so clearly they do have a grasp of the semantic properties of ER and how these relate to those of the quantifier. For a similar finding for the L2 acquisition of the French partitive clitic *en* by L1 German learners, see Sleeman & Ihsane 2021, this volume.

More influence of the L1 is observed when looking at the relative high acceptance rates of the L1 French group on both grammatical and ungrammatical partitive constructions, which may be due to positive influence of the L1, or target-level performance and negative influence of the L1, respectively. For the L1 English group the almost at chance judgements of the ungrammatical condition may also be due to L1 influence. Furthermore, the unexpected finding that the L1 Dutch speakers also accepted the ungrammatical sentences at chance level, needs more investigation and has, in this study, led to a non-significant English-Dutch between-group comparison, and probably to a less strong significant French-Dutch between group comparison.

## 6 Conclusion

The focus of this exploratory study has been on the L2 acquisition of Dutch partitive pronoun ER constructions in various semantic referential contexts and how this acquisition is influenced by the properties of partitive constructions in L1 French (EN) and L1 English (Ø).

Primarily, although De Jong (1983) and De Hoop (1992) claim that partitive ER encodes the referential characteristic [non-presupposition] and that the pronoun can only appear in sentences in which the quantifier encodes the same property, the native speakers of Dutch do not convincingly demonstrate this. They are unanimous in their judgements regarding grammatical sentences, but do not convincingly reject the ungrammatical sentences in which partitive ER appears with quantifiers that encode [\*presupposition] properties. In future research this should be investigated more thoroughly by including similar sentences without partitive ER as well, so that a more complete picture will emerge.

For the L1 French group, positive transfer or target-level performance and a slight negative transfer effect were found for respectively grammatical and ungrammatical constructions with partitive ER. For the L1 English group, a slight transfer effect was found for the ungrammatical constructions with partitive ER. Evidence of L1 transfer is furthermore shown in the within-group analyses: both the L1 French group and the L1 English group discriminate significantly between grammatical and ungrammatical Dutch partitive constructions. This may be

the result of ‘subconsciously knowing’ the difference between the referential characteristics of the quantifier from the L1.

In conclusion we might say that signs of semantic influence of L1 are visible in both L1 groups, emanating from the significant within-group comparisons in both L1 groups. Moreover, it has been revealed that for the L1 French group a semantic presuppositionality difference in partitive constructions between the home and target language will create difficulties in learning the target language, while a semantic presuppositionality similarity between the home and target language will lead to enhanced scores on grammaticality judgements. This finding is partly in line with our previous study about the syntactic influence of L1 in similar constructions.

## References

- Baayen, R. Harald, Richard Piepenbrock & Leon Gulikers. 1995. *The CELEX Lexical Database* (CD-ROM). Linguistic Data Consortium, University of Pennsylvania, Philadelphia, PA.
- Barwise, John & Robin Cooper. 1981. Generalized quantifiers and natural language. *Linguistics and Philosophy* 4, 159–219.
- Bennis, Hans. 1986. *Gaps and dummies*. Dordrecht: Foris Publications.
- Berends, Sanne. 2019. Acquiring Dutch quantitative ER. PhD dissertation, University of Amsterdam. Amsterdam: LOT Publications 547.
- Berends, Sanne, Aafke Hulk & Petra Sleeman. 2016. The emergence of the pronouns Dutch ‘er’ and French ‘en’ in child L1 and the role of complexity. *Language Sciences* 60, 144–159.
- Berends, Sanne, Jeannette Schaeffer & Petra Sleeman. 2017. Cross-linguistic influence in adult second language learners: Dutch quantitative pronoun constructions. In Maria LaMendola & Jennifer Scott (eds.), *BUCLD* 41, 74–87. Somerville, MA: Cascadilla Press.
- Dijk, Chantal van & Peter Coopmans. 2013. On the acquisition of ‘daar’ and ‘er’. *Linguistics in the Netherlands* 30(1), 73–88.
- Gass, Susan. 1984. A review of interlanguage syntax: Language transfer and language universals. *Language Learning* 34, 115–132.
- Gavarró, Anna, Maria-Teresa Guasti, Laurie Tuller, Philippe Prévost, Adriana Belletti, Luca Cilibrasi, Héléne Delage & Mirta Vernice. 2012. The acquisition of partitive clitics in Romance five-year-olds. *IBERIA: An International Journal of Theoretical Linguistics* 3(2), 1–19.
- Hattori, Kota & Paul Iverson. 2009. English /r/-/l/ category assimilation by Japanese adults: Individual differences and the link to identification accuracy. *Journal of the Acoustical Society of America* 125, 469–479. <http://dx.doi.org/10.1121/1.3021295>
- Haeseryn, Walter, Kirsten Romijn, Guido Geerts, Jaap de Rooij & Maarten van den Toorn. 1997. *Algemene Nederlandse spraakkunst*. Second, revised, version. Groningen/Deurne: Martinus Nijhoff/Wolters Plantyn.
- Hoop, Helen de. 1992. *Case configuration and noun phrase interpretation*. University of Groningen dissertation.
- Hoop, Helen de, Guido vanden Wyngaerd & Jan-Wouter Zwart. 1990. Syntaxis en semantiek van de *van die*-constructie. *Gramma: Tijdschrift voor taalkunde* 14(1), 81–106.

- Hout, Angeliek van, Alma Veenstra & Sanne Berends. 2011. All pronouns are not acquired equally in Dutch: Elicitation of object and partitive pronouns. In Mihaela Pirvulescu, María Cristina Cuervo, Ana T. Pérez-Leroux, Jeffrey Steele & Nelleke Strik (eds.), *Selected proceedings of the 4th Conference on Generative Approaches to Language Acquisition North America (GALANA 2010)*, 106–121. Somerville, MA: Cascadilla Press.
- Hulk, Aafke. 1982. *Het clitisch pronomen EN: Een dwarsdoorsnede van de Franse syntaxis*. Amsterdam: Rodopi.
- Ionin, Tania & Silvina Montrul. 2010. The role of L1 transfer in the interpretation of articles with definite plurals in L2 English. *Language Learning* 60. 877–925.
- Isurin, Ludmila. 2005. *Cross-linguistic transfer in word order: Evidence from L1 forgetting and L2 acquisition*. Somerville, MA: Cascadilla Press.
- Jong, Franciska de. 1983. Sommige niet, andere wel: De verklaring van een raadselachtig verschil. *GLOT* 6. 229–246.
- Meisel, Jürgen. 1997. The acquisition of the syntax of negation in French and German: Contrasting first and second language development. *Second Language Research* 13. 227–263.
- Milner, Jean-Claude. 1978. *De la syntaxe à l'interprétation*. Paris: Seuil.
- Muneera, Muftah & Shameem Rafik-Galea. 2013. Language learning motivation among Malaysian pre-university students. *English Language Teaching* 6(3). 92–103.
- Muneera, Muftah & Bee Wong. 2011. The acquisition of English *be* auxiliary and thematic verb constructions by adult Arab ESL learners. *International Journal of English Linguistics* 1(2). 91–105.
- Odlin, Terence. 2003. Cross-linguistic influence. In Catherine J. Doughty & Michael H. Long (eds.), *Handbook of second language acquisition*, 436–486. Malden, MA: Blackwell.
- Oosterhof, Albert. 2005. Verbleekte partitieven: descriptieve, syntactische en semantische aspecten. *Neerlandistiek.nl* 5. 1–28.
- Radden, Günter & René Dirven. 2007. *Cognitive English grammar*. Amsterdam & Philadelphia: John Benjamins.
- Riemsdijk, Henk van. 1978. *A case study in syntactic markedness: The binding nature of prepositional phrases*. Lisse: Peter de Ridder Press.
- Sleeman, Petra & Aafke Hulk. 2013. L1 acquisition of noun ellipsis in French and in Dutch. *Romance languages and linguistic theory 2011: Selected papers from 'Going Romance' Utrecht 2011*, 249–266. Amsterdam: John Benjamins.
- Sleeman, Petra & Tabea Ihsane. 2017. The L2 acquisition of the French partitive pronoun *en* by L1 learners of Dutch: Vulnerable domains and cross-linguistic influence. In Elma Blom, Jeannette Schaeffer & Leonie Cornips (eds.), *Cross-linguistic influence in bilingualism. In honor of Aafke Hulk*, 303–330. Amsterdam: John Benjamins.
- Sleeman, Petra & Tabea Ihsane. 2021, this volume. The L2 acquisition of the partitive pronoun *en* in French by L1 speakers of German and the role of the L1. In Petra Sleeman & Giuliana Giusti (eds.), *Partitive determiners, Partitive pronouns and partitive case* (Linguistische Arbeiten 580). Berlin: de Gruyter.
- Spinner, Patti & Sehoon Jung. 2017. Production and comprehension in processability theory: A self-paced reading study. *Studies in Second Language Acquisition* 40(2). 295–318.
- Strawson, Peter. 1950. On referring. *Mind* 59. 320–344.
- Wouden, Ton van der. 1995. Het partitieve *er*. *Tabu* 25. 205–208.

---

**Part IV: The syntax-semantics correlations of case  
in partitivity**



Klaus von Heusinger & Jaklin Kornfilt  
**Turkish partitive constructions  
and (non-)exhaustivity**

Turkish exhibits explicit partitive constructions as *hayvan-lar-dan beş fil* (animal-PL-ABL five elephant ‘five elephants from / of the animals’) with two overt nouns, one for the superset (animal) and one for the subset (elephant). These explicit partitive constructions show optional accusative case marking on the subset denoting noun in direct object position, i.e. Differential Object Marking (DOM). In an earlier paper (von Heusinger, Kornfilt & Kizilkaya 2019), we argue that the results of a grammaticality judgment task described in that paper can be interpreted as showing that accusative case marking of explicit partitives encodes specificity. However, the results are also compatible with an interpretation of the accusative-marked partitives as definite expressions, encoding definiteness, i.e. exhaustivity. In the present paper we present a follow-up acceptability judgment task that shows that these partitives can easily be interpreted as indefinite, i.e. as non-exhaustive expressions. These original results also support the more general assumption of von Heusinger & Kornfilt (2005) that accusative case marking in Turkish encodes specificity rather than definiteness.

---

**Notes:** This work developed from a collaboration with Semra Kizilkaya and Elyesa Seidel, whom we would like to thank for their valuable input, and Elyesa Seidel and Maximilian Hörl for supporting us with the statistical analyses. We also would like to thank the audiences of the Workshop *Definiteness, possessivity, and exhaustivity: Formalizing synchronic and diachronic connections* at the 50th Annual Meeting of the Societas Linguistica Europaea (SLE 2017), 10 – 13 September 2017, University of Zurich, and of the *PARTE Workshop*, University of Venice; November 13, 2017, for their comments. Further, we would like to thank the editors, Giuliana Giusti and Petra Sleeman, for their constructive criticism and the wonderful work they have done for this edited volume, and an anonymous reviewer for very helpful and detailed comments and suggestions. We feel a significant debt of gratitude to Elisabeth Stark, who took a lot of time to comment on an earlier version of the paper. She made many very valuable comments and suggested a more coherent structure that allows us to present the main insight in a more accessible way. All remaining errors are ours. The research of the (alphabetically) first author has been funded by the Deutsche Forschungsgemeinschaft (DFG, German Research Foundation) – Project-ID 281511265 – SFB “Prominence in Language” in the project B04 “Interaction of nominal and verbal features for Differential Object Marking” at the University of Cologne, Department of German Language and Literature I, Linguistics. Kornfilt’s participation in this research has been supported by a Humboldt fellowship for international collaboration, as well as by Syracuse University.



# 1 Introduction

Turkish has different types of partitive constructions. In this paper we focus on what we call *explicit partitive constructions*, i.e. partitives that show lexical nouns for the superset as well as the subset. In (1) the partitive *meyve-ler-den üç elma* ('three apples from / of the fruits') consists of the DP *meyve-ler-den* expressing the superset and the DP *üç elma* expressing the subset. The two DPs stand in the relation of part-whole on the level of referents, without lexical identity between the two nouns; therefore, this construction qualifies as a proper partitive construction. The whole construction can take any argument position in the sentence. If it takes the direct object position, it can be differentially object-marked by the accusative suffix *-(y)I*,<sup>1</sup> as in (2) vs. (1).

- (1) Meyve-ler-den üç elma ye-di-m.  
 fruit-PL-ABL three apple eat-PST-1.SG  
 'I ate three apples of the fruits.'<sup>2</sup>
- (2) Meyve-ler-den üç elma-yı ye-di-m.  
 fruit-PL-ABL three apple-ACC eat-PST-1.SG  
 'I ate three apples of the fruits.'

Following work on Differential Object Marking in Turkish (Johanson 1977, Erguvanlı 1984, Dede 1986, Enç 1991, Kornfilt 1997, von Heusinger & Kornfilt 2005), we assumed in earlier work that accusative-case marked explicit partitives in object position, e.g. (2), denote a specific referent, while unmarked explicit partitives, e.g. (1), denote a nonspecific referent (von Heusinger, Kornfilt & Kizilkaya 2019). In an acceptability judgment task, we tested the acceptance of accusative case marked and unmarked explicit partitives in specificity vs. non-specificity inducing contexts. In the scopal context (3), we found a statistically significant interaction: Accusative case marked partitives were more acceptable in the scopally

<sup>1</sup> We use citation forms that conform to relevant traditions in Turkological as well as generative literature: Capital letters for vowels whose ultimate shape depends on vowel harmony, and for consonants whose shape depends on (de)voicing rules; parentheses around segments which are deleted after relevant segments. Thus, here, /s/ in *-(s)I(n)* and /y/ in *-(y)I* are deleted after a consonant; /n/ in *-(s)I(n)* is deleted in word-final position. The vowel /I/ undergoes both backness and rounding harmony.

<sup>2</sup> We use the uncommon plural form for "fruit", to signal the reading that there are different kinds of fruit in this example (and in other relevant examples elsewhere in the paper), with apples being one of them. Note that the Turkish noun *meyve* has the plural suffix *-ler*.

specific, i.e. wide scope, interpretation (i) than in the scopally non-specific, i.e. narrow scope, interpretation (ii). For unmarked partitives we found the reverse pattern. The effect was strongest for inanimate nouns (see von Heusinger, Kornfilt & Kizilkaya 2019).

(3) Scopal context

Bütün müdür-ler okutman-lar-dan bir asistan(-ı)  
 All director-PL instructor-PL-ABL an assistant(-ACC)  
 kutla-dı.  
 congratulate-PST

‘All directors congratulated an assistant from amongst the instructors.’

i) scopally specific: All of them congratulated İlhan.

ii) scopally non-specific: Füsün congratulated İlhan, Ömer congratulated Emre, Cahit congratulated Demir.

We interpreted the results as confirming the general claim that accusative case marking of indefinite direct objects encodes specificity and lack of the case marker encodes non-specificity. However, this interpretation contradicts the observation that direct objects without overt indefinite markers are interpreted as definite when the accusative case is overtly marked and as indefinite or incorporated if there is no case marker (see Section 2.2). With respect to the reported experiment, we were not able to exclude the option that accusative case marked partitives are definite, i.e. exhaustive, rather than indefinite specific (and thus non-exhaustive). This option was also suggested to us by two reviewers of a pre-publication version of von Heusinger & Kornfilt (2017). They claimed that the exhaustive reading (ii) is the only available or at least the strongly preferred reading of examples such as (4).<sup>3</sup>

---

3 Reviewer 1 notes: “However, what is also significant is that in (10) [= (4)], in which the head noun bears the ACC marker, there is a very strong interpretation of the ‘exhaustive’ reading of the head. One of the readings, if not the most salient one, of (10) [= (4)], is one in which there were three apples in the set of fruits to start out with and that the speaker ate them all.” Reviewer 2 makes a similar claim: “The translation “I ate three (specific) apples of the (set of) fruits” for (10) [= (4)], is not felicitous either; the sentence signifies ‘I ate the three apples from among the fruit’, with the implication, without additional context, – both in English and in Turkish – that there were exactly three apples and that the speaker ate all of them. Just as the accusative definite article in German *Ich habe den Kuchen gegessen* [‘I ate the cake’] as against *Ich habe vom Kuchen gegessen* [‘I ate of the cake’] implies that the whole cake – not just a part of it – was eaten, the presence of the Turkish accusative suffix in (10) [= (4)], normally implies the eating of the complete set of apples; this is not implied (though not excluded either) when uttering (9) [= (4) without accusative case marker].”

- (4) Meyve-ler-den üç elma-yı ye-di-m.  
 fruit-PL-ABL three apple-ACC eat-PST-1.SG  
 (i) 'I ate three apples of the fruits.' (and there might be more apples)  
 (ii) 'I ate the three apples of the set of fruits.' (and there are no more apples)

Thus, (4) would only express that the speaker ate all the apples contained in the set of fruits (4) expresses that the speaker ate *all three apples*. The exhaustive and thus definite reading in (4) would support the more general claim that Differential Object Marking contributes to the definiteness of the direct object (Öztürk 2005).

In countering the views just expressed, we argue in this paper that the accusative case marking in partitive constructions as (4) does not express exhaustivity, but specificity, see Hypothesis 1 (H1). Alternatively, and following reviewer 2 in footnote 3, one could make the weaker claim that there is not a semantic exhaustivity effect, but a pragmatic one, namely, an *exhaustivity implicature*. However, we do not think that the weaker claim is correct, either. Therefore, we formulated also Hypothesis 2.

- H1 Accusative case-marked partitives do not have a semantic exhaustivity effect  
 H2 Accusative case-marked partitives do not trigger an exhaustivity *implicature*.

To be clear: We do not claim that the accusative-marked partitive construction in (4) is incompatible with an exhaustive reading, i.e. we do not claim that it expresses a non-exhaustivity constraint. What we are claiming is that Differential Object Marking is neutral with respect to exhaustivity and thus is also neutral with respect to encoding definiteness. We rather want to uphold our claim (von Heusinger & Kornfilt 2005, 2017 and von Heusinger, Kornfilt & Kizilkaya 2019) that accusative case marking of direct objects encodes specificity, see discussion in Section 2.2.

Our paper is structured as follows: After this introduction, in Section 2, we provide an overview of partitive constructions in Turkish and argue that explicit partitives, as in (4), qualify as proper partitive constructions. We further give a short overview on the condition of differential accusative marking (DOM) in Turkish and discuss the interaction of partitivity and accusative case marking. In Section 3 we present the design and contents of an acceptability task and the results of the questionnaire as well as a discussion of the results. Section 4 summarizes our findings, and we discuss their implication for a more general theory of partitives and differential accusative marking in Turkish.

## 2 Partitive constructions, DOM and specificity in Turkish

Turkish is a nominative-accusative language with case suffixes. It shows Differential Case Marking, i.e. overt structural case marking vs. the lack of an overt structural case suffix, for the direct object with respect to its accusative marking as well as for the subject in nominalized argument embedded sentences with respect to its genitive marking (see Kornfilt 2008, 2020 for Differential Subject Marking). Differential Object Marking (DOM) follows information structural properties, the Referentiality Scale and the Animacy Scale, see Section 2.2 for the particular conditions. Since Enç (1991), DOM in Turkish has been taken in the literature to be closely related to partitivity and specificity. In von Heusinger & Kornfilt (2005), we have argued that partitive constructions in direct object positions are not necessarily morphologically accusative case marked and that partitivity and specificity are independent linguistic categories. We claim that accusative case marking of indefinite noun phrases and of explicit partitive noun phrases in direct object position encode specificity, and in this paper, we defend this view against the assumption that accusative case marked explicit partitives encode definiteness. In Section 2.1, we provide a brief overview of different partitive constructions in Turkish and argue that explicit partitive constructions are proper partitives with two overt nouns. In Section 2.2, we then summarize the main conditions for DOM in Turkish, and in Section 2.3, we discuss the original examples of Enç (1991) that suggest that all partitives in direct object position are accusative case marked. We argue that this is an overgeneralization, since some partitives show differential accusative marking. This raises the issue of whether differential accusative marking depends on definiteness or specificity.

### 2.1 Partitive constructions in Turkish

Partitivity, i.e. a part-whole relation, can be expressed by different linguistic means, such as partitive pronouns or partitive case markers (see Giusti & Sleeman 2021, this volume, Ihsane & Stark 2020, and Ihsane 2020 for an overview). In the following, we focus on partitives or partitive constructions as they were introduced and discussed by Jackendoff (1977), Hoeksema (1996), de Hoop (2003), Ionin et al. (2006), Koptjevskaja-Tamm (2006) and Falco & Zamparelli (2019). Giusti & Sleeman (2021, this volume, ex. (40)) call complex structures, as in (5), “proper partitive constructions” or “true partitives”. These structures are characterized by a part-whole relation between an indefinite subset, expressed by the

quantifier *many*, and a definite superset, expressed by the noun phrase *the girls I know* in (5):

- (5) many of the girls I know

Falco & Zamparelli (2019: 1) provide a somewhat more general definition of a partitive construction: “The partitive construction is a noun phrase, like the subject of (1b) [= (6b)], which is used to refer to a subset or subpart of another referent, the *antecedent*, typically one which has been previously introduced in the discourse, as in (1a) [= (6a)].”

- (6) a [Twenty students]<sub>i</sub> took the exam.  
 b [Two of {them<sub>i</sub>/ the students<sub>i</sub>/ these students<sub>i</sub>}]<sub>j</sub> c<sub>i</sub> got top grades.

In the following, we use *partitive construction* or *partitives* as terms for this kind of noun phrase consisting of an expression denoting a superset (*them, these students*) and an expression denoting a subset of it (*two students*). The subset expression typically consists of a quantifier or a numeral with an empty noun. Falco & Zamparelli (2019: 24) provide the following structure for the English example (7):

- (7) a two of the pens  
 b [<sub>DP</sub> two N<sub>e</sub> [<sub>PP</sub> of [<sub>DP</sub> the [<sub>NP2</sub> pens]]]]

Partitive constructions follow certain semantic restrictions (Hoeksema 1996, Chierchia 1997, Barker 1998, Zamparelli 1998, Falco & Zamparelli 2019): (i) the subset expression must be indefinite (with certain exceptions), (ii) the superset expression must be definite (or specific), (iii) the superset expression must be plural (if it is headed by a count noun), and (iv) the expressed relation is a part-of relation.

Turkish, like other Turkic languages, provides a broad variety of elements denoting the subset in explicit partitive constructions, as in (8)-(11) (von Heusinger & Kornfilt 2017 for a comprehensive overview).<sup>4</sup> (8a-b) correspond most closely to the notion of “true”, “proper” or “canonical partitive” with a quantifier *bazılan* (‘some’) as a subset and a definite noun phrase *meyvelerden* (‘of the fruits’) in the ablative (8a) or *meyvelerin* (‘of the fruits’) in the genitive (8b). There is no difference

<sup>4</sup> Göksel & Kerslake (2005: 476): “partitive construction: a composite noun phrase (made up of a modifier noun phrase followed by a head noun phrase) used to express part of a whole, or to select one or more items from a type or set; the modifier has either ablative or genitive case marking, and the head may or may not have a 3rd person possessive suffix.”

in meaning between the use of the ablative or the genitive in this construction (see Kornfilt 1997, Göksel & Kerslake 2005, von Heusinger & Kornfilt 2005).

- (8) a Meyve-ler-den bazı-lar-ın-ı ye-di-m.  
 fruit-PL-ABL some-PL-3.SG-ACC eat-PST-1.SG  
 ‘I ate some of the fruits.’  
 b Meyve-ler-in bazı-lar-ın-ı ye-di-m.  
 fruit-PL-GEN some-PL-3.SG-ACC eat-PST-1.SG  
 ‘I ate some of the fruits.’

Note that Turkish does not have a definite article. The combination of an indefinite article or an indefinite pronoun with the superset results in ungrammaticality. Luraghi & Kittilä (2014: 55) observe that many instances of markers of partitive constructions derive from (case) markers of separation, as the ablative, or from case markers for possession, as the genitive. Most Turkic languages have both sources of their partitive construction: the genitive and the ablative.<sup>5</sup> Instead of the quantifier *bazılar* (‘some’), one can also use a numeral, as in (9a-b). Note that in constructions with quantifiers and numerals the nominal agreement morpheme, otherwise encoding agreement between a possessee and a possessor and showing up in this context in its default value of 3.SG, is obligatory,<sup>6</sup> which by itself triggers structural case marking, here accusative case (see von Heusinger & Kornfilt 2017 for discussion).

<sup>5</sup> Yakut (Sakha) has a specialized partitive case; see Stachowski & Menz (1998) and Baker & Vinokurova (2018).

<sup>6</sup> von Heusinger & Kornfilt (2017) attribute this to a morpho-syntactic constraint which requires that nominal phrases must have an overt nominal head. Where there is no such head, a default, 3.sg. nominal agreement marker is inserted into the head position, to provide such an overt head. The pronoun-like properties of the nominal agreement marker require the presence of overt structural case, given that pronouns are high in specificity hierarchies cross-linguistically; see, for example, the Definiteness Scale in Aissen (2003: 437). Please note that in this usage, there is no genuine agreement relationship between the subset expression with this default nominal agreement morphology and the ablative superset, given that, in contrast to the genitive, the ablative does not require (morphological and thus syntactic) agreement with a subset; this can be seen in examples where the subset does have an overt nominal head; e.g.:

- (i) Meyve-ler-den altı elma(\*-sın-ı /\*-ların-ı) ye-di-m.  
 fruit-PL-ABL six apple(-3.SG-ACC/-3.PL-ACC) eat-PST-1.SG  
 ‘I ate six apples of the fruits.’

See also the contrast between the ablative and genitive partitive constructions in (10) and (11) in the text.

- (9) a Meyve-ler-den alti-sin-1 ye-di-m.  
 fruit-PL-ABL six-3.SG-ACC eat-PST-1.SG  
 ‘I ate six of the fruits.’  
 b Meyve-ler-in alti-sin-1 ye-di-m.  
 fruit-PL-GEN six-3.SG-ACC eat-PST-1.SG  
 ‘I ate six of the fruits.’

We also find constructions with classifier (-like) expressions such as *tane* ‘item’, which can exhibit the default nominal agreement marker and therefore the accusative case marker *-(y)I*, as in (10), when the partitive construction is a direct object. However, it can also stand without the default nominal agreement marker (and without an accusative marker) if the superset is expressed by ablative case, as in (11a),<sup>7</sup> but not if the superset is expressed by a genitive, as in (11b), since the genitive always requires agreement on the subset expression.<sup>8</sup>

- (10) a Meyve-ler-den üç tane-sin-i ye-di-m.  
 fruit-PL-ABL three item-3.SG-ACC eat-PST-1.SG  
 ‘I ate three (specific entities) of the (set of) fruits.’  
 b Meyve-ler-in üç tane-sin-i ye-di-m.  
 fruit-PL-GEN three item-3.SG-ACC eat-PST-1.SG  
 ‘I ate three (specific entities) of the (set of) fruits.’
- (11) a Meyve-ler-den üç tane ye-di-m.  
 fruit-PL-ABL three item eat-PST-1.SG  
 ‘I ate three (non-specific entities) of the (set of) fruits.’  
 b \*Meyve-ler-in üç tane ye-di-m.  
 fruit-PL-GEN three item eat-PST-1.SG

Turkish also allows for the generalized partitive (or bare / naked partitive), where the ablative is in direct object position (Kornfilt 1996a). These constructions are not discussed in what follows.

<sup>7</sup> von Heusinger & Kornfilt (2017) assume that this classifier-like element can undergo head movement into the nominal head position of the partitive expression, so as to satisfy the “overt nominal head constraint” referred to in the previous footnote, when that position is empty. This results in expressions such as (11a). When the constraint is satisfied by the insertion of a default 3.sg agreement marker, as in (10a), the obligatory accusative marker is exhibited, as mentioned in the previous footnote. See also Sağ (2019) for a discussion of optional classifiers in Turkish.

<sup>8</sup> This is a general requirement of the genitive and is not limited to partitive constructions; it is found in possessive expressions as well as in nominalized embedded clauses (see Kornfilt 2003a and 2009, among others).

- (12) Meyve-ler-den ye-di-m.  
 fruit-PL-ABL eat-PST-1.SG  
 ‘I ate of the fruits.’ (= ‘I ate some of the fruits.’)

Most interestingly, Turkish also allows, as a direct object, an ablative partitive construction with two overt, lexically not identical full nouns, i.e. with a full noun in the subset expression such as *üç elma* (‘three apples’). In this construction, the subset may take accusative case, as in (13b), or not, as in (13a). This construction is not possible with a genitive superset, as in (14a-b).

- (13) a Meyve-ler-den üç elma ye-di-m.  
 fruit-PL-ABL three apple eat-PST-1.SG  
 ‘I ate three apples of the (set of) fruits.’  
 b Meyve-ler-den üç elma-yı ye-di-m.  
 fruit-PL-ABL three apple ACC eat-PST-1.SG  
 ‘I ate three apples of the (set of) fruits.’
- (14) a \*Meyve-ler-in üç elma ye-di-m.  
 fruit-PL-GEN three apple eat-PST-1.SG  
 b \*Meyve-ler-in üç elma-yı ye-di-m.  
 fruit-PL-GEN three apple ACC eat-PST-1.SG

The discussion of the Turkish partitive constructions shows that the subset expression either has to have a nominal head, as in (13), or the “default agreement marker”, as in (8)-(11) in the position of the nominal head, i.e. as the head of the subset expression (see von Heusinger & Kornfilt 2017). This situation seems to be different from Romance, Germanic or Slavic languages, where a nominal in the subset expression is not very frequent (see Seržant 2020: 9–10 for a corpus search for Russian) or is less acceptable (see Falco & Zamparelli 2019: 38 for discussion). Falco & Zamparelli (2019: 40ff) discuss a particular kind of partitives with two overt nouns (“double-noun partitives”)<sup>9</sup> and report that the judgments of such examples are controversial. Cardinaletti & Giusti (2006) judge the Italian equivalents as ungrammatical, but Falco and Zamparelli report that judgments of the English example in (15a) in crowd-source data show that they are (partly) acceptable.

<sup>9</sup> See Sauerland & Yatsushiro (2017) for a comprehensive discussion of double-noun partitives in Japanese.



- (15) a <sup>ok</sup>I only got two packages of the mail you sent me.  
 b <sup>?</sup>I read two novels of the books you gave me.

They also observe that in these constructions, the NP of the subset nominal should be a lexical hyponym (or maybe meronym) of the superset (packages is a subset of mail; but not the other way around). It seems that this lexical relation of hyponym-hyperonym is crucial to this kind of construction (this was also pointed out to us by Elisabeth Stark, p.c.).

With respect to the Turkish partitive construction with two full nouns, Falco & Zamparelli 2019: 4; 48) suggest the possibility of analyzing these ablative partitives as “among”-partitives, rather than as exemplifying a genuine partitive construction. Elisabeth Stark (p.c.) has made the same suggestion. Giusti & Sleeman (2021, this volume, ex. (43)) and Giusti (2021, this volume) discuss “among-partitives” as “circumstantial partitives” and assume that the partitive preposition *of* is replaced by another preposition, such as *among* or *out of* that is not assigned by the partitive quantifier. In such constructions, a definite subset *these girls* is felicitous, as in (16a):

- (16) a. these girls out of the children who were at the party  
 b. many girls out of the children who were at the party

We do not think that the Turkish partitive constructions with two full nouns are “among-partitives”. First, Turkish does have an “among”-construction which includes a P-like element, *arasından* ‘from between, from among’, which however is not used in our partitive constructions. Second, the ablative can also appear with generalized, bare or “naked” partitives, as in (12). Third, a prepositional phrase would not be felicitous in the direct object position of the verb ‘to eat’. Fourth, the superset expression in Turkish ablative partitives can consist not only of a count noun, as in the examples above, but also of a mass noun, as in (17). Clearly, this is not an “among”-construction and cannot be translated as such: ‘\*Ali drank two glasses from among the wine.’

- (17) Ali şarap-tan iki bardak iç-ti-Ø.  
 Ali wine-ABL two glass drink-PST-3.SG  
 ‘Ali drank two glasses of the wine.’

Summarizing, we think that there is simply no grammatical constraint that prohibits the partitive construction with two full nouns described above in Turkish. Furthermore, the presentation of the different partitive constructions in Turkish suggests that such a double noun partitive is an explicit form for all partitives.

Partitives without such a head noun which is modified by a quantifier, numeral or an adjective are obligatorily marked by the default nominal 3.sg agreement suffix.

In the following, we will use “explicit partitive construction” or “explicit partitive” for this constructions, cf. (18). This stands in an appropriate descriptive and theoretical contrast to “implicit partitives” (also “covert partitives”, see Seržant 2021, § 2.3; Falco & Zamparelli 2019: 6), where the definite superset is only implicitly recoverable from the context, as in (19):

- (18) a. Geçen haftasonu hayvanat bahçesine yeni hayvan-lar<sub>i</sub> ekle-n-di.  
 last weekend to the zoo new animal-PL add-PASS-PST  
 ‘Last week, new animals were added to the zoo.’  
 b. [Hayvan-lar-dan<sub>i</sub> beş fil(-i) ]<sub>jci</sub> besle-di-m.  
 animal-PL-ABL five elephant(-ACC) feed-PST-1.SG  
 ‘I fed five elephants of the animals.’
- (19) a. Geçen haftasonu hayvanat bahçesine yeni hayvan-lar<sub>i</sub> ekle-n-di.  
 last weekend to the zoo new animal-PL add-PASS-PST  
 ‘Last week, new animals were added to the zoo.’  
 b. [Beş fil(-i) ]<sub>jci</sub> besle-di-m.  
 five elephant(-ACC) feed-PST-1.SG  
 ‘I fed five elephants.’

In summary, as illustrated by the examples we have seen so far, the subset expression of partitive constructions is the head of such constructions, given the head-final syntax of Turkish. Partitive constructions are marked with case, depending on their syntactic function in a sentence. Of central interest for us is the fact that in direct object position, the accusative marking (DOM) is determined by the interaction of semantic and morphological constraints.

## 2.2 DOM, definiteness and specificity

Differential Object Marking (DOM) in Turkish is often associated in the literature with definiteness or with specificity (Johanson 1977, Erguvanlı 1984, Dede 1986, Enç 1991, Kornfilt 1997, von Heusinger & Kornfilt 2005). The definiteness view is supported by the contrast between a noun in the direct object position without a determiner or an indefinite marker, cf. (20a), and its case-marked counterpart in (20b). The bare noun (phrase) does not introduce a referential argument and is semantically interpreted as non-referential, i.e. a “pseudo-incorporated” noun

(phrase),<sup>10</sup> which forms a complex predicate with the verb, informally speaking; cf. (20a). A noun in direct object position without an indefinite determiner, but with the accusative case suffix *-(y)I*, is unambiguously interpreted as a definite, cf. (20b). With demonstratives or possessives, direct objects always receive overt accusative case.

- (20) Referential options for the direct object in preverbal position
- |    |       |                          |                          |                         |
|----|-------|--------------------------|--------------------------|-------------------------|
| a. | (Ben) | elma                     | ye-di-m.                 | “(pseudo-)incorporated” |
|    |       | I                        | apple eat-PST-1.SG       |                         |
|    |       | ‘I was apple-eating.’    |                          |                         |
| b. | (Ben) | elma-yı                  | ye-di-m.                 | definite                |
|    |       | I                        | apple-ACC eat-PST-1.SG   |                         |
|    |       | ‘I ate the apple.’       |                          |                         |
| c. | (Ben) | bir elma                 | ye-di-m.                 | indef. non-specific     |
|    |       | I                        | an apple eat-PST-1.SG    |                         |
|    |       | ‘I ate an apple.’        |                          |                         |
| d. | (Ben) | bir elma-yı              | ye-di-m.                 | indef. specific         |
|    |       | I                        | a apple-ACC eat-PST-1.SG |                         |
|    |       | ‘I ate a certain apple.’ |                          |                         |

For noun phrases with the indefinite article *bir*, the picture is somewhat different: Case marking of indefinite direct objects cannot signal definiteness, it rather signals specificity. An indefinite direct object without accusative case is interpreted as non-specific, cf. (20c), while an indefinite direct object with accusative case is interpreted as specific, cf. (20d) (see Sezer 1972, Erguvanlı 1984, Dede 1986, Enç 1991, Erguvanlı & Zimmer 1994, Kornfilt 1997, Aydemir 2004, von Heusinger & Kornfilt 2005, Öztürk 2005, Kornfilt & von Heusinger 2009, Özge 2011).

The contrast between (20a) and (20b) suggests that accusative case expresses definiteness. At first glance, this observation seems to be corroborated by the contrasts in (21), where we have noun phrases without an indefinite determiner. The noun phrase modified by a numeral in (21a) is interpreted as indefinite if there is no accusative case, but with accusative case, as in (21b), it is interpreted as definite. Also, the plural noun phrase without accusative case in (21c) is interpreted

<sup>10</sup> We are using the term “pseudo-incorporated” as a neutral term (rather than as a technical term), because we don’t want to take a stand with respect to the debate in the literature about whether a bare noun that is (almost) obligatorily confined to the position adjacent to and preceding the verb has undergone head-incorporation (an option entertained as a possibility in Kornfilt 2003b) or whether such a noun is actually a *phrase* which is fixed in this position, as posited by Massam (2001) and Öztürk (2005). See Seidel (2019) for a comprehensive overview.

as indefinite, and its case-marked corresponding form as definite.<sup>11</sup> However, if we add the indefinite modifier *bazı* ('some') in (21e), case marking in addition to the plural signals specificity.

- (21) a. (Ben) üç elma ye-di-m  
I three apple eat-PST-1.SG  
'I ate three apples.'
- b. (Ben) üç elma-yı ye-di-m  
I three apple-ACC eat-PST-1.SG  
'I ate the three apples.'
- c. (Ben) elma-lar ye-di-m  
I apple-PL eat-PST-1.SG  
'I ate apples.'
- d. (Ben) elma-lar-ı ye-di-m  
I apple-PL-ACC eat-PST-1.SG  
'I ate the apples.'
- e. (Ben) bazı elma-lar-ı ye-di-m  
I some apple-PL-ACC eat-PST-1.SG  
'I ate some specific apples.'

We can observe a clear contrast between the accusative case-marked and the unmarked direct object. In the absence of indefinite markers, this contrast is often assumed to express definiteness. However, once we use indefinite markers like the indefinite article *bir* or indefinite quantifiers like *bazı* 'some', we see that this contrast cannot be related to definiteness, but rather to specificity, as shown by a possible continuation with "but the other apples I did not touch".

Summarizing this brief review of different views on the function of accusative case marking of direct objects, we can say that some data suggest that case marking signals definiteness and other data suggest that it signals specificity.

---

**11** Example (20c) is not very natural without an appropriate context. However, if we have a richer context as in (i), the direct object with plural marking and without case marking is much more natural:

- (i) Bütün ömr-üm boyunca kırmızı elma-lar ye-di-m,  
all life-1.SG during red apple-PL eat-PST-1.SG  
fakat bugün ilk kere sarı elma-lar ye-di-m.  
but today first time yellow apple-PL eat-PST-1.SG  
'My whole life I ate red apples, but today I ate yellow apples for the first time.'

In what follows, we will take partitives as an additional test field. As reported in Section 1, some experts believe that accusative case marking of explicit partitives yields an exhaustive reading, i.e. that it signals definiteness. However, we dispute this claim, and we will present in Section 3 a questionnaire test whose results support our view that accusative case marking of explicit partitives is related to specificity. But before we turn to the experiments, we define the notion of specificity as we will use it.

As just mentioned in the previous section, DOM in Turkish is associated with specificity (see Erguvanlı 1984, Dede 1986, Enç 1991, Kornfilt 1997, Aydemir 2004, von Heusinger & Kornfilt 2005, among others). However, there are different kinds of specificity, and the literature is not always very clear about which kind is assumed to be determined by DOM. Here we follow Fodor & Sag (1982) and von Heusinger (2002, 2019) and assume that there are three main types of specificity: (i) referential specificity, (ii) scopal specificity, and (iii) epistemic specificity.

The term *referential specificity* is used for the contrast between different indefinite noun phrases in opaque contexts. For example, the intensional verb *aramak* ('to look for') creates an opaque context with respect to its direct object, as in (22).

- (22) a Zeynep parti için bir elbise ara-dı-Ø.  
 Zeynep party for a dress look.for-PST-3.SG  
 'Zeynep looked for a dress (or other) for the party.'
- b Zeynep parti için bir elbise-yi ara-dı-Ø.  
 Zeynep party for a dress-ACC look.for-PST-3.SG  
 'Zeynep looked for a (particular) dress for the party.'

Indefinites in these positions can either get a referentially specific reading, a reading according to which the object is determined and identified by the speaker, or they can get a referentially non-specific reading. There is a clear semantic contrast between these two readings: the referentially specific reading allows for an existential inference ('there is an object of that kind'), while the non-referential or non-specific reading does not allow for this. The referentially specific reading is consistent with the continuation (i) that there is such an object, while the referentially non-specific reading is consistent with the continuation (ii) that there is no such object. It is claimed that the accusative case marked indefinite *bir elbise-ye* ('a dress') in (22b) encodes the referentially specific reading, while the unmarked indefinite encodes the referentially non-specific reading.

The term *scopal specificity* describes the contrast between readings of indefinite noun phrases in the scope of (extensional) operators such as *all* and *every*. The indefinite noun phrase might have wide scope or narrow scope with respect

to that operator. An accusative case marked indefinite direct object typically exhibits wide scope, and the unmarked indefinite direct object exhibits narrow scope.

- (23) a Bütün oyuncu-lar bir kostüm dene-di.  
 all player-PL a costume try-PST<sup>12</sup>  
 ‘All actors tried a costume (or other).’  
 b Bütün oyuncu-lar bir kostüm-ü dene-di.  
 all player-PL a costume-ACC try-PST  
 ‘All actors tried a (particular) costume.’

The third type of specificity is generally known under the term *epistemic specificity*, which refers to the contrasts found in contexts without any other operators and that are triggered by the mere option of a referential intention (Fodor & Sag 1982, Farkas 1994). In this context, the specific vs. non-specific contrast is not reflected in truth conditions and is said to be of arguably pragmatic nature (Heim 1991, but see von Heusinger 2002, Kamp & Bende-Farkas 2019 for a different view). The epistemic specific reading is consistent with a continuation that asserts the knowledge of the speaker about the identity of the referent, while the non-specific reading is consistent with a continuation that expresses the ignorance of the speaker. Following the literature, we assume that the case marked indefinite encodes epistemic specificity and the unmarked indefinite encodes epistemic non-specificity.

- (24) a Mustafa bir sandalye satın al-dı-Ø.  
 Mustafa a chair buy-PST-3.SG  
 ‘Mustafa bought a chair.’  
 b Mustafa bir sandalye-yi satın al-dı-Ø.  
 Mustafa a chair-ACC buy-PST-3.SG  
 ‘Mustafa bought a chair.’

In an acceptability judgment task, von Heusinger & Bamyacı (2017a, 2017b) tested the felicity of i) a specific or ii) a non-specific continuation in a) a transparent context for testing epistemic specificity, b) a context with the universal quantifier

---

<sup>12</sup> In Turkish, in most stylistic levels, there is no plural third person agreement marking on the predicate of tensed clauses, if the overt third person plural subject is marked with the plural suffix. (When a third person plural subject is not overt, i.e. when it is *pro*, the full third person agreement marker on the predicate is obligatory.) In such instances, we do not gloss for agreement on the predicate. For some additional information, see Kornfilt (1991) and (1996b), among others.

for testing scopal specificity, and c) an intensional contexts for testing referential specificity. They found that overt DOM clearly expresses referential specificity, as sentences of type (22b) with the overt accusative marker clearly preferred a referentially specific interpretation. For scopal specificity, they found that overtly accusative-marked indefinites show wide scope and unmarked indefinites show narrow scope. But for neutral contexts, cf (24), they did not find an effect of accusative case marking on specificity. The results of an unpublished replication of this experiment supports the findings reported here, but also shows a significant effect of accusative-case marking for specificity in neutral contexts ( $\beta=-0.89$ ,  $SE=0.33$ ,  $p=0.007$ ). We take this as support for the assumption that accusative case marking encodes all three types of specificity.

DOM in Turkish also depends on animacy. In an acceptability judgment study, Krause & von Heusinger (2019) tested the acceptability of indefinite direct objects with and without accusative case marking in simple transparent contexts. The indefinite direct objects in the experimental sentences denoted entities belonging to three animacy categories (human, animal, and inanimate). The results show a significant main effect of animacy and revealed that the acceptability of DOM depends on the animacy categories (see Krause & von Heusinger 2019: 181–183 for a Linear Mixed Effects (*lme*) analysis).

We have seen that there is an inconsistency with respect to the function of the accusative case when it is found on direct objects: It seems that direct objects without an indefinite determiner are definite with case and indefinite without case. This, however, cannot be the (sole) contribution of the case marker, as for direct objects with an indefinite determiner, case marking signals specificity, rather than definiteness. We have shown that case marking encodes referential and scopal specificity, and in one experiment also epistemic specificity. Finally, we have mentioned empirical evidence that animacy is also a determining factor for accusative case marking: human direct objects prefer case marking, while inanimates prefer to be expressed by noun phrases which are unmarked for case. We will also see this animacy effect in our questionnaires, discussed in Section 3.

### 2.3 Partitivity, specificity and case marking

Before we can discuss the (non-)exhaustivity of explicit partitive constructions, we have to discuss the relation between partitivity, specificity and case marking. Enç (1991) combines the observation that accusative case marking, i.e. Differential Object Marking (DOM), is closely related to specificity with the observation that partitives often (and in her view always) take accusative case when they are direct objects. She argues in her seminal paper (Enç 1991) that case signals

specificity, which, according to her view, is based on partitivity. She illustrates this claim by offering examples that we repeat as (25). (25a) introduces a set of children, out of which the case-marked direct object *iki kız* in (25b) selects two girls. In other words, the specific direct object *iki kız* is an implicit partitive, and the specificity is explained by the discourse givenness of the set out of which the indefinite direct object selects one element (i.e. here, a subset consisting of two entities). The unmarked direct object *iki kız* in (25c), however, is not linked to the set of children, i.e. it refers to a set of girls not included in the set of children introduced in (25a):

- (25) a. (Enç 1991: #16; Enç's translation, our glosses)  
 Oda-m-a birkaç çocuk gir-di-Ø.  
 room-1.SG-DAT several child enter-PST-3.SG  
 'Several children entered my room.'
- b. (Enç 1991: #17; Enç's translation, our glosses)  
 İki kız-ı tanı-yor-du-m.  
 two girl-ACC know-PROG-PST-1.SG  
 'I knew two girls.'
- c. (Enç 1991: #18; Enç's translation, our glosses)  
 İki kız tanı-yor-du-m.  
 two girl know-PROG-PST-1.SG  
 'I knew two girls.'

Enç (1991: 10) argues, based on (26), that case marking is obligatory not only for implicit partitives, as in (25b), but for explicit partitives, as well. The numeral *ikisini* in (26a) exhibits an agreement marker *-(s)I(n)* as well as the accusative marker *-(y)I*, while the form *ikisi* without case (but with the same agreement marker) is ungrammatical, as seen in (26b).

- (26) a. (Enç 1991: #129a; Enç's translation, our glosses)  
 Ali kadın-lar-dan iki-sin-i tanı-yor-du-Ø.  
 Ali woman-PL-ABL two-3.SG-ACC know-PROG-PST-3.SG  
 'Ali knew two of the women.'
- b. (Enç 1991: #129b; Enç's translation, our glosses)  
 \*Ali kadın-lar-dan iki-si tanı-yor-du-Ø.  
 Ali woman-PL-ABL two-3.SG know-PROG-PST-3.SG

To summarize, Enç (1991) argues that accusative case expresses specificity and is based on partitivity. She argues that case marking of an indefinite direct object always signals a partitive reading, which has to be interpreted as specific, and



that likewise a specific object is partitive and therefore must be overtly marked as accusative. Öztürk (2005) even goes a step further in assuming that overt case is the bearer of referentiality.

While we agree with the judgments in (25) – (26), we disagree with both authors on their analyses and argue that neither of these views can be correct. While Enç's approach was an important step forward in understanding the syntax and semantics of structural case in Turkish, there are some important modifications to be made.

First, we have shown (Kornfilt & von Heusinger 2009, von Heusinger & Kornfilt 2017) that the correlation claimed by Enç to hold between case marking, partitivity, and specificity is not valid. This is already illustrated by the contrast between the accusative case marked explicit partitive in (2) and its counterpart without accusative marking in (1). Second, the subset denoted by partitive expressions can be interpreted as specific or non-specific; see examples in (27) from English, where the continuation (i) forces the specific reading and continuation (ii) the non-specific reading.<sup>13</sup>

- (27) a. One of the students has cheated in the exam.  
       (i) I know who.  
       (ii) I do not know who.  
       b. Every student has to read one of the novels of Orhan Pamuk.  
       (i) ...namely, *The White Castle*.  
       (ii) ...each student can choose one.  
       c. Ann wants to marry one of the two nice Norwegians.  
       (i) ...namely, Lars.  
       (ii) ...either one would do.

Third, the ungrammaticality of the subset expression *iki-si*, which is unmarked for accusative in (26b), follows from a more general constraint that requires the 3.sg agreement marker *-(s)I(n)* (whether used as a default nominal marker, as in our examples, or as a genuine agreement marker elsewhere) to be followed by morphological case (see von Heusinger & Kornfilt 2005, also mentioned earlier in this paper, in footnote 6); thus, the ill-formedness of such examples is independent from partitivity – again, contra Enç (1991).

To summarize, Enç's claim of a correlation between (structural) case marking, partitivity, and specificity has initiated very interesting research, but we see that

---

<sup>13</sup> Note that these examples do not allow us to decide whether English indefinites are underspecified with respect to specificity or whether they are ambiguous. Note further that in (27c), both readings are presuppositional.

her claim is not fully correct, once we take more data into consideration. While partitive constructions show typical behavior for specific indefinites, partitivity and specificity are two independent semantic-pragmatic categories. They both contribute to a restriction of the set of referents associated with the descriptive content of the respective subset, but they differ in that partitive indefinites are existential indefinites, which allow for scope interactions and specificity contrasts, as in (27). Specific indefinites are referentially anchored and always show wide scope behavior or epistemic determined referents.

Furthermore, not all partitives are overtly case-marked when they are in positions of structural Case (such as the position of direct object of a transitive verb, or the position of canonical subject in a finite clause), and the obligatoriness of case marking for subsets that are expressed without a lexical noun as their head depends on the presence of a “default agreement marker” (e.g. the suffix *-(s)I(n)* in example (26a)), which occupies the position of the lexical head of the partitive construction.<sup>14</sup>

## 3 Experiment and results

### 3.1 Experimental design

To test the two hypotheses with respect to the exhaustivity of accusative case marked explicit partitives in direct object position repeated below, we designed

---

<sup>14</sup> There is additional evidence that one should not link partitivity too closely to accusative marking, as other cases can host a partitive reading as well (such examples can be found in Nakipoğlu 2009: 1255, ex (4)).

- (i) a. Bahçe-de beş ağaç var-dı-Ø.  
garden-LOC five tree exist-PST-3.SG  
'There were five trees in the garden.'
- b. Çocuk-lar bir ağaç-a tırman-mış-tı-Ø.  
child-PL one tree-DAT climb-PRFCT.PART-PST-3.SG  
'Children had climbed on one (of the) tree(s).'
- c. Kuş-lar iki ağaç-ta yuva yap-mış-tı-Ø.  
bird-PL two tree-LOC nest make-PRFCT.PART-PST-3.SG  
'Birds had made their nests in two (of the) trees.' (The parentheses are ours.)

The locative 'two trees' in (ic) expresses a subset of the 'five trees' in (ia), as does the dative 'one tree' in (ib), thus expressing an implicit partitive reading.

an acceptability judgment task, so as to test the compatibility of the partitive construction with a non-exhaustive meaning.<sup>15</sup>

- H1 Accusative case-marked partitives do not have a semantic exhaustivity effect  
 H2 Accusative case-marked partitives do not trigger an exhaustivity *implicature*

We constructed examples with a context where we had *n* items of the same kind in the superset, say five apples in a set of different kinds of fruit, or eight elephants in a set of animals, see (28b). Then we continued with the target sentence (28c) with less than *n* items, say three apples in the subset, or, as in this example, five elephants (out of eight). If accusative case-marked direct objects expressed an exhaustive reading, informants should judge examples such as (28c-i) as incoherent or at least as less coherent than examples where the subset expresses exactly *n* items. We also had the continuation sentence (28c-ii) without accusative case marking following the context sentences (28a-b). If case marking signaled exhaustivity, we would expect that the rating for accusative case-marked partitives should be worse than for unmarked partitives.

- (28) a. Geçen haftasonu hayvanat bahçesine yeni hayvan-lar  
 last weekend to the zoo new animal-PL  
 ekle-n-di-Ø.  
 add-PASS-PST-3.SG  
 ‘Last week, new animals were added to the zoo.’
- b. Aralarında bir çok zürafa ve sekiz fil var-dı-Ø.  
 among them many giraffe and eight elephant exist-PST-3.SG  
 ‘There were, among them, many giraffes and eight elephants.’
- c-i. Hayvan-lar-dan beş fil-i besle-di-m.  
 animal-PL-ABL five elephant-ACC feed-PST-1.SG  
 ‘I fed five (specific) elephants of the animals.’
- c-ii. Hayvan-lar-dan beş fil besle-di-m.  
 animal-PL-ABL five elephant feed-PST-1.SG  
 ‘I fed five (non-specific) elephants of the animals.’

Test items were small discourses consisting of three sentences, two context sentences and a target sentence. The first context sentence introduced a set with a general description, e.g. *araba* ‘cars’, as in (29a). The second sentence named

<sup>15</sup> We would like to thank Semra Kizilkaya and Elyesa Seidel for their help in creating the test items and constructing the electronic questionnaire. Special thanks to Elyesa for providing us with the statistical analysis.

two sets from the general set, at least one set with an explicit number, as *Bunlardan üçü Passat(tı)* ('three of those were Passats(.PST)) in (29b). The target sentence then introduced the partitive construction using a numeral lower than the one in the second sentence, as in *iki Passatı* ('two Passats-ACC'), forcing a non-exhaustive reading. The alternative continuation (29c-ii) had the same phrase, but without accusative: *iki Passat* ('two Passats').

- (29) a. Ay sonunda galeri-de beş araba  
 at the end of month showroom-LOC five car  
 kal-mış-tı-Ø.  
 stay-PRFCT.PART-PST-3.SG  
 'At the end of the month, five cars were left in the showroom.'
- b. Bunlardan üç-ü Passat, gerisi Mercedes-ti-Ø.  
 of those three-AGR Passat remainder Mercedes-PST-3.SG  
 'Three of those were Passats, and the remainder were Mercedeses.'
- c-i. Araba-lar-dan iki Passat-ı sat-tı-m.  
 car-PL-ABL two Passat-ACC sell-PST-1.SG  
 'I sold two (specific) Passats.'
- c-ii. Araba-lar-dan iki Passat sat-tı-m.  
 car-PL-ABL two Passat sell-PST-1.SG  
 'I sold two (non-specific) Passats.'

We constructed 6 examples with nouns denoting sets of humans, as in (30), 6 items with non-human animate sets, as in (28), and 6 items with inanimate sets, as in (29):

- (30) a. Bu sabah ver-diğ-im İngilizce dersine bütün  
 this morning give-NOM-1.SG to the English lesson all  
 öğrenci-ler katıl-dı.  
 student-PL participate-PST  
 'All students participated in the English class that I gave this morning.'
- b. Bunlardan 14-ü kız, 16-sı erkek-ti-Ø.  
 of those fourteen-AGR girl sixteen-AGR boy-PST-3.SG  
 'Of those, 14 were girls, and 16 were boys.'
- c-i. Öğrenci-ler-den beş kız-ı seç-ti-m.  
 student-PL-ABL five girl-ACC choose-PST-1.SG  
 'I chose five (specific) girls of the students.'
- c-ii. Öğrenci-ler-den beş kız seç-ti-m.  
 student-PL-ABL five girl choose-PST-1.SG  
 'I chose five (non-specific) girls of the students.'

We tested the reaction of our participants to sentences like the one in (30c-i), i.e. with accusative case marking, vs. sentences like the one in (30c-ii), i.e. without accusative case marking, and constructed thus two lists via Latin Square, with 18 items, 9 with accusative and 9 without accusative case marking. We added to each of the two lists 18 differently structured items, among which we had 12 controls, i.e. 6 coherent discourses, as in (31), and 6 incoherent discourses, as in (32). We added 6 discourses with a violation of a conversational implicature, like in (33), to test how informants react to these violations. For each of these groups we had sentences with human, with animate and with inanimate arguments. All control items had a structure similar to that of the corresponding test items. They consisted of three sentences, the first setting the scene, the second introducing explicitly a set and the third referring back to the set in different ways. The coherent control items used an explicit anaphoric noun phrase to refer back to the antecedent establishing coreference, as in (31).

## (31) Coherent control items

- a. Bu sabah ayakkabı dolab-ım-ı düzenle-di-m.  
 this morning shoe cabinet-1.SG-ACC organize-PST-1.SG  
 ‘I organized my shoe cabinet this morning.’
- b. İhtiyac-ım ol-ma-yan altı çift eski-miş ayakkabı-yı  
 need-1.SG be-NEG-AN six pair old-PRFCT.PART shoe-ACC  
 ayır-dı-m.  
 sort out-PST-1.SG  
 ‘I sorted out six pairs of worn-out (old) shoes that I didn’t need.’
- c. Eşyalar-ım-dan ayrıl-a-ma-dığ-ım için, onlar-ı  
 ware-1.SG-ABL leave-ABIL-NEG-INDIC.NOM-1.SG for they-ACC  
 at-a-ma-dı-m  
 throw.away-ABIL-NEG-PST-1.SG.  
 ‘I couldn’t throw them away, because I cannot part from my things.’

The source of the incoherence in discourses like (32) is the bare, “(pseudo-) incorporated” direct object in the last sentence, i.e. (32c); this usage runs counter to the fact that the discourse has introduced a definite, specific pigeon (in (32b)). Therefore, the pragmatically very strong anaphoric reference to the previously introduced pigeon is infelicitously expressed by a bare noun in (32c); such an anaphoric reference should have been expressed by a case-marked (definite) direct object.

## (32) Incoherent control items

- a. Pazar yerin-de güvercin-ler var-dı.  
 market place-LOC pigeon-PL exist-PST  
 ‘There were pigeons at the market place.’

- b. Çocuklar yavaşça yaklaş-ıp aralarındaki tek beyaz  
 child-PL slowly come near-IP among them only white  
 güvecin-i tut-ma-yı planla-mış-lar-dı.  
 pigeon-ACC catch-NOM-ACC plan-PRFCT.PART-PL-PST  
 ‘The children had planned to slowly come near them and to catch  
 the only white pigeon among them.’
- c. Sonunda güvercin tut-tu-lar.  
 in the end pigeon catch-PST-3.PL  
 ‘In the end, they caught pigeons (lit.: they pigeon-caught).’

There was a third set of items that consisted of discourses violating a scalar implicature. The first sentence provides a frame, the second introduces a list of objects, and by Gricean Maxims raises an exhaustivity implicature, namely that there are no other objects. The third sentence introduces objects with a definite possessive reading that were however not mentioned in the list introduced in the second sentence. Thus the definite *his cows* in (33c) cannot be accommodated in the context as there were only goats and lambs mentioned previously. We think that it is Grice’s Maxim of Quantity that blocks this accommodation. We assume that the judgment of these examples mirror the way informants include violation of the Maxims (or pragmatic inferences in general) in their judgment task. Informants who judge this set of three sentences as bad take the Maxims as part of coherence of the discourse. Informants who judge the example acceptable do not consider violations of the Maxims as relevant for the coherence of the discourse or sentences.

(33) Violation of implicature

- a. Mehmet geçen sene çiftliğ-in baş-ın-a geç-ti-Ø.  
 Mehmet last year farm-GEN head-3.SG-DAT become-PST-3.SG  
 ‘Mehmet became the director of the farm last year.’
- b. Çiftliğ-in-de keçi-ler ve kuzu-lar var.  
 farm-3.SG-LOC goat-PL and lamb-PL exist  
 ‘There are goats and lambs in his farm.’
- c. Sabahları inek-ler-in-i sağ-ıyor-Ø.  
 in the mornings cow-PL-3.SG-ACC milk-PROG-3.SG  
 ‘In the mornings, he milks his cows.’

We used these sets of items to find out how our informants react to violations of scalar implicatures. This was important in order to test our hypothesis 2, which postulates that case marking does not even signal an exhaustive implicature. Following hypothesis 2, informants should behave similarly independently of whether they like a violation of the scalar implicature in sentences like (33) or not.

Participants received a web-based questionnaire on Google Forms. 60 native speakers of Turkish, all of whom were university students, answered the questionnaire. They were given one of the two lists of discourses, consisting of 18 test items, the 6 items to test the ‘exhaustivity implicature hypothesis’, and 12 control items, in a pseudo-randomized order. We asked informants to rate the third sentence in terms of how well it fits the first two sentences on a scale from 1 (the last sentence is very badly linked) to 7 (the last sentence is very well linked). We eliminated 12 participants, since they did not react to the coherent and incoherent contexts among the control items correctly. We analyzed the judgments of the remaining 48 (24 for each list) participants.

### 3.2 Results and discussion

Figure 1 provides the mean values for the 12 control items and the 6 ‘implicature violation’ items, i.e. the coherent items, as in (31), the incoherent ones, as in (32), and the violated implicature items, as in (33). The mean values clearly show that participants do distinguish between coherent and incoherent discourses and that the judgments of discourses with a violated implicature are between the coherent and the incoherent discourses. We think that these results show that participants were attentive to the task and that they were able to judge semantic-pragmatic relations between sentences. Below we discuss the reaction to the 6 ‘implicature violation’ items in more detail.

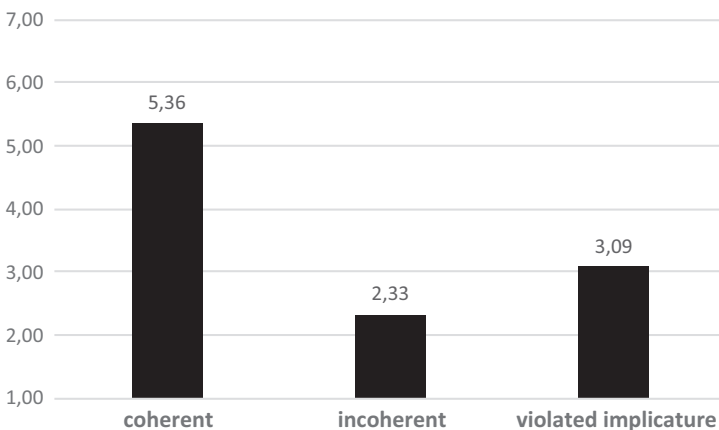

**Figure 1:** Mean scores for the coherent, the incoherent, and violated implicature items on a scale from 1 (badly linked) to 7 (very well linked).

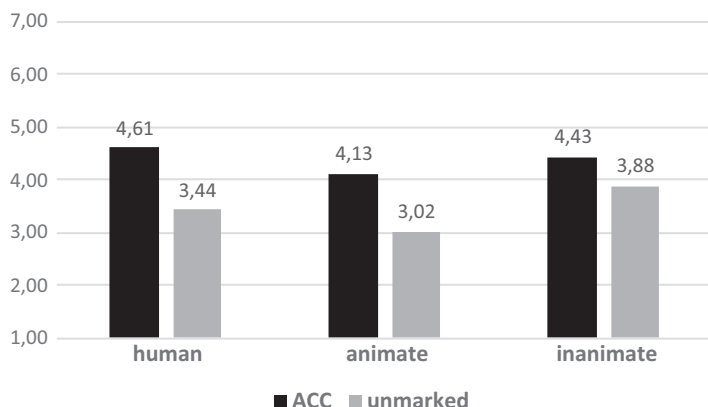

**Figure 2:** Mean scores for accusative case marking and animacy of the explicit partitives on a scale from 1 (badly linked) to 7 (very well linked).

Figure 2 summarizes the mean scores of the judgments for the 18 test items concerning partitive constructions with or without case marking. First, we observe that sentences with accusative-marked explicit partitives in direct object position, such as (28c-i; 29c-i, 30c-i), are nearly as acceptable (mean 4,39) as the coherent control items (5,36), as illustrated in Figure 1. Second, we see that sentences with unmarked explicit partitives in direct object position, such as (28c-ii; 29c-ii, 30c-ii), are less acceptable (3,45) than the sentences with accusative-marked explicit partitives (4,39). In both conditions the acceptability is much higher than for the incoherent examples (2,33). Third, there is no clear difference between the different animacy values. But for humans and non-human animates, the accusative case-marked explicit partitive is rated better than the unmarked one, while this contrast is almost neutralized with inanimates. This effect replicates the results of Krause & von Heusinger (2019) reported in Section 2.2 above, showing that human and animate direct objects have a higher preference for accusative marking. Statistical analysis<sup>16</sup> supports the results represented in Figure 2, showing that there is an overall significant effect of case marking, but only a minor effect of animacy.

<sup>16</sup> Statistical analyses were conducted in R version 1.0.136 using the lme4 package (Bates et al. 2015) to perform linear mixed-effect models (LME) with the score as outcome variable. As fixed effects, we entered case marking and animacy into the model. As random effects, we had intercepts for subjects and items, as well as by-subject and by-item random slopes for the effect of case marking. The ACC condition and the human condition were mapped onto the intercept. To identify the best model fit, we performed likelihood ratio tests. The model with two main effects, namely animacy and case marking, was chosen on the basis of a likelihood ratio test ( $\chi^2(1) = 0.28, p < .01$ ). The results show a significant main effect for *case marking*  $b = -0.94, SE = 0.20$ ,



Summarizing, participants have rated the discourses with an exhaustivity violation much better than the incoherent discourses and more similar to the coherent discourses. The somewhat degraded rating of the explicit partitives might come from their infrequent form of two full noun phrases in the partitive construction. These results confirm our Hypothesis 1 that accusative case-marked partitives do not have a semantic exhaustivity effect. Furthermore, we see that accusative case-marked partitives are significantly rated more highly than morphologically unmarked partitives. This would not be expected if accusative case marking expressed definiteness and thereby contributed to an exhaustive reading. Therefore, we take this significant result as additional evidence for our Hypothesis 1 that accusative case marking does not express exhaustivity or definiteness.

We still have to discuss the possibility that the exhaustivity effect arises by a pragmatic inference, which means that it would not be covered by a judgement task of participants that do not regard pragmatically infelicitous contexts as unacceptable. In order to test this possibility, we included in our questionnaire 6 items that had a violation of an implicature, as in (33)

We found that we had a high interindividual variation in the judgments for these items. Therefore we divided the 48 participants into two groups of 24 participants each, such that Group 1 is below the median of the judgments for these sentences (<2.7) and Group 2 is above the median (>2.7). We assume that Group 1 represents participants that take pragmatic violations as unacceptable, while

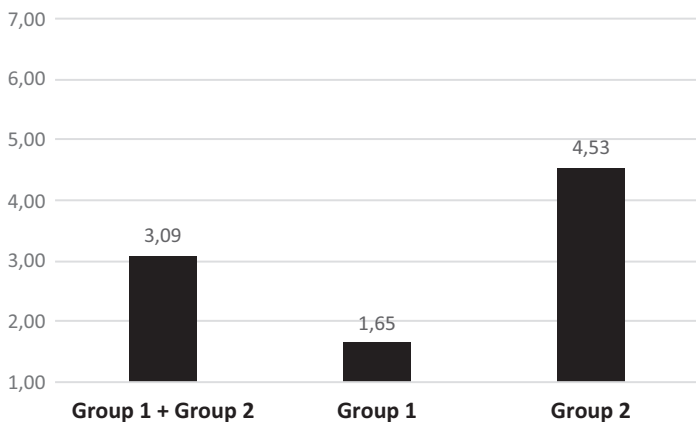
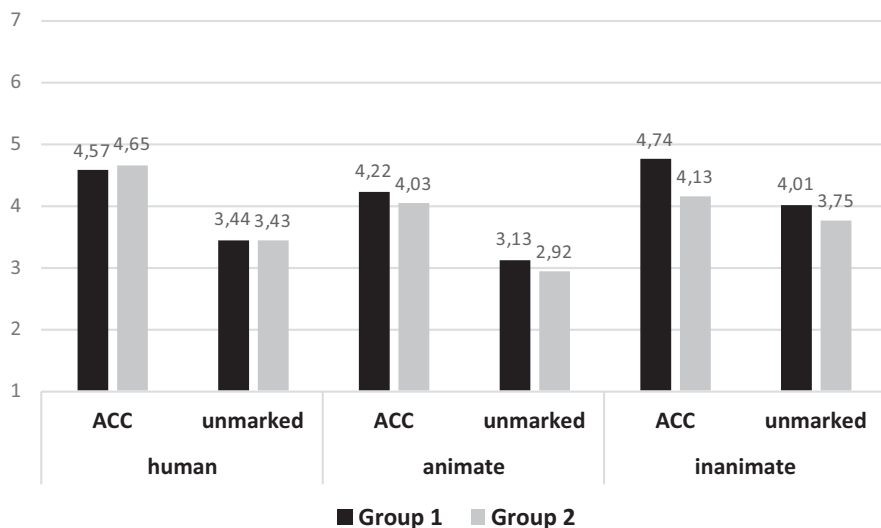

**Figure 3:** Mean scores for the items with the violation of the implicature on a scale from 1 (badly linked) to 7 (very well linked) for both groups and each group separately.

$t = -4.69$  and *animacy*  $b = 0.58$ ,  $SE = 0.25$ ,  $t = -2.37$ , only for the comparison between animate and inanimate conditions. As can be seen from Figure 2, there is no significant interaction of case marking and animacy.

Group 2 represents participants that are more tolerant towards pragmatic violations. This corresponds to the more general observation that informants vary whether or not pragmatic violations influence acceptability. In other words, some informants show more “pragmatic tolerance” than others (Katsos & Bishop 2011).

Figure 3 shows the mean values for all 48 participants and then for each group of 24 participants separately. We do see a stark contrast between these two groups with respect to the violation of pragmatic inferences. We can now verify our Hypothesis 2 according to which accusative case marking does not trigger an ‘exhaustivity implicature’. If exhaustivity were an implicature, we would predict that the group that does not like the violation of implicature in the 6 relevant test items would also judge a potential violation of the alleged ‘exhaustivity implicature’ triggered by accusative case marking in our partitive constructions as unacceptable, while the other group would not. Thus we would expect a clear contrast between these two groups.



**Figure 4:** Mean scores for accusative case marking and animacy of the explicit partitives for Group 1 and Group 2 on a scale from 1 (badly linked) to 7 (very well linked).

Figure 4 shows the mean scores of the six conditions for the two groups – always pairwise. We see a marginal tendency in the two right columns representing the mean acceptability for inanimate partitives. However, overall there is no difference in the judgments of the participants in the two groups. We interpret these findings as absence of evidence for an ‘exhaustivity implicature’ in our test items, thus confirming our Hypothesis 2.

## 4 General discussion and conclusion

This paper contributes original empirical data to the discussion of the semantic-pragmatic functions of case marking in Turkish noun phrases, by studying explicit partitive constructions in direct object position. Turkish does not have a definite article, but a direct object that does not have any indefinite marker can be interpreted as definite if it has overt accusative case, and it is interpreted as non-referential if it does not show case marking. A direct object with an indefinite marker, such as the indefinite article *bir* or the quantifier *bazı* ‘some’, is interpreted as specific if it has accusative case and as non-specific without case, see Section 2.2 above. In a series of papers (Kornfilt & von Heusinger 2009, von Heusinger & Kornfilt 2017, von Heusinger, Kornfilt & Kizilkaya 2019), we investigated the function of accusative case marking in different types of partitives. We were able to show that accusative case marking for proper partitives *kadın-lar-dan iki-sin-i* (woman-PL-ABL two-3.AGR-ACC ‘two of the women’) is obligatorily triggered by the “dummy” (i.e. default) agreement marker *(s)I(n)* and does not encode definiteness or specificity. Explicit partitives based on hyponymic relations between the subset noun (hyponym) and the superset noun (hyperonym), such as *hayvan-lar-dan beş fil* (animal-PL-ABL five elephant ‘five elephants from / of the animals’), show optional accusative case marking. We argued that accusative case marking in these cases encodes specificity (Kornfilt & von Heusinger 2009, von Heusinger & Kornfilt 2017).

In von Heusinger, Kornfilt & Kizilkaya (2019), we presented original data from a grammaticality judgment study that tested explicit partitives in different types of contexts that trigger specificity. We concluded from those results that accusative case marking does encode specificity. However, the data would also be consistent with an alternative claim that accusative case in explicit partitives encodes definiteness. This was also suggested to us by two anonymous reviewers of von Heusinger & Kornfilt (2017). Those reviewers suggested an exhaustive reading of case-marked nominals, i.e. a definite reading for accusative case-marked explicit partitives.

Therefore, we undertook the present study and tested whether the accusative marking of explicit partitives in direct object position is obligatorily interpreted as exhaustive. We designed a questionnaire with examples consisting of three sentences such that the third sentence would violate an exhaustive interpretation. We found that Turkish native speakers do not find these sentences and the resulting discourse unacceptable. This clearly shows that these sentences with accusative-marked explicit partitives allow for a non-exhaustive reading alongside an also acceptable exhaustive reading. From this we conclude that accusative case marking of explicit partitives does not encode definiteness. These

findings support our Hypothesis in the earlier experiment that accusative case marking of explicit partitives in direct object position encodes specificity, as it does for non-partitive noun phrase with the indefinite article (*bir kadın-ı* ‘a specific woman’).

These original results also support the more general assumption of von Stechow & Kornfilt (2005) that accusative case marking encodes specificity, rather than definiteness, and therefore contribute to the analysis of Turkish noun phrases in particular and, more generally, to the interaction of structural case marker, agreement marker (in its default value and pronominal clitic-like usage) and classifier in noun phrases in Turkic languages.

## References

- Aissen, Judith. 2003. Differential Object Marking: Iconicity vs. economy. *Natural Language and Linguistic Theory* 21(3). 435–483. <https://link.springer.com/article/10.1023/A:1024109008573>.
- Aydemir, Yasemin. 2004. Are Turkish preverbal bare nouns syntactic arguments? *Linguistic Inquiry* 35(3). 465–474.
- Baker, Mark & Nadezhda Vinokurova. 2021. Rethinking structural case: Partitive case in Sakha. In András Bányi, Theresa Biberauer, Jamie Douglas & Sten Vikner (eds.), *Syntactic architecture and its consequences III: Inside syntax*, 51–67. Berlin: Language Science Press. DOI: 10.5281/zenodo.4680264.
- Barker, Chris. 1998. Partitives, double genitives and anti-uniqueness. *Natural Language and Linguistic Theory* 16(4). 679–717. <http://www.jstor.org/stable/4047919>.
- Bates, Douglas, Martin Mächler, Ben Bolker & Steven Walker. 2015. Fitting linear mixed-effects models using lme4. *Journal of Statistical Software* 67(1). 1–48. <https://arxiv.org/abs/1406.5823>.
- Cardinaletti, Anna & Giuliana Giusti. 2006. The syntax of quantified phrases and quantitative clitics. In Martin Everaert & Henk van Riemsdijk (eds.), *The Blackwell companion to syntax*, vol. V, 23–93. Oxford: Blackwell.
- Chierchia, Gennaro. 1997. Partitives, reference to kinds and semantic variation. In Aaron Lawson (ed.), *Proceedings from Semantics and Linguistic Theory VII*, 73–98. Ithaca: Cornell University. <http://journals.linguisticsociety.org/proceedings/index.php/SALT/article/viewFile/2792/2532>.
- Dede, Müşerref. 1986. Definiteness and referentiality in Turkish verbal sentences. In Dan I. Slobin & Karl Zimmer (eds.), *Studies in Turkish linguistics*, 147–163. Amsterdam: Benjamins. <https://doi.org/10.1075/tsl.8.09ded>.
- Enç, Mürvet. 1991. The semantics of specificity. *Linguistic Inquiry* 22. 1–25. <http://www.jstor.org/stable/4178706>.
- Erguvanlı, Eser Emine & Karl Zimmer. 1994. Case marking in Turkish indefinite object constructions. In *Proceedings of the Twentieth Annual Meeting of the Berkeley Linguistics*

- Society*, 547–552. Berkeley, CA: Berkeley Linguistics Society. <http://www.journals.linguisticsociety.org/proceedings/index.php/BLS/article/viewFile/1442/1226>.
- Erguvanlı, Eser Emine. 1984. *The function of word order in Turkish grammar*. Berkeley: University of California Press.
- Falco, Michelangelo & Roberto Zamparelli. 2019. Partitives and partitivity. *Glossa: A Journal of General Linguistics* 4(1): 111. 1–49. <https://doi.org/10.5334/gjgl.642>.
- Farkas, Donka. 1994. Specificity and scope. In Lea Nash & Georges Tsoulas (eds.), *Actes du Premier Colloque Langues & Grammaire*, vol. 1, 119–137. Paris: Université Paris-8. <http://citeseerx.ist.psu.edu/viewdoc/summary?doi=10.1.1.22.9999>.
- Fodor, Janet & Ivan Sag. 1982. Referential and quantificational indefinites. *Linguistics & Philosophy* 5. 355–398. <https://link.springer.com/content/pdf/10.1007/BF00351459.pdf>.
- Giusti, Giuliana. 2021, this volume. Partitivity in Italian: A protocol approach to a multifaceted phenomenon. In Petra Sleeman & Giuliana Giusti (eds.), *Partitive determiners, partitive pronouns and partitive case*. (Linguistische Arbeiten 580). Berlin: de Gruyter.
- Giusti, Giuliana & Petra Sleeman. 2021, this volume. Partitive elements in the languages of Europe. An advancement in the understanding of a multifaceted phenomenon. In Petra Sleeman & Giuliana Giusti (eds.), *Partitive determiners, partitive pronouns and partitive case*. (Linguistische Arbeiten 580). Berlin: de Gruyter.
- Göksel, Aslı & Celia Kerlake. 2005. *Turkish: A comprehensive grammar*. London: Routledge.
- Heim, Irene. 1991. Artikel und Definitheit. In Arnim von Stechow & Dieter Wunderlich (eds.), *Semantik: Ein internationales Handbuch der zeitgenössischen Forschung*, 487–535. Berlin: de Gruyter. <https://doi.org/10.1515/9783110203363.487>.
- von Heusinger, Klaus. 2002. Specificity and definiteness in sentence and discourse structure. *Journal of Semantics* 19(3). 245–274. <https://doi.org/10.1093/jos/19.3.245>.
- von Heusinger, Klaus. 2019. Indefinites and specificity. In Barbara Abbott & Jeanette Gundel (eds.), *Oxford handbook of reference*, 146–167. Oxford: Oxford University Press. <https://doi.org/10.1093/oxfordhb/9780199687305.013.9>.
- von Heusinger, Klaus & Elif Bamyacı. 2017a. Specificity effects of Turkish Differential Object Marking. In Leyla Zidani-Eroğlu, Matthew Ciscel & Elena Koulidobrova (eds.), *Proceedings of the 12th Workshop on Altaic Formal Linguistics (WAF 12)*, 309–319. Cambridge, MA: MIT Press. <http://mitwpl.mit.edu/catalog/mwpl83/>.
- von Heusinger, Klaus & Elif Bamyacı. 2017b. Specificity effects of Turkish Differential Object Marking in monolingual and bilingual speakers. Paper presented at the *Workshop on (In) definiteness and (Non)specificity: Meaning and usage*, Berlin, June, 2017.
- von Heusinger, Klaus & Jaklin Kornfilt. 2005. The case of the direct object in Turkish: Semantics, syntax and morphology. *Turkic Languages* 9. 3–44. [http://www.digizeitschriften.de/dms/img/?PID=PPN666048797\\_0009%7CLOG\\_0014](http://www.digizeitschriften.de/dms/img/?PID=PPN666048797_0009%7CLOG_0014).
- von Heusinger, Klaus & Jaklin Kornfilt. 2017. Partitivity and case marking in Turkish and related languages. *Glossa: a journal of general linguistics* 2(1). 1–40. <http://doi.org/10.5334/gjgl.112>.
- von Heusinger, Klaus, Jaklin Kornfilt & Semra Kizilkaya. 2019. Differential Object Marking, partitivity and specificity in Turkish. In Tanya Bondarenko, Justin Colley, Colin Davis & Mitya Privoznov (eds.), *Proceedings of the 14th Workshop on Altaic Formal Linguistics (WAF 14)*, 145–156. Cambridge, MA: MIT Press.
- Hoeksema, Jacob. 1996. Introduction. In Jacob Hoeksema (ed.), *Partitives: Studies on the syntax and semantics of partitive and related constructions*, 1–24. Berlin: de Gruyter. <https://doi.org/10.1515/9783110908985.1>.

- de Hoop, Helen. 2003. Partitivity. In Lisa Cheng & Rint Sybesma (eds.), *The second Glot International state-of-the-article book. The latest in linguistics*, 179–212. Berlin: de Gruyter. <https://doi.org/10.1515/9783110890952.179>.
- Ihsane, Tabea (ed.). 2020. *Disentangling bare nouns and nominals introduced by a partitive article* (Syntax and Semantics 43). Leiden: Brill. <https://library.oapen.org/handle/20.500.12657/48299>.
- Ihsane, Tabea & Elisabeth Stark. 2020. Introduction: Shades of partitivity: Formal and areal properties. *Linguistics* 58(3). 605–619. <https://doi.org/10.1515/ling-2020-0078>.
- Ionin, Tania, Ora Matushansky & E.G. Ruys. 2006. Parts of speech: Toward a unified semantics for partitives. In Christopher Davis, Amy Rose Deal & Youri Zabbal (eds.), *Proceedings of NELS*, vol. 36, 357–370. Amherst, MA: University of Massachusetts, GLSA.
- Jackendoff, Ray. 1977. *X'-Syntax: A study of phrase structure*. Cambridge, MA: MIT Press.
- Johanson, Lars. 1977. Bestimmtheit und Mitteilungsperspektive im türkischen Satz. *Zeitschrift der Morgenländischen Gesellschaft* 3(2). 1186–1203.
- Kamp, Hans & Agnes Bende-Farkas. 2019. Epistemic specificity from a communication-theoretic perspective. *Journal of Semantics* 36(1). 1–51. <https://doi.org/10.1093/jos/ffy005>.
- Katsos, Napoleon & Dorothy V.M. Bishop. 2011. Pragmatic tolerance: Implications for the acquisition of informativeness and implicature. *Cognition* 120. 67–81.
- Koptjevskaja-Tamm, Maria. 2006. Partitives. In Keith Brown (ed.), *Encyclopedia of languages and linguistics. 2nd ed.*, 216–221. Amsterdam: Elsevier.
- Kornfilt, Jaklin. 1991. Some current issues in Turkish syntax. In Hendrik Boeschoten & Ludo Verhoeven (eds.), *Turkish linguistics today*, 60–92. Leiden: Brill.
- Kornfilt, Jaklin. 1996a. Naked partitive phrases in Turkish. In Jacob Hoeksema (ed.), *Partitives: Studies on the syntax and semantics of partitive and related constructions*, 107–142. Berlin: de Gruyter.
- Kornfilt, Jaklin. 1996b. Turkish and configurationality. In Bengisu Rona (ed.), *Current issues in Turkish linguistics*, vol. 1, 111–125. Ankara: Hitit Yayınevi.
- Kornfilt, Jaklin. 1997. *Turkish*. London: Routledge. <https://www.routledge.com/Turkish/Kornfilt/p/book/9780415587167>.
- Kornfilt, Jaklin. 2003a. Subject case in Turkish nominalized clauses. In Uwe Junghanns & Luka Szucsich (eds.), *Syntactic structures and morphological information*, 129–215. Berlin: de Gruyter.
- Kornfilt, Jaklin. 2003b. Scrambling, subscrambling, and case in Turkish. In Simin Karimi (ed.), *Word order and scrambling*, 125–155. Malden: Blackwell.
- Kornfilt, Jaklin. 2008. DOM and two types of DSM in Turkish. In Helen de Hoop & Peter de Swart (eds.), *Differential Subject Marking*, 79–111. Dordrecht: Springer.
- Kornfilt, Jaklin. 2009. Subject – Agreement correlations and their syntactic effects in some Turkic relative clauses. *Turkic Languages* 13(1). 70–96.
- Kornfilt, Jaklin. 2020. DOM and DSM in Turkish: Not only dependent case, but also dependent Agree. In András Bányi & Laura Kalin (eds.), *Case, agreement, and their interactions. New perspectives on Differential Argument Marking*, 127–174. Berlin: de Gruyter. <https://doi.org/10.1515/9783110666137-004>.
- Kornfilt, Jaklin & Klaus von Heusinger. 2009. Specificity and partitivity in some Altaic languages. In Ryosuke Shibagaki & Reiko Vermeulen (eds.), *Proceedings of the 5th Workshop on Formal Altaic Linguistics (WAFL 5)*, 19–40. Cambridge, MA: MIT Press.
- Krause, Elif & Klaus von Heusinger. 2019. Gradient effects of animacy on Differential Object Marking in Turkish. *Open Linguistics* 5(1). 171–190. <https://doi.org/10.1515/opli-2019-0011>.

- Luraghi, Silvia & Seppo Kittilä. 2014. Typology and diachrony of partitive case markers. In Silvia Luraghi & Tuomas Huomo (eds.), *Partitive cases and related categories*, 17–62. Berlin: de Gruyter. <https://doi.org/10.1515/9783110346060.17>.
- Massam, Diane. 2001. Pseudo noun incorporation in Niuean. *Natural Language and Linguistic Theory* 19(1). 153–197. <http://www.jstor.org/stable/4047915>.
- Nakipoğlu, Mine. 2009. The semantics of the Turkish accusative marked definites and the relation between prosodic structure and information structure. *Lingua* 119. 1253–1280. <https://doi.org/10.1016/j.lingua.2009.02.006>.
- Özge, Umut. 2011. Turkish indefinites and accusative marking. In Andrew Simpson (ed.), *Proceedings of the 7th Workshop on Altaic Formal Linguistics (WAFL 7)*, 253–267. Cambridge, MA: MIT Press.
- Öztürk, Balkız. 2005. *Case, referentiality and phrase structure*. Amsterdam: John Benjamins.
- Sağ, Yağmur. 2019. *The semantics of number marking: Reference to kinds, counting, and optional classifiers*. New Brunswick, NJ: Rutgers University dissertation. <https://doi.org/doi:10.7282/t3-7dny-mz84>.
- Sauerland, Uli & Kazuko Yatsushiro. 2017. Two nouns in partitives: Evidence from Japanese. *Glossa: A Journal of General Linguistics* 2(1). 1–29. <https://doi.org/10.5334/gjgl.171>.
- Seidel, Elyesa. 2019. Bare direct objects in Turkish: Pseudo-incorporated or weak arguments. In Tanya Bondarenko, Justin Colley, Colin Davis & Mitya Privoznov (eds.), *Proceedings of the 14th Workshop on Altaic Formal Linguistics (WAFL 14)*, 277–288. Cambridge, MA: MIT Press.
- Seržant, Ilja A. 2020. Typology of partitives. *Linguistics*. 1–67. <https://doi.org/10.1515/ling-2020-0251>.
- Seržant, Ilja A. 2021, this volume. Diachronic typology of partitives. In Petra Sleeman & Giuliana Giusti (eds.), *Partitive determiners, partitive pronouns and partitive case* (Linguistische Arbeiten 580). Berlin: de Gruyter.
- Sezer, Engin. 1972. Some observations on the role of genitive phrases in Turkish nominalizations. Unpublished ms., Harvard University.
- Stachowski, Marek & Astrid Menz. 1998. Yakut. In Lars Johanson & Eva Agnes Csató (eds.), *The Turkic Languages*, 417–433. London: Routledge. <https://doi.org/10.4324/9780203066102>.
- Zamparelli, Roberto. 1998. A theory of kinds, partitives, and *of/z* possessives. In Artemis Alexiadou & Chris Wilder (eds.), *Possessors, predicates and movement in the determiner phrase*, 259–301. Amsterdam: John Benjamins.

Tuomas Huumo

## Longitudinal or transverse?

How the unbounded quantity expressed by the Finnish partitive case relates to time

One important function of the Finnish partitive case is the expression of unbounded quantity. An unbounded quantity can consist of a homogeneous substance, expressed by a mass noun in the partitive singular, or of a multiplicity, expressed by the partitive plural. The opposite meaning with a bounded quantity is typically expressed by the nominative or the accusative. The main purpose of this paper is to give an account of how such quantities, bounded or unbounded, relate to time. I argue that there are two main options, referred to as **longitudinal** and **transverse quantity**. A longitudinal quantity is conceptualized as parallel to the time axis: it is distributed in time in such a way that its sub-quantities participate in the event consecutively, one after another, as in ‘**Water** was leaking from the pipe’ (mass) or ‘I was eating **apples**’ (multiplicity). In such expressions, the event is telic at the level of any conceivable sub-quantity. In other words, each sub-quantity (e.g., one apple) participates in one telic component event, in which it is fully affected. These consecutive component events then constitute a higher-order event, which can be telic or atelic depending on whether the longitudinal quantity is bounded (as in ‘I ate the apples’) or unbounded (as in ‘I ate apples’). A transverse quantity, in contrast, is conceptualized as perpendicular to the time axis: all its sub-quantities participate in the event simultaneously. The event can be punctual (as in ‘I found **mushrooms** under the tree’) or durative (‘I was carrying **mushrooms** in my basket’). In this paper, I demonstrate how longitudinal and transverse quantities are expressed by Finnish S and O arguments in the partitive vs. nominative/accusative, and how they contribute to the aspectual meaning of the clause.

### 1 The Finnish partitive as an indicator of unboundedness

The Finnish partitive case is known for the complexity of the rules that govern its uses (for accounts in English, see e.g. Heinämäki 1984, 1994, Kiparsky 1998, Huumo 2003, 2005, 2010, 2013, 2018, 2020, forthcoming and the literature cited in these works). The partitive is ostensibly a grammatical case that marks O



arguments in transitive clauses (1), S arguments in existential clauses (2), and predicate adjectives (PA) in copular clauses (3).

- (1) Lue-n                    kirja-a. (O)  
 read-PRES.1SG    book-PAR<sup>1</sup>  
 ‘I am reading a/the book.’
- (2) Pöydä-llä            on                    kirjo-j-a. (S)  
 table-ADE            be.PRES.3SG    book-PL-PAR  
 ‘There are books on the table.’
- (3) Kahvi                on                    musta-a. (PA)  
 coffee.NOM            be.PRES.3SG    black-PAR  
 ‘(The) coffee is black.’

The problem is that the partitive is never the exclusive marker of all nominals (NPs) in a particular grammatical function. In each of the functions illustrated above, it alternates with other cases: the accusative<sup>2</sup> (examples 1 vs. 4) and the nominative (examples 2 vs. 5 and 3 vs. 6). Furthermore, negation triggers the partitive in all O (7) and existential S (8) arguments.

- (4) Lue-n                kirja-n.  
 read-PRES.3SG    book-ACC  
 ‘I will read a/the book (completely).’
- (5) Pöydä-llä            on                    kirja.  
 table-ADE            be.PRES.3SG    book.NOM  
 ‘There is a book on the table.’

---

**1** The following glosses are used: ACC = accusative, ADE = adessive, ALL = allative, CNG = con-negative form, ELA = elative, GEN = genitive, ILL = illative, INE = inessive, NOM = nominative par = partitive, (number+)PL = (person+)plural, (number+)PLPX = (person+) plural possessive suffix, PRES = present tense, PTCP= participle, PST = past tense, REL = relative pronoun, (number+)SG = (person+) singular.

**2** Unlike Hakulinen et al. (2004) in their grammar, I use the traditional term *accusative* for the ending *-n* that marks some object nominals in the singular and outwardly resembles (but is historically distinct from; see e.g. Anttila 1989: 103) the genitive, which likewise has the ending *-n* in the singular. In the plural, the nominative is used to express accusative-like meanings (bounded quantity + culmination).



The object-marking partitive can likewise express quantification, but it additionally has an aspectual function whereby it indicates lack of culmination of the event (see also Seržant 2021, this volume). This means that the case marking does not indicate quantity oppositions as systematically in O arguments as in S arguments: non-culminating aspect triggers the partitive O irrespective of whether the quantity is bounded or unbounded. The non-culminating aspectual types that trigger the partitive include both lexical and viewpoint aspects (see e.g. Heinämäki 1994; Kiparsky 1998; Huumo 2010). For instance, the partitive O in example (1) indicates progressive viewpoint aspect, while the accusative O in (4) signals that the event is telic and reaches its culmination. Since the verb in (4) is in the present tense, this results in a future reading with regard to the culmination.

Example (3) illustrates the use of the partitive in the marking of predicate adjectives (PA) in copular clauses. The PA in (3) is in the partitive because the subject nominal of the copular construction, itself in the nominative, designates a substance ('coffee'). In example (6) the PA is in the nominative, because the subject nominal now designates a discrete entity ('chair'). In the marking of predicate adjectives, the partitive thus reflects a mass conceptualization of the subject referent (see also Huumo 2009, forthcoming). Note that this function is different from the quantificational one, since in the marking of predicate adjectives the question is not one of quantity as such. The nominative S in (3) is quantitatively bounded and gives an exhaustive reference either to the maximal extension of coffee, in which case the reference is generic ('Coffee is black'), or to a contextually relevant extension of coffee ('The coffee [in my cup] is black'). The relevant matter that triggers the partitive PA is that 'coffee' is a mass noun and designates a homogeneous substance.

Figure 1 illustrates the different types of quantity that play a role in the examples above: a discrete object (e.g., 'a book'), a bounded mass ('the coffee [in my cup]'), a bounded multiplicity ('the books [in my bag]'), an unbounded mass ('[sm] coffee'), and an unbounded multiplicity ('[sm] books'). In cases where quantification is the only factor regulating case marking, the default case for types (i)–(iii) is the nominative (or the singular accusative for type (i) in O marking); for types (iv)–(v), it is the partitive.

In this article, the focus will be on the quantificational functions of the partitive marking S and O arguments, and on its quantity-based opposition to the accusative and the nominative. The clearest case in point is the case alternation in the S arguments of affirmative existential clauses, since in such clauses quantity is the sole factor regulating choice of case. Quantity, however, also plays a role in object marking: when potential aspectual factors (the lack of

culmination expressed by the partitive) are eliminated, the case marking of O in affirmative clauses indicates quantification in the same way as in existential S arguments. This is illustrated by examples (9) and (10), which both include the achievement verb ‘find’. The events they designate thus culminate instantly, and aspect is not a factor motivating the partitive case, which expresses quantity only (10).

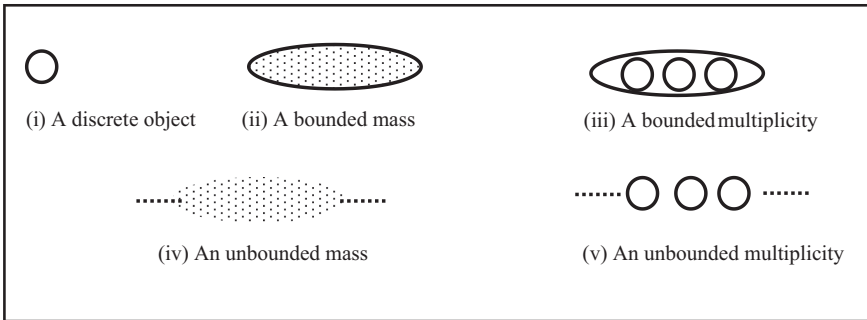

**Figure 1:** Different kinds of quantity relevant to this study.

- (9) Löys-i-n                      avaim-e-t.  
 find-PST-1SG                key-NOM.PL  
 ‘I found the keys’; ‘I found [a bunch of] keys.’
- (10) Löys-i-n                      avaim-i-a.  
 find-PST-1SG                key-PL-PAR  
 ‘I found (sm) keys.’

The plural nominative O in (9) refers to a bounded quantity of keys, while the partitive O in (10) refers to an unbounded quantity. Because of the achievement verb ‘find’, the partitive O in (10) cannot have an aspectual motivation (as it does in example 1).

In addition to the quantity opposition, the case marking of the O in (9) and (10) has corollaries in the expression of definiteness. In Finnish, which lacks explicit grammatical markers for definiteness, partitive-marked nominals that designate an unbounded quantity are practically always indefinite (Vilkuna 1992: 52–55; Huumo forthcoming; for a detailed Finnish–English contrastive analysis, see Chesterman 1991). Correspondingly, a plural nominative O, as in example (9), is typically definite (‘the keys’). However, the O in (9) can be alternatively conceived of as indefinite if it refers to a set, such as a bunch of keys conceptualized as a discrete entity. In this respect, plural nominative objects that refer to sets

resemble nominals in the singular accusative that refer to single discrete entities and are vague with respect to definiteness (11).

- (11) Löys-i-n            avaim-e-n.  
 find-PST-1SG    key-SG.ACC  
 ‘I found a/the key.’

In expressions of non-punctual but telic events (accomplishments), the aspectual and quantificational functions of the case marking intertwine, and ambiguities often arise as to whether the partitive expresses quantity, aspect, or both. Consider (12).

- (12) Lu-i-n            kirjo-j-a.  
 read-PST-1SG    book-PL-PAR  
 a) ‘I read (sm) books.’  
 b) ‘I was reading books.’  
 c) ‘I was reading the books.’

In reading a), the partitive expresses quantity only; the event is referred to in full from its beginning to its end, and concerns an unbounded quantity of books. The partitive O thus expresses quantity. The unbounded quantity, however, is not without its aspectual corollaries: it renders the higher-order event atelic, even though the component events (of reading one book at a time) are most likely<sup>4</sup> telic. In reading b), the quantity of the books (to be read) is likewise unbounded, but the partitive now has the main function of expressing a progressive viewpoint aspect: the speaker is reading (an unbounded quantity of) books, one after another. In reading c), the partitive is purely aspectual and expresses progressive viewpoint aspect, while the quantity of books read is bounded. However, it can again be pointed out that the aspectually motivated partitive in reading c) has quantificational implications as well. At the topic time (i.e., the time for which a claim is made, see Klein 1994: 3–9), the event is conceptualized as ongoing, and concerns only a sub-quantity of the books read or potentially available for reading. In cognitive linguistics, Lindner (1983, cited in Boers 1996: 145) uses the term *processed region* for the affected part of the object referent upon which the process has already acted. At any intermediate phase of the higher-order event

---

<sup>4</sup> In principle, it is also possible for the component events (of reading each book) to be atelic, if no book is read completely. In this reading, the partitive has a distributive aspectual reading and designates the non-culminating aspect of each component event individually.

that precedes its culmination, the processed region is quantitatively unbounded. The processed region will ultimately coincide with the overall, bounded quantity at the point when the event culminates and all relevant books have been read. In formal semantics, such meanings have been discussed in detail; see e.g. Dowty (1991), Krifka (1992), Tenny (1992), and the overview in Levin and Rappaport Hovav (2005: Ch 4.2).

It is thus somewhat of a simplification to say that the partitive expresses quantity alone in reading a), or aspect alone in reading c). This follows from the conceptualization in which the books are read one after another. The gradually increasing processed region interlaces with the aspectual nature of the event. In the terminology of Krifka (e.g., 1992), the O argument is **quantized** in reading c). It thus serves to “measure out” the telic higher-order event in the sense of Tenny (1992).

In atelic examples, such as (13) below, the partitive expresses aspect only: the verb designates a static situation that continues (in principle) indefinitely, and the object nominal designates a discrete entity that participates in that situation in its entirety (it is not an incremental theme).

- (13) Rakasta-n      tuo-ta      kirja-a.  
 love-PRES.1SG    that-PAR    book-PAR  
 ‘I love that book.’

The same is true of the plural partitive O in (14).

- (14) Rakasta-n      kirjo-j-a.  
 love-PRES.1SG    book-PL-PAR  
 ‘I love books’; ‘I love all those books.’

For aspectual reasons, the object nominal in example (14) can only be in the partitive case, irrespective of whether it is intended as generic, giving an exhaustive reference to the maximal extension of books (the generic ‘I love books’), or as a specific reference to a contextually relevant extension of some particular (bounded) quantity of books (‘I love all those books’). Metaphorically speaking, the aspectual case marking system “conceals” quantity in such expressions (see Huumo 2013), and without a specific context it is impossible to say whether the quantity is to be conceived of as bounded or unbounded.

Table 1 (from Huumo, forthcoming) sums up the main functions of the partitive case in each of its central grammatical functions (O, S and PA).

**Table 1:** Main functions of partitive in marking of core arguments.

Function	Partitive O	Partitive S <sub>e</sub>	Partitive PA
Non-culminating aspect	+	–	–
Nominal under negation	+	+	–
Unbounded quantity	+	+	–
Indefiniteness	(+)	(+)	–
Conceptualization as mass	(+)	(+)	+

Table 1 first lists the three main functions of the partitive object (aspect, negation and quantity), followed by two additional functions related to the quantificational one: the expression of indefiniteness and conceptualization as a mass, which are most relevant for the partitive PA. The plus symbol + means that the partitive can exclusively express the function in question, while the minus symbol – signals that the partitive does not have that function. A plus symbol in brackets (+) means that the partitive can express the meaning indirectly, in addition to its more fundamental function.

The column on the left in Table 1 lists the three main functions of the partitive O (aspect, negation, and quantification). In addition, the object-marking partitive that expresses quantification also implies indefiniteness and conceptualization of its referent as a mass; hence the (+) marks in brackets. The middle column sums up the functions of the partitive S: like the partitive O, it expresses negation and quantification but lacks the aspectual function. Again, indefiniteness and mass conceptualization are not directly expressed by the partitive S, but are implied when the partitive expresses unbounded quantity. The righthand column characterizes the use of the partitive in predicate adjectives, and shows that the function of the partitive PA is to express conceptualization (of the subject referent) as a mass.

Since the functions of the object-marking partitive are especially complex and intertwined, it may be helpful to illustrate their interplay in the form of Chart 1 (adapted from Vilkkuna 1996).

Chart 1 shows the hierarchical order of the three rules that govern the case marking of the O in Finnish. The strongest rule concerns the partitive of negation (e.g., example 7): all objects under grammatical or semantic negation are in the partitive, irrespective of aspect or quantification. The label ‘semantic’ means that formal clausal negation is not necessary for the use of the partitive of negation; it suffices if there are negative-polarity items, such as adverbs. The second-highest rule in the hierarchy concerns aspect (in affirmative clauses that have passed the first condition): if the aspect is non-culminating (as in examples 1, 13, and 14), the object is in the partitive irrespective of quantification. The third, hierarchically

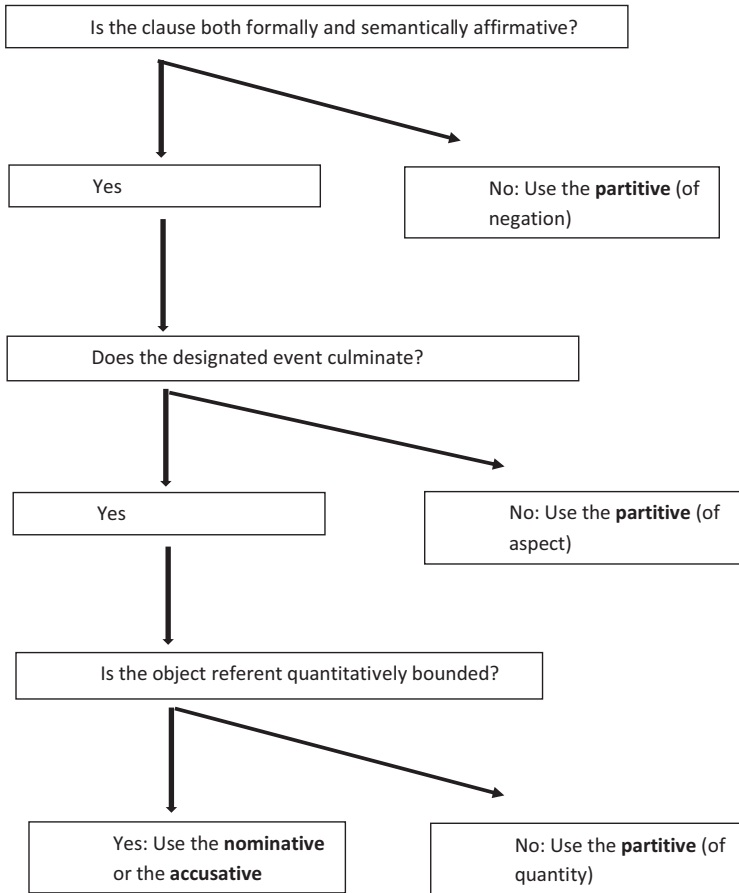

**Chart 1:** Hierarchy of rules mandating partitive object (modified version of Vilkkuna 1996: 119).

lowest rule concerns quantification in clauses that have passed the two higher conditions: if the object referent is quantitatively unbounded (as in example 10), the object is in the partitive.

If we apply this hierarchy to the three alternative readings of example (12), we see that readings (b) and (c) both rely on the aspectual condition and assign an aspectual reading to the partitive object. Under this reading, the example instantiates progressive aspect, which is a non-culminating aspect type. Since non-culminating aspect mandates that the object be in the partitive, the quantity of books remains unexpressed and may be bounded (reading c) or unbounded (reading b; see Huumo 2013 for a detailed account). Reading (a) arises only if the aspect-related condition has been passed. The quantity-based rule then selects the partitive of unbounded



quantity. In other words, the partitive O can explicitly express unbounded quantity only if the hierarchically higher aspectual function has been rejected. Alternatively, one might argue (following Larjavaara 2019) that the unbounded quantity of books in reading (a) of example (12) is in fact an aspectual one and renders the aspect non-culminating (atelic). Such an analysis attempts to reduce the quantificational function of the partitive O to its aspectual function. This argument, however, becomes problematic if applied to examples such as (10), in which the event is clearly punctual (and hence culminating) but concerns an unbounded number of keys.

In sum, the examples discussed in this section demonstrate that it is crucial to distinguish between different kinds of relationships possible between quantity (bounded or unbounded) and time. In the following sections, I explicate these relationships in more detail. In Section 2, I introduce the crucial distinction between **longitudinal** quantities, which can be figuratively characterized as *parallel to the time axis*, and **transverse** quantities, which are *perpendicular to the time axis* (for the relevance of these notions to an analysis of Finnish quantifiers, see Huumo, 2020). I also discuss the ways in which the Finnish partitive and its counterparts in case alternation express these types of quantities. In Section 3, I give a more detailed account of the subtypes of transverse quantities and their relationship to (in)definiteness and reference. Section 4 sums up the results of the study.

## 2 Longitudinal and transverse quantities

The above discussion has made it clear that there are two different ways in which a quantity (bounded or unbounded) can relate to time. As such, this is not a new observation: it has long been known that the extent (quantity) of the referent of a nominal contributes to the aspectual meaning of the clause in telic events where the quantity participates one sub-quantity after another (e.g., Krifka 1992; Rappaport Hovav and Levin 2002). In the present terminology, such quantities are called longitudinal. If a longitudinal quantity is bounded, the higher-order event is telic, as in the English example *John ate the apples (in an hour)* (see the Finnish example 15 below) or *John drank the water (in one minute)* (16). If a longitudinal quantity is unbounded, the higher-order event is atelic, as in *John ate apples (for an hour)* (17) or *John drank water (for one minute)* (18). The temporal *in* and *for* phrases serve as standard diagnostics for the (a)telicity of predications: an *in* phrase only combines with otherwise telic predications, while a *for* phrase combines with otherwise atelic predications (cf. Klein 1994; Carlier 2021, this volume; for the corresponding Finnish expressions, Heinämäki 1984, Kiparsky 1998, Huumo 2010, 2020).

- (15) John sö-i omena-t tunni-ssa.  
 NAME eat-PST.3SG apple-PL.NOM hour-INE  
 ‘John ate the apples in an hour.’
- (16) John jo-i vede-n minuuti-ssa.  
 NAME drink-PST.3SG water-ACC minute-INE  
 ‘John drank the water in one minute.’
- (17) John sö-i omeno-i-ta tunni-n.  
 NAME eat-PST.3SG apple-PL-PAR hour-ACC  
 ‘John ate apples for an hour.’
- (18) John jo-i vet-tä minuuti-n.  
 NAME drink-PST.3SG water-PAR minute-ACC  
 ‘John drank water for one minute.’

The nominative plural object in (15) and the accusative singular object in (16) express bounded longitudinal quantities, the first consisting of a multiplicity of entities and the latter of a homogeneous substance. The higher-order event in these examples is thus telic, as are the component events of eating one apple at a time, each one completely, in (15). Even in (16), one can argue that the event is telic for any conceivable sub-quantity of the water John drank, even though it is more difficult to distinguish discrete component events in the same way as in (15). The telicity of these examples is corroborated by the well-formedness of the inessive-case (‘in’) time-frame adverbials *tunnissa* ‘in an hour’ in (15) and *minuutissa* ‘in one minute’ in (16), which correspond to English *in* phrases and combine with telic predications.

In (17) and (18), the partitive object renders the longitudinal quantity unbounded, and the higher-order events are atelic (non-culminating). This is corroborated by the compatibility of such examples with the accusative-case temporal measure phrase *tunnin* ‘for an hour’, which, like English *for* phrases, is only felicitous with atelic predications. Example (17), with its plural object, also encompasses component events of eating one apple at a time, and such component events are most likely telic, although it is again in principle possible to have a distributive-atelic reading in which no apple is eaten completely (see fn. 4). Since the component events are telic, it is (marginally) possible to use the inessive-case time-frame adverbial in (17), with a distributive reading (as pointed out by Yli-Vakkuri 1973, 1979).

- (17') John sö-i omeno-i-ta minuuti-ssa.  
 NAME eat-PST.3SG apple-PL-PAR minute-INE  
 'John ate / was eating apples, one minute apiece.'

The expression of bounded and unbounded longitudinal quantities by S arguments is illustrated in examples (19) and (20), respectively.

- (19) Vieraa-t saapu-i-vat yksitellen.  
 guest-PL.NOM arrive-PST-3PL one.by.one  
 'The guests arrived one by one.'

- (20) Viera-i-ta saapu-i yksitellen.  
 guest-PL-PAR arrive-PST.3SG one.by.one  
 'There arrived guests, one by one.'

Example (19) is a non-existential intransitive clause that designates the successive arrivals of individual guests. The quantity expressed is longitudinal, and the arriving guests constitute a contextually relevant extension, to which the nominative S gives an exhaustive reference. The arrivals that follow each other in time are component events that constitute a higher-order collective and iterative event. Since the nominative S designates a bounded quantity, the quantity of component events is likewise bounded. Thus the aspect of the higher-order event is telic and culminates when all the guests have arrived. In (20), which despite its non-canonical (for existential clauses) SV word order is classified by Finnish grammarians as an existential clause,<sup>5</sup> the partitive S designates an unbounded number of guests. Hence the overall quantity of component events (the arrivals of individual guests) is likewise unbounded, and the higher-order event is atelic.

A common feature of all quantities expressed by the O or S arguments in (15)–(20) is that they participate in events one sub-quantity after another. Such quantities are thus longitudinal, and their magnitude can be characterized as parallel to the time axis (see also Huumo, 2020, for some quantifiers in Finnish). When the higher-order event unfolds, the sub-quantities of the longitudinal quantity participate in it one after another, and their overall quantity determines the duration of the

---

<sup>5</sup> The boundary between existential and non-existential (locative-intransitive) clauses is vague in Finnish. The main criteria are 1) canonical word order (SV in intransitives, VS in existential clauses), 2) person and number agreement between the S argument and the verb in intransitives (and their absence in existential clauses), and 3) the possibility of using the partitive S in existential clauses (the S of non-existential intransitives is always in the nominative). It is thus a matter of definition whether S-initial examples such as (20) are referred to as existential clauses or not.

higher-order event. If the longitudinal quantity consists of discrete entities, such as the apples in examples (15) and (17), it is typically possible to distinguish component events (e.g. eating one apple at a time) that follow each other in time. In (16) and (18), the homogeneous nature of the O ('water') makes it less natural to distinguish component events. Nevertheless, the event of 'drinking' is likewise telic for any conceivable sub-quantity of the water consumed, irrespective of whether the overall quantity of water is bounded or unbounded. The nature of the overall quantity determines whether the higher-order event is telic (16) or atelic (18). In any case, a bounded longitudinal quantity (as in 15 and 16) renders the higher-order event telic, while an unbounded longitudinal quantity (17 and 18) renders it atelic.

Alternatively, all sub-quantities of an overall quantity (bounded or unbounded) can participate in the event simultaneously. In that case, the boundedness type of the overall quantity does not contribute to the aspectual meaning of the clause. It is also more difficult to distinguish component events in which sub-quantities of the overall quantity might participate; rather, it is natural to assume that they all participate in a single event collectively. Such a quantity can be thought of as transverse to the time axis. Transverse quantities can occur in punctual events (consider the O arguments in 21 and 22), but also in durative telic (23) or atelic (24) events.

- (21) Löys-i-n            laatiko-sta        avaim-e-t.  
 find-PST-1SG        drawer-ELA        key-NOM.PL  
 'I found the keys in the drawer'; 'I found [a bunch of] keys in the drawer.'
- (22) Löys-i-n            laatiko-sta        avaim-i-a.  
 find-PST-1SG        drawer-ELA        key-PL-PAR  
 'I found (sm) keys in the drawer.'
- (23) Pan-i-n            avaim-e-t        laatikko-on.  
 put-PST-1SG        key-PL.NOM        drawer-ILL  
 'I put the keys in the drawer.'
- (24) Kanno-i-n        avaim-i-a        kukkaro-ssa-ni.  
 carry-PST-1SG        key-PL-PAR        purse-INE-1SG  
 'I carried (the) keys in my purse.'

Disregarding an iterative reading in which the keys are found one after another, the quantities designated by the O arguments in (21) and (22) are transverse: the person finds simultaneously all members that constitute a bounded (21) or unbounded (22) quantity of keys. It is more natural to argue that the whole quantity of keys participates in a single 'finding' event (which in aspectual terms is an

achievement) rather than to assume the existence of separate though simultaneous component events, each involving one key.

Example (23) is durative and telic, and the nominative O designates a bounded quantity of keys. In addition to the quantitative boundedness, the nominative object also indicates culminating aspect, i.e., that the keys actually become located in the drawer. The quantity is transverse, assuming that the AGENT takes all keys to the drawer simultaneously. However, a reading with a longitudinal quantity is also possible, assuming that the AGENT takes the keys to the drawer one by one. In the atelic example (24), the non-culminating aspect triggers the partitive irrespective of quantity. The example is vague as to whether the quantity of the keys is bounded ('the keys') or unbounded ('[sm] keys'). In any case, all the keys referred to participate in the event throughout. Since their participation is simultaneous, the aspectual nature of the event is independent of the quantity type.

The quantificational opposition is clearer in S arguments, which do not code aspectual features with case marking. Consider the S arguments in the punctual examples (25) and (26) and the durative-atelic (27) and (28).

(25) Äkkiä puu-sta putos-i omeno-i-ta.  
Suddenly tree-ELA fall-PST.3SG apple-PL-PAR  
'Suddenly, apples were falling from the tree.'

(26) Äkkiä omena-t putos-i-ivat puu-sta.  
Suddenly apple-PL.NOM fall-PST-3PL tree-ELA  
'Suddenly, the apples fell from the tree.'

(27) Pöydä-llä ol-i kirjo-j-a.  
table-ADE be-PST.3SG book-PL-PAR  
'There were books on the table.'

(28) Kirja-t ol-i-ivat pöydä-llä.  
book-PL.NOM be-PST.3PL table-ADE  
'The books were on the table.'

Because of the adverb *äkkiä* 'suddenly', an iterative reading (with different apples falling at different times) is unlikely in (25) and (26). Both examples indicate one instantaneous event in which all apples fall at once. The quantity of apples is unbounded in (25) and bounded in (26). In each case, the quantity is transverse.

Examples (27) and (28) are a typical contrasting pair with an existential clause (27) and its non-existential locative-intransitive counterpart (28). The partitive S in (27) signals that the quantity of books is unbounded, while the nominative S in

(28) signals a bounded quantity of books. Since both examples designate a state in aspectual terms, the quantities participate in the event throughout (i.e., all relevant books continue their presence on the table), and no sequential meaning arises. The quantity indicated is again of the transverse type. Consider Figure 2.

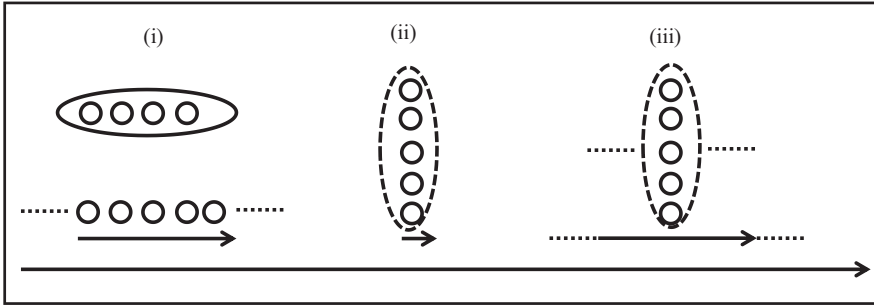

**Figure 2:** Relationship between quantity and time, illustrated with multiplicities:

- (i) Longitudinal quantity (bounded type above; unbounded type below).
- (ii) Transverse quantity (bounded or unbounded) in a punctual event.
- (iii) Transverse quantity (bounded or unbounded) in a durative event.

Figure 2 illustrates the opposition between longitudinal quantity and the two subtypes of transverse quantity discussed above. Part (i) of Figure 2 illustrates bounded (above) and unbounded (below) longitudinal quantities. The default expression for the former in both S and O marking is the nominative (the accusative for O arguments in the singular). For the latter, the partitive is the default option in both S and O marking. In the examples discussed thus far, the nominative O in (15), the accusative O in (16), and the nominative S in (19) illustrate bounded longitudinal quantities. The partitive O in (17) and (18), as well as the partitive S in (20) illustrate unbounded longitudinal quantities.

Part (ii) in Figure 2 illustrates transverse quantities (bounded or unbounded) in punctual events. In the examples above, the nominative O in (21) and the nominative S in (26) illustrate bounded transverse quantities in punctual events, while the partitive O in (22) and the partitive S in (25) illustrate such open quantities. Part (iii) in Figure 2 illustrates transverse quantities in non-culminating durative events. In such expressions, the case marking of S arguments still indicates the opposition between bounded (28) and unbounded (27) quantities. In O marking, by contrast, the aspectual rule triggers the partitive irrespective of quantity. Example (24) thus serves to illustrate both options, and is indeterminate with respect to quantity.

In the following section, we take a closer look at the subtypes of transverse quantity from the point of view of definiteness and reference.

### 3 Subtypes of transverse quantity

In the examples discussed thus far, the entities that constitute a transverse quantity (bounded or unbounded) have in each case maintained their identity throughout the event. In expressions of a longitudinal quantity, on the other hand, the reference necessarily changes during the overall event, since sub-quantities participate in it one after another. However, it is also possible for the reference of a transverse-quantity O or S argument to change in the course of the event, without changing the quantity to the longitudinal type. This concerns in particular expressions of unbounded quantities which in addition are indefinite. It concerns bounded quantities to a lesser extent (although there are some instances, to be discussed at the end of this section). The difference becomes clear if we add a temporal measure phrase to examples such as (27) and (28); consider (27') and (28').

(27') Pöydä-llä      ol-i      kirjo-j-a      koko      viiko-n.  
 table-ADE      be-PST.3SG      book-PL-PAR      whole      week-AC  
 'There were books on the table all week.'

(28') Kirja-t      ol-i-vat      pöydä-llä      koko      viiko-n.  
 book-PL.NOM      be-PST.3PL      table-ADE      whole      week-ACC  
 'The books were on the table all week.'

In (27') it is possible that some or even all of the individual books that are on the table at the beginning of the week are not there at the end of the week, as long as there are (some) books on the table at every point in time throughout the week (see Huumo 2003 for a detailed account). Figuratively speaking, the indefiniteness of the partitive S “repeats itself” over time and allows the reference of the nominal to change. By contrast, the nominative S in (28') keeps the same reference throughout the week: the books that are on the table at the beginning of the week are still there at the end of it. With the reading that allows a changing reference, (27') shares some features with a longitudinal quantity. Yet it belongs to the transverse type, since there are no telic component events with sub-quantities participating in them one after another, and the quantity expressed in (27') does not measure out the event in the sense of Tenny (1992). It is also possible to use (27') to describe a situation in which the books on the table remain the same; this is merely information not explicitly stated.

Again, the aspectual partitive of O arguments “conceals” such oppositions, which is why example (29) is ambiguous as to whether the same individual cows remain in the pasture throughout the summer (and whether the reference to the cows is definite or indefinite).

- (29) Maanviljelijä pit-i lehm-i-ä laitume-lla  
 farmer.NOM keep-PST.3SG cow-PL-PAR pasture-ADE  
 koko kesä-n  
 whole summer-ACC

- a) 'The farmer kept the cows in the pasture (for) the whole summer.'  
 b) 'The farmer kept cows in the pasture (for) the whole summer.'

In reading a), the transverse quantity of cows is of the bounded kind and the reference is definite: the same cows remain in the pasture throughout the summer (cf. the books on the table in 28'). In this reading, the partitive O expresses atelic aspect only, not quantitative unboundedness. In reading b), the object nominal gives a non-exhaustive reference ('[sm] cows') and allows the identity of the cows to change during the summer, as long as the pasture contains some cows (more than one) at every point of time during the summer.

What such examples show is that we need to distinguish between two subtypes of transverse quantity in atelic clauses: i) those that maintain the same reference throughout the event, and ii) those that allow their reference to change in the course of the event. As the above examples suggest, subtype (i) is typically quantitatively bounded and definite, while subtype ii) is unbounded and indefinite. The difference is illustrated in Figure 3.

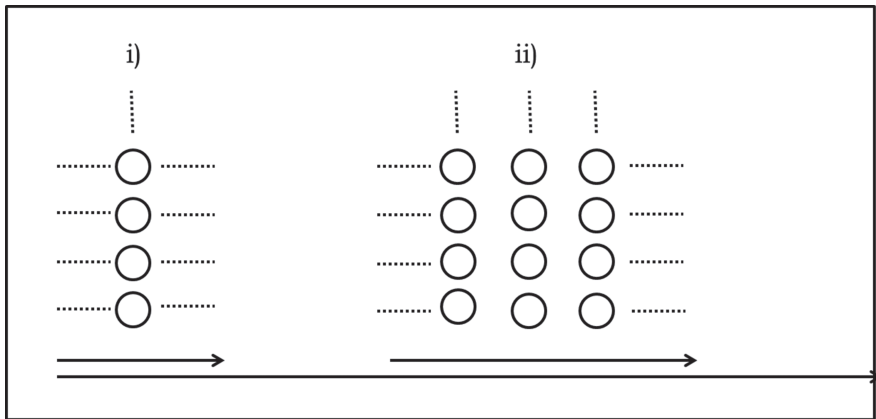

**Figure 3:** A transverse unbounded quantity that (i) maintains its reference over time; (ii) allows its reference to change over time. Illustrated with multiplicities.

Part (i) in Figure 3 illustrates a transverse quantity that maintains its reference over time: the same entities or sub-quantities continue to participate in the event. Their transverse quantity can be bounded, as in the nominative S in (28'), or



unbounded, as in (27') with its partitive S (in the reading whereby the books remain the same throughout the week). In O marking, the aspectual object marking rule again triggers the partitive irrespective of quantity. Example (29) thus serves to illustrate both options: the transverse quantity is bounded under reading (a) and unbounded under reading (b), on condition that the same individual cows remain in the pasture throughout the summer. Part (ii) of Figure 3 illustrates a transverse quantity with a changing reference, which is the alternative reading for the partitive S in (27') and the partitive O in (29).

A few Finnish transitive verbs do not obey the general aspectual object-marking rule. Kiparsky (1998:4) points out that these verbs also reject degree adverbs, with meanings such as 'some more', 'very much', 'considerably' and 'slightly'. According to Kiparsky, these verbs express **non-gradable predications**, which may be telic (such as 'find' or 'kill') or atelic (such as 'contain' or 'own'). When atelic, the exceptional aspectual nature of such verbs is clearly manifested in Finnish object marking. This class of verbs comprises for instance non-agentive verbs of perception, such as *nähdä* 'see' (with its stative meaning 'to have continuous visual contact with'; examples 30 and 31), as well as stative verbs such as *omistaa* 'own, possess' (32 and 33). These verbs present non-gradable predications in Kiparsky's sense: they reject degree adverbs and allow accusative/nominative objects in spite of their atelicity, where the aspectual partitive object would be the expected alternative (see also Huumo 2005 and the literature cited there). With respect to case marking, the objects of these verbs behave essentially like existential S arguments.

- (30) Nä-i-n            lehm-i-ä            laitume-lla  
 see-PST-1SG    cow-PL-PAR    pasture-ADE  
 koko    päivä-n  
 whole   day-ACC  
 'I [could] see cows in the pasture throughout the day.'
- (31) Nä-i-n            lehmä-t            laitume-lla  
 see-PST-1SG    cow-PL.NOM    pasture-ADE  
 koko    päivä-n  
 whole   day-ACC  
 'I [could] see the cows in the pasture throughout the day.'
- (32) Omist-i-n        lehm-i-ä        viisi            vuot-ta.  
 own-PST-1SG    cow-PL-PAR    five.NOM    year-SG.PAR<sup>6</sup>  
 'I owned cows for five years.'

- (33) Omist-i-n lehmä-t viisi vuot-ta.  
 own-PST-1SG cow-PL.NOM five.NOM year-SG.PAR  
 ‘I owned the cows for five years.’

In (30) and (32), the partitive object expresses unbounded quantity (and indefiniteness), not aspect. As in S arguments, the plural nominative in (31) and (33) is definite and expresses a bounded quantity of cows which consists of the same individuals over time. In (31) the speaker had seen the same cows in the pasture throughout the day, and in (33) s/he had owned the same cows for five years. In the partitive examples (30) and (32), the quantity of the cows is unbounded and the reference indefinite. This is why these examples allow the identity of the cows to change over the course of the designated period, as long as there are some cows in the pasture (in 30) or in the speaker’s possession (in 32) at every point of time. In sum, the quantity expressed in (30–33) is transverse in each case, but in (30) and (32) it is unbounded and allows its components to change over time, while in (31) and (33) it is bounded and its components remain the same through time.

In some cases, a transverse quantity with a potentially changing reference is bounded. This is possible if the plural nominative expressing a bounded quantity has indefinite reference, as in example (9) with the ‘bunch of keys’ reading. Consider the existential S argument in example (34) and the O argument in example (35).

- (34) Laatiko-ssa ol-i aina pelikorti-t.  
 drawer-INE be-PST.3SG always playing.card-PL.NOM  
 ‘There was always [a deck of] playing cards in the drawer.’
- (35) Laatikko on aina sisältä-nyt  
 drawer.NOM be.PRES.3SG always contain-PTCP  
 pelikorti-t.  
 playing.card-PL.NOM  
 ‘The drawer has always had [a deck of] playing cards in it.’

In (34), the existential S argument is in the nominative plural and refers to a bounded quantity, a deck of cards. The semantically close transitive clause (35) expresses a similar relationship, but now the nominative that means ‘[a deck of]

---

6 Note that Finnish numerals take the quantified nominal in the partitive singular. According to most Finnish grammars, the numeral, which is itself in the nominative, is analyzed as the head of the phrase and the partitive form as a post-modifier. Finnish numerals (with the exception of *yksi* ‘one’) do not have a distinct *-n* accusative form. Thus, in spite of its idiosyncratic morphosyntax, the phrase *viisi vuotta* ‘for five years’ is a temporal measure phrase.

playing cards' is the object. The verb *sisältää* 'contain' is non-gradable in the sense of Kiparsky (1998), and thus escapes the aspectual object-marking rule that would require a partitive object. The nominative plural expresses a similar kind of bounded quantity in (34) and (35). This bounded quantity is transverse: there is a full deck of cards in the drawer at every point of time during the atelic event. However, since the nominal 'playing cards' most naturally refers to a set (deck) of cards, it is understood as indefinite (like count nouns in the singular; e.g., 'the key' in example 11). As many of the examples discussed above have shown, indefinite nominals in stative, atelic predications commonly allow their reference to change during the event. It is thus possible that the deck of cards in the drawer is a different one at different times, as long as some deck of cards is in the drawer at every point of time during the event. What we have in such a case, accordingly, is a bounded transverse quantity with an (optionally) changing reference.

## 4 Conclusions

In the foregoing discussion, I have argued for the importance of distinguishing between two types of relationships a quantity can have with regard to time, longitudinal and transverse. I have also distinguished a number of subtypes for the latter. I have demonstrated that the distinction is relevant to the analysis of the quantificational and aspectual functions of the Finnish partitive, and potentially for nominals more generally.

While the Finnish aspectual object-marking system assigns the partitive case to objects in non-culminating predications, irrespective of the quantification they express (with the exception of the non-gradable verbs discussed in Section 3), the partitive vs. nominative case alternation in S arguments expresses quantification. We have seen that a longitudinal quantity expressed by an S argument contributes to clause-level aspect, as in examples (19), 'The guests arrived one by one' (bounded) and (20), 'There arrived guests one by one' (unbounded). Such examples designate iterative higher-order events consisting of culminating (telic) component events, with one individual referent participating in each. After their participation in a component event, these individuals do not continue their participation in the higher-order event (more concretely, each guest only arrives once). When a longitudinal quantity is bounded, the higher-order event becomes telic: it ceases when the complete quantity has participated in it (e.g., all the guests have arrived). If the longitudinal quantity is unbounded, the higher-order event is atelic: the number of guests, and hence of their arrivals (the component events), is indeterminate.

Longitudinal quantity can also be expressed in Finnish by the case marking of the object. Since the component events are all telic, the aspectual object-marking system does not trigger the aspectual partitive object. The case marking of the object then remains free to express quantity: whether it is bounded (NOM/ACC), as in ‘John ate the apples’ (cf. Finnish example 15), or unbounded (PAR), as in ‘John ate apples’ (17).

A transverse quantity does not contribute to clause-level aspect, since it does not “measure out” the event. Transverse quantities can be further divided into two main subtypes: a) that which maintains its reference throughout the (telic or atelic) event, b) that which allows its reference to change during the (atelic) event. In the marking of Finnish S arguments, the nominative S (which is definite in most cases) favors the reading with an unchanging reference, as in ‘The books were on the table for the whole week’ (example 28’). The partitive (which has an indefinite reading) allows its reference to change during the event, as in ‘There were books on the table for the whole week’ (example 27’; see also Huumo 2003).

It needs to be emphasized that a transverse quantity with a changing reference is not the same as a longitudinal quantity. With a transverse quantity, the changing reference is merely an optional reading that follows from the indefiniteness of the nominal. There are no culminating component events, with a sub-quantity of the overall quantity participating in each. A transverse quantity with a changing reference lacks the “cumulative” sense typical of longitudinal quantities, and does not serve the function of measuring out the higher-order event.

## References

- Anttila, Raimo. 1989. *Historical and comparative linguistics*. 2nd revised edn (Current Issues in Linguistic Theory 16). Amsterdam: John Benjamins.
- Boers, Frank. 1996. *Spatial prepositions and metaphor: A cognitive semantic journey along the up-down and the front-back dimensions*. Tübingen: Günter Narr Verlag.
- Carlier, Anne. 2021, this volume. *Du/des*-NPs in French: a comparison with bare nouns in English and Spanish. In Petra Sleeman & Giusti, Giuliana (eds.), *Partitive seteterminers, partitive pronouns and partitive case*. (Linguistische Arbeiten 580). Berlin: de Gruyter.
- Chesterman, Andrew. *On definiteness. A study with special reference to English and Finnish* (Cambridge Studies in Linguistics 56). Cambridge: Cambridge University Press.
- Dowty, David. 1991. Thematic proto-roles and argument selection. *Language* 67. 547–619.
- Giusti, Giuliana & Petra Sleeman. 2021, this volume. Partitive elements in the languages of Europe: An advancement in the understanding of a multifaceted phenomenon. In Petra Sleeman & Giuliana Giusti (eds.), *Partitive determiners, partitive pronouns and partitive case* (Linguistische Arbeiten 580). Berlin: de Gruyter.
- Hakulinen, Auli, Maria Vilkuna, Riitta Korhonen, Vesa Koivisto, Tarja Riitta Heinonen & Irja Alho. 2004. *Iso suomen kielioppi*. Helsinki: Finnish Literature Society.

- Heinämäki, Orvokki. 1984. Aspect in Finnish. In Kasper de Groot & Hannu Tømmola (eds.), *Aspect bound: A voyage into the realm of Germanic, Slavonic and Finno-Ugrian aspectology*, 153–177. Dordrecht: Foris.
- Heinämäki, Orvokki. 1994. Aspect as boundedness in Finnish. In Carl Bache, Hans Basböll & Carl-Erik Lindberg (eds.), *Tense, aspect, and action: Empirical and theoretical contributions to language typology*. (Empirical Approaches to Language Typology 12.) Berlin: Mouton de Gruyter.
- Heusinger, Klaus von & Jaklin Kornfilt. 2021, this volume. Turkish partitive constructions and (non-)exhaustivity. In Petra Sleeman Giuliana Giusti (eds.), *Partitive determiners, partitive pronouns and partitive case* (Linguistische Arbeiten 580). Berlin: de Gruyter.
- Huomo, Tuomas. 2003. Incremental existence: The world according to the Finnish existential sentence. *Linguistics* 41(3). 461–493.
- Huomo, Tuomas. 2005. How fictive dynamicity motivates aspect marking: The riddle of the Finnish quasi-resultative construction. *Cognitive Linguistics* 16(1). 113–144.
- Huomo, Tuomas. 2009. Fictive dynamicity, nominal aspect, and the Finnish copulative construction. *Cognitive Linguistics* 20(1). 43–70.
- Huomo, Tuomas. 2010. Nominal aspect, quantity, and time: The case of the Finnish object. *Journal of Linguistics* 46(1). 83–125.
- Huomo, Tuomas. 2013. On the many faces of incompleteness: Coercion phenomena and the Finnish partitive object. *Folia linguistica* 47(1). 1–23.
- Huomo, Tuomas. 2018. The partitive A: On uses of the partitive case in the marking of A arguments in Finnish. In Ilja A. Seržant & Alena Witzlack-Makarevich (eds.), *The diachronic typology of differential argument marking*. 423–453. Berlin: Language Science Press.
- Huomo, Tuomas. 2020. Layers of (un)boundedness: The aspectual–quantificational interplay of quantifiers and partitive case in Finnish object arguments. In Tabea Ihsane & Elisabeth Stark (eds.), *Shades of partitivity: Formal and areal properties*. *Linguistics* 58(3). 905–936.
- Huomo, Tuomas. Forthcoming. Toward a Cognitive Grammar account of the Finnish partitive case. To appear in Tiina Onikki-Rantajääskö & Minna Jaakola (eds.), *Cognitive linguistic perspectives on the Finnish case system*. Helsinki: Suomalaisen Kirjallisuuden Seura.
- Karttunen, Lauri. 1975. On the syntax of the word *paljon* in Finnish. In Valmen Hallap (ed.), *Congressus tertius internationalis fenno-ugristarum, I: Acta linguistica*, 227–235. Tallinn: Valgus.
- Kiparsky, Paul. 1998. Partitive case and aspect. In Miriam Butt & Wilhelm Geuder (eds.), *Projecting from the lexicon*. Stanford: CSLI Publications.
- Klein, Wolfgang. 1994. *Time in language*. London: Routledge.
- Krifka, Manfred. 1992. Thematic relations as links between nominal reference and temporal constitution. In Ivan Sag & Anna Szabolsci (eds.), *Lexical matters*, 29–53. Stanford: CSLI Publications.
- Langacker, Ronald W. 2008. *Cognitive Grammar: A basic introduction*. Oxford: Oxford University Press.
- Langacker, Ronald W. 2016. *Nominal structure in Cognitive Grammar. The Lublin lectures*. Edited by Adam Głaz, Hubert Kowalewski & Przemysław Łozowski. Lublin: Marie Curie-Skłodowska University Press.
- Larjavaara, Matti 2019. *Partitiivin valinta*. Helsinki: Suomalaisen Kirjallisuuden Seura.
- Levin, Beth & Malka Rappaport Hovav. 2005. *Argument realization*. Cambridge: Cambridge University Press.

- Lindner, Susan. 1981. *A lexico-semantic analysis of verb-particle constructions with up and out*. San Diego, CA: UCSD dissertation.
- Rappaport Hovav, Malka & Beth Levin. 2002. Change of state verbs: Implications for theories of argument projection. *BLS* 28. Berkeley: Berkeley Linguistic Society. Available at: <https://journals.linguisticsociety.org/proceedings/index.php/BLS/article/view/3842/3543>
- Seržant, Ilja A. 2021, this volume. Diachronic typology of partitives. In Petra Sleeman & Giuliana Giusti (eds.), *Partitive determiners, partitive pronouns and partitive case*. (Linguistische Arbeiten 580). Berlin: de Gruyter.
- Tenny, Carol L. 1992. The aspectual interface hypothesis. In Ivan Sag & Anna Szabolcsi (eds.), *Lexical matters*, 1–27. Stanford: CSLI Publications.
- Tuomikoski, Risto 1978. Objektinsijaisista määrän adverbiaaleista. *Virittäjä* 82. 26–51.
- Schlachter, Wolfgang 1958. Partitiv und Inkongruenz beim Subjekt des Finnischen. *Finnisch-Ugrische Forschungen* 33. 3–95.
- Vilkuna, Maria. 1989. *Free word order in Finnish: Its syntax and discourse functions*. Helsinki: Suomalaisen Kirjallisuuden Seura.
- Vilkuna, Maria. 1992. *Referenssi ja määräisyys suomenkielisten tekstien tulkinnassa*. Helsinki: Finnish Literature Society.
- Vilkuna, Maria. 1996. *Suomen lauseopin perusteet*. Helsinki: Edita.
- Yli-Vakkuri, Valma 1973. *Suomen kielen peruslauseen komplektisista konstruktioista: Suomen kielen objektikonstruktioista*. University of Tampere: Licentiate's thesis.
- Yli-Vakkuri, Valma 1979. Partitiivisubjektin toiset juuret: eräs kvantiteetin ilmaisujärjestelmän ilmentymä. In Kallio, Jussi & Kaisa Häkkinen & Leena Kytömäki (eds.), *Sanomia. Juhlakirja Eeva Kangasmaa-Minnin 60-vuotispäiväksi 14. 4.1979* (Turun yliopiston suomalaisen ja yleisen kielitieteen laitoksen julkaisu 9). 155–192. Turku: University of Turku.



Urtzi Etxeberria

# The partitive marker in Basque, and its relation to bare nouns and the definite article

This paper aims at making a thorough description of the use of bare nouns, the definite determiner as well as the partitive marker in Basque and its varieties. Concerning the definite article, and assuming that Souletin (the most eastern dialect of Basque) is a previous stage compared to Standard Basque (cf. Michelena 1964, Camino 2017; cf. also Manterola 2012, 2015), the main aim of this paper is to explain how Basque historically moves from a situation where bare nouns are allowed (in some restricted argument position) to a situation where bare nouns are not allowed in argument position. The paper argues that the reason we move from system A to system B is basically due to a semantic weakening and loss of the Souletin null D. In addition, this paper describes the use of the Basque partitive determiner [-*(r)ik*] (cf. de Rijk 1972, 1996, Etxepare 2003, Etxeberria 2014), its relation with the use of the definite determiner and its evolution from the partitive case marker. Finally, the paper argues that the partitive determiner creates a complex Polarity determiner with a null polarity D.

---

**Note:** The research conducting to this paper has benefited from the Netherlands Organisation for Scientific Committee project *Partitivity in European Languages (PARTE)*, the ANR project BIM ANR-17-CE27-11, the Franco-German ANR-DFG project UV2 ANR-18-FRAL-0006, as well as the Spanish MINECO projects INTERCAT FFI2017-82547-P and PGC2018-096380-B-100. I'm very grateful to Giuliana Giusti and Petra Sleeman for inviting me to write this paper, and above all, for their patience throughout the whole process. Thanks also to the audience of the *PARTE Workshop* in Venice and to the reviewers for this volume for the extensive and helpful comments. Thanks also to Klaus von Heusinger for the careful reading of the paper and for the interesting comments. Finally, thanks also to Ricardo Etxepare, Anastasia Giannakidou, Aritz Irurtzun, and Maia Duguine for helpful comments. Usual disclaimers apply.

Abbreviations used in the glosses: AUX = auxiliary; AUX.SG = singular auxiliary; AUX.PL = plural auxiliary; ABS = absolutive; ALL = allative; DAT = dative; ERG = ergative; GEN = genitive, IN = inessive; INS = instrumental; PART = partitive; SUP = superlative; D.SG = singular definite determiner; D.PL = plural definite determiner; PROG = progressive.



# 1 Introduction

In this paper, I aim to make a description of the use of bare nouns (henceforth BNs), the definite determiner (D), and the partitive determiner in Basque, and to show how these three nominal elements, their use, and their meaning are interconnected and related to each other.

Throughout the paper, I will be making a division, mainly when I talk about the definite determiner, between Souletin, which is the most eastern dialect of Basque, spoken in the area of Zuberoa (a dialect which is considered to be an older version of Basque; cf. Michelena 1964, Camino 2017),<sup>1</sup> and the rest of the Basque dialects plus Standard Basque. Thus, when I use the term Standard Basque in this paper, I will be making reference to Standard Basque plus the rest of the Basque varieties, except for Souletin. Obviously, by this I do not mean to say that the behaviour of the varieties that I call Standard Basque is parallel in all respects, but when it comes to the use of nominals in argument position, their behaviour appears to be similar (cf. Manterola 2008, 2015).

The paper is organized as follows: in Section 2 I present, (i) the way in which the definite determiner behaves in Standard Basque, where nominals in argument position cannot appear bare, (ii) the behavior of nominals in Souletin, where nominals can appear bare and be arguments but only in direct object position. In line with Etxeberria (2014), I argue that BNs in Souletin project a full DP with an empty D position occupied by a phonetically null D (cf. i.a. Contreras 1986, Longobardi 1994, 2001, Munn & Schmitt 2005, Cyrino & Espinal 2014), which provides an indefinite interpretation with narrow scope and is unspecified for number. Then, it is argued that bare nominal expressions in Souletin, and in Basque in general, are unspecified for number or number neutral and their semantic type  $\langle e, t \rangle$ , i.e. a predicate denoting set. Finally, I argue that the reason why Standard Basque begins to use the definite article [-a(k)] to express an existential interpretation with narrow scope is due to a semantic weakening of the Souletin null D and an eventual loss. This loss forces the overt definite article of Standard Basque – a semantically flexible element (Etxeberria 2005, *et seq.*) – to be used in some positions usually reserved for indefinites. In Section 3, I concentrate on the Basque partitive [- (r)ik] where I first show both its histori-

---

<sup>1</sup> The Basque determiner article historically derived from the distal demonstrative (cf. Azkue 1905, Mitxelena 1979, Irigoien 1981, Azkarate & Altuna 2001, Etxeberria 2005, Manterola 2012, 2015). Due to space considerations, I will not be addressing the idea that Souletin Basque is an older version of Standard Basque; cf. Michelena (1964), Camino (2017), a.o. for extensive discussion on this. The reader is referred to Manterola (2012, 2015), for a historical developmental presentation of the Basque D.

cal as well as its current uses, from its origin as an ablative, its use as a marker of the range of superlatives or of quantifiers, and a partitive determiner. This is, actually, in line with de Rijk (1972), the evolution that we assume in this paper as correct. Then, it is shown that the partitive determiner, the element on which this article concentrates in, is a super weak Polarity Item (PI) and sensitive to the semantic notion of non-veridicality. Its interpretation in negative contexts is the equivalent of the existential interpretation of the Basque definite article. Finally, taking into account the historical evolution of the partitive, we propose a full DP with a null PI. Section 4 concludes the paper.

## 2 Nominals in Standard Basque and Souletin

### 2.1 Nominals and the definite article in Standard Basque

The Basque D is a bound morpheme that takes the phonetic forms [-a] (when singular) and [-ak] (when plural).<sup>2</sup>

- (1) a. mutil-a  
       boy-D.SG  
       ‘the boy’  
       b. mutil-ak  
       boy-D.PL  
       ‘the boys’

The article appears in the final position of the nominal phrase, attached to the noun as in the example in (1) or attached to an adjective (*liburu urdin-a* ‘lit.: book

---

<sup>2</sup> Some authors argue that the plural form of the Basque D [-ak] is a single element (cf. Goenaga 1980, 1991, Euskaltzaindia 1993, Artiagoitia 1997, 1998, 2002, 2004, 2012, Rodríguez 2003, Trask 2003). Based on Etxeberria (2005, 2010, 2014), I assume that singular and plural markers and the D are base-generated in different syntactic position, although I will not be providing arguments for it, the reader is referred to Etxeberria (2005, 2010, 2014); see also Eguren (2006). However, for ease of exposition, I will refer to [-a] and [-ak] as the singular and the plural Ds respectively.

Apart from the Basque definite article, the Basque article system also possesses an indefinite article: *bat* ‘one’, which is identical to the numeral *bat* ‘one’ and probably originated from it (the two can be differentiated through accentuation; when we focus *bat* the interpretation we get is that of the numeral). *Batzuk* ‘some.pl’ is the plural form of the indefinite *bat* ‘one’, to which we add the plural marker *-zuk*. The reader is referred to Etxeberria (2008, 2012, 2014) for extensive discussion on the article system. See also Trask (2003).

blue-D; *liburu urdin txiki-a* ‘lit.: book blue small-D’; *liburu urdin txiki polit-a* ‘lit.: book blue small nice-D’). These two properties of the Basque D apply to all dialects. Now, there are some other properties of the use of D in argumental nominal expressions that show dialectal variation.

Initially, we will concentrate on the use of the D in Standard Basque, and then we will move on to Souletin data. As we mentioned in the introduction, it has been assumed (cf. Laka 1993, Artiagoitia 1997, 1998, 2002, 2006, 2012, Etxeberria 2005, 2006, 2010, 2012a, among many others) that BNs cannot be used in argument position in Standard Basque and that the use of the definite article is necessary if sentences are going to be grammatical (the presence of the indefinite article or a weak quantifier also makes the sentence grammatical; due to lack of space we do not provide examples here; cf. Etxeberria 2005, 2008, 2012). This is actually one of the most characteristic properties of the Basque definite article [-a(k)] in Standard Basque.<sup>3</sup>

(2) Subject position:

- a. Lagun\*(-a)      berandu    etorri    zen.  
 friend-D.SG.ABS   late            come    AUX.SG  
 ‘The friend came late’
- b. Lagun\*(-ak)      berandu    etorri    ziren.  
 lagun-D.PL.ABS   late            come    AUX.PL  
 ‘The friends came late’

(3) Direct object position:

- a. Amaia-k      liburu\*(-a)      erosi    zuen.  
 Amaia.ERG   book-D.SG.ABS   buy    AUX.SG  
 ‘Amaia bought the book’
- b. Amaia-k      liburu\*(-ak)      erosi    zituen.  
 Amaia.ERG   book-D.PL.ABS   buy    AUX.PL  
 ‘Amaia bought (the) books’

---

<sup>3</sup> Basque verbal inflection agrees with the arguments that bear ergative, absolutive and dative case. Thus, the finite verbal form shows different agreement markers for each of the participants of the event expressed by the verb. The auxiliary also agrees with the number (singular or plural) of the participants, see e.g. (2) and (3).

In sentences with transitive verbs, the subject is morphologically marked as ergative and the direct object in the absolutive case (zero suffix). As for one argument-verbs, Basque expresses morphologically a distinction between unaccusative and unergative predicates (Perlmutter 1978; Burzio 1981). Subjects of unergative predicates take the ergative case; subjects of unaccusative predicates, on the other hand, take the absolutive case.

The presence of the definite determiner is also necessary to express the kind reading, as in many other European languages, e.g. Romance languages, or Greek (cf. Kleiber 1990, Krifka et al 1995, Chierchia 1998b, Zamparelli 1998, Fara 2001, Dayal 2004, Borik & Espinal 2015, Lazaridou et al 2016, et seq., among many others; see also Carlier 2021, this volume, Giusti 2021, this volume).

- (4) a. Dinosauru\*(-ak) aspaldi desagertu ziren.  
 dinosaur-D.PL.ABS long time ago disappear AUX.PL  
 ‘Dinosaurs disappeared a long time ago’  
 b. Nitrogeno\*(-a) ugaria da gure unibertsoan.  
 nitrogen-D.SG.ABS abundant is our universe.IN  
 ‘Nitrogen is abundant in our universe’

What is really interesting about the Basque definite article is that when Basque definite DPs (plurals and masses) fill the direct object slot (and only the direct object slot), the definite DP can, but need not make reference to a specific set and can obtain the so-called existential interpretation. In (5), for example, we need not be talking about a specific set of candies or a specific quantity of wine (cf. Section 2.6; cf. also Artiagoitia 1998, 2002, 2006, 2012, Eguren 2012, Etxeberria 2005, 2010, 2014 for alternative (synchronic) analyses).

- (5) a. Amaia-k liburu-ak erosi zituen.  
 Amaia.ERG book-D.PL.ABS buy AUX.PL  
 ‘Amaia bought (the) books’  
 b. Amaia-k garagardo-a edan zuen.  
 Amaia.ERG beer-D.SG.ABS drink AUX.SG  
 ‘Amaia drank (the) beer’

Note that in the examples in (5) the object can also obtain a definite interpretation; so (5a) and (5b) are ambiguous between a referential and an existential interpretation: (5a) ‘Amaia bought *the books*’ or ‘Amaia bought *books*’; (5b) ‘Amaia drank *the beer*’ or ‘Amaia drank *beer*’.<sup>4</sup> No kind interpretation is possible.

---

<sup>4</sup> Due to space considerations, I will not be considering weak definites at all in this paper. Interestingly, weak definites do exist in Basque, as shown by the example in (i).

- (i) Ane-k *egunkari-a* irakurri zuen.  
 Ane.ERG newspaper-D.SG.ABS read AUX.SG  
 ‘Ane read the newspaper.’

Just note that some properties that weak definites are assumed to have (e.g. habitual or institutionalized activity; stereotypical enrichment; see Carlson & Sussman 2005, Aguilar-Guevara &

One may be led to think that the reason why Standard Basque makes use of the definite determiner [-a(k)] to get the existential interpretation is that it does not have indefinite articles. This is not correct, as Basque possesses singular and plural indefinite articles: *bat* ‘a, one’ and *batzuk* ‘some.pl’ (cf. Etxeberria 2005, 2008, 2012a for more on this).

It is important to note that the existential interpretation of the object DPs in the examples in (5) has obligatory narrow scope – while the run-of-the-mill indefinites can get both narrow and wide scope –, as is the case with BNs in the object position in English (cf. Carlson 1977; see Dobrovie-Sorin & Laca 2003, Dobrovie-Sorin 2009, Carlier 2021, this volume, Giusti 2021, this volume, among many others, for Romance). Take the examples in (6).

- (6) a. #Nere aitak        bi sator        hil zituen ordubetez.  
          my father.ERG two mole.ABS kill AUX.PL hour-for  
          ‘My father killed two moles for an hour.’
- b. Nere aitak        satorrak        hil zituen ordubetez.  
          my father.ERG mole-D.PL.ABS kill AUX.PL hour-for  
          ‘My father killed moles for an hour.’

The sentence in (6a) can only be interpreted with the indefinite *bi sator* ‘two moles’ having wide scope over the atelic adverbial *ordubetez* ‘for an hour’ and asserts that the same two moles were killed again and again; a rather strange state of affairs. The sentence in (6b), on the other hand, is completely grammatical. The reading we get is one where my father killed different moles and the existentially interpreted definite DP must necessarily take narrow scope below the adverbial *ordubetez* ‘for an hour’, i.e. [adv. *for* > *satorrak*]. It is true that the DP object of the sentence in (6b) can also get a wide scope reading, but only with the definite reading, and this interpretation would make the sentence as strange as the one in (6a).

In the next section I will concentrate on describing the behavior of nominals (in argument position) and the definite determiner in Souletin.

---

Zwarts 2010, Aguilar-Guevara 2014, Aguilar-Guevara et al 2014, a.o.) do not apply to the readings the definite article is shown to be obtaining in Basque, cf. Section 2. The reader is referred to Etxeberria (in prep.).

## 2.2 The use of the definite article in Souletin

The definite article of Souletin is a ‘well-behaved’ definite article; it forces a kind-level interpretation when combined with kind-level predicates (just like in Standard Basque), and it always forces a referential interpretation in episodic contexts with stage-level predicates.

(7) Subject Position:

- a. *Lagun-a*            garaiz    iritsi    zen.  
 friend-D.SG.ABS on-time arrive AUX.SG  
 ‘The friend arrived on time’
- b. *Lagun-ak*            garaiz    iritsi    ziren.  
 friend-D.PL.ABS on-time arrive AUX.PL  
 ‘The friends arrived on time’

(8) Direct Object Position:

- a. *Amaiak liburu-a*            erosi    zuen.  
 Amaia.ERG book-D.SG.ABS buy    AUX.SG  
 ‘Amaia bought the book.’
- b. *Amaiak liburu-ak*            erosi    zituen.  
 Amaia.ERG book-D.PL.ABS buy    AUX.PL  
 ‘Amaia bought the books.’

The example in (8b) is the one that differs from Standard Basque where the definite DP can get both the referential definite reading and the existential interpretation with narrow scope (in (5a)). In Souletin, on the other hand, *liburuak* can only get the referential meaning, as shown by the translation in (8b).<sup>5</sup> In order to express the kind-meaning, the definite article is obligatory, as was the case in Standard Basque.

## 2.3 Existential interpretation: BNs in Souletin

In order to get the existential interpretation (with narrow scope) Souletin makes use of BNs (only in direct object position; and these BNs can be mass or count),<sup>6</sup> as

<sup>5</sup> The indefinite article (singular and plural) is available also in Souletin and it allows both the wide scope and narrow scope interpretation; cf. example (12) below.

<sup>6</sup> Mass Ns and count Ns are lexically distinguished in Basque (cf. Etxeberria 2005; cf. also Etxeberria in prep). The reader is referred to Etxeberria (2012) for extensive discussion on mass/count Qs.

shown by the examples in (9) (cf. Txillardegi 1977, Coyos 1999, Casenave-Harigile 2006, Etxebarne 2006, Manterola 2015, Etxeberria 2014).<sup>7</sup> Recall that BNs cannot be used in argumental position in Standard Basque; see examples (2–4).

Direct Object position:

- (9) a. Bortüan                      ikusi dit            *behi*.  
           mountain.D.SG-IN see    AUX.SG cow  
           ‘I saw cows in the mountain’
- b. Dembora da (...) ičan      deçadan *diru*.  
           time            is            is-have aux            money.ABS  
           ‘It’s time for me to have money’            (Bourciez 1895)
- c. Zer    agitü    da?      *Sagar* ebatsi dü.  
           what happen AUX.SG apple steal    AUX.SG  
           ‘What happened? She/he stole apples’

These BNs get an existential interpretation, which means that the BNs in (9) do not refer to a specific set of whatever the NP denotes; rather, they seem to be non-specific, weak indefinites, like bare plurals of other languages in this position (e.g. English, Spanish). In this paper, we argue that BNs in Souletin are unspecified for number; see Section 2.5.

The fact that BNs in Souletin appear in direct object position and get an existential interpretation suggests that an analysis along the lines of Longobardi (1994, 2001) might be on the right track. Thus, in line with Etxeberria (2012, 2016), the assumptions that I will be making are the following: (i) a null element exists if it alternates – is part of a paradigm – with one or more phonologically realized morphemes and if each element of the paradigm contributes a distinct semantic value; (ii) the DP layer must be projected with a null D (Contreras 1986, Longobardi 1994, 2001, Cyrino & Espinal 2014, etc.);<sup>8</sup> (iii) The null D has a default existential interpretation (Longobardi 1994, 2001); (iv) Syntactically, null structure is expected to be subject to licensing conditions (e.g. to appear in object position).

The syntactic structure that these assumptions entail for Souletin BNs is as in (10), a full DP with an empty D head occupied by a phonetically null D.

- (10) [<sub>DP</sub> [<sub>NP</sub> *behi* N] -∅ D]]

<sup>7</sup> BNs cannot be used in subject position; see Section 2.4.

<sup>8</sup> Brazilian Portuguese BNs in preverbal position cannot get an existential interpretation, as shown by Cyrino & Espinal (2014); see also Section 2.5.

The next subsection provides evidence for this structure by presenting a more complete picture of the behavior of BNs in Souletin.

## 2.4 Souletin BNs are syntactically DPs

One of the predictions of the proposal that Souletin BNs are full DPs with an empty D head is that these BNs will only be able to figure in object positions, not in subject positions. The prediction is borne out.

Subject position:

(11) a. Ergative:

- |       |                          |          |      |        |
|-------|--------------------------|----------|------|--------|
| (i)   | *Ikasle-k                | hori     | egin | dü.    |
|       | student.ERG              | that.ABS | do   | AUX.SG |
| (ii)  | Ikasle-ak                | hori     | egin | dü.    |
|       | student-D.SG.ERG         | that.abs | do   | AUX.SG |
|       | ‘The student did that.’  |          |      |        |
| (iii) | Ikasle-ek <sup>9</sup>   | hori     | egin | düe.   |
|       | student-D.PL.ERG         | that.ABS | do   | AUX.PL |
|       | ‘The students did that.’ |          |      |        |

b. Absolutive:

- |       |                      |      |        |
|-------|----------------------|------|--------|
| (i)   | *Ikasle              | jin  | da.    |
|       | student.ABS          | come | AUX.SG |
| (ii)  | Ikasle-a             | jin  | da.    |
|       | student-D.SG.ABS     | come | AUX.SG |
|       | ‘The student came.’  |      |        |
| (iii) | Ikasle-ak            | jin  | dia.   |
|       | student-D.PL.ABS     | come | AUX.PL |
|       | ‘The students came.’ |      |        |

One other property of Souletin BNs is that they cannot be combined with kind-level predicates, and the presence of the definite article is necessary in order to be able to refer to the species as a whole (e.g. *Lehu\*(-ak) desagertzera dia* ‘Lions are about to disappear’). This is expected: if null D can only get the existential interpretation, no kind reading will be available for Souletin BNs.

---

<sup>9</sup> When the ergative marker attaches to the plural -ak the resulting form is -ek.



Third, BNs in Souletin cannot refer specifically to the set denoted by the NP, suggesting that they take obligatory narrow scope, again, something expected under the null D proposal. The sentence in (12), for example (where we have the indefinite plural *eli bat* ‘some’ in direct object position), is ambiguous between a wide scope reading of the direct object over the verb *want* where it is possible to refer to the boys denoted by the object NP and a narrow scope reading below the verb *want* (see von Heusinger & Kornfilt 2021, this volume). In (12b), the indefinite has narrow scope below *want* and cannot refer back to the set of boys.

## (12) a. some &gt; want

Anek *pottiko eli bat* nahi dizü ezagutu. Jon, Peru, eta Mikel.  
 Ane.ERG boy some want AUX.SG meet Jon Peru and Mikel  
 ‘Ane wants to meet some boys. Jon, Peru and Mikel.’

## b. want &gt; some

Anek *pottiko eli bat* nahi dizü ezagutu. Jon, Peru, eta Mikel.  
 Ane.ERG boy some want AUX.SG meet Jon Peru and Mikel  
 ‘Ane wants to meet some boys. Jon, Peru and Mikel.’

The narrow scope reading or the non-specific interpretation of the indefinite in (12b) can also be argued for by a continuation like “but there were no boys”, as in (13), where we would show the non-existence of the set of “boys”. With such a continuation only the scope relationship in (12b), and by extension, (13b), where the indefinite gets narrow scope below the verb, would be grammatical.

## (13) a. some &gt; want

Anek *pottiko eli bat* nahi dizü ezagutu. # Baina ez da  
 Ane.ERG boy some want AUX.SG meet but NEG is  
 pottikorik inguruan.  
 boy.PART around.IN  
 ‘Ane wants to meet some boys. But there are no boys around.’

## b. want &gt; some

Anek *pottiko eli bat* nahi dizü ezagutu. Baina ez da  
 Ane.ERG boy some want AUX.SG meet but NEG is  
 pottikorik inguruan.  
 boy.PART around.IN  
 ‘Ane wants to meet some boys. But there are no boys around.’

In (14), on the other hand, the BN in object position only gets the narrow scope reading and the continuation is as strange as in (12b) and as grammatical as (13b) in (14a) and (14b) respectively.

- (14) a. Anek *pottiko* nahi dizü ezagutu. # Jon, Peru, eta Mikel.  
 Ane.ERG boy want AUX.SG meet Jon Peru and Mikel  
 ‘Ane wants to meet boys. Jon, Peru and Mikel.’
- b. Anek *pottiko* nahi dizü ezagutu. Baina ez da  
 Ane.ERG boy want AUX.SG meet but NEG is  
*pottikorik* inguruan.  
 boy.PART around.IN

Thus, these BNs are really non-specific, narrow scope indefinites, equivalent to incorporated nominals in languages that would allow incorporation, e.g. Greenlandic Eskimo (van Geenhoven 1998). In Basque, which does not allow noun incorporation (at least in the constructions we are considering here), upon loss of null D, as we will argue to be the case later, the only strategy to salvage the structure is using the next available element, which is the phonologically weak D [-a]; cf. Section 2.6.

Furthermore, the above examples show that Souletin possesses other means to express indefinite/existential readings: *zumait* ‘some’ or *eli bat* ‘some’ in (12). However, there is a difference between the existential interpretation that these indefinite quantifiers obtain and the one obtained by BNs (see (12), (13), (14)): the latter take obligatory narrow scope, (13–14), in opposition to weak quantifiers, which can get both narrow or wide scope. It is important to recall also that in Souletin the definite article is needed to express both the definite interpretation and the kind interpretation (cf. examples (7), (8)). Thus, the null D<sup>0</sup> appears to be part of a paradigm: (i) D [-a(k)]: definite (referential), and kind reading; (ii) *bat* ‘one’, *zumait* ‘some’, *eli bat* ‘some’: indefinite readings with wide/narrow scope; (iii) null D<sup>0</sup>: existential reading with narrow scope.

Finally, more evidence in favor of the existence of the null D head in Souletin comes from the possibility of “real” BNs, in languages such as Spanish and other Romance languages (where they have been shown to be real bare nominal expressions, see Espinal 2010, Espinal & McNally 2011, etc.), to combine with any kind of episodic predicate. These bare nominal expressions, in those languages where they are argued to be really bare, that is, with no null D (as opposed to what we are arguing here for Souletin), are assumed to not be able to combine with predicates of the type *break* – real episodic predicates – which do not accept as internal arguments elements of type *e,t* or incorporated type elements (cf. i.a. Espinal & McNally 2011). In other words, DPs are blocked in incorporation constructions. In fact, when there is an incorporation process, there arise special semantic effects, e.g. the incorporated predicate (V+NP) designates some typical, characterizing, or generic activity. When incorporating BNs are combined with real episodic predicates the sentence is ungrammatical – or at least pragmatically

odd. If the nominal expression contains a null D, as we are arguing to be the case in Souletin, no incorporation would be necessary (see above). It follows from here then that Souletin BNs should be able to appear freely as verbal complements and would show no restriction to combine with real episodic predicates of the *break* type. The prediction is borne out as the example in (15) shows.

- (15) Gaur goizeko festan, Peiok godalet hautsi dizü. (Souletin)  
 today morning.GEN party.IN Peio.ERG glass.ABS break AUX.SG  
 ‘In the party this morning, Peio broke glasses’

In the next section we will briefly argue for the idea that bare nominal expressions in Souletin, and in Basque in general, are number neutral.

## 2.5 Denotation of bare nominal expressions in Basque

In the existential interpretation of the bare nominal expressions (in object position) in examples such as (9) (repeated as (16)), these bare nominals make non-specific reference to what the noun denotes.

- (16) Bortüan ikusi dit behi.  
 mountain.D-IN see AUX.SG cow.ABS  
 ‘I saw cows in the mountain.’

In other words, bare nominal expressions in Souletin, and in Basque in general, are unspecified for number or number neutral (cf. Jespersen 1924, Chierchia 1998a, Corbett 2000, Dayal 2004, Rullman & You 2006, Wilhelm 2008, Espinal & McNally 2007, 2011, Krifka et al 1995, Perelstvaig 2013, Görgülü 2018, among many others), that is, a bare nominal expression in Basque can be used to make reference to a singularity or to a plurality, that is, to the whole lattice (not to a kind; or in other words, be compatible with atomic and non-atomic entailments).<sup>10</sup>

As evidence, note that, in Basque (both in Souletin and Standard Basque), numerals combine directly with bare nominal expressions. Thus, in (17a), the phrase *ikasle bat* ‘one student’ is semantically singular, while in the example in

---

<sup>10</sup> The property of Basque BNs being number neutral resembles East Asian languages like Mandarin, Cantonese, Thai, etc. where BNs can make reference to singularities or to pluralities. However, despite appearances, there are clear-cut differences between the behavior of Basque BNs and the behavior of the BNs of East Asian languages. The reader is referred to Etxeberria (2014).

(17b) the phrase *hamar ikasle* ‘ten students’ is semantically plural. Yet, the noun *ikasle* ‘student’ remains completely uninflected for number in both cases.

- (17) Souletin & Standard Basque
- |    |               |     |    |                |         |
|----|---------------|-----|----|----------------|---------|
| a. | ikasle        | bat | b. | hamar          | ikasle  |
|    | student       | one |    | ten            | student |
|    | ‘one student’ |     |    | ‘ten students’ |         |

Furthermore, in both Souletin and Standard Basque it is possible to use bare nominal expressions as stage-level predicates, denoting a temporary property; and the same nominal, *artzain* ‘shepherd’ in (18), can be used to predicate of a singularity or of a plurality.

- (18) Souletin & Standard Basque:
- |    |   |                |       |                |              |        |              |
|----|---|----------------|-------|----------------|--------------|--------|--------------|
| a. | Miren   | <i>artzain</i> | joan  | zen            | Ameriketara. |        |              |
|    | Miren   | shepherd       | go    | AUX.SG         | America-to   |        |              |
|    | ‘Miren went to America (as) shepherd.’            |                |       |                |              |        |              |
| b. | Jon   | eta            | Miren | <i>artzain</i> | joan         | ziren  | Ameriketara. |
|    | Jon   | and            | Miren | shepherd       | go           | AUX.PL | America-to   |
|    | ‘Jon and Miren went to America (as) shepherd(s).’ |                |       |                |              |        |              |

Finally, in Souletin, bare nominal expressions are also used to express individual-level predicates (this is not allowed in Standard Basque; see Zabala 1993, 2003, Artiagoitia 1997, 2012, Eguren 2006, 2012; see also Etxeberria in prep), and again, a BN can serve as predicate to both singular subjects such as proper names (19a) and plural subjects such as conjoined NPs (19b). Note that this predicative use of bare nominal expressions is not restricted to capacity nominals (*cf.* de Swart, Winter, & Zwarts 2007) since *haür* ‘child’ is not a capacity nominal.

- (19) Souletin:
- |    |                                |             |       |             |        |
|----|--------------------------------|-------------|-------|-------------|--------|
| a. | Miren                          | <i>haür</i> | düzü. |             |        |
|    | Miren                          | child       | is    |             |        |
|    | ‘Miren is a child.’            |             |       |             |        |
| b. | Miren                          | eta         | Peru  | <i>haür</i> | tützü. |
|    | Miren                          | and         | Peru  | child       | are    |
|    | ‘Miren and Peru are children.’ |             |       |             |        |

## 2.6 From Souletin to Standard Basque

One important assumption that this paper is making is that Souletin is closer to Old Basque than the Standard Basque concerning the nominal system, in line with Manterola (2012, 2015); see also Etxeberria (2014); cf. fn.2. Thus, the question that remains is why/how Standard Basque began to use the D to express the existential interpretation with narrow scope. If bare nominal expressions in Basque are number neutral (see Section 2.4 and Etxeberria 2014) and if in Souletin they are grammatical in internal argument position with an existential interpretation, the use of the Standard Basque D does not appear to be making any semantic contribution in the existential reading since it does not provide any kind of definiteness,<sup>11</sup> as can be seen in the English translations provided for the sentences in (20).<sup>12</sup>

- (20) a. Amaia-k liburu\*(-ak) erosi zuen.  
 Amaia.ERG book-D.PL.ABS buy AUX.SG  
 ‘Amaia bought (the) books.’  
 b. Amaia-k garagardo-a edan zuen.  
 Amaia.ERG beer-D.SG.ABS drink AUX.SG  
 ‘Amaia drank (the) beer.’

With all this in mind, what motivated Standard Basque to begin to use [-a(k)]<sup>13</sup> in order to get the existential reading (with narrow scope), we argue, is twofold: (i) loss of null D, (ii) number morphology.

The null D of the previous stage of Basque, *i.e.* Souletin dialect, becomes a very weak form semantically as it is non-referential and unspecified for number. This vagueness, *i.e.* indefiniteness plus number vagueness, eventually dooms this form to loss of its semantic indefinite feature and given that it is a null form, it cannot be reanalyzed and as a consequence it gets lost. The appearance of the overt D in Standard Basque in the indefinite/existential object position, thus, is a kind of reanalysis of the available form D [-a] as a D with existential interpretation (with narrow scope) in these cases. In other words, what I postulate is that the available form D of Basque is reanalyzed and takes over the function of the indefinite null D (*cf.* Manterola 2008, 2015, for a possible grammaticisation process – à la Greenberg – of the Basque D). And in fact, this makes sense con-

11 Cf. Etxeberria 2005, 2010 for a different synchronic analysis of the Basque [-a(k)].

12 The objects in (20) can also get the definite interpretation, see (5). I ignore this reading here.

13 [-k] is the plural number marker; *cf.* also Etxeberria (2005, 2010).

sidering that the Basque D [-a] is a phonologically weak element, and as such, it appears to be the first immediate ‘proximate’ phonologically to the null D.<sup>14</sup> As a consequence, Basque can be said to move from the syntactic situation with a null D to a syntactic situation where the [-a] takes the place of this null D. The need to have the D position filled is syntactic: the loss of null D. Syntactically, the definite article [-a] is always a D, but now it also functions as the overt counterpart of the (otherwise) covert indefinite existential in object position. So in this reading the definite article has a weak function: it applies vacuously, *i.e.*, it is an element of semantic type (et,et). Thus, in this case, we have an asymmetry between syntax (need to always have functional structure above the NP in Basque, for an NP to function as an argument), and the semantics, which imposes indefinite meaning.

A second motivation why Standard Basque starts using [-a(k)] instead of the Souletin null D comes from the fact that Basque begins to mark number morphology explicitly.<sup>15</sup> In Souletin (and in Standard Basque, see Section 2.5), BNs are number neutral and there is no morphological number on the noun itself as shown by the following example (as is the case in Spanish or in English where plurality is marked by means of [-s]; *cf.* Delfitto & Schroten 1991, Bouchard 1998, 2002, Dobrovie-Sorin 2012 for extensive discussion on Number realization and Number interpretation).

- (21) Bortüan            ikusi   dit        *behi*.  
 mountain-D.IN   see   AUX.SG   COW.ABS  
 ‘Lit.: I saw cow in the mountain.’

<sup>14</sup> The reason why Basque did not begin to use the indefinite article *bat* ‘a/one’ to get the existential reading with narrow scope is probably due to the fact that the indefinite article already has its own indefinite interpretation(s): existential reading with wide and with narrow scope, in opposition to what happens with Souletin BNs and the existential reading of the Standard Basque D, which only get the narrow scope reading.

<sup>15</sup> According to some authors, *e.g.* Irigoien (1985), Manterola (2006, 2012), the reason why Standard Basque begins to mark number explicitly by means of [-a(k)] is the result of language contact, as the languages around have overt plural markers, *e.g.* Spanish and French mark plural number on nouns by means of [-s]. This could of course be the case, however, what is left unexplained is why Souletin did not already take the same route and began to mark plural by means of [-ak], because Souletin is also in contact with French. One possibility would be to think that other languages that are in contact with Souletin, *e.g.* Occitan’s variant Gascon, would behave just like Souletin in possessing BNs with no number marker, *i.e.* no plural marker, and in allowing them only in internal argument position. However, this appears not to be correct, as Occitan and its variant Gascon do have plural morphology [-s]. Thanks to Francesc Roca and Xavier Llamuela for help with Occitan data.

It is important to emphasize that Basque possesses a plural marker: [-k]. But this plural marker cannot be applied to nouns directly, as the plural marker is a suffix, and as such categorically as well as phonologically dependent on the presence of another category, in this case, the definite article [-a]. So, unless the definite article is present, the plural marker cannot appear in Basque (*cf.* Etxeberria 2005, 2010 for extensive discussion on where number is interpreted in Basque).

- (22) a. \*ikasle-k  
           student-PL  
       b. ikasle-a-k  
           student-D.PL

Thus, in this final section, assuming that Souletin is a previous stage compared to Standard Basque when it comes to the D system (as shown by Manterola 2012, 2015; *cf.* Michelena 1964, Camino 2017), I have argued that Basque historically derived from a stage where BNs were allowed in internal argument position (i.e. object position) to a stage where BNs in argument position are completely ungrammatical, and the definite article is introduced to express existential interpretation with narrow scope.

In the next section, I will concentrate on the Basque partitive determiner, its relation with the definite determiner, its evolution from the partitive case marker to finally argue that it creates a complex Polarity determiner. Before that, however, I will first concentrate on the partitive case, which is distinguished from the determiner and which is from where it is assumed to have historically derived.

### 3 Partitive [- (r)ik]

#### 3.1 The partitive case

The Basque partitive [- (r)ik] was originally named ‘negativus’ by Oihenart (1638), and it was Lécuse (1826) who began to call it *partitive*. It is de Rijk (1972, 1996) who makes a thorough study of the use of the partitive marker. The partitive attaches to a nominal expression (either count or mass) or to an adjective and it always appears in the final position of the phrase, as is the case with the definite article.

- (23) a. *mutil-ik* ‘boy-PART’  
       b. *garagardo-rik* ‘beer-PART’  
       c. *mutil/garagardo on-ik* ‘boy/beer good-PART’

- d. *mutil txiki on-ik* ‘boy small good-PART’
- e. *garagardo hotz on-ik* ‘beer cold good-PART’

Historically, the partitive case [-*(r)ik*] is assumed to have originated as an ablative or an elative (see Rijk 1972; see Seržant 2021, this volume for a crosslinguistic survey and a diachronic evolution of the partitive), although nowadays the partitive is not allowed in these constructions.

- (24) [-*rik*] > [-*tik*]  
 Jon Venezia-*tik*/\*-*rik* dator.  
 Jon Venezia-ABL come.SG  
 ‘Jon comes from Venice.’

However, as a proof of this idea, it is important to note that the partitive functions as an allomorph of the ablative paradigm in Eastern dialects.

- (25) a. Eastern dialects: [-*tarik*] and [-*etarik*]  
*Ikasle-eta-rik* ‘student-D.PL-ABL’  
 b. Rest of dialects: [-*tatik*] and [-*etatik*]  
*Ikasle-eta-tik* ‘student-D.PL-ABL’

The partitive case is assumed to be the precursor of the partitive determiner (see de Rijk 1996). However, in the way towards the use of [-*(r)ik*] as a partitive determiner, it has also been used in three other constructions and contexts: adverbial contexts, superlative constructions, and quantificational contexts (quantifier expressions and PIs) (see Section 3.2.2).

The use of the partitive in adverbial contexts specifies the nature of the action, and it either involves two instances of the same count noun as shown in (26a) or two nouns that denote time as in (26b).

- (26) a. *ahorik-aho* ‘from mouth to mouth’, *etxerik-etxe* ‘from house to house’, *mendirik-mendi* ‘from mountain to mountain’, *herririk-herri* ‘from town to town’  
 b. *asterik-aste* ‘week by week, week after week’, *urterik-urte* ‘year by year, year after year’

The partitive [-*(r)ik*] can also be used to mark the range of the superlative as shown in (27a). Note that the range of superlatives can also be expressed in Basque by a BN (27b) or by the quantificational partitive construction *NP-etatik* ‘of the NP’ (27c).



- (27) a. *Neska-rik* altu-en-a.  
 girl-PART tall-SUP-D.SG  
 ‘the tallest girl’
- b. *Neska* altu-en-a.  
 girl tall-SUP-D.SG  
 ‘the tallest girl’
- c. *Nesk-eta-tik* altu-en-a.  
 girl-D.PL.ABL tall-SUP-D.SG  
 ‘the tallest (of the) girls’

In quantificational contexts, the partitive case has been used combined with the nominal expression to mark the range of the quantifier. However, the quantificational use in (28a) is completely lost except for the fossilized *eskerrik asko* ‘thank-part many’. Actually, nowadays, the correct form is necessarily without the partitive case as in (28b) for all cases.

- (28) a. *ikasle-rik* asko  
 student-PART many  
 ‘many students’
- b. *ikasle* asko  
 student many  
 ‘many students’

Finally, the partitive case can also combine with the nominal expression that combines with PI expressions such as *inor*, *ezer*, etc. (see de Rijk 1972, Laka 1990, Uribe-Etxebarria 1992, Euskaltzaindia 1993, Etxepare 2003. See also Etxeberria et al 2018, Etxeberria et al 2021 and Espinal et al in prep, who show that these PIs are indefinites), that historically have behaved as quantificational (examples taken from de Rijk 1996).

- (29) a. Beretzat ez zegoen beste *gizon-ik inor*.  
 for her/him NEG AUX other man-PART anybody  
 ‘For her/him, there was no other man.’  
 (Agirre, *Kresala*, 190)
- b. Ez zekien Liberen *bihotz-barrengorik ezer*.  
 NEG AUX Libe-gen heart-inside-PART anything  
 ‘S/he knew nothing of what was inside Libe’s heart.’  
 (Agirre, *Uztaro*, 114)

From all the above-mentioned uses of the partitive case, only the adverbial and the superlative uses are nowadays active, the two quantificational uses (partitive combined with Q expressions such as *asko* and partitive combined with NPIs) are lost. In the next subsection I will concentrate on the partitive determiner, which, I assume, in line with de Rijk (1972, 1996), evolved from the partitive case passing by a process when it functioned as the marker of the range of quantifiers. Finally, in Section 3.3 I will propose an analysis of the partitive determiner in terms of a null Polarity determiner.

### 3.2 The partitive determiner

Many authors have treated the partitive [-*(r)ik*] as an article (Larramendi 1729; Azkue 1905, 1923 among others; see de Rijk 1972 for historical references). If this is really the case (and it is true that syntactically it behaves as an article) the partitive must be a special kind of an article since it does not accept overt case markers (in opposition to what happens with any other Basque article, e.g. the definite article). This impossibility may be related to the fact that the partitive determiner derived, as we assume to be the case, from a case marker. In this paper, we will use the term ‘partitive’ to refer to the particle [-*(r)ik*] (in line with other traditional grammars; see Lafitte 1944).

- (30) a. Absolutive case:
- (i) Mutil-a-∅  
boy-D.SG-ABS
  - (ii) Mutil-ik-∅  
boy-PART-ABS
- b. Ergative case:
- (i) Mutil-a-k  
boy-D.SG-ERG
  - (ii) \*Mutil-ik-(a)k  
boy-PART-ERG
- c. Dative case:
- (i) Mutil-a-ri  
boy-D.SG-DAT
  - (ii) \*Mutil-ik-(a)ri  
boy-PART-DAT

The fact that the partitive can only appear with absolutive case explains the fact that only attaches to transitive direct objects (31) and to intransitive subjects (32).

- (31) a. Kepak ez du baloi-rik ekarri.  
 Kepa.ERG NEG AUX ball-PART bring  
 ‘Kepa has not brought any ball.’  
 b. Anek ez du garagardo-rik edan.  
 Ane.ERG NEG AUX beer-PART drink  
 ‘Ane has not drunk beer.’
- (32) a. Mendian ez da hildako animalia-rik azaldu.  
 mountain-IN NEG AUX dead animal-PART appear  
 ‘No dead animal appeared in the mountain.’  
 b. Bilerara ez da irakasle-rik etorri.  
 meeting-to NEG AUX teacher-PART come  
 ‘No teacher has come to the meeting.’

Obviously, since the partitive can only take absolutive case it cannot be used as subject of transitive sentences which in Basque require the subject to appear with the ergative case, something that partitives cannot do (see (30b)).

- (33) a. \*Katu-rik sagua jan du.  
 cat-PART mouse eat AUX  
 b. \*Katu-rik ez du sagua jan.  
 cat-PART NEG AUX mouse eat

One interesting property of the partitive determiner is that it behaves as a “polarity element” in that it only appears in polarity contexts. Thus, as expected, it can appear in negative contexts, as in the previous examples (31–32), and as shown by the following example.<sup>16</sup>

- (34) a. Ane-k ez du garagardo-rik edan.  
 Ane.ERG NEG AUX beer-PART drink  
 Ane did not drink any beer.  
 b. \*Ane-k garagardo-rik edan du.  
 Ane.ERG beer-PART drink AUX

<sup>16</sup> Note that the sentence in (33a) is ungrammatical for two reasons: (i) the subject is not marked with ergative case, and (ii) the sentence is not negative. The presence of negation does not improve the sentence by itself, as shown by (33b).

Apart from negative contexts, some other syntactic environments allowing the partitive are the following (cf. de Rijk 1972, 1996; Trask 2003; Etxepare 2003 for a complete description): (i) existential sentences (35a); (ii) yes/no questions (35b); (iii) protasis of conditional (35c); (iv) *before* clauses (35d); (v) *without* clauses (35e); (vii) epistemic modals (35f).

- (35) a. Bada turista-rik Donostian!<sup>17</sup>  
 yes-is tourist-PART Donostia-IN  
 ‘There are (lots of) tourists in Donostia!’
- b. Goxoki-rik nahi al duzu?  
 candy-PART want QUEST AUX  
 ‘Do you want any candy?’
- c. Istilu-rik badago, ospa egin  
 riot-PART if.AUX flee do  
 ‘If there are any riots, get out.’
- d. Zozo keria-rik egin baino lehen, goazen. hemendik  
 silly thing-PART do than before let-go here-from  
 ‘Go home before you do silly things.’
- e. Diru-rik gabe atera naiz etxetik.  
 money-PART without leave AUX home-from  
 ‘I left home without money.’
- f. Beharbada entzungo dut albiste on-ik.  
 perhaps hear.FUT AUX new good-PART  
 ‘Perhaps I will hear good news.’

The examples above come to show that the partitive [-(r)ik] is licensed by an anti-morphic operator, e.g., by sentential negation, (31-32-34-35). Partitive [-(r)ik] can also be licensed in anti-additive contexts such as the restriction of the universal quantifier *guzti* ‘all’ (36), as well as in downward entailing contexts such as the scope of the weak quantifier *gutxi* ‘few, little’, (37a), or the scope of affective predicates such as *zalantza egin* ‘doubt’, (37b). Finally, partitive [-(r)ik] can also occur in non-veridical contexts, such as the protasis of a conditional, (35c).

<sup>17</sup> Constructions such as those in (35a) are only possible as an exclamation; see de Rijk (1972, 1996). The interpretation of these kinds of sentences is parallel to *bada atzerritar asko* ‘there are many foreigners’; see example (28). If we add an adjective to the noun, the sentence needs not be an exclamation: *ardo onik badute taberna honetan* ‘they have good wine in this bar’, *gizon onik bada Euskal Herrian* ‘there are good men in the Basque Country’ (cf. de Rijk 1972: 178; cf. also 30<sup>th</sup> law of the Academy of the Basque Language, Euskaltzaindia). These cases will not be considered in this paper.

- (36) Historia libururik irakurri duten ikasle guztiek Frantses iraultza  
 History book.PART read AUX student all-D.PL French revolution  
 ezagutu behar dute.  
 know must AUX  
 ‘Every student who has read any history book must know the French  
 revolution.’
- (37) a. Ikasle gutxik irakurri dute libururik.<sup>18</sup>  
 student few.ERG read AUX book.PART  
 ‘Few students read any book.’  
 b. Zalantza egiten dut Anek libururik irakurri duen.  
 doubt do.IMPf AUX Ane.ERG book.PART read AUX.COMP  
 ‘I doubt that Ane read any book.’

This comes to show that the contexts in which the partitive [-(r)ik] appears and the behaviour that it shows are parallel, except for the existential contexts, to the *inor*, *ezer* type of PI (See Etxeberria et al 2018, Etxeberria et al submitted and Espinal et al in prep).

According to Hoeksema (2012)’s *Extended Zwarts’ hierarchy* for PIs (combining Zwart’s 1981 and van der Wouden’s 1994 classification; that we offer in (38)) – the partitive [-(r)ik] would qualify as a *superweak* PI. In other words, the partitive [-(r)ik] is licensed in the contexts expressed by the most external of the concentric circles in (38).

---

**18** The downward entailing quantifier *gutxi* ‘few’ behaves like focus operators in that it induces a change in the basic word order of the clause (cf. Etxepare 2003; Etxeberria 2005, 2008, 2012, in prep). Focus phrases in Basque must appear in the immediately preverbal position, which produces a change in the basic SOV Basque word order (cf. a.o. Eguzkitza 1986, Ortiz de Urbina 1983, 1989, 1999, Uriagereka 1999, Arregi 2003, Irurtzun 2006, 2016).

- (i) a. \*[Peru-k]<sub>F</sub> baloi-a zulatu du.  
 Peru.ERG ball-D.SG.ABS burst AUX.SG  
 ‘Peru has burst the ball.’  
 b. Baloia [Peruk]<sub>F</sub> zulatu du.  
 c. [Peruk]<sub>F</sub> zulatu du baloia.

This is exactly what happens with *gutxi* in (37a), i.e., it must necessarily occupy the preverbal (focus) position, as the ungrammaticality of the example in (ii) shows.

- (ii) \*Ikasle gutxi-k ezer ikusi dute.  
 student few.ERG anything.ABS see AUX

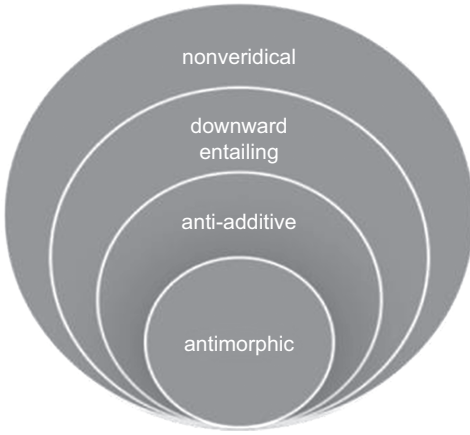

(38) Hoeksema (2012, p. 4): *Extended Zwart's Hierarchy*

Thus, what all the examples above show is that the partitive [-*(r)ik*] is sensitive to the semantic notion of (non-)veridicality (Zwarts 1995, 1998; Giannakidou 1997 et seq.; Hoeksema 2012; etc.).

A veridical context is one that allows the speaker to infer the truth of a sentence, that is, veridicality is a property of sentence embedding functions: a function  $F$  is veridical if  $F(p)$  entails or presupposes the truth of  $p$ . Thus, for example, an adverb like *unfortunately* in a sentence like *Unfortunately, Mary saw a snake* is veridical in that *Mary saw a snake* is true. A non-veridical context, on the other hand, is one where the truth inference seems to be suspended (e.g. modal adverbs like *possibly* or *maybe*). Non-veridicality, which is defined in (39), introduces a function  $F$  that can be expressed by means of negation (an anti-veridical operator), polar questions, *before*-clauses, downward entailing quantifiers, and conditionals, among others.

(39) *Non-veridicality*

A function  $F$  is non-veridical if and only if  $F(p)$  does not entail  $p$ .  
(Giannakidou 1997)

Observing all the examples that we have provided, a clarification is in order here concerning the example in (35a), repeated here for convenience, where partitive [-*(r)ik*] appears inside an existential sentence.

(35a) Bada turista-rik Donostian!  
yes-is tourist-PART Donostia-IN  
'There are (lots of) tourists in Donostia!'



context. As a consequence, if we would translate the sentence in (40a) we would be forced to use the definite determiner due to the fact that the only possible interpretation of *ijittoa* ‘gipsy-D.sg’ in (40a) is definite and specific. Thus, the correct English translation is the one we have in the glosses, i.e. *we have seen the gipsy* (and not the one in (40b), for which Basque has a perfect counterpart: *ijito bat ikusi dugu* ‘lit.: gipsy one see AUX’). And the negative form of (40a) would be (40d); in both cases we are making reference to a specific gipsy.

Then, it is clear from the examples above that it is impossible to use the partitive [-(r)ik] as the negative form of elements that force a definite and specific reading (as is the case with the article [-a] when combined with count terms; see Etxeberria 2005, 2008, 2014). In fact, we get exactly the same effect with the plural version of the definite article [-ak] in (41a): if the sequence [ikasle-ak] is interpreted as definite and specific, its negative form will also make use of the definite article [-ak] (41b). However, if the sequence [ikasle-ak] is interpreted existentially (remember that this interpretation is only allowed in direct object position; see Section 2.1), its negative form will make use of the partitive [-(r)ik], as shown in (41c).

- (41) a. Izarok ikasle-ak ikusi ditu.  
 Izaro.ERG student-D.PL.ABS see AUX.PL  
 ‘Izaro saw (the) students.’  
 [√ definite / √ existential]
- b. Izarok ez ditu ikasle-ak ikusi.  
 Izaro.ERG NEG AUX.PL student-D.PL.ABS see  
 ‘Izaro did not see the students.’  
 [√ definite / \* existential]
- c. Izarok ez du ikasle-rik ikusi.  
 Izaro.ERG NEG AUX.SG student-PART see  
 ‘Izaro did not see (any) students.’  
 [\* definite / √ existential]

We would observe exactly the same behaviour if we used the definite article [-a] with mass terms. Thus, the sentence in (42a) is ambiguous between a definite and an existential interpretation of the direct object: in the definite interpretation, we would be talking about a specific cognac, e.g., one that has been mentioned before in the conversation; in the existential interpretation on the other hand, we would not be talking neither about a specific cognac nor about a specific quantity of cognac. The negative form of the definite interpretation is the one in (42b), whereas the negative form of the existential interpretation will make use of the



partitive form [-*(r)ik*] as in (42c) (see Huumo 2021, this volume for the unbounded interpretation of the Finnish partitive).

- (42) a. Izarok ardo-a edan du.  
 IZARO.ERG wine-D.SG.ABS drink AUX.SG  
 ‘Izaro drank (the) wine.’  
 [√ definite / √ existential]
- b. Izarok ez du ardo-a edan.  
 IZARO.ERG NEG AUX.SG wine-D.SG.ABS drink  
 ‘Izaro didn’t drink the wine.’  
 [√ definite / \* existential]
- c. Izarok ez du ardo-rik edan.  
 IZARO.ERG NEG AUX.SG wine-PART drink  
 ‘Izaro didn’t drink the wine.’  
 [\* definite / √ existential]

Note that in Souletin, the partitive would be used as the counterpart of the BN in object position, which can only obtain an existential interpretation (see Section 2.3).

Interestingly, just as was the case with the existential interpretation of the definite article in Standard Basque and the BNs in Souletin, partitive [-*(r)ik*] can only get narrow scope interpretation when combined with sentential negation, for example, as shown by the example in (43a) (see Giusti & Sleeman 2021, this volume). This narrow scope interpretation is not an option for the run-of-the-mill indefinite article *bat*, which resists being interpreted below negation, (43b). It is neither a possibility for the anti-specific, referentially vague indefinite *-ren bat* ‘lit.: genitive one’ which cannot appear combined with negation and results in ungrammaticality, (43c) (see Haspelmath 1997, Giannakidou 1997, 2001, Kratzer & Shimoyama 2002, von Stechow 2000, Alonso-Ovalle & Menéndez-Benito 2010, 2011, Giannakidou & Quer 2013, Giannakidou & Yoon 2016, etc.; see Etxeberria in prep., for Basque).

- (43) a. Anek ez du goxokirik jan.  
 Ane.ERG NEG AUX.SG candy-PART eat  
 ‘Ane didn’t eat any candy.’  
 [√ NEG > -RIK / \* -RIK > NEG]
- b. Anek ez du goxoki bat jan.  
 Ane.ERG NEG AUX.SG candy one eat  
 ‘Ane didn’t eat a candy.’  
 [# NEG > BAT / √ BAT > NEG]

- c. \*Anek ez du goxoki-ren bat jan.  
 Ane.ERG NEG AUX.SG candy.GEN one eat  
 ‘Ane didn’t eat some candy (or other).’  
 [\* NEG > BAT / \* BAT > NEG]

This could be the result of a blocking effect: since negation triggers an NPI interpretation, any other indefinite under negation is a marked, and therefore, a dis-preferred option.

Finally, note that, as expected, the interpretation of the partitive [-*(r)ik*] is non-specific, in the sense that the speaker cannot have a specific set in mind (see von Heusinger & Kornflit 2021, this volume).

- (44) Anek ez du lagun-ik ikusi. \*Jon eta Miren ziren.  
 Ane.ERG NEG AUX.SG friend-PART see Jon and Miren be.PL  
 ‘Ane didn’t see any friend. They were Jon and Miren.’

Summarizing, the properties of the Basque partitive [-*(r)ik*] in general are the following: (i) it behaves as an anti-specific and narrow scope indefinite that furthermore needs to appear and be licensed in non-veridical contexts; (ii) it is used as the negative form of the existential interpretation of the Basque definite article (or Souletin BNs); (iii) it makes reference to an unspecified quantity of what the nominal expression denotes, which is related to the fact that BNs in Basque are unspecified for number or number neutral. In other words, what the speaker aims at expressing when using a N combined with the partitive in a negative context is that there are no elements from the set denoted by the NP.

### 3.2.2 Historical evolution of the partitive determiner

Historically, and in line with de Rijk (1996), I assume that the Basque partitive determiner [-*(r)ik*] follows the process where it is created as the ablative or the relative case (as suggested in Section 3.1), so as a case marker: [-*rik*] > [-*tik*]. *Jon Venezia-tik dator* ‘Jon comes from Venice’ (see Seržant 2021, this volume, for a diachronic analysis of the partitive from a crosslinguistic perspective; see also Carlier 2021, this volume).

As we said, this would explain the presence of the partitive as an allomorph of the ablative paradigm in Eastern dialects as in *ikasle-eta-rik* ‘student-D.pl-abl’ in opposition to what happens in the rest of the variants *ikasle-eta-tik* ‘student-D.pl-abl’.

In a second step, it would behave as the range of some quantifiers, such as *asko* ‘many, much’ or PIs of the type *inor* ‘anybody’, *ezer* ‘anything’, uses that are lost and not productive anymore. Finally, in a third step, it starts behaving as an indefinite, a non-specific PI with narrow scope.

(45) Partitive case > Range of Quantifiers > Partitive article

Carlier (2007) argues that in French there is a development of a partitive article from the partitive construction that brings a meaning shift and which developed in Middle-French. The reader is referred to Carlier (2007) for more specifics about her proposal and analysis (see also Carlier 2021, this volume). What interests us here is the conceptual shift from partition to indefiniteness that she argues has existed in French as well as in other Indo-European languages with case inflection (e.g. Russian, see Timberlake 1977, Paykin & van Peteghem 2002, or Finnish, see Laasko 2001, Karlsson 1983; see also Carlier 2021, this volume). This partitive article expresses indefiniteness and non-limited quantity, that is, it makes quantitatively unspecified reference. In the end, this is also the case for the Basque partitive [-*(r)ik*], as we argued above concerning its number neutrality.

### 3.3 The partitive determiner: Null Polarity D

The syntactic structure that I propose for a construction where we combine a nominal expression with the partitive determiner [-*(r)ik*] is the one expressed in (46).

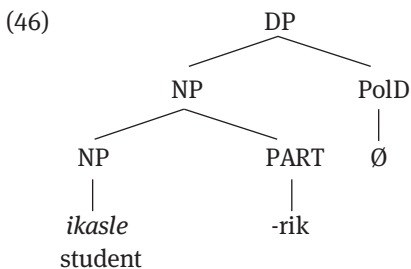

Assuming this structure as correct comes to say that the partitive [-*(r)ik*] behaves as a modifier in the sense that it does not change the type of the nominal expression, i.e. it takes an element of type  $\langle e, t \rangle$  and gives back an element of the same type  $\langle e, t \rangle$ , so it is an element of type  $\langle et, et \rangle$ . Therefore, what I will argue is that the partitive does not add much except for the fact that it expresses the need of

polarity (or non-veridicality). This structure reminds us of the structure we would be proposing for the Souletin BNs in object position.

The reason why I put forward the structure in (46) for a construction like [NP-(r)ik] comes from the fact that historically, as I argued in the previous subsection and as already argued by de Rijk (1996), the partitive [-(r)ik] evolved from the ablative case marker that in an in between step marked the range of quantificational elements of the type *inor/ezer* which are themselves nowadays PIs (see de Rijk 1972, de Rijk 1996, Laka 1990, Uribe-Etxebarria 1992, Euskaltzaindia 1993, Etxepare 2003; see also Etxebarria et al. 2018, Etxebarria et al. submitted, and Espinal et al., in prep), as shown by the example in (29), repeated here for convenience as (47). It is important to keep in mind that the structures that we offer in (47), i.e. *gizonik inor* ‘any man’ and *bihotz-barrengorik ezer* ‘any guts/intrails’ are ungrammatical nowadays.

- (47) a. Beretzat ez zegoen beste *gizon-ik inor*.  
 for her/him NEG AUX other man-PART anybody  
 For her/him, there was no other man.  
 (Agirre, *Kresala*, 190)
- b. Ez zekien Liberen *bihotz-barrengorik ezer*.  
 NEG AUX Libe-GEN heart-inside-PART anything  
 S/he knew nothing of what was inside Libe’s heart.  
 (Agirre, *Uztaro*, 114)

From these kinds of constructions, we evolve towards the partitive article by eliminating the quantificational *inor/ezer* from the structure, which become to be used as pronominal indefinites. Thus, what the Null Polarity Determiner does is take the place of these PIs and the partitive becomes a PI itself.

In line with Giannakidou (1998 et seq.) we assume PIs to introduce a dependent variable. Giannakidou (1998 et seq.) and Giannakidou & Quer (2013) propose that NPIs may contain a dependent variable and Greek, Mandarin, and Korean NPIs have been argued to belong to this class. As a consequence, the dependent character of NPIs becomes part of the elements that show referential ‘deficiencies’ like, for instance, anaphoric nominals, anti-specific and obligatorily narrow scope indefinites, English bare plurals (Carlson 1977), distributivity markers (Farkas 1998, Pereltsvaig 2008, Henderson 2014), etc.

- (48) Dependent variables of NPIs (Giannakidou 2011)  
 An existential quantifier  $\exists x_d$  is dependent iff the variable  $x_d$  it contributes does not introduce a discourse referent in the main context.

Thus, a dependent variable (i) is lexically dependent and as a consequence has limited distribution, (ii) cannot introduce a discourse referent in the actual world, (iii) is unable to get a value from the context and will always take narrow scope, and (iv) its distribution is constrained in contexts where there is an operator it can be bound by.

The Basque partitive [-*(r)ik*] then, will be taken to introduce a dependent variable that is licensed in non-veridical contexts, as it has been shown in Section 3.2.

## 4 Final remarks

In the first part of the paper, assuming that Souletin is a previous stage compared to Standard Basque when it comes to the D system (as shown by Manterola 2012, 2015), it has been argued that Basque historically derived from a stage where BNs were allowed in internal argument position (i.e. object position) to a stage where BNs in argument position are completely ungrammatical, and the definite article is introduced to express existential interpretation with narrow scope. In support of this analysis, the paper first made a thorough description of the use of BNs, and of the use of the definite article in both Souletin (the most eastern dialect of Basque) and in Standard Basque (plus all the rest of the dialects). I also argued that in Souletin, BNs are full DPs with an empty head occupied by a phonetically null D – with indefinite reference and unspecified for number –, partly in line with Longobardi (1994, 2001).

I have argued that the reason we move from a system like Souletin to a system where BNs are not allowed, i.e. Standard Basque, is basically due to a semantic weakening and loss of the null D: (i) in Souletin BNs are full DPs with an empty head occupied by a phonetically null D – with indefinite reference and unspecified for number–; (ii) this null D loses its semantic features and since it is null it cannot be reanalysed and gets lost; (iii) in Standard Basque the definite article [-*a*] is reanalysed and takes the place of the null D and begins to acquire the function of the lost null D.

In the second part of the paper, I have concentrated on the partitive [-*(r)ik*], where I have assumed, in line with de Rijk (1996), that the partitive determiner evolved from the partitive case passing by a process when it functioned as the marker of the range of quantifiers. Taking into account the *Extended Zwarts' hierarchy* as proposed by Hoeksema (2012), I have shown that the partitive determiner is licensed in non-veridical contexts and that it is a *superweak* PI. Furthermore, the partitive [-*(r)ik*] has been shown to be the negative form of the existential interpretation of the Basque definite article [-*a(k)*] (or BNs in Souletin),

an anti-specific indefinite that always takes narrow scope. Syntactically, I have proposed the existence of a Null Polarity Determiner that introduces a *dependent variable* that needs to be bound.

## References

- Agirre, Txomin. 1906. *Kresala*. Durango: Florentino Elosu-ren echean.
- Agirre, Tomas. 1937. *Uztaro*. Bilbao: Editorial Vasca.
- Ana Aguilar-Guevara. 2014. *Weak definites: semantics, lexicon, and pragmatics*. Utrecht: LOT.
- Aguilar-Guevara, Ana, Bert Le Bruyn & Joost Zwarts (eds). 2014. *Weak referentiality* (Linguistics Today 219). Amsterdam: John Benjamins.
- Alonso-Ovalle, Luis & Paula Menéndez-Benito. 2010. Modal indefinites. *Natural Language Semantics* 18(1). 1–31.
- Alonso-Ovalle, Luis & Paula Menéndez-Benito. 2011. Domain restriction, modal implicatures and plurality: Spanish `algunos'. *Journal of Semantics* 28(2). 211–240.
- Arregi, Karlos. 2003. *Focus on Basque movements*. Cambridge, MA: MIT dissertation.
- Artiagoitia, Xabier. 1997. DP predicates in Basque. In Maria Galvão (ed.), *University of Washington Working Papers on Linguistics* 15 (UWWPL), 161–198.
- Artiagoitia, Xabier. 1998. Determinatzaile Sintagmaren Hipotesia Euskal Gramatikan. *Uztaro* 27. 33–61.
- Artiagoitia, Xabier. 2002. The functional structure of Basque noun phrases. In Xabier Artiagoitia Patxi Goenaga & Joseba Andoni Lakarra (eds.), *Erramu Boneta: Festschrift for Rudolf P. G. de Rijk*, 73–90. Bilbao: University of the Basque Country.
- Artiagoitia, Xabier. 2004. Izen-Sintagmaren birziklatzea: IS-tik izenaren inguruko funtzio-buruetara. In Pablo Albizu & Beatriz Fernandez (eds.), *Euskal Gramatika XXI Mendearen Atarian: Arazo Zaharrak, Azterbide Berriak*, 13–38, Vitoria-Gasteiz: UPV/EHU.
- Artiagoitia, Xabier. 2006. *Euskarazko izen sintagma: arkitektura eta egitura funtzionala*. Unpublished manuscript, UPV/EHU.
- Artiagoitia, Xabier. 2004. Izen-Sintagmaren birziklatzea: IS-tik izenaren inguruko funtzio-buruetara. In Pablo Albizu & Beatriz Fernández (eds.), *Euskal Gramatika XXI Mendearen Atarian*, 13–38. Gasteiz: EHU-Arabako Foru Aldundia.
- Artiagoitia, Xabier. 2012. The DP hypothesis in the grammar of Basque. In Urtzi Etxebarria, Ricardo Etxepare & Myriam Uribe-Etxebarria (eds.), *Noun phrases and nominalization in Basque: Syntax and semantics*, 21–78, Amsterdam: John Benjamins.
- Azkue, Resurrección María. 1905. *Diccionario vasco-español-francés*. Bilbao: La Gran Enciclopedia Vasca.
- Azkue, Resurrección María. 1923. *Morfología Vasca*, Bilbao: La Gran Enciclopedia Vasca. [Edizio berria: 1969]
- Borik, Olga & M. Teresa Espinal. 2015. Reference to kinds and to other generic expressions in Spanish: Definiteness and number. *The Linguistic Review* 32(2). 167–225.
- Bouchard, Denis. 1998. The distribution and interpretation of adjectives in French: a consequence of bare phrase structure. *Probus* 10. 139–183.
- Bouchard, Denis. 2002. *Adjectives, number and interfaces. Why languages vary*. Amsterdam: Elsevier.

- Burzio, Luigi. 1981. *Intransitive verbs and Italian auxiliaries*. Cambridge, MA: MIT dissertation.
- Camino, I. 2011 [2014]. Ekialdeko euskararen iraganaz. In Irantzu Epelde (ed.), *Euskal dialektologia: lehena eta oraina* (Supplements of the *International Journal of Basque Linguistics and Philology* [ASJU] 69), 87–153. Bilbao: University of the Basque Country.
- Carlier, Anne. 2007. From preposition to article: The grammaticalization of the French partitive. *Studies in Language* 31(1). 1–49.
- Carlier, Anne. 2021, this volume. *Du/Des* NPs in French: a comparison with bare nouns in English and Spanish. In Petra Sleeman & Giuliana Giusti (eds.) *Partitive determiners, partitive pronouns and partitive case*. (Linguistische Arbeiten 580). Berlin: de Gruyter.
- Carlson, Greg. 1977. *Reference to kinds in English*. Amherst: University of Massachusetts dissertation.
- Carlson, Greg & Jeffrey Pelletier. 1995. *The generic book*. Chicago: University of Chicago Press.
- Carlson, Gregory & Rachel Sussman. 2005. Seemingly indefinite definites. In Stephan Kepser & Marga Reis (eds.), *Linguistic evidence: Empirical, theoretical, and computational perspectives*, 71–85. Berlin: Mouton de Gruyter.
- Casenave-Harigile, Junes. 2006. *Xiberotar gramatika llaburra*. Maule: Sü Azia.
- Chierchia, Gennaro. 1998a. Plurality of mass nouns and the notion of 'semantic parameter'. In Susan Rothstein (ed.), *Events and grammar*, 53–103. Dordrecht: Kluwer.
- Chierchia, Gennaro. 1998b. Reference to kind across languages. *Natural Language Semantics* 6. 339–405.
- Chierchia, Gennaro. 2009. Mass nouns, vagueness and semantic variation. *Synthese* 174. 99–149.
- Contreras, Heles. 1986. Spanish bare NPs and the ECP. In Ivonne Bordelois, Heles Contreras & Karen Zagana (eds.), *Generative studies in Spanish syntax*, 25–49. Dordrecht: Foris.
- Corbett, Greville. 2000. *Number*. Cambridge: CUP.
- Coyos, Battittu. 1999. *Le parler basque souletin des Arbailles: Une approche de l'ergativité*. Paris: L'Harmattan.
- Cyrino, Sonia & M.Teresa Espinal. 2014. Bare nominal in Brazilian Portuguese: more on the DP/NP analysis. *Natural Language and Linguistic Theory* 33: 471–521.
- Dayal, Veneeta. 2004. Number marking and (in)definiteness in kind terms. *Linguistics & Philosophy* 27. 393–450.
- Delfitto, Denis & Jan Schroten 1991. Bare plurals and the number affix in DP. *Probus* 3(2). 155–186.
- Dobrovie-Sorin, Carmen. 2009. Existential bare plurals: From properties back to entities. *Lingua* 119. 296–313.
- Dobrovie-Sorin, Carmen. 2012. Number as a feature. In Laura Brugé, Anna Cardinaletti, Giuliana Giusti, Nicola Munaro & Cecilia Poletto (eds.), *Functional heads*, 304–324. Oxford: Oxford University Press.
- Dobrovie-Sorin, Carmen & Brenda Laca. 2003. Les noms sans déterminant dans les langues romanes. In Danièle Godard (ed.), *Les langues romanes. Problèmes de la phrase simple*, 235–281. Paris: Editions du CNRS.
- Dobrovie-Sorin, Carmen & Claire Beyssade. 2012. *Redefining indefinites*. Dordrecht: Springer.
- Eguren, Luis. 2005. Marcos de predicación en vasco. In Beatriz Fernández & Itziar Laka (eds.), *Andolin gogoan: Essays in honour of Professor Eguzkitza*, 233–250. Bilbao: UPV/EHU.
- Eguren, Luis. 2006. Non-canonical uses of the article in Basque. *Proceedings of the 32nd Annual Meeting of the Berkeley Linguistics Society (BLS)*, 111–122. Berkeley: University of California.

- Eguren, Luis. 2012. Predication markers in Basque. In Etxeberria, Urtzi, Ricardo Etxepare & Myriam Uribe-Etxebarria (eds.), *Noun phrases and nominalization in Basque: Syntax and semantics*, 243–266. Amsterdam: John Benjamins.
- Eguzkitza, Andolin. 1986. *Topics in the syntax of Basque and Romance*. Los Angeles: UCLA dissertation.
- Espinal, M.Teresa. 2010. Bare nominals in Catalan and Spanish. Their structure and meaning. *Lingua* 120. 984–1009
- Espinal, M.Teresa & Louise McNally. 2007. Bare singular nominals and incorporating verbs. In Georg Kaiser and Manuel Leonetti (eds.), *Proceedings of the 3rd Nereus Workshop*, 45–62, Universität Konstanz Arbeitspapier 122.
- Espinal, M.Teresa & Louise McNally. 2011. Bare nominals and incorporating verbs in Spanish and Catalan. *Journal of Linguistics* 47(1). 87–128.
- Etxebarria, Urtzi. 2006. *Xiberotar gramatika*, Maule: Sü Azia.
- Etxeberria, Urtzi. 2005. *Quantification and domain restriction in Basque*. Bilbao: University of the Basque Country (UPV/EHU & HiTT) dissertation.
- Etxeberria, Urtzi. 2008. On quantification in Basque and on how some languages restrict their quantificational domain overtly. In Lisa Matthewson (ed.), *Quantification: A crosslinguistic perspective*, 225–276. London: Emerald.
- Etxeberria, Urtzi. 2009. Contextually restricted quantification in Basque. In Anastasia Giannakidou & Monika Rathert (eds.), *QP structure, nominalizations, and the role of DP*, 76–107. Oxford: Oxford University Press.
- Etxeberria, Urtzi. 2010. Making a definite be interpreted as an indefinite. In Roberta Pires & Carmen Dobrovie-Sorin (eds.), *Journal of Portuguese Linguistics* 9(1). 29–51.
- Etxeberria, Urtzi. 2012. Quantification in Basque. In Ed Keenan & Denis Paperno (eds.), *Handbook of Quantifiers in Natural Languages*, 183–164. Berlin: Springer.
- Etxeberria, Urtzi. 2014. Basque nominal: from a system with bare nouns to a system without. In Ana Aguilar-Guevara, Bert Le Bruyn & Joost Zwarts (eds.), *Weak referentiality*, 335–364. Amsterdam: John Benjamins.
- Etxeberria, Urtzi. In preparation. *Nominal expressions in Basque*, Ms. CNRS-IKER.
- Etxeberria, Urtzi & Anastasia Giannakidou. 2009. *Contextual domain restriction across languages: Definiteness, indefiniteness, and the structure of QP*. Ms. CNRS-IKER & University of Chicago.
- Etxeberria, Urtzi, Susagna Tubau, Joan Borrás-Comes, Viviane Déprez & M. Teresa Espinal. 2018. Relating (un)acceptability to interpretation. Experimental investigations on negation. *Frontiers in Psychology* 8: article 2370.
- Etxeberria, Urtzi, Susagna Tubau, & M. Teresa Espinal. 2021. Polarity items in Basque. Experimental evidence for the lack of negative concord. *Natural Language and Linguistic Theory*. DOI: <https://doi.org/10.1007/s11049-021-09513-2>.
- Espinal, M. Teresa, Urtzi Etxeberria & Susagna Tubau. In preparation. The limits between polarity licensing and negative concord: a reference to Basque in contrast to other languages.
- Etxepare, Ricardo. 2003. Negation. In Jose Ignacio Hualde & Jon Ortiz de Urbina, (eds.), *A grammar of Basque*, 387–421. Berlin: Mouton de Gruyter.
- Euskaltzaindia. 1993. *Euskal Gramatika Laburra: Perpaus Bakuna*, Bilbao: Euskaltzaindia.
- Fara, Delia G. 2001. Descriptions as Predicates. *Philosophical Studies* 102. 1–42.
- Farkas, Donka. 1998. Dependent indefinites. In Francis Corblin, Danièle Goddard & Jean-Marie Marandin (eds.) *Empirical issues in formal syntax and semantics*, 243–267. Frankfurt: Peter Lang.



- Fintel, Kai von. 2000. Whatever. In Brendan Jackson & Tanya Matthews (eds.), *Proceedings of SALT 10*, 27–40. Ithaca, NY: Cornell University.
- van Geenhoven, Veerle. 1998. *Semantic incorporation and indefinite descriptions: Semantic and syntactic aspects of noun incorporation in West Greenlandic*. Stanford, CA: CSLI Publications.
- Giannakidou, Anastasia. 1997. Linking sensitivity to limited distribution: the case of free choice. In Paul Dekker, Martin Stokhof & Yde Venema (eds.), *Proceedings of the 11th Amsterdam Colloquium*, 139–145. Amsterdam: ILLC, University of Amsterdam.
- Giannakidou, Anastasia. 1998. *Polarity sensitivity as (non)veridical dependency*. Amsterdam & Philadelphia: John Benjamins.
- Giannakidou, Anastasia. 2000. Negative . . . concord? *Natural Language and Linguistic Theory* 18. 457–523.
- Giannakidou, Anastasia. 2001. The meaning of free choice. *Linguistics and Philosophy* 24. 659–735.
- Giannakidou, Anastasia. 2006. N-words and negative concord. In Martin Everaert, Henk van Riemsdijk, Rob Goedemans & Bart Hollebrandse (eds.), *The Blackwell companion to syntax*, 327–392. Malden, MA: Blackwell.
- Giannakidou, Anastasia. 2011. Positive polarity items and negative polarity items: variation, licensing, and compositionality. In Claudia Maienborn, Klaus von Heusinger & Paul Portner (eds.), *Semantics: An international handbook of natural language meaning* (2nd edn), 1660–1712. Berlin: de Gruyter.
- Giannakidou, Anastasia. 2017. Polarity in the semantics of natural language. In *Oxford research encyclopedia of Linguistics*. <https://doi.org/10.1093/acrefore/9780199384655.013.7>
- Giannakidou, Anastasia & Josep Quer. 2013. Exhaustive and non-exhaustive variation with anti-specific indefinites: free choice versus referential vagueness. *Lingua* 126. 120–149.
- Giannakidou, Anastasia & Suwon Yoon. 2016. Scalar marking without scalar meaning: Non-scalar, non-exhaustive even-marked NPIs in Greek and Korean. *Language* 92(3). 522–556.
- Giusti, Giuliana. 2021, this volume. Partitivity in Italian: A protocol approach to a multifaceted phenomenon. In Petra Sleeman & Giuliana Giusti (eds.), *Partitive determiners, partitive pronouns and partitive case* (Linguistische Arbeiten 580). Berlin: de Gruyter.
- Giusti, Giuliana & Petra Sleeman. 2021, this volume. Partitive elements in the languages of Europe. An advancement in the understanding of a multifaceted phenomenon. In Petra Sleeman & Giuliana Giusti (eds.), *Partitive determiners, partitive pronouns and partitive case* (Linguistische Arbeiten 580). Berlin: de Gruyter.
- Goenaga, Patxi. 1980. *Gramatika bideetan*. Donostia: Erein.
- Goenaga, Patxi. 1991. Izen sintagmaren egituraz. In Joseba Lakarra (ed.), *Memoriae L. Mitxelena magistri sacrum*, 847–865. Donostia: EHU.
- Görgülü, Emrah. 2018. Nominals and number neutrality in languages. *Language and Linguistics Compass* 12. <https://doi.org/10.1111/lnc3.12301>
- Haspelmath, Martin. 1997. *Indefinite pronouns*. (Oxford Studies in Typology and Linguistic Theory). Oxford: Oxford University Press.
- Henderson, Robert. 2014. Dependent indefinites and their post-suppositions. *Semantics and Pragmatics* 7. Article 6. 1–58.
- Heusinger, Klaus von & Jaklin Kornfilt, 2021, this volume. Turkish partitive constructions and (non-)exhaustivity. In Petra Sleeman & Giuliana Giusti (eds.), *Partitive determiners, partitive pronouns and partitive case* (Linguistische Arbeiten 580). Berlin: de Gruyter.

- Hoeksema, Jack. 2012. On the natural history of negative polarity items. *Linguistic Analysis* 38(1–2). 3–34.
- Huuro, Tuomas. 2021, this volume. Longitudinal or transverse? How the unbounded quantity expressed by the Finnish partitive case relates to time. In Petra Sleeman & Giuliana Giusti (eds.), *Partitive determiners, partitive pronouns and partitive case* (Linguistische Arbeiten 580). Berlin: de Gruyter.
- Irigoin, Alfonso. 1985. Euskarako izen sintagma mugatzailerik gabekoez. *Euskera* XXX. 129–139.
- Irurtzun, Aritz. 2006. Focus and clause structuration in the minimalist program. In Cedrick Boeckx (ed.), *Minimalist essays*, 68–96. Amsterdam: Benjamins.
- Irurtzun, Aritz. 2016. Strategies for argument and adjunct focalization in Basque. In Beatriz Fernández & Jon Ortiz de Urbina (eds.), *Microparameters in the grammar of Basque*, 243–263. Amsterdam: Benjamins.
- Jespersen, Otto. 1924. *The philosophy of grammar*. London: Allen & Unwin.
- Karlsson, Fred. 1983. *Finnish Grammar*. Porvoo, Helsinki, Juva: Werner Söderström Osakeyhtiö.
- Kleiber, Georges. 1990. *L'article LE générique. La généricité sur le mode massif*. Genève-Paris: Droz.
- Kratzer, Angelika & Junko Shimoyama. 2002. Indeterminate pronouns: the view from Japanese. In Yukio Otsu (ed.), *Proceedings of the 3rd Tokyo Conference on Psycholinguistics*, 1–25. Tokyo: Hituzi Syobo.
- Krifka, Manfred, Francis J. Pelletier, Gregory N. Carlson, Alice ter Meulen, Gennaro Chierchia & Godehard Link. 1995. Genericity: An introduction. In Gregory N. Carlson & Francis J. Pelletier (eds.), 1–124. *The generic book*. Chicago: University of Chicago Press.
- Laakso, Johanna. 2001. The Finnic languages. In Östen Dahl & Maria Koptjevskaja-Tamm (eds.), *The Circum-Baltic languages: Typology and contact*, vol. 1, 179–212. Amsterdam: John Benjamins.
- Lafitte, Piarres. 1944. *Grammaire basque (navarro-labourind littéraire)*, 2<sup>nd</sup> edn Bayonne: Amis du Musée Basque, 1962. (Repr. Donostia-San Sebastián: Elkar, 1979).
- Laka, Itziar. 1990. *Negation in syntax: On the nature of functional categories and projections*. Cambridge, MA: MIT dissertation.
- Laka, Itziar. 1993. Unergatives that assign ergative, unaccusative that assign accusative. In Jonathan Bobaljik & Phillips Collin (eds.), *MIT Working Papers in Linguistics* 18 (Papers on Case and Agreement I). 149–172.
- Larramendi, Martin. 1729. *El imposible vencido. Arte de la lengua bascongada*. Salamanca. A. J. Villagorde Alcaráz.
- Lazaridou-Chatzigoga, Dimitra, Napoleon Katsos & Linnaea Stockall. 2016. The effect of context on generic and quantificational statements. In Fabienne Salfner & Uli Sauerland (eds.), *Pre-proceedings of trends in experimental pragmatics*, 87–94. Berlin: XPRAG.de.
- Lécluse, Fleury. 1826. *Manuel de la langue basque*. Bayonne: L. M. Cluzeau.
- Longobardi, Giuseppe. 1994. Reference and proper names: A theory of N-movement in syntax and logical form. *Linguistic Inquiry* 25(4). 609–665.
- Longobardi, Giuseppe. 2001. The structure of DPs: some principles, parameters, and problems. In Mark Baltin & Chris Collins (eds.), *The handbook of contemporary syntactic theory*, 562–603. Oxford: Blackwell.
- Manterola, Julen. 2006. -a euskal artikuluko definituaren gainean zenbait ohar. In Joseba A. Lakarra & José I. Hualde (eds.), *Studies in Basque and historical linguistics in memory of R.L. Trask – R.L. Trasken oroitzapenetan ikerketak euskalaritzaz eta hizkuntzalaritza historikoaz*, 651–676. Donostia-Bilbo: Gipuzkoako Foru Aldundia-EHU. (Supplements of ASJU).

- Manterola, Julen. 2008. -a morfemaren erabilera (eza) ekialdeko euskaretan. In Joseba Andoni Lakarra, Joaquín Gorrotxategi & Blanca Urgell (eds.), *Proceedings of 2nd conference of the Luis Michelena Chair*, 71–95. Vitoria-Gasteiz: University of the Basque Country Editorial Service.
- Manterola, Julen. 2009. *-a and bat Basque articles and recent contact theories*. -a and bat Basque articles and recent contact theories. Paper presented at the workshop *Language contact and morphosyntactic variation and change*, September 2007, Paris, France. <https://artxiker.ccsd.cnrs.fr/artxibo-00350278/document>
- Manterola, Julen. 2012. Synchronic ubiquity of the Basque article -a: A look from diachrony. In Urtzi Etxeberria, Ricardo Etxepare & Myriam Uribe-Etxebarria (eds.), *Noun phrases and nominalizations in Basque: Syntax and semantics*, 179–208. Amsterdam: John Benjamins.
- Manterola, Julen. 2015. *Euskararen morfologia historikorako: artikulua eta erakusleak*. UPV/EHU dissertation.
- Michelena, Luis. 1964. *Sobre el pasado de la lengua vasca*. Donostia: Auñamendi.
- Michelena, Luis. 1987. *Palabras y textos*. Bilbao: UPV/EHU.
- Munn, Alan & Christina Schmitt. 2005. Number and indefinites. *Lingua* 115. 821–855.
- Oihenart, Arnaut. 1638. *Notitia utriusque Vasconiae*. Paris: Cramoisy.
- Ortiz de Urbina, Jon. 1983. Empty categories and focus in Basque. *Studies in the Linguistics Sciences* 13(1). 133–156.
- Ortiz de Urbina, Jon. 1989. *Parameters in the grammar of Basque*. Dordrecht: Foris.
- Ortiz de Urbina, Jon. 1999. Focus in Basque. In George Rebuschi & Lorie Tuller (eds.), *The grammar of focus*, 311–333. Amsterdam: John Benjamins.
- Paykin, Katia & Marleen van Petegehem. 2002. Definiteness in a language without articles: A case-study of Russian. *Recherches linguistiques de Vincennes* 31: 97–112.
- Pereltsvaig, Asya. 2008. Russian nibud'-series as markers of co-variation. In Natasha Abner & John Bishop (eds.), *Proceedings of the West Coast Conference on Formal Linguistics (WCCFL) 27*, 370–378. Somerville, MA: Cascadilla Press.
- Perlmutter, David M. 1978. Impersonal passives and the Unaccusative Hypothesis. In *Proceedings of the fourth Annual Meeting of the Berkeley Linguistics Society*, 157–189.
- Rijk, Rudolf P. G. de. 1972. Partitive assignment in Basque. *ASJU* 6: 130–173. [Reprinted in de Rijk 1998].
- Rijk, Rudolf P. G. de. 1996. On the origin of the partitive determiner. *ASJU* 30 [Reprinted in de Rijk 1998].
- Rijk, Rudolf P. G. de. 1998. *De lingua vasconum: Selected writings*. EHU. (Supplements of ASJU 43).
- Rodríguez, Sonia. 2003. *Euskal artikuluaeren sintaxiaz*. Ms. UPV/EHU.
- Rullmann, Hotze & Aili You. 2006. General number and the semantics and pragmatics of indefinite bare nouns in Mandarin Chinese. In Klaus von Stechow & Ken P. Turner (eds.), *Where semantics meets pragmatics*, 175–196. Amsterdam: Elsevier.
- Seržant, Ilja. 2021, this volume. Diachronic typology of partitives. In Petra Sleeman & Giuliana Giusti (eds.), *Partitive determiners, partitive pronouns and partitive case* (Linguistische Arbeiten 580). Berlin: de Gruyter.
- Swart, Henriette de, Yoad Winter & Joost Zwarts. 2007. Bare nominals and reference capacities. *Natural Language and Linguistic Theory*, 25(1). 195–222
- Timberlake, Alan. 1977. Reanalysis and actualization in syntactic change. In Charles N. Li (ed.), *Mechanisms of syntactic change*, 141–177. Austin: University of Texas Press.

- Trask, Larry. 2003. The noun phrase: Nouns, determiners, and modifiers; pronouns and names. In José I. Hualde, & Jon Ortiz de Urbina (eds.), *A grammar of Basque*, 92–134. Dordrecht: Kluwer.
- Txillardegui. 1977. L'emploi de l'indéfini en souletin. *Fontes Linguae Vasconum* 25. 29–54.
- Uriagereka, Juan. 1999. Minimal restriction on Basque movements. *Natural Language and Linguistic Theory* 17. 403–444.
- Uribe-Etxebarria, Myriam. 1992. On the structural position of the subject in Spanish, their nature and their consequences for quantification. *Syntactic Theory and Basque Syntax; Supplements of the International Journal of Basque Linguistics and Philology* XXVII. 447–493.
- Wilhelm, Andrea. 2008. Bare nouns and number in Dene Suline. *Natural Language Semantics* 16. 39–68.
- Wouden, Ton van der. 1994. Polarity and 'illogical negation'. In Makoto Kanazawa & Christopher J. Pinon (eds.), *Dynamics, polarity and quantification*, 17–45. Stanford, CA: CSLI.
- Zabala, Igone. 1993. *Predikazioaren teoriak gramatika sortzailean*. Bilbao: UPV/EHU dissertation.
- Zabala, Igone. 2003. Nominal predication: copulative sentences and secondary predication. In José I. Hualde & Jon Ortiz de Urbina (eds.), *A grammar of Basque*, 324–339. Dordrecht: Kluwer.
- Zamparelli, Roberto. 1998. A Theory of Kinds, Partitives and *Of/Z* Possessives. In Artemis Alexiadou, & Christopher Wilder (eds.), *Possessors, predicates and movement in the Determiner Phrase*, 259–304. Amsterdam: John Benjamins.
- Zwarts, Frans. 1981. Negatief polaire uitdrukkingen I. *GLoT* 4(1). 35–133.
- Zwarts, Frans. 1995. Nonveridical contexts. *Linguistic Analysis* 25. 286–312.
- Zwarts, Frans. 1998. Three types of polarity items. In Fritz Hamm & Erhard W. Hinrichs (eds.), *Plurality and quantification*, 177–238. Dordrecht: Kluwer.



# Index

- Ablative (see also *case*) 3, 6, 7, 11, 14, 20, 34 (fn. 2), 123, 126–27, 134, 140, 148, 178 (fn. 9), 268–72, 321, 335, 345, 347
- Accusative 5, 12, 15, 19–21, 23, 33, 43–45, 48, 51, 66–72, 131, 144–145, 148, 263–291, 295–313
- Accusativus graecus 131
- Acquisition 15–17, 21–22, 213–236, 237–260
- Adposition 22, 111, 113, 122–126, 131, 140–42, 153, 158
- Africa 112, 122, 124, 140
- America 122, 133
- Ancient Greek 102, 131–134, 139, 148, 150, 176, 178
- Article
- definite 2, 7, 12, 15, 18, 22–25, 34, 36, 38, 41 (fn. 7), 44, 47, 52–57, 62 (fn. 17), 63 (fn. 19), 72, 103, 137, 169–170, 173, 176, 179–183, 186–199, 207, 215, 221–233, 265 (fn. 3), 269, 290, 319–325, 327, 329, 333–334, 337, 342–344, 348
  - indefinite 5, 21, 53–56, 79, 85, 97–99, 179–186, 103, 105, 171, 198, 215, 220, 222–232, 269, 274–275, 290–291, 297 (fn. 3), 321 (fn. 2), 322–325, 333 (fn. 14), 344
  - partitive 5, 25, 33, 36, 54–56, 79–81, 83–85, 92 (fn. 3), 95 (fn. 5), 99 (fn. 6), 101–105, 169–199, 346–347
- Aspect 3, 18, 20–21, 23, 77, 81, 91–92, 98, 106, 295–315
- atelic 91, 98, 304, 311
  - telic 77, 91, 98, 106
- Aspectuality 111–112, 131, 136, 145–146, 151–159
- Australia 112
- Balto-Slavic 5, 10–12
- Bantu 124–125, 150, 154–156
- Bare
- indefinite 9, 16, 33, 50 (fn. 13)
  - mass noun (uncount noun) 80–81, 96
  - nominal 5, 25, 35, 54–55
  - nominal expression (NomExpr) 16, 36 (fn. 5), 44–46, 49 (fn. 12), 51, 53, 55, 57, 62, 64, 66–72
  - noun (BN), (bare NP) 2, 7, 25, 33, 55, 77–84, 86, 91–99, 104, 106, 171, 179, 185, 188, 194–198, 273–274, 284, 319–320
  - partitive 14, 52–53, 70
  - plural 77–80, 86–95, 98, 100, 105–106, 326, 347
  - preposition 50 (fn. 13)
  - quantifier 211
- Basque 20–21, 23, 41 (fn. 7), 118, 140, 329–349
- Belarusian 156
- Case
- ablative 3, 7, 11, 20, 34 (fn. 2), 123, 126–127, 140, 148, 178 (fn. 9), 268–272, 321, 335, 345, 347
  - absolutive 12, 319, 322 (fn. 3), 327, 337–338, 342
  - accusative 5, 12, 16, 19, 20, 21, 23, 45 (fn. 10), 48, 68, 144–145, 148, 263–291, 295–314
  - genitive 3, 5–13, 16, 20, 33–41, 47–51, 56–57, 60–72, 94, 95 (fn. 5), 102, 118, 125–132, 139, 143–146, 149–150, 154, 178–179, 206, 267–271, 296 (fn. 2), 319, 344
  - locative 3, 6–7, 66, 70, 121–127, 139, 150, 153–155, 158, 281, 306, 308
  - nominative 5, 12, 16, 23, 45, 69, 71, 143, 145, 267, 295–299, 303–315
  - partitive 12–14, 16–17, 20–23, 34 (fn. 2), 36 (fn. 6), 44, 48, 51, 68–69, 102, 118, 123, 126, 127, 131, 140, 144–147, 159, 267, 269 (fn. 5), 295–296, 299–314
- Catalan 5–6, 15–17, 41 (fn. 7), 95 (fn. 5), 206
- Clitic
- accusative 43–44, 48, 51, 66–72
  - oblique 33, 51, 66, 67 (fn. 22), 72
  - partitive 5, 13, 15–17, 33, 36 (fn. 6), 38–41, 72, 258

- quantitative 25, 206 (fn. 1)
- resumptive 36, 56, 65, 68, 72
- Construction
  - partitive 1–3, 7, 12–14, 17–18, 21, 23, 34–42, 44, 46, 51, 54–55, 62, 101–104, 114, 126–127, 129, 131, 136–141, 158, 170, 173, 177–179, 189–190, 237, 239, 245, 257–259, 263–265, 267–272, 278, 281–283, 287–291, 335, 346
  - proper partitive 1, 23
  - pseudo-partitive 1, 23, 117–118
  - quantitative 24–25, 36, 38–46, 56, 67, 69
  - *van die* 8, 41 (fn. 7)
- Copular clause / construction 296, 298
- Davon* 7–8, 115–116, 207, 212 (fn. 8)
- Definiteness 3, 5, 20, 34, 45, 57, 134, 144, 263, 266–267, 269 (fn. 6), 273–276, 278, 288–291, 299–300, 304, 332
- Demonstrative 9, 24, 41, 52–53, 56–57, 63, 79, 103, 120, 124–126, 183–185, 215, 274, 320 (fn. 1)
- Determiner 143, 158, 179, 182, 197, 273
  - definite 15, 17, 19, 44, 319–321, 323–325, 334, 343–349
  - indefinite 2, 9, 12, 18, 33, 36 (fn. 4), 55, 72, 100, 111–112, 141–143, 218, 274, 278, 334
  - interrogative *welch* 9
  - negative 221
  - partitive 3–5, 7–9, 12–16, 19–23, 25, 35–36, 38–44, 50, 52–56, 62 (fn. 18), 66, 68–72, 319–321, 337–343, 345–348
  - zero (null / non-overt) 4, 8, 15, 43–44, 56, 63, 72
- Dialect
  - Basque 320, 322
  - German 5, 125, 206, 211 (fn. 7), 218
  - Italian 5, 11, 196–197
  - Russian 142, 146, 156
- Differential Object Marking (DOM) 12, 20, 111, 135, 263–267, 273, 276, 278, 286
- Direct object (DO) 12, 16, 24, 34, 48–51, 57, 66, 69–70, 91, 98, 100, 127, 134–135, 144–145, 147, 149, 159, 169, 172–173, 176–177, 179–181, 183–199, 263–267, 270–284, 287, 290–291, 320, 322–328, 337, 343
- Dutch 16–17, 22, 25, 41 (fn. 7), 114, 118, 123, 125, 137, 138, 139, 141, 206, 215–216, 219–220, 233, 237–258
- Elative 6, 123, 127, 140, 296, 335, 345
- Ellipsis 4, 22, 112, 131, 133, 244
- En* (also EN) 2, 5–6, 15–17, 22, 39–41, 47, 94–95, 111, 125, 135, 153, 205–234, 237–245, 249–250, 253–254, 256–258
- English 2–3, 7, 15–16, 21–22, 44, 47, 60, 77–81, 86–94, 96–101, 105–106, 113, 115–118, 120, 122, 125, 129, 136, 138, 143, 146–147, 152–153, 155–156, 158–159, 173, 208 (fn. 3), 211, 215–216, 233, 237, 239–240, 243–246, 249–258, 265 (fn. 3), 268, 271, 280, 283, 295, 297 (fn. 3), 299, 304–305, 324, 326, 332–333, 342–343, 347
- Er* 2, 9, 16, 22, 41, 114, 125, 206, 221, 233, 237–258
- Ere* 9–10
- Ervan* 240–244
- Estonian 16–17, 134, 144–145, 159
- Eurasia 22, 112, 120, 124, 140
- Event 23, 137, 151–152, 155–156, 295, 298, 300–315, 322 (fn. 3)
  - atelic 295, 300–301, 304–308, 314–315
  - telic 295, 298, 300–301, 304–310, 314–315
- Exhaustivity (exhaustive reference) 20, 23, 263, 265–266, 276, 278, 281–291, 297–298, 301, 306, 311
- Existential
  - clause 195, 296–298, 306, 308
  - indefinites 281, 333
  - inference 225 (fn. 16), 225, 276
  - interpretation 23, 320–321, 323–327, 329–330, 332, 334, 342–345, 348
  - operator 86
  - predicate 134, 172
  - presupposition 102–104, 146
  - quantifier 12, 35, 43, 48, 55–57, 72, 88, 125–126, 143, 158, 347
  - reading 83, 105, 329, 332, 333 (fn. 14)
  - sentence 339–342
  - use (of bare nouns) 79, 85
  - verb 9, 12–13, 172

- Finnic 123, 126–127, 143–148, 151, 155–156, 159
- Finnish 10–13, 17, 20–21, 23, 102, 131, 134, 140, 142, 144, 151–153, 155, 195, 295–315
- Finno-Ugric 3, 11–12, 41 (fn. 7), 126
- Franconian 8–9
- French 2, 5–7, 9, 12–13, 15–22, 25–26, 33, 38, 40–44, 47, 50 (fn. 13), 52, 72, 77–106, 111, 123, 125, 135, 141–142, 148, 153, 169, 171, 174–175, 177, 178 (fn. 9), 179, 195, 205–234, 237–259, 297, 333 (fn. 15), 340, 346
- Gallo-Romance 5, 7, 25, 41–42, 72, 142, 197 (fn. 17)
- Gascon 5, 333 (fn. 15)
- Generic
- interpretation / reading / meaning 54, 78, 84, 105, 116, 184, 193
  - noun 184–185, 194
  - reference 297–298, 301
  - sentence / event / activity 25, 85, 103, 137, 329
- Genitive (see also *case*)
- argument of verb 35
  - determiner 8, 13
  - *en/ne* 47–48, 50–51, 56, 64, 66, 69, 72, 94
  - morphology 35, 38–41, 72.
  - partitive 10, 127–128, 131–132, 144, 146, 150, 154, 178 (fn. 8, 9)
  - possessor 35, 62 (fn. 17), 165 (fn. 18)
  - preposition / PP 6–7, 34, 41 (fn. 7), 57, 60–62, 64–66, 72, 149, 178
  - pronoun 9, 13, 33, 94–95, 206
  - under negation 144
- German 7–9, 13, 17, 22, 95, 113, 115–118, 123, 125, 131, 139, 205–208, 210–214, 216–226, 228–234, 258, 265 (fn. 3)
- Germanic 5–9, 12–13, 22, 25, 41 (fn. 7), 206, 271
- Greek 139, 178, 347
- Implicit
- expression 24, 112, 115–116, 119–120, 132–133
  - partitive 24, 273, 279, 281
  - quantifier 133
  - subset 159
- Indefiniteness 3, 7, 13–14, 36 (fn. 6), 41 (fn. 7), 44, 77, 103, 111–112, 126, 130, 134–135, 140, 144, 150, 158, 169, 171, 173–174, 184, 186 (fn. 12), 188, 190, 197–199, 302, 304, 310, 315, 346
- Individual-level 78, 81, 331 (see also *predicate*)
- Indo-European 23, 41 (fn. 7), 118–119, 127–133, 138–139, 142, 144, 146–152, 155–156, 178 (fn. 8), 346
- Information structure 82–84, 267
- Ingrian 147
- Intensional
- context 5, 93–95, 98, 147
  - predicate 77, 86–87, 91, 98, 100, 104–106, 112, 119 (fn. 4), 144–146, 159, 278.
  - verb 146, 276
  - reference 19, 58–59, 191
- Intransitive
- clause 306
  - predicate 134
  - subject 134, 135, 149, 337
- Italian 2, 5–7, 9, 11–15, 18, 21–22, 25, 33–72, 78, 89, 92, 95 (fn. 5), 99 (fn. 6), 101 (fn. 7, 8), 111, 125, 141, 169–199, 206, 211, 215, 271
- Karelian 147
- Kind 18, 25, 54–56, 62, 77–78, 105, 113, 115, 117, 136–138, 143, 209, 241–244, 276, 282, 323, 325, 327–330
- L1 15–17, 22, 205–234, 237–259
- L2 15–17, 21, 22, 205–234, 237–259
- Latin 6–7, 12, 123, 125, 130, 138–141, 148, 170, 173, 177–179, 189, 197 (fn. 16), 206
- Latvian 123, 139, 146
- Lithuanian 3, 10, 24, 102, 118–119, 128, 130, 134, 139, 145–148, 152–156, 159
- Locative (see also *case*) 3, 6–7, 10, 66, 121–127, 139, 150, 153–155, 158, 281, 306, 308
- Luxembourgish 8



- Mass noun (uncount(able) noun) 20–21, 52, 67, 79–81, 91, 96, 98, 102–105, 141, 170–175, 182, 187, 189–192, 198, 211, 215, 224–226, 230–233, 272, 295, 297 (fn. 3), 298
- Measure noun (measure phrase) 23, 54–55, 57, 62–64, 72, 117, 305, 310, 313 (fn. 6)
- Ne* 2, 5–6, 40, 41 (fn. 8), 47
- genitive 36, 47, 50–51, 64, 66, 69, 72
  - oblique 36, 48, 51, 60
  - partitive 36, 38, 47–51, 67–72
  - quantitative 36 (fn. 5), 48
- Negation 10, 18, 20–21, 23, 135, 140, 144–151, 157–159, 197, 212 (fn. 9), 221, 296, 302–303, 338 (fn. 16), 341, 344–345
- discontinuous 111–112, 131, 148–149
  - predicate 148–150, 156
  - scope of 10, 19, 50 (fn. 13), 53, 77, 81, 86, 88–91, 98, 100, 104, 106
  - sentential (clausal) 18, 20, 339, 344
- Nominal expression (NomExpr) 2–3, 18, 24, 33, 36, 40, 44–51, 57–59, 62, 72, 330, 334–336, 346
- bare 36, 44–46, 49, 51, 53, 55–57, 62, 66–68, 71, 320, 329, 330–332
  - definite 38, 43, 45, 48, 51, 57, 59, 64, 67, 69, 71
  - extraction out of 60–61
  - indefinite 24–25, 33, 36, 38–51, 56–57, 66–68, 170
  - quantified 24, 34–35
  - with partitive determiner 38, 40, 55, 66, 69, 71
- Nominative (see also *case*) 5, 12, 16, 23, 45 (fn. 10), 69, 71, 143, 267, 295–299, 303–315
- Non-referential 39, 34, 146–147, 191, 193, 209–212, 223–231, 233–234, 273, 276, 290, 332
- Non-veridical 23, 321, 339–348
- Noun 10, 11,
- bare (see *bare*)
  - mass (uncount(able)) 20–21, 52, 67, 80–81, 91, 96, 102–103, 105, 141, 170–172, 175, 182, 187, 189–192, 198, 211, 215, 224–226, 230–233, 272, 295, 297 (fn. 3), 298
  - measure (quantity, qN) 1, 7, 23, 34 (fn. 3), 44–46, 54–57, 62–64, 72
  - plural / singular count 2, 21, 33, 52, 67, 79, 99, 102–105, 170, 172, 176, 178, 187, 192–193, 198, 268, 272, 314, 335
- Null
- bare NomExpr 49
  - category 45
  - determiner (D) 2, 8, 15, 44, 56, 72
  - NP 42
  - (polarity) D / determiner 319–349
  - *pro* 56
  - pronoun 9, 69, 215
  - quantifier 7, 52, 180–181
  - subject (pronoun) 38, 44, 48, 51, 72, 215, 217
- Occitan 5
- Oceania 112, 124, 140, 149, 156
- Old French 12, 101–104, 127, 134, 138, 141
- Old Italian 14, 22, 42 (fn. 9), 138, 169–199
- Old Portuguese 12
- Old Spanish 12–13, 128, 138
- Partitive
- article 5, 18, 25, 33, 36 (fn. 4), 77–106, 169–199, 346–347
  - bare 9, 14, 24, 52–53, 70
  - case 1–26, 33–72, 102, 118–159, 267, 269 (fn. 5), 295–315, 319–349
  - clitic 5, 13, 15–17, 33, 36 (fn. 6), 38, 40–41, 72, 258
  - construction 1–26, 33–72, 101–104, 111–159, 169–199, 237, 239, 245, 257–259, 264–291, 335, 346
  - determiner 1–26, 33–72, 319–349
  - element 4, 15
  - explicit 263–291
  - expression 22, 44, 120, 128, 157, 270 (fn. 7), 280
  - faded 22, 24, 52 (fn. 14), 137, 141, 157
  - generalized 12, 14, 22, 24, 111–159, 270
  - genitive 10, 127–154
  - implicit 24, 115, 273, 279, 281 (fn. 14)
  - index 154

- marker 11, 12, 111–159, 319, 334
- marking 144–151, 298
- particle 122, 125, 148, 150, 190
- plural 145, 295, 301
- PP 3, 21, 23–24, 33–72
- prefix 135, 147, 149
- preposition 2, 72, 148, 149, 272
- pronoun 1–26, 111–159, 171 (fn. 3), 205–234, 237–259, 267
- proper 1, 4, 12, 21, 23, 41 (fn. 9), 117, 264, 266, 267, 290
- pseudo 1–26, 33–62, 111–159
- singular 295, 313 (fn. 6)
- subject 172, 195
- superset 24
- true 12, 23, 24, 54, 111–159, 178, 267
- Partitivity
  - constraint 116, 136–138, 157
  - cycle 12, 112, 135, 139
  - proper 18, 23
  - pseudo-partitivity 6, 12, 138
  - true 117
- Part-whole
  - interpretation 38, 46, 56
  - relation 7, 12, 23, 24, 46, 58, 111, 170, 173, 243, 264, 267
- Plural
  - bare 77–106, 236, 347
  - count noun 2, 21, 33, 52, 102, 105, 178, 187, 192, 193, 198
- Polarity 3, 20, 23, 302, 319–349
- Polish 10, 148, 149, 156, 159
- Portuguese 5, 12, 13, 17, 78, 95 (fn. 5), 206, 326 (fn. 8)
- Possessive 64, 121, 122, 126, 153, 179, 192, 270 (fn. 8), 274, 285
  - genitive case 145
  - index 122, 139, 159
  - pronoun 65
  - strategy 121–139
  - suffix 268 (fn. 4), 296 (fn. 1)
- PP
  - circumstantial (partitive) 24, 33, 57–59, 72, 272
  - *di-* 33–72
  - genitive 51, 56, 60, 62, 64–66, 72
  - oblique 33, 50, 71
  - partitive 3, 21, 23, 24, 33–72
  - *tra-* 58, 59, 66
  - *wh-* 55
- Predicate
  - adjective (PA) 296, 298, 302
  - atelic 5, 18, 304–305, 312, 314
  - bounded 10
  - hypothetical 112, 146
  - individual-level 331
  - intensional 77–106, 112, 119 (fn. 4), 146, 159
  - negation 111, 112, 148, 150, 156, 159
  - property-denoting 78
  - stage-level 325, 331
  - telic 5, 305, 312
  - unbounded 10
- Preposition
  - ablatival 123
  - bare 50 (fn. 13)
  - covert 45
  - functional 57, 59, 60, 65
  - genitive 6, 34, 41 (fn. 7), 149
  - inflected 35
  - locative 6, 7
  - partitive-locative 150
  - semi-lexical 9
- Prepositional phrase (PP) 3, 23, 34 (fn. 2), 141, 178 (fn. 9), 243, 272
- Presuppositionality 237–259
- Pronoun
  - adverbial 206
  - anaphoric 22, 77, 92–94, 100, 106, 234
  - clitic 2, 6, 47, 71, 72
  - definite 16, 218, 220, 221, 223, 224, 226, 229, 232–234
  - genitive 13, 94, 95 (fn. 5)
  - indefinite 49, 116, 118, 125, 178, 269
  - indefinite-partitive 211
  - locative 124
  - null 9, 69, 215
  - null subject 33, 44, 51, 215
  - partitive 1–26, 111, 114, 122, 124, 125, 131, 135, 139, 153, 171 (fn. 3), 205–234, 237–259, 267
  - personal 94, 104, 125, 126, 144
  - quantitative 8, 25, 205, 206 (fn. 1), 216, 237, 238
  - subject 33, 44, 49, 51, 215

- third-person 122, 124, 125
- weak 2, 7, 9, 16, 41 (fn. 7), 215
- Protocol linguistics 21–22, 33–72
- Provençal 5, 197
- Pseudo-partitive 1–26, 33, 34 (fn. 2), 36, 62, 111–159
  
- Quantified expression 2
- Quantifier
  - adverb (A-quantifier) 146, 152, 153
  - bare 211
  - covert 39, 40
  - definite 129, 240, 241, 243
  - deleted 101
  - determiner (D-quantifier) 146, 152, 153
  - existential 12, 35, 43, 48, 55, 56, 72, 88, 125, 126, 143, 158, 347
  - explicit 131, 159
  - hidden 35
  - implicit 133
  - indefinite 111, 119, 130, 131, 133, 158, 171, 240, 243, 275, 329
  - modifying 141, 143
  - overt 52
  - presuppositional 240, 247, 249, 250, 256
  - pronominal 113, 118
  - silent 101
  - strong 240, 241, 243, 244
  - subset 119, 121, 128–131, 133, 158
  - unexpressed 132
  - universal 48, 49, 51, 57, 59, 277, 339
  - weak 240, 243, 244, 322, 329
- Quantitative
  - clitic (see *clitic*)
  - construction 24, 25, 36–46, 56, 67, 69
  - partitive 117
  - pronoun (see *pronoun*)
  - unboundedness 101, 311
  - underspecification 103
  
- Referential
  - identity 93–98, 104
  - interpretation 39, 40, 43, 48, 57, 62 (fn. 17), 137, 323, 325
  - plural indefinite 205–234
  - properties 39, 77–106
  - specificity 276, 278
  
- Romance 5–9, 12, 13, 22, 25, 41 (fn. 7), 54, 77–81, 95 (fn. 5), 105, 123, 127, 138, 139, 170, 173 (fn. 4), 177–179, 206, 271, 323, 324, 329
- Romanian 5–7, 78
- Romansh 5
- Russian 10, 16, 118, 123, 128, 129, 134, 139, 143–146, 152, 154–156, 178 (fn. 8), 271, 346
  - North 134, 142, 147, 151–153, 155
  - Old 131, 132, 148
  
- Sardinian 5
- Scope
  - ambiguous 5, 53
  - below negation 38
  - narrow 18, 50, 77–106, 265, 276–278, 320, 324, 325, 328, 329, 332–334, 344–349
  - of negation 10, 50 (fn. 13), 88, 89
  - over negation 19, 53, 56
  - wide 19, 50, 53, 77–106, 265, 276–278, 281, 324, 325 (fn. 5), 328, 329
- Slavic 41 (fn. 7), 129, 139, 143, 144, 271
- Souletin 319–349
- Spanish 5, 13, 15–17, 21, 25, 77–106, 128, 206, 215, 326, 329, 333
- Specificity 3, 20, 23, 62 (fn. 18), 263–291
- Stage-level (see also *predicate*) 325, 331
- Subset 1, 18, 23, 81, 85, 87 (fn. 2), 103, 111–159, 170, 209, 211, 240–244, 263–291
  - quantifier 119, 121, 128–131, 133, 158
- Superset 1–3, 7, 13, 18, 20, 21, 23, 24, 34 (fn. 2), 111–159, 170, 209, 263–291
  
- Task
  - Acceptability Judgment 15–16, 263, 264, 266, 277, 282
  - Binary-choice 219
  - Dictogloss 15, 216
  - Dutch proficiency 246–247
  - Grammaticality Judgment (GJT) 16, 22, 205–208, 216, 219, 221, 237, 245–246, 248, 263
  - Oral Production 15–16
  - Test of Dutch Vocabulary (TDV) 246–247, 251

- Transfer 15–17, 22, 205–234, 237–259
- Transitive
- clause 296, 313
  - sentence 150, 338
  - subject 134–135, 159
  - verb 9, 12, 57, 69, 83, 91, 98, 100, 148, 172, 281, 312, 322 (fn. 3)
- Turkic 12, 41 (fn. 7), 121, 123, 127, 140, 147, 268, 269, 291
- Turkish 3, 7, 19–21, 23, 135, 263–291, 297
- Unaccusative 12, 13, 48, 69, 82, 83, 91, 98, 100, 322 (fn. 3)
- (Un)boundedness 10, 23, 101, 295, 307, 308, 311
- Underspecification 103
- Unergative 12, 69, 172, 322 (fn. 3)
- Uralic 11, 142, 143, 145, 148, 151, 156
- Van die* 8, 9, 25, 41 (fn. 7), 137, 141
- Variation
- cross-linguistic 4
  - diachronic 12, 13
  - dialectal 322
  - diaphasic 171
  - diatopic 12, 171
  - extra/intra-genealogical 112
  - intragenetic 140
  - (morpho-)syntactic 3–4, 11
  - semantic 3–4, 11
  - synchronic 113
- Veps 142, 143, 147
- Volgaic 127, 148
- Weak indefinite 3, 25, 79, 105, 326
- Welch* 9, 22, 116, 125, 205–234

