

SEGEDUNUM

Excavations by Charles Daniels in the Roman Fort
at Wallsend (1975–1984)

VOLUME 1: The Structural Remains



Alan Rushworth and Alexandra Croom

SEGEDUNUM

Published by
Oxbow Books, Oxford, UK

© Oxbow Books and the individual authors 2016

ISBN 978-1-78570-026-2

A CIP record for this book is available from the British Library

*This book is published with the aid of a grant
from English Heritage.*

English Heritage is now Historic England



Historic England

This book is available to download from

<http://books.casematepublishing.com/Segedunum.pdf>

*Front cover: A 1975 view of Building 1 and the north-east corner of the fort,
taken from the roof of Simpson's Hotel during the first season of Charles Daniels' excavations at Wallsend.*

SEGEDUNUM

EXCAVATIONS BY CHARLES DANIELS IN
THE ROMAN FORT AT WALLSEND (1975–1984)

Volume 1: The Structural Remains

by A. Rushworth

With contributions by

M. C. Bishop, I. D. Caruana, C. M. Daniels, P. Moffat

Illustrated by

C. MacRae, M. Johnstone

CONTENTS

<i>Acknowledgements</i>	vii
<i>Summary</i>	ix
<i>Résumé</i>	xi
<i>Zusammenfassung</i>	xiv

Volume 1

PART 1 INTRODUCTION AND DISCUSSION	1
1 Introduction	2
2 The History and Development of the Fort	15
3 Pre-Roman Cultivation	51
PART 2 THE BUILDINGS OF THE CENTRAL RANGE	59
4 The Granary (Building 7)	60
5 The Hospital (Buildings 21 and 8)	88
6 The Timber Buildings Around the Granary	124
7 Cistern 1, The 'Assembly Area' and Associated Roads	153
8 The <i>Principia</i> (Building 14)	177
9 The <i>Praetorium</i> (Building 13)	219
10 The Forehall (Building AO), Central Roads and Building 15	267
11 Workshop Building 16 and the Eastern <i>Via Principalis</i>	300

PART 3 THE BUILDINGS IN THE NORTHERN PART OF THE FORT	327
12 The Evidence for Timber Barracks in the <i>Praetentura</i>	328
13 The Second-Century Stone Barracks in the <i>Praetentura</i>	332
14 The Third-Century and Later Buildings in the <i>Praetentura</i>	377
PART 4 THE BUILDINGS IN THE SOUTHERN PART OF THE FORT	431
15 The Earlier Cavalry Barracks in the <i>Retentura</i>	432
16 The Chalet-Barracks in the <i>Retentura</i>	468
PART 5 THE DEFENCES	521
17 The Western Defences, <i>Intervallum</i> Road and Hadrian's Wall	522
18 The Northern Defences	545
19 The South and East Defences	556
20 The Defences – an Overview	571

Volume 2

PART 6 THE FINDS	1
21 Building Material, by A. T. Croom	2
22 The Pottery, by B. Dickinson, A. T. Croom, K. F. Hartley and R. McBride	16
23 The Vessel Glass and Graffiti, by D. Allen and R. S. O. Tomlin	88
24 The Coins, by P. J. Casey and R. Brickstock	98
25 The Small Finds, by L. Allason-Jones, R. Brickstock, A. T. Croom, W. B. Griffiths, M. Henig, J. Tipper, C. Waddington and R. G. Willis	133
26 Metalworking and Environmental Evidence, by L. Allason-Jones and L. J. Gidney	217
Bibliography	233
Abbreviations	233
Bibliography	234
Index	245

ACKNOWLEDGEMENTS

Thanks must first go to all those who participated as volunteers, workers or supervisors in the excavations at Wallsend fort reported on here and in particular to Pete Moffat, Ian Caruana and Nigel Neil who were the principal site supervisors at different stages of the project. Pete Moffat and Ian Caruana worked on the initial programme of post-excavation with Charles Daniels, with Pete bearing the brunt of the work, dealing with both the structural report and the finds, and above all the colossal task of assembling, cataloguing and cross-referencing the structural data from such a large and complex site (at a time when computing technology was only just beginning to become widely available). The ordered context databases, phased site plans, preliminary structural analysis and the first parts of the structural report derive from this period. The structural report chapters incorporate sections of text initially compiled by Pete Moffat (Buildings 1, 2 and 4 and north-east defences), Ian Caruana (the north-west angle tower and Mike Bishop (the north-west *praetentura*). Louise Barker and Rhodri Jones, working on behalf of Newcastle University Archaeological Practice in 1997–8, undertook initial cataloguing work on the archive and assisted with compilation of the post-excavation assessment and project design, whilst Chris Lucas completed the site matrices. Chief illustrators for the Archaeological Practice were Claire MacRae and Marc Johnstone with some preliminary work being undertaken by Tony Liddel. The illustrator during the initial post-excavation period (1984–9) was Sheila Galbraith. Her plans, scanned, modified and adapted as required, form the origin of most of the final detailed

building phase plans. The comparative building plans, fort period and summary plans were produced by Claire MacRae and Marc Johnstone.

The excavations were funded on a rescue basis by North Tyneside Council, the University of Newcastle upon Tyne (through Charles Daniels' salary) and, between 1983 and 1984, the Manpower Services Commission. English Heritage has generously funded the post-excavation work and publication. Thanks are also due to the English Heritage monitors, successively Tony Wilmott, Alex Gibson, Pete Wilson, Jonathan Last and most recently Andrew Lowerre, for their patient forbearance in steering the project through to completion. John Dore and Richard Carlton also provided much valuable advice and support during the course of the project.

Permission to reproduce extracts from the 1740 Dean and Chapter estate map of Wallsend (DCD E/AA/23) and the 1801 Bell survey of Wallsend township (DCD/E/CC – shelf 85a) as Figs 2.10 and 2.11 respectively has kindly been granted by Durham University Library Archives and Special Collections. Figs 1.01, 1.02, 2.08, 6.02–6.05 and 16.30 are reproduced here by kind permission of Nick Hodgson and Tyne and Wear Archives and Museums.

Many thanks are due to Paul Bidwell, who was involved in the study of the pottery at all stages. The chief illustrators for Part 6, working on behalf of Tyne and Wear Archives and Museums, were Graham Hodgson and Dave Whitworth, with the help of Roger Oram and Dave Nelson amongst others. The intaglio photographs are by R. L. Wilkins, F.S.A. of the Institute of Archaeology, University of Oxford.

SUMMARY

Between 1975 and 1984 almost the entire area of the Roman fort of Segedunum in Wallsend was excavated under the direction of Charles Daniels, senior lecturer in the Department of Archaeology at Newcastle University. This represented one of the most ambitious and prolonged programmes of fieldwork attempted on the northern frontier up to that point and has made Wallsend one of the most fully investigated of Roman forts in Britain. It is these excavations which form the subject of this publication.

Although the 1975–84 excavations revealed most of the fort interior in most areas the remains were not excavated down to natural and even the primary Hadrianic deposits were often not fully investigated. Moreover the late Roman levels had been severely damaged by medieval and later ploughing as well as colliery activity and residential development from the beginning of the nineteenth century onwards. Accordingly the remains revealed were predominantly those of the second and third centuries, though some late Roman features did survive in little pockets here and there, providing clues as to the character of fourth-century occupation.

The opening chapters provide an introduction to the project (1), outlining the history of the project, the sequence and methodology of excavation, and the impact of renewed excavation by Tyne and Wear Museums in 1997–8 on Daniels' initial interpretations of the results. It also offers an assessment of the significance of Charles Daniels' work at Wallsend. Chapter 2 summarises the structural history of the fort as revealed by the excavations. In particular it shows how the structural phases of individual buildings relate to the overall periods of activity within the fort, and thus the way in which construction in the one part of the fort corresponded with and affected that in another. Full Period and Phase concordance tables are included. A summary of the post-Roman history of the site is also provided. Chapter 3 then presents the data gathered by the 1975–84 excavations regarding pre-Roman agricultural features within the fort.

Part 2, comprising Chapters 4–11, covers the buildings of the fort's central range, namely the granary (Chapter 4), hospital (5), headquarters (*principia*) (8), commanding officer's house (*praetorium*) (9), the forehall fronting the *principia* and granary (10), and a long narrow building, perhaps a workshop, on the north side of the eastern *via principalis* (11). In the case of all but the *praetorium* these buildings were fully exposed. The surviving remains are largely of the second and third centuries, the hospital, and perhaps the *praetorium*, being demolished by the later third century. Remains of a timber building, perhaps associated with the fort's construction phase, were found underlying the *principia*, plus two sets of abortive foundations for a south range of offices in that building, perhaps hinting at a prolonged period of construction. The remains of the forehall are particularly significant as this type of structure has only rarely been found in forts in Britain and a number of internal features as well as an external timber portico were identified. An assortment of smaller buildings lining the *via quintana*, along the south side of the range, are also covered in this section. These include a trio of multi-phase timber buildings, tucked into the recess at the south end of the granary, between the hospital and headquarters, which belong to the third century (Chapter 6). Following re-excavation in 1997–8 these were interpreted as a row of *contubernia* for irregular troops (Row 20), however it can now be determined that a further group of timber buildings, overlying the hospital, were contemporary only with the latest phase of Row 20. Further east, another group of three buildings, this time built of stone, was strung along the south side of the *praetorium* (9). There is no indication that these served as supplementary *contubernia*, however, and some ancillary function is more likely. The fragmentary remains of yet another stone building of similar size and form attached to the south face of the *principia* suggests this may have been a relatively widespread pattern along the *via quintana*.

Chapters 12, 13 and 14 cover the buildings in the

northern third of the fort, revealed to be a group of six infantry barracks. There is a little evidence for the existence of an entirely timber phase of barrack blocks here, relating to the initial Hadrianic period of occupation, though the remains are not as conclusive as those uncovered in relation to the cavalry barrack blocks in the southern part of the fort during 1998 (Chapter 12). These were followed in the mid-second century by a series of blocks with stone external walls (13). Internal details revealed in the *contubernia* include timber partitions, hearths, side entrance passageways and thresholds with pivot holes for the doors. These blocks underwent rebuilding in the early decades of the third century (14), which involved the substitution of stone partition walls for timber ones but retained the form of a conventional barrack block in contrast to the chalet-barrack ranges erected in the southern part of the fort. Most intriguing was the evidence for a significant reduction in the unit strength in this period. Thus in the north-east corner one of the three barracks was replaced by a stable block. Survival of the comparable third-century remains in the north-western quarter of the fort was much more fragmentary, but the buildings there were clearly laid out on a different footprint from their predecessors and the most plausible restoration of that layout can likewise only comfortably accommodate two barrack blocks.

In Part 4 Chapters 15 and 16 respectively examine the second- and third-century cavalry barracks in the southern part of the fort (*retentura*). Two of the second-century barracks (9 and 12) were previously analysed in the report on the 1998 excavations where they were first interpreted as cavalry stable-barracks. Chapter 15 summarises the related features revealed by the Daniels excavations and integrates the remains of the other two barracks into the same framework. In Chapter 16 a clearer understanding is provided of aspects of the third-century chalet-barracks, which were better preserved when first uncovered by Daniels in 1978–9. Structural details in one of the chalet-barracks (9) suggest the original intention was to lay the third-century cavalry barracks out as conventional barrack blocks, resembling the roughly contemporary infantry barracks, but perhaps arranged back to back. The reduced number of *contubernia* in the chalet-barracks by comparison with the second-century stable-barracks again points to a reduction in the size of the overall garrison in the third century.

Part 5 (Chapters 17–20) covers the excavations which were undertaken to examine the defences, looking in turn at the western (X), northern (8) and southern and eastern (19) sides of the fort. Much of this work was restricted to investigating discrete structures such as towers and gates, and in the case of the towers around the south-eastern corner of the circuit little remained apart from the primary foundation levels so severe was the post-Roman disturbance in this

area. However the western and northern stretches were more extensively explored with two successive revetment walls being traced behind the north rampart, whilst the remains of Hadrian's Wall were also uncovered adjoining the west gate, revealing two successive layers of cobble foundations. Chapter 20 provides an overview of the development of the defences at Wallsend, summarising the evidence for modifications to the gates, the presence of ovens and rampart buildings and late refurbishments of the curtain wall, for example, and comparing these sequences with those identified in other frontier forts.

The chapters on the material culture from the site looks at the stonework, pottery, coins and small finds recovered. The finds come from across the site and from all phases, but due to the post-Roman history of the site almost half of them are unstratified.

The stonework and ceramic building material catalogued in Chapter 21 provides information on the appearance of the fort, including a noticeable proportion of poorly made tiles. The finds include a very rare stone latrine seat and a bench support.

The site produced almost 1100kg of pottery, over half of which was unstratified. Chapter 22 consists of reports on the samian, mortaria, amphorae and coarse wares. The mortaria includes a large collection of vessels stamped by Anaus, making the site one of his largest markets. There is a general overview of the pottery from the site, but the report concentrates on the study of a number of large assemblages of interest, including two second-century groups from an alley deposit (Alley 1) and from a possible rampart building, as well as a group closely dated to c.270 from the infilling of Cistern 1.

The assemblage of vessel glass in Chapter 23 is small, and fourth-century material is poorly represented, but it includes a good collection of colourless tablewares of the second and third centuries. The same chapter also looks at the lead sealings and graffiti from the site. Chapter 24 catalogues the coins from the site. This is a small assemblage of only 295 coins, with the fourth-century coinage under-represented due to the post-Roman disturbance of the site.

The small finds are studied in Chapter 25. This is a large assemblage, with a catalogue of over 1000 finds. Most are second or third century in date, but there are a few first-century items and some fourth-century material. The finds are studied by material, and then by building and themes such as ritual and cavalry fittings. The distribution pattern of a number of categories is discussed. There is a small collection of post-Roman material, including Anglo-Saxon pieces.

The report on the animal bone in Chapter 26 looks in detail at two assemblages, from Cistern 1, which had an unusual deposit resulting from an episode of specialised meat processing, and from the Commanding Officer's house, which had a wider species list than the fort as a whole, including evidence for hunting.

RÉSUMÉ

Entre 1975 et 1984 presque toute la zone du fort romain de Segedunum à Wallsend fut fouillée sous la direction de Charles Daniels, maître de conférence à la faculté d'archéologie de l'université de Newcastle. Cela constituait l'un des plus ambitieux et des plus longs programmes de travaux de terrain jamais entrepris sur la frontière nord à ce moment-là et a fait de Wallsend l'un des forts romains de Grande-Bretagne les plus minutieusement fouillés. Ce sont ces fouilles qui font l'objet de cette publication.

Bien que les fouilles de 1975–84 révèlent la plus grande partie de l'intérieur du fort, dans la plupart des endroits les vestiges ne furent pas excavés jusqu'au naturel et même les dépôts primaires hadrieniques n'ont souvent pas été complètement examinés. De plus, les niveaux de la fin de la période romaine ont été sérieusement endommagés par les labours au moyen-âge et plus tard ainsi par des activités minières et l'aménagement de résidences à partir du XIXe siècle. Pour cette raison les vestiges mis au jour datent essentiellement des IIe et IIIe siècles, bien que des traits de la fin de la ère période romaine tardive aient survécu dans de petites poches ici et là, nous apportant quelques indices quant au caractère de l'occupation du IVe siècle.

Les premiers chapitres constituent une introduction au projet (1), esquissant les grandes lignes de l'histoire du projet, la séquence et la méthodologie des fouilles et l'impact de nouvelles fouilles menées par les musées de Tyne & Wear en 1997–98 sur les travaux de Charles Daniels à Wallsend. Le chapitre 2 résume l'histoire structurelle du fort telle que l'ont révélée les fouilles. Il démontre en particulier comment les phases structurelles de bâtiments particuliers s'inséraient à l'ensemble des périodes d'activité du fort, et ainsi la manière dont les travaux de construction dans une partie du fort correspondaient à et en affectaient une autre. Toutes les tables de concordance période et phase sont incluses. Un résumé de l'histoire post-romaine du site est également fourni. Puis le chapitre 3 présente les données collectées au cours des fouilles

de 1975–84 sur les vestiges agricoles pré-romains à l'intérieur du fort.

La deuxième partie, qui comprend les chapitres 4 à 7, ouvre les bâtiments de la partie centrale du fort, c'est à dire le grenier à grain (chapitre 4), l'hôpital (5), le quartier général (*principia*) (8), la maison de l'officier en charge (*praetorium*) (9), la halle devant le *principia* et le grenier (10) et un bâtiment long et étroit, peut-être un atelier, du côté nord de la *via principalis* à l'est (11). Dans tous les cas, sauf pour le *praetorium*, ces bâtiments étaient totalement exposés. Les vestiges qui ont survécu sont pour la plupart du deuxième et du troisième siècles, l'hôpital, et peut-être le *praetorium*, avait été démolis d'ici la fin du troisième siècle. Les restes d'un bâtiment en bois, peut-être associé à la phase de construction du fort ont été découverts sous le *principia*, ainsi que deux exemples de fondations avortées pour une rangée de bureaux au sud dans ce bâtiment-là ce qui suggère peut-être une période de construction prolongée. Les vestiges du hall avancée sont particulièrement significatifs car ce type de structure n'a que rarement été trouvé dans les forts en Grande-Bretagne et un nombre de traits internes aussi bien qu'un portique en bois externe ont été identifiés. Un assortiment de bâtiments plus petits, bordant la *via quintana* le long du côté sud de la rangée, sont aussi traités dans cette section. Ceux-ci comprennent un trio de bâtiments en bois construits en plusieurs phases, blottis dans le recul à l'extrémité sud du grenier, entre l'hôpital et le quartier général, qui font partie du troisième siècle (chapitre 6). Suite à de nouvelles fouilles en 1997–98 on les interprète comme une rangée de *contubernia* pour des troupes occasionnelles (rang 10), cependant on a pu maintenant vérifier qu'un autre groupe de bâtiments en bois, recouvrant l'hôpital, n'étaient contemporains que de la dernière phase de Row 10. Plus à l'est, un autre groupe de trois bâtiments, cette fois-ci construits en pierre s'étirait le long du côté sud du *praetorium* (9). Il n'est pas avéré qu'ils servaient de *contubernia* supplémentaire, cependant, et un rôle

ancillaire est plus probable. Les restes fragmentés d'un autre bâtiment de pierre de taille et de forme similaires attaché à la façade sud de la *p incipia* donne à penser que cela aurait pu être un trait relativement répandu le long de la *v a quintana*.

Les chapitres 12, 13 et 14 couvrent les bâtiments du tiers nord du fort, qui se sont révélés être un groupe de six casernes d'infanterie. Il n'y a que peu de témoignages de l'existence d'une phase de blocs de casernes entièrement en bois ici, ayant un rapport avec la période d'occupation d'Hadrien initiale, bien que les restes ne soient pas aussi concluants que ceux découverts en relation avec les blocs de casernes de cavalerie dans la partie sud du fort en 1998 (chapitre 12). Ceux-ci furent suivis, au milieu du deuxième siècle, par une série de blocs dont les murs externes étaient en pierre. Les détails internes révélés dans la *contubernia* comprennent des cloisons en bois, des foyers, des passages d'entrée sur les côtés et des seuils avec des trous pour les pivots des portes. Ces blocs subirent des modifications, reconstructions dans les premières décennies du troisième siècle qui impliquèrent la substitution de cloisons en bois à la place des cloisons en pierre mais la forme d'un bloc de casernes conventionnel fut conservée contrairement à la rangée de casernes chalets érigées dans la partie sud du fort. Plus intrigant était le fait que le nombre d'unités fut sérieusement réduit à cette période. Ainsi, dans le coin nord-ouest, une des trois casernes fut remplacée par un bloc d'écuries. La survivance de restes comparables du troisième siècle dans le quartier nord-ouest du fort était bien plus fragmentaire, mais les bâtiments là étaient clairement arrangés sur une différent schéma par rapport à leurs prédécesseurs et la restauration la plus plausible de cette plan ne peut de la même manière n'avoir accueilli confortablement que deux blocs de casernes.

Dans la partie 4 chapitres 15 et 16 examinent respectivement les casernes de la cavalerie des deuxième et troisième siècles dans la partie sud du fort (*retentura*). Deux des casernes du deuxième siècle (9 et 12) furent analysées précédemment dans le rapport des excavations de 1998 où on les a d'abord interprétées comme des écuries pour la cavalerie. Le chapitre 15 résume les caractéristiques révélés par les fouilles de Daniels et intègre les restes des deux autres casernes dans le même cadre. Dans le chapitre 16, nous fournissons une connaissance plus éclairée de certains aspects des casernes chalets du troisième siècle qui étaient mieux préservés quand ils furent pour la première fois mis au jour par Daniels en 1978-79. Des détails structurels dans une des casernes chalet donnent à penser que l'intention au départ était construire les casernes de cavalerie du troisième siècle comme des blocs de casernes conventionnels, ressemblant aux casernes d'infanterie quasiment contemporaines, mais peut-être arrangées dos à dos. Le nombre réduit de

contubernia dans les casernes chalets en comparaison avec les casernes écuries du deuxième siècle suggère une réduction de la taille de l'ensemble de la garnison au troisième siècle.

La partie 5 (chapitres 17-20) couvre les excavations qui furent entreprises pour examiner les défenses, considérant chacun à son tour les côtés ouest (17), nord (18) et sud et est (19) du fort. Une grande partie de ces travaux fut restreinte à l'investigation de structures dispersées telles que les tours et les portes, et dans le cas des tours autour du coin sud du circuit peu de chose restait à part les niveaux de fondations primaires, la destruction post-romaine dans cette zone ayant été si sévère. Cependant les ailes ouest et nord, tandis que les restes du mur d'Hadrien furent aussi mis au jour adjacents à la porte ouest, révélant deux couches successives de fondations de cailloux.

Le chapitre 20 offre un aperçu du développement des défenses de Wallsend, résumant les témoignages de modification des portes, la présence de fours et de bâtiments de remparts et des restaurations tardives de la courtine, par exemple, et comparer ces séquences avec celles identifiées dans d'autres forts frontières.

Les chapitres sur la culture matérielle du site considèrent le travail de la pierre, la poterie, les monnaies et petites trouvailles mises au jour. Les trouvailles proviennent de l'ensemble du site et de toutes les phases, mais en raison de l'histoire post-romaine du site presque la moitié n'est pas stratifiée.

Les matériaux de construction, la pierre et la céramique catalogués au chapitre 2 fournissent des renseignements sur l'apparence du fort, y compris une remarquable proportion de tuiles de mauvaise qualité. Parmi les trouvailles se trouvent un très rare sigle de latrine en pierre et un banc de soutien.

Le site a produit presque 1100 kilos de poterie dont plus de la moitié n'était pas stratifiée. Le chapitre 22 consiste en rapports sur les objets samiens, mortaria, amphores et grossiers. Les mortaria comprennent une importante collection de récipients estampillés Ahaus, faisant du site l'un de ses plus grands marchés. Il y a un aperçu général de la poterie du site, mais le rapport se concentre sur l'étude d'un nombre d'assemblages qui présentent un intérêt, y compris deux groupes du deuxième siècle d'un dépôt dans une allée (Alley 1) et d'un éventuel bâtiment de rempart ainsi que d'un groupe daté précisément de C.270 du comblement de la citerne 1

L'assemblage de verre à récipients du chapitre 3 est petit, et le matériel du quatrième siècle est peu représenté, mais il comprend une bonne collection de vaisselle incolore des deuxième et troisième siècles. Ce même chapitre considère aussi le sceau plomb et les graffiti du site. Le chapitre 24 catalogue les monnaies du site. C'est un assemblage qui ne comprend que quelques pièces, les monnaies du quatrième siècle y sont sous-représentées à cause des perturbations du site à la période post-romaine. Les menues trouvailles sont

étudiées au chapitre 2. C'est un grand assemblage avec un catalogue de plus de 1000 trouvailles. La plupart date du deuxième ou troisième siècle, mais il y a quelques articles du premier siècle et du matériel du quatrième. Les trouvailles ont été étudiées par matière et ensuite par bâtiment et thème tels que ornements rituels et cavaliers.

On discute du schéma de répartition d'un nombre de catégories. Il existe une petite collection de matériel

post-romain, y compris des pièces anglo-saxonnes.

Le rapport sur les os animaux, au chapitre 26 examine en détail deux assemblages de la citerne 1 qui avait un dépôt inhabituel résultant d'un épisode de transformation de viande spécialisée et de la maison de l'officier en charge, qui avait une liste plus longue d'espèces que tout le fort, y compris des témoignages de chasse.

Traduction: Annie Pritchard

ZUSAMMENFASSUNG

Zwischen 1975 und 1984 wurde unter der Leitung von Charles Daniels, Senior Lecturer am Archäologischen Seminar der Universität Newcastle, fast das gesamte Areal des römischen Kastells Segedunum in Wallsend ausgegraben. Dies ist eines der ambitioniertesten und ausgedehntesten Ausgrabungsprojekte, die bis dahin an der Nordgrenze in Angriff genommen wurden und aufgrund dessen Wallsend nun eines der am besten untersuchten römischen Kastelle Großbritanniens ist. Diese Ausgrabungen sind das Thema des hier vorgelegten Bandes.

Obwohl während der Ausgrabungen 1974–84 fast der gesamte Innenbereich des Kastells freigelegt wurde, wurden die meisten Befunde nicht bis auf den anstehenden Boden ausgegraben und selbst die primären, hadrianischen Schichten sind häufig nicht vollständig untersucht worden. Darüber hinaus waren die spät-kaiserzeitlichen Schichten durch mittelalterliches und jüngeres Pflügen sowie Kohlebergbau und Wohnbebauung seit Beginn des 19. Jahrhunderts stark gestört. Dementsprechend stammten die aufgedeckten Befunde größtenteils aus dem 2. und 3. Jahrhundert, obgleich sich vereinzelt später-kaiserzeitliche Befunde fanden, die Aufschluss über den Charakter der Besiedlung im 4. Jahrhundert vermitteln.

Das einleitende Kapitel gibt eine Einführung in das Projekt (1): es werden die Geschichte des Projekts, die Abfolge und Methodik der Ausgrabung sowie die Auswirkung der von den Tyne and Wear Museen 1997–8 durchgeführten neuerlichen Grabungen auf Daniels ursprüngliche Interpretationen der Ergebnisse vorgestellt. Daneben bietet es auch eine Einschätzung der Bedeutung von Charles Daniels Arbeit in Wallsend. Kapitel 2 fasst die durch Ausgrabungen erschlossene Baugeschichte des Kastells zusammen. Insbesondere wird dargestellt, wie sich die Bauphasen einzelner Gebäude in die umfassenden Aktivitätsperioden innerhalb des Kastells einfügen, womit sich zeigen lässt, wie sich die Bebauung in einem Bereich des Kastells auf jene in einem anderen

Bereich auswirkte. Vollständige Konkordanztabellen für Perioden und Phasen sind beigelegt. Darüber hinaus wird auch die nach-römische Geschichte des Fundplatzes zusammengefasst. Kapitel 3 präsentiert die während der Ausgrabungen 1975–84 innerhalb des Kastells gesammelten Daten zu den vor-römischen landwirtschaftlichen Befunden.

Teil 2, mit den Kapiteln 4 bis 11, behandelt die im zentralen Bereich des Kastells gelegenen Gebäude, und zwar den Speicher (Kapitel 4), das Krankenhaus (5), das Stabsgebäude (*principia*), das Kommandeurswohnhaus (*praetorium*) (9), die Vorhalle vor *principia* und Speicher (10) sowie ein langes, schmales, an der Nordseite der östlichen *via principalis* gelegenes Gebäude – vielleicht eine Werkstatt (11). Abgesehen vom *praetorium* wurden all diese Gebäude vollständig freigelegt. Die erhaltenen Gebäudereste stammen größtenteils aus dem 2. und 3. Jahrhundert, das Krankenhaus und vielleicht das *praetorium* wurden im späten 3. Jahrhundert abgebrochen. Reste eines Holzbaus, der möglicherweise aus der Errichtungszeit des Kastells stammt, wurden unter der *principia* gefunden, zusätzlich zu zwei nicht fertiggestellten Fundamenten für einen Südflügel mit Schreibstuben/Archiven innerhalb des Gebäudes, was vielleicht auf eine längere Bauzeit schließen lässt. Die Überreste der Vorhalle sind von besonderer Bedeutung, da derartige Strukturen in Kastellen in Britannien bislang nur selten nachgewiesen und eine Reihe interner Befunde sowie ein äußerer Holzportikus identifiziert werden konnten. Verschiedene kleinere Bauten beiderseits der *via quintana*, entlang der Südseite der Gebäudeflucht, werden ebenfalls in diesem Abschnitt behandelt. Es handelt sich dabei u.a. um drei mehrphasige Holzbauten des 3. Jahrhunderts, die in die Lücke am Südende des Speichers, zwischen Krankenhaus und Kommandantur, gezwängt wurden (Kapitel 6). Nach ihrer erneuten Ausgrabung 1997–8 wurden sie als eine Reihe von *contubernia* für irreguläre Truppen (Row 20) gedeutet, jedoch kann nun festgestellt werden, dass eine weitere Gruppe von

das Krankenhaus überlagernden Holzbauten lediglich mit der letzten Phase von Row 20 zeitgleich war. Weiter ostlich, in einer Reihe entlang der Südseite des *praetorii*, lag eine weitere Gruppe von drei Gebäuden, diesmal aus Stein errichtet (9). Es gibt jedoch keine Anzeichen dafür, dass sie als zusätzliche *contubernia* dienten, so dass eine wie auch immer geartete Nutzung als Nebengebäude wahrscheinlicher ist. Die fragmentarischen Überreste eines weiteren, an der Südfassade der *principia* angebauten Steingebäudes vergleichbarer Größe und Form deuten darauf hin, dass dies entlang der *via quintana* wohl ein recht verbreitetes Bebauungsmuster war.

Die Kapitel 12, 13 und 14 behandeln die Bauten im nördlichen Drittel des Kastells, die sich als eine Gruppe von sechs Infanteriebaracken herausstellten. Es fanden sich hier einige wenige Hinweise auf eine komplett in Holz errichtete Bauphase von Mannschaftsbaracken aus der hadrianischen Anfangsperiode der Kastellbelegung, allerdings sind die Befunde nicht so aufschlussreich wie jene, die 1998 im Zusammenhang mit den Kavalleriebaracken im südlichen Teil des Kastells freigelegt wurden (Kapitel 12). In der Mitte des 2. Jahrhunderts wurden diese durch eine Reihe von Gebäudeblöcken mit steinernen Außenmauern ersetzt (13). Die in den *contubernia* nachgewiesene Details der Innengliederung umfassen u.a. hölzerne Trennwände, Herde, Korridore für Seiteneingänge und Türschwelle mit Zapflöchern für die Türen. In den frühen Jahrzehnten des 3. Jahrhunderts wurden diese Gebäudeblöcke umgebaut, wobei u.a. die hölzernen Trennwände durch steinerne ersetzt wurden, jedoch – im Gegensatz zu den im südlichen Teil des Kastells errichteten Chalet-artigen Barackenblocks – unter Beibehaltung der Form konventioneller Mannschaftsbaracken. Von besonderem Interesse waren die Hinweise auf eine deutliche Reduzierung der Mannschaftsstärke in dieser Periode. So wurde in der Nordost-Ecke eine der drei Mannschaftsbaracken durch einen Stall ersetzt. Die Erhaltung vergleichbarer Befunde des 3. Jahrhunderts im nordwestlichen Viertel des Kastells war wesentlich fragmentarischer, aber die Gebäude sind dort offensichtlich nach einem anderen, von den Vorgängerbauten abweichenden Grundriss errichtet worden, und die plausibelste Rekonstruktion der räumlichen Anordnung bietet auch hier lediglich ausreichend Platz für zwei Mannschaftsbaracken.

In Teil 4 werden in den Kapiteln 15 und 16 die Kavalleriebaracken des 2. und 3. Jahrhunderts im südlichen Bereich des Kastells (*retentura*) untersucht. Zwei der Baracken des 2. Jahrhunderts (9 und 12) wurden bereits im Bericht über die Ausgrabungen von 1998 analysiert, wo sie zunächst als Kavallerie Stall-Baracken gedeutet wurden. Kapitel 15 fasst die in Daniels Ausgrabungen freigelegten zugehörigen Befunde zusammen und integriert das ruinen der beiden anderen beiden Baracken in denselben

Erklärungsrahmen. Kapitel 16 bietet ein besseres Verständnis von Aspekten der Chalet-artigen Baracken des 3. Jahrhunderts, die 1978–9 bei ihrer ersten Entdeckung durch Daniels noch besser erhalten waren. Konstruktive Details in einer der Chalet-artigen Baracken (9) lassen vermuten, dass ursprünglich beabsichtigt wurde, die Kavalleriebaracken des 3. Jahrhunderts wie konventionelle, den zeitgleichen Infanteriebaracken gleichenden Barackenblocks anzulegen, aber vielleicht hintereinander angeordnet. Die im Vergleich zu den Stall-Baracken des 2. Jahrhunderts geringere Anzahl von *contubernia* in den Chalet-artigen Baracken deutet wiederum auf eine Reduzierung der Mannschaftsstärke im 3. Jahrhundert hin.

Teil 5 (Kapitel 17–20) behandelt die zur Untersuchung der Verteidigungsanlagen durchgeführten Ausgrabungen, und zwar der Reihe nach der westlichen (17), nördlichen (18) sowie der südlichen und östlichen (19) Kastellseiten. Ein Großteil dieser Arbeiten beschränkte sich auf die Untersuchung einzelner Strukturen wie Türme und Tore. Im Falle der Türme entlang der südöstlichen Ecke des Verlaufs der Anlagen hat sich aufgrund starker nach-römischer Störungen abgesehen von den ursprünglichen Fundamenten wenig erhalten. Im Gegensatz dazu wurden die westlichen und nördlichen Abschnitte umfassender untersucht, wobei zwei aufeinanderfolgende Schalmauern hinter der nördlichen Wehrmauer nachgewiesen werden konnten, während sich im Anschluss an das Westtor Reste des Hadrianswalls in Form zweier aufeinanderfolgender Bruchsteinfundamente fanden. Kapitel 20 bietet einen Überblick der Entwicklung der Verteidigungsanlagen in Wallsend, wobei z.B. die Hinweise auf die Umbauten der Tore, die vorhandenen Öfen und Wallbauten sowie die späte Renovierung der Umfassungsmauer zusammengefasst und mit den Entwicklungen anderer Grenzkastelle verglichen werden.

In den Kapiteln zum Kulturmaterial des Fundplatzes werden das geborgene Mauerwerk, die Gefäßkeramik, Münzen und Kleinfunde betrachtet. Die Funde stammen aus allen Bereichen und Phasen des Kastells, aber fast die Hälfte ist aufgrund der nach-römischen Geschichte des Fundplatzes unstratifiziert.

Das in Kapitel 21 katalogisierte Mauerwerk und keramische Baumaterial, darunter ein bedeutender Anteil minderwertiger Ziegel, liefert Hinweise auf das Aussehen des Kastells. Unter den Funden befinden sich unter anderem ein sehr seltener steinerner Latrinsitz und ein Sitzbankunterbau.

Es wurden fast 1100kg Gefäßkeramik geborgen, wovon mehr als die Hälfte unstratifiziert ist. Kapitel 22 beinhaltet die Berichte zur Terra sigillata, den Reibschalen, Amphoren und der Grobkeramik. Unter den Reibschalen befindet sich eine große Gruppe von Gefäßen mit dem Stempel des Anaus, was den

Fundplatz zu einem seiner größten Absatzmärkte macht. Neben einem generellen Überblick über die Gefäßkeramik des Fundplatzes konzentriert sich der Bericht auf die Auswertung einer Reihe größerer, wichtiger Fundkomplexe, darunter zwei Fundgruppen des 2. Jahrhunderts aus einem Befund in einer Gasse (Alley 1) und einem möglichen Wallgebäude, sowie einem recht genau auf ca. 270 datierten Fundkomplex aus der Füllung von Zisterne 1.

In der kleinen Menge des in Kapitel 2 vorgelegten Gefäßglases ist Material des 4. Jahrhunderts unterrepräsentiert, es findet sich aber eine gute Sammlung von farblosem Tafelgeschirr des 2. und 3. Jahrhunderts. In demselben Kapitel werden auch die Bleisiegel und Graffiti betrachtet. Die Fundmünzen werden in Kapitel 24 katalogisiert. Mit lediglich 295 Münzen ist dies eine kleine Münzreihe, in der Prägungen des 4. Jahrhunderts aufgrund der nach-römischen Störung des Fundplatzes unterrepräsentiert sind.

Die Kleinfunde werden in Kapitel 25 untersucht. Dies ist eine große Sammlung mit einem über 1000 Funde umfassenden Katalog. Die meisten Funde datieren in das 2. oder 3. Jahrhundert, aber es sind auch einige Gegenstände des 1. sowie Material des 4. Jahrhunderts darunter. Die Funde wurden nach Materialgruppen getrennt bearbeitet und dann nach Baubefunden und Themen wie rituelle Gegenstände oder Kavallerieausrüstung analysiert. Die Verbreitungsmuster einer Reihe verschiedener Fundkategorien werden diskutiert. Eine geringe Anzahl nach-römischen Materials umfasst u.a. angelsächsische Funde.

Der Bericht zu den Tierknochen in Kapitel 26 beschäftigt sich detailliert mit zwei Fundkomplexen: aus Zisterne 1, die eine ungewöhnliche, von einer Episode spezieller Fleis Zubereitung herrührende Deponierung enthielt, sowie aus dem Haus des Kommandeurs, in dem sich eine umfassendere Anzahl von Spezies als im gesamten Rest des Kastells fand, darunter auch Hinweise auf Jagd.

Übersetzung: Jörn Schuster

PART 1

INTRODUCTION AND DISCUSSION

1. INTRODUCTION

Between 1975 and 1984 a major programme of area excavations was conducted over the entire site of Segedunum Roman fort, in Wallsend, under the direction of Charles Daniels (then senior lecturer in the Department of Archaeology at Newcastle University). This transformed our understanding of the fort interior, making its plan – hitherto a virtual blank – one of the most comprehensively revealed on the northern frontier. This was subsequently amplified by further work undertaken by Tyne and Wear Museums as part of the Segedunum Project in 1997–8. Following completion of the 1975–84 fieldwork, a significant amount of post-excavation analysis was carried out in the Department of Archaeology during the years 1984–9. A further programme of post-excavation work was undertaken by the Newcastle University Archaeological Practice and Tyne and Wear Museums in conjunction with the Segedunum Project, commencing in 1997, with The Archaeological Practice Ltd taking the place of Newcastle University in 2003. This volume represents full report on that important programme of excavations.

Background

The Site

The Roman fort of Segedunum stood in a strong position at the eastern terminal of Hadrian's Wall (Fig. 1.01), and indeed its Roman name is thought to mean 'Strong Fort' or 'Victory Fort' (Rivet and Smith 1981, 452–3). Its location on a spur overlooking a bend of the River Tyne provided commanding views in every direction, but particularly up and down the stretches of river to the east and south. The river was wider in antiquity (prior to the reclamation of land for shipyards as part of the Tyne Improvement works in the nineteenth century) and the ground dropped away fairly steeply from the south side of the fort

down to the river bank (Fig. 1.02).

The fort was associated with the extension of Hadrian's Wall four miles east from Newcastle c. AD 125 (Daniels 1989, 77). Enclosing an area of 4.1 acres, it was probably designed to hold an equitate quingenary cohort of about 600 soldiers, including c 120 cavalry. The primary layout of the internal barrack accommodation, with six infantry barracks and four cavalry 'stable-barracks', appears to confirm this (Hodgson 2003, 13). In the third and fourth centuries the *Cohors IV Lingonum equitata* was stationed there (Daniels 1978, 57 and Breeze and Dobson 2000, 256–7, 273; cf. *RIB* 1299–1301). Occupation probably continued right up until the end of the Roman period. The *Notitia Dignitatum*, compiled towards the end of the fourth century puts its commanding officer – the *tribunus cohortis quartae Lingonum, Segeduno* (*ND Occ* XL 33) – first on the list of the Wall's regimental commanders headed *Item per lineam valli*, ('Also, along the line of the Wall' ...). At some point in the second century the *Cohors II Nerviorum*, may have served as the garrison (*RIB* 1303), although it was not an equitate unit.

A civil settlement extended in the angle between the Wall and the Fort, stretching down to the river-bank (Fig. 1.02). A bath-house, temple or shrine, two burials, two or three roads and a potter's kiln have so far been recorded. The eighteenth-century antiquary, Wallis, also noted the remains of a possible quay at the shore of the river (cf. Snape and Bidwell, 1994). The ultimate stretch of Hadrian's Wall running from the south-east corner of the fort down to the river was partially uncovered in 1903, whilst recent excavation of the Wall along Buddle Street to the west of the fort has revealed post holes and a ditch system, thought to be part of the *vicus* defences (Snape 1992).

Today the site is located in the centre of urban Wallsend and is presently under the guardianship of North Tyneside Metropolitan Council.

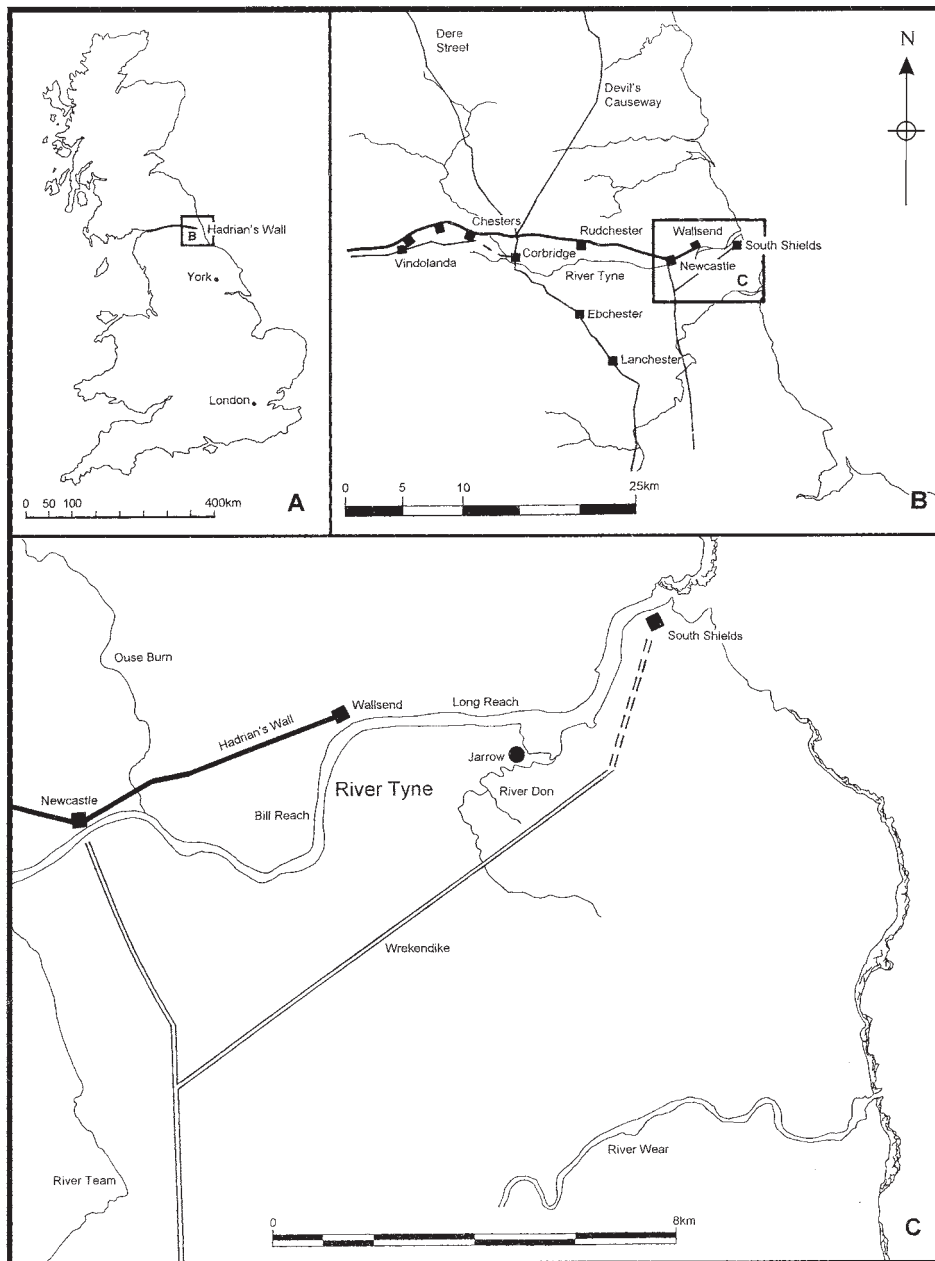

Figure 1.01: The location of Wallsend fort (taken from Hodgson 2003, fig. 7, with kind permission).

The 1975–84 Excavations

Between 1975 and 1984 a detailed programme of archaeological investigation was carried out at Wallsend on the site of the Roman fort of Segedunum. The excavations covered virtually all areas of the fort with the exception of Buddle Street and an area destroyed by the cellars of the Simpsons Hotel.

The excavations were directed by Charles Daniels, with funding and support from the Department of the Environment, North Tyneside Council, the Manpower Services Commission, Newcastle University and the Society of Antiquaries of Newcastle upon Tyne.

Methodology

The whole fort was divided up into 10×10 metre grids, which were ordered alphabetically and numerically, running from B–R and 2–17 (Fig. 1.03). Each grid reference provided the recording and location of contexts and features across the fort. In total 18 sites were excavated in the ten years of work at Wallsend, each site covering a number of grids (Fig. 1.04; and see Table 1.01 for a listing of the grid squares in each site).

Excavation began in the fort's *praetentura* (front third) between 1975 and 1976, with Sites 1–5 examining the barrack buildings (1–2, 4–5), along with part of the fort's northern defences and road system. Between 1977 and 1979 excavations moved to the central range and the *retentura* (rear third) of

Table 0 Concordance table listing the sites and grid squares excavated in each year

Year	Site	Grids
1975	1	M4, M5, N4, N5, P4, P5, Q4, Q5
	2	E4, E5, F4, F5, G4, G5, H4, H5
1976	3	H4, H5, J4, J5, K2, K3, K4, K5, L2, L3, L4, M3, M4, M5
	4	E2, E3, F2, F3, G2, G3, H2, H3
	5	Q5, R5
1977	6	F13, F14, D10, D11, D12, D13, D14, D15, E10, E11, E12, E13, E14, E15, F10, F11, F12, F13, F14, F15, G11, G12, G13, G14, G15, H11, H12, H13, H14, H15
	7	G15, G16, G17
	8	C11, D11
	9	B14, B15, C14, C15
	10	C11, C12
1978	11	C13, C14, D12, D13, D14, D15, E12, E13, E14, E15, F12, F13, F14, F15, G13, G14, G15, G16, H13, H14, H15, H16, J13, J14, J15, J16, J17, K13, K14, K15, K16, L13, L14, L15, L16, M14, M15, M16, N14, N15, N16
	12	P13, P14, Q14
	13	N16, N17, P16, P17
	14	L16, L17, M16, M17
1979	15	J13, K10, K11, K12, K13, L10, L11, L12, L13, L14, M11, M12, M13, M14, M15, M16, N11, N12, N13, N14, N15, N16, N17, P11, P12, P13, P14, P16, P17, Q11
1980/81	16	F8, F9, F10, F11, G7, G8, G9, G10, G11, H7, H8, H9, H10, H11, H12, J7, J8, J9, J10, J11, J12, K7, K8, K9, K10, K11, K12, L7, L8, L9, L10
1983	17	C7, C8, C9, C10, D7, D8, D9, D10, E7, E8, E9, E10, F7, F8, F9, F10, F11, G7, G8, G9, G10, G11, H7, H8, H9, H10, H11
1983/84	18	L7, L8, L9, L10, M7, M8, M9, M10, N7, N8, N9, N10, P7, P8, Q7, Q8

the fort (Sites 6–15) examining the remaining barrack buildings and chalet ranges (Buildings 9–12), the southern parts of the hospital and the commanding officer's house (*praetorium*), and elements of the fort's southern and western defences and road system. During the final years (1980–4) excavation focussed on the central range of the fort, with the examination of the headquarters (*principia*) and granary plus their associated forehall, the remainder of the hospital and *praetorium*, the west gate together with adjoining stretches of the fort curtain and Hadrian's Wall, and a workshop building (16) and barrack (3) to the north-east of the *via principalis* along with a further trench across the fort's eastern defences and *intervallum* road.

In general, the buildings were fully exposed wherever possible and their later surviving features and deposits were extensively explored and recorded, but the earliest levels, particularly in the barracks were often investigated by means of small sondages, to avoid removing the later structures.

The building numbers and codes featured below (14, AZ etc.) are those adopted in the site and research archive documentation. The detailed breakdown of the separate stages of excavation is as follows:

1975 Sites 1 and 2 were excavated in the fort's *praetentura*. Site 1 covering an area of 670m² examined the north-east angle of the fort. Excavation revealed two barrack blocks, Building 2 with its associated 'shacks' and Building 1. Little of the southern barrack (2) was

available for examination except a small strip across its north-western end. A segment of the north fort wall, angle tower and north interval tower, along with the *intervallum* road and the alley between the two buildings, was also investigated.

Site 2, covering an area of c.500m², examined an area in the north-west of the *praetentura*. Three buildings and the late overlying 'shacks' were examined, comprising the south-western half of Building 4, the western half of Building 5 and the north-west corner of Building 6. Part of the *intervallum* road was also uncovered. (*Britannia* 1976, 7, 306–8)

1976 Sites 3, 4 and 5 were excavated in the north and north-west of the *praetentura*.

Site 3 covered an area of 1100m² in the north central area of the *praetentura*. This included the area of the fort lying between the 1975 excavations which overlapped with the western area of site 1 and the eastern area of site 2. The north gate with two guard chambers and part of the *via praetoria* were examined along with the western half of Buildings 1 and 2 and the eastern half of Buildings 4 and 5.

Site 4 covered an area of 400m² in the north-west part of the *praetentura*. Part of the robbed north fort wall, interval tower, north-west angle tower, *intervallum* road and the north-west corner of Building 4 were examined. (*Britannia* 1977, 8, 371–2)

Site 5 investigated a narrow strip across the *intervallum* road to the east of Building 1 as well as a small segment of the north-east fortification wall and outer ditch.

1977 Sites 6–10 covered an area of 2000m² in the south-

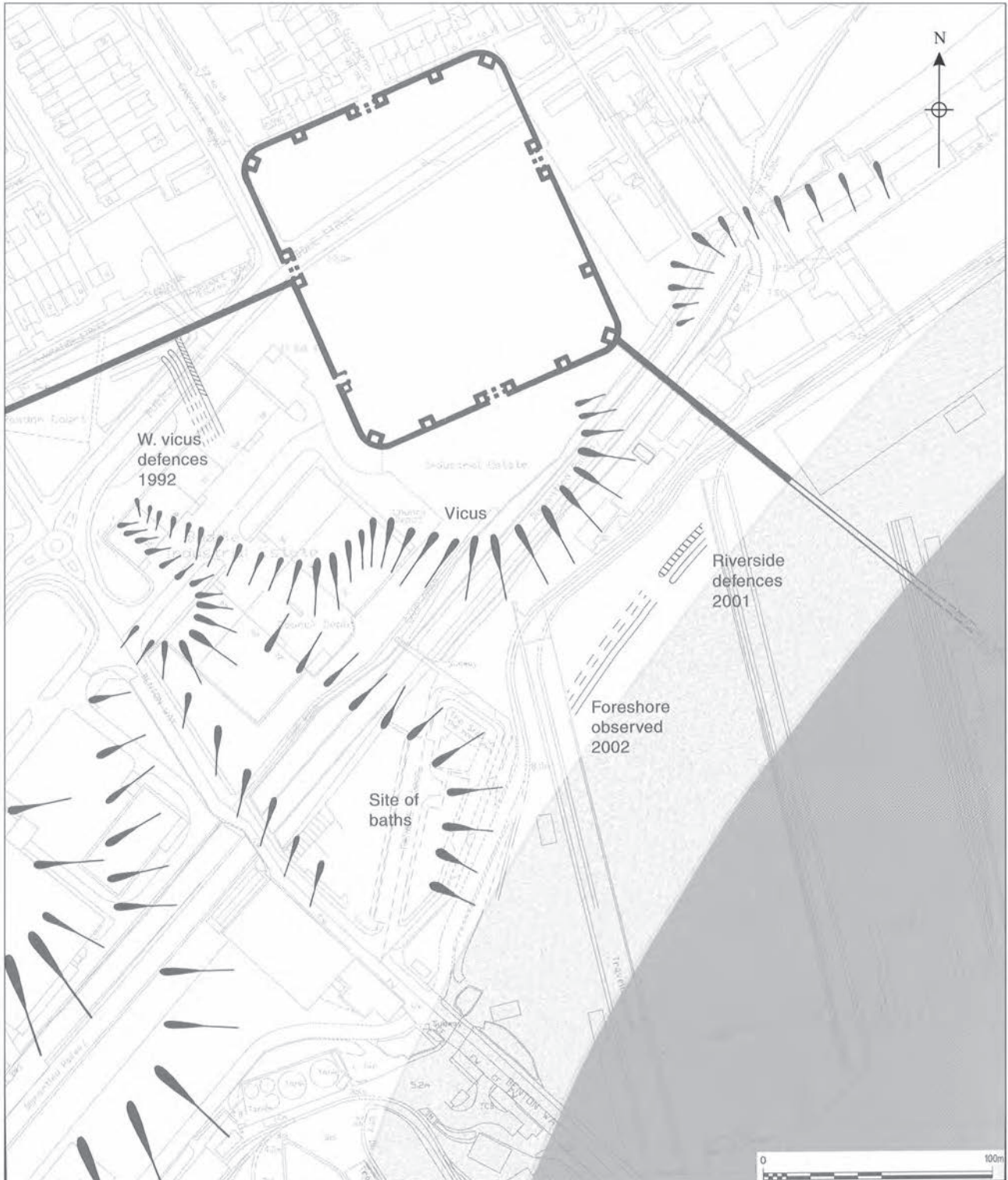

Figure 1.02: The site of Wallsend Fort (taken from Hodgson 2003, fig 8, with kind permission).

west angle of the *retentura*.

Site 6, the largest area, examined part of the *via quintana*, the southern half of the hospital (Building 8), Buildings S/T, AV and AX to the east of the hospital and began clearance of two complete barracks (9 and 10) plus the *intervallum* road to the south.

Site 7 sectioned the southern defences locating the ditch to the south of the fort.

Site 8 examined a segment of the western fort wall.

Site 9 investigated the south-west angle of the fort wall.

Site 10 examined the *porta quintana sinistra*.

(*Britannia* 1978, 9, 419)

1978 Excavation was undertaken on Site 11, in the *retentura*.

This continued the investigation of Buildings 9, 10 (as

WALLSEND SEGEDUNUM

HADRIANIC FORT

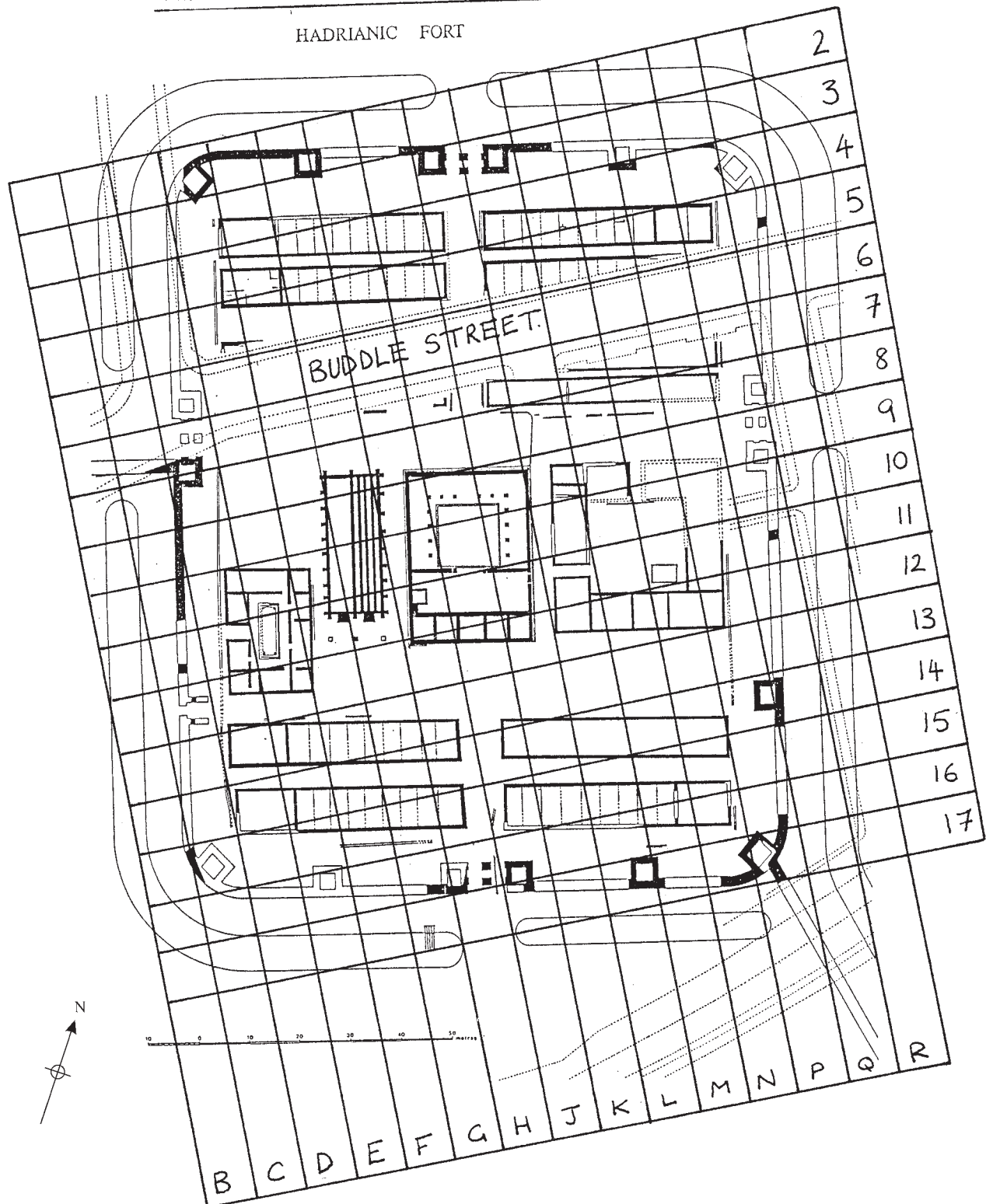

Figure 1.03: Wallsend Fort. Plan of the grid system used during the 1975–84 excavations.

begun in 1977, Site 6), extending the excavation area eastward to include Barracks 11 and 12 with their overlying chalet ranges. In addition, various components of the south-eastern

defences were investigated, including the interval tower between the east gate and south-east angle (Site 12), the south-east angle tower and Branch Wall leading down to the river (Site 13), and the interval tower

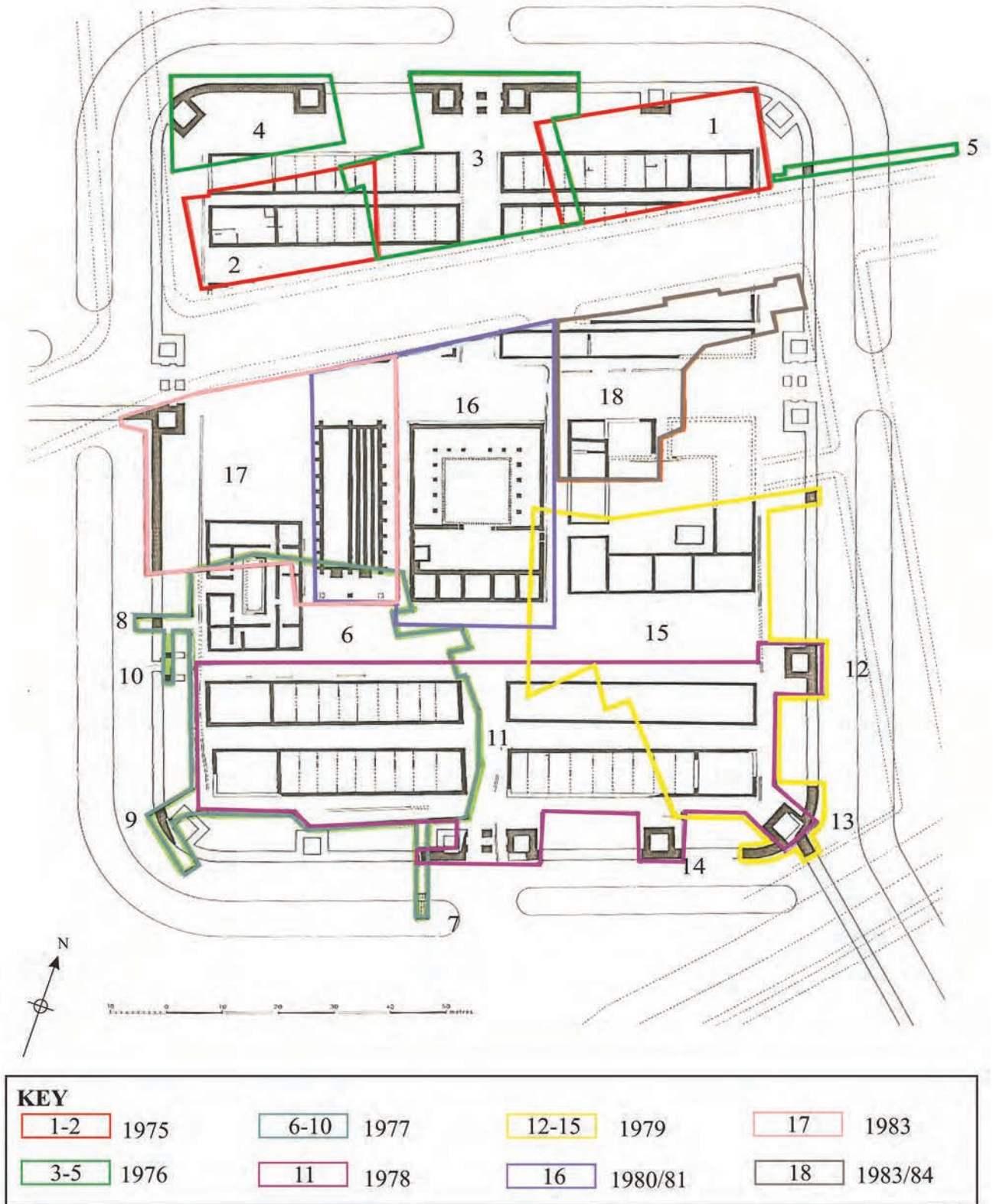

Figure 1.04: Wallsend Fort. Plan of the yearly stages and constituent site numbers of the Daniels excavations.

between the south gate and south-east angle (Site 14), and a large part of the south gate (*porta decumana*).

1979 Excavation was undertaken in the eastern areas

of the *retentura* and central range.

Site 15 covered a large area in the south-eastern quarter of the fort, including the southern half of the *praetorium* (Building 13), the eastern part of the *via quintana* with

Buildings AZ, BA and BB overlying it. The eastern half of Buildings 11 and 12 in the *retentura* were investigated continuing the 1978 excavations.

Investigation of towers on the southern and eastern defences continued (Sites 12–14), in particular the south-east angle tower and Branch Wall and a section across the east defences a little way south of the east gate (in Q11).

(*Britannia* 1980, 11, 355–8)

1980/1 Site 16 was excavated in the fort's central range (*latera praetorii*).

The headquarters (Building 14) and the granary (Building 7) including the *via principalis* and forehall (Building AO) were examined up to the edge of Buddle Street. To the north of the *via principalis* two other buildings (Workshops 15 and 16) were partially excavated (*Britannia* 1981, 12, 322).

1982/3 Excavation of Site 17 began in the fort's central range.

An area extending from the granary (exposed 1980/81, Site 16) and the west gate of the fort was examined. The north-west corner and north wall of the hospital were examined in continuation of the excavation of Site 6 (1977). The south guard chamber of the west gate, part of the fortification wall and foundations of Hadrian's Wall were also located. Additionally, the *intervallum* road and *via principalis* to the north of the hospital were examined, revealing more of Building 15 (previously investigated in 1981). Features associated with the eighteenth- and nineteenth-century collieries were also revealed in this area. (*Britannia* 1983, 14, 289–90 and 1984, 15, 277–9)

1983/4 Site 18 in the central range previously covered by Simpsons Hotel was excavated.

The north-west corner and part of the *via principalis* frontage of the *praetorium* was examined (the southern end having been excavated in 1979). North of the *via principalis* (which itself was also investigated) Building 16, a workshop (previously examined in 1980/1), was almost totally excavated. Building 3, a barrack block, was only partially examined. (*Britannia* 1985, 16, 268–70).

The initial post-ex avation work

A preliminary interpretation of the phasing of the fort was presented in 1989 by Charles Daniels (1989, 77–83), which essentially followed the Wall Period model, with four main phases of activity defined – Hadrianic, Severan, Tetrarchic, and late fourth-century (Figs 1.05–1.08). Post-exavation proper followed on immediately after completion of the final season of excavation (1984), with Peter Moffat being employed as a research assistant whilst Ian Caruana was also involved in the writing-up, having played a key supervisory role in much of the excavation. A set of indices for the Level 3 archive was produced by 1989. A draft text for part of the structural discussion was then completed along with preparatory analysis of the

coarse ware, and most of the other specialist reports were commissioned. A number of these latter were completed (e.g. the quernstones and vessel glass) or at least full catalogues produced (coins, small finds), however none of these were published and most still lacked accompanying illustrations. A publication synopsis was devised and the plans were drawn up for final publication.

The sum total of all this initial analytical work was a substantial research archive for the project, comprising:

- Draft text or outline notes for the majority of the structural discussion.
- Level 3 archive indices.
- Specialist reports (some, not all).
- Small finds and specialist reports illustrations (a few only).
- Inked plans (majority of those required for the final report).

However, following the end of Peter Moffat's research assistant contract, progress largely came to a halt until 1997, when an opportunity to revive the post-exavation work was presented by the Segedunum Project.

The 19 20 post-ex avation stag

The Segedunum Project, which commenced in 1997 and ran until 2000, involved the partial re-exavation and display of the Roman fort, the building of a new museum immediately adjacent and reconstruction of the fort bathhouse. As part of this scheme a sum was made available to publish the results of the earlier Daniels excavations with English Heritage contributing an additional sum.

It was decided by English Heritage that the structural report should be written up by the Archaeological Practice, University of Newcastle upon Tyne, with Alan Rushworth acting as project manager and principal researcher, and the finds report should be produced by Tyne and Wear Museums, with Alex Croom as principal researcher, coordinator and editor for the material assemblages. In furtherance of this an Assessment and Project Design was produced by the Newcastle University Archaeological Practice, with the assistance of Tyne and Wear Museums, in 1997 (NUAP/TWM 1997), setting out in detail what further work was required to bring the final report to publication and ensure the significant potential of the 1975–84 excavation data was fully realised. This contained a full quantitative and qualitative summary of the site and research archives, together with a statement appraising the archaeological potential of the data contained therein, formulated according to the principles set out by MAP2 (English Heritage 19 1). On receiving approval, work by the NUAP and TWM teams commenced, following the methods and programme set out in the Project Design.

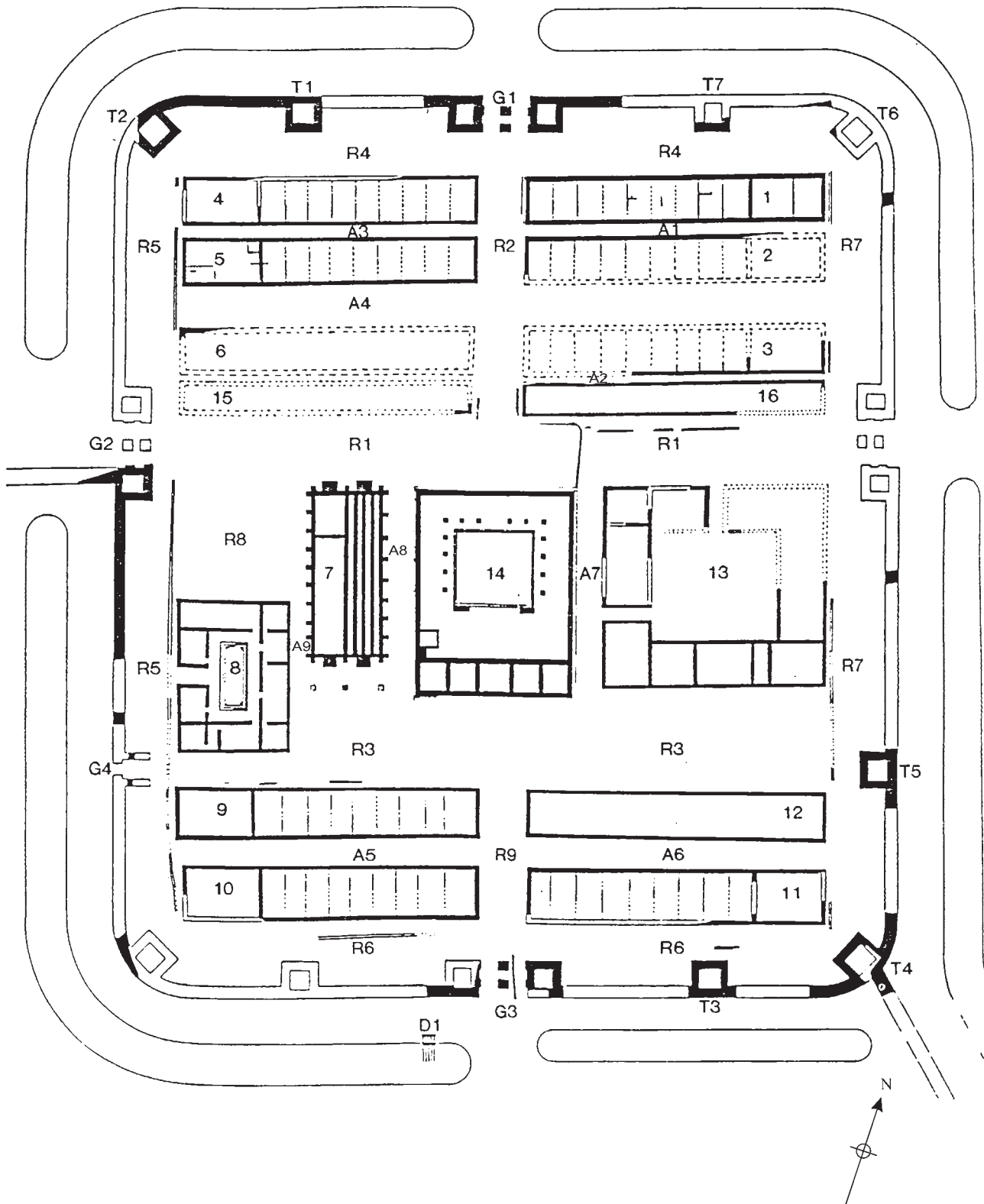

Figure 1.05: The Hadrianic fort as shown in Daniels 1989, 78, fig 39.

The Segedunum Project and its implications

A profound reassessment of the 1975–84 results was sparked by the new information provided by the Segedunum Project excavations conducted by Tyne

and Wear Museums. Although not on the same scale as Daniels programme, the 1997–8 excavations were still extensive and, in large measure, complemented Daniels work by providing a clearer understanding of the primary, Hadrianic levels, which had not been

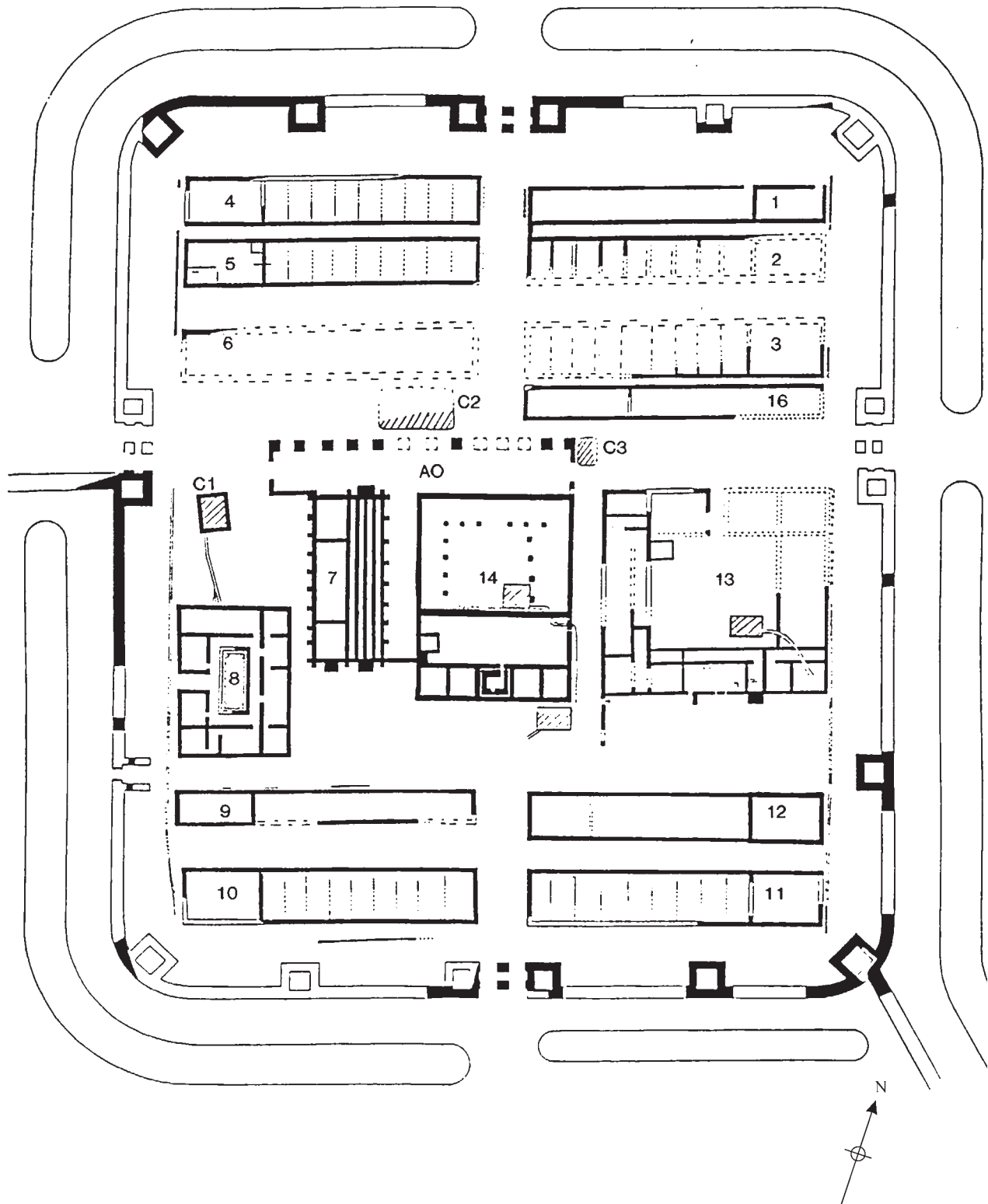

Figure 1.06: The early 3rd-century fort as shown in Daniels 1989, 80, fig 40.

fully exposed in 1975–84. The Project involved, *inter alia*, the re-excavation and display of the hospital, granary, forehall and Buildings 9 and 12 with their overlying chalets (Fig 1.09). The excavation results, published by Tyne and Wear Museums (Hodgson 2003), had implications far beyond these areas,

however, affecting our understanding of the phasing of the fort as a whole.

The results

Several important results of the 1997–8 excavations

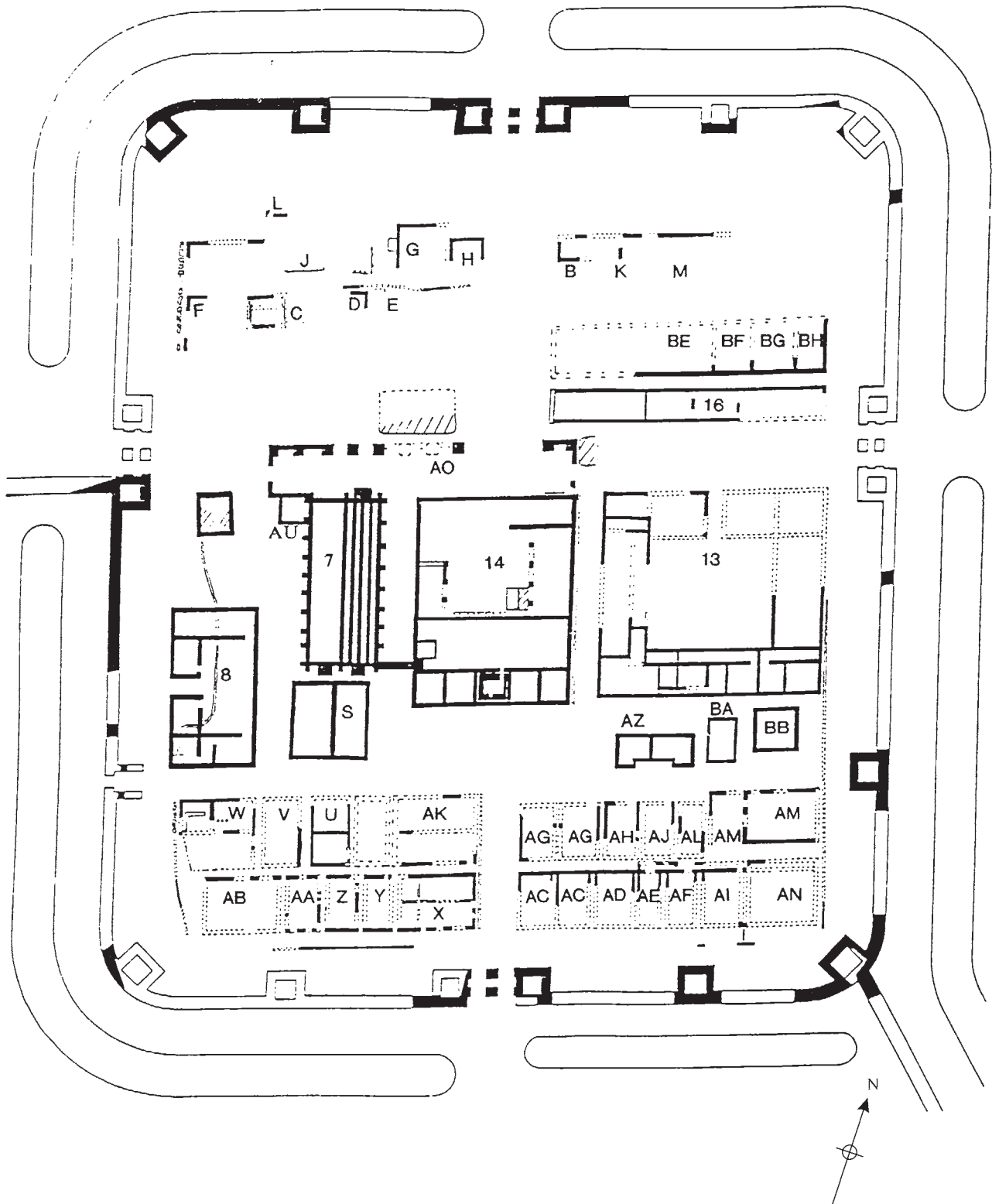

Figure 1.07: The early 4th-century fort as shown in Daniels 1989, 81, fig 41.

are listed below. This is not an exhaustive list of the conclusions of the 1997–8 programme. Rather it represents those conclusions which had major implications for the writing-up of the Daniels excavations, in terms of changing the wider understanding of the fort's development:

- 1 The barrack blocks were built of timber during the fort's primary phase.
- 2 A timber building also occupied the site of the stone hospital in this phase and, although built to a different plan, may represent the primary hospital.
- 3 The four barracks in the *retentura*, formed what are now termed stable-barracks, designed to accommodate

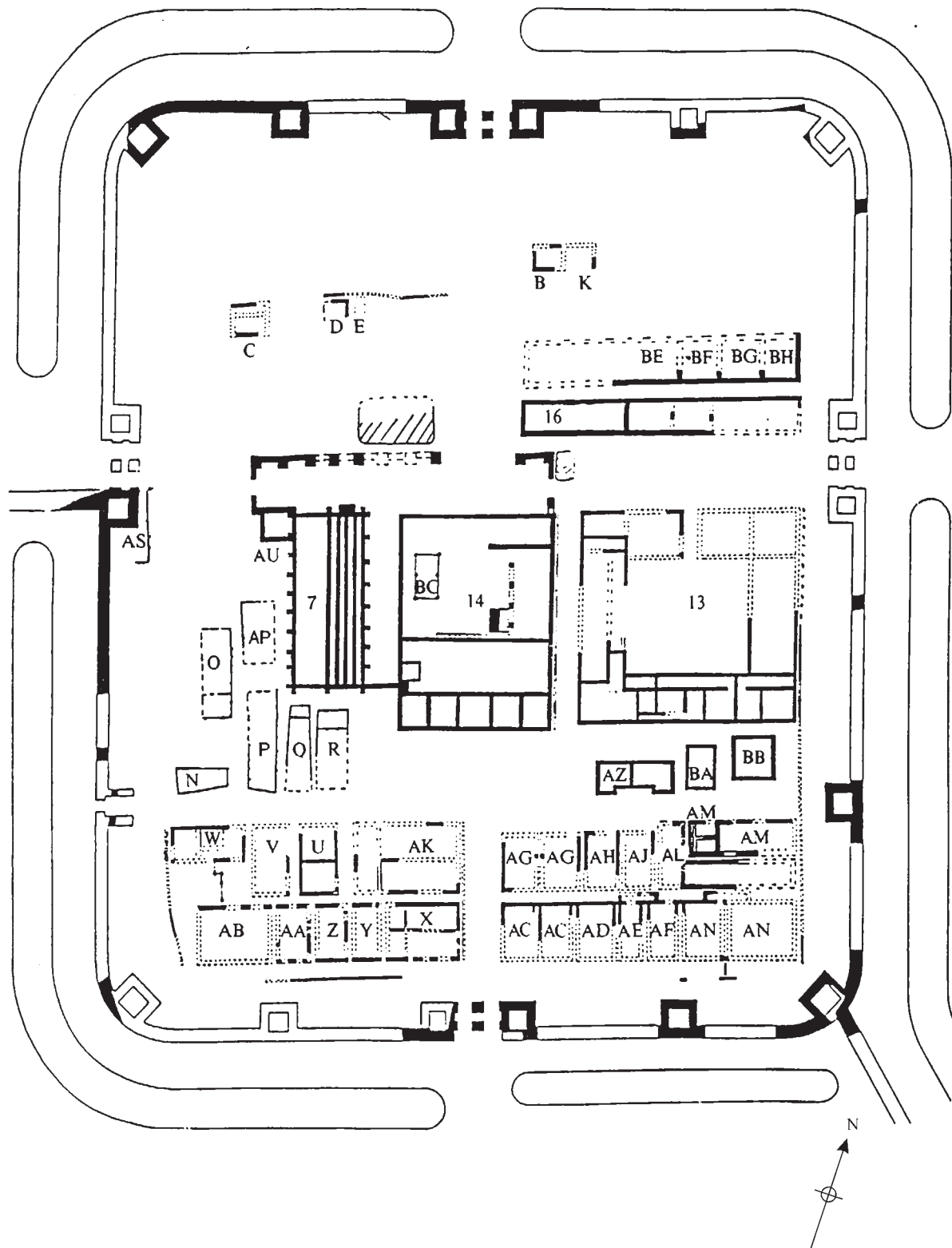

Figure 1.08: The late 4th-century fort as shown in Daniels 1989, 82, fig 42.

both the men and horses of a cavalry *turma* within the same block.

- 4 Work on the ditches outside the fort in 1991 and 1997 has clarified the changing patterns of access into the fort and provided clues to the history of the gates.
- 5 Most of the fourth-century structures and deposits

had been destroyed by much later agricultural and industrial activity. Accordingly many of the structures assigned to the fourth century by Daniels should belong to an earlier period. The four chalet ranges in the *retentura* and the post-hole buildings over the hospital and south of the granary are considered to have been

erected *c.* 225–35 or slightly later, but certainly by the mid-third century. The hospital would have been demolished at this stage.

The consequences of those findings in interpreting the results of the Daniels excavations are apparent in the next chapter and, in much greater detail in the chapters relating to the individual fort buildings and building groups.

The significance of Charles Daniels' excavations at Wallsend

The overriding significance of the 1975–84 excavations was not lessened by the 1997–8 programme. The site of Segedunum, in Wallsend, at the eastern end of Hadrian's Wall, has the distinction of being amongst the most extensively revealed of Roman forts. Only one site in Britain has been more completely explored with modern excavation techniques, the Flavian fort at Elginhaugh, but this was only occupied for short and chronologically tightly defined period, whereas Wallsend presents the opposite case of a site with multiple structural phases of occupation. Whilst other comparable sites may eventually attain a similar or greater level of excavation and understanding, notably Arbeia-South Shields and Vindolanda, none as yet matches Segedunum in the sheer extent of excavation and range of fort buildings fully investigated.

This statement needs qualifying, however. Most of the late Roman levels had been destroyed by post-Roman activity. Moreover the earliest levels (Period 1 – Hadrianic) were not fully investigated by Charles Daniels as the 1997–8 programme of excavation has made clear. For the most part, the remains revealed by Charles Daniels' work fell within the period extending from the mid-Antonine rebuilding of *c.* 160 up to the late third century, but not exclusively so. Sufficient early features can be identified to give an impression of the primary layout of the fort, particularly when interpreted in the light of the results of the 1997–8 excavation campaign. Some late Roman features also survived the devastation wrought by medieval ploughing and colliery era intrusions, in little pockets here and there. Although nowhere near sufficient to establish a coherent overall plan of the fort in the later period they do provide clues as to the character of fourth-century occupation.

It should also be noted that even with an excavation programme as extensive as that undertaken in 1975–84 not all the fort could be examined. One area which was never available for excavation was the course of Buddle Street, which runs from the north side of the west gate towards the north-east corner of the site. The second area partially excluded from Daniels excavations was the fort defences, which were only investigated by selected trenches extending into the area of the defences to reveal specific structures, such as interval and angle towers or gates, or to

record a section across the rampart, curtain and, at one point on the south side, the lip of the ditch. The only extensive excavations of the defences were the area of the western defences extending south of the west gate investigated in 1983 and substantial stretches of the north defences uncovered in the first two seasons. However the boundaries of the 1975–6 excavation sites, which were often determined by still functioning streets and lanes associated with the surrounding housing terraces, meant that even here the ramparts were not entirely exposed. Even so, when combined with the 1997–8 excavations which fully explored the rampart area on either side of the minor west gate, some idea of changing nature of the defences can be gained.

The site was excavated under what was essentially a rescue programme, the entire area of the fort being scheduled for redevelopment following the demolition of the existing terraced housing. Recording was therefore not as complete as more recent programmes at South Shields or Birdoswald. Context descriptions are often very summary and the record of stratigraphic relationships somewhat haphazard and occasionally contradictory. As a consequence, interpreting the results, as documented in the archive, involves grappling with many uncertainties. Nevertheless these problems should not be overstated. The site was among the first on Hadrian's Wall to be excavated according to the principles of modern open area excavation, as opposed to the small box trenches still in use at sites like Corbridge and Haltonchesters in the 1960s. Cases where an identifiable feature or deposit was not allocated a context number or where two features were given the same number were very rare and the vast majority of contexts can be pinpointed on an accurately drawn site plan or at least a sketch plan overlay. It must also be admitted that the state of preservation of the various buildings uncovered at Wallsend generally leaves much to be desired. Practically every type of structure can be paralleled by better-preserved and hence individually more informative examples elsewhere.

Nevertheless, even with all the above caveats, the evidence generated by the Daniels excavations at Wallsend has, uniquely, provided an opportunity to analyse in detail the changing layout and pattern of occupation across an entire fort, particularly in the first two centuries of its occupation. Building activity in the forts of Hadrian's Wall was traditionally presented as a series of discrete periods of widespread activity. Whilst it is certainly still true that there were times when the northern frontier was a focus of more intense imperial concern and patronage, the 'Wall Period' model is no longer rigidly adhered to today. A brief glance at the corpus of building inscriptions from northern frontier forts, for example, is sufficient to demonstrate that the physical infrastructure of these military bases was being renewed throughout the period from the late second right up to the mid-

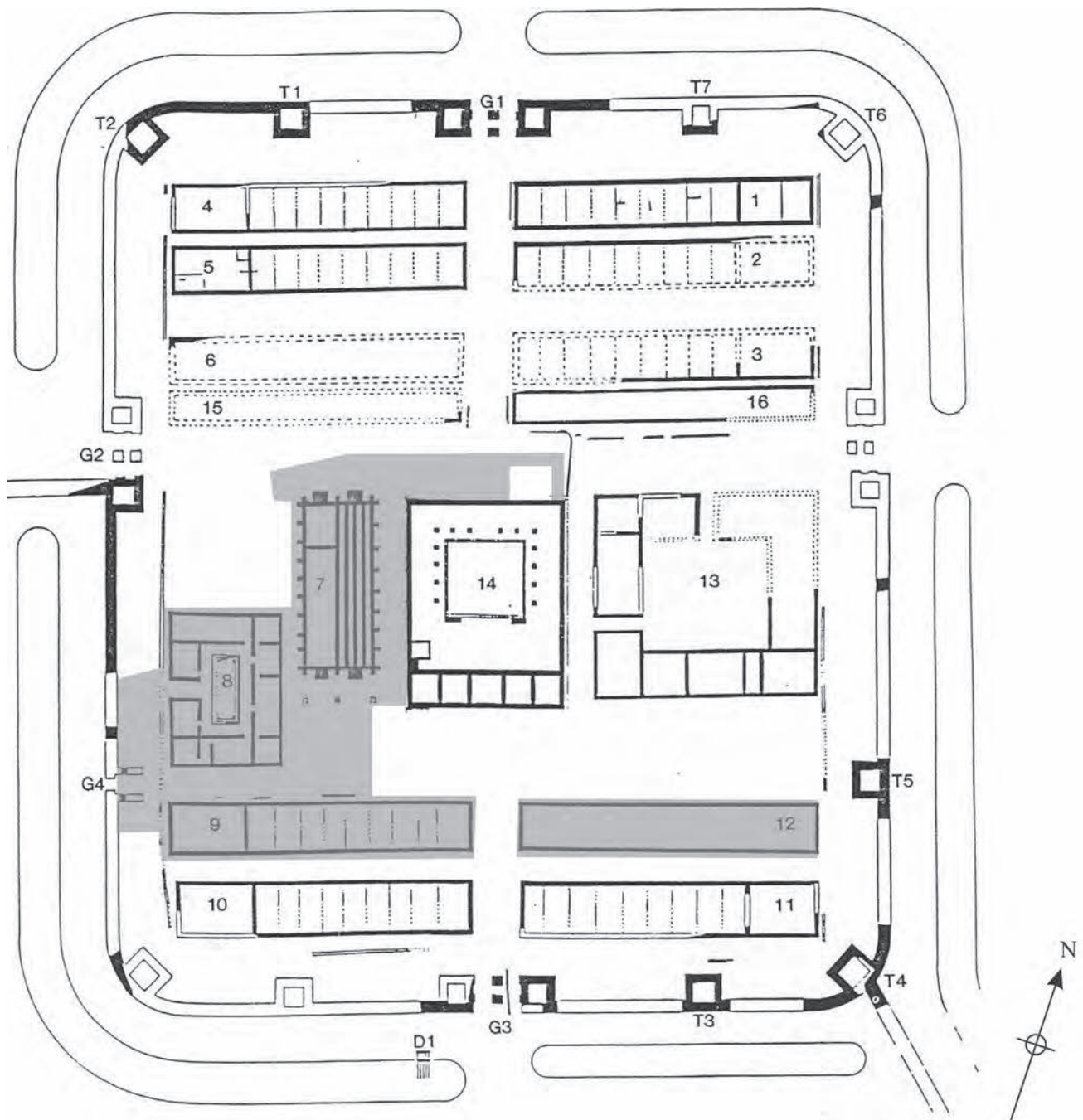

Figure 1.09: Areas of the fort re-excavated in 1997–8 (taken from Hodgson 2003, fig. 6, with kind permission).

third century, with new buildings being erected and old ones refurbished. The data from Wallsend provides the opportunity to chart this process right across one site in the second and third centuries. In the absence of numerous inscriptions and with never as many securely-stratified coins as one would like, the predominantly pottery-based dating evidence available from a fort like Wallsend means there is a limit to the chronological precision which can be achieved. However, detailed analysis of the relationships between the various buildings, provides

a relative chronology which helps to narrow the chronological parameters of the fort's structural phases or periods.

That such an exercise is possible at all is a testament to the inspiration and sheer, indomitable energy of Charles Daniels in sustaining so large and complex an excavation project over a period of ten years and ensuring its continuance under differing management frameworks. It is to be hoped that this report represents a fitting tribute to his life and work.

2. THE HISTORY AND DEVELOPMENT OF THE FORT

Introduction

This chapter is principally intended to summarise the changes in the layout of the fort and the pattern of occupation across the site. In so doing, in combination with the structural concordance tables, it aims to provide a lead-in to the detailed evidence set out in the chapters relating to individual buildings or building groups. Not every structural alteration to every building is discussed. Instead, aspects of the fort's development which appear most significant within each period are focussed upon, in particular to show how changes in one building related to those in another. A summary of the post-Roman history of the site is also included to provide a context for the widespread destruction of the Roman archaeological levels.

Pre-Roman occupation

Early Prehistoric

The assemblage of struck flint recovered inside the fort in the course of both the 1975–84 and 1997–8 excavations provides a strong indication that the site was used by groups of hunter-gatherers during the later Mesolithic period (Hodgson 2003, 23, 34–6). Furthermore, reworking of long-discarded flint tools in this period points to even earlier use of the site, whilst the proportion of finished tools implies habitation, rather than simply flint-working or hunting activities, on the site. Lithics of both the early Neolithic and the late Neolithic or early Bronze Age were also well-represented amongst the 1975–84 finds and in excavations undertaken in the areas around the fort in the 1990s., pointing to the presence of early farming communities in the area. No structures relating to any of these periods have so far been revealed, however.

The attractiveness of this location is not especially

surprising. The undulating coastal lowlands of Tyne and Wear were a relatively resource-rich area providing a range of wildlife habitats for hunter-gatherer exploitation and good conditions for early farmers. The site later occupied by the Roman fort formed a broad elevated spur (labelled 'Well Lawe or Wall Lawe' on the 1st edition Ordnance Survey), which was defined by stream valleys to the east and west, and overlooked a bend of the river with extensive views both upstream and downstream. From these bluffs it was possible to see four miles down the Long Reach towards South Shields and two miles up the Bill Reach to the south, providing the best vantage point for hunters to observe game coming down to the riverbanks.

Late Prehistoric settlement

Aerial photography and fieldwork in the coastal plain of north-east England, suggests that this landscape was intensively exploited by later prehistoric communities. Numerous cropmarks, predominantly rectilinear in plan, have been identified which are representative of a class of enclosed farming settlements found throughout the north-east coastal lowlands during the late Iron Age and Romano-British periods (Jobey 1960; 1982, 1–23; Higham 1986, 186–97). When excavated these have frequently displayed considerable complexity of development and longevity of occupation (Heslop 1987; Haselgrove 2002; Jobey 1963; 1970; 1982; Proctor 2009).

Traces of occupation associated with this period have been identified in the vicinity of the site. The antiquary John Horsley refers to a possible site which may belong to this period immediately north of the fort (1732, 135–6): 'on the north side of the station there are some crooked risings and settlings of the ground, which at first view appeared to me not unlike a round fort or tower, projecting from the station with a triple rampart or ditch'. Horsley's suggestion that

this was an Iron Age hillfort, partly obliterated by the construction of the Roman military base, is startling and difficult to evaluate. It would seem surprising if the Roman garrison allowed any earthworks to remain standing so close to their own defences since such earthworks could potentially have provided cover for any attacker. Without more detail, however it is impossible to reach any conclusion. Within the fort itself the Daniels excavations exposed widespread traces of cultivation pre-dating the construction of the fort, comprising areas of plough marks cut into the subsoil and the furrows of cord-rig cultivation (see Hodgson 2003, 23–36). Further areas of cultivations furrows and plough marks were uncovered and fully recorded in 1997–8. The excavated evidence suggested that this activity continued right up until the construction of the fort with freshly cut cultivation furrows being filled by Roman construction deposits (Hodgson 2003, 13, 33–4).

The structural development of the fort

Roman armies first crossed the Tyne during the later first century AD, but it was not until the construction of Hadrian's Wall in the 120s that the complex of military installations at Wallsend was established. The building of the fort at Wallsend has traditionally been associated with an apparent decision to extend the Wall four miles from Newcastle to Wallsend and to add garrison forts to the actual line of the curtain a few years after the frontier barrier was begun in AD 122 (Daniels 1989, 77).

Period 1 (Fig. 2.01)

Fundamental to our overall understanding of the Hadrianic fort is the work undertaken by Tyne and Wear Museums in 1997–8. By exposing larger areas of the earliest levels, below the remains of the stone buildings which Daniels had assumed represented the initial fort structures, the 1997–8 excavators were able to demonstrate that timber buildings underlay the stone hospital and two of the barrack blocks, forming part of a more extensive pattern of timber construction in the primary, Hadrianic period. The stone hospital and the first phase of stone barrack blocks, which Daniels had attributed to the Hadrianic phase, were instead shown to be part of a mid-Antonine or later second-century remodelling. This in turn has enabled detailed reinterpretation of the Daniels excavation results, with those features which can be related to the earliest fort layout being integrated into the pattern proposed in the TWM excavation report (Hodgson 2003).

The barracks

Perhaps the greatest development in our understanding relates to the plan and function of the barracks of the

Hadrianic and later fort. Two of the barrack blocks in the *retentura* (Buildings 9 and 12) were re-exposed in 1997–8, revealing the existence of sleeper beam slots, post holes and post-in-trench slots relating to timber predecessors of the stone barracks previously excavated on those sites. These were broadly similar in plan to the succeeding stone buildings with an officer's house at one end and nine *contubernia*, although the former was detached from the range of *contubernia*, which was not the case subsequently. Excavations in most of the other blocks in 1975–84 revealed a number of partition slots which could not be integrated into any coherent *contubernium* spacing within the confines of the external walls of the stone barracks (See Buildings 1, 2, 3, 4, 10 and 11). (no definite examples of such anomalous slots were identified in Building 5 but this may simply reflect a failure to excavate down to the right level whilst too little of Building 6 was uncovered for any meaningful analysis.) The number of out of sync partition slots identified in 1975–84 varied greatly from block to block. In some cases there were no more than a single example but in others, specifically in Buildings 1, 4, 10, 11, they are more numerous and taken as a whole their evidence implies that all ten barracks in the fort were probably built of timber initially.

The two barracks excavated in the *retentura* in 1997–8 were seen to be furnished with oval or oblong pits in the front room of each *contubernium* and in the officer's quarters. These were interpreted as sumps for the collection of urine from cavalry horses stabled in the front room, drawing on parallels with barrack blocks previously excavated in Germany. In the later stone phases of these barracks the sumps were replaced by stone-lined drains. Similar stone lined drains were revealed by the Daniels excavations of Building 10 and particularly Building 11, in successive stone barrack phases, implying that all four barracks in the southern part of the fort held cavalry, each block housing a *turma* of around 30 men commanded by a decurion, with a troop of three *equites* and their horses being accommodated in each *contubernium*, the men occupying the back room whilst the horses were stabled in the front. Equivalent sumps or drains were largely absent from the barracks in the *praetentura*, to the north of the central range. The only similar features were a couple of stone-lined drains identified in Building 1, which were assigned to the first sub-phase of what is now understood as the Period 2 stone barrack. However it may be strongly suspected that these most probably related to the complete remodelling of this building as a dedicated stable block in the third century. The drains in any case occupy the southern side of the block, in what would have been the inner rear rooms of *Contubernia* 2 and 3 and could thus not have been directly comparable with the front room sumps or drains of the *retentura* cavalry barracks. The overall lack of such features

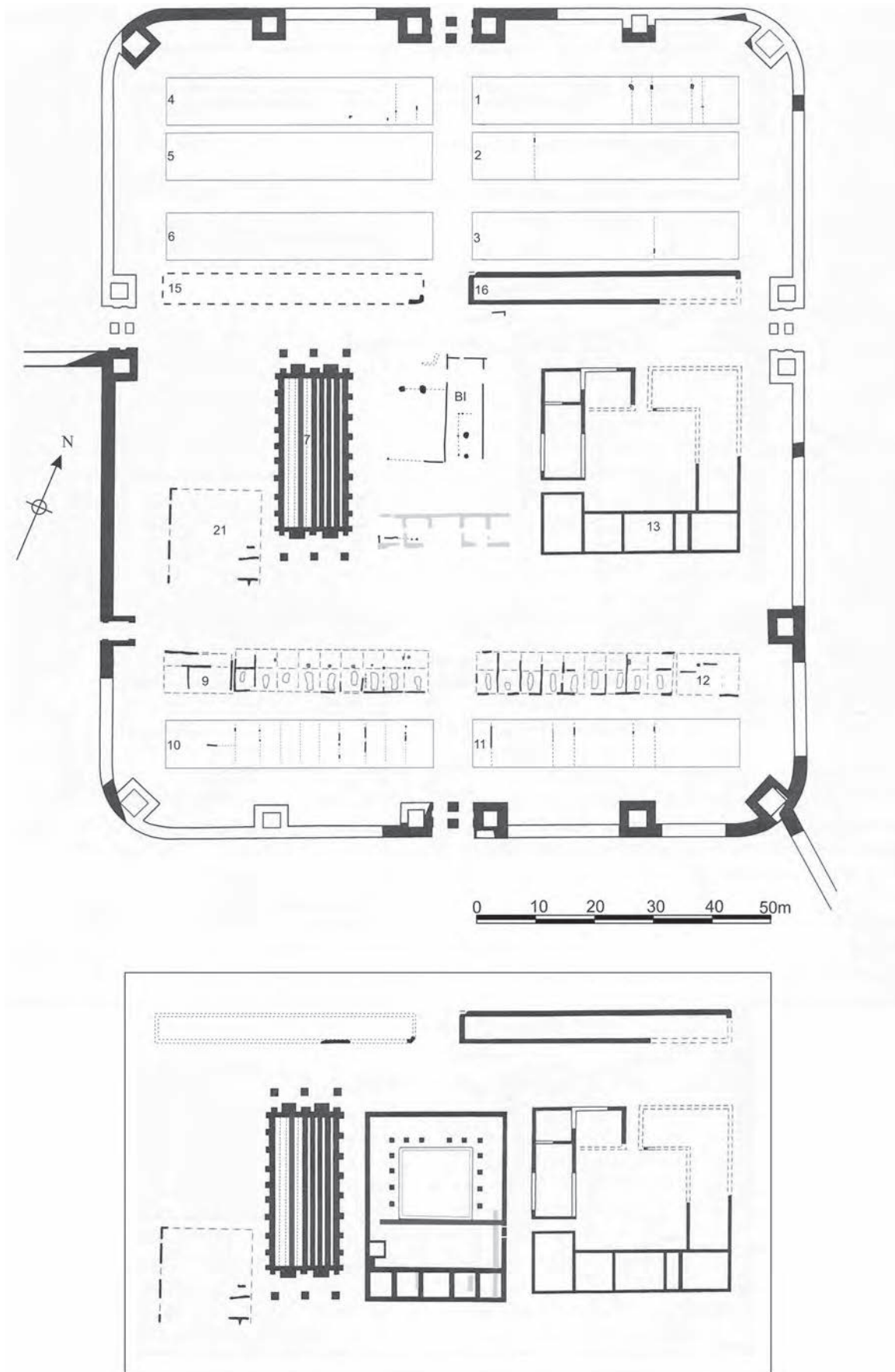

Figure 20 Period 1 The Hadrianic Fort, with inset showing possible secondary Hadrianic features, 0

suggests on the contrary that the six barracks in the *praetentura* were designed to accommodate infantry, with each building holding a century, in the normal manner. A complement of six infantry *centuriae* and four cavalry *turmae* matches that generally allocated to a quingenary equitate cohort with a notional strength of roughly 600 men (comprising 120 cavalry and 480 infantry). Although the evidence regarding the plan of the initial Hadrianic phase of the six *praetentura* barracks is admittedly very fragmentary, as far as can be gauged this arrangement of six infantry and four cavalry barracks appears to have applied even at that stage, indicating that the fort was laid out for a quingenary equitate cohort from the very start.

The buildings of the central range

The second substantial contribution of the 1997–8 excavations to revising our understanding of the earliest period of the fort's occupation was the discovery of a timber building (labelled 21) beneath the stone hospital. Daniels had in fact found the construction beam slot forming the west wall of this structure but had interpreted it as a water conduit feeding the latrine in the south-west corner of the later stone hospital. The building was almost square in outline and may have represented the Hadrianic predecessor of the stone hospital, though its plan clearly differed and other functions such as a some kind of workshop (but probably not for metalworking), a stores building or an undefined residential structure cannot be entirely ruled out (see Hodgson 2003, 126–7 for full discussion). The demonstrated existence of a Hadrianic timber structure in one part of the central range in turn focuses attention on the early timber building which the Daniels excavation team did identify in this section of the fort, namely the building labelled BI, located beneath the *principia* (Daniels' Building 14). In the interpretive plans in the Daniels research archive this is shown as a long, narrow, rectangular structure, extending beneath the east side of the courtyard, northward across the north portico and over part of the *via principalis*. The long continuous construction slots which form the east west and north sides of this building are plotted on the plans, however the context database lists many other features attributed to BI which were not plotted on the interpretive plans, including rows of post holes within the main rectangular structure, other post hole and slot alignments to the west and areas of substantial flagging, linear clay spreads and patches of cobbling beneath the *via principalis* street levels to the west of the building's notional north-west corner. The definitive form of this structure remains uncertain and it is likely that it did not survive completely (as was also the case with Building 21) or was not fully exposed, but it is clear that it was not simply a direct timber replica of the subsequent stone *principia*, though it

may conceivably have performed the same function. The excavators however suggested it was associated with the construction phase, perhaps envisaging a store building for equipment and materials or a shelter for the workforce, and hence may have had only a relatively brief period of occupation. The only pottery attributed to BI consists of three joining sherds of a collar-rimmed mortarium, dated to 140–300, which were associated with a surface of flat stones beneath the later courtyard. This would be consistent with a building which was not demolished until the Antonine era, or perhaps the end of Hadrian's reign, but obviously represents very meagre and rather loosely associated evidence on which to base any hypothesis.

The sequence in the area of the *principia* is further complicated by the existence of two abortive sets of foundation trenches which evidently preceded the construction of the definitive stone headquarters building. The first of these represented foundations for the south range of offices, which occupied a more northerly footprint than the range eventually built and were uniformly composed of substantial, roughly cut blocks of sandstone rubble set in grey-orange or pink-grey clay. As such, their composition differed markedly from the deposits of pink clay and sandstone mason's chippings in the foundation trenches associated with the final plan. The initial trenches were backfilled with a variety of deposits which included dark brown/black clay soil, orange clay and chippings, and at one point incorporated a small spread of tumbled worn cobbles. The excavators suggested that this indicated the trenches had lain open for some time, interpreting the dark brown/black clay soil as representing the pre-fort plough soil. This would appear to denote a hiatus in construction of some kind. It could be as little as a season or two or represent an initial attempt to construct a stone headquarters in stone later in the Hadrianic period, which was abandoned with building work conceivably not resuming until the fort was reoccupied in the mid-Antonine period. Unfortunately no surviving dateable material was found in association with any of these foundation or backfill deposits.

A second set of foundations appeared to represent a headquarters laid out a slightly more westerly footprint and again had clearly been abandoned before completion. Only the southern half of the east wall foundations and a couple of south range office walls were identified. The east-west aligned walls probably occupied the same positions as those of the final layout. These foundation deposits were composed of sandstone fragments in an orange clay matrix and more closely resembled those of the final scheme, though they had not been capped with clay and chippings ready to receive the wall courses. The intermediate layout closely resembles that finally built and it is easy to envisage the two being closely

associated chronologically with the former simply reflecting an error or slight change of plan in laying out the building (although again there was unfortunately no dateable material associated with the 'intermediate' foundations). The earliest foundations appear much more distinct in character from those associated with the building's definitive form, and possibly therefore more distant chronologically. The possibility that Building BI and the original foundations might both represent Hadrianic construction work and the implication that the *principia*, as built, could even be Antonine, like the stone hospital, have been alluded to above. It must be emphasised, however, that this cannot be substantiated on the basis of the material from the Phase 1 *principia* contexts. Although the contexts assigned to Phase 1 do contain quite a lot of late second- or third-century material most of it can be excluded from consideration. Thus material from the flagged courtyard surfaces, which survived only patchily and even the underlying bedding layer could well have been trodden in at a later date, rather like material intruded in road surfaces, particularly as the flagging remained in use throughout the life of the building. The assemblages in the external gutter fills can be discarded for similar reasons whilst the phasing of another context is rather doubtful. There was a single sherd of BB2 from one of the *principia* foundation deposits, but even this could be intrusive, given that all such deposits were exposed by emptying post-Roman robber trenches which regularly contained residual Roman pottery.

The evidence relating to the other buildings in the central range, namely the granary and the commanding officer's house (*praetorium*), suggests they were constructed in stone from the beginning. Intensive investigation of pre-Roman Iron Age cultivation furrows associated with cord-rig agriculture beneath the granary in 1983 and 1997–8 could not have failed to also expose any trace of a timber granary if such had been present. Similarly no trace of a timber commanding officer's house was recognised either, although in this case it is admittedly conceivable that such remains might remain hidden beneath the remains of the stone *praetorium*. The pottery recovered from contexts securely assigned to Phase 1 of the commanding officer's house would not contradict a Hadrianic date for the building, but amounted to no more than a single sherd of samian.

The granary (Daniels' Building 7) was divided into two halves by a longitudinal spine wall. Both halves of the resultant double granary were furnished with raised floors, supported by sleeper walls, and were accessed by sets of steps at either end. The entrances were sheltered beneath deep porticos, each supported by three piers. The only observable difference between the two parts of the building was the solid rubble base on which the sleeper walls of the west granary were set, whilst the east granary sleeper walls were

constructed directly on the earlier ground surface. For its part the *praetorium* (Building 13) was a very substantial, almost square, courtyard house of the usual type and covered the largest area of any single building in the fort. Its initial form as restored by Daniels was very simple, consisting of ranges of rooms around all four sides of the courtyard, with as yet no connecting corridors. This in part reflects an overarching view of the building's development from a simple to complex layout and that stratigraphic evidence would not rule out the possibility that the building's plan was somewhat more complex from the start (see Chapter 9).

Buildings 15 and 16 pose further problems. They were interpreted by Daniels as long narrow stone-walled buildings forming part of the primary Hadrianic fort. The burnt clay charcoal and ash deposits, stone platform, pits and kiln found within 16 suggest it functioned as some sort of workshop. Too little could be exposed of 15 to make any judgement as most of the building was covered by Buddle Street, but it may conceivably have performed a similar function or perhaps served as some kind stores building. Although the evidence relating to Building 15 was particularly exiguous, two phases did appear to be represented since the two short stretches of walling uncovered, comprising the south-east corner and a length of the south wall, did not actually line up. These may constitute a timber phase, represented by a clay-filled sleeper beam trench, and a stone-walled phase, of which only rubble foundations remained. The evidence was not conclusive, however, and there was in any case no dateable material to differentiate the two chronologically. The remains of Building 16 gave every sign of having constructed of stone from the start, but much of the material from the contexts which can be identified as belonging to Phase 1 of this building was of late second- or third-century date, which only serves to emphasise the interpretative problems posed by the structural record for 16.

The defences

In contrast, the layout of the fort defences remains essentially unchanged from that envisaged by Daniels. These were largely built in stone and followed the conventional Hadrianic form, the defensive circuit comprising a stone curtain wall and earthen rampart, furnished with four main double portal gateways, a single portal west quintan gate and a further nine towers disposed at the four corners of the fort and at intervals along its north, south and east walls. The *porta quintana sinistra* resembled an interval tower its single passageway being surmounted by a tower whilst it lacked flanking guardchambers (at least in its initial form though it was later furnished with a additional room inserted in the rampart on its south side). One of the interval towers occupied the

corresponding position on the east wall, there being no need for an east quintan gate as the branch wall continued the course of the Hadrianic barrier down to the river, extending right into the channel. The other four interval towers were distributed along the north and south walls, flanking the *porta praetoria* and the *porta decumana*.

Clay deposits representing the primary rampart were encountered at various points around the circuit, but little trace was identified of the other types of structure commonly accommodated along the defences, associated with the basic service functions of cooking, water supply and sanitation, specifically bread ovens, water tanks and latrines. It is possible that the primary ramparts housed bread ovens, either erected on low flagged shelves, as encountered at Birdoswald, or housed within dedicated bakehouses as at Housesteads. Alternatively bread ovens might be accommodated within some of the towers. An area of burnt clay and heat shattered tiles was noted in the rampart bank immediately south of the west gate, which could relate to this sort of activity, though no definite trace of an oven was identified here. In any case it is probably more likely that this belonged to a later period, involving the removal of the primary rampart to make space for the activity in question. Water collection and storage could be augmented by setting upstanding water tanks into the rampart bank to catch runoff from the bank or from the tower roofs, but no such features have been identified as yet, so extensive has been the destruction of all but the base of the ramparts.

Hadrian's Wall

In 1983–4, the stretch of Wall curtain directly adjoining the west gate was uncovered, the excavations extending from the south edge of the foundations up the edge of Buddle Street, which overlay the north face and ran at an oblique angle across the line of the Wall. This exposed the Wall foundations, overlain by disturbed and robbed core. The north face of the Wall had, rather famously, been revealed by F. G. Simpson, in the 1929, with the assistance of the Wallsend Borough Engineer, whose workmen tunnelled beneath the carriageway of Buddle Street (see Spain and Simpson 1930, 488, 493, and fig 7; reproduced below, in Chapter 17, as Fig. 17.04). In both these excavations, the exposed remains displayed certain unexpected and distinctive features. At the very end of the Daniels campaign in March 1984, what appeared to be two layers of cobble or rubble foundation were revealed, one superimposed over the other and set on different alignments with the upper 'course' offset by as much as 1m to the north. No masonry belonging to the Wall's south face (nor any intact core for that matter) remained, in contrast to the north face which was composed of very

large and neatly squared stone blocks ('exceptionally massive masonry'). Two courses of these stone blocks survived, the upper being set back slightly. The dimensions of the stone blocks are not recorded in the published description, but the height of each course can be roughly estimated at perhaps 0.45m-0.50m by reference to the shovel appearing in the background of F.G. Simpson's photograph of the tunnel. The blocks were set on a rubble/cobble footing or foundation which can be seen protruding northward perhaps 0.10-0.15m on Simpson's photograph. This layer of cobbles may be the same as the upper foundation layer uncovered in 1984.

The apparent existence of two separate foundation layers could indicate the junction of the Wall curtain with the west gate of the fort was rebuilt or at least replanned at some stage. Simpson's feat of tunnelling demonstrated that the form this junction took at Wallsend was atypical, with the Wall's north face and the north face of the tower forming one continuous line, the tower and Wall being bonded together, whereas the norm elsewhere was for the Wall to meet the fort gate facade at about the middle of the south tower. This positioning of the Wall curtain with respect to the gate, coupled with the use of large stone blocks in the Wall's north face, similar to those typically used in fort gate portals, was probably deliberately intended to integrate Wall and gate portals into a single, harmonious scheme for impressive effect, with the massive dressed stonework of the Wall facing simply forming a continuation of the blockwork of the west gate portals. The discovery of two levels of foundations suggests that scheme was an alteration to the original plan, however neither excavation yielded any evidence as to when the alteration took place. It could conceivably represent a very early change in design, of the kind with which the Hadrianic building scheme is littered, but it might equally represent a later rebuilding, involving both the Wall curtain and at least part of the west gate.

Conclusions

Thus the Hadrianic fort presents a mixture of stone and timber construction, with stone being reserved for those buildings where it was deemed most necessary, namely the buildings of the central range, and not even all of them. This was perhaps an expedient, practical response to the demands imposed by the scale of the Hadrianic building programme. Even with three legions and other contributing regiments, such as the *Classis Britannica*, at their disposal, the building of Hadrian's Wall would appear to have stretched the stone-working resources of the British *exercitus* to its limits. Moreover this was an army still well-accustomed to constructing its buildings in timber. Nevertheless, a building such as BI, for example, may have always been intended to be

temporary and it is possible that its replacement by a stone *principia* had already been accomplished by the end of Hadrian's reign, even though this would appear to have involved at least two separate episodes of building work (Fig. 2.01 with inset). However, the possibility cannot be excluded either that rebuilding operations had only just begun by that stage and were left unfinished on the emperor's death with the Antonine push forward into Scotland. Unfortunately, although the Daniels excavation data allows such questions to be posed, the small size of the dateable assemblages recovered, particularly from the earliest phases, does not permit their definite resolution.

Wallsend and South Shields

The striking resemblance of the Hadrianic fort's layout to that of the mid-Antonine stone fort at South Shields has previously been highlighted by Bidwell and Speak (1994, 18; cf. Hodgson 2009, 62–63, fig 5 for most up to date outline of the South Shields Period 4 fort plan; see Fig. 2.02 here). Like Wallsend, South Shields appears to have been laid out for an equitate cohort, with definite evidence for four cavalry stable-barracks (B6–B9) in the *retentura*. These were initially constructed in timber then rebuilt in stone, as were those at Wallsend in Period 2, and correspondingly positioned. In the *praetentura* a pair of long narrow

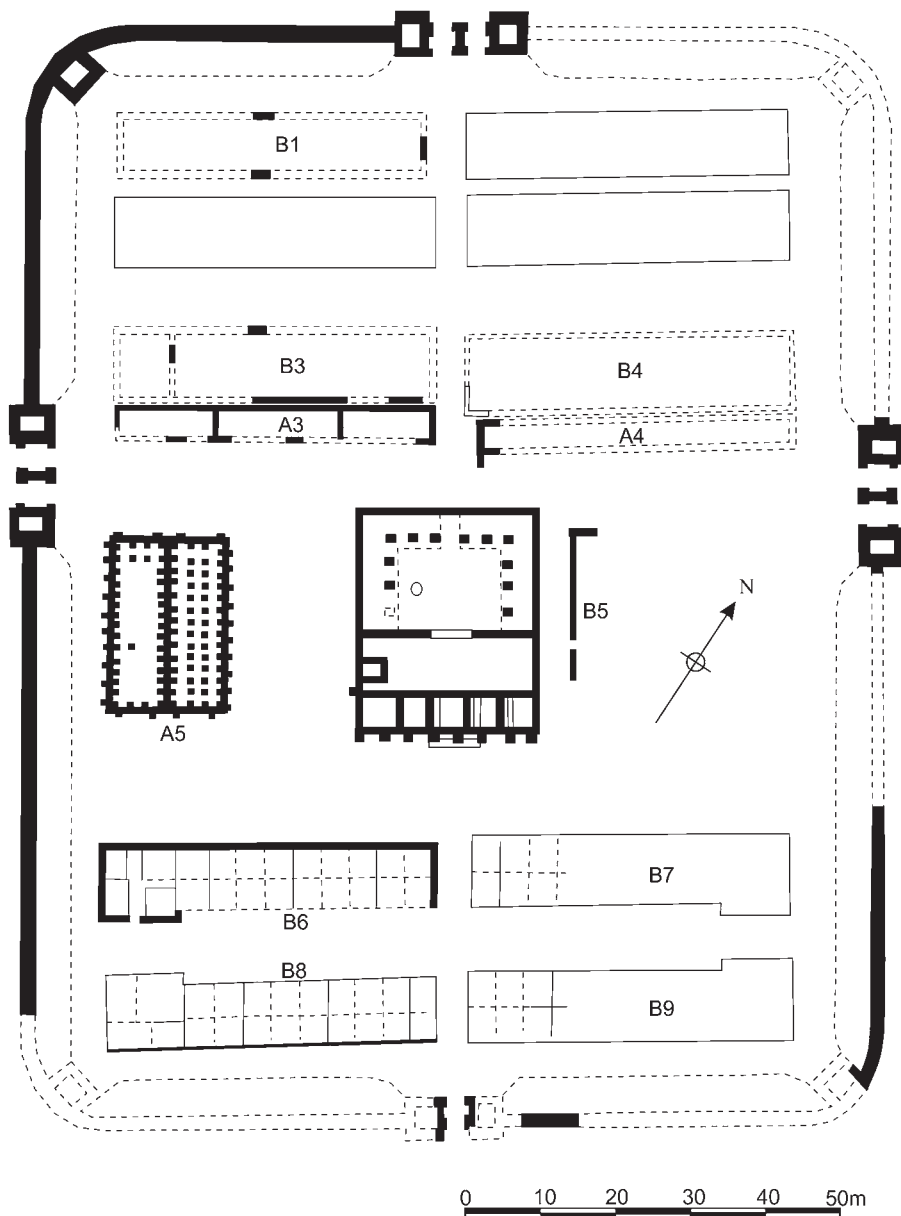

Figure 2.02: The later second-century fort at South Shields (Period 4) with barracks rebuilt in stone (after Hodgson 2009, fig 5)

buildings (A3 and A4), which have been identified as workshops, can be seen lining the north side of the *via principalis*, facing the central range, like 15 and 16. The more westerly of the two, A3, was subdivided into three chambers, the central one being somewhat longer than the end rooms, but too little is known of A4 to determine whether it was similarly treated. However a projecting stub wall prolonging the line of its west wall southward might imply A4 was fronted by a portico of some kind. Only three buildings (B1, B3, B4) have so far been located in the remainder of the *praetentura*, and very little is known of their internal layout, but their positioning, outline and proportions are consistent with their identification as three of the required six infantry barracks (corresponding to Buildings 4, 6 and 3 respectively at Wallsend).

In the *latera praetorii*, too, the similarities of layout are greater than the differences, though the latter do exist. The most obvious contrast is the position of the granary (A5) at the very end of the range, rather than next to the *principia*, as at Wallsend, and its use of stone pilae to support the raised floors instead of sleeper walls as in Building 7. Nevertheless A5 adopted the same basic double granary form as Building 7 and was furnished with a portico of four columns at the south end. Like Wallsend it may have been double-ended for there was evidence for at least one timber loading platform at the north end, which would surely have been protected by a portico to match the one at the southern end. The use of timber for the loading platforms may have resulted in their traces going unrecognised at the south end (Dore and Gillam 1979, 29–30; and see Chapter 4). After all, the double-ended nature of the primary granary at Wallsend was only finally confirmed in 1997–8. The *principia* too was very similar in form to the Building 14 Phase 1, with no internal row of piers or columns in the cross-hall to create a side aisle, though the unusual provision of buttresses along the building's south-east wall, presumably to support a two-storey rear range of rooms, was not replicated at Wallsend. In addition there was an uncompleted headquarters at South Shields, as at Wallsend. This consisted of the central *aedes* flanked by a single room on either side (Bidwell and Speak 1994, 56–8). The excavators suggested that the three-room structure was completed up to its full height to provide a religious focus for the garrison, housing its standards, whilst the fort was under construction. The intention was probably that this would be incorporated when the rest of the *principia* was finally completed, as may have occurred at Brecon Gaer (*ibid.*, 58). Instead it was eventually demolished and an entirely different *principia* erected over its remains. The *praetorium* (B5) occupied the same position to the right (east) of the *principia* as at Wallsend, but this is so common as to lack any significance, and nothing is known of the building's internal layout. There is also evidence

for the existence of another building, lying between the granary and the *principia*, its floor being seen by Richmond in 1949 (*ibid.*, 18), but the space was too narrow to permit the construction of a building with the same dimensions as the hospitals found at Wallsend, either the Antonine stone building, 8, or its possible timber predecessor, 21.

One of the most distinctive aspects of the overall design at both forts is the very broad space at the rear of the central range, which greatly increased the normal width of the *via quintana*. At Wallsend, first Building 21 and later the stone hospital encroached southward onto this space, leaving a large open area to the north instead, which Daniels designated the 'assembly area'. In contrast the space was entirely vacant on the completed fort plan at South Shields, but its south-western half had apparently been utilised during the construction period itself by a long rectangular building with a front corridor and wings projecting southward at either end (A6). This is now interpreted as providing temporary accommodation for soldiers overseeing the construction of the fort (Hodgson 2009, 62). The *via quintana* space which was to be left empty provided a convenient location for this building which could then be dismantled once all the surrounding works had finished.

Observing that three or four decades separated the construction dates of the two forts, Bidwell and Speak suggested that close resemblance of the two plans 'might have resulted from reference by their builders to the same text or drawing, describing or illustrating the ideal disposition of buildings in a fort' (*ibid.*). This is possible, but in that case one might have expected the plan to appear more widely (though it must be admitted that few British forts have been so extensively explored as South Shields or Wallsend), and it doesn't answer the question as where the plan had been kept in the intervening period to be revived when soldiers arrived to build the new fort at South Shields. It seems likely that the close proximity of the two sites must in some way help to explain their similarity. If there was a Hadrianic fort on a different site at South Shields as has been postulated, perhaps it too took on a very similar form to Wallsend and was largely copied when laying out the Antonine fort. Moreover it should be remembered that building work was probably being carried out at Wallsend at the same time as the stone fort at South Shields was being established, with the erection of the stone hospital and the renewal of the barracks in stone, for example. Specialist staff, such as legionary engineers responsible for supervising the more technical aspects of the work, may have shuttled between both sites, perhaps thereby contributing to some convergence in the plans. Finally the possibility that the Hadrianic building programme was more extended than previously assumed would obviously help to shorten the timescale over which these shared ideas regarding the ideal form of fort planning needed

to be transmitted, and this would be especially true if some of the major buildings at Wallsend were still awaiting completion.

Period 2 (Fig. 2.03)

The second overall structural period in the fort witnessed a radical overhaul, involving the replacement in stone of all the timber buildings belonging to the first period of occupation. This represented a majority of the fort's internal buildings, including most probably all the barrack accommodation. Presumably, the timber structures had decayed too greatly in the intervening two decades, since the abandonment of the Hadrianic barrier in favour of the

Antonine Wall, to make their reoccupation feasible, even if they escaped systematic demolition when the Antonine advance was initiated.

The central range

Significant alterations were made to the buildings of the central range, as well as the barracks. Building 21 was replaced by a larger stone hospital (Building 8) supplied by water from a substantial stone-lined cistern in the open area to the north, opposite the west gate. If not already erected, the *principia* certainly was by this stage. It comprised a colonnaded courtyard, with a cross-hall along the south side and a range of five rooms, probably functioning as administrative

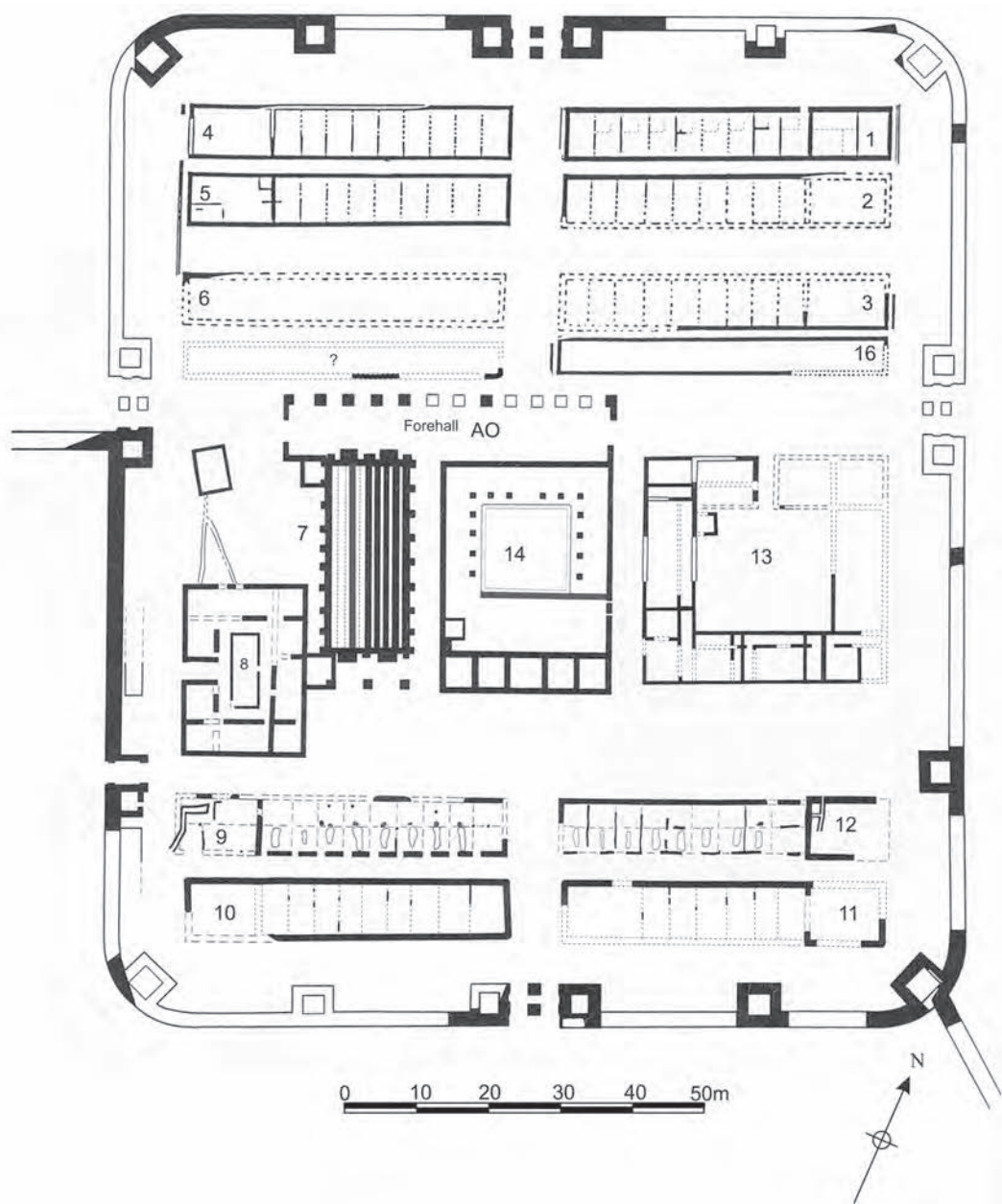

Fig. 2.03 Period 2 The mid-Antonine or later second-century fort, 0

offices with a regimental shrine in the middle of the row in the normal manner. A definite addition of this period, extending right along the frontage of the *principia* and the neighbouring granary, and straddling the *via principalis*, was a large forehall (Daniels' Building AO). This was furnished with wide, arched entrances at the east and west ends and an arched façade along the north side supported by a row of 13 square piers and infilled by panel walls which perhaps carried window openings above. The forehall was probably roofed covering the northern approaches to both the *principia* and the granary, and its construction entailed the demolition of the granary's north portico which had been rendered redundant. The forehall would have sheltered loading and unloading of provisions at the north end of the granary and perhaps helped to control access to that building. It probably also served as a covered assembly point in front of the headquarters building where troops could be marshalled for ceremonial purposes. It did not, however, in all probability, function as a drill hall (*basilica exercitatoria*) of the kind mentioned on an inscription from Netherby (RIB 978), a role more plausibly performed by the type of structure revealed by recent excavations at Birdoswald (Wilmott 1997, 75–82, 95–8; 2001, 70–2; Wilmott *et al* 2009, 216–19; cf. Hodgson 2003, 181–2). Small square buildings, possibly associated with the administration of the granary – monitoring the receipt and disbursement of supplies to the garrison for example, were attached to the south-west (AV) and north-west (AU) corners of the granary at some point during this period. Building AU was tucked into the angle formed by the west wall of the granary and the south wall of the forehall and clearly post-dated the latter's construction.

The barracks

The barracks were rebuilt with stone external walls and internal partitions of timber and wattle-and-daub. The same disposition of four cavalry blocks in the southern part of the fort (*retentura*) and six infantry blocks to the north in the *praetentura* which was a feature of Period 1 seems to have been retained in Period 2. Excavation of Buildings 9 and 12 in 1997–8 showed a urine pit was inserted in the front (south) room of each Period 2 *contubernium*, just as was the case in Period 1. These pits were typically surrounded by flagged flooring. Although the Daniels excavations revealed less complete plans of the other two *retentura* barrack blocks, sufficient features were preserved to indicate that these followed the same pattern as 9 and 12. No equivalent pits were preserved in any phase of the north barracks confirming that these were laid out for infantry *centuriae* throughout their history.

All the barrack blocks seem to have taken the form of rows of nine *contubernia* and an attached officer's

house at the end nearest to the defences. A figure of ten *contubernia* is the number which has generally assumed for a full-strength infantry century, so the centuries at Wallsend would appear to have been just a little understrength when the stone barracks were first constructed, amounting to around 72, rather than 80, men, based on the usual assumption that an infantry *contubernium* comprised eight men. The standard number cavalry barracks would each appear to have housed 27 ordinary troopers in their nine *contubernia*, based on an assumed complement of three *equites* per *contubernium*. The junior officers of *dup icarius*, *sesquiped icarius* and perhaps *vexillarius* may have been accommodated along with the decurion, in the officer's house. It has been suggested that this indicates the standard complement for a cavalry *turma* (Hodgson 2003, 88). However it is worth pointing out that if the number infantry *contubernia* per barrack was one less than the notional standard so too might the number of cavalry *contubernia*. Some cavalry barracks might therefore have contained 10 *contubernia* giving a notional total of 30 ordinary troopers per *turma*, or perhaps the junior officers were sometimes accommodated together in an ordinary *contubernium* and sometimes with the decurion in the attached house. In practice there was probably always some measure of variation in this, even when the unit was close to full strength.

The officer's houses were divided from the range of *contubernia* by a stone wall, otherwise the internal partitions were generally of timber and wattle-and-daub panels, their position indicated by linear slots housing sleeper beams. Of the infantry barracks Building 1 was the best preserved and can serve as a representative example of the type. The *contubernia* were sub-divided into front and rear rooms (*arma* and *papilio*). The rear (south) room generally seems to have been approached by a side passageway which was screened off from the front (north) room by a further partition wall. In all but one case where it could be determined, in this block, the passageway ran along the east side of the respective *contubernium* and it is clear that for the most part the external doorway was positioned on this side. In a number of instances the stone threshold of the main doorway through the north wall into the *contubernium*, the adjacent doorway leading off the passageway into the front room and the doorway into the rear room at the southern end of the passageway survived complete with pivot holes for the doors, raised door thresholds and threshold slabs immediately inside the internal doorways. This arrangement incorporating a side-passage screened off from the front room is found in barrack blocks at neighbouring forts, for example the Period 5 and 6 barracks at South Shields (cf. Bidwell and Speak 1994, 24–5; Hodgson 2003, 38–40; Hodgson and Bidwell 2004, 137–9).

Whether designed for infantry or cavalry, the

barrack blocks at Wallsend presented a relatively utilitarian plan, taking the form of a long, narrowly proportioned, rectangular building, which is paralleled at the neighbouring site of South Shields. None possessed the architectural flourish observed in equivalent structures elsewhere on the northern frontier, at sites such as Housesteads, Birdoswald and Chesters, whereby a colonnaded veranda was set in front of the *contubernium* ranges. This entailed recessing the front wall of the *contubernium* range in relation to the adjoining officer's house, with the vacant strip instead being occupied by the veranda, and would have provided shelter for the *contubernium* entrances and perhaps given the buildings a more classical aspect.

The developed mid-Antonine fort

The treatment of the barracks stands as something of a contrast to the effort apparently lavished on the principal buildings of the fort, which display a rather elaborate aspect. The forehall, discussed above, is one example of a Period 2 structure apparently designed to give the fort a highly monumentalised appearance, perhaps associated with the performance of the auxiliary regiment's calendar of imperial and religious ceremonies. Another, rather more subtle case is represented by Building 8, almost certainly to be interpreted as a hospital. Its plan has direct parallels at Housesteads, perhaps Benwell and earlier, in timber construction, at Hod Hill, and took the form of ranges of rooms arranged around all four sides of a colonnaded rectangular courtyard. These ranges may have been two storey, but no clear traces of stairs were recognised. The colonnade was set on a low stylobate and sheltered a paved walkway around the cobbled courtyard. The latter was provided with a gutter channel running alongside the stylobate, in order to catch and channel rainwater flowing off the pentice roof of the walkway. The gutter was constructed of lengths of carved gutter stones and was connected to circular basins located in all four corners of the courtyard. The building was supplied with water from the large cistern (Cistern 1) to the north of the building. Some the arrangements whereby this was achieved remain obscure, but one of the conduits leading from the cistern the building ran through a doorway in the north wall of the hospital across Room 8, probably exiting through another pre-existing doorway, then crossed the walkway and passed through a deliberately constructed gap in the stylobate to feed into the north-east corner of the courtyard gutter. It is possible that the flow was then directed from the south-west corner of the courtyard (its lowest point) into drains designed to flush the latrine in the south-west corner room. This form of courtyard building, which combined classical architectural elements, such as colonnaded

walkways, with a practical concern for sanitation and water supply, appears to symbolise an implicit promise on the part of the imperial state to provide its soldiers with the benefits of the civilised world's medical knowledge, and forms just one aspect of the pseudo-urban environment surrounding the garrison in the rebuilt fort.

The building sequence

With such a substantial building programme, the work must have taken place over a number of years, even if all the projects were undertaken at broadly the same time as part of a single overall programme. However it is quite possible that Period 2 embraced more than one discrete building episode. It would be quite easy to envisage some work taking place in the 160s and a second episode in the 180s, for instance. Here we come to the heart of the problems faced in analysing the overall pattern of building work at Wallsend, as revealed by the Daniels excavations. Most of the pottery assemblages associated with individual building phases or sub-phases are fairly small and hence not capable of being subjected to the kind of quantitative analysis – examining the proportions of BB2 relative to other wares for instance – which would help to achieve greater precision in dating. Thus only one context definitely associated with initial phase of the forehall yielded pottery in the course of the Daniels excavations and, furthermore, no stratified material was found in such contexts in 1997–8. Some material was found in the contemporary levels of the central *via principalis*, but material from such contexts has a higher potential to be intrusive, as a result of being trodden into the surface from a higher level, and is particularly problematic where later disturbance removed patches of the overlying layer of metalling.

A relative structural sequence can sometimes be established. The two square buildings attached to the west side of the granary, AU and AV, probably followed construction of, respectively, the forehall and the hospital. Two sub-phases, marked by renewal of partitions and relaid floors can be identified in at least some of the stone barracks in the *praetentura*, but the second of these might still have fallen within Period 2 rather than Period 3. The more southerly of the two phases of walling associated with Building 15, which perhaps represented stone wall foundations and was very tentatively interpreted as the later of the two phases (see above: Period 1), was in turn cut by the post holes of a timber portico along the north side of the forehall. This clearly indicates this phase of 15 had gone out of use by the time the portico was constructed. However, even if the foundations have been correctly interpreted as representing the second phase of Building 15, rather than the first, it is not clear that the portico was an original component of the

forehall. Hence it is still possible that there might have been a chronological overlap between the forehall and 15, with both buildings being used simultaneously for a time. In that case the second phase of 15 might itself represent a Period 2 construction. This possibility would also apply if the forehall constituted a later structural episode within the period, perhaps being erected in the 180s, whilst the stone barracks, hospital and Building 15 Phase 2 (and perhaps even the stone *principia*?) were first erected in the 160s.

Period 3: late second or early third century (Fig. 2.04)

This period, which probably corresponds to the decades on either side of 200, was principally distinguished by a major reduction in the area of the hospital and, conversely, significant if less well preserved alterations to the granary which resulted in the expansion of that building's capacity. The modifications to the hospital were the most striking, involving the demolition of the entire east range and the colonnade in the courtyard. A timber portico erected instead along the east side of the courtyard, which was entirely resurfaced with cobbling. These changes had the effect of converting the architecturally distinguished building of the Antonine era into a smaller, more utilitarian, if perfectly serviceable, structure. Indeed improvements were made to the stone-lined conduits, which now channelled water more directly from Cistern 1 to the latrine in the south-east corner and may have improved its functioning (although two successive alterations to the channels later on suggest that this aspect of the design may have continued to pose problems for the occupants of the hospital). The former east range was covered by cobbled road surface, which led round from the minor west gate (*porta quintana sinistra*) and northwards towards the forehall entrance and access to the doorways at the north end of the granary. This metalling was heavily rutted and evidently saw heavy traffic for a period. The need to facilitate the path of this traffic from the *porta quintana* (which was probably in actual fact the most important gate on the west side of the fort by this stage, providing direct access from the Military Way) in all likelihood supplied the motivation for these alterations.

Changes affecting the granary were perhaps related to the same overall process, although these would appear to have begun before the reduction of the hospital. A series of alterations were carried out at the south end of the granary around this time. The square office building (AV), which was attached to the south-west corner of the granary at some point during Period 2, completely blocking the alley between the granary and the hospital (Alley 7), was demolished (but AU, tucked in the angle formed by the granary and forehall walls may have

remained in use). A substantial drain channel, lined and capped with stone slabs, ran round the south end of the granary, cutting through the remains of AV. It connected with a similar drain which headed south-eastwards from a point on the south wall of the granary near the building's south-east corner, running on past the south-west corner of the *principia* and across the *via quintana*, perhaps continuing down the *via decumana* and out through the south gate. The heavily rutted road surface recorded at the southern end of the alley probably overlay the drain, or at any rate impinged upon it, and was therefore later in date. (The picture is somewhat confused by the way that Daniels' investigation of this area was undertaken in several separate seasons – 1977, 1980–81 and 1983, with further work in 1997–8. The rutted road surface was clearly recorded when most of the hospital was excavated and the area south of the granary first uncovered in 1977, but was less apparent when the rest of the alley was excavated along with the northern part of the hospital in 1983).

The granary seems to have been extended to the east, absorbing the alley which separated it from the *principia* (Alley 8), the extension being labelled Building AW by Daniels. The southern end of the alley was blocked off by a stone wall that continued the line of the granary south wall. The new wall had later been robbed out, leaving only foundations, but it was evidently buttressed along its south side, like the original granary walls, suggesting that it was not simply a wall designed to block off the alley and thereby reduce access to the forehall and the north end of the granary. Instead it would appear that the area of the alley must have been roofed and treated as part of the granary structure with supplies presumably being stored inside. The west wall of the *principia* presumably served as the east wall of granary extension AW. There is some indication that the original east side of the granary was also rebuilt at this stage. The slab-lined drain described above commenced at a point on the south wall opposite the most easterly sleeper wall rather than the building's original east wall, perhaps indicating that the sleeper wall was rebuilt to help support a roof valley. No trace of sleeper walling was noted over the metalling in the former alley, perhaps a result of post-Roman destruction. Nor was an equivalent wall definitely identified at the northern end of Alley 8, but a modern drain trench running along the very line such a wall would have occupied could have removed any traces which might have existed. A spread of dressed stones on either side of the sewer trench might conceivably represent the displaced remains of such a wall, however.

The programmes of work on the hospital and granary were probably connected. They appear to have had the threefold purpose of tightening control over supplies held in the granary by only giving

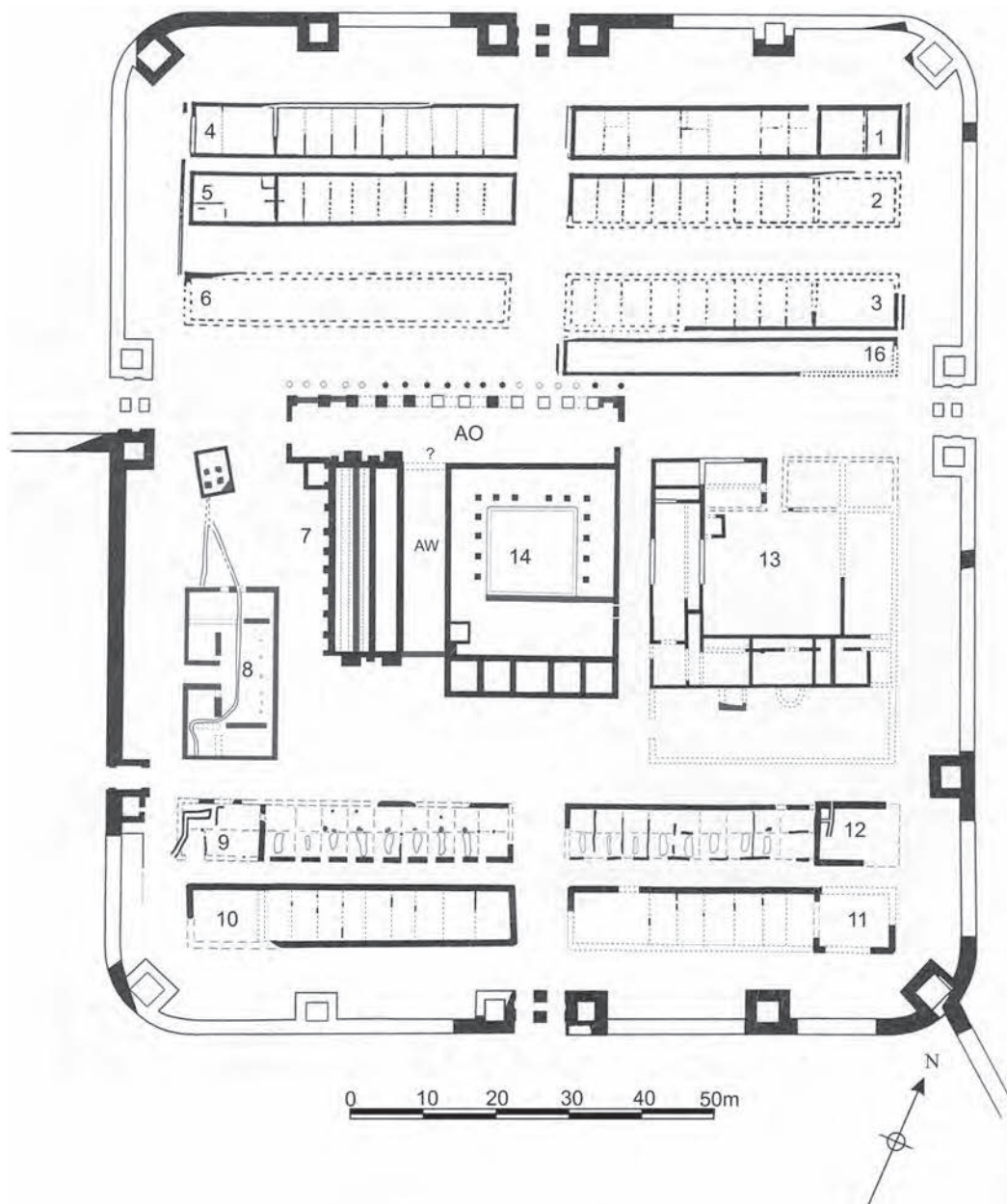

Fig. 2. Period 3. The fort in the late second/early third century.

access to the building via its the north end, which was already enveloped within the forehall, of easing the movement of supplies to that end of the granary by widening Alley 7 and of expanding the building's overall capacity by encompassing Alley 8 within it. The widening of Alley 7 made possible by the demolition of the hospital's east range would enable cart traffic moving between the *porta quintana* and the north end of the granary to follow a circular one-way route, via the west *intervallum* road and *via principalis* oneway and Alley 7 and the west *via quintana* the other way. It has been noted that this implies an unusual level of activity which might be associated with the movement of supplies during the Severan campaigns of 208–11, with Wallsend perhaps being used as a

transshipment point for supplies arriving by vessel from South Shields for onward movement by cart along Hadrian's Wall (Hodgson 2003, 16).

A number of relatively minor alterations were made to the other central range buildings as set out in the period concordance tables at the end of this chapter. Those relating to the *principia* and the *praetorium* being grouped together as respectively Building 14 Phase 2 or perhaps 3 and Building 13 Phase 3i-ii (but possibly incorporating sub-phases iii and iv as well). The portico along the north side of the forehall could also conceivably belong to this period if it was a secondary component rather than an original feature of the building. This would indicate that the second phase of Building

15 must certainly have been demolished by this stage if not much earlier. The difficulty in accurately assigning such minor alterations to a chronological period, whether considered individually or grouped together into a notional building phase, should not be underestimated, however, given the small size of the associated assemblages of dateable material.

Period 4: from c 220 to the mid-third century (Fig. 2.05)

The rebuilding of the barracks

The infantry barrack blocks

During the third century, the barrack accommodation was renewed once again in both the north and south parts of the fort. However, in demonstrable contrast with the previous period, the third-century infantry and cavalry barracks took a markedly different form. As regards the infantry barracks, those in the eastern *praetentura* were the best preserved. Buildings 2 and 3, though partially covered by Buddle Street, demonstrate the basic characteristics of this phase. They took the form of conventional rectangular barrack blocks, retaining the outer walls from the previous building phase, but employing stone dividing walls rather than timber/wattle-and-daub partitions to separate one *contubernium* from another. In Building 2 stone walls dividing each *contubernium* into front and rear rooms survived in a few cases and this pattern was probably universal. Because the stone partition walls were wider than the preceding timber ones, each block probably contained one less *contubernium* than the previous phase, reducing the total to eight. The *contubernium* at the end farthest away from the centurion's house may conceivably have performed some service or utility function, as appears to have been the case in barrack blocks at South Shields, rather than accommodating a squad of soldiers. This would accord with the evidence from the end *contubernium* in Building 2, which was found to have a heavy flagged floor across the entire interior, with no evidence for an internal cross wall at the beginning of this phase. Later on the *contubernium* appears to have been reduced in width, whilst *Contubernium* 7 was enlarged at its expense. A reduction to seven manned *contubernia* would mark a diminution in the strength of each *centuria*, but not a drastic one. Centurion's houses were still attached to the eastern ends of each range, next to the *intervallum* road, as evident in the case of Building 3.

Building 1, on the other hand, was replaced by a dedicated stable building. This was the same length as the previous barrack block and reused some of the latter's outer walls, but was more narrowly proportioned, with a new north wall being constructed. The stable was devoid of internal partitions and was furnished with a drain running

the length of the building alongside the inner face of the south wall and may also have had some shorter north-south aligned drain channels feeding into the main drain.

The west *praetentura* was more difficult to interpret due to the degree of damage to the Roman levels by later agricultural and colliery period activity, which was amongst the most severe encountered in any part of the fort interior exposed by the Daniels excavations. However, the surviving fragments of stone walling suggest that conventional stone barrack blocks, similar to those erected in the east *praetentura* at this stage, were also present here, with evidence for stone partition walls separating the constituent *contubernia* one from another and cross-walls dividing the latter into front and back rooms.

Less clear was the number and overall pattern of the blocks. It does appear certain that the footprint of the new blocks was different from that of the three blocks which previously occupied this part of the fort (Buildings 4, 5 and 6). In marked contrast to the situation pertaining in the east *praetentura*, Buildings 4–6 were evidently superseded, although individual structural elements may have been incorporated in the new layout. This would imply that the number of blocks erected in west *praetentura* in the new scheme was different from that applying previously. This could conceivably reflect the need to squeeze in an extra block to make up for the shortfall in barrack accommodation resulting from the conversion of Building 1 into a stable. The only way to retain the previous number of six barrack blocks in the north part of the fort would have been to insert four in the west half of the *praetentura*, laid out in pairs of back-to-back blocks in order to fit the available space there (see Fig. 2.05 inset). Even so the most northerly block would have to encroach on the north *intervallum* road.

This layout of four back-to-back blocks is consistent with those elements of the third-century barrack plan which can be substantiated from surviving remains uncovered by Daniels in 1975–6. However there are a number of caveats which need addressing with regard to this hypothetical plan. Firstly, there is no surviving evidence whatsoever for any of the required structural features making up the most northerly and southerly of the four blocks. Of itself this is not at all decisive. The southern block would have been entirely hidden beneath Buddle Street, whilst part of the northern block could also have lain unexcavated beneath the late nineteenth-century lane which separated the 1975 and 1976 excavation sites in this part of the fort (but note however that the north-west corner of Building 4 was relatively well-preserved with several courses of masonry surviving). Still more problematic for this restoration of the third-century scheme is the way the two central blocks faced one another across a relatively narrow lane (c 2m wide) which would obviously have very awkward when both centuries

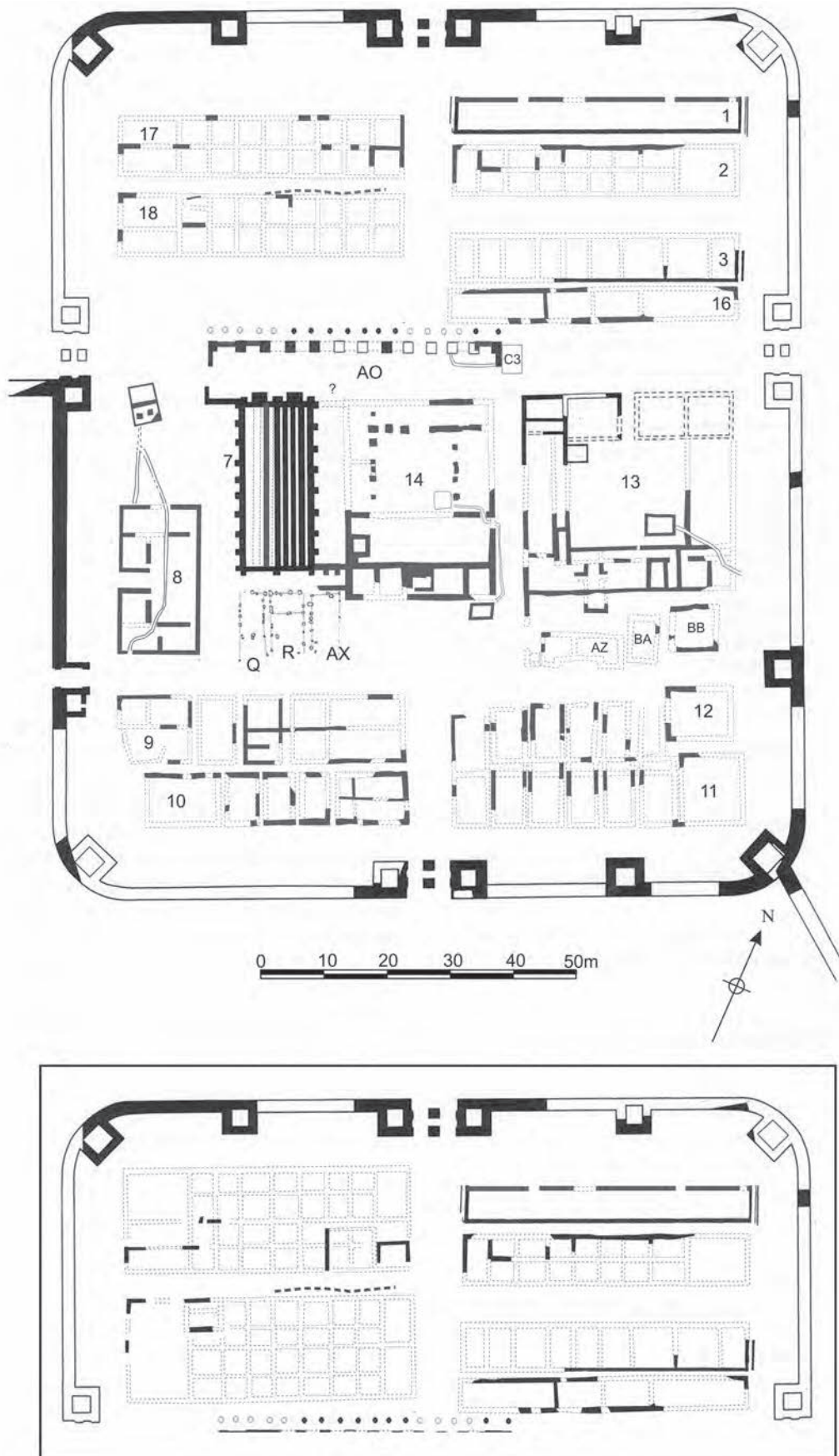

Figure 8 Period 4 The fort between ca 3 and the mid-third century with inset showing an alternative possible layout of the praetentura barracks.

were trying to issue from their respective blocks and form up at the same time. If such a layout was the only one which was feasible to retain the four blocks it might still be accepted as valid, but clearly a much less cramped layout could have been maintained in the west *praetentura* if three barracks had been retained in the east *praetentura* and the much narrower stable block switched to the west *praetentura* and laid out back-to-back with one of the barracks.

These problematic aspects of the four barrack back-to-back restoration suggest that the previous number of barracks may not have been maintained after all, and that only two barracks were laid out in this part of the fort, facing away from each other with the intervening lane forming a back lane for both blocks. This would deal with the overriding difficulty with the back-to-back version, namely that it entails one half of the *praetentura* being more crowded than previously whilst the other half was less so than before. Far from being overcrowded, the infantry garrison quartered in both the north-east and north-west parts of the fort had a great deal more space than previously, with the result that an additional stable block could easily be fitted into the area. Of course a reduction from six to four infantry barracks would mark a substantial diminution in the overall strength of the garrison. The implications of this are considered below.

The cavalry barrack ranges

The cavalry barracks in the south part of the fort adopted a very different form, comprising ranges of free-standing *contubernia*, or chalets as they have been labelled. Each range included five or six chalet-*contubernia* and a detached officer's house at the *intervallum* end of the range. Though different from their predecessors these chalet ranges were still recognisably functioning as cavalry barracks. Cross walls survived in many instances, dividing the chalet-*contubernia* into front and rear rooms, the front rooms being provided with a stone-lined drain along the central north-south axis, the equivalent of the waste pit in the earlier cavalry barrack *contubernia*.

Dating and building sequence

The report on the 1997–8 excavation report assigned a date of 225–235 or perhaps a little later to the two chalet-ranges, 9 and 12 re-excavated in the *retentura* (Hodgson 2003, 16, 115). The buildings were certainly considered to be in existence by the mid-third century. The dating evidence retrieved from all four *retentura* chalet-barracks by the Daniels excavations would not contradict that dating. It is tempting to envisage the remodelling of the infantry barracks in the *praetentura* as beginning somewhat earlier since these adopted a more traditional layout. The argument is not of itself beyond question, however. Conventional barrack blocks with ranges of conjoining *contubernia* certainly

continued to be erected in the third century. This is the form of the Period 6 barracks at South Shields which are considered to date to the period 225–235, that is to say directly contemporary with the proposed date for the chalet-barracks at Wallsend, and these were replaced by barracks of the same general type in the late third or early fourth century.

The dating evidence from the *praetentura* barracks is considered in detail in Chapter 14. In Building 1, layers of clay and daub thought to represent the demolition of the Stone Phase 1 (i.e. Period 2) barrack and the makeup for the flagged floor of the stable did contain mid- to late third-century pottery and a slightly worn coin of 249–51 (Herennia Etruscilla) as well as BB2 and allied fabrics (which made up two-thirds of the assemblage) and Nene valley ware. These layers were not securely sealed, as the overlying flagging was very patchy, and some of the material could therefore be intrusive. If that were the case the relatively small proportion of diagnostically mid- and late third century pottery might reflect the duration of the building's occupation, rather than the period of its construction, and the Stone Phase 2 *praetentura* barracks could be assigned an earlier third-century date, broadly similar to that of the *retentura* chalet-barracks. There was mid- to late third century pottery associated with the flagged floor of Building 1 and a secondary occupation level in Barrack 2, but there was nothing which would indicate that the buildings continued in use beyond the late third/early fourth century when Crambeck reduced ware and calcite gritted ware first appeared on the northern frontier. This would be a problem if a late third century *terminus post quem* was applied to this phase of barracks as it would imply a short period of occupation which is challenged by the evidence for repeated modification in the interior of Building 2, the best preserved of the barracks.

One structural feature which might support the initial hypothesis proposed above that the third century remodelling of the barracks began in the *praetentura* and then moved on to the *retentura* is the curious medial spine wall running much of the length of Chalet Range 9. This curious feature was originally regarded by Daniels as part of a Phase 2 remodelling of conventional barrack block and then as the south wall of a narrow stable like Building 1. Neither of these interpretations can be sustained and the 1997–8 excavations showed that the spine wall was essentially contemporary with the chalet side walls. Nevertheless it remains a puzzling structural component. At the eastern end of the range the wall bisected three conjoining *contubernia* (the easternmost pair may conceivably have faced east towards the *via decumana* rather than north onto the *via quintana* with the wall separating rather than bisecting them, although the surviving evidence in this part of the range is too fragmentary

to be certain). However it then continued westward to bisect the next freestanding chalet-*contubernium* (U) terminating in a butt-joint against the west wall of that chalet. The structural function of this wall, particularly in Chalet U, is unclear. Whilst it might have helped to support an east-west aligned gable roof covering the three easternmost *contubernia*, the chalet-*contubernia* are most likely to have had separate roofs with gable ends at the front and back of the building rather than the sides. The spine wall's role in Chalet U was probably limited to that of the internal partition wall separating the front and rear rooms of the *contubernium* (indeed it may simply have been a sleeper wall supporting a timber/wattle-and-daub partition). Even so it contravened the basic principle of structural independence underpinning the chalet-*contubernium* form which allowed individual groups of *contubernales* to maintain their own quarters without impinging on their neighbours. Moreover if the spine wall actually performed the more significant structural function of supporting an extension over Chalet U of the pitched roof covering the three eastern *contubernia* why would U have been constructed as a freestanding *contubernium* at all?

It seems preferable, therefore, to regard the spine wall as the fossilised remnant of a building plan which was begun, but not fully implemented. Indeed, the wall's existence serves to emphasize that, with its mix of freestanding and conjoining *contubernia*, Chalet-Barrack 9 as a whole was a hybrid structure – part chalet range and part conventional barrack – perhaps indicative of a change of plan at an early stage in construction.

The initial intention may have been to rebuild the cavalry barracks in the *retentura* as conventional blocks, continuing a pattern established with the infantry barracks in the north part of the fort. The spine wall would have separated the front and rear rooms of the conjoined *contubernia* in the new block and helped to support the weight of its roof. The proportions of this remodelled Barrack 9 (like the chalet range actually built) would have been wider than those of the preceding barrack and were perhaps intended to apply to all the rebuilt *retentura* barracks with a back-to-back arrangement of the four blocks perhaps being envisaged. Instead a decision was taken at an early stage in the work to switch to the chalet-range type. Range 9 was completed on the same footprint as that intended for Block 9, the freestanding chalet-*contubernia*, U and V, being laid out according to a very regular module, as though forming a blueprint for the type. The next range to the south (10) was likewise quite regular in plan, but appears to have been restricted to the smaller footprint of the previous block. Ranges 11 and 12 in the east *retentura* may have been laid out back-to-back, but the slightly staggered positioning of the chalet frontages belonging to Range 12 emphasises the degree to which there were minor

variations between individual *contubernia*. Indeed, the nature of the chalet-ranges was such that they facilitated a greater range of variation, with scope for alterations initiated by the *contubernales* themselves. The rebuilding programme can thus be envisaged as progressing around the fort, one barrack at a time, with occasional changes of plan according to circumstance or a shift in ideas.

The size of the third-century garrison

Evidence suggesting that the number of infantry barracks in the northern part of the fort was reduced by a third, from six to four, in this period, was outlined above. Taking into account the evidence for the reduction in the number of *contubernia* from nine to eight and the possibility that in some (though not necessarily all) cases the end *contubernium* may have served as a barrack store or similar, an overall total of 240 infantrymen can be estimated, based on a figure of around 60 men per century.

The rebuilding of the cavalry accommodation in the southern part of the fort clearly did not entail a similar reduction in the number of barrack ranges. However, here too, analysis of the structural remains points to a similarly dramatic reduction in troop numbers. Chalet-Ranges 9 and 10 had only five *contubernia* each, in addition to the decurion's quarters, Ranges 11 and 12 may have had six *contubernia* apiece in the initial chalet phase, although survival of this phase at the east end of the ranges, next to the decurions' houses, was so poor that arrangements there are very obscure. Hodgson (2003, 101–4, 109, 118) suggested that Chalet-Ranges 11 and 12 contained only five *contubernia* each, with the areas where their respective sixth *contubernium* would have lain being incorporated in enlarged decurion's houses. There certainly are some indications, in both Ranges 11 and 12, that the officer's quarters did extend that far westwards, but these may have been associated with later alterations to the scheme which obscured the remains of the original sixth *contubernium*. Either way, whether five or six *contubernia* in each range, this should mark a significant reduction in the complement of each *turma* from 27 men, plus officers, to 15–18, plus officers, giving a total cavalry strength for the regiment in garrison at this stage (assumed to be the *cohors IV Lingonum equitata*) of 66 *equites* plus perhaps a dozen officers.

Hodgson (2003, 119–20) has suggested this reduction was more apparent than real, suggesting that although the number of *contubernia* may have been reduced the total number of troopers in each individual *contubernium* may have been correspondingly increased, perhaps up to six men and horses. This is based on the larger size of the chalet-*contubernia*, with respect to their earlier, barrack block counterparts, and on the appearance of the rank of

hexarchus or *exarchus* (commander of six) amongst the junior officer ranks of the new-style regiments of the late Roman armies.

This argument must be regarded with great caution. There were obvious practical limits on how many horses could be squeezed into a given *contubernium*. Although the *contubernia* of Chalet-Range 9 do appear to have significantly greater internal space than their predecessors in Barrack Block 9, this can perhaps be explained by the building's place within the sequence of reconstruction, as outlined above. The chalet-*contubernia* of Range 10, on the other hand do not appear to have been any longer than those of Barrack Block 10 since, as far as can be gauged, the chalet range occupied the same footprint as the barrack block, nor were they even any wider in some cases. As regards Ranges 11 and 12, no partitions separating the front and rear rooms survived, as is evident from the Daniels excavation record, nor did any of the frontages of Range 11. The chalet-*contubernia* in Range 11 appear to have been a little wider than their barrack block predecessors, but little else can be said without the risk of generating a circular argument, since there are so many uncertainties with regard to the range's overall plan, whilst those in Range 12 were sometimes a little wider, sometimes a little longer, sometimes both. In general, therefore, the *contubernia* in the chalet-barracks appear to have been somewhat larger than their barrack block predecessors – though not always, as exemplified by the case of Range 10 – but, with the possible exception of Range 9, this does not appear sufficient to permit a doubling of the number of horses stabled. In any case, even if more space was available, it does not necessarily signify that it was filled with more horses. A smaller garrison could have afforded to be more generous in its space allocation, and perhaps thereby derive benefits from the horses being easier to manage.

Furthermore, it is not clear how relevant officer ranks in the new style units are to the *contubernia* of a traditional auxiliary cohort. If the rank of *exarchus* is recorded so too is that of *biarchus* (commander of two) and it should be noted that the ground floor stable rooms in the two-storey *contubernia* in the Tetrarchic fort of Qasr Bshir (Praetorium Mobeni) contain three stone feeding troughs per room (Parker 1987, 469, fig 88), whilst the equivalent rooms in the sixth-century fort at Timgad generally contain only two such mangers (Lassus 1981, 169–214 esp figs 134–6; Pringle 1981, 85–8, 235–6, 547 fig 2, pl XIb). It is possible that in late Roman cavalry *vexillationes* each pair of *contubernia* was placed under a *hexarchus*, residing in one of the *contubernia*, with a *biarchus* (commander of two plus himself?) as his subordinate in the other *contubernium*. Alternatively, where two-man cavalry *contubernia* prevailed, the *hexarchus* may have been the senior cavalryman for every three *contubernia* with a subordinate *biarchus* being nominated as senior *eques*

in each of the other two *contubernia* in the grouping.

If the arguments presented above, regarding the reduction in the strength of both the infantry and cavalry, are accepted, a total regimental strength of somewhat in excess of 300 ordinary soldiers can be estimated, based on sub-totals of c. 240 infantry *milites* and 60–70 cavalry *equites*, plus all the junior officers. Although that would mark a substantial reduction in unit strength, it should be emphasised that a body of over 300 soldiers still represents a considerable aggregation of military force, particularly in the context of the districts immediately to the north of the Wall.

Finally, some comment may be necessary on the circumstances which may have led to such a marked reduction in the size of the regiment at Wallsend during the early decades of the third century. When the units of the British *exercitus* returned to their bases, after the Severan campaigns in Scotland, many may have been significantly understrength. Campaigning generally had an attritional effect on troop numbers and the historical sources suggest that the Severan campaigns were particularly difficult, with losses from both guerrilla warfare and appalling conditions in the field. The losses through casualties and ill-health would be over and above the normal rate at which unit strengths declined unless replenished. Once it became apparent that there was to be no resumption of the campaign, and with little immediate prospect of being restored to nominal full strength with drafts of new recruits, as imperial focus shifted to other frontiers, the cohort at Wallsend may have taken the decision to renew dilapidated barrack accommodation in a form which matched its reduced complement. This provided space for additional stabling in the north-east corner of the fort, a less cramped layout of the barrack blocks in the west *praetentura* and the scope to provide more generous allocation of space in the individual cavalry *contubernia*.

Buildings along the via quinta a

The post hole buildings south of the granary

A row of three timber buildings were erected immediately to the south of the granary, in the recess opening off the *via quintana*, flanked by the hospital and Alley 7 to the west and the *principia* to the east. These buildings employed individual post hole construction and were discussed in detail in the report on the 1997–8 excavations (Hodgson 2003, 140–52), when the area was re-examined, leading to the discovery of further post holes associated with the structures, over and above those already identified by the Daniels excavations. They were referred to as Units 1–3 of Building Row XX (hereafter Row 20) and corresponded to the Daniels Buildings Q, R and the southern part of AX (labelled AX(S) here). These structures provided evidence for as many as three

distinct phases, in the form of multiple alignments of postholes and successive flagged and clay floor levels. Pottery from the floor deposits suggested unequivocally that these buildings were erected in the third-century, probably contemporaneously with the Period 4 barracks. The fact that they differed so markedly in construction method from the stone barracks, both the rectangular blocks in the *praetentura* and the chalet ranges to the south, led to the suggestion that these were designed for a different type of troops, perhaps irregular ethnic *numeri*, rather than providing additional accommodation for the main auxiliary regiment. The units must have fronted onto the *via quintana* street carriageway, to the south, and the presence of a stone-lined drain at the southern end of one of the buildings (Q) hinted that they might have accommodated cavalry, although a mixed unit is also possible.

Post hole buildings were also erected over the remains of the hospital, immediately to the west (Daniels Buildings N, O, P and AP). However the evidence of the Daniels excavations contradicts the suggestion expressed in the 1997–8 that these were directly contemporary with the three building units south of the granary. Pottery recovered in 1977 and 1983 in levels associated with the hospital suggests that the building continued in use up to the late third century. Most crucially, a group of assemblages derived from the hospital demolition rubble and the overlying dark clay makeup deposit, some of which was sealed beneath the only surviving pocket of flagged flooring belonging to one of these buildings (N). These yielded a significant number of late third-century vessels, including Crambeck reduced ware, Lower Nene Valley mortaria and Nene Valley funnel necked beakers. This confirms the impression provided by the structural remains of the post hole buildings, with evidence for multiple phases in the case of the three building units south of the granary, but nothing comparable in the case of those over the hospital. However it is possible that the final phase of the Row 20 units were constructed at the same time as or at any rate were still in use when those over the hospital were erected.

The buildings of the praetorium south annexe

Further east, a row of three very different buildings (AZ, BA, BB) was erected along the south side of the *praetorium*, on the edge of the walled yard attached to the house. These were stone built, as was evident from the surviving fragments of wall masonry in the distinct robber trenches associated with AZ and BA. Only rubble foundations survived in the case of BB, which might even have been slightly later than the other row, but these foundations too were clearly intended to support stone walls. The westernmost, AZ, resembled a tiny wing corridor villa in plan and contained *opus signinum* floors, at one stage in its life

at least. It is likely these were associated in some way with the complex sequence of alterations to the internal arrangements in the *praetorium* which particularly focussed on the hypocausts serving a probable bath suite in the central part of the south range and a heated room in the south-west corner room. The clay base of rectangular stone water tank was recognised next to AZ, tucked into the south-west corner of the walled yard, with a well-constructed gateway into the yard immediately to north complete with carved threshold stone. If not related in some way to activities inside the commanding officer's house they might conceivably have provided accommodation for officials resident in the fort. However there is no indication, in the form of structural similarities with the post hole buildings south of the granary, that they housed soldiers belonging to irregular, ethnic units.

The mid-late third century (Fig. 2.06)

Most of the buildings associated with the Period 4 fort probably continued in use up until the end of the third century, in one form or another, though potentially with many alterations. In the cavalry chalet-barracks in the southern part of the fort, remodelling can be glimpsed, though the pattern can rarely be plotted out in full so the implications of and reasoning behind the alterations can rarely be understood. Examples include work in the eastern half of Range 9 (over ET), which might be fragment of a fairly extensive replanning, apparent reshuffling of chalet footprints in part of Range 11 and successive alterations to the decurion's quarters at the west ends of Ranges 9 and 10 (W and AB). Indeed the officer's quarters generally appear to have been a focus for continual attention with evidence for remodelling of those associated with Ranges 11 and 12 as well (AN and AM respectively). The sequence relating to the latter, involving a series of inter-related alterations to the decurion's quarters and the adjoining chalet (AM and AL) at the east end of the range, is particularly complex and eventually resulted in wholesale replanning of this area. This is one of the rare instances where the plan is relatively complete and, although areas of uncertainty remain, it certainly serves to underline just how radical some of the chalet-barrack remodelling could be.

Comparable work can be identified in the north barracks, at the eastern end of Building 2 for example, where *Contubernium* 7 was enlarged at the expense of the undivided end (utility?) room, and the floor levels in 7 were relaid several times, but the general impression here is of much less radical replanning than in the *retentura*. The flexible format of the chalet ranges may have encouraged such repeated alterations, though in doing so it may have led to the very disruption it was perhaps designed to minimise. Dating these alterations with any precision is difficult as most have only small groups of pottery associated

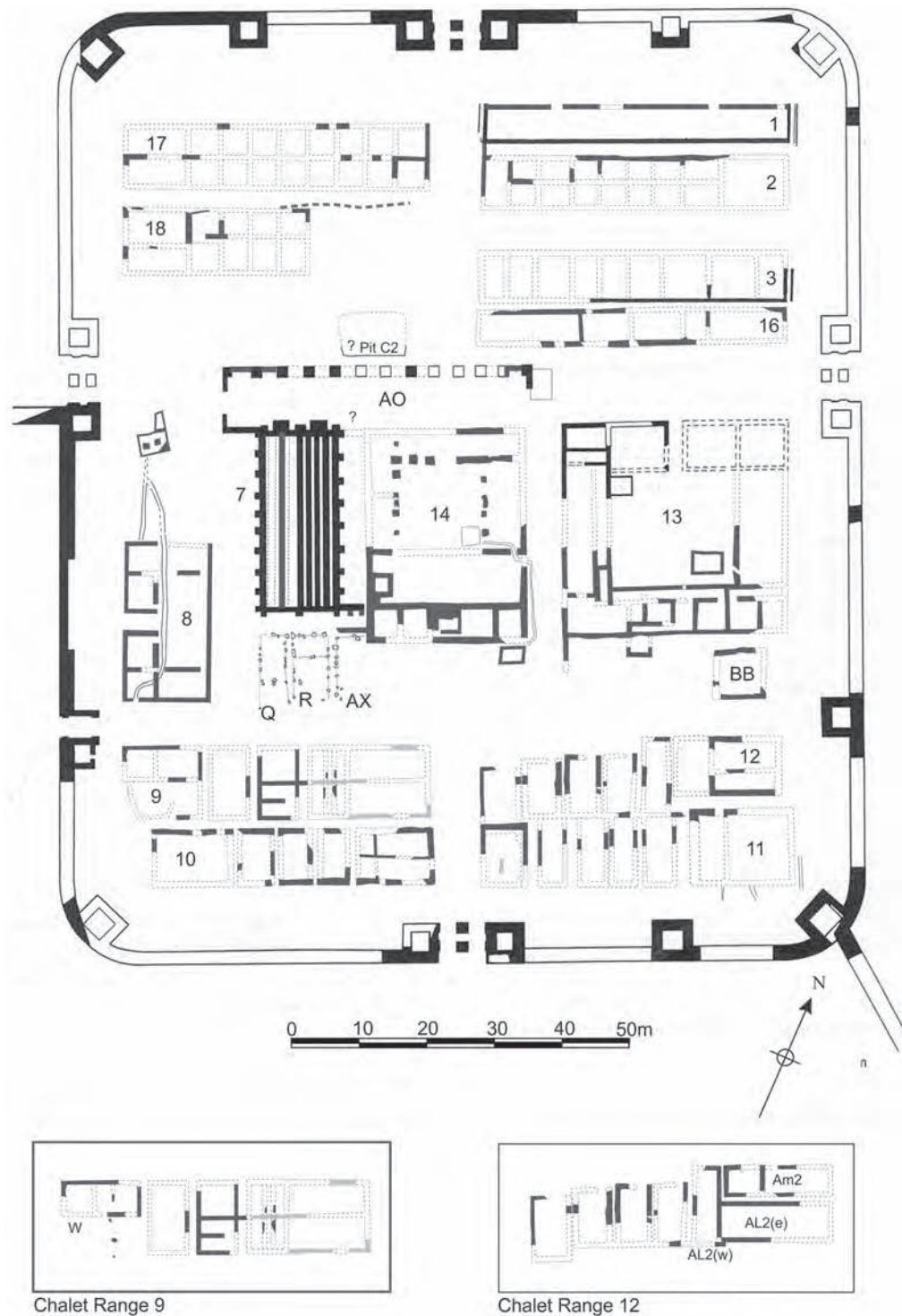

Figure 2.06: The fort in the mid- to late third century with insets showing the latest alteration to the officers quarters at the ends of Chalet Ranges 9 (W) and 12 (AL2 AM2).

with them, but the overall impression is of occupation continuing up to and probably into the later third of the third century. The final rebuilding at the east end of Range 12 may indeed not have occurred before the late third century.

In the central range the latest pottery from the hospital suggests it too was probably still occupied

up to the late third century, rather than going out of use at the end of Period 3 or early in Period 4, as was previously suggested on the basis of the 1997–8 excavations. When finally demolished the hospital was apparently replaced by several posthole buildings, perhaps similar in character to those already standing south of the granary. Period 4 was characterised by

yet another realignment of the water conduit leading through the hospital yard to the building's south-west corner, where the latrines were again rebuilt, with an reverse L-shaped channel running alongside the room's east and south walls, presumably surmounted by seating (perhaps wooden).

The cistern in the open area to the north may have gone out of use at the same time as the hospital. The rubble backfill contains a large number of BB1 flanged bowls typical of the late third century, but no Crambeck reduced ware or calcite gritted ware, suggesting a date soon after 270. The structural evidence suggests the two halves of the cistern were backfilled in stages, but the two operations could not be distinguished chronologically on the basis of the pottery assemblages, probably signifying that only a few years, at most, separated the two events.

Certain of the latest changes to the hospital, notably the rebuilding of the north wall, appear rather irregular and there is a strong possibility the north range was no longer standing by this stage. No certain signs of equivalent dilapidation are identifiable in the granary or the *principia*. However it should be emphasised that floor surfaces later than Period 4 probably did not survive in the *principia* cross hall and south range (these areas yielded no diagnostically certain mid- or late third century pottery apart from a single sherd of calcite gritted ware), and the same is true of the granary where only the sub-floor structures of sleeper walling and foundation raft remained of course.

One building where the possibility of disuse and demolition should be acknowledged in this period is the *praetorium*. The rooms in the south range – the only part of the building where preservation is sufficient to make any kind of judgement – were clearly still functioning in Phase 3vi, with significant alterations to the east hypocaust and the arrangements in the south-west corner for example. Little structural activity was associated with Phase 4, on the other hand. Levels interpreted as floors were encountered in the south range corridor and the rooms associated with the east hypocaust, consisting of dark grey silt flecked with tiny stones and charcoal, or spreads of mortar decay and brown silty clay loam, but it is not clear whether they represented actual floors in all cases or simply the residue from demolition and backfilling. The backfill encountered in the south-west room, which consisted of a jumbled mass of stone and creamy yellow mortar, mainly comprising relatively small fragments of flat slabs with some rubble and brick/tile, certainly sounds like demolition debris. The material was not highly compressed and there were numerous voids with air pockets lower down. The courtyard water tank was also probably backfilled at this time. Very little subsequent activity is recorded on the site. There was possible rubbish dumping in a depression in the south-west corner during the mid-

to late third century. In the courtyard, a spread of hard mortar laid over the backfilled cistern, perhaps to level it off, and also extending over the courtyard flagging, was found to contain Crambeck reduced ware, whilst a pit was dug at the western edge of Room 7, the fill of which included calcite gritted ware including Huntcliff ware.

It is possible that this marks a levelling up for a complete reconstruction of the building, but if so it was not marked by any foundation trenches which cut down into the earlier levels nor did sub-floor hypocausts intrude either. It is quite possible that a substantial structure was erected on the site at some stage in the late third or fourth century, when the building of new *praetoria* is attested at South Shields (Bidwell and Speak 1994, 35–9), Binchester (Ferris 2010) and Chester-le-Street (Evans *et al* 1991; Todd 2006). If a timber-framed construction was employed, set on substantial stone sills, similar to the 'park-railing' buildings encountered at Haltonchesters, for example, all trace of such a structure could quite conceivably have been removed, given the history of post-Roman destruction at Wallsend. In fact, a small pocket of stratigraphy preserved in the area south of the house did provide fragmentary evidence of later building, which may conceivably have been associated with a reconstructed *praetorium*. This consisted of a short length of stone walling and a strip of flagged flooring labelled 'Building BK', overlying the earlier third-century remains of AZ, BA and BB. However, too little was preserved of BK to form any idea of its character or overall plan and its remains yielded only single, probably residual, sherd of a BB2 bowl or dish, so its date is uncertain.

Whatever the later history of the site, the assembled evidence would suggest widespread backfilling, perhaps consequent upon demolition or at any rate decay and collapse, well before the end of the third century. Indeed, none of the backfill deposits contains any pottery which necessarily postdates the first half of the third century. This calls to mind the well-known case of the *praetorium* at Birdoswald, restored between 296 and 305, which had been covered in earth and collapsed into ruins (*praetor(ium) quod erat humo copert(um) et in labe(m) conl(apsum)* – RIB 1912). It has been argued that this may be a reflection of the widespread appointment of serving junior officers, such as legionary centurions or cavalry decurions, as acting commanders (*praepositi*), rather than members of the wealthy equestrian or curial classes seeking to achieve or preserve equestrian status through the tenure of three regimental commands. (Ironically Flavius Martinus, the officer recorded on RIB 1912 supervising the rebuilding of the *praetorium* at Birdoswald, was just such a *centurio praepositus*.) With relatively small households, used to occupying much more confined accommodation within forts, serving officers may not have required such a larger

courtyard house or been able to occupy more than a small portion of it, perhaps giving rise to decay and dereliction of the kind apparently experienced at Wallsend in the mid- to late third century.

The fourth-century fort (Fig. 2.07)

Most of the levels associated with the fourth-century fort had been destroyed by post Roman agricultural and colliery era activity across the site. Consequently, it is impossible to present a coherent overall plan of the fort in this period. Nevertheless the site figures in the schedule of imperial dignitaries, the *Notitia Dignitatum*, probably compiled at the end of the fourth century, where it is listed in the chapter of the *dux Britanniarum*, like the other Hadrian's Wall forts (*ND Occ.* XL, 33). The coin sequence and pottery from the site demonstrates that it remained occupied up until the Theodosian period from the 380s onwards, when coin use appears to virtually cease at a majority of the Hadrian's Wall forts. Given that the later Roman phases of stratigraphy have effectively been planed off any calculations based on the proportions of fourth-century material from the site may well be suspect since the sample is surely skewed by comparison with other sites where the late Roman levels were better preserved and have been extensively excavated. Moreover fragmentary remains of late Roman features do survive here and there, which give an impression of the *kind* of structural activity present in the fourth-century fort.

Timber buildings employing individual post hole construction have been identified in many parts of the fort and may well be one type of structure characteristic of its later occupation. The series of buildings over the hospital were probably erected towards the end of the third century (it can scarcely have been later than the beginning of the fourth) and may well be contemporary with the last phase of the three similar buildings south of the granary. How long these remained in use is unclear, but post holes were also recorded in the southern part of the officer's house at the west end of Chalet Range 9, which were thought to be representative of the latest surviving occupation on that site (Hodgson 2003, 101 and fig 68) and a row of three post holes was identified during the Daniels excavations cutting the latest Roman road surfaces of the western *via quintana*. This row of posts ran along the southern edge of the substantial stone kerb (D12:12) in the street surface and probably represented the north wall of a building (BM) fronting onto the street, the latter having evidently been reduced in width to become a narrow lane by this stage, with the kerb now forming its southern edge. The pattern of numerous fourth-century coin losses in this area suggested the streets just inside the minor west gate were the site of marketing area where individual traders or pedlars

might sell their wares (see Hodgson 2003, 166–7), and this could perhaps help to explain the tight clustering of buildings in this area.

Other examples of the same type include Building J in the west *praetentura*, perhaps a substantial rectangular building, though bisected and partially destroyed by colliery era trackways, and the small rectangular building (BC) identified in the north-west part of the *principia* courtyard, over the area of the west portico. An adjacent row of post holes to the west, labelled BD, might represent an ancillary structure – a boundary wall or fence replacing the west wall of the courtyard perhaps. These structures are difficult to date absolutely since they have yielded little or no dateable material, but J must postdate the third-century barracks which occupied the same area in the north-west part of the fort.

A different type of structure can be seen in the north-east part of the fort, where a few lengths of substantial stone sill walls survived beneath the medieval plough soil. These were labelled Building A at one stage in the Daniels post-excavation process and clearly sat on top of and post-dated the remains of the third-century stable, though most occupied the same essential building plot and respected the principal alignment of the principal fort axes. One was associated with a drain which ran round the north-west corner of the Building 1 plot. These stone sills may have been intended to form the base for a timber-framed structure or structures.

Late antique-early medieval

The post-hole buildings discussed in the previous section respected the main axes, building plots and roadways of the Roman fort (albeit with evidence for some encroachment in that latter case). They are therefore considered most likely to date to the later Roman phases of the site, but, with the exception of a small area of flagging in Building N, overlying the south range of the hospital, no floor surfaces can definitely be associated with these structures and, technically, it is possible, albeit unlikely, that some could be later in date, representing post-Roman occupation of the fort. Any early medieval deposits have been which may once have existed inside the fort have been removed by later activity. However, there is some evidence that the site remained a focus of activity of some kind in the centuries immediately following the end of Roman Britain, in the form of a small number of early medieval finds recovered from the interior or the immediate vicinity. A fragment of a pottery vessel, probably sixth-century in date, which may have been used in a funerary context, was found unstratified in the area of the headquarters building (*principia*) during the 1975–84 excavations, whilst a glass bead with polychrome decoration, also tentatively dated to the sixth century, has been found

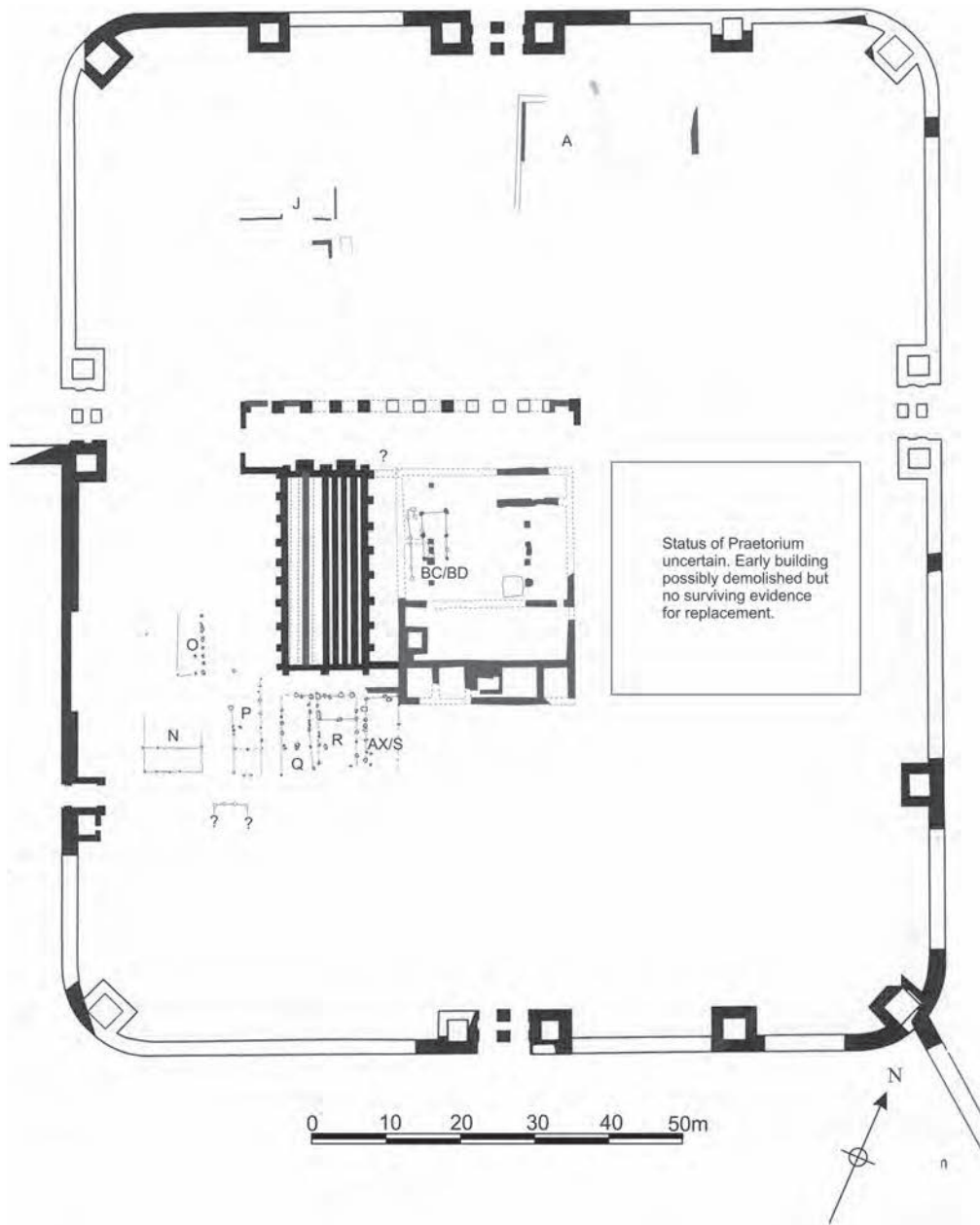

Fig re 0 Survivng evidence for th fort in th fourth century 0

in a post-Roman deposit excavated outside the east gate (Hodgson 2003, 19). These add to the notable corpus of early medieval material found inside or

in close proximity to Roman forts on the northern frontier (cf. Loveluck 2002, 135; Sherlock and Welch 1992, 2–7).

Fort period-building phase concordance (Tables 2.01 and 2.02)

Table 0 Building Phases ordered by Fort Period

<p>Period 1</p>	<p>Central range Timber Building 21 Granary Bldg 7 Phase 1 Timber Building BI (under stone <i>principia</i> – initial construction? or Hadrianic <i>principia</i>?) <i>Principia</i> – Building 14 Phase 1 (or perhaps Period 2?) <i>via principalis</i> (central) Phase 1 Building 15 Phase 1 <i>via praetoria</i> (S) Phase 1 (possibly 2 levels) Building 15 Phase 2 <i>Praetorium</i> – Building 13 Phase 1 South annexe Phase 1 (cobbling, stone-capped drains) Building 16 Phase 1 (continues into Period 2?) <i>via principalis</i> (E) Phase 1 Praetentura Buildings 1-6 – Timber phase barrack phase (where features – mainly partition slots – identifiable) Retentura Buildings 9, 10, 11, 12 – timber barrack features Defences Gates, interval towers, angle towers curtain wall, Hadrian’s Wall North gate east guardchamber wall foundations North gate east guardchamber – Internal occupation levels (Period 1-2) West gate south guardchamber floors – Level 1 North rampart deposits (Period 1 with some intrusive material) West rampart Primary levels (D09/D10) North rampart – occupation trample on path to interval tower T7 (Periods 1-3)</p>
<p>Period 2</p>	<p>Central range Hospital - Building 8 (stone) Phase 1 Granary (7) Phase 2 (including AU & AV) Cistern 1 (assembly area) Phase 1 (contemporary with the stone hospital) <i>Principia</i> – 14 Phase 2? Stone forehall (Building AO) <i>via principalis</i> (central) Phase 2 <i>via praetoria</i> (S) Phase 2 <i>Praetorium</i> – 13 Phase 2 S annexe (no change) Building 16 Phase 1? <i>via principalis</i> (E) Phase 2 Praetentura Building 1 – Stone Phase 1 (sub phases 1 & 2 (L2C?)) Building 2 – Stone Phase 1</p>

	<p>Building 3 – Stone Phases 1 & 2 (barely differentiated and only a little evidence for timber barrack here)</p> <p>Building 4 – Phase 1 (includes Period 1 timber barrack slots but not fully differentiated from Period 2 stone barrack walls)</p> <p>Building 4 – Phase 2 – main stone barrack levels</p> <p>Barrack 5 – Phases 1 & 2 (both Period 2? But may include Period 1 material if some of slots belong to earlier timber barrack).</p> <p>Building 6 – (very little material)</p> <p>Retentura</p> <p>Buildings 9, 10, 11, 12 Phase 2 – the stone barracks (Barrack 12 Phase 2: stone officer's quarters/timber <i>contubernia</i>)</p> <p>Barrack 12 Phase 3: stone barrack with timber frontage – Period 2 or 3?)</p> <p>Defences</p> <p>North gate east guardchamber – Internal occupation levels (Period 1-2)</p> <p>North rampart – occupation trample on path to interval tower T7 (Periods 1-3)</p>
Period 3	<p>Central range</p> <p>Hospital (8) Phase 2</p> <p>Granary (7) Phase 3 (AU continuing, AW)</p> <p>Cistern 1: Later modifications – pillars, buttress, rerouted <i>via principalis</i></p> <p>Forehall – timber portico added along north side?</p> <p><i>Principia</i> – 14 Phase 3</p> <p><i>Praetorium</i> – 13 Phase 3i-ii (-iv?)</p> <p>S annexe Phase 2 (walled yard)</p> <p>Building 16 Phase 2</p> <p>Praetentura</p> <p>Stone-walled, timber-partitioned barracks 1–6 continuing</p> <p>Retentura</p> <p>Buildings 9, 10, 11, 12 - occupation of stone barracks continuing through Period 3</p> <p>Barrack 12 Phase 3: stone barrack with timber <i>contubernia</i> frontage (Period 2 or 3?)</p> <p>Defences</p> <p>Occupation trample on path to interval tower T7 (Period 1-3)</p> <p>West gate south guardchamber floors – Level 3 (Period 3-4?)</p>
Period 4	<p>Central range</p> <p>Hospital (8) Phase 3</p> <p>Granary (7) Phase 4 (post hole buildings blocking off south end)</p> <p>Cistern 1: Division into 2 tanks (Period 4-mid 3C?)</p> <p>Post Hole Buildings south of Granary (Q, R, AX(S)) Phase A ('Bldg T' phase)</p> <p><i>via principalis</i> (central) Phase 3 (Period 4-mid/late 3C)</p> <p><i>via praetoria</i> (S) Phase 3 (2 levels) (Period 4-mid/late 3C)</p> <p>Forehall Phase 3</p> <p><i>Praetorium</i> 13 Phase 3(?iii)-v-vi</p> <p>South annexe Phase 3-4 (clay makeup, Buildings AZ (1), BA, BB)</p> <p>South annexe Phase 5: Building AZ (Ph 2), BB continuing?</p> <p>Building 16 Phase 3</p> <p><i>via principalis</i> (E) Phase 3 (Period 4-late 3C)</p> <p>Praetentura</p> <p>Building 1 – Stone Phase 2 (stable) (Period 4? but dating evidence assemblages in Bldgs 1 and 2 problematic – look mid-late 3C but potential for intrusive material)</p> <p>Building 2 – Stone Phase 2 barrack (stone partition walls) (see above) – later sub-phases of flooring represented by Daniels 'B K M'</p> <p>Building 3 – Stone Phase 3 & 4 barrack (stone partition walls - Ph 4 only minor alterations)</p> <p>Building 4 – Phase 3 (Poss associated with complete 3C remodelling)</p> <p>Building 6 – adjacent drain fills probably continue up to end of building's life in 3C</p> <p><i>W praetentura</i> Period 4 remodelling – Daniels structures C, D, E, F, G, H, L representing fragmentary remains of conventional stone barracks 17 and 18</p> <p>Retentura</p> <p>Chalet Ranges 9, 10, 11 & 12 – Chalet Phase 1</p> <p>Range 10 - Chalet AB (dec qtrs) Phase 2 (Period 4 (-mid 3C?))</p> <p>South <i>intervallum</i> road (W) secondary surface & drain fills</p> <p><i>via quintana</i> (E) extant surface</p> <p>Defences</p> <p>North defences – demolition of interval tower T7 and extension of rampart revetment wall (Period 4 – mid-3C)</p>

	Reinstated west rampart deposit – D08 & C11 (Period 4 – mid-3C?) W rampart (N) – E03 – Reinstated?? (Period 4 – mid-3C?)
Mid-3C	<p>Central range ?Hospital 8 Phase 4 (bldg probably continues in use in some form till late 3C) Cistern 1: Infilling of south tank (mid-late 3C), surrounding rubble ? Post Hole Buildings Q, R, AX(S) Phase B ('Bldg S' phase) Cistern 3 <i>Praetorium</i> (13) Phase 4 – demolition? Building 16 'Phase 4' (sub-phase - mid-3C - late 3C) Praetentura Building 2 – later <i>contubernia</i> floor levels? Retentura Range 9 – new layout over Chalet ET (mid-late 3C?) Range 10 Chalet AB (dec qtrs) Phase 3 (Mid 3C? (-late 3C?)) Range 11 secondary alterations (Period 4-mid 3C?) Range 12 secondary alterations (initial) (Period 4-mid 3C) Defences (see Period 4)</p>
Late 3C/early 4C	<p>Central range Cistern 1: Infilling of north tank (c 270) Latest road surfaces & structure overlying Cistern 1 (late 3C-early 4C) ? Post Hole Buildings Q, R, AX(S) Phase C Post hole buildings over hospital (N, O, P, AP) <i>Principia</i> – 14 Phase 4 (courtyard only) 'Cistern 2' (fills) Surfaces/revetments over 'C2' Later activity on site of 13: fill of depression over W bath – rubbish dumping?; mortar layer over courtyard cistern Building BK – south of <i>praetorium</i> (post mid-3C) Praetentura NE <i>praetentura</i> late remodelling – 'Building A' fragmentary sill walls & gutter/drain channels Retentura Range 9 – Chalet W (dec qtrs) Phase 2 (and 3?) Range 12 – Chalet AL2/AM2 (dec qtrs) final remodelling ((mid-)late 3C) Defences North Gate passageway surface West gate south guardchamber floors – Level 4</p>
4C	<p>Central range ?Bldg 14 Phase 5 (post hole buildings BC & BD in <i>principia</i> courtyard) (no finds) Pit N12:28 (fill N12:27) in <i>praetorium</i> (mid/late 4C) Praetentura W <i>praetentura</i> post hole structures? – Building J Retentura Post-holes along south kerb of 4C <i>via quintana</i> (over remains of Chalet Range 9)</p>

Table 2 Ph sing Periodisation ordered by Building

1. Central Range

Building	Building Phase	Fort Period
Hospital (Buildings 8 & 21)	Timber Building 21	Period 1
	8 (stone) Phase 1	Period 2
	8 Phase 2	Period 3
	8 Phase 3	Period 4
	8 Phase 4	Mid-3C? (8 probably continues in use in some form till late 3C)

Granary (Bldg 7, also Buildings AU, AV & AW)	7 Phase 1	Period 1
	7 Phase 2 (inclu AU & AV)	Period 2
	7 Phase 3 (AU continuing, AW)	Period 3
	7 Phase 4 (post hole buildings blocking off S end)	Period 4
Assembly area Cistern 1	Phase 1	Period 2 (contemporary with the stone hospital)
	Later modifications – pillars, buttress, rerouted <i>via principalis</i>	Period 3
	Division into 2 tanks	Period 4-mid 3C?
	Infilling of S tank	Mid-late 3C
	N tank	Late 3C
	Surrounding rubble	Mid-late 3C
	Latest road surfaces & overlying structure	Late 3C-early 4C
Post Hole Buildings S of Granary (Q, R, AX(S))	Phase A (Daniels' Building T phase)	Period 4
	Phase B (Daniels' Building S phase)	Mid-third century?
	Phase C	Late third century?
Post hole buildings over hospital (N, O, P, AP)		Late third century
<i>Principia</i> (14, also BI and post hole structures BC and BD in courtyard)	Timber Building BI	Period 1 (initial construction? or Hadrianic <i>principia</i> ?)
	14 Phase 1	Period 1? (or perhaps 2?)
	14 Phase 2	Period 2?
	14 Phase 3	Period 3
	14 Phase 4 (courtyard only)	Late 3C-early 4C
	14 Phase 5 (BC, BD)	4th C? (no finds)
Forehall (AO), Building 15 & <i>via principalis</i> (central)	Building BI	Period 1
	<i>via principalis</i> Phase 1	
	Building 15 Phase 1	
	<i>via praetoria</i> (S) Phase 1 (poss 2 levels)	
	Building 15 Phase 2	
	Stone forehall (AO)	Period 2
	<i>via principalis</i> Phase 2	
	<i>via praetoria</i> (S) Phase 2	
	<i>via principalis</i> Phase 3	Period 4-mid/late 3C
	<i>via praetoria</i> (S) Phase 3 (2 levels)	
	Forehall Phase 3	Period 4?
	Cistern 3	Mid-3C
	'Cistern 2' (fills)	Late 3C
Surfaces/revetments over 'C2'	Late 3C-early 4C	
<i>Praetorium</i> (Bldg 13, also yard & Bldgs AZ, BA, BB & BK to south)	13 Phase 1	Period 1
	S annexe Phase 1 (cobbling, stone-capped drains)	
	13 Phase 2	Period 2
	S annexe (no change)	
	13 Phase 3i-ii (-iv?)	Period 3
	S annexe Phase 2 (walled yard)	
	13 Phase 3(?iii)-v-vi	Period 4 (220s- mid 3C)
	S annexe Phase 3-4 (clay makeup, Buildings AZ (1), BA, BB)	
	S annexe Phase 5: Building AZ (Ph 2), BB continuing?	Period 4
	13 Phase 4 – demolition?	Mid 3C-

Later activity on site of 13:

Fill of depression over W bath –

rubbish dumping?

Late 3C

Mortar layer over ctyd cistern

Late 3C/early 4C

Pit N12:28 (fill N12:27)

Mid/late 4C

Building BK

??

Building 16

Phase 1

Periods 1 & 2

Phase 2

Period 3

Phase 3

Period 4-mid 3C

'Phase 4' (sub-phase)

Mid-3C - late 3C

Via principalis (E)

Phase 1

Period 1 (no material)

Phase 2

Period 2

Phase 3

Period 4-late 3C

2. Retentura

Building

Building Phase

Fort Period

Buildings 9, 10, 11, 12

Phase 1 – the timber barracks

Period 1

Phase 2 – the stone barracks

Period 2

(Barrack 12 Phase 2: stone officer's quarters/timber *contubernia*

(occupation of barracks continuing through Period 3)

Barrack 12 Phase 3: stone barrack with timber *contubernia* frontage)

Period 3?

Chalet Ranges 9, 10, 11 & 12

Chalet Phase 1 (9, 10, 11, 12)

Period 4

Range 9 later modifications

Chalet W (dec qtrs) Phase 2

Late 3C/early 4C

Chalet W Phase 3

new layout over Chalet ET

Mid-late 3C?

Range 10 modifications

Chalet AB (dec qtrs) Phase 2

Period 4 (-mid 3C?)

Chalet AB Phase 3

Mid 3C? (-late 3C?)

S intervallum road (W) secondary surface & drain fills

Period 4

Range 11 secondary alterations

Period 4 – mid 3C?

Range 12 secondary alterations

Initial

Period 4-mid 3C

Chalet AL2/AM2 (dec qtrs) final

(mid-)late 3C

Post hole structures on S side of *via quintana* (W) opposite former hospital

Post-holes alongside S kerb of 4C *via quintana* (over remains of Chalet Range 9)

4C?

Via Quintana (E)

Period 4

3. Praetentura

Buildings 1-6

Timber phase barrack phase (where features – mainly partition slots – identifiable)

Period 1

Building 1

Stone Phase 1

Period 2

Sub-phase 1

Sub-phase 2

L2C?

Building 2

Stone Phase 1

Period 2

Building 1 (stable)

Stone Phase 2

Period 4 (but dating evidence

Building 2

“ “ “

assemblages in Bldgs 1 and 2 problematic – look mid-late 3C but potential for intrusive material)

Building 3

Stone Phase 1

Period 2

Stone Phase 2

(barely differentiated)

(only a little evidence for timber barrack here)

Building 3	Stone Phase 3 & 4 (Ph 4 only minor alterations)	Period 4
Building 4	Phase 1 (timber barrack slots but not fully differentiated from stone barrack walls) Phase 2 – main stone barrack levels Phase 3	Period 1 (but may include Period 2 material) Period 2
Building 5	Phase 1 Phase 2	Poss associated with 3C remodelling Both Period 2? (may include Period 1 material if some of slots belong to earlier timber barrack).
Building 6	V little material Drain fills probably continue up to end of building's life in 3C	Period 2-3
W praetentura remodelling	Stone-walled barracks 17 and 18 represented by fragmentary Daniels structures C, D, E, F, G, H, L	Period 4
NE praetentura late remodelling 'Building A'	'Building A' fragmentary sill walls & gutter/drain channels	Late 3C/early 4C
W praetentura post hole structures	Building J	4C?

4. Defences

North gate	Guardchamber wall foundations Internal occupation levels Gate passageway surface	Period 1 Period 1-2 L3C-4C
North rampart	North rampart deposits Occupation trample on path to interval tower T7 Demolition of T7 and extension of revetment wall	Period 1 (with intrusive material) Periods 1-3 Period 4 – mid-3C
West gate	S guardchamber floors – Level 1 Level 3 Level 4	Period 1 Period 3-4? Late 3C
West rampart	Primary levels (D09/D10) Reinstated rampart deposit (D08) " " " (C11) W rampart (N) (E03)	Period 1 Period 4 – mid-3C? " " Reinstated?? Period 4 – mid-3C?

Roman settlement and activity outside the fort

The fort ditches

The fort was surrounded by a series of defensive ditches, the number and disposition of which changed over time. Excavations by Tyne and Wear Museums have greatly improved our understanding of this changing pattern of defensive ditches (see Hodgson 2003, 18–21 with fig. 13, adapted as Fig. 2.08 here; cf. Archaeological Practice 2006), but the restored pattern is based on relatively limited sampling and may change when further evidence emerges. Originally there were two ditches on the west side of the fort to the north of Hadrian's Wall. A narrower gully or trench was added beyond these, probably in the third century, which may have represented a defensive feature other than a ditch. It is uncertain whether

all these ditches and gully were all still in use in the fourth century, but evidence from other sectors of the defences, notably beside the east gate and south gate, suggests there was a single large ditch on the line of the former inner ditch.

The vicus

Traces of a civil settlement, or *vicus*, have been found around the fort, particularly to the south and west. Our knowledge of the settlement has improved in recent years, as a result of a series of excavations by Tyne and Wear Museums, by although by comparison with sites like Vindolanda and Housesteads, it is still relatively poorly understood. The site's present urban context prevents the use of aerial photography or extensive geophysical survey to determine the extent of the *vicus*, but some measure can be gained by plotting

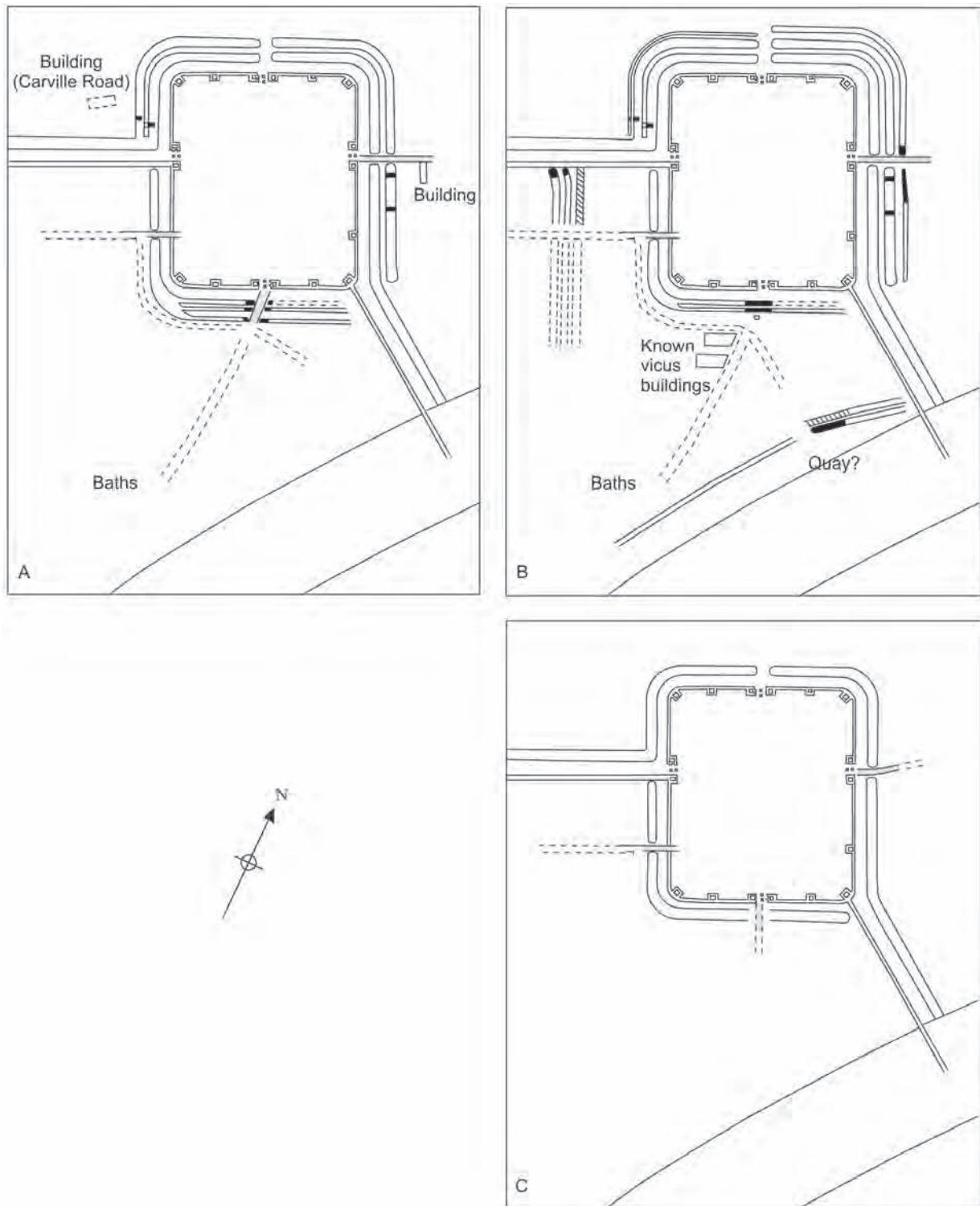

Figure 8 Plans to illustrate the development of the defensive ditch system, access roads and known vicus remains around the fort. Approximate scale 1:4000 (based on Hodgson 2003, fig.13, with additions). A: Second century; B: Third century; C: Fourth century

recorded findspots of material or individual structures (cf. Snape and Bidwell 1994, 19, fig. 2). A bath-house, a temple or shrine, two burials, two or three roads and a potter's kiln have so far been recorded. Buildings have been excavated outside the south gate of the fort and most recently the bathhouse uncovered to the south-west. A branch wall, running from the south-

east corner of the fort down to the river, was partially uncovered in 1903. This formed the terminal length of Hadrian's Wall. The eighteenth-century antiquary, Wallis, also noted the remains of a possible quay at the shore of the river (cf. Snape and Bidwell 1994).

On the basis of this evidence, the settlement appears to have stretched from the south east angle



Figure 2 View from the east of the walls of the building uncovered beside Carville Road, north of Hadrian's Wall, in 2006

right around the south and west sides of the fort, and extended down to the river bank. Streams formed a valley on the west side of the fort which may have provided a natural boundary to the settlement, but one temple or shrine lay as much as 475m west of the fort (Snape and Bidwell 1994, 22–3), although how densely the intervening area was built up is unclear.

More startling is the evidence for settlement around the sides of the fort beyond the protective shield of Hadrian's Wall. One timber building has been identified flanking the road leading out of the east gate of the fort during the second century (Hodgson 2003, 19, fig. 13). Furthermore trial excavation in the scaffolding yard at 52 Carville Road, next to the north-west corner of the fort, partially uncovered a stone rectangular strip building (Figs 2.08, 2.09), demonstrating that the *vicus* extended beyond Hadrian's Wall on the west side of the fort too (Archaeological Practice 2006). The stone building was further away from the nearest fort gate (the west gate) than was the case with the timber building on the east side of the fort. The position and ENE-WSW orientation of the stone building suggests that it may have faced onto a road which emerged from the west gate and then veered towards the north-west. The two walls uncovered in the trench would represent part of the rear of the building (to the east) and the northern side wall. With the addition of the newly uncovered building it becomes much more difficult to argue that these were merely isolated occurrences. Instead it is quite conceivable that there was ribbon development of a similar sort lining the roads leading away from all

the fort gates, including the north gate. On this basis it is reasonable to conclude that, at certain times in the site's history, most probably during the second century, the mere presence of the fort and its garrison of up to 600 men was considered adequate protection by the *vicani*, making it largely irrelevant which side of Hadrian's Wall they were settled on. There is no evident reason why this pattern of settlement should be restricted to the civil settlement at Wallsend.

Otherwise the area beyond Hadrian's Wall seems to have been cultivated in the Roman period (see below), whilst the berm on the north side of the Wall, between the ditch and the Wall curtain, was furnished with an additional defensive system of pits which, as currently understood, stretched for 65m west of the fort curtain and was apparently integrated with the defences provided around the civil settlement during the third century (Hodgson 2003, 20). Traces of the third-century *vicus* defences, which consisted of a rampart and a series of ditches, have been recognised along the river bank and 65m west of the fort. Outlying elements of the civil settlement may have been left outside the defended area. By 270–80 occupation in the *vicus* had ceased or drastically diminished.

Field systems beyond the Wall

Excavations in 1994 on the site of the former Rawdon Court flats to the north of Hadrian's Wall revealed two phases of gulleys which probably formed drainage channels/plot boundaries for a field system. A large quantity of Roman pottery was found in the gulleys

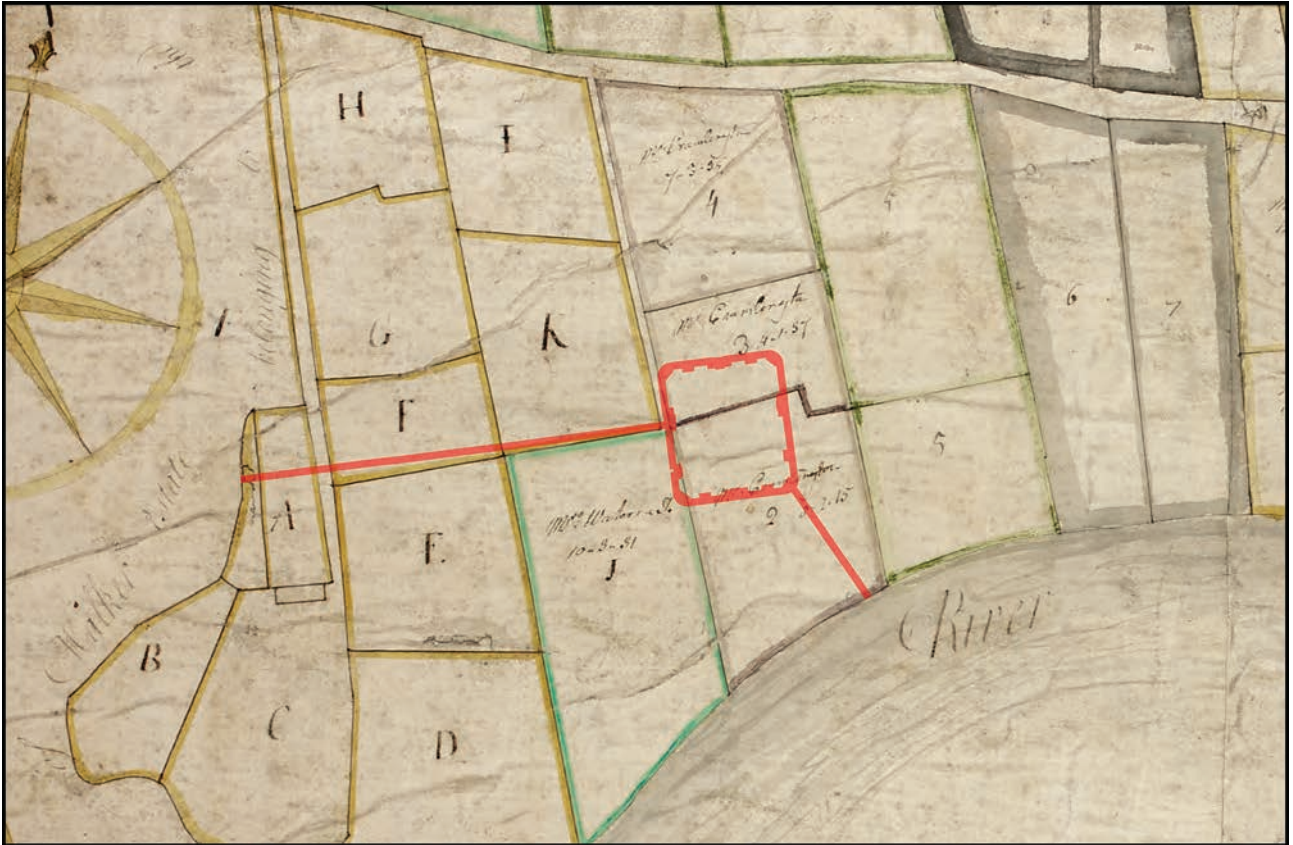

Figure 20 Extract from the Richard Hornsby's 1790 survey of the Dean and Chapter of Durham's estate in Wallsend (DCD E/AA/3) showing the fort site before colliery development, with the positions of the Roman fort, Hadrian's Wall and Branch Wall outlined in red. Reproduced by permission of Durham University Library

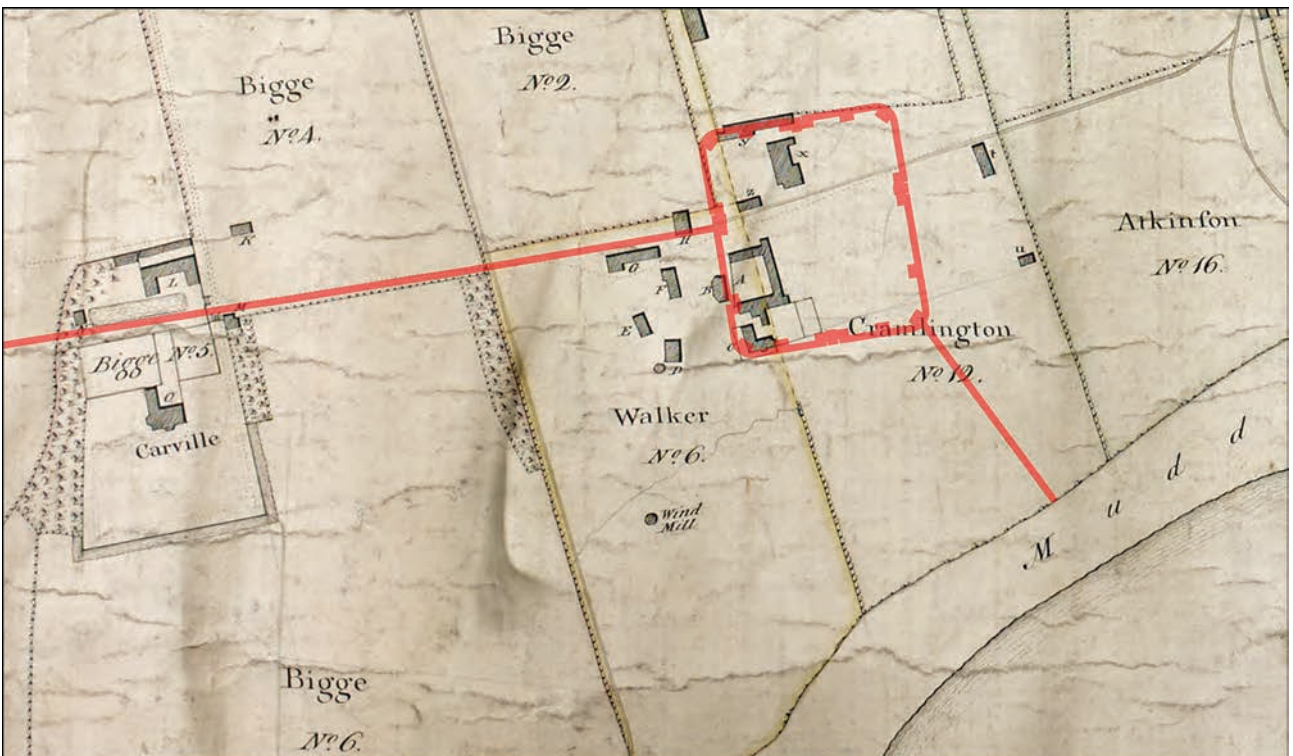

Figure 21 Extract from an 1800 Bell survey of Wallsend Township (DCD/E/CC - sheet 5) showing the colliery site. Reproduced by permission of Durham University Library

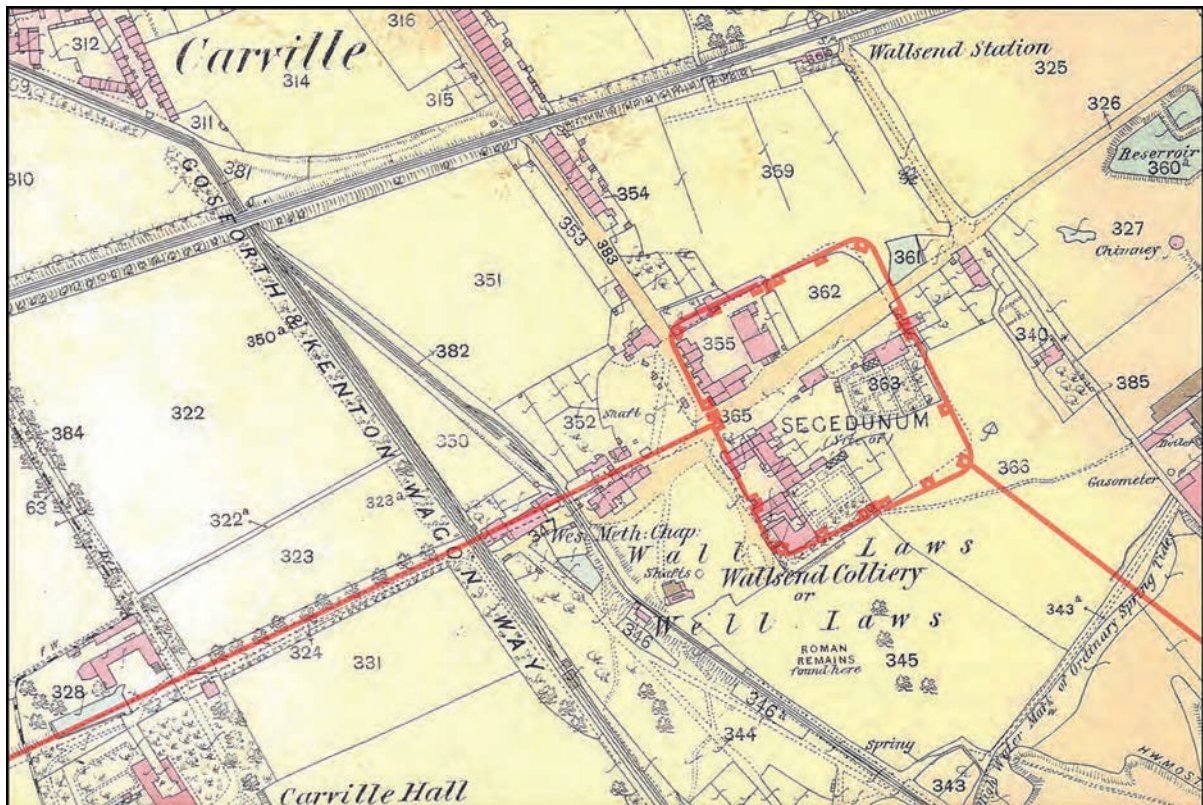

Figure 2 2 Extract from the 1st edition Ordnance Survey showing Wallsend following closure of the colliery with the fort and Hadrian's Wall outlined in red.



Figure 2 3 Extract from the 10th edition Ordnance Survey showing Wallsend following the erection of terraced housing across the site, with the fort and Hadrian's Wall outlined in red.

and in the overlying ploughsoil as well as rarer finds such as a folding spoon and knife set. This material demonstrates the field system was in use in the Roman period (Snape and Bidwell 1994, 14, fig. 1, 18; Griffiths 1994b). More extensive excavations in 1993, in the Swan Hunter car park to the north east of the fort, revealed a further series of gulleys and quarry pits which were dated to the third century on the basis of pottery evidence (Griffiths 1993). This suggests that an extensive area immediately to the north of the fort and Hadrian's Wall was covered by agricultural field systems during the Roman period.

The post-Roman history of the site

The medieval period

The vill (township) of Wallsend was held by the Benedictine Priory attached to Durham Cathedral during the medieval period and following the Reformation passed into the hands of the Dean and Chapter in whose possession it remained right up until the nineteenth century (Richardson 1923, 28–42). It formed one of the priory's original holdings, acquired when the lands of its predecessor, the quasi monastic Northumbrian Community of St Cuthbert, were divided between the bishop and the cathedral priory in the late 11th/early 12th century. The Community had presumably acquired the vill and its associated lands at some point in the turbulent period between the late ninth century, when it left its original home, the monastery on Lindisfarne, and the 11th century, by which time it had re-established itself further south, first at Chester-le-Street, and finally at Durham, towards the end of the tenth century. As a result of its association with the priory at Durham, abundant documentation has survived relating to medieval Wallsend, amongst the priory's medieval muniments now preserved in Durham University Library's Archives and Special Collections. Many of the more important documents have been published in volumes of the Surtees Society. These include extracts from the halmote court rolls (Longstaffe and Booth 1889), several of the bursar's rentals, which list the various tenants at Wallsend, their individual holdings and the rent paid in the 14th and 15th centuries (Lomas and Piper 1989, 23 (1270), 32 (1340–1), 73 (1396/7) 134 (1495), plus another inventory (1464) and rental (1539), published by Greenwell (1872, 104, 306). The documents suggest that in the twelfth and early thirteenth centuries the village community was composed of thirteen customary tenants, each with holdings of 24 acres of arable land, six of whom were husbandmen, who paid money rents only, and seven bondmen, who performed various labour services on the priory's manorial farm there (Lomas and Piper 1989, 201).

However the village which formed the core of

this agricultural community lay along The Green, beside the Sir G. B. Hunter Memorial Hospital, almost 1km to the north of the Roman fort (Richardson 1923, 70–1). This village is shown on the earliest county maps of Northumberland from Saxton (1577) onwards (initially figuring as 'Wawson'), but with no topographical detail. Some impression of the likely layout of the medieval settlement can be gained from more detailed historic maps which begin with 1740 plan of the Dean and Chapter's Wallsend estate surveyed by Richard Hornsby (DCD E/AA/23; see Fig. 2.10 here). This shows the village buildings set around a large, roughly rectangular, green to the north of the road from Tynemouth to Newcastle which became the later town's High Street. The site of the fort lay even further south, between the main road and the river and is shown simply as undisturbed agricultural fields on the 1740 map. Hence the site of Roman Segedunum lay in the outlying fields of the township with little evidence for significant settlement or other development until the late eighteenth century.

As a consequence, the area of the fort was probably extensively impacted by arable cultivation during the Middle Ages and early modern era. A ploughsoil was also recorded overlying Roman remains in the north part of the fort in 1975–6, with wide furrows, which can be interpreted as the result of ridge and furrow cultivation, being noted in the western *praetentura*, in particular, cutting right down into the third-century levels. The undulating traces of east-west aligned ridge and furrow were also noted in the natural clay subsoil to the west of the Wallsend B Pit shaft during excavation of that site in 1997 (Oram *et al.* 1998, 117).

The early modern era (sixteenth-eighteenth centuries)

Horsley provided a description of the fort and its environs in the early eighteenth century which gives a clear impression of contemporary land use: 'The ruins of the Roman station and town at this place are still very discernible, tho' it has all been ploughed and is now a very rich meadow' (1732, 135). The area of the *vicus* outside the fort had been levelled but the remains were close to the surface. The area of the fort and that immediately to the west were known as Well Lawes (the 1st edition Ordnance Survey gives the alternative Wall Lawes as well) and was divided into two fields divided by a north-south hedge, as depicted on a map of 1781 (NRO ZAN M17 197a no. 60 = SANT/BEQ/09/01/01 page 60). The line of Hadrian's Wall seems to have been followed by another field boundary immediately west of the fort, whilst a lane which followed the course of the present Carville Road gave access to this area from the north. Further west, Hadrian's Wall curtain still survived as an upstanding feature between Wallsend and Newcastle as late the early to mid-eighteenth

century to judge from maps such as Isaac Thompson's 1745 survey of Walker.

Wallsend township is well-served by historic maps in part because of the colliery operations which developed on the west side of the fort from the 1780s onwards (see, for example the 1781 map and another somewhat later eighteenth-century map showing the site of the initial colliery operations with associated buildings and waggonways: NRO ZAN M17 197a nos 60 & 62 = SANT/BEQ/09/01/01 pages 60 & 62). These and subsequent maps, plus the watercolour and lithograph views of the riverbank by Charles and Henry Richardson and S Storey (reproduced in Spain and Simpson 1930, pls 1–2 and fig. 5), show the gradual encroachment of colliery operations with their associated buildings from the original focus around the two shafts sunk just outside the west gate, with building subsequently extending eastwards across the central part of the fort site. However the land around the fort was still predominantly farmland as late as the mid-nineteenth century, well after the establishment of the Colliery.

The late eighteenth to mid-nineteenth centuries: Wallsend colliery

The development of coal mining at Wallsend, which was to spread the township's name far and wide, has been covered in detail by Richardson (1923, 226–40; cf. Oram *et al.* 1998, 143–4, 152). The first exploratory shaft was sunk in 1778 by the Chapmans, a Newcastle Quaker family, but had to be abandoned after encountering water and quicksand (NRO/ZAN M15/A22). Its precise location is not known. In 1781, however, a new shaft, the A shaft, was sunk to the west of the fort which quickly reached a good seam of coal. This was followed in the same year by another shaft, labelled the B Pit, which was sunk just to the north of the line of Hadrian's Wall and west of the fort site. The seam, known as the High Main seam, was six and a half feet thick and was house coal of exceptional quality, 90 percent of its output being large coal. This made Wallsend coal the benchmark for other collieries which labelled their coal 'Wallsend Coal' if it reached the required standard. Several other shafts were sunk around the district in succeeding years to reach this seam, culminating in G Pit or Church Pit in 1802. The renowned mining engineers John Buddle senior and junior were associated with these works, being successive 'viewers' or managers of the colliery, and occupying a house situated over the west part of the fort.

The remains of the B Pit were revealed in a surprisingly good state of preservation in excavations conducted by Tyne and Wear Museums as part of the Segedunum Project in 1997 (Oram *et al.* 1998), and have been consolidated and displayed as part of the Segedunum archaeological park. The excavation

report provides a detailed analysis of the development of the installations on the south side of the shaft which include the bases for three haystack boilers to power coal lifting gear and pumping engines, plus several furnace shafts to help ventilate the workings.

By the early nineteenth century a small pit village had grown up around the A and B shafts, particularly on the east side within the area of the fort. The development of this settlement can be traced on successive historic maps, notably the fine map of the township prepared for the Dean and Chapter of Durham by John Bell in 1800 (two separate copies preserved: NCL L912.2.82 W215 no. 94950; DCD/E/CC – shelf 85a – see Fig. 2.11 here; cf. Richardson 1923, 70–1), the 1841 tithe map (NRO DT 474 M), two detailed maps of c 1848 and 1849 showing the buildings and 'damaged ground' to be covered for the resumption of colliery operations (NRO 309/M127), MacLauchlan's 1854 plan of the fort (MacLauchlan 1857), and the 1st edition Ordnance Survey (see Fig. 2.12). A further impression of the appearance of Wallsend colliery and the surrounding settlement is provided by Hair's watercolour of A Pit, painted in the 1839 (cf. Hair 1844, facing p 10). A whole series of wagon-ways are shown on these maps running on a variety of different courses from the two pits across the fort from west to east or north-west to south-east. These had a significant impact on the survival of Roman archaeological deposits within the fort as was evident during the 1975–84 excavations.

The lucrative High Main seam was closed in 1831 when nearly exhausted, the gas-coal of the Bensham seam being worked instead, until colliery itself closed in 1847. Reopened again in 1848, Wallsend the colliery was finally abandoned following catastrophic flooding in 1854, which also brought to an end many other mines in the mid-Tyne coal basin (Richardson 1923, 239–40, 247–9). The last B Pit structures were probably demolished subsequently in the 1850s. However, the B shaft was retained to provide ventilation for the workings accessed via shafts further to the east (G and H Pits) and north (the Rising Sun colliery opened in 1908), when these were reopened following substantial investment in the later nineteenth and early twentieth century. As such the shaft remained open until 1969.

Late nineteenth and early twentieth centuries: the spread of terraced housing

Streets of terraced housing (Tyneside flats) were laid out over the fort and in the area between the fort and the High Street in the late nineteenth century (a date of 1884 is given by Spain and Simpson 1930, 488) and these are depicted on the Second edition Ordnance Survey which was surveyed in 1895.

Most of the colliery complex and village depicted on the First edition Ordnance Survey was swept away

in the following 37 years, to the extent that there are relatively few firm points of reference between the First and Second editions in the immediate vicinity of the fort. The points of reference which do exist include the shafts of the A and B Pits; and a house with gardens and outbuildings to the south of Buddle Street in the eastern part of the fort. This building was replaced by Simpson's Hotel in 1912 and does not figure on the Third edition Ordnance Survey. Other survivors include the Wesleyan Methodist Church and School, sandwiched between the two lines of the Gosforth & Kenton Wagonway, plus further buildings on the other side of the easterly branch of the wagonway. The course of the branch wagonway can be traced as a lane on the 2nd edition. The main line of the wagonway is represented by Benton Way and Benton Road on the 1895 survey.

The spread of terraced housing was, of course, related to the phenomenal growth of shipbuilding which now replaced coal mining as the principal industrial enterprise and employer of labour in Wallsend. The new shipyards, such as the Swan Hunter site on the river bank immediately to the south of the fort, required large workforces which had to be accommodated close to the yard.

The later twentieth century

The remaining open plots were built up with additional terraced housing during the early twentieth century (Fig. 2.13). One of the few to remain was that surrounding the shaft of the B Pit

which was still retained to provide ventilation into the underground workings. The last remaining colliery period buildings inside the fort were swept away to be replaced by Simpson's Hotel in 1912. Thereafter successive Ordnance Survey editions record relatively little change until the last quarter of the twentieth century. The terraced housing west of the fort was demolished and replaced by the Rawdon Court flats in the great post-war rebuilding phase but these too have been removed relatively recently to be replaced by a new housing development (Roman Court).

The aspect of the surrounding area has changed dramatically in recent years. The terraced housing overlying and surrounding the fort was demolished along with Simpson's Hotel and the fort interior progressively excavated area by area between 1975 and 1984 by Charles Daniels. Further excavation in 1997–8 was followed by the consolidation and display of much of the site as part of Segedunum Roman Fort project, with a new museum being constructed on the east side of the fort. Excavations associated with the Segedunum Project, which were undertaken on the west side of the fort, also revealed a substantial stretch of Hadrian's Wall, fronted by a network of pit defences or barbed-wire-like entanglements (*cippi*), plus the well-preserved remains of Wallsend B Pit.

New housing has now been built to the north and north-west (Roman Court) of the fort whilst the Buddle Industrial Estate built in the late 1970s occupies the area to the west of the fort on the south side of Buddle Street.

3. PRE-ROMAN CULTIVATION

Introduction

The site of Segedunum was used as agricultural land prior to the construction of the fort. This was revealed by extensive areas of plough marks and cord-rig furrows uncovered in a number of places under the fort buildings during 1975–84 (Fig. 3.01). These usually took one of two forms. The first comprised narrow, but generally inconsistent trenches of various depths on roughly the same alignment as the fort. These were located in small pockets the north-east corner of the fort and beneath the northern end of the east *intervallum* road. The second featured regularly cut and spaced trenches, the result of agricultural lazy-beds or cord-rig, on the same alignment as the fort. These were found under buildings in the north-west, centre and south-east areas of the fort.

Further evidence for prehistoric cultivation was revealed by the 1997–8 excavations (see Hodgson 2003, 23–36). Indeed one of the aims of that research programme was to examine the prehistoric features beneath the fort in more detail, accompanying this with an environmental strategy. Narrow ridge-and-furrow cultivation of the kind previously identified by Daniels was noted beneath the hospital, the granary and Alley 8 between the granary and the *principia*. Two areas of well-preserved ridge-and furrow cultivation located to the north of the granary and the *principia* and to the south of the granary were comprehensively excavated in parts being taken down to natural subsoil to reveal the entire surviving sequence of prehistoric agricultural activity at those points. In reporting on this work Hodgson has provided full analysis of the different types cultivation systems and the possible layout of the fields or cultivation plots (*ibid.*, 29–34). The rest of this chapter will therefore focus on providing a summary of evidence collected by the 1975–84 excavations for pre-Roman farming in the various parts of the fort. It should be noted that while the ploughmarks were immediately recognised for

what they were, such evidence having already been noted beneath Roman sites along Hadrian's Wall, this was not the case with the ridge and furrow systems. It was initially thought they might represent the remains of timber granary sleeper walls. By the end of the excavation, and certainly by the time post-excavation analysis was beginning, their true significance as cultivation furrows was appreciated, aided by the identification of extensive systems of 'cord-rig' as surviving earthworks in the uplands. All the systems were recorded on site plans, but only a relatively small proportion of the furrows were sectioned to show their profiles and the context descriptions are frequently terse.

The Daniels Evidence

North-east corner (Figs 3.02–3.03)

In the north rampart, west of the north-east angle tower and immediately south of the section of fort wall (Q04:03, 04), a small area 2.00m square was excavated down to the level of the subsoil. This revealed a series of irregular plough marks cut mainly in two directions, but on a similar alignment to the fort. They varied in width from 0.05m to 0.15m and contained a dirty greyish-brown loam which was quite distinct from the dark yellow loam of the natural subsoil. Several were cut by the foundation trench for the fort north wall. A further area of ploughmarks (N04:17) cut into brownish greyish clay and extending up to 1.50m the south of secondary rampart revetment N04:02, was exposed in a 0.70m wide strip excavated through the *intervallum* road levels some 5.5m west of the interval tower.

North-west corner (Figs 3.04–3.06)

A row of twelve trenches on a roughly north-south alignment were uncovered under the west ends of

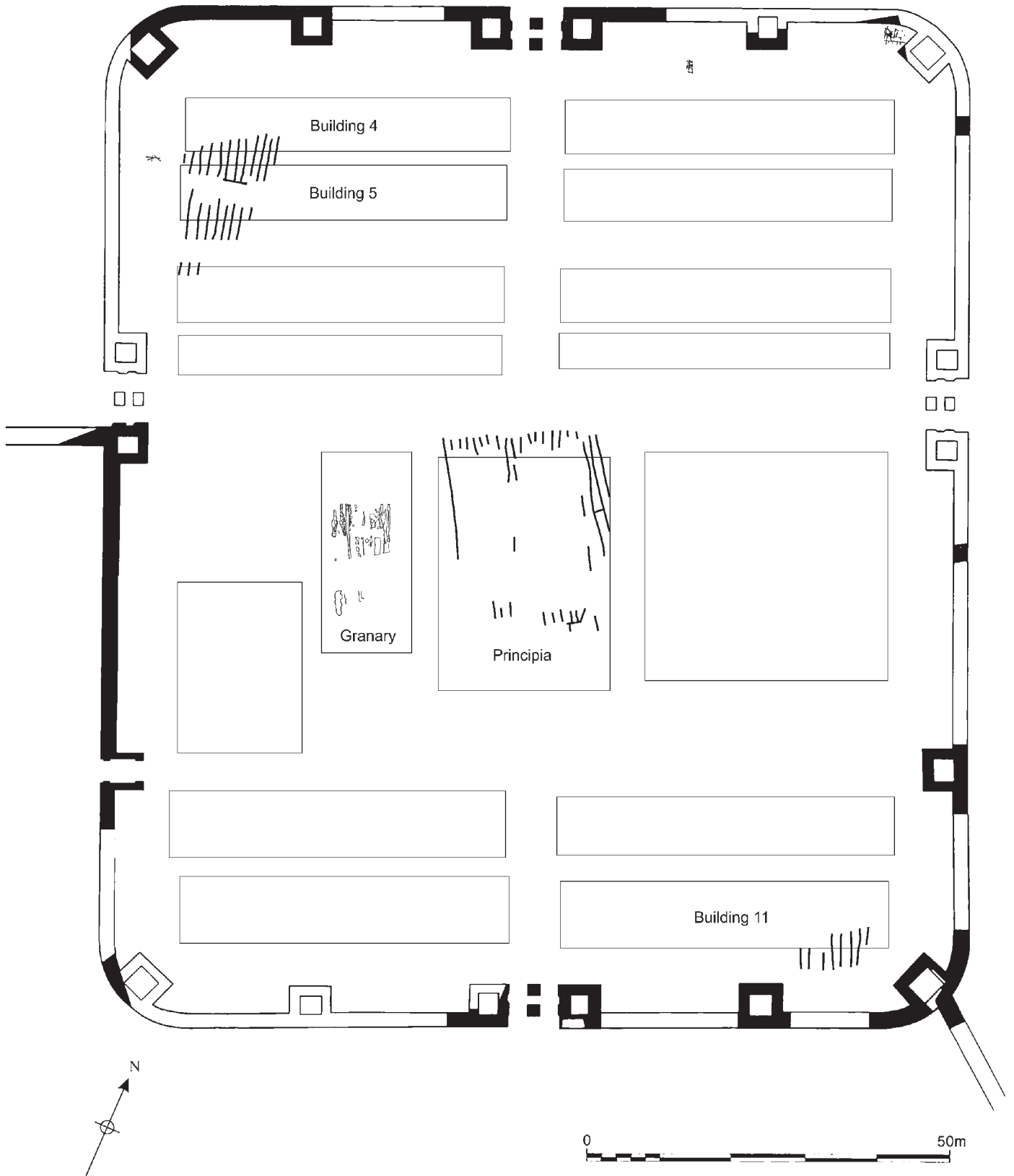

Figure 10 Evidence for pre-Roman cultivation beneath the fort, uncovered by the Daniels excavations, 1960-1961.

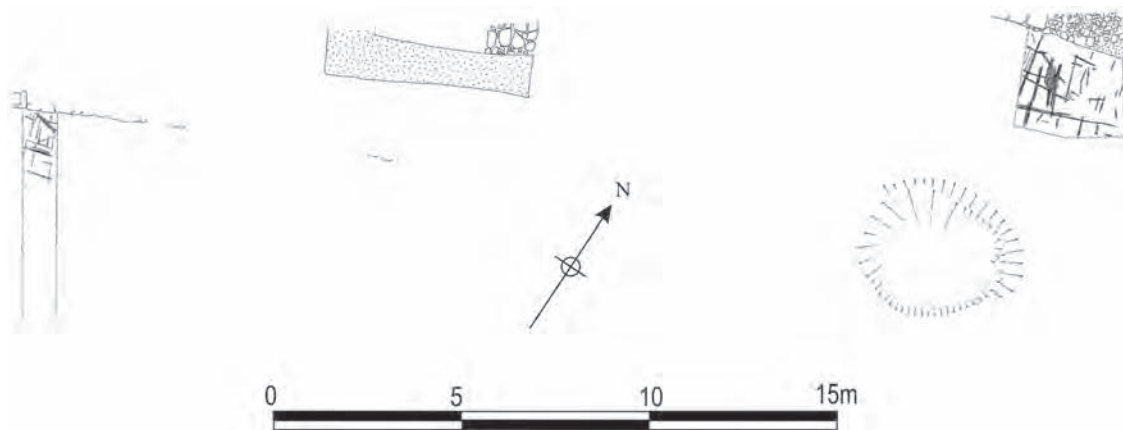

Figure 3.03: Plough marks exposed next to the north east defences. Scale 0



Figure 3.04: Ardmarks below the ramp next to the foundations of the north curtain wall in the north east corner of the fort, from the south

Buildings 4, 5 and 6 and the roads between them. These were cut with the north-south axis slightly more to the north-east than the buildings. Traces of east-west trenches, probably of the same series, were uncovered under Building 5 and the street between Buildings 5 and 6 (F04:46, perhaps E05:16). It was not possible to say whether this was cross-ploughing or trenches marking the limits of the field system. The trenches consisted of shallow cuts on average 0.25m wide and up to 0.05m deep with dish-shaped profiles and usually spaced between 0.75m and 1.00m apart. The fill was a mixture of sand, clay and grit. These trenches were not like the room dividing slots in the officer's quarters of Building 5 which were on a slightly different alignment, had bowl-shaped profiles and contained a fill of dirty yellow clay and fragments of sandstone.



Figure 3.04: Cultivation remains excavated beneath the Roman levels in the north-west corner of Building 4 with the intervallum drain and ramp next to the revetment wall also evident beyond the building looking west.

Two of furrows or gulleys (E03:16, F03:32) were recorded beneath the northern end of the east intervallum road and the north-west corner of Building 4, together with part of an oval pit (E03:17). These two lay on a slightly more north-westerly alignment than the main system beneath Buildings 4 and 5. A little

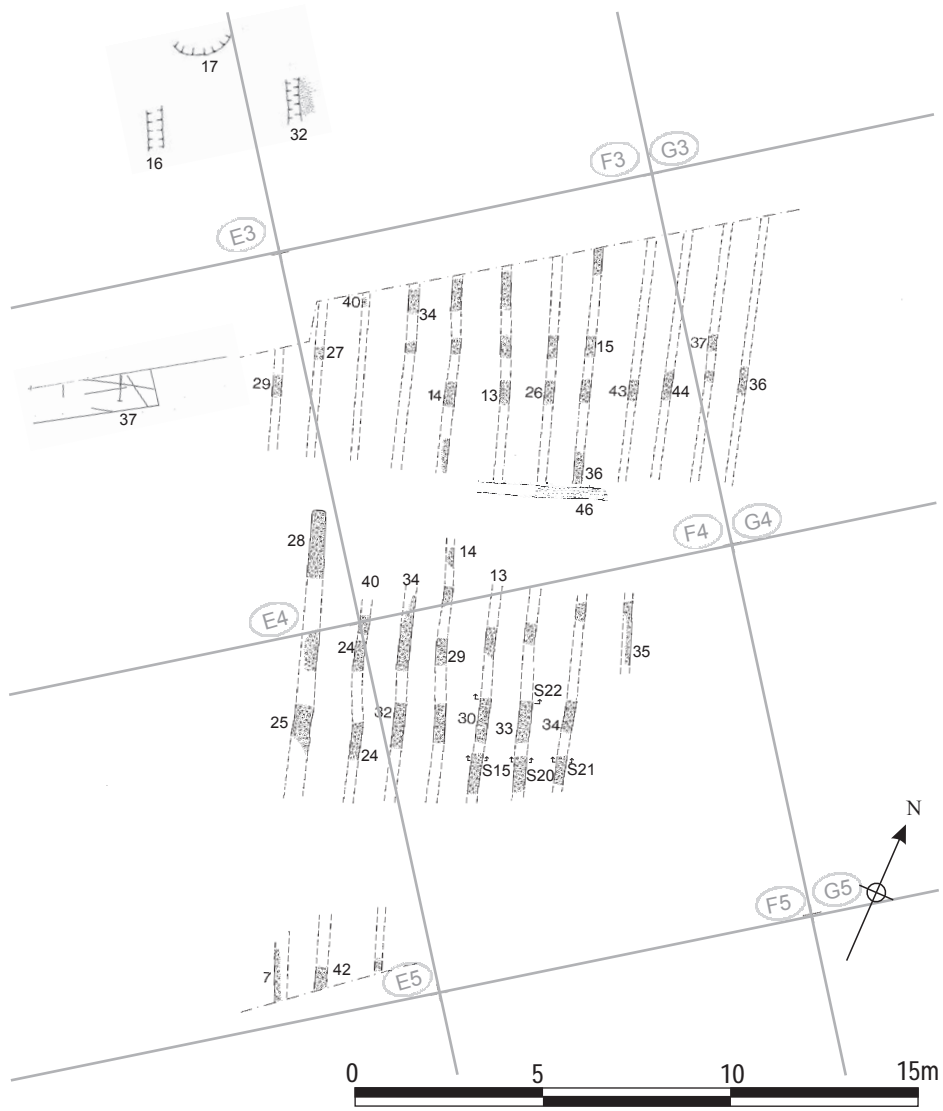

Fig re 8 Pre-Roman cultivation in the north west area of the fort, 8

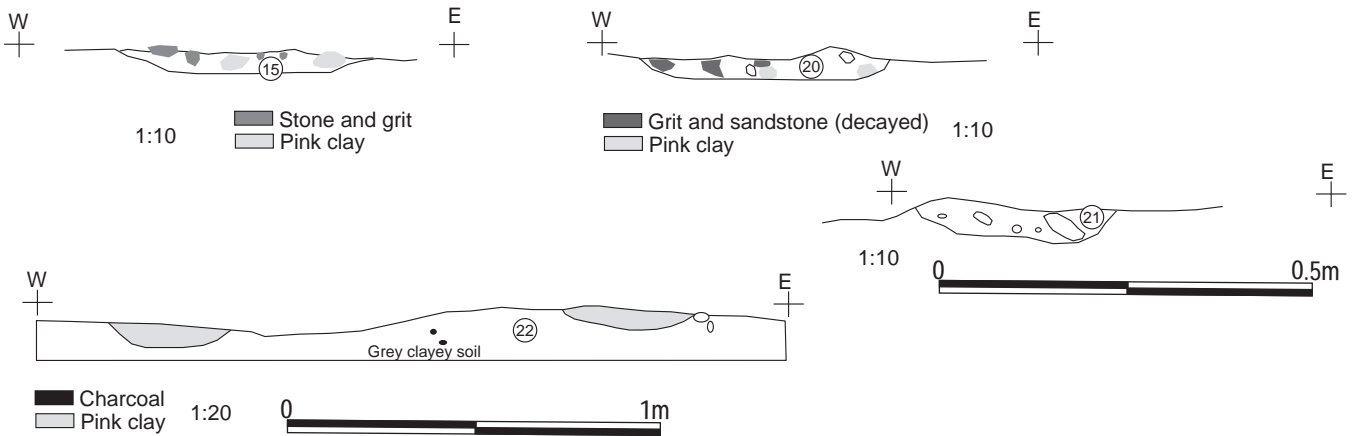

Fig re 8 Sections across cultivation furrows in grid square F5 south of Building 5



Fig re 8 Pre-Roman cultivation furrows beneath the principia and via principalis, 8

further south, a small area of plough marks (E04:37) was exposed at the base of a 3m x 1m sondage cut through the *intervallum* road levels.

The pre-fort ploughsoil beneath Building 5 was composed of very clayey, medium grey or olive coloured loam (E04:26, E05:26, F04:22, F05:31, G04:20, G05:23) which contained charcoal and was heavily stained with orange iron pan in places.

Central area – beneath the principia and via principalis (Figs 3.07 and 8.02)

The most extensive area of furrows was revealed beneath the *principia* forecourt and crosshall and the area of the *via principalis* immediately to the north in 1980–81. These were on a more north-westerly orientation than the fort buildings. Only one example, recorded just by site plan, appeared to cut across the main orientation on an east-west alignment and then appeared to turn north following a more north-

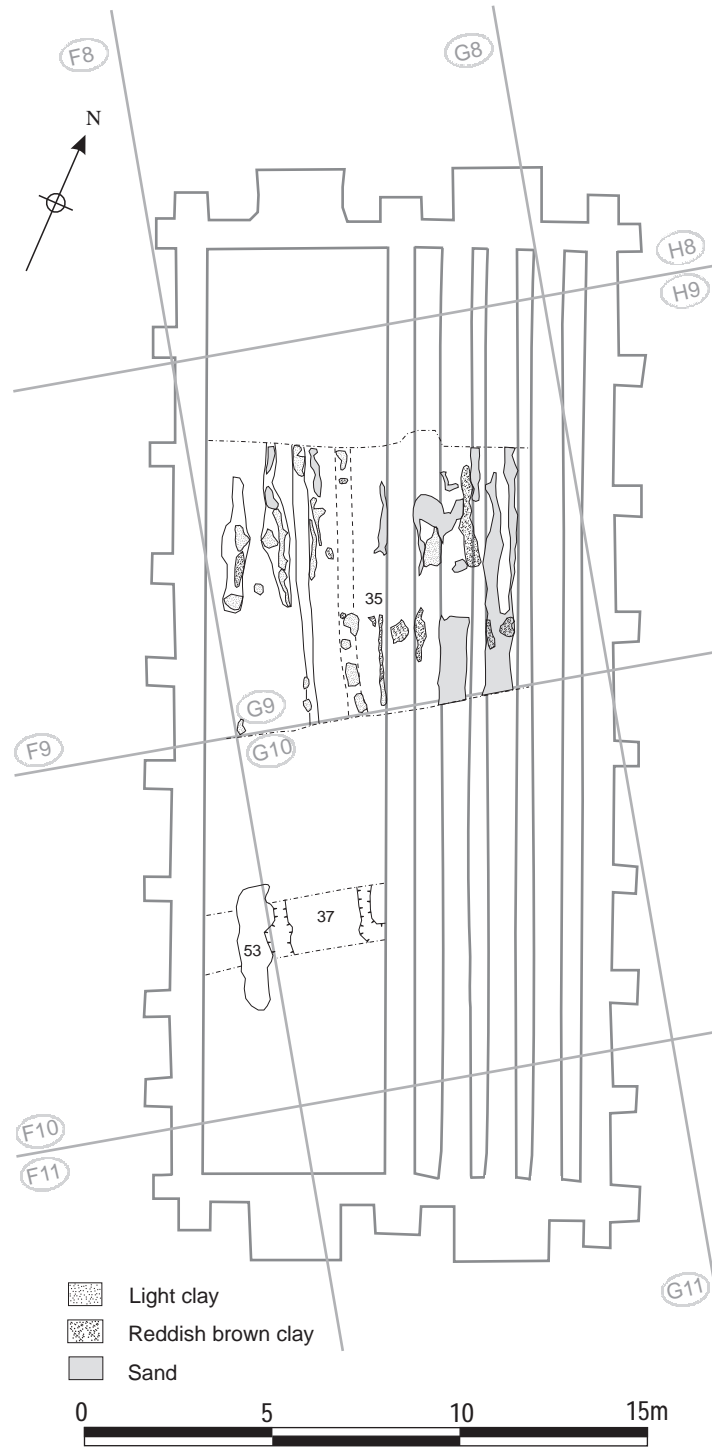

Figure 8 Evidence for pre-Roman cultivation beneath the granary at D

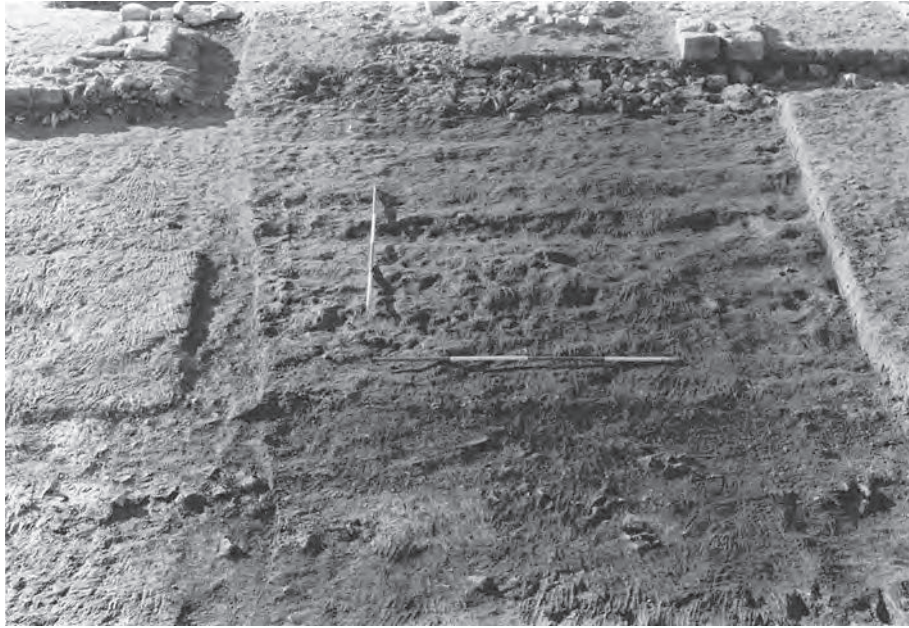

Figure 3.09 Cultivation furrows exposed during excavation of a slot beneath the granary in grid square G9

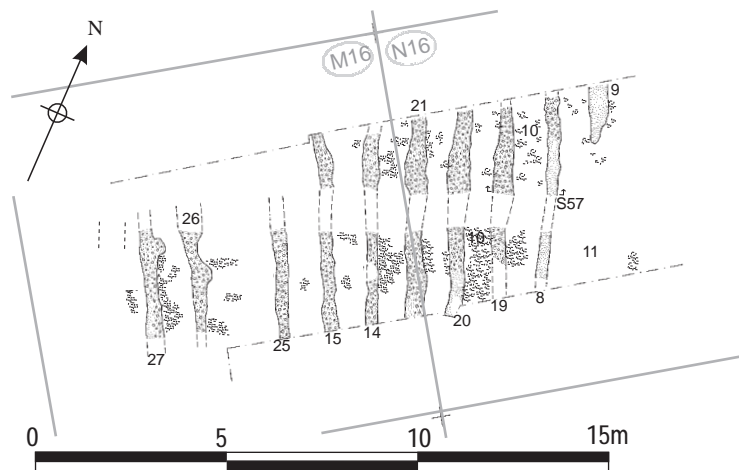

Figure 3.10 Cultivation furrows in the south east corner of the fort beneath Building 1 and the south intervallum road, 10

easterly orientation than the rest. The surviving depth of the furrows was 50–100mm and their width was 0.20–0.40m. Those extending along the southern edge of the *via principalis* were generally filled with sandstone fragments and yellow sand. Further south in the area of the forecourt and crosshall the fills were predominantly described as orange clay, often qualified as ‘dirty’.

Beneath the granary (Figs 3.08–3.09)

Two areas in the interior of the granary were excavated to sufficient depth to expose traces of pre-Roman agriculture in 1983.

In the northern half of the building a 6–8m wide strip was excavated across the virtually its entire width in grid square G09 (see Fig 3.09). A series of apparent furrows (G09:35) were recorded on the site

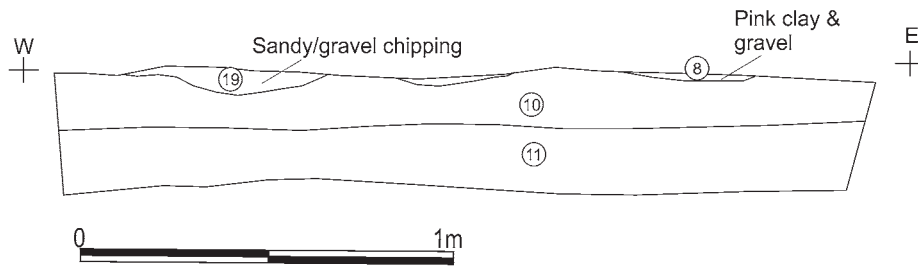

Figure 3 Section S3 across N0 and N0 in the south east corner of the fort, at 0

plan (but only summarily described), distinguished by fills of reddish-brown and lighter clay and sand. Their orientation was slightly to the north-west of the main axis of the granary itself.

In the southern part of the granary a 1.5m wide strip was excavated across the western half the building revealing two further furrows (F10:53, G10:37), which followed a similar orientation to those recorded further north and were filled with deposits of clay, possibly burnt.

South-east corner (Figs 3.10–3.11)

A system of ten cultivation furrows was uncovered beneath the south-east corner of Building 11 and

the adjacent south *intervallum* road levels in 1978–9 (M16:14, 15, 25–27, N16:08–09, 19–21). The surviving depth of the furrows ranged from 30mm to 80mm, with most c. 50mm, whilst they were 0.25–0.65m wide. They were predominantly filled with orange/white sandy gravel chippings and some deposits of pink clay.

Extensive areas of burning were noted around these furrows and these may be comparable with the burning noted in the 1997–8 excavations and at Denton on Hadrian's Wall. Analysis suggested this was deliberately undertaken, probably on a regular basis, to destroy all the weeds and shoots of weeds and increase the latent fertility of the soil (Hodgson 2003, 31–2).

PART 2

THE BUILDINGS OF THE CENTRAL RANGE

4. THE GRANARY (BUILDING 7)

Grid squares: F08, F09, F10, F11, G08, G09, G10, G11, H08, H09, H10, H11

Introduction (Fig. 4.01)

The granary posed the particular problems of interpretation because it was excavated in three separate stages: 1977 (southern end only); 1981 (remains exposed but little excavation); 1983 (full excavation). Moreover it appears the excavators in 1983 were largely unaware of the results of 1981. It should be emphasised that this is virtually the only instance, in what was a huge programme of excavation, spanning ten years, whereby the process of excavating and re-excavating particular areas over several seasons became uncoupled in this way and the results of a previous season's work were not fully taken into account. The 'decoupling' in this instance caused particular problems in analysing the area immediately to the south of the granary. It also led to the 1981 discovery of a secondary sleeper wall and associated flagging over the layers of the floor base in the west granary being ignored in 1983, which in turn resulted in the base layers being interpreted as successive floor levels. It would appear that the excavators in 1981 were principally focussed on uncovering the remains of the headquarters building, with the work on the granary and adjacent area to the south forming a peripheral element of that season's investigation. There was a hiatus in 1982, when no excavation was undertaken in the fort, and, consequently, when work resumed in 1983, largely with different personnel (although Charles Daniels was still involved), the significance of the 1981 season's results for interpretation of the granary was not recognised.

On excavation the granary (numbered Building 7 by the excavators) was found to have been severely damaged. The outer walls were extensively robbed

and the deposits associated with the internal layout of the structure, particularly its western half, had been truncated. Furthermore there were very few finds.

Remains of cord-rig cultivation were revealed beneath the granary in a section cut across the centre of the building and in further, smaller spit cut towards the south end of the west granary (G09:35, G10:37, F10:53 – see Chapter 3). Blackened patches of clay amongst the rig features suggested burning on the site, probably prior to construction. These deposits were covered by a spread of redeposited yellow/red clay and small stones (F10:54, G10:36, G11:77). In the south-west corner of the granary this clay was in turn overlain by a layer of small/medium sized stones set in sandy yellow clay (F10:41, F11:76, G10:38, G11:76), which was interpreted as a possible laid surface.

Phase 1 (Figs 4.02, 4.03)

In its primary phase, Building 7 comprised a rectangular, double granary measuring 26m × 11.40m. The structure was orientated north-south. The floor of the east granary was supported by three longitudinal sleeper walls. The west granary had a solid base composed of several layers of clay and stone. This again supported a series of longitudinal sleeper walls of which only a small fragment of one wall survived when uncovered in 1981. The two halves of the granary were separated by a north-south spine wall, which has been entirely removed by later robbing (G08:29, G09:15, G10:32, G11:64). The outer walls, too, were heavily robbed down to their foundations after the Roman period, the outline of the building being defined by robber trenches, with only two short stretches of actual masonry surviving on the north and west sides (G08:12, F09:14). These were constructed of roughly squared sandstone facing stones with a rubble core and varied in thickness between 0.80m and 0.65m. They were set on

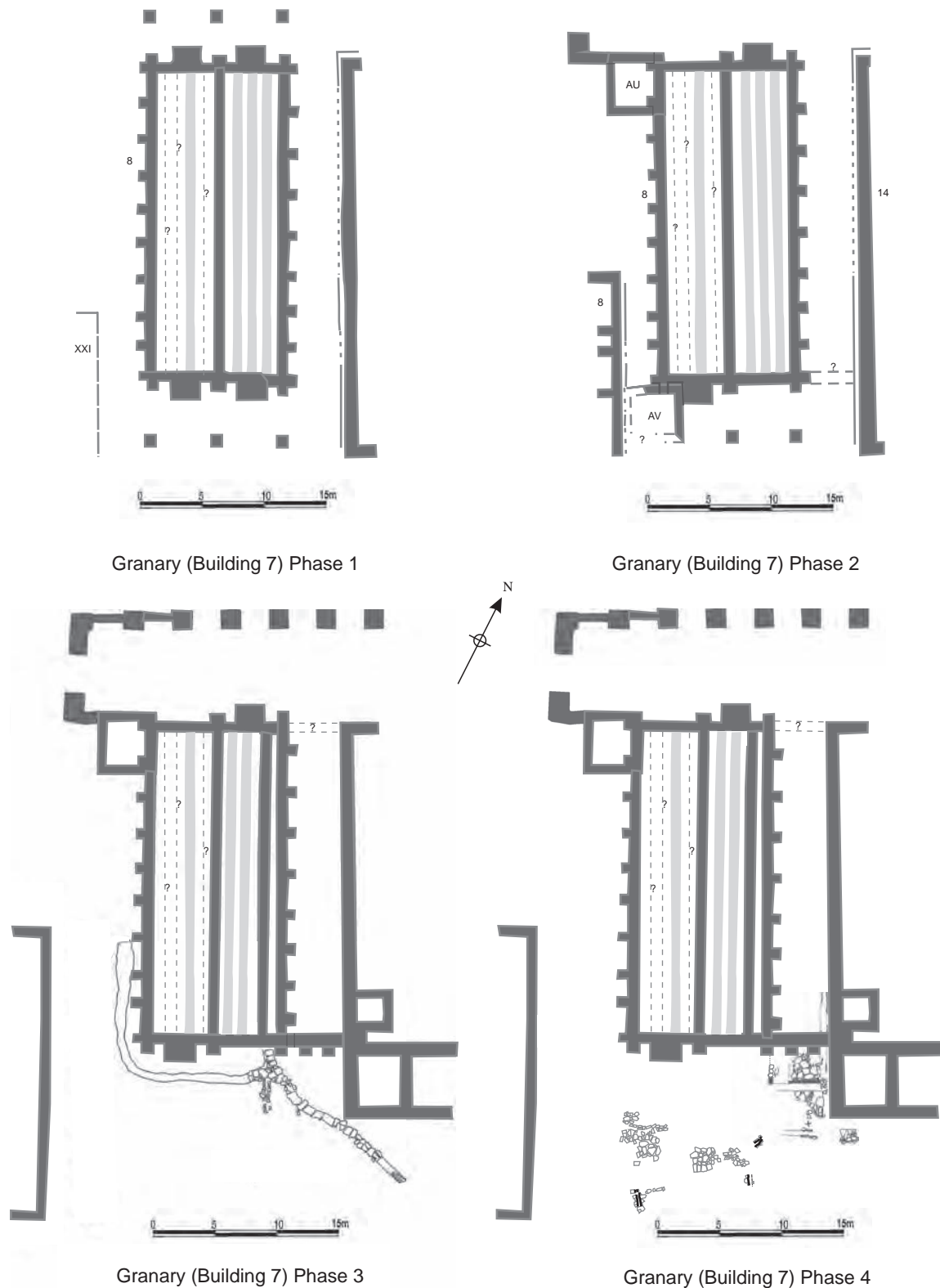

Figure 4 Phase plans of the granary building at 4

rubble foundations. The outer walls were externally buttressed along each side. On the north and south walls buttresses were provided at the terminals of the three main longitudinal walls, whilst the west wall was furnished with ten buttresses, but only nine were

attached to the east wall. These buttresses survived better than the outer walls themselves, with several along the west and, to a lesser extent, the east sides being missed by the stone-robbing trenches.

East granary

The east granary was characterised by three, parallel, north-south sleeper walls, which would have supported an elevated floor composed either of stone



Figure 4.03 Granary and Alley 8 from the north. Note the robbed outer walls, the NW loading steps and the well preserved sleeper wall G8

flags (as at Corbridge) or timber joists and planking. Raising the floor in this way was designed to reduce problems of damp and vermin. The easternmost of the sleeper walls (H08:24, H09:19, G08:30, G09:05, G10:24, G11:57) was relatively well-preserved, surviving to two courses for much of its length, but the others were severely robbed (G08:25, G09:11, G11:59; G08:27, G09:13, G11:61) with only short stretches of surviving masonry remaining near the centre of the building (G10:19, G10:22). Flags were laid on the ground surface in the 0.50m wide channels between the walls and measured up to 0.50 by 0.50m in size. Again these survived only in a central strip across the width of this half of the granary and at the southern end of the easternmost channel (G10:20, 21; G10:18, G11:56). (See Hodgson 2003, 173–4 for re-excavation of the flagging in 1997–8.)

West granary

The arrangements in the west granary differed quite markedly from those in the east granary. A series of distinct makeup layers, composed of clay or rubble, cobbles and flags, were identified when the building was fully excavated in 1983 (see Table 4.01; Fig. 4.04). These were interpreted by the excavators as successive floor levels, each representing a different structural phase, which were integrated into the overall four-period framework envisaged at that stage. In actuality these layers of clay and stone provided a base or raft on top of which were constructed a set of sleeper walls and flagging. Only a fragment portion of one sleeper wall (G10:07) and a small area of flags (G10:02) survived when these features were recorded in 1981 (see Fig. 4.03). These were broadly similar in form to, but differed in detail from, those recorded in the east granary. No equivalent levelling deposits were reported in the east granary, though the likely existence of some kind of clay construction deposit

Table 4.01: Sequence of west granary 'floors'

Description	F10	F11	G08	G09	G10	G11
Flags/sleeper wall					02/07	
Gravel & soil bedding					03, 05	
Clay levelling layer	48	12	10	06	04	
Rubble and flags in clay	24, 25	68, 69, 72	18, 19	17, 18, 19, 20, 21, 22	12, 13, 25, 28, 30, 31	52, 53, 70
Rubble and flags in clay	31, 26, 30	74	31	29, 28, 34	33, 14, 29	74
Clay layer	40	75	32	30, 31	34, 35	75
Pre-building/ Early?	41	76			38	76
	54				36	77
Plough marks/agric. deposits	53			35	37	

Italics = 'Partitions'

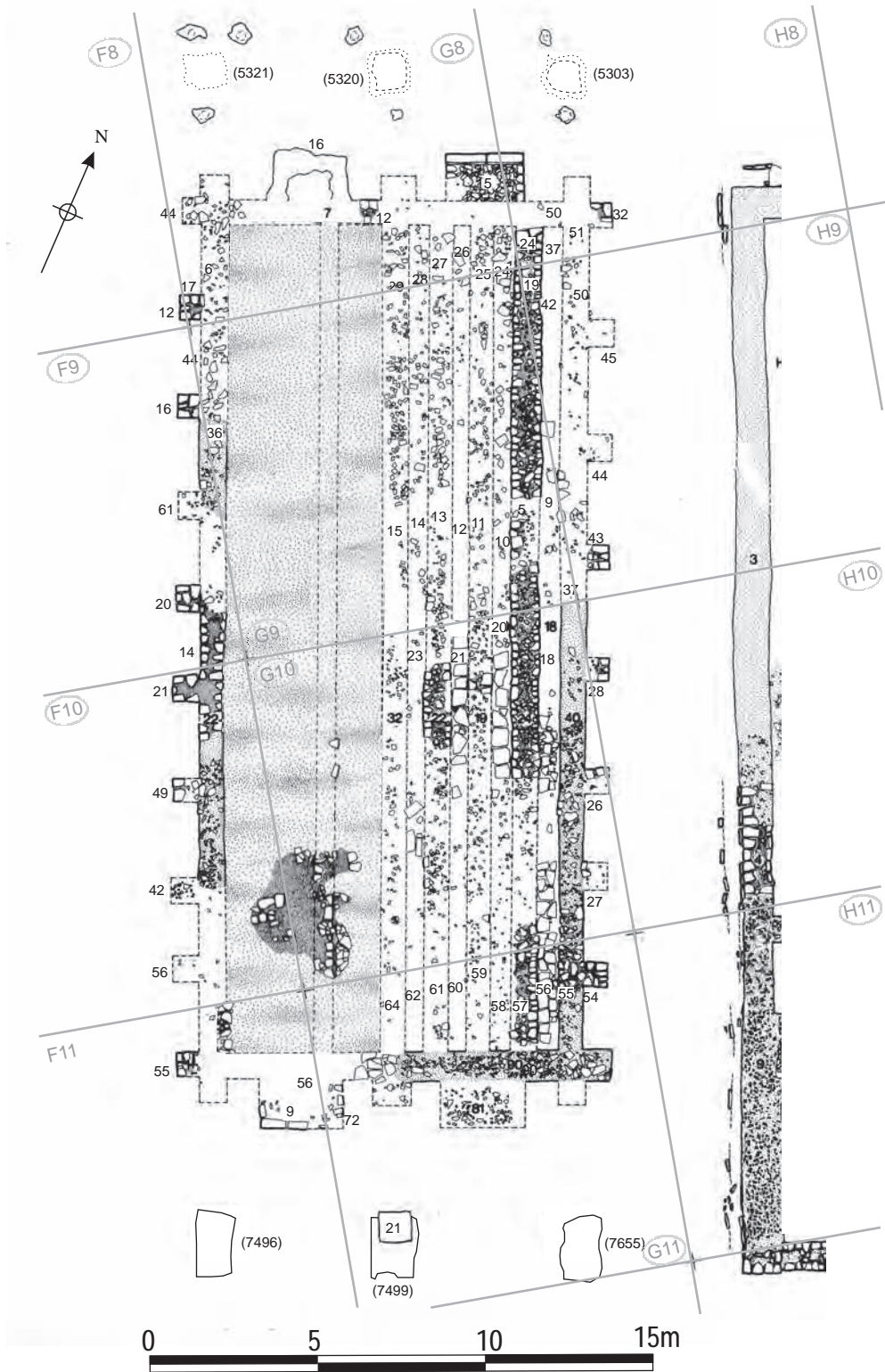

Fig re 4 Granary (Building 7, Phase 1 at 0

under both granaries may be suspected, as the photographs and plans make it clear that the pre-fort cultivation furrows were only revealed at the base of the shallow trench cut across the centre of the granary following the removal of the structures (see Fig 3.9).

The lowest of the levelling deposits was composed of clay (F10:40, F11:75, G08:32, G09:30, G10:34, 35,

G11:75) with a wide darker band running east-west approximately one third of the way down (G09:31) – see Figs 4.04 (left) and 4.05. The latter was originally interpreted as evidence for some kind of floor partition. The clay band was narrower at its west end (0.30m) than its east (1.30m), and rather irregular in its course. Its significance remains unclear. It is

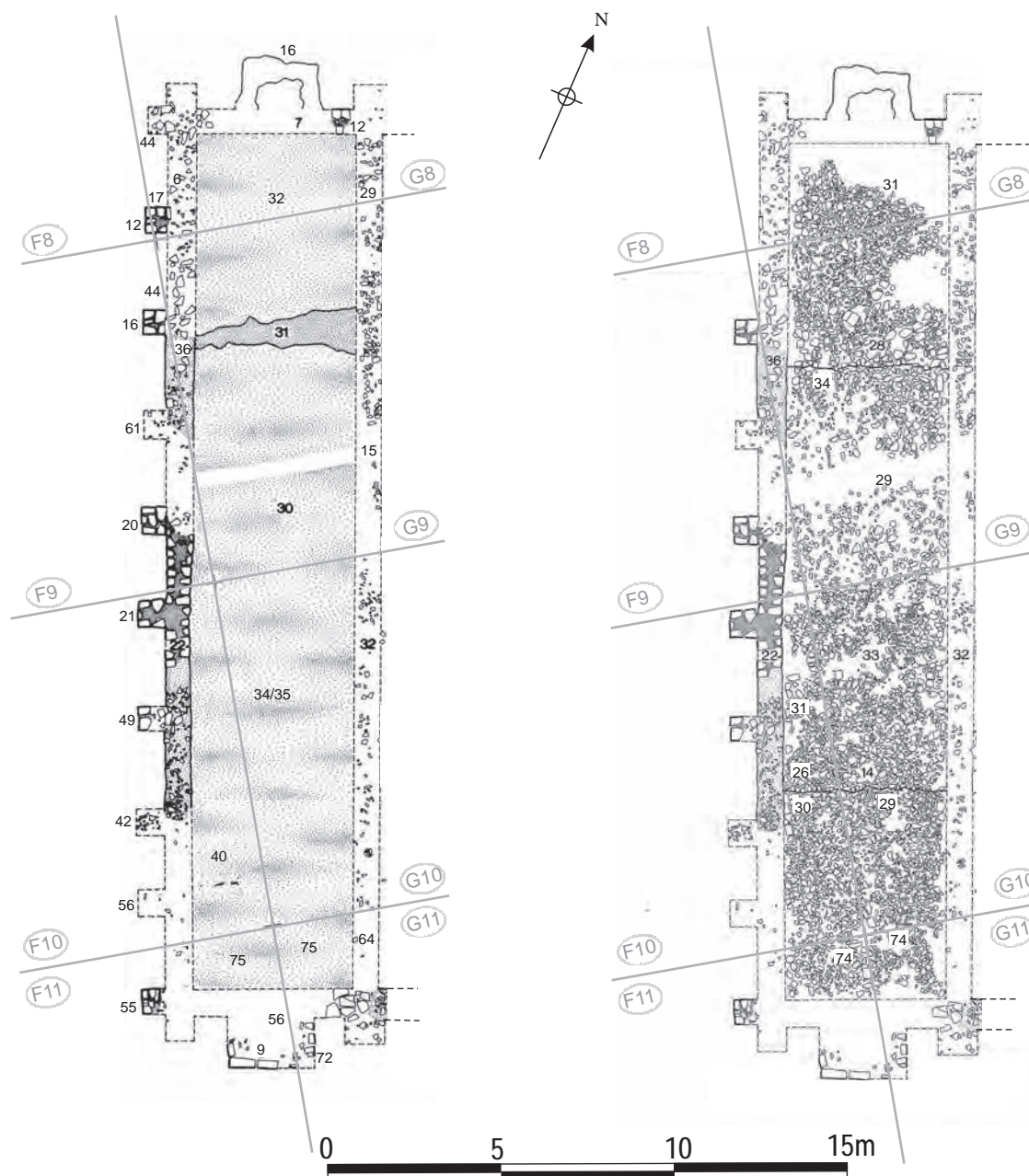

Figure 4.04: Clay base and cobble and flag makeup layers of the west granary at 1:200.

rather too wide and irregular for a timber and wattle partition. Also a possible post-hole (G09:33), filled with clay and coal (G09:32), was identified 1.00m north of the clay band and 2.30m from the west wall of the granary. This post may have been associated with the construction of the building.

Next a clay and cobble level (F10:31, F11:74, G08:31, G09:29, G10:33, G11:74), which incorporated areas of flagging within it, was deposited over the clay level (Figs 4.04 right; 4.06–4.08). Slight traces indicating the presence of two 'partitions' (neither of which was visible in the levels above or beneath) were noted in this layer, dividing it into unequal thirds, with the smaller areas situated at the north and south ends of the Granary and a larger undivided area in the

centre. The southern partition was indicated by a rough edge or face to a line of stones (F10:26, G10:14) clearly differentiated from a small area of flag stones to the south (F10:30, G10:29). The northern one was marked by a straight edge where an area of flagging (G09:28) butted against a spread of cobbles (G09:34). Two possible post-holes were also noted in the northern half of this surface (G09:24; G09:27), one actually being set on the line of the northern partition (G09:24). The lines of stones and edges of flagging probably simply reflect the manner in which the layer was constructed, perhaps in three discrete dumps. The stone and clay may have been dumped from either end of the granary first, perhaps packed up against a vertically set plank or beam, in much the same way



Figure 4.05: The clay base layer in the west granary in 1983, looking south-west.



Figure 4.06: As 4.05. A modern drain trench has cut a section through the make up. The large posthole towards the north end of the structure is a colliery era intrusion.



Figure 4.07: The flag and rubble make up for the west granary viewed from the west in 1983. Note the exceptional preservation of the sleeper wall G08 in the east granary.



Figure 4.08: As 4.07. Compare Fig. 4.05 from the same viewpoint.

that modern concrete surfaces are often laid. Once stabilised the planks would have been removed and the central dump of clay and stone deposited. The post holes, too, might be functionally related to the actual construction process. The flags incorporated in this layer may conceivably have been deposited deliberately, in order to facilitate access during the dumping of the stone and clay.

A further layer of rubble set in clay (F10:24, F11:68, G08:19, G09:18, G10:12, G11:52) with patches of flagging (F10:25, F11:69, 72, G08:18, G09:17, 19–22, G10:13, 25, 28, 30–31, G11:53, 70) was laid over the previous layer. The rubble used in this layer was more angular, in contrast to the rounded cobble stones employed in the first dump, and no evidence for any divisions was recognised in this surface. Again the deposition of patches of flagging may have had a deliberate purpose.

The upper level of rubble and flags was itself completely covered by a further clay layer (F10:48, F11:12, G08:10, G09:06, G10:04), which formed a level bedding for the flagged floor and sleeper walls above.

The site context records are not very informative, but the summary descriptive 'Buildings Notes', compiled in 1984 following excavation, indicate that this layer of clay, observed covering the entire western half of the granary (apart from the robbed area at the north end of the structure in grid square G08), was 0.10m thick. Only a small area of flagged flooring (G10:02) and a portion of one sleeper wall (G10:07), on a bedding of soil and gravel (G10:03, 05), survived over clay layer F10:48, but they are sufficient to confirm that the different layers of clay and cobbles plus flagstones in the western granary did indeed represent a sequence of makeup deposits for the granary rather than a series of floors as first believed (Fig. 4.03). The deposits were in any case too low to represent granary floors, given that the existence of stepped loading platforms shows both the east and west granaries were entered at a similar, elevated, level. The makeup layers had the effect of raising the base for the sleeper walls in the west granary to a higher level than that in the east granary. However, as the full height of the sleeper walls in either half of the structure is not known,

the actual floor supported on the sleeper walls need not have differed from that of the east granary. The surviving sleeper wall (G10:07) was orientated longitudinally, roughly north south, like its primary counterparts in the east granary, but its position shows that the spacing was rather different and there were perhaps two or four such walls rather than the three of the east granary layout. A possible break was identified in the west granary sleeper wall, which may originally have formed one of a whole series of such ventilation gaps deliberately inserted to facilitate the circulation of air beneath the floor. That this break was not simply a reflection of the partial survival of the wall is suggested by the fact that a flag was laid in the break. In the east granary, the sleeper walls are abutted by flags laid in the intervening channels, but no flagging underlies the walls and there are no evident breaks in the walls.

Loading steps and porticos

The steps

At either end of both the eastern and western granaries were substantial stone steps, termed 'loading platforms' by Daniels, which led up to the granary entrances at the level of the raised floor. There was definite evidence of one bay at the southern end of the western granary and another at the northern end of the eastern granary. There were traces of possible robbed bays at the other ends of both. There was no stratigraphic link between any of these stepped platforms and the remainder of the granary structure since the adjacent outer walls had been removed by robbing trenches. None of the steps survived higher than lowest tread.

The north-eastern loading platform (G08:03) was the best preserved and was c. 2.40m long and 1.4m wide. It was constructed of rubble, revetted on the east and west sides by small, roughly-cut blocks, tapering inwards to key them in. The north face, however comprised a pair of large, well-cut, oblong slabs (G08:13), each measuring 1.20m by 0.30m. The northern lips and corners of the two slabs were rounded either by extensive wear or more probably by design (see below), whilst the southern edge of the stones was rebated, to take two further slabs forming the next step. This demonstrates (if demonstration were needed) that the 'platform' was originally stepped and the threshold and floor of the east granary were at a somewhat higher level than the building's surviving remains. The dimensions of the south-west platform (F11:09) were virtually identical to those of its north-eastern counterpart and the form of construction very similar, though this platform was less well-preserved (Fig. 4.09). In this case no trace of a rubble core remained, but a rectangular spread of clay formed the base for the platform (F11:56). Again there were two stone



Figure 4.09 Close up of the SW loading step serving the west granary. The NE corner of Building AV is also visible.

slabs on the outer (southern) edge of the platform but neither was as long as the north-east pair and there was a gap where at least one additional slab had been removed. The inner edge of the surviving slabs was rebated, exactly like their counterparts on the north-east platform, and presumably similarly once held the slabs which formed the next tread of the steps. Parts of the side walls of the platform also remained. The south-east and north-west platforms had been virtually totally robbed away or demolished, the former only being represented by a spread of small-medium sized stones set in dark brown silty clay (G11:81) in the corresponding position. A similar platform-shaped stone scatter (G08:16) represented the robbing residue of the north-west platform, but here, beneath the spread, the trench (G08:39) cut to rob out the facing stones were recognised, enclosing the clay base of the platform.

South portico (Fig. 4.10)

Evidence for a portico on the south side was identified in the form of a single pier base (G11:21; TWM 7907), on the same north-south line as the central dividing wall of the granaries. The base was a large, well-shaped block of coarse-grained green sandstone,

0.90m square and 0.10m high (dimensions recorded by TWM: 0.94m × 0.92m in plan with a maximum height of 0.23m), very neatly cut with rounded top edges, very like the lips of the loading platform steps. It was set in the primary gravel surface (F11:53, G11:20, G12:23, G12:16?) of the *via quintana*, which was composed of small cobbles c. 0.005m in diameter interspersed with flags up to 0.20m in diameter (F11:73, G11:71). No evidence was identified in 1983–84 for the other two bases which originally stood opposite the south-east and south-west corners of the granary, but the substantial oblong foundations (TWM 7496, 7499 and 7655) for all three piers were identified in 1997–8, along with a number of other pits and post holes probably associated with the construction of the portico (see Hodgson 2003, 172–3 for a detailed description). One of the pits (7442) was interpreted as having held an upright post for a crane or similar device associated with the erection of the south-eastern pier. The three foundation pits were filled with sandstone fragments and cobbles capped with red clay. The westernmost pit (7497), which was emptied, had dimensions of 1.80m × 1.16m with a maximum depth of 0.21m.

North portico

The area of the corresponding portico north of the granary was investigated by Tyne and Wear Museums in 1997 (see Hodgson 2003, 172, for full description). The earliest Roman deposits encountered in this area were dumps of clay and layers of sand and crushed white and yellow sandstone similar to the crumbled sandstone spreads found immediately to the east of the south portico (south of Alley 8 – G11:82–83, H11:69–70). These layers were connected with the construction of the fort. They rested on the Iron Age cord rig and the clay dumps filled slots which had been dug in the furrows by the native farmers. The foundations for the two flanking piers of the north portico (TWM 5321, 5303) were cut from the surface of these deposits whilst the foundation for the central pier (5320) was cut from the level of the underlying, pre-fort soil horizon (5302). The foundations comprised deposits of sandstone fragments packed in brown clay filling roughly square pits. Each foundation pit had postholes to the north and south which also cut the construction dumps and which were probably connected with raising the columns on the tightly packed foundations. Layers which were laid down during fort construction covered the southern edge of the fill of the central foundation pit and its associated postholes. All the pits and other postholes were sealed below an extensive layer of blocks which were the bedding for a street surface. As this was the lowest street surface on the *via principalis* it was probably primary to the building of the fort.



Figure 4 The south end of the granary viewed in 1997. Note the SW loading step, the central pier base of the portico, the remains of Building AV and drain F11:53. In the background sleeper wall G11:57, drains G11:07 and G11:79 and the crosswall foundation trench of AW can also be seen.

FINDS

West granary make up layers

Samian stamp: 130–50 (no. S8, F11:12)

Coin: Trajan, 103–11 (no. 52, G09:30)

Lead: disc (no. 33, G09:29)

Stone: whetstone (no. 12, F11:12)

Quern: beehive (no. 8, G10:12)

Dating evidence

Most of the make-up layers in the west granary produced only a few sherds of pottery, including two sherds of second-century mortaria and a few sherds of reduced wares. The largest group came from context G10:35, which was still approximately only 20 sherds in total, most of which was made up of the locally produced second-century grey wares.

The floor of the east granary produced only six sherds of pottery in total, including two BB2 sherds (G10:18), which appears in small quantities from the 160s, but only in any quantity in the third century.

The sleeper wall produced a further two sherds of BB2 (G10:19). One sherd of possibly intrusive third-century Nene Valley ware (G10:02) was associated with the west granary floor.

The structural evidence all points to this being the primary granary and therefore presumably Hadrianic in date. No trace of an underlying timber granary was identified comparable to the timber phase of the hospital. The small quantity of coarse pottery in the granary makeup deposits and pre-fort levels was consistent with this dating, being predominantly composed of the second-century grey ware vessels, found in clay layer F10:40 (context G10:35) and in the underlying pre-fort plough furrows (G10:36). The little-worn Trajanic coin of 103–111 from layer F10:40 (context G09:30) would also be consistent with a Hadrianic construction date and may provide a closer indication of the date of the primary granary.

None of the material from the east granary floor or sleeper wall can be regarded as deriving from sealed contexts. Similarly, the flagged floor in the west granary (G10:02) from which a single sherd of third-century Nene Valley ware derived, also yielded early modern pottery demonstrating that the third-century sherd could be intrusive.

Building 7 Phase 2: Remodelling of granary and its relationship to adjacent structures (Fig. 4.11)

The loading steps and the Forehall (Building AO)

The granary entrances may have undergone a secondary remodelling, occasioned by the erection of the stone forehall (Building AO) along the north front of the *principia* and granary. Construction of this massive piers structure over the *via principalis* must have entailed the demolition of granary's northern portico. From the surviving remains of the loading platforms it may also be inferred that both halves of the *horrea* were modified to become single-ended structures, with the east granary now being entered from the north end only, whilst the west granary retained its south entrance, but lost its north one. Thus, whilst substantial elements of the base course of the north-east and south-west platforms remained (Fig. 4.12), their south-east and north-west counterparts were only represented by stone spreads of robbing residue (G11:81; G08:16) in the appropriate positions and, in the case of the north-west platform, the trench (G08:39) cut to remove the facing stones enclosing the clay base of the platform (Fig. 4.13). Five, large, well-cut blocks, measuring 0.65–0.80m × 0.25–0.35m (height not recorded, but c.0.20 to judge from photographs) and very similar in form to those used for the granary steps, were incorporated in the masonry of one of the piers (G07:03) of the forehall

(Fig. 4.14). It is tempting to interpret these blocks as representing the reuse of material from the north-west steps, only 6.00m from pier G07:03 (which was the nearest of any of the AO piers to that platform – Fig. 4.15). If correct this would not only imply that the removal of at least one of loading platforms occurred during the Roman period, rather than simply representing post-Roman robbing, but would also indicate that the demolition of the two loading platforms and the construction of the forehall were essentially contemporaneous, linked structural events. It should be noted however that if this is the case some means of entering the west granary at its north end must have been re-established later on when all access to the southern end of the building was blocked off by a row of timber buildings (see Chapter 6). Perhaps the original doorway was reopened and a simple set of wooden steps resting directly on the ground surface were installed at that point. Doorways may also have been inserted between the two halves of the building, if none existed previously.

FINDS

North-west loading steps robber trench

Architectural stonework: pier base (no. 23, G08:39)

Building AU and AV (Figs 4.16–4.17)

Grid squares – AU: F08, F09, G08; AV: F11

Two small buildings, labelled AU and AV, were attached to the north- and south-west corners, respectively, of the granary. Certain structural relationships and features suggest the building of AU and AV may be connected with the remodelling of the *horrea* entrances and the construction of AO.

Building AU took the form of a small, rectangular room, measuring 5.20m north-south by 3.90m east-west, and was tacked onto the north-western end of the granary (Figs 4.11, 4.16). Its floor (F08:17) was composed of small packed stones which showed some signs of wear. This was overlain by a rubble spread (F08:16) which may relate to the period after the building had gone out of use and reflect post-Roman disturbance. The excavation revealed the full length of the south and west walls, which survived up to two courses high and were evidently of one build (F08:06, 63, F09:33). The walls were 0.60m wide with no trace of foundations and may simply have been sleeper walls supporting a half-timbered superstructure. The south wall of Building AU (F08:63, F09:33) clearly butted up against the south face of granary buttress F08:12/G08:17 and presumably, therefore, also against the west wall of the granary (which served as the east wall of AU), although the exact relationship between these two walls has been obscured by robbing. The north wall of the building was shared with Forehall AO, forming the southern wall of that part of the forehall extending to the west of the granary. Only

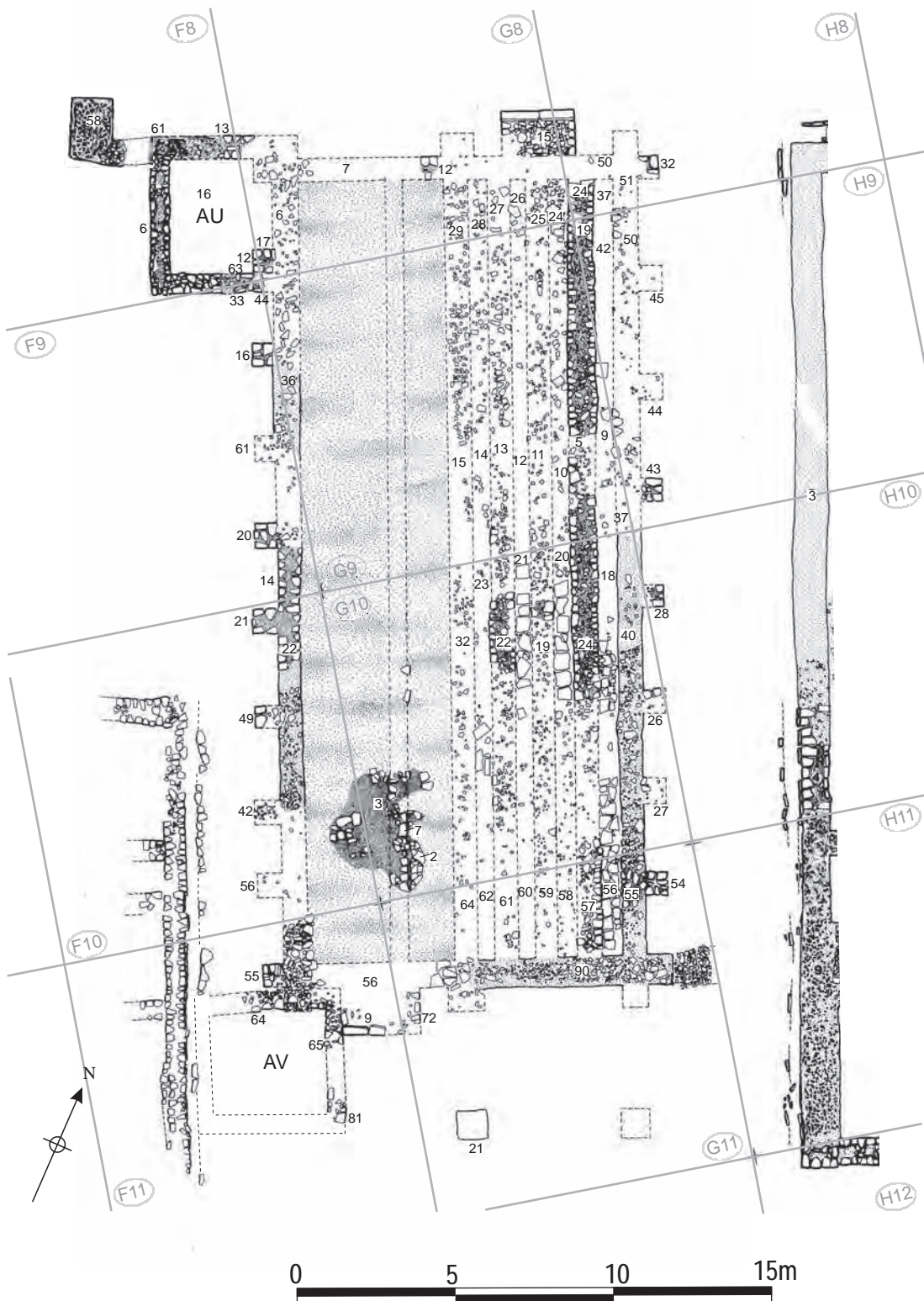

Fig re 1 Granary (Building 7, Phase 2 at 0

a one metre length of this wall's masonry survived (F08:13), the remainder having been robbed out (F08:51), but, at 0.75m broad and set on rubble foundations 1.00m wide (F08:61, G08:43), it was clearly more substantially built than the south and west walls of AU. Wall F08:13 was probably therefore

integral to Building AO rather than AU, implying the construction of AU was subsequent to that of the forehall. In effect Building AU was created simply by building its western and southern walls in the pre-existing corner formed by the junction of the granary and the forehall.



Figure 4.12: Granary SW loading steps, seen from the north in plan. The rebate for the next step clearly. Fragments of the west wall of Building AV can be discerned but are not yet fully exposed.



Figure 4.13: The piers of the forehall (AO) from the east, in plan. Note the location of the robbed out pier (G07:12) and the long blocks, incorporated in the pier (G07:03), in the background which may have been reused from the NW loading steps of the granary.

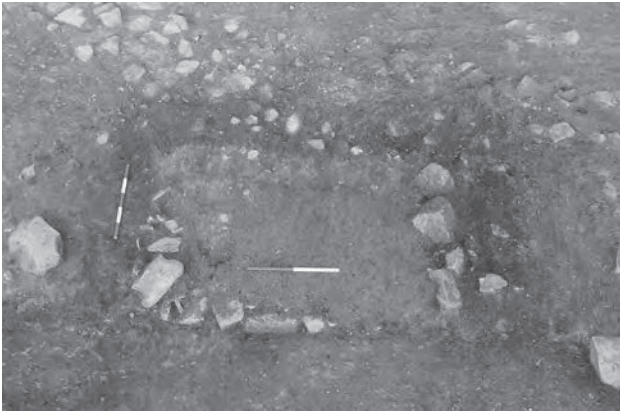

Figure 4.14: Close up of the robbed remains of the NW loading step.



Figure 4.15: The north end of the granary and the forehall seen in plan. Note the proximity to forehall pier (G07:03) to the robbed out NW loading step.



Figure 4 Building AU at the NW corner of the granary viewed from the north in 1977. The remains of the drying malting kiln are also visible.

A second small rectangular building, labelled AV, was built at the south-west corner of the granary (Figs 4.11, 4.17). Slight traces of the north (F11:64) and east (F11:65, 81) walls of this building run across and appear to be set on a layer of cobbling which was identified by the excavators as the primary road surface (F11:73), immediately to the south and west of the granary. The north-east corner of AV sat in the angle formed by the granary's south wall and the west face of the south-west loading platform, butting up against these pre-existing structures. The north wall of AV must have incorporated the westernmost buttress on the granary south wall. There was no trace of the south wall of AV, which had presumably been entirely removed by later activity. However, AV clearly extended southwards beyond the steps of the south-western entrance, though probably no further than the line of the existing granary portico. Similarly, no evidence for a western wall was recovered. It is possible that the east wall of the hospital was used for the purpose, with the north and south walls of AV butting directly up against it. If that was the case, the positioning of Building AV would have interrupted the line of the gutter (F10:50,



Figure 7 The remains of Building AV viewed from the west in 1981, comprising fragments of the building's north and east walls next to the SW corner of the granary. Note the gutter alongside the east wall of the hospital.

F11:77), which ran alongside the hospital wall, and the building's construction would therefore have to have been secondary to the erection of the stone hospital (Building 8 Phase 1). This would represent a useful piece of relative chronology, even though the two structural events need not have been separated by any great interval of time. However it is not certain that Building AV did extend right up to the hospital wall. It may conceivably have stopped short of the hospital east wall leaving sufficient space for the gutter to pass between. The west wall of AV could conceivably have been robbed in its entirety, like the south wall. Judging from the photographic record (Fig. 4.17) the gutter lining incorporated a couple of large, neatly-squared oblong blocks which resemble those used in the granary loading platforms. It is conceivable that these blocks derived from the redundant south-east loading platform and were reused to line the gutter alongside the hospital wall at this time. However they appear to lack the distinctive rebates present on the surviving *in situ* blocks so it is impossible to verify now whether this was their original purpose.

The relationship between AV and the adjacent road surfaces implies that the building was broadly contemporary with the initial phase of the stone hospital (Building 8 Phase 1). The later phases of the hospital (Building 8 Phases 2–4) were associated with a series of rutted road surfaces which overlaid the original east wing of the hospital and extended to the east of that building into the area occupied by AV. Although the stratigraphic relationship between the fragments of wall belonging to Building AV and the rutted road surfaces is not explicitly documented in the site records, the fact that AV was not recognised when these surfaces were investigated in 1977 and indeed was not identified until the 1980–81 season strongly implies that the remains of the building underlay the later road surfaces and predated the hospital building phases with which those layers were

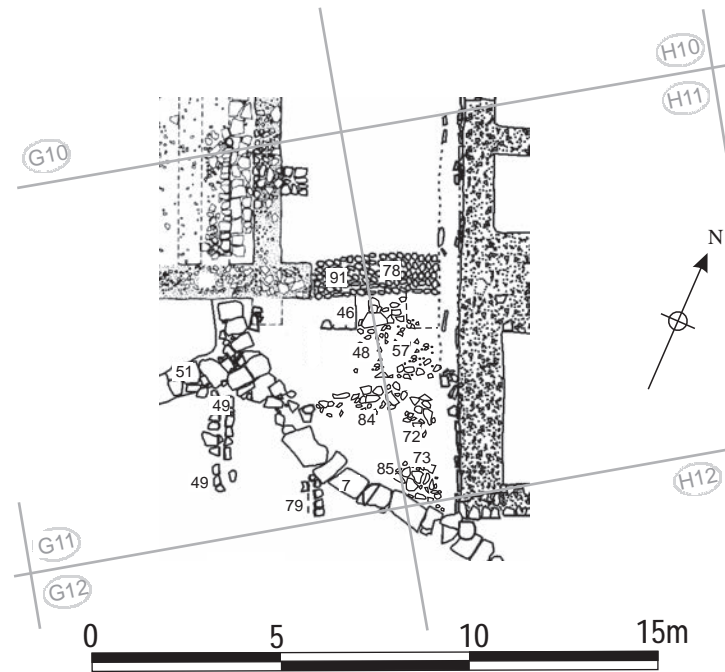

Figure 4.18: The remains of the wall closing off the south end of Alley 8 (Building AW), plus the drains and surfaces in the area to the south at 0

associated. Furthermore, the southern fragment of AV's east wall (F11:81) was recorded as overlying the lowest layer of metalling noted in the area south of the granary (F11:82 – described as 'road foundation?'). The next layer of cobbling was interpreted by Daniels as the primary road surface (F11:73 = F11:53?). The relationship of F11:73 to the surviving walls of AV is, again, not explicitly defined in the context records, but examination of the site plans and photographs suggests the walls were probably set on this surface.

Dating evidence

Only three sherds of pottery were recovered from Building AU. This includes a sherd of BB2, and two sherds of samian, one of which was Antonine (F08:17).

Discussion

The remodelling of the granary entrances, which converted the twin granaries into single-ended structures, facing in opposite directions, formed part of a larger phase of building work in the central range that included the construction of the forehall and the stone hospital (Building 8 Phase 1). The alterations to the granary may have been intended to separate the stored supplies of the two main components of the garrison. This remodelling was probably also associated with the addition of small buildings (AU and AV) at the north- and south-west corners, respectively, of the double granary, which was perhaps designed to establish tighter control over the issuance of supplies to the troops.

Thus the six infantry centuries of the equitate cohort, which were lodged in the northern part of the fort (*praetentura*), were probably provisioned from the north-facing, east granary, whilst the cavalry *turmae*, which were evidently housed with their horses in the four stable-barracks in the southern part of the fort (*retentura*), were presumably supplied from the south-facing, west granary.

The excavators cautiously, but plausibly, interpreted Building AU as a quartermaster's office, and a similar identification might apply to AV, with the implication that each half of the granary was provided with an attendant office intended to house an official monitoring deliveries to and issuance of supplies from the *horrea*. On this basis, Building AV, which directly abutted the south-west platform, could have served the west granary, whilst AU might relate to the east granary. Physically locating officials close to the granary entrances in this way would have provided tighter control over access to that building. The construction of AU and AV may therefore be seen as contemporary episodes forming part of the wider reconstruction of the granary, rather than representing two consecutive phases, as suggested in the Tyne and Wear Museums report (Hodgson 2003, 174). There it was argued that AU may have replaced AV when the east wing of the hospital was demolished and replaced by a thoroughfare, which also impinged on the area of AV. This possibility cannot be excluded, and it must be admitted that both suggestions are ultimately based on interpretations of the likely causal sequence of events.

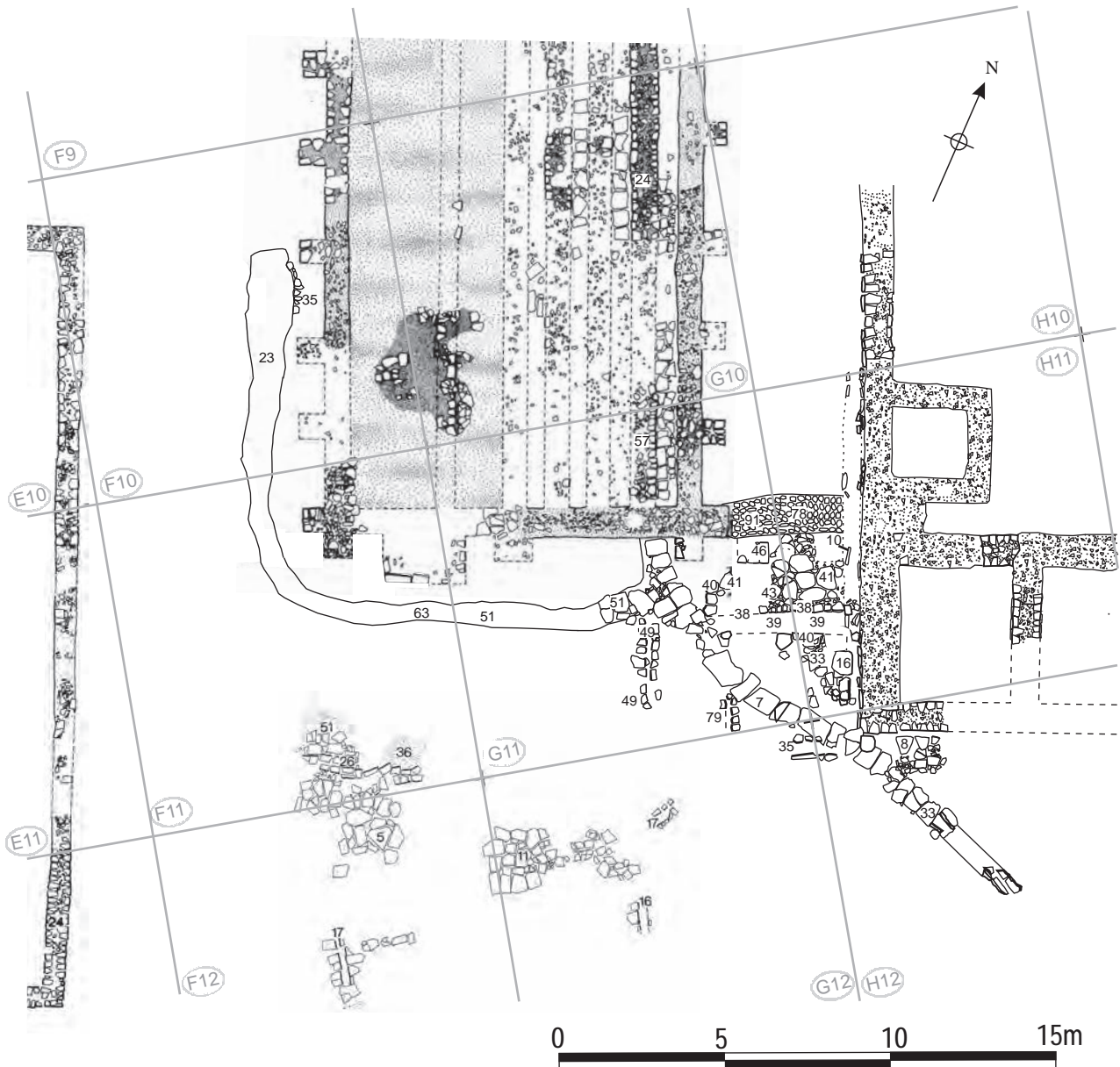

Figure 4.9 The south end of the granary (Phases 3 and 4) showing the south wall of AW and the surrounding storm drains F10:23/F11:63/G11:51 and G11:07/H12:33, at 1:200. Also shown for reference are the flagged floors of the third-century timber building in this area.

Building AW and the alley between the granary and the *principia* (Alley 8)

Grid squares: G10 G11 H8 H9 H10 H11

A further major alteration to the granary is signified by the construction of a wall blocking off the southern end of the alley to the east of the building (Alley 8). Much remains uncertain regarding the form of this remodelling, as its remains had largely been robbed out or removed by later activity. However, several features suggest that it involved more than simply closing off the end of the alley and may have entailed enclosing and roofing over the alley space to convert it into a third chamber for the granary. This structure was labelled Building AW by the excavators.

The southern end of the alley was blocked off by a wall which continued the line of the granary south wall (Figs 4.18, 4.19). This blocking wall was represented by a pitched, rubble foundation (G11:91, H11:78), up to 1.3m wide, overlain by yellow clay, which abutted the most southerly buttress of the granary east wall. The superstructure of this wall has been entirely removed by robber trench H11:71, which, in so doing, has also obscured the original relationship between the wall and the adjacent surfaces. However, in the 'Building notes' compiled following the 1983–1984 seasons it is stated that the foundation was clearly added against the most southerly buttress of the granary east wall, and was therefore a secondary feature. On the south side of

Table 2 Equivalence table of surfaces in Alley 8

Alley 8 surfaces	Context numbers
Alley surface 4	G10:10, G11:42?, H09:14, H09:46 (patch of resurfacing), H10:26, H11:32
Alley surface 3	G10:39, G11:87 (?), H08:46, H09:15/47, H10:27, H11:35
Alley surface 2	G11:94, H10:47, H11:76
Alley surface 1	H11:75

the robber trench, roughly midway along its length, the remains of a possible buttress (G11:46) survived. Site plan P278 also shows a very similarly shaped, rectangular depression, 1.5m further east, perhaps marking the outline of a partially excavated robber trench for another buttress, although this is not identified in the context records. Robber trench H11:71 also apparently cut the northern edge of a large shallow pit (G11:92, H11:77), which itself cut into the layer of dark brown soil interspersed with small stones (G11:86, H11:74) that covered much of the area south of the alley (this was the lowest level investigated in this area in 1983). The pit fill was not fully identified in the context records, but would appear to correspond to a spread of cobbles and flags (G11:48, H11:57) which site plans and associated sketches from the 1981 season show covered this same area. Indeed the 'pit' uncovered in 1983 may simply represent the feature left by the excavation and removal of the cobbles and flags in the 1981 season. The cobbles and flags were, in turn, covered by a layer of coal dust and chippings (G11:47, H11:56a). Two further patches of well-worn flagstones (G11:84/H11:72; G11:85/H11:73), which may be contemporary with this phase, were revealed further south, close to the south-west corner of the *principia*. These were explicitly interpreted as deliberately laid surfaces rather than random scatters of flagstones.

Up to four clay and cobbled surfaces were laid in the alley (see equivalence table 4.02), although the relationships and equivalences between the lower examples were not always clearly expressed in the site records. CMD noted that these surfaces looked weathered, but not worn, and the context descriptions are indeed more characteristic of road metalling rather than internal building floors which would imply the area served as an enclosed yard. A drain or gutter (H08:18, 19, H09:49, H10:46, H11:10, H12:10), which was probably a primary feature, was constructed beside the west wall of the *principia* and ran the full length of the alley. This was comprised two lines of thin slabs set vertically on edge, the eastern line being laid right up against the west wall of the *principia*. The drain fill (H08:21, H09:48, H10:48, H11:34, H12:11) was not fully described, but included rubble

blocks in its uppermost level, perhaps representing demolition debris from the adjacent buildings. None of the surfaces in Alley 8/Building AW extended over the remains of the granary's east wall which would imply that the wall remained standing and formed the eastern edge of that area throughout the period represented by the four clay and cobbled surfaces, whether the area functioned as an alley, an enclosed yard or a covered storehouse.

There were no definite remains of a corresponding blocking wall at the north end of the alley, but a modern drain (H08:08/09) had removed most of the stratigraphic evidence at precisely this point. The Building Notes indicate that CMD did recollect finding a tiny fragment of a wall somewhere in this area. This may be a reference to a short section of the granary north wall (H08:31), found here, or to the scatter of dressed facing stones, which are depicted clearly on site plan P244, clustered on either side of the modern drain, but not identified as a separate context.

Drains

Further evidence is provided by presence of a series of drains to the south of the granary. Most intriguing was a very substantial drain (G11:07, H12:33; TWM 7687), as much as 1.0m wide at the top, which was constructed using thin sloping slabs to form the side walls and covered by similar flat slabs. This appeared to run from the southern end of the east granary past the south west corner of the *principia* and thence down the *via decumana* and perhaps exited the fort through the south gate where a similarly constructed drain was encountered. It appeared to cut another drain (G11:49; TWM 7215), which was only 0.15m wide and some 2.50m in length, its side walls being composed of small stone blocks, of which only a single course survived (Figs 4.19, 4.20). A further branch of the main



Figure 4.20: Drains G11:49 (foreground) and G11:07/51 (mid left to bottom right) at the south-east corner of the granary, viewed in 9

drain joined the previously described section just south of the granary. This branch extended around the south end of the granary, starting from a point not quite half way along the length of the building (F10:23, F11:63, G11:51). Virtually all its side walling and cover slabs had been robbed out at some point. The position of drain G11:07 in relation to the granary is puzzling. It certainly ran right up to the south end of the building. However the drain could not easily have collected rainwater falling from the roof of the primary granary. It terminates at a point immediately west of the granary's east wall, opposite the line of flagging (G11:56) which separates that wall and the most easterly of the sleeper walls (G08:30, G09:05, G10:24, G11:57, H08:24, H09:19) in the east granary. The position of the drain instead suggests that there was a roof valley between the two walls and further implies that the internal wall was rebuilt to form a partition wall supporting one side of the roof valley.

Discussion

The evidence regarding the form and function of the structures grouped together under the label 'Building AW' is somewhat contradictory and was not fully resolved by the excavators. Charles Daniels considered it unlikely that the alley was incorporated within the granary, but other comments in the post-excavation archive imply that AW was reckoned to be a building of some sort. Several pieces of evidence need to be reconciled. Both the extent and the location occupied by the cobbles and flags (G11:48), which were set in shallow pit G11:92, would be consistent with their interpretation as foundations for another set of loading steps giving access to an elevated granary floor. However the absence of any other evidence for such raised internal flooring within the alleyway north of the cross wall implies that the area never formed part of a conventional granary structure (even if some caution may be merited in this respect, bearing in mind how little survived of the sleeper walls and associated flagging in the west granary). Indeed the surfaces present in the alleyway would be more consistent with an open yard rather than a roofed structure. Yet the clear evidence that the wall across the southern end of the alley was furnished with one or perhaps two buttresses provides decisive confirmation that the wall formed part of an enlarged structure, integrated to a significant degree with the existing granary (though not necessarily performing an identical function), and was not intended merely to close off access to the alley. Accordingly a third storehouse chamber must be envisaged, but one equipped with a cobbled hard-standing, rather than an elevated floor, and presumably intended to house non-perishable items such as tools, carts, or stores which could be hung from internal roof beams. In these circumstances the spread of cobbles and

flagging south of the cross wall is most plausibly interpreted as a metalled approach to an entrance through the wall, all trace of the actual threshold having been robbed away with the rest of the wall's masonry. It is uncertain whether there was a wall across the north end of the alley. A wall may not have been necessary here in any case since the forehall to a large degree closed off access to the area.

Finally, the location of drain G11:07 also points to a significant remodelling of the granary, which not only involved enclosing and roofing over the alley, but conceivably also heightening the eastern sleeper wall (G08:30) to serve as the new east wall for the pre-existing granary chambers, whilst the granary's former east wall now served as the west wall of a chamber enclosing the former alley. Between the two walls an eave-level valley presumably discharged rainwater into drain G11:07 at the south end of the building. This valley would have covered a narrow space separating the old and new chambers, an arrangement which may be paralleled at Housesteads where there appears to have been a similar enclosed space between the two third-century *horrea* which replaced the double-width Hadrianic granary. It must be admitted that there is no evidence that the former sleeper wall was strengthened in any way to perform its new function, but it is otherwise difficult to explain the positioning of the drain which was evidently one of the principal stormwater channels in the fort.

FINDS

Building AW – S wall robber trench
Copper alloy: loop (no. 375, H11:71)

Drain F10:23/F11:63/G11:51 south and west of the granary
Coin: 'Constantius II', 353+ (no. 207, G11:51)

Dating evidence

The area south of Building AW

SOIL G11:86/H11:74

Dark brown soil G11:86/H11:74 contained a more sizeable combined group than other contexts in this area, which could be either late second or third century in date (all the coarse ware of G11:86 is BB2 and allied fabric, but there is too little material from this context on its own for this to be significant).

FLAGGING G11:84/H11:72

Flagging H11:72 was associated a small group of only a few sherds and therefore of limited use.

Alley 8

ALLEY 8 SURFACE 2

There was a single sherd of mid- to late Antonine samian (H11:76).

RUBBLE OVER ALLEY 8 SURFACE 3

There were only a few sherds of pottery in the material over alley surface 3 H09:15, including third-century BB2, and an intrusive Huntcliff-type calcite-gritted ware rim (H09:16).

ALLEY 8 SURFACE 4

The uppermost surface produced reduced Crambeck ware of the late third century or later (H09:14, H10:26).

Alley 9 and the drains south of the granary

DRAIN F10:23/F11:63/G11:51 SOUTH AND WEST OF THE GRANARY

The substantial drain extending around the west and south sides of the granary contained a large group of pottery of third-century date from its northern end, in Alley 9, with almost all of the coarse ware made up of sherds of BB2 and allied fabrics, including a G151 rim (F10:23). Nene Valley ware made up the fine wares. There were very few sherds of pottery in the upper fill in this stretch (F10:18), and nothing later in date than in the lower fill.

Further south, where it curved round to run along the south side of the granary, cutting the *via quintana*, three sherds of Antonine samian and a Colchester mortarium rim dated 130–70 were recovered from the drain (F11:63), whilst the section continuing eastwards along the south side of the granary contained a few sherds of BB2 and allied fabrics of third-century date (G11:51).

DRAIN G11:49 IN THE VIA QUINTANA (ROAD 3)

The north-south aligned drain G11:49, south of the granary, contained a few sherds of BB2, plus Nene Valley ware of third-century date.

DRAIN G11:07/H12:33

Much of the material was made up of BB2 and allied fabrics, with a single sherd of Crambeck reduced ware and a BB1 flanged bowl providing a late third century date (G11:07).

The dating of the drains

The short stretch of drain G11:49 (TWM 7215) was assigned to Period 1 or 2 by the 1997–8 excavators who re-exposed the feature. It was presumed to have continued northward to the south wall of the granary, following much the same course as the north end of drain G11:07 (Hodgson 2003, 174). The much more substantial drain which ran around the south end of the granary and continued past the south-west corner of the *principia*, was assigned to Period 2/3 (*ibid.*, 175). It was suggested that the northern end of G11:49/7215 running south from the granary was recut and realigned at this time to feed into the new drain, though it is so much wider and deeper that it should surely be treated essentially as a new structure (G11:07).

The sequence of these drains was never properly established during the Daniels excavations and some key stratigraphic relationships are unclear. F10:23/F11:63/G11:51 certainly ran through the area of Building AV and most likely post-dated it (the surviving fragments of the building's north and east walls do not continue across the line of the drain and may have been cut by it). This drain also traversed the area covered by the south portico and it is likely this had already been dismantled by the time the drain was dug. The portico would not have been needed once all access to the southern end of the granary was closed off, which may have coincided with the demolition of AV. Indeed the drain's most plausible interpretation is as a kind of ring ditch, collecting runoff from the truncated granary roof and helping to keep the area around the lower, southern end of the building relatively dry. The northern end of G11:07 extending up to the granary south wall would have completed this 'ring ditch'. Although it may have been constructed before the three timber buildings, Q, R and AX(S) were erected, the latter do not impinge on the 'ring ditch' drain and it is likely that it was still operating during at least part of their lifetime (see Chapter 6 for a description of the timber buildings). Indeed it would have been essential in helping to keep the north ends of these structures dry, preventing them from being flooded by runoff from the granary roof and it is not impossible that it formed part of the same structural programme.

The location of drain G11:49 corresponded to the narrow alley between the two easternmost timber buildings, R and AX(S). Its function may have been to drain rainwater from that alley into the ring ditch. Unfortunately the stratigraphy relating to this drain is very uncertain. It appears in site plans of 1981 and the subsequent plans and photos of 1983 standing proud, set on top of earlier road surfaces. Hence it was assigned to Period 1/2 in 1997–8. It was not recorded in 1977, but it lay on the periphery of that year's excavation site to the east of timber building R where there was relatively little investigation and the layers described in the site notebooks are very difficult to interpret.

In contrast to F10:23/F11:63/G11:51 and G11:49, which apparently respected the positioning of the timber buildings, the course of drain G11:07/H12:33, running south-eastwards from the granary past the south-west corner of the *principia*, cut diagonally across the northern half of the easternmost timber building. Whereas F10:23/F11:63/G11:51 was devoid of cover slabs when first exposed, those of G11:07/H12:33 remained in situ at the time of initial excavation in 1981. The site plans drawn at that stage, plus photographs taken in 1977 when the drain was first exposed at the edge of the Site 6 excavation area, but not otherwise recorded, show that stone surfaces which can now be associated with timber building AX(S) did not then extend over the drain cover slabs,

though they did survive on either side. It is possible that the cover slabs were incorporated to form part of the building's stone floor or that the overlying floor surface had already been removed by the excavators, perhaps inadvertently, to expose the slabs. However it is also conceivable that the drain was constructed across the site of the timber building after the latter had gone out of use, perhaps in the late third century, cutting through the building's floor.

Thus ring ditch F10:23/F11:63/G11:51/G11:07 (north) may have been constructed in the early third century (Period 3) or perhaps somewhat later in that century, in association with the timber buildings of Row 20 (Period 4), to which stage drain G11:49 can also be assigned. G11:07/H12:33 may have been associated with the ring ditch from the start, designed to carry away the collected stormwater, but the possibility that it was a later modification inserted after the abandonment of all or part of Row 20 cannot be excluded. The inclusion of some late third century pottery in that drain would be consistent with the latter hypothesis, but the quantity is small – a single sherd of Crambeck reduced ware and a BB1 flanged bowl – and it could simply represent material which found its way into the drain later in its life. The overall character of that assemblage, being dominated by BB2 and allied fabrics, would imply a date earlier in the third-century and, on balance, suggests that G11:07/

H12:33 was constructed at much the same time as F10:23/F11:63/G11:51 and may have been an integral component of the latter.

Drying kiln

The traces of a possible corn-drying or -malting kiln (F08:05) were identified tucked in the angle created by the west side of AU and south-west corner of AO (Figs 4.21, 4.22). The kiln took the form of a squarish, clay platform, with two parallel flue channels, orientated roughly north-south, set in it. The easterly of the two flues was the better preserved, comprising two facing lines of flat, roughly worked stones, roughly parallel to the west wall of AU (F08:06) to the east. The two walls were c.0.40m apart and 2.20m long, although only seven facing blocks remained *in situ*, three belonging to the western 'wall', at the southern end of the kiln, and four at the northern end belonging to the east wall (B91/2a–4a, B93/36–37). The north end of the structure, where the two walls may originally have joined, must have abutted the south wall of the forehall AO (F08:13/58). The structure sat on a layer of dark-brown clay with traces of burning (F08:39). The strip of clay and tile between the two walls was heavily burnt, with traces of coal also present, particularly towards the north end. In the case of the western flue, masonry side walls did not survive, but

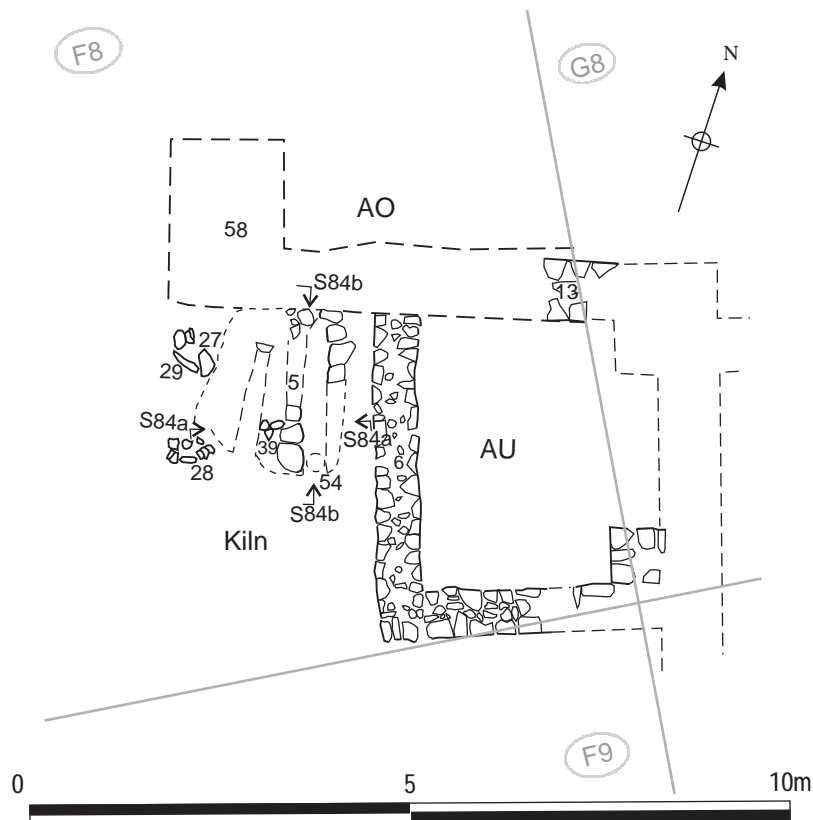

Fig re 42 Kiln F08 at 0

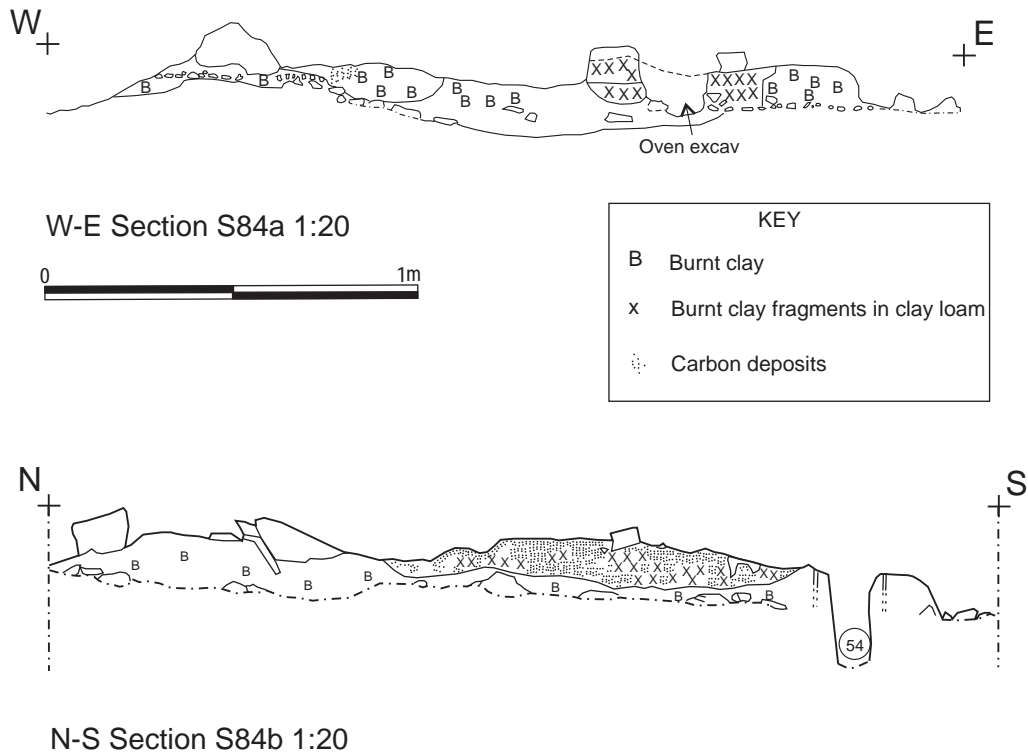

Figure 4.22: Sections 84a and b across drying kiln F08:05, at 1:20.

the channel in the clay base shows up clearly as a darker line on photographs (cf. Fig 4.23 here). It was of similar length and form to the east flue, and there was much reddening of the clay on the west side of the channel. A black deposit, rich in coal and ash, covered the stones of surface F08:18 outside the southern end of the kiln and was assumed to represent the stoking area. Within the very southern end of the eastern flue there was a circular hole (F08:54), 0.10m wide, which was interpreted as a possible vent or crucible, though it is unclear precisely how it could have served either function. The hole could not be excavated to its full depth, which was clearly in excess of 0.25m. Despite the apparently deliberate and precise placing of the hole right within the southern end of one of the flues, it is possible that it simply represents a much later, post-Roman post hole.

Only a single course of the side walls survived and the form of the kiln superstructure is therefore very uncertain, though it may be presumed that the walls originally stood somewhat higher and were perhaps covered by the same clay upon which the structure was bedded. One of the wall stones had a groove cut in, perhaps for an iron shelf, but the block may well have been reused. Along the western limit of the clay spread F08:39, two squarish post-holes (F08:27–28), respectively 0.27m and 0.36m wide and roughly 1.00m apart, may have held timbers supporting a lean-to roof over the kiln, giving the whole structure an east-west dimension of c.2.50m. The northern of the

two post settings (F08:27) incorporated a quernstone (F08:29; see Chapter 25) amongst its packing- or prop-stones. The form of the kiln remains and their proximity to the granary suggest that it was used as a drying platform, perhaps to malt barley or wheat required for the production of beer as an alternative to the garrison's wine ration. Although no carbonised grain was noted in excavation, no environmental sampling was undertaken here. Certainly there is no mention in the site records of any metalworking slag being found, nor does the masonry of the side walls appear to have been subjected to the kind of intense heat which would be expected if the structure had been used for metal working or processing. It was uncertain whether this represented a single structure with twin flues or perhaps two successive single-flue ovens or kilns, with the eastern one succeeding the western example, however doubled flued structures are certainly known on Romano-British agricultural sites. Comparison with corn dryers uncovered at such sites (cf. for example Morris 1979, 170, fig.13 c–d – Hambleton) suggests that the east and west sides of the structure may have extended further southwards than is now apparent, to enclose a single stoking area, from where the hot air could flow along both flues.

Dating evidence

The kiln superstructure produced only 0.024kg of pottery, mostly BB2 cooking pot sherds (F08:05). The



Figure 4.23: Drying/malting kiln F08:05.

clay base produced the scattered sherds of the lower part of a burnt reduced ware cooking pot, and two sherds of a storage jar, possibly of third-century date (F08:39). The fill of the post-hole (F08:27) included three sherds from a BB1 plain-rimmed dish and a sherd of decorated samian dated 160–200 (no. D21/S14).

Robbing of the granary

The walls of the granary were extensively robbed. This was probably a post-Roman event. Two of the robber trenches contain early modern material – clay pipes and early Black ware providing a late sixteenth- or early-seventeenth century *terminus post quem*. The pattern of robbing has two slightly puzzling elements. Firstly, the masonry of the eastern sleeper wall in the east granary masonry displays exceptional degree of preservation, with one or two courses of the wall surviving along virtually its entire length. As described above, this wall may have played a more significant structural role later in the life of the building, perhaps being raised to support one side of a roof valley, rather than functioning simply as a sleeper wall supporting the elevated floor. Nevertheless it is difficult to explain why this should be so much better preserved than the other sleeper walls or the original outer walls of the building. Secondly, the masonry

belonging to several walls which were otherwise entirely robbed out, plus adjacent strips of flagging, did survive in the centre of the building, forming a band of better-survival extending across the width of the granary. Was this area covered by a building when the main phase of stone-robbing was underway, rendering it inaccessible to those quarrying the stone?

FINDS

East granary flagged floor – robbed areas

Coin: 'Gallienus', 260+ (no. 146, G09:14)

Flint: blade (no. 15, G10:18)

East wall robber trench

Samian stamp: 140–70? (no. S19, H09:18)

South wall robber trench

Mortarium stamp: 110–40 (no. 37, F11:07)

Glass: window (no. 42, F11:07)

Dating evidence – Robbing of the granary

The demolition material over the granary remains contained relatively little pottery, but there was one sherd of late third century or later Crambeck reduced ware (G09:07). The robber trenches produced about 40 sherds of pottery, mostly dating to the third century,

but including four body sherds of calcite-gritted ware of the late third or later.

Wallsend granary and the *horrea* of the northern frontier

Horrea have perhaps been subject to more extensive and detailed analysis than any other type of building within Roman forts, with the possible exception of barrack blocks. Major surveys covering, respectively, Roman *horrea* in general and stone-built military granaries in Britain, in particular, have been compiled by Rickman (1971) and Gentry (1976). More recently, the evidence relating to the building type has been re-examined by Wilmott (1997, 132–41), in the light of the excavation results from the especially well-preserved pair of *horrea* at Birdoswald. That study placed particular emphasis on assembling the data to enable the pictorial reconstruction of the two buildings. In contrast, the poor preservation of the Wallsend *horreum* inevitably means its remains are much less informative, although this is to some extent balanced by the fact that its entire area was excavated. The following discussion provides comparative analysis of the building and its various structural features in the context of similar examples, especially from the northern frontier.

Overall form

Double granaries

The provision of granaries in auxiliary forts typically conformed to three basic patterns, a single granary, a pair of separate single granaries (Fig. 4.24) or a conjoined double granary (Fig. 4.25), with Wallsend falling into the last category. Double granaries were less prevalent than pairs of separate *horrea*, but they were not uncommon. In some cases these structures were divided midway along by a wall running across the width of the building, as at Birrens, for example, which was also furnished with two single granaries (cf. Gentry 1976, 60–62, fig. 6; Christison 1896). More often the partition wall ran down the length of the building, as was the case at Bar Hill, Brecon Gaer, Hardknott, Lyne and Slack, as well as Wallsend itself

(Gentry 1976, 58, 62, 80–81, 84–5, 90; Charlesworth 1963 and Bidwell *et al* 1999, 39–41 (Hardknott)). Perhaps most significantly with respect to Wallsend, examples of this type are found at the neighbouring forts of Benwell and South Shields (Fig. 4.25), the former dated by its dedicatory inscription (RIB 1340) to 122–126, whilst the latter was associated with the Antonine fort (Gentry 1976, 59, 92; Simpson and Richmond 1941, 17–19; Dore and Gillam 1979, 29–32, fig. 9). Indeed they seem to be characteristic of the Tyneside forts, whereas the next two forts along the line of the Wall, Rudchester and Haltonchesters, both appear to have contained a single granary in their primary, Hadrianic form (Gentry 1976, 80, 90; Dore 2010, 9–14). The Benwell granary was substantially larger than Wallsend's, but it was relatively similar in overall proportions, as reflected in the ratio of its length to width. It is also worth noting that some single granaries, such as the Hadrianic structure at Housesteads, resembled a double granary in overall proportions, but were divided into two aisles by a row of piers rather than a longitudinal spine wall (Crow 2004, 56). Table 4.03 compares the overall dimensions and ratio of length to width of the most closely comparable of these *horrea*.

The variation in scale of granary provision in forts may be assumed to reflect the anticipated food storage requirements of the garrison, which in turn was presumably a consequence of the size and type of unit(s) present. In some cases further granaries appear to have been added, perhaps in response to an increase in the size of the garrison. It is tempting to suppose that the decision to erect a double granary instead of two single *horrea* was taken when there was judged to be insufficient space for a pair of buildings. However pairs of freestanding granaries could be very closely spaced indeed (Fig. 4.24). Thus, the two exceptionally well-preserved granaries at Corbridge, were positioned so close to one another that their buttresses were touching in places though they were demonstrably separate buildings (cf. Dore 1989, 5–7; Gentry 1976, 72–5). The same cannot be said in some other instances where it is unclear whether the *horrea* should be classified as twin granaries or a double granary. In the case of Templeborough, for example,

Table 4.03 Double granaries – overall dimensions and ratio of length to width

Fort	Overall dimensions (after Gentry 1976, except Wallsend)	Ratio of length:width
Wallsend	26.00m × 11.40m	2.28:1
Benwell	45.72m (max) × 18.29m; 34.75m (min) × 18.29m	2.5:1
South Shields	22.86m × 15.24m	1.5:1
Brecon Gaer	29.26m × 14.00m	2.09:1
Housesteads	25.60m × 14.50m	1.765:1
Hardknott	16.45m × 13.48m	1.22:1

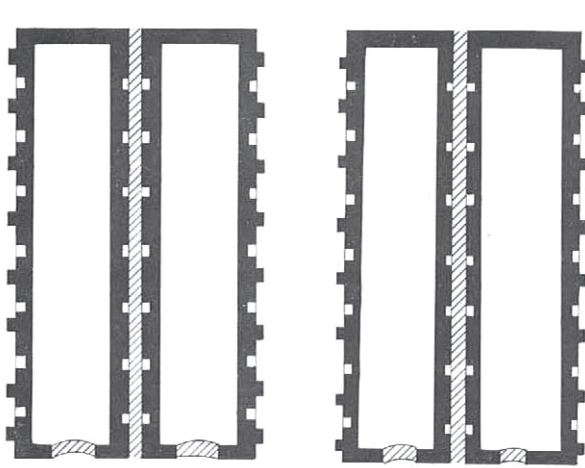

High Rochester

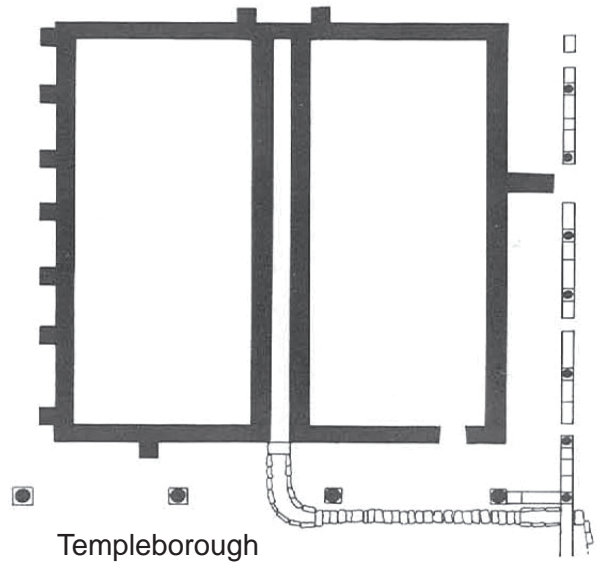

Templeborough

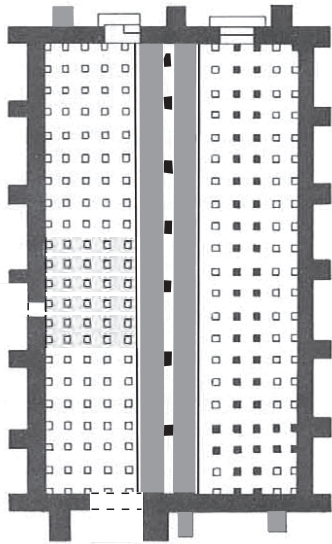

Housesteads (black) and Severan (?) Phases (grey)

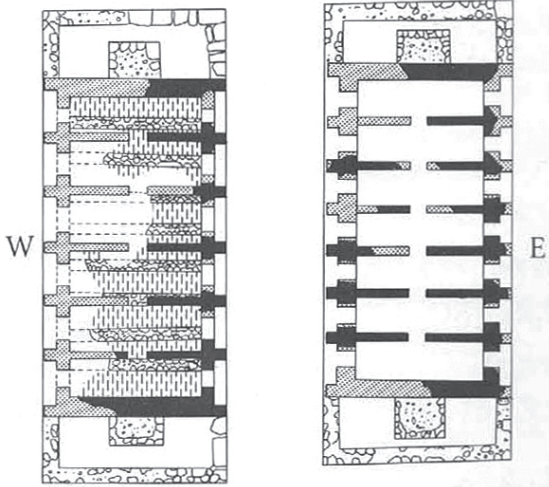

Gelligaer

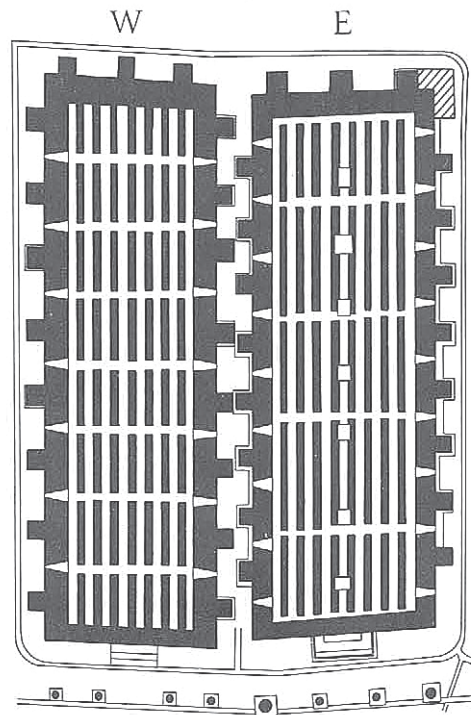

Corbridge, Phase 4

Figure 4.24: Granary comparison plan, showing examples of paired and double-ended granaries, 1:400.

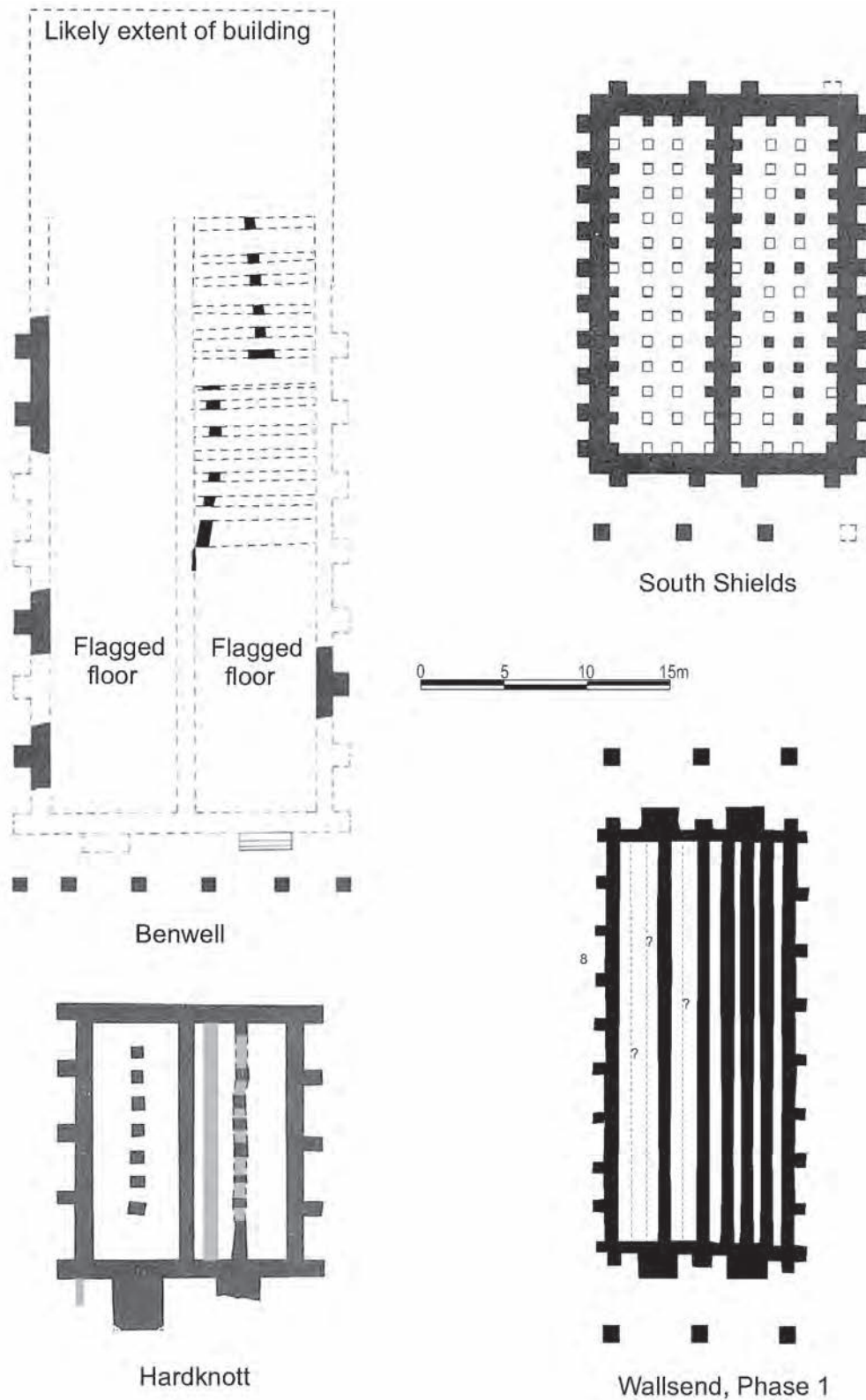

Figure 2 Granary comparison plan, showing examples of double granaries, 1

which Gentry (1976, 93–4) categorises as a double *h rreum*, a flagged drain ran between the two halves of the building, each of which was furnished with its own side wall, implying they were roofed separately. This arrangement of separate side walls is paralleled in

the two double granaries revealed at High Rochester in the mid-nineteenth century and was essentially the same as that adopted in the second phase of the Housesteads *h rreum*, when distinct north and south granaries were apparently created by the construction

of longitudinal partition walls on either side of the primary, central row of piers (Crow 2004, 56–7). A second longitudinal partition wall was added in the double granary at Hardknott, resulting in a similar layout (Charlesworth 1963, 148, Gentry 1976, 81). A puzzling feature at Housesteads (and at Hardknott for that matter) is the lack of a drain between the north and south granaries to collect and carry away rainwater running off the roof eaves, or even of any opening at the east end of intervening passage to allow the water to escape and thereby prevent ponding. Perhaps the two longitudinal walls were not in fact the side walls of independent buildings, but were simply intended to support a combined upper floor spanning the full width of the *horreum*, with the weight of the roof above that still being carried by the central piers. This may have appeared preferable to tying the upper floor joists into the piers as well. The piers would in that case only have been dismantled when the northern part of the building was abandoned, perhaps during the third century.

The problems faced in attempting to understand the form of the Housesteads *horreum* – one of the very best preserved on the northern frontier – only serves to emphasise the limitations of the evidence when only an outline ground plan can be retrieved, as at Wallsend. However the degree of variety evident from the foregoing might imply that localised similarities in form – as typified by the adoption of the double granary in Hadrianic/Antonine forts on Tyneside – could reflect accepted ideas of what constituted a properly laid out *castra*, within a particular military community or cluster of adjacent communities. There was plenty of space to construct a pair of separate granaries at Wallsend, for example, if the fort builders had believed it appropriate to do so. The same appears to have been true at South Shields. Indeed the close resemblance of the overall plans of Wallsend and South Shields, despite the three or four decades separating the initial construction of the two forts, has been noted elsewhere (Bidwell and Speak 1994, 18).

Evidence for building height and a second storey

In his analysis of the height and architectural form of the forehall, Hodgson (2003, 180–81) considered the relationship of that building to the granary and *principia* which it fronted and the implications for the form of the granary itself. He concluded that the height of the forehall roof must have been determined by and have matched the height of the pre-existing granary and *principia* forecourt roofs. Based on the building's likely proportions, given the known width of its arched openings, Hodgson estimated that the forehall, and by implication the granary, must have had an absolute minimum eaves height of 6m, with 7–8m being more likely. This would make the granary two storeys high, probably spanned by a single overall roof which was later extended forward to connect

with the slope of the forehall roof. This in turn accords with more recent thinking regarding the height and overall mass of granaries, the evidence for two storey *horrea*, as a whole, having been reviewed by Wilmott, with particular reference to the two Severan examples at Birdoswald (1997, 137). Thus, the possibility that the aisled *horreum* at Housesteads had an upper storey has been noted, based on the solidity of its external walls and its overall proportions (ibid; Crow 2004, 56, fig. 30). Similarly the likelihood that the Severan east granary at Corbridge had two storeys has long been acknowledged, on the evidence of the row of seven large pillar or column bases running down its central axis (Richmond and Gillam 1950, 157; Gentry 1976, 75; Dore 1989, 5; see Fig. 4.24 here). Moreover civil and commercial *horrea* standing to two storeys in height have survived elsewhere in the Roman world, at Rome, Ostia and Trier, for example (Rickman 1971; Eiden 1949; Wilmott 1997, 137.)

Internal flooring

The two halves of the Wallsend granary differed in their layout and construction in a number of ways, but this is not unparalleled. Some of these differences were relatively minor, for example the number of buttresses along their long external faces – nine and ten for the east and west granaries respectively. Much more significant is the different form taken by the internal floors in the two halves of the building, with the sleeper walls which supported an elevated floor in the east granary being laid directly on the ground surface whereas a substantial, carefully constructed clay and stone raft or platform was laid down in the west granary. The raft was in turn surmounted by flagging and sleeper walls which supported the west granary floor (see Figs 4.03 and 4.04). Such stone and clay platforms, forming a raised, solid floor base, were not uncommon in Roman fort granaries. At Haltonchesters the raft consisted of broken limestone overlain by a layer of stiff yellow clay bounded by a stone kerb one or two courses high (Dore 2010, 9). At Benwell too, a massive base of yellow clay and pitched stone was recognised in the southern part of the building (Simpson and Richmond 1941, 19; Gentry 1976, 59; Holbrook 1991). Solid floors of flagstones were laid on the clay and stone base, both at Benwell and at Haltonchesters, with a network of sleeper walls, surviving up to three courses high, being erected on top of the flagging in the latter case. No traces of equivalent sleeper walling were found sitting on the flagged floor at Benwell. Instead the foundations of eleven transverse sleeper walls, situated at intervals of 0.5m to 1.6m, were identified further north, beyond a transverse partition wall, where the clay-bonded rubble platform was not present. The transverse partition was located some 15m from the building's south wall, hence perhaps roughly a third of the way

along the granary, assuming that the latter extended northward, more or less the full distance to the edge of the *via principalis*, in which case the building would be approximately 46m long (or perhaps c. 43.5m if there was a portico at the north end as well as the south). Like the sleeper walls the partition was only seen in the trench for a gas main cut through the eastern half of the granary in 1990 and it is unclear whether the west granary was similarly subdivided and whether there were other partitions further north in the unexcavated parts of the building. In other cases raised floors were converted to solid ones either by infilling the ventilation channels, demolishing the sleeper walls or removing *pilae* and laying new flagged floors. Thus, around the mid-third century, the sleeper walls in the two granaries at Birdoswald were partially removed and infilled to create a solid floor at the western end of the north granary and a solid, though partially ventilated floor in the west-centre of the southern granary (Wilmott 1997, 122–26, 136, fig. 91). The alteration of raised floors to solid ones was also recognised at South Shields, where some of the supply base granaries were converted to barracks c. 300 (Bidwell and Speak 1994, 35, and 43–4 for later floor replacements). Also probably of late Roman date were the changes to the western half of the south granary at Housesteads (Crow 2004, 95), where the stone *pilae* were removed and a flagged floor laid on the interior ground surface, again perhaps associated with the conversion of this part of the building to living accommodation (the eastern half of the granary probably retained its raised floor accessed by a new stepped east entrance).

By comparison, the Wallsend granary appears relatively simple with no evidence for partitions other than the longitudinal one dividing the building into two halves but two different types of flooring were recognised. As at Haltonchesters there was evidence that a network of sleeper walls was constructed on top of the clay and rubble base in the west granary, however it is noteworthy that this walling survived only in a very fragmentary state in one small area. It could quite easily have been entirely destroyed and the 1983 excavators were in fact unaware of its existence following its removal in 1981. By analogy it is not inconceivable that a system of sleeper walls was originally set on the stone platform in the Benwell granary and were later removed either as a result of later modifications or post-Roman robbing. The level of the flagged surface over the clay and rubble base at Benwell was as much as 0.5m above the top of the sleeper wall foundations in the adjoining in part of the granary, but the floors at Corbridge and Birdoswald were significantly higher (1.1m in the case of the third phase of the Corbridge west granary for example, cf. Gentry 1976, 74).

The use of different sub-floors at Wallsend is somewhat puzzling. At Benwell, less perishable

foodstuffs might have been kept in the parts of the building with solid flooring, assuming that was indeed their finished state, whereas grain was perhaps stored in the sections with the raised floors where it would be less vulnerable to damp. However it is more difficult to appreciate the reasoning behind the arrangements at Wallsend where both halves of the building had raised floors supported by sleeper walling, but only in the western half did this rest on a solid base. The benefits of a clay and stone platform of this kind, in terms of raising the entire floor substructure, keeping it clear of any flood damage caused by stormwater runoff and ponding, would appear to apply whatever was being stored above. There is no indication that the sleeper walls in the west granary were a later addition, constructed on top of an original, flagged, solid floor, since the flagging and the sleeper walls appear to have belonged to the same phase. They were set on top of the same soil and gravel bedding layer with the flagstones surrounding and abutting the base of walls rather than underlying them, just as the flagging in the east granary was laid between, but not beneath the sleeper walls there. Indeed, the solid base would have been too low to have served as a floor on its own as its upper surface must have lain well below the level at which entry was gained to the building via the broad stone steps positioned at either end. Perhaps the west side of the building was judged to be more exposed to storm water flooding and it was calculated that, if its raised floor had been supported on sleeper walls alone, the structure would have been at risk of water penetrating beneath the raised floor and ponding there. Construction of the solid raft lifted the whole western half the building clear of such ponding water.

Porticos and entrances

The Wallsend granary preserved clear evidence with regard to the treatment of the narrow ends of the building, including the provision of porticos and the means by which access was gained, which adds significant information to our understanding of this building type. This relates both to the initial layout of the building and the changing pattern of provision over time as the orientation of the two halves of the granary was altered.

The Daniels excavations found the remains of a portico pier at the southern end and evidence for sets of steps at either end of both halves of the double granary, two of which had been completely robbed out. All trace of any door thresholds had of course been lost when the granary walls were demolished and robbed. Following completion of the excavations, the question of whether the building was originally single- or double-ended and, if the former, whether it faced north or south provoked considerable discussion, which is reflected in the research archive. This discussion

revolved around the number and position of access steps, or 'loading platforms' as they were generally termed in the archive. Since there was no stratigraphic relationship between the steps and the remainder of the granary structure, as a result of later wall-robbing, the original layout and sequence of use of the loading platforms – and hence any change in the orientation of the building – could only be inferred on the basis of the relationship of the granary to adjacent structures and road surfaces. Thus it was tentatively suggested that there were originally two platforms on the southern side and perhaps none on the north, with the implication that grain wagons entered and left the fort through the south gate and *p rta quintana* originally, rather than the west or east gates. The latter two gates are both situated to the north of Hadrian's Wall and, it was therefore assumed, would not have been used for grain deliveries. Underlying this argument was the apparent absence of any evidence for a portico to the north of the building, which clearly pointed to a single-ended south-facing structure.

However, the discovery of the pier foundation pits to the north of the granary in 1997, in a demonstrably primary context, proved that the granary was indeed furnished with a northern portico and associated stepped entranceways in its initial phase. Moreover the near identical form, dimensions and construction of the surviving north-east and south-west steps, plus the manner in which their rounded lips and corners echo those of the surviving pier base on the south side of the building, strongly imply the granary was initially double-ended with both the eastern and western halves possessing entrances at either end of the building.

Porticos

Three piers made up the porticos at either end of the Wallsend *horreum*, lying directly opposite the two side walls and the central longitudinal partition. Elsewhere, however, four piers or columns were more typically encountered. Best known is portico fronting the two principal granaries at Corbridge from the late second century onwards, composed of eight substantial columns, four in front of each building. Examples have also been found associated with the south faces of the double granaries at Benwell and South Shields and Templeborough, all somewhat better preserved than was the case at Wallsend. The portico at Benwell consisted of six piers constructed of two courses of small dressed stonework capped by a course with a rounded chamfer on which the pier proper or column would have sat. The three central bays were wider than those at either end of the façade (Simpson and Richmond 1941, 18, pl. v). Four piers were in evidence at South Shields, with square chamfered bases surviving in three cases (Richmond 1934, 93, pl. xiii fig. 1; Dore and Gillam 1979, 29–30, fig. 9). At Templeborough there were four

columns along the south façade and a further seven small ones along the east side probably supporting a veranda lining the *via principalis* (Gentry 1976, 93–4). Elsewhere the evidence is more tenuous, with no remains of actual portico columns or piers surviving, but indications that they can be restored. Thus the wall forming the perimeter of a rectangular extension at the south end of the granary at Haltonchesters may have supported a portico around the edge of a loading platform (Dore 2010, 9–10, 86–9), as may the similar structures at either end of the two *horrea* at Gelligaer where the position of the individual piers or columns was perhaps indicated by the pattern of worn and unworn flagstones (Gentry 1976, 78). It would not be surprising either if a portico was set along the edge of the massive masonry platform measuring 9.75m by 3.05m attached to the south end of the granary at Rudchester, spanning its full width (Gentry 1976, 90). Indeed porticos may have been much more common than generally recognised, as the areas in front of granaries have not always been explored very extensively and in any case obvious traces of column bases might have been swept away by later remodelling or post-Roman robbing.

Steps and loading platforms

The granary entrances were commonly furnished with solid rectangular stone platforms – generally referred to as 'loading platforms' – positioned immediately in front. The term implies that supplies were loaded into the granary by lifting them directly across onto the elevated platform from carts which had drawn up alongside, rather similar to the procedure in the loading bays of modern goods depots. Perhaps the best-preserved example is that attached to the front of the Corbridge east granary. Though stepped, the lower treads were relatively narrow making it more difficult to ascend carrying a load and suggesting material was lifted directly across in this case. Access at Wallsend, however, was evidently via broad flights of steps. Supplies were presumably carried on the backs of individual soldiers up the steps into the building from a cart or pack animal standing in front of the granary, perhaps having been manoeuvred under the portico. Similar steps, consisting of three treads, 2.89m broad, gave access to the south end of the Benwell granary (only those associated with the eastern half survived – Simpson and Richmond 1941, 19; Gentry 1976, 59). This type may actually have been more common than is apparent since it is not always possible to determine from the surviving remains what form the 'platforms' took above the bottom course and many may in fact have been straightforward flights of steps.

Double and single-ended granaries

The double-ended form of granary evident at Wallsend, with entrances at either end, was probably

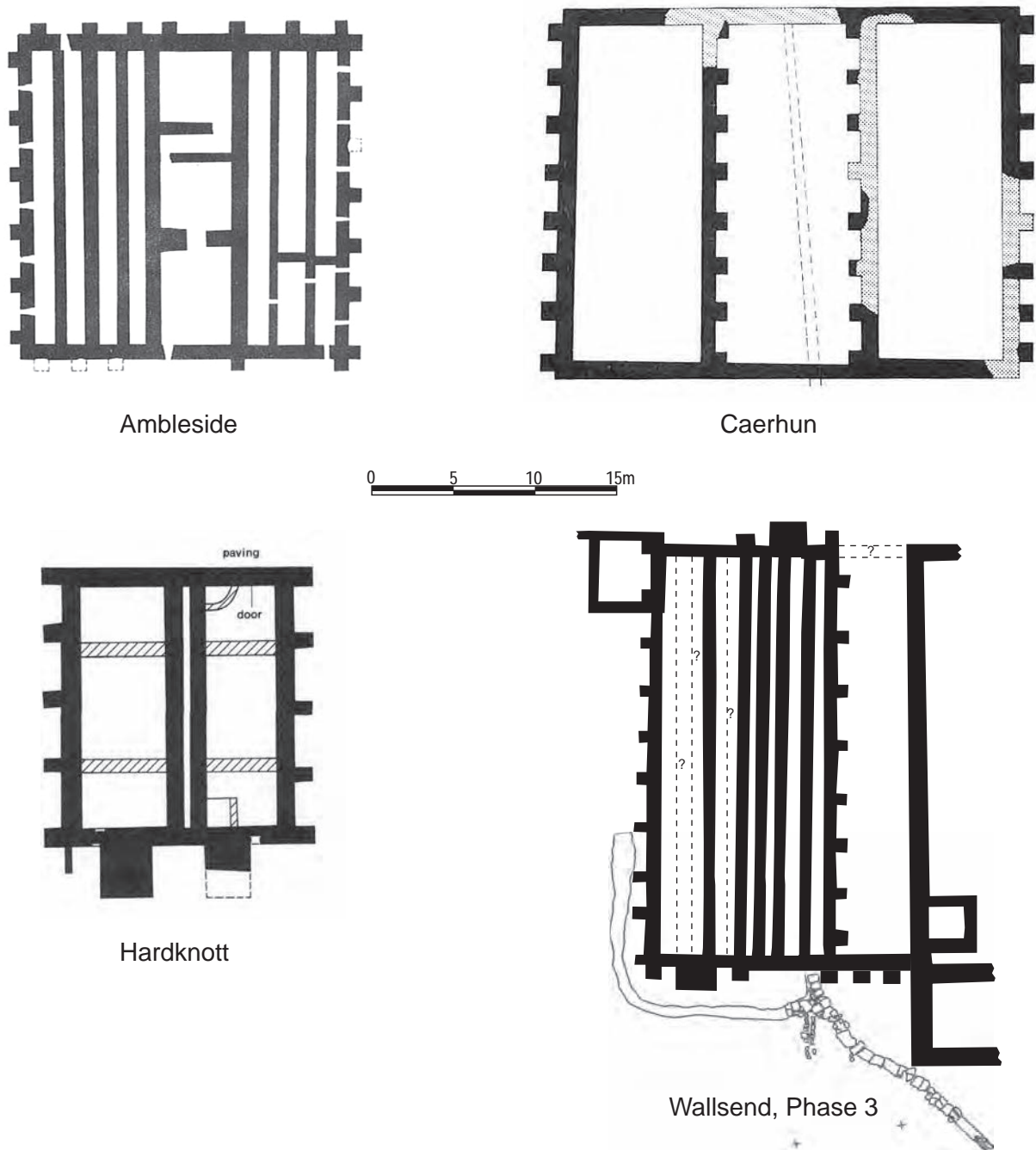

Fig. 4.24 Granary comparison plan, showing examples of granaries with enclosed yards or covered extensions, ④

less common than single-ended version, but it is paralleled at Gelligaer (see Fig. 4.24), for example, where both *horrea* were double-ended (cf. Gentry 1976, 78–79, fig. 10). The apparent rarity of this type may be overstated however. Whilst some granaries definitely were single-ended – notably the two late second/third-century examples at Corbridge, the Housesteads granary in both its primary Hadrianic and secondary remodelled forms, and the double *horreum* at Hardknott – many have not been fully exposed and have simply been assumed to be single-ended. The double granary at Benwell is a case in

point, the north end of this building not having been excavated. The same is true of Haltonchesters and Rudchester where, like Wallsend and Benwell, the granaries were positioned in the central range next to the headquarters, perpendicular to both the *via principalis* and *via quintana*. It seems inherently likely that all four of these Hadrianic granaries were double-ended and originally intended to be accessed from both the *via principalis* and *via quintana*, to the north and south respectively. A double-ended layout is also possible in the case of the Antonine double granary at South Shields. This possessed a portico of four

columns at the south end and pitched stone supports for one timber loading platform at the north end of the western half. The loading platform for the eastern half was probably obscured by a modern wall and it is possible that the remains of a northern portico had been similarly obscured, whilst timber loading platforms at the south end might have left relatively little trace and gone unrecognised by the excavators in 1875 and 1949 (Dore and Gillam 1979, 29–30). Indeed the difficulties of determining the original form of granaries is emphasised by the process of discovery at Wallsend, where, despite extensive excavation in the 1980s, the double-ended nature of the primary granary was only established beyond doubt in 1997–8, when the foundations of the north portico piers were identified.

Enclosed yards and covered extensions (Fig. 4.26)

A final type of granary worthy of note in connection with Wallsend, which can be identified at Ambleside and Caerhun, is characterised by a pair of granaries with adjoining walls enclosing a central space or courtyard between the two. At Caerhun the intervening space seems to have been an open courtyard with a silt-filled gutter running down the middle, although the enclosing walls were evidently contemporary with granaries, continuing the line of their end walls (Gentry 1976, 64). Ambleside is more

complex however (*ibid.* 57), with three transverse walls crossing the space, whilst the walls closing it off at either end were furnished with buttresses and a vent like the granary walls. It is possible in this case that the intervening space was actually incorporated into the roofed area of the *horrea*, perhaps as a secondary modification if not originally, converting the ensemble into a triple granary.

Such arrangements bear some similarity to Wallsend's Building AW, the designation given to the structure encompassing the alley (8) between the granary and the *principia*. The wall closing off the southern end of Alley 8 was apparently furnished with two buttresses suggesting that, like the medial yard at Ambleside, it was integrated into the structure of the granary and may well have been roofed over at this stage. There is, however, no indication of transverse partition or sleeper walling inside AW, nor any other means of supporting a raised floor, imply that the cobble surfaces of the alley remained in use as flooring. No definite remains of a wall closing off the north end of the alley were found, although modern drain trenches had destroyed much evidence at this point, but such a wall would not necessarily have been required as construction of the forehall restricted access to the area in front of the granary and headquarters. Indeed the creation of this annexe to the granary may well have been associated with construction of the forehall or followed on from it.

5. THE HOSPITAL (BUILDINGS 21 AND 8)

Grid squares: D10, D11, D12, E10, E11, E12, F10, F11, F12, G11, G12

Fort Period 1 – Timber Building 21

Introduction

Evidence for a timber structure, which was interpreted as the primary Hadrianic phase of the hospital (*valetudinarium*), was identified by Tyne and Wear Museums in 1997 beneath the remains of its stone successor, Daniels' Building 8. The remains of the timber structure (assigned the label Building XXI – here designated Building 21) were fragmentary, but it is clear that it was significantly smaller than the subsequent stone hospital (Building 8) and was not built to the same plan. Traces of the west wall of this structure had actually been recognised in 1977 in the form of strips of pink clay (D10:23, 33, D11:56; TWM 5626) which were revealed in three rooms of the west wing of the stone hospital. These actually represented lengths of the construction trench for the timber wall, shown in 1997–8 to be of post-in-trench construction with post settings interspersed along a flat-bottomed, vertical-sided trench. However the trench was interpreted by Daniels as the remains of a water channel, which he thought was associated with the stone hospital. A full account of the primary timber hospital, as revealed in 1997–8, is included in the publication of Tyne and Wear Museums' programme of excavations (Hodgson 2003, 124–9). The following description is restricted to those features uncovered in 1977, outlining how they relate to the remains found in the more recent excavations and discussing their place in Daniels' interpretation of the hospital's development.

The structural evidence (Fig. 5.01)

The southernmost length of the construction slot found in 1977 was encountered in the western part of Room 1, immediately to the south of the entrance passageway of the stone hospital building. A 2.50m length of the slot was uncovered here (D11:56), 0.25m wide and 0.30m deep, filled with pink clay with a slight amount of gravelly silt in the bottom and some stone in the lower packing (Section 54). On the other side of the entrance passageway, the trench was seen extending northwards from the centre of Room 9, where it again appeared as a strip of pink clay (D10:23, D10:33). Three stones observed here, and thought to represent fragments of drain side walling when excavated in 1977, may have been packing stones for a couple of the posts set in the trench. (The slot had been removed by a mid-nineteenth-century stone-lined cesspit (D10:02) in the southern part of the room.) In 1983 the pink strip was shown to extend further north (Fig. 5.02), continuing into Room 8, and was recorded as a slot 0.085m deep and 0.21m wide (D10:33). Re-excavation in 1997 revealed that the trench turned sharply westwards in Room 8. This represented the north-west corner of the timber building. Removal of the lowest metallised surface in the entrance passage exposed a further section of the trench not seen in 1977.

The construction slot appeared to either cut or be respected by cobbled surfaces revealed within Rooms 1 and 9 of the stone hospital. These surfaces were attributed to Building Phase 1 by Daniels, but their relationship to the construction slot suggests they must be associated with Building 21. In Room 9 the pink clay-filled slot was overlain by a wider strip of grey, clayey loam and smallish cobbles (D10:22) which apparently cut a surface composed of small, well-packed stones (D10:19) and might be associated with the dismantling of the timber building. The presence

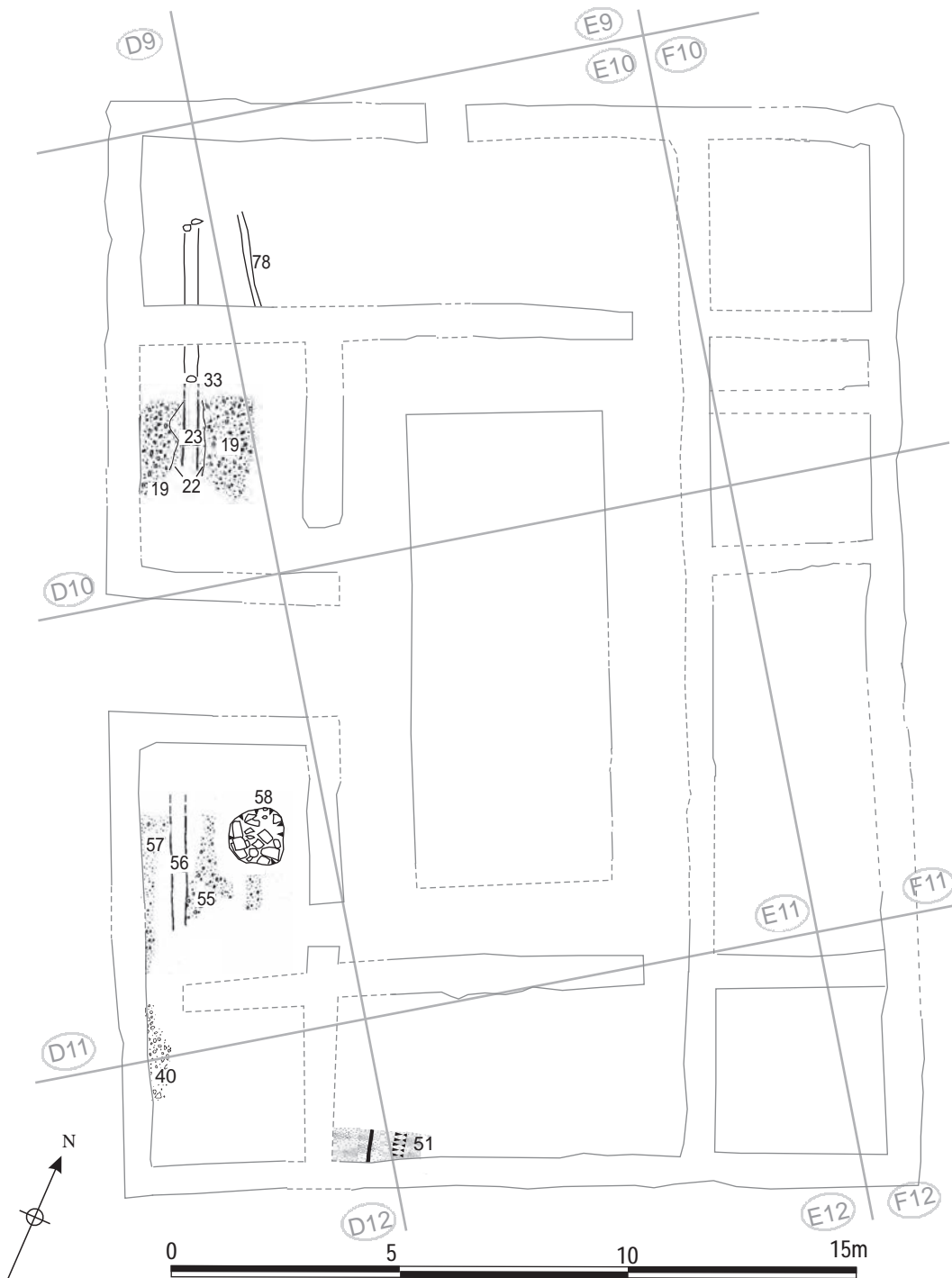

Figure 5.03 Evidence for the timber hospital (Building 21) (at 1:10 scale) with the outline of Building 8 shown for reference.

of the compacted stone layer on either side of the slot suggests that the layer was deposited to provide a solid structural base for the timber hospital, rather than forming an internal floor level, in which case it should only have been encountered to the east of the slot. In the southern room a surface of small cobbles and sandstone chippings (D11:55) was exposed on the east side of the slot, which it apparently respected (Fig. 5.03). To the west, alongside the outer wall of the later stone hospital, the underlying bedding of

orange gravel and grit (D11:57, perhaps equivalent to TWM 5634) was apparent, though here too the odd patch of cobbling was recorded. These layers were covered by clayey, grey loam (D11:53), perhaps associated with the end of the timber hospital. In the centre of Room 1 the cobbled surface was cut by a large pit (D11:58), c. 1.10m in diameter, backfilled by large stones, some of them apparently dressed facing blocks, but no finds. The stone fill was covered by and intermixed with clayey loam (D11:54), like that



Figure 5.02: The construction trench for the west wall of timber building 2 (D10:33), from the south. The slot is cut by the internal wall foundations D10:33 of Building 8 Phase 1

which extended over the slot and the gravelled and cobbled surfaces in the remainder of the room. The function of the pit was unclear.

To the south of Building 21, a well-packed, worn surface of small cobbles (D12:40) revealed in Room 2 of the stone hospital, immediately to the west of the latrine drain (D12:38), may have formed part of the *intervallum* road surface contemporary with the timber building (probably equivalent to TWM context 5533). It thus might correspond to cobbling D11:57 and D10 19, laid on the west side of the slot further north. Daniels on the other hand considered D12:40 was a later internal floor surface, assigning it to Building 8 Phase 2 (TWM Period 3). The surface was actually level with the bottom of the west wall of the hospital (Fig. 5.03 and cf. Fig. 5.16 below), so it seems unlikely that it was laid as late as Daniels supposed. However the resilient road cobbling may have remained in use as part of the internal floor of Room 2 during Phases 1 and even 2 of that building (no other surface which could be confidently attributed to either Phase 1 or 2 was recognised in the area to the west of drain D12:38).

Immediately to the east of D10:33, another linear slot (E10:78), only c. 0.15m wide, was cut into the



Figure 5.03: Gravel surfaces D12:40 visible beneath the later floor of Building 8, Room 1 (to left), viewed from the west.



Figure 5.04: The stone filled pit D11:58 exposed beneath the floor of Building 8 Room 1.

subsoil and filled with dark ash. It was traced over a length of 2.0m within Room 8 of Building 8, running north-south, but followed a significantly different alignment to D10:33 and the other components of Building 21 identified in 1997–8. For this reason it is not certain that this slot was associated with Building 21 or, for that matter, its stone successor, Building 8, which followed the same essential alignment. It might even predate the construction of the fort. Another feature which may predate the timber hospital is the narrow gully (E12:50), 0.12m wide, which was exposed, cut into the natural, in a small area in the south-west corner of Building 8, Room 3.

Discussion: Daniels interpreted the post-in-trench slot found in Rooms 8, 9 and 1 as the remnants of a water channel leading to the latrine pit associated with the initial phase of the stone hospital building. No other means of flushing the latrine pit was apparent in the stone hospital's first phase and the slot certainly lined up with the stone lined channel (D12:38) in Room 2, which fed into the north side of the cesspit in the south-west corner of the stone hospital, although it was nowhere near as wide as

the stone channel. It was also thought to be linked to the stone-lined conduit (E08:60, E09:06/29), to the north of the building. This connecting stretch (D10:33/E10:79) is shown on the interpretive overlay to site plan P386, but no feature is marked on the underlying plan and the plan would therefore appear to be recording interpretation rather than actual observation. It was assumed that the conduit's side walls must have been robbed out subsequently and the channel backfilled with pink clay (the wider strip of clay in Room 9 – D10:22 – was thought to represent the robbing of the channel side-walls). Re-excavation in 1997–8 established the actual function of the trench as a construction slot for a timber-built wall. This was clearly cut later on by the stone wall foundations of Building 8, for example those separating Rooms 8 and 9 (D10:31, E10:77; cf. Fig. 5.02). No evidence was found of a conduit through these foundations or any other of the later stone hospital walls which interrupted the slot's course. The means by which the latrine pit in Building 8 was actually sluiced out, which probably involved a combination of rainfall collected from the courtyard roof and water channelled from Cistern 1 via the courtyard, is outlined below. The possible function of the stone conduit E08:60 is also discussed below in relation to the gutters and other drains associated with the Phase 1 stone building.

Dating evidence

The only pottery was a single, very small sherd from a flagon (D10:22).

Fort Period 2 – Building 8 Phase 1: The hospital (Fig. 5.05)

Introduction

The timber structure was replaced by a stone courtyard building positioned right beside the main carriageway of the *via quintana*, its southern face lying between 8.8m and 9.6m further south than the south portico of the granary and the other principal buildings of the *latera praetorii*. The building measured 17.25m east-west by 23.70m north-south and comprised a series of nine rooms arranged around the colonnaded courtyard, with the entrance passage on the west side opening onto the *intervallum* street. The area to the east of Building 8 and south of the granary seems to have been open and devoid of buildings at this stage (with the exception of the small Building AV attached to the south-west corner of the granary).

The hospital's southerly position enabled a large stone-walled cistern (Cistern 1) to be located in the open area to the north of Building 8, which the excavators labelled the 'assembly area', beside the western end of the *via praetoria*. The cistern evidently supplied water to flush the latrine in the south-west

corner room of the hospital (Room 2), although the means by which this was achieved in Phase 1 was not altogether clear. However, the cistern was itself perhaps a secondary feature in the fort, like Building 8, since its layout was not parallel to the main axis of the fort, as might have been expected in the case of a primary structure. If so the existence of the cistern cannot be used to explain the position of Building 8's predecessor, Building 21, which was laid out on essentially the same plot (though it did not cover as large an area, or, in all probability, extend quite as far south as Building 8). It has been plausibly suggested that some other building may have occupied the plot to the north, between Building 21 and the *via principalis* during the fort's primary, Hadrianic period of occupation (Hodgson 2003, 126).

External walls, gutters and water conduits

The four outer walls of the building were constructed with a clay-bonded core of small rubble faced on both sides by neatly-dressed stones and set on foundations of cobbles packed with pink clay. Up to three courses survived. The recorded width of the upper courses was 0.63–0.65m. The lowest course visible along the northern part of the west wall had an external offset of 0.10–0.15m giving a maximum width of c. 0.80m. A narrower offset was also visible at points along the external face of the east wall. The walls were best preserved along the west (D10:06, D11:09, D12:04) and south (D12:07, E12:05, 33, F12:20; foundations: E12:34) sides of the building. The east wall (F10:05, F11:40, F12:19), by contrast, had been demolished at the end of Phase 1 and incorporated in later road surfaces with the result that the surviving masonry exhibited heavy wear and rutting, with some stones knocked out of alignment, all probably a reflection of the wear and tear caused by the carts entering the fort through the *porta quintana sinistra* and swinging northwards around the south-east corner of the building to reach the granary. In places only a single course remained, however at best, particularly along its northern half, it survived to a height of two courses featuring a narrow, external offset at certain points. The north wall was the most severely damaged with only two short sections of masonry surviving (E10:61, F10:10), each no more than a single course high. One of these sections, in the central part of the wall, did, however, reveal evidence of a doorway, 1.1m wide, with a pivot stone on the west side (E10:42). Elsewhere merely the foundations remained (D10:34, E10:70, 80, F10:47).

An external gutter was recorded running along the north and east sides of the building. Near the north-west corner a very short length (0.85m) of the northern gutter survived (D09:15, E09:50), immediately west of the point where the water conduit (E08:60, E09:06/29) leading from the cistern entered the building. The gutter was perpendicular to the water conduit and



Figure 8 Hospital (Building 8) Phase 1 at 8

similar in form, comprising a pair of single faced walls, neither more than a single course high, and 0.15m apart. However the conduit walls appeared to cut through the line of the gutter, interrupting latter's channel suggesting that construction of the conduit occurred later than that of the gutter. The east gutter (F10:50, F11:77) was constructed with a single line of

blocks, a few of which were fairly well-cut, distinctive examples, oblong in form. The other side of the gutter was provided by the external face of the hospital east wall, giving a width varying between 0.20–0.40m. The gutter was traced for a total of 14.20m beside the northern half of the wall during the 1983 season and evidently extended along the full



Figure 5.06: The west range and intervallum drain. The section exposed by a modern pipe trench shows the flags of drain side wall D10:11 butting neatly up against the offset course of the west wall (2).

length of the building. Although the southern stretch was not exposed in 1977, it was uncovered in 1997–8 (TWM 5504; Hodgson 2003, 133, fig. 93). Alongside the south wall, a strip of sandstone fragments uncovered in 1997–8 may mark the position of another gutter associated with this phase (TWM 7984; Hodgson 2003, 158, fig. 110, cf. 133, fig. 93). The exposed stretch was 0.40m wide and extended over a distance of 5.20m eastwards from the latrine outflow drain. There was no trace of any stone blocks lining the gutter, but these had probably been robbed out at when the gutter was infilled.

On the west side of the building a line of flags (D10:11), c.0.70m wide, abutted the offset course of the northern half of the west wall and formed part of the *intervallum* surface. The cover slabs of the *intervallum* road drain (D10:27) rested on top of these flags, which served as the uppermost course of the east wall of the drain (Figs 5.06–5.07). This substantial drain was traced from the southern edge of the *via principalis* (and may have originated in the north-west *praetentura* where a comparable drain was recorded running on the same line alongside the



Figure 5.07: The intervallum road and drain beside the west wall of the hospital. Note the way in which the flags belonging to the east side wall (D10:11) of the drain neatly abut the offset course of the hospital wall (2).

western ends of Buildings 4, 5 and 6). It continued along the full length of the hospital where it linked into the latrine outflow sewer next to the south-west corner of the building. The report on the 1997–8 excavations suggested that this *intervallum* drain was contemporary with Phase 2 of the stone hospital rather than Phase 1 (Hodgson 2003, 160: Fort Period 3). The section through the *intervallum* road recorded in the course of that programme (*op. cit.* 169, fig. 119: Section 13) appears to indicate that the drain was cut through the Phase 1 (Fort Period 2) levels. However, the exceptionally neat manner in which the flags were laid right up against the west wall's offset course, to the north of the entranceway, implies that the offset course was still clearly exposed when the drain was first constructed and would appear more in keeping with the high standard of construction displayed during the primary phase of Building 8 than later. There are other possible explanations for TWM Section 13 which could be compatible with an earlier date for the drain. Perhaps the drain was a secondary addition to the Phase 1/Period 2 layout, but was still built during the timespan of Period 2 and Building 8 Phase 1. Alternatively, it may originally have been constructed at the same time as the Phase 1 stone hospital, but later rebuilt along the southern part of its course (south of the hospital entrance), in Phase 2–3/Period 3, which could have involved raising it to the level of the Period 3 road surface.

The hospital was supplied with water from the large cistern situated in the open area to the north of the building, via a network of stone conduits. Two of the channels leading off the cistern may be associated with Building 8 Phase 1. The first, which took the form of a stone-walled, flag-bottomed conduit (E08:60, E09:06/29), 0.20m wide, ran from the south-west corner of the cistern across the 'assembly area', reaching the north wall of the hospital only 2.60m from the north-west angle of the building. It was well-



Figure 5.08 The junction of the Phase 1 water conduit south of Cistern 1

preserved in this area, with both of the single-faced side walls surviving one and occasionally two courses high for most of their length, although no capstones remained *in situ* (Figs 5.06–5.07). This was probably the earliest of the stone conduits leading from the cistern to the hospital, as it followed the most direct course. Particularly instructive is the junction 3.00m south of the cistern, where another conduit, E09:34, branched off E08:60 (Fig. 5.08). Although the side walls on the combined section between the cistern and the junction had largely been robbed away, the flagged base of the channel did survive, showing that this stretch followed the alignment of E08:60, with E09:34 quite clearly forming a secondary offshoot. At the other end of its course, the conduit clearly cut through the line of the external gutter beside the hospital's north wall (Fig. 5.09). Construction of the conduit must therefore have postdated that of the gutter and, by implication, perhaps the other principal structural elements of the building as well (although not necessarily by any great length of time). One facing stone belonging to the hospital wall survived at this point, and may have flanked the channel's passage through into the building, but the wall was too poorly preserved to provide any further evidence on the arrangements here, so it is unclear, for example, whether the conduit made use of a pre-existing doorway through the wall.

The exact function of this particular conduit is unclear. Daniels assumed that it was designed to sluice out the latrine pit in the south-west corner of the hospital, believing it was connected to the cesspit by the clay-packed linear feature (D10:23/33, D11:56) which was traced in several rooms of the west range and which Daniels interpreted as a water channel. However, as noted above, the 'channel' was actually a construction trench associated with timber predecessor of Building 8, and, hence, the stone conduit cannot have been connected with the latrine. Instead, the conduit was presumably intended to provide a water supply into the north-western part of the hospital, but



Figure 5.09: Conduit E09:6/29 intersecting gutter D09:15 near the north west corner of the hospital.

the internal arrangements in this part of the building have been too badly disturbed to preserve any trace of a water tank or other related features.

The second channel (E09:34, E10:62), which branched off the first conduit 3.00m south of the cistern, entered the hospital through the doorway not quite midway along the north wall (Fig. 5.10). This was certainly used to flush the latrine during Building 8 Phase 2, when it continued directly across Room 8 and down the west side of the courtyard to the south-east corner of the building. However the conduit must have originated during Phase 1. A line of small stone blocks, which can be seen on Figs 5.10 and 5.11, extending across the north portico, evidently represented one side wall of this conduit in its first phase. Having passed through Room 8, the channel veered in a south-easterly direction across the portico and fed water into the courtyard gutter (which was only in use during Phase 1). Another sluice, perhaps following the line of the Phase 2 conduit via Room 1, may have connected the lowest point of the gutter in the south-west corner of the courtyard to the latrine pit in Room 2. This rather elaborate network of conduits and gutters would thus have enabled water to flow all the way from the cistern to the latrine, though it



Figure 10 Successive phases of water conduit crossing the north range, from right to left: Phase 1 channel approaching the gap in the courtyard stylobate, centre: Phase 2-3 channel. Left: Phase 4 channel.



Figure 11 Phase 1 surfaces in the entranceway



Figure 12 The north-east corner of the Phase 1 courtyard showing the surviving side wall of the water conduit passing through the gap in the stylobate.



Figure 13 The entranceway from the north with the Phase 1 surfaces exposed and south pivot stone and threshold blocks visible.

Entranceway (Figs 5.12–5.13)

The principal entrance into the building was via a passageway 2.40m wide and 5.00m long, surfaced with gravel and flags (D11:43). The door opened inwards and was probably double-leafed, although only the southern door pivot (D11:48) was found. The small extant pivot hole, D11:48, could scarcely have housed a shaft capable of sustaining the weight of a door large enough to close the entire entrance (Fig. 5.13). The leaves were checked by a threshold consisting of a row of seven neatly-cut blocks set on edge (D11:44 – comprising one short stone and six long, of which one had been removed by modern pipe D11:05). Inside, bands of unmetalled clay on the south and north sides of the passageway (D11:45–46), 0.50 and 0.35–40 m wide respectively, were tentatively interpreted as evidence for benches (visible on Fig. 5.12). The fact that the gravel and flagged passage surface did not extend over these clay bands, which were simply extensions of the underlying pink clay foundation of the passage walls, was thought to reflect the presence of superimposed structures – wooden

is not clear with how much force. It is possible that it developed in a piecemeal fashion during the life of the Phase 1 building, rather than being constructed as an integrated system from the outset.



Fig re 54 The courtyard from the north.

benching perhaps – which prevented this and have left no other trace. However, any such benching would also have prevented the doors in the entrance from opening fully to stand flush against the passage walls, even if the door was double-leaved, which seriously calls into question the validity of this earlier interpretation.

The courtyard (Fig. 5.14)

The courtyard had a stylobate, 0.45m wide, on all four sides, which presumably provided a low base for columns supporting a lean-to roof over the surrounding walkway, though no trace of the colonnaded superstructure survived. The stylobate took the form of a low wall, composed of thin, fairly neatly cut stones with little core (north: E10:20; south: E11:28, with foundation E11:49; east: E10:21, E11:18; west: E11:51). It nowhere survived to more than two courses and perhaps never originally stood any higher, as the few extant stones of the upper course which were present appeared to form a cap of interlocking flat slabs leaving scarcely any of the core exposed. The western stylobate had been largely removed by the later water conduits, but the rubble foundation remained (E10:29, E11:50). There was a neat break

in the northern stylobate near its north-east corner, where the water channel, which crossed Room 8 and the north portico, was connected to the courtyard gutter, as evinced by the surviving remains of one the channel's side walls (see above, Fig 5.11). The central part of the courtyard (which measured 9.25m by 3.00m) was surfaced by small cobbles showing hardly any wear (E10:27, E11:53). In two of the corners, the north-east and south-east (and presumably originally in all four) were circular, carved stone water basins (E10:22, E11:36), with external and internal diameters of 0.49m and 0.36m respectively. The basins were 0.06m deep, with a central area in each basin, 0.19m in diameter, recessed a further 0.035m. The basins were connected by spouts to carved stone gutters running alongside the stylobates (Fig. 5.15). The surviving 14 gutter stones from the eastern half of the courtyard were c. 0.30m wide and varied markedly in length from 0.66m–1.10m (north: E10:24; south: E11:44 east: E10:23, E11:41). The system was doubtless designed to collect rainwater running off the roof. The gutter on the west side, like the adjacent stylobate, plus the north-west and south-west basins had been entirely obliterated by the later conduit (E10:25). Around the courtyard the colonnade walkway, 1.60m wide, was surfaced with a mixture of cobbles and flags, all well-worn (north: E10:31; east: E10:21, E11:34; west: E11:52). A patch of sandy gravel (E10:26) towards the western end of the north walkway may represent part of the bedding layer for this surface. A large BB1 cooking pot (E11:45) 'found *in situ*' towards the south end of the west walkway and abutting the west stylobate foundation was probably set into the walkway surface.

Room by room description

The rooms of the building are numbered from 1 to 9 proceeding in anti-clockwise order from the south side of the entranceway

Room 1

Immediately south of the entrance passage, Room 1 comprised an oblong chamber, measuring internally 5.00m north-south by 3.50m east-west. Its west wall was formed by the outer wall of the Hospital. The north wall (D11:11), which closed the room off from the entrance passage, was 0.65m wide with no offset and survived to a height of three courses at its west end. The east wall (D11:20, E11:05), which separated the room from the courtyard, typified the construction employed in the hospital's internal walls. The wall was 0.60–0.68m in breadth, built of roughly-dressed blocks, which varied in size from 0.13 × 0.20m to 0.16 × 0.35 m and faced a clay-bonded core of small rubble, and was set on a foundation of pink clay (E11:25). It survived two courses high with no offset. The



Figure 5 Water basin in the south east corner of the Phase 1 courtyard.

doorway, opening onto the courtyard, was situated at the south end of this wall. A later blocking of this doorway clearly butted up against the primary north jamb (see Fig. 5.28 below). The width of this doorway was uncertain as the southern jamb was more difficult to identify than its northern counterpart due to later rebuilding and the obliteration of the masonry at the junction between Rooms 1, 2 and 3 by a modern earthenware pipe (E11:20), but was probably between 0.90–1.10m. The south wall (D11:10), which was shared with the south-west corner latrine room, displayed evidence of later rebuilding. Although this wall survived to a height of two courses and more at the west end, only the lowest course was original and was actually narrower than the course above, which must belong to a later rebuild. There was a neat break in the masonry of the lower course towards the west end of the wall, indicating the presence of a doorway connecting Room 1 with the latrine (see Fig. 5.28 below). This doorway, like that in the east wall, was certainly utilised during Phase 2 of the stone hospital to enable a water conduit (D11:33) to reach the latrine cesspit and, like the other doorway, was subsequently blocked, probably when the conduit was taken out of use. Thereafter the wall was totally rebuilt. The east end of the wall had been destroyed by the modern pipe (E11:20), which made it impossible to determine conclusively the sequential relationships between this wall, with its later rebuild, and the adjoining north-south walls, D11:20 and D12:05 (the east wall of the latrine), which themselves must have incorporated at least partially rebuilt elements.

Room 2

The south-west corner of the building was occupied by a small, almost square room (2), with internal dimensions of 3.50m north-south by 3.40m east-west, which evidently served as a latrine. At the west end of the north wall (D11:10) a 0.75m wide doorway gave access from Room 1. The east wall (D12:05), which

formed the other internal wall, was c. 0.65m wide with no offset. A primary wall probably occupied the same position, but was subsequently demolished to permit the passage through of the water conduit during Phase 3 of the building. The extant wall reflects the reinstatement of the wall as part of the Phase 4 remodelling of the latrine. As a result, none of the surviving stonework can be attributed to Phase 1 with certainty, though short sections of the lowest course might conceivably be primary.

A stone-lined cesspit (D12:36), measuring 1.50 east-west by 1.30m north-south, was located in the south-west corner of the room (Figs 5.16, 5.17). This was probably the very first part of the building to be constructed. The sides of the latrine were built of large blocks up to 0.45m long and 0.20m high, this stonework being noticeably more substantial than the south and west walls of the hospital, which were set on the corresponding walls of the latrine with a careful offset c. 0.10m wide. The east side was largely removed by subsequent reconstruction, but a few of the original facing blocks were recognised beneath the later water channels. A stone-lined drain (D12:38) fed into it from the north. The drain was 0.60m wide and 0.50m deep and stood three-four courses high. To the west of the drain, a well-packed, worn surface of small cobbles (D12:40) may have formed part of the earlier *intervallum* road surface reused as part of the internal floor surface in Room 2 during this phase. No trace of the cobbling was recognised on the east side of the drain, where a patch of flags overlying a mixed clay layer (D12:45) might have been primary, but could also have belonged to the building's second phase. The outlet, which was 0.65m wide and rose the full height of the cesspit walls, lay on the south side. Two 0.80–0.85m long rectangular slabs (D12:13) formed the lintel over the outlet. The base of the pit was formed by the natural clay partially covered by a deposit of light grey silt between the water channel inlet and sewer outlet. Overlying this silt was the main fill of the pit, a very dirty, tacky, dark-brown clayey soil (D12:34), which was exceedingly moist. Assuming the cesspit was cleaned out periodically, the bulk of this fill will have built up late in the life of the latrine, or even upon its disuse, but the lowest part of the fill might have been deposited at a much earlier stage, depending on how thorough the cleaning was. The course of the outlet channel beneath the *via quintana* was not exposed in 1977, but was revealed in 1997–8 (see Hodgson 2003, 130, 158–61, fig 90) and was shown to be of one build with the cesspit south and west walls.

The arrangements whereby the latrine cesspit was sluiced out were clear during the later phases of Building 8, when it was flushed with water from the large cistern (Cistern 1) beside the *via principalis*, c. 12m to the north of the hospital, but were somewhat more obscure during Phase 1. As described above,



Fig re 6 The latrine pit and Phase 1 channel to the north

rainfall was certainly collected from the courtyard roof into a system of shallow basins and guttering around the edge of the central cobbled area. This source was apparently supplemented by water from Cistern 1, which was channelled through a stone conduit across the north range and portico to feed into the courtyard gutter near the latter's north-east corner. The gutter in turn conducted all the water to the south-west corner of the courtyard, its lowest point. From there the water may have been channelled to the latrine pit through the southern part of Room 1, following the same route that was employed in Phase 2. This entered the Room 1 through a doorway in the south-east corner, ran westwards to the south-west corner of the room where it curved sharply round and entered the latrine chamber through another doorway. However the early arrangements in the south-west corner of the courtyard have been obscured by later alterations. Finally, it is also possible that the pit was sluiced out manually on a regular basis (Hodgson 2003, 129).

Room 3

To the east of the latrine, the central room of the



Fig re 7 The latrine cess pit from the north east side wing the outlet opening the large masonry of the pit side walls and offset for the hospital walls.

south wing, Room 3, took the form of a long, roughly rectangular room measuring internally 7.50m east-west by 3.70m north-south. The south wall (D12:07, E12:05, 33) was formed by the outer wall of the building whilst the west wall (D12:05) was shared with the latrine room. The north wall (E11:10, E12:32) was 0.65m wide and was set on cobble foundations packed with pink clay (E11:26). It survived to a height of one or two courses. A doorway into the courtyard was located in the north-east corner of the room and was 1.00m wide. The east wall (E12:24) was shared with Room 4 and formed the west wall of the east wing (see below). It is clear from the way this wall was bonded with the south wall of the hospital that it was at least partially rebuilt in Phase 2. Primary flooring was only recognised in the south-west corner of the room where a small spit was cut down to the natural, a mottled pink and yellow clay (E12:51). Cut into the natural clay was a narrow gulley (E12:50), 0.12m wide, which may predate the fort. These features were covered by a dump of grey, silty clay (E12:49), varying in depth between 0.05–0.31m, which may represent levelling-up for the primary floor. This was in turn overlain by a further, undescribed layer of 'material' (E12:46), which may conceivably represent an occupation deposit associated with the primary phase or alternatively makeup for the flagged floor of Phase 2 (E12:47).

Room 4

The south-east corner of the building was occupied by a small room, roughly 3.70m square, labelled Room 4. The north wall separating 4 and 5 had been demolished and robbed out at the end of stone phase 1, but the 0.70m wide foundation (F12:33) survived, cut into underlying, natural, grey clay (F12:34). Its construction incorporated large stones up to 0.30m × 0.30m in size, set in greyish clay, similar to the east-

wall foundation of Room 9. The primary floor surface had gone apart from three flags in the north-west part of the room, the largest being 0.35m × 0.30m.

East wing

The wall between Rooms 3 and 4 (context E12:24) continued northwards forming the west wall of the east wing, separating Rooms 5 and 6 of the wing from the courtyard (E10:14, E11:33), as well as dividing Room 7 from 8 at the north end (F10:06). The wall was 0.67–0.72m wide and utilised fairly large, faced stones up to 0.40m long, neatly laid though not well cut, set on a 0.75m wide foundation of large cobbles packed with pink clay (E10:32). It survived best at the south end and towards the north end. The central stretch on the west side of Room 5 was severely robbed.

The east wing survived very poorly as a result of its demolition at the end of Phase 1 and the laying of road surfaces over it. Room 5 runs most of the length of the courtyard's east side with internal dimensions of c. 8.50 × 3.50m. No clear extent of flooring was identified in this room, however, nor any trace of a doorway from the courtyard as a result of the fragmentary state of the west wall. Room 6 was smaller, measuring internally 4.40m north-south by 3.30m east-west. A floor of stone flags (F10:15, F11:43) survived in the south-east corner along with the adjacent length of the 0.60m wide party wall which separated 5 and 6 (F11:41). A narrow passageway, no more than 1.00m in width, may have been inserted in the north end of this room, providing access from the east side of the building through to the courtyard. The south side of the passageway was defined by wall F10:52, only a short length of which survived, abutting the main east wall of the building (see Fig. 5.18), all archaeological deposits and structures in the western half of the room having been severely truncated down to the natural (F10:17). If wall F10:52 continued as far as the west wall of Room 6 (E11:14), it must have abutted that wall for there is no indication it was properly bonded to E11:14, nor were there any obvious remains of a doorway or threshold at either end of the supposed passageway, although only a single masonry course survived at any point. Alternatively wall F10:52 might have supported a staircase leading to an upper storey, in which case the wall may not have extended as far as the west wall and there is no need to restore doorways at either end.

Room 7

Another small room (7), roughly 3.50m square internally, similar to Room 4, occupied the north-east corner of Building 8, separated from Room 6 to the south by wall F10:07. The latter wall was 0.65–0.70m wide and butted up against the external east wall of the Hospital (F10:05). The west end of F10:07 did not



Figure 8 The north east corner of the Phase 1 hospital wing the possible entrance through the east wing. Some of the later road surfaces remain.

survive, but it was clearly not bonded to the west wall of the east wing (E10:14) implying that there was either a 0.50 wide doorway between rooms 6 and 7 at this point or, more probably, that F10:07 simply abutted E10:14. A primary floor (F10:46), composed of dark-brown clay with occasional small stones, was subsequently replaced by a further clay surface (F10:33) uncovered in the western half of the room. The relationship between F10:33 and F10:46, which both occupy the same area, is not stated in the context records, but the F10:33 was recognised at a significantly higher level (0.17m) than F10:46 and hence is likely to represent a replacement of F10:46 rather than simply a duplicated context identification.

Room 8

Room 8, covering the remainder of the north wing, comprised a long rectangular room, 11.85m east-west by 3.65m north-south, making it the largest in the building. An exterior doorway was located roughly midway along the north wall with a surviving pivot stone positioned beside the west jamb (E10:42). The doorway from the internal courtyard was situated in the south-east corner of the room. It was 1.00m wide with a threshold composed of large flags (E10:58). Immediately to the west was the sole surviving stretch of masonry, only 1.70m in length and 0.65m broad, belonging to the south wall of the room (E10:55). Otherwise only the foundations (D10:31, E10:77, 81) of this wall remained. The primary floor deposits still extant across much of Room 8, especially its eastern half, was comprised of clay with odd patches of ash (E10:76). A floor of sparse gravel set in yellow-brown clay (E10:72), which might also conceivably belong to this phase, was noted in the central part of the room and may be equivalent to the layer of stone chippings (D10:32) set in clay towards the western end of the room. The gravel lay immediately to the west

of the stone-lined conduit E10:25/62, and, although their stratigraphic relationship is not expressed in the context records, E10:72 perhaps represents the surface associated with the construction of the drain during Phase 1. It overlies another layer of cleaner clay, possibly natural (E10:74). Deeper excavation, by machine, of an area further to the west in the room, did uncover the natural yellowish clay (E10:45 cf. also D10:35, E10:82). To the east of the drain, an area of flat stones (E10:69) set in a more extensive spread of yellowish-brown stony clay (E10:67), with patches of ash (E10:68), may represent the remnant of a stone floor associated with this phase, overlying the clay makeup (E10:76). However, this could also be interpreted as part of the Phase 2 flagged floor, given the difficulty, across much of Room 8, in establishing a clear sequence of floors which could be assigned with confidence to successive phases.

Room 9

Room 9, immediately to the north of the entrance passage, was another oblong room measuring 5.00m north-south by 3.70m east-west. The east wall had been robbed out, but the 0.85–0.90m wide clay and cobbled foundation (E10:06) survived. At the south end of this wall a doorway, 0.95–1.00m wide with a flagged threshold (E10:08), opened onto the courtyard. The north wall (shared with Room 8) had also been reduced to little more than foundations (D10:31, E10:77). The south wall was formed by the northern wall of the main entrance passage (D11:07, E11:12) and was set on clay foundations (D10:14, E11:27). A strip of pink clay (D10:20), which lay beside this wall along the south edge of the room and probably represented the residue from the construction of the wall, sealed a group of pottery and included an additional, unsealed rim sherd (see below). Much of the floor had been removed by a mid-nineteenth-century stone-lined cesspit (D10:02) and other intrusions.

FINDS

West wall

Copper alloy: brooch (no. 36, D11:09)

'Occupation' material, Room 3

Flint: scraper (no. 13, E12:46)

Floor, room 6

Iron: curved object (no. 70, F10:15)

Natural soil, Room 8

Coin: Trajan, 98–103 (no. 30, E10:74)

Pottery: lamp (no. 6, E10:74)

Clay floor, Room 8

Coin: illegible first century (no. 230, E10:76)

Iron: spearhead (no. 12, E10:76)

Foundation of south wall, Room 8

Pottery: disc (no. 52, E10:77)

Dating evidence

The foundation of the south wall of Room 8 and the wall dividing Rooms 8 and 9 both contained a few sherds of BB2, suggesting a construction date of c.160. Some of the rooms produced only a few sherds of pottery in this phase (Room 1, less than ten; Rooms 6, 7 and 9 three each), although it is likely some pottery has been lost as some contexts contain only rims, or more rims than body sherds. The largest group of pottery comes from Room 8, including two sherds of Antonine samian and a Mancetter-Hartshill mortarium rim dated 170–230, and a sherd of a Nene Valley coloured coated pinch-neck flagon of the third century.

The presence of BB2 in the pottery assemblage associated with Phase 1 of the stone hospital is consistent with a date of c. 160 for the building's construction. The small amount of third-century Nene valley ware in the assemblage, comprising two sherds, plus a sherd of a third-century Horningsea storage jar, from context E11:18 and three sherds from a single vessel in E10:58, are more likely to represent contamination or might conceivably reflect the lifespan of the Phase 1 building which may have extended into the third century.

The latrine pit and primary drain channel

The latrine pit contained approximately 45 sherds of pottery, mainly of BB1 and flagon fabrics, but with a few sherds of BB2 and allied fabrics. There was also a spout from an Antonine Corbridge mortarium and a sherd of decorated samian dated 130–65 (D12:34). The backfill of the associated primary drain contained a large group of pottery consisting of BB1, local grey wares and flagons and two sherds of Hadrianic samian (D12:37). Strictly speaking these assemblages only provide *termini post quem* for the backfilling of the two structures when they went out of use, which in the case of the drain channel did not occur until the beginning of Phase 3, whilst the pit was largely filled when the latrine was remodelled in Phase 4, though the section nearest to the outflow drain continued to function right up to the end of the hospital's life. However the material from the two groups appears much earlier. The pottery from the latrine channel, in particular, looks to be a second-century group. This might imply that the pottery all derived from the primary fills at the very bottom of the channel and pit, where it had escaped periodic cleaning out.

Via quinta a (west)

Grid squares: D12, E12, F11, F12, F13, G11, G12, G13, H11, H12

The western stretch of the *via quintana*, between

Table 5.01 Sequence of road layers on the west via quintana and the street east of Building 8

Phase	Description	D12	E11	E12	F10	F11	F12	F13	G11	G12	G13	H12
5	Rubble	11	55	6, 8	12, 13	19						
4	Road Surface	12		11	14							
3	Road Surface	27?	56	12, 30	32, 34, 36	23	14					
2	Drain								07, 50, 93			33
2	Road Surface	27?		22, 31	16, 38, 39, 43, 51	24, 38, 39, 42, 78	03, 15, 28	09		02	04	
1	Drain								04, 49, 51, 67, 69			23
1	Road Surface			21	45	53, 73	16, 29	24	20, 71	23	(04)	
1	Road Foundations					82			89			
Unphased	Road Surface								19, 68, 82, 85			08 34
	Drain								79, 84			35
	Late Structure	15										

Italics = Contexts with dateable material

Buildings 8 and 7 to the north and Barrack 9 to the south, preserved a good sequence of road surfaces (see Table 5.01) which helped to establish a reasonably clear phasing for the hospital and this part of the fort. In all, four successive phases of the *via quintana* were identified in this area during the 1975–84 excavations. Because of the eccentric southerly position of the hospital, by comparison with the other buildings of the central range, the east-west carriageway was only 5m wide between the hospital and Building 9, increasing to c. 14m–15m further east. The roadway continued westward through the single gate portal of the *porta quintana sinistra* (see Chapter 17).

The lowest road surface identified during the Daniels excavations was composed of fine gravel and very small cobbles, roughly 0.05m in diameter. This was recognised in one relatively small section of the *via quintana* south of the hospital (E12:21), where a modern trackway (E12:45) had removed the later road levels, and, more extensively, in the area east of the hospital and south of the granary (F11:53, 73, F12:16, 29, F13:24, G11:20, 71, G12:23), where the later road surfaces were not present. A similar level was also observed to the north in the alley between the granary and the hospital (F10:45). The surface generally had an orange colouring due to iron panning and was not extensively worn. It varied in thickness to upwards of 0.10m. The gravel and small cobbling was set on a layer of larger stones (F11:82, G11:89), which was most clearly recognised in the area immediately south of the granary (grid squares F11, G11). This layer

was not described in detail, but was interpreted as a foundation or makeup for the overlying gravel and cobble surface, which, in this particular area, was interspersed with flags ranging from 0.05m to 0.20m in diameter (cf. F11:73).

The gravel and small cobbling was assumed by Daniels to be the primary surface and was considered to be contemporary with the initial phase of the stone hospital. However, the excavators in 1977 and 1983 were unaware that Building 8 had been preceded by an earlier structural phase, represented by Building 21, the timber hospital. In these circumstances, it is conceivable that the underlying ‘foundation’ of larger stones (F11:82,) actually formed an earlier road surface associated with the primary, Hadrianic, occupation in this part of the fort. Conversely, if the layer of larger stones was indeed a makeup deposit for the Period 2 (Building 8 Phase 1) *via quintana* metalling, an earlier road level, unrecognised by the 1975–84 excavators, must be postulated.

On the south side of the road, a stone-lined drain or gutter (F13:13, G13:05), associated with Barrack 9, was interpreted as part of the primary layout of the road, although this may in fact have been associated with the Period 2 stone barrack rather than the Period 1 timber block. The outflow channel from the latrine in the south-west corner of the hospital was not investigated in 1977, but was uncovered in 1997–8 (TWM 7171), when it was shown to have crossed the *via quintana* and continued southward along the *intervallum* road to the west of Barracks 9

and 10 (7660). The *intervallum* drain running down the west side of the hospital was shown to feed into the outflow channel midway across the *via quintana* (see Hodgson 2003, 158–60).

The Phase 1 road produced only seven sherds of pottery, including BB2 (surface F10:45, foundation F11:82).

The Phase 2 hospital (Fig. 5.19)

Summary: Phase 2

The second phase of the stone hospital saw it transformed into a rather more utilitarian structure. The east range of rooms was demolished and cobbled over to form a north-south street corresponding to the second phase of road surface identified by Daniels on the *via quintana*. This street was heavily rutted and worn and had been patched. The courtyard too was radically altered with the demolition of the colonnade and the covered ambulatory around the central cobbled area. A stone-lined water conduit was taken through Room 8 across the courtyard and then through Room 1 to feed into the latrine in Room 2.

New floor surfaces were laid in at least some of the rooms. These cannot always be directly associated with the secondary water channel and in such cases their attribution to a particular phase is assumed on the basis of their relative position in the stratigraphic sequence rather than proven.

Courtyard

Inside Building 8, the stylobates were eliminated and the gutters and water basins were filled with a grey-green clayey loam (E10:16–18, E11:31) and, in places, rubble (E11:30). The primary courtyard surface was overlain by a mixed layer of very dark, grey-green soil and pink clay with patches of daub, variously-sized stones and charcoal (E11:32). The layer had a pinkish colour overall. This probably represents residue from the demolition of the east wing. A new, rough surface of flagging and large cobbles (E10:19, E11:35) was laid over the yard, overlying a level of light clayey silt, between 30mm and 50mm thick. A line of six postholes, running parallel to the east wall of the courtyard and cutting through the east stylobate wall, was recognised during the 1997–8 excavations (TWM 7253, 7255, 7264, 7276, 7278, 7280; three were apparent on 1977 plan P98, cf. Fig. 5.19). The relationship of these postholes to the Phase 2 or later courtyard surfaces could not be ascertained, since the latter had all been removed in 1977. However, the fact that the postholes cut through the neatly constructed stylobate wall renders an association with the initial phase of the stone hospital highly unlikely. Conversely, the manner in which the postholes closely followed the line of the stylobate indicated the posts

had most probably been erected at the beginning of Phase 2, before the stylobate had been covered over by the new cobbled surface which extended across the full extent of the yard.

Water channels (Figs 5.20–5.22)

A major alteration was also made to the course of the water channel (E09:34, E10:62), which entered the hospital through a doorway almost midway along the north face. This originally fed water from Cistern 1 into the peristyle gutter in the north-east corner of the courtyard (see above Phase 1). The channel was now realigned to run directly to the latrine in the south-west corner of the building, diverging from the earlier course – which must have become redundant and had largely been robbed out – in Room 8 and following a north-south course across the courtyard (E10:25, E11:42), where some of its cover slabs still remained *in situ* (Fig. 5.20). It then turned westward to enter Room 1 through the pre-existing doorway, running along the south side of the room into the south-west corner where it turned sharply southward to pass through the doorway connecting Rooms 1 and 2 (D11:33 – see Fig. 5.21). In the north-west part of Room 2, a junction was made between the new channel and the earlier stone channel (D12:38) leading into the cesspit in the southern part of the room. The secondary conduit was significantly narrower than primary channel in Room 2, which resulted in a slightly awkward junction where the two eastern side walls met (Fig. 5.22; cf. Fig. 5.16 above). It is likely that the channel was originally covered by capstones, though none survived in Rooms 1 and 2, having probably been removed for use elsewhere when the conduit went out of use and was backfilled.

The north-south channel (E10:25, E11:42) removed any trace of the gutter and the two water basins which must have lain on the west side of the primary courtyard and reduced the west stylobate down to foundations for virtually its entire length. However the drain did not reuse the west stylobate to form one of its side walls as might have been expected. Instead the west wall of the conduit ran a mere 0.25m to the east of the west stylobate east face. The circuitous course of the southern stretch was presumably determined by the position of the two doorways into Rooms 1 and 2 which provided the easiest access to the cesspit, obviating the need to demolish walls. The drain walls survived up to four courses high in these two rooms and were constructed of long thin stones laid lengthways. A deposit of grey silt (D11:50) filled the bottom of the conduit.

Entranceway

A new surface of fine gravel (D11:38), 0.01m–0.03m deep, was laid in the entrance passage. This surface,



Figure 9 Hospital (Building 8) Phase 2 Scale 1:100

like its predecessor, still respected the clay bands beside the passage walls. No stratigraphic link could be made between the yard and passageway surfaces, however.

Room 1

In Room 1 the early levels, including the features

associated with Building 21, were covered by a layer of grey clayey loam (D11:53), which might conceivably represent either an occupation deposit associated with the Phase 1 or makeup for the subsequent phase of flooring. This was overlain by a gravel floor (D11:39), which seems to be associated with the drain channel (D11:33) running along the south side of the room, and which had the effect of raising the floor level



Figure 5.20 The intervallum drain along the west wall of the hospital plus the phases of water conduit entering the hospital.

about 0.15m. This gravel survived only patchily and was not found at all in the north part of the room.

A rectangular stone setting (D11:19) was placed against the east wall. It took the form of a large flat slab framed to the north, south and east by faced stones forming a wall, one stone wide, around the slab on these three sides. Two courses of the wall survived on the east side. The feature as a whole measured 0.85m north-south and 0.55m east-west and there was some blackening in the centre. To the south of the setting, a spread of charcoal and coal (D11:28) (1.15m N-S, 0.60m E-W) abutted the east wall of the room and stretched for c. 1.15m southward to a clay edge or strip which ran perpendicular to the east wall. This clay 'edge' followed the same alignment as the north jamb of the doorway for at least 0.90 m into the room and may conceivably have continued further originally. Its interpretation is unclear, but it perhaps represents the base of a timber partition screening off the doorway. To the north of the stone setting an area of grey loam (D11:25) was heavily flecked with coal. The framed slab presumably formed either a hearth or perhaps the base for an upright brazier. The coal and charcoal deposit may represent the residue from a fuel stock next to the hearth or perhaps the trail resulting from fuel being carried into the room.

It is unclear whether gravel D11:39 represented a surface in itself or served as bedding for a flagged floor. The gravel survived much higher in some areas – notably between the conduit and the south wall of Room 1 and in a small patch against the west wall – than others. It seems likely that the water channel at least was covered by flags, which were subsequently removed for reuse elsewhere when the drain went out of service and was backfilled. Furthermore a single flagstone remained to the north of the conduit in the east doorway with the later blocking wall sitting on top of it. There was no trace of gravel in the northern part of the room, which was covered, incompletely,



Figure 5.21: The latrine in Room 2 and the Phase 2 and possible Phase 1 conduit in Room 1.



Figure 5.22: The latrine in the south-west corner of the hospital (Room 2) showing successive phases of water channel.

by large sandstone flags (D11:16). The flagstones may represent a later, Phase 3 resurfacing, in the north part of the room, but it is equally possible that there was a combination of flags, gravel bedding and infilling from the start. Associated with flagging D11:16 was a BB2 cooking pot with lattice decoration (D11:23), set into the floor, its rim having been deliberately trimmed, and probably used for some sort of storage. Seven-eighths of the vessel survived and a round stone found within the pot may have originally served as a lid. The vessel type first appears in the late second century.

Room 2 – the latrine

In the latrine, the spread of cobbles (D12:40 = TWM 5533?) to the west of the drain channel, which may originally have formed part of the primary *intervallum* road surface (see above), perhaps still remained in use during this phase as part of the room's flooring. A mixed clay-loam with some charcoal flecking overlain by fragmentary stone flagging (D12:45) covered the north and north-east part of Room 2. It is not clear

whether this flagging and clay makeup should be assigned to Phase 1 or 2, or whether the surface was in use during both phases.

Room 3

In Room 3 no surfaces were identified which could be clearly associated with this phase. All the Roman period deposits in the central portion of room had been removed by a two nineteenth-century drain conduits (E11:07; E11:04/16) and associated disturbance (E10:07). The flagged floors recorded in the remainder of the room were more likely associated with later phases of activity, this being particularly clear in the case of the successive levels of flagging in the western part of the room.

Room 8

The structural history in the area of Room 8 is more difficult to interpret, with a dearth of distinct, uniform floors and features clearly associated with successive phases. However the remains of a flagged floor (E10:54) uncovered in the centre of the room were probably associated with this phase, the flags being level with the cover slabs of the drain. The wall separating Room 8 and the courtyard was very poorly preserved and consequently there was no way of confirming whether the realigned drain passed through a pre-existing doorway here, although this is very likely. Indeed the secondary conduit lay close enough to the line of its predecessor of Phase 1 for both conduits to have shared the same doorway. A spread of small cobbles (E10:66), immediately to the east of the conduit, may have been deposited in this doorway after the stretch of the original Phase 1 conduit, leading to the north-east corner of the courtyard, had been robbed out.

Room 9

In Room 9, a floor consisting of a make-up layer of yellow-white sandstone chippings (D10:10) with a surface of small flat slabs and gravel on top (D10:15) was attributed to Phase 2 by Daniels. This covered a layer of light-medium grey, clay-loam (D10:21).

INTERPRETIVE PROBLEMS – THE PHASE 1 AND PHASE 2 FLOOR LEVELS

The description of Building 8 Phase 2 provided above is largely that arrived at by Daniels following excavation in 1977 and 1983. However, the discovery, in 1997–8, that there had been a timber building (21), preceding the stone hospital, raises questions with regard to certain aspects of that phasing. Specifically, both in Room 1 and Room 9, only a layer of clay loam (D10:21, D11:53) separated the floor levels attributed to Phase 2 by Daniels from those now reinterpreted

as being associated with Building 21. In neither room was a distinct intervening surface identified, which might be attributable to Phase 1. This might be explained by a truncation episode which had removed the Phase 1 floor. However, it is also possible that Daniels' Phase 2 floor should actually be assigned to Phase 1. In Room 1, in particular, the level of the floor in relation to the surrounding walls would not preclude this. Unfortunately the quantities of pottery from these floor levels were too small to provide a conclusive guide either way.

FINDS

Floor, Room 1

Stone: lid (no. 35, D11:23) associated with buried pot

Coal/charcoal spread, Room 1

Lead: plug (no. 3, D11:28)

Secondary courtyard surface

Decorated samian: 125–45 (no. D28, E11:35), 160–80 (no. D29, E11:35)

Dating evidence

The rooms produced little pottery in this phase. A BB2 cooking pot (D11:23), complete apart from its rim and with a circular stone lid, had been deliberately incorporated into the floor in Room 1.

Demolition of the Phase 1 courtyard

BB2 and allied fabrics made up three quarters of the assemblage, and there was a sherd of East Gaulish samian dated to the late second or first half of the third century (E11:32).

Water conduit

The fill of the water conduit north of the building contained a sherd of Central Campanian amphora dated to after the mid-third century, and a sherd of East Yorkshire grey ware of the late third century or later (E09:33, E09:34). In the northern part of the courtyard the fill included a third-century vessel of form Gillam 151 (E10:25), whilst further south (E11:42), although there were only five sherds from the lower fill of conduit, these did include a sherd of south-east reduced ware and a scrap of Nene Valley (E11:39).

Where the channel extended into Room 1 (D11:33), BB1 made up approximately half of the pottery assemblage of the lower fill of the conduit (D11:49), while there was only a small scrap of possible BB2 in the silt layer at the very bottom of the channel (D11:50). Most of the pottery could be second-century in date. This stretch of the conduit may have originated in Phase 1 (Fort Period 2), which would not be contradicted by the assemblage from the lower fill and silt.

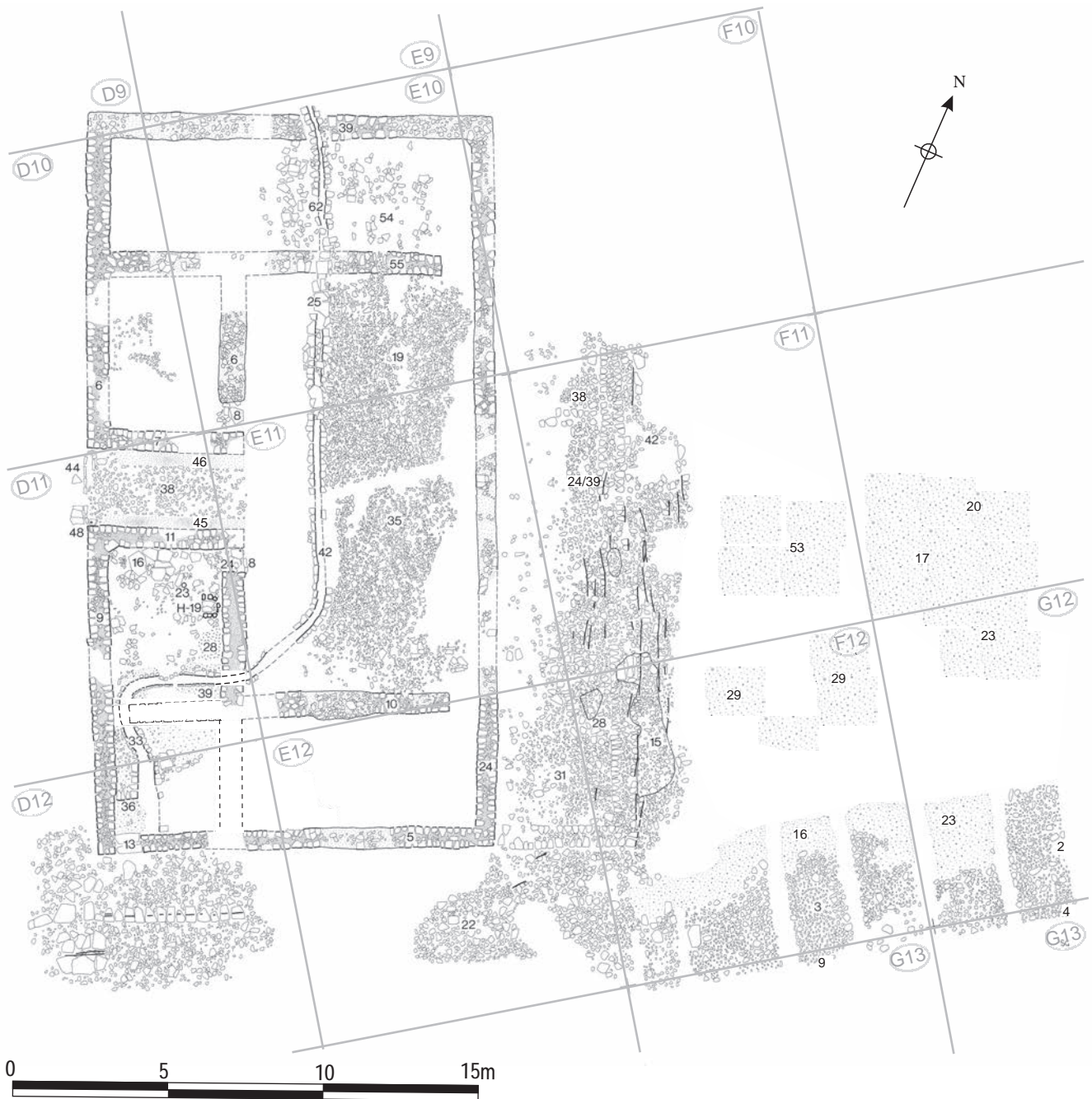

Fig re 3 Building 8 and adjacent road surfaces, Phase 2 Scale 0

Courtyard

The surfaces within the Phase 2 courtyard produced a quantity of pottery, approximately half of which was made up of BB2 and allied fabrics, indicating a third-century date. Context E11:35 also had sherds from three Antonine samian vessels, a decorated bowl dated 160–80 and an East Gaulish bowl of the late second or first half of the third century. A third-century date is also indicated by some sherds of Nene Valley colour-coated ware in another sizeable group filling the east gutter (E11:31).

The via quinta and the street to the east of the hospital (Figs 5.23, 5.24; Table 5.02)

The *via quintana* was resurfaced following the demolition of the hospital east range. The new metalling consisted of medium-sized cobbles, on average c. 0.10m in diameter, worn very smooth and flat, with small building rubble and a lot of quern stones set into it (context E12:22). This surface was recognised on the east-west carriageway between Buildings 8 and 9 and also running north-south over the former east wing of the hospital, on either side of the primary east wall (F10:05, F11:40, F12:19) of

Table 8 Via quintana road levels contemporary with Building 8 Phase 2 (Period 3)

Phase	Description	D12	E11	E12	F10	F11	F12	F13	G11	G12	G13	H12
2	Road Surface	27?		22, 31	16, 38, 39, 43, 51	24, 38, 39, 42, 78	03, 15, 28	09		02	04	

that building, clearly demonstrating that the second phase of the western *via quintana* identified by Daniels followed on from the demolition of the east range of the hospital. Towards its south end, where it was three courses high, the surviving masonry of the former east wall protruded above the surrounding road surface (E12:31, F12:28, F12:15), which lay against the lowest course of the wall. The cobbling continued into the alleyway between the granary and the hospital (F10:16, 38, 43) where the gutter alongside the hospital's primary east wall was filled by similar material (F10:51, F11:78). The west side of this north-south metalling, adjacent to the east wall (E10:14, E11:33, E12:24, F10:06) of the truncated hospital building, did not survive, having been removed by a trackway (E10:13, E11:17, E12:45, F11:20) of probable early modern date.

This Phase 2 roadway showed signs of heavy wear, with deep rutting on the surface and areas of patching on the north-south carriageway (contexts F11:38–39; see Figs 5.23–5.24; cf. Fig 6.21 below). The ruts were also particularly pronounced on the north-south carriageway and seemed to run past the south-west steps of the granary. The former east wall of the building had been demolished down to its bottom two or three courses, and these surviving remains too were heavily rutted with the stones knocked out of alignment. This rutting was probably caused by the movement of laden supply carts towards the granary and is a common characteristic of roads which have reinforced surfaces in them, like kerbs that have been incorporated into the surface, or, as in this case, where a building has been demolished and the lower courses of the walls used in the road surface. The carts probably entered via the *p rta quintana*, continued along the *v a quintana* and turned north at the south-east corner of the Phase 2 hospital. They were probably unloaded beside the south-west steps of the granary.

Much of the surface overlying the east wing was cleared by the excavators in 1977 and 1983 to reveal the remains of the hospital, but some areas of metalling were left in place, notably by the south-east corner (TWM 7698, corresponding to E12:22) and partially alongside and overlying the primary east wing (TWM 5501 = F12:15, F11:24/39, 42), and were re-exposed in 1997–8 (Hodgson 2003, 135–6, fig. 94).

Dating evidence

The cobbling and patches in the roads produced BB2



Figure 5.23 Phase 2–3 road surfaces overlying the east wing of the hospital.

and Nene Valley colour coated ware, indicating a third-century date.

The Phase 3 hospital (Fig. 5.25)

Summary: Phase 3

This phase of activity, like those immediately preceding and following it, was defined principally by a combination of significant realignment of the channel which flushed water through the latrine, alterations to the layout of the latrine itself and the laying of new surfaces in the courtyard and entranceway. The composition of the courtyard and

passageway surfaces resembled that of the third layer of metalling recorded by Daniels on the *via quintana* and the road east of the hospital, being largely made up of squared blocks which may have derived from the demolition of an unidentified structure. This helped to convince the excavators that all these surfaces should be treated as part of the same structural phase.

Entranceway

In the entrance passageway a new layer of metalling, comprising a pack of medium-sized sandstone blocks (D11:21), was laid over the preceding gravel surface. The pack survived best towards the east end of the passage. Towards the west end a rough line of faced blocks (D11:41) over the rubble and stone packing was interpreted as providing a step down from the *intervallum* street, though the impression provided by the surviving remains may be misleading. Later disturbance in the central part of passageway – in the form of a layer of greenish-grey, clayey-loam with a lot of pink clay (D11:36) – had removed any trace the stone pack immediately to the east of the ‘stone line’ and it is likely that D11:41 was actually simply part of the same stone pack as D11:21, which originally extended, uninterrupted, for the full length of the passageway.

The excavators considered that, as initially constructed, the layer of stone blocks of D11:21, like previous entranceway surfaces, did not encroach on the clay bands alongside the passage walls, which were interpreted as the site of side benches. At a later stage (Phase 4?) it was argued, these benches were removed and the pre-existing surface pack of cut sandstone was extended (D11:42) up to the side walls. As noted above, the theory of side benches is questionable, since they would have prevented the door leaves opening fully to rest against the passageway walls. If the stone layer alongside the passageway walls was actually distinct from that covering the central carriageway, which is by no means certain (D11:42 does incorporate some large blocks which could form an edge on the south side of the passageway but this is much less clear on the north side), it is perhaps more likely that the slabs and blocks along the side walls (D11:42) were laid first, in effect as pavements to keep pedestrians clear of any mud on the main surface. The level in the main carriageway may subsequently have been raised to the same level (D11:21).

It should be noted that stone surface D11:21 was only attributed to Phase 3 because of the relative sequence in the passageway and the characteristics of the surface itself which were considered to resemble the Phase 3 surfaces in the courtyard and on the road levels. The relationship of the stone pack to the nearby Phase 4 water conduit was, unfortunately, unclear, since the stone surface did not continue unbroken up

to the channel. Hence, it was not possible to establish conclusively whether the channel was contemporary with this passageway surface or was a later insertion, as proposed here.

Courtyard

A new surface was laid in the courtyard, composed of medium-sized stones including squared blocks and some flags and boulders (E10:11, E11:22), all well packed and worn. Towards the south end of the courtyard, where the surface was very shattered, smaller stonework, including many tiny slabs (E11:23), was used. (Site plan P92).

Water channels

The defining feature of this phase was the re-routing of the water channel from the south-west corner of the courtyard to run southward into Room 3 and then diagonally across Room 2 to empty into the north-east angle of the cesspit. This meant the earlier, circuitous channel through Rooms 1 and 2, with the pronounced and conceivably problematic bend where it negotiated the doorway between the two rooms, could now be taken out of service and backfilled. The doorway between Rooms 1 and 2 was blocked. The blocking wall, between three and four courses of which survived, cut the uppermost courses of the drain walls, one course of blocking actually sitting in the channel, D11:33, with some fill beneath, demonstrating that this occurred whilst the conduit was being taken out of service (see Fig. 5.26). The backfill in the redundant channel overlying a 30mm thick deposit of yellow-grey drain silt (D11:50, E11:40) was similar throughout, consisting of a mixed, dark greenish-grey, clayey loam, siltier with much charcoal flecking and coal towards the bottom (D11:49, E11:39), and with a lot of pink clay and stone in the upper packing (D11:40, E11:38). Several capstones were found in the fill in Room 2 (D12:37). The doorway between the courtyard and Room 1 was also blocked and a new entrance provided at the north end of the east wall. In this case the blocking (D11:31) was simply carried over the drain fill (see Fig. 5.27), indicating that this operation was accomplished after the modifications to the water channels had been completed, though not necessarily long after. The new, 0.75m wide threshold (E11:24), in the north-east corner of the room, was composed of small, flat sandstone slabs and a flagstone with a peck hole, presumably to hold the door pivot, and now, if not earlier, the room was floored with flagging D11:16 (see above Phase 2).

Just to the north of the junction between the old and the new drain courses the channel still retained two of its cover slabs. The replacement channel (E11:43) was not more than 0.20m wide, narrowing to c. 0.15m at certain points within Room 2, with even less space



Fig. 5.28 Hospital (Building 8) Phase 3 at 8

between the upper courses. The side walls were built of small, neat stonework. Larger stonework was employed in the stretch approaching the cesspit, where the north-west wall (D12:23) of the channel survived up to three courses (0.40m) high and two courses of its south-eastern counterpart (D12:35) remained (cf. Fig. 5.28). The terminal of the conduit cut through the

former east wall of the cesspit and projected into the pit, virtually closing off the southern end of the primary and now backfilled channel. Thus, by straightening out the course of the channel to a considerable degree, the new arrangement was presumably intended to improve the flow of water into the cesspit.

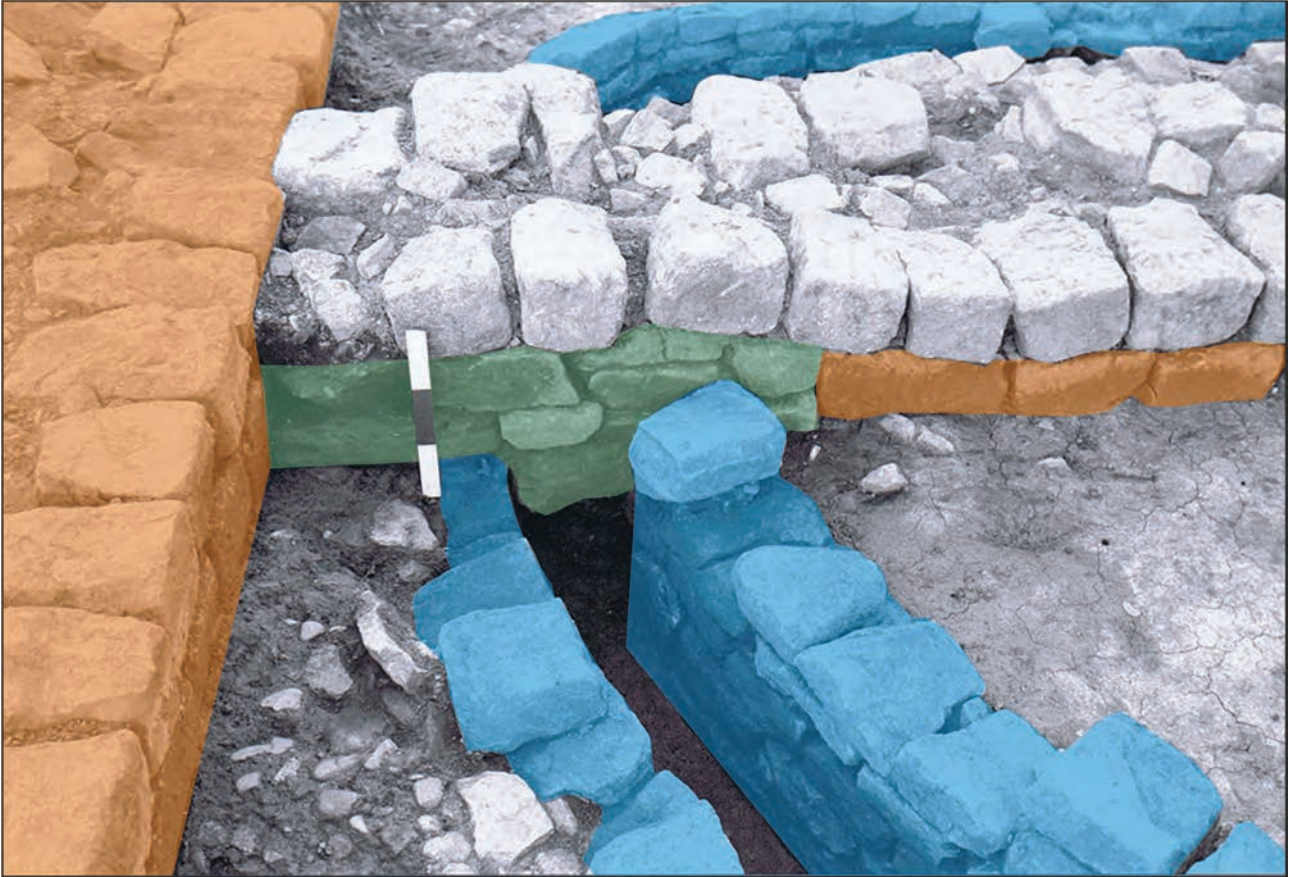

Figure 5:26: The passage of the Phase 2 (possibly Phase 1) conduit between Rooms 1 and 2. Pink represents Phase 1 walls. Blue: the stone conduit. Green: blocking of the doorway (Phase 3) with the wall later being rebuilt over the top.

Room 2

Construction of the new water channel must have entailed the demolition of much if not all of the wall between Rooms 3 and 2 and it is likely that, to accommodate the new conduit, Room 2 was enlarged with its east wall shifted c. 1.80m eastward. The east face of the new, 2.50m long, east wall (E12:35) survived, the west face having been entirely removed (Fig. 5.29). A wide doorway at the north end of this wall gave access to the latrine from Room 3, whilst direct access into Room 2 from the courtyard may also have been provided where the conduit passed through wall E11:10 (Fig. 5.30). Construction of the drain passage must have entailed the demolition of wall E11:10 at this point, and the surviving remains indicate the rebuilt wall was not carried over the channel, its place presumably being taken by a doorway. The channel was doubtless covered by capstones, providing a convenient flagged threshold. To the west of the new east wall, E12:35, a floor of sandstone flags (E12:47), laid on a 0.10m–0.15m deep makeup (?) deposit of undescribed 'material' (E12:46), may be associated with this enlargement of Room 2. A spread of sandstone flags (D12:14) to the north-west of the new conduit may, in part at least, be the equivalent

E12:47, but here it is more difficult to differentiate the successive levels of flagging associated with Phases 3 and 4 than it is in the area immediately to the east.

Room 3

In what remained of Room 3, now reduced to an internal length of 5.40m–5.85m, there was a flagged floor (E12:36) butting up against the east face of wall E12:35. Only a narrow area of this flagging survived, noticeably cracked with wear, right beside the wall, the remainder having been removed by nineteenth-century conduits (E11:07; E11:04/16; E10:07), but it was once probably an angular floor surface of evenly-cut squarish slabs. In the eastern part of the room a fragmentary floor surface, consisting mostly of small slabs and very shattered flags (E12:20), may belong to this phase and may indeed form the continuation of flagging E12:36, though much damaged. In addition a line of three stones (E12:29), was interpreted as possibly forming part of a north south dividing wall. This may, however, be a misleading impression created by the destruction of the deposits immediately to the west and partial dislocation of the three stones by the post-Roman conduit and disturbance

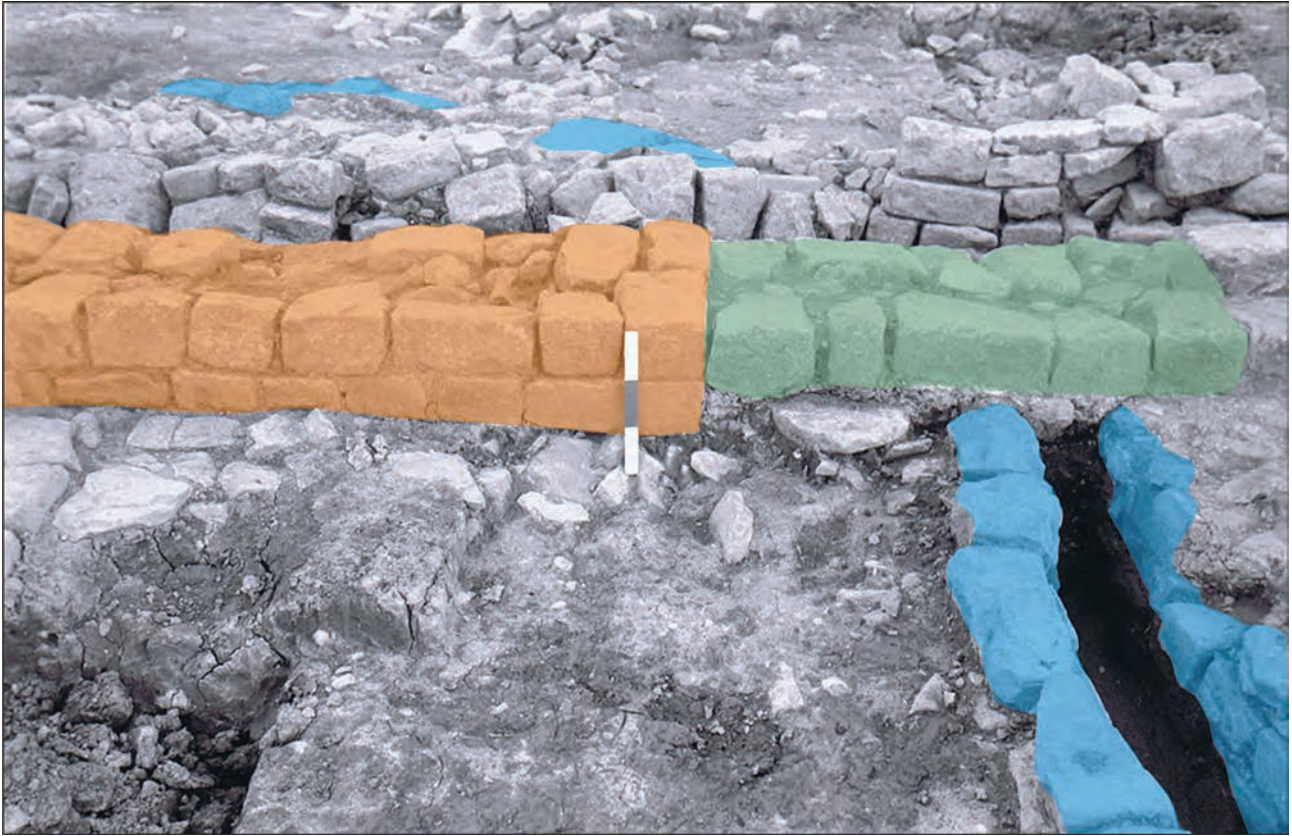

Figure 5:27: The passage of the Phase 2 conduit from the courtyard through the doorway into Room 1 (foreground). Pink: primary east wall of Room 1. Blue: the conduit. Green: the Phase 3 blocking of the doorway, after this conduit had been replaced.



Figure 5:28: The latrine, from the west, showing the Phase 3 and 4 channels.

(E11:04/16). The stones may in fact simply have formed part of the flagged surface E12:20.

Rooms 8 and 9

No distinct floor surfaces were recognised in Rooms 8 or 9 which could be assigned to this phase.



Figure 5:29: Room 3: remains of Phase 3 wall E12:35 separating 3 (foreground) from an enlarged Room 2. The Phase 4 wall with capstone over the drain is visible in the background. Also visible beyond wall E12:35 are the fragmentary remains of flagged floor E12:04, dark clay makeup E12:03 and V-shaped drain E12:02 associated with timber building N, overlying the flagged floors of the hospital.

FINDS

Metalling in entranceway

Copper alloy: strap-end (no. 160, D11:21)



Figure 5:30: Phase 3 and 4 conduits entering Room 3 from the courtyard.

Courtyard

Pottery: counter (no. 54, E10:11)

Courtyard surface

Decorated samian: 160–200 (no. D26, E11:22), 160–90 (no. D27, E11:22)

Graffito: (no. 11, E11:22), (no. 20, E11:22)

Quern: lava (no. 22, E11:22)

Stone: throwing stone WSS113 (E11:22)

Upper fill of secondary drain

Lead: disc (no. 25, E11:38)

Dating evidence

The pottery from Phase 3 of the building is no later in date than that found in Phase 2, apart from a single sherd of late third- or fourth-century East Yorkshire grey ware in the passageway that has perhaps been pressed in from a later layer (D11:21). The silt in the bottom of the tertiary drain in Room 2 produced only four sherds, consisting of two mid- to late Antonine samian sherds, two sherds of south-east reduced ware and a scrap of flagon.

Conduit fill (Room 1)

Most of the Phase 2 conduit remained in use in this phase. The later pottery types found in the courtyard channel fills (see Phase 2) might therefore have been deposited during or at the end of Phase 3, including a third-century vessel of form Gillam 151 (E10:25), plus a very small body sherd of Nene Valley (1 gm), and a body sherd of south-east reduced ware which was not much bigger (E11:39).

However the section running through Rooms 1 and 2 was taken out of use and completely backfilled at the beginning of Phase 3. The full pottery assemblage from the fills in this stretch of the channel comprised at least 40 body sherds. A higher proportion of BB2 would be expected if this was simply a third-century group. BB2 was present in the upper fill (D11:40), but the BB2 in the lower fill (D11:50) was only possibly BB2, and comprised one small sherd (out of a total of 12+ sherds). There was also a sherd of shell-gritted ware from the context, which is usually third-century Dales ware, but some second-century shell-gritted ware is known, and as it this is a featureless body sherd, its dating is uncertain. Therefore there is no pottery to give a certain date to this context, but the material in this lower fill may reflect the earlier use of the channel during Phase 2, and perhaps even Phase 1, of the building. The same is perhaps true of the large pottery group (D12:37), apparently of second-century date (see Phase 1), found in the connecting primary drain channel in Room 2 (D12:38), which was taken out of use and backfilled at the same time as conduit D11:33.

The via quinta a and the street to the east of Building 8 (Fig. 5.31)

A heavy stone surface was now laid over the western *via quintana* (D12:27, E12:12) and the north-south roadway to the east of the hospital (E12:30, E11:56, F12:14, F11:23, F10:32, 34, 36), forming the third phase of metalling recognised in 1977 on these roads. It was composed of fairly large, angular stone up to 0.40m long, incorporating flags and building material, including some facing stones. The stone was well packed and exhibited varying degrees of wear, but did not display the distinctive cart ruts of the preceding, Phase 2 road surface. To the north of the hospital the equivalent metalling (F10:36) included fewer large blocks. The survival of this metalling was patchy, being limited to areas immediately south of the hospital and at either end of the north-south roadway. The inclusion of so much building material in this surface suggests it may have been laid following the demolition of certain fort buildings. The surface is also markedly similar in composition to the Phase 3 surfaces in both the entrance passageway and the courtyard of the hospital, providing a probable association between

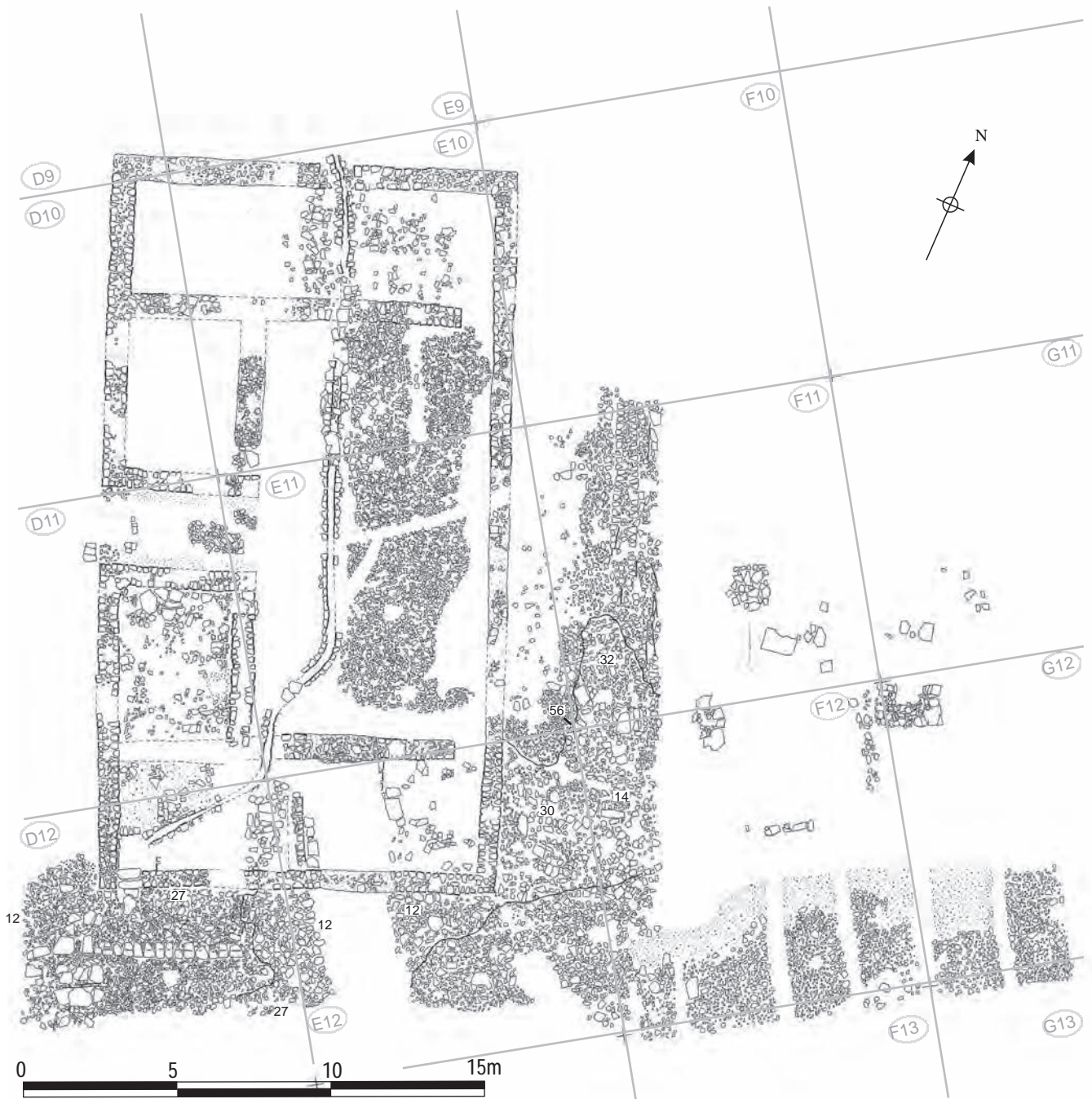

Figure 3 Building 8 and adjacent road surfaces, Phase 3 at 0

the phasing of the hospital and the *via quintana*. The use of angular stone blocks to form the surfaces in all these areas, but not in the internal rooms of the hospital would appear to rule out the possibility that the stone derived from the demolition of the hospital itself.

This surface was completely cleared from the north-south street and the east wing of the hospital by the excavators in 1977 and 1983 and did not therefore figure in the section of the TWM 1997–8 excavation report which dealt with the road surfaces on this street (Hodgson 2003, 133, 136). There is no explicit

reference in the context records to the equivalent deposits on the *via quintana* being removed, but this may have occurred there too, since, despite their distinctive character, they were not recorded in 1997–8.

Dating evidence

The road contained pottery of the third century. The largest group came from E12:30, which also contained a few sherds from a single Crambeck reduced ware jar, possibly pressed in from a later period.

The Phase 4 hospital (Fig. 5.32)

Summary: Phase 4

This phase was defined by the insertion of a new conduit along the west side of the courtyard (E10:30), leading to a remodelled latrine. The courtyard was resurfaced with river cobbles (E10:09, E11:02), with gravel intermixed in certain areas (E10:10). This surface was reportedly similar to the fourth layer of metalling (D12:12) uncovered by Daniels at the west end of the *via quintana*, but there was no evidence of a comparable surface surviving over the north-south street, to the east of the building.

Water channel

The Phase 4 conduit (E09:53) diverged from the earlier channel (E09:34) in the southern part of the assembly area, c. 4.00m north of the hospital, the redundant stretch (E09:33) of the old channel being blocked off by the east wall of the new drain. The conduit pierced the north wall of the building and crossed Room 8 (as E10:33), although the drain side walls did not survive within this room, only a scar left by the actual channel (E10:75). Adoption of the new drain course must have entailed rebuilding at least part of the hospital's north wall and it is likely that the short surviving stretch of rebuild (E10:39) to the east, which deviated southward from the original line of the north wall, belongs to this phase. Continuing southward, the new channel (E10:30, E11:13) ran parallel to and only 0.50m from the west wall of the courtyard, much closer than its predecessor (E10:25). The gap between the east wall of Room 1 and the side wall of the drain was filled by a dark grey-green clayey loam (E11:15). The width of the actual channel varied between 0.25m–0.35m, averaging 0.30m, reaching 0.70m–1.10m with the side walls included. The construction was much rougher than its predecessor, the side walls generally consisting of just a single course of large blocks or sometimes flat stones pitched nearly vertically (see Fig. 5.30 above, 5.38 below). No capstones remained. In the south-west corner of the courtyard the new conduit followed the line of and incorporated the previous, Phase 3 channel, the small stonework of the earlier drain walls being surmounted by the much larger blockwork of this final phase of the water supply. The new, upper level channel was wider than the lower, Phase 3 channel, measuring between 0.35m–0.40m.

Rooms 2 and 3

The Phase 3 wall (E12:35), which had separated Rooms 2 and 3, was demolished and the latrine room reduced back to its original size by constructing a new wall (D12:05), c. 1.80m to the west, on essentially the same line as the primary wall which had divided

Room 2 from Room 3 during Phases 1 and 2. The southernmost stretch of the conduit, which reused the Phase 3 drain, ran through the area reincorporated into Room 3, and was associated with a new stone-flagged floor (E12:02), laid over the demolished wall, E12:35.

The latrine

The reinstatement of wall D12:05 was probably accompanied by the rebuilding of the north wall of Room 2 as well. The lowest, primary course of north wall, D11:10, and the blocking of the doorway at the west end of this wall, inserted in Phase 3, were both overlain by a quite distinct course clearly belonging to a later rebuild (see Fig. 5.26 above). This upper course was actually wider than the courses it overlay. The reinstatement of east wall D12:05 and rebuilding of the other walls were associated with a major remodelling of the latrine. The cesspit and the Phase 3 channel running diagonally across the room were abandoned and filled in. Instead the conduit now issued into an L-shaped latrine channel set against the south and east walls of the room, the walls actually forming one side of the channel. The channel ran the full length of the east and south sides of the room and averaged c. 0.40m in width, with a single-faced wall forming the north (D12:24) and west (D12:17) sides (Fig. 5.33). Presumably the channel was surmounted by bench toilet seating set against the two walls. In the south-west corner, the drain wall (D12:24) extended across the former cesspit to abut the west wall of the room. Foundation packing (D12:41) in the form of flat stones or small blocks was laid in the east side of the cesspit to support the drain wall, whilst a large rectangular slab was laid in the western part of the pit, over the tacky, dark-brown clayey fill (D12:34). The slab was itself partially capped by one of the stone seats presumably belonging to the previous phase(s) of the latrine (Fig. 5.34). The effluent was still flushed out through the original outflow in the south-west corner of the room.

The south-east side wall (D12:35) of the Phase 3 channel was partially dismantled – presumably the stones were pulled out for reuse in the Phase 4 drain walls – and the resultant cavity filled with loose black soil (D12:30), overlying the silt (D12:31) deposited while the channel was in use during Phase 3. The black soil was in turn overlain by soft, yellow lumps of limey mortar (D12:16). Over the remainder of the room there survived the remains of a flagged floor (D12:14) and a layer of brown loam flecked with charcoal (D12:25), presumably bedding for the sandstone flags, which overlay grey clay makeup (D12:33) in the south-west part of the room.

Right in the south-east corner of the room, the lowest course (D12:39) linking the south and east walls curved round to improve the flow of water



Fig re 3 Hosp tal (Building 8 Ph se 4 at 0

around the bend, whilst the courses above made a normal a right-angled junction. The northern side wall of the drain (D12:24), originally neatly-constructed, was apparently furnished with a very rough cladding of blocks (D12:43), to form a rounded corner matching the opposite face of the channel, narrowing the width of the channel from 0.38m to 0.28m at this point. This was considered by the excavators to have been a deliberate later modification, designed

to improve the flow around the bend, rather than simply representing the partial collapse of the drain wall's upper courses into the channel.

Entranceway (Fig. 5.35)

The doorway into the building was narrowed by the construction of short responds on either side (D10:08, D11:12). The responds were 0.58m wide and



Fig re 3 The Ph se 4 latrine from the west with a reused latrine seat forming part of the side wall of the south channel.



Fig re 5 The Ph se 4 entranceway



Fig re 3 The large slab and latrine seat used to form the side wall of the Ph se 4 latrine channel in the south west corner of the hospital.

their respective lengths were 0.40m–0.45m (north) and 0.60m–0.65m (south), reducing the width of the doorway to 1.50m. The south respond sealed a deposit of light yellow-grey clay loam (D11:47) which in turn lay on top of the stone pack on the south side of the entrance (D11:42).

Room 1

The floor level in Room 1 was raised, most probably during this phase, with the deposition of a makeup layer of dark, clayey loam and stone (D11:15/27) over flagging D11:16. Only one fragment of the surface survived, however, in the form of a small patch of flags (D11:29) on the west side of the room, most traces of this latest floor having been destroyed by eighteenth- to twentieth-century disturbance. At the same time, the secondary doorway (E11:24) into Room 1 was either blocked or more likely its sill was raised with a course of faced stone and rubble (E11:08) to match the new floor level.

Room 8

A level of heavy flags (E10:36), revealed in the eastern half of Room 8, was attributed to this phase by the excavators in 1983. This flagging overlay a layer of rubble (E10:43, 53), which covered the previous flagged floor (E10:54) and may have derived from the partial demolition of the north and south walls of the room. The flagging appeared to extend over the remains of the south wall of the room (E10:55), implying that the area was open to the courtyard by this stage. Construction of the new water conduit must have involved demolishing at least a section of the north wall and a new doorway may have been established at this point where the channel entered the building. To the west, the remainder of the north wall would appear to have been rebuilt at this stage, with the new wall diverging onto a slightly more southerly alignment than its predecessor, although only a 1.90m length of this rebuilt wall survived (E10:39). At only 0.60m in width, the new wall was significantly narrower than the original north wall.

FINDS

Make up for floor, Room 1

Coin: Domitian under Vespasian, 76 (no. 18, D11:27)

Pottery: lamp (no. 7, D11:15), pierced disc (no. 78, D11:15)

Quern: beehive (no. 3, D11:15)

Cess pit fill

Architectural stonework: latrine seat (no. 8, latrine wall in cess pit)

Samian stamp: 175–200 (no. S15, D12:34)

Demolition/rubble, Room 8

Amphora: incomplete stamp (no.10, E10:43)

Pottery: counter (no. 55, E10:43)

Dating evidence

The two assemblages from the floor makeup within

the Room 1 were very different in character, though deriving from different cleanings of what was essentially the same context (D11:15/27). The smaller group, from the second cleaning, had a lot of BB1, some sherds of second-century fine wares and only a few sherds of BB2 (D11:27), whilst BB2 and allied fabrics made up three-quarters of the coarse wares in the larger group (D11:15). This context also had material dated to the third century in the form of a G151 cooking pot and a Nene Valley colour-coated ware beaker.

The pottery in Room 8 consisted of a high proportion of BB2 and allied fabrics. Third-century pottery included Nene Valley colour coated wares and a Yorkshire grey ware vessel (E10:43, E10:33). Only a single sherd of late third century+ material was recovered – a fragment of Crambeck mortarium flange (11g) in the rubble layer (E10:43) beneath the Phase 4 flagging.

Room 2 drain fill

The fill of the Phase 3 drain in the latrine chamber produced third-century material such as Nene Valley colour coated wares and Dales ware, as well as a single sherd of a thin-walled calcite-gritted ware vessel (D12:19, D12:22). Although major importation of this ware into the region only began from the late third century, it is clear a few vessels arrived earlier in the third century, perhaps alongside Yorkshire grey ware vessels from the same area.

Secondary conduit

A small quantity of third-century pottery was found in the secondary conduit, which became redundant at the beginning of Phase 4, including a sherd of Central Campanian amphora dated to after the mid-third century (E09:33) and a third-century vessel of form Gillam 151 (E10:25) (see under Phase 2). In all likelihood the backfilling of the channel represents the final point when this material could have been deposited in the conduit, although it should be noted that neither this channel nor its Phase 4 replacement was apparently sealed after its abandonment, both being largely devoid of capstones when excavated.

These assemblages hint at a mid-third-century date for Phase 4, perhaps just stretching up to c. 270.

The via quinta a (Figs 5.36, 5.37)

The fourth distinct layer of metalling identified by Daniels over the western *via quintana* was characterised by large, rounded, river cobbles (D12:12, E12:11), up to c. 0.20m in length, worn smooth, but not flat, similar to those used in the Phase 4 surface of the hospital courtyard (E10:09, E11:02). This road metalling was recorded in the stretch of the *via quintana* near the south-west corner of the hospital and also extended northward as the uppermost surface of the *intervallum*

road (D12:10, D11:18, D10:09). A small patch of metalling, which may belong to the same period, was recorded towards the north end of the street on the east side of the hospital, overlying the remains of primary east wall of the building, although there is no direct link with the other areas of Phase 4 surfacing.

The surface incorporated a line of worn flagstones (in D12:12) which ran for 7.00m along the centre of the carriageway, parallel to the south wall of the hospital (Fig. 5.36). The flags varied in width from 0.20m–0.60m and were interpreted as the cover slabs of a central drain, though no attempt was made to lift them and the fact that they were all flush on the south edge with tails laid towards the north is more characteristic of road kerbstones than drain cover slabs (and this is how they were interpreted in 1997–8: see Hodgson 2003, 160–1). The line of flags changed direction slightly at the west end of the excavated area and were in line with slabs forming the northern side of the central drain which led through the *porta quintana*. These formed part of the penultimate road surface revealed in the *porta quintana* (TWM 7044, probably equivalent to Daniels' C12:04). The metalling to the north of the line of slabs was largely removed



Figure 5.6 The *via quintana* south of the hospital with the late Roman level exposed including the kerb line.



Fig re 5 37 The *via quintana* beside the south west corner of the hospital with predominately late Roman surfaces exposed. The flags to the south of the kerb may be a relic of an earlier road surface (early 3rd century – TWM Period 3).

by Daniels in 1977 (although one patch may have been left *in situ*, being recorded in 1997–8 – TWM context 7154). That to the south was left in place and was re-excavated in 1997–8 (TWM 7697). The cobbled metalling must have extended at least 1.50m further east wards (as E12:11) when first exposed in 1977, but this part of the surface was not planned and was removed to reveal the previous level (E12:12).

To the north, between the kerb line and the latrine outlet, several more flagstones were evident in this surface when first uncovered, including two, immediately to the south of the latrine outlet, which gave the appearance of being possible cover slabs for the latrine outflow drain. Further investigation, in 1997–8, however, revealed that these were only the most visible examples of a more extensive cluster of irregular flags at this spot (Hodgson 2003, 160, fig. 115), which were considered to form part of the road level (TWM 7154) associated with the kerb line (7911). On the other hand, excavation in 1997–8 suggested that another group of large, flat slabs, which were very apparent at this level (see Figs 5.36–5.37), actually belonged to an earlier road surface (TWM Period 3). These were laid in a roughly rectangular setting in the road surface immediately to the south of the kerbstones, and represented capstones (TWM 7314) over the latrine outflow drain, which ran southward along *intervallum* road (see Hodgson 2003, 160–1, fig. 112).

Like those in the gate passageway, all the *via quintana* slabs were heavily worn with wheel ruts running the full length of the kerb, being especially pronounced on the five most easterly stones. These ruts were similar to those observed on the Phase 2 road surface east of the hospital, and were presumably caused by heavy cart traffic.

Dating evidence

LATEST SURVIVING SURFACE OF THE *VIA QUINTANA*

Coin: Constantius II, 330–35 (no. 187, E12:11)

The five sherds of pottery from this phase were all samian (D12:12, E12:11), the latest sherd dated to the late second or first half of the third century (D12:12), but a coin of Constantius II (330–35) was also found in E12:11.

Discussion

The uppermost *via quintana* surface, which incorporated the stone slab kerb, was ascribed to the mid-fourth century when re-excavated by Tyne and Wear Museums in 1997–8, whereas Daniels had considered this road surface to be contemporary with the last phase of the hospital. There is no evidence that occupation of the hospital lasted into the fourth century. It appears to have been demolished and replaced by a series of timber buildings using post-hole construction well before then (see below and Chapter 6).

Abandonment and demolition of the Hospital

In the courtyard, the Phase 4 conduit was filled, presumably on abandonment, by a greenish-black, clayey silt (E11:37) and a dark clayey loam containing a lot of charcoal (E11:14). This upper fill included one of the primary courtyard gutter stones (Fig. 5.38). The L-shaped latrine channel in Room 2 was filled with dark clay containing small fragments of coal (D12:19, 22).

Over most of the hospital the rubble layers which might have resulted from the demolition of the building were thoroughly disturbed and contaminated by effect of later ploughing and other post-Roman activity (see below). Only in the south-west corner of the courtyard was relatively undisturbed demolition rubble present which can be associated with the end of the hospital (E11:09 – see Fig. 5.39). The rubble was covered by and intermixed with a layer of dark clay loam (E11:06), heavily flecked and stained by charcoal and coal. The loam extended southward into western half of Room 3 (D12:08, E12:03), where it covered the Phase 4 flagged floor (E12:02) and was in turn overlain by a small area of surviving flagged flooring (E12:04 – see Fig. 6.21 below). The latter incorporated a shallow drain, V-shaped in section, and may have been associated with post-hole building, N, which replaced Building 8 on this part of the site (see Fig. 5.29 above).

FINDS

Fill of Phase 4 conduit in courtyard

Copper alloy: brooch (no. 31, E11:37)

Graffito: (no. 43, E11:14), (no. 50, E11:14)



Figure 5 Phase 4 water conduit with one of the original gutter stones sitting in the channel having formed part of its fill. View looking south.

Dating evidence

Pottery from the abandonment of the building was very similar in date to the material from Phase 4 occupation.

Fill of the Phase 4 drain

The fill of the Phase 4 drain cut contained a Mancetter-Hartshill mortarium dated 170–230 (E10:75), whilst a sherd of BB1 cooking pot with a groove above obtuse angle lattice suggests occupation lasting at least until the middle of the third century (E10:33). Approximately three-quarters of the larger group of pottery from context E11:14 was made up of BB2 and allied fabrics, including an example of a third-century Gillam 151 rim and Nene Valley ware. The associated channel north of the building (E09:34) contained a sherd of East Yorkshire grey ware of the late third century or later.

Hospital demolition rubble (E11:09)

Context E11:09 produced over 100 sherds of coarse wares, most of it BB2 and allied fabrics, and sherds



Figure 9 Hospital demolition rubble E11:09 (from south).

from four mortaria, including an incomplete Mancetter-Hartshill mortarium rim that was probably third century in date. There was also the rim sherd from a Nene Valley funnel-necked beaker, and a sherd of Central Campanian amphora. The beaker type was made from the second quarter of the third century, but may not have reached the north in any numbers until after 250, while the amphora dates to the mid-third century or later. Overall the assemblage was mainly composed of third century material, including Yorkshire grey ware and BB1 with a groove above the lattice decoration (250+), but no Crambeck reduced ware and no calcite gritted ware, pointing to a date after *c.* 250 but before *c.* 270 for the demolition of the hospital.

The dark soil layer (D12:08, E11:06, E12:03, 04), which overlay the demolition rubble and formed the makeup and bedding for the fragmentary flagged floor of post hole building N, was also predominantly composed of BB2 and allied forms. However it also contained four sherds of Crambeck reduced ware and several other forms dated to the late third century or later, including the spout of a Lower Nene Valley mortarium (E11:06), two Nene Valley ware funnel-necked beakers with slightly beaded rims, as well as a number of BB1 vessels, which begin to reappear in quantity in the late third century. There were also four radiate or illegible coins (nos 156, 163, 169, 264) giving a *terminus post quem* of 273 (D12:08). There are joining sherds between E11:09 and E11:06 (suggesting some mixing between the two). The small quantity of Crambeck reduced ware and lack of calcite gritted ware in the soil suggests a date not long after 270 for the construction of the timber buildings which replaced the hospital (see Chapter 6), slightly later than that provided for the demolition of the hospital itself by the assemblage in the underlying rubble (E11:09).

Rubble demolition/disturbance layers over Building 8 and associated road surfaces (b3)

Much of Building 8 and all of the surrounding roads

were covered by rubble layers which were probably a mixture of building demolition and, more especially, plough disturbance. The rubble to the east of the hospital (E12:08, E11:55, F11:19) was contaminated by upcast from an adjacent early-modern trackway (E11:17, F11:20, E12:45, E10:13) which ran on a roughly north-south alignment immediately to the west.

FINDS

Rubble over Building 8

Graffito: (no. 34, D12:09)

Glass: bead (no. 18, D12:09)

Pottery: counter (no. 59, E10:53)

Rubble over Building 8 and intervallum road

Coin: illegible, first to third century (no. 249, D12:02)

Copper alloy: rod (no. 326, D11:02)

Lead: disc (no. 30, D11:02)

Rubble over Building 8, via quintana and road to the east

Copper alloy: strip (no. 299, E12:08)

Intaglio: goat (no. 4, E12:08)

Quern: lava (no. 26, E12:08)

Rubble east of Building 8

Coin: illegible, first century (no. 231, F11:04)

Dating evidence

Context E12:08 produced over 30 sherds of pottery, much of it BB2 and allied fabrics, but only two sherds of Crambeck reduced ware. One of these was a Type 1b bowl, dated to after 360, but as the assemblage contained only two sherds of this ware and no calcite-gritted ware at all, it is likely this sherd is intrusive. Context D12:11, however, did contain fourth-century material. About a third of the assemblage was made up of calcite-gritted ware, including a Huntcliff-type rim dated 360+. There was also a Crambeck mortarium rim of a similar date.

Most of the material over Building 8's west wall and the *intervallum* road was third-century in date, as was material from the spread over Rooms 8 and 9. The latest material came from D11:02, with at least three Crambeck reduced ware vessels, providing a third-century date.

The rubble over the east side of the building contained a single sherd of Crambeck reduced ware, but the pottery from the rubble to the east of the building was made up of approximately 20% Crambeck reduced ware and calcite-gritted ware (F11:02).

Discussion: auxiliary fort hospitals (Fig. 5.40)

The structural parallels for Buildings 21 and 8, and

the evidence for their function were discussed in the report on the 1997–8 excavations (Hodgson, 2003, 126–7, 139–40). There is relatively little which can be added to that treatment here, but it is worth recapping and, where possible, augmenting Hodgson's arguments.

A strong case was made for interpreting Building 8 as a hospital. Building 21 was also identified as a possible hospital on the basis of parallels with other structures, although much more tentatively. Some kind of stores building, workshop (though no trace of metalworking was found) or as yet unidentified residential purpose are also possible functions for this structure and perhaps the strongest support for its identification as a hospital is the fact it occupied the same site as Building 8.

Hospitals (*valetudinaria*) were certainly present in at least some auxiliary forts. They are mentioned in the Vindolanda tablets (*Tab. Vindol.* 2, 155.6) and in some inscriptions (e.g. ILS 9174=CIL III 14537). Two types of building which might represent such *valetudinaria* have been identified archaeologically. The first takes the form of a rectangular courtyard building with linear ranges of rooms disposed on all four sides of the central courtyard. The best known examples of this group are Housesteads Building IX and Wallsend Building 8 itself. Indeed the overall size and proportions of the original Hadrianic version of Housesteads Building IX, before its later slight enlargement, are virtually identical to those of Building 8, but the same is also true of a much less extensively excavated courtyard building of very similar form at Hod Hill and it clearly belongs to the same group. Benwell is somewhat different being squarer in plan. It was firmly identified as a courtyard building by Simpson and Richmond after the final work on the structure in 1937 (1941, 22), but this is not apparent in Petch's accounts of the much more intensive 1926–8 excavations, responsible for uncovering the eastern half of the building (1927, 153–6; 1928, 48–52). Those reports talk only of rooms in the centre of the building. Simpson and Richmond are probably correct and it is likely that the flagged central rooms, 5 and 7, identified by Petch actually formed part of a courtyard, but the presence of stretches of walling there implies that rooms did encroach on the area at some stage in its history and its layout may have been more complicated than the other buildings of the group.

The second type of building consists of two rows of rooms laid out on either side of a broad corridor or central space. It is this type which Building 21 most closely resembles. Other possible examples are known at Strageath, at Kunzing and Oberstimm (Building 3) on the German frontier, and perhaps at Corbridge. The suggested courtyard building on the west side of the granary at Haltonchesters might also fall into this category, if the plan of those complex remains has been correctly interpreted (cf. Dore 2010, 15–24).

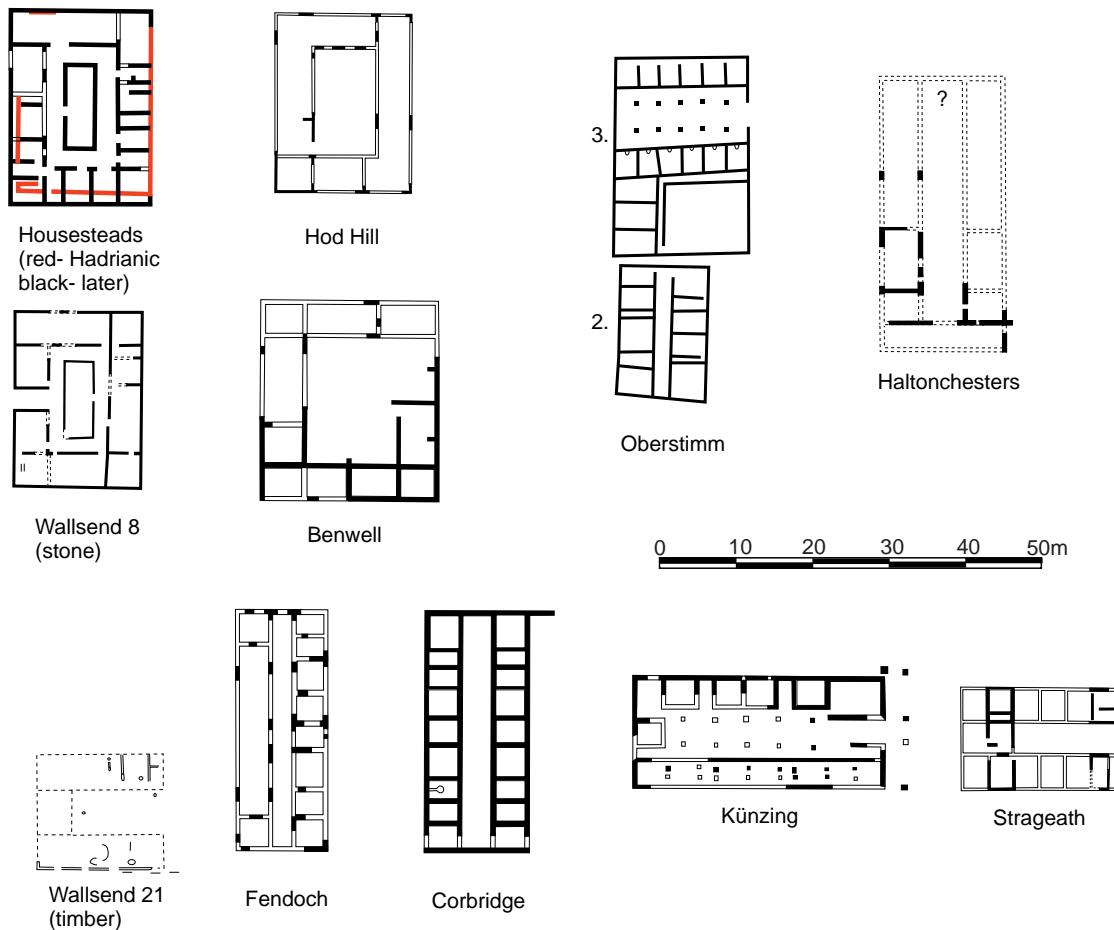

Figure 5.40: Comparative plans of a range of possible hospital buildings based on Hodgson 2003, fig. 88, with additions. Scale 1 0

A number of other buildings previously grouped with the second type, characterised by rows of rooms on either side of a narrower corridor were discarded by Hodgson because of their similarity to a workshop building at Corbridge Red House (2003, 126–7). These included examples at Fendoch, Oberstimm (Building 2) and perhaps the Corbridge building noted above. It is also worth noting that at least some of the buildings with a central space, notably Haltonchesters, Strageath, and Künzing, appear to have been furnished with a third range, closing off at least one of the narrower ends. This suggests that these two types were not so very different in their form and were distinguished principally by the change in the character of the central space from a central lightwell to a fully fledged courtyard.

It should be emphasised that the identification of these building types as hospitals is not based on their direct association with finds of medical implements or dedications to healing deities, let alone an inscription actually designating one of the buildings in question as a *valetudinarium*. Hodgson (2003, 140) noted the possible significance of the unusual concentration of finds of lamps from Building 8 in view of their

suspected associations with death and religion. In addition, two medical instruments (copper alloy: nos 99–100) were found with other copper alloy small finds in a layer of ash, coal waste and other debris over the remains of a workshop in the west rampart space, directly opposite Building 8, on the other side of the *intervallum* road. This was perhaps metalworking debris redeposited when the rampart bank was reinstated over the workshop and the instruments might conceivably have originated as scrap gathered for recycling from the hospital directly opposite. The paucity of direct evidence is in marked contrast to hospitals excavated in legionary fortresses, such as Neuss and Novae, where finds of medical instruments and, in the case of Novae, a shrine to Aesculapius and Hygieia in the central courtyard, have been made. Instead their interpretation as hospitals is based on the overall morphological characteristics of these structures, including their supposed resemblance to the legionary hospitals.

Despite the lack of direct evidence, it was not long after the first known example of the courtyard building type – Building IX at Housesteads – was excavated and published by Bosanquet (1904, 239)

that it was identified as a hospital (Stuart-Jones 1912, 255, cited by Simpson and Richmond 1941, 22–3 when comparing Benwell with that building). This interpretation has generally been accepted since (cf. Charlesworth 1976, for example). The type certainly displays a distinctive combination of features. These include the presence of domestic hearths in some rooms, suggesting a possible residential function, and the provision of a communal latrine in one corner. However the lack of a bath suite or other underfloor heated rooms demonstrates these buildings would not have provided accommodation for senior dignitaries – officials with rank approaching or greater than that of the regimental commander. Any such visitors probably have resided in the *praetorium* as guests of the commanding officer during their stay. Thus, despite provision of a colonnaded courtyard, these buildings were not simplified versions of the commandant's peristyle house nor even *mansio*-type hostels, since a bath suite would be anticipated even in the latter case. Nor does it appear likely that these buildings were intended to provide accommodation for officers and officials of lesser rank, whose status would not require the provision of underfloor heating or their own bath suites. There was no obvious need since such officers – the centurions and decurions – had their own houses attached to the barracks of the men under their charge.

The articulation of the rooms also appears simpler in these buildings than in the *praetoria* where there is evidence for suites of interconnecting rooms. In Building 8 most rooms appear to have been entered directly from the courtyard, although the relatively poor preservation of several of the ranges at both Wallsend and Housesteads means that some evidence for connecting doorways has been lost. There is no indication as to how access to the south-east and north-east corner rooms, 4 and 7, was gained, but it must have been from one of the adjacent rooms since neither room could directly open on to the courtyard. Thus the similar latrine room (2) was originally entered from Room 1 and later (in Phase 3) was enlarged at the expense of Room 3, to permit direct access to the courtyard. Housesteads Building IX is more difficult to disentangle, the picture being complicated by a substantial secondary rebuilding. Some rooms do appear to have had interconnecting doors, particularly in the east range, but generally only pairs of rooms or three at the most (Charlesworth 1976, 20).

Perhaps the most significant characteristic of these buildings is the elaborate treatment given to the courtyard. The Daniels excavations in the courtyard of Building 8 provided abundant evidence of this treatment, exposing the surrounding portico, complete with a low stylobate for the colonnade, the carefully constructed gutter channel alongside the stylobate plus the connecting carved stone basins

in the corners which collected rainwater flowing off the portico and the main inward-facing roof slopes. There is also some evidence that water from the large cistern to the north of the hospital (Cistern 1) was fed via a conduit into this guttering, perhaps with the aim of directing the water round the courtyard ultimately to flow into the communal latrine in the south-east corner of the building. The courtyard of Housesteads Building IX was similarly furnished with a surrounding portico in its earlier phases and a drain channelling rainwater from there to the latrine in the building's south-east corner. Such features would have been wholly unnecessary in a workshop or storehouse and their presence in these courtyard buildings provides the strongest indications that this type of structure performed a very different function. Instead the buildings clearly represent communal facilities imbued with the aesthetic values of classical urban civilisation. If correctly interpreted as hospitals – and all the other possibilities would appear to have been ruled out – they would have constituted a powerful symbol of the emperor's concern for his soldiers and his determination to furnish them with the best facilities that Roman civilisation could offer.

Thus the purpose of the ornate portico may be regarded as essentially propagandistic or ideological. One could imagine recuperating soldiers being brought out from the wards and laid beneath the portico during warm weather, but it was clearly not necessary for the actual functioning of the courtyard buildings since it was subsequently demolished and flagged or cobbled over at both sites. In Building 8 a covered walkway supported by timber uprights was provided along the east side of the courtyard, instead, during Phase 2, but there is no evidence for even this kind of replacement shelter at Housesteads.

The positioning of those buildings which could be interpreted as hospitals shows a degree of variation. Two main locations appear to have been favoured, either at one end of the main central range buildings or in a more withdrawn position to the rear of that range. Thus the Building 8 was positioned immediately west of the granary, but set further to the south than the other three main buildings. The courtyard building at Haltonchesters too was situated between the granary and the *intervallum* road, but the corresponding position at Benwell was occupied by a narrower building interpreted as a *fabrica* on the basis of the discovery of a mass of smithing debris (Simpson and Richmond 1941, 21–2). The suggested courtyard hospital at Benwell was not even located in the *latera praetorii* at all but in the north-east corner of the *retentura*, opposite the *praetorium*. Housesteads Building IX, on the other hand, was located in the central range, behind the *principia* which was smaller than usual because of the difficult nature of that site. At Fendoch the central corridor building lay in the *latera praetorii*, in this case behind the *praetorium* and

principia, although this building may have been a workshop, as argued by Hodgson. Other ancillary buildings (for stores?) lay behind the granary and the rest of the *principia* at that fort. Although this only represents a small sample it appears sufficient to show that priority was given to the *principia*, *praetorium* and granaries in the allocation of building plots along the frontage of the central range. In forts with squarer proportions, such as Wallsend or Haltonchesters, the hospital might be slotted in there as well. However in more narrowly proportioned, oblong forts, such as Housesteads, Benwell and Birdoswald for example, there was insufficient space and the hospital – assuming there was one – would have been slotted in wherever convenient to the rear of the principal buildings, along with other ancillary structures.

The courtyard hospital buildings are generally reconstructed as having two storeys. The various

reconstruction drawings of Housesteads Building IX prepared since its excavation in 1969–73 all depict it in this form (see Charlesworth 1976, 21, fig 2; Crow 1989, 23 (Frank Gardiner); 2004, pls 3 & 11 (Philip Corke)). Gardiner's illustration shows the superstructure as half-timbered with wattle and daub infilling, at least at first floor level, but more recently Corke has depicted the walls as stone-built to their full height and there is no reason to doubt this was feasible even if it cannot be proved. Certainly, no definite remains of stairs leading to an upper storey have been found, however the narrow space at the north end of Room 6 in the east range of Building 8 could have been designed to support just such a staircase, rather than representing an entrance passage through the range. Similar narrow spaces are also evident on Charlesworth's plan of Building IX, again particularly in the east range.

6. THE TIMBER BUILDINGS AROUND THE GRANARY

Introduction

The area bounded by the south end of the granary, the south-west corner of the *principia* and the east side of the hospital witnessed further phases of activity corresponding to Fort Period 4, which principally involved the construction of a series of timber buildings employing the post hole technique. Three such buildings, each roughly the size of a *contubernium*, were laid out in a row immediately south of the granary. These went through a succession of structural alterations. Other post-hole buildings also appeared to extend westwards and northwards over the southern approaches to Alley 9 and the remains of the hospital, which must therefore have been demolished by the time these particular structures were erected.

As noted previously, interpretation of the structures encountered in this area was complicated by the fact that it was excavated in three separate stages – 1977, 1981 and 1983 – with the significance of the 1981 season’s results, in particular, not being fully

appreciated when the Daniels structural summary and overall phasing was formulated. The interpretation outlined above represents a wholesale revision of that previously presented by Charles Daniels in summary form and was first proposed following re-excavation of this area by Tyne and Wear Museums in 1997–8 (Hodgson 2003, 140–52). Daniels previous interpretive scheme is summarised below, followed by a discussion of the reasoning behind its revision following renewed excavation. The results of the 1975–84 excavations are then set out in detail. Re-examination of the Daniels excavation data in the light of the revised interpretation of 1997–8 has in turn led to further improvements in our understanding of this area’s structural development.

Daniels’ interpretation (Fig. 6.01)

The structural sequence which Charles Daniels’ team proposed began with a stone building (labelled Building T), erected in the area to the south of the

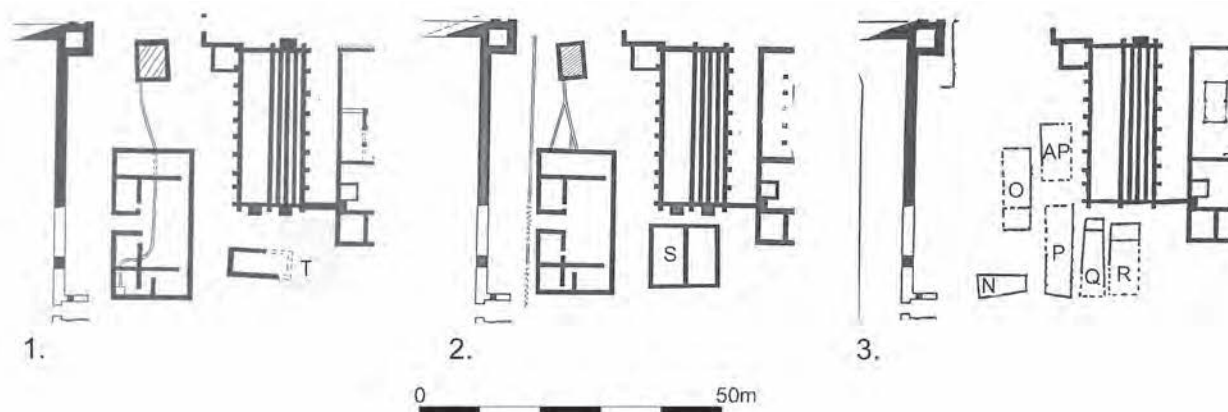

Fig. 6.01 Daniels’ interpretation of the later structured phases in the eastern part of the central range. 1. Late third/early fourth century 2. Early fourth century 3. Later fourth century Scale 0 50m

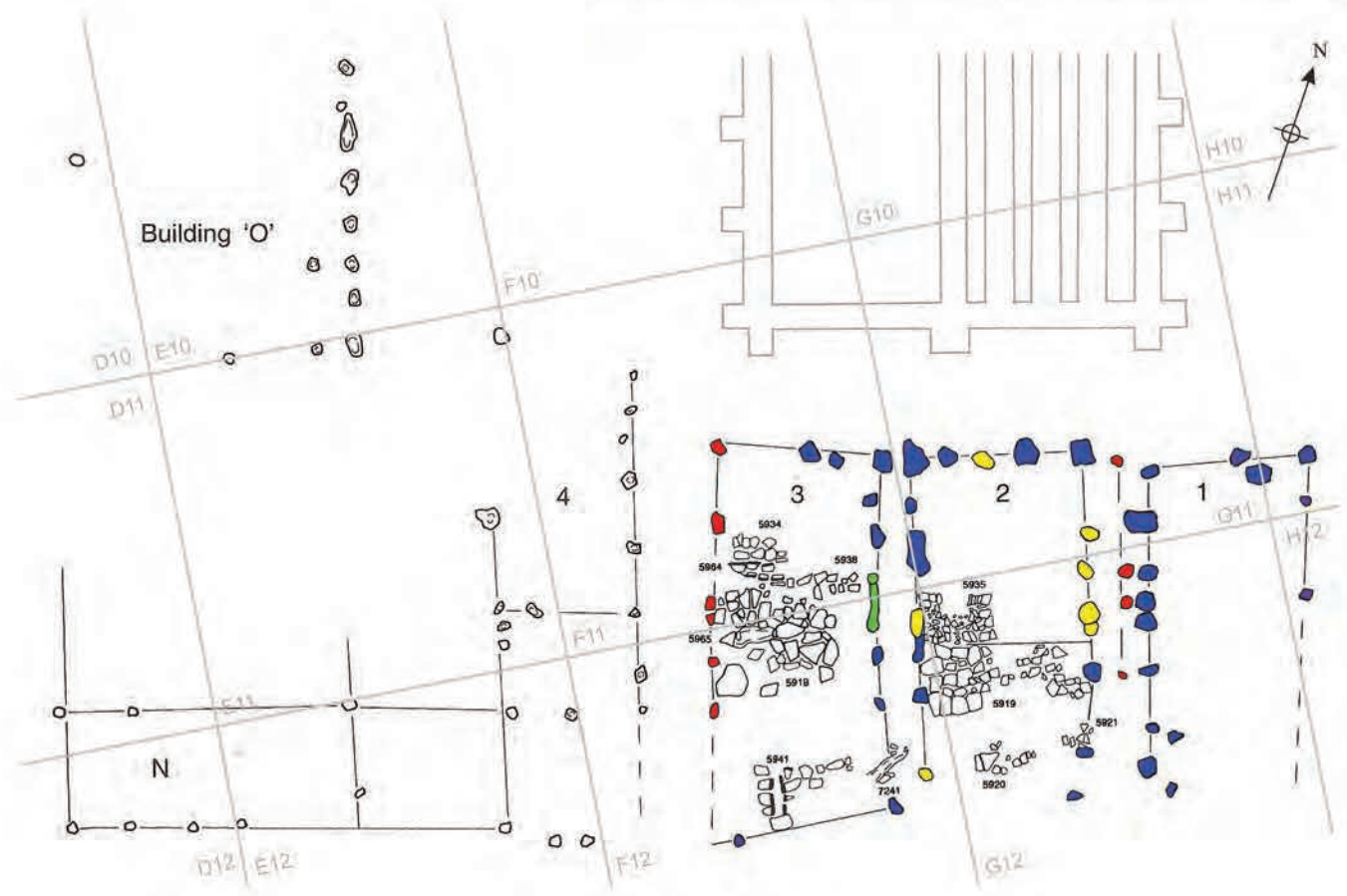
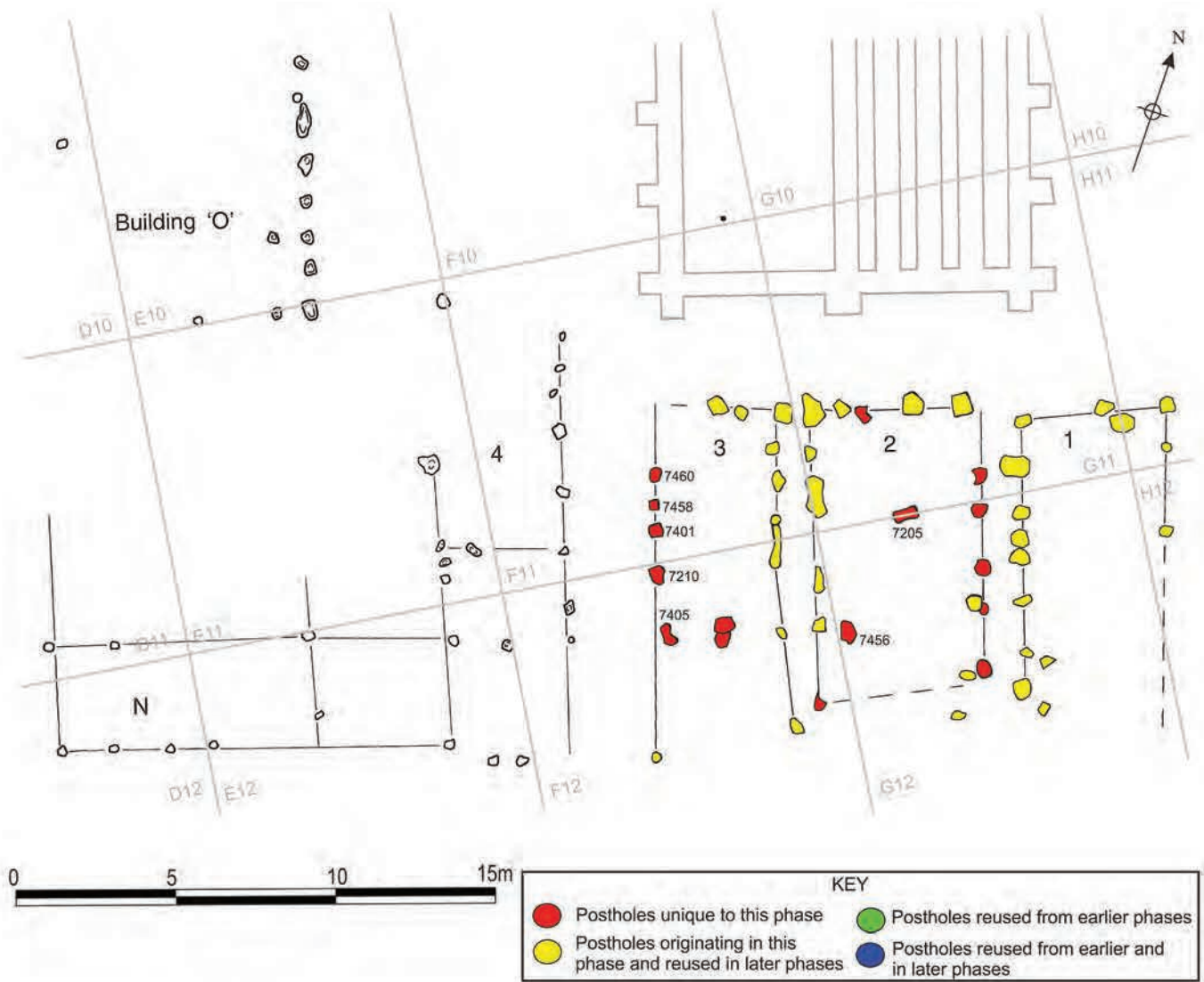

Figure 6.02: 1997–8 excavation phases A (top) and B (bottom) (based on Hodgson 2003, 144 figs. 99–100). Scale 1:250.

granary and immediately to the east of the north-south road which covered the former east wing of the hospital. This was ascribed to Daniels' Fort Phase 3 (i.e. the late third/early fourth century) and considered to be contemporary with Phase 2 of the hospital. However the remains of the structure, as restored, were very fragmentary. The most substantial surviving components comprised areas of flagged flooring. The building was interpreted by the excavators as a rectangular structure, aligned roughly east-west with overall dimensions of approximately 11.5m east-west by 5m north-south (internally). The long side was roughly parallel to the *via quintana* and a small, east-facing porch was restored. This interpretation was essentially arrived at by considering a rough line of stones (F11:26) within the flagging (F11:10) as the disturbed base of the north wall and the north edge (G12:24) of a large, rectangular, hearth base (G12:13), composed of pitched stones, which lay on the same general alignment, as another fragment of the same wall. Hypothetical lines for the other walls were then simply traced around the two main surviving areas of flagging to the south (F11:10; G12:11). Effectively this restored the building as a single, open-fronted chalet, though it clearly did not share the same alignment as any other chalets or neighbouring buildings.

Building T, was subsequently replaced by a new structure, labelled Building S. This again was assigned to Fort Phase 3, and judged to be contemporary with Phase 3 and 4 of the adjacent hospital. Like its predecessor, Building S was defined by the surviving remains of the floors, in this case spreads of pink-brown clay (F11:11, G11:13), rather than firm evidence of external walls. On the basis of the distribution of the clay spreads, the new building was interpreted as a rectangular structure with dimensions of approximately 9m (north-south) by 11m–12m (east-west). It was not considered entirely certain whether the walls were of stone or timber, but the balance was felt to be in favour of stone. A line of sandstone rubble (F12:06) including occasional faced blocks, which ran north-south between the two main spreads of clay and was continued to the north by a robber trench (F11:18), was thought to represent the partially robbed foundations of an internal, north-south partition dividing the building into two. Surrounding and delineating the extent of the clay spreads were areas of disturbance which the excavators interpreted as robber trenches although the outer edges of these trenches were difficult to define.

Building S, in turn, was replaced by two post-hole constructed buildings, labelled Q and R. These were orientated roughly north-south, on the same alignment as the two halves of S. Other post hole buildings, designated P, N, O, and AP were recognised to the west and north-west, overlying the remains of the hospital, which must have been demolished by this stage, and the north-south street. However no

floor levels associated with the lines of post-holes were identified with certainty and it was assumed that these levels had largely been removed by post-Roman truncation of the archaeological deposits across the site. These timber buildings were attributed to Fort Phase 4 (the later fourth century) and were considered to represent the final phase of Roman occupation in this part of the fort.¹

This remained the preferred structural sequence, published in a variety of interim reports, until fieldwork resumed in 1997, although a number of issues were not fully resolved. 'Building T', in particular, appeared somewhat suspect – linking a collection of disparate elements, whilst excluding other apparently closely related structural components.

The 1997–8 excavation results (Figs 6.02, 6.03)

When the area was re-excavated by Tyne & Wear Museums in 1997–8 it was recognised that the flagging of Building T and clay spreads and overlying flags of Building S simply represented the floor levels associated with successive phases of two of the timber post-hole buildings, Q and R, rather than the remains of a series of robbed-out stone buildings. A number of additional post-holes were discovered, enabling the excavators to identify a further building, which was located immediately to the west of the *principia*, and to restore as many as three phases of the timber structures. The layout suggested by the combined evidence took the form of a row of four north-south aligned buildings and one east west oriented structure (Building Row XX, hereafter Row 20). A further example, Daniels' Building O, was located over the northern part of the hospital, the interpretation of this building being essentially unchanged. The three structures south of granary (Units 1 to 3) were roughly similar in size, measuring between 4m and 5m in width and between 9m and 10m in length, each roughly equivalent to barrack *contubernium*. Units 2 and 3 essentially corresponded to Daniels' Buildings R and Q respectively, whilst the newly discovered building (Unit 1) was sandwiched between the Building R and the south-west corner of the *principia*. Unit 4, which was equivalent to Daniels' Building P, was located immediately to the west, over the road leading from the *via quintana* into Alley 9, and, at c. 13.50m in length, was considerably longer than its neighbours. Finally, at the western end of the row, the roughly east-west aligned Building N was smaller than the rest, with dimensions of only 8m × 3.30m. The published plans (Hodgson 2003, 142–5, figs 97–101) restore Unit 4/Building P and Building N as, respectively, the east wing and south-west corner of a larger building complex of somewhat indeterminate form, rather than as a freestanding buildings in their own right, as presumed by Daniels.

The posthole buildings were thought to represent

a single contemporary group and, based on the fact that Buildings N and O were erected over the remains of the hospital, they were all presumed to post-date the demolition of that building. The floor levels of Q and R (i.e. those assigned to Buildings T and S by Daniels) contained third-century pottery assemblages, with no late third century material, and this in turn was considered to indicate that the hospital went out of use and was demolished by the mid-third century and perhaps as early as 225–235 (Hodgson 2003, 139, 147–8, 246).

Discussion

The 1977 excavators were, in fact, acutely aware that two differing interpretations of the evidence were possible in relation to the structures in this area and hence were conscious of the importance of establishing the relationship between the floors levels, particularly those associated with Building S, and the post holes. Consequently the site notebooks contain much discussion of this question under the relevant contexts. It was apparent that *some* post holes did cut through the clay floors of Building S and had clay fill. It would seem that these specific relationships were assumed to apply to all the post holes, even where no trace was noted in the clay, the post-settings essentially being treated as belonging to a single phase. The excavators may not have been confident that post holes which were not recognised prior to the removal of the clay levels did actually predate the clay floors, particularly given the inexperience of much of the excavation workforce and the inherent difficulty in recognising post holes backfilled with clay in a clay level.

The apparent lack of any consistent correlation between the post holes on the one hand and the flagged and clay floor levels on the other led Daniels to conclude that they were not related. Instead the floor levels were seen as representing earlier structures distinct from post-hole buildings Q and R. It was presumed that the floors associated with the latter had been destroyed by later ploughing and robbing disturbance, as in the case of the corresponding post structures over the hospital. Even the possibility that the upper flagging over the clay floors might relate to the later timber buildings, whilst not rejected out of hand, was considered doubtful.

What misled the 1975–84 excavators above all was the sheer complexity of the activity associated with these buildings, with multiple phases involving the repeated replacement of one wall of ground-set posts by another. Whilst some post-hole alignments *did* cut through and post-date the uppermost surviving floors in this area, but this does not mean that all the post-holes belonged to a structural phase which was later than the flagged and clay floor levels. The repeated digging of post holes and the creation of parallel wall

alignments close together also explains the rather ragged form of some of the features. However, the detailed observations made in 1977 are invaluable in helping to phase the various alignments of post-holes.

Linking the post holes and floor levels in this way is easily the most economical interpretation. The absence of even the shortest fragment of surviving masonry walling associated with either the flagging or clay floor seems decisive, particularly when contrasted with the row of small buildings south of the *praetorium* and *principia* (AZ, BA, BB, BK), where fragmentary stretches of stone walling were preserved even though these buildings had been substantially robbed out. Some modifications to the 1997–8 scheme have been made to take account of additional evidence yielded by the 1975–84 excavations, notably at east end of the site, south of Alley 8 ('Building AX'). References to Buildings T and S have been retained as additional labels for the *phases* associated with the lower flagged and clay-floored levels respectively, as the dating evidence has previously been organised under these building headings and this provides a more transparent link to the supporting data in the 1975–84 archive.

The timber building range (Building Row 20)

The three timber buildings south of the granary and the stone structure tacked on to the south-east corner of the granary (TWM Units 1–3 which equate to Daniels' Buildings AX (N & S), R and Q) are discussed first, since a higher degree of preservation was exhibited by this group with surviving floor levels and evidence for replacement of one line of postholes by another, enabling the restoration of several phases of activity. The remaining buildings (N, O, AP, P/Unit 4), which were erected over or immediately adjacent to the remains of the hospital, are described in more summary fashion. They did not appear to have as complex a structural history as their three neighbours to the east/Units 1–3, with far less evidence for the replacement of posts (largely restricted to Building P) and only fragmentary areas of surviving flooring.

Buildings Q, R and AX were all aligned roughly north-south, lengthways, and extended over the area of the former south portico of the granary which must have been dismantled by the time the timber buildings were erected. The surviving base of the portico's central pier was actually enclosed in the north-west corner of R. The pre-existence of the wide, slab-lined drain (F10:23/F11:63/G11:51/G11:07), which skirted around the south end of the granary, within the portico area, and was probably designed to carry away rainwater running off granary roof, suggests that this demolition had already occurred some time previously. Buildings Q and R appeared to respect this drain, which suggests it may still have

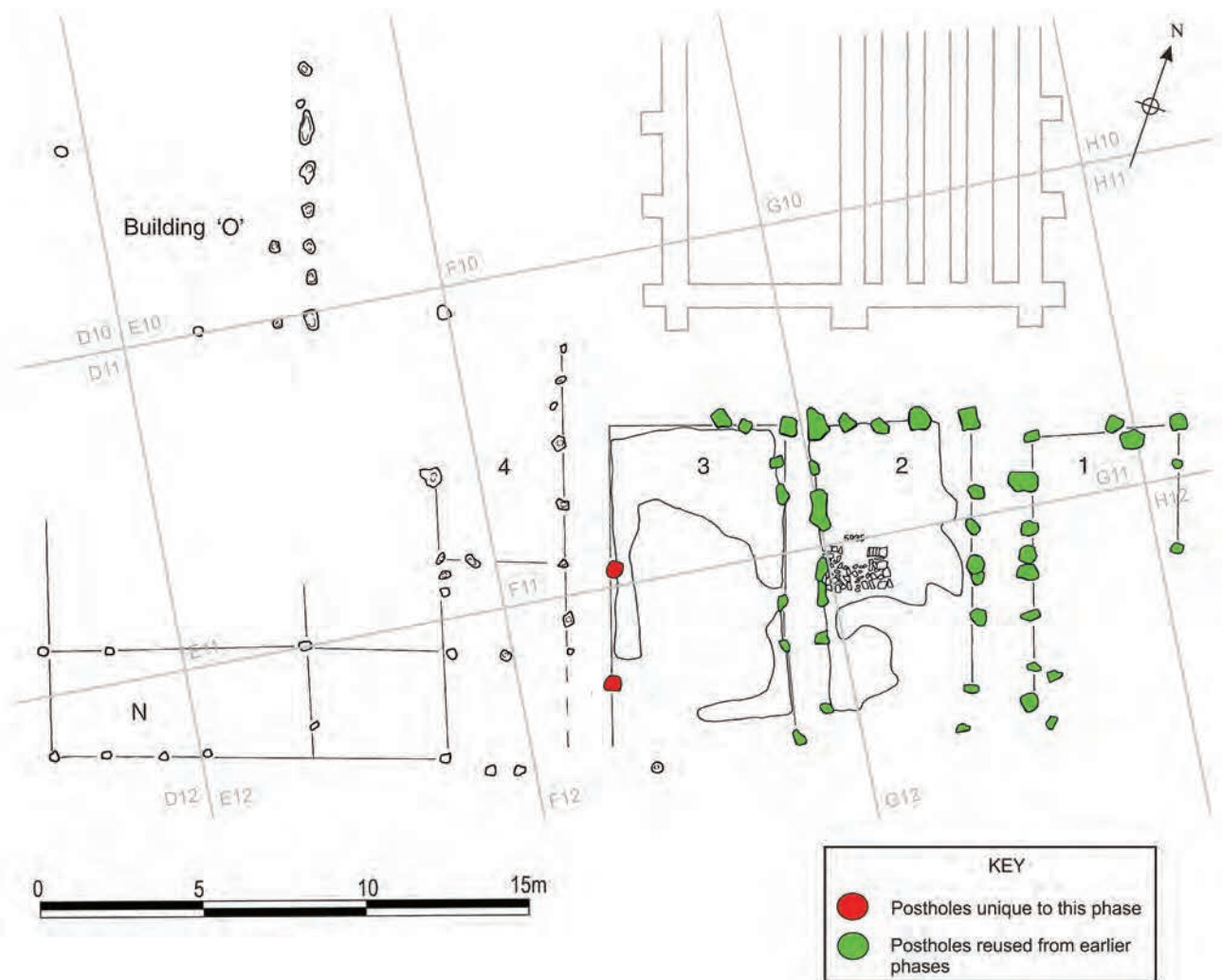

Figure 6.03: 1997 excavation Phase C (based on Hodgson 2003, 145 fig 101). Scale 1:250.

been functioning and was considered worth leaving accessible as far as possible (see below: *Phase B – Building AX*), although, at the point where the drain turned south-eastwards towards the south gate, AX (S) unavoidably extended across its line and must have covered it, unless this branch was a later feature post-dating AX(S) (see Chapter 4). Direct access to the north ends of these buildings would nevertheless have been very constricted by their proximity to the south wall of the granary, and the three structures in the main row (excluding AX (N)) evidently faced south.

Note on the plans

All the post holes identified during the 1975–84 excavations are shown on Figure 6.04, including a number which were shown on the site plans relating to the 1977 and 1983 seasons but never allocated context numbers. Figure 6.05 attempts to correlate the 1977/81/83 record with that of 1997–8, allocating the appropriate Daniels context numbers to those post holes re-excavated by Tyne and Wear Museums and adding supplementary examples not recorded

in 1997–8. Perhaps inevitably, some difficulty was experienced in matching the post holes exactly. The positioning of the supplementary Daniels post holes on Figure 6.05, in particular, is only approximate and the post holes newly identified in 1997–8 have only been transposed onto the Daniels plans in a few instances where this was particularly helpful. The plans may be considered a reliable indication of the general location, spacing and orientation of the different post hole alignments, however, and the overall effect of the combined data is to increase the number of such wall lines, particularly along the north and west sides of Building Q/Unit 3 where as many as three different series of posts were present.

TWM Phase A

The report on the 1997–8 excavations identified an initial phase of Building Row XX for which there was no corresponding evidence in the Daniels excavation record. Accordingly only a summary discussion is provided here. The number of post hole alignments

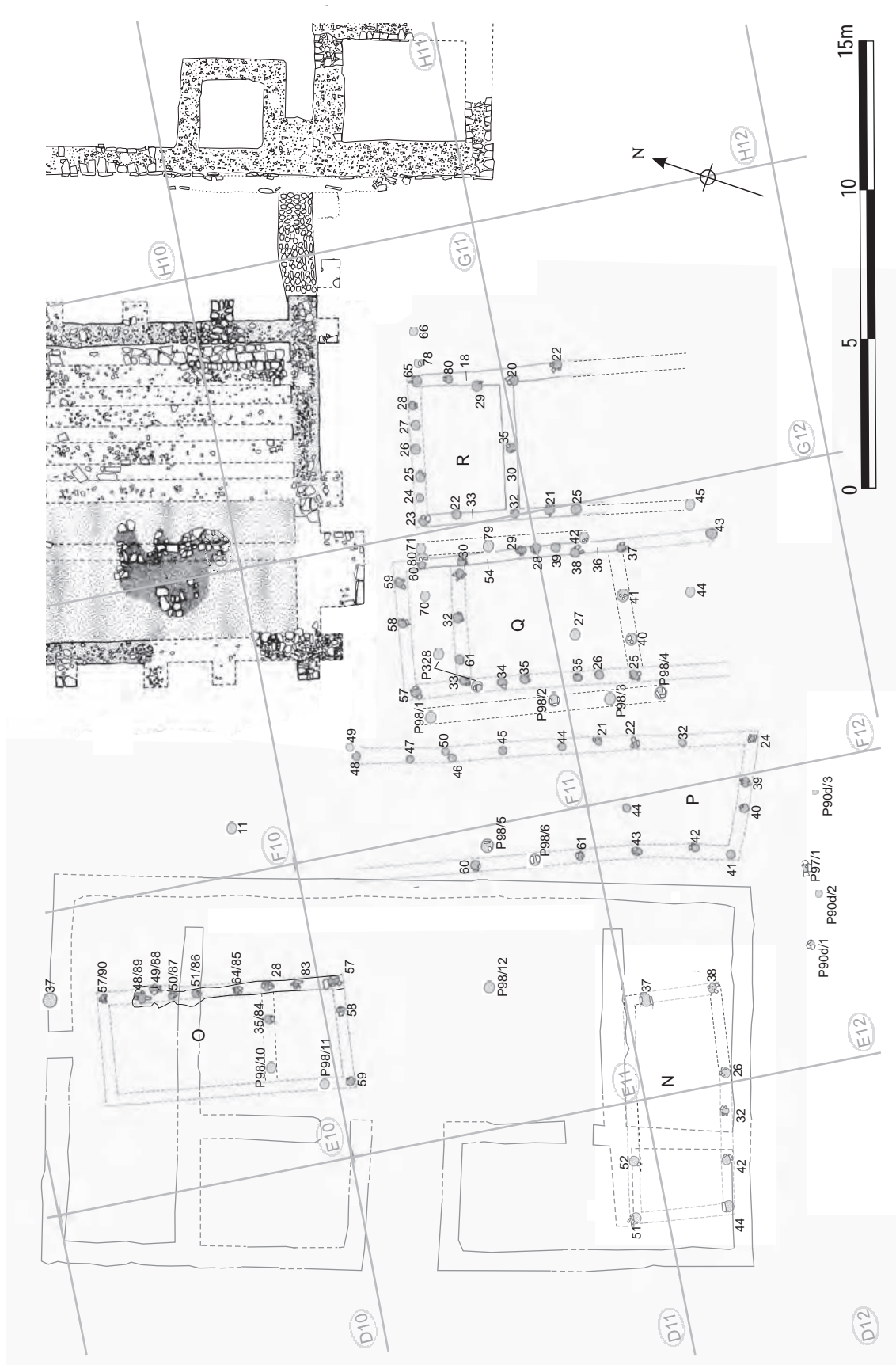

Figure 6.04: Plan of all the postholes associated with Buildings N, O, P, Q, B and AX identified during the Daniels excavation. Scale 1:200



Figure 6.05: Correlation of Daniels posthole context numbers with 1997-8 context (based on Hodgson 2003, 142, fig 97).

identified in the course of the various excavations indicates that there were several structural phases in this range of buildings. This phase was represented by those post hole alignments which were identified as being the earliest in the sequences associated with the row (see Hodgson 2003, 144, fig. 99). Some of the post holes were cut by post settings associated with later parallel alignments, whilst others were overlain by flagging in Units 2 and 3 (Buildings R and Q). These last were crucial in establishing that some post holes belonged to a phase distinct from and earlier than that characterised by the flagged flooring which Daniels attributed to Building T. Comparison of the two phases plans suggests that two of the postholes (TWM 7458 – Unit 3, west wall; 7456 – Unit 2, south interior) shown were definitely sealed by the flagging. Two intersecting post holes (7444 = F12:41, cut by 7411) occupied the same relative position within the southern interior of Building Q/Unit 3 as post hole 7456 did within Building R/Unit 2. It is possible therefore that these two post holes also relate to Phase A and reflect a pattern of internal arrangements common to both Buildings Q and R, albeit one not immediately intelligible. The flagging and clay floor levels associated with the building's later phases did not survive in this part of Q to provide stratigraphic confirmation, however. No evidence for the nature of the floors used in this phase was recognised. Perhaps the pre-existing road levels were reused.

TWM Phase B = Daniels' 'Building T' phase (Fig. 6.06)

Grid squares : F11, F12, G11, G12, H11, H12

Summary

The buildings of this phase were characterised principally by the use of flagstones as flooring. Two extensive areas of flagging (F11:10 and G12:11), which fell entirely within post hole buildings Q and R, respectively, were uncovered in 1977 and re-examined in 1997–8. The probable walls associated with this phase of the two buildings were identified by reference to their position around and adjacent to the surviving floor levels and other structures. There was some difficulty in determining which of the post hole alignments should be attributed to this phase and it is possible that sleeper beam construction was used, in part at least.

To the east, Building AX was also characterised by areas of flagging. The northern part of this appears to relate to a small stone building (AX(N)) tacked on to the southern end of the supplementary granary chamber (AW), which enclosed the former alley (8) between the primary granary and the *principia*. However more flagging survived immediately to the south (AX(S)) which may represent a structure similar to Q and R. The flagging here was largely disturbed

by later activity, but the edges of the flooring survived relatively well, revealing a pattern of parallel linear gaps which were interpreted as drain channels but may in fact represent slots for timber walling employing either post-in-pit or perhaps sleeper beam construction.

Building Q/Unit 3

The floor of Building Q was represented by a 3.5m wide area of substantial stone flagging (F11:10, F12:05), which extended across the centre of the building (Fig. 6.07). Towards the northern edge of the flags lay a crudely-built, east-west aligned wall composed of two lines of roughly faced sandstone blocks (F11:26, TWM 5964). Daniels interpreted this as part of the north wall of 'Building T', but it can now clearly be seen to have been an internal feature. The 1997–8 excavators suggested this was most probably a low screen wall associated with a hearth immediately to the north (Hodgson 2003, 143–5), noting that the flagstones on that side (F11:51; TWM 5934) were worn, fire-reddened and shattered. An alternative possible interpretation as the base of an internal timber partition was dismissed in the 1997–8 excavation report on the basis that the wall was only present in the western half of the building and did not appear to continue further eastwards (those stones which Daniels considered formed the rest of the wall were probably simply a fortuitous linear scatter of surviving flagstones – part of F11:10 – as the 1997–8 excavators noted). However there was clear evidence for a partition line in the equivalent position in Building R and in AX (S) so it is possible the remainder of the wall had simply have been robbed away.

The 1997–8 excavators identified an alternative east-west partition further to the south, taking the form of a slot (5965), 1.03m long and 0.40m wide, which interrupted the flagging (F12:05). The eastern half of this feature corresponded to Daniels post hole F12:27 and a number of vertical packing stones are shown on site plan P96. Although the later clay floor did not survive in this area to provide stratigraphic confirmation, the 1997–8 excavators were surely correct to attribute the slot to Phase B rather than Phase C, given the level of the packing stones sat in relation to the flagstone floor. Daniels also considered this feature was a partition, with post hole F12:27 marking one jamb of a doorway (see F12:27 context entry). However there is no firm evidence that the partition continued across the full width of the building and it might instead represent an internal feature of the front room, such as a stall dividing up the stabling of horses, for example.

No flagging survived in the northern end of Q, with the exception of one small, isolated patch of burnt, shattered stones (F11:52) which may have been another hearth, and, since the same arrangement was



Figure 6.06: South West Central Range, Period 3 showing Building Q, R and AX (S) Phase B (building T phase). More than one phase of AX(S) is displayed. Scale 1:200.

evident in R, it is likely that this part of the building was not furnished with a flagged floor. Instead a fine, silty, green-black layer (F11:36–37) which may represent associated occupation debris extended over the entire area. The silty deposit varied in thickness from a thin skim of 0.02m up as much as 0.07m and contained patches of ash and much pottery.

At the south end of the building, a stone-walled drain (F12:17) probably also formed part of the structure. The channel was 0.20–0.25m wide, 0.20m deep, and survived to a length of c. 1.50m. The channel's side walls were composed of variously-sized facing stones and flags and it was closed off at the south end by a single large flag.

The position of this drain marks the front of Building Q and its alignment indicates the individual units of the range faced southward onto the *via quintana*, largely filling the space between the south end of the granary and the main east-west carriageway of the road. The south face of the structure was probably in line with the south wall of the hospital and the long axis of each building was aligned roughly north-south.

WALLS

In plan, the western edge of the flagging (F11:10/ F12:05) appeared to respect the medial of three post hole alignments on this side of Building Q. It was therefore reasonably identified as the probable western wall associated with this phase of the building in the report on the 1997–8 excavations. However the 1977 context records and relevant site plan (P96) show that several post holes which made up this wall line (F11:33–35 and perhaps F12:26, 36) clearly cut both the clay floor level which directly overlay the flagging and, in two cases, even the upper flagging which was laid on top of the clay deposit. This alignment must therefore relate to a later phase, postdating the laying of the clay and the upper flags (see below: *Phase D*). Neither of the other two post alignments seen on this side of the building appeared to be associated with Phase B. The more easterly alignment lay within the area of the Phase B flagging, which was shown to overlie some of these post holes and therefore postdated the alignment, whilst the westerly of the three alignments lay further from the surviving edge of the flagging and was more probably associated with the following clay-floored phase.

Some indication as to how the building may have been walled is provided on its east side where a linear north-south aligned depression (F11:54, F12:36) was observed in the underlying gravel road surface. Other similar depressions were recorded around Building R. These depressions more or less coincided with some of the post hole alignments. The excavators concluded that the grooves had originated through the weight of the walls of the buildings (presumably panels of wattle-and-daub infill attached to the upright posts



Figure 6.07: Buildings R and Q from the east showing the flagged surfaces and other features of Phase B.

were envisaged), which had pressed the pink clay of the Building S floor level down into the underlying road surface, i.e. the walls sat on top of the clay. This reflected their belief that the timber post hole buildings Q and R followed the clay-floored building (S).

It seems more likely that the linear depression or grooves recorded in 1977 were the result of direct contact between the walls of Q and R and the Period 2/3 gravel road. Moreover the existence of the depressions would seem to point to considerable pressure on the ground surface. The main load-bearing force from the roof in a post hole building would be transmitted downward through the upright posts via the roof plate. Intervening wall panels or wattle-and-daub infill would only have to carry their own weight. The grooves might therefore point to a different construction method, one perhaps involving the upright posts being set into a sleeper beam resting directly on the ground surface. This would have the effect of spreading the weight of both the roof and walls evenly along the base of each wall, creating the linear depression which subsequently became filled with material belonging to the overlying clay floor associated with the next phase (which is how they came to be recognised, showing up as linear strips of pink clay after most of that level had been removed). Alternatively the grooves might represent disturbance of the underlying gravel road surface caused either by the initial bedding in of sleeper beams or by their eventual removal. There is evidence that a similar method of construction was also used in the easternmost building in the row (AX (S)/Unit 3 – see below).

No trace of a similar groove was recognised on the west side of Q, but, as none of the surviving post hole alignments can be assigned to this phase (see above), it may be that a shallow linear depression simply went unrecognised here. The line of the north wall might be represented by post holes F11:60, 70 (TWM 7417) and P328/1, or perhaps TWM 7421 and F11:57 (7619)

instead of P328/1. The first three lay within the area of the later clay floor (F11:11), but do not appear to have cut through that floor, only being recognised after the removal of the clay, and must therefore have related to either Phase A or B. This would give the building a length of c. 10.00m and width in excess of 4.60m (taking the western edge of the surviving flagging as a guide). The partition wall (F11:26) divided the building unequally, the northern inner room being only c. 3.00m from north to south, whilst the southern room was some 7.00m in length.

The way that certain lines of post holes to a large extent coincided with the depressions implies that similar alignments were used in a later phase or perhaps later in this phase.

Building R/Unit 2

FLOOR SURFACES AND INTERNAL FEATURES (Figs 6.08–6.09)

The internal arrangements associated with this phase of Building R were very similar to those uncovered in Q. The floor was likewise represented by substantial stone flagging (G12:11), which again survived best in



Figure 6.08: The flagged floor of Building R from the north with the north-south road over the east wing of the Period 2 *h s p t a l*.



Figure 6.09: The flagged floors of Building Q (left) and clay floor of R (right) viewed from the south.

the central third of the structure where it stretched 4.60m from east to west, probably representing the building's full internal width. The 1977 excavators recorded this as directly overlying the earlier gravel road surface, but in 1997–8 it was noted that the flagged surface was bedded in places upon a 0.08m deep spread of pink clay (TWM 5943; cf. Hodgson 2003, 142). The flagging extended furthest south on the east side, where the edge of flagging was initially interpreted as the side wall of a drain (G12:16), like that in Building Q. The few stones identified as the opposite side wall of this supposed drain are unconvincing, however.

A setting of upright stones (G12:17), 3.00m to the east, was another feature initially interpreted as a possible drain associated with Building T, in this case flowing from south west to north east, but the actual function and phasing of this feature, which probably lay outside Building R in any case, are very uncertain.

A silty, green-black occupation layer (G11:17) covered the northern part of Building R, where the flagged flooring was absent, just as in Building Q. To the east the layer had been disturbed by later activity and the constituent contexts (G11:19; G12:19) were essentially unsealed.

Immediately north of the main area of flagging, a rectangular pack of pitched stones (G12:13, G12:24), was interpreted as the foundation for a large hearth (see Figs 6.10, 6.11). Measuring 2.20m × 1.30m at its widest points, the eastern and western edges of the feature were formed of sandstone and limestone rubble laid flat whilst the intervening infill consisted of sandstone fragments pitched at an angle of 40 degrees to create a rough herring bone foundation. This was apparently packed with pink clay, patches of which were burnt to a red-orange colouration. A large modern intrusion (G12:18) had cut through the northern side of the feature midway along its length.

Daniels had attributed this hearth to Building S, contemporary with the surrounding clay floor.



Figure 6.10: Phase B flagged floor and pitched stone base (G12:13) of Building R with stone packing F12:06 in the foreground.

This was based on his belief that the northern face of the foundation (G12:24) was actually a separate and earlier structural feature, part of the north wall of Building T, which in turn obliged Daniels to allocate the remainder of the foundation to the succeeding phase ('Building S'). Despite the large modern intrusion enough survived of the stone pack's northern edge to show that it was structurally indistinguishable from the rest of the feature (see Fig. 6.11). The same kind of pitched stones as were used throughout the central part of the base could be seen incorporated in the north face, on either side of the intrusion. The position of the foundation, particularly the manner in which it respects the flagging of Phase B (Daniels' Building T phase), and the fact that, like the flagging, it was recorded as resting directly on the (Period 2/3?) gravel road surface (G12:23) suggests that entire feature should be assigned to Phase B along with the flagged surfaces. (Bedding layers were actually recognised beneath the flags in places during the 1997–8 excavations but this does not alter the essence of the observation: Hodgson 2003, 142, 145.)

WALLS

A clear post hole alignment ran along the west side of Building R. However, as with the comparable alignment in Building Q, the Daniels excavation records indicate that several post pits associated with this alignment actually cut through features associated with Phase B and must therefore postdate that phase. Thus one post-hole (G12:21) cut through the western edge of the large, stone-packed hearth, G12:13. Immediately to the south of the hearth, a gap in flagging G12:11 may represent the cut of another posthole (G12:25) in the same row, since its spacing and alignment correspond with the more definite examples G12:21, G11:22–23 and G11:32 and post trench G11:33.

On the other sides of the building there were no definite stratigraphic relationships between its



Figure 6.11: View of stone foundation G12:13 from the north showing the pitched stone techniques used and the gap left by a modern intrusion (G12:25).

internal features and the post hole alignments. Several post hole alignments are present on the north and east sides of R and it is possible that some were associated with Phase B. However, as with Building Q, it is possible that this phase of the building was walled using sleeper-beam construction. A pattern of three linear depressions or grooves, forming an H-plan, was recorded in the underlying gravel road level, which might indicate the position of such sleeper beams. The three grooves corresponded to the east and west walls of the building (G11:18, 33) and an internal east-west partition (G11:30) located to the north of the pitched stone base or hearth. The east groove (G11:18) fitted comfortably with the surviving flagging, closely respecting its eastern edge, but there was some discrepancy in the Daniels plans with regard to the western groove (G11:33). The composite plan compiled to show the location of all the post holes and slots (P98) shows the groove following roughly the same line as the post hole alignment discussed above and extending as far south as post hole G12:25. However there is reason to doubt this record. There is no evidence that the groove or slot cut through the surviving flagging or pitched stone foundation and, since the latter were not removed by the excavators in 1977, the groove can not have actually been observed over the full length shown on P98. The southern end of the slot as depicted on the plan must therefore be an interpretive restoration based on the position of the identifiable post holes with which the feature was thought to be associated. In contrast site plan P103, which showed the flagged floor levels of 'Building T' in detail, suggests the entire course of the groove actually lay further westward, so it too would respect the flagstones and hearth. The edge of the linear depression was only marked very faintly on the plan so it is unclear how much reliance can be placed on this outline, but it would remedy the contradictions inherent in the record presented by plan P98.

There was no trace of a linear groove which might have corresponded to the north wall of R. The line of postholes along the north end of the building was very closely spaced with a number of postholes intercutting one another, implying that the alignment related to more than one phase of activity. Whilst some of the postholes appeared to cut through the edge of the later clay floor, suggesting they were contemporary with that phase (C), others were partially overlain by the clay layer and might therefore have been associated with Phase B. At any rate it is likely that the north wall in Phase B occupied the same general location giving the building dimensions of at least 9.00m by 5.40m. As in Building Q, the partition marked by groove G11:30 divided R into two unequally sized rooms, the northern taking up only 3.00m of the building's total length, whereas the southern was at least 6.00m long.

THE LAYOUT AND FUNCTION OF BUILDING R/UNIT 2

Stone pack G12:13 was interpreted as a hearth, both

in 1977 and in 1997–8. Hodgson further suggested that the partition between the north and south rooms of the *contubernium* lay immediately to the south of the hearth, and ran along the northern edge of stone flagging G12:11, which would place the hearth in the northern, inner room of the *contubernium* where such features were normally located. However the clear evidence noted above for the existence of a partition slot G11:30 to the north of G12:13 poses a problem as it implies that the stone pack was located in the front room of the *contubernium*, rather than the rear room (*papilio*) which typically functioned as the soldier's living quarters, where the hearth would normally be situated. The identification of a comparable groove on the same alignment in the *contubernium* to the west (Q), coupled with the preservation of a slot in the flagging of linear channel for partition slot in the unit to the east (AX(S)/Unit 1), means that the existence of G11:30 cannot be easily dismissed, however. If all the *contubernia* of Building Row 20 were designed to house cavalry, as Hodgson argued (2003, 149), and as implied by the presence of the internal drain at the south end of Building Q, the front rooms would have functioned as stables, in which case the presence of a hearth would have been even more problematic.

It may be that the partition slot was later shifted southward and the hearth only built at that stage, but the fact that the flagging extends no further north than the south edge of G12:13 argues against that. A more attractive explanation is that the troops accommodated in Row 20 formed a mixed unit and this *contubernium* housed infantry rather than cavalry. It is noteworthy that no trace of a stone-lined drain was revealed at the southern end of R (or AX(S) for that matter), comparable with F12:17 found in Q. Moreover, the substantial size of the hearth base, which appears somewhat out of proportion with the heating and cooking requirements of the complement of a single *contubernium*, might imply that this front room functioned as a communal cooking area for all the troops accommodated in Row 20.

Certainly this area seems to have been used extensively for cooking or heating in the subsequent phase. At that stage the *contubernium* was floored with clay which extended over the upper surface of the stone pack. Site plan P96 shows that the clay over the centre and the south-east corner of the base was burnt, but evidence of burning was also found further to the south, with patches burnt to a red-orange colouration extending to the limit of the surviving clay spread in this direction (see Fig. 6.16 below). It is difficult therefore to envisage what scope there would have been for stabling horses in this room.

Buildings AX (N) and (S)

Immediately to the south of the cross-wall (G11:91, H11:78), which blocked off the south end of Alley 8 and defined Building AW, evidence for a further

building was identified in 1981 and 1983 and given the label AX. This was assigned to Fort Phase 3 (the late third/early fourth century) by the excavators and comprised several flagged surfaces, one wall face and what appeared to be a series of parallel drains or channels. Re-examination of Daniels record in the light of the results of the 1997–8 excavations south of the granary has suggested that AX actually comprised two buildings, a small stone-walled structure attached to the southern end of Building AW (AX (N)) and, immediately to the south of that, the third of the timber buildings in Building Row 20 (TWM Unit 1/AX (S)).

BUILDING AX (N) (Fig. 6.12)

The northern building was defined by a short east-west aligned wall (G11:38, H11:38), attached to the west face of the *principia*. This stood on the remains of the earlier cobble and flagstone surface (G11:48, H11:57) and formed the southern kerb of a new flagged floor (G11:43, H11:41), which extended



Figure 6.12: Drain G11:07/H12:33 and flagging H12:08 at the south-west corner of the *principia*, viewed in 1983. Wall G3 of Building AX (N), and the foundation trench and buttress for the crosswall of AW can be seen in the background. The flagging of Building AX (S), excavated in 1981, has been removed.

northwards towards the granary extension wall (AW – G11:91, H11:78) that closed off the end of the former alley. Only the south face of wall G11:38/H11:38 survived, but a spread of tumbled stone blocks (G11:37, H11:37), overlying the flagged floor, evidently represented the wall's collapsed remains. The resultant structure, tucked into the angle between the headquarters and AW, was some 2.50m square. Access to this structure from the south would have been very difficult. Access from the west via the 2–3m wide alley between the south wall of the granary and the rear walls of timber buildings Q, R and AX (S) would have been possible, though somewhat constrained. However it is possible it was connected to the eastern granary extension (AW) by a doorway through wall G11:91/H11:78 which closed off the southern end of the former Alley 8. All the masonry of this wall was robbed out removing any trace of a doorway. Its function is unclear.

BUILDING AX (S)/UNIT 1

Immediately to south of AX (N) and probably butting right up against its southern face was the third building in the row of timber buildings arranged between the hospital and *principia*. The evidence for this building consisted of areas of flagging the edges of which defined linear cavities or slots (G11:39/H11:39, H12:35) which resembled a series of parallel drains or channels. These actually corresponded to the gaps left by timber walls of post hole or sleeper beam construction. The survival of the flagged floor levels was only fragmentary, being largely restricted to the north-east corner of the building next to the *principia* so the full width of the building in this phase could not be determined precisely. The line of the building's north wall was marked by a slot (G11:39, H11:39) located right beside the south wall of AX (N), implying that the two buildings stood right up against one another. The flagging (H11:40) which



Figure 6.13: The south west corner of the *principia* from the north with the gutter alongside the west wall overlain by flagstones of AX (S) evident in the top right corner.

lined the southern edge of this slot also extended south-eastwards (H11:16, 33), overlying the earlier drain or gutter (H08:18) which ran alongside the *principia* west wall, and evidently forming the internal floor surface in this part of the building (Fig. 6.13).

No post holes were identified within the slot itself. Those discovered during the three Daniels excavation seasons and particularly in 1997–8 formed a line just south of the slot and must therefore represent an earlier or later phase of the building. The stratigraphic relationship between the flagging and the post holes was difficult to determine with absolute confidence because of the limited extent of the flagging, its somewhat disturbed condition and, at its north-east corner, the intrusion of a large, colliery period post (H11:30), which was still *in situ* in 1981. However at least one post hole (TWM7644) does appear to occupy the same location as flagging H11:16 at the eastern edge of AX (S), implying it lay beneath and therefore preceded the flagstones. It should be tentatively attributed to Phase A.

Two further lines of flagstones (H12:35) defined the position of a second east-west slot running parallel to and some 3.40m south of the first. These marked the presence another timber wall, which occupied the same relative position as the internal partitions belonging to this phase identified in Buildings Q and R (F11:26, G11:30) and presumably performed the same function.

The remainder of the building's interior arrangements, to the south of the partition slot, had largely been removed by a nineteenth-century brick cellar and the surviving flagging in the northern part of the building did not extend sufficiently far to the west to define the edge of the building on this side. Hence the overall dimensions of AX (S) in this phase are uncertain. However three lines of post holes associated with various phases of the west wall of the building, were identified in the course of the 1997–8 excavations, although only one of these, the medial of the three, survived anything like completely with eight pits being recorded (including G11:66). None of these alignments can be firmly attributed to Phase B, and indeed sleeper-beam rather than post-in-pit construction may have been employed in this phase. Nevertheless, they do give a general indication of the length of the building and the position of the west wall of AX (S) at various stages, suggesting that the building was perhaps as much as 10.50m long and between 4.00m and 5.40m wide. Furthermore, a patch of flagging (G11:79) just to the south-west of the slab-lined drain (seen most clearly in photographs taken in 1977, cf. Fig. 6.14), probably marked the western edge of the building's stone floor during one phase of its existence, though it is not clear which. The edge of this flagging was interpreted by the 1983 excavators as the east side wall of another drain, but the supposed west side wall of this 'drain' was represented by no



Figure 6.14: Drain G11:07 with the possible overlying surface of Building AX (G11:07).

more than a single slab and its validity is questionable. The edge of the flagging respected the projected course of the most easterly of the three post hole alignments noted above. This consisted of only two surviving post holes (TWM 7419, 7427) at the southern end of the building, much of that row having been destroyed by the brick cellar. The building which may be restored on this basis was significantly narrower than the Phase B versions of the two neighbouring buildings, R and Q, with an internal width of only 3.50m as opposed to 4.40m. The alley between AX (S) and R would also have been significantly wider than that between Q and R, all of which implies that these particular arrangements in AX (S) belonged to a different phase when the east wall of R was also located somewhat further to the east.

Conversely, the position of drain G11:49 (TWM 7215) close to the Phase B east wall of R suggests that the west wall of AX (S) may have been located further to the west during that phase. The drain followed a north-south alignment and was probably situated between northern ends of R and AX (S). The drain was assigned to Period 1 or 2 by the 1997–8 excavators (cf. Hodgson 2003, 174–5), but its function in the context of these phases was very unclear. Instead its location suggests G11:49 may have discharged rain water from the gully between the two buildings into the major slab-lined stormwater drain which skirted around the southern end of the granary (F10:23, F11:63, G11:51, TWM 7687) and then headed south-eastward (G11:07, H12:33), beneath AX (S), towards the *via decumana*. The west side of the drain appeared to marginally overlay the lip of a post hole (G11:65) at the north-east angle of R and was itself cut into by a small post hole (G11:78 = TWM 7657), presumably associated with later phase of R or AX (S). It was not possible to confirm a definite stratigraphic relationship between the drain wall and post hole G11:65, however.

Only one row of three post holes was identified in 1997–8 along the east side of the building and this was evidently associated with a phase other than B

(presumably A) since two of the post holes (TWM 7644, 7646) appeared to occupy the same position as flagging H11:16. However, it is noticeable that this same flagging did not extend right up against the west wall of the *principia*. The gap left may mark the position of a sleeper beam supporting the east wall of AX (S) and overlying the earlier gutter channel (H11:10, H12:10), which ran alongside the west wall of the headquarters. The walls of the two buildings would thus have been standing in direct contact with one another.

Immediately to the east of the internal partition slot (H12:35), a further spread of flagging (H12:08) was revealed in 1981 alongside the south face of the *principia*. Though only a small area was exposed, this may represent evidence for a further building, or buildings, in this range, extending eastwards along the *via quintana*, lining the south side of the headquarters. If so it is unclear how such buildings might have been arranged in the more limited space available here (perhaps lean-to structures?). Two layers of this flagging were evident along its northern edge, where it butted up against the south wall of the *principia*, implying more than one phase of occupation.

The relationship to the road surfaces not clear. Only one surface was recorded in the area immediately SSE of granary – G11:71 (which overlay foundation? G11:89). This was considered to have been the primary surface. G11:71 was clearly labelled south and west of drains G11:51 and G11:07, but not to the east. However 1981 site plan P278 clearly records a cobbled road surface in this area. The 1983 context records only note a dark brown soil layer interspersed with small stones (G11:86/H11:74) and spreads of crushed sandstone (G11:82–83, H11:69–70) in this area.

FINDS

Building Q/ Unit 3 occupation/demolition deposit

Glass: bowl (no. 23, F11:37)

Copper alloy: strips (no. 300, F11:36)

Building R/Unit 2 east wall groove

Copper alloy: buckle (no. 151, G11:18)

Building R/Unit 2 occupation deposit?

Decorated samian: 160–90 (no. D58, G11:17)

Graffito: (no. 46, G11:17)

Coin: Marcus Aurelius, 161–2 (no. 103, G11:17)

Building AX (N), underlying flagging

Copper alloy: washer (no. 324, H11:57)

Building AX (N) south wall (G11:38 renumbered from G11:04)

Decorated samian: 160–90 (no. D58), 160–95 (no. D59)

Iron: loop (no. 75)

Dating evidence

Buildings Q and R (Phase B)

Large quantities of BB2 and allied fabrics, and the presence of Nene Valley colour coated ware, indicate third-century dates for the pitched stone foundation in Building R (G12:13) and the possible occupation deposits in both buildings (F11:37, G11:17). The groove for the east wall of Building R (G11:18) contained a sherd of BB1 cooking pot with obtuse angle lattice with a line above, providing a date after the mid-third century for the filling of the wall-groove.

Buildings AX (N) & AX (S)

A sherd of BB1 cooking pot with obtuse angle lattice that can be dated to after *c.* 225 came from the east-west wall (G11:38). The large assemblage from the floor (H11:33, H11:16) was mainly made up of BB2 and allied fabrics, but included a second sherd of BB1 with obtuse angle lattice and a Nene Valley colour coated ware funnel-necked beaker of similar date. There was also a third-century Dales ware rim and one small sherd of Crambeck reduced ware of the late third century or later.

The layers sealed below the flagged surfaces of these buildings may also be third-century in date (see Chapter 4 – Building AW and Alley 8). Flagging H11:72 beneath slot G11:39/H11:39 is a small group of only a few sherds and therefore of limited use. However dark brown soil G11:86/H11:74 is a more sizeable combined group, and could be either late second or third century in date (all the coarse ware of G11:86 is BB2 and allied fabric, but there is too little material from this context on its own for this to be significant).

The remains of AX (S) have been attributed to Phase B in part because its structural features, notably the use of flagged flooring and, possibly, sleeper-beam construction, were similar to those found in Buildings Q and R during Phase B, though it should be noted that the flagging here appeared to extend right to the northern end of the building whereas it was absent in equivalent areas of Q and R in this phase. The dateable material from contexts associated with AX is consistent with that attribution, being broadly similar to that the assemblage deriving from the Phase B ('Building T') levels of Buildings Q and R. The levels underlying AX also contained possible third-century pottery. No evidence for clay floor or an upper flagged surface comparable to the Phase C levels in Building Q and R was identified in AX (S), although the multiple lines of post holes along the west side of the building provides clear evidence that it underwent at least three structural phases. It is possible that the original flagged floor was retained in use, but it is difficult to attribute the individual post hole alignments and other features to a particular phase in the absence of any stratigraphic relationships linking them to a sequence of floor levels.

TM Phase C = 'Building S' phase (Fig. 6.15)

Grid squares: F11, F12, G11, G12

Buildings Q and R were extensively reconstructed in this phase. This was reflected most conspicuously by a change in the character of the floor levels with spreads of clay replacing the flagging of the previous phase to form either beaten earth floors or the makeup for a new flagged surface which has survived in a few patches only. The walls were probably also extensively rebuilt at this stage, as signified by new lines of post holes. No comparable clay level was recognised in Building AX (S) at the eastern end of Row 20, however.

Q and R: floor levels and internal features (Figs 6.16, 6.17)

Extensive spreads of pink-brown clay were deposited in both buildings (Q: F11:11, F12:04; R: G11:13, G12:12) over the flagged floors (e.g. G12:11) and associated occupation deposits (F11:36, G11:17) of the previous phase. These corresponded to the floor levels which Charles Daniels assigned to his putative 'Building S'. The clay contained extensive areas of burning, plus burnt daub and spreads of charcoal and coal, and included within it a distinct lens of green-black soil (G11:16). In Building R, the large, pitched stone hearth (G12:13) was packed with clay. The top of the clay packing was level with the surrounding clay surface and was burnt red. This evidence of burning extended well to the south of the area of the base and similar patches of burnt red clay were also observed in the northern part of Q. Some of these may indicate the position of hearths, although the burnt clay in the southern half of R was so extensive that it may even be associated with the demolition of the building. The pink clay also covered the central pier base of the Granary south portico (G11:21), the only one of the three to survive, which must have been incorporated in the floor of the previous phase. The stone-lined drain (F12:17) at the south end of Q/Unit 3, which was associated with the previous phase of this building, probably continued in use in this phase. The associated flagging immediately to the east of the drain appeared to comprise more than one layer, the upper surface including a reused quernstone.

Patches of flagging over the clay spread were recognised (e.g. F11:08, 25 and F12:31 in Q and G11:15 in R), and it is unclear whether the clay actually represents a makeup layer for a flagged floor or whether the structure was indeed initially floored with beaten clay, which was only later covered by flagstones. A layer of possible occupation debris (G11:10), consisting of a grey-green soil containing a lot of coal, was recognised overlying the pink-brown clay level in the northern half of R.

WALLS

The north and west walls of Q were relatively clear



Figure 6.15: Buildings Q and R, Phase C (Building S phase) at 1:200.



Figure 6.16: Building Q and R viewed from the west. The clay floors of Phase C are evident in both buildings. The flagstones in the right foreground belong to the underlying Phase B surface, the later flagging to the left was laid on the clay layer.



Figure 6.17: Building R Phase C clay floor with Building Q Phase B flagging and C clay/flags in the background. Fragments of AX(S) are visible in the foreground. Compare to Figure 6.10

being represented by lines of post holes surrounding the clay floor (north wall: F11:57–59; west wall: P98/1–4 = TWM 5912, 5915).

The eastern edge of the clay spread (F11:11, F12:04) as recorded on site plan P96 was irregular and discontinuous, having evidently suffered later disturbance. This made it more difficult to establish the relationships between post holes and clay here and hence determine which of the two post hole alignments traced on this side of the building during 1977 and 1997–8 was associated with Phase C. The 1997–8 excavators considered more westerly of the two rows marked the west wall (Hodgson 2003, 145, fig. 101, 147). This identification should be treated with some caution. In the 1977 records several of the pits belonging to this line were recorded as cutting the clay deposits (F11:28, 29, 30 (?), 60 (?), F12:37, 38), which should imply that they were associated with a later phase. However it is uncertain how clearly



Figure 6.18: Stone packing F12:06 viewed from the north.

observed these relationships were, with site plan P96 suggesting that the post holes were distributed along the edge of the clay, so the identification cannot be confidently dismissed. Conversely, no more than four post holes were recognised in the other line (F11:71, 79, F12:42, 43 or 45), but these did appear to respect the edge of the clay floor in a comparable fashion to the post holes in the north and west walls, surrounding the clay without directly impinging upon it. If it was this alignment which was followed during Phase C, Building Q's east wall would have lain close to the west wall of R, however.

The north wall of R was probably represented by the same alignment as figured in previous phases. Some of the post holes in this line did cut the edge of the clay floor deposit (G11:23, 25); others were only recognised after the clay was removed and appear to have been partially overlain by the deposit (e.g. G11:24, 26–27). There was probably more than one phase represented by the closely spaced postholes in this line. The manner in which some postholes cut the edge of the clay could indicate they belonged to a later phase (which was recognised in Building Q – see below *Phase D*), but equally it could simply reflect disturbance to the edge of the clay when the wall was

dismantled and therefore be associated with Phase C. The west wall of the building included one post hole (G12:21 = TWM 5978) which cut through the western edge of the large stone base (G12:13) associated with the previous phase. A 2.50m long line of sandstone rubble (F12:06; TWM 5939, cf. Hodgson 2003, 143), including occasional faced blocks, ran north-south along the west side of R. The site photographs (Fig. 6.18, cf. Fig. 6.10 above) make it clear that this was a deliberately constructed alignment rather than a random accumulation of rubble in the alley between Q and R. It may represent the packing of a drain in the eavesdrip between Q and R, as suggested by the 1997–8 excavators, or the packing for a post trench associated with the west wall of R. The east wall of R was probably represented by the westerly of the two post hole alignments recorded on this side of the building, which was clearly shown by the 1997–8 evidence to cut the other line (see Figs 6.06 and 6.16: note the relationship between post holes TWM 7228 = G11:29 and 7234, 5947, 7284=G12:22 and 7217, and 7219 and 7287).

Based on this evidence the two buildings had dimensions of c. 11.00m by 5.50 or 6.00m (Q) and 9.00m by 5.00m (R).

The west wall of AX (S) was probably represented by one of the three lines of post holes recognised along that side of the building, but little else was clear here, in the absence of any clay level comparable with those defining Phase C in Buildings Q and R.

FINDS

TWM phase C / 'Building S' phase

Building Q clay floor

Mortarium stamp: 135–65 (no. 21, F11:11)

Samian stamp: 170–200 (no. S109, F11:08)

Decorated samian: 125–45 (no. D49, F12:04)

Pottery: perforated disc (no. 22, F11:11)

Building R clay floor (G11:13)

Decorated samian: 130–50 (no. D60)

Coin: illegible, first-second century (no. 234)

Intaglio: Mars (no. 6)

Building R north wall post holes

Copper alloy: ring (no. 361, G11:25)

Building R occupation debris

Coin: Antoninus Pius, 138–61 (no. 84, G11:10)

Bone: pin (no. 18, G11:10)

Dating evidence – Phase C

The clay floors of the two buildings (F11:11/F12:04, G11:13/G12:12) produced a sizeable quantity of third-century pottery, with Nene Valley ware recorded in every context as well as examples of Gillam type 151

jars and Yorkshire grey wares. BB2 and allied fabrics made up to 80% of the coarse and fine wares in some contexts, which is typical of third-century contexts before c. 270. The upper flagging only produced two sherds; a BB2 bowl/dish and a sherd of samian dated to the late second or first half of the third century (F12:31, G11:15). The occupation/demolition material over the clay floor of Building R was very similar in composition to the material from the floors themselves, with BB2 and allied fabrics making up 62% of the coarse and fine wares, and Nene Valley ware 16% (G11:10). The only pottery that could be dated to the late third century came from the post hole G11:25, which contained only a few sherds of pottery, but included a Nene Valley ware funnel-necked beaker with bead rim.

Phase D (Fig. 6.19)

Two lines of post holes were identified in Building Q which clearly cut the Phase C clay flooring and upper flagging, indicating that the building row had undergone a further phase of activity. This phase may be contemporary with the construction of post-hole buildings N, O and P to the west and north-west, which are discussed below.

An east-west aligned row of post holes (F11:31–33, 61) was clearly observed to cut the clay floor F11:11 towards the northern end of Building Q (c. 1.00m in from the northern edge of the surviving clay spread), whilst a second, north-south aligned line, comprising post holes F11:33–35 and perhaps F12:26, 36; also cut the clay between 0.20 and 0.50 m in from the latter's western edge. Two of the post holes (F12:26, 35) in this second row appear to have cut through the flagging laid on top of the clay (F12:31), whilst the northern row excluded a second area of the upper flagging (F11:08) from the interior of the building, implying that both walls postdated even this uppermost surviving floor (the relationship is not quite so decisive in the second case since those stones could conceivably be interpreted as a flagged approach to a doorway in the north wall). In fact the flagstones (F11:08, 25, F12:31) laid on top of the clay level were probably all remnants of a more extensive stone floor and, for the reasons described above, most likely relate to the previous phase. However it is possible that this upper flagging remained in use during Phase D, since no other floor levels were identified which could be attributed to this phase.

The uncertainty over the line of the east wall of Q during Phase C was noted above. The post holes which were recorded as cutting the clay on this side of the building may conceivably have belonged to this phase, rather than Phase C. However, if the more easterly line belonged to this phase, instead, it would mean that construction of the new east and west walls had shunted the Q's footprint slightly eastwards in



Figure 6.19: Building N, O and P, and Q and R, Phase D at 1:200.

Phase D and had only reduced the building's width from c. 5.50m to 5.20m rather than from 6.00m to 4.70m. Assuming the southern frontage remained in the same position as previously, construction of the new north wall will have reduced the estimated length of Building Q, from c. 11.00m in Phase C to 9.00m.

No similar relationship between post holes and clay flooring was recognised in Building R, but, given the number of posthole alignments identified around this building, the possibility that there was a similar phase of activity associated with this building cannot be excluded. One posthole (G11:35), located midway along the line of the Phase B east-west partition groove (G11:30), was said to cut the clay floor level (G11:13) in the building. It was recorded as a gap in the clay packing of groove G11:30, although it is not clear how the fill of the post hole differed from the groove's clay fill and site plan P96 does not show any upright packing stones protruding through the surface of the clay floor at the relevant point. Hence it is uncertain whether the post hole should be assigned to Phase D or to an earlier phase.

FINDS

Dating evidence

There was a substantial number of sherds from a BB2 cooking pot set in a post-hole or the floor of building Q, but there was no base present and it was mixed with sherds from a second vessel, so it may not have been complete when deposited (F11:05). The vessels could date to either the late second or third century.

Stratigraphic comment: A large and near complete, thick-walled BB2 cooking pot (F11:05) was found on the eastern edge of the Phase C clay floor of Building Q. It was initially recorded as being set in the clay (F11:11) and very tentatively interpreted as a urinal. Following the recognition of the upright packing stones of post hole F11:29, it was suggested that F11:05 formed part of the 'packing/backfill' of that post hole. There is consequently a degree of uncertainty as to whether the cooking pot should actually be attributed to this phase or to preceding Phase C. The location and precise extent of F11:29 were not clearly defined on site plan P96. The post hole was shown unambiguously on the overall post hole plan (P98), but the manner in which it was depicted there may have been influenced by the suggestion that the pot was part of the post hole's fill rather than forming the basis for that interpretation.

Later levelling

Surrounding and separating the clay floors of Q and R were areas composed of a mixture of brown or greenish black loam, rubble and cobbles (F11:13, 17, 18, F12:10, 30, G11:14, 19, 34, G12:14, 19). These were interpreted by Daniels as trenches resulting from

the robbing out of stone walls associated with the clay floor levels (Building S). The inner edges of the supposed trenches were clearly marked by the limits of the clay spreads, but the outer edges were very ill-defined, making the width of the 'trenches' difficult to establish, though they were estimated as being as much as 0.90m–1.00m wide in places, whilst the depth varied from 0.05m to 0.25m. The excavators of 1997–8, however, effectively refuted this interpretation. The clay- and underlying flagged floor levels can better be understood as upstanding islands of stratigraphy associated with timber-built structures (cf. Hodgson 2003, 141). The deposits interpreted by Daniels as trench fills must presumably therefore be associated with later operations to level up this area following the dismantling of the timber buildings. The presence of two substantially preserved pots (assigned context nos. F11:03, 06, but actually found in grid square G11 – context G11:14?) found next to one another north of Building R suggests the deposit had not been too badly disturbed in that particular area.

FINDS

North of Q and R

Samian stamp: Hadrianic (no. S6, F11:13)
Coin: Faustina I, posthumous, 141–61 (no. 100, F11:13)
Bone: pin rough-out (no. 24, G11:14)
Quern: lava (no. 25, F11:13)

West of Q

Quern: lava (no. 28, F12:10)

East of R

Copper alloy: ring (no. 339, G12:19)

Between Q and R (F11:18)

Architectural fragments: bas relief (no. 3)
Samian stamp: 160–200 (no. S61), 170–200 (no. S109)
Stone: mould? (no. 52)
Quern: sandstone (no. 50)

Disturbance/levelling NE of R (G11:44?)

Decorated samian: Late second or first half third century (no. D61)

Dating evidence

The material from the levelling fills was third-century in date. The largest group came from a layer between Q and R (F11:18), with a third-century Mancetter-Hartshill reeded hammerhead mortarium and the rim from a Gillam type 151 jar, while BB2 and allied fabrics made up 77% of the fine and coarse wares by weight, and Nene Valley ware 5%. The area north of Q also produced Nene Valley ware and BB2 and allied fabrics, but there was also a sherd from a BB1 cooking pot with decoration (obtuse angle lattice

with a line above it) dating to the mid-third century or later (F11:13). The disturbance/levelling north-east of R contained a sherd from a fourth-century Nene Valley colour-coated bowl or dish (G11:44). The site records refer to two substantially complete vessels (both described as ‘cooking pot’) north of Building R (contexts F11:03 and F11:06). One is the base and about 13% of the body of a south-east reduced ware S-shaped bowl (F11:03; Fig. 22.XX, no. 109, late second or third century), while the second cannot now be identified. (The S-shaped bowl would look very like a cooking pot in the ground.)

The assemblage of material in these levels appears indistinguishable from that associated with the Phase C (‘Building S’) levels of Buildings Q and R, with late third-century pot conspicuous by its absence.

The Roman/post-Roman interface

Overlying the uppermost clay and flagged surfaces of Buildings Q and R and the area to the north was a level described as ‘loose cobbling’ or ‘a rough cobble spread’ (F11:02, 04, F12:02, G11:04, 09). This was considered to be a Roman level, but the excavators in 1977 were clear that it was not a surface. It was contaminated with much later material and had evidently been disturbed by the process of machining off the modern overburden. It probably represented the interface between the surviving Roman levels and the medieval and modern ploughing and colliery activities.

Later features over AX

The flagged floor of Building AX (N) was covered by a mixed layer of rubble, sandstone chippings, mortar and loose, light brown soil (G11:36, H11:42; H11:36), which was overlain by the tumbled masonry (G11:37, H11:37) from the collapsed south wall (G11:38, H11:38). These deposits evidently represent the abandonment and collapse of AX (N). At the western edge of these deposits, some 0.60m to the west of the remains of Building AX (N), a north-south alignment of three facing stones (G11:40), plus another possibly displaced stone (G11:41), were recorded in 1981. There are no photographs of this feature in the 1981 season. However views taken in 1977, when this area was first exposed at the north-east corner of Excavation Site 6, but not planned or investigated, suggest that more extensive remains survived at that stage, including what may have represented a stone-lined drain – somewhat similar to that recorded at the south end of Building Q (F12:17) – which appeared to issue towards the north-west (see Fig. 6.20). It was not possible to integrate this feature into a coherent overall scheme, however it was clearly stratigraphically later than the flagged surfaces of AX (N) and (S), and, on the evidence of the 1977 site photographs, appears to



Figure 6.20: Possible later drain (G11:40/41) viewed from the north in 1977 (left foreground).

have sat at a higher level than the clay floors of Buildings Q and R. It presumably therefore belongs to a period later than Phase C, and perhaps even postdated Phase D.

FINDS

Dating evidence

The pottery from the soil covering the floor of Building AX was mainly third-century in date, including a Dales ware rim (H11:42). There was also a BB1 flanged bowl and one sherd of Crambeck reduced ware of the late third century or later (H11:42, H11:36).

Discussion: The function of Building Row 20

Following re-excavation in 1997–8 the three post-hole buildings south of the granary were interpreted as part of a barrack range – a row of freestanding chalet-*contubernia* forming in effect a timber counterpart of the four third-century chalet-barracks built in stone in the *retentura* to the south (see Hodgson 2003, 148–52, and Chapter 16 below). The presence of an internal drain at the south end of Building Q, similar to those encountered in the stable-barracks of the *retentura*, both in their earlier *contubernium*-block and later chalet-range phases, suggested that horses were being stabled in the front part of these *contubernia* and that like the *retentura* barracks this row was designed to accommodate cavalry.

It was further argued that the different construction technique used in the *contubernia* of Row 20 implied they were not simply intended to provide further accommodation for the *turmae* of the *cohors IV Lingonum* but were instead designed to house irregular troops, organised in what are commonly termed national *numeri* or ethnic units. Troops of this kind, particularly those of Germanic origin, are a widespread feature of the northern frontier in the third century. Most notable are the *cunei Frisiorum*

stationed at numerous forts (see Hodgson 2003, 150 table 6 for details, cf. Rushworth 2009b), though the complete absence of the distinctive pottery forms known as Frisian ware, which has been recognised as a reliable marker of this ethno-military community's presence (cf. Jobey 1979; Peeters 2003; Driel Murray 2009, 818–19), may argue against the occupants of Row 20 belonging to this group. They could however belong to another Germanic group – Suebi are mentioned at Lanchester (RIB 1074), for example, and Tuihanti, i.e. Tubantes from the area of modern Twente on the lower Rhine, at Housesteads (though these latter may have been a more generalised draft of recruits intended to replenish the rosters of the *cohors I Tungrorum*) – whilst Hodgson suggested that they might represent a Moorish unit (2003, 152).

The extent of this ethnic unit's accommodation was not thought to have been restricted to the three structures directly south of the granary. The post-hole buildings overlying the hospital, immediately to the west, were considered to be contemporary, forming integral parts of the same barrack row. Hodgson further argued that the series of small structures revealed by Daniels along the south side of the *praetorium*, might represent a companion barrack, as these occupied an analogous position in relation to the eastern *via quintana* to that of Row 20 on the western *via quintana* (ibid., 149–50). Moreover similar ranges may have inserted in the rampart areas, set against the inner face of the fort's curtain wall, and it was argued that the total strength of the irregulars may have been of the order of 60 men.

Detailed examination of the Daniels excavation data modifies this picture in a number of respects, though the interpretation of the three structures south of the granary, which formed the core of Row 20, as representing a row of freestanding chalet-*contubernia* is not questioned. The date not long after 225–235 proposed for the construction these three structures is consistent with the pottery recovered during 1977, 1981 and 1983, which yielded coherent third-century groups from their floor levels, with nothing to suggest that building occurred as late as c. 270. However the same cannot be said of the post-hole buildings to the west, overlying the hospital (see below for description of these structures). The rubble associated with the demolition of the southern part of the hospital and the overlying makeup for the succeeding timber buildings contained some pottery, including a number of BB1 vessels and small number of sherds of Cranbeck reduced ware, providing a *terminus post quem* of c. 270 for the erection of those structures, though no calcite gritted wares which would have indicated an early fourth-century date were present (see Chapter 5). This was true of the material sealed beneath the surviving fragment of flagged flooring of Building N (E12:04), which was differentiated from the remainder, as well as the unsealed makeup level. It is noticeable moreover how much more complex the structural

sequences are in the eastern trio of chalet-*contubernia* than those over the hospital, with multiple lines of post-holes representing the repair and rebuilding being evident in the case of the former group. It is likely therefore that the timber buildings erected over the remains of the hospital were contemporary only with the latest phases of Q, R and AX(S) south of the granary.

The timber buildings over the hospital may have had a similar function to the constituents of Row 20 to the east. N and O were both roughly equivalent in size to the three eastern *contubernia*, though N was aligned east-west rather than north-south, whilst P might represent a pair of *contubernia* arranged back to back. The apparent presence of a drain in the eastern half N suggests it may have housed cavalry, but the loss of most of the floor levels in these buildings limits the scope for further analysis.

The suggestion that the string of small buildings (AZ, BA and BB) south of the *praetorium* might represent a similar barrack row is also questionable (see Chapter 9). No rows of post holes of the kind discovered by Daniels south of the granary or over the hospital were found in this area. The excavation data is unequivocal in demonstrating that the three buildings were stone-walled, marked by distinct robber trenches, with occasional surviving in situ fragments of walling complete with facing stones, in the case of AZ and BA, and angular rubble foundations in respect of BB. Consequently the outline of each building was clear. Although BA was roughly the same size and proportions as a typical chalet-barrack *contubernium*, BB was somewhat larger and much more squarely proportioned, whilst AZ resembled a miniature wing-corridor villa in outline, consisting of just two rooms floored with clay and *opus signinum*. Perhaps there was a timber verandah between the two shallow projecting wings, its roof supported by posts set either on post pads which have not survived or directly on the solid road metalling. This is obviously a rather disparate collection of structures and it is very uncertain that this was a barrack. Instead of representing a barrack row the structures may have been related to the functioning of the *praetorium* to the north, particularly the hypocausts and bath suite, with a water tank standing next to AZ and large drains running alongside. Another small, stone-walled building (BL) was uncovered further to the west, abutting the south side of the headquarters, and there may conceivably have been others in this area too. This was similar in width to BB, though its full length could not be ascertained. Again although a barrack function cannot be ruled out some sort of ancillary function is equally likely. Even if some or all of these did function as *contubernia* there is nothing in their form or construction technique to indicate that they were erected by the same group that built and occupied Row 20 and it is perhaps more likely in that case that they provided additional accommodation for

the *turma* of Chalet-Barrack 12, for instance.

These modifications reduce the potential size of the unit which may have occupied Row 20. It remains possible that some were housed in uninvestigated stretches of the rampart as previously suggested. Moreover the 1977 evidence might also point to the unit being a mixture of infantry and cavalry based on the apparent positioning of the large hearth G12:13 in the southern room in R, where the horses should have been accommodated, and the discovery of a stable drain only in Q. The resultant complement of the three *contubernia* might be in the range of 15–20 men.

In this context it is worth noting that we do not actually know if the ethnic *cunei* recorded in third-century inscriptions were all cavalry as commonly supposed. *Cuneus* refers to a tactical formation which could be adopted by infantry or cavalry and the late Roman, Danubian cavalry units which incorporate the term are always qualified as *cuneus equitum*, as if implicitly acknowledging the possibility of a *cuneus peditum* or *militum* (cf. *ND Or.* XXXIX, 12–18 and XL 11–17 for example). Moors too could provide both cavalry and infantry, as testified by the *equites itemque pedites Mauri iuniores* recorded as one of the units of the incipient palatine field army under the Severan dynasty (*CIL VIII* 20996 = *ILS* 1356, and *AE* 1966, 596).

Nevertheless even if Row 20 could provide accommodation for only a few troops that need not rule out the hypothesis that ethnic warriors were lodged there, since such groups were not necessarily intended to operate as independent units, but rather may be viewed as dispersed components of a larger whole. When warfare broke out, many similar groups distributed in forts across the northern frontier, would have been assembled to form a single powerful force. During normal conditions, however, whatever the mechanism whereby these troops were recruited or levied, the crucial imperative for the Roman authorities, was to break the force up into manageable groups and house them wherever they could be placed under the close supervision of reliable regular troops to ensure they posed no threat to provincial security. The size of such groups might conceivably have varied considerably, depending on the space available and the internal structure of the wider ethnic unit. The occupants of Row 20 might fall at the lowest end of the scale, a small warband perhaps led by a single distinguished warrior.

Timber Buildings N, O, P and BM (Figs 6.21–6.23)

To the west and north-west of Q, there were four more timber buildings, labelled N, O, P and BM. Like Q, R and AX (S), they were constructed with ground-fast posts, and the group clearly postdated the demolition of the hospital as they extended over the remains of that building and the adjacent north-south roadway which ran between the hospital and the granary.

These may have been contemporary with Phase D of Row 20, though the duration of their occupation is uncertain and BM, set on the *via quintana*, may have been a later construction.

In areas where the room divisions were noted the evidence consisted of a single post off centre and opposite one of the external supports (in Building's P and Q and probably O). It seems likely that the single post was actually the door jamb sunk deeper than the remainder of the internal line.

Building N

Grid squares: D11, D12, E11, E12

Building N was situated over the south-west corner of the hospital covering the area of the former latrine (Room 2) and the western half of Room 3. Its long axis was aligned east-west, running parallel with the *via quintana*, and respecting the road carriageway. The building's dimensions were 8.00m east-west by 3.40m north-south. It appeared to have been laid out



Figure 6.21: Flagging E12:04 and dark clay E12:03 overlying demolition rubble of hospital (from west).



Figure 6.22: Small patch of flagstones possibly associated with Building P overlying the east wall of the Period 2 hospital and the later road surfaces.



Figure 6.23: The relationship of the final phase of posthole buildings to the narrowed via quintana carriageway. Scale 1:200.

in relation to the demolished remains of the hospital. Four of the post holes along the southern side of the building (D12:32, 42, 44, E12:26) were set just inside the demolished remains of the hospital's south wall (or in one instance – D12:42 cutting into the wall's north face) and it is possible that the stone wall's footings were now serving as the north kerb of the *via quintana*. The post holes along the north side of the building (D11:51, 52) were similarly set just inside the north wall of the hospital's latrine room. The building may have narrowed to only 2.70m in width at its east end, where only two post holes were uncovered (E12:37, 38).

A small area of surviving flagged flooring (E12:04) was revealed in the centre of the building (see Fig.6.21), overlying a layer of dark loam (D12:08, E12:03), which in turn covered the Phase 4 flagged floor (E12:02) in the western half of Hospital Room 3. To the east, the flagging incorporated a shallow drain or gutter (E12:28), V-shaped section and composed of pitched slabs (see above Fig. 5.29), which was subsequently rebuilt in a very similar form though of inferior construction (E12:27). The dark loam was seen to extend further northward (E11:06) covering the mass of collapsed rubble (E11:09) in the south-east corner of the former hospital courtyard which evidently derived from the demolition of Building 8 (see above Fig. 5.39).

The presence of a drain in the eastern half of this building is a significant piece of evidence regarding the function of N. The association of internal drains or linear pits with flagged surfaces is characteristic of *contubernia* designed to accommodate a group of cavalymen and their horses, A similar drain was found at the southern end of Building Q, as described above. This in turn implies that N should likewise be restored as a freestanding structure, equivalent in size to a barrack *contubernium*, as previously conceived by Daniels, rather than forming one wing of a larger L-shaped building, as suggested in the published plans of the 1997–8 excavations (Hodgson 2003, 142–5, figs 97–101).

Building O

Grid squares: E10, E11

Like the hospital, the excavation of Building O was undertaken in two separate seasons, with the southern half being revealed in 1977 whilst the northern end was not exposed until 1983. Its posts were very well-defined and gave clear stratigraphic evidence that Building O post-dated the final courtyard surface of the hospital (E10:09, 10, E11:02). The building's long axis was aligned north-south. The east wall was the best preserved, being marked by a 0.50m wide post trench (E10:12, 47) which cut through the heavy flagged surface (E10:36) representing the last phase of the hospital's north wing. The trench was

filled with dark grey ash (E10:41) and contained nine post holes (E10:57, 83, 28, 85–90) along its eastern edge, defined by packing stones. This wall extended for at least 8.00m and may even have been as much as 10m in length, as another post hole (E10:37) was noted further north on the same alignment (although this could alternatively have been associated with Building AQ which lay immediately to the north of the former hospital). No definite trace of the north wall was identified to enable the building's length to be established with certainty, but the south wall was clearly defined by three post holes (E11:57–59), showing that the structure was 3.80m wide. The southernmost 2.m of the building was apparently divided off to form a separate room, the line of the partition being marked by two internal post holes (E10:84, P98/10). One other posthole (P98/12) was identified to the south of the building, the purpose of which was unclear.

Building P

Grid squares: E11, E12, F10, F11, F12

This building occupied the site of the original (Building 8 Phase 1) east wing of the hospital and overlay the remains of the subsequent north-south roadway, its post holes cutting through the road metalling. Its long axis was aligned roughly north-south, with four posts (E12:39–41, F12:24) along the northern edge of the *via quintana* giving P a width of about 4m whilst ten posts (F12:24, 32, 21–22, F11:44–48, plus TWM 7114) which comprised its east wall, indicated the length of the building was at least 13.5m, making it by some measure the longest of the timber buildings erected over the remains of the hospital. A single isolated post hole (F10:11), that could conceivably have formed part of the north wall of P, was identified 4.5m further north, but this could with equal plausibility be assigned to another timber building such as AP (this last structure was less clearly defined, but most of the postholes attributed to it lay to the north of the former hospital). The surviving length of the west wall (E12:41–43, E11:60–61, P98/6, TWM 7272) was only c. 8.80m, the corresponding postholes belonging to northern end of the west wall probably having been removed by the post-Roman intrusions in this area. A single post hole (E12:44) was situated roughly midway between post holes F12:22 and E12:43 belonging to the east and west walls respectively, and might mark the position of a partition wall defining a separate room, c. 4m square, at the southern end of the building. Similarly, a post hole (7125) identified in 1997–8 might mark the position of a wall dividing the building into two halves. A small patch of flagging (F12:18), laid on top of the preceding road levels just inside the line of the east wall, might represent a fragment of surviving flooring or perhaps the threshold of a side entrance

(see Fig. 6.22). In addition, there was evidence for alterations or repairs to Building P in the form of two pairs of closely spaced postholes (F11:46/50, and F11:48/49), towards the northern end of the east wall, indicating replacement of one post by another at these two points. Another possible post hole (P98/5), positioned close to west wall post hole E11:60, but a little further to the east, may signify that the west side of the building was similarly reconstructed at some stage.

Building BM

Grid squares: E12, F12

A line of four post holes was recorded on site plans P90d and P97, cut into the uppermost surviving surface of the *via quintana* carriageway, roughly opposite the south end of Building P (see Fig. 6.23). Although these post holes were never allocated context numbers or otherwise described they can be seen to lie on the same alignment as the southern edge of a line of substantial kerbstones which lay 5m to the west (interpreted as part of road surface D12:12/E12:11; TWM 7911, cf. Hodgson 2003, 164–5 fig. 115). The postholes extended over a distance of 7.20m. The kerbstones may define the southern limit of the fourth-century *via quintana*, which had evidently been reduced to a narrow street or alley no more than 3m wide. The line of post holes may have formed the north wall of a late building, designated Building BM here, located on the south side of this narrower carriageway. No comparable remains were identified directly to the south, in grid squares E13 and F13, over the western part of Chalet-barrack range 9, but these may have affected by the truncation of later levels of the fort. It may however be relevant that lines of substantial timber post holes did feature as structural components in the final phases of the officer's quarters (Building W), at the west end of Chalet range 9, to the south-west of BM. These fenced off an apparent flagged yard on the south side of W, with a further cluster of post holes being identified immediately to the west of the yard in 1998 (Hodgson 2003, 96 fig. 68, 101), though no coherent building could be restored.

FINDS

Building N

Dark soil make-up over Hospital

Decorated samian: 160–90 (no. D3, D12:08), 160–200 (no. D26, E11:06)

Coin: 'Victorinus/Tetricus I', 273+ (no. 156, D12:08), radiate?, 258–73? (no. 163, D12:08), radiate copy, 273+ (no. 169, D12:08), illegible, third or fourth century (no. 264, D12:08)

Copper alloy: candlestick (no. 76, E12:03)

Glass: melon bead (no. 43, E11:06)

Pottery: counter (no. 65, E12:03)

Dark soil (equivalent to D12:08/E11:06/E12:03) directly beneath flagged floor

Copper alloy: jug handle (no. 86, E12:04)

Building O

East wall post trench

Coin: Hadrian, 121–2 (no. 72, E10:47)

Portico floor

Decorated samian: 155–70 (no. D22, E09:09)

Samian stamp: 140–70 (no. S96, E10:44)

Dating evidence

Hospital demolition rubble (E11:09)

The pottery found in the rubble associated with the demolition of the southern part of the hospital, amounting to over 100 sherds of coarse wares, was predominantly composed of BB2 and allied fabrics, but also included some sherds pointing a mid-third-century or later date (Central Campanian amphora and BB1 with a groove above the lattice decoration). However the absence of Crambeck reduced ware and calcite gritted ware would imply demolition occurred before *c.* 270 (see Chapter 5 for fuller description).

Dark soil makeup and flagging in N (E11:06, E12:03, E12:04)

The make-up layer above the hospital demolition material produced sherds from three Crambeck reduced ware vessels and the spout of a Lower Nene Valley mortarium, all dated to the late third century or later (E11:06). There were also two Nene Valley ware funnel-necked beakers with slightly beaded rims, late third- or fourth-century in date. The dark soil sealed beneath the flagged floor in N (E12:04) produced third-century material, as did the unsealed soil layer around it (E12:03), which included Nene Valley ware, a vessel with a G151-type rim and a scrap from the flange of a Crambeck reduced ware bowl dating to the late third century or later (4g). Four radiate or illegible coins (nos 156, 163, 169, 264) giving a *terminus post quem* of 273 derived from the same layer immediately to the west in grid D12 (D12:08).

Overall, the assemblage comprised third-century material, with a large proportion of BB2 and allied fabrics. The quantity of Crambeck reduced ware was small (four sherds out of over 160), but there was also a number of BB1 vessels, which begin to reappear in quantity in the late third century, and a Lower Nene Valley mortarium rim of 270+.

Post hole buildings O and P

The wall trenches and post holes of building O (E10:41, 44, 47, 57) produced a comparatively small assemblage of pottery, but it included third-century

material such as Nene Valley ware and a Gillam type 151 (E10:41, E10:44).

The small quantity of Crambeck reduced ware and the lack of calcite gritted ware in the soil makeup and demolition rubble (E11:06, 09, E12:03, 04) suggests a date not long after 270, rather than fourth-century, for the construction of Buildings N, O and P. There are joining sherds between E11:06 and underlying hospital demolition rubble E11:09 (suggesting some mixing between the two), and sherds from the same vessel (possibly medieval, but not certain) in D12:08 and E12:03. As there is no certain medieval material, and other than these sherds the group makes a coherent group, they can be ignored.

Discussion

The excavators of 1997–8 suggested that the timber buildings erected over the remains of the hospital were fully contemporary with the three other buildings of Row 20, situated to the south of the granary (Hodgson 2003, 140–52). However there are reasonable grounds for considering that the buildings over the hospital were not constructed until the later stages (i.e. Phase D) of Q, R and AX (S). The surviving remains of N, O and P were altogether less complex, with little evidence for multiple phases in these buildings, in marked contrast

to Q, R and AX (S). Building P, admittedly displayed some evidence for repair or alteration, with closely spaced pairs of post holes evident in three places, but this does not necessarily constitute evidence for wholesale rebuilding. The three buildings south of the granary all displayed a pronounced similarity of form and can be convincingly interpreted as a series of free-standing *contubernia* (commonly termed ‘chalets’ by archaeologists), at least one of which may have been designed to accommodate a number of mounted troops and their horses. By contrast the buildings over the hospital display a much greater disparity of size and orientation, though they do share common features with Q, R and AX (S) notably the use of post hole construction and, in N, the presence of a drain in one half of the structure which might imply a continued association with cavalry.

Most significantly, this reinterpretation would help to explain the disparity between the assemblage of dateable material found in the makeup (D12:08, E12:03) beneath the floor of Building N (E12:04), which did contain late third-century pottery, and those associated with the Phase B and C floors of Q and R, from which such material was absent. It also removes the need to compress the chronology of the hospital (Building 8 Phases 2–4), which displayed considerable evidence of alterations particularly in

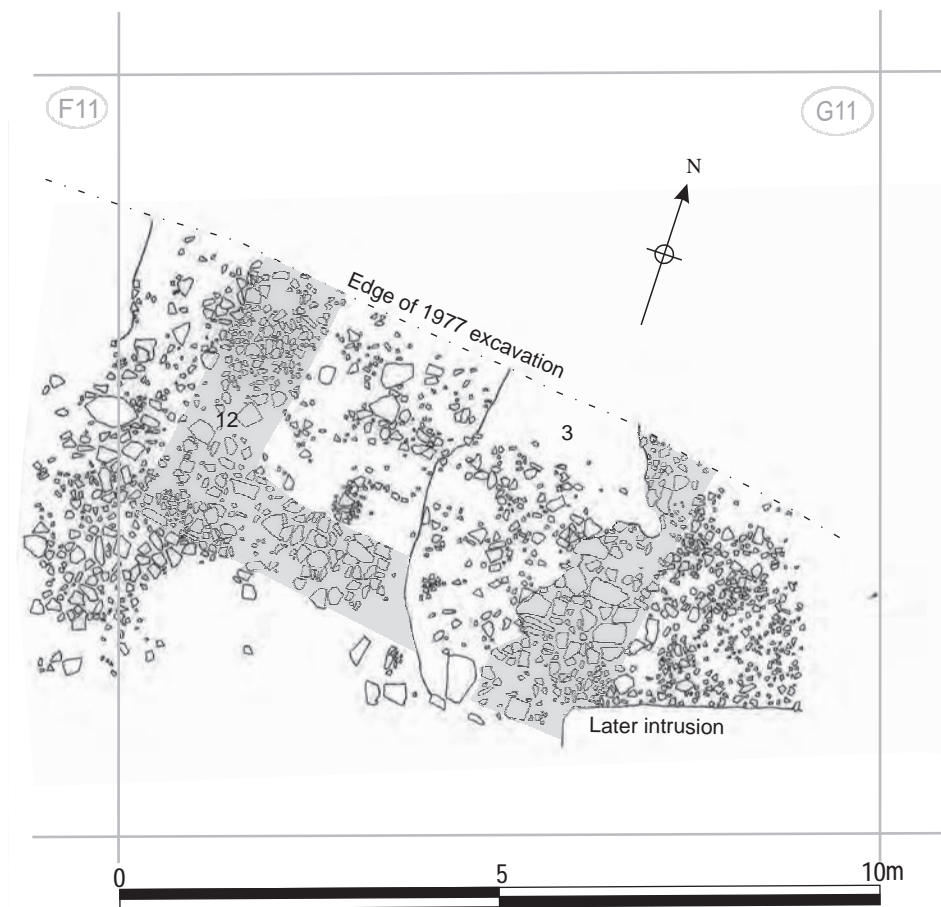

Figure 6.24: The stone foundations of Building BJ as exposed in 1977, at 1:100.

relation to the internal arrangements of the latrine and the provision of the latter's water supply. The earlier phases (A-C) of Buildings Q, R and AX (S) would thus be contemporary with the reduced hospital (Building 8 Phases 3 and 4 and perhaps even Phase 2). The west wall of Q does not appear to overlap the rutted north-south roadway running between the hospital and the granary implying that they could have co-existed.

Despite being somewhat different in scale and plan, it is likely that Buildings N, O and P performed the same function as the three adjacent units, namely that of freestanding barrack *contubernia* or 'chalets'. In the case of N, explicit evidence to support this interpretation was preserved in the form of successive phases of drain or gutter set into the building's flagged floor, as described above. Buildings O and P might have originally incorporated such drains, but the floor levels had not survived here. Both Buildings N and O were roughly *contubernium* sized. P was obviously much longer – about twice the length of the other two. It may have represented a back-to-back *contubernium*, although no definite trace was identified of a central partition dividing the building into two separate *contubernia* (however post hole 7125, uncovered in 1997–8, might have formed part of such a medial dividing wall).

Finally, it should be noted that these structures may have formed part of an even more widespread pattern of post-hole buildings. In particular there is some evidence to suggest the possible presence of comparable buildings on the south side of the *via quintana*, overlying the remains of Chalet-barrack 9. The line of four post holes, designated Building BM, located roughly opposite Building P, may form the north wall of one such building, positioned on the south side of *via quintana* carriageway which had been reduced to little more than an alley by this stage.

Perhaps also associated was a further group of post hole structures identified in the open area, north of the hospital, known as the 'assembly area', though these were less well-defined (see Chapter 7).

Building BJ: The post-Roman structure (Fig. 6.24)

At the northern edge of the 1977 excavation site, immediately to the south of the granary, the remains of the Roman period were overlain by the foundations of a building labelled BJ. This was the latest structure to be identified in this area other than colliery period features and modern intrusions. The surviving remains were composed of a band of pitched sandstone boulders (G11:12), forming three sides of a rectangle which measured 6.50m length and in excess of 4.20m in width (the north side of the structure structure lay outside the area exposed in 1977, but was not traced when the granary was first uncovered in 1981). The boulder foundations were generally 1.10m wide, but increased to as much

as 1.40m at the building's south-west corner, and enclosed an layer of soil tinged a yellowish-green colour deriving from crushed sandstone inclusions.

Building BJ was interpreted by the excavators in 1977 as being a medieval or later structure, based on its position in the stratigraphic sequence and, most significantly, on its alignment, which was very different to that followed by the buildings demonstrably of Roman date. The remains lay directly beneath the layers of modern overburden and were cut towards their eastern end by a broad, irregular linear intrusion (G11:03), evidently of modern date, filled with soil, decayed sandstone, coal and brick fragments. The Roman levels beneath had evidently already been truncated as no fourth-century levels have survived there or indeed anywhere in the wider area south of the granary with very few contexts containing any late third-century pottery.

FINDS

Foundation

Copper alloy: pin (no. 120, G11:12)

Irregular linear intrusion (G11:03)

Samian stamp: Antonine (no. S27)

Coin: Antoninus Pius, 140–60 (no. 89), Septimius Severus, 200–1 (no. 117)

Copper alloy: pendant (no. 171)

Dating evidence

The foundation G11:12 produced 48 sherds of fine and coarse wares. There was nothing that need be later than the third century apart from a single sherd of seventeenth-century English redware. The intrusion G11:03 produced 159 sherds of coarse and fine wares including a number of sherds from a Horningsea storage jar. Most of this pottery probably dates to the third century, but there were two body sherds of calcite gritted ware that were possibly late third-century or later, and one sherd of Crambeck reduced ware that was certainly of that date.

No other post-Roman material is recorded. The remains of the boulder foundations were not sealed so there was potential for later contamination.

Note

- 1 A previous Daniels scheme, apparent on some overall phase plans of the fort, envisaged a tripartite periodisation – Hadrianic/third century/fourth century – with Building S (and by implication Building T also) being assigned to the third century and the post hole buildings to the fourth century. This perhaps reflects a degree of uncertainty on the part of the excavators in dating these structures, particularly the levels associated with T and S which were associated with essentially third-century assemblages.

7. CISTERN 1, THE 'ASSEMBLY AREA' AND ASSOCIATED ROADS

Introduction (Fig. 7.01)

The extensive area to the west of the granary and north of the hospital, was found to have been largely left free of buildings during the earlier periods of the fort's history. It was labelled the 'assembly area' (Road 8) when excavated as part of Site 17 in 1983. This area was bounded to the north and west, respectively, by the metalled surfaces of *via principalis* and the west *intervallum* road, which is also covered here.

The most significant structure revealed in this area was a large stone-lined cistern (Cistern 1), described below. This surprisingly complex structure was linked by a series of channels to the hospital as well as the main *intervallum* drain and was fed by channels running towards it from the north across the *via principalis*. To the south-east a branch of the *via principalis* was laid across the area, apparently leading from the west entrance of the forehall towards the north-west corner of the hospital, where it presumably connected to the *intervallum* road. However it was not possible to achieve a consistent concordance of levels across the original course of the *via principalis* to the west of the forehall as the area was divided by a number of deep modern intrusions.

A number of possible timber post-built structures were also revealed in this area, cutting into the surfaces of the assembly area and, in one case ('Building AS'), the *intervallum* road next to the gatetower. Most of the post holes identified were assembled into one of several groups and assigned building codes (AP, AT, etc.), but, although they clearly performed some structural purpose, none of these groups could be interpreted in such a way as to represent coherent buildings.

Cistern 1 (Figs 7.02–7.04)

The principal feature in the assembly area was a large, stone-lined cistern (Cistern 1). This was constructed

during Period 2 and was designed to supply water to the hospital, principally to flush the latrines in the south-west corner of that building, periodically. It cut the earlier ground level composed of light brown/grey silty loam incorporating some small rubble, which was uncovered to the north, east, south and south-west of the cistern (E08:70, E07:40; E08:73, E09:43). The internal dimensions of the cistern were 5.50m north-south by between 3.80m and 4.00m east-west, and the maximum depth of the tank from top to bottom of a surviving side wall was 1.50m, about midway along the east wall (E08:23). The side walls (E08:23, 25–6, 42) were constructed of coursed sandstone blocks and incorporated a string course of flat slabs, though this was not continuous. The coursing was noticeably irregular in places (see Fig. 7.03). The bottom of the cistern took the form of a carefully laid flagged floor (E08:40, 53), which survived intact. The walls did not survive as well on the western side of the cistern, where an eighteenth- or nineteenth-century culvert had cut a deep and wide trench through the Roman layers. This also had the effect of divorcing the stratigraphy associated with the *intervallum* road, to the west of the water tank, from the levels on the other three sides of the cistern.

It is noticeable that the cistern was slightly misaligned in relation to the other buildings of the fort. This might be explained by the positioning of the cistern against the southern edge of the pre-existing *via principalis* carriageway. As it approached the west *intervallum* road the carriageway perhaps curved slightly to the south, which was in turn reflected by the orientation of the water tank.

Water channels (Figs 7.05–7.07)

At its north end the cistern was fed by a total of at least three water channels, only one of which was primary, and had two outlet drains at its south-west

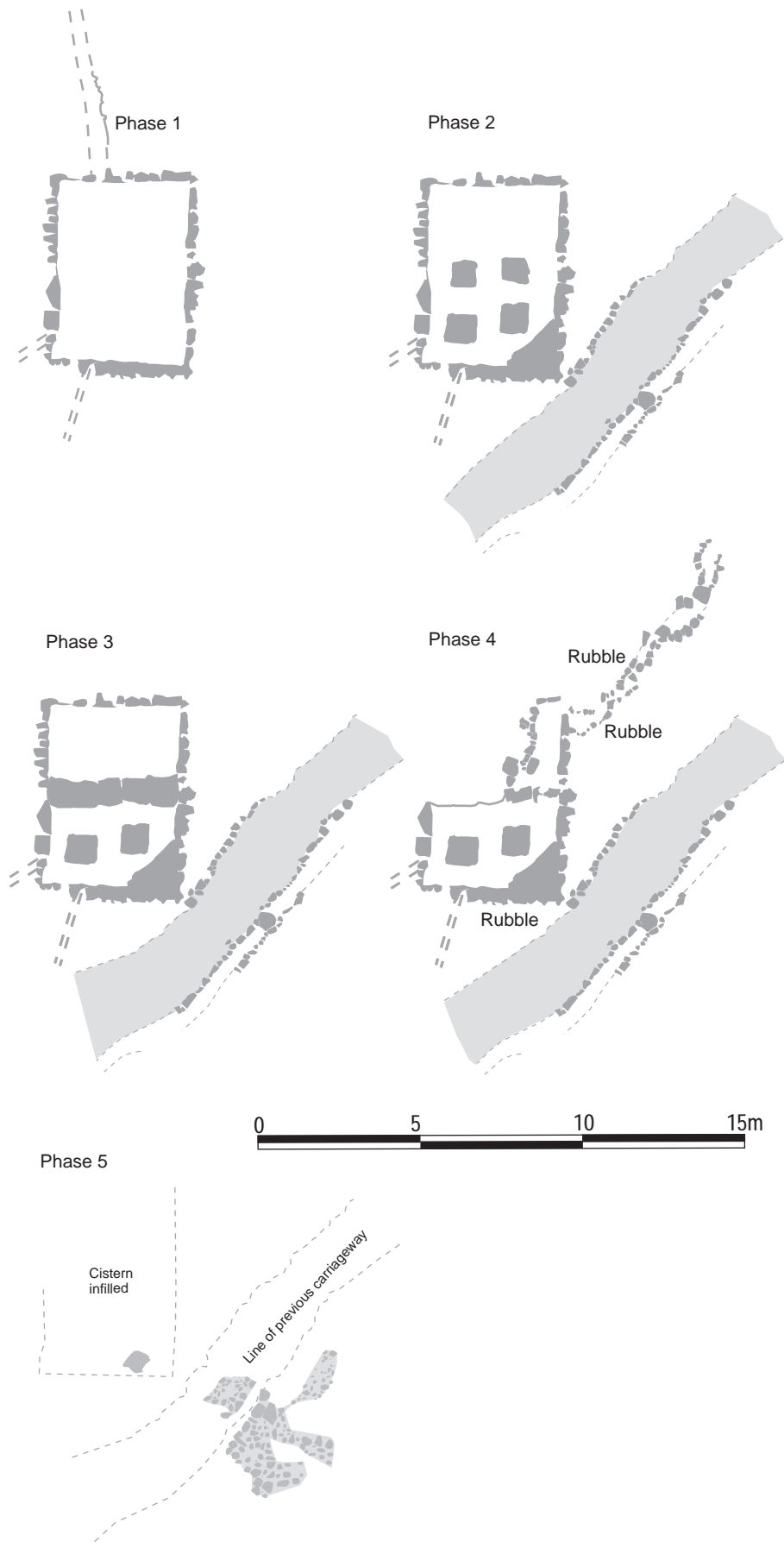

Fig. 10 Cistern 1 and adjacent road surfaces – phases. Scale 0



Fig re 0 Cistern 1 at 0

corner, the lowest point. The primary inlet channel (E08:65) ran from the north and fed into the cistern at its north-west corner (see Fig. 7.01: Phase 1). Its point of origin lay beyond the northern limit of the 1983 excavation site and could not be identified, but the channel may have represented a diversion from the main *intervallum* drain (E07:44, E08:66/67, D08:67, D09:05, D10:11 etc.), which passed some 2m to 3m to the west of the cistern. Stretches of the conduit's east side wall survived (E07:10, E07:42, E08:61). The west side had presumably been robbed when the channel was taken out of use and backfilled with a dark grey-brown clay-silt (E07:43, E08:73). The post-Roman destruction, noted above, meant it was uncertain how long this drain remained in use, as any later levels had largely been removed, but it was clear that it was in use at the same time as the earliest cobbled surface on the north side of the water tank (E08:58 – see below). It may have been replaced by a more direct diversion from the *intervallum* drain, which is represented by

drain side wall E07:27. This would probably have flowed into the west side of the cistern near its north-west corner (for more discussion of this diversion see below: The West *Intervallum* Road and Figs 7.18–7.20).

The two outlet channels at the cistern's south-west corner were probably also part of the structure's initial layout or at any rate were added early in its history. Conduit E08:60, which led south towards the hospital, exited through the south wall and then, some 3m further south, split into two channels reflecting the complex history of the water supply to that building (see Chapter 5). One channel (E09:29) continued straight on towards the north-west corner room (8) of the hospital (Figs 7.05, 7.06), whilst the secondary branch (E09:33–4) diverted on a more south-easterly course, passing through a doorway in the north wall of the building before crossing Room 8 and entering the courtyard. (Both phases probably belong to Period 2, however). Immediately adjacent to the cistern all the stonework associated with the channels had

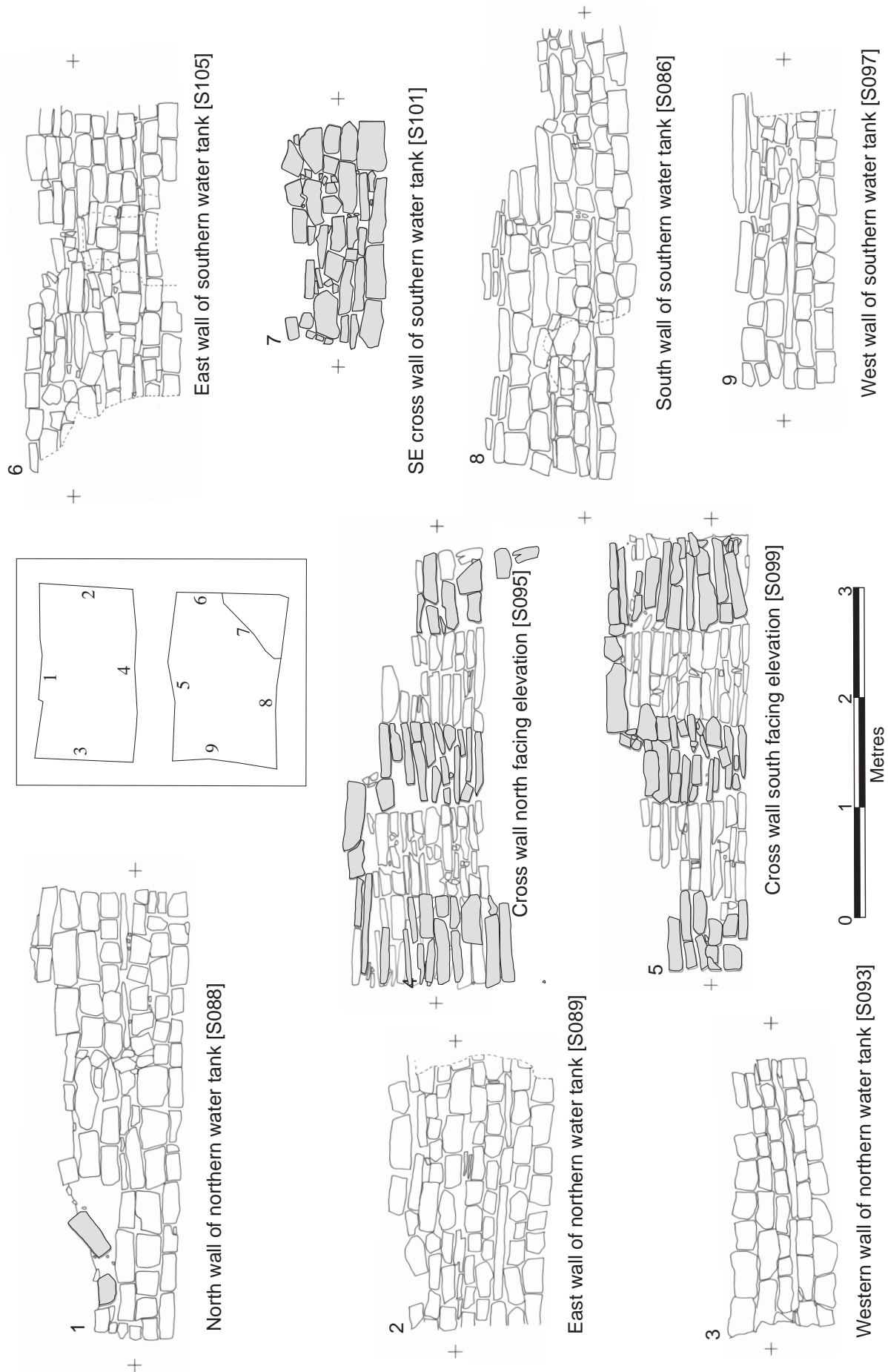

Figure 7.03: Elevation drawings of cistern wall faces. The shaded areas indicate secondary masonry and infilling. Scale 1:50.



Figure 7.06 Overall view of Cistern 1 from the west.



Figure 7.07 Water channels leading from Cistern 1 towards the intervallum drain and the hospital, looking north

been removed by later activity although its course could still be traced, but further south up to two courses of the conduit side walls and the flagged base survived. The width of the channel ranged between 0.20m and 0.30m. A similarly constructed overflow channel (D08:61, E08:55), which fed into the main *intervallum* road drain to the west, was probably broadly contemporary with the south conduit. The channel was c. 0.25m wide and would have helped to regulate the level of water in the cistern.

A rubble surface (E08:45, F08:30), composed of smooth, worn stones which ranged in diameter between c. 30mm and 120mm and were set in a thick light/mid-brown soil matrix, was laid around the south and south-east sides of the cistern, whilst the area to the north and north-east was covered by a silty deposit (E08:64).

Dating evidence

The cistern

This contained over eight sherds of pottery, including third-century pottery and possibly late third-century pottery, probably intrusive material.

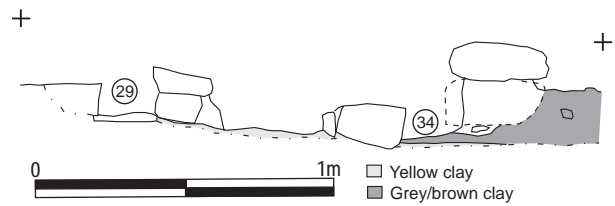

Figure 7.06: Section S120 across Phase 1 water channel E08:29 and Phase 2 conduit E08:34 Scale 1:1

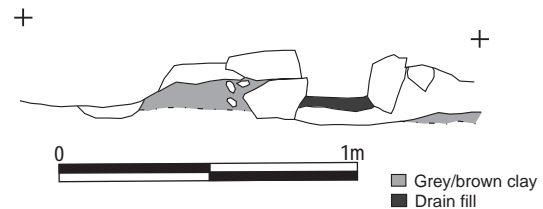

Figure 7.07 Section S2 across water conduit in E9 Scale 1:1

Cistern drains

The wall of the north conduit contained three sherds of BB2 and allied fabrics of the late second century or later and a sherd from a Lower Germany mortarium dating to 140–300, but the fill of the secondary branch contained Campanian amphora of the mid-third century or later and the base of a late third-century or later Crambeck reduced ware vessel (E09:33, E09:34).

Surrounding soil

The rubble surface to the south and south-east of the cistern produced little pottery, but it did include a mortarium rim of the Swanpool/Catterick tradition of the third or fourth century (E08:45, F08:30).

Later modifications

A rubble surface (E08:58, F08:47, F07:18, E07:26), consisting of worn pebbles and stones in a thick silty brown matrix, was laid over the earlier silt and rubble levels on the north and east sides of the cistern and extended north-eastwards forming the surface of the *via principalis*. It included a number of flagstones and incorporated an east–west aligned drain (E07:11, F07:19) towards the northern edge of the main road carriageway.

A further level of tightly packed cobbles of varying size (E08:57, F08:46, F07:17, E07:25, 31), was laid on east side of the cistern, extending eastwards towards the entrance to the forehall. The cobblestones of this surface were worn smooth and set in a light grey, powdery silt matrix. A drain (E07:32, E08:59), which followed a somewhat irregular course from north to south before issuing into the north-east corner of the cistern, was constructed at the interface between the new road level and the pre-existing cobbles (E08:58).



Figure 7.08 The southern half of Cistern 1 from the west showing the two pillars and corner reinforcing wall.



Figure 7.09: Base of the corner buttress, from the north-west.



Figure 7.10 The cistern dividing wall from the south showing the two earlier pillars incorporated.

Kiln

To the west of drain E07:32/E08:59, a kiln (E08:47) – probably intended for drying or roasting grain – was constructed on the north side of the cistern, over the earlier road surface. The surviving remains took the form of a burnt clay spread (E08:46, E07:16, E08:34), scorched to a red colouration, which represented the collapsed or demolished debris of a kiln, and a line of three stones which may have formed one side of the structure (E08:47). The burnt, red clay extended further to the north-west (E07:21), over the main *via principalis* carriageway. At the northern end of the line of three stones, a cluster of four large stones, interpreted as a possible post setting (E07:24, including socketed or dished stone E07:22), was also overlain by the burnt clay and might have formed part of the kiln's structure. If not a post-setting it might represent the end of the flue. These remains overlay a more widespread layer of dark red clay (E08:52) which extended over the earlier cobble surface (E08:58). The northern part of the burnt clay spread (E07:16/E08:46) was cut by a posthole (E07:17).

South-east corner buttress

A single faced wall (E08:37), set on a solid stone base,

was constructed across the south-east corner of the south cistern, the space in the corner being backfilled with soil and stone (Figs 7.03: S 101, 7.08–7.09). This was probably designed to buttress that corner because of the proximity of the re-routed *via principalis* levels (see below). There is no direct evidence that any of the late road levels actually clipped this corner of the cistern and consequently overlaid the buttress, which was only covered by the material later used to fill the southern half of the cistern (E08:29), but the vibration caused by passing traffic may have suggested reinforcement was needed.

Pillars

Four stone pillars, square in plan and constructed of flat slabs, were inserted in the tank (Figs 7.08, 7.10). Two of these were positioned in the centre of the tank, where they were incorporated in a later cross-wall (E08:28) dividing the tank in two, and the remaining pair in the southern half of the cistern (E08:39, 43). The south-east pillar was positioned eccentrically with regard to its south-west counterpart, appearing to respect the south-east corner buttress. This would



Figure 7 View of the assembly area from the north with the rerouted *via principalis* running diagonally from lower left to upper right, the infilled cistern in the centre and the intervallum drain at top right.

confirm the pillars were secondary insertions rather than being part of the initial cistern scheme. No trace of any equivalent pillars was identified in the northern part of the structure and if any had once stood there they had been completely removed later in the history of the cistern. The function of these pillars was unclear. They may have been designed to support a timber floor covering the southern half of the structure, or conceivably some form of roof or canopy, although no evidence was found of any surrounding walls. The cover, whatever form it took, was perhaps also related to the proximity of the rerouted road carriageway and intended to reduce the amount of rubbish entering the tank.

Dating evidence

Kiln

The soil under the kiln contained a sherd of Crambeck reduced ware of the late third century or later (E08:52), although the remains of the kiln itself produced only pottery of the late second century or later.

The rerouted *via principalis*

A distinct road carriageway (E08:21, E09:23, F08:24) was laid, running from north-east to south-west, emerging from the west entrance of the forehall and continuing past the south-east corner of the cistern to reach the *intervallum* road (see Figs 7.11, 7.12, 7.13). This probably represented a diversion of the *via principalis* to provide direct access from the *porta quintana sinistra* to the northern entrances of the granary. The composition of this road surface – small pebbles and cobbles worn smooth – was very different from that of the adjacent, later rubble level. The edge of the carriageway was demarcated by a line of kerbstones, which survived along part of its north-west side. A drain or gutter (E09:21, F08:20) ran along the south-east side of the carriageway, with one cover slab remaining (E08:71, F08:11). The width of the carriageway between the north-west and inner drain kerbs varied from 2.00m to 2.50m.

The construction of a possible buttress, in the form of a short plug of revetment walling in the south-east corner of the cistern, may have been related to laying out of this roadway, which ran close by that corner of the cistern.

Dating evidence

The re-routed *via principalis* road surface contained third-century material, including Lower Nene Valley colour coated ware and an incomplete Mancetter-Hartshill mortarium rim (E09:23).

The infilling of the cistern

The north tank

A wall (E08:28) was constructed across the middle of the tank dividing it into northern and southern halves incorporating the two central pillars in its line (Figs 7.03: S95, S99, 7.10). This may have been intended to convert the northern half of the cistern into a settling tank, presumably to improve the quality of the water issuing from it and perhaps prevent the outlet conduits and the channel in the hospital from becoming clogged with silt. A 0.90m long rectangular stone block with an inset socket sat on top of the medial wall. The northern tank was then apparently allowed to gradually fill with silt. The bottom silt consisted of a dark brown sticky soil (E08:44), incorporating a large number of finds, predominantly bone, whilst the upper fill was composed of a rich black silty soil (E08:41), which was subsequently covered by a level of deliberately laid flags and large stones (E08:27). The bones formed an unusual assemblage, containing a lot of cow cheeks, rather than normal kitchen waste. At any rate this appears to indicate deliberate deposition of waste from butchery or some other process rather than the accidental washing of rubbish into the tank. The overlying flagging appeared to define a channel along the east edge of the infilled northern tank (Figs

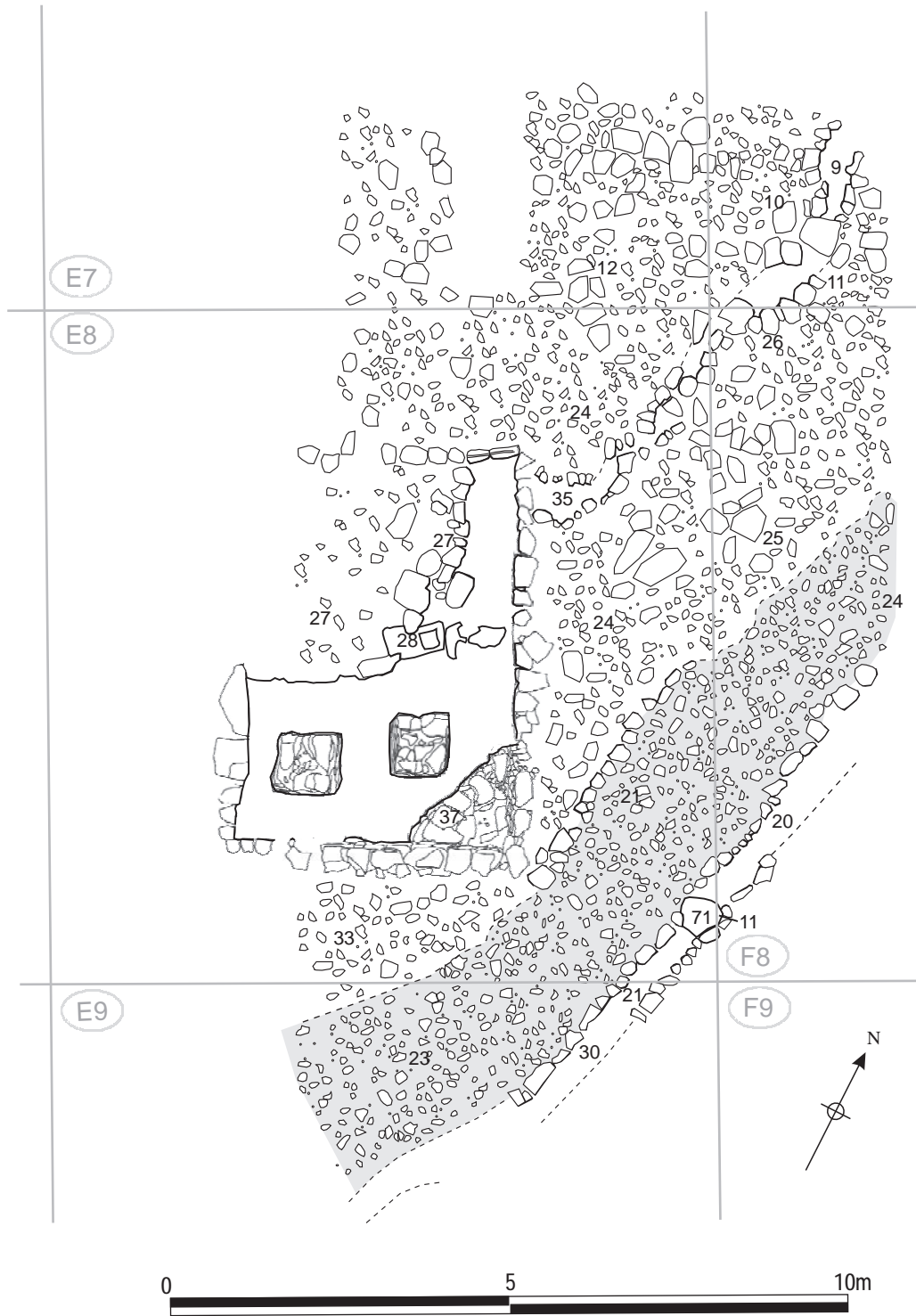

Figure 7.12: Cistern Phase 4, showing the partial infilling and the surrounding rubble spreads. The earlier re-routed via principalis road carriageway is highlighted in grey tone. Scale 0

7.11–7.13, that was presumably intended to enable the water from conduit E08:35 (see below) to flow into the southern tank, which remained in use. The socket stone was situated at the southern end of the channel revetment perhaps hinting at some form of superstructure associated with this remodelling.

The south tank

The fill in the south tank was very different in character from the dark silts of its northern counterpart, being composed entirely of rubble (E08:29), including a carved stone pillar (E08:74), mostly incorporated in a grey powdery soil matrix, though a cluster of collapsed flags in the north-east corner were



Figure 7.13: Closer view of the infilled cistern with channel in the north infilling, the re-routed via principalis, running from mid left to top right corner of the view, and surrounding rubble spread, from the north

intermixed with dark brown clay (E08:38). This suggests the south tank was taken out of use and backfilled as part of a single structural event at a later stage than the north tank.

Dating evidence

Infilling of cistern

The dividing wall in the cistern contained a single sherd of East Gaulish samian dating to the late second or first half of the third century (E08:28). The silt in the northern half (E08:44) contained three Nene Valley ware funnel neck beakers and BB1 cooking pots with obtuse-angle lattice, providing a date after *c.*220, and an unworn *denarius* of Caracalla dated 211 (cat. no. 126). The upper layer (E08:27) contained a slightly worn coin of Elagabalus dated 218–22 (cat. no. 130), a rim from a Campanian amphora of mid-third-century or later date, two Lower Nene Valley mortaria dating to after 250, and a large number of BB1 flanged bowls dating to the late third century or later. The lack of any Crambeck reduced ware or calcite-gritted ware suggests the assemblage dates to soon after 270.

The pottery from the rubble fill of the southern half (E08:29) appeared to be made up of slightly earlier material, with a larger percentage of BB2 and allied fabrics and less BB1, and less pottery dating to after 250. Although it produced just as much pottery as E08:27 (15 kg compared with 11 kg from E08:27 and 5 kg from E08:44), it contained only one bead-rimmed funnel neck beaker of the second half of the third century, one sherd of calcite-gritted ware (possibly from a late fourth-century vessel type and therefore intrusive) and two flanged bowls of the late third century or later. There were a number of cross-joins between vessels between the two contexts.

This is an important assemblage because of the presence of a number of flanged bowls (*c.* 270+), coupled with the absence of Crambeck reduced ware (also *c.* 270+) and extreme paucity of calcite gritted ware (one body sherd, possibly fourth-century) – see Chapter 22 for further discussion.

There are cross-joins between six vessels in E08:44 and E08:27, and between seven vessels in E08:27 and E08:29. All three contexts contained large numbers of cattle scapulas and lower jaws, but little general culinary waste, suggesting a common source or some on-going activity involving processing this meat near the cistern.

Discussion: the cistern fill deposits

The composition of the various fill deposits from the two halves of the cistern give the impression of having been deposited in a single episode. The existence of cross-joins between sherds in E08:44 and E08:27 and between examples in E08:27 and E08:29 appears particularly significant in this regard, as does the presence of very distinct cattle bone assemblages of strikingly similar composition in all three contexts. This conflicts with the structural sequence described above, which comprises a staged process involving construction of a cross wall to establish a (northern) settling tank, gradual silting of the settling tank, followed by its infilling, but continued use of the south tank associated with a shallow channel in the surface of the infilled north tank, then final infilling of the south tank. Such a process is likely to have spanned a significant passage of time, certainly involving a number of years. Some explanation of the apparent contradiction is therefore required.

The first point to note is that, despite the cross-joining sherds and the similar bone assemblages, the overall dates of the pottery assemblages in E08:44 and E08:27 do appear to differ, with that deriving from E08:44 providing an earlier *terminus post quem* (*c.* 220) than that from E08:27 (*c.* 270). Unfortunately, relatively little information was recorded in relation to the fill deposits with no section having been drawn through the fills and no measurements provided regarding the depth of each deposit. Nevertheless it is clear that the material from E08:27 actually derived from

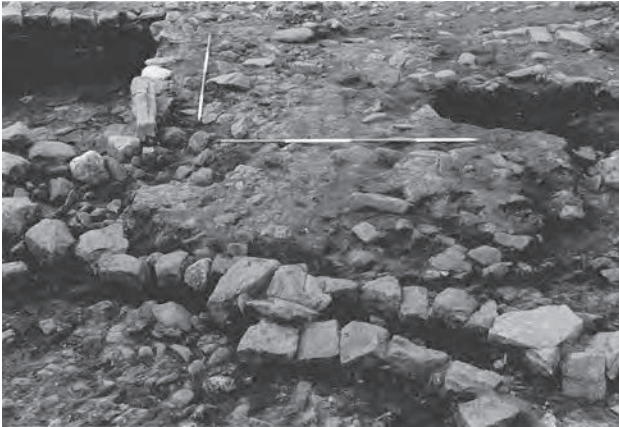

Figure 7.14: Drain E08:35 feeding into the north east corner of the cistern, from the east.



Figure 7.15: The latest surviving road surface on the re-routed *via principalis*.

two distinct features: on the one hand, the rubble and flagstone upper fill of the cistern's north tank, which included a line of facing stones forming the west side of a channel in the top of the fill, and on the other, the rubble on the surface within the channel which was probably associated with the final backfilling and abandonment of the cistern. The rubble and flagstone upper fill would originally have extended across to the western edge of the north tank and may conceivably have been of significant depth, although it is clear that in the western half of the tank the level has largely been removed by the modern intrusions running through this area.

The flagstones on top of E08:27 define an edge which appears to mark one side of a channel (the other side being the top of the east wall of the cistern), however this channel need not be that deep – just enough to allow water from drain E08:35 to flow into the south tank. The existence of the channel was not recognised in 1983, but it is clear on the relevant site photos. The same is true of the cross wall (E08:28) where the excavators' context records did not distinguish between the two earlier piers incorporated in the wall and the later walling which joined these up into a single structure dividing the cistern in two. Thus, although the two fills are not differentiated by separate context numbers, it is likely that a higher proportion of the pottery will derive from the channel rather than the cistern fill which survived to a much lesser extent.

On the other hand E08:41 and 44 in the north tank probably represented essentially the same material. Their respective context descriptions are very similar – E08:41: 'rich black soil (possibly silt)'; E08:44: 'dark brown sticky soil'. If they were the product of the gradual silting of the tank, as suggested above, the heavier rubbish might have continually settled to the bottom of the silt. In other words it is likely that E08:44 was effectively the same as E08:41, but contained pottery, bone and other material which had settled at the bottom of the tank, the layer being defined and differentiated from E08:41 largely on

that basis, that is to say the silt above the point where the uppermost finds had sunk down to was treated as E08:41 whilst that below was labelled E08:44. However this interpretation does make it quite difficult to explain why there are cross-joining sherds in E08:27 and E08:44.

The presence of similar cattle bone assemblages in all three contexts may imply that some butchery or related process was taking place in the vicinity, throughout the period when the structural alterations to the cistern were effected. This could conceivably have been associated with the cutting up for consumption of carcasses stored in the nearby granary. The disposal of such waste in the water tanks implies they were passing out of use by this stage.

Unfortunately the limited nature of the record means we shall probably never fully understand these layers and, consequently, the depositional history of the important pottery assemblages associated with them.

Rubble deposits around the cistern

Abutting the west side of the re-routed *via principalis* carriageway and extending around the remodelled cistern was a level composed of angular rubble in a grey clayey soil matrix (E08:30, E08:24, F08:25, E08:33). On the north side of the cistern this surface (E08:30) covered the remains of the earlier kiln (E08:34, 46–7). It also extended northward over the area of the original *via principalis* carriageway (E07:12, F07:10–11). A drain (F07:09, F08:26, E08:35), set into this surface, followed a meandering course across the carriageway of the *via principalis* (Fig. 7.14), to the north-east of the cistern, flowing into the north tank just south of its north-east corner. The composition of this level was similar to the flagging used to cover the infilled north tank of the cistern and that used to fill the south tank when that too became redundant, suggesting that the deposition of this layer was broadly contemporary with the reduction and eventual redundancy of the cistern.

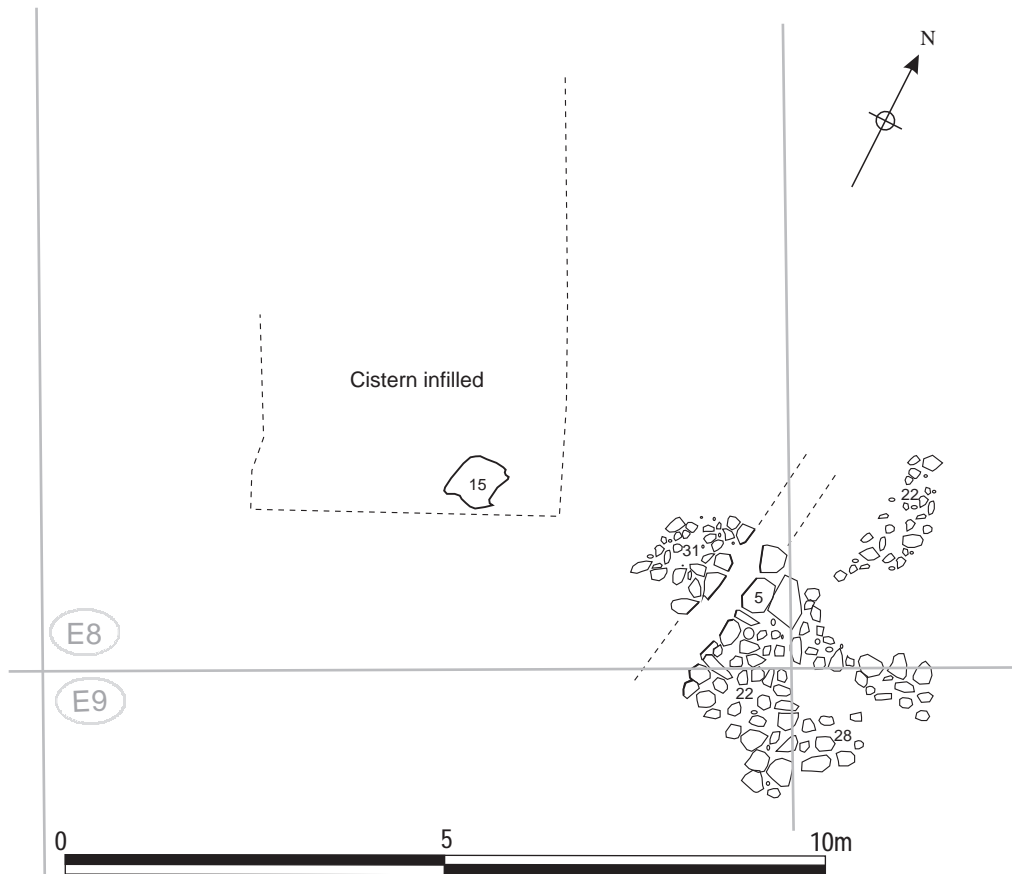

Figure 7.16: Plan of the latest surviving road surface in the vicinity of Cistern 1 (post-dating the cistern's infilling), 1:100.

The latest road surface and other structures

A further road level (E08:31, E09:22, F09:28), which survived only fragmentarily, was subsequently laid over the carriageway. This was composed of somewhat larger cobbles and stone blocks than the previous surface and was not confined within the same limits, extending eastward over the line of the earlier side gutter (see Figs 7.15, 7.16). This surface, too, incorporated a drain (E08:05), positioned slightly to the west of the previous gutter, but the road surface extended on both sides of it.

No road levels were seen to extend over the infilled cistern, but a fragment of walling or pier base (E08:22) did survive on top of the fill of the south tank. This stonework was disposed parallel to the line of the re-routed *via principalis*. Immediately to the east of the 'pier' was a large rock (E08:15) laid out on the same orientation, which protruded through the overlying debris level. These features may have formed part of a structure associated with the road.

Apart from this, the only level which overlaid the cistern fills was the general layer of stone debris (E08:13), marking the interface between the Roman levels and later ploughing, colliery activity and other modern disturbance.

Dating evidence

Roads

The layers round the cistern contained a number of sherds of Crambeck reduced ware of the late third century or later, and a third- or fourth-century mortarium in the Swanpool/Cantley tradition (E08:30, E08:33). The later surfaces and Roman/post-Roman interface did not contain any pottery of a later date.

Other structures in the assembly area (AP, AQ & AT)

Grid squares: E9, E10, F9, F10

A number of additional structures, mostly consisting of groups of post holes, were identified in the assembly area, between Cistern 1 to the north and the north wall of the hospital to the south (Fig. 7.17). None of the structures could be interpreted as coherent building plans, however. Furthermore it was difficult to integrate them into a clear sequential phasing due to widespread inconsistencies and contradictions in the excavation archive. Nevertheless it is clear that these structures were generally relatively late in the surviving structural sequence and can be assigned to Period 4 or later.



Figure 7.17: Plan showing the late timber-built structures identified in the assembly area. The cistern, hospital and other earlier stone structures are shown for reference. Scale 1:200.



Figure 7.18: The remains of the structure labeled AQ immediately north of the hospital's north wall (shown in the left foreground), looking NW. Perhaps associated with Building O.

Building AP

A spread of post holes to the north-east of the hospital and Building O was designated Building AP. These covered the area immediately north of the north-east corner of the hospital and perhaps impinging on that corner of the building. An attempt was made to interpret this as a rectangular building aligned roughly north-south like Building O. A line of post holes which might have formed the west wall of such a building was identified (E10:38, F09:68, F09:71, F10:09, F10:44), but the associated north and east walls were each represented by only a single post hole (F09:56 and F10:37 respectively) and, still more tentatively, post hole F10:11 might be assigned to a south wall. Yet more problematically, there were a whole cluster of associated post holes (E09:35, 39, 40, 51, F09:64, 66, 67, F10:19) spread around the north-west corner of the putative building. Considered objectively it is difficult to see the entire structural assemblage as anything other than a spread of post holes centred on the north-west corner of AP. It may be that more than one phase of a building is represented here and/or more than one building. But this is difficult to disentangle on the basis of the available evidence.

Building AQ (Fig. 7.18)

To the east another 'building' consisted of a small area of flags (E09:09, E10:63) measuring some 2.70m (E-W) by 1.50m (N-S). A stone alignment to the north forming a right angle (E10:08) perhaps defined the north-east corner of this flagged area. Post hole E10:64 reportedly also formed part of this group of features whilst a further post hole (F10:37) on the south side of the flags might also belong to this structural assemblage, rather than forming part of the east wall of Building O to the south, to which it was assigned

in the context database. This group of features lay immediately to the north of the hospital's north wall, but perhaps more importantly was situated directly to the north of Building O, and in the context database it is tentatively suggested that AQ might represent some kind of end 'porch' for that building.

Building AT

This structure, as documented in the context database, consisted of a single square posthole (F09:22) and two short alignments of upright stones (F09:26, 27) immediately to the north and west, which were aligned roughly E-W and N-S respectively. However this cluster of features lay midway along a line of post holes, which extended from east to west right across the assembly area some 2.50m south of the cistern, but were not assigned to any building in the context database. These comprised (in order from west to east): F09:46, 45, 56, 36, 52, F09:52, 38, 45. AT post hole F09:22 adjoined the north-west side of post hole F09:52. Another stone alignment (F09:42), aligned roughly north-south, was situated towards the eastern end of the line, between post holes F09:38 and F09:45. Perhaps this structure formed some sort of fence extending westward from the granary. Its western end was in line with the southern end of a north-south aligned row of postholes extending northward along the *intervallum* road and labelled Building AS by Daniels (see below).

FINDS

Building AP

Associated postholes

Graffiti: fired clay brick (no. 29, F09:66)

Quern: lava (no. 39, F09:66)

Post hole building AP

Postholes associated with AP (E09:40, F09:66) contained some BB2 of the late second or third century, but there was also a mortarium rim, possibly from Norfolk, dated 240–300 in context F09:66 (Fig. 22.08, no. 12).

The west *intervallum* road

The *intervallum* road surfaces are surprisingly difficult to describe. The excavation archive does not present a series of clear equivalences with regard to the levels of road metalling encountered in the different grid squares, partly as a result of the numerous inconsistencies in recording these equivalences. In grid squares D08 and E08, for example, where several layers of the road were revealed, the pattern of equivalences implied by the sequence of the site plans does not entirely correlate with those equivalences specifically documented by the context sheets. Further south, in D09 and D10, fewer levels were preserved, perhaps as a result of widespread



Figure 7.19: The western defences showing the earliest surviving intervallum road surfaces identified in 1983. (N.B. Excavation was not taken down to the pre-fort level in D10). Scale 1:200.

later disturbance, and none of these were explicitly correlated in the excavation record with any road surfaces in adjoining grid squares. This problem was

further compounded by the number of modern sewer trenches and culverts which had the effect of slicing the stratigraphy up into separate islands (for example



Figure 7.20: The earliest surviving metalled surface and stone-capped drain on the west *intervallum* road, looking north. The diversion of the drain via Cistern 1 and the rubble infilling over the redundant stretch are visible.

D08:04–5 between D08 and D09). To the north of the hospital the eastern edge of the *intervallum* road levels were cut away by the broad, deep cut (E08:08) for a colliery era wooden drain culvert (E08:17–18, E09:05) running on a north-south alignment from the northern edge of the excavation site. The stratigraphy of the *intervallum* road was thus divorced from that of the assembly area, though some of the surfaces may originally have extended across both areas.

The *intevalum* drain

The most impressive surviving feature in the *intervallum* area was the drain which ran from north to south, along the eastern side of the road (see Figs 7.05, 7.17 above). This took the form of a substantial stone-capped and lined culvert (E07:44, E08:66/67, D08:67, D09:05, D10:27, D11:35). It was traced from the southern edge of the *via principalis* and perhaps formed a continuation of the equivalent drain in the north-west *praetentura* which was recorded running on the same line alongside the western ends of Buildings

4, 5 and 6. The drain continued alongside the west wall of the hospital. Here, a line of flags (D10:11), c. 0.70m wide, formed the uppermost course of the drain's eastern side wall and abutted the offset course of the hospital wall. The cover slabs of the drain (D10:27) rested directly on top of these flags. The very largest of the slabs were up to 0.90–1.00m across. The drain was seen to extend along the full length of the hospital, those stretches which were not uncovered in 1977 being revealed in the 1997–8 excavations, and ultimately connected into the latrine outflow sewer next to the south-west corner of the building. Fill deposits were noted in the drain in grids D09 and D10 (D09:21, D10:29), but were not described. Further south, three distinct fill deposits were identified in the drain. The bottom 0.15m was made up of yellowish silt and small stones (D11:61). This was overlain by a more friable loamy deposit (D11:60), some 0.20m deep, containing fragments of brick and stone, whilst the uppermost fill consisted of very clayey light grey silt (D11:59), no more than 0.03m thick. Here the channel (D11:35) was recorded as being 0.50m wide and 0.40m deep from the stone-flagged base to the underside of the capstone (0.50m including the capstone), the side walls standing three courses high. Elsewhere, in D09 and D10, the channel can be seen to have varied between 0.35m and 0.50m in width.

The *intevalum* road surfaces next to the west gate (grid squares D08 E08)

Road Level 1 (Fig. 7.19–7.21)

At the northern end of the *intervallum* road, next to the west gate, excavation was taken down to the lowest layer of street metalling which sat directly on top of the loamy layer intermixed with sand and silt designated 'old ground surface' (D07:34, D08:68, E08:68 – but site plan P392 indicates the latter incorporated quite a few cobbles, to the east of the *intervallum* drain). This initial road surface was composed of tightly packed pebbles, smoothed by wear, intermixed with larger stones 0.10–0.30m in diameter, set in a matrix of light brown to grey silt and fine dark brown loam (D07:28, D08:49, E07:35). On the evidence of site plan P375, E08:50, to the east, and E08:51 (to south of feeder channel D08:61/E08:55), also corresponded to this level but different equivalences were proposed on the context sheets).

Intevalum drain diversion

The relationship of the *intervallum* drain to Road Level 1 appears somewhat complex. When the street surface was first exposed the drain was not apparent. It was not covered by the metalling itself, however, but instead by a deposit of irregular stones, averaging 0.30m in diameter, in dark brown soil (D08:51, E08:54), which filled the 1m wide linear depression in the surface, over the drain capstones. The capstones were



Figure 7.21: Schematic plan showing the recorded contexts associated with the earliest level of intervallum road metalling based on site plan P3 Scale 0

not fully exposed until the road level was removed and they appeared to have been laid directly on the old ground surface. The cover slabs were, however, apparent at the level of this road surface to the south of the junction with the feeder conduit from Cistern 1 (D08:61, E08:55). At the north end of the drain, at the point where it emerged from beneath the present course of Buddle Street, a pair of drain side walls (E07:27) were revealed, some 2.20m in length, though somewhat disturbed to the south, and seemingly representing a secondary alteration to the conduit. Although only a single course survived of either side wall, these appeared to sit at a higher level than the extant capstones – or at any rate at the same level – and also to begin to diverge on a more easterly alignment away from the drain's original course, perhaps heading towards the north-west corner of Cistern 1. The rest of the diverted channel would have been destroyed by the deep trench (E08:08) cut for a colliery period timber culvert (E08:17–18, E09:05), which ran across E07 and E08 along the west side of the cistern.

It is possible that construction of the drain postdated that of Road Level 1 with the channel being inserted through the metallated surface, the capstones then being covered by a deposit of rough cobbling (D08:51, E08:54) to bring the surface over the drain up to the

same level as the rest of the drain. However the fact that the fact that two sections of the conduit were treated differently, with the capstones being covered over to the north of feeder channel D08:61/E08:55 but left exposed to the south, would suggest that a more complex sequence is possible. It is possible that the drain even predated the road level, perhaps even being a Period 1 feature, with the metalling subsequently being laid on either side, but with the capstones left exposed in a slight linear depression to allow access to the channel for the purposes of cleaning out and maintenance. Even if the drain was cut through Road Level 1, it is likely the capstones were left exposed for the reasons given above. At a later stage, but probably still during the lifetime of Road Level 1, the drain channel was redirected (E07:27) via the large cistern on the west side of the assembly area. At that point the section between E07:27 and the junction with feeder channel D08:61/E08:55 became redundant and was covered over by stone and dark soil deposit D08:51/E08:54, since access was no longer required. Feeder channel D08:61/E08:55 may well have been newly constructed at this stage as part of the diversion, although, equally, it could quite conceivably have functioned as an overflow channel for the cistern from an earlier date.



Figure 7.22: Schematic plan showing the recorded contexts associated with the second recorded level of intervallum road metalling next to the west gate, based on sketch plan D08/Fig 7, at 1:200.

Road Levels 2 and 3 (Fig. 7.22)

The initial street surface was overlain by a layer of worn pebbly gravel and loosely packed worn cobbles in matrices of gritty soil and fine brown soil respectively (D08:43, E08:50) perhaps roughly equivalent to the surface of tightly packed, well-worn cobbles (D08:44, E08:51) on the south side of the feeder channel leading from Cistern 1 to the *intervallum* drain. At the southern end of D08 this level was reportedly partially covered in turn by another layer of stones, worn smooth by wear, set in a matrix described as in crushed gravel (D08:42) and powdery grey-brown gravelly soil (E08:49). This level was not planned in detail, the extent of its various layers of cobbling only being plotted on one of the sketch plans (D8: fig 7).

Road Level 4 (Fig. 7.23–7.25)

A further cobbled road surface, or perhaps two successive surfaces, was identified in D08 and D07, made up of stones averaging 0.10–0.15m in diameter, intermixed with crushed gravel and worn pebbles (D07:09, D08:19, 21). The west side of carriageway was bounded by a stone kerb (D08:31). In places, particularly towards the north, a second kerb line, immediately to the west of the main one, is recorded on plan P355. There was no trace of a corresponding

eastern kerb, the surface on this side having been cut away by a wide linear intrusion, but the *intervallum* road levels here may in any case simply have been continuous with the layers of cobbling over the assembly area.

Considerable uncertainty surrounded aspects of this road level, however. Initially D08:19 and D08:21 appear to have been regarded as two separate surfaces, with D08:21 underlying D08:19, being recorded as such on their respective context sheets. Consistent with this, D08:19 was depicted on site plan P330 with a distinct edge along its east side where it overlay D08:21. Subsequently, in course of excavation, D08:19 and D08:21 were treated as equivalent and essentially indistinguishable layers, being shown as such on site plan P355, and this was reflected or at least implied in the context records compiled later on, notably those relating to the post holes of 'Building AS' as well as the corresponding surface in D07 (D07:09) and the western kerb (D08:31), for example.

Building AS (Figs 7.23–7.26)

A large number of postholes were cut into *intervallum* road surface D08:19/21 and D07:09. These were labelled Building AS, although it was not possible to plot a coherent structure from the surviving post

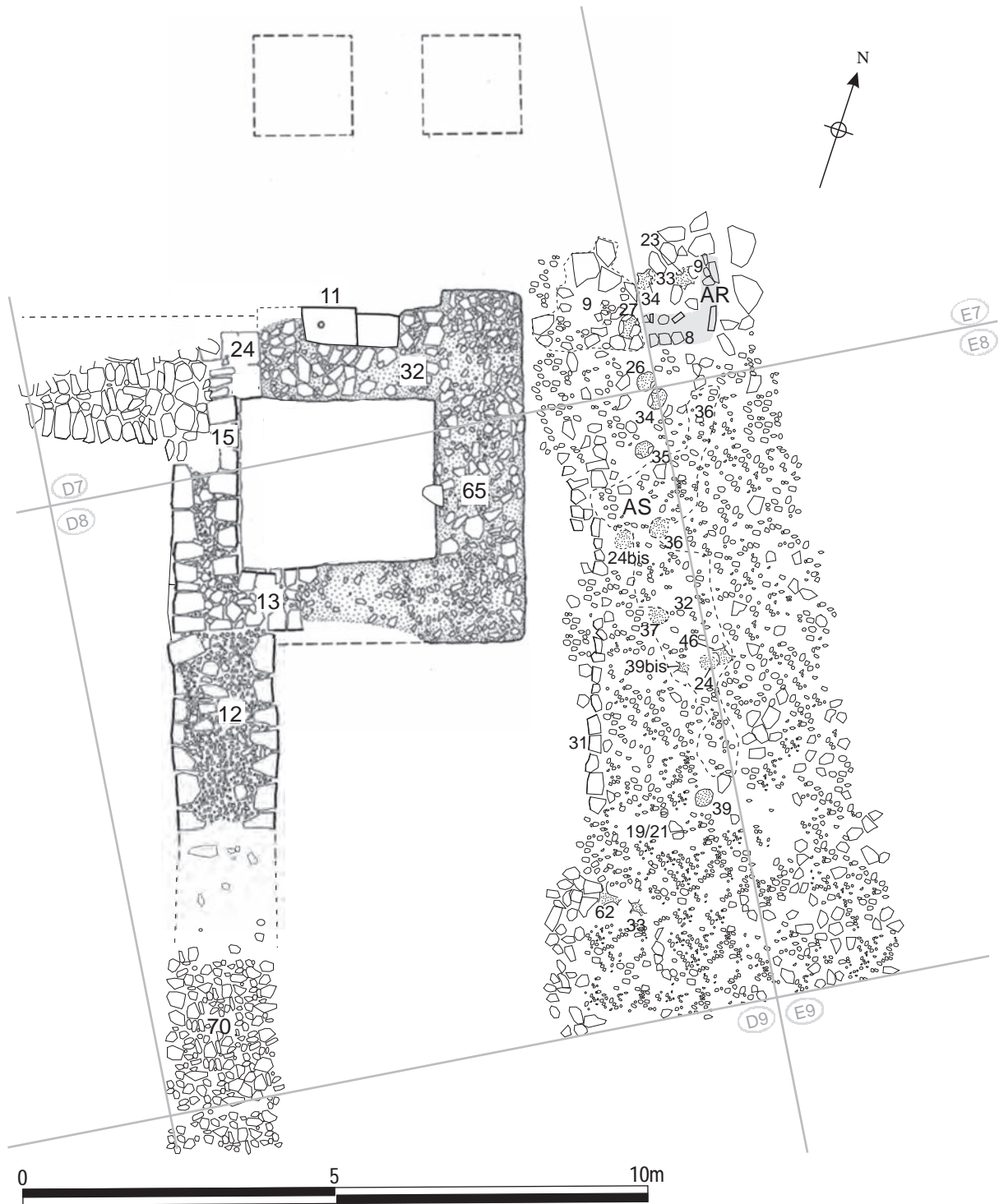

Fig re 3 The Level 4 intervallum road surfaces next to the west gate with the postholes of Building AS and the remains of AR (suggested wall lines highlighted with tone), 1:100.

holes. As many as 13 were assigned context numbers, with most featuring on site plan P375 or one of the two previous plans, whilst a couple of the context numbers were apparently assigned to two separate post holes (three post holes were also numbered twice: D07:20/26, E07:14/33, E07:34/D07:19). Thus the position of D08:39 on a couple of the sketch plans is not the same as that shown on site plan P375, whilst

D08:24 is likewise located at different spots on plans P330 and P355 (the sketch plan and P355 duplicate post holes are numbered D08:39bis and D08:24bis here, for convenience). The post holes were revealed by groups of packing stones protruding into the road surfaces (Fig. 7.26). They were arranged roughly in a line, some 10.30m in length, oriented north-south, and lay some 2.0–3.0m east of the gate tower and 5.5m



Figure 7.24: The Level 4 road surface (D08:19/21) cut by the postholes of Building AS, looking north.

east of the curtain wall. The northernmost postholes (E07:33–34) lay roughly in line with the north wall of the tower and the southern edge of the gate portal, but they were also only c. 0.90–1.00m from the northern edge of the excavation site so it remains conceivable that the full northern extent of the post-hole structure was not exposed in 1983. No trace was found of anything resembling an internal floor, such as stone flagging or a beaten clay deposit, and consequently the nature of the structure represented by these post holes is very unclear. However, it is possible that they represented the remains of a timber lean-to building attached to the east side of the tower and extending some 4.0m further south beyond it. No trace was identified of an east-west line of post holes running across the rampart area to form a south wall for the building, but the widespread modern disturbance in this area had removed most of the rampart deposits and potentially any trace of the south side of AS along with them.

Building AR

Over the north end of AS very fragmentary traces of stone walling were interpreted by the excavators as the remains of a second possible structure, which they labelled Building AR (see Fig. 7.23). These



Figure 7.25: The Level 4 intervallum road surface, looking south. The postholes of AS are apparent as is the north end of the earlier intervallum drain realignment (E07:08 in the bottom left corner).

remains were, it must be emphasised, extremely ephemeral, at least in their surviving condition, so much so that their identification as part of a distinct, coherent structure must remain open to question. They comprised an east-west aligned dry stone wall (E07:08), perhaps 1.15m in length and 0.50–0.60m wide, made up of six stones on the south face and five on the north, including stones pitched upright. This lay roughly in line with the north wall of the gatetower. A second wall (E07:09) extended c. 0.90m northward from the east end of E07:08, although the site plan (P326) identifies no more than four stones, labelled 'rubble', totalling 0.60m in length and 0.30m in width, as actually belonging to the putative wall. The cobbled surface, D07:09, immediately to the west of wall E07:08, was also tentatively associated with the structure, although this was more generally interpreted simply as part of the *intervallum* Level 3 road surface equivalent to D08:19/21. On site plan P330 the line of the south 'face' of E07:08 can be seen to continue in D07:09, but this gives it more of the appearance of an east-west aligned road kerb rather than a wall. At any rate, the ephemeral, fragmentary

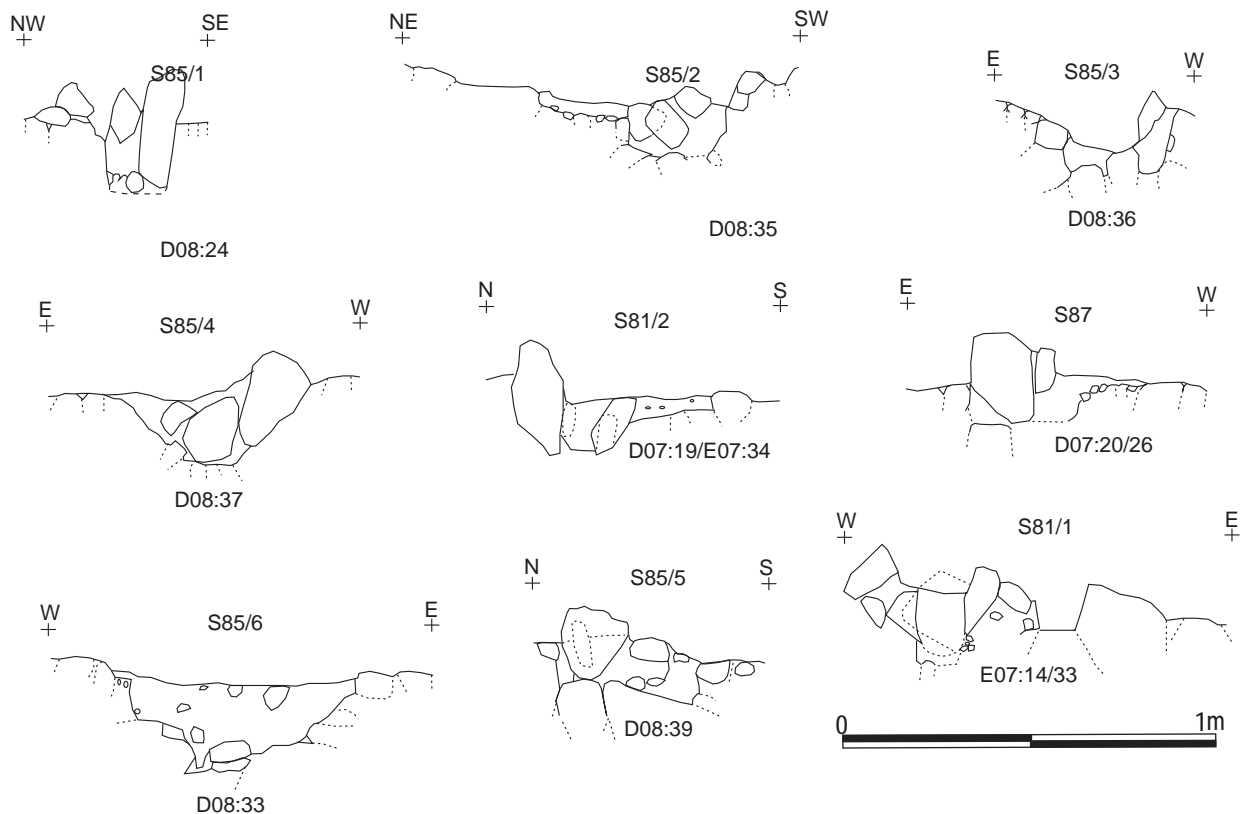

Figure 8 Section drawings of postholes associated with Building AS, at D

nature of the suggested walling means that no coherent interpretation of the structure's original form, function or overall dimensions can be offered.

The latest intervallum road surfaces next to the west gate (Fig. 7.27)

Overlying D08:19/21 was a spread of small crushed pebbles in light brown sandy soil intermixed with larger stones averaging 0.05m in diameter (D08:32, E08:36). This may have represented the uppermost surviving layer of metalling over this part of the *intervallum* road, although the possibility that D08:19 and D08:21 constituted two successive surfaces rather than one, discussed above, complicates this interpretation. As recorded on P355, the spread was very irregular in plan, perhaps implying that it only represented a fragment of its original extent. As discussed below, only one post hole associated with the putative Building AS reportedly cut this layer (D08:46 on its eastern edge – actually just in grid square E08). Conversely D08:32/E08:36 was explicitly recorded as overlying five of the post holes (D08:34–37, 39), although the extent of the road surface, as documented by site plan P355 and associated sketch plans would imply that not all of these post-settings could have lain directly beneath the surviving cobbling, unless part of the surface had already been removed before it was planned.

The uppermost levels of the *intervallum* road – both D08:32/E08:36 and D07:09/D08:19/21, however

the latter was constituted – were partially covered by a spread of rubble in light grey clayey soil (D07:10, D08:20), considered to be post-Roman by the excavators. This may be equivalent to the layer of disturbed rubble debris (E08:14) extending along the west edge of E08 as far as the broad linear cut made by colliery era drains (E08:08, E07:07?).

Discussion

There are many areas of uncertainty in the foregoing analysis and especially in the reconstructed relationships between the post holes of AS and the series of *intervallum* road levels. Most critically, the great majority of the post holes were only planned in relation to the lowest road surface (D07:28, D08:49, E07:35, plus rubble infill D08:51/E08:54, shown on P375). Only a handful of examples (D08:24, 24bis, 33, 46; shown on P330 and P355) were also plotted cutting the upper road surfaces, which were exposed earlier on during the excavation. Taken at face value this should imply that Building AS was relatively early in the structural sequence. However, most of the relevant context sheets (D07:19, 26, 27, D08:24, 33–37, 46, 62) explicitly record that the post holes cut or overlay road surface D07:09/D08:19/21. Moreover, the four post holes recorded on the plans of the later road levels appear to fall into the same overall pattern as the remainder, which figure on plan P375, and it is therefore reasonable to suppose that they might belong to the same structure rather than representing

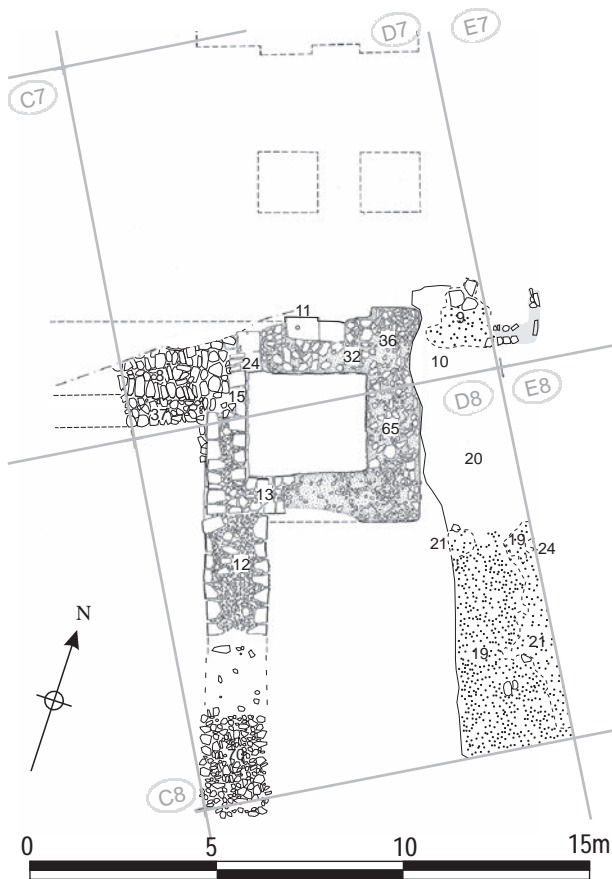

Figure 7 Latest surviving levels of the west intervallum road next to the west gate (based on site plan P330), 1:200.

a few isolated posts belonging to a different phase. Hence it is the record of the context sheets which has largely been followed here. Only D08:46, set right next to D08:24 (and perhaps a replacement for it), was explicitly documented as cutting the subsequent road level, although the latter was admittedly much more limited in its surviving extent than surface D07:09/D08:19/21.

A further problem concerns the correlation of the contexts relating to each *intervallum* road level across all the grid squares next to the west gate and, in particular, the difficulty of matching the contexts in E08 to the sequence identified in D08. As many as seven spreads of cobbling representing five or six distinct road levels were distinguished by context numbers in D08, whereas only four were so identified in E08, resulting in numerous inconsistencies between the apparent equivalences displayed on the plans and those set out, to a limited degree, on the context sheets. Thus cobbling E08:50 is given as equivalent to both the two successive road surfaces in D08 – D08:49 and D08:43 – corresponding to the first and second road levels respectively. This uncertainty also has implications for surface D08:44/E08:51 at the south end of grid squares D08 and E08. This is perhaps most

likely to correspond the Level 2 road surface further north (D08:43, E08:50?), but E08:51 is also shown as equivalent to the initial road level, D08:49/E08:50, on plan P375. Similarly cobbling E08:49 which probably corresponded to Road Surface 3 (D08:42) is also shown as equivalent to subsequent surface D08:19/21 on site plan P355). Overall, this would suggest that perhaps as many as three of the context numbers used to designate *intervallum* road cobbling in E08 actually related to more than one layer of metalling.

The intervallum road surfaces in grid squares D09 and D10 (Fig. 7.28)

In the grid squares further south, D09 and D10, far fewer levels of the *intervallum* road were identified than was the case next to the west gate. This might imply there was a greater degree of post-Roman disturbance in this area. It would also appear that excavation was not taken down to pre-fort levels everywhere in this area.

The road surfaces in D09

The lowest level extensively exposed in D09 was the rampart base of brown soil and thinly dispersed rubble (D09:12) which was seen to extend beyond the area of the rampart bank across the line of the *intervallum* road as far eastward as the stone-capped drain (D09:05). The soil was overlain by a metallated surface (D09:28), described as a spread of large stones in light brown soil (though the evidence of site plan P354 would indicate that smaller stones were also intermixed in places), which was up to 2.5m wide, extending from the edge of the *intervallum* drain westward. This was cut by an area of disturbance consisting of dark soil with loose metal slag (D09:25). The corresponding level over the western part of the assembly area was perhaps represented by a layer of closely packed, heavy cobbles or rubble (D09:33, E09:48), described as road foundation, which stretched up to 3.5m eastward from the *intervallum* drain beyond which there was a rubble and gravel spread (E09:47). The 'road foundation' was depicted on site plan P354 as a mixture of flagstones (especially in D09:33) and cobbles. Towards the south, the rubble had largely been robbed away over an area measuring some 4m (N-S) by 3m (E-W) to expose a light brown soil (D09:13, E09:49), whilst towards the north it partially overlapped the capstones of the *intervallum* drain in places.

The lower road surface to the west of the drain was overlain by D09:03 and D09:16 which, stratigraphically, seem to have formed different parts of the same secondary level. D09:03 was described as a worn cobble and flagstone surface on the relevant context sheet. On site plan P331, however, it is shown as comprising discrete patches of scattered flagging, whilst only one patch of D09:16 resembled its context



Fig re 2 8 Later west intervallum road surfaces in grid squares D9 and D10 (based on site plans P331 and P332),

sheet description – uneven broken flagstones – the remainder of that layer apparently consisting of much smaller cobbling, which surrounded the scattered patches of D09:03. This was 2.0–2.5m wide from the edge of the *intervallum* drain. To the east of the drain (and overlapping it towards the north), an extensive area of worn stones (D09:11) on the edge of the assembly area was interpreted as another possible road surface, which was perhaps equivalent to the stone surface in orange/brown soil (E09:12) in grid square E09, these layers together overlying the earlier ‘road foundation’ D09:33/E09:48. Overlapping the eastern margin of E09:12 and overlying sub-base E09:47, was a further patch of worn stone surfacing (E09:11), measuring 5m (N–S) by 2m (E–W).

The road surfaces in D10

A clear, though almost certainly incomplete, sequence of *intervallum* street levels was apparent in the parts of D10 and D11 excavated in 1977. A surface comprising small cobbles and pieces of sandstone set in light brown clay loam (D10:12) was exposed in a small strip revealed by removal of a modern brick-lined drain (D10:03). Excavations were not taken down to subsoil in this area so it is by no means certain that this was

the lowest level of metalling actually constructed. The relationship of D10:12 to the *intervallum* drain was not clear as the latter’s remains had been removed by the modern drain in the area exposed. The surface was not recorded on the relative site plan (P91a), but the sketch plans imply that it extended as far as the edge of the line of flagstones situated between the drain and the hospital’s west wall (i.e. they suggest that the cobbling extended over the line of the drain). However, without the verification of a detailed plan or even a specific record of such relationships on the relevant context sheets, this may be regarded as an oversimplification of the true picture. In the next grid square to the south, D11, the lowest road level revealed was not described (D11:37). However the relevant site plan (P91b) indicates that it was composed of a mixture of small cobbles larger stones up to 0.20m in diameter and small flags up to 0.40m square and probably abutted the edges of the *intervallum* drain cover slabs. On the evidence of the site plan the carriageway in this phase was 5.70–6.00m wide overall, including the drain (4.30–4.50m wide west of the drain). Cobbling D10:12 was overlain by a further, undescribed, *intervallum* road surface (D10:09) which was not removed in 1977. This was equivalent to the surface of very worn cobbles (D11:18) exposed at this level in the next grid square to the south. Cobbling D10:09/D11:18 largely covered the remains of the *intervallum* drain (although one or two capstones were apparent on site plan P91a amidst the cobbling) and the adjoining flags, D10:11, which directly abutted the hospital’s west wall. The road surface was in turn overlain by a layer of fairly densely packed small cobble rubble (D10:04, D11:02), 0.05–0.10m deep, which also extended over the area of the hospital, covering the surviving remains of the building’s walls. This rubble might conceivably represent the bottom of the post-Roman disturbance overlying the surviving Roman levels, rather than forming a distinct stratified layer in its own right.

When this part of D10 was re-excavated in 1983, along with the rest of the grid square to the north, more of the *intervallum* drain capstones were apparent. This applied not only in area to the north, not seen in 1977, but also to the small pocket re-exposed, suggesting that some of the levels equivalent to those seen in 1977 had been removed, either during the earlier backfilling or perhaps during the initial clearance in 1983. The context number D10:09 was allocated to a level exposed in 1983, but it is uncertain whether it was in fact equivalent to the layer recorded in 1977. To the north D10:09 (1983) was reportedly overlain by a surface of small flags, levelled rubble and gravel (D10:28). This is the relationship expressed on the context sheet, but the site plan P332 shows both contexts apparently on the same level, whilst annotation on plan P356, drawn subsequently, implies D10:09 was over D10:28. The site plans indicate that the two levels were both c. 2.3–3.0m wide. The offset

course of the hospital west wall (D10:06) and the row of flags (D10:11), positioned between that wall and the *intervallum* drain, were overlain by a deposit of mixed small rubble set in grey silt soil (D10:26, possibly equivalent to TWM 5621), which might be identical to that part of D10:09 recorded overlying flags D10:11 in 1977.

Discussion – the intervallum road

As will have been apparent from the foregoing, some difficulty has been encountered in establishing a coherent sequence *intervallum* road levels along this stretch of the western defences due to a combination of considerable post-Roman disturbance affecting certain parts of the site and multiple inconsistencies in the excavation record. A clearer picture of the development of the western defences, and in particular the *intervallum* road, was provided by the excavations undertaken during 1997–8 in the adjoining stretch, between the minor west gate (*porta quintana sinistra*) and the southern edge of the 1983 excavations. This work included the recording of a detailed section across the western defences (Section 13: Hodgson 2003, 169, fig 119). Given the difficulties of equating road levels uncovered in 1983 excavations in adjoining grid squares, it may seem overly courageous to attempt to correlate those results with the 1997–8 findings. However a few observations may be worthwhile.

The 1997–8 excavations revealed a series of road levels comparable in complexity to the sequence uncovered in D08, next to the west gate, but different to that encountered in D09 and D10 where only upper and lower road levels could be identified. The only *intervallum* street surface associated with Period 1, which was exposed in 1997–8, lay sealed beneath construction deposits in the west range of the stone hospital (Building 8). The metalling lay immediately to the west of the Hadrianic, timber building (21) which preceded the stone hospital and was contemporary with the Period 1 surface. No equivalent metalling was exposed at any other point north of the *porta quintana* (none is identified in Section 13 for example) and this is comparable with the results obtained in 1983 when no *intervallum* street surface was identified which can now be convincingly assigned to Period 1, despite excavation down to what were interpreted as pre-fort levels ('OGS') in many areas. A Period 2 street level dateable to the mid-Antonine era or later second century was exposed in plan and section (7927) and was cut by the *intervallum* drain (which the 1997–8 excavators assigned to Period 3). No Period 3 or 4 levels were traced in 1997–8, north of the *porta quintana*, the next street surface being attributed to the late third or early fourth century (5620, 7056). Contemporary with this level, a gully (7056) was cut along the rampart back, about 3m from the inner face of the curtain wall. No trace of this gully was noted

further north in the 1983 excavation area. A dump of cobbles and sandstone fragments (5621), 0.12m in depth and set in grey silty clay, was attributed to the same period as street surface 5620/7056. This formed a levelling deposit between the *intervallum* drain capstones and the west wall of the hospital, and was presumably equivalent to the deposit of 'mixed small rubble set in grey silt soil' (D10:26) identified further north, over flags D10:11, in 1983. A final surviving road level (5616=5617=7026), composed of well-worn pebbles and stone fragments, was attributed to the mid-fourth century.

The multiple road levels identified in D08 lie too far removed from the 1997–8 excavation area to be able to equate the surfaces there with those in the 1997–8 sequence with any confidence. Road Level 1 may plausibly be assigned to Period 2, but there is no guarantee that the subsequent street surfaces follow the same chronological pattern as those revealed further south in 1997–8. Unfortunately, moreover, not many of the *intervallum* road contexts identified next to the west gate in 1983 yielded dateable material and such pottery as was recovered did not provide any kind of informative seriation either. The upper and lower road levels very tentatively identified in D09 and D10 could perhaps be equated with the late third/early fourth-century street and the Period 2 (later second-century) street, respectively, though only with the greatest degree of caution. Of the levels exposed in 1977 in the very area re-examined in 1997–8, the upper street surface, D10:09/D11:18, may be identified with the late third/early fourth-century *intervallum* metalling or perhaps the mid-fourth century level, whilst the lower surface, D10:12, D11:37 could perhaps represent the Period 2 level. If the rubble deposits covering the entire area (D10:04, D11:02) did actually represent a road surface, rather than simply being a result of post-Roman disturbance, this might correspond to the mid-fourth century street metalling.

The date of the intervallum drain

The phasing of the drain requires some discussion. It gives every appearance of being a relatively early feature, if not primary, at any rate broadly contemporary with the construction of the hospital in Period 2. It is notable that the line of flags, D10:11, which formed the uppermost course of the drain's east side wall, were very carefully laid right up against the west wall of the hospital, neatly abutting the wall's offset course, particularly to the north of the building's entranceway, and suggesting that the offset course was still clearly exposed when the drain was first constructed. Moreover the drain's capstones were only fully exposed once all the road cobbling had been removed, which could imply that its construction predated the laying of even the earliest of the surviving *intervallum* road levels. It is unclear whether it was inserted through Road Level

1 in D07-D08 and E07-E08, or whether the metalling was laid on either side of a pre-existing drain, but either way the drain would appear to have been functioning at the same time as that street surface, which should probably be assigned to Period 2. The infill deposit (D08:51, E08:54) over the line of the drain should probably be associated with later diversion of the channel to flow via Cistern 1 on the western edge of the assembly area.

In the report on the 1997–8 excavations, however, it was suggested that this *intervallum* drain was somewhat later in date, contemporary with Phase 2 of the stone hospital rather than Phase 1, that is to say Fort Period 3 rather than Period 2 (Hodgson 2003, 160). The section through the *intervallum* road recorded in the course of that excavation programme (*op. cit.* 169, fig. 119: Section 13) appears to indicate that the drain was cut through the Phase 1 (Fort Period 2) levels. However, in view of the observations summarised above, it seems more likely that, although the drain may have been stratigraphically later than the Period 2 road levels and perhaps followed the construction of the initial stone hospital (Building 8 Phase 1), its construction cannot have followed on after any significant interval. Creation of the drain would thus have still fallen within the overall chronological parameters of Period 2 and would have formed an integral component of the Period 2 remodelling, although as one of the fort's principal storm drains it may well subsequently have been subject to repeated maintenance and minor alterations.

FINDS

West intervallum street (Road 5)

Road surfaces

Architectural stone: guttering (no. 9, E08:50)

Iron: martingale? (no. 39, D07:28)

Quern: lava (no. 38, D:08:32)

Rubble over Road 5

Bone: offcut (no. 66, D07:10)

Dating evidence

The west intervallum street (Road 5)

THE INTERVALLUM DRAIN

The *intervallum* drain contained three sherds of BB2 and allied fabrics, and a sherd of late third or fourth century calcite gritted ware (E07:27, E07:44).

Further south the lowest fill of the drain contained a single sherd of a locally produced second-century flat-rimmed bowl (D11:61). There were three other sherds from the upper fills, including a body sherd of calcite-gritted ware and a Huntcliff-type rim in the same fabric, dated to after 360 (D11:60; D11:59).

THE INTERVALLUM STREET SURFACES

The surviving pottery from the road surfaces is mainly made up of BB2 and allied fabrics (with a high percentage of rims) and a rim sherd from a Lower Nene Valley colour-coated ware Castor box lid, all dating to the third century (E08:48). There is also a sherd from a Crambeck reduced ware hemispherical bowl of the late third century or later (E08:50).

RUBBLE OVER ROAD 5

Half of the pottery recovered was made up of Dressel 20 amphora sherds. There was also a third-century Gillam Type 151 rim (D07:10).

Building AS

There was a single body sherd of BB2 (D08:46).

Building AR

The four sherds of pottery recovered from the building included a BB2 cooking pot rim, and a Gillam Type 151 rim, of the third century (E07:09).

8. THE *PRINCIPIA* (BUILDING 14)

Grid squares: H8, H9, H10, H11, H12, J9, J10, J11, J12, K9, K10, K11, K12, L9

Introduction

The headquarters building, or *principia*, was revealed in the normal position in the very centre of the fort. A large structure, measuring 32m in length (north-south) by 23.8m wide (east-west), it sat in the middle of the central range of buildings (*latera praetorii*), facing northward onto the intersection of the *via praetoria* and the *via principalis*, being flanked by the granary (7) to the west and the *praetorium* (13) to the east. Labelled Building 14 in the Daniels structural code, it was excavated during 1980–81 as part of Site 16, which also involved initial work on the adjacent granary and investigation of the adjoining stretch of the *via principalis*, the forehall (AO) and the western end of Building 16 to the north. It took the form of a flagged courtyard with a colonnaded covered walkway around its north, west and east sides. The main cross-hall occupied the remaining side of the courtyard and was furnished with a square tribunal at its west end whilst the usual row of five rooms, including the central *aedes* and subterranean strong-room, were ranged along the south side of the hall.

Discussion of phasing

The Daniels research archive, which resulted from initial post-excavation analysis, included a series of inked phase plans, a full database of phased contexts and a draft text providing a very summary outline of the building's structural phasing. The sequence of four main phases presented here corresponds to that displayed in the inked plans and referenced in the context database, with each phase encompassing the entire building.

However, it must be emphasised that there were

very few stratigraphic links between the courtyard and the cross-hall or between the latter and the south range of rooms, or even between adjacent rooms in the south range. Indeed in the summary report the cross-hall and south range were described separately from structural sequences in the courtyard. In effect all these sequences constituted isolated islands of stratigraphy and the Daniels phasing assumed that the structural development in all of these areas proceeded at a broadly parallel rate with the second phase of activity in the courtyard being contemporary with second phase in the cross-hall and so forth.

One exception to this pattern is represented by the overflow drain (K10:18, K11:24), which ran from the water tank in the south-east corner of the courtyard, through the north-east corner of the cross-hall, and out beneath the east entrance of the building. In theory this should provide a clear stratigraphic relationship between the courtyard and some of the floor levels in the cross-hall. Unfortunately, even in this case the context entries relating to this feature include contradictory statements regarding its relationship to the Phase 4 floor level. The overflow drain, which was assigned to Phase 3 of the courtyard, was reported to cut the Phase 2 cross-hall floor K11:32 and Phase 3 floor K11:36. The context record for the Phase 4 gravel floor K11:27 states that K11:24 lay beneath the floor, but conversely the record for drain K11:24 indicates that the drain cut gravel K11:27. The relationship of the drain cover slabs (K11:16) to the gravel K11:27 was not noted, but it is likely that they were incorporated in the flagged floor (K11:15) which survived in a few places at the east end of hall, overlying the earlier gravel surface. The sketch plans, however all clearly show the drain cutting the gravel surface and this is the solution preferred here. This, in turn, implies that the later structural sequences in the courtyard were better preserved than those in the cross-hall since the drain, and hence, presumably, the south-east water

tank (J10:22, K10:16), post-dated everything except the final flagged cross-hall floor, K11:15. However, it is now apparent that such extensive truncation of the late Roman levels in the interior of the fort's buildings actually conforms to the usual pattern at Wallsend (compare the neighbouring *praetorium* for example), something the excavators in 1975–84 were unaware of and hence caused them such interpretive headaches, as they tried to identify sufficient phases to span the full duration of Roman occupation on the site.

The earliest activity was represented by cord-rig furrows beneath the courtyard and cross-hall which continued northward beneath the levels of the *via principalis* (see Chapter 3). Some of the cultivation furrows were in turn cut by timber beam slots which the excavators interpreted as the partial remains of a rectangular building (BI) perhaps associated with the initial construction of the fort. There is evidence that the stone headquarters was twice abortively laid out, neither of these schemes apparently rising above foundation level, the footprint of the first being offset slightly to the north and the second to the west of the definitive *principia* layout. The four principal phases of the building followed in the excavators' scheme. These were allocated to Fort Phases 1, 2 and 3, with Building 14 Phases 2 and 3 both falling within Fort Phase 2, which corresponded to the third century. The final activity associated with Building Phase 4 may have extended into Fort Phase 4, the Roman period sequence closing with the construction of timber structures (BC, BD) over the west portico of the courtyard, which the excavators firmly allocated to Fort Phase 4 rather than the post-Roman period. Some modification to this phasing is now required, particularly for the southern half of the building where Phases 3 and 4 cannot be considered contemporary with courtyard Phases 3 and 4.

The construction phase

Pre-headquarters timber structure (Building BI)

Beneath the stone *principia* various features identified as slots for timber beams or post in trench constructions were distinguished from the underlying agricultural cord-rig earthworks. These features represented the remains of a timber building, labelled BI by the excavators, which was interpreted as a structure associated with the initial construction work on the fort.

Description (Figs 8.01–8.03)

The most obvious components of this structure were three narrow, steep-sided slots, interpreted as trenches for sleeper beams, which formed the east (K09:40, K10:57), west (J08:28, J09:56, J10:64) and north (K08:51) sides of a rectangular building, measuring

18m (N-S) by 6.5m (E-W) externally. The position of this structure corresponded to the eastern part of the courtyard of the later stone headquarters, extending north across the north portico and up to 3m into the area of the *via principalis*. The trenches were generally 0.30–0.45m wide and were filled with a mixture of redeposited grey clay (perhaps ploughsoil) and natural orange clay with flecks of charcoal, sandstone 'blocks' (perhaps rubble rather than dressed stones) and small lumps of decayed sandstone (separate contexts were only assigned to the fill deposits in the case of the west slot: J09:54, J10:58). The site photographs clearly show rubble filling the trenches at some points, presumably backfill material after the building had been demolished. The depth of the slots was not recorded but the site photographs suggest it was similar to the width of the trenches.

It is important to note that a widespread pattern of cultivation furrows predominantly aligned north-south was also recorded in the same area (see Chapter 3). The alignment of the beam slots was sufficiently different from that of the furrows to enable the two to be distinguished, but even so some scope for confusion remained, particularly at the north end of the building. For example it was unclear whether north wall K08:51 continued eastward, beyond the line of the east wall, in the form of K09:35 – a narrow trench filled with sandstone fragments in medium-brown silty soil – or whether the latter simply represented an east-west aligned cultivation furrow, the interpretation eventually placed upon it in the context database. The somewhat different composition of the fill of K08:51, as described – essentially mixed clay and stone – would support the latter interpretation, but no other east-west furrows were identified in this part of the fort.

No trace of a south wall slot was noted, but a further 3.40m long, shallow slot (J10:69) was seen to extend westwards from the south end of trench J09:56/J10:64. This was only 0.20–0.30m wide and was filled with small angular pieces of sandstone, grit and mixed dirty orange and grey clay. Towards its west end the packing stones for an upright timber post (J10:70) were set into the slot. Another shallow post hole (H10:45) lay directly in line with this slot some 6m further west in the area of the later west portico. This was oval in shape, measuring 0.45m by 0.33m and was 0.25m deep with a sandstone pack in the bottom. Immediately to the south of slot J10:69, a steep-sided circular pit (J10:59), c. 0.75m in diameter and backfilled with tightly packed stones in a dirty orange clay matrix, might represent another post hole.

Another east-west aligned row of post holes was recognised 12m north of slot J10:69. Three large post pits were identified in this line (from east to west: J09:48, J09:44, J09:58). The easternmost (J09:48) was located some 3.40m from the west wall slot and was sub-rectangular in plan (1.35m × 1.00m), with a post

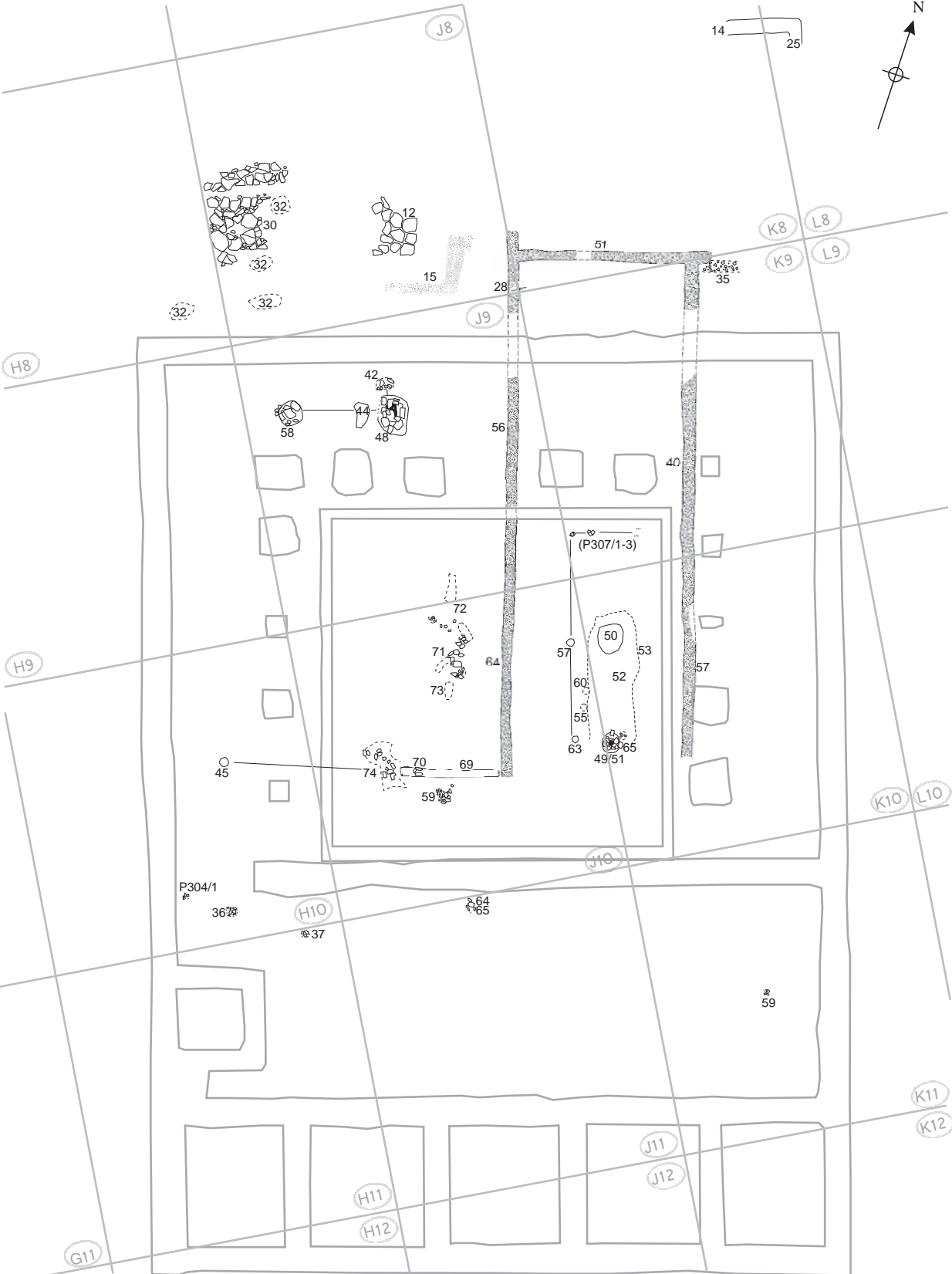

Fig re 8 Building BI, at 8



Figure 8 The north end of Building BI construction slots in the foreground beneath the *via principalis* with pre-Roman cultivation furrows evident beyond, looking west.



Figure 8 The main construction slots of timber building BI, looking south

pipe (J09:47), 0.20m in diameter, filled with grey clayey soil within packing of large sandstone blocks in a mixed orange and grey clay matrix incorporating charcoal/coal flecks and smaller stones (J09:45). The second pit (J09:44), smaller and roughly oval in form (0.85m N-S by 0.45m E-W), contained a similar fill of mixed orange, yellow and grey clay and stones, whilst the third (J09:58), located 7.80m west of beam-trench J09:56/J10:64 formed another large sub-circular pit, 0.80m in diameter, packed with angular stones in mixed orange grey. Another smaller post hole or shallow pit (J09:42) lay just to the north of J09:48. It was oval in plan, measuring c. 0.65m by 0.50m, but only c. 0.17m deep and was again tightly packed with stones in a dark gritty clay fill flecked with coal or charcoal.

To the north and west of this row of post pits and extending west of the north-west corner of the timber structure a more complex sequence of construction levels and cobbled and flagged surfaces was uncovered. First there was a layer of masons chippings and construction debris (H09:39, J08:35,

J09:49) beneath the north-west corner of the *principia*, consisting of sandstone chippings in 'lemon yellow' coloured sand and brown silt with patches of dirty orange clay and some larger stones. This covered an area some 7.70m (N-S) by 5m (E-W) which also extended beneath the southern edge of the *via principalis*. It was evidently cut by post pit J09:58 as well as by the north wall of the headquarters and directly overlay the grey clay forming the pre-fort ploughsoil (H09:38, J08:36, J09:46) and cultivation furrows J08:37–41. Immediately to the north, adjoining deposits of soft orange sand mixed with soft grey loam (J08:33), 50–100mm thick, and rusty brown loamy soil (J08:42) might also represent initial construction levels. These spreads of probable construction debris were overlain by layers of small cobbles set in dark grey silty loam (J08:34) and cobbles set in orange/yellow sand (J08:43) in the area of the *via principalis*.

Areas of flagging (J08:12, 30), plus a shallow L-shaped strip of yellowy-pink clay (J08:15) and a few scattered spreads of small sandstone cobbles (J08:32) were identified beneath the main road surfaces and cobbled foundation layers of the *via principalis*. Cobbles J08:32 and flagging J08:30 appeared to be bedded on an extensive layer of compact dark yellow sand, sandstone grit and small stones (J08:31), overlying lower cobbling J08:34 and J08:43. Flagging J08:30 covered an area measuring 3.30m (N-S) by 2.80m (E-W) and is probably equivalent to the 1.40m × 0.80m area of green sandstone slabs found 7m to the north-east of the north-west corner of the *principia* in 1997–8 (TWM 5255), although evidently much of the flagging must have been removed in the course of the 1980–81 excavation or subsequent re-exposure. The largest of the flags measured 0.70m × 0.60m, though 0.35m × 0.30m was more typical.

These features were tentatively associated with Building BI and the initial construction levels of the fort, but the possibility that the cobbling and flags might represent the primary levels of the *via principalis* was also acknowledged.

To the south, between the two east-west alignments of post holes or posts and slot, there were a number of spreads of flat angular stones, small pebbles, grit and dirty clay (J10:71–73) which may have formed the patchy fragments of an associated surface. A similar, slightly larger spread of stones (J10:74) lay next to the west end of slot J09:69.

More post hole alignments were noted within the main timber structure. The principal feature here was a long pit or trench (J10:60/K10:53) located at the southern end of the structure, aligned north-south roughly along the building's longitudinal axis. The pit was up to 4.80m long and 1.70m wide. Its depth was uneven, being shallower at the north end, where it was as little as 0.10m, generally increasing nearer the south end, reaching a maximum depth of 0.48m.

It was filled with mixed orange, yellow and grey clays, occasionally flecked with charcoal, plus some fragments of sandstone (J10:55, K10:47, 52). At its north end the trench fill was cut by a shallow, oval pit (K10:50), measuring 0.75m by 0.50m, but no more than 0.20m in depth, which was filled with mixed medium brown clayey soil. A post pit (K10:51), 0.65–0.70m in diameter and a maximum of 0.45m deep, occupied the corresponding position at the southern end of the shallow trench. This had very steep or vertical sides and was packed with sandstone blocks in a mixed grey-orange clay and silt matrix (K10:49), the blocks defining a post pipe (K10:48), c. 0.17m in diameter, filled with grey/dark brown silt. Immediately to the east of K10:51, the trench was partially cut by another probable post hole (K10:65), c. 0.50m in diameter, filled with dark grey-brown clay/loam, small stones and grit, with some large packing stones (K10:64). Two small, circular post holes (J10:63, J10:57), only 0.20m and 0.25m in diameter, were identified 0.35–0.45m to the west of the shallow trench. These were spaced 3.10m apart on an alignment running parallel with east and west walls of the building and were filled with small pebbles in grey silty clay. The southern post hole (J10:63) lay on roughly the same east-west alignment as K10:51 and K10:65 and was c. 0.13m deep. Some 2.60m to the north of trench J10:60/K10:53, a row of features extending from east to west was recorded on site plan P307. These consisted of two small postholes spaced 0.40m apart (P307/1 and P307/2) and, 1.40m further east, a 0.25m wide channel or slot (P307/3). The post holes were only c. 20m in diameter, with small packing stones evident on the plan, whilst the channel was cut away by a much later pit (K09:16–17) to the west and hidden beneath courtyard flagging to the east so that only a very short length (0.25m) of the channel was exposed. The westernmost post hole (P307/1) was also in line with post holes J10:63 and J10:57, lying some 3.55m north of the latter, giving that north-south alignment a total length of 7m.

Further south, a number of post holes that might plausibly be regarded as associated with the construction phase were uncovered in the *principia* crosshall. Three were located in the north-west part of the hall. They cut into the pre-fort ploughsoil or construction makeup level (H10:39) and lay beneath the Phase 2 floor level (H11:46), but did not follow the building's main alignments as would have been expected if they were Phase 1 internal structural features. The post holes formed a line extending from the north-west corner of the hall into the interior at an oblique angle to its north wall. The example in the north-west corner was recorded only on site plan P304, measuring c. 0.35m in diameter with two upright packing stones remaining in situ. The other two (H10:36–37) were described as steep-sided, narrowing towards the bottom, with very mixed fills

of orange, yellow and grey clay with charcoal and coal inclusions and were probably c. 0.40–0.50m in diameter judging from the sketch and site plans. Their spacing was uneven with only c. 0.90m separating H10:36 from P304/1, but 2m lying between H10:36 and H10:37, the most easterly of the trio which was located just over 1m from the crosshall north wall. Another couple of postholes (J11:64, 65) were situated close to the north wall roughly midway along its length. J11:64 lay only 0.30m from the wall foundations and was cut by J11:65 immediately to the south. Both were relatively small, measuring no more than c. 0.25m in diameter, with depths of 0.10m and 0.13m respectively, and contained mixed clay, sand and pebble fills. A single, larger and deeper post pit (K11:59) was recorded in a fairly central position near the east end of the crosshall. This was oval (0.45m × 0.55m), with steep sides, and contained packing stones and a fill of medium brown clayey soil.

In the remainder of the crosshall and south range areas a number of restricted spreads of flagstones and timber slots and postholes were identified which were clearly relatively early in the stratigraphic sequence and were similar in character to those associated with Building BI. In each case, however, there are grounds for following the excavators in attributing these more southerly features to the Phase 1 *principia*, albeit with a degree of caution.

The initial foundations (Figs 8.04–8.06)

As originally designed the headquarters was laid out on a slightly more northerly footprint than the definitive Phase 1 building. Thus, in the case of the building's south wall, the southern edge of the original foundations lay some 2.40m to the north of the south face of the offset course in the final building. Similarly the north edge of the foundations of the south range lay anything between 2.10m and 2.40m to the north of the north face of the equivalent wall as finally erected. The original south wall would have been in line with the portico on the south side of the granary. The footprint was also offset slightly to the east by comparison with the definitive Phase 1 plan. Thus, the eastern edges of the original side wall foundations in the south range lay c. 0.10–0.25m beyond the eastern edges of the corresponding Phase 1 side walls. At the eastern end of the range's south wall, a short stretch of the foundations of the main east wall (K12 no number assigned) projected 0.25m beyond the Phase 1 east wall, extending over a distance of 1.50m, from north to south. All other trace of the east and west walls had evidently been removed during construction of the definitive Phase 1 building.

Only the foundations of the south range associated with this layout were uncovered, and it is possible the scheme was abandoned before it proceeded further.

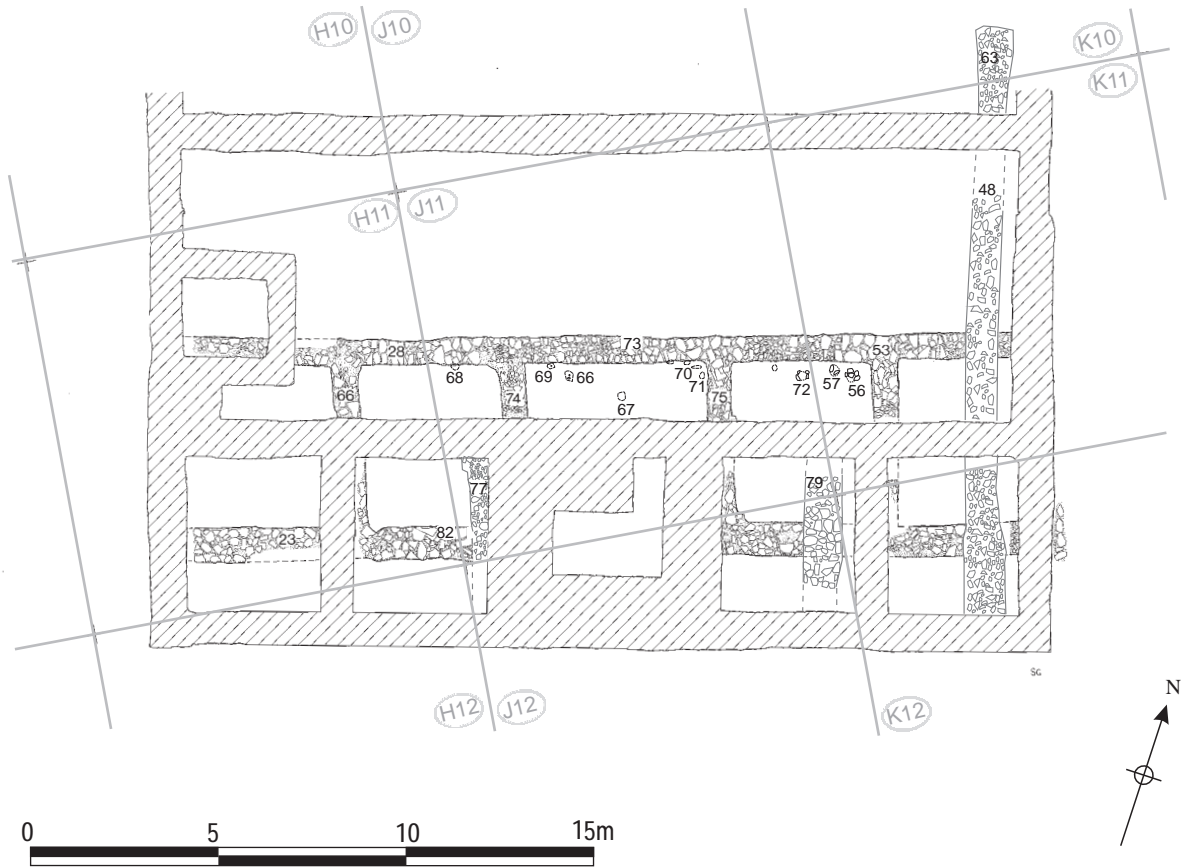

Figure 8.05: First and second phase of aborted foundations for the principia south range, with outline of definitive layout of crosshall and south range shown in red for reference (at 1:50).



Figure 8.06: General view of the principia south range and crosshall looking west with the earlier unfinished foundations apparent in the centre and the intermediate foundations running from left to right just beyond the east wall in the foreground.



Figure 8.06: Detail showing the original south range foundations cut by the north wall of the range as built, looking east.

There is no definite evidence that the foundations were ever built upon and Daniels certainly regarded it as unlikely. As was the case in the ultimate plan, the range contained five rooms, designated A to E, from west to east. The central room was about 1.0m wider than the others, measuring c. 4.80m, internally, from

east to west, whereas Rooms B and D, on either side, were both c. 3.75m wide. The internal east-west width of Room E could not be established precisely, as most of the foundations of its east wall lay beneath the east wall of the Phase 1 headquarters (K11:06, K12:12), but it was probably very similar to those of Rooms

B and D. Room A appeared to be slightly wider than B, D or E, since no trace of its west wall was exposed, suggesting it must have lain beneath the west wall foundations of the Phase 1 building (K11:09) and implying that the room was at least 3.90m wide. Even so, it was obviously much closer to the dimensions of the other three side rooms, which would presumably have served as offices if they had ever been completed, than those of C which would have represented the central regimental shrine, or *aedes*.

The foundations were uniformly composed of substantial, roughly cut blocks of sandstone rubble set in grey-orange or pink-grey clay (see Fig. 8.06). Their width varied, those belonging to the south wall (H11:23, J11:82 (also present in grid squares J12 and K12 but no context numbers assigned)) being the broadest, at 0.70–0.90m. The north wall foundations (H11:28, J11:73, K11:53) and foundations between the various rooms of the south range (separating Rooms A and B: H11:66, B/C: J11:74, C/D: J11:75, D/E: also K11:53) were similar in width, generally varying between c. 0.55m and 0.70m.

The deposits used to backfill the construction trenches were recorded in the area of the later cross-hall (encompassing the north wall foundations and the northern parts of the various side walls). In the western half of the cross-hall the trenches appeared to have been deliberately backfilled with a series of deposits, an orange clay incorporating some stones (H11:63, J11:47) overlain by fairly compacted yellow sand and sandstone chippings (H11:62, J11:46) and a narrow linear fill containing many small pebbles (H11:61). To the east the foundations were covered by a very mixed layer of dark brown/black clay soil, orange clay and some stones (J11:50, K11:45), which at one point incorporated a small spread of tumbled worn cobbles (J11:63). The excavators suggested that this indicated the trenches had lain open for some time, with the dark brown/black clay soil representing the pre-fort plough soil (J11:45, K11:43) which had eroded off the sides. The site plans and accompanying sketch plans appear to indicate that the western fill deposits (H11:63/J11:47 and to a lesser extent H11:62/J11:46) extended southwards over the interior of the abandoned south range and presumably also served as more widespread levelling deposits in that area. On the north side of foundations H11:28, one of the patches of flagging (H11:64) interpreted as the remnants of the Phase 1 floor in the cross-hall extended over the lip of the trench to sit directly on top of fill deposit H11:62.

A series of post holes were uncovered during the digging of excavation trenches (J11:80, K11:63) to expose the initial foundations. All were located along the southern side of the north wall foundations (J11:73/K11:53) in Rooms B (J11:68), C (J11:66–67, 69–71) and D (J11:72, K11:55–57) and were perhaps associated with this episode of construction work.

Four of these (J11:68–71), all filled with grey clay, were very small (c. 0.15m in diameter and c. 0.09–0.15m deep) and were situated very close to the foundations. Accordingly they were interpreted as holding scaffolding poles for the building of the walls. Two other post holes in Room C (J11:66, 67) lay slightly further way from the foundations (0.25m and 0.80m respectively), but might still have been contemporary with their construction. J11:66, like J11:69, was rectangular in plan (0.20m × 0.25m) and was more substantial than the others, being some 0.35m deep, with steep sides and a mixed fill of clay, sand and pebbles. J11:67, however, was so shallow (0.06m) that even its identification as a post hole was uncertain. The cluster of four closely spaced post holes in Room D (apparently adjoining in the case of J11:72 and K11:55) were somewhat larger (0.22m in diameter and 0.28m deep in the case of J11:72 for example) and contained actual packing stones as well as fills of sand and mixed orangey-grey clay (J11:72) or medium brown clayey soil (K11:55–57), but they too lay close to the southern edge of the foundations (within 0.10–0.25m) and might have performed an analogous function, though strictly speaking they could have been associated in some way with the construction of the definitive Phase 1 *principia* crosshall instead.

Intermediate foundation plan (Figs 8.04–8.06)

A second layout appears to have been begun which entailed shifting the east wall of the building c. 1.20m westward, with respect to both the original foundations and those of the definitive version. The east wall foundations of the cross-hall and south range (K11:48) were traced and were observed to continue a further 3.0m beyond the north wall of the cross-hall, along the east side of the courtyard before coming to a stop (K10:63). The foundations were generally c. 0.80m wide (though broadening to as much as 1.0m wide in places) and were composed of large pieces of sandstone rubble set in orange clay. No east-west walls associated with this phase were conclusively identified, that is to say the south wall of the building or the north and south walls of the cross-hall, but these were all assumed to lie on the same line as their later counterparts. It is likely that the building's west wall would have lain to the west of that finally built, but the levels in the alley (Alley 8) to the west were not removed to a sufficient extent to confirm this.

Evidence was uncovered in two places that the footprint of the rooms of the south range was also different with the north-south walls separating the rooms being offset westward to match the main external east wall. Thus the foundations of the wall separating the two easternmost rooms of the range, D and E, were exposed 0.30m beyond the west face of the corresponding wall in the definitive Phase 1 building.

Again these were composed of medium to large pieces of sandstone in an orange clay matrix (J11:79) and were c. 0.85–1.10m broad. Similarly the foundations of the east wall of Room B (J11:77) were partially uncovered on the west side of the corresponding Phase 2 wall (which itself probably lay to the west of its Phase 1 counterpart). Their composition was like that of J11:79 and K10:63/K11:48.

FINDS

Dating evidence

The only pottery recovered from any context which might relate to BI was three joining sherds of a Rhineland collar-rimmed mortarium, dated 140–300, found in association with a spread of flat stones (J10:71) located to the west.

Discussion

The remains described above – the timber post pits and slots, the stone surfaces and the series of unfinished foundations – together imply that the construction of the headquarters was a relatively long and complex process, involving a number of changes of plan. Many of the post holes and slots may represent features directly associated with the construction work.

The composition of the initial south range foundation deposits was significantly different from the deposits revealed in the foundation trenches associated with the subsequent intermediate and final layouts. The earlier foundation trenches were narrower than the later ones whilst the clay fill in the initial trenches was reportedly greyer in colouration than the equivalent material in the intermediate and definitive Phase 1 trenches (described as orange and pink clay respectively). The presence of small post holes, interpreted as holding scaffolding uprights, alongside the initial foundations, might imply that some of the associated superstructure was actually erected, but the evidence is obviously not conclusive. What does seem clearer is that there was a hiatus after the abandonment of these foundations with the trenches apparently left open for material to erode in from the sides and the surrounding ground surface before the trenches were properly backfilled. However that hiatus need not have been longer in duration than a few weeks or months. The intermediate layout is much closer in plan and positioning to that finally executed and may simply reflect an error in laying out.

Most intriguing is the timber building, BI. The precise form of this structure is unclear as it is uncertain whether some or all of the various post pit alignments noted above formed an integral part of the building or alternatively belonged to an entirely separate stage in the construction process. At the core is what appears to resemble a substantial

rectangular hall, not as large as the crosshall of the stone headquarters, but still enclosing a sizeable area of c. 100 square metres. To the west two east-west aligned rows of posts may have enclosed an additional enclosure whilst some additional post hole alignments might represent internal partitions within the southern half of the hall, but these elements are very much more conjectural. In these circumstances the function of the building is also very open to question. Is it possible that the building served as a temporary headquarters building, particularly if construction of the stone *principia* was abandoned for a time? The main timber structure might conceivably have performed the function of the crosshall, but no trace was found of an attached range of offices comparable with the south range of rooms in the stone headquarters and the long axis of the timber 'hall' was aligned north-south rather than east-west. If it had formed part of a conventional *principia* plan, only partially revealed, the building would have faced towards the west gate (*porta principalis sinistra*) rather than the north gate (*porta praetoria*) as was normal. More likely it performed some role in the construction process, perhaps providing temporary shelter or storage.

The interpretation of the overall construction process is rendered all the more difficult by the lack of any securely stratified material from the relevant features and in particular from the foundation deposits and the beam slots of BI. This means, for example, that there is no way of determining the duration of the construction phase (or phases). It may be assumed that all the structural episodes described above fell within the Hadrianic period, but the absence of clear Hadrianic pottery groups from the definitive Phase 1 foundations of the headquarters prevents a conclusive Hadrianic end date being placed on the construction process. Indeed there is the odd sherd of BB2 pottery in the Phase 1 foundations, but this could easily represent much later intrusion. The clean nature of the early features and deposits may be characteristic of fort construction phases when the troops were perhaps quartered elsewhere, conceivably in a temporary camp of some kind outside the fort, resulting in limited contamination of the construction levels with occupation material. Moreover the 'greenfield' nature of the site meant there was essentially no residual material in earlier contexts which might get reincorporated in the construction levels.

By way of comparison an uncompleted headquarters was associated with the mid-Antonine fort at South Shields (Period 4a – Bidwell and Speak 1994, 56–8). It comprised only the central *aedes* plus a single flanking room on either side, the latter perhaps mainly serving to provide structural buttressing for the *aedes*, with its wide, arched opening at the front. The excavators concluded that this three-room

structure was completed up to its full height, to house the regimental standards and provide a religious focus for the garrison, while the fort was under construction. The remainder of the building could have been completed after the fort defences, the unit accommodation and other buildings essential to the day to day running of the garrison had been erected. Bidwell and Speak suggest that the original intention was probably to incorporate this structure when the *principia* was finally completed, as may have occurred at Brecon Gaer (*ibid.*, 58), but for reasons which are unclear the three rooms were ultimately demolished and an entirely different *principia* (Period 4B) erected over its remains. This is not the only evidence for an abortive or temporary *principia* layout. The footings of an earlier wall are visible below the aedes at Housesteads, perhaps forming an initial south wall. These have been interpreted as evidence of a primary Hadrianic headquarters, largely removed to make way for the present building accordingly identified as Severan (Daniels 1978). However Crow has argued that, in view of the lack of any other evidence for the supposed primary *principia*, it is more likely to represent an uncompleted structure comparable to those at Wallsend and South Shields (2004, 51).

The Phase 1 headquarters (Fig. 8.7)

This represents the first phase of the *principia* which the excavators confidently asserted was constructed above the level of the foundations. It followed the conventional layout of such buildings with a colonnaded forecourt, a cross-hall and rear range of five rooms including a centrally placed shrine, or *aedes*, of which only the sunken strongroom survived. The building effectively faced northwards towards the *porta praetoria*, the courtyard occupying the northern half of plot with the cross-hall and attached shrine and offices to the south. Its overall dimensions measured 32m north-south by 23.8m east-west.

External walls and drains

The building's external walls had been substantially robbed out along most of their length leaving only the foundation deposits composed of pink puddled clay and sandstone fragments presumably representing mason's chippings (west wall: H08:03, H09:03, H10:03, H11:09; north wall: H08:05, H09:05, J09:03, K09:03; east wall: L09:12, K11:49, 54; south wall: H12:06, J12:20–21). However the southern half of the east wall (K10:04, K11:06, K12:12) survived rather better with up to two courses of facing stones remaining in places, particularly along the external face which exhibited a 0.05m wide offset. Short fragments of masonry belonging to the south wall (H12:07 (also listed as H11:07), J12:03) also remained *in situ*, as did a 3.10m length of the west wall (H10:04). One of the

stretches of the south wall (H12:07) survived to the greatest height (0.45m), with two courses standing on the wider offset course. The external offset on the south wall was recorded as 0.08m, a narrow 0.02m internal offset also being reported in the context record (J12:03), although this was not evident on any of the site plans. All trace of the south wall had been lost at the south-east corner as a result of the cutting of modern drains. The walls varied between 0.90m and 1.0m in width at the level of the bottom offset course and the individual courses were 0.15–0.18m high.

There were noticeable differences in the character of adjacent stretches of the foundations in the central part of the south wall (J12:20, 21). Whereas the composition of J12:20 was similar to the foundations of the other lengths of the building's outer wall which were exposed, J12:21, just to the west, contained much more abundant quantities of small to medium-sized masons' chippings and sandstone fragments very closely packed in pink clay. The excavators suggested this stretch, of which only 1.40m was exposed, may have formed part of the intermediate foundation layout (context database) or a later rebuild, or perhaps was simply the product of a different work gang.

Stone-lined drains or gutter channels ran along the outer face of the building on all four sides. The drain alongside the west wall (H08:18, H09:49, H10:46, H11:10, H12:10) was composed of upright slabs set vertically on either side of the drain channel. This form of construction continued around the north-west corner of the building and was traced alongside the north wall for 6.50m (as H08:12, J08:06), surviving particularly well next to the corner, where several capstones remained *in situ* (H08:13, J08:07; also H08:19 at the north end of the western drain). The fill (H08:20, J08:05) was described as a silty grey-brown soil. Further east this drain had largely been destroyed by a modern drain channel, but, towards the building's north-east corner, the fragmentary remains of side-walling again survived (K09:32). Here, however, ordinary sandstone facing stones had been used to form the drain sidewalls and the same form of construction was recorded alongside the east wall (K09:09, K10:06, L09:06), although upright slabs were also noted in the channel in places (K10:07) perhaps signifying the drain was relined at some stage. Further south, the drain (K11:09b) may have been later adapted later on (in Phase 3?), to take the overflow channel from a cistern in the south-east corner of the courtyard, which emerged beneath the east end doorway of the cross-hall. Here the drain diverged away from the east wall of the *principia* slightly, and for most of its length only the west side wall was exposed. The excavators seem to have been uncertain whether this part of the drain was primary, or perhaps a secondary realignment. It was not included on their inked plans of Phase 1 and 2 of the building, but the manner of its construction



Fig re 0 7 Building 4 Ph se 1 at 0

was similar to that observed further north with side walls composed of courses of roughly faced stone rather than upright slabs. Most significantly of all, the side wall was clearly overlain by the earlier of

the levels of road metalling uncovered in Alley 7 (K11:10), which was assigned to Fort Phase 2 in the context database. The channel ultimately fed into a large water tank behind the building's south-east

corner, which was also assigned to a later phase, but this may have been effected by a secondary rerouting of the course of K11:09b, the arrangements at this point being destroyed by a modern drain channel (K12:03). A further drain ran along the south side

of the building, but only short stretches of this were actually traced next to the south-west corner (H12:09), where the side walls were again formed of upright slabs, and the south-east corner (K12:28). The latter was not described, but its line was indicated on a sketch plan (K12: fig 3) with no indication that any side walling remained, implying it survived simply as a gulley.



Figure 8.08 General view of the courtyard, looking west.

The courtyard and colonnaded portico (Figs 8.08–8.12)

The northern half of the *principia* took the form of a flagged courtyard with a colonnaded covered walkway around its north, west and east sides plus an eaves-drip on all four sides (Figs 8.08–8.10). The entire area formed a rectangular space with dimensions of 22m east-west by 17m north-south, whilst the open central yard delimited by the eaves drip gutter was just over 11m square. The surface of flagging within the central yard bounded by the eaves drip was very worn and shattered and had



Figure 8.09: The very worn, fragmentary flagging of the primary courtyard surface looking south with the west eaves drip gutter visible on the right.



Figure 8.10 North portico column base, K10 after Simpson 1930, fig 3



Figure 8.11 The west portico from the north with primary column bases and eaves drip gutter visible.



Figure 8.12 West portico column base, H10 after Simpson 1930, fig 3

been replaced in many places, having obviously seen a great deal of use, probably over a long period (Figs 8.08, 8.09). It survived best to the west (J09:14, J10:29) and south (J10:07, 14), there consisting of fairly regular sandstone slabs measuring on average c. 0.70m × 0.55m. Elsewhere the surface was so badly worn that only the odd flag remained relatively intact, the remainder being so fractured and disturbed that individual slabs could not be distinguished within the degraded layer of crushed sandstone fragments intermixed with medium brown or grey clay (J09:31, J10:42, K09:20, K10:36). The courtyard flagging was set on a layer of mottled yellow and brown silty soil (J09:38, J10:49, K10:44) which was interpreted as a make up material. A patch of orange clay with some stone inclusions (K10:47) was also noted beneath the south-western part of the courtyard, although it is not altogether clear that this deposit was distinct from the underlying clay fills (J10:55, K10:52) of the beam slots (J10:60, K10:53) for the earlier timber building (BI).

The colonnade was composed of four columns along each side (north, west and east) plus one at each of the north-east and north-west corners. There was a wider gap in the middle of the north side (3.5m between the edges of the foundation pits), forming a central entrance which presumably lay opposite the main gate in the north wall of the *principia* (although no trace of that gate remained). In most cases all that survived were the square foundation pits which supported the columns (west side: H09:41, H10:22/35, 44, J09:51; north-west corner: J09:50; north side: J09:37, 52, and two unnumbered foundation pits in K09; east side: K10:42, 43, 55, 66). These took the form of shallow, steep-sided pits, generally around 1.3m square, though dimensions varied considerably, and packed with medium-sized, angular sandstone fragments in an orange clay matrix. In some cases rounded cobbles were also recorded in the packing (H10:35, J09:37). However, three column bases survived *in situ* along the west side (H09:07, H10:12, set on foundation deposits H09:41 and H10:44 respectively) and in the north-east corner (K09:07) of the colonnade (Figs 8.11, 8.12). These measured c. 0.65–0.8m square and were rounded along their upper margins with a smaller 0.4m square area marked out with an incised groove along the upper surface where the column would have been positioned. The western pair had previously been uncovered by the Wallsend borough engineers working with F. G. Simpson in 1929, the earlier excavation trench (H10:13) being rediscovered in 1980 (cf. Spain and Simpson 1930, fig. 3). There were also two bases made up of faced stone forming part of the east colonnade (K09:11/K10:27, K10:30), the more northerly of the two being the better preserved (K09:11/K10:27), measuring 0.7m by 0.8m. The excavators were uncertain whether these belonged to the same primary phase given their very different character. However, even if they

were secondary, this replacement must have occurred relatively early on since the two bases clearly reflect the original layout of the colonnade as demonstrated by their positioning with respect to the eaves drip and the two other column foundations (K10:42–43). In the building's second main phase the east colonnade was repositioned 1.0m further westward with the new column bases sitting on top of the former eaves drip channel.

The portico around the sides of the courtyard was 4.0m wide (including the column bases themselves). There was no evidence that this space was originally divided into rooms. The only trace of occupation was noted on the west side where a roughly circular patch of burning (H09:32) overlying an area of fire reddened flags (H09:25) appeared to represent the site of a hearth. However it is possible that this burning should be assigned to the next phase. Very little flooring which might be attributed to the primary phase of the portico (or any of its subsequent phases for that matter) survived, but several other patches of flagging similar to H09:25 were noted in the north-west corner of the portico (H09:27, J09:29, 30) and further south (H10:18), in the west colonnade. In the south-west part of the courtyard a 50–150mm thick layer of small gravel in a silty clay matrix with some stone inclusions (H10:23, J10:56) which extended from the eaves drip channel westward into the area of the west portico. The flagging was apparently bedded on a layer of mottled yellow or medium-brown clayey silt incorporating a few stones (H09:13, H10:20, 24) which was revealed throughout the west portico from the north-west corner southward and was similar to the silty material noted beneath the flagging of the central courtyard (J09:38, J10:49, K10:44). At the southern end of the west portico an orange clay layer (H10:25) with some stone inclusions was exposed beneath the silt and flagging. There was some suggestion that this might form part of an earlier and very poorly preserved floor surface, with the context record making reference to the occasional possible flagstone on top of the clay, but this could not be confirmed and it is probably preferable to regard the clay as a construction deposit of some kind.

In the north-east corner of the courtyard, a surface variously described as being composed of compacted gravel or small pebbles or small/fine cobbles set in dirty mortar and gravel (J09:17, K09:13, K10:31) was recognised between the eaves drip channel and the columns of the portico. This surface overlay a mixed yellow-grey clay loam with frequent patches of sand and sandstone chippings (K09:38, K10:28) which was thought to perhaps represent spreads of construction debris in redeposited plough soil material. Elsewhere a layer of crushed sandstone fragments and chippings intermixed with brown clayey soil (J09:32), similar to the degraded parts of the courtyard surface, extended from the north west corner of the eaves drip right into

the area of portico. Later disturbance had removed all the equivalent levels in the north-east corner of the portico down to a level of yellow clay construction make-up (K09:18), some 150–200mm thick. Similar material (K10:45) survived in the south-east corner, beneath the yellow-grey clay loam (K10:28) and in both areas the clay make-up directly overlay the dark grey clay and burnt spreads interpret as the pre-fort plough soil (K09:36, K10:46).

The eaves drip channel itself survived best along on the west side of the courtyard (J09:08, J10:28) where both the north-west (J09:10) and south-west corners (J10:04, 05) were present and only a couple of relatively short sections were missing. The north-east corner also survived (J09:12, K09:10, 33, K10:37), but most of the remainder of the east side was destroyed and long sections of the north and south sides were lost (surviving fragments of the south eaves drip: J10:04, 05, 06). The eaves drip was made up of oblong sandstone blocks up to 1.20m in length, though most had been cracked and broken over time, and 0.35–0.40m wide. They varied in thickness between 0.12m and 0.20m, whilst the channel cut in the upper surface ranged between 30mm and 100mm in depth. Some blocks were repositioned and re-used in later phases (K10:10).

Cross-hall

To the south of the courtyard, a rectangular cross-hall or *basilica* stretched across the full width of the *principia*, measuring, internally, 22m long and 7.20m wide. Its north wall survived mainly as foundation of pink puddled clay, masons' chippings and sandstone rubble (H10:09, J10:11, K10:09, K11:31). Along the north wall's internal face, where its construction trench was wider than the foundations, the gap was filled with sandy brown soil, patches of orange clay, sandstone chippings and pebbles (J11:59, K11:46). Two relatively small patches of flagging (H11:64, J11:48) were all that remained of the cross-hall's primary floor (Fig. 8.13). The flags certainly belonged to the Phase 1 *principia* rather than the earlier unfinished headquarters' building since the more westerly patch of flagging (H11:64) overlay the north wall foundations of the latter building's south range (H11:28). Both patches of flagging rested directly on a layer of homogenous grey clay (H10:39, H11:60, J11:45, K11:43), some 100–150mm thick, the uppermost 10mm being discoloured a dark reddish-brown or black incorporating concentrations of charcoal on the surface, presumably the result of burning. At the time of excavation this layer was interpreted as the pre-fort ploughsoil with evidence for the burning off the last crop. However the summary structural report labelled it a makeup or foundation deposit for the building.

Tribunal

At the west end of the cross-hall a roughly square arrangement of foundation trenches, 0.70m wide, marked the position of a tribunal (H11:58), which would have enabled the commander to address the assembled garrison from an elevated platform. The tribunal measured c. 3.00m east-west by 3.50m north-south, with an additional 1m wide foundation trench on the south side probably supporting a set of steps providing access to the top of the structure. The foundations consisted of sandstone rubble tightly packed in clay and covered by a clay capping. Only two facing stones remained of the tribunal's masonry superstructure (H11:29).

Courtyard entrances

The excavators suggested that there was probably an entrance to the cross-hall in centre of its north wall (although there were no surviving remains in the wall itself which conclusively prove this), but there were also doorways at either end of the hall providing direct access to/from the courtyard portico. The central entrance may be associated with several layers of flags and broken flags (J10:09) overlain by a band of thick, homogenous, puddled pink clay (J10:08) midway along the north wall, which the excavators tentatively interpreted as the base for a pillar or column (perhaps forming part of a double doorway?). This feature, including both flags and clay, was c. 1.50m in overall length. Around 1.50m further east, a slightly raised, roughly rectangular area of the foundation clay, c. 1m in length and packed with masons chippings (J10:23), was still more cautiously interpreted as evidence for another pillar base perhaps defining the eastern edge of the central entrance.

The original entrance from the west portico is obvious. A butt joint in the north wall of the cross-hall 2.60m from the west wall shows the wall H10:08 on



Figure 8.13: Early flagging J11:48 in the crosshall associated with *principia Ph se 1* viewed from the east.

the west side to be later, and H10:14/J10:13 extending eastward to be original. It is probable that there would have been an equivalent entrance providing access from the portico at the east end of the hall, but the north wall here was so badly robbed and damaged that no direct evidence survived. However it is probably significant that the overflow channel (K11:24) from the cistern in the south-east corner of the courtyard was routed through the north wall at this point and then turned to exit the cross-hall through the east wall, passing beneath the threshold slab of the east doorway (K11:07). Routing drain channels or water conduits through existing doorways was common practice as it simplified construction work and probably made for easier maintenance if the channel needed to be cleaned out, as it would have required no more than the lifting and reinstatement of the threshold rather than digging beneath or dismantling and rebuilding part of a wall to gain full access to the channel.

The east entrance

There was a doorway through the east wall, giving direct access into the cross-hall from the adjacent alley. This was represented by a substantial threshold stone complete with side grooves, pivot-holes and bolt-hole (K11:07). Some iron even still survived in the south pivot hole. Presumably this entrance was provided for the convenience of the commanding officer, being directly opposite a west entrance to the *praetorium*. This threshold stone (if it is original) must have been lifted to take the overflow drain K11:24 through the doorway, and then reinstated. The threshold stone probably supported two monolithic stanchions, which in turn probably held up a lintel stone, so some form of scaffolding must have been used to support the lintel while the drain was being inserted to avoid having to dismantle this whole section of the east wall.

Southern rang

Overall form and interpretation

A range of five rooms were constructed which opened off the south side of the cross-hall. These were designated A, B, C, D and E, running from west to east. The wall separating these rooms from the main body of the cross-hall survived in somewhat better condition than the hall's north wall, with several lengths of masonry remaining (H11:11, J11:02, K11:19) in addition to the usual foundation deposits. The latter consisted of puddled pink/grey clay and sandstone masons chippings (H11:13, J11:04, K11:18), sitting in a construction trench (S side: H11:68, J11:78; N side: H11:65, J11:49, K11:47) with mixed fills of yellow sand, sandstone chippings medium brown soil and some orange clay and mortar on either side. Of the actual wall masonry, only the bottom offset and,

in places, the first course above actually survived, their respective widths being recorded as 0.95–1.0m and 0.90m, whilst each course was 150–180mm high and constructed of large-grained, yellow sandstone facers with a mortar and rubble core. The excavators suggested that the three central rooms possibly had wide, arched open fronts giving access off the cross-hall, as was the case at Chesters originally, however the evidence was not conclusive. There was certainly no trace of any screen slots over the fronts of the rooms like those accompanying the south range rooms at Chesters.

In its definitive form the central room (C) contained a sunken strong room to house the pay chest, whilst shrine (*aedes*) housing the regimental standards would have been located on a raised level above. However, the excavators suggested that the sunken room was a later insertion and that the three central rooms were initially of roughly equal size (3.75–3.85m wide, E–W), whilst the end rooms, A and E, were somewhat smaller (3.40–3.45m wide, E–W). In support of this interpretation of the primary arrangements it may be noted that the surviving west wall of Room C was not bonded into the north wall of the south range, but butted against it, whereas the wall separating Rooms D and E was bonded to the north wall. Furthermore, the foundation clay of the east wall of Room C could be distinguished from the foundation of the north wall and appeared to run over the top of it. Although this evidence is not conclusive, it does suggest that Room C (as it was found) was not constructed at the same time as Room E.

The floors of these rooms pose the same sort of problems of interpretation as the surfaces over the cross-hall. Each room had different 'floor' surfaces but it is difficult to perceive any overall pattern of types of 'floor' being laid for specific periods. Much of the evidence might in fact represent constructional layers deposited during the building of the *principia* (cf. the centurion's quarters Barrack XIII Housesteads). In the initial programme of post-excavation analysis these clay layers were taken to be the actual laid floors and the other levels were interpreted in accordance with this, but the numbers of phases possibly reflects, more than anything else, the extent to which certain floors were dug and not others. It does not appear that the floors were entirely dug down to the underlying natural yellow clay subsoil, though that subsoil was seen where trenches were cut through the floors to reveal the earlier phases of foundations. The relationship between the floors and the natural should have been evident in section where the trenches cut through, but there is no explicit confirmation in the context records that any of the lowest floors exposed directly overlay the natural and therefore belonged to the primary phase of the headquarters. Room E was the most revealing with two periods of post-holes and collapsed plaster (painted red and black).

Internally, the rooms were all between 4.00 and 4.10m deep, from north to south, but their east-west widths varied quite markedly, the two rooms at either end of the range (A and E) being 3.40–3.45m wide, whilst the estimated widths of the central trio (as restored by the excavators) ranged between 3.75m and 3.85m.

Room A

This room was 3.40m wide east-west. The northern half of the room's east wall (H11:14) survived over a length of 1.9m, standing three courses high (total height c. 0.45m). The wall was 0.90m wide and constructed in the usual manner with small to medium-sized facing stones and a mortar and rubble core. The junction with the north wall of the south range (H11:11) had been robbed down to the foundations so it was uncertain whether the two walls were bonded together, but there was no obvious distinction in the pink clay and sandstone fragment foundation deposits (east wall: H11:21; north wall: H11:13). The room contained a layer of compacted yellow/orange sand and sandstone chippings (H11:51), which was interpreted as foundation material for a floor rather than an actual floor surface.

Two linear slots (H11:49, 50), filled with medium brown silty soil, were cut into the sand and presumably originally held timber/wattle-and-daub wall panels. One was aligned east-west (H11:49) and positioned some 0.90m south of wall H11:11. It measured 2.60m in length, varied between 0.20m and 0.40m in width and was 0.15–0.20m deep with vertical sides. The second (H11:50) was aligned north-south and extended for at least 2.50m alongside the building's west wall (H11:09) (its full extent to the south could not be traced). Its northern terminal was formed by a post hole located 0.75m beyond the western end of slot H11:49, the relative positioning suggesting the two slots were contemporary and related. The diameter of the post hole was 0.35m and its depth was 0.15m, whilst the remainder of the slot was 0.05–0.10m deep and c. 0.15–0.20m wide. Comparison of site plans P258 and P280 indicates that north-south slot H11:50 and floor level H11:51 lay on top of the eastern edge of west wall foundations H11:09 (which here entirely filled the bottom of the construction trench) and therefore clearly belonged to the stone headquarters.

The east-west slot may have held an inner screen along the north side of the room with a doorway at the west end. It may conceivably have defined a corridor along the north side of the room which may even have continued through a doorway in wall H11:14 into the next room, B (*see below*). Such arrangements would have been particularly useful if the rooms did have wide arched open fronts as suggested by the excavators.

Room B

The east-west dimensions of Room B, as excavated, were 3.50m. However it was subsequently argued, during the Daniels team's post-excavation analysis, that the sunken strong room was not inserted in Room C until Phase 2 and that in Phase 1 all three central rooms of the south range had broadly similar dimensions. This is reflected in the inked plan for Phase 1 on which the width of Room B is shown as c. 3.85m. Two pieces of evidence appeared to suggest the surviving east wall of Room B was secondary: firstly the masonry of the wall (J11:13) butted against the north wall of the range (unlike the wall separating Rooms D and E which was clearly bonded to the north wall); secondly the wall's clay and sandstone foundations (J11:14, J12:18) lay at a much higher level than those supporting the other partition walls of the south range (e.g. H11:21). However, it should be noted that no trace is evident in the excavation records – whether site plans, photographs or context notes – of any foundations which could be attributed specifically to Phase 1, beneath the surviving east wall foundations. If the excavators' interpretation is to be accepted therefore, it must be assumed that the earlier, Phase 1, foundations were masked or obliterated by the surviving foundations.

The room contained a layer of yellow/orange clay (H11:54) interpreted as a floor level or the base for a floor level. This was cut by two post-holes (H11:52, 53) which were positioned 0.60m apart, 1.0m from the projected inner face of the north wall. Both were roughly circular, with diameters of 200mm and 250mm respectively, and were 150mm deep and filled with grey clay. It was suggested that these post holes might be associated with the construction of the building rather than its occupation during Phase 1. Intriguingly, both post pits lay broadly in line with the east-west aligned slot in Room A (H11:49) raising the possibility that they were functionally related. However layers H11:51 and H11:54, which were cut by the slot in Room A and the post holes in Room B, fill the interiors of their respective rooms and are not demarcated in any way by the slots or posts. This implies that, whether they represent construction features or internal partitions, these slots and post holes relate to the stone headquarters building and not to any earlier timber structure like the features designated Building BI, uncovered beneath the *p incip a* courtyard.

Room C

The suggestion that the sunken strong room in the central room, C, was a later insertion further implied that all visible remains of definitive primary layout of this part of the south range had been destroyed or obscured by the later construction. On the Phase 1 post-excavation plan of Building 14 Room C was restored with narrower dimensions than its Phase 2 counterpart (c. 3.80m wide internally),

more comparable with Rooms B and D. There was, however, no concrete evidence that the east and west walls of Room C were actually located in the positions shown on the phase plan.

Room D

The inked post-excavation plan restored the width of Room D in Phase 1 as c. 3.75m and marked the inner face of its primary west wall as c. 0.25m further west than the one excavated, which was attributed to Phase 2, although no actual remains of any such Phase 1 foundations were revealed beneath the surviving west wall foundations (J11:30, 76).

A line of four facing stones, apparently forming the butt end, were evident at the level of the upper surviving course belonging to the north wall of Room D, immediately west of the room's east wall. The excavators suggested that this might form one side of a wide arch with the room effectively having an open frontage onto the cross-hall, later blocked. In the equivalent position on the west side of the room, only the lower of the two courses survived and, since the eastern butt joint was not evident at this level either, conclusive proof that room was open fronted is lacking (this is the case whether the width of Room D is assumed to have been 3.50m as in Phase 2 or 3.75m as restored by the excavators for Phase 1). However, if instead the butt end did represent the east jamb of an ordinary narrow doorway into Room D, the demonstrable lack of corresponding west jamb would imply that the north wall was substantially rebuilt at a later stage.

The room contained a layer of yellow/orange sand, incorporating much stone and some lumps of clay and flags (J12:31). Numerous large flat slabs may represent the remains of a flagged floor bedded on this layer. In the centre of the room, an area roughly 0.80m square had been reddened by burning (J12:30) and was surrounded by large stones set in the sandy layer, J12:31, doubtless marking the site of a central hearth. Immediately to the north of the hearth, two roughly circular, vertical sided post-holes (J12:28, 29) were set 0.40m apart. Their respective diameters were c. 250mm and 150mm, and their depths, 230mm and 110mm, the holes being filled with dark brown/black soil with much coal. On the west side of the room, a 30–40mm thick patch of collapsed white plaster or mortar (J12:27), covering an area up to 2.20m long by 1.20m wide, may represent collapsed debris from the west wall. The mortar partially overlay a deposit of pebbles (J12:32), perhaps a cache of slingshots, also located next to the west wall but extending over 1.20m as far as the north wall.

Room E

Virtually the entire length of this room's west wall (K11:20, K12:18) survived, as did the corresponding length of the building's east wall (K12:12), showing

that the room was 3.45m wide. However the south wall had been almost entirely obliterated. The west wall stood up to three courses high and was clearly bonded with north wall of the range, demonstrating that it formed part of the building's Phase 1 layout. A layer of orange clay and rubble (K12:38) filled the interior of the room. This dipped towards the centre of the room and was cut by a single post hole (K12:39) in the north-west corner. The post hole was roughly oblong in shape, some 0.45m long, 0.25m wide and 0.20m deep, with vertical sides, and was filled by medium brown soil and some packing stones.

FINDS

Phase 1

Robber trench for unfinished building
Quern: lava (no. 43, K11:45)

Drain in north wall
Graffito: (no. 38, H08:12)

Drain in west wall
Copper alloy: stud (no. 291, H11:34)

Drain in south wall
Graffito: (no. 59, H12:09)

Crosshall
Copper alloy: stud (no. 290, H11:51)
Pottery: counter (no. 93, K11:55)

Courtyard
Decorated samian: 135–65 (no. D92, K10:28)
Copper alloy: bead (no. 59, J10:56)

Floor of room D
Bone: counters (no. 42, 44, both J12:31)

Dating evidence

Foundation
The foundation of the east wall produced a number of sherds from a cooking pot in an unidentified reduced ware, and a single sherd from a BB2 bowl (K11:54).

Drains
The fill of the drain on the south side (H12:09) produced a large quantity of pottery. BB2 and allied fabrics made up almost 80% of the coarse wares present. There was a sherd from a BB1 cooking pot with obtuse angle lattice with a groove above, dating to after the middle of the third century, and there were a few sherds from a Crambeck reduced ware jar, dating to the late third century or later. The drain on the north side (K09:32) only produced a single sherd of pottery, but as this was a flanged bowl it is clear its fill dates to the same period.

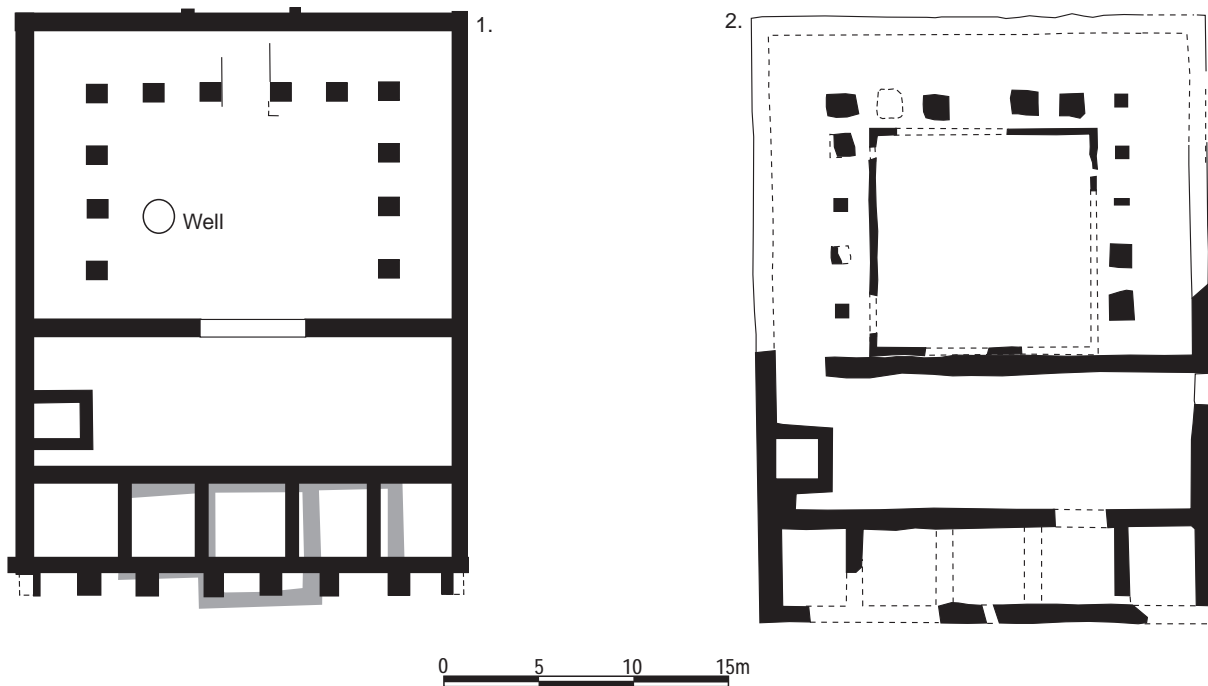

Figure 8.14 The Phase 1 principia at Wallsend shown alongside the mid-Antonine principia at South Shields for comparison. Scale 0

Courtyard

The make-up layer under the flagging (J09:38) produced 39 sherds of a third-century group of pottery (having a high proportion of BB2 and a sherd of Nene Valley colour coated ware). The surface of the courtyard produced only a very few sherds, but these also included BB2 as well as allied fabrics (J09:31–2). The possible floor surface in the north-east portico (K10:28) produced a probably Hadrianic flat-rimmed carinated bowl, a sherd of a Hadrianic form 18/31R and central Gaulish form 37 dated c.135–65.

Crosshall and south range

The construction layer in Room A produced two sherds of two different second-century grey ware cooking pots (H11:51) and the post-hole in Room B a single rim sherd of the late second or third century (H11:52).

Discussion

A large proportion of the pottery yielding contexts identified as Phase 1 contain post-Hadrianic material such as BB2, or even later wares. Only two groups, those associated with north-east portico surface K10:28 and Room A level H11:51 appear convincing as primary, Hadrianic assemblages. To some degree the anomalies can be explained as material intruded later on. The late third-century coarseware in the external drains/gutters (K09:32, H12:09) could have entered at any stage during the life of these open features so poses no difficulty. Similarly, the courtyard surfaces

seem to have remained in use for a very long time, perhaps right up to the end of the Roman occupation in some areas, so pottery could conceivably have been trodden into the surfaces at any stage and penetrated to underlying makeup levels through gaps in the flagging. As regards the BB2 in the foundation of the building's east wall this might have been intruded when the foundation was exposed by post-Roman robbing.

Certain features of Building 14 Phase 1 recur in the mid-Antonine principia at South Shields (Period 4B; see Bidwell and Speak 1994, 58–75), a site which provides so many parallels for Wallsend (see Fig. 8.14). These included the lack of a north aisle in the cross-hall which is a very common feature elsewhere. Curiously the tribunal in both buildings is still offset to the south of the cross-hall's centreline as though there was a north aisle in place. The steps up to the tribunal were clearly located on the south side at Wallsend and the same was probably true at South Shields. Both buildings had a doorway in their east wall opening into the north-east corner of the cross-hall from the adjoining alley and probably designed to give the commanding officer convenient access from the *p aetorium*. Nevertheless there are also many significant differences and these buildings cannot be regarded as carbon copies of one another. The external buttresses provided along the south-east wall of the South Shields headquarters have no parallel at Wallsend. These were presumably intended to support a two-storey rear range, similar to that which

Bosanquet convincingly identified as forming part of the late Roman phase of the Housesteads *principia*, on the basis of surviving evidence for collapsed upper rooms (1904, 222–3; cf. Crow 2004, 96–8). The positioning of the strongroom beneath the tribunal at South Shields is also unusual. The arrangements regarding the Phase 1 strongroom in Building 14 are obscure. It may have been located in one of the rooms next to the central *aedes*, perhaps with direct access only possible from the shrine itself. Finally the guttering around the forecourt appears to have been carried across the entrance at Wallsend rather than turning to flank the approach to the entrance.

Phase 2 (Fig. 8.15)

Courtyard

Structural activity which can be assigned to Phase 2 took place on both the east and west sides of the courtyard.

The east colonnade

The four columns of the east colonnade were demolished and a new colonnade erected 1.0m to the west, over the line of the eastern eaves drip channel which went out of use (Fig. 8.16). The new colonnade was represented by three roughly square pillar bases made from facing stones (K10:19, 38, 40) and one foundation deposit (K10:29). The form of the bases was similar to K09:11 and K10:30 belonging to the Phase 1 east colonnade. The best preserved of the pillar bases was K10:19, which was neatly constructed and measured 0.85m × 0.75m, whilst the dimensions of K10:38 were c. 1.00m × 0.90m, though its stones may have spread slightly. The foundations were composed of deposits of tightly packed, angular sandstone rubble set in orange pink clay (K10:29, K10:54 for base K10:19, K10:67 for base K10:38). The site plans suggest these deposits were set in squarish pits (dimensions: K10:29, 1.40m × 1.10m; K10:54, 1.25m × 1.15m), but there is no reference to such pits in the context records and no record of the depth or thickness of the foundation deposits either.

Several areas of flagging were laid on the west side of the central courtyard, immediately in front of the new colonnade (K10:20, K10:21, K09:15) and the surface may originally have been continuous across this area. The best preserved of these patches of flagging lay next to base K10:19, stretching 2.20m north-south and 1.40m east-west, but all the flags there and further north were extensively cracked through heavy wear. The area of flagging to the north (K10:21) extended between bases K10:38 and K10:40 (where it could be seen to overlie the eaves drip gutter stone K10:37), and through into the portico.

There was evidence that the new east colonnade was blocked in, at least partially. Between bases

K10:19 and K10:40, in the middle of the colonnade, a linear spread of sandstone rubble (K10:39), 0.60m wide, was interpreted as the foundations for a wall. It was suggested that flagging K10:21, which extended through the next bay to the north, might have formed part of an entrance into a walled off portico (but note that flagstones K09:15, although much more patchy, also appear to have extended between pillar/column base K10:38 and the north eaves drip channel).

The west colonnade

There is some evidence, albeit very fragmentary, to suggest that the southern end of the west portico may have been walled off and converted into an enclosed room. A line of lightly packed stone (H10:21), c. 0.50m wide, was traced between the two of the columns (H09:07, H10:22/35 (foundation only)) in the centre of the west portico. This was interpreted as the possible foundation for a wall blocking in this part of the portico. To the west, within the portico, a thin layer white mortar or plaster (H10:19), which most likely represented either a deposit of fallen wall plaster or a mortar floor, came to a definite straight edge along its north side as though extending up against a wall running westwards from column H09:07. The entrance from the west portico into the cross-hall was also blocked, perhaps at the same time, with wall H10:08 clearly butting up against the jamb of the pre-existing cross-hall north wall (H10:14). This may all have been designed to create a room comprising the three southernmost bays of the west portico. This may have been walled simply with timber/wattle and daub panels resting directly on the ground or on rather ephemeral stone footings like H10:21. At least one of the bays at the southern end was presumably been open to enable access. There is no evidence as to the function of the room, though an office or storage area might be envisaged, but it was evidently thought necessary to close off direct access to it from the cross-hall. Within this space, the south-west corner of the west portico was covered by a 50–100mm thick layer consisting of a medium brown clay/silt and a few stones (H10:24), which adjoined blocking wall H10:08. There was confusion in the post-excavation records as to whether this layer should be assigned to Phase 1 or 2 and the relationship to blocking wall H10:08 was not recorded on the context sheet to provide confirmation one way or the other.

Discussion

It is conceivable that the sections of wall blocking off parts of the portico were surviving fragments of a process which involved blocking off the entire courtyard portico, or at any rate substantial parts of it. A much more substantial foundation (K09:08) blocked off part of the north east colonnade, but this was considered to be later in date (Phase 3). Also regarded as part of the same feature was K09:39, a



Fig. 8 Building 14 Phase 2 at 0

foundation blocking off the east end of the north east portico, but the latter resembled more closely the relatively narrow foundation deposits, H10:21 and K10:39, and also abutted column base K09:07. This poses the question – was the later more substantial foundation K09:08 built over an earlier blocked

colonnade of which the only surviving portion was K09:39? The narrower rubble foundation deposits might represent the bases of timber/wattle and daub wall panels rather than stone blocking walls.

The similarity of Phase 1 bases K09:11 and K10:30 to those of the new east colonnade led the excavators

to speculate that K09:11 and K10:30 might actually have formed part of the same secondary remodelling. However the latter cannot readily be integrated into any coherent scheme with the rest of the Phase 2 courtyard. It was suggested they might form a pillared doorway, but the Phase 2 bases did not lie directly in line with them so it is difficult to envisage how this would have worked.



Figure 8 The east portico with Phase 1 (to right) and Phase 2 (centre) column/pillar bases apparent, looking north

It is conceivable that the date of the water tank J10:22 was earlier than assumed. It was regarded as having cut through the pillar base foundation K10:29, but it appears to be on the very edge of it. However there must be a question mark as to whether it would have been structurally sound to build the pillar base foundation K10:29 on the edge of a water tank.

Cross-hall

A new surface composed of clay, variously described as red, orange/mauve, or pink in colouration, with patches of sandy gravel (H11:46, J11:19, K11:32, J10:36?) was laid in the cross-hall over a 30–40mm deep layer of make up material recorded as yellow/orange sand or sandy soil with sandstone chippings and some orange clay (J11:51, K11:44).

A number of post holes and other features were cut into these levels. In the majority of cases no overall structural pattern could be discerned to the disposition of the post holes, which were distributed across the central and eastern parts of the hall. Furthermore there was considerable uncertainty regarding which phase they should be assigned to, as their fills were predominantly composed of medium brown silty soils very similar in appearance to the 'occupation' deposit (H11:27/J11:31/K11:36) which

Table 8 Post holes in the Phase 2 principia cross hall

Context	Description	Fill	Depth (mm)
J11:36	steep-sided post hole near the S wall, roughly rectangular, 0.40m × 0.30m	medium brown silty soil	200
J11:43	Possible stake hole, diameter c. 60mm, near the S wall; u. J11:31	black soil with much coal	100
J11:35	Vertical sided pit/post hole adjoining S wall, 0.48m × 0.35m	black soil and charcoal/coal	230
J11:42	Squarish post hole, 0.30m × 0.25m, near the N wall; u. J11:31	medium brown/grey clayey soil with packing stones	180
J11:41	D-shaped post hole, c. 0.45m × 0.42m, near the N wall, u. J11:31	medium brown/grey clayey silt	130
J11:40	Squarish post hole, c. 0.62m × 0.60m, on the centreline of the hall, flat-bottomed with further round hole cut in the centre; u. J11:31	medium brown/grey clayey silt with charcoal & lumps of orange clay	400 max.
K11:37	Oval post hole, c. 0.50m × 0.40m, northernmost of a N–S line of 3 post holes; u. K11:36	medium brown silty soil	170
K11:38	Oval post hole, c. 0.48m × 0.30m, medial of a N–S line of 3 post holes; u. K11:36	medium brown silty soil	270
K11:35	circular post hole, diameter c. 0.45m, southernmost of a N–S line of 3 post holes	medium brown silty soil, some packing stones	420
K11:39	rectangular post hole, c. 0.50m × 0.30m, just E of K11:35	medium brown silty soil	250
K11:40	rectangular post hole, c. 0.48m × 0.40m, in SE part of cross-hall	medium brown silty soil	210
K11:41	circular post hole, diameter c. 0.35m; on the centreline (in line with J11:40); u. K11:36	medium brown soil, with packing stones	260
K11:42	circular post hole, diameter c. 0.35m; u. K11:36	medium brown soil, with some packing stones	260

covered the interior in Phase 3. Thus J11:35 and J11:36 might conceivably have cut Phase 3 occupation deposit J11:31 (they appear to have been recognised at an earlier stage than the others and the context record for J11:31 states J11:35 cut it), but J11:31 may not actually have been as prevalent next to south wall, negating any possible judgement on the stratigraphic relationship. The majority of postholes, like J11:35 and J11:36, were assigned to Phase 2, however, and these are detailed in Table 8.01, set out roughly from west to east.

Two other features were also cut into the clay level in the centre of the cross-hall. A north-south aligned, linear slot (J11:32) extended at right-angles from the north wall, across the interior of the hall for a distance of some 2.90m. The slot, which may have accommodated a timber wall partition, was up to 0.35m wide and c. 0.10m deep and was filled with medium to dark brown silty soil, incorporating some charcoal. Adjoining the south wall, further west, was a large, irregularly shaped, shallow pit (J11:33), some 2.20m long (east-west) by up to 1.15m wide (north-south), filled by medium brown soil and rubble. Its function was unclear. These two features provoked particularly acute uncertainty regarding their phasing, with their respective context sheets recording that the features both underlay occupation material J11:31 and cut that deposit, all the relationship entries being accompanied by a question mark. In other words the features were evidently not recognised until they were seen cutting the underlying clay and gravel level (H11:46/J11:19/K11:32) of Phase 2, where they showed up quite clearly, but the excavators were not confident that they would have recognised them if they had indeed cut the silty brown occupation material of Phase 3.

The site of a possible hearth near the centre of the cross-hall was indicated by a patch of clay J11:19 which had been reddened by fire (J11:38). This was c. 1.05m in length and at least 0.50m wide. On the south side of the patch of burning and partially overlying it, to judge from site plan P262, was an oval patch of yellow sand, gravel and some fragments of white mortar (J11:39), measuring 0.95m by 0.70m. There was evidence that this hearth continued in use or was renewed in the same position in the next phase. It was even suggested that all these features might simply be the result of heat from a Phase 3 hearth affecting underlying clay level J11:19. However comparison of site plans P261 and 262 indicates that the burnt clay of the Phase 2 hearth (J11:38 = J11:19) would have been insulated from the flagstone hearth of Phase 3 (J11:37) by sand and gravel deposit J11:39, whilst the burning associated with the later hearth lay on the south-east side of the flagstone, rather than the north side like J11:38, and affected the overlying Phase 3 occupation material (J11:31) rather than the underlying clay. Thus it would appear more plausible that there was a hearth in use at this spot in both phases.

The context records reflect a degree of uncertainty regarding the interpretation of the levels in the cross-hall. The lower layer was described as ‘destruction/make-up?’ whilst in record J11:19 it was suggested that the sandy gravel patches in the upper layer might represent the destruction or dilapidation of the cross-hall with the clay possibly forming make-up to a floor surface.

To the west of gully J11:32 and hearth J11:19/38, a path, constructed of small, tightly compacted and well-worn cobbles (J11:44), extended from the centre of the north wall across the hall in a diagonal south-westerly direction, terminating just short of the south wall near pit J11:33. The pebbles making up the path averaged 10–30mm in diameter and the deposit was some 20–40mm thick. In plan the path was rather irregular with its width varying from 2.80m, where it adjoined the north wall of the cross-hall, to 1.30m at its southern end, whilst at its narrowest point, midway across the hall, it was no more than 0.40m wide. Some evidence of patching, represented by the differing character of the surface, was noted during excavation. The path presumably led from a doorway in the centre of the north wall towards a doorway into Room B of the south range, perhaps implying that room was the most intensively used in the range, with traffic to and from it causing the greatest wear on the courtyard surface. This feature implicitly provides further evidence for a centrally positioned doorway leading from the *principia* courtyard into the cross-hall.

At the west end of cross hall, next to the tribunal, several spreads of loose white mortar (H11:47, 48) were present over the clay and gravel levels of Phase 2. The largest (H11:47), spreading across the gap between the south-east corner of the tribunal and the hall’s south wall, covered an area measuring up to 1.50m by 0.90m and was 20–30mm deep, whilst the other (H11:48), near the north-west corner of the tribunal, was 1.30m in length and 10–40mm thick.

The cobbled path and mortar spreads were assigned to Phase 3 in the post-excavation analysis and clearly recorded as such in the phase plans, structural summary and context database, for example. However nothing would appear to rule out the more plausible alternative interpretation that the cobbled path (and probably the mortar spreads as well) was simply laid over the surface of the Phase 2 clay and gravel (H11:46, J11:19, K11:32) as part of that same overall period of structural activity.

Southern Rang

Room A

The westernmost room of the south range was covered by a layer of dirty pink/grey clay, containing flecks of mortar, sandstone and tile fragments and cobbles (H11:04, H12:15), which was tentatively interpreted as a possible floor surface. A possible post-hole (H11:44),

c. 350mm in diameter, but only c. 50mm deep, was cut into this layer near the centre of the room and was filled by light to medium brown silty soil. A shallow pit or depression (H11:45), filled by medium brown sandy silt, was also cut into the clay right against the north wall in the north-east corner of the room. This measured c. 1m across from east to west and 0.70m from north to south, but attaining a maximum depth no greater than c. 0.15m. Its function was uncertain and its attribution to Phase 2 equally unsure. No later levels survived in this room, but it is possible such levels once existed only to be truncated by post-Roman disturbance, in which case both post-hole H11:44 and pit H11:45 might represent later features cut down from a higher level.

Room B

Much of the interior here had been cut away by modern drain trenches, but a possible floor surface, composed of fragments of sandstone and possible mortar in dirty yellowish pink/grey clay (H11:05, J11:15), was exposed in the northern half of the room. It was noted that the surface of this layer was considerably lower – 0.25/0.30m – than that of the clay level, H11:04/H12:15 in the neighbouring room, A, and roughly on the same level as the top of the lowest course of the room's east (J11:13) and west (H11:14) walls. This prompted the excavators to consider whether this layer might represent a construction deposit or make-up level, rather than an actual floor surface, but it is not clear that a definitive interpretation was arrived at. The insertion of the sunken strongroom in Room C meant that the width of Room B was now, if not already in Phase 1, only 3.50m.

Room C – the strong room (Figs 8.17–8.20)

The construction of a sunken strong room within Room C was assigned to Phase 2 in the Daniels post-excavation summary. This may also have involved widening the overall dimensions of the room. The work involved erecting single-faced walls which backed onto all four external walls of the room to form a partially subterranean chamber within it, 2.90m long, from east to west, and 2.00m wide (north-south). The north and south inner walls probably carried the springing for a barrel-vaulted ceiling, as key-stones were found amongst the collapsed rubble filling the room when first exposed, and this vault would have supported the floor of the raised shrine, or *aedes*, above, where the regimental standards were housed. The room's outer walls enclosed an area extending 4.00m north-south by at least 4.20m east-west, which probably reflects the internal dimensions of the *aedes*. Certain features suggested that the east and west external walls were newly constructed at this stage and did not form part of the original layout of Room C, although the evidence was not really conclusive.

The strong room's inner walls survived up to five

courses high, the west wall standing the highest. Although it did not survive completely intact, the north wall (J11:10) appeared to continue westward to butt up against the external west wall (J11:13). The inner south wall (J12:10) may have done the same, but its west end was cut away by a modern drain (J12:04). The north wall was as much as 1.10m thick from its face to the inner face of the north wall of the range (J11:02), whilst the corresponding width of the south wall was rather less, though still substantial at c. 0.90m. The facing stones in all four walls were bonded together with mortar, but whereas the north (J11:10) and east (J11:05, J12:09) walls were backed by a mortar and rough stone core, the west wall (J11:12, J12:14) appeared to have clay and cobble backing. In the case of the south inner wall (J12:10), its backing had largely been destroyed by a modern drain (J12:04), perhaps belonging to the colliery period, but slight remains of dirty pink bonding clay (J12:22), which it was suggested may have formed part of a similar clay and cobble core, did survive beneath the drain. The excavators considered these apparent differences in construction technique – the use of mortared or clay wall backing – might reflect alterations to the strong room, which would not therefore represent a single construction event in the form revealed. However, elsewhere it was noted that the suggested clay backing might simply represent make up material below or for the original floor of Room C, which was then cut into when the inner walls of the strong room were inserted, in which case these differences might be more apparent than real. The facing of the south wall displayed less regular construction than the other walls, incorporating a variety of differently shaped facing stones – some flat and wide and some with long narrow proportions. A niche (J12:19) was located in the centre of the south wall (Fig. 8.18). This was some 0.60m wide and used large, thin blocks stood on their ends to form its east and west sides, but its depth could not be accurately estimated as the back of the niche had been cut away by the modern drain.

The entrance was in the north-east corner of the room, the passage descending from the cross-hall being 2.10m long and 0.80m wide. The passageway would originally have been furnished with steps, a total of five treads being estimated by Daniels (see *Britannia* 12, (1981), 322), but all had been robbed except for bottom one (J11:28). This step projected forward of the line of the north wall and was 0.90m long (E-W), 0.44m wide (N-S) and 0.16m high. The upper surface of the block was chamfered along its north and east sides, with traces of *opus signinum* surviving along the lower edge, and the excavators considered that it might have formed part of a reused base, perhaps a pillar base or column base. To the north of the surviving step, the passageway floor was covered by a deposit of mortar, clay and cobbles (J11:29), which represented the foundation



Figure 7 View showing the two successive phases of the strong room north wall, from the south east.



Figure 8 The niche in the strong room south wall, later blocked up

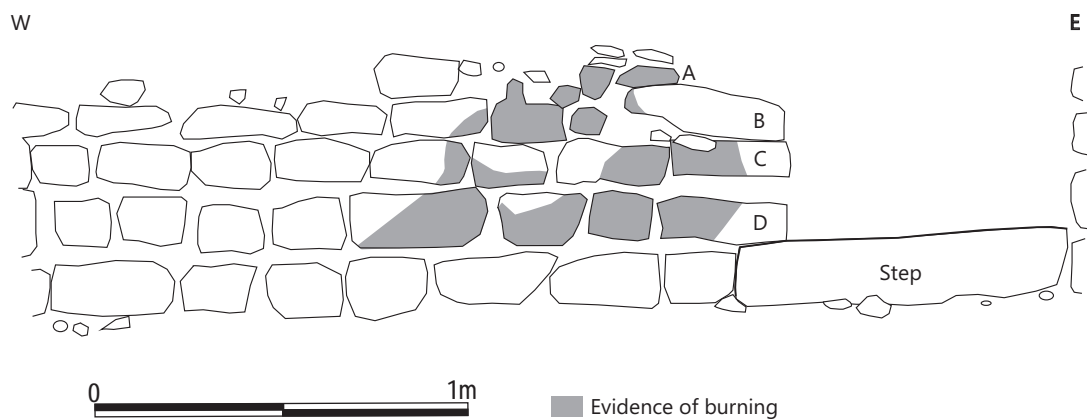

Figure 9 Elevation of the north wall of the strong room, at the phase at 10

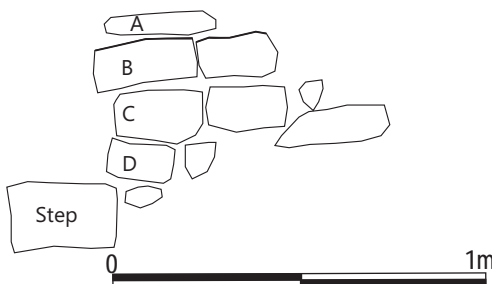

Figure 10 West elevation of entrance to strong room, at the phase at 10

for the steps. In the interior of the room the ground was entirely covered by a layer of small sandstone fragments set in pink/grey puddled clay (J11:27, J12:37), which was interpreted as the base for a floor surface which had not survived.

Relatively little survived of the east and west external walls of Room C. In the case of the east wall only traces of the foundations remained, in the form of a band of pink puddled clay and masons chippings, c. 0.85–1.10m wide (J11:30, 76, J12:24), overlain by a

robber trench (J11:06, J12:08). It must have abutted the lowest course of the north wall of the range, however, because no scar is evident in the south face of that wall which did survive at the relevant point. A single course of masonry did survive for a distance of c. 1.0m at the north end of the west wall (J11:13) and clearly abutted the bottom course of the north wall of the range (J11:02). The wall was 0.80m wide and was constructed with small facing stones and a mortar and rubble core. The remainder of its length was marked by pinkish grey foundation clay, c. 1.0m wide, incorporating the usual sandstone fragments (J11:14, J12:18). It was noted that this foundation was at a higher level than any of the other walls separating the rooms of the south range, by which it is presumably meant that the deposit was shallower than its counterparts, since the wall itself was at the same level as the north wall of the range.

Room D

The suggested open frontage of this room was probably blocked at this stage, as evinced by a second course of north wall J11:02 which butted up against

the obvious jamb (K11:19/20) at the east end of the room. No trace of a narrower doorway survived, however, so it is not clear how the room was now entered, but perhaps the threshold was raised at the same time as the wide opening was blocked.

The primary levels in Room D were entirely covered by a mixed layer of brown-black soil, c. 0.10m thick, with clay coal and charcoal inclusions (J12:26). Reddish staining of the deposit and the presence of charcoal indicated widespread burning in this room. Here too, construction of the sunken strong room in Room C, which was attributed to Phase 2 rather than the primary phase by the excavators, resulted in the width of D being reduced to 3.50m, as the south range attained its definitive layout.

Room E

A layer of red/brown clay (K11:21, K12:35) incorporating a few stones and some coal, and varying in thickness between 40mm and 250mm, was deposited across the interior of Room E, over the uneven clay and rubble of Phase 1, providing a level surface which was interpreted as a possible floor. The reddish colour of the clay suggested it had been affected by burning. Towards the eastern side of the room a 5mm thick deposit of brown soil with charcoal (K12:37), measuring at least 1.70m east-west by 1.0m north-south lay over the clay. Several patches of white plaster or mortar (K12:33), some 10–20mm thick, were present across the eastern half of the room, partially overlying the red/brown clay and the brown soil. A neatly squared rectangular, cracked flagstone, measuring c. 0.35m × 0.40m, also sat on top of the soil. A possible post hole (K12:36), measuring c. 0.60m by 0.40m but no more than 0.06–0.07m deep, was identified against the north wall of the room. Filled by dark brown soil with much coal, this was interpreted as a colliery period feature, but examination of site plan P226 shows its location was partially overlain by one of the flagstones belonging to Phase 4 (K12:21), which would imply the post hole should be assigned to either Phase 2 or 3 of this room, unless the flag had been displaced in more recent times.

FINDS

Phase 2

Floor of room A

Bone: counter (no. 51, H11:04)

Make-up for floor in room C

Glass: counter (no. 11, J12:37)

Floor of room D

Bone: counter (no. 52, J12:26)

Post hole in crosshall

Copper alloy: bell-shaped stud (no. 279, K11:39)

Dating evidence

South range: pit in room A

The pit contained five sherds from a burnt BB2 bowl or dish, and three sherds from a second dish (H11:45).

No securely stratified datable material was recovered from any of the contexts associated with Phase 2. Pit H11:45 in Room A might have been cut down from a higher level, if it is assumed the deposits in the rooms of the south range have been subject to truncation. However the date of the pottery retrieved from the pit is not inconsistent with the proposed phasing.

Phase 3 (Fig. 8.21)

Courtyard

The south-east cistern (Figs 8.22–8.25)

Water tanks were cut into the south east and south west corners of the courtyard. The one in the south east (J10:22, K10:16) was substantial, stone built, with a flagged bottom (Fig. 8.22). The dimensions of the tank were 2.86m (N-S) by 2.65m (E-W). The single-faced side walls stood between 0.94m and 1.16m high, with seven or eight courses preserved (north: J10:16, K10:13; south: J10:21, K10:12; east: K10:11; west: J10:15). They were constructed of irregular sandstone blocks and shallow flags, bonded with mortar and sealed by clay behind the wall faces, and were 0.30–0.50m wide. The uppermost stones were level with flagged surface of courtyard (J10:14). The bottom of the cistern was floored with large irregular flags (J10:24, 52, K10:15), up to 1.40m in length and 1.10m wide in the case of the largest example, these being set in pink puddled clay, with orange clay infilling the gaps between the flags (J10:53). A set of steps (J10:54) descended into the cistern at its north-west corner, with a total of three treads below the courtyard level, incorporating re-used *spolia* (Fig. 8.23). The uppermost of the three was an eaves drip corner stone whilst the bottom step was formed by an upturned column base (which could imply that part of the colonnade and associated eaves drip only went out of use when the water tank was inserted). The east side wall apparently cut into the foundation of the Phase 2 column base on the east side (K10–29), whilst the south wall intruded across the line of the eaves drip channel, which may have been the origin of the stone used at the top of the steps. Another displaced gutter stone from the eaves drip channel (K10:10) was revealed at the south-west corner of the tank. This was some 1.30m long, 0.34m wide and 0.14m deep and was clearly *ex situ* as it partially overlay the tank's south wall, its west end indeed forming the wall's uppermost course, even though it was still on the exact line of the eaves drip.

An overflow drain with stone side walls (K10:18) headed eastward from the south-east corner of the cistern, running parallel with the north wall of the



Fig re 2 Building 14 Phase 3 at 0



Figure 8.2 Courtyard cistern fully emptied, viewed from the south



Figure 8.25: The south-west courtyard pit, half sectioned, viewed from the north



Figure 8.3 The steps down to the courtyard water tank with the reused eaves drip corner stone at the top and an upturned column or pier base at the bottom.



Figure 8.4 The water conduit from the courtyard cistern cutting through the crosshall north wall foundation then turning to pass beneath the threshold slab of the east doorway

cross-hall, before tracing a sharp dogleg, involving a turn of almost 90 degrees to enter the north-east corner of the cross hall (as K11:24), perhaps via an existing doorway, then another 90 degree turn to the

east to exit through the hall's east doorway (Fig. 8.24). There it turned 90 degrees once more to run south alongside the headquarters' east wall perhaps reusing an earlier drain here. This is discussed in more detail below, in relation to the levels in the cross-hall. The stretch which crossed the east portico had largely been robbed out (K10:17), leaving only a 1.0m length near the cistern, where a single course of the south wall (one stone) remained and two courses of the north wall, defining a 0.25m wide channel. The drain contained a fill of sandy silt, but no finds.

The south-west cistern or pit (Fig. 8.25)

The other water tank in the south west (J10:47) seems never to have been finished. The cutting was made for it but never used. It consisted of a straight-sided, flat-bottomed pit, roughly rectangular in shape, but with an additional small semi-circular cut projecting into the courtyard midway along its north side. The pit was c. 3.00m deep and roughly 1m square at bottom and 2m square at the top. It cut through the western eaves drip gutter and had apparently been deliberately backfilled with medium brown/dark grey clayey soil containing charcoal inclusions (J10:45) and pink clay with tile and some stone (J10:46). These deposits had evidently subsided to some degree subsequently, the resultant depression being filled by a level of medium brown soil which included fragments of tile and flagstones (J10:37). The excavators speculated that this tank may have been abandoned before completion in favour of the cistern in the south-east corner.

DISCUSSION

The south-west pit is a rather perplexing feature. Although assigned to Phase 3, as outlined above, it should be noted that no courtyard surfaces or deposits were recorded overlying the fill deposits, just topsoil. Furthermore, the pit appeared to cut through the line of the Phase 4 wall footing H10:11/J10:03, which was set on the line of the western eaves drip and probably provided the base for a row of timber uprights (cf.



Figure 8.26: The north portico, looking west with per/column base K09:07 and wall foundations K09:39 visible.

reused altar J10:12). This suggests the pit should be reassigned to Phase 4. However the tank's main fill deposits appear to contain nothing later than third-century Nene Valley ware (J10:45), although the fill of the upper depression (J10:37) did include some East Yorkshire Grey ware.

The portico (Figs 8.26, 8.27)

The north-east portico was blocked off at this stage. The evidence is provided by a substantial foundation deposit consisting of a 1.0m wide band of compacted river cobbles in a medium brown loam (J09:21, K09:08) with some pink clay bonding. The rounded cobbles averaged 100mm in length. The foundation deposit followed an east-west alignment on the same line as the colonnade of the north portico. The west end of the foundation was obscured by the later flagged entrance (J09:04). At its east end, the deposit ran up towards the sole surviving column base of the north portico (K09:07), falling just short according to the context record and an earlier site plan (P232), but continuing, on the evidence of site plan P269, which appears to show it narrowing where it abutted the column base. In fact the full width deposit appears to terminate roughly in line with the pillar/column bases of the repositioned (Phase 2) east colonnade. Abutting the east side of base K09:07 was a rough alignment of jumbled stone blocks (K09:39), perhaps disturbed, which continued the alignment of J09:21/K09:08 up to the east wall of the headquarters (Fig. 8.26). In



Figure 8.27: The Phase 3 wall, H09:26/J09:15 incorporating column base J09:06, viewed from the north, with primary portico flagging H09:27, visible to the right.

plan, K09:39 appears to be similar to the foundations associated with the walling in of various sections of the east and west portico in Phase 2 – H10:21 and K10:39 – and quite different from J09:21/K09:08. It is, however, similar in width to the narrowed eastern terminal of J09:21/K09:08, abutting the west side of column base K09:07. As noted previously, in connection with the Phase 2 courtyard, it is possible that H10:21, K10:39 and K09:39 could all belong to the earlier phase, with K09:39 originally continuing further westwards, only to be replaced there by J09:21/K09:08 in Phase 3. The latter's broader width suggests it might represent the foundations for a stone wall, which would have been built over the stone base for timber-panelled walling of Phase 2. Alternatively J09:21/K09:08 and K09:39 might both be contemporary, with the former representing the exterior stone wall closing up the eastern half of the north portico, whilst K09:39 (and the very eastern end of K09:08) merely supported an internal wall, either a timber partition or a much less substantial stone wall, with the area of the east portico to the south having already been closed off, at least partially, in Phase 2.

A rather puzzling group of structures in the north-west portico can also be attributed to this phase. A column base (J09:06) was set on top of the portico's primary flagging (J09:30), only 1.0m from the north wall of the building, and in line with the original columns of the west portico, to the south. On either side of the base, short stretches of narrow walling (J09:15, H09:26) were preserved which may have formed part of a single east-west aligned wall running parallel to the north wall (Fig. 8.27). The 0.80m length to the east (J09:15) was in the better condition, consisting of a single course of walling, 0.50m wide, faced on both sides with a rubble core. On the west side a 1.45m long survived, but was much more disturbed with individual stones being displaced, although the wall's north face was apparent. The base was unlike any other found in the headquarters,

having a 0.70m square base with a 0.44m diameter circular torus designed to support a stone column, carved on top. Neither of the surviving wall fragments actually continued on to directly abut the base so it was not clear whether the latter was incorporated in the wall or inserted later on.

DISCUSSION

The fragmentary nature of these structures makes their interpretation difficult, particularly as their function is not immediately obvious. The positioning of base J09:06 on the same north-south line as the column bases of the west colonnade suggests the latter was extended northward in this phase which in turn would imply the section of the north portico immediately to the east was no longer standing by this stage. It also suggests that the only the southern end of the west portico had been walled in during Phase 2, after all with remainder continuing as an open colonnade or lean-to structure. The function of the east-west walls J09:15 and H09:26 is still more problematic. Given their proximity to the north wall of the building the walls could only have demarcated a 0.90m wide corridor. Such a corridor might have led to a putative doorway in the north-west angle of the building, but it is not clear why that passage needed closing off from the west portico and still less why was it necessary to continue the corridor eastwards with wall J09:15. Alternatively, and more radically, might these structures instead represent a new north wall of the *principia*? In this case wall H09:26 would block in the north end of the west portico, whilst J09:15 may have represented a not necessarily very substantial wall defining the northern edge of the courtyard. If the original north wall of the *principia* was still standing, perhaps its sole function now was to support the forehall roof (which could not exist without it), it having been considered beneficial to structurally detach the *principia* from the forehall for some reason.

Cross-hall

Cross-hall Phase 3

The features and deposits of Phase 2 were overlain by a layer of medium to dark brown silty soil with flecks of charcoal (H11:27, J11:31, K11:36). The deposit ranged between 10mm and 70mm in thickness, and covered the entire cross-hall interior except at the west end, where it was patchy, and the south-east corner. In some of the context records this was interpreted as a possible build up of soil resulting from the dismantling or collapse of the cross-hall roof, but elsewhere it is simply labelled 'occupation material' or 'occupation level'.

A square-shaped post hole (J11:34), measuring c. 0.30m by 0.25m, with vertical sides c. 0.15m deep, cut the surface of cobbled path J11:19 not quite midway

along the latter's course. It may also have cut through the overlying silty 'occupation' deposit (J11:31), but this was very uncertain as its fill consisted of medium brown silty soil similar to J11:31. The hearth located towards the south side of the cross-hall, roughly midway along its length, appears to have continued in use in this phase, as discussed above. It now took the form of a fire-cracked flagstone, around 0.50m square, with an underlying spread of reddening in J11:31, resulting from burning, extending up to 1.50m to the south-east (J11:37).

Two post-holes (H11:55–56) were located in corresponding positions at the south-east and north-east corners of the tribunal. These were, respectively, 0.25m and 0.28m deep and filled with medium brown soil, collapsed packing stones and mortar. The post holes cut through the Phase 2 clay surface (H11:46) and mortar spread H11:47, implying that the posts could not have been erected prior to that phase. Moreover it was noted in relation to southern post hole H11:55 that its fill was difficult to distinguish from the silty soil level H11:27 so the relationship between the two was uncertain, that is to say the post holes may have cut that Phase 3 floor level but were not recognised by the excavators until H11:27 was removed. Attributing the post holes to Phase 3 would also be more consistent with the third-century date of some of the pottery recovered from northern post hole H11:56. The posts presumably formed part of an addition to the tribunal, perhaps supporting a cupola or canopy over it or perhaps held substantial carved wooden statues flanking the structure.

Cross-hall Phase 4

A new surface predominantly composed of gravel (H11:25, J10:35, J11:26, K11:27) was laid over the cross-hall in this phase. In the centre this was seen to be made up of several discrete layers or patches with differing characteristics, some higher (J11:21, 22, 24), some lower (J11:23), some with more tile fragments (J11:26), some with spreads of small sandstone fragments (J11:24). Overall, where best preserved it was made up of very worn gravel and fine, compacted pebbles with very small tile fragments (e.g. J11:20), but in some parts it was rather disturbed and composed simply of unworn gravel, rather than a fine pebble surface, suggesting the material had perhaps been redeposited (J11:22; disturbance was also evident in parts of K11:27 to the east). However, during removal all these deposits in J11 were all treated as one context (J11:26) for finds processing purposes. At the west end of the hall the composition of the surface was somewhat different, described as light brown-white mortar, with some stone rubble and tile fragments (H11:25). Overlying the gravel at the east end of the cross-hall were small areas of surviving flagging (K11:15). These were worn, decayed and perhaps disturbed, in part at least, and represented

the top of the sequence of Roman stratigraphy in the cross-hall. The fact that the gravel layer across the courtyard exhibited signs of pronounced wear implies that it functioned as a distinct surface in its own right and was not simply makeup for flagged floor K11:15. Hence the flags may represent another phase or at any rate sub-phase of activity. A layer of brown silt (K11:33) was preserved directly beneath the flags, and was interpreted as the result of silt from upper layers accumulating around and under the flagstones. Next to the south wall, the gravel was cut by a sub-rectangular post hole (K11:34), measuring 0.45m by 0.25m and filled by medium brown silty soil, with some packing stones and an amphora fragment still remaining.

An overflow drain from the water tank in the south-east corner of the courtyard (J10:22, K10:16) was constructed through the north-east corner of the cross-hall (K11:24), under the east entrance of the cross-hall and then down the west side of the north-south road between the headquarters and the *praetorium*, perhaps reusing an existing drain there, heading towards the water tank tucked behind the building's south-east corner. The adoption of this rather sinuous course through the cross-hall can be explained by the convenient presence of the doorway in the hall's east wall (K11:07) and in all probability of another between the east portico and the cross-hall, which together would have greatly simplified the construction work involved, with no need to dismantle standing walls. The drain's side walls were composed of up to three courses of facing stones, forming a channel generally 0.35–0.50m wide, but narrowing to 0.25 where it cut through the foundations of the cross-hall's north wall. Here the upper courses did not survive on the east side, but the lower course incorporated a narrow oblong block, some 0.90m long but only 0.15m wide, using it lengthways. The drain's construction trench cut through gravel K11:27 and the underlying layers. However the drain was partially overlain by a spread of worn flags (K11:16) in the north-east corner, which may have formed part of the same overall surface as flagging K11:15 further south and would have formed cover slabs for the drain. The channel was filled with medium brown silty soil (upper fill: K11:25; lower: K11:26 – distinction not otherwise described).

Discussion

In the phasing for Building 14, the silty 'occupation level' is treated as though it was a distinct structural phase in its own right, equivalent to a floor surface. However the description of the material suggests it represented either a build-up of occupation trample in the cross-hall over the Phase 2 clay floor and the cobbled path, or, perhaps more likely a make-up layer for the gravel floor identified as Phase 4. Furthermore cobbled path J11:44, laid over the Phase 2 floor, has also been assigned to that secondary phase here,

rather than Phase 3 as proposed by the Daniels scheme. Hence, if the silt were to be interpreted as occupation or makeup, this could, potentially, eliminate the previously envisaged Phase 3 of the cross-hall altogether, with the result that the silty layer and the worn gravel floors would be combined to form Phase 3, whilst the flagged surface (K11:15) at the east end of the hall would represent a fourth phase.

Southern Rang

Room A

At the western end of the range, no further levels were encountered in Room A, above the clay floor assigned to Phase 2 (H11:04, H12:15). It is likely that all the later stratigraphy had been truncated in this area.

Room B

A small area of flagging (H11:19), sitting directly on the earlier clay floor (H11:05, J11:15), was preserved against the west wall of Room B. Covering an area measuring no more than 0.80m north-south and a maximum of 0.90m east-west, and bisected by a late 19th/20th century sewage pipe trench (H11:06), this might nevertheless represent the surviving remnant of a floor which was originally much more extensive, perhaps covering the entire room. It is possible that the remainder of the flagging had been removed along with any later Roman levels by modern, colliery era and later disturbance. The post-excavation analysis interpreted this flagging as a phase of flooring distinct from the clay beneath. However it is quite possible that the clay H11:05/J11:15 merely represented the make-up level for the flagged floor, rather than a surface in its own right, which would reduce to two the number of surviving structural phases in Room B.

Room C (Figs 8.28–8.30)

A new face (J11:11), c. 0.30m deep, was added to inner north wall of the strong room (Fig. 8.29), in front of the original north wall face (J11:10) and tied into the western side wall of the entrance passageway (Fig. 8.30). This reduced the north-south width of the room to 1.70m. The new face was flush with the southern edge of the bottom step (J11:28) into the room and its second course actually sat on the western end of that stone, which probably explains why this step was left *in situ* when the others robbed at the end of the life of the strong room. The facing stones were bonded with mortar and a limited amount of rubble core with up to six courses surviving at the eastern end of the wall.

The niche (J12:19) in the centre of the inner south wall was also blocked up (J12:16) at some stage prior to the final abandonment and collapse or demolition of the strong room, though not necessarily at the same time as the north wall was refaced (see Fig. 8.18 above). Large rectangular stone blocks averaging

0.35–0.40m (L) × 0.15m (W) × 0.10m (D) were used, with smaller ones wedged in between, the whole being mortar bonded.

Room D

In Room D, a layer of clay (J11:07, J12:07, K11:22), interpreted as a floor surface, was deposited across the entire room over the previous reddish brown-black soil level. This was the uppermost Roman period level uncovered in the room. It was described as dirty pink/grey with yellow flecks or dirty yellowish/grey in colour, with an undulating surface, and contained fragments of sandstone flagging and patches of mortar. The excavators noted that this could represent either a floor surface proper or levelling up material, the former interpretation being generally preferred owing to the presence of fragments of flagging or mortar (though not with sufficient to conviction to warrant removal of the inverted commas bracketing “floor”).

Room E

ROOM E PHASE 3

A layer of reddish/brown clay (K12:31), 30–40mm

thick and incorporating a few stones, covered the centre of the range’s easternmost room and probably extended as far as the east wall originally. Its reddish colouration and presence of charcoal in this layer indicated it had been affected by burning. The northern edge of the clay was cut by a roughly oval post-hole (K12:34) measuring c. 0.45m × 0.35m. This was c. 0.30m deep and filled by medium brown clayey soil with three of its packing stones still in situ. A 30–40mm thick layer of collapsed wall plaster (K12:32) overlay the burnt clay and probably post hole K12:34 since the latter was not observed until the plaster was removed. The layer was very jumbled up, with faces of plaster lying in various directions. Several colours were noted, including red, green, black and plain white. The presence of this wall plaster over the floor does seem to be consistent with a definite end to a phase of occupation, perhaps reflecting the removal of old plaster or wall panels prior to renewal. However the earlier distinction between Phase 2 and Phase 3 in this room seems much less clear cut. The two phases comprised a sequence of activities, marked by deposits and features in the northern and eastern parts of the room, with no wholesale reflooring to divide that sequence. Instead, burnt clay layer K12:31 appears to have been identified, rather arbitrarily, as marking the beginning of a new phase. An interpretation which conflated the two into a single overall structural phase consisting of several sub-phases of activity could be equally plausible.

ROOM E PHASE 4

A further phase of activity was identified in this room. This has also been assigned to the overall Building Phase 3 rather than Phase 4, based on the likelihood that the later levels in this area have been truncated and the absence of any Roman pottery giving a later *terminus post quem* than BB2. A scatter of flagstones (K12:21) were present, extending from north-west to south-east, overlying plaster spread K12:32 and burnt clay K12:31. The largest of the flags, with dimensions of c. 0.60m by 0.75m, lay in the centre of the room and



Fig re 8 The strong room with the secondary north wall and the psag way evident, looking north west.

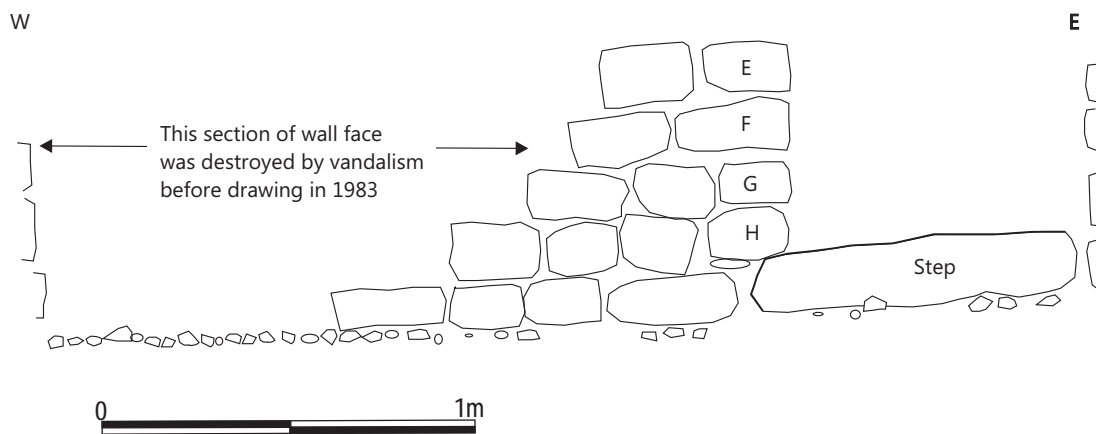

Fig re 8 Elevation of the north wall of the strong room, as depicted at 8

was cracked into three pieces. Perhaps contemporary with this flagging were a posthole (K12:20), measuring c. 0.60m × 0.50m, which cut the south-west edge of plaster spread K12:32, and, on the west side of the room, an upright slab, c. 0.85m long and 0.10m thick. The slab was located on the north side of and probably associated with a (?) pit (K12:19), some 1.0m in length (east-west) and 0.80m wide (north-south), which appeared to cut the very western extremity of burnt clay K12:31.

Water tank south of the building (Figs 8.31–8.33)

A rectangular water tank (K12:26) was probably inserted at this stage on the south side of the *principia*, next to the building's south-east corner, to link up with the overflow channel from the courtyard water tank. This was bounded to the east and south by a road surface composed of roughly laid cobbles averaging 50–150mm in diameter (K12:27), which extended from the southern end of Alley 7 round the south-east corner of the *principia* onto the *via quintana*.

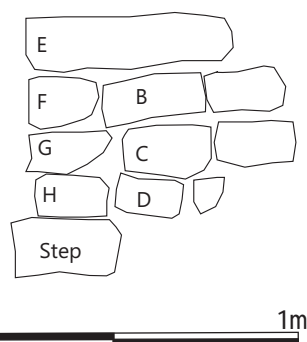

Figure 8 West elevation of entrance to strong room, and detail at 10



Figure 8 The cistern next to the south east corner of the principia with the inlet for the channel from the principia cistern visible in the north east corner. View looking east.

The water tank was lined with neatly constructed, stone revetment walling, bonded with mortar. This revetment included courses made up of headers (note in particular the third course from the top of the south wall) and culminated at the top in walls faced on both sides, at any rate along the east, west and south sides of the tank. To the north, the tank's east wall probably butted up against the south wall of the headquarters and its west wall may have done



Figure 8 South west corner of the cistern south of the principia, showing the outlet prior to the exposure of the channel.



Figure 8 The water channel at the south west corner of the cistern with the filter stone apparent in the channel.

the same, perhaps with a gap to allow the gutter or drain channel which ran along the south side of the building to feed into the cistern. It is not clear whether the surrounding wall ever rose substantially higher, perhaps forming a low parapet around the cistern. Including the surrounding wall, the tank measured 4.50m (E-W) by 3.00m (N-S) and was c. 1.50m deep. The revetment walling lining the south, east and west sides of the cistern stepped inward once or twice (see Figs 8.31, 8.32), with the result that the internal dimensions of the tank were significantly greater at the top (3.50m E-W × 2.20m N-S) than at the bottom (3.00m E-W × 1.80m N-S).

The precise details as to how the water tank was supplied are unclear as the various water channels and surrounding road levels only underwent limited investigation. The tank was fed by an inlet at the north-east corner with a stone-capped channel passing through the perimeter wall (Fig. 8.31). This probably connected to the conduit (K11:09b) which ran down the southern end of Alley 7, leading from the tank in the south-east corner of the courtyard via the east entrance to the crosshall, although this could not be confirmed because the connecting section was not exposed beneath the later road surfaces and was in any case interrupted by a broad modern drain cut (K12:03). An overflow channel (J12:35) ran from a stone-capped outlet at the south-west corner of the tank and was traced heading in a south-westerly direction for a distance of 4m (Figs 8.32, 8.33). It perhaps led towards a major slab-sided drain which headed diagonally across the *via quintana* from just outside the south-west corner of the headquarters (G11:07/H12:33). The channel ranged in width from 0.15m to 0.40m, with side walls composed of up to two courses of roughly dressed facing stones, and was capped at its south-west end by a substantial block of stone, 1.35m long, 0.60m wide and perhaps c. 0.20–0.25m thick, which was cracked diagonally across the middle and probably reused. At its north-east end a triangular slab, 0.70m long on each side and 0.10m thick, was wedged point down in the channel. The slab was perforated by three holes 100–110mm in diameter and was interpreted as a filter stone, perhaps a reused drain cover. A filter stone would be more appropriate for an inlet channel, perhaps, and in any case it is not clear how well the stone would have functioned since it largely blocked the channel, so it may simply have formed part of the later stone backfill in the channel (J12:34). The bottom of drain channel J12:35 was filled by a medium brown sandy silt and few stones (J12:36).

To the south of the water tank, some 1.30–1.50m from its perimeter wall, another stone-lined drain was partially exposed and recorded on site plan P306 at the end of the 1981 excavation, but not allocated a context number. The channel was traced for only 2.50m and was 0.20–0.45m wide, apparently with only a single

course of side walling on either side. Comparison of successive site plans would imply it must have been covered by road surface K12:27, whilst its orientation suggests the channel skirted round the south-east corner of the water tank and was perhaps connected to drain conduit K11:09b further north, although this is speculative.

FINDS

Phase 3

Silt layer in crosshall

Coin: Hadrian, 134–8 (no. 76, K11:36)

Glass: counter (no. 13, J11:31)

Gravel layer in crosshall

Glass: counter (no. 12, J11:26)

Dating evidence

Crosshall

The silt and charcoal layer produced less than 20 sherds of pottery, from about six vessels. There was a mid to late Antonine form 31R (H11:27), sherds from a south-east reduced ware storage jar (J11:31) and a scrap of a Nene Valley ware beaker of the third century (K11:36). The pit (J11:33) contained sherds from a mid to late Antonine form 31 bowl and an East Gaulish form 31R of the late second or first half of third century.

The gravel layer also contained a small sherd from a second East Gaulish form 31R of the same date (J11:26), small sherds from a different Nene Valley colour coated ware vessel and a BB2 bowl or dish (K11:27). The occupation layer over the gravel produced only four sherds; a Hadrianic form 18/31 dish, a Dressel 20 amphora sherd, a piece of BB2 covered in mortar, and a body sherd of calcite-gritted ware, probably from the late third century (K11:33).

The tribunal posthole produced nine small sherds, including an East Gaulish dish of the late second or first half of the third century, a sherd from a BB1 cooking pot with obtuse angle lattice (dating to after c.225) and a sherd from a Nene Valley colour-coated ware pentice-moulded beaker of the late third or fourth century (H11:56).

Crosshall drain

The crosshall drain produced only a few sherds of pottery, including an Antonine form 31 bowl, and BB2 sherds (K11:24).

South range

Room D produced 14 sherds, mainly of Dressel 20 amphora, but including a second-century BB1 flat-rimmed bowl and sherds from a Hadrianic samian flanged bowl (J12:07). The equally small assemblage from Room E consisted of BB2 and allied fabrics, with

an Antonine form 31 and a mid to late Antonine form 31R (K12:31, K12:32).

Courtyard

The lower fill of the tank dates to the third century, containing six sherds of pottery including an Antonine form 38 samian bowl, BB2 and allied fabrics and a sherd from an indented Nene Valley colour-coated ware beaker (J10:45). The upper fill contained two sherds, one of which came from a Crambeck reduced ware bowl, of the later third century, possibly the result of subsidence (J10:45).

Phase 4 (Fig. 8.34)

Courtyard

This phase was marked by the laying of two lines of north-south kerbs and paths/surfaces over the east side of the courtyard. A massive stone-flagged floor was subsequently added at the north entrance of the building. The volume of the south-east cistern was reduced by infilling and revetting the western part of the water tank. A north-south aligned plinth course was laid in the south-west corner of the courtyard.

Courtyard surfaces (Figs 8.35–8.37)

On the eastern side of the courtyard two north-south kerbs were laid parallel to one another, around 1.60–1.70m apart. These were not quite parallel with the north-south axis of the building, veering a little over towards the north-west., instead. The more westerly kerb (J09:07, J10:32) was one or more often two stones wide, sometimes resembling a wall with an apparent face on both sides, but lacking any bonding material and generally faced only on its west side (Figs 8.35, 8.36). On site plans P233/240 and P269 it is shown extending for c. 4.0m in length, but its length is recorded as 5.0m on the context sheet, perhaps indicating its length as finally observed after removal of the substantial flagged surface at the entrance to the courtyard (J09:04). The kerb functioned with the flagging, but also appeared to run underneath it, implying that this kerb, at least, pre-dated the flagging. At its southern end the kerb curved round slightly towards the south-east. A surface of small to medium-sized sandstone fragments and river cobbles in a matrix grey clayey loam and medium to dark brown/black soil (J09:25, J10:38) was bounded by kerb J09:07/J10:32 to the west and extended as far east as the second kerb, J09:13/J10:34. To the west of J09:07/J10:32 there was another area of rounded cobbles forming a definite surface (J09:22).

The second kerb (J09:13, J10:34, 31) lay to the east of J09:07/J10:32 and followed a roughly parallel course. It consisted of a single line of stones, one course high, again with no bonding material, and again the kerb's face lay on the west side. This kerb survived in two

separate sections (J09:13/J10:34 and J10:31), stretching over a total distance of around 5.0m, which appeared to be associated with compacted rubble surfaces extending to the east (respectively J09:18/K09:14/K10:26 and J10:40/K10:25). Odd pieces of flagstone were included in the more northerly of the surfaces and some stones were pitched vertically (K10:26), whilst that to the south was described fairly worn, tightly packed cobbles (J10:40). In the latter case, the kerb (J10:31) was set back from the western edge of the cobbling and appeared to overlie it, suggesting J10:31 might have been a replacement for an earlier kerb which did not survive. A third possible kerb, in this case orientated east-west with its face to the south (J10:48), was located in the centre of the courtyard, 1.7m south of J09:07/J10:32 and 1.9m west of J10:31 (Fig. 8.35). This was abutted by cobbling J10:38, apparently marking the southern edge of that surface and perhaps also cobbling J09:22. Some of its stones were perhaps displaced.

A surface composed of large irregular flags (J09:04) was added over north entrance (Figs 8.35, 8.37). Two of the flags represented a single re-used eaves drip stone, which was broken in two midway along its length (SF 2122 & 2123). One of the larger slabs located immediately south of the headquarters north wall (here marked only by the clay foundations and overlying robber trench) had a small rectangular slot in the centre, perhaps a socket to hold timber upright associated with the entrance such as a gate post. The flagging was laid on a 100m–200mm thick layer of varying sized rubble, including some dressed stones, set in a medium to dark brown clayey soil (J09:39, K09:37). This was perhaps deliberately deposited as make-up for the large slabs, but it is conceivable that it originally formed a surface in its own right, associated with kerb J09:07/J10:32. To the west of the flagging, in the former north-west portico, there was a rough cobble surface of irregular sandstone fragments (J09:05) which incorporated and overlay the earlier fragment of walling (H09:26/J09:15) and column base J09:06. This surface also extended further south over parts of the west portico (as J09:23). It did not appear to extend over the earlier Phase 2 wall footings in the west portico, although this may simply reflect its lack of survival in this area due to later disturbance. In the north-east portico, to the east of the flagging, a spread of rough cobbles and sandstone rubble in a matrix of dirty dark brown/black loam (K09:12), some 100m–200mm thick, may have represented the heavily disturbed remains of another surface. Further east this layer had been removed altogether by a variety of modern disturbance.

INTERPRETATION

The interpretation of the courtyard resurfacing of this phase poses a number of difficulties. The flagging to the north is most plausibly associated with the

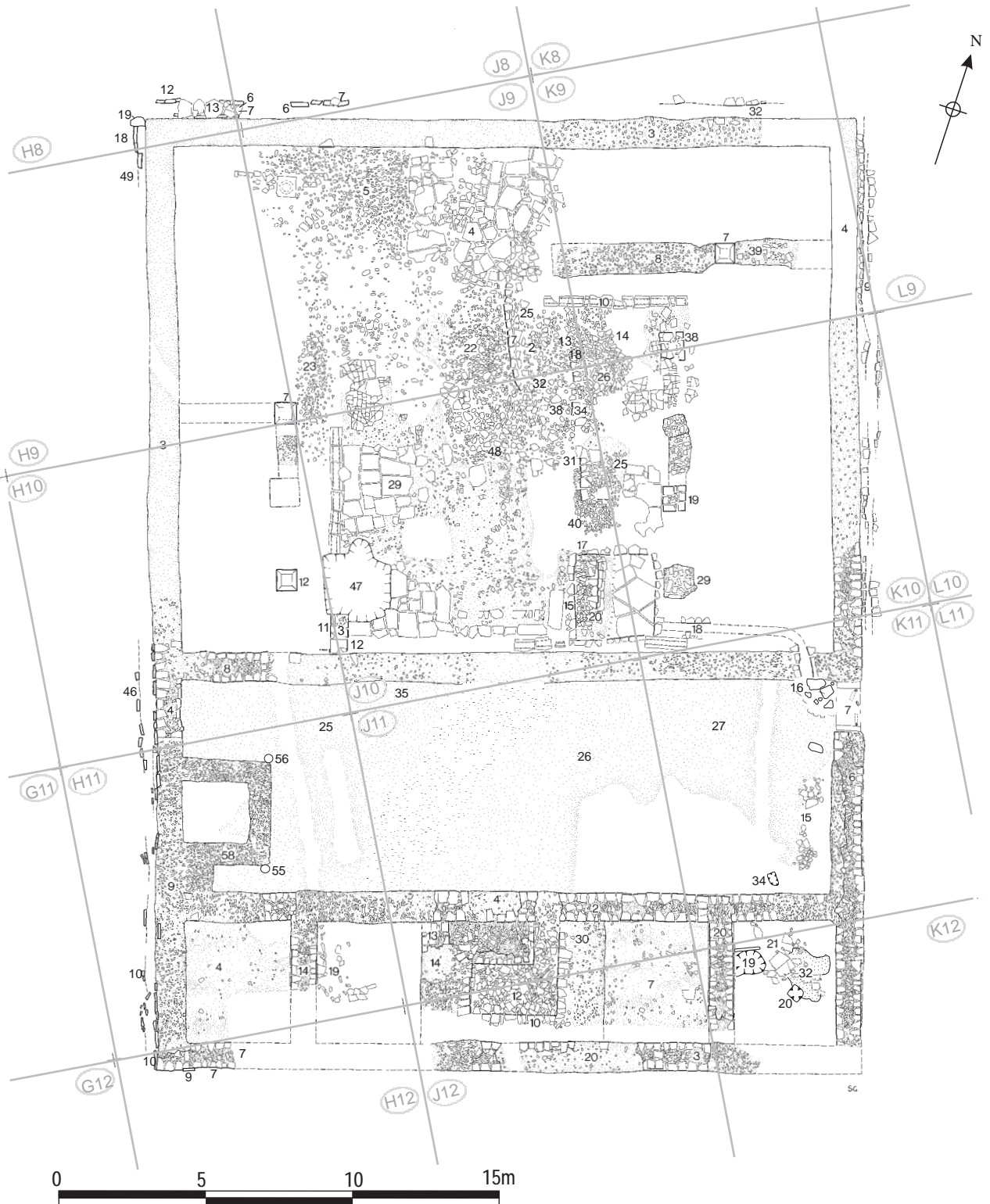

Fig re 8 Building 4 showing the Phase 4 courtyard and the latest recorded Phase 3 activity in the cross hall and south range where the Phase 4 levels were truncated, plus the rubble demolition fill in the strong room. Scale 1:200.

entrance to the compound and suggests there was still a defined perimeter on the line of the north wall. However the various kerbs and their related rubble or cobble surfaces are more puzzling. The bulk of this activity is concentrated on the east side of the

courtyard, though areas of cobbling and even kerbing (J10:48) also spread into the centre of the yard and into the west and north-west portico (J09:23, J09:05). Various interpretations suggested by individual members of the excavation team were noted in the



Figure 8 Late surfaces and features in the centre of the courtyard, looking north towards the entrance flagging (J09:04). East-west kerb J10:48 is in the foreground with north-south kerb J09:07/J10:32 beyond.



Figure 8.36: Phase 4 'kerb' J09:07/J10:32, from the west.



Figure 8.37: Phase 4 flagging J09:04 in the area of the courtyard entrance, looking north

research archive notes: that the kerbing may have been intended to steer traffic past the water tank, away from its edge; that they might have been supports for a stone channel or aqueduct supplying the water tank; or even that they were parts of drains or channels

themselves. It is not clear that any of these suggestions attracted universal support. The main lines of kerbing were oriented towards the western edge of the south-west cistern and the associated roadways may have been designed to provide access to the water tank. There is no evidence that these surfaces continued across cistern J10:22/K10:16, even after the latter had been fully backfilled (J10:18).

It is not clear how much, if any, of the portico was still functioning as such in this phase. The new surfaces do not extensively cover the portico area except in the north west and the entrance area, but given the degree of later disturbance affecting the building this may not be significant, that is to say it is possible that later surfaces over the east and west porticos have simply been stripped away. A possible timber (post-hole) building (BC/BD) was identified over the west portico, but no floor surfaces associated with this structure can be identified.

The south-east cistern (Figs 8.38, 8.39)

The western side of the south-east water tank (J10:22, K10:16) was deliberately infilled. The infilling was carefully constructed, beginning with a 0.40–0.50m deep base of burnt and soot-stained sandstone rubble (J10:25), including large irregular flags but no facing stones. This was sealed by a cap of pink/grey sandy clay (J10:19), some 0.42m deep. A stepped revetment wall (J10:20), 0.46m high, was set this clay foundation and comprised four courses of single-faced walling, each course stepped back behind the line of the one below, the lowest course lying 0.93m east of the original west wall of the cistern. The revetment facing stones were bonded with mortar, but rather irregular, and revetted a core of mortared rubble. The uppermost course (J10:17) was composed of quite small stones. Although the infill walling clearly stood to its full height, just below the lip of the original west wall of the tank, it was not preserved intact. The southern end of the stone infilling had been removed



Figure 8.38: The partial infilling of the courtyard south-east cistern, from the south



Fig re 9 Rubble, clay cap and stepped revetment wall of the courtyard cistern infilling.

by later robbing or disturbance, along with most of the uppermost course, which largely only survived in the north-west corner (J10:17).

The south-west corner

A short length of wall footing or a base plinth course (H10:11, J10:03) survived in the south-west corner of the courtyard, sitting on the junction of south and west eaves drip channels. The 0.64m wide structure ran north-south for a distance of 0.77m, on top of the west eaves drip channel. It was constructed of broken flags and incorporated part of a carved stone altar (J10:12) at its southern end, adjoining the cross-hall. The surviving length ended abruptly at the southern lip of the large pit interpreted as an aborted cistern (J10:47 – see Phase 3), suggesting it may have been cut by the digging of that pit. If correctly identified as a footing or plinth course, it may have supported timber-framed walling or a line of timber or stone uprights and it was noted that the face of altar J10:12, where any dedication would have been inscribed, was cut away to form a rectangular depression, presumably intended to seat a squared timber upright. It is not possible to determine how the plinth related to other structures in the courtyard given its fragmentary condition, though it may conceivably have been associated with the late post-hole buildings, BC and BD, which stood further to the north over the site of the west portico.

Plinth course H10:11/J10:03 was abutted on its east side by a possible decayed surface (J10:02), consisting of fragments of tile, decayed mortar, small pieces of flagstone in a dirty grey/brown sandy loam 50–100mm thick. This layer covered the south-west corner of the courtyard, overlying primary flagging J10:07 and extending across an area 3.0m east-west by 2.5m north-south.

A drain consisting of upturned *imbrex* roofing tiles (J10:33), laid end to end, was uncovered in the courtyard just to the north-west of the cistern. The

surviving length of the feature was 1.30m and its width 0.20m. The context record notes that the tiles lay under the Phase 1 courtyard flagging (J10:14 or 29), but examination of site plan P240 casts doubt on this reported relationship. Only a single stone is shown overlying the drain and this could either belong to a later phase or simply have been displaced. The tile drain probably belongs to one of the later phases of the building and may have fed the cistern, but whether it should be assigned to Phase 3 or 4 is not clear.

Cross-hall and south rang

No alterations which could be attributed to this phase were identified in the cross-hall or in Rooms A, B and D of the south range, although this might simply reflect the truncation of the later levels in the southern half of the building. The rubble infilling of the strong room attributed should probably be related to the final abandonment of the building rather than a late structural modification. A further phase of activity in Room E, which was assigned to Building Phase 4 by the excavators has been treated here as a sub-phase of Building Phase 3, in view of the likelihood that the levels in this part of the *principia* have been truncated. However it should be noted that no dateable material was recovered from contexts associated with this phase of Room E which might support or contradict such an interpretation.

South water tank

The water tank south of the headquarters (K12:26) may have been backfilled at this stage and then covered by the latest surface of the *via quintana* to survive in this area, composed of loose cobbles and largish blocks of rubble in a loose black-brown soil (K12:23). The backfill of the tank (K12:29) was a mixture of silt, gravel and stones, most of which were dressed, overlain by a 0.50m thick layer of tumbled, predominantly angular rubble in a matrix of brown soil (K12:25). The drain (J12:35) from the south water tank was also blocked, its channel filled up with medium-sized, rounded stones in a dark brown, silty soil matrix (J12:34).

The road east of headquarters (Alley 7) was resurfaced (K11:08, K12:06, probably equivalent to K12:23), covering former drains and leaving a gully down the west side of the building to act as a drain (K11:09, K12:11/K12:22, L09:04). The gully may have continued alongside the east wall of the water tank (as K12:30), before appearing to turn around the latter's south-east corner. Beyond that point the course of this channel is uncertain. Site plan P254 suggests K12:30 was roughly revetted on its east side by stone kerbing forming part of road surface K12:27. However no trace of gully K12:30 was recognised in overlying surface K12:23, though K11:09/K12:11/22 was recognised in

the equivalent level ((K11:08, K12:06/23) further north in Alley 7, as well as in the underlying metalling (K11:10) where that was exposed.

FINDS

Phase 4

North portico of courtyard

Iron: lift-key (no. 28, J09:05)

Glass: bead (no. 34, J09:21)

Courtyard

Stamped tile (no. 1.3, J10:02)

Drain from tank south of building

Copper alloy: spoon (no. 112, J12:34), plate (no. 305, J12:34), sheet (no. 311, J12:34)

Dating evidence

Courtyard

The very small group of pottery from the late surface (J10:02) included a sherd from a Crambeck reduced ware bowl. The cobbled surface J09:25 produced a single sherd of pottery, a calcite-gritted Huntcliff-type rim of 360+. The only reasonably-sized group of pottery (0.349kg) came from the rubble make-up (K09:37), which consisted entirely of BB2 apart from four sherds, one of which was a Huntcliff-type rim.

Water tank blocking

The foundation make-up for the wall blocking the tank (J10:25) produced one of the largest groups of pottery recovered from the building (0.760kg), half of which was made up by BB2 and allied fabrics. There was also a BB1 flanged bowl and a bead-rimmed funnel-necked Nene valley colour-coated ware beaker, both dating to the late third century or later.

Tank south of the headquarters

The fill of the tank south of the building contained a form 31 bowl of the late second or first half of the third century, a handle from a Campanian amphora dating to the second half of the third century or later, and a BB1 flanged bowl, dating to after *c.*270 (K12:29). The fill of the drain leading from the tank produced only a few sherds of pottery, mainly third-century BB2 and allied fabrics (J12:34). The road surface over the tank produced mainly third century pottery, but also two Huntcliff-type rims in calcite-gritted ware of 360+ (K12:23).

Phase 5

Courtyard

The courtyard water tank was filled with a deposit of dirty dark greyish brown clay loam (J10:18), some

1.05m deep. The composition of the fill became silty towards the bottom of the tank and contained fragments of flags and facing stones, large lumps of *opus signinum*, fragments of *tegulae* (some badly stamped) and *imbreces*, and small lumps of mortar.

A timber building (BC) was erected on west side of the courtyard at some stage after the cobbled surface J09:23 had been laid (see below). The building's post-holes clearly cut through cobbling and the eaves drip beneath. It is uncertain whether the rubble and cobbled surfaces on the east side of the courtyard were still functioning at this stage.

The strong room (south rang Room C)

In the Daniels post-excavation structural summary it is suggested that the strong room was deliberately demolished in Building 14 Phase 4, a process that included robbing of the steps and the removal of the flagged floor which was presumed to have existed. Only the bottom step (J11:28) was left *in situ* as it was overlain by secondary face of the room's north wall (J11:11). The interior of the room was filled with rubble (J11:09, J12:12), as was the entrance passage (J11:60). This rubble contained a high proportion of dressed facing stones with mortar still adhering and including key stones presumably deriving from the room's barrel-vaulted ceiling (Fig. 8.40). Fragments of flags were also noted, mainly on the surface of the rubble fill, and it was suggested these might represent the remnants of the floor of the shrine or *aedes* above the strong room.

The rubble filling the strong room was interpreted, albeit very tentatively, as deliberate packing, and it was suggested that this might have been intended to provide a stronger foundation for the *aedes* above. The fact that all of the stone appeared to have fallen within the confines of the room was regarded as too neat to simply represent general dereliction and collapse. Even so the post-excavation notes do



Figure 8.40: Rubble collapse(?) filling the strong room, looking north

contain significant expressions of doubt regarding this interpretation, with the looseness of the rubble fill being noted, for example. Moreover the descriptions contained in the actual context records indicate a process of abandonment and natural collapse was envisaged during the excavation itself, and the sequence described therein does appear more plausible. Whilst the robbing of the steps and the presumed flooring (perhaps flagstones) was clearly deliberate, this could simply signify the removal of certain useful components for reuse elsewhere when the structure was abandoned. Thereafter the building may have been left to decay naturally, ultimately resulting in the collapse of the barrel-vaulted ceiling and the floor of the *aedes* above into the interior of the strong room. The structures excavated in 1980–81 represent what remained after a long process of medieval and modern destruction, which, in effect, stripped off the later Roman levels in this area down to the current level and explains why the only surviving rubble collapse was that preserved within the confines of the sunken strong room.

FINDS

Phase 5

Backfill of water tank

Stamped tiles (nos 0.1, 0.2, 0.3, 1.2, 2.5, all J10:18)

Pit/post hole

Copper alloy: sheet (no. 310, H09:34), washer (no. 323, H09:34)

Iron: stud (no. 64, H09:34)

Dating evidence

Pit/post hole

The pit/post hole H09:34 contained a single sherd of an unidentified reduced ware.

Backfill of tank

The back-fill of the tank produced four sherds, including two sherds of Crambeck reduced ware of the late third century or later, one from a plain-rimmed dish and one from the base of a second bowl or dish (J10:18).

Buildings BC and BD (Fig. 8.41)

A number of post holes were recognised across the north-west corner of the *principia*, cutting the latest surviving surfaces of the courtyard. Six of the post holes were interpreted as forming a rectangular building which was designated BC. The remaining eight, the majority of which appeared to form a series of pairs, were grouped together for convenience and categorised as BD, though no convincing overall building plan unifying all these post holes was

identified. These structures were assigned to Fort Phase 4 by the excavators essentially forming part of the latest phase of activity in the area of the *principia* (i.e. Building 14 Phase 5).

Building BC

This took the form of a rectangular building, its long axis aligned north-south, parallel with the west wall of the *principia* courtyard. It measured c. 6.5m by 3m, with the east and west walls each comprising a trio of post holes (respectively from north to south: J09:11, 09, J10:30 and H09:31, 09, H10:15). The east wall generally followed the course of the courtyard eaves drip channel, cutting the gutter stones, particularly noticeably in the case of J10:30. More significantly perhaps it was also in line with the late plinth course (H10:11/J10:03) overlying the south end of the eaves drip, which included an altar reused as a post pad (J10:12). The post holes were generally oval or sub-rectangular in form, judging from site plan P270, the largest measuring c. 0.70m × 0.60m (H09:09), the smallest c. 0.50 × 0.40m (J10:30), and, where recorded, their depth varied from 0.34m (J09:09, 11) to 0.50m (H09:31). They contained in situ packing stones in matrix material variously described as medium brown silty soil (H09:09, 31), fairly homogenous clean dark grey loam/silt (J09:09), or dirty dark grey clay/silt (J10:30). No floor surfaces directly attributable to this building were preserved. It is possible that the existing courtyard flagging was reused, although it was probably already very worn and cracked. Perhaps more likely, the floor surfaces belonging to this period have been removed by later ploughing and disturbance.

Building BD

The post holes designated BD (H09:28–30, 35–37, H10:33–34) were not dissimilar in form or dimensions to those of BC, but, at c. 0.25–0.35m in depth, they were generally shallower. They all contained packing stones in a medium brown silty soil. Much charcoal was also present in the fill of H09:36, whilst H09:37 reportedly contained only charcoal and one dressed stone. These last two postholes may conceivably have belonged to an earlier stage as they were reported to lie beneath earlier portico flagging H09:25, but that surface was so fragmentary that this relationship is not conclusive. A further post hole (J10:66, filled with dark brown loam, grit and stone J10:65), may be added to this group since its position appeared to correspond to a gap in courtyard flagging J10:29 and was probably obscured by a patch of trampled excavation debris when the underlying silty and sandy makeup layer (J10:49) was first exposed. Six of the post pits appeared to be grouped close together in pairs (H09:28 and 29, H09:30 and 36, and H10:33 and 34) whilst five of



Fig re 8 : Building BCB D, at 0

these also appeared to form a possible north-south alignment positioned only c. 0.50m from the west wall of the *principia* and 1.20m west of BC (from north to south: H09:30, 28, 29, H10:33, 34). This 8.70m long alignment extended beyond the south end of BC and may have turned to the east at its north end where H09:36 lay very close to H09:30.

Discussion

The six post holes of BC appear to have been separated out simply because they could be arranged into a coherent rectangular structure. Otherwise there was little to distinguish those six from the remainder, classed as BD. Indeed, two of the latter, post pits J10:66 and H09:35, could have formed part of, respectively, the east and west walls of BC since they fell on the same alignments, though they would have disrupted the neat symmetry of the six post building if they did. Thus the two groups are best considered together as a single assemblage. The line of posts to the west of BC was significantly longer than the latter and could represent a timber boundary wall or fence, perhaps replacing the west wall of the courtyard which might conceivably have been in a state of disrepair or partial collapse by this stage, rather than signifying the existence of a larger twin-aisled building. Equally, it

is possible that BC might have formed part of larger structure together with plinth course H10:11/J10:03 and post pad J10:12 to the south, for example, which would have belonged to Phase 4 of the *principia*. However, in the absence of any identifiable floor levels which could indicate the extent of these structures, no definitive interpretation is possible.

No dating evidence was recovered from any of the postholes attributed to BC or BD. The structures were assigned by the excavators to the last overall phase of the Roman period (Fort Phase 4), corresponding to the late fourth century, on basis of their position within the north-west part of the *principia* courtyard, with their alignments respecting the overall orientation of the building. An association with the later Roman occupation of the courtyard area does remain the most likely context for BC/BD. Nevertheless the remains of ruined Roman buildings might well have continued to determine the positioning and orientation of any structures erected inside the fort long after the fourth century so a later date cannot be entirely ruled out. It may be coincidental, but the discovery of a single sherd of sixth-century, decorated handmade pottery amongst the overburden in grid square J09 should be noted (J09:01; see Chapter 25: The post-Roman finds, fig. 25.40). Such decorated Anglo-Saxon pottery would, however, normally be associated with a

funerary context, perhaps as a cremation urn or an accessory vessel in an inhumation burial, with the latter considered more likely this far north. No trace of a grave cut has been found in this or any other part of the fort, but it may have been removed by later truncation.

FINDS

Post-Roman robbing activity?

Robber trenches

Glass: bead (no. 35, H08:04)

Stone: disc (no. 38, K11:30)

Dating evidence

The robber trenches (H11:24, K09:30) produced just four sherds of pottery. One was a body sherd of calcite-gritted ware of the late third century or later (H11:24).

Roads associated with the principia

The street between the *principia* and *praetorium* was designated Alley 7 by Daniels. The surfaces here were traced further southward as well, beyond the limits of the two buildings over the section of the *via quintana* to the south of the alley and the eastern half of the *principia*.

Interpretation of these levels was complicated because they were excavated in three distinct stages. The southern half of the alley and a strip of the *via quintana* lying directly beyond were completely exposed in 1979 when the adjacent ranges of the *praetorium* and the structures immediately to the south were excavated (see Chapter 9). The western half of the alley was re-examined along with parts of the *via quintana* to the south of the headquarters in 1980–81. Finally the northern third of the alley was fully exposed in 1983, when the corresponding parts of the *praetorium* were investigated. Inevitably there are some difficulties in matching up what was found in the different seasons. More importantly, however, it is clear that in none of these areas was the full sequence of road levels excavated. In the southern part of Alley 7 and the adjoining areas of the *via quintana*, in particular, only the later road surfaces appear to have been examined. No direct equation was made between the levels in the northern and southern halves of the alley so the two are considered separately although in both sections two main levels – an upper and lower – were recognised which may indeed be equivalent.

Alley 7 (north)

In the northern part of the alley two separate levels of road metalling were recorded in 1980–81 and 1983–84

(although the two levels were not distinguished in grid square L10 where both were identified with the context number L10:05). The pre-fort ground surface, a mid-grey clay-silt (L09:26), was exposed in a box section dug down to natural across the north end of the alley. However no record of the section through the road levels appears to have been made and there is no indication that the lowest road level exposed sat directly on top of L09:26.

Lower surface

The lower surface, which was exposed along the east side of the street in 1983–84, consisted of small and medium-sized, well-worn cobbles (L09:21, L10:05a). The relevant site plans (P334 and P414) suggest the cobbles became more sparsely distributed towards the south in this level than in the one above and it may therefore equate with the layer of mottled grey, silty clay (K10:34), which could be seen in patches on the west side of the alley, beneath upper road metalling K10:08. Alternatively the clay might represent the pre-fort ground surface exposed in places where all the road levels were absent or a makeup layer. This road level was treated as primary in the context database.

Upper surface

The remains of a subsequent street surface survived in the western half of the alley, overlying L09:21/L10:05a. This was composed of pebbles and small to medium-sized cobbles ranging from 30mm to 200mm in diameter and averaging c. 100mm (K10:08, L09:05, L10:05b). It partially overlay the side of the drain (K10:06, K09:09, L09:06, 22) which ran down the east side of the headquarters. At its western edge the road surface appeared to have been removed by a shallow cut forming a gutter channel (L09:04) next to the east wall of the headquarters. The gutter was filled with very dark grey soil. In the context database this road level's constituent contexts were variously assigned to Fort Phase 2 or 3.

Alley 7 (south) and the via quinta a

Lower surface

In the southern part of the alley the lowest level revealed was a worn cobble surface (K11:10) exposed in two areas where the overlying surface was not present. This covered the earlier drain (K11:09b) which emerged beneath the east doorway of the *principia* cross-hall. It may be equivalent to the surface of roughly laid cobbling (K12:27, K13:20) uncovered to the south of the alley and the south-east corner of the headquarters building in 1981. These cobbles were c. 50–150mm in diameter, with the majority falling in the lower end of that bracket (c. 50–100mm). It is not clear whether the water tank at the south-east corner was still in use when this surface was laid. K12:27 surrounded the tank, but the enclosing walls

of the latter (K12:26) were still evident in the surface of the metalling. Overlying the main backfill deposit (K12:29) was a second layer (K12:25) which may have been intended to provide an equivalent surface. This level was assigned to Fort Phase 2 in the context database and regarded as contemporary with Phase 3 of the *principia*.

Upper surface

The lower street metalling was covered by a further surface which extended over the southern half of the alley and the strip of the *via quintana* immediately beyond in K12 and K13 and was described, in 1979, as consisting of small, well-worn river cobbles, 30–120mm in diameter (K11:08, K12:06). This should be equivalent to the level re-exposed during 1980–81 in the same area (J12:25, J13:02, K12:23, K13:18), though the latter's description – a loose cobble/tumbled rubble mix in loose dark brown soil differs quite markedly from that provided in 1979. This completely covered the remains of water tank K12:26 and incorporated a spread of sizeable flagstones (K13:19), covering an area c. 2.70m (E-W) by 2.00m, at the southern edge of the exposed roadway. It is unclear whether the flagging represented a later patching of the road surface. These surfaces were attributed to Fort Phase 3 and treated as contemporary with Phase 4 of the *principia* according to the interpretation expressed in the context database.

The gutter channel

A gully or gutter channel (K11:09, K12:11, K12:22), c. 0.90m wide and 0.40m deep, was cut through these two road levels against the east wall of the headquarters. This was probably equivalent to

channel L09:04 in the northern part of the alley and was filled with dark grey loam not dissimilar to the modern overburden, plus a few cobbles and the occasional dressed facing stone. A southward continuation of this channel, alongside the east wall of water tank K12:26, was evident in the surface of cobbling K12:27 (as channel K12:30). However K12:30 was overlain by later surface K12:23 and must have gone out of use by that stage. This might imply that, rather than being cut down from the level of the upper road surface, the gully was first established at the same time as the lower surface was laid down, or cut through shortly afterward, at which stage it continued south along the east side of the water tank. Subsequently, when the upper road surface was laid, the channel was either left open by deliberately not laying the new cobbling right up to the *principia* east wall or alternatively was recut from the higher level, apart from the southward continuation next to the tank which was now redundant and was abandoned at this stage.

The final level

The uppermost level identified in 1979 comprised a densely packed layer of mixed cobble rubble, and brick or tile (K12:02 but also extending into grid square K13), which extended over an area of the *via quintana* up to 6.80m N–S by 3.70m E–W immediately to the west of the structures south of the *praetorium*. Despite its densely packed character the excavators were not certain that this level represented a deliberately laid surface rather than rubble debris and it was ultimately classed as unstratified.

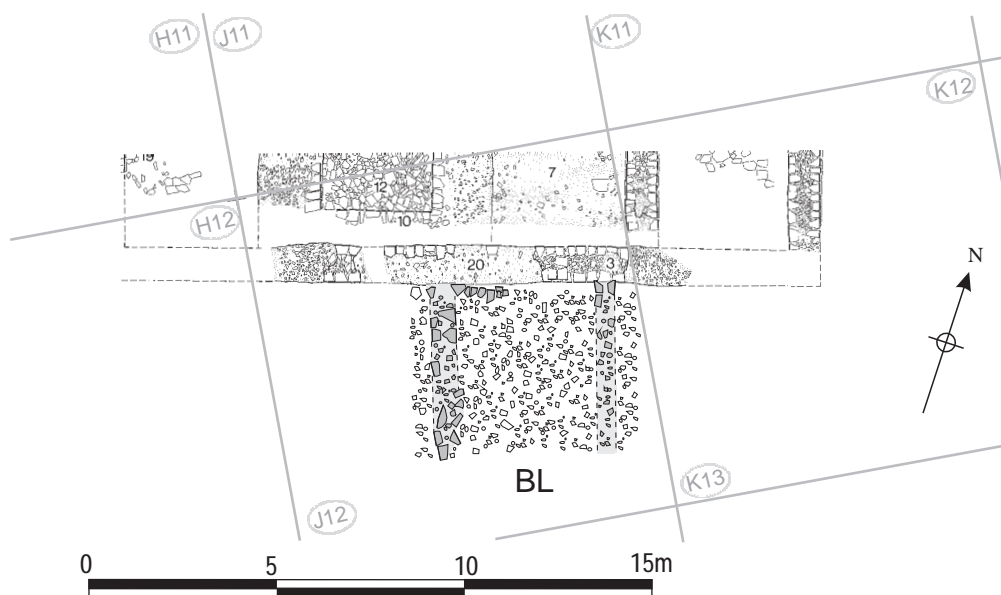

Fig. 8 Building BL south of Building 4 at 0

The via quintana and Building BL (Fig. 8.42)

The mixed rubble and cobble surface next to the south wall of the *principia*, did not display the same degree of wear as the cobbled surfaces in the alley, implying it saw less traffic, and was noticeably less built up. It was composed of medium-sized sandstone fragments and river cobbles, partially worn in places (J12:05), overlying a possible makeup layer composed of varyingly sized rubble set in orange-brown clay (J12:33).

The very fragmentary remains of two stone walls, both aligned north-south, some 3.70–3.80m apart, were shown sitting on top of 'road surface' J12:05 by site plan P255 (context numbers assigned

subsequently for convenience). Only a 0.70m length of the east wall (J12:38) was preserved, abutting the south face of the *principia*, but a 3.80m length, albeit very discontinuous, of the west wall (J12:39) was traced, and if it too had originally extended right up to the south wall of the headquarters, as seems likely, its original length must have been at least 4.75m. There is no evidence as to the function of this rectangular building (designated BL here to fit into the Daniels sequence), but it falls into the pattern of small stone ancillary buildings extending along north side of the *via quintana*, which is more readily apparent to the south of the *praetorium* (see Chapter 9).

9. THE *PRAETORIUM* (BUILDING 13)

Grid squares: L9, L10, L11, L12, M9, M10, M11, M12, N9, N10, N11, N12, P11, P12

Introduction

At the eastern end of the central range, next to the *principia* (14), was situated the largest single structure in the fort, which Daniels labelled Building 13. This took the form of a large courtyard building measuring 34.8m by 31.6m, and was immediately recognised as the commanding officer's house (*praetorium*) on the basis of its size and form. Daniels investigated the structure over the course of two separate seasons, several years apart. Excavation in 1979 concentrated on the southern half of the building and a series of adjacent structures on the north side of the *via quintana*. The north-west corner, including the main entrance, was uncovered during the final season of excavation in 1983–4. A substantial part of the building remained uninvestigated, including the north-east corner and much of the east wing and courtyard, areas which had largely been destroyed by the cellars of Simpson's Hotel. Indeed the two areas which were excavated were not actually linked up, with a 5.0–6.0m wide strip of the west range remaining unexplored. The survival of the remains varied markedly across the building. Effectively all that remained in the north-west corner were rubble foundations, which marked the line of the building's walls, and occasional fragments of primary flooring, but parts of the southern range displayed much better preservation with complex structural sequences evident, reflecting repeated alterations to hypocaust heating systems for example.

Initial post-excavation analysis was summarised in a series of inked phase plans and a draft text providing a grid-by-grid outline of the building's structural phasing (covering the 1979 excavation area only). The latter was divided into five main phases with

Phases 3 and 4 consisting of two and three sub-phases respectively. The summary text included a number of variant interpretations, attempting to resolve problems and inconsistencies which were apparent in the structural sequence initially presented. This scheme was subsequently reworked by Peter Moffat, resulting in a revised structural outline comprising four main phases, with Phase 3 being divided into six separate sub-phases. The new phasing was embodied in the database listing of Building 13 contexts and represented most clearly in a second set of inked phase plans, but no actual descriptive text was prepared before the initial post-excavation programme came to an end in 1989. It is evident, however, that it represents a far more coherent and satisfactory scheme which resolved many of the problems inherent in the initial scheme and essentially is that followed here.

In terms of the overall periodisation of the fort, Phases 1 and 2 of the building were considered to fall within Daniels' Fort Phase 1, which spanned the second century, with Phase 1 representing the initial Hadrianic structure whilst the Phase 2 modifications may be assigned to the Antonine period. Building Phase 3, with its six sub-phases, was thought to correspond with Fort Phase 2, beginning in the Severan era, c. 200, and encompassing most of the third century, whilst Phase 4 was believed to equate to Fort Phase 3, beginning during the Tetrarchy at the end of that century. However, the composition of the dateable material recovered from the building, and in particular the extreme paucity of late third- and fourth-century pottery, even in Phase 4 contexts, would imply that Moffat's four phases probably did not extend as late as he presumed. This need not mean that the *praetorium* was abandoned by the late third century, merely that here, as elsewhere, the later Roman levels had been destroyed by medieval and later ploughing and colliery era activity. Thus,

in terms of the periodisation adopted by the 1997–8 excavators, and with the exception of one or two isolated, possibly late features, Phases 1–4 of Building 13 may be judged to roughly correspond with Periods 1–4.

The rooms of the primary building are numbered in anti-clockwise direction proceeding from Room 1, on the west side of the main entrance, round to Room 9 in the southern half of the east range.

Phase 1 (Fig. 9.01)

In its primary phase the commanding officer's house was composed of a series of rooms arranged around an almost square courtyard and probably opening directly on to it. Corridors between the rooms and the courtyard were not considered by the excavators to be a feature of the house in this initial phase.

Courtyard and entrance

The dimensions of the courtyard were 17.70m north-south and 18.50m east-west. The main entrance was positioned in the centre of the north side of the building, opening onto the *via principalis*. The entrance passage was 6.10m long (the established width of the north range). Its width was restored by the excavators as 2.40m, although no trace of the east wall was found in the expected position, only what appeared to be a gravel surface (N10:13) comparable with primary level in the courtyard (M10:15, N10:11), so it is possible that the entrance was somewhat wider than anticipated and not perfectly centred along the north face of the building. The metallised surface only survived on the east side of the passageway. At the north end of the entrance it comprised a light yellow gravel (N09:13), associated with very fine, bright yellow-orange sand (N09:16). Further south it was recorded as a layer of orange and red gravel, including pebbles and cobbles, 0.10–0.30m in diameter, smoothed by wear (N10:13). Elsewhere only a very light yellow clay layer (N09:17) was present, perhaps a levelling deposit for the construction of the fort. The clay was cut by the foundations for the west wall of the entrance (M09:23, N09:18) and was probably overlain by the gravel surface (N09:13/16), although this was not explicitly stated.

The primary surface in the courtyard was variously described as being composed of 'loose rubble in dark brown silt' (M10:15), and light red and grey gravel incorporating smooth, worn stones, 0.30m in diameter, associated with traces of burning and fine black grey silt (N10:11). The site plan (P417) indicates the surface was predominantly brown-orange in colour with sandy patches. Despite any apparent dissimilarity in the above descriptions, the site plans clearly indicate that the two were regarded as equivalent contexts, belonging to the same layer of

metalling. A patch of very light yellow silt (M10:13), c. 1.50m in diameter, was also associated with this primary courtyard level. Running parallel with, and around 1m to the south of the northern edge of the courtyard was a stone-lined drain (M10:16, N10:09). The drain was traced for some 9m, as far as the eastern edge of the 1983–4 excavation area, and probably originally extended the full distance from one side of the courtyard to the other. Although it cut the primary courtyard surface the drain was assigned to Phase 1 by the excavators. Presumably the top of its side walls appeared flush with the courtyard surface implying they were broadly contemporary. A distinct black strip (M10:14), 0.30–0.55m wide, which extended southward from the east-west drain, was interpreted as the robbed-out remains of a second drain. This was in line with the west wall of the entrance passage and could not have extended further northward. Its phasing was uncertain. There was no indication that it interrupted the course of the east-west drain, but it did cut the primary courtyard surface (M10:15, M10:13) and was overlain by later courtyard levels (M10:02, 04), so its construction might belong to this phase.

In the southern part of the courtyard the earlier levels were only investigated by means of small sondages or by examining areas such as the south-west corner, where the upper levels had not survived so completely. This inevitably resulted in an imperfect understanding of the development of the courtyard. It is not clear that the sondages were all taken down to the same level which makes the interpretation of the results more problematic. Nevertheless a reasonable sequence can be proposed.

On the west side of the courtyard the lowest level was a grey sandy silt loam (L11:50) observed in a small pocket next to the courtyard wall (L11:34). This was overlain by a layer of mixed grey silt containing charcoal and small fragments of grey-white mortar (L11:47). Two small sondages were also excavated beside the west wall of the large cistern, which was constructed in the south-east corner of the courtyard in Phase 2 or 3. The fullest sequence was revealed next to the north-west corner of the cistern. Here the lowest level recorded was layer of large angular sandstone rubble (N11:39). The excavators noted that this did not really look like a surface, being less flat and even than later stone layers, and it was interpreted as a makeup layer instead. It was said to overlie the original ground surface, although the latter was not actually described or assigned a context number and it is uncertain to what if any degree that underlying level was ever properly exposed. The rubble was overlain by a layer of smallish sandstone cobbles (N11:38), averaging 0.10m in diameter, set in a very sandy matrix. The surface of the cobbles was slightly worn and was covered by grey sandy silt.

Some 1.50m further south, near to the south-west corner of the cistern, a second sondage revealed a 0.55m

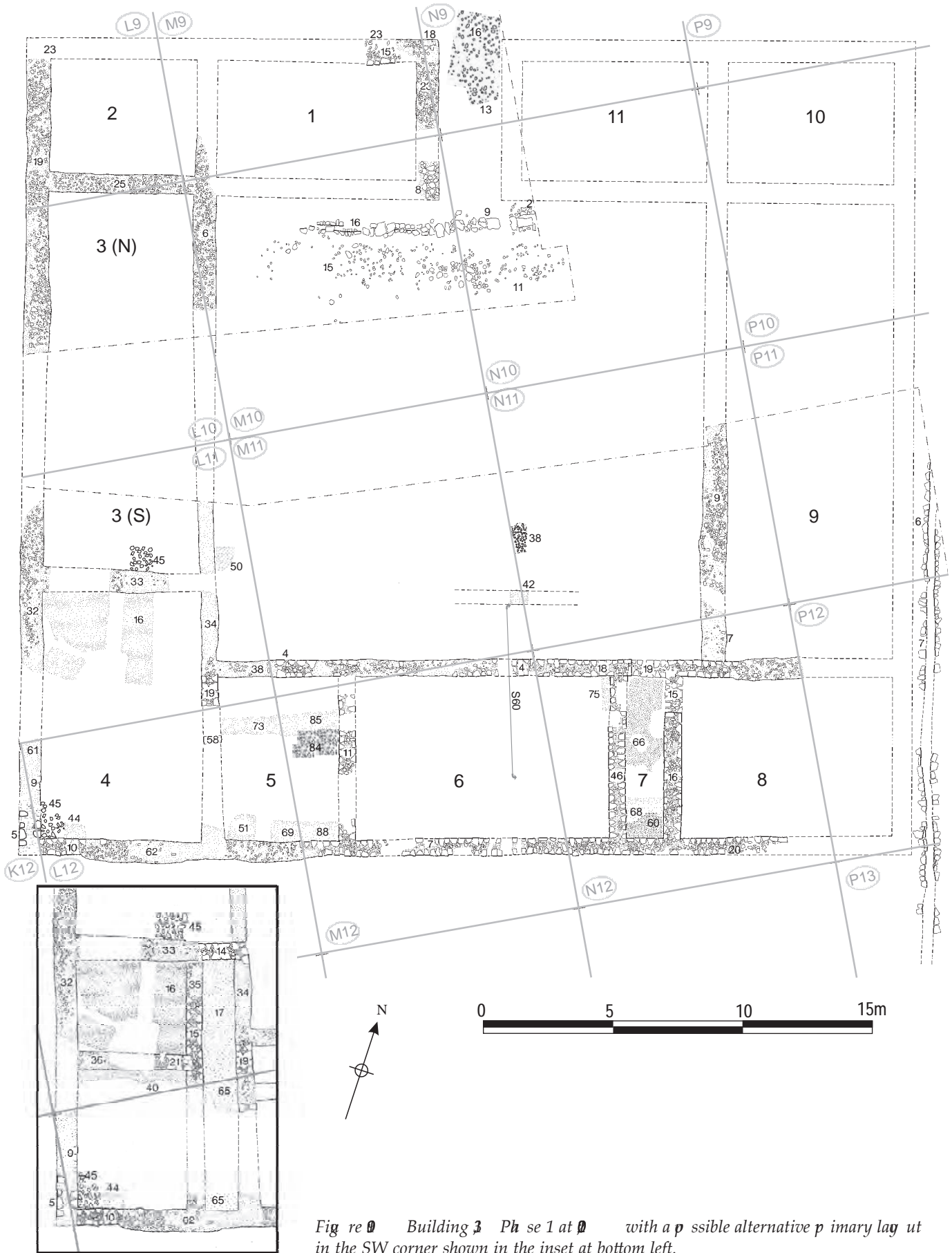

Fig re 10 Building 3 Phase 1 at 10 with a possible alternative primary layout in the SW corner shown in the inset at bottom left.

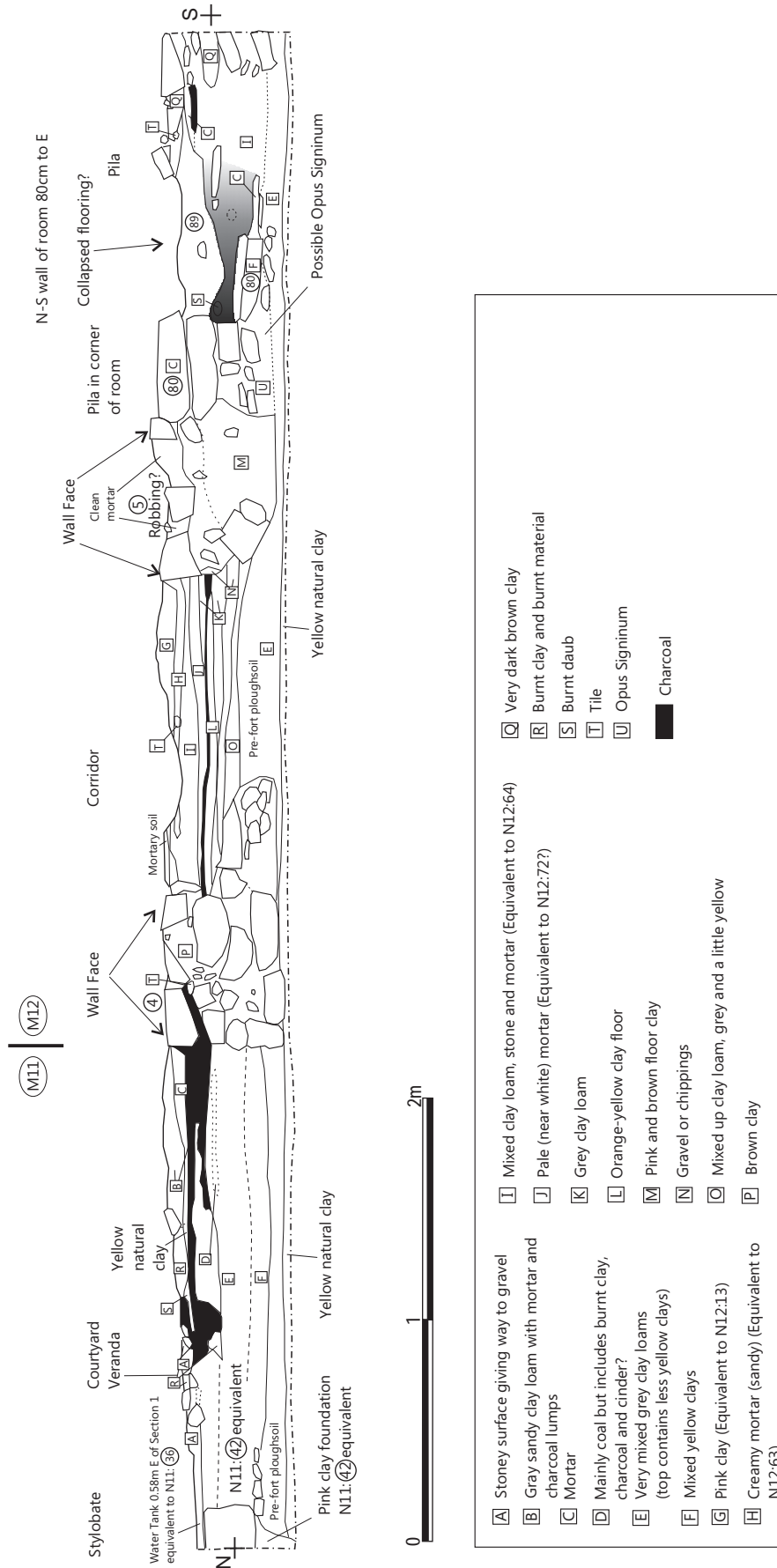

Figure 9.02: N-S section across the south range in M11 and M12, recorded along the east side of modern drain cut M11:02/M12:02. Scale 1:30.

wide strip of angular rubble and pink clay (N11:42). This apparently ran on an east-west alignment and was interpreted as the foundation of a stylobate which would have supported a colonnaded portico. It was overlain by dirty grey clay-loam (N11:41). The context records, site plans and sketch plans do not record any surviving remains of the stylobate itself, which was presumably largely removed during later remodelling, but a large, apparently squared, stone block, 0.22m high and in excess of 0.27m wide, is shown in the corresponding position, overlying the foundation deposit at the northern edge of section S60 (see Fig 9.02). A line of small stones extending southward from the base of the large block, and overlying the layer identified as pre-fort ploughsoil ('OGS' – original ground surface), might represent the surface portico walkway. No trace of an equivalent stylobate or colonnade was identified on the other sides of the courtyard.

The north rang

In the north-west quarter of the building for the most part only the rubble foundations of walls were preserved and these generally ranged between 0.85m and 1.00m in width for the main external walls, although internal partition walls such as that between Rooms 2 and 3 (L09:25, L10:07) were as little as 0.70m wide in places. As regards actual standing masonry, only one short stretch of the inner face of the north wall (M09:15) survived, comprising no more than four stones. Initial observation suggested these facing stones were slightly out of line with the foundations of the north wall, raising the possibility that they might reflect the rebuilding of this wall. However, given the very fragmentary condition of the north wall's surviving remains, it is by no means clear that the short stretch of facing was actually out of line.

There was evidence for one room (1) on the west side of the entrance and another in the north-west corner (2). Room 1 measured internally c. 7.60m from east to west by 4.50m, north-south. Most of its area had been removed by one of the cellars in Simpson's Hotel and other modern intrusions, leaving only the northeast corner and stretches of its east wall foundations. The internal dimensions of Room 2, which occupied the north-west angle of the building, were 5.60m by 4.30–4.40m. Excavation in the room's interior revealed a mid-grey clay-silt (L09:26) which was interpreted as the pre-construction ground surface with some surviving floor deposits.

The west rang

The west wall of the building was preserved only in the form of its orange clay and angular rubble foundations (L09:19, L10:02, L11:32, L12:61) with the exception of a 2.70m length of masonry (K12:05,

L12:09) at the wall's southern end, which had escaped robbing. This stretch of masonry was 0.55–0.65m wide and was constructed of fine-grained sandstone facing blocks, olive-yellow in colour, like the masonry of the adjoining length of the south wall (L12:10). Some rubble core survived in places, although the mortar bonding material had entirely decayed. There were, however, certain indications, noted in the context records, that it had been rebuilt during Phase 3 (perhaps 3vi). The wall's foundations were 0.80–1.05m wide. The east wall of the range was marked by similarly poor preservation. This continued the line of the partition wall (M09:31) between Rooms 1 and 2 southward, forming the courtyard frontage of Rooms 3 and 4 (M10:20, L10:08, L11:34), with only the clay and rubble foundations surviving again.

Room 3

As restored by the excavators, Room 3 occupied almost all of that part of the west range which lay on the west side of the courtyard. Its south wall was represented by the line of its foundations consisting of orange-pink clay and rubble packed in a 0.65–1.00m wide trench (L11:33). A 1.25m surviving length of masonry wall (L11:14) over this foundation was evidently considered by the excavators to represent a Phase 2 rebuild. The reasoning behind this was not made explicit in the excavation archive. However, it could be related to the recorded differences in the stone and mortar used in the masonry. Coarse grained sandstone blocks, with a very orange colouration derived from the mortar bonding, were used in L11:14, whereas the primary east and west walls of the range were composed of fine-grained sandstone, olive yellow or yellow-green in colour with mortar which was off-white when dry and yellowish when wet. On the other hand the masonry composition of other walls supposedly belonging to Phase 2 (e.g. L11:15, 21) was similar to that of the primary walls so it is not altogether clear how useful this distinction might be.

On the basis of the layout suggested above, the room's external dimensions were 7.50m by 16.00m. Internally it was 5.55m wide at its north end and 6.00m wide at its south end, and would have been 14.20–14.40m in length from north to south. It is, however, quite feasible that another partition wall, dividing this part of the range into two separate rooms, could have been remained undiscovered in 5.00–6.00m wide central strip which was not investigated in 1979 or 1983–4. Excavation at the northern end of the room exposed a layer described as dark grey-brown soil (L10:03), interpreted as the pre-construction ground surface with some surviving floor deposits, like that found in Room 2. At the southern end of the room a surface of largish sandstone cobbles and flags (L11:45), up to 0.30m across, was exposed in one small pocket next to the south wall (L11:33).

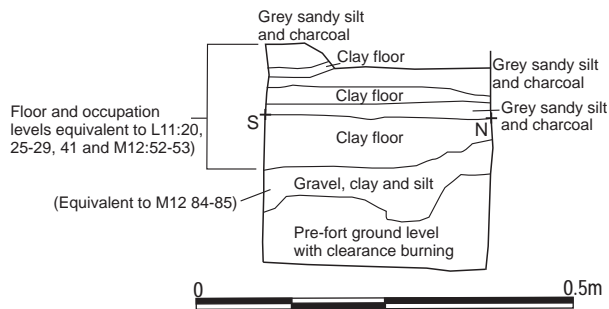

Figure 9.03: Section S58 on the west side of colliery era posthole (M12:30) in the south corridor, at 1:20.

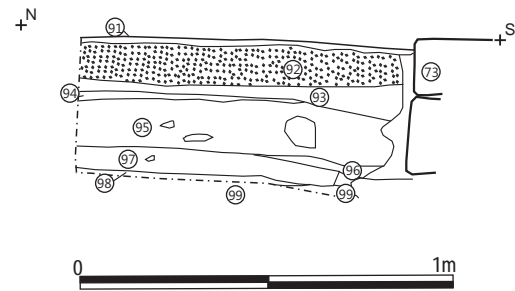

Figure 9.04: West facing section (S62) of a sondage through the floor levels in the south corridor in M12, at 1:20.

Room 4

With internal dimensions of 9.50m from north to south and 6.10m wide from east to west, Room 4 occupied the entire south-west corner of the building and also extended sufficiently far along the west range to face directly onto the southern end of the courtyard. The main doorway, providing access to the room, was presumably located here, although no remains of a threshold survived. It was separated from Room 5 to east by a 0.65m wide partition wall (L11:19, L12:58), which formed a continuation of the east wall of the range. As was typical of the building's primary walls, this was constructed of fine-grained sandstone facing stones, keyed into a rubble core bonded with gritty, off-white mortar and set on foundations of orange-pink clay and sandstone rubble (L11:34, L12:62). In the interior, a surface of brown-grey, silty clay loam with flecks of stone and charcoal (L11:16) was present across the northern part of room. In a small pocket next to the south wall, a yellow sandy clay floor (L12:44) was exposed, over a makeup layer of small sandstone pieces, up to 0.12m across, including small fragments of micaceous slabs and a little off-white mortar in a dark grey soil matrix (L12:45).

The south rang

The structures of the south range were the best-preserved in the building, with a higher proportion of the walling here having escaped robbing. Substantial lengths of masonry belonging to the north and south walls of the range survived along with corresponding masonry associated with the internal partition walls separating its constituent rooms. These walls were constructed of medium-sized, fine-grained sandstone facing stones, which were keyed into a rubble core bonded with gritty, off-white mortar and set on foundations of orange-pink clay and sandstone rubble. The north wall (M11:04, M12:04, N12:18; foundations: L11:38), forming the courtyard frontage, was 0.60–0.68m wide. Its line was continued eastward by the partition wall separating the south-east corner room (8) from Room 9 in the east range only marked by rubble foundations (N12:30) at this point. The

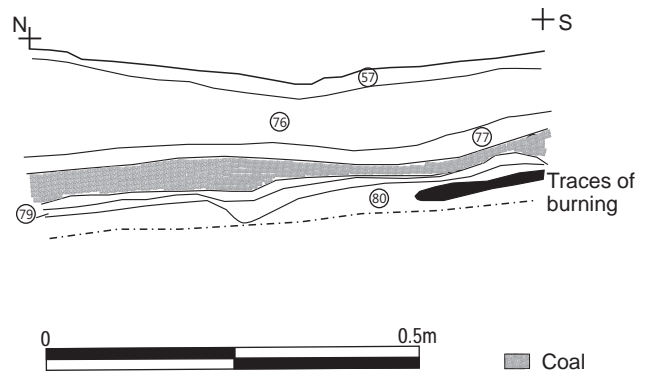

Figure 9.05: Section S59 through unexcavated layers of Room 6 seen in the east side of later intrusion N12:28, at 1:10.

recorded width of the south wall (L12:10, M12:07, N12:17, 20; foundation L12:62) ranged between 0.63m and 0.68m. The external width of the range was 7.40m and the internal width generally around 6.15m.

Room 5

Next to the large south-west corner chamber (4), was a smaller room (Room 5), measuring internally 4.60m from east to west by 6.25m from north to south. The wall (M11:10, M12:11) which separated it from Room 6 to the east was 0.68m wide and was bonded to both the north and south walls of the range in the normal fashion. Like the other rooms of the primary phase this occupied the full width of its respective range. Again little evidence remained regarding the room's initial function. A yellow sandy clay floor, with some overlying grey silt, was noted in pockets in the centre of the room (L12:73, M12:85), where it was observed at the bottom of a later robber trench (L12:11, M12:19), and alongside the south wall (L12:51, 69, M12:88). This was similar to the floor surface noted in the southern part of Room 4 (L12:44) and covered an orange-yellow gravel makeup deposit (L12:71, M12:84), composed of stones up to 0.05m across, which in turn directly overlaid a grey clay loam (L12:72) interpreted as the pre-fort ground surface. In the north-east corner of the room, advantage was taken of the deep cut made by a colliery era post hole (M12:30) to record a section

through the Roman levels on the west side of the pit (site drawing S58 – Fig 9.03 here). The pre-fort ground surface showed signs of clearance burning and also appeared to feature one and perhaps two narrow furrows, 0.12m wide at the top (0.05m at the bottom) and 0.09m apart. This was overlain and levelled by a layer of yellow-orange gravel clay and silt evidently equivalent to M12:84–85.

Room 6

Located in the centre of the south range, the largest room on this side of the building, Room 6, had internal dimensions of 9.70m by 6.15m. Its west wall was formed by M11:10/M12:11, whilst its eastern limit was represented by a similarly constructed wall (N12:46), 0.65m wide, which also extended the full width of the range and was likewise bonded to the north and south walls. There was evidence for an entrance into the room at the northern end of this wall where several, apparently primary, levels present in the narrow passage to the east (N12:66, 70–71) extended across the remains of the wall's footings (see below – Room 7).

Two small sondages through the full sequence of floor levels in the northern part of the room revealed the composition of the room's earliest surfaces. One 0.70m square trial trench was excavated roughly mid-way along the length of the room, towards its north edge, in the area of the Phase 2 corridor (see section S62 – Fig 9.04 here). The lowest level revealed here was a mixed yellow sand-clay floor (M12:99). This was overlain by a thin mortar level (M12:98) – thickest at its southern end where it reached 25mm, decreasing to as little as 10mm elsewhere – which perhaps represented another floor surface. A further deposit, up to c. 55mm deep, composed of dark grey silt and charcoal in equal measure (M12:97) covered the floor levels and might represent occupation debris. In the north-east corner of the room, a series of floor levels and occupation deposits were uncovered up against the east wall (N12:46). The lowest floor was composed of a mixture of stone and sandy clay (N12:75), which was overlaid by dark grey silty clay loam flecked with charcoal (N12:74), probably representing occupation silt/debris. This in turn was covered by a hard mortar floor surface (N12:72), pinkish-white in colour, changing to buff/white lower down where its composition was more mixed and included some stone. This surface was level with the top of the lowest course of the east wall and was overlain by a thin layer of charcoal and silt occupation debris (N12:73).

Further south, advantage was taken of a later intrusion (N12:28) in the eastern part of the room to record the full sequence of early layers (the west-facing section recorded as S59 – Fig 9.05 here). The pre-fort ground surface (N12:80) was drawn but not described, though it evidently displayed patches of burning, presumably reflecting clearance of vegetation. Directly overlying this was a thin layer of yellow/

grey clay loam (N12:79), tentatively interpreted as a floor, then a 'coaly layer' (N12:78), 20–60mm thick, presumably associated with early activity in the room. Above the coaly material was a mixed yellow-pink clay (N12:77), again perhaps a floor, overlain in turn by a 60–130mm thick level of grey clay loam (N12:76), and finally a spread of orange gravel (N12:57), which was interpreted as a surface or, perhaps more plausibly, a makeup level like that uncovered in Room 5. At only 20mm, this orange gravel was a relatively thin deposit, like the two possible clay floors (N12:79, N12:77 – 10–20mm and 20–30mm respectively). It was the first layer in the sequence to be exposed over a significant area, extending for 1.50m right up to the east wall, where its width was in excess of 2.20m. The gravel was overlain to the south by a surface of pink clay (N12:56), c. 20mm thick, which extended into the south-east corner of the room where site plan P203 suggests it was associated with small patches of mortar. As with the underlying gravel layer the western extent of this surface could not be gauged as it was cut by later features. A spread of charcoal and coal intermixed with a little grey silt (N12:54), which was present in patches over both the gravel and clay might represent an occupation deposit. The gravel (?) makeup, pink clay floor and charcoal/coal debris were associated with Phase 1 by the excavators, however the apparent existence of two possible underlying clay surfaces revealed by the N12:27 section might suggest that N12:54, 56 and 57 should be allocated to the subsequent phase, instead.

Room 7

Separating Room 6 from Room 8, in the south-east corner of the building, was a narrow space, no more than 1.45m wide which ran the full width of the range. A doorway (N12:19) through the north wall (N12:18) provided access to this room from the courtyard. No equivalent jamb existed on the east side, but the position of the west wall (N12:16) showed the doorway could have been up to 1.30m wide, though it is perhaps more likely to have been slightly narrower. The west wall was 0.65m wide and of standard construction with fine-grained sandstone facing stones keyed into a mortar-bonded rubble core. It is possible that the room functioned as a passage with an equivalent entrance at the southern end of the corridor, which would have provided access to the *praetorium* from south side, or rear, of the building. There was no clear trace of a threshold at the relevant point in the south wall (N12:17), with only a single course remaining at the relevant point, but the other doorways into this room were represented by single courses of ordinary walling, flanked by squared off jambs, rather than obvious threshold slabs. Two courses survived to the west, which would be consistent with such an interpretation, but the second course came to a ragged end rather than a distinct

jamb. Even if this room did function as a passageway at certain stages it cannot have done so for the entirety of its life. During the later stages of Phase 3 (Perhaps Sub-Phase 3iv) a rectangular stone platform (N12:45) was set against the external face of the south wall at the end of the passageway, which would have blocked access. It remains the most plausible interpretation of the room's function, however. Suggestions in the context records that the room might represent a firing area for hypocausts in one or both of the neighbouring rooms are unconvincing as there was no evidence for flues through either side wall.

A doorway (N12:15) into Room 8 was apparent at north end of the east wall (N12:16). This was perhaps 1.35m wide and comprised a single course of the wall constructed in the typical manner – that is to say it was not furnished with slabs spanning the full width of the threshold – but its position was clearly indicated by a straight jamb at the south side of the doorway, where two courses of the wall survived. As noted above, there was probably a corresponding doorway at the north end of the west wall (N12:46), providing access to Room 6 on that side of the corridor. The wall footings did not survive as a single complete course at this point, the west face being better preserved than the east, but various, apparently primary, levels present at the north end of Room 7 (N12:66, 70–71) extended across these footings. This might imply that the doorway was not part of the original layout and was knocked through at a subsequent, but, evidently, still very early, stage in the building's history, before the construction of the corridor along the north side of the range. Thus, the earliest level exposed at the north end of the passage, a sandy yellow-brown or grey loam (N12:71) interpreted as a possible surface, extended into the remains of the footing course of N12:46, but not beyond, into Room 6. Similarly the overlying layer of collapsed daub, mortar or plaster (N12:70), which varied between 20mm and 100mm in thickness, stretched right across the wall as did the substantial silty coal spread (N12:66), some 30mm thick, which also extended southward more than halfway along the passage, where it was the lowest layer exposed. Neither of these levels extended beyond the western face of wall N12:46 into Room 6, although the coal spread might be broadly equivalent to the thin layer of charcoal and silt (N12:73) encountered in the north-east corner of that room. However the overlying layer of mixed grey silt and dirty white mortar (N12:64, 67) clearly extended right into the north-east corner of Room 6. This material, which reached mid-way up the lowest course of the adjacent walls, was interpreted as debris or makeup. With the underlying coal layer it was clearly cut by the clay-packed angular rubble foundations (N12:62) for the corridor wall which was inserted along the north side of the range in Phase 2.

At the southern end of the passage the lowest layer exposed was a pink-grey clay loam incorporating

brown-orange sandy material (N12:68). This abutted the bottom of the adjacent wall courses and was therefore presumed to lie on top of the pre-fort ground surface, although the latter was not actually observed in this area. The clay loam filled the full width of the passage and extended at least 1.20m northward along the space, as far as the later 'drain' N12:58. Level N12:68 was in turn overlain by a thick clean surface of yellowish mortar (N12:60) and then a pink clay floor (N12:59) which did not extend as far as the south wall. To the north all these levels were probably cut by a curious 'drain' or soakaway feature (N12:58), belonging to Phase 3i, which extended across the width of the passage, although this relationship was not made explicit in the context records.

Room 8

No information was recovered during the 1979 excavations regarding the primary levels in the south-east corner of the building, which was occupied by Room 8. Practically all the levels along the eastern end of the room had in any case been destroyed. More substantial archaeological deposits, comparable with those in the other rooms of the south range, evidently did survive on the western side of the room, but the late levels exposed on initial excavation here were not removed to enable investigation of the primary deposits. The internal width of the room from north to south was 6.15m, but the near total destruction of the building's east wall meant that the room's length from east to west could only be approximately estimated at c. 8.00m. Access to the room was via the doorway (N12:15) at north end of the west wall (N12:16), which led into the adjacent passageway and thence into the courtyard.

The east rang

By contrast with the south side of the building, the east range was very poorly preserved, with only the most deeply cut features surviving – that is to say essentially certain drain channels. Virtually all trace of the building's east wall had been removed, leaving only a linear spread of rubble (P12:16) – presumably disturbed foundation material – and one short trench (P11:10), measuring 1.40m by 0.35m, interpreted as a remnant of the foundation trench, though it might equally represent a robbing cut which had gone a little deeper than elsewhere. The wall's position can, however, be gauged by reference to the stone-lined drain (P11:06, P12:07) which ran alongside the wall, on the western margin of the *intervallum* road (P11:11, P12:13). The foundations of the west wall of the range did survive, however, taking the form of a line of closely distributed sandstone rubble (N11:13) overlain by pink plastic clay (N11:09, 17–18, N12:07), in places set in a distinct trench varying between 0.90m and 1.15m in width.



Figure 9.06: Building 13, Phase 2 at 1:200.

If the entire area on the east side of the courtyard was taken up by a single room (9), as was considered to have been the case on the west side, the internal dimensions of Room 9 can be estimated at 17.40m × 6.40m, based on the limited data available. However the arrangements here might quite conceivably have

been more complex. Most internal features had been destroyed by the very extensive post-Roman disturbance, which had effectively stripped away virtually all the floor levels right down to a clean, orangy plastic clay (N11:06, P11:09), that represented either the underlying natural subsoil or perhaps a

levelling deposit of imported natural clay associated with the initial construction of the fort. The only possible floor or makeup level was recorded on site plan P176, where a deposit marked in yellow and labelled 'as N11:34' is shown extending along the west side of the room and presumably represented a spread of orange gravel similar to that used to surface the courtyard in Phase 3.

The *inte vallum drain*

The stone-lined conduit (P11:06, P12:07), located beside the east wall of the *praetorium*, was traced for 17.70m, continuing on, beyond the southern line of the building, across the *via quintana*. This was presumably the same drain that was uncovered further south alongside the eastern end of Barrack 11 and further north beside the east walls of Buildings 1 and 3, evidently constituting one of the major storm drain conduits of the early fort. It was constructed of two lines of sandstone facing blocks. These side walls were estimated to have originally had three courses giving the channel a depth of c. 0.40m, but in general only two courses survived with recorded depth of 0.32m. The overall width of the drain, including both sidewalls, was 0.65–0.75m, with the width of the channel itself varying between 0.20m and 0.35. No capstones remained *in situ*.

Two distinct fill deposits appear to have been recognised, namely an olive green or grey-black silty clay loam with charcoal flecks and rubble chips (P11:07, P12:08/2), and a pink- or orangey-brown silty clay with charcoal and mortar flecks (P11:07, P12:08/1). These are likely to reflect the drain's full lifespan and might even encompass deliberate backfilling after the drain went out of use.

The east *intervallum* road (Road 7)

The primary surface of the *intervallum* road (P11:11, P12:13) was exposed on the east side of the storm drain and was seen to be composed of cobbles averaging 0.09m across, set in an ironstone sandy matrix. This metalling was shown to have been c. 3.60m wide when a trench was excavated extending eastward, from the north-east corner of the main 1979 excavation site right across the *intervallum* area and defences.

FINDS

West range Room 3 surface

Quern: beehive (no. 7, L11:45)

Clay floor in Room 4

Coin: Caracalla, 208 (no. 125, L12:44)

Fill of intervallum drain

Samian stamp: 150–80 (no. S12, P12:08)

Decorated samian: 115–45? (no. D132, P12:08)



Figure 9.07: The west half of the courtyard cistern emptied out.



Figure 9.08: South wall of the courtyard cistern (N11:11).

Coin: Trajan 103–17 (no. 56, P12:08)

Copper alloy: clip (no. 295, P12:08)

Dating evidence

Walls

The west wall of Room 8 (N12:16) produced a single sherd of a Hadrianic Form 18/31R from La Madeline. A slightly worn coin of Caracalla dated 208 (cat. no. 125) came from the clay floor in Room 4 (L12:44).

Drain fill (P12:08)

This produced a sizeable assemblage, mainly third century in date, but including a fourth-century Huntcliff-type rim. The presence of such third- and fourth-century pottery in the *intervallum* drain fill simply reflects the continued use of the drain in later periods.

Phase 2 (Fig. 9.06)

The second phase of the *praetorium* was distinguished principally by the addition of corridors along the

length of the south, west and probably north-west ranges. The east and north-east wings may have been treated similarly but no information survived there. The other major innovation was the construction of a large stone-walled cistern set into the south-east corner of the courtyard.

Clear evidence that the corridors were secondary features was present only in the case of the one running along the south range, the others being attributed to this phase purely by analogy with the southern corridor.

Courtyard and entrance

A new metalled surface (N09:12, N10:07) was laid in the entranceway. This was composed of stones ranging between 0.30m and 0.80m in diameter, set in light yellow gravel and smoothed by wear. It was overlain only by modern disturbance.

In the north-west corner of the courtyard, a small almost square structure, measuring 2.00m by 2.40m internally, was attached to the side of west range and protruded into the courtyard. The structure was represented by spreads of rubble which were interpreted by the excavators as the remains of stone foundations (M10:19). To the west, the edge of a distinct cut through the earlier gravel surface (M10:15) was shown on site plans P417 and P427, giving the foundations a width of 0.80–1.10m on this side, but no equivalent limit was marked on the south side where the rubble extended some 1.30–1.45m to the limit of the 1983–4 excavation area. To the north the rubble had largely been removed by the cellaring of Simpson's Hotel, but appeared to extend across the line of the earlier east west drain (M10:16, N10:09). If the position of its outer edge apparently varied or was indistinct, there was a clear inner limit to the rubble on all three sides, defining a rectangular area where only the primary gravel courtyard surface was present. Rather than interpreting the rubble as the foundations of a square stone building, it might conceivably represent a resurfacing of the west side of the courtyard which respected a small pre-existing lean-to structure, perhaps of timber construction, attached to the west range. Whatever its precise form the lack of any surviving internal levels over the primary gravel surface of the courtyard, means the function of the new structure remains unclear.

In the southern part of the courtyard a stone surface (L11:39, M11:14, N11:36) was encountered at various points, including the south-west corner, and the western edge of the yard (L11:39), and along the west side of the cistern (N11:36), where it overlaid both the earlier cobble surface (N11:38) and the clay-covered remains of the stylobate footing (N11:41, 42). The surface was constructed of largish, irregular sandstone pieces averaging 0.25m in length occasionally incorporating larger slabs up to 0.60m

long, again irregular in shape. Towards the south-west corner, the flagging (M11:14) incorporated a drain or gutter channel (M11:13), some 0.20–0.25m wide, which ran parallel with the courtyard's south wall. The southern lip of the drain was 1.70m from the south range and its sides were constructed of neatly faced blocks. Only a 0.90m length of the channel was exposed in the small sondage, although a further 0.65m, extending eastward, could be seen to have been robbed out, the fill comprising dark grey sandy silt and charcoal (M11:12). The drain and adjacent flagging were overlain by a deposit of pink clay and orange gravel (M11:11) which was also cut by the robbing. The western end of the channel was not exposed, but it was traced to a point only 1.10m from the west wall, so, if it then turned northward to run parallel with the west wall of the courtyard, for instance, it must have lain significantly closer to the west side of the courtyard than the south.

The cistern (Figs 9.07, 9.08)

A large rectangular cistern was constructed in the south-east corner of the courtyard either in this phase or conceivably early in the subsequent one. This was 5.30m long (4.50m internally) and was slightly wider at its west end than its east end, the respective dimensions being 3.95m (3.20m internally) and 3.70m (3.00m internally). The floor of the cistern was composed of large rectangular flagstones (N11:32), up to 1.10m in length, the edges of this floor being overlapped by the sidewalls. The bottom two courses of the side walls (N11:10–12, 23) were constructed of faced stone blocks, then a string course of flagstones, followed by another course of faced stones, then a further flagged string course, another two courses of facing stones and a final string course level giving the cistern a total depth of 0.83m from this point. Its resultant capacity was calculated at c. 12.62m³. Up to two further courses of stone blocks stood above this level, but these had not survived completely. These side walls were bonded with mortar and could be seen to be faced on both sides, predominantly with small blocks averaging 0.10–0.20m in width. A very narrow fill of small rubble pieces was incorporated between the two faces giving the walls each a total width of c. 0.30–0.40m. Most of the upper courses of the west wall were missing, with only a short stretch of the outer face surviving there and at the western end of the north wall. The courses all appeared to dip down particularly towards the centre of the cistern's north wall which had evidently bulged inward and subsided somewhat.

A layer of dark grey sandy silt (N11:31) was present in the bottom of the tank over the flagged floor. The silt incorporated a number of facing stones (N11:30) which mainly lay close to the sides of the cistern and had presumably collapsed from the side walls above, leading the excavators to suggest that

those walls may once have stood one or two courses higher than surviving. The later flagged surface (M11:07, N11:14), attributed to Phase 3v, which was laid in the courtyard immediately to the north of the cistern, certainly respected the line of the cistern wall (N11:12), even though the uppermost course of that wall dipped below the level of the adjacent flagging. It is possible that the cistern sidewalls were heightened during Phase 3 to match the level of the courtyard resurfacing.

A stone-lined overflow channel (N11:21), c. 0.25m wide and a minimum of 0.35m deep, led away from the east side of the cistern towards the south-east, continuing (as N12:22) through the south-east corner of the building (see below – The east range). The side walls (N11:05) lining the conduit were composed of sandstone blocks with up to two courses surviving. The outflow point for the conduit was located midway along the east wall of the cistern (N11:10). The site photographs show that the second course of the conduit sidewalls was level with the very top course of the cistern's east wall which was composed of sandstone facing blocks overlying a flagged course. The section of upper course where the outlet was located did not survive intact and it is quite feasible that there was an opening through it at that point, though none was evident in the underlying flagged course.

The cistern appears to extend across the projected line of the south perimeter drain/gutter (M11:13). It is not clear how these two structures related. The gutter may conceivably have belonged to a slightly earlier phase but could perhaps still have functioned after the cistern was constructed. There is no indication that the gutter channel fed into the cistern but the evidence may have been destroyed.

The north rang

A corridor separating Rooms 2 and 3 was created by constructing a wall across the southern part of Room 2 reducing the internal dimensions of that room to 2.60m × 5.60m. Only the 0.70m wide rubble foundations (L09:18) of the new partition wall survived. The internal width of the corridor was c. 100m. It may well have continued eastward, occupying what had formerly been the south part of Room 1, in which case it would have resembled the corridors in the west (probably) and south ranges (see below), but the remains of Room 1 – including any trace of the corridor – had been destroyed by cellaring and other modern intrusions. It is conceivable that there was a doorway at the west end, which would have opened onto the alley between the *praetorium* and the *principia* (Alley 7). However, as all trace of the west wall's superstructure, including any remains of a threshold, had been destroyed this could not be confirmed. The destruction of practically all the

wall masonry in this part of the building also meant that there is no concrete evidence – in the form of obvious structural relationships between different walls, for example – that the corridor was actually inserted during Phase 2, rather than being a feature of the primary layout. No significant distinction in the foundation deposits could be discerned.

Patches of flagged flooring were also uncovered in the north-east corner Room 1 (M09:17) and the northern part of Room 2 (L09:24). The flags varied in length from 0.20m to 0.75m. These were assigned to Phase 2 by the excavators, although, again, they could equally plausibly be interpreted as primary floor surfaces, with the underlying clay soil layers (L09:26, L10:03) perhaps forming makeup or bedding levels for the flagging.

The west rang

A north-south aligned corridor was also inserted along the inner side of the west range, marked by the construction of a partition wall (L11:13, L11:15). The corridor regulated movement between the courtyard and the two rooms in the range and continued across the width of the south range, perhaps terminating in a doorway through the building's south wall, although any trace of a threshold had been robbed away with the remainder of the wall's masonry at this point. The corridor was only recognised in the southern half of the range, during the 1979 excavations. The lack of any equivalent evidence in the northern part of Room 3, excavated in 1983, may simply reflect of the degree of post-Roman disturbance affecting this part of the building, which presumably also explains the absence of any floor surfaces that might have been associated with Phase 2 here. However the layout proposed by the excavators inferred that the corridor continued north to meet the east-west corridor aligned corridor in the north range where there was presumably a connecting doorway, although, again, no tangible evidence of such survived. As a result of the insertion of the corridor the internal width of Rooms 3 and 4 was reduced to c. 4.20m.

The excavators assumed that the full length of the corridor was inserted as a single action in Phase 2, however there are a number of irregularities in its construction which imply that the true picture may have been more complex. The corridor was apparently interrupted by the former south wall of Room 3 (L11:14). The footings of this Phase 1 wall remained *in situ* across the width of the corridor with different surfaces on either side (see below). It is uncertain whether wall L11:14 remained standing to its full height or perhaps now served as the threshold of a doorway between two sections of the corridor. If the latter was the case it is unclear why such a doorway was needed. What is apparent is the markedly different character of the corridor wall to

the north (L11:13) and south (L11:15) of wall L11:14. L11:15 was c. 0.60–0.65m wide and constructed of dressed stones facing a mortar-bonded rubble core, all set on clay packed rubble foundations (L11:35), like most walls of the *praetorium*, and still had layer of plaster, some 20mm thick, adhering to its east face. In contrast, L11:13 was much narrower (c. 0.44m) and consequently was just composed of mortar-bonded facing stones, with scarcely any rubble core. The foundations of L11:13 are described as ‘small angular sandstone rubble’ (L11:44), with no mention of clay packing. Equally significantly, its alignment was offset slightly to the west of that of L11:15.

The only level recorded in the corridor south of partition wall L11:14 was a layer of decayed plaster fragments in light grey clay loam (L11:17, L12:65). To the north of the wall, a sandy stony level with some silt (L11:49), was assigned to this phase, being the lowest level exposed in this area. The remainder of wall L11:14 was demolished down to its rubble and clay foundations (L11:33) and Room 3 extended 4.40m southward. A new floor was laid there, directly overlying the foundations of the room’s primary south wall (L11:33) and composed of river-washed cobbles and pebbles (L11:11a). These varied in length between 0.03m and 0.20m, but averaged c. 0.07m, and were closely packed to form a hard, even surface. Thus enlarged, the internal length of Room 3 could potentially have been as much as 18.70m, although it is quite possible that there was another cross wall in the 5.0–6.0m wide unexcavated strip in the centre of the range, which would have divided the latter into more manageable rooms. A newly constructed wall (L11:21), which was bonded with corridor wall L11:15, formed the new division between Rooms 3 and 4. The new wall was mortar-bonded and set on clay-packed rubble foundations (L11:36) in the usual manner. The southward extension of 3 reduced the internal length of Room 4, from north to south, to c. 5.30m. A surface (L11:40) of dark grey silt incorporating off-white mortar/plaster lumps and overlying a level of small dirty yellow sandstone fragments was recognised along northern edge of the room. This was not exposed in the adjacent corridor or in Room 3 and was therefore presumed to represent the Phase 2 floor.

The south rang

The corridor

A similar corridor was created in the south range by constructing a new wall (M12:05, N12:14), c. 1.35m to the south of the range’s pre-existing north wall. The new wall, which survived up to two courses high, extended from a junction with the west corridor right through to the east side of the building, and provided the clearest evidence that it was a secondary insertion where it overlay the remains of the west wall of north-south passageway (Room 7 – see below). It varied

in width between c. 0.60m and as much as 0.75m, further east, and was similarly constructed to the primary walls of the building, with medium-sized facing stones of fine-grained sandstone keyed into a rubble core and bonded with off-white, gritty mortar, but it lacked foundations. The westernmost 4.40m of the wall had been removed by later robbing (L12:11, M12:19), as far as the possible east jamb of a doorway connecting the corridor with Room 5. Access to and from the courtyard was maintained via the primary doorway (N12:19) at the south-east corner, and there may have been other entrances further west which provided access into different sections of the corridor, but no evidence survived.

A patchy surface (L11:41, but actually in grid squares M11 and M12), composed of small, worn pebbles averaging c. 30mm in length, was exposed towards the west end of the corridor. This was covered by a layer of grey ash, silt and charcoal, c. 20mm thick, representing occupation debris. Both these layers respected the west face of primary wall M12:11 (the original partition wall between Rooms 5 and 6) where the latter extended across the line of the corridor. It is conceivable, therefore that the corridor was divided into sections, perhaps with connecting doorways on the site of earlier walls M12:11 and threshold N12:15. Further to the east, the 0.70m square sondage excavated against the south wall of the corridor revealed a grey sandy silt (M12:96) overlying the primary floor surfaces and occupation deposits of Room 6 (recorded in section S62). This was interpreted as the Phase 2 level here, although the description seems more characteristic of an occupation level than a new floor surface which might have accompanied the construction of the corridor.

Room 5

The internal dimensions of Room 5 were reduced to 4.50m, east-west, × 4.20m, north-south, by the creation of the corridor. A small pocket of a possible floor makeup level survived in the north-west corner of this room, in the form of a layer of off-white mortar, stone and grey-brown sandy loam (L12:57).

Rooms 6W and 6E

Room 6 was subdivided into two unevenly sized rooms by a stone partition wall (M12:73). This wall was demolished in the subsequent phase, leaving only stubs surviving at either end, in the form of two facing stones bonded to the south wall of the building and one block projecting from the south face of the corridor wall. This showed the wall was 0.65m wide, bonded with off-white gritty mortar and set on clay packed foundations. The site plans (e.g. P175 and P206) suggest that corridor wall may actually have butted up against the east face of the partition (there was a doorway on the west side) implying that the latter was structurally earlier than the corridor wall.

However the evidence is not conclusive and in any case the small sondage dug against the north face of the wall showed that the partition wall definitely did not continue onward to reach the north wall of the range, unlike the primary partition walls, indicating that this structure was essentially contemporary with the Phase 2 corridor rather than belonging to Phase 1.

The western room (6W) was much the smaller of the two and was narrower from east to west than north to south, measuring only 2.40m × 4.25m internally. No floor surface associated with this phase was identified but evidence for a possible entrance from the corridor was identified in the room's north-east corner, the width of the doorway being estimated at roughly 0.75m. The other room (6E) measured 4.15m north-south by 6.60m east-west and comprised the central and eastern parts of the original Room 6. A patch of flagging (M12:88a) was exposed between *pilae* of the later hypocaust (M12:80 N/O/P) in the south-west corner of the room. The flagstones ran up to the bottom course of the south wall and were interpreted as part of a floor associated with this phase. Along the north side of the room traces of plaster covered the face of wall N12:14.

In the south-east corner of the room, as was noted previously, the gravel makeup or surface (N12:57), overlying pink clay floor (N12:56) and charcoal and coal debris (N12:54), which were discussed in relation to Phase 1 and allocated to that phase in the overall context database listing, may instead have been laid down in Phase 2 or at any rate continued in use into this phase as the context listing implies. Indeed the phase plans appear to associate the charcoal/coal debris N12:54 with the possible hypocaust channels of Phases 3i-ii (N12:50). A thin strip of mixed grey clay loam (N12:51), with charcoal and orange and white clay flecking, noted in plan (site plan P200), was thought to represent the remnant of a more extensive surface cut by the later hypocaust walls of Phase 3i-ii, and might therefore have also belonged to this phase. The grey clay was considered by the excavators to have been cut by a band of pink clay (N12:53) which was thought to represent the foundation packing for a much later (Phase 3v) north-south wall (M12:06, N12:21). However comparison of site plans P200 and P203 suggests that the grey clay may actually have overlain the pink, implying that N12:53 might simply have formed part of the same floor level as pink clay N12:56.

The north-south passage (Room 7)

The wall on the south side of the corridor (N12:14) extended 0.35m beyond the west side of the passageway creating a 1.10m wide doorway connecting the two. The clay-packed angular rubble foundations (N12:62) of the corridor wall actually extended right across this doorway cutting through the earlier floor levels and occupation debris. North of the doorway, overlapping

the northern edge of foundations N12:62, a surface of clean, very fine, yellowish mortar (N12:63) was present over the corridor. In the southern part of the passage, the pink clay floor (N12:59) noted under Phase 1 may actually have belonged to Phase 2 instead, or at any rate continued in use in this phase. It was assigned, with a question mark, to Phase 2 in the context database, but was shown on the Phase 1 plan.

Rooms 8W and 8E

In the south-east corner of the building, the corridor continued as far as the east wall and the remainder of Room 8, like Room 6, was divided in two by the construction of a new north-south aligned partition wall, of which only the 1.00m wide sandstone rubble foundations (N12:29) survived. The corridor wall, too, was represented only by the rubble foundations (N12:36), with air pockets visible amongst the sandstone and some clay packing remaining towards the west. The western of the two rooms (8W) thus created was almost square, measuring internally c. 4.25m from east to west by 4.15m north-south, whilst the eastern room (8E) was smaller, its internal dimensions being estimated at c. 3.00m east-west by c. 4.10m north-south. The entrance into the western room, from the corridor, lay in the north-west corner of that room, where the foundations of the corridor wall stopped c.1.20m short of the west wall (N12:16). There was no evidence regarding the position of the doorway into Room 8E and no floor surfaces or deposits attributable to this phase were uncovered in this part of the corridor or in either of the two rooms.

The east rang

No trace of a corridor remained along the inner side of the east range, similar to those in the other ranges of the building, although, given the degree of devastation caused by later disturbance in this area, this does not represent conclusive proof that none was ever constructed. The drain channel or conduit (N11:05, 21, N12:22), which led from the cistern in the south-east corner of the courtyard and perhaps represented an overflow channel for that tank, ran diagonally across the south-west corner of Room 9, cutting through foundations of the west wall of the range (N11:09, 13, 17, 18, N12:07), then though the room's south wall (N12:30). This channel was c. 0.25m wide and a minimum of 0.35m deep, with up to two courses of the side walls remaining, and was filled with deposit of silt (N11:21, N12:23). Immediately before it cut through the south wall of Room 9, the drain was joined from the north by another channel, only one side wall and a 1.35m length of which survived. A further, 1.10m long stretch of the conduit (P12:05) was noted in the northern part of Room 8E. The channel probably passed through east wall of the building, near to the south-east corner, and

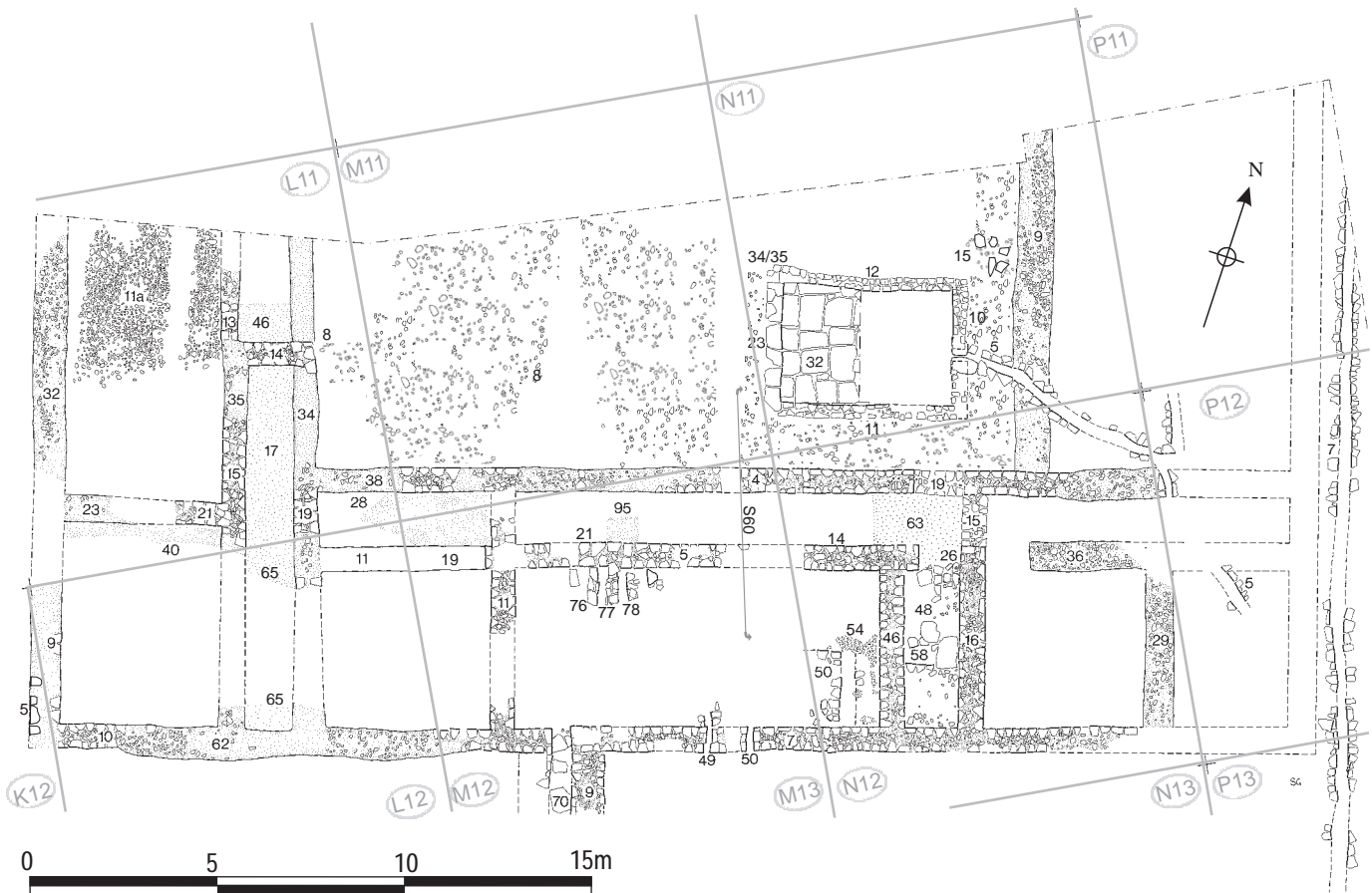

Fig re 9 Building 13 Phase 2 at 0

connected with the adjacent main storm drain which ran alongside the *intervallum* road (P12:07). It is conceivable that this system of channels served to flush a latrine, either in Room 9 or 8E, or conceivably formed part of a system of stable drains, but there was no direct evidence, the surviving remains being cut right down into the orangey clay subsoil (N11:06) with no trace of any superstructure being preserved in this part of the building.

FINDS

Room 3 surface

Bone: ring (no. 58, L11:11)

South corridor occupation silt

Bone: pin (no. 16, L11:29)

Dating evidence

The Phase 2 assemblage has a high proportion of rims and is almost certainly missing a number of body sherds. The courtyard (M11:11–12) produced only eight surviving sherds, the cistern wall and drainage channel (N11:21, 23) nine, and Room 6 (N12:54) four, mainly consisting of BB2 and locally produced wares of the late second century. The silt in the corridor

(L11:29) produced a mid to late Antonine Form 31. There were only 13 sherds in the silt in the cistern (N11:31) including a Form 18/31 of the late second or first half of the third century and sherds of BB2.

This assemblage could all easily be mid- to late Antonine equivalent to Fort Period 2.

Discussion

The excavators assumed that the *praetorium* underwent a straightforward development from a very simple primary plan, consisting of ranges of rooms laid out around a roughly square courtyard, to a slightly more complex Phase 2 plan with corridors inserted along the length of most if not all the ranges regulating access and circulation from the courtyard. However, whilst this hypothetical development is not implausible it by no means certain either. It is entirely possible that the building's layout was more complex from the start, with some sections of corridor already incorporated in the Phase 1 *praetorium*. To be sure there was clear evidence that the corridor in the south range was secondary – namely the relationship between the west wall of the passage (Room 7) and the south wall of the corridor – but the irregularities observed in the west corridor might imply that this feature

was constructed in two separate stages. Thus the section in the south-west corner could conceivably have belonged to Phase 1, whilst the corridor's northward continuation was perhaps added in Phase 2, when corridors were inserted in the other ranges. The function of the primary southernmost section of corridor may be explained if there were two rooms in the south-west corner of the building during Phase 1, rather than one (Room 4) as assumed by the excavators. These two rooms (4N and 4S) would have been separated by wall L11:21, which, like corridor wall L11:15, would therefore have been a primary feature, whilst wall L11:14/L11:33 would have formed the northern limit of Room 4N and the short section of primary corridor. The corridor would served to give direct access to both rooms without the need to pass through 4N to reach 4S.

Phase 3

The courtyard

The square structure (M10:19) in the north-west corner of the courtyard was evidently demolished at some stage. The remains of its foundations were covered by a spread of yellowish gravel and silt (M10:06) which extended eastward into the courtyard where it was in turn overlain by a patch of rubble, silt and ash (M10:03), including displaced cobbles. To the east lay a surface of small, well-worn cobbles set in crushed grey gravel (M10:02), which, along with the rubble, might represent the remains of a resurfacing of the courtyard, both layers being overlain by a 4.50m wide area of broken flags (M10:04) along the southern edge of the 1983–4 excavation site. No dateable material was recovered from any of these contexts, which in any case directly below modern disturbance, so the chronology of this resurfacing is uncertain. Moreover the complete removal of any superstructure and interior remains of the square structure in the corner of the courtyard might suggest a degree of truncation occurred during or after its demolition.

Across most of the southern part of the courtyard, a new surface of gravel and cobbling (L11:18, M11:08, N11:34, 35) was laid, set in an orange sand. The overall colour was predominantly orange, but sometimes yellow. It incorporated small pebbles or cobbles up to 0.05m across, with some larger cobbles, up to 0.15m across, to the west, again set in orange sand and pebble matrix. To the east of the cistern, a mixed pebbly spread of grey-brown silty clay, rubble chips and off-white sandstone pieces (N11:15) was present. On the west side of the cistern it was possible to differentiate between the orange gravel top surface (N11:34) and an underlying layer of fairly small, worn cobbles beneath (N11:35). It is possible that this distinction prevailed everywhere. In removing part of M11:08 the excavators noted that it could



Figure 9.10: 'Drain/soakaway' N12:58 from the west.

have comprised several layers recorded as one. It is not clear whether the cobbling was actually made up of two or more distinct sub-phases of courtyard surface, or whether such apparent layering simply reflects the manner in which the courtyard metalling was constructed. It was tentatively assigned to Sub-Phase 3i, although useful stratigraphic links with the complex sequence of activity in the south range, which provided the basis for the detailed phasing of the building, were lacking and, as noted above, it is possible that the gravel and cobbling actually represented more than one sub-phase.

The west corridor

At some stage during Phase 3 a new surface of grey sandy silt (L11:46) was laid in the section of the west corridor north of wall L11:14. No corresponding surface was noted to the south of the wall.

Phase 3 (Fig. 9.09)

Room 6

The wall separating Rooms 6W and 6E (M12:73) was evidently demolished at this stage and Room 6 restored to its original size with short stub walls being inserted to support the raised floor for a hypocaust heating system. The doorway into the former west room (6W) was blocked up (M12:21) as part of these alterations. The blocking was composed of flat, slab-like stones, somewhat larger than those originally used to construct the corridor wall (M12:05, N12:14). Four courses of this blocking, some 0.45m high in total, survived, the bottom of the blocking being on a level with the bottom of the hypocaust walls. The flue to fire the hypocaust was located at the south west corner of the room. The east side wall of the flue (M12:09) was the better preserved, with almost all of one course surviving, and was 1.80m in length, north–south, and up to 0.90m wide. Only part of the stokehole face of the west wall remained (c. 0.90m), however, the rest having been destroyed when a

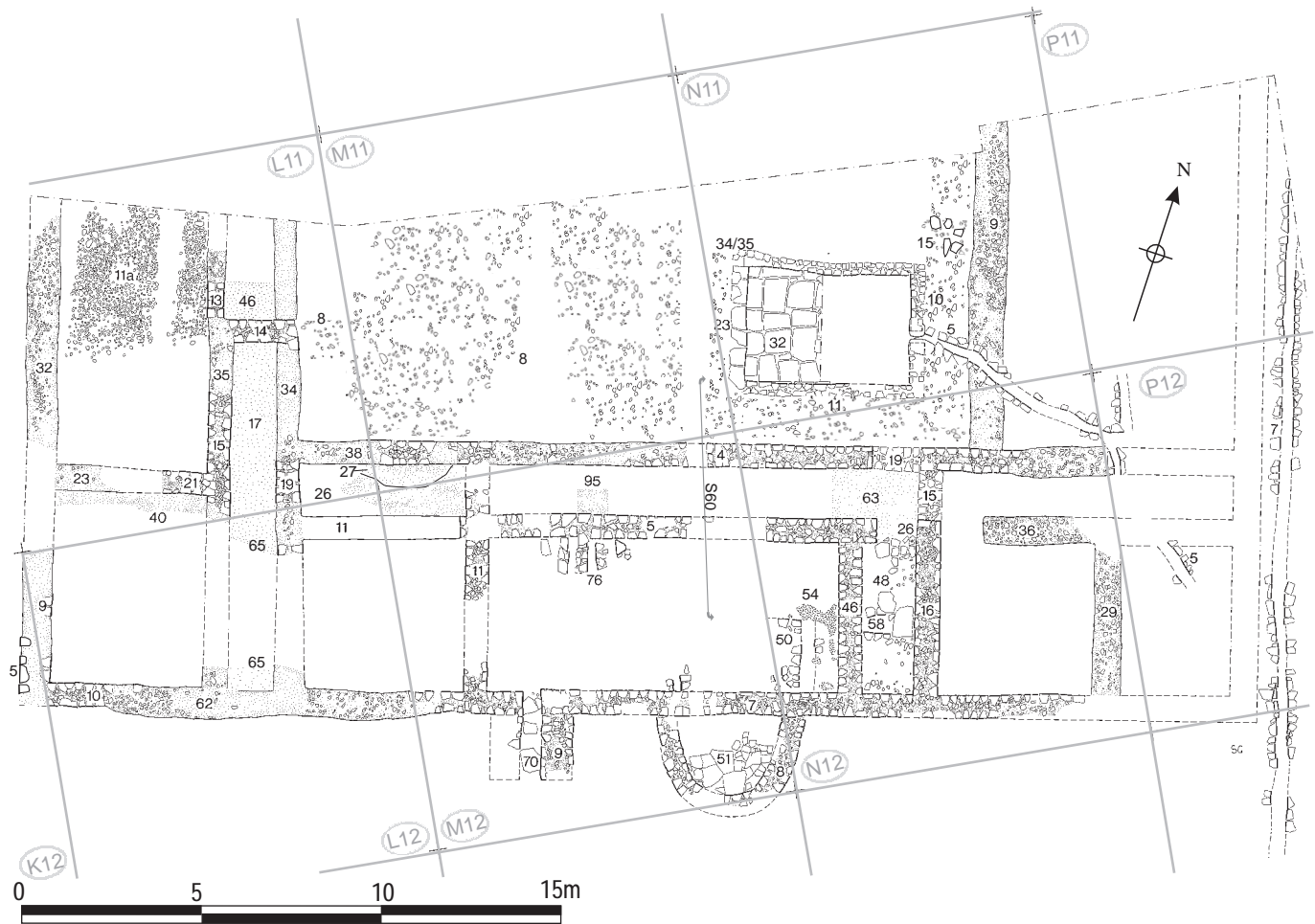

Figure 9.11: Building 13 Phase 3iv at 0



Figure 9.12: Initial flagged floor M12:51 in apse M12:08 from the south. The earlier phase cast vents in the south wall can be seen in the background.



Figure 9.13: Apse M12:08 from the west.

square apse was constructed immediately to the west in Sub-Phase 3iv. The flue channel averaged c. 0.50m in width, and was floored with several large flags (M12:70), up to 0.65m long and 0.10m thick. The maximum surviving depth of the stokehole was 0.30m and its sides were blackened and reddened through

heat. (See below – The area south of the praetorium: Phase 1 – for discussion of the possibility that the flagged floor of the flue represented a reused, primary drain outlet from a bath suite in the south range, which connected to a stretch of drain seen further to the south-east (N13:29).)

Two narrow vents through the south wall (M12:49, 50) were probably also inserted at this stage, roughly

mid-way along the length of Room 6. The vents were spaced 1.15m apart, centre to centre, the eastern one (M12:50) being 0.19m wide and 0.30m deep (as surviving), whilst the western was similar width at its southern end but narrowed to as little as 0.12m at its northern outlet, the irregularity of its channel demonstrating these were secondary features in relation to the south wall. Both vents were filled by rather dirty greeny-grey clay loam or silty clay (M12:49) and grey-brown silt loam (M12:50) flecked with stone and mortar, which was presumably allowed to accumulate during later sub-phases when the vents were no longer deemed necessary.

Fragmentary traces of the support walls for the hypocaust survived in two places in the room. Beside the north wall, near the north-west corner, three or perhaps four short lengths of sleeper walling (M12:76–78) remained, standing up to two courses high (0.13–0.16m) and one or two stones in width. Their surviving length varied between 0.75m and 1.03m (the central wall, M12:77, incorporated a surviving fragment of partition wall M12:73), whilst the width of the intervening channels varied between 0.15m and 0.30m. The walls were set on a grey clay loam which might represent the original Roman ground surface. The walls appeared to be faced more neatly on one side than the other (sometimes the west face, sometimes the east), although such distinctions may not have been significant in what were essentially floor substructures which were never intended to be seen. A mixed level of gravel, clay and mortar (M12:87) noted in the north-west corner of Room 6 might represent construction debris associated with this sub-phase. In the south-east corner, other fragments of walling (N12:50), which were originally interpreted as a possible latrine, may have belonged to the heating system sub-flooring. One wall, evidently only partially preserved, extended c. 2.00m northward from the south wall. It was faced on its east and north sides (the latter face being 0.65m in length), with a deposit of yellow-white mortar filling the west side the facing stones were largely missing. Some 0.35m to the east a further two facing stones might represent the very fragmentary remains of the west face of another wall on the opposite side of the hypocaust channel, whilst at the southern end of the main wall another channel appeared to curve round from its south-east corner to the west side of the wall. It is possible that the spread of charcoal and coal intermixed with a little grey silt (N12:54), to the north of the hypocaust wall fragments, was also associated with the hypocaust rather than representing an earlier occupation deposit (see Phase 1 and 2 descriptions of Room 6 and 6E for previous discussion). It is shown on the research archive Sub-Phase 3i and 3ii plans although the relevant context sheets indicate that walling N12:50 overlay the coal/charcoal spread.

Room 7

In the passage, a rather patchy flagged floor was laid (N12:48), of which two large slabs survived in the centre of the room (one overlying 'drain' N12:58) with smaller flags along the southern edge of the doorway, including a threshold pivot stone (N12:26) positioned right beside east wall. Elsewhere all that remained was a scatter of small stones and patches of pink/grey streaky clay to judge from site plan P200. Into this flagged floor was set a 'drain' or soakaway feature (N12:58) which extended across the width of the passage, from east to west, and was composed of two lines of facing stones set on either side of a flagged base (Fig. 9.10). The side walls were placed 0.50m apart, narrowing to 0.35m at its west end. Three packing stones were wedged in towards the eastern end of the feature, which was covered by a large flagstone (part of floor N12:48) sealing a deposit of loose grey sticky silt (N12:61). The remainder of the drain/soakaway was filled by a very loose packing of stone rubble and brown loam with slight traces of charcoal (N12:55), perhaps representing the backfilling of the structure at the end of its life.

The south corridor

A new floor surface composed of yellow gravel and mortar (L11:28), c. 20mm thick, was laid in the western section of the corridor. This was overlain by a 40mm thick deposit of occupation material (L11:26), consisting of pink clay, coal, charcoal and silt. The small sondage in the central section of the corridor showed that a new floor was laid in that area too, made up of yellow-white gritty mortar (M12:95), some 0.11m thick, covered by a thin occupation deposit of grey sandy silt (M12:94).

Sub-Phase 3i (Fig. 9.11)

Room 6 (semi-circular apse)

A semi-circular apse (M12:08) was added against the outer face of the south wall (Figs 9.12, 9.13), opposite the eastern part of Room 6 and overlying the street surface of worn orange sandstone cobbles (L12:38, M12:39), which extended along the south side of the *praetorium*. The east-west width of the apse, at its broadest point next to the building's south wall, was 4.10m and its maximum extent from north to south was estimated at c. 2.80m. The enclosing wall was up to 0.57m wide and of typical mortared construction, surviving two and sometimes three courses high. Its western end blocked the westerly (M12:49) of the two narrow vents through the south wall which were inserted during the previous sub-phase.

The apse underwent a series of alterations over the course of its life. A floor of fine grained sandstone flags (M12:51) was present in the southern half of the structure. This had settled unevenly so that it no longer formed a flat surface when excavated and



Figure 9.14: Building 13, Phases 3.iii and 3.iv with inset showing second phase of flooring in the semi-circular apse at 1:200



Figure 9.15: Blocking M12:79 (Phase 3iii) in the Room 6 hypocaust flue M12:70, from the north.

abutted the middle or top of the second course of the apse wall. The flagged floor was replaced by a hard mortar floor, also described as a 'concrete floor' in the context records and represented by a 0.10m thick level of very gritty, hard off-white mortar (M12:46),

which directly and almost exactly overlay the area of surviving flagstones and butted against the third course of the apse wall. Both the flagging and the mortar surface had presumably floored the entire apse originally, to judge from the irregularity of their northern edge, but had been partially removed during later alterations. The residue of those alterations was a layer of mixed stone rubble and various off-white and creamy brown mortars (M12:82) in the eastern half of the apse, between the flags and the main south wall of the *praetorium*, whilst a black silty deposit containing the odd stone and flecks of mortar (M12:83) was observed in western half. The mortar floor was reinstated in the north-east part of the apse, over rubble and mortar debris M12:82, in the form of a very hard creamy mortar spread containing various patches of yellow/white clay (M12:16). In contrast, a 0.25m thick 'foundation' layer of orange pink plastic clay (M12:31) was dumped over the black silty deposit (M12:83) in the north-west corner of the apse, where the mortar floor was absent. This clay which extended up to 1.40m from east to west and 0.95m

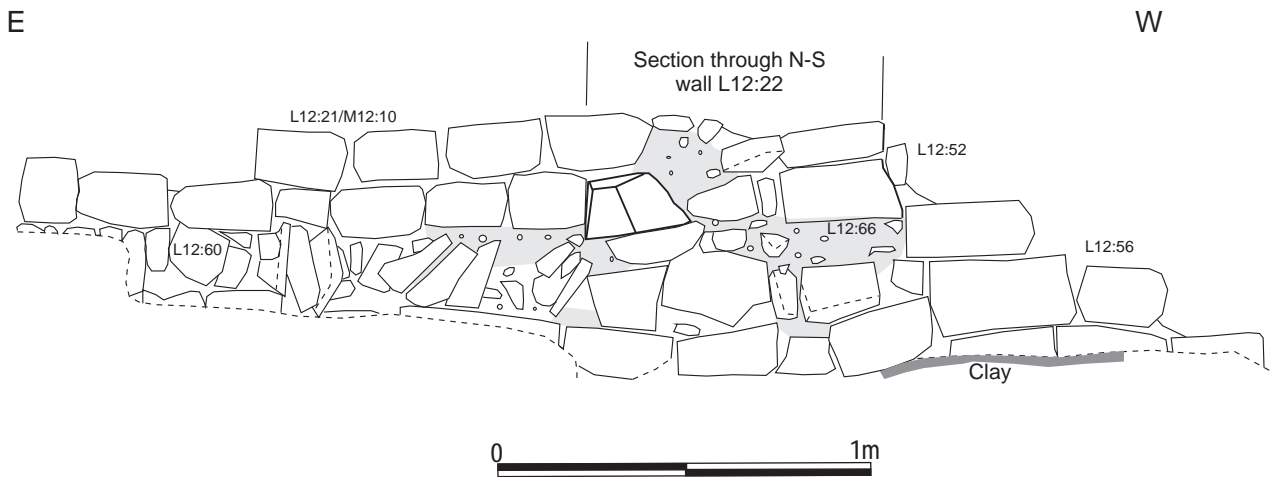

Figure 9.16: Elevation drawing (S61) of the south face of the flue at 1:20



Figure 9.17: View of the stoking chamber from the west hypocaust with the west flue in the fore and the east flue in the far background. The south flue is to the right beyond the later crosswall.



Figure 9.18: The initial (Phase 3iii-iv) form of the west flue.

north-south, may have provided the base for some kind of structure. The later phases of apse flooring may coincide with the subsequent overall sub-phases of the *praetorium*. Other arrangements relating to the hypocaust were unchanged.

The south corridor

In the western section of the south corridor a 30–40mm thick layer of yellow mortar grit (L11:27) was recorded, overlying the earlier occupation deposit (L11:26). This was only present along the north side of the corridor and may represent a partial resurfacing attributable to this sub-phase.

Sub-Phases 3iii- v (Fig. 9.14)

These sub-phases of the Daniels/Moffat sequence were characterised by the shifting of the main hypocaust from Room 6 to the south-west corner of the building, where it took over the entire area of what had formerly been Room 4, the southern end of the

west corridor and the western half of Room 5. The flue for the hypocaust in Room 6 (M12:70) was blocked with a couple of large facing stones and pink clay (M12:79- see Fig. 9.15) and the excavators seem to have assumed that the semi-circular apse (M12:08) to the east was taken out of use and demolished at the same time, although no surfaces or structures attributable to this sub-phase were identified in Room 6.

The eastern half of Room 5 was divided off from the new hypocaust by the construction of a partition wall (L12:15, M12:14), up to 0.55m wide. The narrow chamber thus created, which measured c. 4.30m north-south by 1.90m east west, became the area from which the hypocaust was fired. The stokehole was floored with two large flagstones (L12:67, M12:68), 0.85m and 0.95m in length and both c. 0.65m wide, which were blackened and scorched by heat. The flue was 0.65m wide, its side walls (L12:55, 56) projecting up to 1.80m westward into the hypocaust area (Figs 9.16–9.18). These comprised single-faced walls surviving up to three courses high, with rubble backing, their recorded width varying between 0.20m and 0.35m. The flagged base (L12:67/M12:68) was only found in

the flue opening in wall L12:15//M12:14 and extending eastwards in the stoking chamber. To the west, between the two side walls of the flue (L12:55, 56), the bottom was formed by a layer of rubble (L12:74). This rubble abutted the lowest course of the flue sides whereas the flagging was level with the second course. In the context notes it is suggested that the rubble formed the base of the flue during its first phase whilst the flagging was associated with a second phase. However, this may be to overcomplicate the sequence. At the flue opening, the northern edge of flagstone L12:67 was marginally overlain by wall L12:15/55/M12:14, which would imply that the flagging cannot be part of a secondary arrangement of the flue unless the west wall of the stoking chamber – one of the defining features of the sub-phase – was also secondary. In contrast, at its western end, flagstone L12:67 sat on top of the lowest, slightly offset, course of flue side wall L12:55. The simplest explanation is that all three features – west wall L12:15/M12:14, flue wall L12:55 and flags LL12:67/M12:68 – formed part of a single contemporary construction work. Examination of the site photographs suggests that L12:74 actually consisted of some rubble blocks (perhaps deriving from the partial demolition of the flue walls at a later stage) overlying a layer of flagstones in the base of the flue channel. Although somewhat smaller in size than flagstones M12:68 and L12:67, and set at a slightly lower level, the flags in the flue channel probably nonetheless represented a continuation of the large slabs in the stoking chamber and the flue opening since flagstone L12:67 itself appeared to sit at a slightly lower level than those in the stoking chamber (M12:68). Thus the flagstones in the flue probably stepped down gradually from the level of the stoking chamber floor to the bottom of the hypocaust and all were probably laid at the same time.

Charcoal (L12:60), presumably representing furnace debris, was noted in the bottom of the hypocaust spreading westward from the end of the flue, overlying mortar and stone construction debris. Similar mortar and stone debris (L12:49) was noted in the western part of the hypocaust, although it was not possible to determine whether that debris related to the construction or demolition of the hypocaust.

The pillared hypocaust (L12:48) was constructed using *pilae* constructed of slabs, flagstones and reused facing stones of varying thickness, set in a oblong pit up to 7.00m long from east to west by c. 3.00m north to south. Eleven of these *pilae* survived to some degree. They were near square or sub-rectangular in plan, with sides ranging between 0.40m and 0.50m, and were disposed in north-south aligned rows of each consisting of four *pilae*. The two most westerly rows (comprising *pilae* A, I and J, and B, C, and D) were each missing one of their *pilae* (between I and J and B and C respectively). The next row to the east had been entirely destroyed by the subsequent construction of a



Figure 9.19: Remnants of south flue M12:74, from the east, in the southern part of the stoking chamber incorporated in later flagged floor L12:70 after the room was subdivided.

pitched stone wall foundation (L12:46). All four of the *pilae* (E-H) in the fourth row survived, but only one example remained in the eastern half of the pit, near the end of the flue. *Pila* A, in the north-west corner of the hypocaust, was the best preserved, standing 0.55m high and made up of six courses, comprising two thick slabs, one above the other, a course of facing stones, a thin slab and two flags. In this form it was probably completely intact, the pieces of flagging on top perhaps forming part of the floor (*suspensura*). Of the other *pilae*, B-H were substantially intact, standing between 0.40m and 0.22m high, and doubtless owed their survival to later reuse to contain the packed stone foundation (L12:46), whilst I and J had been demolished down to the reused facing stones which formed their bases.

A short length (1.80m) of the hypocaust pit's stone revetment survived on the south side (L12:47), comprising four or five courses of slabs and blocks, bonded and backed by pink clay. The side sloped down with a slight batter. It was cut away immediately to the west by the later packed stone foundation and beyond that had been robbed away. A mass of



Fig re 2 0 Building 3 Phase 2 at 0

plastic pink clay in the north-east corner (L12:54) might represent part of the clay backing of the corresponding revetment on the north side of the pit. No trace of an equivalent lining was recognised on the west side of the pit, and the excavators suggested that none may ever have existed there, but a small area of flagged flooring did survive at the western edge of the room (L12:59). Together with the flagstones on top of the adjacent *Pila* A and others that had apparently collapsed into the intervening part of the pit (L12:35 fill), this flagging probably represented a remnant of the floor which covered the entire hypocaust chamber. Certainly there was no indication that the room was ever floored with *opus signinum* or concrete.

A channel (L12:50) was also made from the hypocaust pit through the west wall, on a north-east to south-west orientation, cutting the earlier floor deposits and original ground on the western edge of the room. The cut was 0.90m wide at the top, c. 0.40m wide at its bottom, which was rounded and some 0.45m deep. No trace of any stone lining was recorded. The excavators considered this represented a drain channel (from water tanks in a bath suite?).

It may have connected to a drain flowing southward alongside the exterior of the west wall. Such a drain does appear to have existed at the south-west corner, but no clear evidence of a junction was seen.

Opposite the southern end of stoking chamber, a roughly square apse, measuring 3.90m east-west by 3.15m north-south, was attached to the exterior of the building. Its walls (west: L12:23; south: L12:24, M12:26; east: M12:27) rested directly on the earlier (Phase 1 or 2) cobbled street surface (L12:38, M12:39), with no foundations, and were up to 0.65m thick with a 0.22–0.28m wide stone ledge (L12:26, M12:28) set alongside the inner face of the south and east walls (the west wall was too badly damaged to determine whether it was once furnish with an equivalent ledge, although it appears quite likely that it was). Some of the facing stones, which were a mixture of coarse and fine grained and micaceous sandstone, showed signs of fire-reddening, on the east wall, for example. Only one course survived, and this showed signs of surface wear on top. The apse was filled with a jumble of cobbles, pebbles and mortar in a grey silty clay loam (L12:25, M12:24) some 0.10m



Figure 9.21: Rubble in lowest fill in the courtyard cistern (below the piers), from the south west, with the courtyard flagging in the background.



Figure 9.22: Piers N1 and N2 in the courtyard cistern.



Figure 9.23: The east hypocaust viewed from the south-east (Phase 3v) with Phase 3vi east-west wall foundations M12:69 also visible to the right, reducing the area of the hypocaust.

deep, which may represent the later backfilling of the structure after it had gone out of use. The structure was tentatively interpreted as a possible hot room of a bath suite, although its position, isolated at the end of the stoking chamber, would seem to exclude such

an identification. The square apse also resembled an external furnace chamber, but such an interpretation would likewise be difficult to reconcile with the evidence that the adjacent room of the *praetorium* functioned as a stoking chamber, representing an apparently unnecessary duplication. It is likely however that the function of this structure was related to the remains of a possible flue identified just inside the *praetorium*, immediately to the north of the apse (Fig. 9.19). These remains took the form of a patch of cracked flagstones, measuring 0.46m by 0.70m and flanked by a pair of single-faced walls (M12:74) standing one course (0.12m) high, all sitting directly over the earlier sandy clay floor (L12:51, 69, M12:88). The walls appeared burnt, with quite a lot of charcoal around, and the structure, which was c. 1.00m wide overall, was interpreted as a possible hearth or fragment of a hypocaust flue and assigned to Phase 3iii or 3iv by Moffat. The remainder of the flue, to the north, had probably been destroyed by a later wall (L12:21, M12:10), belonging to Phase 3vi, whilst, to the south, it may have been associated with a corresponding gap noted in the masonry of the *praetorium* south wall. This was described as oblique and narrow in the context records, with additional comments indicating that it was considered more likely to be the result of later robbing or disturbance than a deliberate break for a stokehole. However its recorded characteristics would perhaps be compatible with a gap which was knocked through the south wall as a secondary modification, which is what is proposed here. In these circumstances the flue may have been fired from the same point in the stoking chamber as the west hypocaust, and the square apse might conceivably have housed a hot water tank heated by that furnace. Such a tank could have been mounted on the ledge (L12:26, M12:28) running along the inner face of the apse walls and would presumably supplied a bath suite within the building.

In the south corridor, new surfaces were laid in the western section (L11:25, M12:53) and in the central part (M12:93). That towards the west end was composed of very patchy yellow sandy clay (L11:25, M12:53) interspersed with greenish grey silt. The sondage in the central part of the corridor showed another floor of yellowish white gritty mortar (M12:93) was laid here generally around 20mm deep, though thicker nearer to the south wall of the corridor.

Perhaps in Phase 3iv, a solid, roughly constructed stone platform (N12:45), consisting of large stones with an outer facing (see Fig. 9.39 below), was built against the outer face of the south wall at the end of the passageway (Room 7). One layer of stones remained. The roughly rectangular space between the stone platform and the semi circular apse, to the west, was covered by a layer of yellowish mortar (N12:65), up to c. 20mm thick, which may have been structurally related to the stone base. Alongside the south wall of



Figure 9.24: The initial (Phase 3iii–iv) form of the east flue serving the east courtyard.

the building the east-west dimension of this structure was 2.35m, almost exactly corresponded with that of the passageway, which narrowed to c. 2.10m along its southern edge, the breadth of the structure from north to south being 1.40m. Initially, tentatively interpreted as a buttress, its function may have been related to the activities being carried out in the passage and adjacent rooms and it was subsequently suggested that it might represent the support for a water tank perhaps associated with a bath suite in the heated rooms of the south range. Any doorway at the south end of the passage, if one existed was presumably blocked by this structure.

There is clear stratigraphic evidence that construction of the stone base took place at some point after the addition of the semi-circular and square apses to the south range. Both the stone base and the associated mortar spread (N12:65) were set on top of the extensive layer of grey silty clay loam (N12:69, N13:03, L12:14, L13:38, M12:38, M13:24), which was deposited over much of the area south of the *praetorium* at some stage during Phase 3, whereas the clay loam, for its part, was laid right up against the walls of the semi-circular and square apses and the stoking flue, making it apparent that



Figure 9.25: Phase 3v – flagged floor N12:47 incorporating demolished wall N12:46.

it post-dated those structures. On the other hand the base was marginally overlapped by the foundations of the north wall of Building BB (N12:43, N13:28), showing its construction preceded that of BB. After its demolition, during the latter stages of Phase 3 or perhaps Phase 4, the base was covered by a spread of light, brownish-yellow clay loam and mortar (N12:13).

In the west range the cobbled surface in Room 3 was renewed with a further level of smallish, river-worn cobbles and pebbles including some crushed tile (L11:11), very similar to the previous floor.

Sub-Phase 3v (Fig. 9.20)

Courtyard (Fig. 9.21)

To the north and north-west of the cistern, extending right to the limit of 1979 excavation area, well-laid, neatly squared-off rectangular flags (M11:07, N11:14) took the place of the gravel and cobble surface. The southern edge of this flagging respected the north wall of the cistern (N11:12), demonstrating that the cistern was already in existence when the flagstones were laid (Fig. 9.21). The flags were composed of fine-grained, slightly micaceous sandstone and were a mixture of orange, off-white and greyish/green, with grey being the dominant colouring. They generally averaged c. 0.70m by 0.75m, although the largest examples were as long as 0.90–1.05m. The laying of the flagstones was attributed to Sub-Phase 3v in the Daniels/Moffat phase plans and context database, although there were no useful stratigraphic links to permit any direct equivalence between activity in the courtyard on the one hand and the interior of the south range on the other. Over the remainder of the courtyard it is presumed that the earlier gravel and cobbled surface remained in use. Indeed M11:08 was recorded as slightly overlapping the adjacent flagstones (M11:07). It is unclear why the flagging was laid only in this particular part of the courtyard. The flagstones do not appear to have stretched beyond the line of the cistern's eastern sidewall, but did extend

beyond its west wall and their edge here appears less regular than that to the east.

Cistern (Fig. 9.22)

A thick deposit of slightly brownish-grey silty clay-loam (N11:29) flecked with coal and pink clay lumps covered the bottom of the cistern. This was some 0.40m deep in the centre of the tank, but was, respectively, as much as 0.80m and 0.87m deep further north and south, where the deposit sloped down the sides of the tank. Three stone pillars (N11:25, 26, 27) were uncovered in the western half of the tank, set on top of this layer of silt (Fig. 9.22). The pillars were constructed of roughly faced sandstone blocks or, in the case of N11:27, superimposed flat flagstones and were bonded with orange-brown sandy mortar. A similar spread of orange brown sandy mortar (N11:28) lay beneath the northernmost pillar (N11:25), but was separated from direct connection with it by a lens of silt. The northernmost pillar (N11:25) measured 0.80m by 0.70m and stood 0.40m high; the south-western example (N11:26), which measured 0.90m (N-S) by 0.60m, was somewhat damaged and only stood 0.26m high. The south-eastern pillar (N11:27) measured 0.90m × 0.60m and stood 0.40m high. Similar structures were found in southern half of Cistern 1, to the north of the hospital, and they were presumably designed to support a floor covering at least part of the tank. Other pillars may have stood in the eastern half of the cistern which was not emptied.

Room 6 (east hypocaust)

A pillared hypocaust (M12:80) was inserted in Room 6 (Fig. 9.23), which was simultaneously truncated in length towards the east by the construction of a new dividing wall (M12:06, N12:21). This reduced the dimensions of Room 6 to 7.00m by 4.20m. The wall was up to 0.68m wide and of typical construction, featuring fine-grained sandstone facing stones bonded with gritty, off-white mortar, the core also containing several tiles. A doorway in the north-east corner of the room provided access from the corridor. A total of 16 *pilae* (A-H, J-Q) belonging to the hypocaust survived, most of which were located in the eastern half of the room. They were mainly composed of flat slabs, though some stone blocks were used, notably in A, which resembled the earlier dwarf walls immediately to the west (and might even represent another one of those, rather than a *pila* of this sub-phase). Single upright blocks were incorporated in P and Q, the one in the latter case being interpreted as a possible altar (but does not appear to have been retained as small find). Many of the *pilae* were not fully exposed so their full height could not be accurately gauged. However, *Pila C*, which was measured from its base, stood to a height of 0.55m and was composed of seven slabs. The size of the *pilae* varied considerably, with Q and O amongst the largest, measuring 0.50m

square and 0.58m × 0.45m respectively, whilst the plan dimensions of M were no more than 0.30m × 0.27m (the respective recorded heights of these three *pilae* were 0.33m, 0.42m and 0.45m). Along the northern side of the room, the dwarf walls (M12:76-78) of the previous hypocaust were probably incorporated in the new layout since these survived standing to much the same height as the pillars.

The hypocaust was fired from the west end of the room using the same stoking chamber from which the west hypocaust was heated. Only the north side of the flue was preserved (Fig. 9.24). The surviving flue side wall (M12:71) was bonded to the west side wall (M12:11) of the stoking chamber, which was carefully rebuilt at that point (M12:20), and projected c. 0.50m into the hypocaust. The combined length of flue (M12:20 and 71) was 1.23m. Its width could not be gauged with certainty, but it was probably in the order of 0.70m, the bottom of the channel being floored with small flagstones (M12:86) along its full length. The projecting side wall was the width of two facing stones, splaying slightly from 0.35m at its junction with wall M12:11 to 0.43m at its eastern end. Some 0.40m further east and directly in line with the flue wall there was a stone base (M12:72), measuring 1.05m east-west by 0.50m north-south. Like the flue side wall, it was composed of two lines of facing stones with no real core. It was interpreted as the support for a bath and perhaps functioned with a corresponding base to the south so that the bath supported by these bases would have straddled the flow of heat from the flue. The side wall of the flue opening (M12:20) was heavily burnt to a pinkish red colour. The nearest stone *pila*, of the hypocaust (M12:80Q), immediately to the west of base M12:72, also showed signs of burning.

A general level of grey, stony, sandy silt (M12:61-63) was encountered in the bottom of hypocaust right across the north-west part of the chamber, overlying the earlier construction debris (M12:87). This deposit may have built over the entire life of the east hypocaust. The corresponding silt deposits (M12:47-48) found between dwarf walls M12:76-78 contained a high concentration of animal bones but relatively little charcoal.

Room 7 (Fig. 9.25)

Contemporary with the construction of the new partition wall (M12:06, N12:21), the west wall of the north south passage (N12:46) was demolished to create an enlarged Room 7 also encompassing the former eastern end of Room 6. Thus remodelled, the room was almost square with internal dimensions of 4.15m east-west by 4.10m north-south. It is noteworthy that the new west wall (M12:06/N12:21) appeared to cut very neatly through the room's north wall (N12:14), suggesting the latter may have been rebuilt at the same time. A flagged floor composed of thick, regularly proportioned slabs, up to 0.45m



Figure 9.26: Building 13, Phase 3vi at 1:200

in length, was laid in the north-west corner of the room (N12:47), alongside walls N12:14 and M12:06/N12:21. The slabs extended eastwards towards the footings of demolished passage wall (N12:46), which were probably also incorporated in the floor along with the pre-existing patchy flagged surface of the passage (N12:48) and the demolished remnants of earlier (Phase 3i–ii) hypocaust walls (N12:50) in the south-west corner. A light grey-brown loam containing a lot of mortar (N12:52) covered the area between the demolished remnants of the hypocaust and the footings of the former passage wall. The doorway into the room remained unaltered. It was perhaps at this stage that the enigmatic stone-lined feature (N12:58), interpreted as a possible drain or soakaway, was backfilled with a very loose packing of stone rubble and brown loam, including slight traces of charcoal (N12:55).

A new floor level revealed in the sondage in the central part of the corridor was attributed to this sub-phase by Daniels and Moffat as expressed in the context listing and the phase plans. It was composed of a layer of pinky grey-brown clay (M12:92), as much as 0.08m deep.

Discussion: Sub-Phases 3i–iv

On the Daniels/Moffat phase plans nothing is shown in Room 6 in respect of Sub-Phases 3iii–iv whilst the west hypocaust was functioning in the south-west part of the building and conversely the south-west part of the building appears empty in Sub-Phase 3v when the new pillared hypocaust was constructed in the reduced Room 6. Rather than envisaging a kind of structural vacuum in either room, it would seem more plausible to conflate these sub-phases, with the implication that both hypocausts were in operation simultaneously and were heated from the same firing chamber, as apparently was the square apse. This would have made efficient use of space in the south range.

Thus, instead of presenting the development of the two hypocaust rooms as a sequence of discrete and mutually exclusive sub-phases, their structural history can be seen as overlapping and proceeding in parallel. When the west hypocaust was constructed and the internal firing chamber created, the original east hypocaust with its associated semi-circular apse was probably still fully functioning. The only change was the blocking up of the external stokehole and

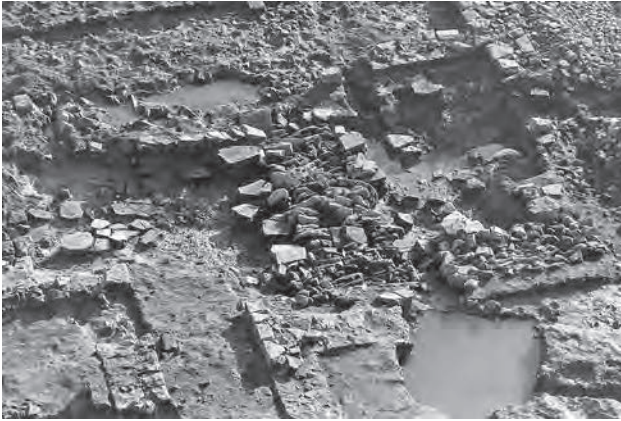

Figure 9.27: The west hypocaust from the north with Phase 3vi wall foundation L12:46 subdividing it (pitched stone packing N-S).

its replacement with a flue at the west end of the room, fired from the stoking chamber. Indeed there is some evidence that the firing chamber may have been functioning in relation to the east hypocaust before the west hypocaust was operating. A spread of charcoal (M12:90) found underlying flags M12:68, and evidently representing furnace debris, indicates that a flue was functioning in this area before flags M12:68 were laid. Since the laying of the flags was probably contemporary with the construction of the flue serving the west hypocaust, for the reasons outlined above (see Sub-Phases 3iii–iv), the charcoal spread most probably derived from the flue serving the east hypocaust which was more closely associated with flags M12:86 rather than L12:67/M12:68. This interpretation would be compatible with the prolonged usage of the semi-circular apse implied by the existence of three successive phases of flooring in that structure. The first floor, composed of flagging, might have been in use when the hypocaust room was still heated via the external stokehole, whilst one or both of the secondary phases of mortar and clay flooring may have been contemporary with the period when the hypocaust was fired from the internal stoking chamber and the west hypocaust had come into use. Moreover it was probably before the latter had ceased to function, that the east hypocaust underwent a further, more substantial remodelling, which involved reducing the length of the room, abandoning the semi-circular apse and largely, though not completely, replacing the earlier hypocaust substructure with stone *pilae* similar to those used in the west hypocaust. It is this overlapping sequence which is presented here in the phase plans (Figs 9.14 and 9.21).

The function of the two hypocaust chambers is not altogether clear. The excavators seem to have interpreted the rooms as bath suites, perhaps functioning successively, with suggestions in the context notes that the semi-circular apse was a *frigidarium* or cold bath, since it had a solid floor with

no underfloor heating, and stone base M12:72 perhaps providing part of the supporting substructure for a hot bath. The presence of the stoking chamber separating the two chambers suggests they did not function as an integrated suite of rooms whether for bathing or some other role although access between the two was possible via the south corridor. There is no indication that either hypocaust had an *opus signinum* or concrete floor. Most likely both were flagged, a more utilitarian form of flooring which may have implications for the activities undertaken there and would probably not be characteristic of the house's principal heated dining room, for example, where a more luxurious level of internal appointment might be expected.

Sub-Phase 3i (Fig. 9.26)

Cistern and courtyard

The overflow drain or conduit from the cistern was taken out of use at this stage, the outlet mid-way along the tank's east wall, being blocked by a plug of pink clay, 0.80–0.90m in length and two vertically set slabs (N11:33).

The south-west corner (Fig. 9.27)

The line of the south corridor wall (L12:11) was extended as far as the main west wall of the building, and the former west hypocaust chamber further subdivided by the construction of a north-south wall (L12:46). Both the north-south and east-west aligned walls survived only in the form of very broad foundations constructed of very closely set pitched slabs. Those of the north-south wall were 1.25m wide filling the space between two rows of *pilae* with a central row taken up. To the north and south the foundations extended beyond the cut for the earlier hypocaust. The slabs were almost all fine-grained sandstone, 50–80mm thick, and included two or three very smooth slabs which resembled those used in the *pilae*. The chamber in the south-west corner of the building created by these two new walls was largely filled by a dump of fairly homogenous, plastic pink grey clay (L12:13) containing relatively few impurities – a little tile, coal and some stone. The clay covered an area c. 2.70m by 3.00m and the depth of the deposit varied between a few centimetres to c. 0.30m, but its surface was very uneven with a pronounced dip in the centre where it filled the hypocaust pit. This depression, which was some 0.50m deep and measured c. 2.75m north-south by 2.00m east-west, may have been the result of gradual settling of the clay dump. The pink clay also filled the earlier (Sub-Phase 3iii?) opening (L12:50) through the west wall (which the excavators interpreted as a drain outlet), blocking it up completely.

In the site context listing, clay L12:13 was interpreted as the base for a bath inserted in the western hypocaust. It was also suggested that the surrounding



Figure 9.28: Phase 3vi blocking of the west flue.

pitched stone foundations may have formed part of the support for the bath, although these were also interpreted as possible wall foundations. In fact the interpretation of clay dump L12:13 and foundations L12:46 as the supports for a bath is problematic. Construction of wall L12:46 and the dumping of a solid mass of clay would have prevented any heat circulating under the putative bath. Moreover the west hypocaust no longer seems to have been functioning, the flue having been blocked by the construction of a new wall on the west side of the stoking chamber. It seems preferable therefore to consider the pitched stone foundations as having supported the north and east walls of a newly created room in the south-west corner of the building, and the clay as make up for the floor. The internal dimensions of the room can be roughly estimated at c. 4.10m north-south by 3.00m east-west. In the northwest corner, it appeared that a small part of the earlier, suspended flagged surface between *Pila* A and the similar flagging at the edge of the room (L12:59), had been left *in situ*, rather than being lifted and replaced by clay dump. The flags had subsequently collapsed into the underlying cavity (L12:35). Elsewhere the flags on top of the former *pilae* protruded through the clay dump.



Figure 9.29: Phase 3vi east flue from the east showing flags M12:65, modified north wall M12:12 and crosswall L12:21/M12:66

Furnace chamber and east hypocaust (Room 6)

The east hypocaust underwent further substantial alterations. A new west wall (L12:22) for the furnace chamber was erected immediately to the west of the pre-existing one, increasing the internal width of the room to c. 2.40m. The northern half of the wall had been robbed out at a later stage (L12:37), but it seems clear that the wall continued right across the west hypocaust flue which must now have been redundant. The site plans and photographs show the wall was carried across the flue supported by a substantial rubble foundation (L12:66, M12:69) which blocked the channel completely (Fig. 9.28). The west hypocaust must therefore have been out of use at this stage. There are also indications, in the form of a row of four facing stones, that the wall may have continued south beyond the line of the building's external wall to form a rebuilt west wall for the square apse. The northern half of the former west wall of the firing chamber (M12:15) was not completely demolished, unlike the southern stretch, of which all trace was removed. Perhaps the wall was retained as a low bench along the west side of the truncated chamber.



Figure 9.30: The later flagged floor with hearths in enlarged Room 7, from the north (Phase 3vi).

The north-south wall (L12:22) was bonded to an east-west aligned wall (L12:21, M12:10) which extended east ward on a line just south of the east hypocaust flue, reducing the internal, north-south length of the firing chamber and the equivalent width of the east hypocaust chamber to c. 2.70m. This east-west wall was set on the same pitched stone foundations (L12:66, M12:69) which supported wall L12:22 over the west hypocaust flue. These foundations were as much as 1.50m broad towards their east end. The masonry of the wall survived for 4.70m, the foundations for a further 1.75m, where it joined a north-south wall, of which only the stone foundations (M12:36) survived, and which ran up to join the room's north wall (M12:05). Construction of these two walls (L12:21/M12:10 and M12:36) reduced the size of the hypocaust chamber to something of the order of 4.00m long by 2.70m wide. There were also alterations to the north side of the stokehole where a new facing of roughly worked blocks (M12:12) was laid at an oblique angle to the earlier face (Fig. 9.29). These stones were burnt to a maroon red colour on their south side. A new flagged base (M12:65) was laid in the stokehole, over a layer of makeup consisting of dark grey silty clay loam, with some charcoal and stone debris (M12:64). The flags were burnt and cracked by the heat in the stokehole and extended into the firing chamber, which was covered by a deposit of coal and ash (L12:64, M12:37). A similar layer of mixed furnace debris (M12:45, M12:57), comprising coal, ash, charcoal, silt and mortar, was also present in the stokehole flue itself, over flagging M12:65 and the foundations (L12:66, M12:69) of wall L12:21/M12:10, which formed the south side of the flue and firing chamber. In the hypocaust chamber, furnace debris consisting of charcoal and dark silt (M12:60), overlying earlier flue side wall (M12:71) and stone base (M12:72), was probably associated with the remodelled flue of this sub-phase. Its presence would imply that the earlier flue side wall and the rectangular base had been demolished by this stage.

In the remaining area beyond wall M12:36, at the east end of the former Room 6, the hypocaust probably went out of use. A layer of pink-grey clayey material (M12:89) was packed around the bases of the redundant hypocaust *pilae*, and a brown silty clay backfill (M12:54, 58), which included a lot of small stones and pieces of mortar, deposited over it. A flagged floor (M12:59) was then laid over the top, incorporating the tops of the most of the pillars.

A narrow corridor like space was also created on the south side of east-west wall L12:21/M12:10, the purpose of which was unclear. A single large flagstone (L12:70), measuring c. 0.60m by 0.70m and cracked down the centre, was uncovered at the west end of this passageway. This directly overlay the sandy clay floor (L12:51, 69, M12:88) attributed to Phase 1, and was interpreted as a surviving fragment of the floor associated with Phase 2 in Room 5. However it lay on the line of the initial west wall of the firing chamber (L12:15, M12:14) and it is difficult to imagine it would have survived both the construction and demolition of that wall. It is more likely it was laid after the southern end of wall L12:15 had been demolished and all trace removed. Immediately to the east, the demolished remains of flue M12:74 and the former east wall of the stoking chamber (M12:11) may also have been incorporated in this floor. They certainly appeared to sit at the same level as L12:70, suggesting the flags and walls all now formed part of the same floor surface or substructure.

Room 7

A new floor was laid in this room (Fig.9.30). In the area of the former passage this was composed of a 0.10m thick layer of yellow-orange sandy mortar in grey/black silty clay loam (N12:38), with much charcoal interspersed, which probably represented the remnant of a mortar floor. In the centre of the room, the flooring took the form of worn sandstone flagging interspersed with pebbles (N12:37), set on a 0.10m deposit of mortar and soil makeup or debris. Traces of burning at three points in the room (two in the south-west corner and one near the entrance in the north-east corner) may indicate the position of hearths (N12:40–42).

FINDS

Room 7 (Phase 3vi)

Decorated samian: Antonine (no. D127, N12:38)
Copper alloy: statuette (no. 73, N12:38), tweezers (no. 98, N12:37?)
Stone: whetstone (no. 27, N12:37)

South corridor floor

Copper alloy: strap end (no. 162, L11:25)

Coal and ash in stoking room (Phase 3vi)

Copper alloy: stud (no. 266, M12:37)



Fig re 9 Building 3 Ph se 4 at 0

Silt in east hypocaust

Coin: Severus Alexander, 222–8 (no. 290, M12:61)

Backfill of east hypocaust

Decorated samian: 130–50 (no. D113, M12:58)

Vessel glass: bowl (no. 21, M12:54)

Copper alloy: pin? (no. 127, M12:54)

Bone: pin (no. 30, M12:67)

Courtyard and cistern

Architectural stonework: worked (no. 24, M11:08)

Coin: illegible third or fourth century (no. 277, N11:25)

Copper alloy: mount (no. 306, N11:34)

Foundation of S wall reducing furnace room (Phase 3vi)

Architectural stonework: roofing slate? (no. 17, L12:66)

Dating evidence

This phase produced less than 3kg of pottery, half of which came from the fill of the cistern. The cistern fill contained some third-century pottery, including

sherds from three or four separate Nene Valley beakers, a Yorkshire grey ware bowl and two North African-style vessels, in contexts both pre-dating and post-dating the insertion of the pillars (N11:24, N11:28–9). The low proportion of BB2 and allied fabrics suggest a date before the middle of the century. Third-century Nene Valley was also found in the ash of the stoking room, in the backfill in the east hypocaust and in Room 7 (M12:37, 54; N12:37–8 respectively). A slightly worn coin of Severus Alexander dated 222–8 (cat. no. 290) came from the silt on the bottom of the east hypocaust (M12:61). The debris at the east end of the west hypocaust also produced a single sherd of Central Campanian amphora, of the mid-third century or later (L12:60).

Phase 4 (Fig. 9.31)

Courtyard and cistern (Fig. 9.32)

The cistern was taken out of use and backfilled with a jumbled mass of light brown/yellow mortar with broken coarse yellow sandstone flags, small stones,

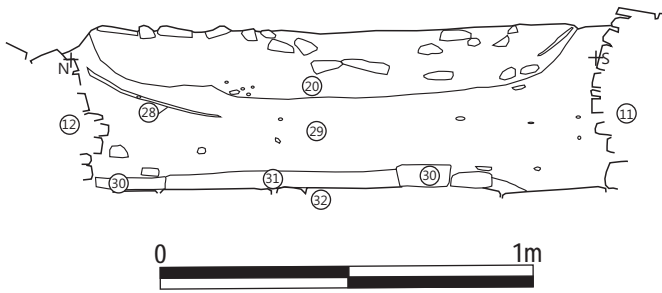

Figure 9.32: Section S56 across the fills of the courtyard cistern at **A**

pieces of brick rubble, gravel chips and off-white mortar (N11:20), the whole deposit being some 0.35m deep. There were slight indications of layering in the material, suggesting it had been tipped in from the east, this being particularly evident in regard to the flagstones, which gave the impression of sloping down from east to west.

The south rang

The east hypocaust, like the west hypocaust before it, was taken out of use in Phase 4 and backfilled with a variety of demolition material. The east wall of the former firing chamber (M12:11) was extended across the mouth of the flue, blocking it (M12:13). The backfill included sandstone rubble, creamy mortar, painted plaster and tile (M12:17). The material in the area the east hypocaust flue was fairly compressed and appeared to be composed of smaller fragments of greyer colouration than that encountered elsewhere (M12:44), but it is not clear that any significance should be attributed to these variations. The earlier floors in the south corridor were covered by a spread of mixed sandy grey or light brown silt and mortar (M12:91, N12:12), whilst similar mortar spreads, representing possible surfaces, were also present in Room 8 (N12:08) and in the former firing chamber (M12:18). Most of the finds attributed to the mortar spread in Room 8 actually derived from an associated thin level of dark grey/black occupation silt, including a lot of charcoal and patches of sandy clay. A large flagstone (M12:34), measuring c. 0.55m × 0.35m, was laid in the former firing chamber, opposite the mouth of the blocked flue. A possible occupation level was also recognised in the west section of the south corridor (L11:20, M12:52), in the form of a dark grey silt flecked with tiny stones and charcoal, the layer having a purplish and greenish hue overall. Very similar deposits were encountered in the rooms associated with the east hypocaust (M12:15, 67, 17), consisting of spreads of mortar decay and brown silty clay loam, but it is not clear whether they represented actual floors in all cases or simply the residue from demolition and backfilling. In the south-west room, formerly occupied by the west hypocaust,



Figure 9.33: Metalworking hearth N12:24 in Room 8W (Phase 4 or later), from the west.

the fill deposits (L11:24, L12:16, 42) extended over the pitched stone foundations of the Phase 3vi walls (N12:46). The backfill here consisted of a jumbled mass of stone and creamy yellow mortar, mainly comprising relatively small fragments of flat slabs with some rubble and brick/tile. There was quite a lot of grey silt lower down whilst the mortar concentrated towards the top. The material was not highly compressed and there were numerous voids with air pockets lower down. In addition, the depression in the surface of the clay dump (L12:13), which had been constructed in the south-west corner of the building during Phase 3vi, was perhaps filled by a deposit of grey silty clay loam which had a very slight olive green tint (L12:02) at this stage. The excavators suggested that this was the result of silting or deliberate rubbish disposal, the greenish tint indicating the former organic content of the material, which contained a substantial amount of pottery. This could postdate the main demolition activity of Phase 4.

In Room 8W a mortar and clay surface was laid (N12:09). A possible metalworking hearth (N12:24) occupied the west side of the room near the south-west corner (Fig.9.33). This was formed by two large slabs, set vertically, 0.65m apart, on the north and south sides of a rectangular pit. The latter, which measured as much as 0.90m from east to west, was filled by a 0.35–0.40m deep deposit of burnt debris consisting of brown/black gritty and silty clay loam (N12:25), including a lot of copper-alloy fragments, ferrous material and charcoal, with ash around the edges. The two vertical slabs also showed signs of burning. In the north-east corner of the pit, a roughly square facing stone, measuring 0.25–0.30m on each side, rested on the burnt debris and was thought to have been perhaps functionally related. The copper alloy fragments were not present in the lower fill of the hearth pit. Spreads of coal (N12:33) over surface N12:09 might also have been associated with this hearth. Immediately to the south-east, there was a curious channel (N12:49), aligned north-south and c.

1.60m in length. It was up to 0.70m wide overall and lined with facing stones, often pitched at an angle. The channel was 0.20–0.25m wide and 0.13m deep, and filled by grey clay loam and small stones (N12:44), but the structure was probably damaged by later disturbance. This feature was interpreted as a drain of some sort though there was clearly no outlet through the adjoining south wall.

The west rang

The stretch of the west corridor to the north of cross wall L11:14 was apparently demolished at this stage, reducing the width of the west range in this area. A drain-like feature (L11:48), comprising two lines of facing stones set 0.40m apart, extended northward on roughly the same line as the former east wall of the range for at least 1.20m. This feature may have been disturbed, with only a few facing stones remaining of the side walls, their course being indicated for the most part by lines of rubble, with a dark grey sandy silt (L11:43) packed between them. A spread of fine, sandy, yellow-white mortar (L11:37) over the former corridor was interpreted as a possible surface. Patches of the same deposit were also present on the other side of the drain-like feature, along the western edge of the courtyard. Room 3 remained in use, apparently unaltered, however.

All this would seem to presage a major remodelling of the commanding officer's house, but the outline of that remodelling cannot be discerned

FINDS

Mortar/clay floor in Room 7

Vessel glass: cup (no. 28, N12:08)

Bone: needle (no. 26, N12:08)

Jet: rod (no. 6, N12:08)

Mortar/clay floor in Room 8

Bone: offcut (no. 68, N12:09)

Fill of pit in Room 8

Copper alloy: stud (no. 256, N12:25)

Backfill of east hypocaust

Stamped tile: Legio VI (no.17, M12:17)

Vessel glass: cup (no. 22, M12:43), bowl (no. 24, M12:43), cup (no. 27, M12:17)

Backfill of west hypocaust

Vessel glass: cup (no. 19, L12:42)

Coin: Elagabalus, 218–22 (no. 129, L12:16)

Fill of depression over west bath

Graffito: (no. 53, L12:02)

Bone: pin (no. 20, L12:02)

Dating evidence

The backfill of the hypocausts contained a slightly worn coin of Elagabalus dated 218–22 (cat. no. 129) and third-century pottery including Nene Valley ware and a Gillam type 151 (L12:16). Sherds of BB1 with obtuse angle lattice suggest a date in the second quarter of the century or later, and body sherds of two Lower Nene Valley mortaria a date after 230 (L12:16, M12:17). A joining sherd from one of these mortaria came from the fill of the depression over the west bath (L12:02), which also produced the latest pottery in this phase, comprising sherds of BB1 with a groove above obtuse angle lattice (after c.250) and a Nene Valley bead-rimmed beaker of the late third century or later.

As they survive at the moment, the pottery assemblages associated with the hypocaust backfills are not very large – E less than 1kg, W less than 500g. Some of the context assemblages can be combined together. With regard to the backfill of the eastern hypocaust the initial context assigned (M12:17) was later subdivided into two separate contexts (M12:43 and M12:44) as possible distinctions were recognised in the fill, with M12:43 being considered a possible later fill in the flue area. The context sheet for M12:17 notes 'it is by no means certain that these distinctions are archaeologically significant and only need to be taken to be so if examination of finds shows a distinction between pot from (M12:43) and (M12:44).' As M12:43 had only 20g of pottery and M12:44 only 30g, nothing meaningful can in fact be said about dating differences.

Later activity

The courtyard

Fragmentary traces of later activity were indicated by the presence of late third- or fourth-century pottery in a few later features. A spread of off-white mortar (N11:07), roughly 2.50m by 1.25m in extent, lay over the backfilled cistern in the south-east corner of the courtyard. It formed a hard layer with possible traces of burning in places and was interpreted as a floor perhaps representing an attempt to level off the backfill. Two rims in Crambeck reduced ware were found in this layer suggesting it may have been associated with the next phase of activity towards the end of the third century. A similar mortar spread (N11:08) was present over the flagstones to the north of the cistern and may have been contemporary with and related to the mortar layer over the cistern, but this did not yield such late pottery.

Room 7

A pit (N12:28), measuring 0.75m by 0.60m and c. 0.20–0.25m deep, was cut right through the floor levels at the western edge of Room 7 (Fig. 9.34).

The pit was straight-sided with a flatish bottom but rounded at the junction of the sides and bottom. It was filled with brown, crumbly sandy silt loam including some mortar (N12:27). There was a lot of stone at the edges and some flat slabs lay upright against both the north and south sides, though these were considered to form part of the fill rather than performing any structural function. Intriguingly the fill was seen to continue under the west wall of Room 7 (M12:06, N12:21) into the adjoining Room 6. The function of this feature was unclear, but the fill contained calcite gritted coarseware including Huntcliff ware, implying that the backfilling of the pit, at least, was the latest Roman action that can be identified in the area of the *praetorium*, all the late Roman structural levels having been removed by post-Roman activity and disturbance.

FINDS

Pit in Room 7

Bone: offcut (no. 72, N12:28)

Robbing

Coin: 'Elagabalus', 218+ (no. 132, M10:14)

Dating evidence

The mortar layer over the cistern (N11:07) produced an everted rim from a jar and a rounded rim from a Corder and Birley 1937 type 13 bowl in Crambeck reduced ware of the late third century or later. The pit contained a few large sherds from a single calcite-gritted ware vessel, a probable wide-mouthed bowl with a Huntcliff-type rim of the late fourth century or later (N12:27, N12:28). The mortar layer N11:08 only has five sherds of pottery.

Robber trenches (L11:06, M12:32, 35) produced 0.422kg of pottery, with only a single sherd of a possible Crambeck reduced ware everted rim jar (burnt), dating to the late third century or later (M12:35).



Figure 9.34: Late pit N12:28 dug at the western edge of Room 7.

It is slightly puzzling that even the robber trenches lack later pottery although only three contexts are represented. Taken at face value it might imply that these walls were robbed out during the third-century and the *praetorium* was then completely rebuilt, but in that case one might expect that traces of the foundations of the principal new walls would survive even if nothing of the internal levels or wall superstructure remained. However, the building seems to have as much late third-century – and late fourth – material in the unstratified assemblages as elsewhere across the site, and the character of the robber trench assemblages may say more about the 1975–84 excavators' finds retention policies with regard to such contexts than it does about the date of robbing activity itself. Unaware as they were of the loss of most of the late Roman levels, it was naturally assumed that any robber trench cut down through all the surviving Roman levels must by definition be post-Roman and it was therefore unnecessary to retain post-Roman material to provide confirmation of the date of this robbing activity.

The area south of the *praetorium* including Buildings AZ, BA, BB and BK **Grid squares: K12, K13, L12, L13, M12, M13, N13**

Introduction and outline summary (Figs 9.35, 9.36)

The structural sequence in the area south of the *praetorium* was first outlined in *Britannia* Volume 11, in the annual roundup 'Roman Britain in 1979' (*Britannia* 11, (1980), 355–7). The principal features uncovered in this area were a row of three stone buildings, labelled AZ, BA and BB by the excavators. Initially there was some divergence of opinion regarding the phasing of these three structures. Thus Daniels considered that AZ was a workshop and was built along with BA during Fort Phase 2, the two buildings subsequently being amalgamated. Moffat, on the other hand, thought these buildings must post-date the walled yard south of Building 13, which had also been identified, and were probably contemporary with the remodelling of the barrack blocks as ranges of free-standing *chalet-contubernia* (i.e. Daniels' Fort Phase 3, then attributed to c. AD 300). The surviving road levels appeared to support this interpretation, as the road surface uncovered immediately to the north of the Chalet-Range 12 also appeared to be associated with AZ and BA. Moffat further argued that Building BB, at the eastern end of the row, must also be contemporary with AZ and BA. The fragmentary remains of a further possible structure BK, which survived at a much higher level over BB, were representative of a subsequent structural phase which probably replaced all three buildings.

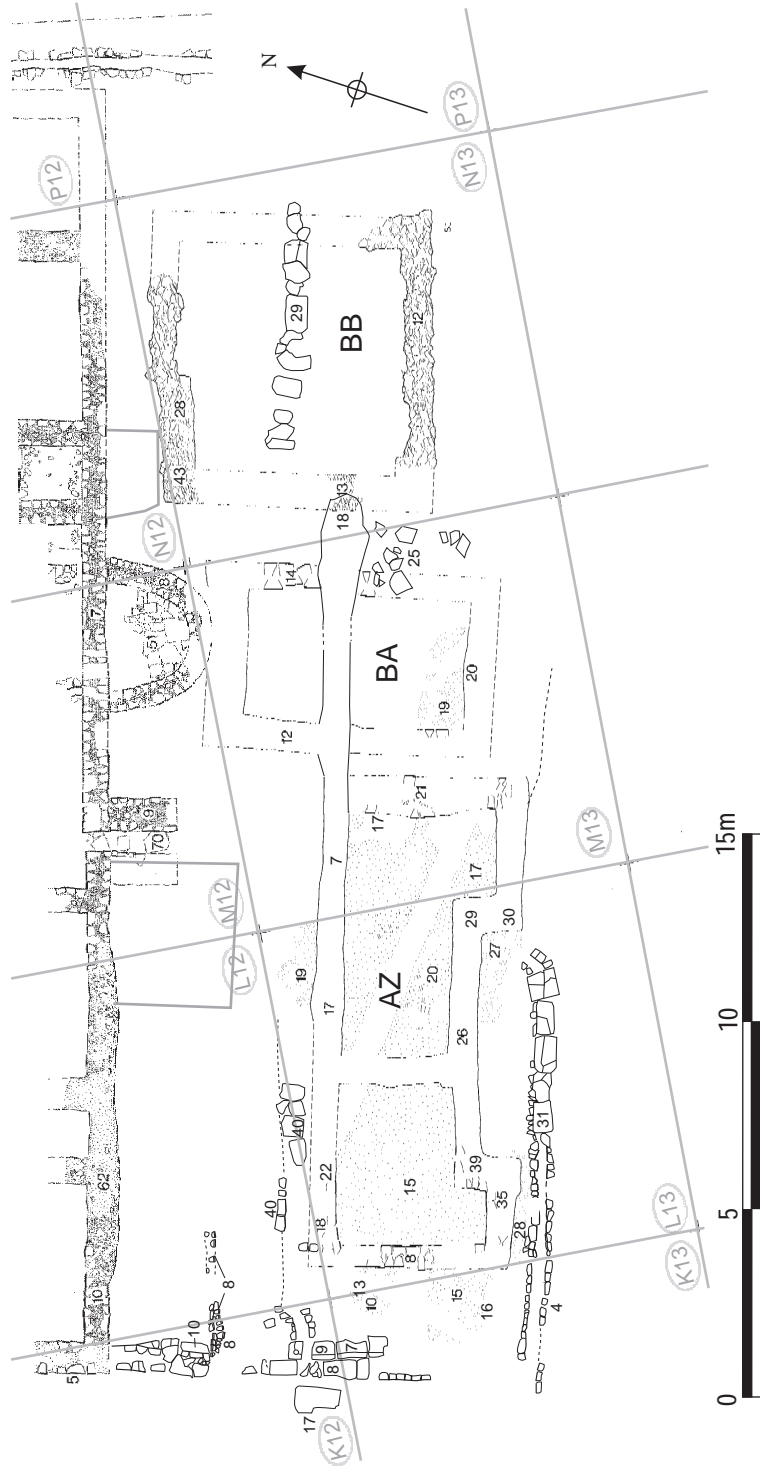

Figure 9.35: All features south of the praetorium Phases 1–5. Scale 1:200.



Figure 9.36: Southern part of the praetorium and the structures to the south under excavation in 1979, viewed from Simpson Hotel, looking south.

The definitive Daniels structural sequence proposed in relation to this area – which emerged following further post-excitation analysis undertaken by Moffat and was reflected in the latest published plans – comprised the following stages:

1. *Via quintana* road surface, no yard;
2. walled yard (W wall only surviving) with entrance through the west wall close to the south wall of Building 13 – function probably related to stoking the bath suite from outside the south wall of the building – and hence the necessity to keep the area cordoned off;
3. a new yard entrance further south and wall built over line of former entrance, possibly during this period that a silty grey clay soil formed over the surface of the yard;
4. the walled yard went out of use and Buildings AZ, BA, BB were erected on the site;
5. AZ and BA amalgamated?? (note the robber trenches running further east than the end of the north wall of AZ);
6. AZ and BA, BB were demolished and BK erected

This sequence is essentially followed here. One problem in analysing this area is the small number of detailed photographs taken (the few examples which can be found in the photographic archive principally focus on the remains of the latest structure, BK), despite the existence of a number of unusual and interesting structures.

Phase 1 (equivalent to Building 13 Phases 1 and 2) – Fig. 9.37

The lowest level exposed south of the *praetorium* was a worn surface of orange sandstone cobbles (L12:38, M12:39) alongside the south wall of the building. An area of this surface, up to 1.75m wide, was exposed, extending from the building's south-west corner as far as the semi-circular apse. This perhaps represented the primary surface of *via quintana*, although no excavation took place beneath the cobbling to confirm

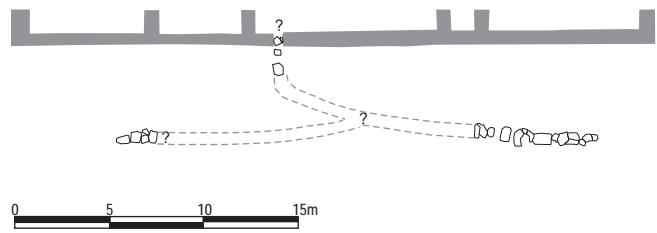

Area south of Building 13, Phase 1 (at 1:400)

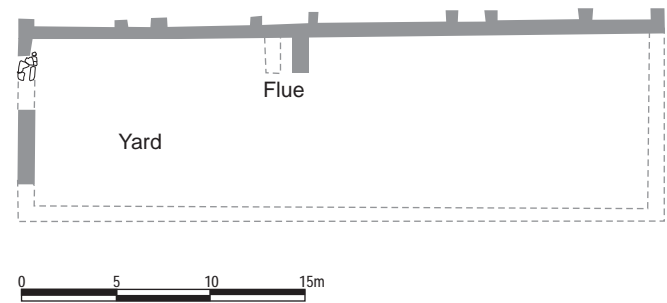

Area south of Building 13, Phase 2 (at 1:400)

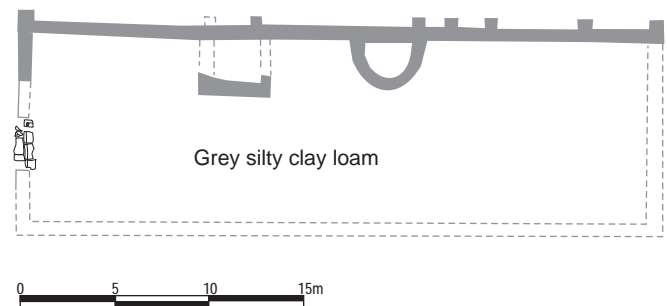

Area south of Building 13, Phase 3 (at 1:400)

Figure 9.37: Phases 1–3 in the area south of the praetorium

this. It was certainly seen to continue beneath the square apse, the stoking flue sidewalls (e.g. M12:09) and the semi-circular apse (M12:08) and the later grey clay deposit (L12:14, M12:38) which covered much of the area south of the *praetorium*. Towards the south-east corner of the building a comparable and perhaps contemporary cobbled surface (N13:09, N13:21) was revealed beneath the later Building BB. The composition of this metalling was described as ranging in size from small pebbles to river-worn cobbles up to 80mm in diameter (N13:21), but perhaps averaging around 30mm in diameter (N13:09) and set in a matrix described as dirty pink clay, gravel chips, charcoal and off-white mortar. Like the cobbling further west this surface also lay directly beneath the extensive grey clay layer (N13:03), which would imply that all this cobbled surfaces were contemporary.

Perhaps associated with this road surface was a drain (N13:29) which ran on an east-west alignment c. 4.50m south of the *praetorium*. Only the line of

large flagstones capping the drain was exposed, the largest being up to 1m in length and 0.60m wide, the majority being rather irregularly shaped. These were apparently level with the surrounding cobbling (N13:09) – the cobbles and capstones were described as ‘abutting’ one another – and were likewise covered by the later grey clay layer. In places a second, upper capstone was noted over the lower one. A seven-metre length of this drain was uncovered, but neither its origin nor its destination was evident. A further possible section of this channel, consisting of two upright stones belonging to the sidewalls, was seen on the same alignment 7m further west, in the bottom of the robber trench for the west wall of Building BA (M13:12). The context record for the drain indicated it ran from west to east, suggesting it must have continued eastward to join the drain which ran down the east side of *praetorium* along the edge of the *intervallum* road, and also equated it to context M12:40, the flagged base of flue M12:70. It is clear that, when first excavated, flagstones M12:40 were interpreted as a drain outlet from a bath suite in the south range of the *praetorium*, their function as the base of the flue designed to fire the east hypocaust not yet having been recognised. Hence the original interpretation could simply be discarded altogether. However, site plan P175 shows that the flagstones M12:40/70 extended in excess of 2.50m from the south wall and it is clear that the full length of these flags was not revealed. Moreover the southernmost flagstone, although not fully exposed, does appear to differ in its alignment from the adjoining slabs to the north, adopting a more NW-SE orientation towards the remains of drain N13:29. Examination of the site photographs suggests there may have been voids beneath the slabs of M12:40/70, although there is no sign of drain side walls in section in the sides of the modern sewer pipe cuts. Thus it is possible that an earlier drain outlet was reused to form a flue, even if a direct connection between the separate elements of the drain outflow was not revealed to substantiate this. Presumably, if there was once a corresponding system of drains in the interior of the south range, which fed into the outlet, this was destroyed when the east hypocaust was constructed.

Certainly if drain N13:29 was not connected to an outlet on the site of the later flue, as suggested above it is not clear what its function might have been since no other outlet through the south wall has been identified. One alternative possibility is that it was connected to another recorded length of drain (L12:40), further to the west, which it can be seen to line up with on the site plans. This drain (which was also interpreted as a outlet drain for the *praetorium* bath suite) had been partially robbed out (L12:18, 36) at a much later stage, but part of the north sidewall and a line of large sandstone flags forming the base of the structure survived, enabling its course to be

traced for a distance of around 7m from the later yard wall westward. The robbing obscured some of the drain’s relationships to adjacent levels. In particular, there is no record of its relationship to the extensive clay deposit (L12:14 etc – see below) which covered the entire area south of the *praetorium* during the next phase (equivalent to Building 13 Phase 3) and generally provides a clearly defined horizon between the different phases there. Nevertheless, there are strong grounds for arguing that, in the form recorded, drain L12:40 belonged to a later phase, perhaps contemporary with Building AZ (see below). Despite this, it is conceivable that the slabs at the bottom of this drain, which were traced for a distance of 2.15m towards the east end of L12:40, were actually the cover slabs of an earlier phase of drain, associated with N13:29. If this were the case drain N13:29/L12:40 (lower slabs) might simply have functioned as a storm-water drain carrying away rain water on the north side of the *via quintana*, or perhaps outlet channel M12:40 and drain L12:40 were both connected to N13:29 in Phase 1, but the equation between the lower slabs of L12:40 and N13:29 is obviously even more tentative than that between M12:40 and N13:29 and no firm conclusions can be drawn.

Phase 2 (contemporary with Building 13 Phases 3 + v) – Fig. 9.37

The yard

The next structural phase was manifested by the construction of a walled yard attached to the south side of the *praetorium*. Only the west wall (K12:05, K13:08, L12:27) of this yard survived, and formed an extension of the west wall of the *praetorium*. The junction with the south-west corner of the *praetorium* was damaged so it is not clear whether it formed a simple butt joint which would point to it being a secondary addition. (The east face of the yard wall could be seen to butt against *praetorium* south wall, but the west face was destroyed at the relevant point, so might conceivably have formed an alternate butt joint like many of the joints in this building, in which case it could have been a primary structural component.) Moffat considered the yard was secondary, belonging to Phases 3i–ii, and contemporary with the use of the external stokehole (M12:70) through the south wall of the *praetorium*. The yard wall extended at least 8.30m southward from the *praetorium* (its south-west corner did not survive) and was c. 0.65m wide. For the most part only a single course of masonry remained. Nevertheless two distinct structural phases were evident in the extant fabric. Towards the northern end of the wall, the existence of an area of 1.00m wide sandstone slabs (K12:10), beneath the surviving course of masonry, suggested that the original entrance lay here and was later blocked. This was confirmed by the survival of two stones immediately

to the north of the flagging, which evidently belonged to the original east face of the wall and followed a slightly different alignment from the masonry of the rebuilt wall above.

The yard was presumably also enclosed on its south and east sides as well, but no definite traces of walling remained on either of these sides. The east wall most probably continued the alignment of the *praetorium* east wall, virtually all Roman levels having been destroyed by later disturbance on this side of the building. The position of the south wall is more difficult to estimate, but it may well have lain in roughly the same position as the south walls of Buildings AZ and BB, on the north side of east-west drain K13:04/L13:31. Its remains were perhaps removed when those buildings were constructed.

Phase 3 (equivalent to Building 13 Phase Ⓓ – vi) – Fig. 9.37

A layer of grey silty clay loam (L12:14, L13:38, M12:38, M13:24, N12:69, N13:03) covered the entire area south of the *praetorium*. This was described as olive green-grey (N13:03) in colour or mid-grey with a slight olive tinge (L12:14), and fairly intense concentrations of charcoal were noted in places (M12:38). The clay loam was seen to ride up against the walls of both the square and the semi-circular apses (L12:23–24; M12:08) and the stoking flue wall (M12:09) and the east face of the yard wall (L12:27), as well as the south wall of the *praetorium* (L12:10, M12:07), indicating that its deposition post-dated the building of those structures. It was overlain by the floor levels (L13:15, 20) and clay packing (L12:19, 27–8) associated with Building AZ.

Perhaps contemporary with the deposition of the silty clay loam over the interior of the yard, the original entrance through the west wall was replaced by a new one just to the south. This was marked by a line of flags or footing slabs, each 0.35–0.55m wide and up to 0.75m in length, where the wall had previously stood, whilst, immediately to the east, a series of large slabs (K12:09, K13:07) furnished with pivot holes and a raised flange along the surviving west and north edges. The raised moulding along the edge of the slabs probably served as a sill. One pivot hole was located in north west-corner of the most northerly of these slabs whilst part of another hole may have been preserved at the corresponding corner of the most southerly slab, which did not however survive in its entirety to provide definitive confirmation. This would suggest the width of the doorway was c. 2.45m. The eastern edge of the moulded slabs was fairly irregular and it is uncertain whether they originally extended further eastwards or were perhaps reused from an earlier structure, but even so their elaborate quality may be a reflection on the nature of the activities in this yard area, implying that it was not simply the focus for minor ancillary service functions.

FINDS

Clay over yard south of Building 13

Decorated samian: late Antonine (no. D103, L12:14)

Graffito: lead seal (no. 1, N13:03)

Coin: Titus under Vespasian, 76 (no. 17, L12:14)

Pottery: counter (no. 56, N13:03)

Dating evidence

The clay loam layer (N13:03, L12:14 and M12:38) produced a third-century assemblage consisting of 89% BB2 and allied fabrics, and including Nene Valley ware and a Gillam type 151 cooking pot. There were also two sherds from a flanged bowl and a closed form in Crambeck reduced ware, of the late third century or later.

Discussion – Phase 3

Moffat considered that the grey silty loam deposit represented a distinct phase in the use of the yard, however the deposit is somewhat puzzling in this regard. It cannot be explained by natural build up and it did not resemble stoking debris – there was no reference to significant quantities of coal or ash for instance, though fairly intense concentrations of charcoal were noted. Moreover it extended right across the yard. One possibility is that this signifies the conversion of the yard area to a walled garden for the commander's household. This would have occurred at some point after the external stoking area went out of use and the various apsidal additions to the bath suite had been made, and could explain the degree of elaboration exhibited by the stonework of the secondary entrance. The blocking of the first doorway through the west wall and its replacement by one further south, furnished with moulded stone sills and pivot holes for the gates, could therefore mark the point at which the activities being undertaken in the yard changed from stoking, and perhaps other ancillary functions which have left no trace, to the private relaxation of the commander and his household. It must be admitted, however, that the clay does not appear to have possessed the characteristics one might expect of a garden soil – there is no reference to humic content and no trace of any kind of garden layout, such as paths or demarcated areas for plants. An alternative would be to envisage this simply as a dump of material to level up the site prior to construction of the Phase 4 buildings (AZ, BA, BB etc), in which case Phase 3 should essentially be conflated with Phase 4. The pottery assemblages from the two levels would not contradict this. The clay loam yielded a clearly third-century pottery assemblage, which even included sherds from a couple of later third-century or later vessels, whilst AZ, BA, and BB produced a late second- to third-century assemblage, with only a single sherd which was definitely third century in date.

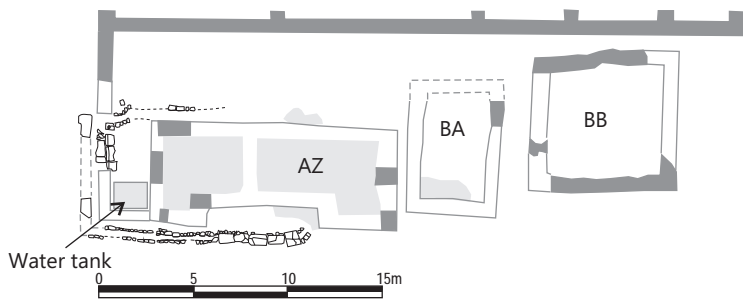

Area south of the Building 13, Phase 4 (at 1:400)

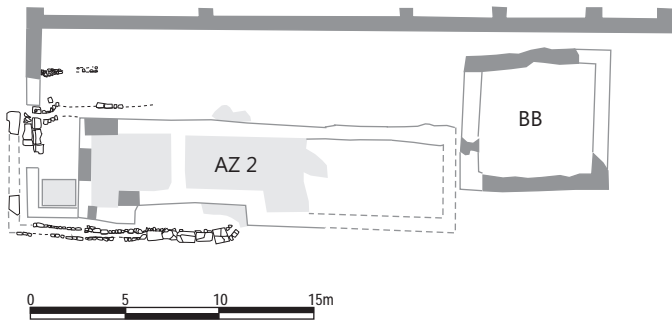

Area south of the Building 13, Phase 5 (at 1:400)

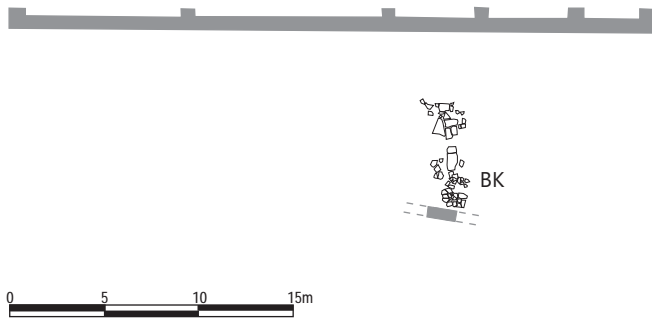

Area south of the Building 13, Phase 6 (at 1:400)

Figure 9.38: Phases 4–6 in the area south of the praetorium

Phase 4 (equivalent to Building 13 Phase δ – vi)

The next phase south of the *praetorium* was marked by the construction of three small buildings, labelled AZ, BA and BB by the excavators (Figs 9.35, 9.38).

Building AZ

This structure had a very distinctive plan. It was essentially a rectangular building, some 13m in length and c. 4.40m wide, with its long sides orientated east-west, but at either end it was furnished with a small wing which projected southward a further 1m. It thus resembled a miniature wing corridor villa. The plan was somewhat asymmetrical, however, the frontage of the east wing being broader, at around 4m, than

that of the west wing (c. 3m). A cross-wall roughly midway along the length of the building divided it into two rooms. The outer walls had almost entirely been robbed out, but definite fragments of masonry survived at several points along the east (M13:21), west (L13:08), north (L13:18) and south (L13:35, 39) walls and the plan of the building could be reconstructed from the course of the robber trenches which were quite distinct (L13:09, 17, 22, 21, 26, 29–30). In particular, sufficient masonry belonging to the projecting ‘west wing’ remained – especially its internal facing – including the junctions between its southern ‘frontage’ and its east and west walls (L13:35, 39), plus the adjoining section of the south wall associated with the central recessed section, to leave no doubt regarding the essential validity of the building’s unusual plan. The width of the walls could only be gauged precisely in a few places, where both faces survived, but was surprisingly variable ranging from 0.56–0.58m in the case of the west wall (L13:08), through 0.68m (west wing south wall – L13:35) up to c. 1.05m for the east wall (M13:21). The anomalous size of the latter might imply its masonry had been displaced and spread by later disturbance. (By comparison the recorded width of robber trenches generally varied between 0.60m and 0.80m.) The walls were constructed of the usual dressed sandstone facing stones, but little core remained and it was unclear whether they were mortar- or clay-bonded. They were not provided with clay or rubble foundations, a point confirmed by the shallow depth of the robber trenches – generally no greater than a single course of masonry (c. 0.20m: L13:09, 21; the north wall robber trench (L13:17/22, M13:07) did cut deeper 0.30–0.45m) – which exposed the grey clay loam of the previous phase, upon which the walls sat.

Deposits of pink or pinkish-grey plastic clay were packed around the outer face of the building at various points and were originally probably more extensive. The deposit packed against the north wall (L13:19) was c. 0.20m deep and 0.50m wide, whilst that found in the angle between the east wing and the central section of building (L13:27) was up to 1.15m in width and probably once filled the entire space between the two projecting wings, the section further west having been removed by an area of modern disturbance (L13:37). A further deposit, in front of the west wing (L13:28), was 0.35–0.40m wide, filling the area between the façade of the west wing (L13:35) and drain L13:31. The purpose of all this clay packing was uncertain, but it was clearly a deliberate feature of the construction.

The east room was floored with *opus signinum* (L13:20, M13:17). This was composed of red mortar and small tile fragments set on a layer of buff grey mortar with sparser but larger tile fragments 0.08m thick. The buff mortar did not appear to form a

worn surface and was interpreted as a base for the *opus signinum*. The floor level was as much as 0.20m thick overall, but this varied, the surface being very broken up probably as a result of post-Roman disturbance. On site plan P214 the *opus signinum* is shown extending across the line of the building's east wall (M13:21) towards its north end, a relationship explicitly confirmed by the context records where it is noted that that wall M13:21 was sealed by a patch of *opus signinum*. This might imply the presence of a doorway at this end. Two small patches of *opus signinum* were also recorded in the west room, in its south-east corner and in the middle of the projecting wing, overlying a c. 0.15m deep deposit of mixed creamy mortar (L13:15) which extended across the entire room. The excavators suggested that this mortar layer represented the sub-floor base for an *opus signinum* floor similar to that in the east room. A large patch of the underlying clay loam deposit (L13:38) was exposed near the centre of the room suggesting the truncation of Roman levels caused by modern disturbance was more severe in this half of the building and had removed virtually all the *opus signinum* here.

A block of small tiles (L13:42), each up to 0.18–0.20m square (including one stamped COH III L – stamped tile: no. 7 in the catalogue), was present in the centre of the room. The surviving east and north edges of the tile block were aligned parallel with the building's walls, implying it was the surviving in situ fragment of a larger, deliberately constructed feature of uncertain dimensions (0.80m square is stated in the context record, but this is not evident on site plan P170). The tiles were bonded together with red mortar and set in the buff mortar base layer, with a skin of *opus signinum* extending over them, at least partially. The uppermost tiles – presumably those not covered by the *opus signinum* – were seen to be cracked by heat, suggesting the feature may have formed a hearth of some kind. In the context database compiled by the excavators this feature is assigned to the preceding phase (3), the assumption being that the mortar and *opus signinum* (L13:20) were laid over this pre-existing hearth, which went out of use when AZ was constructed. However, its function as a hearth is much more comprehensible if it was located in the interior of Building AZ – serving to heat the east room – than if it was simply sitting on the grey clay loam deposit (L13:38 etc) in an open yard. Moreover the manner in which its sides paralleled the wall alignments of AZ gave the clear impression it was laid out in relation to that building. In the discussion of Phase 5 (the remodelling and extension of AZ), below, the possibility is noted that the mortar and *opus signinum* represented two distinct floor levels, associated with Phases 4 and 5 respectively. If it is assumed that the tile hearth was set into a mortar floor associated with the initial stage of AZ and only later

covered over by the *opus signinum* when the building was substantially altered and the hearth went out of use in Phase 5, the hearth's structural context would be much more intelligible.

Water tank

On the west side of AZ, right beside the south-west corner, a rectangular foundation deposit (K13:16, L13:11) was laid, composed of pale pink plastic clay, 0.20m thick and measuring 2.00m east-west by 1.45m north-south. A layer of gritty off-white, creamy mortar (K13:15, L13:10), c. 70mm thick with some tile inclusions, was deposited on top of the clay and measured 1.75m east-west by 1.25m north-south. The two deposits clearly formed part of a single structure, the surface of the clay being recessed to take the mortar. The raised lip of clay, which bounded the mortar on every side, was visible on the surface as a c. 10mm wide pink strip, even on the east side, between the mortar and the adjoining west wall of AZ. The combined feature was interpreted as the base and mortar bedding for a small rectangular structure, most probably a water tank. Another spread of pink-grey plastic clay (K13:10, L13:13), was positioned 0.85–0.95m further north and again directly abutted the west wall of AZ. This was some 0.30m deep and was more irregular in plan than southern base, measuring a maximum of 1.30m east-west by 1.50m north-south. The clay used in these bases was similar to the somewhat narrower deposits packed around the other sides of AZ at various points (see above). The area between the bases was filled by a 50–70mm thick deposit of *opus signinum* (L13:16) which was rather broken up and did not have the appearance of a convincing surface, with some pieces lying on their edge. Consequently this was interpreted by the excavators as rubbish dumped in the space between the two bases. This in turn was covered by a layer of brown silty clay loam and sandstone rubble (L13:12).

On its west side, the water tank must have virtually abutted the yard wall. Daniels and Moffat considered the yard wall was redundant and therefore probably demolished at this stage. However the manner in which the course of the drain to the north of AZ (L12:40) deviated to pass through the yard gateway implies that the west wall was still standing (see 'Drains and conduits' below). The water tank would thus have fitted snugly between the yard wall and AZ and it is conceivable that it was also enclosed by the yard on its south side. Flagstones recorded here might represent footing slabs for the south wall, similar to those used on the west wall, and it is possible the stretch between the south-west corner of the yard and AZ was retained and rebuilt to butt neatly up against the south-west angle of AZ. If the more northerly clay spread (K13:10, L13:13) attached to AZ was also the base of a water tank that structure would partially have obstructed the yard entrance

(although it would not have completely blocked it). However it is far from certain that clay spread K13:10/L13:13 did perform the same function as rectangular clay/mortar base K13:15–16/L13:10–11. The clay spread was much less regular or carefully constructed than the rectangular base and indeed more closely resembled the clay spreads packed around the other sides of AZ at various points, notably that on the north side (L13:19), which was 0.20m thick and equally irregular in plan, measuring up to 2.20m east–west by 1.00m north–south. These irregular clay spreads were presumably related in some way to the construction of AZ or perhaps provided bases for smaller structural features attached to the building.

Building BA

Another building, which Daniels labelled BA, lay c. 0.55m to the east of AZ and was probably contemporary with it. This area, extending eastward from AZ, had been cut by numerous sewer pipe trenches and other modern intrusions, which had severely impacted upon the remains of BA. Nevertheless the building appeared to have a much simpler layout than AZ, taking the form of a rectangular building, measuring c. 7.50m by 5.00m, externally (perhaps 5.80m by 3.50m internally), with its long axis aligned north–south. Only fragments of the masonry of the east (M13:14) and west walls survived, the rest of the walls having been robbed out or destroyed by later intrusions. Whilst all but three internal facing stones of the west wall (no context number assigned) had been robbed, the east wall was a little better preserved, with both faces surviving at one point, establishing its width as 0.70m. It was set on foundations composed of large, faced sandstone rubble, packed and bonded with buff yellow mortar. Where no masonry remained, the presence of distinct robber trenches meant the course of the west wall (robber trench M13:12) and the inner face of the south wall (trench M13:20) could be traced with reasonable accuracy. In the case of the north wall, however, even the remains of the robber trench had been entirely obliterated (by colliery drain trench M13:05/06) so that wall's position could only be estimated approximately. A layer of makeup, comprising a spread of buff-coloured mortar and stone in a grey silty loam matrix (M13:10), was apparently present right across this area. It was exposed at various points in the northern half of the building interior, also extending beneath the west wall, and filling the narrow alley between AZ and BA, to judge from the evidence of site plan P214. In the south-west corner, a block of pale yellow brown clay (M13:19) was interpreted as a surviving remnant of a possible floor. However no direct stratigraphic relationship between the makeup and floor was recorded. An area marked in red on site plan P214, immediately to the north of clay M13:19, may represent burning, perhaps marking the site of

a hearth, though this is not referred to in the context record.

Building BB

A third building in the row south of the *praetorium* lay to east of BA. This structure, which was labelled BB by the excavators, differed from both AZ and BA, the lack of uniformity being one of the characteristics of the buildings in this area. Indeed it was sufficiently different for the excavators initially to suggest that it belonged to a later phase than AZ and BA (though it clearly preceded the overlying BK). It was roughly square, but a little irregular in its layout, the slightly longer east–west dimension, measuring between 8.00m and 7.80m externally (being wider along its southern face), whilst the north–south external dimension ranged between 7.15m and 7.50m (being wider at the eastern end). Only certain stretches of the wall foundations remained, cut into the grey clay loam of the preceding phase (N12:69, N13:03 etc.). These comprised substantial lengths (6m and 6.80m respectively) of the north and south walls (N12:43, N13:28; N13:12), including the north–west and south–east corners with a short adjoining length of the east wall, and a very short (0.90m) section of the west wall (N13:13) exposed beneath the remains of the later building, BK. They were composed of angular sandstone rubble of varying size, colour and character, including some reused facing stones, and their width varied between 0.45m and 1.10m, but averaged 0.65–0.70m. No coursed masonry belonging to the superstructure survived, nor did any clay or mortar packing or bonding material remain in association with the north or south foundations, although the rubble of the west foundation was said to be set in fairly clean, brown, silty clay loam. The position of the building was offset to the north in relation to AZ and BA, its south wall being set some 2m or more behind the projected line of the corresponding wall of BA. The north wall foundations (N12:43, N13:28) marginally overlapped the southern face of the stone



Figure 9.39: Stone base/buttress N12:45 overlapped by the foundation of the north wall Building BB, from the west.

buttress or base (N12:45) which was attached to the south range of the *praetorium* and which itself probably overlay the grey clay loam deposit of Phase 3 (Fig. 9.39). Nothing survived of the interior levels, only the underlying grey clay loam being exposed, and there were no clues as to the function of the building.

Drains and conduits

A stone-lined, flag-floored drain (L12:40) ran from east to west along the north side of Building AZ (see above for discussion of the possibility that the flagged floor of L12:40 might represent the western branch of primary stone drain N13:29). This had been extensively robbed (L12:36) and there was some confusion in the context records between the robber trench for the drain itself and that of the north wall of AZ (L13:17, 22), but the site plans show that the two were distinct structures, albeit occupying closely parallel courses. In addition to the large sandstone flags, which formed the base of the structure at its eastern end, part of the north sidewall was preserved to the west of the flags. At the north-west corner of AZ, the drain turned south, before almost immediately turning west again to cut through the flagging of gate sill K12:09/K13:07 in the yard wall, both sidewalls surviving at this point. This deviation around the corner strongly suggested that the drain was laid out with respect to AZ and therefore post-dated it. It might also imply that the yard wall was still standing when the drain was constructed and was taken though the gateway for convenience. Where both sidewalls survived, the channel could be seen to be 0.30–0.40m wide. Only a single course of the walls remained at any point and it is not clear that they ever stood any higher. The conduit was interpreted as an outlet from a bath suite in the south range of the *praetorium*, but no outlet contemporary with this phase could be traced through the *praetorium* south wall to link up with drain L12:40, so the suggestion must remain conjecture.

After passing through the yard entrance, the east-west drain, L12:40, may have either turned sharply southward or connected to a pre-existing drain which ran north-south along the western edge of the alley separating the *praetorium* and the *principia* (Alley 7). The existence of a drain which followed this course is suggested by two large, isolated rectangular slabs (K12:17), measuring 1.25m by 0.70m and 0.90m by 0.70m, which were uncovered 0.25–0.30m west of the yard wall. The more northerly slab exhibited a lot of cracking. These may represent cover slabs and mark the position of a drain which ran from north to south, alongside the yard wall, and fed into the east-west drain K13:04/L13:31 to the south of the yard. The slabs were overlain by the penultimate surviving road surface in the alley (K12:06), which was largely left in situ, and consequently the full length of the drain was never traced by exposing

more cover slabs nor was either of the slabs lifted to confirm that they were indeed covering a drain. Hence, it is unclear whether the cover slabs formed part of a much longer, pre-existing drain, which ran down the west side of the *praetorium*, and into which L12:40 subsequently connected or whether L12:40 and K12:17 simply represent different sections of the same drain, constructed during Phase 4. The attribution of drain K12:17 to a particular phase is therefore somewhat uncertain.

To the south, a stone-lined drain (K13:04, L13:31) ran from east to west. Both side walls consisted of four courses, the height of the north wall being recorded as 0.55m. It was noted that the uppermost course was composed of much smaller stones than the courses beneath suggesting that this might indicate a secondary heightening of the drain, but its construction was noticeably less neat than the primary road drains. Two of the stones used in the sidewalls had pivot holes cut in them. The channel was 0.28m wide and was traced for a distance of c 12m, appearing to turn northward at its very eastern end towards the south-west corner of the east 'wing' of Building AZ. It was not traced beyond that point and it is unclear whether it originally continued further to the north-east beneath AZ. At its west end it probably connected to the north-south drain (K12:17), which ran down the east side of the alley separating the *praetorium* and the *principia*. It certainly extended westward across the line of K12:17. Towards its eastern end, a 4.50m stretch of the drain's cover slabs remained in situ. These consisted of five large rectangular or square slabs of fine-grained micaceous sandstone, all of which were cracked through wear up to 1.00m long and 0.75m wide and between 50mm and 120mm thick. A deposit of silt (K13:06) was present in the bottom of the drain channel beneath an upper fill of olive-grey, silty clay loam (K13:05). At a much later stage, during the modern era, a dog was buried in the western end of the drain (K13:02), which resulted in the removal of a 1m length of the southern sidewall (the date is indicated by the coaly fill and the presence of a sherd of blue-and-white striped china and other modern finds).

Both the function and phasing of this drain are problematic. It may have been designed to take rainwater flowing off the roof of AZ, but it is not certain that the course of the drain was investigated with sufficient thoroughness to exclude the possibility that it originally extended beneath the site of AZ and was related in some way to activities in the south range of the *praetorium* (bath suite outflow?), particularly if it began life before the construction of AZ. The difficulty in phasing the structure is a result of some confusion and contradiction in the recorded relationship of the drain to the *via quintana* road levels on either side of it (L13:32–34). On the north side, the top of the sidewall was at same level as surface

L13:32, composed of worn river cobbles, which was interpreted as a primary road level. This cobbling was apparently seen to extend beneath the grey clay loam deposit (L13:38 – see above Phase 3), the north wall of AZ and adjacent pink clay dump (L13:18, 19) and the robber trench for the west wall of AZ (L13:09). On its south side, however, the top of the sidewall was level with worn road cobbling L13:34, which was assigned to Daniels Fort Phase 3 and considered to relate to Building AZ, whilst the uppermost layer of *via quintana* road cobbling (L13:33), which survived in places over L13:34, particularly towards the eastern end of the drain, was reportedly level with the drain's capstones or slightly higher in places. This last layer was regarded by the excavators as contemporary with the secondary alterations to the *contubernia* of Chalet Range 12 to the south, on the opposite side of the *via quintana*. No road levels beneath L13:32 or L13:34 were exposed. On balance, given the inference, albeit tentative, in the context record, that the height of the drain side walls was raised after their original construction, it does seem likely that the drain originated before Building AZ, perhaps when the yard enclosure wall was erected, but it clearly continued in use throughout the life of AZ. It is uncertain how late in the Roman period the drain went out of use and was backfilled or allowed to silt up completely (K13:05).

FINDS

Soil and mortar debris south of the praetorium and NW of BB

Glass: window (no. 42, N12:13)

Graffiti: (nos. 21, 36, both N12:13)

Coin: illegible second or third century (no. 254, N12:13)

Building AZ

Stamped tile: *cohors IIII Lingones* (no. 7, L13:42)

Building BA

Copper alloy: folded sheet (no. 297, M13:10)

Dating evidence

Buildings AZ, BA and BB

The buildings produced less than 50 sherds of pottery in total. Only the make-up layer in BA (M13:10) produced pottery that need be third-century in date: a single sherd of Nene Valley ware.

Rubble makeup over clay L12:14, south of Building 13

The make-up produced a few sherds of second-century greyware, a sherd of Hadrianic or early Antonine samian, and a scrap of Antonine or later samian (L12:33)

Discussion – Phase 4

The excavators' reconstruction of the layout of AZ, as set out above, is reasonably convincing, despite its unusual plan, being based on the evidence of clearly identifiable robber trenches and short but crucial surviving fragments of wall masonry, plus extensive floor deposits, which together marked the outline of the building. To the east of AZ, however, the evidence is much more fragmentary and the interpretation correspondingly more tenuous, the area being sliced up into small pockets of stratigraphy by a maze of modern drain trenches. Although the scheme proposed by Daniels is the most plausible and straightforward restoration of the structures in this area, based on the remains recorded, it is distinctly possible that crucial evidence, which would alter our understanding of their development, has been removed in its entirety as a result of this modern disturbance. What is clear, however, is that the buildings in this area were stone-walled structures and were a rather disparate group in terms of floor plan and proportions. Thus they certainly do not resemble the row of timber buildings (Row 20) inserted to the south of the granary and over the hospital, in the western part of the central range. The latter were constructed with clearly defined post-holes and at least some of which appear to have been furnished as stable-barrack *contubernia*, housing both cavalrymen and horses (see Chapter 6). In addition to the lack of ancient postholes and the contrasting survival of unmistakable fragments of masonry walling, none of the three buildings south of the *praetorium* yielded any traces of urine sumps or drains designed to cope with the waste from the cavalry horses, of the kind revealed in *retentura* cavalry barracks and some of the timber buildings. Hence, although BA may be similar in size and proportions to one of the detached chalet-barrack *contubernia* the same is not true of its two neighbours, and there is no compelling evidence that, as a group, they represent another row of such structures, associated with Chalet Range 12 on the opposite side of the *via quintana*, for instance. It is noteworthy that the fragmentary remains of another small, stone-walled building (given the label BL) are shown on one of the site plans (P255), immediately to the south of the headquarters (in grid square J12 – this is not otherwise noted in the research archive). This may be similar to AZ, BA and BB, and it is possible that the placing of small ancillary structures behind the major buildings of the central range was one of the characteristics of Segedunum in the third century (see Chapter 8 above for a more detailed description of BL).

Phase 5 (Fig. 9.38)

Building AZ Phase 2

One anomalous feature which deserves attention

is the robber trench for the north wall of AZ which clearly continued (as M13:07, 09, N13:18) beyond the eastern end of that building, across the full width of BA as far as the west wall of BB (N13:13). The logical implication is that this marked the course of an eastward extension of the north wall of AZ (L13:18). Moffat suggested that this reflected a remodelling of this row which brought about the amalgamation of AZ and BA. This remodelling was probably somewhat more drastic than the term amalgamation might suggest, however, involving the complete demolition of BA and the extension of AZ across the southern part of the former building as far as BB. The robber trench may have impinged on the west foundations of BB (as N13:14 – a pocket of small, mortar bonded sandstone fragments at the end of the trench, adjoining foundations N13:13), but the robbing of the extended north wall and the removal of the superstructure of BB meant there was no means of ascertaining the relationship between the enlarged AZ and BB. Consequently it is not clear whether BB continued in use during this phase or was abandoned.

The remains of a flagged floor (M13:25) associated with the extension of AZ was found to the south of the robber trench. This was equated by the excavators with the floor of the later Building BK (N13:04), immediately to the east, however the evidence of both site photography (see Fig 9.42) and site plan P172 – which marks a line of hachures between M13:25 and N13:04 – shows that flagging M13:25 was at an appreciably lower level than the stone floor of BK and this equation should be rejected. Significantly, the lower flagging did not extend north of the robber trench, but did extend across the line of the former east wall of BA, with one or two of the wall's stones being incorporated in the surface. It is unclear how the south wall was treated in the extension of AZ, i.e. whether it continued the line of the original east wing frontage or that of the recessed central section. It was noted above that the *opus signinum* floor (L13:20, M13:17) in the east room of AZ appeared to extend across the line of the building's original east wall, and it was inferred that this might mark the position of an end doorway. Alternatively, however, it might signify that there were actually two floor layers here, associated with the different phases of AZ. If the mortar layer beneath the *opus signinum* was a separate floor surface, rather than being bedding for the *opus signinum*, as suggested by the excavators, it might belong to the initial phase of AZ (AZ 1), whilst the *opus signinum* floor might have been laid after the original wall was demolished and the building extended (AZ 2). This could also explain why the suggested tile 'hearth' (L13:42) was covered by *opus signinum*, if it was associated with the initial mortar floor and went out of use when the *opus signinum* was laid.

Tegula drain

An unusual feature noted in the space between the *praetorium* and Building AZ might also belong to this phase. This took the form of a line of *tegulae* (K12:08, L12:08), some 0.31m wide, laid end to end with their flanges upward. In its surviving state this structure appeared to cut through the remains of the former yard wall (although this point was obscured by a nineteenth-century drain cut) and was traced eastward for a further 3.40m. The *tegulae*, which were originally complete, were packed or revetted on either side with a line of stones or additional tiles, giving the feature an overall width of 0.60m, and were set into the layer of rubble and mortar (make up?) (L12:33) which covered the grey clay deposit in this area. Although the tiles were shattered in pieces and displaced vertically a little by later disturbance, this had not disarticulated the basic structure nor had it removed the broken pieces from contiguity with the pieces to which they were joined. This feature, too, was interpreted as a drain. Its course may then have turned sharply southward and continued alongside the former yard wall. A 0.30m wide gully (K12:16, K13:03), cut into the alley road surface (K12:06) and filled with a mixture of sandstone cobbles and some brick in a very dirty soil matrix, is shown beginning at the point where the line of *tegulae* cut through the remains of the yard wall by one of the site sketch plans (K12 fig 1, cf. K13 fig 1). The fill was considered by the excavators to be modern. Perhaps the line of *tegulae* originally continued southward to feed into east-west drain K13:04/L13:31 and this stretch was robbed out for reuse during the colliery period.

FINDS

Dating evidence

The *opus signinum* floor level (M13:17) in AZ may be associated with this phase rather than the preceding one (see Phase 4 above). It produced a single piece of pottery, a small sherd of BB2.

Phase 6 – Building BK (Figs 9.40–9.42)

The survival of a small pocket of higher stratigraphy over the western end of Building BB provided evidence for a further structural phase, the latest that could confidently be attributed to the Roman period in the area south of the *praetorium*. The phase was represented by the fragmentary remains of another building, labelled BK. The site photographs (B63/08, B64/03a) show that a significant depth of deposits separated the flagstones associated with the floor of AZ 2 (M13:25) from the surviving remains of BK. These deposit(s) included a layer of mortar and rubble debris (M13:13) which was explicitly described as overlying flagging M13:25. This was probably equivalent to the 'stone and mortar spread', N13:19,



Figure 9.40: Area south of the praetorium, Phase 6 – Building BK. Scale 1:200.



Figure 9.41: General view of the remains of Building BK south of the praetorium with cover slabs of primary (?) Drain N13:29 visible at a lower level to the left and Chalet rang 1 *bey nd*.

in the adjoining grid square, which appears to have underlain the remains of BK, on the evidence of sketch plan N13 fig 1, and a supporting inference



Figure 9.42: The remains of Building BK viewed from the north. The lower flags in the right background were associated with the second phase of AZ (AZ 2). Drain N13:29 cover slabs can be just seen in the left foreground.

from context record N13:04 (the flagged floor of BK). To the north, beyond the robbed out north wall of AZ 2 (M13:07, 09, N13:18), a mixed level of brown, sandy loam, with pockets of pink/orange plastic clay, sandstone chips and off-white sandy mortar pieces (N13:20), was noted on the sketch plan and appears to have occupied the equivalent level to M13:13/N13:19, extending beneath the remains of BK. The rubble and mortar deposit should probably be interpreted as debris associated with the demolition of AZ 2, whilst the mixed sandy loam to the north of the remains of AZ 2 was probably a makeup layer to provide a level platform for the new building.

A worn, flagged floor (N13:04), composed of fine-grained sandstone slabs averaging 70mm in thickness, some of which were laminated and flaking badly when excavated, was set on top of the demolition and makeup deposits. This flagging extended some

5.75m from north to south and c. 2.30m from east to west at its widest point. The southern edge of the floor was bounded by a wall (N13:27), c. 0.65m wide, only a 1.60m length of which remained. This wall occupied roughly the same alignment as front walls of the projecting wings of AZ, and hence lay around 1m south of the corresponding wall (N13:12) of Building BB. It should be emphasised that this structure may represent only a small surviving fragment of a potentially much larger building or range of buildings, forming part of a wholesale remodelling of the area along the south side of the *praetorium*, all other trace of which has been swept away by post-Roman disturbance. In view of the very incomplete nature of its plan no interpretation of the building's function can be presented.

FINDS

Upper flagging

Architectural stonework: armchair voisoirs (nos 13, 15, N13:04)

Dating evidence

The only pottery recovered from BK was a single sherd of a BB2 bowl or dish from the layer of mortar and rubble debris (M13:13), which is obviously insufficient to give any idea how much time elapsed between the building of the three third-century structures (AZ, BA and BB) and the construction of BK over their remains.

Robbing (late Roman/post-Roman?)

The walls of AZ and BA were all substantially robbed out with only short stretches of masonry remaining. The rubble foundations of BB, on the other hand, do not seem to have been robbed though here no masonry whatsoever survived and it is possible that the rubble was not considered worth the effort of removing. A short length of walling associated with the later BK did remain, but the too little of this building survived to form any overall judgement regarding the degree to which it had been robbed or not. The robber trenches relating to AZ (L13:09, 17, 21–22, 26, 29–30, M13:07, 09, N13:18) and BA (M13:12, 20) were all cut down from the uppermost of the surviving Roman levels. At its eastern end, the trench relating to the extended north wall of AZ (N13:14, 18) appeared to cut through the flagged floor of BK (N13:04), indicating that the robbing post-dated the construction of the latter building. The fills of the robber trenches were generally composed of mixed grey silty clay loam or sandy silt with much mortar small stones and rubble and were very similar to the fills of the robber trench for the drain north of AZ (L12:18, 36). A couple of the contexts are described as 'mixed greyish-black soil ...' (N13:18) and 'mixed fill

with black silt matrix' (M13:12) there is no reference to coal or brick, or other obviously modern debris, as the excavators noted. The trenches might therefore reflect robbing later in Roman period or perhaps in the medieval or early modern eras, before the colliery was established on the site in the late eighteenth century.

FINDS

Robber trenches

Decorated samian: 115–45? (no. D132, L13:21)
Glass: cup or bowl (no. 20, M13:07)
Coin: Valens, 364–75 (no. 227, M13:12)
Copper alloy: stud (no. 281, L12:18)

Dating evidence

Robber trenches

The robber trenches produced about 33 sherds of Roman pottery, one sherd of French Bellarmine, perhaps second quarter of the seventeenth century, and a scrap of possible nineteenth/early twentieth century pottery. The post-Roman pottery came from the robber trench of the north wall of AZ (M13:07), and also contained a high proportion of Roman sherds covered in mortar (M13:07, M13:09). There was no late material amongst the Roman pottery, but M13:12 produced a coin of Valens dated 364–75 (cat. no. 277).

Unfortunately it must be doubted whether all the post-Roman material from across the site was retained by the excavators (especially the clay pipes). Of the two post-Roman sherds preserved in this group, one was presumably thought to be Roman as it was with the Roman pottery and the other is an easily recognisable post-medieval type. Indeed, it is quite possible that not all the Roman pottery was preserved, either, as one context has three sherds of samian and no coarse wares, a suspiciously unbalanced group.

Roads

Alley 7

Only the uppermost surviving road levels were exposed at the southern end of Alley 7, beside the yard wall. A surface (K11:08, K12:06) composed of small well-worn river cobbles, 30–120mm in diameter, was recorded in grid squares K11, K12 and K13 and assigned to Daniels' Fort Phases 3–4. This incorporated a couple of large slabs (K12:27) which probably formed part of a north south drain, running along the west side of the yard wall K13:08. At its northern end this drain may have been fed by an east-west conduit (L12:40), which passed through the secondary yard entrance to connect with it, whilst at its southern end, K12:17 may have fed into another east-west drain (K13:04, L13:31). The fact that only a couple of cover slabs were visible in the alley surface indicates that the metalling belonged to a later phase and had been laid over the drain. In grid squares K12 and K13 the alley cobbling was partially overlaid by a further level

of mixed cobble, rubble and brick and tile (K12:02), which was described in the context record as 'densely packed but not certainly a surface' and was reported to contain a lot of late Roman bronze coins. This might form part of a stratified road surface (the excavators subsequently interpreted it as such and assigned it to Daniels Fort Phase 4). If it was affected by post-Roman disturbance, this was not reflected in the finds assemblage retained by the excavators, since there was no surviving modern material incorporated in it.

The via quintana (Road 3)

Road metalling considered to represent the primary *via quintana* surface was recorded in two main areas beneath the later yard and buildings on the south side of the *praetorium*, being exposed from the building's south-west corner eastward alongside the south wall of the building (L12:38, M12:39) and towards the south-east corner of the building (N13:09, N13:21). A series of possible drain conduits were associated with this surface with varying degrees of confidence, most certainly in the case of N13:29. (See above Phase 1 for full discussion of the evidence for these early road surfaces and possible drains, and associated interpretive problems.)

Later levels were exposed in two areas further south. Three levels were recorded on either side of drain K13:04/L13:31, which ran along the south side of Building AZ – L13:32 to the north and L13:34 (lower) and L13:33 (upper) to the south. Both drain L13:31 and L13:32 were interpreted as primary features and allocated to Fort Phase 1 by the excavators, whilst L13:34 and L13:33 were attributed to Fort Phases 3 and 4, respectively, by Daniels, corresponding to c. 300 and the later fourth century. The difficulties in understanding the phasing of these road levels and their relationship to drain L13:31 were discussed above, under Phase 3 ('drains and conduits'). The supposed primary level (L13:32) was also noted at various points further north, in the yard, which if correct would imply that, if not primary, the cobbling was relatively early, perhaps pre-dating the creation of the yard. However, no continuous link was observed between the surface on the north side of the drain and those areas of cobbling seen in isolated pockets further north, which are not shown on any plans, so their equivalence is not certain. As regards the levels on the south side of drain L13:31, it seems best to regard them as broadly contemporary with AZ (i.e. Phases 4 and 5).

Two successive levels of sandstone road cobbling were also exposed to the south of Building BB – N13:11 and N13:10. These were also assigned to Fort Phases 3 and 4, respectively, by Daniels. However it is likely they were both somewhat earlier in date, broadly contemporary with the life of BB, perhaps associated with Phases 4 and 5 in the area south of the *praetorium*, although no stratigraphic relationships

between the two road levels and the foundations of BB were explicitly documented in the relevant context records.

FINDS

The via quintana (Road 3)

Lead: disc (no. 26, K13:18)

Alley 7

Samian stamp: mid to late Antonine (no. S11, K12:22), 160–90 (no. S65, K12:23)

Coins: Antoninus Pius, 145–61 (no. 90, L10:05), Gallienus, 258–68 (no. 141, K12:02), Gallienus?, 258–68? (no. 144, K12:02), Carausius, 286–93 (no. 171, K12:02), illegible, second or third century (no. 256, K12:02), illegible, third or fourth century (nos 268, 270, K12:02)

Copper alloy: medical implement (no 102, K12:02)

Iron: chisel (no. 26, K12:23)

Lead: disc (no. 34, L09:13)

Dating evidence

Road 3

The road (K13:05, N13:10) produced seven sherds of pottery, including a sherd of Nene Valley colour coated ware of the third century and a rim sherd from a flanged bowl of the late third century or later.

Alley 7

The small group of pottery from the rubble over the south end of the alley (K12:02) mainly consisted of BB2, but there was a sherd of Nene Valley colour-coated ware with white painted decoration, and a body sherd of calcite-gritted ware and a Huntcliff-type rim of 360+. A group of six coins came from the same context, three of which were illegible, two were probably of Gallienus (258–68) and the latest a coin of Carausius dated 286–93 (cat. nos 141, 144, 171, 256, 268, 270). There was no surviving modern material.

Conclusions: the Wallsend *praetorium* in context

As a result of Daniels' work, Building 13 represents one of the most completely excavated *praetoria* on the northern frontier. Commanding officer's houses as a whole have benefitted from a relatively greater degree of attention in recent years. Most significant, perhaps, has been the excavation and partial reconstruction of the late Roman *praetorium* in the east quadrant at South Shields (Hodgson in Bidwell and Speak 1994, 35–9; Hodgson 1996; Bidwell 1997, 57–8). Also of considerable importance was the investigation of the commanding officer's house and adjoining bath house at Binchester, now fully published (Ferris 2010), although only part of the *praetorium* was uncovered.

Again the most informative structural phases there were of late Roman date. However the immense and elaborately decorated courtyard excavated by Scott in the south-east corner of Piercebridge fort (Cool and Mason 2008) may not be so relevant. Bidwell and Hodgson (2009, 148–50) note that this was of a scale resembling the legate's palace within a legionary fortress and is without parallel in forts in Britain. They suggest it may represent the residence of a very high ranking official, perhaps erected in the pre-existing fort during the late third-early fourth century. Interestingly, a similar explanation was offered for the presence of a second courtyard house in the corner of the fort at Caernarfon (Casey *et al.* 1993, 13–14, 51–9), where a *praetorium* has already been revealed in the conventional position in the central range next to the *principia*, namely that it was built to accommodate an imperial *procurator metallarum* charged with supervising the exploitation of the mineral resources of Anglesey and north Wales. This is plausible, but it should be noted the latter building, which was first constructed in the Antonine period, is on nothing like the same scale as the Piercebridge example where the resident official must have been of altogether more elevated status.

On Hadrian's Wall, besides Wallsend itself, the best understood *praetoria* are to be found at Housesteads, which was fully excavated between 1967–9, prior to consolidation and display (Charlesworth 1975, cf. Crow 1989, 23–5; 2004, 52–4, 91–2; Peter McGowan Associates *et al.* 2002, 113–15), and at Vindolanda, similarly investigated in 1997–8 and subsequently consolidated (Birley *et al.* 1998; 1999). In chronological terms at least, the Housesteads *praetorium* is a closer parallel to Building 13, forming part of the Hadrianic layout. It is a complex structure, made all the more so by the difficult, steeply sloping nature of the site. There is evidence of a clear break in the south wall, implying two periods of construction, although any interval between these could conceivably have been relatively brief. The epigraphic evidence for a Severan rebuilding of the house has, however, been eliminated by Tomlin's revised reading of RIB 1612 (*Britannia* 37, (2006), 485–7) cf. Rushworth 2009, 275–6, fig 11.1). By contrast the remains exposed at Vindolanda were essentially those of the late Roman commanding officer's house, built around 300, with disappointingly faint traces of the early third-century *praetorium*, as a result of thorough ground clearance prior to the later rebuild. However a partial plan of the earlier structure was obtained revealing a courtyard structure of typical form (Birley *et al.* 1999, 8–9, 27).

Hence there is now a corpus of extensively investigated northern frontier *praetoria*, ranging from second to the fourth centuries, to add to those examples revealed by earlier excavations when recording was less meticulous. This could form the basis for an examination of the overall development

of *praetoria*, which might accompany full publication of a well-preserved example. It would however be overly ambitious to attempt to undertake such an exercise with the evidence from Wallsend as the basis of comparison. Over most of the building the evidence recovered amounted to little more than an outline plan, with the northern half of the building and the east wing being especially severely damaged. It is often unclear whether actual floor surfaces were examined or simply make up for the floor levels, with the actual surfaces having been truncated, and there was little evidence for internal decoration which could provide clues as to the function of rooms. Good evidence was recovered from the south range and adjoining parts of the courtyard, however. The development of the heated rooms in the south range can be charted and in particular the repeated alterations to the two hypocaust systems. The presence of an external apse suggests that the central chamber in the range functioned as a baths suite, at least during part of its history. In addition the course of the water conduits leading from the cistern in the south-east corner of the courtyard through the south-east corner rooms of the building might imply that a latrine was located in that area.

One aspect which does emerge with greater clarity from the excavation of Building 13 is the associated service range immediately to the south. There is evidence this area was demarcated from a relatively early stage, initially by a stone wall with an entrance on the west side and then with a row of small buildings extending along the south side. As well as being the area from where the hypocaust in the central room of the south range was initially fired, there is also evidence for water tanks and drain channels here, all probably related to the functioning of the baths-suite in the south range. Such ancillary ranges were more commonly associated with *praetoria* than is perhaps sometimes realised, at least in the forts of the first-third centuries. At Caernarfon (Segontium) a range consisting of two long rooms was attached to the north-west side of the central range *praetorium* on the other side of a walled yard, virtually doubling the size of the entire complex. This arrangement of a second courtyard with adjoining range is also found in conjunction with the timber-built *praetoria* in the first-century auxiliary forts at Pen Llystyn and Nanstallon (Bidwell 1997, 56–7). Three of the tribunes' houses (also timber) in the legionary fortress at Inchtuthil also featured a supplementary range, separated from the main courtyard complex by a corridor, whilst the fourth featured ranges of rooms around three sides of a second courtyard (*ibid.*). Immediately behind (west of) the commanding officer's house at Housesteads, which, in terms of its overall proportions and general layout, was remarkably similar to Caernarfon, lay a relatively narrow building (XI) of unknown purpose. Trenched by Bosanquet in 1898 it was revealed to have

four rooms, the southernmost containing an apsidal feature which has led to the suggestion that this was a baths-suite (Bosanquet 1904, 239, pl. xix; Crow 2004, 54), though Bosanquet noted that the building was constructed 'in the same poor style as the barracks', presumably implying clay-bonded coursed rubble (cf. Peter McGowan Associates *et al.* 2002, 120–21). Finally a narrow yard, enclosed by a stone wall, was attached to the north side of the fourth-century *praetorium* at Vindolanda (Birley *et al.* 1998), although in this case there is no evidence for a supplementary range. Such attached or ancillary ranges and yards merit more detailed examination in future in order to gain a broader understanding of the functioning of *praetoria* and the lives of the commanding officer and his extended household.

The greatest area of uncertainty with regard to the Wallsend *praetorium* surrounds its fate in late third and fourth centuries. The remains of Building 13 were essentially those of the second- and third-century *praetorium*, with no material of late third-century or subsequent date recovered from the recognisable occupation levels in the south range. The Phase 4 levels appeared to consist of demolition material, backfilling the hypocausts, rooms and corridors. Only a very few, actual identifiable features were associated with or demonstrably later than this phase which could mark the end of Building 13. If a replacement courtyard house was later erected over the site its wall foundations did not penetrate the Phase 4 or earlier levels.

Any such demolition appears unusual, however, there being no question of any trend towards the abandonment of *praetoria* in northern Britain during the late empire, not before the late fourth century at any rate. If anything the evidence points in the other direction, with substantial new courtyard houses being erected in the hinterland forts where new-style military units were established from the late third/early fourth century onwards. Thus the large courtyard house at South Shields was associated with structural Period 7, dated to 286/312, the rebuilding marking the arrival of a new unit in the fort, probably the *numerus barcarii Tigrisiensium*. A new *praetorium* of similar date is also attested at Chester-le-Street, its north range was uncovered in the 1960s (Todd 2006; Bidwell and Hodgson 2009, 183–5). At Binchester, too, an extended *praetorium* was erected in the late third century, replacing the original building, and apparently comparable in design and furnishing with its counterparts at South Shields and Chester-le-Street. This however was replaced, in the mid-fourth

century, by yet another large courtyard house on the same site, to which was attached, some time after 350–360, a substantial bath suite (Ferris 2010).

No evidence for completely new *praetoria* has been found within the forts of Hadrian's Wall itself, with their long established auxiliary garrisons which in some form were still in place, *per lineam valli*, at the end of the fourth century, to judge from the Notitia Dignitatum, but there are clear indications of continued use, repair and rebuilding of the pre-existing houses. The well known Tetrarchic dedicatory inscription from Birdoswald, RIB 1912, attests the restoration of the *praetorium* 'which had been covered with earth fallen into ruin' (*quod erat humo copert(um) et in labe(m) conl(apsum)*), along with the *principia* and (probably) the bath house. The excavators suggested a similar state of affairs may have prevailed at Vindolanda at the end of the third century, noting that the debris on which the new *praetorium* there was constructed *c.* 300 included clean earth, such as would be created by weed growth during disuse (Birley *et al.* 1999, 9). The commanding officer's house at Housesteads evidently remained in use throughout the fort's life right up to the late fourth century. It yielded Valentinianic coinage – the latest coins to derive from the fort – and clear evidence of relatively late structural alterations, particularly in the north range, including new hypocausts and new floors constructed of distinctive long blocks, both there and in the courtyard (Crow 2004, 91–2).

Although we shall never know for certain the fate of the *praetorium* at Wallsend due to the loss of the late Roman levels across most of the site, altogether the evidence cited above would suggest that Building 13 is more likely to have remained in use during the later empire, rather than being demolished in the mid/late third century and the site left vacant throughout the fourth century. Perhaps the house was allowed to become derelict after the middle of the third century – like its counterpart at Birdoswald – leading to the collapse or demolition of much of the structure. Regimental command during this period may have been exercised by a *praepositus*, a legionary centurion or *decurio alarius* who perhaps required less lavish facilities, men like Flavius Martinus, the *centurio praepositus* who supervised the eventual restoration of the *praetorium* at Birdoswald. Subsequent rebuilding, if it occurred, perhaps *c.* 300, may have taken place at a higher level, but could conceivably have retained a skeleton from the previous phases, comprising the external walls and certain of the principal internal walls.

10. THE FOREHALL (BUILDING AO), CENTRAL ROADS AND BUILDING 15

Grid squares: F7, F8, G7, G8, H7, H8, L8, L9

Introduction (Figs 10.01–10.04)

The road which traversed the full width of the fort, between the east and west gates, formed the *via principalis*, one of the site's major thoroughfares. It extended along the northern frontage of three of the fort's principal buildings – from east to west, the *praetorium* (13), the *principia* (14) and the double granary (7) – and separated these from the infantry barracks which occupied the northern part of the fort (*praetentura*). The opposite side of the road was lined not by barrack blocks, however, but by a pair of long narrow buildings (15 and 16) which probably functioned as workshops or stores (Building 16, to the east of the *via praetoria*, certainly seems to have functioned as a workshop or *fabrica*, but only the south-east corner of 15 was revealed and the building's function could not be determined). The most substantial structure exposed in this area was the large rectangular forehall (Building AO), which straddled the roadway in front of the *principia* and granary. This building does not, however, appear to have formed part of the original layout of the fort.

The area was excavated in three separate seasons. The central section, north of the *principia* and the double granary, was first uncovered in 1980/81, in conjunction with the excavation of the headquarters, the west end of Building 16 and the initial work on the interior of the granary (Site 16). The western end of the road was excavated in 1983 when the adjoining stretch in front of the granary was re-exposed (Site 17). This phase of work also examined the west gate (*p rta p incip lis sinistra*) plus the adjoining stretch of defences and the open area to the south of the original road carriageway across which the *v a p incip lis* was diverted later in its history. The remaining length of the road, to the east of the *p incip a*, was investigated

in 1983–4 along with the rest of Building 16, the north-west corner of the *p aetorium* and part of Barrack 3 (Site 18), although the cellars and foundations of Simpson's Hotel had destroyed the eastern end of the thoroughfare, leading up to the *p rta p incip lis dextra*. This division between three separate seasons has inevitably rendered the task of relating the surfaces and makeup layers along different parts of its course somewhat more difficult, particularly as there was a substantial change in the on-site excavation personnel and the administration of the project between 1981 and 1983. However, given the size of the area under consideration here, this was to some degree inevitable.

This area of the *via principalis*, with the adjoining roadways and adjacent buildings, was important not only for the structures that were revealed there, such as the forehall, but because the road levels were used in the Daniels post-excavation analysis to substantiate the overall four-phase chronological framework for the entire fort. Thus a total of three, and very occasionally four, main road levels were identified in the archive. This is largely followed here, but it should be noted at the outset that there were many internal contradictions in the relationships documented in the archive and the attributions of contexts or features to a particular phase. Most are too trivial to mention, but in some cases more substantive revisions have been required and these are noted in the text. It also appears that the hiatus in activity between 1981 and 1983 may have led to some layers being numbered twice over when work resumed in 1983. Finally, whilst the overall attribution of cobbled surfaces, foundation and makeup layers to three basic phases appears coherent, it is probably not the only way that the multiple contexts revealed could have been interpreted, particularly with regard to those of the primary level, which are very numerous. This possibility of variant interpretations is explored more fully, where relevant, below.

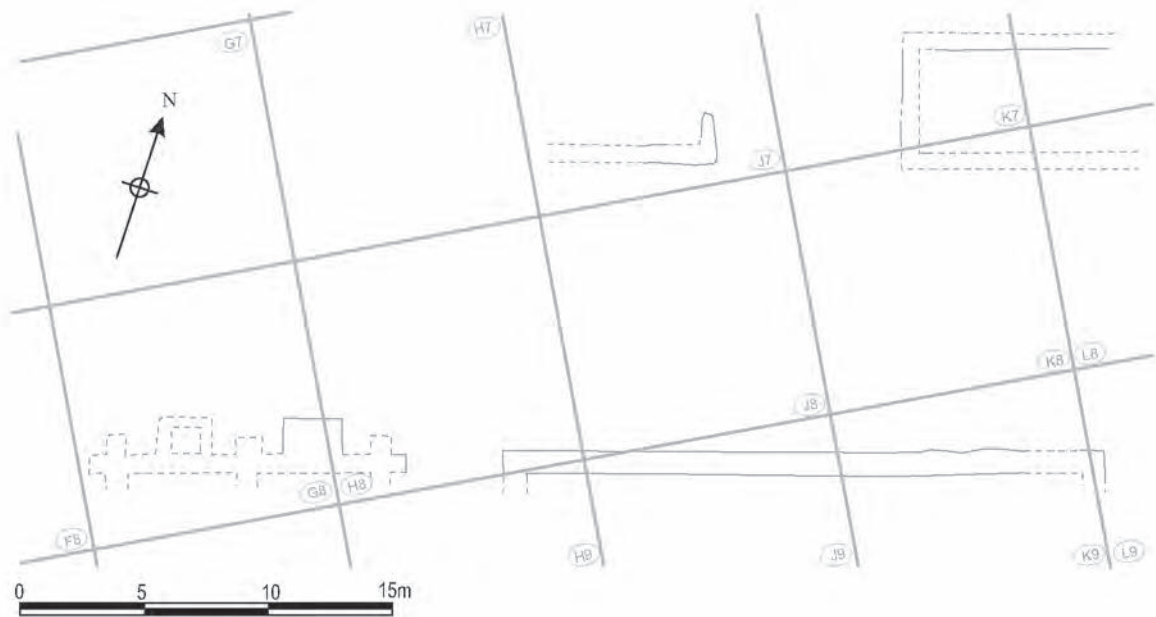

Figure 8.01 The central via principalis, Phase 1 including Building 5 Phase 1 (at 8.01).

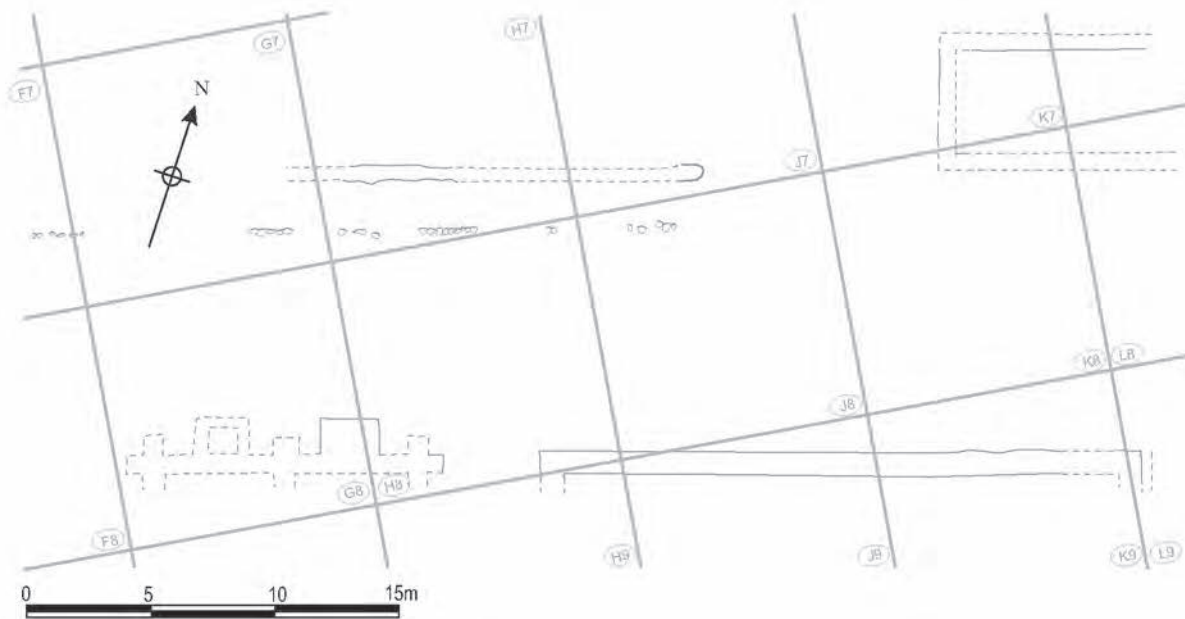

Figure 8.02 Via principalis Phase 2 showing Building 5 Phase 2 Scale 8.02.

Construction features

A number of apparently early features were identified beneath layers of metalling and cobbled foundations of the *via principalis* (see Fig 8.01). These included areas of flagging (J08:12, J08:30), an L-shaped linear strip of clay (J08:15) and patches of bedding sand (J08:31). Flagging J08:30, which covered an area measuring 3.30m (N–S) by 2.80m (E–W), was probably equivalent to the smaller area of green sandstone slabs found in the same spot during 1997–8 (TWM 5255), much

of the flagging presumably having been removed following initial excavation in 1980–81 or during subsequent re-exposure. The excavators tentatively associated these features with the remains of a timber building (BI) which survived in the form of a series of sleeper beam slots underlying the stone *principia* and extending northward beneath the carriageway of the *via principalis* (see Chapter 8 for further analysis of the various features which may be associated with Building BI). Another slot (K08:14, L08:25), probably



Figure 10.06 Via principalis, Phase 2 showing the forehall. Building 15 Phase 2 may be contemporary and the timber portico later. Scale 1:100.

associated with a timber-built structure, was exposed in the bottom of a much later drain channel (K08:15, L08:19) just to the north of the Period 2 forehall's north-east corner. The form of this feature – steep-sided with a flat bottom – suggested it too represented a slot for a timber sleeper beam. It was 0.40–0.50m wide and 0.23m deep and contained a yellowish grey clay-silt overlain by a very gritty, light grey-orange silt, incorporating some coal (see Fig 10.05 – section drawing S64). The slot was traced for a distance of 2.55m, running on an east-west alignment, before appearing to turn and return southward. To the west it was cut by a nineteenth-century cellar, but the plan of the surviving remains suggested that the north-east corner of a timber building might have been exposed. It was cut by one of the post holes (L08:26) of the timber portico attached to the north face of the forehall (AO). Its walls follow the same orientations as the principal Roman stone buildings, but its position beneath the *via principalis* is difficult to correlate with the known fort plan so it may have been associated with the initial construction phase of the fort, and perhaps with Building BI, whatever the latter's function.

Dating evidence

Slot

The slot produced a number of sherds of BB2 allied fabrics and a Nene Valley colour-coated ware indented scale beaker dating to the third century, and a sherd of Northern Campanian amphora dating to the second half of the third century or later (K08:14).

The later drain (L08:19) overlying slot K08:14 also

contained sherds of northern Campanian amphora and Antonine samian ware so the material in the slot is likely to be result of intrusive contamination when the drain was dug or a failure to distinguish between the two features' fills during excavation.

Phase 1 (Fig. 10.06)

The central *via principalis* (Road 1) – Figs 10.07, 10.08

The most detailed description of the primary road surface in the central stretch of the *via principalis* is that relating to J08:29/H08:30 – hard packed road metalling, composed of small pebbles, sandstone chippings and some mixed grey-brown clay, 0.09–0.15m thick and rusty brown in colour. This could be equated with reasonable confidence with the lower surface (H08:27, J08:17) uncovered north of Phase 2 road kerbing H08:22 and J08:14, although the descriptions of the latter differ somewhat – loose cobbles and gravel/ variously sized cobbles 0.05–0.10m thick. A layer of metalling in the corresponding position further west (G07:08, H07:16), which consisted predominantly of variously sized of pebbles with occasional larger stones embedded, probably formed part of the same surface. Where the relationship could be verified, these all clearly underlay the kerbs of the Phase 2 road, where the primary metalling was 0.09–0.10m thick, and were set on a foundation layer (F07:27, G07:13, H07:08, H08:28, 49, J08:18), the composition of which was variously described as large, roughly laid cobbles (H07:08, H08:28), medium/large worn cobbles (H08:49) and tightly-packed medium to large



Forehall, adjoining roads and cisterns/pits, Phase 3 (at 1:300).

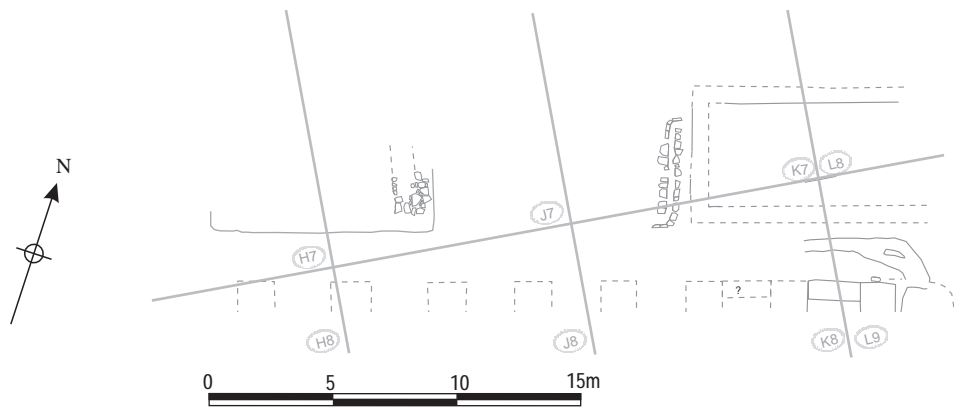

Phase 3 showing flagging laid over east end of infilled rectangular pit ('Cistern 2') (at 1:300).



Phase 3 revetment wall over subsided pit fill (at 1:300)

Figure 4 Forehall Phase 3 plans at 1:300

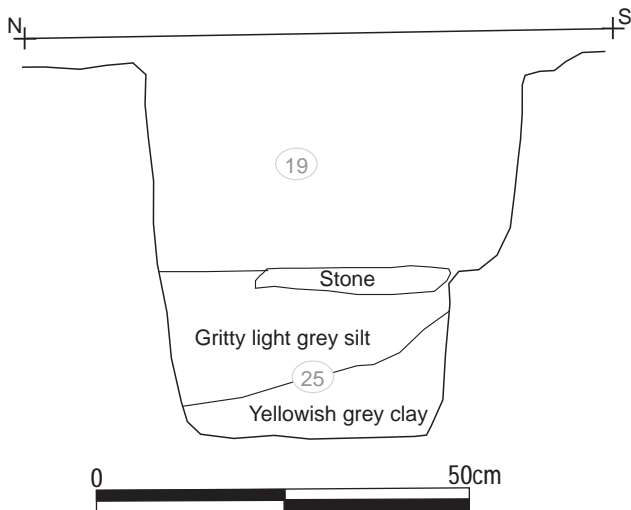

Figure 10.8 Section S4 through drain K08 L0 and slot K08 L0 at 10 (Context numbers relate to grid square L0).

angular stones (J08:18). This foundation layer could be seen to have a very clear northern edge marked by a line surviving kerbstones in the case of H08:28, which continued westward (see below).

A line of very large rubble blocks (H08:35, TWM 5254) appeared to form a north-south aligned kerb within the foundation layer, with a distinct face on the west side. One of the blocks was as much as 1.0m in length, though only 0.35m wide, whilst the surviving overall length of this feature was 2.30m, extending from the northern edge of the road foundations to the kerb of the Phase 2 road. Its function is uncertain. It lay in line with the west side of the *principia*, implying that it might represent one fragment of a drain continuing the line of the gutter running along that side of the headquarters building, but no trace of a western side wall for such a drain was apparent and the feature was not seen to extend further south below the Phase 2 metalling. Alternatively, it is possible the foundation layer was constructed in a series of separate sections, with kerb H08:35 marking the edge of one of those sections.

To the south, the Phase 1 metalling J08:29 sat on a thin layer of dark grey humic loam/silt over earlier features – flags (J08:30) and bedding sand (J08:31) – tentatively associated with timber building BI underlying the *principia*. This metalling was also observed to abut the side walls (J08:06) of the gutter drain running alongside the north wall of the *principia*, but lay below the level of the gutter capstones (J08:07).

Further east, the primary road level, which sat directly on top of the pre-fort ground surface (J08:20, K08:41), was seen to be 0.10–0.15m thick, including both surface metalling and makeup deposit. The surface here was mainly composed of small cobbles with occasional large or medium-sized stones in places (J08:19, K08:40, K09:34), and incorporated an area of

flagging (J08:12) which may have originally formed part of an earlier (construction?) phase, perhaps, again, being associated with timber building BI, occupying the site of the *p incip a*. Probably equivalent to this cobbled surface was the lowest layer of road metalling to be exposed on the other side of the modern, north-south aligned drain (K08:03), just inside eastern entrance to the later forehall. This was described as a well-made road surface of close-packed large, medium and square cobbles (K08:39, L08:43), and, like J08:19/K08:40/K09:34, sat directly on the pre-fort ground level (K08:41, K09:36, L08:46). Immediately to the north, in the area corresponding to of the north-east corner of the later forehall, the Phase 1 road level (K08:42, L08:39) was composed of small cobbles averaging 50mm in diameter, which were fairly rounded but not smoothed or well-consolidated.

In the area to the west, extending towards the western entrance of the later forehall, a variety of road surfaces and foundation deposits and possible bedding layers were revealed in 1983. These included a road foundation level consisting of, from west to east, yellow gravel, smaller flags or tightly packed irregularly shaped stones in light brown to grey silt-loam (F07:20/F08:57/62/G08:41 = TWM 5219?), adjoining an expanse of large flags interspersed with large cobbles or boulders (G07:10/G08:40/H08:47, probably to be identified with the layer of angular blocks and slabs of white, green, yellow and brown sandstone uncovered in the same area in 1997–8 – TWM 5262, see Hodgson 2003, 176–7 – and perhaps also equivalent to the foundation layer of large cobbles present further north – F07:27, G07:13 etc.) and a layer of pale yellow gravel and mid-brown sandy gravel soil (G08:42/H08:48).¹ In the area of the later forehall entrance this foundation level was overlain by two patches of a surface composed of gravel, pebbles and angular stones (F07:22/F08:59, F07:23/F08:60). Overlying the gravel/pebble layer and extending eastwards over the foundation level was a surface made up of well-worn medium-sized cobbles, interspersed with flags, set in a silty soil matrix which varied from yellow to dark brown in colour (F08:55/G08:36, G08:37/H08:43). Further east, over G08:42/H08:48, a bedding (?) layer of brown/yellow sandy soil (H08:45) was overlain by a road surface or foundation level (H08:41, H08:42) composed of well-worn, medium-sized stones and flags, set in dark brown soil, which *might* equate to the 1980–81 Phase 1 metalling H08:30. All of these levels probably belong to the first period of the fort's occupation, although relating the road levels found in the 1983 excavation season to those previously identified further to the east in 1980–81 is problematic. Thus H08:41 and H08:42 might alternatively form part of the Phase 2 road metalling H08:23 (1981) and H08:34 (1983), in which case H08:45 could represent makeup or bedding for that phase of the road.

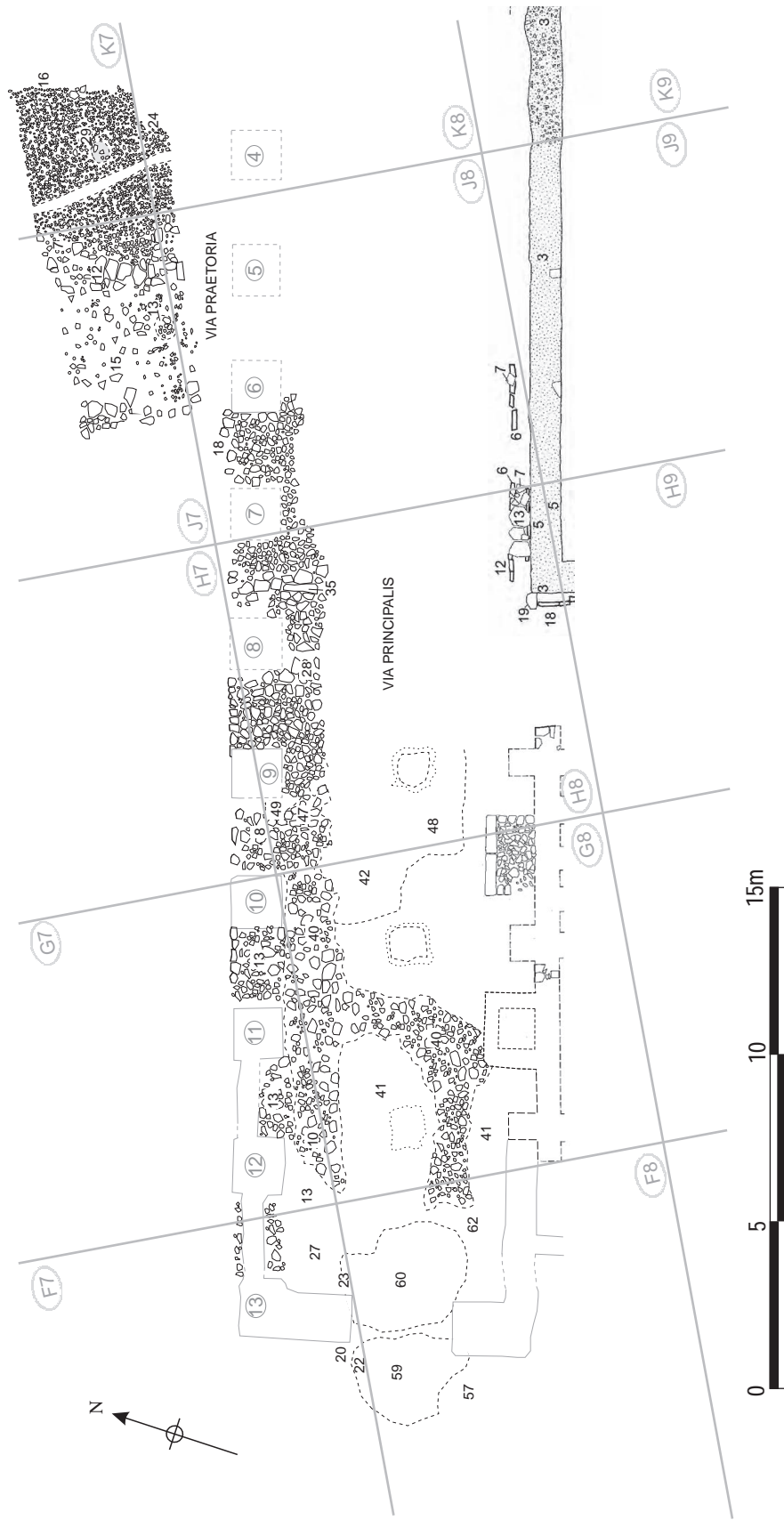

Figure 10.06: Via principalis foundations and via praetoria, Phase 1 (outline of later forehall shown for reference) at 1:200.



Figure 10 Phase 1 road foundations along the north side of the *via principalis* with north-south kerb H08 in the foreground and Phase 2 kerb H08:22, H08:23, G08:3 and G08:4 to the left (Fig. 10).

In the area to the north of the later forehall, a light gravel spread (G07:14) was exposed over the pre-fort ground surface of grey clay-silt (G07:15, H07:19). This was covered by a much more extensive layer of sandstone chippings in mixed yellow sand and medium brown silty soil (G07:07, H07:15), which overlay the south wall foundations of Building 15 (H07:17).

Drains

The remains of a stone-lined drain, running on an east-west alignment along the eastern *via principalis*, were uncovered and assigned to the road's primary phase by the excavators. Arrangements at the junction with the *via praetoria*, where the conduit may have been connected with a north-south aligned channel (such as K07:19/K08:25), had been destroyed by a nineteenth-century cellar, but a 5.00m stretch of the drain's north side wall (K08:19, L08:35) survived in the section of the *via principalis* between the north-east corner of the *principia* and the south-west corner of Building 16. The side wall was backed by a tightly packed spread of small to medium-sized sandstone cobbles



Figure 11 Phase 1 road foundation along the north edge of the *via principalis* with north-south kerb H08 in the foreground and phase 2 kerb H08:22 on the left. Looking west (Fig. 11).

(K08:20, L08:38), which was observed not to be highly worn, but considered to perhaps represent a surface. However it might also represent a further extension of the sand, gravel and sandstone chipping/cobble construction deposit (K07:33, K08:21, 35, L07:15, L08:28), which was seen to extend beneath the western end of Building 16, and beyond, over at least the northern part of the *via principalis*. Traces of dark grey, sandy loam incorporating some stone (L08:36) were present in the bottom of the channel. The drain wall, backing and this lower fill all sat directly on top of a surface of largish worn cobbles (L08:37), perhaps part of the foundation level for the primary *via principalis*. Side wall K08:19/L08:35 lined up with the well-preserved drain further east (L08:49, 59, M08:11, N08:12), which traced a rather sinuous course along the length of the eastern *via principalis*, some 1.50–2.00m south of Building 16, and still retained *in situ* capstones in places.

The *via praetoria* (Road 2)

The southern end of the *via praetoria* just north of the junction with the *via principalis* was also investigated in 1980–81. This comprised the 4.50m long section of the road which survived between the gable ends of Buildings 15 and 16 before its course was interrupted by the line of Buddle Street.

The primary levels

The lowest level of the *via praetoria* to be exposed immediately north of the forehall is shown on site plan P293, drawn in September 1981. The road surface was described as disturbed and covered in debris from the excavation spoil heap, which had been placed on top of the eighteenth/nineteenth-century cellar (J08:02/04, K08:02) to the south, and consequently only a single typical square metre of was actually drawn in order to show the character of the surface. It appeared to consist

of small cobbles and pebbles which were up to 0.10m in diameter, but were mostly much smaller. A further annotation on plan P293 recorded that the surface extended between later drains J07:12 and K07:19. No context number was assigned to this surface on the plan and it is not clear whether this is simply the same as the last surface to be exposed in the previous year (K07:16, K08:24, J07:07), which was recorded on site plan P242, drawn on 20 November 1980. There is certainly no indication in the context records that K07:16/K08:24 was ever removed and an underlying level exposed. However the square metre of cobbles shown on plan P293 does appear to extend south-eastward a little beyond the expanse of K07:16/K08:24 recorded on site plan P242 and beneath the line of later east-west drain K07:20/K08:25 (which admittedly surface K07:16/K08:24/J07:07 also underlay).

The lowest level of the *via praetoria* immediately north of the forehall which was fully recorded in 1980–81 comprised the surface of closely-set small cobbles (K07:16, K08:24, J07:07), shown on site plan P242, referred to above. The carriageway ranged in width between 4.20m and 5.00m. The western edge of the road metalling was bounded by a stone drain (J07:12) represented by a series of fairly large and rather irregularly shaped capstones, 0.55–0.85m in length and 0.35–0.45m wide, and a few surviving edge stones. The width of the drain channel was estimated on site plan P293 as c. 0.30m, but the drain's remains were somewhat disturbed, especially towards its northern end where it disappeared beneath Buddle Street. The road metalling was cut by a single post hole (K07:29).

Road surface K07:16/K08:24/J07:07 clearly underlay and therefore predated the east-west drain (K07:20, K08:25) which cut across the line of the *via praetoria* carriageway. A comparison of site plan P242 with P241 and P239, showing later levels, makes it clear that metalling K07:16/K08:24/J07:07 extended right the way beneath the side walls and channel of drain K07:20/K08:25. Prior to crossing the road, the drain ran down the east side of the carriageway (K07:19), next to the end gable wall of Building 16. Here, and at the point where the drain turned westward, the cobbled surface appeared to have been cut away by the drain's construction. The possibility that the drain had two structural phases represents a complicating factor with regard to the relationship between it and the lower road metalling, however. Two courses of drain side wall were apparent in places. The lower of these appeared to emerge from Building 16, close to the north-west corner of the building, rather than coming down the east side of the road carriageway from the direction of the north gate like the upper course. The function of the drain channel emerging from Building 16 is unclear, but there it may be associated with a small pit feature located in the north-west part of the building, immediately adjacent

to its west wall, at the point opposite the channel's apparent emergence from the building. This pit (K07:26) appears to have been situated relatively early in the structural sequence relating to Building 16 (Phase 1), implying that, if there was indeed a functional association between the pit and the lower course of the drain, the latter must also have been a relatively early feature. If so, the early drain channel or gutter perhaps only continued along the east side of the carriageway as far as the south-west corner of Building 16 since the site plans provide clear evidence that no equivalent early drain crossed the *via praetoria* carriageway from east to west on the same course as the later channel.

Dating evidence

The central via principalis (Road 1) – phase 1

The road foundation produced only two small sherds of pottery, including a body sherd apparently of third-century date (G08:41). The metalling produced only about 10 sherds of pottery in total, including Antonine samian and a mortarium rim probably from Kent dated 140–200 (J08:17). There is also a single sherd of Crambeck reduced ware of the late third century or later that has presumably been pressed down from a later layer in the muddy road (K08:40). The drain produced a sherd of a Nene Valley ware bead-rimmed funnel necked beaker of the late third century or later (L08:36).

Stratigraphic note: The pottery from the primary levels of the *via principalis* includes a significant quantity of material which would appear to be much later in date and incompatible with such an early phase. The Phase 2 carriageway was, however, much narrower than the primary road, leaving much of the latter to be covered by only the uppermost road level, the mixed rubble and cobbling of Phase 3, which was disturbed in many places, providing ample scope for later material to be intruded into earlier levels. Moreover, it may be assumed that the pottery assemblage associated with a layer of road metalling, for instance, might include material found directly on or pressed into the surface, and thus could potentially reflect the full duration of the period the road surface was in use, rather than providing a *terminus post quem* for its construction.

Phase 1 construction

The construction material backing drain K08:19/L08:35 produced only three sherds of pottery, one of which was a piece of BB2 cooking pot.

Discussion

The interpretation set out above broadly follows that proposed by the excavators. This phasing is principally based on the results of the 1980–81 season. The features

uncovered in the 1983 season were partially integrated into this framework, but many individual contexts, particularly at the western end of the area, around the entrance to the Phase 2 forehall (grid squares F07 and F08), were left without any attribution to a specific phase in the post-excavation context database. Examination of the site archive reveals a marked difference in the character of the 1980–81 (Site 16) and the 1983 (Site 17) seasons' archives. It is evident that the excavators in the earlier season had a much clearer idea of the structural sequence which they were exposing, resulting in a more coherent record, explicitly documenting, on sketch plans and context sheets, the broad equivalences they had identified in terms of the contexts relating to a given road level. By contrast, 1983 perhaps yielded more contexts per square metre than 1980–81, but often less clarity as to how these might relate to adjoining features and fit into the overall structural sequence. That is not to say that the 1980–81 archive provides a more accurate record than that of 1983. There is no reason to doubt that adjoining features possessed different characteristics in the way described by the 1983 records, but one suspects that in many instances the 1981–81 excavators would have seen these as variations within one overall level or even context.

The coherent nature of the earlier record has provided a workable basis for the compilation of the structural report presented here, and the foregoing description has attempted to integrate into that same overall framework those contexts which had hitherto not been attributed to any phase. However a caveat should be inserted. The Wall-period analytical paradigm still exerted a powerful influence over the excavators at Wallsend in the 1970s and early 80s, and, arguably, may have predisposed them to analyse the road surfaces in the way they did. It is possible that someone working in a different tradition might have interpreted the layers differently and concluded that more phases were present here. For example, the kerbed 'road foundation' could conceivably be interpreted as one discrete road level and the overlying smaller cobbling, as another separate phase. Nevertheless, it is worth stressing that the deposition of smaller cobbling and gravel over a foundation of larger rubble slabs to provide a more even surface is perfectly consistent with Roman road construction and, on balance, the excavators' interpretation of these two levels as forming a single structural phase remains the most plausible reconstruction. Greater uncertainty surrounds the lowest levels of the *via principalis*, excavated in 1983. It is possible that some of these contexts represent a distinct, initial Hadrianic road level, sandwiched between construction deposits and the main, rubble slab, road foundation, but it is difficult now to differentiate these, retrospectively, with any confidence and the very lowest levels in any case produced almost no datable material,

unlike the overlying surface metalling. What should be emphasised, however, is that all these levels stratigraphically precede the construction of the stone forehall identified as Phase 2.

Building 15 (Fig. 10.09)

Grid squares: H07, J07

Introduction

Only the south-east corner and a stretch of the south frontage of Building 15 fell within the excavation site, the remainder lying beneath Buddle Street. The area which was available for investigation was further reduced by a large rectangular pit or water tank, labelled Cistern 2 (H07:10/J07:18) by the excavators, which had been dug just west of the surviving corner, cutting away a 9m length of the building's frontage.

Description

South-east corner

The south-east corner of the building was represented by an L-shaped trench revealed on the eastern side of the later rectangular pit (H07:10/J07:18). It was filled with patches of light yellow (J07:26) and grey clay (J07:28), including some blocks of medium-sized angular sandstone rubble, a number of which were worked, and was interpreted as a robber trench for the building's south and east walls. From the point where its course was cut by the pit, the trench extended 2.65m eastward, increasing in width from c. 0.65m to 0.85m near the corner. It then turned and continued northward for a further 1m, its width tapering from 0.55m to 0.40m, before it petered out c. 0.50m short of the northern edge of the excavation area. On its north and west sides, partially enclosed by its two arms, the trench cut grey-brown clay interpreted as the original, pre-fort, plough soil (J07:27) and a spread of orange/yellow sand, whilst on its south and east sides it cut a surface of sparsely surviving cobbles (J07:30), set on makeup composed of red-brown clay-loam and grit (J07:29).

South wall

On the other side of rectangular pit H07:10/J07:18, a 5m stretch of the south wall foundations was exposed in 1984. This, however, lay c. 0.70m south of the projected line of the south wall trench exposed further east and consisted of a 0.45–0.65m wide strip of rubble in yellow gravel (H07:17), which cut the pre-fort plough soil of grey clay silt (H07:19, G07:15). This foundation deposit continued westward beneath Buddle Street, whilst to the east it was cut away by the pit. No definite trace of these foundations was found on the same alignment east of the pit (but see below). A light gravel spread (G07:14) overlying the

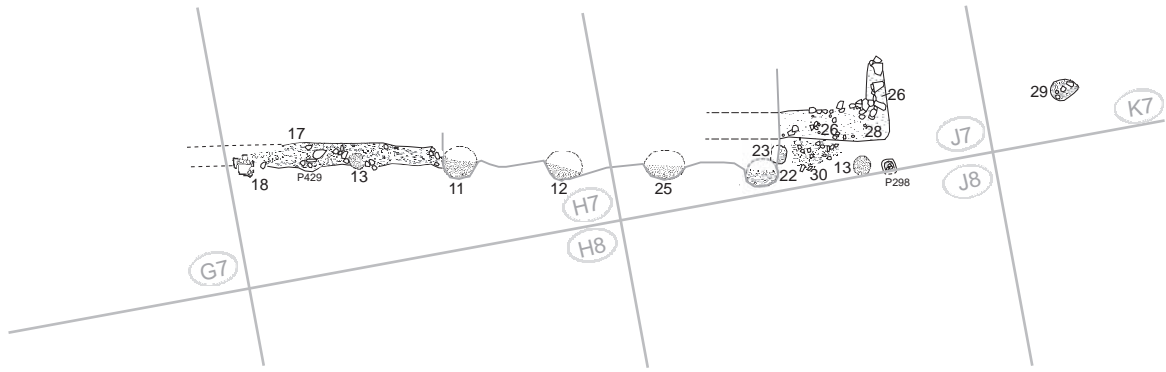

1. All features with forehall portico (AY) postholes and pit C2 shown for reference

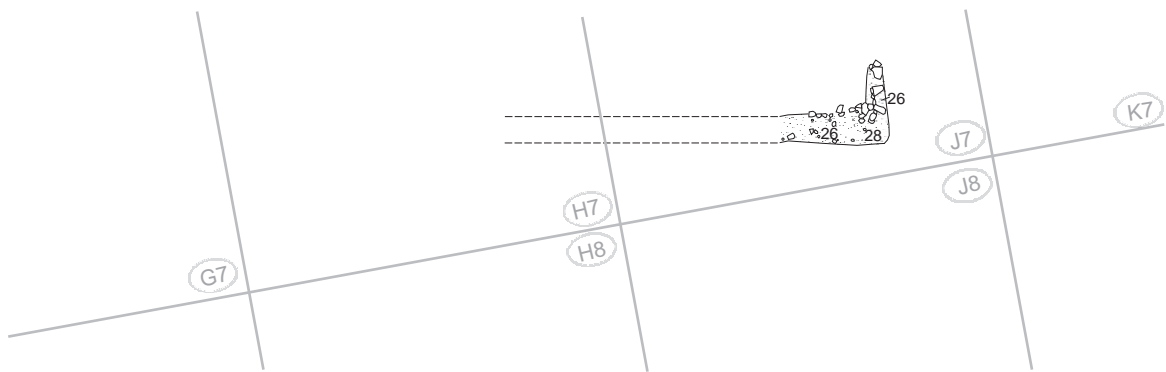

2. Building 15, Phase 1

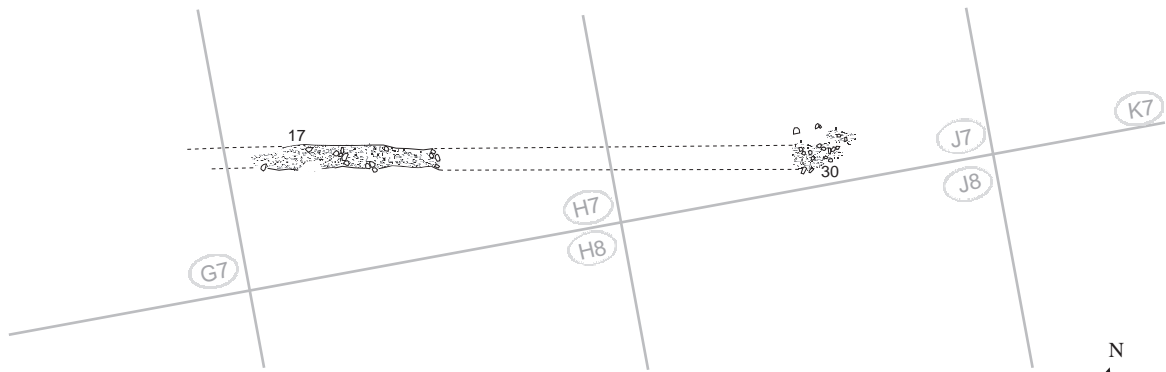

3. Building 15, Phase 2



Figure 10 Building 15 Phases 1 and 2 (at 0)

plough soil a little further to the west might represent a surface in front of and contemporary with the building.

Post-demolition

The remains at the south-east corner were overlain by a mixed layer of sandstone rubble, gravel and sand (J07:20), interpreted as a surface. The foundations

further west were overlain by an extensive layer of mixed yellow sand, medium brown silty soil and sandstone chips (H07:15, G07:07), the sand becoming less prevalent to the east. This extended southward as far as the rubble foundation kerb of the Phase 1 *via principalis* carriageway. The excavators noted that very little sign of a robber trench for foundations H07:17 was seen in plan in rubble H07:15. It seems more likely that the remains of the building were demolished down to the level of the foundations at the end of its life and all internal levels were perhaps truncated at the same time.

Interpretation

Despite their limited extent and preservation, or perhaps because of it, the surviving remains of Building 15 posed some significant interpretative challenges. The differing alignments of the remains of the south wall identified at the south-east corner and further west suggest that two phases of structure may have been present. At the corner of the building the east-west aligned clay-filled trench was relatively broad, perhaps sufficiently so to represent the robber trench for a stone south wall, as suggested by the excavators. However the trench returning northward, which was presumably associated with the building's east wall was much narrower, at 0.40–0.55m. This might therefore signify that these trenches represented slots for timber sleeper beams, the beams being removed and the trenches backfilled at the end of that phase of the building. The apparent gap between the northern end of the trench and the edge of the excavation area might conceivably indicate the presence of a doorway, but with such a limited area exposed it is difficult to be certain.

No certain trace of the wall foundations H07:17 were identified on the east side of the rectangular pit/water tank. It is noteworthy, however, that the projected alignment of H07:17 did converge somewhat towards the south-east corner, so that it would have lain immediately south of the corner trenches discussed above, in precisely the area where site plan P298 shows the most definite remains of cobbles J07:30. No obvious cut for trenches J07:26/28 is shown through these cobbles on the plan, though one was clearly shown through the underlying, presumed makeup layer of red-brown clay loam (J07:29) on the corresponding sketch plan (H07/fig 4). This might therefore hint that the denser spread of cobbles, depicted immediately east of pit H07:10/J07:18 and south of the trench, actually represented the denuded remains of wall foundations H07:17 and can be distinguished from the more extensive sparse cobbling, overlying makeup J07:29, which was described on the context sheet. The tentative nature of this suggestion is obvious. However, plan P298 appears to show one small patch of the cobbling

overlying the edge of trench fill J07:26 which could provide a little support for the hypothesis.

If two phases of Building 15 are represented by the surviving remains exposed in grid squares H07 and J07 – a timber structure and a stone-built successor – it would be likely, based on the sequence observed elsewhere at Wallsend (for example the barrack blocks, hospital and perhaps the *p incip a*), that the timber phase preceded the stone one. This cannot be corroborated in relation to Building 15, however, as there was no direct stratigraphic relationship between the few respective contexts which can be definitely associated with the two suggested phases (J07:26, 28 on the one hand and H07:17 on the other). As discussed above, if the denser patches of cobbling J07:30 shown on site plan P298 are interpreted as the eastward continuation of H07:17, and therefore associated with the stone building, these patches must be distinguished from the more extensive sparse cobbling which, according to context record J07:30, overlay makeup J07:29 and was cut by trench J07:26/28.

The excavators assumed that Building 15 formed a long narrow structure similar to Building 16, occupying the entire plot on the north side of the *via principalis*, between the road and Barrack 6, from which it was probably separated by a narrow alley (though this would be hidden below Buddle Street). This may well have been true of both phases identified above. It perhaps functioned as a workshop or store, although there is no clear evidence, as any levels associated with the interior of either phase of the building would appear to have been truncated during the Roman period. Whatever its purpose, this structure would appear to have been relatively short-lived, the entire building probably being demolished at the end of the initial period of the fort's occupation and certainly before the construction of the timber colonnade (AY), which has been associated with the *p incip a* forehall (AO), since the post-holes of AY clearly cut through south wall foundations H07:17 and the overlying rubble layers (J07:20, H07:15/G07:07).

FINDS

Coin: Trajan, 101–11 (no. 45, J07:20)

Dating evidence

No dateable material or other finds were recovered from the contexts directly associated with Building 15, but a *sestertius* of Trajan, dated 101–11 (cat. no. 45), was found in the rubble, gravel and sand overlying the south-east corner of the building (J07:20).

Phase 2 (Fig. 10.10)

The forehall

A large rectangular forehall, some 46m long from

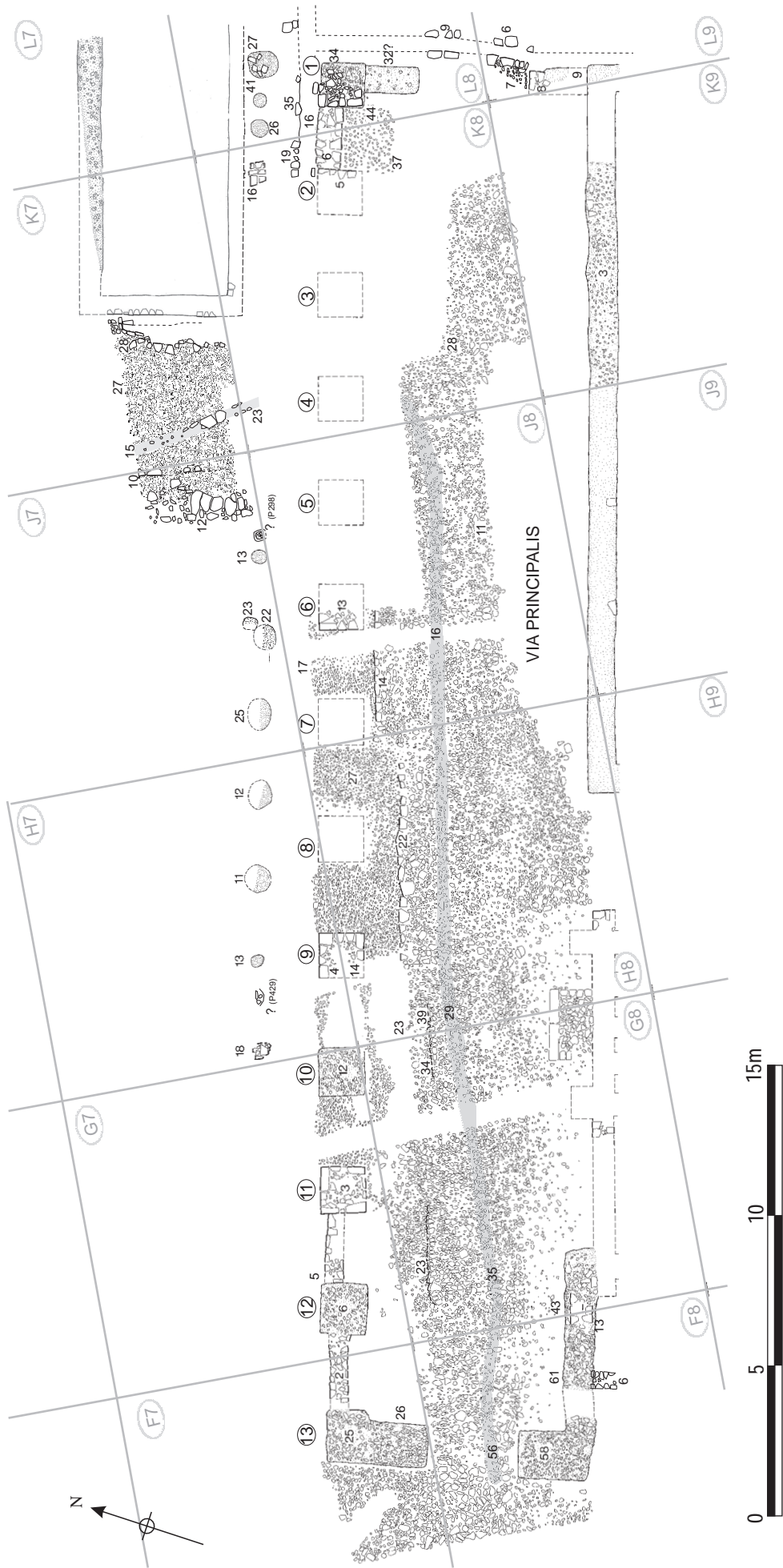

Figure 10.10: Building AO and portico AY, at 1:200.



Figure 10.1 The remains of the western half of the forehall, including Piers 9 and 11, infill wall F07:02, south wall F08:13 and adjoining robber trenches looking east in 2003.



Figure 10.2 The west end of the forehall with Phase 2 via principalis kerbs J08 and H08 looking west in 2003.

east to west and 9m wide, north-south, was erected over the *via principalis* in Fort Phase 2 (Figs 10.11, 10.12). This structure, which was labelled Building AO by Daniels, extended along the full frontage of the *principia* and granary and indeed projected more than 6m further west beyond that. On the other side, however, it did not stretch beyond the *principia*, over the eastern third of the *via principalis*. The building was reinvestigated by TWM in 1997–8 (see Hodgson 2003, 171–82, esp. 176–182). The architectural form of the building was extensively treated in the report on the 1997–8 work (ibid., 180–82) and, accordingly, will only be reviewed briefly here. This report will focus instead on the relationship of the forehall to the underlying and adjoining road levels of the *via principalis* which supplied the evidence for the dating of the structure. Most of these levels were removed in the course of the Daniels excavation and the chronology proposed in the 1997–8 excavation report could therefore only be a provisional one.

The piers of the north side (Figs 10.13–10.16)

The north side of the building was composed of 13



Figure 10.13: Piers 11 and 9 and infill wall G07:05 with the site of pier 1 in the foreground looking east in 2003.

square pier bases, all measuring around 1.5m square and set on the northern edge of the Phase 1 roadway, the north face of each pier base was virtually in line with the kerb of the underlying rubble road foundation. These presumably supported a series of 12 arches, which were not, however, all identical in their span, to judge from the distances between the surviving piers. Most of those which could be measured were 2.30m wide, but the span of the westernmost was greater at c. 2.45m wide, whilst the easternmost spanned as little as 2.10m. Furthermore, the arched apertures in the eastern half of the forehall, in the area destroyed by a nineteenth-century cellar, may have been even narrower, at under 2.00m, although it is possible that the arrangements were a little different here, as the *via praetoria* led up towards the entrance to the *principia*. In the case of five of the pier bases (L08:15, K08:05, J08:13, H07:04/H08:14, G07:03, representing the first, second, sixth, ninth and eleventh examples from east to west respectively), a single course of masonry survived at least partially (two courses in the case of Pier 11 – G07:03 – see Figs 10.13–10.14). Three other examples had been robbed out leaving only foundation deposits (G07:12, G07:06,



Figure 10.14: Pier 11 (G07:03) and adjoining infill wall (G07:03) from the west (N 100°).

F07:25, respectively bases 10, 12 and 13), whilst, of the remainder, bases 3–5 had been destroyed by a modern cellar (J08:02–04/K08:02) and no trace of bases 7 and 8 was identified, although this area was uncovered. Examination of the relevant site plans (P273, P286) shows that the positions of both bases can in fact be recognised with 8 being evident as a gap in successive phases of the surrounding road surfaces where the base had been robbed out, whilst the robbing of 7 is apparent on P272 as an area of slightly larger stones intermixed with lumps of clay amidst road surface H08:27/J08:17. The foundations of 7 are probably depicted on P286 but were indistinguishable from Phase 1 road foundation J08:18. The foundations of these bases were definitively traced in 1997–8 (TWM 5213, 5335).

The piers were constructed of dressed facing stones, enclosing a core of angular sandstone rubble and were all clay-bonded (cf. K08:05, L08:15), although in some instances the bonding material had eroded away. The stones used to face the piers varied in size and form. Many consisted of the usual dressed sandstone rubble, but the quoins were generally more substantial, with faces as much as 0.40–0.50m

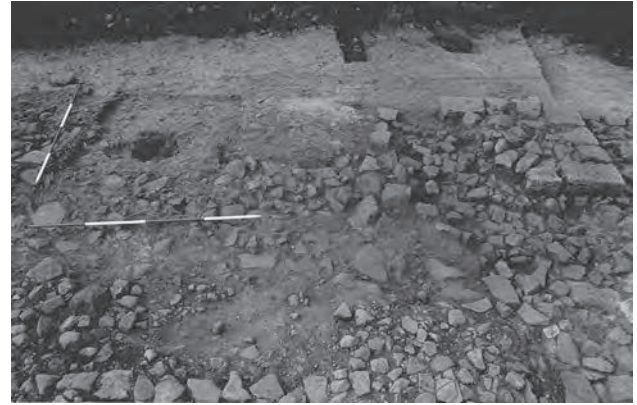

Figure 10.15: Piers 10 (site of) and 9 with road kerbs G07:03 and H08:17 in the foreground, from the south (N 100°).



Figure 10.16: View of Pier 1 and infill wall from the east showing wing pier foundations and underlying cobble surface.

in length. Piers 1, 6 and, most noticeably, 11 (L08:15, J08:13, G07:03) incorporated long, narrow and quite neatly dressed, oblong blocks. These resembled the blocks used to form the treads of the granary steps, and could signify that at least one set of steps was demolished when the forehall was constructed, releasing material for reuse in the construction of the piers (see Chapter 4 for the structural history of the granary steps).

The piers were set on foundations of densely packed rubble. Those of the easternmost pier base (1) were the most thoroughly investigated (L08:34) and seen to be composed of orange-yellow clay on sandstone rubble in a 1.45m square pit, with chippings laid over the top as bedding for the masonry of the pier itself (Fig. 10.16). The pit cut right down into the clay subsoil. Other examples (e.g. pier base 2 – K08:43; 12 – G07:06; 13 – F07:25) were described in less detail, but were clearly similar in construction: rubble in a yellow-clay matrix (K08:43), sandstone fragments closely packed in medium-brown silty soil (G07:06). The foundations of base 2 (K08:43) were observed to cut the Phase 1 road cobbling (K08:42/L08:39). Similarly, Piers 6 (J08:13), 9 (H07:04/H08:14), 11 (G07:03) and 13 (F07:25), are all explicitly recorded as overlying or cutting the rubble road foundation levels along the northern edge of the primary *via principalis* carriageway (J08:18, H07:08, H08:28, G07:13, F07:27). However the relationship between the piers and the Phase 1 metalling (e.g. J08:17, H08:27) overlying the road's rubble foundations is not documented on any of the context sheets.

The infilling walls

The two most westerly archways and the easternmost one were blocked up by panel walls, which abutted the piers on either side (Figs. 10.11, 10.13–10.14, 10.16). These infilling walls (F07:02, G07:05/11, K08:05/L08:15) were faced using roughly-dressed sandstone rubble blocks, enclosing cores composed of angular sandstone rubble, and were mortar-bonded, in contrast to the clay bonding employed in the piers themselves. Only a single course of masonry survived in the case, of the two westerly walls F07:02, G07:05), which were only 0.55–0.60m wide. However, re-examination of the wall infilling the easternmost archway (K08:06, L08:16), in 1983, revealed that three courses survived here and, at 0.80–0.95m, this wall was also significantly wider than those further west. The stonework of wall K08:06/L08:16 was seen to be less neatly squared than that of the adjoining piers and towards its west end actually jutted slightly beyond the north face of Pier 2. The eastern end of the wall butted up flush against pier L08:15, but did not butt quite so neatly up against pier K08:05, suggesting the wall had been constructed from east to west.

It is not clear whether similar treatment was applied to the other archways along the north face of the forehall. Certainly no other remains were found, but such walls could conceivably have been removed leaving very little trace, whilst archways 2–5 (numbered from east to west) had been destroyed by a nineteenth-century cellar. It is quite likely, however, that archway 2 was infilled since a small rectangular timber structure later appears to have been constructed in this corner of the forehall (see Phase 3 below). Conversely, some of the lost archways

to the west were probably open as they would have been associated with the approach of the *via praetoria* towards the *principia* and this area may indeed have received more elaborate treatment.

DISCUSSION

The main question regarding the infill walls is their chronological relationship to the main structural skeleton of the forehall, that is to say, was their construction essentially contemporary with the forehall piers, albeit structurally secondary, or did it occur somewhat later? Daniels certainly considered that they belonged to a distinct secondary structural phase and assigned them to Fort Phase 3, though no stratigraphic evidence to support this reasoning was presented anywhere in the site archive, post-excavation notes or the published summaries. It is likely that Daniels' interpretation was based on assumptions regarding the probable development of the forehall. The clearest evidence is provided by the wall in easternmost archway (K08:06, L08:16, TWM 5216). This reportedly overlies the cobbled surfaces to the north (L08:37) and south (K08:42, L08:39) which were attributed to Phase 1.² On its south side, the wall was reportedly abutted by a 25–50mm thick makeup layer of grey clay and stones (K08:38), overlying the Phase 1 road surface (although site plan P267 *might* indicate that the wall cut K08:38). The makeup was in turn overlain by a 25–50mm thick layer of probable surface metalling, composed mainly of small rounded cobbles and occasional larger stones (K08:37, L08:44), which certainly abutted the infill wall as well as the piers. This would imply that the construction of the panel wall, like the piers, was contemporary with that of the Phase 2 road surface. A further indication was provided by the 1997–8 excavations which recorded that the wall was constructed on a foundation of sandstone chippings, directly overlying the fill of the foundation pit for Pier 1, the implication being that the wall was added immediately after the pier base was erected, before any occupation deposits could accumulate in the forehall (Hodgson 2003, 178). One contrary indication from the other end of the forehall should be noted, however. The surface of small to medium-sized stones in a brown soil matrix (G07:04, H07:07), which extended from the northern edge of the forehall over the remains of Building 15, reportedly underlay the infill wall G07:05 in the second archway from the west end, whilst abutting the pier bases 11 and 9 (G07:03 and H07:04/H08:14). It is uncertain how much weight can be placed on a single observation like this, but it does raise the possibility that the construction of these walls was a more gradual, ad hoc process than suggested. The panels may have been erected at different times, in response to a range of factors we cannot now appreciate, with some of the archways being left completely open. This could also perhaps explain the

variation in form of the panel walls, the easternmost examples (F07:02, G07:05) not only being narrower than K08:06/L08:16, but were also slightly recessed within their respective archways, whereas the outer face of the easternmost wall was flush with the north face of the adjoining piers.

The south side of the forehall

The south side of the forehall was largely formed by the pre-existing walls of the *principia* and the granary which must now have supported the forehall roof as well as the north side of the *principia* forecourt and the north gable of the granary. The forehall extended some 6.65m further west beyond the north-west corner of the granary, however, and here a purpose-built wall was erected, which adjoined the intersection the two buttresses at that corner. Only a metre-long stretch of the wall's masonry superstructure (F08:13) survived. This was 0.75m wide and built of roughly-dressed sandstone rubble blocks facing a clay-bonded core of angular, sandstone rubble. The underlying rubble foundations (F08:61, G08:43) were traced along their full length. These were 1.0m wide and composed of large rubble blocks and cut through earlier road levels (F07:20/F08:57/62/G08:41). The south face of this wall was abutted by the west wall of a small square building, AU, which was located in the angle formed by the forehall and the granary (see Chapter 4 for discussion of this building in conjunction with the granary).

The west entrance

The west face of the forehall was just 8.60m in length, the building being slightly narrower at this end. Only foundations remained of the structures here, on either side of the entrance (F07:26, F08:58), and these were clearly much broader than the foundations of the adjoining south wall. Thus the foundations on the south side of the entrance (F08:58) were as much as 1.50–1.60m wide, thereby resembling the dimensions of one of the pier bases, and measured 2.20m in length from the portal to the south-west corner of the building. The excavators in 1980–81 thought these were composed of smaller rubble material than the adjoining south wall. However more thorough investigation in 1997–8, involving the cutting of a section through the foundation pit, showed the smaller material was merely packed on the surface to form a more level platform for building upon. This covered two layers of larger sandstone rubble packed in clay, the basal raft being composed of pitched stones whilst the overlying layer incorporated the largest sandstone fragments (see Hodgson 2003, 178–9, figs 125–6). The pit cut a possible bedding or makeup level of yellow gravel and grey silt-loam (F07:20/F08:57/62/G08:41 = TWM 5219?) associated with the primary *via principalis*. The foundations on the north side of the entrance portal (F07:26) were almost equally broad,

at 1.40m, only fractionally narrower, indeed, than those of Pier 13 at the north-west corner, to which they were attached. They extended southward 2.00m from south face of the pier (length of west face 3.25m overall) and cut the rubble foundations of the Phase 1 *via principalis* (F07:27). The gap between the edges of the two foundation trenches was 3.20m establishing the minimum possible width for the portal.

The east side of the forehall (Fig. 10.17)

The structures exposed on either side of the forehall's eastern entrance were not on the same massive scale as the foundations at the western end of the building. Moreover they were directly in line with the east wall of the *principia*. The north side of the entrance was marked by pink clay and rubble foundations (L08:32 – also described as 'big stone chippings'), all the wall masonry having been robbed away (L08:31). The foundation trench was 1.90m long and 0.85m wide. The top of these foundations was higher than the top of the foundations (L08:34) for the north-east corner pier (1).

On the south side of entrance, masonry belonging to the north-east corner of an equivalent wall (L09:08) did survive. It was constructed of roughly dressed facing stones with a rubble core and, like the piers, was clay-bonded. The wall was 1.90m in length, from north to south, and was set on foundations composed of pink or red clay and sandstone rubble (L09:09), which reportedly cut the Phase 2 cobbled surface (L09:07, L08:12, K08:13) on either side of the entrance. Its full width did not survive, but could be estimated at c. 0.80m by comparison with foundation remains L08:32 on the north side of the entrance. The east portal of the forehall, thus defined, was c. 3.70m wide.

A stone-lined drain or gutter (L08:09, L09:06) ran along the east side of this wall and cut across the carriageway of the *via principalis*, in front of the



Fig. 10.17 The east end of the forehall looking north in 1980, with Piers 1 and 2 and infill wall in the background and wall L08:32 on the south side of the entrance. Drain L08:09 crosses the road carriageway on the right.

forehall entrance. It formed a continuation of the gutter channel that ran alongside the east wall of the *principia* (L09:06 also, L09:22, L10:06, K09:09), though it was not necessarily contemporary with that gutter, which was assumed to have been a primary component of the headquarters building. Drain conduit L08:09/L09:06 was also assigned to the road's primary phase by the excavators, but this must be rejected as the drain side walls were clearly set on the same pink clay and rubble foundations (L09:09) as forehall east wall L09:08 (see Fig 10.16) and must therefore have been essentially contemporary with that wall. The Phase 2 road surface of worn cobbles (L09:07 equivalent to K08:13/L08:12) reportedly abutted the drain, although the wall foundations were also said to cut the road, indicating a degree of confusion in the record of these relationships. The drain channel was c. 0.30–0.35m wide, whilst the side walls were constructed of roughly dressed sandstone blocks, of which a single course survived on either side, giving the structure an overall width of 0.95m. A deposit of sticky grey silt and small stones lay in the bottom of the drain channel overlain by sandy silt (L08:10, L09:13), which was described as gingery

brown or usually dark grey, but occasionally reddish, in colour. The upper fill of the drain consisted of a mixture of grey clay loam and cobble rubble (L08:29), perhaps backfill material rather than drain silt.

Drain L08:09/L09:06 probably connected with an east-west aligned gutter channel (K08:19, L08:35), which ran alongside the north face of the forehall. This latter may originally have formed part of a primary east-west drain (see above, Phase 1), since it lined up with the well-preserved primary drain further east along the *via principalis* (L08:49, 59, M08:11, N08:12), and was perhaps subsequently adapted to serve as a gutter when the forehall was erected in Phase 2. It comprised a single-faced wall (K08:19, L08:35), lining the north side of a channel in front of Pier bases 1 and 2 and the intervening panel wall of the forehall, its course further west being destroyed by nineteenth-century cellar J08:02–04/K08:02. The channel contained traces of dark grey sandy loam (L08:36), overlain by a deliberate packing of dull pink clay (K08:08, L08:21), which completely filled it, leading the excavators to suppose that this stretch of the drain (K08:19/L08:35) had simply been taken out of use and backfilled when the forehall was erected. The presence of third-century material in both the clay packing and the underlying sandy loam fill makes this last suggestion implausible, however (see below, Phase 3 drains).



Figure 10.16 Postholes of the forehall portico cut by rectangular pit C2 (shown completely emptied) from the west (Fig 10.16).



Figure 10.17 The north edge of the *via principalis* showing Phase 1 road foundations, Phase 2 kerbs J08:02 and H08:02, forehall piers 9 and 11 and portico postholes cut by rectangular pit C2 (Fig 10.17).

The timber portico (AY) – Figs 10.18, 10.19

Charles Daniels considered there had been a timber predecessor to the stone forehall, based on the discovery of a row of ten post holes and one possible post-pad to the north of the piers of AO (H07:11–13, 18, J07:13, 22–23, 25, K08:16, L08:26–27, 41). This timber structure, which Daniels labelled Building AY, was clearly not a part of the initial layout of the fort – the post holes cut the foundations of the south wall of Building 15 – but Daniels regarded it as a relatively early in the structural sequence, assigning it to the first overall phase of the fort (effectively Fort Phase 1b). He envisioned a timber forehall which was shorter but wider than the stone-built structure, AO, effectively just covering the frontage of the headquarters building. However, this was reinterpreted by the 1997–8 excavators as a part of a wooden portico along the northern frontage of the stone forehall (Hodgson 2003, 178). They noted that the line of post holes identified in 1980–81 did not merely lie opposite the north wall of the *principia*, but actually continued westwards in front of the granary, thereby invalidating Daniels' reconstruction. Although no post holes were identified beyond a point opposite the east granary steps, any examples further to the west would have been hidden beneath the present course of Buddle Street, which cuts diagonally across the projected line of the posts, and it is quite conceivable that they originally continued along the full frontage of AO.

The line of posts was positioned c. 1.60–1.70m beyond the north face of the stone forehall. To the east of the *via praetoria*, a total of three post holes (L08:26, 27, 41) and one stone setting interpreted as a post pad (K08:16) were revealed in a 4.00m stretch opposite the north-east corner of the forehall. The largest of the post holes, L08:27, which measured c. 0.75m square, lay directly opposite the north-east corner of the stone forehall and was 0.70m deep. L08:41 and L08:26 were smaller (0.57m E–W × c. 0.60m N–S in the case of L08:26), but were also 0.70m deep and all three were filled with grey clay loam and contained large packing stones, but no evidence of a post-pipe remaining. L08:27 also contained a little pink clay. The post pad (K08:16) was composed of seven stones forming a rectangular setting, measuring 0.80m (E–W) × 0.50m (N–S).

On the other side of *via praetoria*, a further eight post holes were identified in 1980–83, whilst evidence for two more possible examples (retrospectively numbered H07:20 and J07:31 for convenience) can be detected on a couple of the site plans (P298, P429). Six of these (H07:11–13, J07:22, 23, 25) were described, in very similar terms, as steep-sided, flat-bottomed (at least in the case of J07:25) and filled with medium brown silty soil with a few coal flecks and collapsed packing stones, some redeposited natural also being noted in J07:25. Their depth varied between 0.34m

and 0.65m and they ranged in diameter from 0.50m to 1.05m. Next to the south-west corner of Building 15, post hole J07:13 was 0.50m in diameter and was filled with loose gravel and medium-sized stones in dark grey/black soil, with a greasy black deposit of possible organic matter present in its south-west corner. Only 0.20m further to the east, directly opposite the south-east corner of 15, site plan P298 marks a double concentric circle, with a maximum outer diameter of 0.35m, and what appear to be three packing stones in the centre, which may represent another post hole. At the far western end of the row of post holes, H07:18 was described simply as a circular setting of stones on edge and disturbed cobbles, which was 0.65m in diameter and cut the south wall foundations of Building 15 (H07:17). A southward bulge in those wall foundations, c. 0.60m in length, which was evident on site plan P429 between H07:18 and H07:13 and was associated with some relatively sizeable stones in the foundation material, might conceivably represent another post hole in the same row (0.80m from H07:13 and 1.10m from H07:18; see Fig10.10). There is some indication that more than one phase (or sub-phase) of activity may be represented by the surviving post holes. One of the smaller post settings, J07:23, lay immediately to the north of the much larger J07:22, in such close proximity that the two may well have intercut, though the Cistern 2 pit has obliterated that stratigraphic relationship. J07:23 may well be a replacement for J07:22, which was more closely in line with the other post holes, and some of the other examples are quite closely spaced.

No further postholes could be traced beyond H07:18 as their alignment was overlain by the course of Buddle Street. Similarly the area between post hole J07:13 and post pad K08:16, where the line of posts would have crossed the *via praetoria*, was destroyed by nineteenth-century cellaring. However one post hole (K07:29) was uncovered c. 1.50m north of the main post hole alignment, sitting in the middle of the carriageway at the southern end of the *via praetoria* where it cut the Phase 1 surface (K07:16 – see Fig 10.6). This post pit was oval in plan, measuring 0.70m × 0.55m, and, like J07:13, was filled with loose gravel and medium-sized stones in dark brown/grey soil. Given its position, K07:29 might not have formed part of the same structure as the other post settings, but, *if* the entrance to the forehall from the *via praetoria* was given special treatment – projecting forward for instance – and *if* the post holes do represent a portico attached to the forehall, then K07:29 might have been associated with the portico arrangements around the entrance. The fact that it appears to have stood in isolation in the middle of the carriageway would tend to argue against that, however.

Surfaces

Perhaps contemporary with the portico was a spread

of rubble in a matrix of sand and brown soil (J07:15), which extended from the edge of the *via praetoria* over the site of Building 15 and around some of the post holes (notably J07:13). This overlay the earlier (demolition?) rubble spread (J07:20) and might be equivalent to the rough rubble spread exposed a little further west (J07:24) along the south side of the postholes. However, the relationship of these two possible surfaces to the portico post holes, as substantiated in the site archive, appears contradictory (see below).

Stratigraphic relationships

A number of clear stratigraphic relationships between individual elements of AY and adjoining structures enable the timber structure to be slotted into the overall structural sequence in the area of the central *via principalis*. Two of the structure's post holes (H07:13, 18) cut the south wall foundations of Building 15 (H07:17), demonstrating that its construction occurred at some stage after the demolition of 15. Conversely, the next five post holes to the east (H07:11, 12, J07:22, 23, 25) were all partially cut away by the large rectangular pit labelled Cistern 2 (H07:10/J07:18; see Figs 10.18–10.19), whilst L08:26 and L08:27 at the east end of the structure were also seen to have been cut by drain channel K08:15/L08:19, immediately to the south. This implies not only that AY must pre-date both the drain and the cistern, but also that it had probably gone out of use by the time these features were constructed. A note of caution should be expressed regarding this last observation. L08:26 was only slightly clipped by the cut for drain L08:19 and, although L08:27 was more substantially impacted, it is perhaps possible that the upright posts set in these two pits could both still have remained standing, although the arrangement would scarcely have been ideal. However the post holes intersected by Cistern 2 were all very substantially cut away, with as much as half the pit having been removed in each case. Even allowing for the possibility that some of this damage may have been caused later on by the collapse of the clay sides of the pit or the removal of stone revetment walls lining the pit, if such ever existed, it is difficult to imagine that AY would not have been destabilised by the digging of the cistern pit so close to its northern edge.

Greater uncertainty surrounds the relationships between the post holes of AY and the various cobbled surfaces or rubble layers on the north side of the *via principalis*, with some obvious contradictions being apparent when taken together. Thus post holes H07:11, 12, 13 and 18 at the western end of the exposed extent of AY, were reportedly covered by the surface of small and medium-sized angular stones (H07:07), which was interpreted as part of a northern extension of the Phase 2 *via principalis* metalling (with G07:04). In contrast, the records for J07:22, 23 and

25 indicate those post holes were overlain only by a rough rubble spread (J07:24) associated with the disturbed Phase 3 surface, whilst J07:13 was clearly shown to *cut* the supposedly equivalent rubble spread J07:15 over the east end of Building 15. If the reported relationships were accurately observed and the various equivalences correctly interpreted these post holes could not all have belonged to the same structure or phase. However it is likely the excavators experienced some difficulty in spotting the post holes amidst the extensive rubble spreads, the overall integrity of these later 'surfaces' being in any case, rather questionable (see below Phase 3 – *via principalis*).

Discussion

The suggestion, made by the 1997–8 excavators, that the post holes represented a timber portico along the north side of the stone forehall, is certainly a more coherent interpretation of their function than that presented by Daniels, although the stratigraphic relationships noted above are not sufficient to determine whether the portico was an integral element of the initial forehall design or a secondary feature added at a later date. Certain functional aspects of this structure are still very puzzling, however, most notably its relationship to the south-west corner of Building 16. Post holes L08:26, 27, 41 and post pad K08:16 were constructed right alongside the south wall of Building 16, with the result that any rainwater flowing off the pentice roof of portico AY would have poured directly onto that wall – clearly an unsatisfactory arrangement and all the more so if the forehall itself was roofed since the portico would then have directed rainwater falling on the north slope of that roof onto the corner of 16 as well. The combination of the portico, the north-east corner pier and east wall of the forehall, extending across the *via principalis*, between the *principia* and Building 16, would have substantially obstructed movement further westward along that road. The only means of proceeding directly from the eastern part of the *via principalis* to the *via praetoria*, without entering the forehall, to which access may have been controlled or at any rate scrutinised, would entailed walking beneath the portico. Any cart traffic would have had to enter and then exit from the forehall or circulate via the *intervallum* road.

Also curious is the relationship of the portico to the gutter K08:19/L08:35 running along the north side of the stone forehall, immediately adjacent to the piers and blocking wall at the north-east corner. The 1980–81 excavators assumed the surviving north side wall formed part of a primary drain running on an east-west alignment along the *via principalis*, which was taken out of use and backfilled with clay packing (K08:08, L08:21) when the forehall was constructed. (Indeed the eastward continuation of the drain on

essentially the same alignment, some 1.50–2.00m south of Building 16, was exposed when the eastern *via principalis* was excavated in 1983–4.) This perfectly logical sequence, which would be consistent with the interpretation of the portico as an original component of the forehall, is called into question by the presence of third-century pottery not only in the clay packing (which contained sherds of mid-third century black sand amphora), but also in the underlying drain silt (L08:36). This demolition appears much too late to be contemporary with the initial construction of the forehall, on the basis of other evidence. If K08:19/L08:35 was in use contemporaneously with the forehall, it is most plausibly to be interpreted as a gutter running at the foot of the piers and blocking walls, either built at the same time as the forehall or, more likely, adapting the course of a primary *via principalis* drain conduit where it passed in front of the forehall. Yet why would such a gutter have been necessary, if the frontage was already protected by a timber portico, with a pentice roof which would have carried away rainwater from the forehall footings?

None of these observations provides any kind of conclusive argument to refute the suggestion that AY represents a forehall portico. The fact that an arrangement may have been awkward or unwise does not prove it was never implemented. However it is worth considering whether there is an alternative explanation for some of these post holes which would avoid some of the problematic aspects outlined above, particularly around the north-east corner of the forehall. One possibility is that the post holes might represent a secondary phase of Building 16, perhaps involving the reconstruction part of its south wall in timber. The postholes could represent continuous walls constructed using individual earth-fast posts rather than sleeper-beam slots or post-in-trench, but open-fronted sheds or workshops could also be envisaged. This hypothesis is outlined in more detail in the section relating to Building 16. Hence, the portico might only have covered the western frontage of the forehall, as far as the crossing of the *via principalis* and *via praetoria*. It is uncertain how the forehall was laid out at the junction of the two roads as this part of the structure had been destroyed by a nineteenth-century cellar, but it is clear that it must have been somewhat different since the spacing of piers observed to the west cannot have been evenly maintained in the available space. The disposition of piers plotted by Daniels in this area is a hypothetical restoration, but it is possible that the actual arrangement was more elaborate with, for instance, a couple of piers projecting northward along the *via praetoria* to create a more impressive articulation of the arcade. Any such projection would have represented a suitable terminal for the timber portico to the west.

The central *via principis* is (Fig. 10.19)

In the interior of the forehall, a new road surface was laid over the previous *via principalis* metalling along the full length of the building. This was considerably narrower than its predecessor and nowhere extended as far north as the line of pier bases. The northern edge of this road metalling was retained by a series of stone kerbs (from east to west: J08:14 = TWM 5212, H08:22, H08:39/G08:34, G08:23) which formed neat vertical north faces and extended over a total surviving distance of 23m (Figs 10.10, 10.19). No corresponding south kerb was identified. Although they followed the same general orientation, the north kerbs did not form a single continuous line, being interrupted by gaps and staggered in relation to one another, perhaps indicating the road was constructed in a series of sections. The kerb's overall alignment drifted southward gradually over its course from east to west, to bring the edge of the road carriageway directly in line with the north side of the forehall's west entrance. Thus, kerb J08:14, at the eastern end, lay only 0.30m from the south face of Pier 6, whilst G08:23 at the western end was located up to 2.15m south of Piers 11 and 12. The two easternmost kerbs (J08:14 = TWM 5212; H08:22) were constructed of large-medium sized kerbstones and were the most prominent of the series, with surviving lengths of c. 4.40m (J08:14) and 6.50m (H08:22), the former being truncated to the east by a nineteenth-century cellar (J08:02–04/K08:02). H08:22 was staggered some 0.80–0.85m further south than J08:14, following a line some 1.20m from Piers 8 and 9. The kerbs further west (H08:39/G08:34 and G08:23) were constructed of smaller cobbles and therefore appeared less prominent, but site plan P272 shows they protruded sufficiently to have been apparent as soon as the Phase 3 road level was removed, and before cleaning had revealed any extensive areas of the adjoining Phase 2 road metalling.³

The road surface adjoining the kerb, on its south side, was composed of a mixture of small and medium-sized, well-worn sandstone cobbles (G08:04, H08:23, J08:11, K08:28), which varied in diameter from 20mm to 100mm. These were set in a matrix of dark red-brown sandy loam, becoming orange-brown in patches, over a compact makeup layer of mixed grey and brown silty loam, which was some 20–40mm deep, the overall thickness of the road level being some 100–150mm. At the western end of the forehall, the road metalling was described as being made up of stones, 50–100mm in diameter, smoothed by wear and intermixed with crushed gravel and set in powdery light brown soil (F07:08, F08:23). In one spot this was overlain by a patch of flagging (F08:35). Towards the eastern end of the building, however, the surface had been much more heavily disturbed (K08:30). The layer of small flagstones and packed cobbles, 30–70mm in diameter, set in grey silt and crushed stones (F08:38, G08:21, H08:34), identified

during the 1983 excavation season in the western half of the forehall, was probably equivalent to Phase 2 metalling G08:04/H08:23 etc., representing, in part at least, the re-exposure and cleaning of levels already examined and perhaps partially removed in 1980–81. An underlying layer of very light grey soil (G08:38/H08:44) may represent bedding or makeup for the Phase 2 road metalling, although there are problems in reconciling the records from the two campaigns which hinder confident interpretation of the road levels in this area.

Both kerbs H08:22 and J08:14 clearly sat on top of the primary road surface (H08:27, 30, J08:17, 29), which extended further north than the Phase 2 road metalling, with those northerly stretches that were still exposed inside the forehall (H08:27, J08:17) continuing in use during this phase. Immediately to the north of the forehall, another metalled surface, composed of mainly angular, small to medium-sized stones in a brown soil matrix (G07:04, H07:07), c. 0.25m thick, may also be contemporary with the Phase 2 road level. This surface extended over the demolished remains of Building 15, but reportedly underlay the infill wall G07:05 in the second archway at the west end of the forehall, whilst abutting the pier bases 11 and 9 (G07:03 and H07:04/H08:14) and overlying AY post holes H07:11–13.

Just inside the eastern entrance of the forehall (on the east side of modern drain K08:03), the equivalent metalled surface, attributed to Phase 2, was composed of very smooth, worn cobbles, up to 0.25m in diameter, but averaging 0.10–0.15m, and forming a good, very flat surface (K08:13, L08:12, L09:07). In the north-east corner of the forehall, a 25–50mm thick deposit of grey clay containing small stones and larger cobbles (K08:38) was also assigned to this phase. This was overlain by a 25–50mm thick layer of small cobbles with occasional large stones (K08:37, L08:44), mainly rounded, which abutted the north-west piers (K08:05, L08:15) and the infilling wall (K08:06, L08:16) of the forehall. These two layers are more likely to represent the makeup deposit and overlying surface metalling of the Phase 2 road, rather than two separate phases of road surface, as interpreted in the context database.

In the interior of the forehall, the road surface was cut by a gully (F08:56, G08:35, H08:29, J08:16; equivalent to TWM 5207), some 0.30–0.55m wide and up to 0.27m deep, which ran at least 36m from the direction of the *via praetoria*, as far as the western entrance of the forehall. To the east, its course was truncated by a nineteenth-century cellar (J08:02–04/K08:02) so its relationship to the various drain channels recorded on the *via praetoria* could not be established, although, in form, it most closely resembled K07:15. The fill of this gully was variously described as consisting of large and medium-sized stones in a matrix of dark brown soil and gravel (H08:29, J08:16) or small stones in brown/yellow soil (F08:56). If this

feature represented a deliberately constructed drain, as appears most likely, it is notable that absolutely no trace of stone lining was found either in the form of vertically set slabs or courses of masonry. If the stone lining had been robbed out the robbing would have had to have been exceptionally thorough. More likely, perhaps, if the feature was indeed lined, timber planks were used instead. Alternatively, the layers of road metalling, through which the gully was dug, may have been considered sufficiently firm and compacted that it had no need of lining. The context records state that the gully lay beneath the Phase 3 road surface and, certainly, no trace of it is apparent on the site plans depicting that surface, whereas it is clear on the plans of the Phase 2 metalling, and can therefore be assigned to that phase with reasonable confidence. It was thus broadly contemporary with the construction of the forehall, however its appearance suggests that it was inserted in the road surface after the latter had been laid and it was probably a secondary addition to the building. The 1997–8 excavators note that the drain cut the infilled robbing pit associated with the removal of the western pier base of the granary portico (Hodgson 2003, 180) – an integral part of the remodelling connected with the construction of the forehall – which would be consistent with this phasing.

The via praetoria

A well-set cobbled road surface (K07:27), some 25–50mm thick, was laid over the earlier layers of metalling on the *via praetoria* (see Fig. 10.10 above). It appeared to be composed of small to medium-sized cobbles, none larger than 150mm in diameter, to judge from site plan P241. The carriageway was 4.30–4.70m wide (the width increasing towards the north) and was bounded by kerbs on either side. The west kerb (J07:10) was the better preserved of the two, although it survived only partially and was composed of roughly worked slabs 0.20–0.50m in length. The east kerb (K07:28) was more disturbed, perhaps by the construction of drain K07:19, the kerbstones being inset irregularly on the west of the drain side wall. A surface of rough cobbles (described as ‘almost rubble’) extended westward from kerb J07:10 as far as flagged drain J07:12 marking the edge of the earlier road carriageway. This may represent a widening of the road, infilling this strip to bring it up to the level of the main road carriageway.

A drain channel (K07:15, K08:23), orientated broadly north-west to south-east, was constructed, cutting through road surface K07:27. This did not run down one edge of the road, as was the case with most of the *via praetoria* drains, but instead appeared to cut diagonally across the western half of the exposed carriageway, being traced over a distance of 4.40m from Buddle Street to the modern cellar. Very

little of the side walls of the drain survived, having probably been robbed out when the drain was taken out of use. Those sections which did remain were built using fairly small stones 0.10–0.30m in length. A few capstones also survived, however, taking the form of slabs up to 0.50m long and 0.40m wide. The conduit was 0.20–0.25m deep and 0.25–0.40m wide overall, the channel being 0.15m wide at the only point where edge stones survived on both sides, and was filled with grey-brown soil containing a few stones. Where it was cut by the later drain, which cut across the *via praetoria* carriageway from east to west, the small stones of the drain's side wall were preserved in the bottom of the later drain channel. There was some confusion in the excavation archive regarding the stratigraphic relationship between these two drains, but the relationship seems essentially clear. It is possible that drain K07:15/K08:23 connected with apparently unlined gully or drain channel (F08:56, G08:35, H08:29, J08:16; TWM 5207), which ran along the length of the *via principalis* carriageway from the nineteenth-century cellar as far as the western entrance of the forehall. Although no trace of side walling was found lining the gully nor any capstones, it does share some characteristics in common with K07:15/K08:23. Both were cut fairly centrally through the Phase 2 road surfaces, rather than running along the edge of the respective carriageways, and could have joined up without the course of either channel having to be substantially redirected. The channels were both secondary features of this phase, being constructed after the road surfaces had been laid and were certainly not carefully laid out in relation to the Phase 2 carriageways, but equally clearly predated the next phase of metalling on the two roads.

Discussion – the forehall

Five examples of such forehalls are known in Britain, at Brecon Gaer, Newstead, Ribchester and, on Hadrian's Wall, at Haltonchesters, as well as Wallsend, but over 30 have been recognised altogether and they appear commoner in other parts of the empire, notably the forts of the German frontier. There is evidence that with the exception of Ribchester, all the British examples were additions to the original fort plan, but this was not necessarily the case elsewhere, for example at Hesselbach in the Odenwald (see below). Of all the British forehalls Wallsend appears the most architecturally ambitious, covering not just the entire frontage of the *principia* but also the granary forming the largest integrated composition of its kind.

Form

The breadth of the foundations flanking the western entrance to the forehall suggests that the piers arcade was effectively continued around the west side of the building. The structures on the east side appear

much slighter by comparison however. The use of clay-bonding for the piers may have dictated their size. The thinner, panel walls used to infill at least some of the archways were mortar-bonded. It is not clear how many of the archways were infilled in this manner or if this infilling all took place at the same time. Only three such walls were identified, but more might have been removed leaving very little trace if they were set directly on the pre-existing road surface. Evidence from the easternmost archway suggests that the blocking-up of that particular archway took place when the forehall was first constructed. However this need not be the case everywhere. In some cases the north face of the panel walls was directly in line with the north faces of the adjoining piers but elsewhere they were slightly recessed, which might hint that their construction was more ad hoc, although such minor irregularities might not have been all that evident in the standing structure. The panel walls would perhaps not have risen right to the top, with arched widow openings left at the top to allow in light, particularly if a high proportion of the archways were indeed infilled and the forehall was roofed as suggested by Hodgson (2003, 180–81), otherwise the interior would have been very gloomy.

The forehall was a large and potentially very grand structure. Its northern façade, in particular, with its long sweeping arcade, must have been very impressive, although its lower levels, at least, would have been obscured by the timber lean-to portico attached to the frontage. The demolition of Building 15 meant that most of the forehall's northern façade was not hemmed in by adjacent buildings allowing onlookers to more readily appreciate the overall appearance of the building. Some idea of the kind of architectural embellishment the forehall might have received can be gauged by the extremely well-preserved example which still stands to its full height today in the legionary fortress at Lambaesis in eastern Algeria (anc. Numidia), though this has been partially restored. It took the form of a structure of two apparent arcaded levels with string courses and cornices separating the two levels and set at eaves level. The finely dressed ashlar masonry employed by *legio III Augusta* at Lambaesis was doubtless superior to anything that the garrison at Wallsend could manage, but any deficiencies in the latter's stone-masonry may well have been remedied by rendering the stonework and then painting with a false ashlar design.

Function

The forehall was originally interpreted by Daniels as a cavalry drill hall. In doing so he was following the suggestion first made by Wheeler (1926, 42) and Richmond (Simpson and Richmond 1937, 169–70; cf. Richmond 1950, 24), prompted by the discovery of similar forehall structures at Brecon Gaer and Haltonchesters in the 1920s and 1930s respectively. In

both cases the forehall was explicitly identified with a building type known as a *basilica equestris exercitatoria*, which is mentioned on an inscription of 222 from Netherby (RIB 978), although the dedication was not found in close association with a forehall building and indeed no forehall has ever been revealed at Netherby. Indeed, although all the known British examples are located in forts with cavalry or equitate garrisons, only half of the overall total are connected with cavalry units and in the case of Hesselbach, where a small forehall formed part of the original fort plan, it was clear that the garrison was composed solely of infantry from the very start (Baatz 1973; Frere 1974, 495). Schonberger (1969, 169) rejected the notion that forehalls were for cavalry, arguing instead that they were covered spaces where troops could assemble, and Hodgson (2003, 181–2) has now reinforced this argument, with particular reference to the example at Wallsend itself, pointing out the impracticality of the cavalry drill hall concept in relation to the circulation of traffic to the granary in particular. Moreover excavations at Birdoswald in 1987–98 resulted in the discovery of a basilical hall in the south-west quarter of the *praetentura* (Wilmott 1997, 79–82, 95–8; 2001, 70–72; Wilmott *et al.* 2009, 216–20) which appears a much more convincing candidate to represent a *basilica exercitatoria*. In fact it is difficult to imagine a more awkward and inconvenient location for a training hall than the central crossroads of the fort, where the troops' exercises would have obstructed the entrances to the both the headquarters building and the granary and generally impeded the circulation of traffic within the fort. It seems more likely that, as Hodgson has argued (*ibid.*), the forehall provided a sheltered location both for the benefit of those conducting business at the entrances to the granary, including delivering and removing supplies, and for the wider garrison to assemble in front of the *p incip a* during ceremonial and religious events.

FINDS

Forehall building (AO)

Timber portico (AY)

Samian stamp: 160–90 (no. S64, H07:11), 160–200 (no. S67, H07:11)

Rubble spread (J07:15)

Glass: melon bead (no. 42)

Pottery: spindlewhorl (no. 44)

plus a post-medieval button

Via principis surfaces Phase 2

Coins: Gallienus?, 255–8? (no. 139, F08:35); Constantine I, 330–5 (no. 175, G08:04); 'Magnentius', 351+ (no. 224, G08:04)

Bone plate (no. 73, F07:08)

Dating evidence

Forehall and Portico

FOREHALL INFILL WALL

There were two sherds of pottery from the infill wall (F07:02), one of which was from a BB2 cooking pot of the late second century or later, while the other was undiagnostic.⁴

PORTICO POSTHOLES

Posthole H07:11 produced two sherds of samian dated c.160–190 and 160–200 (cat nos S64, S67), and posthole L08:27 a single sherd of BB2 of the late second century onwards. There was a larger quantity of pottery in posthole J07:25, but most of it came from a single BB2 cooking pot.

RUBBLE SPREAD

There was a single sherd of pottery from the rubble spread over the east end of Building 15, a BB2 base sherd dating to the late second century or later (J07:15).

The via principalis (Road 1) – Phase 2

SURFACES

Almost all the pottery from the Phase 2 road surfaces came from context F08:23, which consisted mainly of BB2 sherds. There was a Crambeck reduced ware jar rim and base of a bowl, dating to the late third century or later; a coarse ware flanged bowl in G07:04 is of a similar date. There were three coins from the road surfaces: a corroded coin of Gallienus?, 255–8 (F08:35, cat. no. 139), a worn coin of Constantine I dated 330–5 (G08:04, cat. no. 175) and an unworn coin of 'Magnentius' dated 351+ (G08:04, cat. no. 224).

DRAINS

The quantity of BB2 from the drains suggest a third-century date to the fill (G08:35, L08:10).

The via praetoria (Road 2) – Phase 2

The Phase 2 *via praetoria* metalling produced little material, but included two samian sherds of the late second or first half of the third century (K07:27).

Third-century activity

The Phase 3 via principis

The *via principalis* was resurfaced once again, this operation being assigned by the excavators to the overall Fort Phase 3. The road metalling was composed of rough cobbling, 10–30cm in diameter, quite well laid places, but mixed with patches of rubble and areas of disturbance (G07:02, G08:02, H07:02, H08:17, J08:10, J07:24, K08:27). To the west, smaller cobbling, as little as 5cm in diameter (F07:03, F08:10), predominated, the stones here being set in a matrix of light grey soil. To the east of modern drain

K08:03, in the area of the forehall's eastern entrance, a very disturbed surface composed of cobbles of varying sizes (K08:12/L08:11) was present.

The via praetoria

Phase 3

A new surface of relatively compact cobbling (K07:14, J07:08), some 0.05–0.10m in thickness, was laid over the southern end of the *via praetoria* carriageway. The cobblestones were c. 2.5–10cm in diameter and were more extensive than the previous road levels, spreading from the gable end of Building 16 westwards over the line of primary drain J07:12 and around 3m beyond, giving the new carriageway a maximum width of 9.5m. Towards the south the surface incorporated a few surviving capstones of drain K07:15/K08:23, associated with the previous phase, but to the north the cobbled surface extended over the drain which had evidently been robbed and backfilled. No distinct kerb survived on the west side, but the eastern edge of the road was formed by the drain (K07:19) which ran alongside the gable end of Building 16. At its southern end, next to the South-west corner of Building 16, the drain turned and cut across the carriageway (K07:20, K08:25). This conduit was probably constructed at the same time as road surface K07:14/J07:08 and in its definitive form was clearly contemporary with that road level (the possibility that the north-south channel may have had an earlier phase, perhaps designed to take some kind of effluent from Building 16, was discussed above – *via praetoria*: primary phases).

Drain K07:19–20/K08:25 was a substantial structure. The north-south aligned stretch (K07:19) survived in good condition, with both side walls present along virtually its entire exposed course. The channel here was 0.20–0.35m wide. After turning to head west the channel appeared to widen out to 0.35–0.50m, although this stretch of the drain (K07:20/K08:25) was quite badly damaged and both side walls were only present in a few places. No capstones remained. The drain was filled with loose gravel intermixed with dark brown soil and a few stones (K07:11, K08:22, J07:06, 09). It was also partly filled with cobbles from a later, overlying road surface (K07:05, K08:18). The drain extended westward into grid squares J07 and J08, but its remains were progressively more disturbed there, with no definite intact stretches of side walling surviving, its course being indicated by the continuation of the fill deposits (as J07:06, 09) in a linear gully. Here it may conceivably have connected to the earlier underlying north-south drain (J07:12), which ran down the west side of the previous road carriageways, but the southern end of this conduit was also very disturbed so the structural relationship between the two drains could not be definitively resolved. However road cobbling K07:14/J07:08 extended right across the line of J07:12, completely covering it, suggesting that the

earlier north-south drain had gone out of use by this stage and was simply overlain by the new east-west drain. Site plan P239 actually shows a linear depression, which might represent the robbed out channel of the east-west drain, tracing a rather sinuous meandering course for a further 1.30m, beyond J07:12. Thereafter drain K07:20/K08:25 probably then turned southward towards the area of the forehall, since its course appears to be interrupted by the modern cellar which occupied the north part of that building at the intersection of the *via praetoria* and the *via principalis*.

An upright slab (recorded as SF 2054 in fill context K08:22), which was pierced by a single circular hole towards its upper edge, was set across drain channel K07:20/K08:25 some 3.50m from its eastern end. It appeared to represent some kind of filter stone similar to the one perforated by three holes which was present in drain channel J12:35 leading to cistern K12:26, next to the south-east corner of the *principia*. The latter was presumably designed to trap sediment and prevent it filling up the cistern, however the function of stone 2054 is less clear since drain K07:20/K08:25 was not connected to any known cistern unless one lay just to the south, inside the forehall on the site of the modern cellar.

In the area between drain K07:19/20 and the earlier drain course (K07:15/K08:23), an extensive spread of large, well-set cobblestones (K07:17), which were up to 0.35m in length, was laid over smaller cobbling K07:14. Despite its different composition this was interpreted as part of the same road level as K07:14.

Phase 4

Another cobble surface (K07:05, K08:18), some 0.10–0.15m thick, worn smooth in places but elsewhere fairly rough and possibly a little disturbed, was laid over the *via praetoria*. This appeared to extend over the west end of Building 16 and over street drain K07:19–20/K08:25, forming the upper fill in the drain channel. This surface was probably equivalent to the adjoining layer of fairly well-packed sandstone cobbles (J07:04) in the next grid square to the west. The north-west part of this layer was overlain by a spread of larger sandstone cobbles (J07:03), again identified as a road surface. Both J07:03 and J07:04 were cut to the west by the area of loose cobble rubble (J07:05), probably representing post-Roman disturbance. To the east cobbling K07:05/K08:18 was directly overlain by the 0.10–0.30m deep layer of fine, medium brown, silty soil (K07:03) which represented the medieval ploughsoil.

The excavators considered that road surface K07:05/K08:18 was equivalent to the uppermost *via praetoria* surface K05:15 identified further north. This too reportedly extended over the western end of the former building plots in the northern *praetentura* (Buildings 1 and 2) and together these contexts may represent the *via praetoria* surface metalling associated with the fourth-century fort.

Interpretation: the final *via principis* and *via praetoria* road levels

The uppermost surviving levels over the *via principalis* (Phase 3) and the *via praetoria* (Phase 4) were treated as distinct road surfaces by the excavators, rather than simply spreads of disturbed rubble at the bottom of the post-Roman stratigraphic sequence. This potentially has certain significant implications. *Via principalis* surfaces F07:03 and F08:10 were recorded as overlying the remains of the westernmost archway infilling wall (F07:02) and the south wall of the forehall (F08:13), respectively. Equivalent road level G07:02 was recorded as abutting both the next infill wall (G07:05) and Pier 11 (G07:03), but again site plan P246 suggests the surface in fact covered the western edge of the pier. If this accurately documents the relationships in question, it would imply that the forehall, or at least its western portion, had been demolished by the time this road level was laid.

However, there must be some question over the integrity of the latest surviving road levels. As is the case practically everywhere else at Wallsend, the uppermost layer of rubble represented the interface between the surviving stratified Roman levels and the disturbance resulting from medieval/early modern ploughing, colliery era activity or the construction of late Victorian terraced housing. The rubble was typically overlain by a layer of ploughsoil or structural features relating to more recent activity. The 1975–84 excavators interpreted these levels, on the *via principalis* and elsewhere, as a deliberately constructed phase of road surfacing, albeit disturbed in many places, whilst equivalent material over the sites of Roman buildings was typically regarded as the remains of late Roman demolition and levelling up. In places a Phase 3 road surface may indeed have been preserved relatively intact, but the excavators were unaware of the degree to which the late Roman levels had been stripped off by later activity, with the result that what they observed, far from being the final aspect of the site at the end of the Roman period, was in fact a product of later plough action and other disturbance. In these circumstances there was clearly potential for material to have been spread by plough action, and, given the significant degree of disturbance evident in the Phase 3 *via principalis*, it is not clear how much reliance should be placed on the documented relationships between the uppermost road surfaces and adjacent structures, particularly at the west end of the forehall.

The forehall (Fig. 10.20)

A deposit of pinkish grey clay (K08:10, L08:22) was laid in the north-east corner of the forehall, overlying cobbled surface K08:37/L08:44 and incorporating a mixture of angular stones, cobbles and chippings. This clay spread extended some 7.40m east-west and c.2.80m north-south. A very shallow slot or gully

(K08:11, 31, L08:13), 0.50–55m wide, with vertical sides, was cut into clay just inside the southern edge/limit of the spread. Its fill is variously described as grey loam, dark grey-brown loam or sticky grey silt, with some stones also being present. This probably represented the slot for a timber sleeper beam. However, site plan P247 gives the impression that trench K08:31 contained the remains of a robbed out wall with a few facing stones still left in the fill. Given the relative narrowness of the slot this may be misleading, but it could conceivably represent a shallow foundation trench for a narrow, stone sleeper wall supporting a timber superstructure. Whether associated with a timber or stone structure, the slot extended some 7.70m from the east wall of the forehall, then appeared to turn north and probably abutted the south-west corner of pier base 3, though this junction had been destroyed by the modern cellar. The internal width of the space enclosed, from north to south, was only c. 2.0m, measured from the south face of infill wall K08:06/L08:16, and even less opposite pier 2, although the course of the slot did appear to bow outwards a little towards the south. In the interior of the enclosed space over the clay spread a mass of broken, flat and angular fragments of fine-grained, yellow sandstone (K08:07, L08:14), some 0.05–0.15m thick, was deposited, perhaps as the bedding for a floor timber or flagged surface of which all trace has been lost.

Around the south-west angle of the north-east corner structure, a shallow gully (K08:32), c. 0.20m wide, was traced in the surface of the primary road metalling K08:40 (the only *via principalis* surface which survived in a relatively undisturbed condition at this point). The gully ran parallel with slot K08:31, 0.30–0.45m from its southern edge, but turned and continued northwards 0.70–0.80m from the western end of the slot, appearing to gradually diverge away from the latter's course. It was filled with small cobbles in a grey loam matrix, which the excavators thought had probably settled in the gully rather than representing deliberate backfill. The gully was interpreted as either a drip trench associated with overhanging roof of the building in the north-east corner of the forehall (which would imply that the forehall itself was unroofed by this stage) or the impression left by removal of a stone kerb skirting around the corner building. In the latter case, the kerbing would have formed part of a road level above the surviving Phase 1 surface (K08:40/K09:34) and would have been comparable with J08:14 and H08:22 etc., further to the west.

Cistern 3 (see Figs 10.20, 10.21)

Immediately to the east of the forehall, a large pit (L08:08) was dug. This was interpreted as another water tank, labelled Cistern 3. The top of the pit

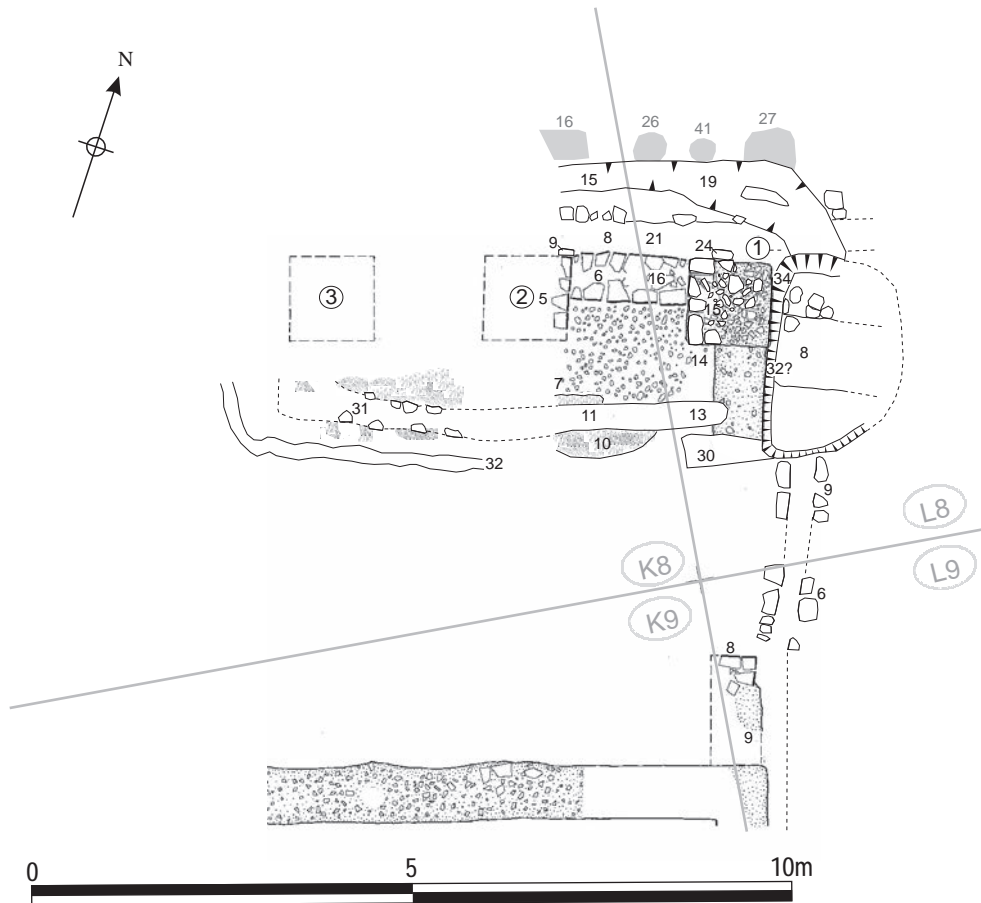

Fig re 10 North East corner of Building AO showing later features, (at 10)

measured some 3.76m along its west side (c. 3.20m at its base), next to the forehall, where it was widest, but only around 2.00m on its east side, being somewhat irregular in plan, whilst its breadth from east to west was 2.60m and its maximum depth was 1.25m. The sides were steep but not quite vertical. The north side was furnished with a step or ledge, c. 0.80m wide, 0.40m high and 0.85m below the top of the pit. The ledge was constructed of yellow, coarse-grained sandstone blocks bonded with an off-white gritty mortar. A similar stone ledge had probably existed along the south side, but had been robbed out leaving only a 0.20m high and up to 1.25m wide raised area of mortar which also extended a further 0.25m up the side of the pit. In the central section, between the two 'ledges', the base of the tank was covered by a shallow (0.03–0.04m high) deposit of mortar, similar in composition to the residue of the southern ledge. Later on, the pit had been backfilled with loose, medium sized rubble, containing many air pockets but no soil matrix, overlain by areas of mortary lumps and all sealed beneath a 0.06m thick capping of orange-yellow and grey clay. A shallow layer of light-medium grey silt and rubble was present at the bottom of the tank, also overlying the ledges and extending about halfway up its sides.

Drain channels (Figs 10.22, 10.23)

The course of the earlier drain L08:09/L09:06, which cut across the *via principalis* carriageway, was interrupted by the cistern and presumably now flowed into the south side of the tank. To the north, a new drain channel may have been cut along the north side of the forehall at this stage, positioned c. 1.25m beyond the north face of the piers and infill wall, and appearing to curve round the north-east corner of the building to flow into the cistern (see Fig. 10.20 above). The channel was steep-sided, with a flat bottom and was 0.5m wide. To the north of Pier 1 it appeared to split into two channels briefly (two sub-phases?), before merging again and running up to the cut for Cistern 3, where the combined channel was c. 0.95m wide. It was filled by dark grey, loose, crumbly loam flecked with charcoal (K08:15, L08:19). No trace of any stone lining or drain supports was found, but a number of stone slabs along its course were tipped in such a way as to suggest they originally formed capstones which had later broken and partially collapsed into the silt in the channel. Presumably the channel was lined with wooden planks. How far westward this drain continued beyond Pier 2 is unclear, but it may have connected with a north-south drain on the *via praetoria* (e.g. K07:15) and/or perhaps the channel which ran

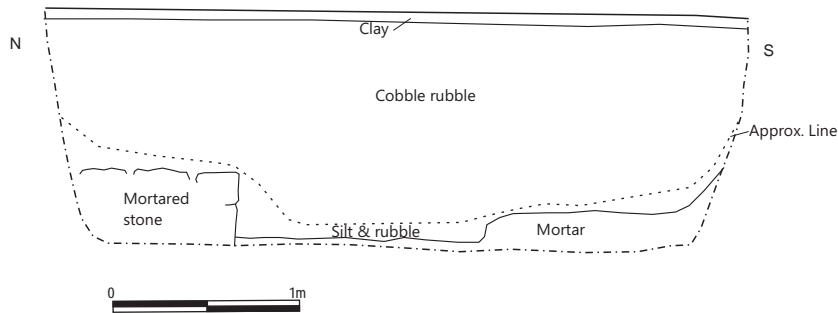

Figure 10.21: Reconstructed profile (S63) through Cistern 3 (L08:08). Scale 1:40.



Figure 10.22: Piers 1 and 2 and infill wall K08:06/L08:16, gutter K08:19/L08:35 and later drain K08:15/L08:19 over deep r early slot K08:15/L08:19 on the right, looking west (A).



Figure 10.22: The north east corner of the forehall wing gutter K08:19/L08:35 packed with clay (K08:08/L08:21) in front (left) of Piers 1 and 2 and infill wall K08:06/L08:16, looking east (A).

down the middle of the *via principalis* carriageway (F08:56, G08:35, H08:29, J08:16).

Slightly problematic was the relationship of drain K08:15/L08:19 to the post holes of the timber portico (AY) along the north face of the forehall. Two of the post holes (L08:26, 27) intersected with the channel. It is tempting to suggest that the apparent bifurcation in the channel north of Pier 1 could represent a southward diversion of the channel to allow for the

digging of post hole L08:27, in which case the portico would *post-date* the cutting of the original channel. However the drain channel/fill was clearly recorded as cutting postpad K08:16, posthole L08:27 and, less certainly, posthole L08:26. Presumably therefore the drain fill could be seen cutting across the southern lip of the post holes. If this interpretation is correct the timber portico had probably already been dismantled by the time the drain channel was dug.

Discussion – phasing

Cistern 3 was clearly constructed after the forehall, judging from its positioning directly alongside that building. The cistern was assigned to Fort Phase 4 by the excavators and certainly appeared to be one of the latest features in the surviving Roman sequence, but, as virtually everywhere else within the fort at Wallsend, it should be emphasised this was a sequence largely stripped of its fourth-century and later levels. The backfilled remains of the pit with its clay capping were overlain only by a rubble layer (K08:04, L08:06) which represented the bottom of post-Roman disturbance whilst the cut for the tank went down through all the adjoining Roman surfaces and deposits (L08:29, 32, 14, 11, 19). However a note

of caution should be expressed here. No trace of stone walls revetting the sides of the tank, survived, which seems highly unlikely to have represent its original form since such lining would surely have been necessary to prevent the sides collapsing. Given that stone-built ledges did survive at the bottom of the tank on one side, stone is perhaps more likely to have been the material used to revet the sides of the cistern, in the form of single-faced walls, rather than timber planks, for instance. Either way, it is possible that the surviving form of the cut for the tank reflected the action of robbing or removing the lining, rather than the initial construction, and may have intruded from a higher level than was originally the case, destroying the original relationships around the lip of the tank. Later robbing of this kind might also account for some of the irregularity in the plan of the water tank. It would certainly call into question the validity of the excavators' argument, put forward in a short structural summary compiled in 1983, that the east wall of the forehall must have been demolished by the time the cistern was constructed, on the basis that the cistern pit appeared to cut the edge of the foundations for that wall (L08:32).

Cistern 2 (Figs 10.24–10.28)

A large rectangular pit (H07:10, J07:18) was dug through the mixed layer of sand, silty soil and sandstone chips (G07:07/H07:15) covering the demolished remains of Building 15. It was positioned along the northern edge of the timber portico (AY) fronting the forehall, but chopped away substantial portions of several post holes (H07:11, 12, J07:22, 23, 25) belonging to the timber structure, suggesting the portico had probably been dismantled by this stage (Fig. 10.24).

The pit measured c. 9.0m in length (east–west). Its full width from north to south could not be determined as it continued beneath Buddle Street, but it must have been at least 2.70m (on the overall plans of the fort in Phases 2–4, Daniels estimated its full width was at perhaps c. 7.0m). The pit was steep-sided with a fairly flat-bottom and was c. 1.0m deep, as can be seen in the section drawing (S65 – see Fig 10.25).

The pit was generally interpreted as a water tank by the excavators and, accordingly, the feature was labelled Cistern 2, although the suggestion that it served as a clay puddling pit, perhaps associated with the construction of the forehall, is also found occasionally in the archive. However, no trace was revealed of a flagged bottom or of any stone revetment walling along the sides of the pit, comparable with Cistern 1 to the north of the hospital or the water tanks associated with the *principia* and *praetorium*. Moreover, the section drawing and photographs show that particularly towards the eastern end of the pit, the transition from side to bottom was rounded, rather

than displaying the kind of abrupt shift from near-vertical sides to a flat bottom compatible with a tank lined by single-faced walls and floored with flags.

The fills

The lowest fill of the pit was described as a grey clayey layer (H07:09, J07:19) on the bottom of the tank, containing fewer stones than the silt above. This was overlain by soft, dark grey/black silt (H07:03, J07:14) which gave off quite a strong smell. The clayey layer might conceivably represent a deliberate backfill deposit over which dark silt then began to accumulate. However no such distinction is apparent on the section drawing (Fig. 10.25) – which is difficult to correlate with the context descriptions in several respects – and no indication of the depth of H07:09/J07:19 is provided on the context records. Indeed the colour photographs taken of the east-west section through the pit, directly beneath Buddle Street, display a uniformly, very dark grey/black fill and the same is true of the photographs showing the north–south section, before the fill at the eastern end of the tank, beneath later flagging J07:17 and revetment J07:16, was removed.

Later flagging and road revetment (Figs 10.24–10.28)

A 0.10–0.15m thick level of large, medium and small stones, mainly comprising rounded cobbles, but including some flags and dressed facing stones (J07:17), was laid over the silt and intermixed with it c.0.90–1.00m above the bottom of the pit (Fig. 10.26). This stone layer can be seen clearly in section, being the equivalent to two 'courses' deep. It may have been designed to form a rough surface over the back-filled pit similar to the rubble deposits laid over adjacent areas. It was covered by further dark silt which was essentially indistinguishable from that which lay beneath and formed a matrix for the stones, and was treated as the same context. Some 1.8m from the eastern lip of the pit this stone layer took on a much more definite character, being composed of larger slabs which formed a deliberately laid surface with a distinct edge or kerb along its west side (see Figs 10.24 & 10.25). When originally laid, this surface was probably flush with the ground surface surrounding the pit and may have been associated with a widening of the carriageway at southern end of the *via praetoria*, however it had evidently subsided subsequently, doubtless as a result of the gradual settling of the underlying silt. This is demonstrated by the way the slabs along the eastern edge tipped downwards from the lip of the pit to the level of the main flagging and presumably accounts for the way silt continued to accumulate over the stone layer. A single-faced wall (J07:16), which was positioned some 0.80–1.20m from the edge of the pit and survived up to three courses high, was set on top of the stone slabs,

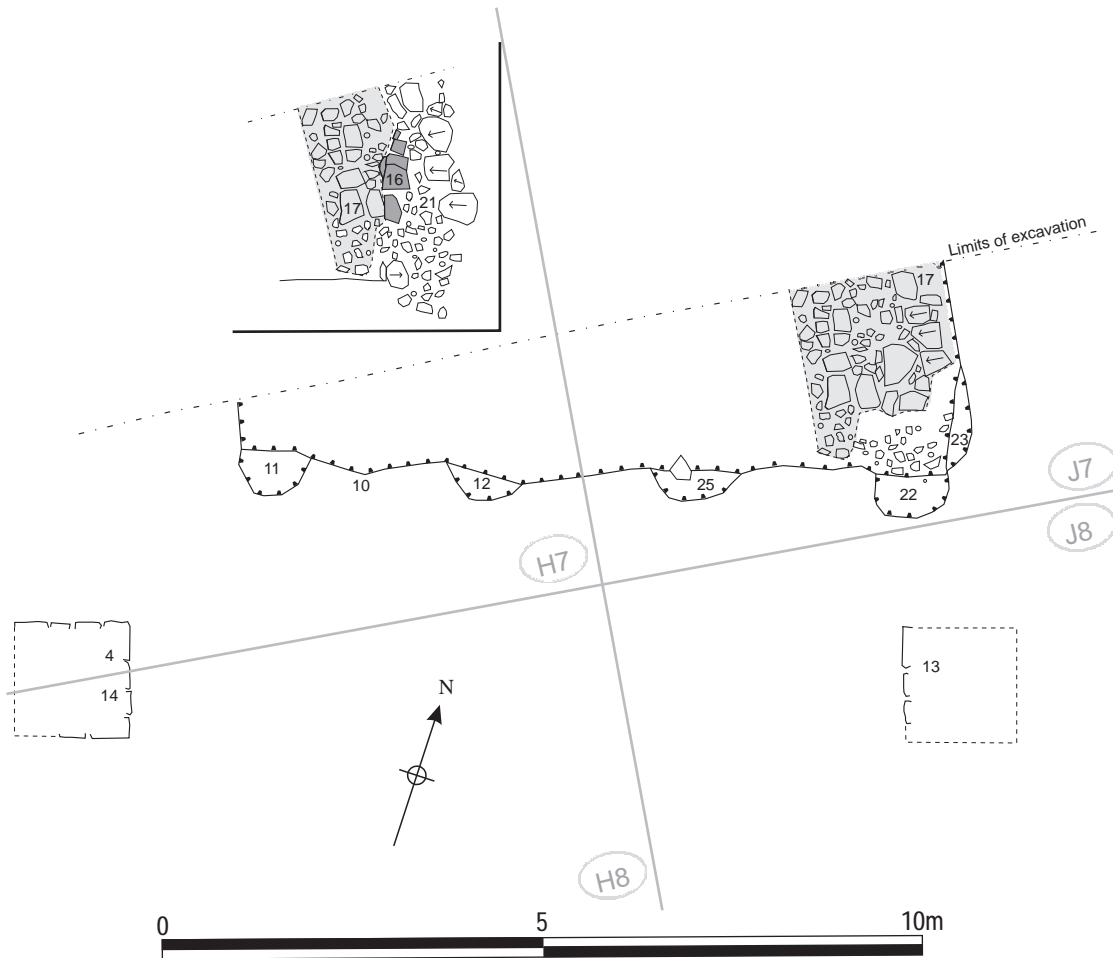

Figure 10.24: The rectangular pit (Cistern 2) north of forehall AO (at 1:100) with stone level (surface?) J07:17 over the fill also shown. The inset shows stonework of a possible side wall (J07:17).

presumably to counteract the subsidence, and was probably designed to retain the west side of the road carriageway (Figs 10.27–10.28). The space between the revetment wall and the edge of the pit was filled with rubble consisting of medium-sized stones in a matrix of medium brown clayey soil.

Discussion

The large rectangular pit, labelled Cistern 2, remains a puzzling feature. It was interpreted as a water tank but this is cast into doubt by the complete absence of any evidence for stone revetment walls lining the tank to prevent its sides collapsing. Along with flagged bases, such side walls are normal features of cisterns in the fort, typified most impressively by the large water tank north of the hospital (Cistern 1). If the tank was in use for any length of time there would have been a continual danger of the sides collapsing, a curious state of affairs to let develop in the centre of the fort, only 2m north of the massive piers of the forehall. This difficulty might be resolved if it is assumed that the pit was originally revetted, the side walls and flagged base later being robbed out. However, as noted above, the profile of the pit's

sides is not always as close to vertical as would be compatible with stone revetment walling.

An alternative, perhaps a more straightforward possibility, is that the feature represents a quarry pit designed to provide clay for a substantial construction project. The pit may also have been used for puddling the clay. Given its proximity to the forehall, it is tempting to associate the pit with the construction of that massive edifice which employed clay-bonding in the piers and other principal components. However this appears to be ruled out by the relationship of the pit and to row of post pits labelled AY. If these are interpreted as the remains of a timber portico lining the north side of the forehall, as discussed previously, they, and by implication the forehall, must predate the pit as they were clearly substantially cut by the latter. Nevertheless there are other construction projects which might be plausible candidates, such as the extensive early third-century remodelling of the barracks in the *praetentura*.

A further difficulty applies whether Cistern 2 represents a clay pit or a robbed water tank. Although its fill deposits are not meticulously described in the site archive, such analysis of their composition as is

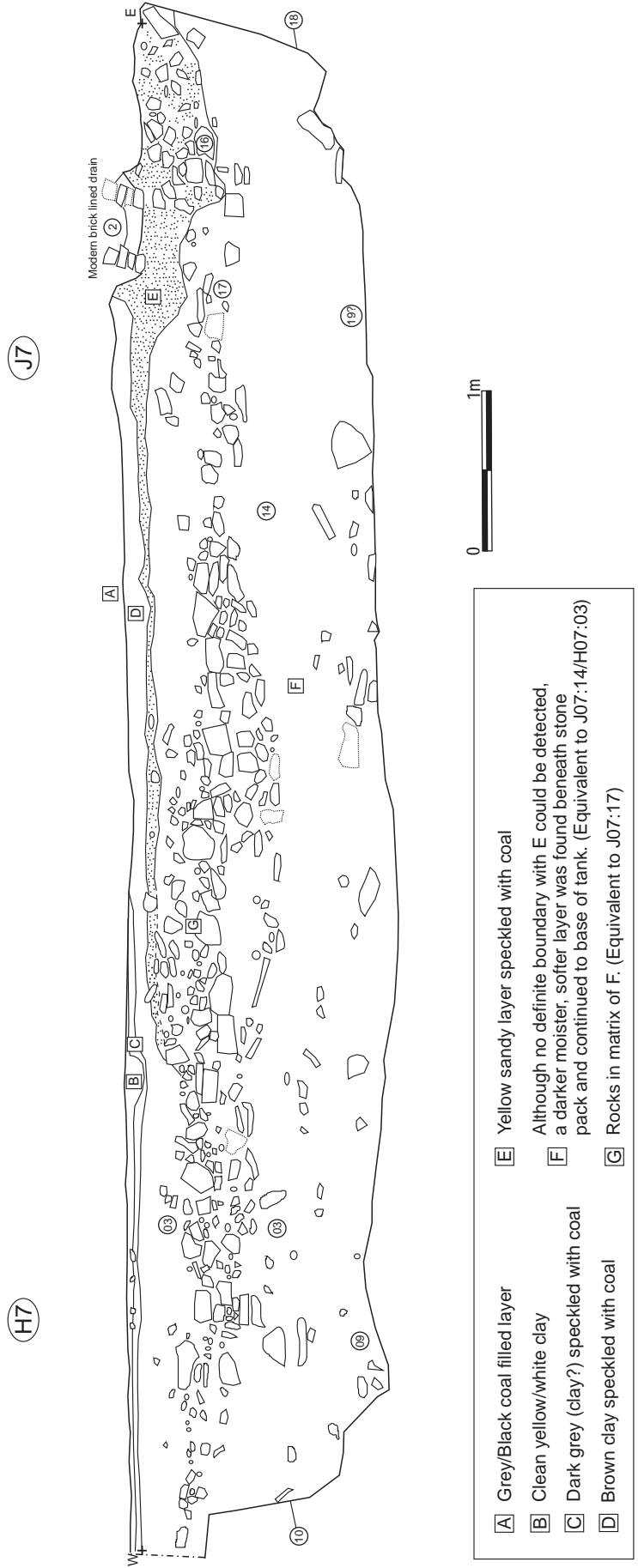

Figure 10.25: South facing section (S65) through Cistern 2 (H07:10|J07:18) along south side of Buddle Street. Scale 1:40. (Context numbers and equivalences were not shown on the original drawing and have been restored on the basis of the information on the context sheets.)

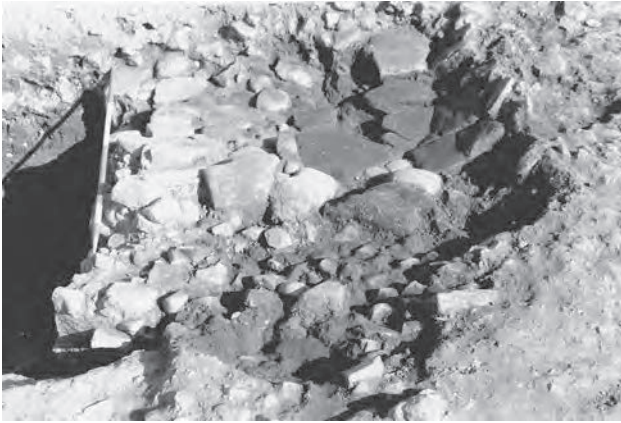

Figure 10.26 Flagging J07:17 laid over the east end of the rectangular pit C2 from the south (1981).

possible does not suggest that much if any deliberate backfilling occurred. The grey clayey lower fill might conceivably represent backfilling, but the overall impression provided by the archive is that the deposit was not all that thick and, indeed, it is impossible to identify it all on the section drawing and photographs. The clayey layer might simply represent material from the sides which had collapsed onto the floor of the pit or perhaps was simply the result of denser material settling to base of the pit, that is to say pit was filled with dark silt which gradually became more clayey in consistency towards the base, but was not essentially different in any other respect. Thus if the pit was dug to provide and process clay for a construction project it was then apparently left open and allowed to fill up naturally over time, presumably with silt washed off the surrounding roads. Similarly, no robbing cuts were present at the edge of the fills, so it is clear that the same observation applies even if the pit was once a revetted water tank, that is to say the *entire* and potentially lengthy process of silting up took place only after any side walling and flagging had been removed. It is puzzling that such a situation should have been allowed to develop, particularly in front of one of the most imposing structures in the fort. Even after the pit had apparently filled up and rubble was deposited over most of the pit to cap it, whilst a flagged surfaced (J07:17) was laid over the eastern end, the soft, loose nature of the silt fill – a consequence of the failure to actively backfill with more solid material such as clay or rubble – caused these levels to settle below the surrounding ground level. As a consequence, the depression must have continued to turn into a muddy pond after every downpour.

FINDS

Sandstone make-up layer in forehall

Coin: Severus Alexander, 229 (no. 135, K08:07)



Figure 10.27: Rectangular pit C2 looking east (1981). Note the later revetment J07:17 (for the *via principalis carriageway*) overlying flagged surface J07:17 and the dark silty sill of the cistern.

Gulley or slot in the NE corner of AO

Coin: of Gallienus, 258–68 (no. 143, K08:11); 'Constantius II' 353+ (no. 208, K08:11)

Phase 3 via principalis surface

Samian stamp: late second or first half of third century (no. S133, F07:03)

Coin: Trajan, 103–11 (no. 55, F07:03); Trajan/Hadrian?, c.93–117 (no. 65, F07:03); Tetricus II, 270–3 (no. 160, K08:12); radiate copy (no. 168, G08:02)

Phase 3 via praetoria

Copper alloy: binding (no. 144, K07:14), mount (no. 242, J07:08)

Phase 4 via praetoria

Copper alloy: stud (no. 254, K07:05), sheet (no. 313, J07:03)

Cistern 3

Lead: pierced disc (no. 28, L08:08)



Figure 8 Rectangular pit C2 from the east (Fig 8) with revetment wall J07:16 overlying flags J07:17 in the foreground.

'Cistern 2' lower fill

Graffiti on BB2 (nos 61, H07:09; 45, H07:09)
Copper alloy: button and loop fastener (no. 189, J07:19)

'Cistern 2' upper fill

Decorated samian: early Antonine? (no. D72, H07:03);
160–180 (no. D73, H07:03)
Amphora stamp: illegible (no. 14, H07:03)
Graffiti on BB2 (no. 33, H07:03)
Stone: disc (no. 39, J07:14), throwing stone (WSS83, H07:03)

Dating evidence

Forehall (AO) structure in NE corner

The clay in the north-east corner of the forehall produced two sherds of pottery, a Gillam type 151 rim and a body sherd of a Nene Valley ware beaker, which are both of third-century date (L08:22). The chippings (K08:07) produced an unworn coin of Severus Alexander dated 229 (cat. no. 135), while an unworn coin of Gallienus dated 258–68 (cat. no. 143) and a worn/corroded coin of 'Constantius II' dated 353+ (cat. no. 208) came from the gully slot (K08:11).

Phase 3 drain packing

Much of the pottery in the fills of the east-west drain channel was made up of BB2 and allied fabrics, which,

with a body sherd of Nene Valley ware, suggests a third-century date (K08:08, L08:21, L08:36). The presence of a sherd of northern Campanian amphora indicates a date after the middle of the century (K08:08).

Cistern 3 and associated drains

The backfilled Cistern 3 produced only two sherds of pottery, of the late second century or later (L08:08). The drain on the north side of the forehall produced a Lower Nene Valley ware mortarium rim dated 230–400, and a single sherd of northern Campanian amphora dating to the second half of the third century or later (L08:19).

Stratigraphic note: There was no differentiation in terms of context numbering between the cistern structure, the mortar layer at the bottom of the pit, or the backfill rubble and clay capping, all being grouped under L08:08. Thus the pottery and finds associated with context L08:08 cannot necessarily provide a *terminus post quem* for any action prior to the backfilling of the cistern.

Phase 3 via principalis

Context F07:03 produced a large group of pottery, which included a rim of a Lower Nene Valley mortarium dated 250–400, and three Crambeck reduced ware flanged bowls plus a body sherd of calcite gritted ware dating to the late third century or later.

The surfaces produced two second-century coins, an unworn coin of Tetricus II dated 270–3 and a corroded radiate copy dated 273+ (cat nos 55, 65, 160, 168).

Phase 3 via praetoria

There was a single East Gaulish Form 31 of the late second or first half of the third century from the fill of drain K07:19/20 (K07:11).

Pit C2

The material from the post holes associated with the forehall portico (e.g. H07:11 and J07:25), provides a late second-century *terminus post quem* for the digging of pit C2, since the latter bisected several of the post pits.

Pit C2 fills

The pit produced 16.912kg of pottery, excluding samian. There were four contexts in all, with frequent joins in the pottery between H07:09 in the lower fill and H07:03 in the upper fill, but few joins between pottery in any of the other contexts. BB2 and allied fabrics made up 76% of the coarse wares in the lower fill and 63% in the upper. There were 11 samian vessels of the late second or first half of the third century, three Nene Valley ware vessels and a number of sherds of Horningsea, probably dating to the third

century. There was one BB1 flanged bowl, three sherds of Crambeck reduced ware and two sherds of calcite gritted ware; this late third century material makes up only approximately 1% of the coarse wares, suggesting a date early in the final quarter of the third century for the final filling of C2. There was also a very leached and battered Huntcliff-type rim which must be contamination (there were also a few sherds of post-medieval pottery).

Stratigraphic note: Context records H07:03 and J07:14 indicate that the finds labelled as coming from J07:14 were all recovered from the silt sealed *below* stone layer J07:17, whereas those from H07:03 derived from silt both above and below the stones. Any finds from the silt above the stones in grid J07 were also assigned to H07:03. The records also note that the distinction between H07:03 and H07:09 was unclear during the actual process of excavation.

Later activity over pit C2

The pottery in rubble fill J07:21, behind revetment J07:16, suggests a late third-century date for construction of this retaining wall along the western edge of a widened *via praetoria*.

Disturbed levels and post-Roman (?) robbing

Rubble over the via praetoria

A dense spread of loose cobble rubble (J07:05), which was exposed by excavation clearance (J07:01) and was not regarded as a deliberately constructed surface, overlay the area of the east end of Building 15, to the west of uppermost *via praetoria* carriageway (J07:03, J07:04), which it cut. This may have formed the interface between relatively undisturbed Roman layers below and later overlying ploughing or other more recent generalised disturbance.

FINDS

Robbing of the forehall S wall

Coin: 'Constantine I', 341–6 (no. 179, F08:19),
Valentinian I, 364–75 (no. 226, F08:51)
Copper alloy: bracelet (no. 55, F08:19)
Iron: ferrule (no. 13, F08:19)

Dating evidence

Only three sherds of pottery were recovered from the rubble on the west side of the *via praetoria*, dating to any time after the late second century (J07:05).

Robbing of the forehall

The robber trench of the south wall (F08:19) produced a corroded coin of 'Constantine I' dated 341–6 (no. 179),

while that of the south-west wall (F08:51) produced a worn coin of Valentinian I, dated 364–75 (no. 226). The very small quantity of pottery from the robber trenches (F07:14, F08:51, L08:50) was predominantly third-century or later in date, including a samian bowl or dish of the late second or first half of the third century (F08:51), and a third-century Nene Valley ware beaker rim (F07:14).

There is no post-Roman pottery recorded from these contexts. The quantity of Roman pottery is small (only about 15 sherds), so although there is no distinctive late third/fourth-century pottery, this could just be a matter of chance.

The robbing seems a little haphazard, in any case, with some piers being robbed of all their masonry whilst in other cases one or two courses survive, which might argue against deliberate demolition in advance of a putative fourth-century remodelling.

Notes

- 1 In 1997–8 the southern edge of street foundation 5262 appeared to be retained by a kerb (TWM 5393). This was not identified as a specific feature in 1980–81 or 1983, but probably corresponds with the southern edge of G07:10/G08:40/H08:47 shown on site plan P399, although one branch of this layer was seen to extend further south and south-west in 1983. Whatever its precise interpretation, 'kerb' 5393 should not be identified with kerbs G08:23, G08:34/H08:39, H08:22 (TWM 5262 (E)) and J08:14 (TWM 5212), which, in 1980–83, were clearly seen to belong to a later phase of the road, contemporary with the forehall. G08:23 was positioned c. 0.40–0.50m to the south of TWM 5393 and at a higher level.
- 2 It is unclear whether surfaces L08:37 and K08:42/L08:39 actually represented the same layer of metalling on different sides of the wall. This would seem logical but no such equivalence was made in the site archive or context database and the descriptions of their composition – largish worn cobbles (L08:37) and small rounded cobbles av. 50mm diameter, (K08:42/L08:39) – are quite dissimilar.
- 3 None of these kerbs should be confused with any kerbing which may be apparent along the edge of Phase 1 rubble foundations in 1980–3 or 1997–8 (e.g. TWM 5393), *contra* Hodgson 2003, 176 which identified H08:22 as the eastward continuation of 5393. These all clearly belonged to the secondary phase and, with the exception of J08:14, were removed in the course of excavation in 1983.
- 4 Notes compiled by Peter Moffat refer to a coin of Severus Alexander found in the construction material of one of the pier bases of the forehall. However no coin of Severus Alexander with such a provenance is identified in the catalogue. A coin dated to 229 (no. 135) was recovered from a sandstone makeup or bedding layer (K08:07) for a structure in the north-east corner of the forehall, but that layer post-dated the building's initial construction.

11. WORKSHOP BUILDING 16 AND THE EASTERN *VIA PRINCIPALIS*

Grid squares: K07, K08, L07, L08, M07, M08, N07, N08, P08, Q08

Introduction

The building located on the north side of the *via principalis*, between the *via praetoria* and the east *intervallum* road, was numbered Building 16 in Daniels structure list. It was excavated in two separate stages with its west end being investigated in 1980–81 along with the *principia*, forehall, and adjoining roads, the central *via principalis* and southern end of the *via praetoria* (Site 16). Most of the remainder of the building was uncovered at the very end of 1983 and early 1984, in conjunction with work on the south-eastern segment of Barrack 3, the eastern *via principalis* and the north-west corner of the *praetorium* (Site 18). However, in certain areas excavation was not possible, notably the south-east corner, which had been destroyed by the cellars of Simpson's Hotel. This cellaring had also isolated the building's north-east corner from the remainder of the structure. This inevitably resulted in some interpretative difficulties, particularly as, with the exception of Charles Daniels himself, entirely different personnel were involved in the two programmes.

Building 16 was distinguished by its long, narrow proportions, being of equivalent length to the *praetentura* barrack blocks, at c. 45.90m, but narrower in width at 5.50m. Unlike its counterpart on the west side of the *via praetoria*, Building 15, a structural sequence involving a number of phases, was apparent in 16, although its later Roman levels had probably been truncated by post-Roman ploughing and colliery-related disturbance. The clearest sequence was preserved at the west end of the building, investigated in 1980. Post-excavation analysis identified four phases in common with the rest of the fort, but on re-examining the evidence it

is difficult to avoid the impression that, even more than elsewhere, the structural sequence was being somewhat arbitrarily subdivided to fit a pre-existing concept of four phases or periods. The range of features and character of the deposits which were present in the successive phases suggest the building may have functioned as a workshop.

Building 16 Phases 1 and 2 (Fig. 11.01)

Building 16

The robbing of the primary external walls was very thorough. Only the north-east corner of the building preserved a substantial stretch of masonry (north wall: P08:02; north and east walls: Q08:02), with up to three courses of the wall surviving at the angle itself (Fig. 11.02). This section of wall was 0.60–0.70m wide and was composed of roughly dressed rubble facing stones, with a mortared rubble core. Elsewhere, all that survived were stretches of the outer facing of the west wall (K07:30 – Fig. 11.03) and the inner face at the south west corner (K08:36), and one short fragment of the south wall (L08:72), which may however form a later rebuild. Otherwise only foundation deposits were preserved – north wall (L07:18, 25, M07:12?, 19); south wall (K08:36, L08:42, M08:41, N08:33, 45); west wall (K07:35) – composed of yellow clay, packed on top of blocks of sandstone rubble, c. 0.10–0.30m in diameter. To the east, where the foundations were described as 'black and yellow claggy, silty clay' (N08:33) and 'stones . . . in black silt' (N08:45), it is possible that these black silty deposits signify a degree of contamination, perhaps as a result of the later wall robbing. The south wall foundation trench, which was the most extensively exposed, varied in width between 0.75m and 1.20m.

At the west end of the building, the 1980 investigations revealed a layer composed of orange



Figure 11.01: Building 16, Phase 1 and 2 features at 1:200.



Figure 11.02: The north-west corner of Building 16, looking north.



Figure 11.03: The west end of Building 16, looking east, with the wall robber trenches emptied, the Phase 1 floors and post holes apparent and *via praetoria* drain in the foreground.

sand, gravel and sandstone chippings (K07:33, K08:35, L07:15, L08:28) was deposited over this entire area, extending beyond the southern limit of the building over the northern part of the *via principalis* (as K08:21, L08:28). This was interpreted as a construction level, providing a firm surface on which to build, and represented the lowest level examined in the interior of 16 in 1980. In five small sondages dug to locate the foundations of the north, south and west walls the construction level was seen to lie directly over the pre-fort ground surface. This latter was exposed more extensively further south, beneath the *via principalis* carriageway, where it consisted of grey clay ploughsoil with burnt patches of reddish clay and charcoal (K08:41, L08:46). The sandy, gravelly chippings were initially thought to have been laid over the exterior wall foundations, but more careful examination, in the sondage undertaken to locate south wall foundations L08:42, revealed traces of a cut through the construction deposit marked by a narrow band of grey clay loam and the slightly differing characteristics of the chippings within the

cut, which seemed yellower than the rest of L08:28. This appeared to signify that the foundation trench had been cut through the construction deposit (L08:28), the clay and rubble base (L08:42) laid in and then a layer of chippings thrown back into the top of the trench to level it off. The chippings thus represented the earliest Roman level in this area. A post hole (K07:34), positioned on the central axis of the building, but not seen at a higher level, was cut through this layer and may also have represented a construction feature.

A layer, composed of mixed yellow-orange sandy clay with grey silt and patches of burning marked by a reddish brown discolouration and charcoal (K07:08, K08:34, L07:13, L08:40) was deposited on top of the gravelly chippings right across the western interior of the building. This probably represented a floor surface.

When the investigation of Building 16 was extended eastwards, in 1983–4, excavation was taken down to the same primary clay floor surface/makeup level, described as yellow clay (L07:22). This was reportedly interspersed with a yellow sandy layer sometimes associated with small cobbles/flags and patches of charcoal (L07:24, L08:64, M07:14, M08:34). It seems more likely that the yellow sandy layer was actually overlying clay L07:22, but did not completely cover it, and perhaps should be interpreted as a resurfacing for industrial purposes. L07:22 was probably equivalent to the ‘floor make-up’ of yellow clay (M08:35, N08:43), encountered throughout the interior of the building, further to the east (beyond modern brick wall M07:04/M08:04). These levels were interpreted as the surface and/or makeup for the primary floor, like the clay deposits at the western end of the building. However no attempt was made to remove the clay and expose any underlying construction levels here. Clay M08:35/N08:43 was overlain by a dark red-brown sandy clay layer (M08:26) containing ‘carbon’ and burnt clay flecks, on the surface of which were found one gold and twelve silver coins, doubtless a dispersed hoard (see discussion of stratigraphy in *Finds* below). This layer spread between the modern brick wall (M07:04/M08:04) and the later, Phase 3 partition wall, M08:21. Beyond that partition, the clay was covered by areas of charcoal (M08:37, N08:42), whilst, further east still, extensive areas of clay over the east-central part of the building were burnt to a black, red or dark brown colour with traces of coal in places (N08:20, 22, 29, 31). These various overlying deposits from L07:24 etc eastwards might represent occupation deposits, deliberately laid floor surfaces – either primary or renewal – or areas where the character of the original floor level had been so substantially altered by heat that it was treated as a different context.

In the north-east corner of the building the lowest level exposed was described as a floor surface of light yellow sandy clay (P08:05) with patches of darker



Figure 11.04: The arrangement of postholes in the western part of Building 16. The postholes (L08:26, 27) and pier base or wall (K08:16) in the foreground are probably later but note the north-south alignment of the postholes line up with K08:16.

loam, stained by coal, and pieces of flagging ranging from 0.10m to 0.45m square. Again this level was presumably equivalent to the yellow clay floor or make-up levels revealed further west and abutted the inner face of the building's external walls.

Various features which the excavators assigned to Phase 1 and/or 2 were constructed over or cut into the clay flooring. At the west end of the building the clay was cut by several post holes (from west to east – K07:31–32, K07:23–6, L07:16–17). Three of these (K07:23–5) form a line running roughly north south, across the width of the building some 3.30–3.50m from its west end (Fig. 11.04). These post holes were fairly evenly spaced and might conceivably be associated with an internal partition, but it is difficult to discern any meaningful pattern in the positioning of the remainder, although the five post holes, K07:31–32, 23 and L07:16–17, did appear to form a very gently curving, west-east alignment. The post holes were generally around 0.25–0.40m across and 0.15–0.20m deep and were filled with grey silty clay-loam. Most still contained roughly square or oval settings of packing stones – pitched pieces of sandstone of varying size – the internal dimensions of the settings suggesting that they were designed to house slender timbers or scantlings no more than 0.12–0.15m thick. In north-west corner of the building, K07:26, was interpreted as another post hole, but its dissimilar characteristics suggest it may have had a different function. It was larger than the other post holes, taking the form of a roughly rectangular pit, 0.60m long and 0.40m wide, and was filled with a very mixed deposit of sandy grey soil and white mortar and grit, with no mention of packing stones. A circular socket, c. 0.10m in diameter, is apparent in the site photographs (B67/34–6; cf. Fig. 11.05 here), positioned fairly centrally in the base of the pit, and was perhaps designed to house a post. In addition, a cylindrical stone – perhaps a column base or upturned



Figure 11.05: Small oblong pit K07:26 with socket hole in the base and a cylindrical stone set at its northern end.

capital and upper section of shaft – was set into the ground on the northern edge of the pit. Intriguingly, the pit was positioned only 0.10m from the west wall of the building, directly opposite the point where one branch of the external drain running down the side of the *via praetoria* (K07:19) appeared to emerge from Building 16, hinting that there might have been some functional link between the two features. Despite their proximity, no direct physical link between the pit and the drain was apparent and it is not clear what the functional association between the two features might have been. In its definitive form, moreover, the drain channel belongs to a later period (Phase 3 of the *via praetoria*).

Sitting on the clay surface, were two flagged hearths. One (K07:22), near the west wall, consisted of a row of three small flags, measuring 0.65m by 0.35m overall, their surfaces burnt red and black, with a large patch of burnt daub and coal on the east and south sides. The other hearth (L07:14) lay 4.40m further east and comprised a pair of burnt, oblong flagstones, set end to end. The hearth was surrounded by soil burnt red and brown and formed part of a rather patchy flagged floor (L07:04, L08:18) which sat directly on the clay L07:13/L08:40. A collection of sherds (L07:06) belonging to a broken amphora was found resting directly on top of a couple of the flagstones associated

with this surface and partially underlying a later flagged floor (L07:02). Flagging L07:04/L08:18 only covered a relatively small area, stretching c. 2.50m from the south wall into the interior of the building and about 4m from east to west, but may originally have been more extensive. There is a confused record of sporadic flagging further west (K07:13), which *might* conceivably equate to L07:04/L08:18. K07:13 is not identified on any plan although several unidentified patches of flagging and scattered stones are shown in grid squares K07 and K08 on site plans P237 and P238 and it is possible that these represent that context. They are not explicitly equated with flagging L07:04/L08:18 on site plan P238 however.

Covering part of L07:04/L08:18 was a spread of yellow-orange clay (L07:07). This was in turn overlain by another very fragmentary stone floor (L07:11) composed of flat slabs, much smaller than the flags used in the underlying surface. Again this only survived over a relatively small part of the interior of the building, extending up to 2.80m from the north wall and around 2.70m from east to west, but did not stretch all the way to the west wall. Along the eastern edge of the stone spread there was some evidence for a timber partition. This was represented most clearly in the form of two parallel rows of upright slabs (L07:12), 0.60m apart and 0.45m in total length, but continued on the same alignment across the full width of the building as a narrow gap respected by the flagstones of both surfaces L07:11 and L07:04/L08:18, implying that it may have remained in use throughout the life of both floors. A mixed grey, silty clay loam (K07:18, K08:33, L07:10), which included patches of orange-reddish and more sandy soil, extended over flagging L07:11 and the associated partition slot and continued right up to the western end of the building. This covered the earlier features in this area, including the clay floor level (K07:08/K08:34/L07:13/L08:40) – where it formed the matrix for rubble used to fill a depression in clay K08:34 – plus flagging K07:13, clay spread L07:07, pit K07:26 and post holes K07:23–4, 31–32. This material may represent an occupation deposit over the early floors or perhaps levelling up for the Phase 3 flagged flooring (K07:07/L07:02/L08:04) which partially overlay it.

A large, roughly square base or platform (L08:70) composed of clay and flagstones edged by roughly dressed facing stones was set against the south wall of the building. (However, the south wall had been robbed away at this point and no part of the south face nor south-west corner of feature L08:70 survived either so the precise relationship of wall and platform was uncertain.) The edges of platform were not quite square to alignment of the building, particularly so in the case of the north face. The platform measured 1.80–1.90m (E-W) by 1.80–2.00m (N-S) and survived to a height of one course. It is unclear whether it stood higher or supported some sort of structure, but the

south-east corner of a possible second course was recorded on an earlier site plan (P401), inset some 0.25–0.30m from the building's south wall-line and 0.40–0.50m from the east face of the platform's lower course.

A group of three more post holes was identified further east (L08:73–5). These formed no clear pattern but one (L08:74) was recorded as cutting the robber trench of the south wall (L08:65), which would imply that this section of the south wall had already been demolished and the masonry robbed when it was dug. Post hole L08:74 was the largest of the trio, measuring 0.50m in diameter with five packing stones still in situ, whereas the other two were no more than 0.25–0.30m in diameter and only L08:75 contained packing stones. The two smaller post holes cut sandy layer L08:64.

Towards the centre of the building two large pits cut into the clay floor/makeup were revealed (M08:43, M08:31), one of which was interpreted as a kiln (M08:31). The latter took the form of a narrow oval pit, some 1.10m long (E-W) and up to 0.60m wide (N-S), filled by burnt clay and charcoal (M08:14) and surrounded by flags, which gave the feature respective overall dimensions of 1.20m by 1.25m (Figs 11.06, 11.07). The flagstones were laid flat around the lip of the pit and were absent on the west side perhaps indicating the kiln (if such it was) was worked from this end. A second pit (M08:43), sub-rectangular in plan and measuring 1.00–1.30m (N-S) by 1.40–1.60m (E-W), lay 1m west of the suggested kiln and directly in line with it, implying that the pit might have been functionally related to the kiln in some way, although this could not be confirmed. The pit was filled by yellow sandy material (M08:34), which, on the evidence of site plan P413, also extended beyond the lip of the pit over clay M08:35/N08:43 and was equivalent to the sandy spread (L07:24/L08:64/M07:14) to the north and west. On site plan P426 a couple of large upright stones are shown set in the southern side of the pit and might be associated with an adjoining setting of three smaller upright stone slabs (M08:42) shown on an earlier plan (P413), which were aligned east-west and positioned on the lip of the pit, close to its south-east corner. These slabs resemble packing post-pit stones, but they were not identified as a post-setting. The feature was recorded as cutting makeup M08:35, but its relationship to sandy fill and overlying spread M08:34 is unclear ('?butted by 34', 'contemporary with pit fill 34'). However, its positioning on the very edge of the pit appears too precise to be coincidental and implies that the stone setting must have been associated with the pit in some way. Rather than cutting through the sandy fill or spread, the stones perhaps protruded up through that material which was deposited over them at a later stage without fully covering them. A third pit (M08:33) was located just to the south-east of the suggested kiln. This was cut into the dark red-brown

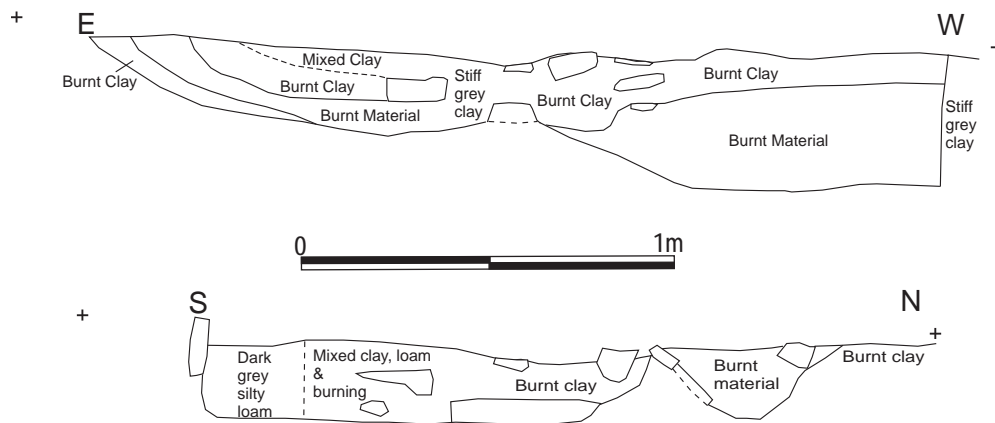

Figure 11.06: North (top) and east (bottom) facing sections through furnace M08:31 (S115) at 1:20.



Figure 11.07: Kiln M08:31 under excavation, looking north-east.

sandy clay layer (M08:26) overlying M08:35/N08:43, so must be later than the other two pits which were covered by M08:26 or by mixed sandy spread L07:24/L08:64/M07:14/M08:34. It was also more irregular in plan than the other two and was slightly larger, measuring 2.20m (E–W) by 1.30m (N–S). The pit was filled by black burnt silt and red and yellow clay similar to the many spreads overlying clay makeup M08:35/N08:43.

In the north-east corner of the building a roughly L-shaped pit (P08:24) was dug into clay floor P08:05. The pit was c 1.30 in length from east to west and 1.05m north-south and was generally around 0.50m

in width. It was filled with yellow-orange burnt clay whilst the surrounding surface was covered by black-grey silt. At its northern end the pit may have been cut by a post hole (P08:08). Three possible packing stones were identified and an oval post pit 0.45–0.50m in diameter was excavated. However a degree of uncertainty was expressed in the context record, following excavation, as to whether this feature really was a post setting rather than a series of upright stones forming one edge of a hearth, the presence of which was indicated by a heavily scorched patch of the clay surface, some 0.45m in diameter (P08:09), just to the west. The latter interpretation was subsequently

favoured in the context database and P08 grid square matrix, although the evidence appears inconclusive either way. The scorching was certainly recorded as partially extending over the fill of the pit P08:24 and the area of putative post hole P08:08, implying it was later in the stratigraphic sequence. A second post-setting (P08:07), marked by four upright packing stones, was identified north of pit P08:24 and east of P08:08/9. This post hole was treated as modern in the P08 matrix but there is no indication of such dating on the context sheet itself nor is it reflected in any of the initial post-excavation analysis.

Interpretation – Phases 1 and 2

The features making up the first two structural phases of Building 16 defined in the course of the Daniels' post-excavation analysis have all been presented together in the foregoing description as the individual features are not consistently differentiated between phase in the context database and grid square matrices. Thus there are many instances of a context being attributed to Phase 1 in one grid square whilst the equivalent context making up the same feature in the adjoining grid square was assigned to Phase 2 or of features being allocated to different phases in the database and the relevant matrix. The inked phase plans for the building, which went through two drafts, provide no additional guidance, as both phases are incorporated on a single plan (which may in itself be symptomatic of the problems the excavators experienced in differentiating the two phases). The descriptive summary text prepared by the site supervisor, which first enumerated a four-phase structural history for the site was very short and was evidently soon superseded by later analysis.

Most significantly, the excavators did not identify any evidence for an overall reconstruction of the entire building, which would have clearly defined the transition to Phase 2 through the presence of distinct horizon or resurfacing across the entire building, for example, nor can any defining level be retrospectively teased out of the site archive. Rather the picture is one of a series of piecemeal changes in different parts of the structure which can be expressed as a set of relative sequences. These were not tied together by stratigraphic links but instead, to a large extent, float in relation to one another. There is, therefore, no guarantee that these alterations proceeded at the same rate throughout the building. Several alterations may have followed in quick succession in one part of the building, forming short-lived sub-phases within a single overall phase, whilst elsewhere the pace of change might conceivably have been slower, with fewer modifications. In general it is difficult to avoid the impression that any division between a 'Phase 1' and '2' was fairly arbitrary and was primarily motivated by the perceived need to establish a four period phasing which would correspond to the overall

fort phasing and which was itself doubtless influenced by the Wall-Period chronology still widely accepted when the Daniels excavations first commenced.

What follows below is an attempt to distinguish primary and potentially relatively early features from the more secondary elements. For convenience these have been grouped into two phases, but the tentative nature of this grouping should be noted and full account taken of all the caveats expressed above.

Thus, in the western part of the building the gravel construction level was overlain by clay which was in turn cut by several post holes and overlain by a hearth (K07:22) and a flagged floor (L07:04/L08:18) incorporating a further hearth (L07:14). A second stone floor (L07:11) followed, all the features being overlain by an extensive occupation or levelling deposit. The shift from the clay-flooring to flagging might represent a second phase, but it is conceivable that this area was floored from the start by flags with the clay serving simply as a bedding layer. The interpretation of these levels is rendered more difficult by the very patchy survival of the stone floors which obscures the nature of the relationships between the flagging and the other features cutting or overlying the clay. Only one post hole (L07:16) was reported to be overlain by the first flagged floor (and even this relationship is not conclusively substantiated on the relevant site plan, P238). Neither stone floor was definitely shown to have extended west of the row of three post holes (K07:23–5), which extended across the width of the building from north to south and could plausibly be interpreted as forming an internal partition. However the possibility that an equivalent flagged surface was present at the very western end of the building cannot be excluded either, as noted above. Based on the recorded relationship of post hole L07:16 to the flagging, it would be possible to assign the stone surfaces and associated features and the possible occupation deposit to Phase 2 and all underlying deposits/features to Phase 1. However, it is also possible that the lower flagging (L07:04/L08:18) also belonged to Phase 1 or even that some or all of the postholes were associated with that flagging, forming partitions separating off particular flagged workrooms. The only real certainty is that the upper stone floor (L07:11) and overlying occupation/levelling deposit were later.

In the west-central parts of the building, two of the pits (M08:43, M08:31), including the stone-lined example which was interpreted as some form of kiln (M08:31), may be relatively early in the sequence. This was certainly the case with the westernmost pit (M08:43) which was filled by the same mixed yellow sandy material as overlay the clay L07:22. Kiln M08:31 is more problematic as the relationship of the kiln pit and its burnt clay and charcoal fill (M08:14) to the surrounding dark red-brown clay layer M08:26 is not defined in the site archive. The

pit with its flagged surround was certainly cut down into the lower clay layer M08:35/N08:43. Site plan P412 suggests that clay M08:26 might have extended over the pit, but it depicts numerous spreads of red clay and black patches of coal and burning over the site of the kiln, whilst the previous site plan, P407, shows the burnt clay and charcoal spread M08:14 was apparent at a higher level over the same area. It was probably difficult to distinguish the kiln fill from the overall clay spread, M08:26. This might imply that the kiln was constructed during the primary phase of the building but remained in use throughout the earlier periods of the workshop's occupation. The burnt clay deposits (M08:26, N08:20, 22, 29, 31) and charcoal spreads (M08:37, N08:42), presumably reflect the occupation and usage of the building. Sandy layer L07:24/L08:64/M07:14/M08:34) might represent some kind of resurfacing and could conceivably be assigned to Phase 2 or a subsidiary episode of Phase 1. The third pit (M08:33), however, was cut through clay M08:26 and must therefore be later in date than the two neighbouring pits, whilst post holes L08:73 and 75 were cut through the mixed sandy layer and consequently must post-date it, like the stone platform (L08:70) which appeared to have been constructed over same layer. These features might therefore be assigned, at least notionally, to a second structural phase.

In the north-east corner of the building the area examined was so small that little in the way of a structural sequence could be established. The features cut into the clay floor – pit P08:24 and post hole P08:07 (if it was actually Roman in date) – could conceivably have belonged to the primary phase, although it is impossible to determine how they functioned together. Feature P08:08 must, however, be later in date, whether it represented a post-setting cutting the north end of pit P08:24, as suggested by site plan P408, or formed part of hearth P08:09, which certainly extended over the pit fill and must therefore be a secondary element.

FINDS

Phase 1 finds

Building 16 Phase 1 construction level

Intaglio: (no. 1, L08:28)

Phase 1 wall foundations

Coin: Domitian (no. 22, M07:12)

Phase 1 post holes

Bone: needle (no. 27, K07:26)

Phase 1 clay floor

Decorated samian: (no. D91, K07:08)

Samian stamps: Late second or first half of third century (no. S44, K07:08), undated (no. S140, K07:08)

Copper alloy: terminal (no. 199, L07:13)

Iron: shackle (no. 35, L07:13)

Glass: armlet (no. 3, L07:13)

Stone: whetstone (no. 17, K07:08), throwing stone (SF2102, L07:13)

Burnt clay occupation/floor levels (but see below)

Gold and silver coin hoard (M08:26): L. Antes Gragy, 136 BC (no. 1), C. Postumi, 74BC (no. 2), Vespasian, 67–79 (no. 5), Trajan, 100 (no. 29), illegible C2BC-AD; four C1-C2, C2, 200–53, disintegrated, C1-C2 (nos 229, 233, 241–2, 244, 251, 261, 288, 292)

Metalworking debris: casting waster (no. 3, M08:26)

Mixed sandy level over clay

Flint: blade (no. 14, L08:64)

Phase 1? hearth

Copper alloy: brooch (no. 26, K07:21)

NB: The stratigraphic provenance of the M08:26 coins

The gold and silver coin hoard was assigned to context M08:26 on the relevant context sheet and in research archive records compiled subsequently. However it should be noted that a sketch plan and section (reproduced here as Figs 11.08, 11.09), drawn and annotated by the site supervisor (NG) when the find was reported the police, provide a much more detailed record which indicates that the coins were found at the base of the overlying pitched rubble layer (M08:23), on or over the surface of burnt clay M08:26. The clear implication is that the coin hoard could be associated more properly with M08:23 and certainly cannot provide a *terminus post quem* for burnt clay layer M08:26.

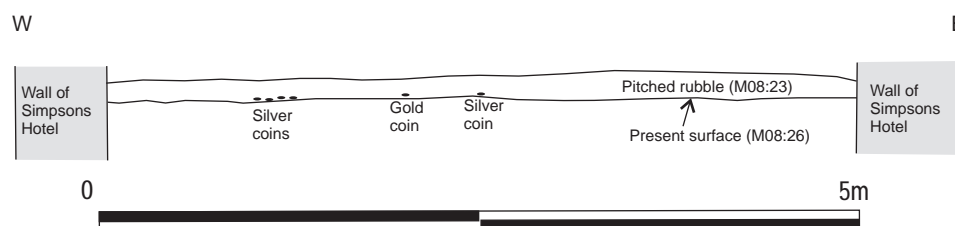

Figure 11.08: Schematic measured sketch showing positions of coins, projected in a single section, at 1:50.

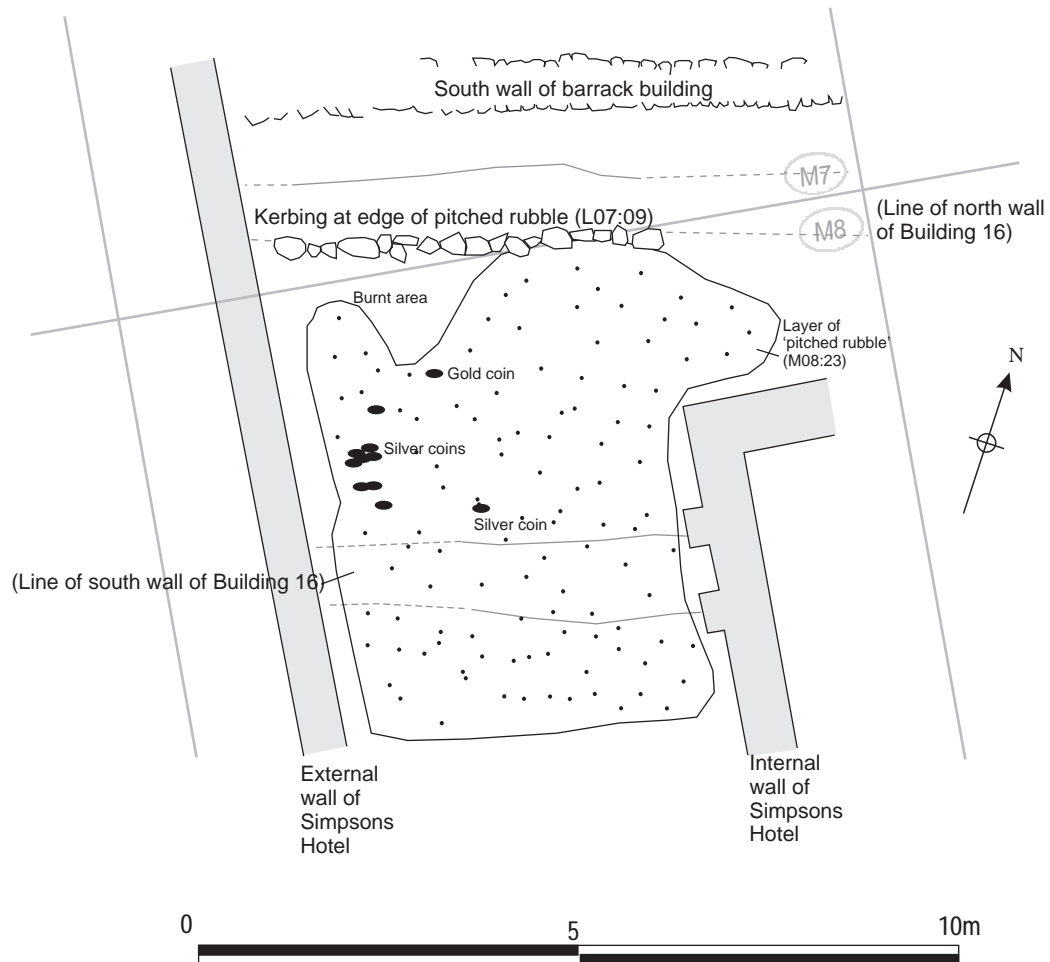

Figure 11.09: Measured sketch plan showing the findspots of the coins. Context numbers added and the position of the north and south walls of Building 16 shown for reference though not recognized at the time of excavation, at 1:100.

Phase 1 dating evidence

Phase 1 make up for clay floor

There was little pottery from the make-up (M08:35, N08:43) for the clay floor, but it did include some BB2.

Phase 1 clay floor

Context K07:08 produced over 2.5kg of coarse wares (and a further 5kg of Dr 20 amphora), made up of over 70% BB2 and allied fabrics and including sherds from two Nene Valley vessels, providing a third century date. There was also a stamped Form 32 etc, dated to the late second or first half of the third century. The assemblage from the floor did, however, contain a lot of residual mid-second century or earlier material, including two South Gaulish Dr 37s (dated 70–90 and Flavian-Trajanic; no. D91), and a Trajanic or early Hadrianic Form 30 or 37 as well as locally produced wares. The only other context with a sizeable amount of pottery was L07:21, which looked to have a lot of residual material in, being made up of roughly 80% BB1 (with acute angle lattice decoration where it survived) and only a few sherds of BB2 and allied fabric.

Phase 1 kiln

The kiln (M08:31) produced very little material, and was contaminated by post-medieval material.

Phase 2 finds

Yellow sandy layer over the lower clay floor/ makeup

Copper alloy: pin (no. 124, M07:14)

Kiln fill

Lead: rod (no. 4, M08:14)

Phase 2 pits

Coin: Nerva (no. 26, M08:33)

Phase 2 occupation material

Decorated samian: Trajanic-Hadrianic (no. D101, L07:10)

Samian stamp: Hadrianic – early Antonine (no. S111, L07:10)

Iron: awl (no. 23, L07:10), plate (no. 65, L07:10), strip (no. 67, K07:18)

Intaglio: (no. 2, K08:33)
Stone: disc (no. 37, K08:33)

Phase 2 dating evidence

Flagged floor

There were only a few sherds of pottery from floor L07:04, mainly BB2 and allied fabrics.

Phase 2 occupation material (K07:18/K08:33/L07:10)

A sherd of decorated South Gaulish samian joins that found in the clay floor K07:08 (no. D91). The largest group of pottery (approximately 14 sherds of pottery) included an East Gaulish Form 31 of the late second- or early third-century, Nene Valley ware and shell-gritted ware of the third century, and a sherd of late third-century Crambeck reduced ware.

Sand resurfacing (M08:34)

This produced two sherds, including one of BB2.

Phase 2 pit (M08:33)

This produced only a very few sherds, including one of BB2.

The via principis (east) – Fig. 11.10

A further section of the *via principalis* was exposed and investigated as part of Site 18 in 1983–4, extending for over 20m to the east of the forehall and Cistern 3, along the southern frontage of Building 16. This stretch was cut into three separate sections by brick walls belonging to Simpson's Hotel (M08:02, 04), erected at the end of the nineteenth century. The eastern end of the road was not uncovered, however, as this area had been destroyed by the cellaring for Simpson's Hotel, along with the south-east corner of Building 16 and the north-east part of the *praetorium*. In addition much of the south side of the roadway, next to the north-west corner of the *praetorium*, had also been removed by later disturbance.

The pre-fort ground level (M09:30) was exposed only in one relatively small area on the south side of the road, but was not described. This was covered by a layer of fine, silty sand (M09:26), very bright yellow in colour, which was only observed in the same small area to the south of the more southerly of the two drain channels which ran along the length of the road. This sand may have represented a bedding layer for the road or a part of a general construction deposit. Overlying this was the first road level to be exposed more widely across this part of the *via principalis*. This was composed of large flags and cobbles set in a fine sandy gravel matrix (M08:40, M09:27, N08:46, N09:21). The flags were most densely laid towards the north-west in grid square M9 where the largest measured c. 0.50–0.60m by 0.45m, becoming smaller

and more cobble-like towards the east where they were generally c. 0.10–0.30m in length fading out altogether to the south and especially the south-east. This surface was uncovered as far north as the more northerly of the road's two longitudinal drains (L08:49/59/M08:11/N08:12). The northern drain channel cut down through this level. However, excavation was not taken down to the equivalent level in the area to the north of the drain. The more southerly drain, by contrast, did not cut down into this level, the drain's side walls instead being set on surface.

Overlying the gravel and flagged surface (M08:40/M09:27/N08:46/N09:21) a layer of cobbles (N08:38), 0.30m in diameter and worn smooth, was identified in one area whilst a light yellow gravel surface (N09:23), tightly packed with small stones 0.10m in diameter, was seen in a small area on the south side of the more southerly longitudinal drain (next to side walling N09:22).

These levels might be equivalent to the lowest road surface exposed to the north of drain L08:59/M08:11/N08:12, the composition of which was variously described as pebbles and gravel (M08:39) and 'orange red gravel with traces of black' (sic; N08:40). In the context note for N08:40 it is suggested that this might have constituted the first proper metalled surface, with the underlying gravel and flagging, M08:40/M09:27/N08:46/N09:21, representing a foundation level for the road, however the available evidence does not really provide any means of discriminating now between such combined road base and metalling levels and a straightforward resurfacing.

The gravel between Building 16 and the northern drain was overlain by light brown and dark clay covered by a layer of stones 0.08–0.30m in diameter (N08:34) and, further to the east, tightly-packed, irregularly shaped rubble in black silt (N08:35). This may be at the same level as the next extensive surface of road metalling laid to the south of drain L08:59/M08:11/N08:12, the composition of which was described as small cobbles with patches of gravel and sand (M08:24, M09:06, N08:26). This was in turn equated to a rubble spread (M09:21, N09:02) uncovered further to the south-east, in front of the main entrance to the *p aetorium*. The rubble surface was composed of stones 0.10–0.30m in length set in black silt and incorporated an patch of large flagstones (M09:16), covering an area measuring up to 1.70m (E-W) by 1.20m (N-S) next to the north wall of the *p aetorium*, on the west side of the entrance. However considerable confusion surrounded level M08:24/M09:06/N08:26 and its equivalences in the excavation record. Many of the relevant stratigraphic relationships are simply not recorded on the context sheets and it is the series of site plans which is most informative in determining the sequence of road levels on the *via principis*, yet even these plans contain contradictory data. Thus, on

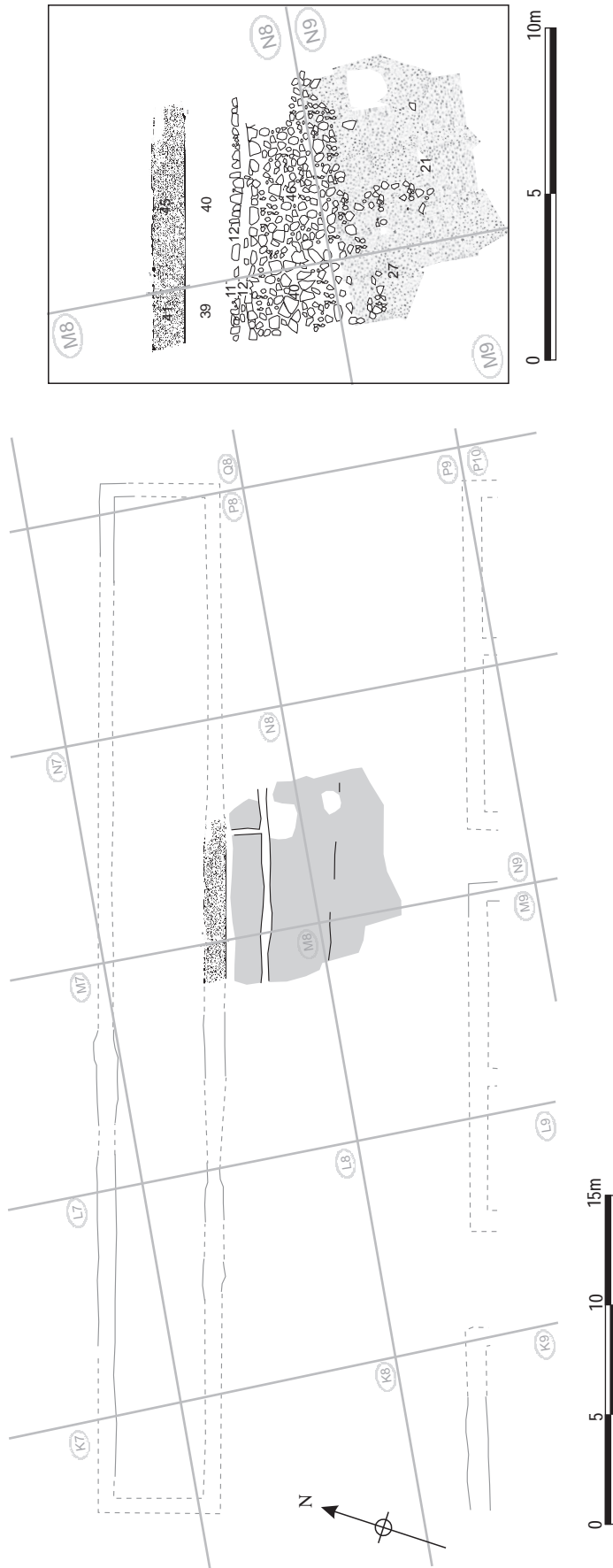

Figure 11.10: Plan showing the location of the earliest road levels exposed on the eastern via principalis at 1:300, with a more detailed plan of the surface at 1:200 in the inset box.

site plans P410 and P412, surface M08:24 is shown as overlying M08:39 and extending north of drain M08:11/N08:12, as far as the robber trench for the south wall of Building 16, on both sides of the modern brick wall M08:02, with plan P410 also implying that M08:24 (or perhaps M08:39) was equivalent to N08:34–5 further to the east. On the other hand, the corresponding pair of site plans, drawn slightly earlier during the course of the excavation, P405 and P407, show M08:24 only to the south of drain M08:11/N08:12, with a rubble surface or spread (M08:23/N08:24) being depicted on the north side of the drain, instead. This rubble extended over the northern part of the *via principalis* and right across the interior of Building 16 without any apparent interruption and was assigned to Building 16 Phase 3 by the Daniels post-excavation analysis. No equivalent Phase 3 surface was shown over M08:24 on the south side of the drain. This would imply that rubble M08:23 covered the northern part of cobbling M08:24 in Phase 3, whilst the cobbled surface remained in use over the remainder of the *via principalis* during this period, and this is the interpretation followed here. It should be noted, however, that the depictions of surface M08:24 in the two sets of plans do not appear to match one another at all, there being almost no visible points of correspondence. This suggests that the excavators may have conflated two separate road levels into a single context, with the second level, shown on sites plans P405 and P407, representing a Phase 3 surface contemporary with rubble M08:23/N08:24.

To the west of the external brick wall of Simpson's Hotel (M08:04) the lowest road surface exposed was not described (L08:66; L09:07). Site plan P413 indicates it was composed of small- to medium-sized cobbles. This incorporated or was perhaps overlain by several patches of yellow sandy soil (L08:68), whilst a further, extensive spread of brown/yellow soil (L08:69) was incorporated within the surface along its southern edge and was tentatively interpreted as the remains of a robber trench for an east-west drain, although without any really firm basis. An area of flags and cobbles (L08:63), c. 2m wide (E-W), was laid over surface L08:66 between the south wall of Building 16 and drain L08:59/M08:11/N08:12. The flags were up to 0.50m in length and appeared to form straight, north-south aligned edge on the west side, but this was not thought to represent one side of a drain. L08:63 was interpreted in the context database as a possible patching of the existing road surface, L08:66, rather than as the surviving fragment of a new layer of metalling which originally extended more widely over the *via principalis*. The stratigraphic link with the road levels further east was severed by the west wall of Simpson's Hotel (M08:04) and consequently it was not clear which level of road surface L08:66 corresponded to on the other side of wall. On site plan P413 road surface L08:66 was equated with M08:39, an equivalence implicitly echoed on the context sheet for

L08:63 which was recorded as overlying both L08:66 and M08:39. However L09:07 is shown as equivalent to M09:06 on plan P414 and was also equated with the Phase 2 levels around the south-east corner of the forehall (K08:13, L08:12 – described as very smooth, worn cobbles). Moreover no surface equivalent to M08:24/M09:06/N08:26 was recorded overlying L08:66 or its related contexts, either on the site plans or context sheets. L08:66, 63 and 68 were assigned to Phase 2 in the context database, like road surface M08:24 and M09:06, whereas M08:39/N08:40 was treated as part of Phase 1 (perhaps a secondary sub-phase, depending on what interpretation was placed on the lowest level uncovered, M08:40/M09:27/N08:46/N09:21 – road base or actual surface metalling). Hence, the most economical solution would be to regard L08:66/L09:07 as equivalent to M08:24/M09:06/N08:26, which was similarly the lowest level investigated between brick walls M08:04 and M08:02, and to assume that the lowest, primary road levels were only revealed in the area to the west and south of brick walls M08:02 and N08:03.

Two drains ran along the length of the *via principalis* on parallel, roughly east-west alignments. Both were set into the Phase 2 road level, described above, and were therefore probably contemporary with the latter although they were still apparent after the subsequent Phase 3 surface (M08:23/N08:24) had been laid and may have remained in use during that phase. The more northerly drain (L08:49, L08:59, M08:11, N08:12) was the better preserved of the two, with three large cover slabs being preserved towards its western end. The largest of these, a rectangular slab measuring 1m by 0.70m, was pierced by a circular hole, c. 0.20m in diameter, in the centre to allow surface water to flow into the drain channel below (Fig. 11.11). The side walls of the drain were constructed using blocks of coursed and roughly dressed sandstone rubble, but the descriptions of its various stretches were very summary and it is not at all clear how many courses survived at any point. However, examination of the site photographs, plus a reference in context record L08:48, suggests that two courses may have survived in places, although only one course can be substantiated at most locations. The channel ranged in width between 0.20m and 0.35m. Its fill was identified (M08:12, N08:30), but not described. The drain was traced over a distance of 22m from east to west then appeared to fork with one branch (L08:49) continuing westward. This formed part of the same channel (K08:19/L08:35) that was excavated in front of the forehall in 1980–81. The other branch (L08:48) curved round to head north running right up to the wall of Building 16. It is unclear whether this was simply designed to collect runoff from the roof of Building 16 which may have collected at the base of the wall or whether it was associated with some activity inside the building, perhaps



Figure 11.11: Perforated drain cover at the junction of drain L08:59 (E-W) and L08:60 (N-S), looking north.

carrying away industrial effluent of some kind. It lay directly opposite the roughly square platform (L08:70) abutting the south wall. The excavators suggested that this branch cut and was therefore stratigraphically later than L08:49. Two stones on the south side of L08:59 appeared to form the east side of a possible southward continuation of L08:48 which perhaps connected the drain with the north-east corner of Cistern 3. Certainly, if its construction preceded that of Cistern 3 (L08:08), the drain's course must later have been interrupted by the cistern.

The second drain (L08:67, M08:25, M09:20, N09:14, 20, 22), positioned some 2.70–3.00m further south, roughly along the centreline of the *via principalis*, was more severely affected by modern disturbance. It was traced over a distance of c. 20m, though the surviving stretches were discontinuous and sometimes very fragmentary. The manner of construction was similar to that of the more northerly drain, but no capstones remained and only a single course of side-walling remained at any point. The best preserved stretch was M08:25 and formed the only section where both side walls survived, showing the channel was 0.20–0.30m wide.

A further drain (L08:60, L09:17) ran roughly north-south across the road carriageway from the north-west corner of the *praetorium* towards the perforated cover slab sitting on top of conduit L08:59. Like the other drains in this road surface it was constructed with side walls made up of blocks of coursed and roughly dressed sandstone rubble, forming a channel which was 0.10–0.25m wide. The side walls were only a single course high, when excavated, with some 3.5m of their course extant, though originally the drain was probably at least 8.5m long, stretching the full distance from drain L08:59 to the north end of Alley 7 next to the corner of the *praetorium*. Even in its truncated state the channel appeared to cut across the line of the more southerly east-west drain (L08:67 etc), implying that it might represent a later feature, but L08:67 was too

badly damaged to allow any conclusive judgement to be reached regarding its relationship to the other conduits on the *via principalis*.

A couple of additional features should be noted. Firstly, a short north-south drain (N08:21), situated between the northerly east west drain and south wall of Building 16, should probably be assigned to the next phase, although it does figure on site plan P410, which predominantly shows Phase 2 levels, presumably because it was cut down into those levels. Secondly, a linear strip of black or dark brown soil (L08:62, M09:19), c. 0.60m wide, which ran roughly NW-SE across the *via principalis* carriageway, was tentatively interpreted as a possible robbed-out drain channel. It was traced over a distance of c. 17m in the Phase 2 surfaces L08:66 and M09:06/21, perhaps extending into N09:02, and presumably formed a shallow gully cutting into the metalling, although this was not explicitly stated. At its north-west end, it *may* have connected with the northerly longitudinal drain (L08:59 etc.) or north-south drain L08:60, at point somewhere near to the perforated capstone, whilst, to the south-east, it apparently cut across the line of the southerly longitudinal drain (L08:67 etc). The alignment traced on site plans P402 and P413 is not altogether convincing, however, since it apparently made a sharp change of direction at the point where it moved from one plan to the other. It was reportedly overlain by later levels, particularly in grid square L08, and may represent a feature similar to the gully which ran much of the length of the forehall interior (F08:56, G08:35, H08:29, J08:16), but, given its rather indistinct character, it could conceivably represent a later feature, perhaps even a product of modern disturbance, which was not recognised in the later levels.

FINDS

Dating evidence

Phase 2 via principalis surface

Only a few sherds of pottery were recovered from the Phase 2 road surface, mainly BB2 and allied fabrics probably dating to the third century (L08:69, M08:24, M09:06). The cobbles over the road surface also produced the base of a Crambeck reduced ware jar of the late third century or later (L08:63).

Drain channels

The various drain channels produced some sherds of Antonine samian and a number of sherds of BB2 and allied fabrics (L08:59/M08:11, L08:60, N09:22).

Possible robbed drain L08:62/M09:19

This feature produced two reeded hammerheads, one from Mancetter-Hartshill dated 240–350 and from Catterick/Swanpool/Cantley dated to the third or fourth century (L08:62, M09:19).

Building 16 Phases 3 and 4

Building 16 (Fig. 11.12)

The third phase of Building 16, as defined by the excavators, was marked by substantial alterations to the internal arrangements (Fig. 11.12). The building was divided by a series of north-south cross-walls (M07:10/M08:15, M08:21, N08:02, N08:06) into at least four and perhaps five rooms. The cross-walls were constructed with a narrow rubble core between faces of roughly dressed sandstone rubble blocks and were probably bonded with clay, although this is not described, whilst the rooms appear to have had floors constructed of stone – composed of either flagging or pitched rubble – rather than the clay floors which predominantly characterised the earlier phases. Preservation of these levels was very patchy, however, and the surviving features provided far less indication regarding the purpose of the building in this phase. In addition, the record of the various features and deposits associated with this phase contained in the site archive presents a number of significant problems with regard to its interpretation.

Room 1 at the western end of the block was a long rectangular room, 14.60m in length (E–W) and 4.00m wide (N–S), internally. The next two rooms to the east (2 and 3) were smaller, both measuring 7.00m by 4.00m, whilst Room 4 was even narrower taking up only 3m of the building's frontage. The easternmost room (5) was longer again, with east-west dimensions of 11.20m. It may be significant that if Rooms 4 and 5 are combined the resultant internal length would be almost identical (c. 14.80m) to that of Room 1, at the other end of the building, whilst Room 1 was the same length as Rooms 2 and 3 combined. It seems unlikely these dimensions were coincidental, implying that the building was subdivided according to a highly regular layout. If this is the case, it is conceivable that cross wall N08:06, which separated Rooms 4 and 5, was a later addition to the scheme which disrupted the symmetry of the original Phase 3 ground plan. There was, however, no stratigraphic evidence to indicate that N08:06 was any later than the other partition walls.

The apparent, at least partial symmetry of the Phase 3 layout was not highlighted by the excavators as they considered that the building was truncated by some 3.30m at its west end in this period. This idea was influenced by previous excavation findings from Building 2, situated further to the north in the eastern *praetentura*, which appeared to show that this building too had been shortened in its later phases. The suggested demolition of the westernmost 3.30m of Building 16 at the end of Phase 2 and the largely hypothetical construction of a new west wall, associated with that building's later phases of occupation, brought 16 into line with Building 2. The latter block's truncation, however, can be

dismissed as simply a false impression caused by patterns of survival and in particular the manner in which the surviving third-century floor surfaces and internal features at the west end of the barrack block were apparent amidst the rubble of the post-Roman disturbance layers when the north-east corner of the fort was first exposed (see Chapter 14). Although a context number was assigned to the robber trench for repositioned west wall (K07:09) of Building 16, there was no actual evidence for existence of this wall or robber trench, as was essentially admitted in the context description ('presumed line of ... west wall. No clear signs on ground ...'). In reaching this interpretation the excavators were also influenced by the apparent extent of the Phase 3 and 4 flagged surfaces K07:07/L07:02/L08:04 and K07:06/L07:09. The western edge of these flags was believed to respect the line of the robbed out wall. However, survival of both these surfaces appeared too irregular and patchy for this to provide a reliable indication of their original extent or the line of any robbed out walls.

Room 1

A floor composed of substantial stone flags (K07:07, L07:02, L08:04) was laid in the western part of Room 1 (Fig. 11.13). In its surviving state it covered an area measuring 3.40m (E–W) by 3.75m (N–S). A short stretch of drain channel (L07:03), aligned north-south, was located along the eastern edge of this flagging, abutting the north wall. Its side walls were composed of upright slabs up to 0.40m in length. The flagging may originally have been more extensive, but any levels above Phase 2 occupation/levelling deposit K07:18/K08:33 appear to have been destroyed by later disturbance over the western end of the building.

A spread of medium-sized flagstones (L07:20, L08:47) was exposed in 1984 extending across the eastern end of the room. This was interpreted as a deliberately laid surface, although there were many gaps between the flags and they were clearly disturbed (L08:55) where they butted up against the east wall of the room. The flags overlay a dark brown soil matrix interspersed with small stones (L07:21, L08:57, M07:11, M08:19). The interpretation of this layer is problematic. It might be equivalent to the levelling deposit (K07:18/K08:33/L07:10) revealed further west in 1980–81, although the description of the latter – mixed grey silty clay loam – does not sound that similar. Moreover the dark brown soil is shown on site plan P401 as extending over the line of the robber trench for the south wall and southward across the *via principalis*, covering the earlier Phase 2 road metalling. To further complicate matters no equivalent level, forming an apparent interface between the Phase 1/2 levels and the Phase 3 surfaces, can be identified in the context record in the area further to the east, beyond modern brick wall M07:04/M08:04. It is therefore possible that,



Figure 11.12: Building 16, Phase 3 at 1:200.

rather than underlying the flags, the soil matrix should be seen as surrounding and intermixed with them, a residue of later disturbance enveloping the uppermost surviving Roman surfaces and structures, like the deposits over the remains of Building 16, Alley 2 and the *via principalis* further east, which are recorded on site plan P398 (e.g. M07:07, M08:09, 13, N07:09, N08:15–17).

Room 2

The partition wall (M07:10, M08:15) which separated Rooms 1 and 2 was 0.50m wide and was preserved over its entire length, although only a single course survived. The wall was erected over the site of the earlier backfilled pit (M08:43) and as a result its central section had partially subsided into the pit (see section drawing S122 – Fig 11.14 here). Here it was also seen to sit on top of a group of amphora sherds, perhaps the remains of a vessel associated with the pit infill. Elsewhere the wall reportedly sat directly on the ‘floor makeup’ (probably M08:35) with no trace of any foundations. At its southern end the partition wall butted up against the sole surviving masonry fragment of the building’s south wall (L08:72). Stone surfaces were identified in various parts of Room 2. A spread of rubble perhaps forming a flagged surface



Figure 11.13: Phase 3 stone floor K07:07/L07:02/L08:04, with the short drain channel (L07:03) to the right, looking north-west.

(M08:16) was recorded along the east side of wall M07:10/M08:15 whilst the eastern half of the room was covered by a dense layer of pitched stones (M08:23). This surface was recorded by the excavators on site plan P407 as continuing over the line of the south wall and across the northern part of the *via principalis* as far as drain M08:11/N08:12. Along the north side of the room, a line of stones (M07:06, 09) formed a clear edge to the stone floor having escaped robbing (Fig. 11.15). These stones were dressed to a roughly straight face abutting the building’s north wall, which was later robbed out.

Room 3

Much less survived of the next cross wall (M08:21), which divided Room 2 from Room 3, the southern half having been destroyed by the brick cellar wall of Simpson’s Hotel. All that remained was a metre long section, plus a further couple of facing stones abutting the presumed line of the building’s north wall. The partition wall was 0.50–0.60m wide and the site photographs suggest that two courses survived, with, again, no evidence for any foundations. On the east side of the cross-wall in the north-west corner of Room 3 a somewhat patchy stone surface (M08:37) which was not described further was shown on plan P407. It appeared to consist of a mixture of flagstones and cobbles. The south-east quarter of the room was covered by a spread of rubble blocks which were 0.10–0.50m long set in a matrix of black silt (N08:24). This was considered equivalent to pitched rubble M08:23 in Room 2 and like the latter was recorded on site plan P405 as extending across the line of the south wall and over the northern part of the *via principalis* as far as drain M08:11/N08:12. In the south-west corner, a linear stone setting (M08:36) was uncovered, consisting of two lines of steeply pitched slabs forming a V-shaped channel 1m in length. At the western end of the pitched stone setting, and laid perpendicular to it, was a line of three flags which might have been associated in some way.

Rooms 4 and 5

The southern end of partition wall separating Rooms 3 and 4 had been destroyed by one of the concrete

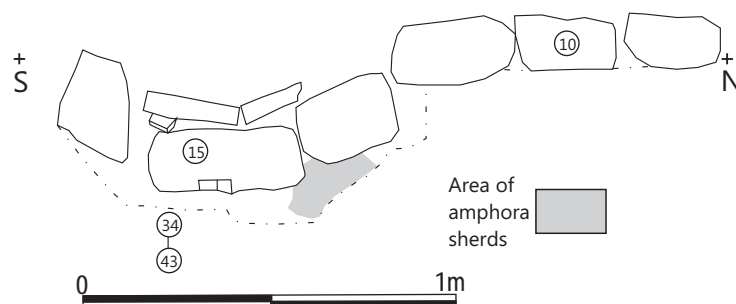

Figure 11.14: Section S122 at 1:20 showing the north end of partition wall M07:10/M08:15 in Building 16.

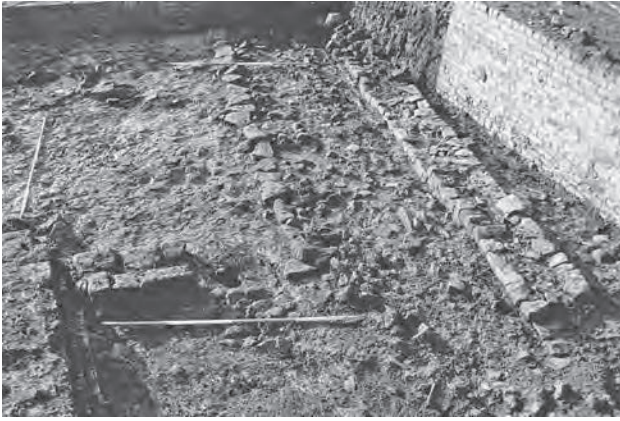

Figure 11.15: Phase 3 stone kerb M07:08 (marking the north edge of stone floor M08:23 already excavated), with crosswall M08:21 in the left foreground, looking west. The north wall against which the kerb butted has been robbed out but the south wall of Building 3 is visible to the right on the other side of Alley 2.

piers of Simpson's Hotel (N08:04), whilst no trace whatsoever was found to the north of the modern brick wall N08:03/19, the partition having presumably been robbed out here, with the result that a 1m long section in the middle (N08:02) was all that remained of the wall. This was 0.50m wide and set in dark grey silt. Its description as 'a small section of double course wall' in the context record might imply that two courses survived, but only one course is shown on the plans and the, admittedly rather distant, site photographs so the record may simply have been intended to indicate that both faces remained. Inside the room a possible surface was uncovered next to the wall, being composed of irregular stones c. 0.05–0.15m in length (N08:10), set in light brown clay. As discussed above, it is possible, on spacing grounds, that the easternmost cross-wall (N08:06) was a secondary addition to the layout. A 2m length of walling, set in powdery black silt, was preserved, representing the northern half of its course. Even this surviving stretch was quite badly damaged, with most of the west face having been destroyed, but one facing stone remained in situ on that side to demonstrate that wall was the same width (0.5m) as the other cross walls. On the west face one block of the second course also survived. Little of the interior of Room 5 was available for excavation because of the cellaring of Simpson's Hotel. The only possible surface exposed was represented by a scatter of rough flags (P08:25) in the north-east corner of the room.

Later alterations ('Phase 4') – Fig. 11.16

A further series of alterations to Building 16 were evident. For convenience these are labelled Phase 4, but there is no clear evidence that they formed a coherent structural phase in the sense of a group of related features constructed at the same time. They

are simply constitute surfaces which were secondary to the initial Phase 3. Cross-wall N08:06 between Rooms 4 and 5 might also fall into this category, as discussed, but there can be no certainty regarding this. In Room 1 the flagged surface towards the north-west corner (K07:07/L07:02/L08:04) was overlain by a further layer of flagging of more limited extent and very patchy survival (K07:06, L07:09), composed of several moderately-sized flat stones. An L-shaped spread of large flagstones (M08:22), overlying the layer of pitched rubble (M08:23) in Room 2, formed the latest surviving occupational layer in this part of the building. On its south side this flagging appeared to respect the line robbed-out south wall. This interpretation was based on the assumption that the flagging and the pitched rubble were structurally distinct, rather than latter forming some kind of foundation for a flagged floor, for instance, which cannot be entirely ruled out.

The via principis is (east)

The interpretative uncertainties already noted in relation to the later phases of Building 16 also apply to the adjacent surfaces of the *via principalis*, with better apparent survival at the western end of the area investigated in 1983–4, between Cistern 3 and outer wall of Simpson's Hotel (M07:04/M08:04). Several spreads of different surface material were noted in this section of the road. As with the stone surfaces inside Building 16, all these levels were reported to sit the layer of dark brown soil (L08:57/M08:19; equivalent to L07:21/M07:11 further north over Building 16), which covered this part of the *via principalis*. A layer of well-worn medium-sized cobbles (L08:50) formed a surface extending across the middle of the carriageway and most obviously resembled road metalling. A smaller spread of similarly worn cobbling to the north (L08:53), may have formed part of the same road level. This appeared to overlap or perhaps simply abut a small patch of flagging (L08:54) to the west. To the south, adjoining what appeared to be a 1.20m length of drain side wall (L08:76), lay a further well-packed layer of road metalling composed of well-worn cobbles intermixed with pebbles and gravel in a matrix of dark soil (L08:56/L09:16). Immediately to the north-east of cobbling L08:50, an area of deliberately laid flagstones (L08:51, M08:18), ranging in length from 0.10m to 0.60m and covering some 2m by 2.40m, was interpreted as a possible floor surface. Along its north side, this area of flagging was in turn partially overlain or perhaps abutted by a spread of medium-sized rubble including some cobbles (L08:52, M08:17). Sandwiched between cobbling L08:53 and rubble L08:52/M08:17, a line of three flagstones (L08:58), up to 0.40m wide and 1.10m in combined length, was described simply as 'hearth' in the context record and presumably therefore exhibited some signs of heat and burning though this is not explicitly mentioned.

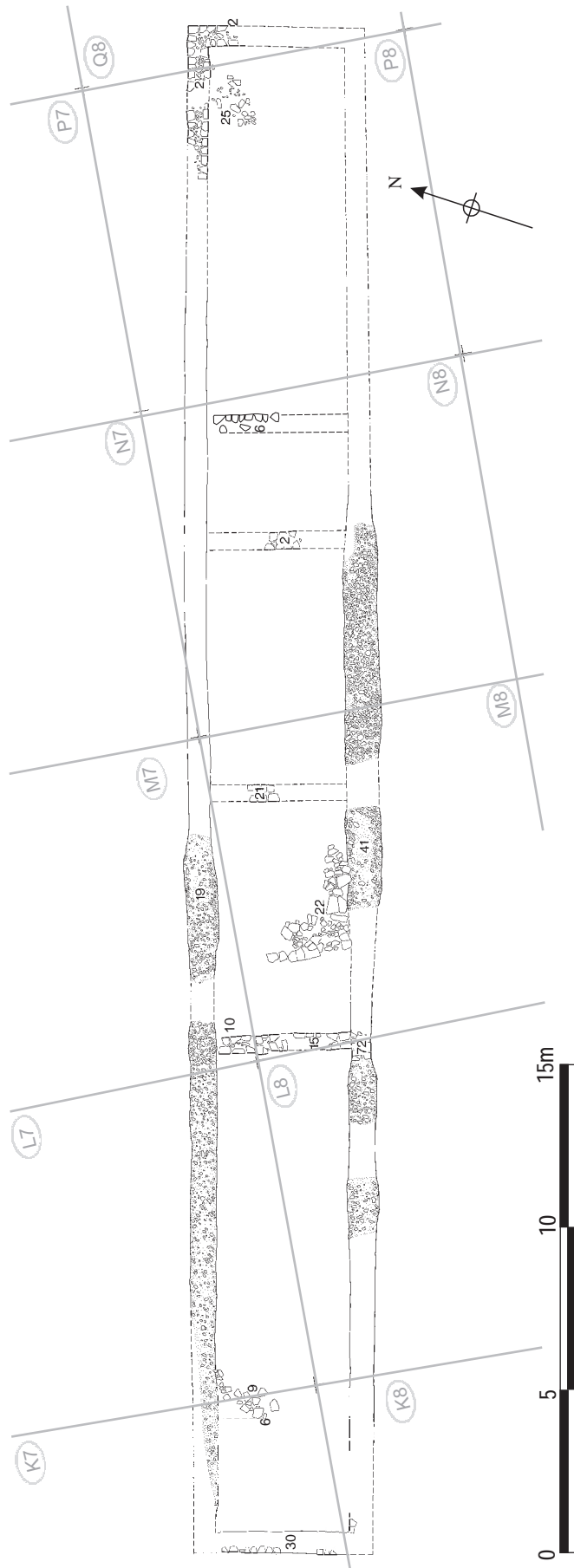

Figure 11.16: Building 16, Phase 4 at 1:200.

Some 2.20m north of the *praetorium*, cobbling L08:56/L09:16 was overlain by a line of three mortared stone blocks (L09:29), with a combined length of 1.20m. These were square and oblong in form, the largest measuring 0.40m × 0.50m and were interpreted as the fragmentary trace of a stone structure perhaps of medieval or post-medieval date (Building BJ (E)). A late Roman date is equally if not more likely, given that it is now appreciated the most of the later Roman levels in the fort had been destroyed by more recent activity, leaving only occasional surviving fragments. Furthermore, the presence of patches of flagged surfacing and, perhaps even more significantly, the apparent remains of a hearth also hint at the possible presence of a building erected over this part of the *via principalis*. This may be what was implied by the reference, in the site supervisor's notes, to 'one narrowish building over' the east *via principalis*, though no further details are provided. If these features did form part of later Roman structure, this would imply that the road carriageway was no longer respected the later period. However the remains are really too ephemeral to prove that a structure did stand in this area, let alone be certain that it was of late Roman date. A variety of surface materials might have been incorporated in the roadway and this could account for the flagging, for example.

It is not clear whether the four surviving stone blocks of drain side walling L08:76 represented the westward continuation of longitudinal drain L08:67, which was associated the underlying Phase 2 road level. The earlier drain channel was apparent nowhere else in this level and, although it followed a generally similar orientation, side wall L08:76 lay somewhat to the south of the projected westward course of L08:67, suggesting it may have formed a later channel performing a similar function to the earlier one. None of the other channels recorded in the Phase 2 road level were still featured in the Phase 3 surfaces in this area, although a few of the side wall stones at the western end of the northerly east-west drain and its north-south offshoot (L08:48, 49) protruded through the dark soil, L08:57.

Further east, both the longitudinal drain channels (M08:11/N08:12 and M08:25/M09:20/N09:14/20/22) were still apparent in the uppermost distinct road level. This comprised a spread of large rubble in black silt (M08:23, N08:24) which only extended southward from Building 16 as far as the more northerly of the two drains (M08:11/N08:12). This was not differentiated from the rubble spreads in the interior of Rooms 2 and 3 of Building 16, which were assigned the same context numbers. Indeed site plans P405 and P407 show the rubble extending apparently without a break from the interior of Building 16 across the line of the south wall and across the *via principalis* as far as drain M08:11/N08:12. In the central section of the road, between the two longitudinal drains, only

the Phase 2 road level (M08:24/N08:26) was apparent, and this was also the case along the south side of drain M08:25/M09:20/N09:14/20/22, where surfaces M09:06 and M09:21/N09:02 figure on site plan P402. Along the southern side of the carriageway, however, just in front of the *praetorium* entrance, distinct surfaces associated with this phase were preserved. These comprised a layer of clean yellow gravel and stones worn smooth (M09:22, N09:07) set in a light yellow to orange gritty silt which also extended northward as N09:06. The former partly overlay the possible Phase 2 rubble metalling M09:21/N09:02 and perhaps flags M09:16 and the stone and gravel surface N09:12 in the entrance passageway.

The short north-south aligned drain (N08:21) which ran across the northern part of the *via principalis*, between Building 16 and longitudinal drain M08:11/N08:12, directly opposite cross-wall N08:02, was also definitely in use in this phase as it is shown very clearly on site plan P405, set into surface N08:24. The drain channel was 1.10m in length and 0.10–0.20m wide, and was probably constructed in this phase rather than earlier, with rubble surface N08:24 reportedly abutting the drain side walls.

Rubble disturbance/dereliction layers (Fig. 11.17)

Across grid squares M7, M8, N7, N8 and parts of M9, the remains of Building 16 and the *via principalis* were covered by a general spread of rubble in dark grey/brown silt (M07:07, M08:09, 13, M09:05, N07:09, N08:15/17, P08:21, Q08:17). A similar layer consisting of fairly small pieces of rubble was noted over the western end of the building and the road (K08:04, L08:06). It is uncertain whether this rubble, which was revealed immediately upon the clearance of the modern overburden, represents the bottom of modern disturbance or dereliction following the demolition of the building. The former appears most likely, but traces of later Roman structures could conceivably survive amidst this disturbance, perhaps, for example, the patch of large, cracked flagstones (M08:06) covering an area measuring 1.20m by 0.70m over the northern part of the building, although a more recent date for this feature cannot be ruled out. Further consideration is given to the problems associated with the rubble layers overlying the site and the robber trenches relating to Building 16 in the next section.

FINDS

Building 16

Phase 3 partition

Coin: Constantius II, 332–3 (no. 188, N08:02)

Phase 3 flagged floors

Decorated samian: 160–80 (no. D73, N08:24)



Figure 11.17: Rubble deposits recorded over the centre of Building 16 and the via principalis (at 1:200).

Mortarium stamp: 150–70 (no. 17, N08:24)
 Coin: C1/C2 illegible (no. 246, L08:47)
 Copper alloy: brooch (no. 33, L07:02), key (no. 94, L07:02), spoons (no. 107, L08:47; 110, P08:05)
 Pottery: lamp (no. 48, N08:24)
 Stone: fossil (no. 55, L07:20)

Robber trenches

Copper alloy: brooch (no. 16, M08:29)
 Quern (no. 58, P08:27)

Disturbed rubble spreads

Graffiti: no. 18, (M07:07)

Dating evidence

Building 16

PHASE 3 AND 4 FLAGGED FLOOR (N08:24, L07:20, L08:47, K07:06)

The samian included a sherd from a decorated bowl dated 160–80 (N08:24; no. D73), also found in Cistern 2, and a Form 31R dated to the late second or first half of the third century, but a body sherd of black sand amphora (N08:24) suggests a date in the second half of the third century. Floor L07:20/L08:47 produced a single sherd of locally produced ware of the mid-second century.

PHASE 4 ?FLOOR

The possible stone floor surface N08:10 produced over 15 sherds of pottery, approximately 65% of which were BB2 and allied fabrics. A flanged bowl in an unidentified reduced ware provides a later third-century date.

Robbing and post-Roman dereliction etc

Context N08:05 produced a late fourth century or later calcite-gritted ware Huntcliff-type rim.

POST-BUILDING 16 ROBBING

The west wall robber trench (K07:12) produced a single sherd of pottery, the base of a Crambeck reduced ware beaker dating to the late third century.

DEMOLITION (?) RUBBLE ALONG THE SOUTH SIDE OF BUILDING 16

The rubble along the south side of Building 16 (L08:17) contained a sherd of Lower Nene Valley mortarium of 220+, a rim in late grey gritty ware and a few sherds of Crambeck reduced ware of the late third century.

The via principalis (east)

FILL OF THE NORTHERLY LONGITUDINAL E–W DRAIN, SOUTH OF BUILDING 16

There were approximately 10 sherds of coarse wares in the fill of northerly drain M08:11 (M08:12, N08:30), half of which were BB2 and allied fabrics.

THE SOUTHERLY LONGITUDINAL DRAIN

The fill of drain M08:25 (M08:27) produced about 10 sherds of pottery, including a sherd of late third-century Crambeck reduced ware.

The two longitudinal east–west drains were constructed during Phase 2, but appear to have remained in use during Phase 3 (contemporary with Phases 3 and 4 of Building 16). The drain fills presumably reflect the full duration of that usage and has therefore been assigned to the later phase.

Building 16 and the *via principalis* – interpretive problems

There were significant problems in understanding the development of Building 16 and the adjoining stretch of the *via principalis*, particularly with regard to the later phases, as has been indicated at several points in the foregoing description.

The later surfaces (Fig. 11.18)

It is very difficult to correlate the uppermost levels exposed on the west side of the outer brick wall of Simpson's Hotel (M07:04/M08:04) with those on the east side. To the west, all the Phase 3–4 surfaces or stone spreads, both inside the building and over the road carriageway, were recorded as overlying a dark brown soil layer (L07:21/L08:57/M07:11/M08:19) which appeared to form a horizon over the entire area. There is no parallel for this dark soil to the east of wall M07:04/M08:04 unless it is the general spread of rubble in dark grey/brown silt revealed across the entire area immediately upon the clearance of the modern overburden and recorded on the initial plan of this part of the site, P398 (cf. e.g. M07:07, M08:09, 13, M09:05, N07:09, N08:15/17, P08:21). If this is the case, however, the underlying stone surfaces M08:23 and N08:24, east of wall M07:04/M08:04, would have no parallel to the west. One possibility is that the dark soil matrix should be seen as surrounding and intermixed with the cobbles, flagging and other stone spreads west of the brick wall, rather than underlying them. In that case the soil might constitute the residue left after the robbing of much of the Phase 3 surface material, and partially equate to the deposits shown to the east on P398, with more of that material, however, having perhaps been cleaned off in the western area to expose the Phase 3 surfaces. The rather convoluted and speculative nature of such an explanation needs no emphasis. Furthermore there remain significant differences between the two areas notably the continued appearance of the earlier longitudinal drain channels to the east of wall M07:04/M08:04, not only in the Phase 3 road surfaces but even in the overlying rubble deposits, whereas the channels were for the most part obscured to the west of Simpson's Hotel.



Figure 11.18: Plan to show the extent of later surfaces over Building 16 and the east *via principalis* (at 1:300).

The south wall

Still more problematic was the evidence relating to the south wall of Building 16 which to a degree calls in to question the very existence of the building in Phase 3. The dark brown soil to the west of wall M07:04/M08:04 and the rubble spreads M08:23 and N08:24 to the east are shown by the site plans as extending across the line of the south wall with no interruption. Indeed the robber trench for the south wall does not appear at all on the initial 1984 site plans, P401, P405 and P407, which show these levels, first appearing on the later set (P410, P412 and P413). Taken at face value, this should imply that the south wall had been demolished and robbed out, presumably at the end of Phase 2, before the Phase 3 surfaces were laid inside the building and over the *via principalis*. It could in turn signify that the building was either open-fronted in its later stages or even that it had been entirely demolished, in which case the later stone surfaces would relate to structures post-dating Building 3 which were not recognised. An open-fronted Building 16 would probably have required additional timber supports at points along the south frontage. No obvious pattern of post holes emerged in this area during the 1983–4 work, but timber uprights could have been supported on post-pads which either did not survive or were not identified.

The question is therefore whether the evidence of the site plans should be accepted at face value with respect to the south wall robber trench. In general the site plans provide a more reliable record for this area than the context sheets which are often very brief in their descriptions and incomplete or even misleading in their record of the relevant stratigraphic relationships. In this case, however, there is cause to

doubt the apparent evidence of the three initial 1984 site plans. It is noticeable that the stone surfaces west of the outer wall of Simpson's Hotel, in particular L08:47, 55, 53 and 52/M08:17, did not extend over the line of the robber trench to any significant degree, only the dark soil layer is shown doing so (of the stone surfaces only L08:53 impinged, marginally, on the line of the robber trench). Further east, although rubble M08:23 is shown extending across the area of the robber trench, the overlying, 'Phase 4' flagging, M08:22, appeared to respect the wall line. Moreover, the site plans suggest that the rubble inside and outside the building were quite dissimilar in character, despite not being differentiated in the context record, with M08:23, in particular, and N08:24, to a lesser extent, appearing much more densely packed inside the building. These observations may indicate that the robber trench was actually cut right down through the surviving upper levels, but simply not recognised until a later stage in the 1984 excavation. The south wall foundations and the short fragment of extant masonry were included in the inked plans of Phases 3 and 4 of the building with no indication that any of the stone surfaces might have extended across their line, suggesting that the original post-excavation team perhaps came to the same conclusion, but if so this is not documented anywhere in the secondary archive.

The possibility that the south wall robber trench initially went unnoticed in 1983–4 is supported by the fact that just such a trench (K08:17, L08:20), was recognised during the excavations at the western end of the building in 1980–81. The trench was filled with rubble in a grey clay loam matrix and was recorded cutting through the layer of large rubble pieces including building stones (L08:17), which was set in a

grey loam matrix with much coal/charcoal intermixed in places, and covered the area along the south side of the building. This area provides the clearest understanding of the stratigraphic relationships associated with the robber trench. Over most of its length exposed in 1980 the trench was overlain only by the uppermost level of loose and fairly small sandstone rubble in grey clay loam (K08:04/L08:06). This latter contained medieval and post-medieval pottery and was interpreted as the bottom of post-Roman disturbance. At the very western end of the building, however, the robbed remains of the south and west walls were covered by latest road surface of the *via praetoria* (K07:05, K08:18, J07:04?) to have survived, which implies that building did indeed go out of use before the end of the Roman period, although the road lacks a clearly defined kerb.

Phase 2/3 rebuilding?

There are further issues concerning the south wall of Building 16, notably its relationship to the structural features associated with the suggested forehall portico (AY) and the tentative evidence that the wall underwent at least partial rebuilding at some stage. The context record for the sole surviving fragment of the south wall (L08:72) explicitly states that it sat over the robbing debris in trench L08:65, implying that the wall had been demolished, robbed and rebuilt. In addition, 2m to the west of masonry fragment L08:72, robber trench L08:65 was cut by a post setting (L08:74) which did not appear to be modern and was treated as a Roman period feature (tentatively assigned to Building 16 Phase 2). The uncertainty regarding the function of the three post holes (L08:27, 28, 41) and the post pad (K08:16), positioned directly alongside Building 16's south wall, has already been noted in the discussion of the forehall portico (see Chapter 10). If these features formed part of a forehall portico, like the post holes further west, this would have resulted in rainwater runoff pouring off the forehall roof and portico on to the south side of the adjacent Building 16. The difficulties inherent in this interpretation would be resolved if the post holes were instead associated with the rebuilding of part of the south wall of Building 16 on a slightly different line. Although interpreted as a post pad, K08:16 might actually represent the eastern end of a stretch of repositioned south wall. The remainder of that wall to the west would have been cut away by a nineteenth century cellar (J08:02/K08:02). Its south face was clipped by drain channel K08:15, which made its original form less obvious, but it appears fairly convincing as a wall fragment on site photographs (e.g. B70/19–22, 25–6; see Fig 11.19 here, cf. Fig. 11.04 above) and it was explicitly recorded as overlying and post-dating robber trench K08:17 (the stonework does not appear to impinge on the line of the robber trench



Figure 11.19: View of the west end of Building 16, looking west, showing the proximity of stone masonry K08:16 and L08:26 to the primary south wall of the building.

on site plans P237 or P238 but it may have appeared to sit at a higher level). Immediately to the east, the building would either have been open-fronted or perhaps have had a timber wall marked by the three post holes L08:26, 27 and 41. Post hole L08:74, cutting the line of the old robbed-out south wall, might also form part of this timber section whilst the surviving fragment of wall masonry nearby (L08:72) would mark the resumption of the stone wall (this latter may or may not have been rebuilt depending on how much credence is attached to the context descriptions of the relationship between wall masonry L08:72 and robber trench and fill L08:65). In addition, it might also be significant that suggested terminal K08:16 was roughly in line with the north–south row of three postholes (K07:23–5) which cut the earlier clay floor of Building 16 (see Fig. 11.04 above). This row of posts could conceivably have been associated with a partition separating off the west end of the building, although the posts were assigned to Phase 2 and may be too early to be associated with the suggested rebuild.

The hypothesis of a rebuilt south wall avoids some of the functional problems which must be confronted if post holes L08:27, 28 and 41 and stonework K08:16 are interpreted as part of a forehall portico. Admittedly the form of the suggested rebuild was rather irregular, involving the reconstructed south wall projecting slightly beyond its original line at the west end, but this might be more apparent in plan now than it was when the structure was standing. Likewise, there could be a straightforward explanation for the lack of extant, internal floor surfaces extending over the line of the original south wall at the west end of Building 16, where most of the features which could be interpreted as part of the rebuild were located. Although robber trench K08:17/L08:20 was apparent as soon as the modern overburden and the rubble disturbance layer (K08:04/L08:06) were removed in 1980, this absence of an

overlying floor surface clearly associated with the suggested rebuild may simply reflect the generally limited surviving extent of the later stone surfaces (K07:07/L07:02/L08:04 and K07:06/L07:09) in this area, a result of the considerable post-Roman disturbance affecting that part of the site. However there remain more substantial objections to the theory that the south wall was rebuilt in the manner described, which cannot be so readily dismissed. Principal amongst these was the obvious manner in which the postholes coincided with the extent of the forehall frontage, with none being found on the same line further to the east, in 1983–4, which would be consistent with their interpretation as part of an associated portico. Moreover, if the stratigraphic relationships set out in the relevant context records are all accepted as valid, post pad/wall masonry K08:16 should be later than the three post holes, L08:26, 27 and 41, and cannot have formed part of the same structure, whether rebuilt workshop frontage or forehall portico.

Thus no interpretation of the structural components around the western end of Building 16 is sufficiently devoid of difficulties to command whole-hearted acceptance. It is possible that the layout of the buildings in this area was indeed very awkward, involving the tight juxtaposition of workshop and portico, or that the structural history of Building 16 and its environs was simply more complex than can be fully substantiated from the fragmentary surviving remains. For example, a sequence could be envisaged whereby the eastern end of the forehall portico, represented by post holes, L08:26, 27 and 41, was built right alongside the south wall of Building 16 with exactly the adverse consequences for that building which might be predicted. This could eventually have necessitated the dismantling of that part of the portico and the reconstruction of the south-west corner of Building 16. perhaps on a slightly different footprint (wall masonry K08:16) from its predecessor. The section of Building 16 immediately to the east of K08:16 may have been left as an open, flagged area (K07:07/L07:02/L08:04), perhaps even unroofed, before the original frontage resumed with masonry L08:72 adjoining cross wall M07:10/M08:15. Such a sequence would fit the available evidence, but it is not necessarily the only one which would do so.

The cross walls

A final interpretative problem is represented by the cross walls in Building 16. The structural description above has followed the outline set out in the Daniels research archive which consistently attributed those walls to Phases 3 and 4 of the building. It should be noted however that the evidence supporting this phasing is far less substantial than might be imagined. Their spatial distribution suggests that most of the partition walls were laid out in a regular pattern and

perhaps therefore contemporaneously, but there is relatively little secure evidence regarding the date of their construction. Cross wall M07:10/M08:15 clearly overlay and post-dated Phase 1 pit M08:43, but no other stratigraphic relationships were recorded which demonstrated that the cross walls post-dated the early levels and there was nothing at all which would necessarily exclude the possibility that the cross walls belonged to Phase 2, for instance.

It is striking that at various points in the context records the cross walls are described as chalet walls and it seems clear that the site supervisor or on-site team as a whole were under the impression that all the barrack-length rectangular buildings they encountered in the *praetentura*, which were partitioned with stone walls, were to be interpreted as chalet ranges comparable with those already revealed in the *retentura*. Thus Building 3, immediately to the north was interpreted in the same way. This is despite the evident fact that both these buildings lacked the defining characteristic of chalet-barracks, namely the intervening alleys between individual chalet-*contubernia* which made each chalet largely independent of its neighbours, at least in structural terms. During post-excavation many of the descriptive references in the context records which labelled structural components of Building 16 as chalet features were struck out (though this is less often the case with Building 3), but this preconception will obviously have affected interpretation of the archaeological remains during the course of excavation. It is not clear why these buildings came to be misinterpreted as chalet ranges which they manifestly do not resemble, but it is possible that the misconception was an outgrowth – somewhat misconstrued – of Charles Daniels' own published ideas regarding chalets and their occupants, which envisaged each such structure as the dwelling of a *limitaneus* or frontier soldier and his dependents. If all barrack-length rectangular buildings or building ranges with stone partition walls were envisaged as housing such military family units, then they were by definition 'chalets'. This has a further implication, with particular relevance to the phasing of Building 16. If stone partition walls were considered to be characteristic of late Roman structures – and indicative of chalets – then cross walls may consequently have been assigned to the later phases of a building with relatively little consideration of the stratigraphic evidence.

Building 16 in context – workshops in Roman forts (Fig. 11.20)

Long narrow buildings, like Buildings 15 and 16 at Wallsend, which lined the *via principalis* and faced the major buildings of the central range, were a common feature of Roman fort planning. (cf. Wilmott 1997, 95). They can be seen in the Antonine fort at South Shields

(Dore and Gillam 1979, 34–6; Bidwell and Speak 1994, 17–18, fig 2.4; Hodgson 2009, 63, fig 5), the layout of which closely parallels that of Wallsend, and at Birdoswald for example. Away from the northern frontier, parallels have been identified in the Flavian timber forts at Pen Lystyn in Wales (Jarrett 1969, 102–3, fig 53) and Kunzing in Germany and in the fort of the *ala I Tungrorum Frontoniana* at Aquincum, Pannonia (Nemeth 1991, 98, abb. 1).

These narrow buildings serve many different purposes (*see below*). The excavation data strongly suggests that Building 16 functioned as a workshop, or *fabrica*. The presence of hearths, large and small pits, one of which was interpreted as a kiln, burnt surfaces and deposits, including charcoal spreads, and a large rectangular stone base or platform, is all consistent with interpretation of the building as a workshop. The narrow buildings in the Antonine fort at South Shields were also interpreted as workshops, whilst features similar to those recorded in Building 16 were found in successive phases of the building lining the western half of the *via principalis* at Birdoswald, excavated between 1987–92 (Wilmott 1997, 82–3, 145–8, 155–65, 173–6). The remains of this building were much better preserved than those of 16 and the excavation has set the standard for the investigation of this type of building, providing a clear picture of the workshop's development during the three centuries of military presence on the site and the kinds of activity undertaken there. The first building, 4400, was undivided like its counterpart alongside the other half of the *via principalis*, excavated in 1929, the pair being interpreted as stores or stables (*ibid.*, 95), although this lack of subdivisions obviously resembles the initial phase or phases of Building 16. Later in the second century, 4400 was subdivided by several partition walls and may have been given over to some kind of craftwork at this stage. Then, in the earlier third century, it was split into two separate buildings, one (4402) taking up the central and (probably) eastern stretches of the previous building plus a much smaller structure at the western end (4401) where iron-working was definitely practised. An open space separated the two, the aim perhaps being to provide separate buildings for different crafts. This is reminiscent of the suggested partial demolition of the south wall of Building 16. The ironworking was associated with the second and third quarters of the third century, apparently coming to an end in the last quarter (*ibid.*, 168), followed by a period of dereliction before the buildings were rebuilt in the early fourth. The industrial activities recognised in 4401 in the third century were not attested in the fourth century.

Two solid clay platforms, revetted by stone in one case, present in the partitioned Building 4400, and a cobbled platform enclosed by low walls, in its successor 4402, may bear some functional similarity to the solid stone platform revealed in 16. However

one group of features found in Building 4401 at Birdoswald, but not identified in Building 16, were sunken stone-lined boxes, interpreted as quenching boxes. These also featured in a similarly positioned workshop at Cramond, where they were associated with two tanks, a kiln and a hearth (*ibid.*, 165; Rae and Rae 1974, 181–3).

It should not be assumed that workshops only took the form of long narrow buildings, whether subdivided or not, nor that they were invariably located along the *via principalis*, on the opposite side from the *latera praetorii*. Hodgson's suggestion (2003, 126–7) that the type of building characterised by two rows of rooms separated by a corridor, encountered at Fendoch and Oberstimm (2), might represent a *fabrica* rather than a hospital was noted in Chapter 5. Somewhat closer in form to the Wallsend and Birdoswald examples was the long rectangular building which occupied the western end of the central range at Benwell, between the granary and the *intervallum* road. This was interpreted as a *fabrica* based on the discovery of a thick blackish deposit of ironworking debris against the inner face of its east wall (Simpson and Richmond 1941, 21–2). When analysed, this debris was found to consist of mud, dust, coal and a high proportion of hammer-scale thought to represent sweepings from the workshop floor. Proportionally this building was wider than structures like Building 16 measuring 14.25m (47ft 6ins) in width and perhaps 45m in length (its full length was not traced being instead estimated on the basis of the presumed position of the *via principalis*). It was subdivided at its south end with a narrow passage separating a roughly square room from the rest of the building.

At Housesteads the buildings in the *praetentura* and *retentura* were laid out *per striga*, parallel to the *via praetoria* and *via decumana*, rather than *per scamna*, perpendicular to those roads, as at Wallsend and Birdoswald. The two buildings equivalent to 15 and 16 were separated with one (XV) lining north side of the *via praetoria* and the other (IV) the south side of the *via decumana*. Building IV was described as the 'Iron Works' by Bosanquet (1904, 241), based on the discovery of iron slag and burnt clay especially at the west end. His plan (1904, pl. xix, facing p. 300) suggests it was subdivided into three large oblong rooms, the westernmost of which contained two smaller rooms in the south-west and south-east corners, and its overall proportions were similar to those of the fort's barrack blocks rather than the narrow workshops at Wallsend or Birdoswald. Considerable bodies of clay were described by Bosanquet as extending across the *via decumana* to the barrack opposite and this has led Crow (2004, 59–60) to suggest that the walls of the workshop were built of mud brick or 'cob' on stone footings to provide better fire resistance than timber and wattle and daub could afford.

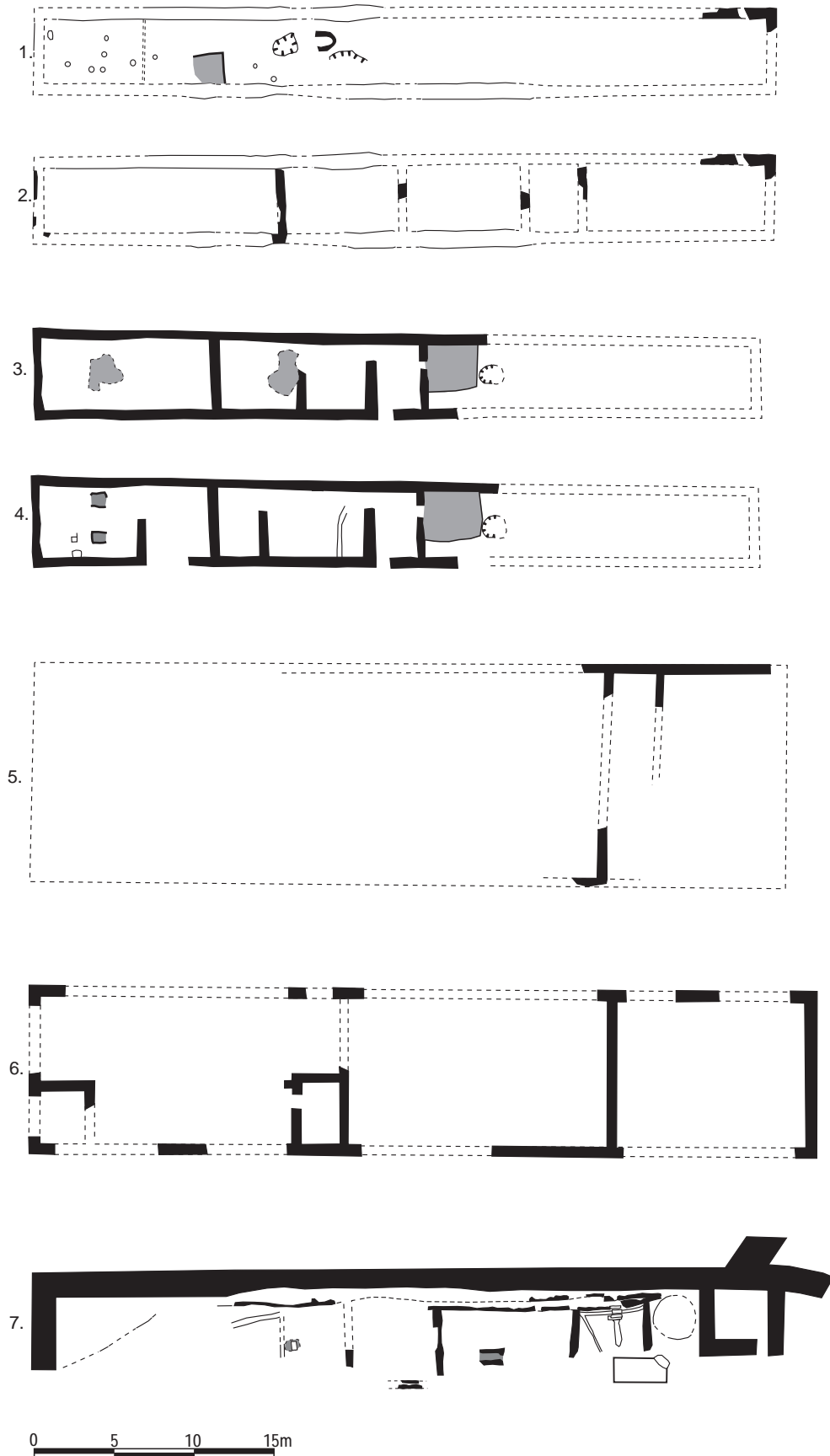

Figure 11.20: Workshops on Hadrian's Wall: 1. Wallsend Building 16 Phase 1–2, 2. Building 16 Phases 3–4, 3. Birdoswald Building 4400 Period 2b, 4. Birdoswald 4401 and 4402 Period 4a. 5. Benwell, 6. Housesteads Building IV, 7. Housesteads north rampart early third century. Scale 1:400

Moreover workshop activities did not even need to be accommodated in discrete buildings or purpose built structures. They could be undertaken in the rampart space in rows of small, open-fronted stone or timber sheds set against the inner face of the curtain wall. This has been examined in most detail in the north-east corner of Housesteads (Rushworth 2009, 53–60, 65–7, 280–82). Around the beginning of the third century a row of three stone open fronted buildings were attached to the inner face of the widened north curtain wall separated by an open flagged area from the bakehouse attached to the angle tower. These contained several hearths, including a substantial rectangular, stone-revetted clay example. Similar structures were probably present along the adjoining stretch of the east rampart, on either side of the bakehouse, where clear traces of several hearths were noted. On the north side these were probably contained in a stone building, but this had been completely demolished and its plan could not be restored. Immediately to the south of the bakehouse two lines of post pits define a small timber lean-to building again associated with a succession of hearths and burnt deposits. Analysis of the debris, including crucibles, from these areas, and in particular material overlying the contemporary surface of the east *intervallum* road, indicated that copper alloy working was the most prevalent activity, involving the manufacture as well as repair of objects (Dungworth and Starley 2009). There was much less evidence for ironworking. The remains of a comparable timber building, marked by two beam slots and a clay and partially flagged floor, were found in the west rampart to the north of the *porta quintana sinistra*, at Wallsend itself, in 1997–8 (Hodgson 2003, 157). This structure was dated to Periods 2–3 and was likewise interpreted as a workshop associated with metalworking, based on the presence of much redeposited ash and coal, including clinker and hammer-scale, in the reinstated rampart bank, directly overlying the dismantled remains of the building.

The gates and towers of the fort defences also constituted underutilised spaces which could be adapted for metalworking and other types of craft activity. At the same time as ironworking was most firmly attested at Birdoswald, in Building 4401, the adjacent west gate was also adapted for use as a workshop, with hearths and diagnostic ironworking waste residues being found in the north and south guardchamber, the blocked south passage and an adjoining annexe building (Wilmott 1997, 150–54). Similarly, the interval tower erected north of the east gate at Housesteads, c. 300, was found to contain a very substantial, D-shaped stone hearth in its initial phase (Rushworth 2009, 157). This was associated with spreads of charcoal and dirty reddened clay, which were cut by a pit containing pieces of third-century, copper alloy military equipment (four

scabbard runners and a chape), probably ready for recycling. The combined structural and artefactual assemblage demonstrates metalworking activity continued in this area after the demolition of the third-century workshops and the reinstatement of the rampart bank.

Overall, it may be concluded that the term *fabrica* simply denotes the activity carried out within a building and does not define a specific building type.

Finally not all of the long narrow buildings can necessarily be interpreted as workshops. We have no information as to what function Building 15 performed, though there is evidence that it was rebuilt in the relatively short period before its final demolition. However Building XV, lining the north side of the *via praetoria* at Housesteads, demonstrates just what a range of functions such ancillary building plots could be associated with (Leach and Wilkes 1962; Rushworth 2009, 49–51, 95–102, 133–4, 171–3). The initial rectangular building consisted of a range of small rooms with cobbled floors. Its function was unclear, but it was clearly not a barrack as it lacked the portico associated with the other Hadrianic barracks at Housesteads and the rooms had no internal partitions. A stone-lined pit ‘filled with crushed animal bones’ (Leach and Wilkes 1962, 88, pl XIV.1), excavated in 1961, might be associated with one of the rooms. Crow (2004, 60) has suggested that it was perhaps a stores building or armoury. This was replaced by a block comprising a range of rooms containing hearths and fronted by a portico. This may have been a barrack block. However no officer’s quarters was found, much of the building having been removed by later construction works, and it is conceivable the building was fronted by a portico simply to match that of the barrack on the other side of the street and provide a more impressive, ornate approach up the *via praetoria* towards the *principia*. In the third century a stable replaced the colonnaded block and was in turn replaced, probably at the end of that century, by a very large storehouse. Finally the eastern half of the storehouse was demolished in the second half of the fourth century and a small bath house inserted there. The Building XV plot was wider than that occupied by Building 16 and its counterparts at Birdoswald, South Shields and elsewhere and hence perhaps provided greater flexibility and scope for adaption to multiple functions. However the 1929 Birdoswald excavations, which investigated part of the corresponding narrow building fronting onto the eastern half of the *via principalis*, demonstrated that such plots could have an equally complex history. Indeed, in the third of the structural periods the very integrity of the plot was abandoned with a square building containing a small hypocaust in one room extending over part of the earlier narrow building and the one to the north (Richmond and Birley 1930; cf. Wilmott 1997, 8–14).

PART 3

THE BUILDINGS IN THE NORTH PART OF THE FORT

12. THE EVIDENCE FOR TIMBER BARRACKS IN THE *PRAETENTURA*

Introduction

The Daniels excavations uncovered only limited evidence for earlier phases of timber partitions in the *praetentura* barracks, of the kind which clearly emerged in the *retentura* barracks during both the 1978–9 and 1997–8 excavations and which may be taken to indicate the existence of an earlier, timber barrack phase. The relevant features uncovered in each of the barracks are described below and their significance assessed in a concluding discussion.

Structural evidence

Building 1 (Fig. 1)

Several features which could represent the remains of a possible earlier timber barrack were recognised in the eastern half of the Phase 1 stone barrack. These remains took the form of three clay-filled slots which probably held timber sleeper beams and did not fall comfortably into the successive series of slots associated with the two sub-phases of the Phase 1 stone barrack. The three slots were located within *Contubernia* 1 and 2 (P05:34, N05:49) and inside the western room of the officer's quarters (P05:48). Only their northern terminals were exposed, evident as streaks of yellow clay. Slots P05:34 and N05:49 were spaced 3.10m apart, a feasible *contubernium* spacing, whilst P05:34 was 6.80m from slot P05:48, further east, which could conceivably represent the width of two *contubernia* assuming there was an intermediate slot which was not located by the excavators in 1975. All three terminated between 0.20m and 0.40m to the south of the stone barrack's north wall, with no trace of an earlier north wall – whether of timber or stone – directly linking-up these partitions. In this they resembled the partitions identified in the Phase 1 levels of Building 3 (M07:20, N07:19, 22, 23), which all similarly terminated between 0.4m and 0.5m

short of the south wall (see Fig. 13.10). Moreover, the three anomalous slots in Building 1 were completely at variance with the positioning of the other slots defining the *contubernium* layout of the Phase 1 stone barrack (see Fig 12.01). The slots ranged in width from 0.20m in the case of P05:34 to up to 0.30m in the case of N05:49. None was observed to extend the south of the secondary north wall of Building 1 and hence the recorded surviving lengths of these slots from north to south nowhere exceeded 0.80m. N05:49, the longest of the slots, as revealed, also featured a dogleg at its northern end giving it an inverted L-shape.

In addition to the three north-south aligned examples described above, a very short length of east-west aligned slot (Q05:57), of uncertain phasing, could be relevant in this context. Found in the west room of the officer's quarters, this was not assigned to any particular phase by the excavators and could conceivably be associated with a timber barrack block on the site of Building 1, although, equally, it could also belong to the Sub Phase 1 of the stone barrack.

One problem with identifying these slots as part of an earlier timber barrack is that they apparently cut into clay floor levels (e.g. N05:47, P05:33, 45) which, in the course of post-excavation analysis, were firmly assigned to Sub Phase 1 of the Phase 1 stone barrack by Daniels and Moffat, as set out below. Thus, as might be expected, the building's stratigraphic phasing cannot now be disentangled in a fully satisfactory manner, which would enable features such as the partition slots described above to be confidently reinterpreted in the light of more recent discoveries elsewhere in the fort.

If the slots do represent an earlier timber barrack it is not clear how much weight to put on the apparent lack of a north wall associated with them. If it is not simply a factor of differential survival, it could signify that the barrack frontage featured a different form of construction, perhaps employing a sill-beam resting on the ground surface rather than being set in

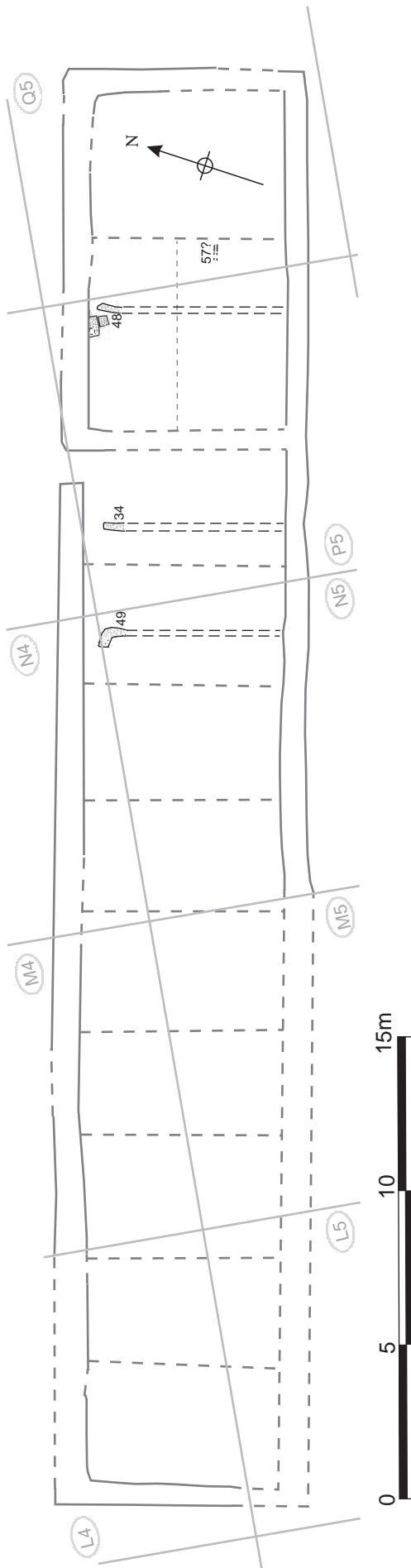

Figure 12.01: Building 1. Features associated with a possible timber barrack phase, with plan of later stone barrack shown in outline at 1:200

a narrow trench like the side walls of the *contubernia*. There could conceivably have been a functional reason for using a different type of construction here, if, for example, the wall panels along the barrack frontage took the form of shutters which could be removed during the heat of summer.

Building 2

Only one partition (M05:41) was identified in Building 2 which may have belonged to a timber phase preceding the stone-walled barrack (see Fig 13.09). Not only did it appear to be out of step with the other timber *contubernia* partitions associated with the stone building (too close to L05:55 to the west and too distant from M05:42 to the east – 3.10m and 4.50m respectively), but also site plan P216 suggests that this partition continued northwards under the line of the north wall of the building, being visible at the base of robber trench M05:31, and cannot therefore have formed part of the stone barrack (see below Chapter 13, Building 2, *Contubernium* 6). Although no evidence was recovered for timber outer walls which might have been associated with partition M05:41, the analogy with the Period 1 barracks revealed in the *retentura* in 1997–8, suggests that Building 2 may similarly have been constructed entirely of timber in its primary phase.

Building 3

Evidence for two phases of timber partition walling can also be identified in Building 3, although once again the earlier phase, which might be associated with a timber barrack, is represented by only by a single slot, N07:23 (see Fig 13.10). This was 0.15m wide and filled with stone chippings. It was traced over a distance of 1.50m, being cut by the rubble foundations of the south wall of the stone barrack (N07:24) at one end and overlain to the north by a 1.70m long stone alignment (N07:18), which ran parallel to the south wall and probably also represented a feature of the early stone barrack. The slot was located 1.70m from the west wall of the centurion's quarters (P07:23) and 1.90m from the next partition (N07:22). It clearly did not fall into the same pattern as the three other partition slots (M07:20, N07:19, 22), which were fairly evenly spaced, 3.40–3.60m apart, and convincingly define the four easternmost *contubernia* of a subsequent stone barrack block.

As a consequence of its anomalous position N07:23 was interpreted by the excavators as a possible cord-rig cultivation furrow, pre-dating the construction of the fort and similar to those recognised elsewhere on the fort site. However it appears to have been an isolated slot rather than one of a whole series of such features, running parallel with one another, as was the case with the other cultivation furrows, and was also perhaps rather too narrow, though

some irregularity in its width was noted. It might therefore be interpreted as a primary partition instead, associated with an initial timber barrack like those clearly identified in the *retentura*. No construction slots which might represent the exterior walls of a timber barrack were uncovered beneath the stone foundations of Building 3 in the short lengths where this was checked, but an earlier timber barrack might not have occupied precisely the same footprint as the stone barrack block and hence may conceivably not have been detectable by that means.

Building 4

There was clear evidence for the existence of two phases or sub-phases of partition slot in Building 4. As was the case in Building 1, both sets of partitions were attributed to the stone barrack in Daniels' initial post-excavation analysis. The two successive phases are clearest towards the west, with the Phase 1 and Phase 2 slots lying alongside one another, separating *Contubernia* 1–4, and in this part of the block it is certainly the case that both phases of partition can be fitted comfortably into the plan of the stone barrack. Further east, however, only a single set of partitions formed a coherent pattern within the stone block. Four additional partitions (J04:29, 31, 32, K04:25) at this end of the building were more difficult to fit into the standard layout of a north-facing barrack *contubernia*, with the two easternmost (J04:32 and K04:25) being spaced one *contubernium* width apart, along the central north-south axes of *Contubernia* 8 and 9 respectively (see Fig 13.11).

The most westerly of these slots (J04:31) was uncovered in *Contubernium* 6, some c. 1.10m from west wall and 2.10m from the east wall of the *contubernium*, just north of the stone barrack's south wall, and was rather unusual in form. It consisted of two adjacent lines of yellow clay and small stones clearly visible in the clay make-up (J04:25). On the site plan (P62a), one smear of clay, c. 0.50m north of the south wall, is shown branching off eastward for at least 0.20m, and this interpreted on the inked all period plans as an arm of the slot although it is not mentioned in the relevant context entry in the site notebook.

Another slot (J04:29), some 0.30m wide, was uncovered only 0.65m from the west partition slot of *Contubernium* 8 (J04:28), marked by a line of grit with very occasional flecks of yellow clay. A further possible slot (J04:32) was traced in the same *contubernium*, 1.90m from the latter's west wall and c. 1.25m from its east wall (J04:26). This slot was only identified after excavation, on the basis of details recorded on site plan P62b, and was depicted on the inked plan showing all the features associated with Building 4 (reproduced here as Fig 13.11), but never given a numbered entry in the site notebook. The site plan shows a thin, 1.25m long, yellow streak,

presumably meant to represent clay, associated with small patches of charcoal and pink clay in the southern part of the *contubernium*.

The easternmost of the four anomalous partitions was located in *Contubernium* 9 and took the form of a north-south slot (K04:25), 0.10m wide, situated 2.00m from the east wall of the building and c. 0.10m from the slight remains of the timber partition slot (J04:32) forming the west wall of the *contubernium*. Intermittent traces of the southern part of this were found.

None of the four slots described above corresponded to a recognisable component of a typical barrack *contubernium* plan and it is unclear what function they could have performed within the stone barrack block. These anomalous slots might therefore have been associated with a timber barrack block, with *contubernia* occupying different footprints from their counterparts in the stone barrack. However, but it is not easy to integrate these into a coherent pattern with the Phase 1 slots in the western part of the building, so there may have been a timber barrack and two phases of *contubernium* partitions relating to the subsequent stone block.

Building 5 and 6

Unlike the barrack blocks previously considered here, there were no features in Building 5 which could not be quite plausibly attributed to the stone barrack phases. The description of those phases set out in Chapter 13 follows the outline originally arrived at by the Daniels post-excavation team in the structural sequence in the context database and outline plans which accommodated all the known features in a two-phase scheme for the stone barrack. However it is noticeable that an east-west oriented partition (E04:27, F04:39, F05:59), extending the length of the officer's quarters, lined up perfectly with a slot in the adjoining *Contubernium* 1 (G05:29), on the other side of the stone wall separating the two parts of the barrack, both slots lying some 2.00–2.20m from the south wall of the building (see Fig 13.21). This raises the possibility that, rather than representing two separate partitions, as set out in Chapter 13, they might have formed a continuous wall slot associated with a timber barrack preceding the stone block. Such a wall slot might have been an internal partition but it is also possible that it represented an exterior wall – the north wall being most likely – for a timber block which occupied a more southerly footprint, only partially underlying its stone successor. This could also potentially affect the interpretation of other partition slots in the southern part of the officer's house (e.g. E04:25, F05:58). A further slot (E05:16), interpreted as a post trench, could represent part of the south wall of such a putative timber block. It was located in the area of Alley 4, between Buildings 5 and 6, just south of unused wall foundations E05:04/F05:12. The slot was traced for a

length of 1.80m and was 0.25m wide, 0.05m deep, with a bowl-shaped bottom, and was filled with yellow and pink clay. If E05:16 was the southern counterpart of wall slot E04:27/F04:39/F05:59, it would give the timber barrack an internal width of 6.30–6.40m, which compares very closely to the equivalent dimensions of the timber cavalry barracks in the *retentura* excavated in 1997–8 (c. 6.40–6.60m).

According to this reconstruction of these fragmentary remains, the initial timber version of Building 5 would have lain around 6.30m south of Building 4, presumably separated from it by a street (assuming the timber south wall of 4 lay somewhere within the footprint of the corresponding later stone wall). If it is assumed that another, as yet undiscovered, timber barrack occupied the site of Building 6, that barrack would in turn have lain only c. 2.70–3.00m from the Period 1 timber Building 5. Thus it is possible that the disposition of the Hadrianic barracks in the *praetentura* – or the western half of it at least – was somewhat different from the later arrangements there. Specifically, the two southerly barracks – equivalent to Buildings 5 and 6 – would initially have been paired more closely together and separated only by a narrow alley, whilst the most northerly barrack – equivalent to 4 – stood in a more isolated position on the other side of a street from 5, an arrangement which was clearly reversed when the barracks were rebuilt in stone in Period 2.

Conclusions

Daniels and his team were themselves conscious of the possibility that the barracks might have been

built entirely in timber initially. However they were unable to find evidence for timber outer walls, except in the case of Building 12, and this caused them to discard the idea. The fragmentary traces described above do not conclusively prove that the barracks in the *praetentura* were timber-built, though they are, cumulatively, very suggestive. The evidence is essentially based on the anomalous positioning of certain features, rather than a series of clearly recorded stratigraphic relationships. In the case of the slots identified in and around Buildings 5 and 6, in particular, the interpretation outlined above remains only a tentative hypothesis and it is still very uncertain whether they should indeed be attributed to a Period 1 timber barrack or to a subsequent stone barrack. Ultimately, therefore, it is recent discovery of more extensively preserved timber barracks in the *retentura* which underpins the overall interpretation. Otherwise the anomalous slots would have been dismissed as construction features or cultivation furrows.

The sparsity of features in the eastern half of the *praetentura* can be explained by the better preservation of the stone barracks there, which limited the scope of the excavators to investigate the underlying levels. This is less true of the western *praetentura*, where excavation was taken right down to the natural subsoil in substantial areas of Sites 2 and 4, revealing parallel rows of pre-Roman cultivation furrows on a slightly different alignment from that of the fort buildings. Hence it is perhaps somewhat surprising that the layout of the primary timber barrack phase did not emerge more clearly here.

13. THE SECOND-CENTURY STONE BARRACKS IN THE *PRAETENTURA*

Introduction

The remains of six stone-built barrack blocks associated with the second-century occupation of the fort were uncovered in the northern part of the fort, or *praetentura*. As noted in the previous chapter these may have replaced a series of primary timber barrack blocks though these may not all have occupied exactly the same footprints. The stone blocks were laid out on an east–west alignment, parallel with the *via principalis* and north *intervallum* road, with three blocks on either side of the *via praetoria* – Buildings 1, 2 and 3 to the east and 4, 5 and 6 to the west. The two most northerly barracks, 1 and 4, faced north towards the *intervallum* street and the rear of the defences. The remaining four barracks were laid out as two facing pairs, each separated by a 6m wide street – although only the street (Alley 4) and associated barrack frontages to the west were actually exposed, and even then only partially – whilst narrow back alleys (Alleys 1 and 3) separated Barracks 1 and 4 from their respective neighbours to the south, 2 and 5.

These buildings were investigated over three excavation seasons, in 1975, 1976 and 1983–4, with the bulk of the work, involving excavation of most of the area on the north side of Buddle Street, taking place in 1975–6. The eastern and central parts of Buildings 1 and 2 (Site 1) and the western and central parts of Building 5, the adjacent southern strip of 4 and the north-west corner of 6 (Site 2) were excavated in 1975. In the following year the eastern ends of 4 and 5 (Site 3) plus the north-west corner of 4 (Site 4) were uncovered, along with the north gate, the western ends of Buildings 1 and 2 and the north-west defences. The south-eastern segment of Building 3, located on the south side of Buddle Street, was exposed in 1983–4.

In addition, two narrower rectangular buildings, numbered 15 and 16, were identified lining the *via principalis* to the south of the barrack blocks. These

were interpreted as a possible stores building and a workshop. The six barrack blocks are discussed here. Building 15 is discussed in Chapter 10, in conjunction with the structures along the central *via principalis*, most notably the forehall (AO), whilst Building 16 is the subject of Chapter 11.

Building 1

Grid squares: L4, L5, M4, M5, N4, N5, P5, Q5

Summary

This was the most northerly building on the east side of the *praetentura*. A narrow alleyway (Alley 1) separated it from Building 2, 1.70m to the south.

Stone Phase 1 was a fairly typical barracks with a large officer's quarters situated at the east end of the building and the remainder of the block being occupied by nine *contubernia*. The outer walls were built of stone whilst the internal *contubernium* partitions were of timber. Only two constituent structural sub-phases are evident, distinguished largely on the basis of differing types of floor surface, prior to the building's reconstruction as a stable in the third century (Building 2 Phase 2 – see below Chapter 14). Originally the rooms had only clay floors, recognisable as clean orange-coloured clay, trodden to a dirty grey in places. In Sub-Phase 2 these were replaced by stone flagged floors, at least in the southern part of the rooms.

Layout and external walls (Figs 13.01, 13.02)

The building measured 46m by 8m externally. In the few areas where the walls survived, sometimes as two courses of masonry, the average width was 0.70m. These were probably sill walls carrying timber-frame upperwork with daub and wattle infilling. A shortage of tiles and stone roofing slabs suggests that

wooden shingles were the likely roofing materials. The standard construction of the barrack was in sandstone blocks with the face cut to a flat rectangle. The core was of small rubble and grey clay was used for the bonding. The average length of each facing stone was 0.20m and the height of each course 0.12m. This sat on a foundation of pink puddled clay 0.08m deep, slightly wider than the walls, and which lay on a base of a single layer of densely packed angular pieces of sandstone up to 0.15m in size.

The north wall, which was completely demolished in Phase 2, was represented almost wholly by the clay foundation (L04:22, M04:04, N04:19, P04:14, P05:38, Q05:32) and could be traced along virtually the entire length of the building. A couple of facing stones (L04:28) marked the the north face of the wall where it fronted *Contubernium* 8, towards the west end of the block, and a further solitary stone indicated the position of the north face in the officer's quarters. The thoroughness with which the masonry of the north wall was removed, in contrast to the intermittent survival of the other walls, implies this robbing probably occurred at the beginning of Phase 2 when the primary north wall was demolished and a new one built further south.

The east wall (Q05:06, 19) survived for most of its length as two courses of stone and was bonded to the south wall. Two sections of the wall were altered in Phase 2. One, in the north-east corner had been removed but the line could be clearly seen by the clay foundation (Q05:23). The second section was towards the southern end where the wall had been rebuilt over the trench from the latrine.

A large portion of the south wall had been altered in Phase 2, but the south wall of the officer's quarters (Q05:08), a short stretch further west beyond this (P05:05, N05:08)), and a length of clay and cobble foundation (N05:25) were original.

The central sector of the west wall had also survived (L04:13) but the junctions with the north and south walls had been removed by the alterations in Phase 2. The corner with the north wall was indicated by the foundation only (L04:22). The original junction with the south wall was not investigated as it was fairly clear that the higher Phase 2 foundation of the south wall (L05:18) was on exactly the same line as the primary wall.

The officer's quarters

A stone wall (P05:10), 0.70m wide, divided the officer's quarters from the remainder of the block. The accommodation measured 10.80m internally and extended across the barrack's full width. The junction with the north and south walls had been destroyed by the Phase 2 alterations, but the foundation of the north-west corner (P05:39) survived well enough to indicate that it had been laid as part of one process.

A slot (Q05:48), 0.20m wide, for a timber partition, separated the quarters into two rooms. The west room measured 6.00m wide and the east 4.80m. The slot was clearly visible for 1.50m at its southern end and the edges of clay floor Q05:40 and coal Q05:39 revealed its line further north. The fill was a mixture of fine orange gravel and yellow puddled clay.

In an effort to retain what remained of the later floors, only small areas of the rooms were investigated, but sufficient to establish a reasonable picture of the sequence of occupation. The sequence of events seems fairly clear here and can be paralleled in the *contubernia*.

Spreads of orange puddled clay and gravel were used as the original floor materials, in some places worn away to appear as a dirty trodden layer. In a few areas a substantial spread of reddish daub lay immediately above the clay of the floor. This was regarded as material from the demolition of the original partition wall. Above this lay patches of coal and charcoal, possibly the result of burning the old partition timbers, or even the occupation of the rooms during the construction of the Sub-Phase 2 partition (although there was no evidence of burning underneath them), prior to the laying of the stone floor.

Sub-Phase 1

THE EAST ROOM

No evidence of the primary floor or occupation levels were uncovered in the east room. Patches of coal (Q05:39, 50) occurred immediately east of the line of the partition, and another (Q05:33), mixed with plaster and fragments of iron and lead, lay on top of a deposit of daub and masons chippings (Q05:53) in the north-east corner of the room. Collectively these represent the material from the demolition and burning of the primary partition at the end of the original phase of occupation.

A stone lined trench (Q05:46), probably a latrine, was inserted into the south-east corner of the room. It had been partially robbed at the beginning of Phase 2 and the remainder had collapsed during the backfilling, but fragments of the sides had survived. It measured 1.80m long (north-south) and was on average 0.60m wide. The depth varied from 0.40m at the north end to 0.55m at the deepest parts in the south. A narrow unlined trench (Q05:43), 0.30m wide, ran from the south end of the latrine and under the east wall of Building 1, to the street drain (Q05:03), entering the drain at the level of the second course. Although later alterations had damaged the original west side of the street drain, it did appear that the trench had been a breakthrough and not part of the original construction. This, coupled with the lack of any lining of the trench under the east wall of Building 1, suggested the latrine was an insertion during Sub-Phase 1.

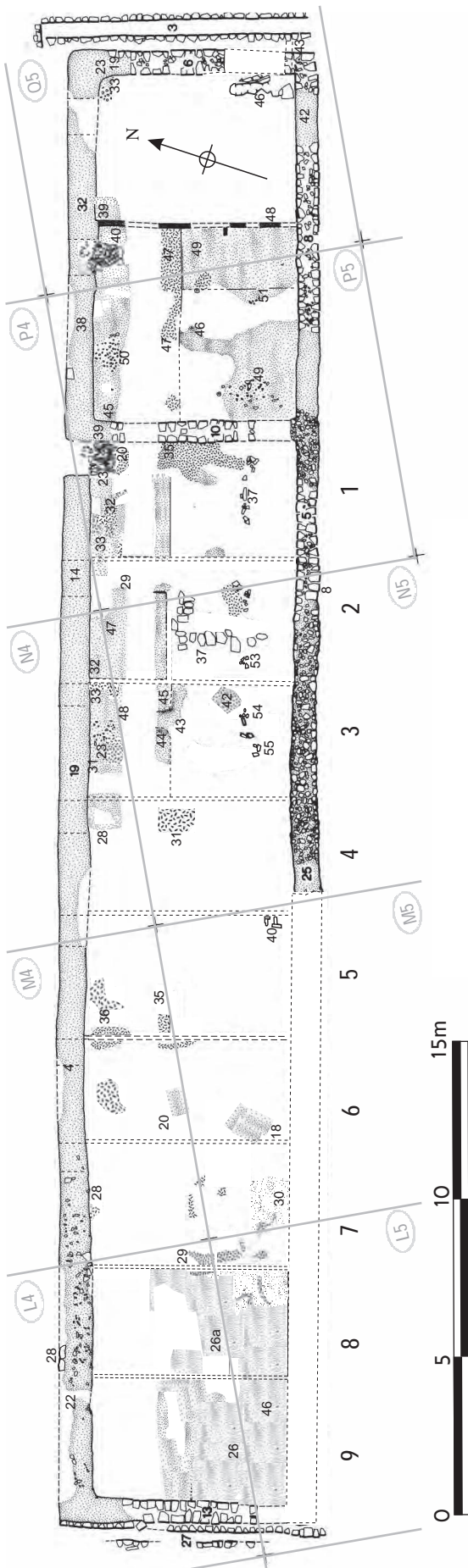

Figure 13.01: Building 1, Phase 1, Sub-Phase 1 at 1:200.

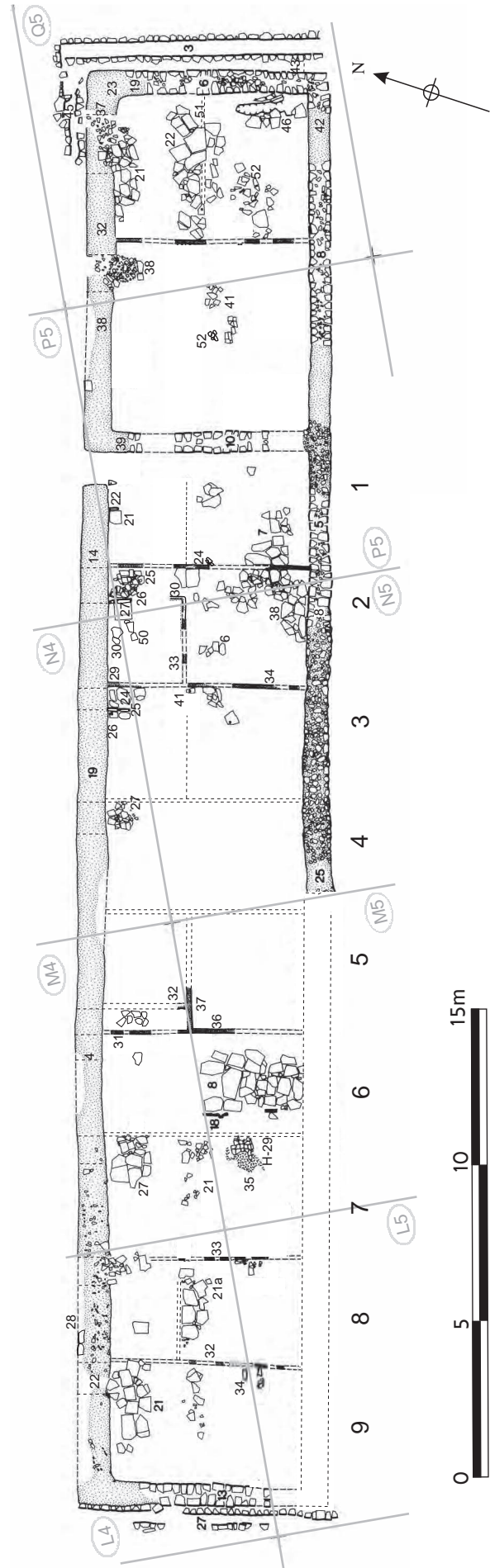

Figure 13.02: Building 1, Phase 1, Sub-Phase 2 at 1:200.

Although the surfaces of the entrances to the rooms were not excavated below the level of Sub-Phase 2 in most places, it can reasonably be assumed that they represent the position of the original doorways. The entrance to the east room was through a centrally placed doorway through the north wall.

THE WEST ROOM

The west room of the officer's quarters provided more clues to the original living arrangements. This room had been divided into at least three separate areas. Orange puddled clay (P05:46, Q05:49), probably primary floor material, was found over the southern area of the room. This had a distinct northern edge giving the impression of an east–west room divider creating a north room 2.00m wide (north–south), and a south room 3.60m wide. Another divider was revealed by the edge of a gravel surface (P05:51), a small packing stone, and a post-pipe, dividing the southern room into two areas 4.00m and 2.00m broad (east–west). Clay floor material (P05:45, Q05:40) over the northern room survived to a depth of 0.07m in places. There were also patches of gravel and decayed sandstone over other parts of the north and south-west rooms (P05:49, 50), probably used for resurfacing. Demolition material in the form of daub (P05:44, 49, Q05:31) and a large expanse of coal and charcoal (P05:43, 47, Q05:47) overlay the clay floors.

The north room of the suite was entered by a doorway in the north-east corner of the room. The surface of this entrance may have been part of Sub-Phase 2, but it was very different in character to the flagged surface of the entrance into the east room, which was obviously part of the later flagged floor. In the west room the area of the doorway through the north wall was made up of river cobbles, fragments of sandstone, and slightly further south, larger, rounded flags. The whole surface was well compacted and extremely worn. It is possible that the spreads of gravel and sandstone staining over parts of the room, are the remains of this type of surface.

SUB-PHASE 2

A new partition dividing the officer's quarters into two rooms probably replaced the original on exactly the same north–south line.

THE EAST ROOM

A flagged floor (Q05:21, 22, 52) was laid over the demolition levels of Sub-Phase 1. This floor consisted of closely packed angular flags, on average 0.08m thick and packed down dark reddish-brown, dirty clay, probably the remains of the earlier partition wall daub. The surface of the floor was fairly well worn. The room was divided into two areas by an east west partition (Q05:51) indicated by a southern edge to some of flagged floor Q05:22 (this partition is almost on the line of the east–west divider in the

early phase of the west room). A pivot stone 1.00m from the west end of the slot marked the doorway between the north and south areas.

The flags over the north area (Q05:21) extended right into the entranceway to form the threshold.

The latrine in the south-east corner of the room continued in use, the trench being extended by 0.50m to the north. Some of the flagging (Q05:52) survived immediately west of the latrine.

THE WEST ROOM

Virtually all of the floor of Sub-Phase 2 had been robbed away and only several flags (P05:41) remained. The doorway (Q05:38) (if it was not laid at this time) continued in use.

The contubernia

The *contubernia* were numbered 1 to 9 from the officer's quarters. These measured on average 6.50m (north–south) by 3.50m. Each was entered via a doorway in the north-east corner of the room. All the doors were recessed and inside the inner face of the north wall of the building. Evidence from several of the *contubernia* suggests that they were partitioned into two separate north and south compartments, roughly 2.50m and 4.00m broad. Although later robbing, alterations and disturbance had removed a large proportion of the *contubernia* floors, sufficient survived in a number of examples to piece together a reasonably accurate picture of events, where the sequence is much the same as that encountered in the officer's quarters.

Contubernium 1

SUB-PHASE 1

The original partition slot separating *Contubernia* 1 and 2 was probably in exactly the same position as that in Sub-Phase 2, giving a width of 3.60m to *Contubernium* 1. The primary floor (P05:33) of reddish-brown clay was exposed on both sides of the Phase 2 north wall, the area to the south ending in a distinct edge, suggesting a room divider. This would have divided the *contubernium* into two rooms, 2.60m and 3.90m broad.

The foundation of the north wall of Building 1 ended 1.00m west of the west wall of the officer's quarters, allowing for an entrance in the north-east corner of *Contubernium* 1. A surface of worn, broken sandstone (P05:20) lay over the area immediately south of the entrance. In the south-west corner of the doorway was a pivot stone (P05:23) which, with the surface P05:20, suggested that the door opened towards the interior (Fig. 13.03).

The only other levels found were two dense patches of coal and charcoal (P05:32, 35) and an area of daub (P05:17), probably the remains of demolition. Over the north room the coal (P05:32) and daub overlay the primary floor (P05:33), and lay directly under the later

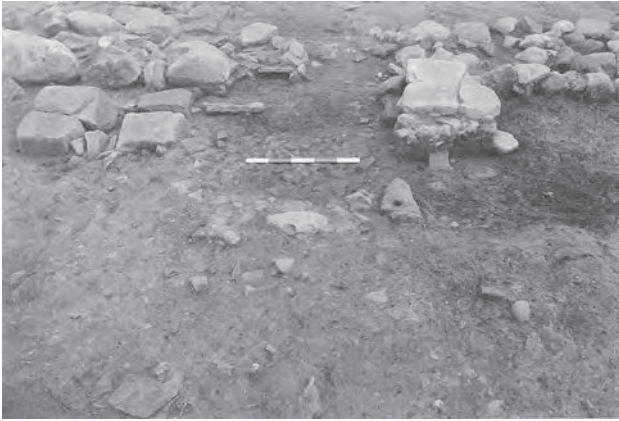

Figure 8 Pivots tone P05:21 associated with the Phase 1 Sub-Phase 1 doorway into the side passage of Contubernium 1 from the north.

stone surface (P05:21, 22) of Sub-Phase 2. In the south, lying up against the stone wall of the officer's quarters, the coal (P05:35) was quite extensive, covering an area 2.80m long (north–south) and up to 1.20m wide.

There was a possible east–west partition within the southern room indicated by a line of small upright stones (P05:37), 1.60m from the south wall. Unfortunately they had been badly damaged by later alterations, and no floor surfaces survived around them.

SUB-PHASE 2

A flagged floor was laid in the *contubernium* (P05:07), but it was not possible to say whether it extended over the whole area, or even whether the former room division survived into this phase. A single flagstone (P05:21) and an upright stone (P05:22) immediately east of it, probably a door jamb, were found 0.80m west of the original north-east entrance. These features resemble the internal doorways found leading off a side passage into a front room in both *Contubernia* 2 and 3 (see below), but threshold P05:21–2 occupied a more westerly position with respect to the main doorway than did the corresponding features in 2 and 3. If this threshold was associated with a side passage, therefore, the passage would be abnormally wide and the front room unusually small. Alternatively it is conceivable that the doorway may represent some kind of alteration to the entrance arrangements during Sub-Phase 2, perhaps in favour of a centrally placed doorway. The partition between *Contubernia* 1 and 2, (P05:24), is attributed to this sub-phase because of the edges to stone floors P05:07 and N05:38, which left a gap of 0.15m for the dividing wall. It also appeared north and south of the north wall foundation of Phase 2, (which cuts through the northern parts of the *contubernia*) as a light brown band of clay and gravel, on average 0.12m wide.

Contubernium 2

SUB-PHASE 1

The partition slot between *Contubernia* 2 and 3, and an internal divider in *Contubernium* 2, were again on the lines of later dividers, but there was just slight evidence of the original *contubernia* dividing slot towards the southern end of the rooms. This was a narrow yellow clay strip, 0.70m long and 0.09m wide, which was cut by the slot (N05:34) of the Sub-Phase 2 divider.

The north room had a floor of yellow-orange clay (N04:32, N05:46, 47, P05:29) containing fragments of sandstone. Fragments of a worn stone floor (N05:37), made up of slightly larger flags 0.08m deep were found in the south room. Although the flagging might not have been an original feature, it undoubtedly belonged to Sub-Phase 1, as it sat at a noticeably lower level than the remains of the flagged floor (N05:38) of Sub-Phase 2. A small area of coal, possibly a hearth, was found to the east of the drain.

The entrance of the later sub-phase was not removed, but it must have replaced the original in the north-east corner of the *contubernium*.

Although no demolition levels from this phase were recorded specifically from *Contubernium* 2, a general context number (N05:32), was assigned to a level which covered the floors of *Contubernia* 1, 2 and 3, comprising reddish-brown clay, probably daub from the demolition of the Sub-Phase 1 partitions.

SUB-PHASE 2

The partition slot (N04:29, N05:34) between *Contubernia* 2 and 3 was uncovered in three places. Most noticeable was the length (N04:29) east of the flagged floor (N05:24) of *Contubernium* 3, which lies immediately south of the entrance, where the eastern edge of the floor respects the edge of the slot. On average it measured 0.10m wide, with a fill of reddish-brown clay, probably daub from the demolished upright of the previous phase. This gave *Contubernium* 2 a width of 3.60m. The slot (N05:33) of an east–west room divider ran adjacent to this, almost on the same line as those in *Contubernia* 1 and 5, dividing the *contubernium* into north and south rooms. They measured 2.40m and 3.80m respectively. The slot was the same width, and contained the same fill as N05:34. The room divider ended 0.90m before the west wall of the *contubernium* and turned north for 0.40m (P05:30), marking the beginning of a side passageway and leaving a doorway between the two rooms opposite the north east entrance. This plan was repeated in *Contubernium* 3 where a pivot stone (N05:41) probably marks the west edge of a doorway in exactly the same position.

A substantial flagged floor (N05:06, 38) was uncovered over the south room, mainly in the south-east corner where it respected the edge of the slot between *Contubernia* 1 and 2. A large worn, broken flag lay over the doorway between the rooms.

An area of small, worn, broken flagstones (P05:25) covered the north-east entrance into the *contubernium*. A second doorway was indicated by three upright stones (P05:26, 28), set along the east edge of a 0.55m square flagstone (P05:27), which together formed a threshold and door-jamb 0.13m high. Two of the stones were probably re-used as they had rounded upper edges. In the much rougher stone (P05:28) at the north end of the jamb was a pivot hole 0.03m diameter. These features are most plausibly explained as the threshold and pivot stone of a doorway opening into the front room (*arma*) from the north end of the side passage. The main doorway in the north wall did not provide direct access into the north room, but instead led into a passageway (cf. P05:30) which led along the east side of the *contubernium* towards the south room. At the southern end of the passage, half way down the length of the *contubernium*, a doorway opened into the south room, as noted above, whilst the doorway represented by features P05:26–8 opened into the north room at the other end of the passage, directly adjacent to the main doorway. Fragments of a slightly worn flagged floor (N04:30, N05:50) were found over other areas of the north room at roughly the same level as the threshold surfaces.

Contubernium 3

SUB PHASE 1

A large area over the site of the partition slot between *Contubernia* 3 and 4 was not available for investigation, but the east edge of the north-east entrance (N04:27) to *Contubernium* 4 probably indicates the line of the slot, giving a width of 3.65m for *Contubernium* 3. The divider between the north and south rooms was revealed by a distinction between the fairly clean yellow clay floor (N05:44, 45) over the southern corners of the north room and the dirtier trodden layer (N05:43) in the south. The dirtier material also extended slightly into the north room at one point, indicating a doorway to the east of centre. This divider was on roughly the same line as those in *Contubernia* 1 and 2. Over the north end of the north room the floor survived as a mixture of clay and sandstone fragments (N04:31, N05:48).

The entrance into the *contubernium* was not excavated to this level.

Daub from the demolition of the partition was uncovered in the general level N05:32 across *Contubernia* 1, 2 and 3.

Coal from burning the partition was found extensively over the north room (N04:23, 33) and seemed to run under the flags of the later north-east entrance, although they were not lifted. Small patches of coal and charcoal (N05:42) occurred to the east of the drain in the south room, but it was not possible to say whether these represented occupation hearths, or evidence of demolition.



Figure 10 Flagging inside the side passage (left) and the doorway threshold (right) into the north room of *Contubernium* 3 (N04:27), from the north

SUB-PHASE 2

Very little of this sub-phase survived in *Contubernium* 3. Virtually all of the floor surfaces had been removed. Over the north-east corner were several worn irregular flags (N04:24), possibly the remains of the Sub-Phase 2 stone entrance. Abutting the west side of these was a threshold composed of two upright stones (N04:25) which were laid end to end and stood 0.20m above the stone surfaces on either side. Immediately to the west of these was a small worn flag (N04:26) containing a pivot-hole in the north-east corner. The threshold probably belonged to a doorway leading from the north end of a side passage into the front room of the *contubernium*, an arrangement paralleled in *Contubernium* 2 (Fig. 13.04).

A room divider probably occurred on the same line as that in the earlier phase indicated by a small pivot stone (N05:41) found on this line at the east end, immediately west of the partition between *Contubernia* 2 and 3. The new doorway between the rooms was now in the same position as those in *Contubernia* 1 and 2.

Contubernium 4

A large portion of *Contubernia* 4 and 5 was removed when a clay puddling pit (N05:13, 14, 15, 22 etc.) was dug through the floors after the demolition of the building at the end of Phase 2. The only areas available for investigation in *Contubernium* 4 occurred north and south of the trench of the later north wall foundation in the north-east corner of the *contubernium*, and over a small area in the south west. An area of coal (N04:28) was found around and running under the Sub-Phase 2 stone surface of the north-east entrance. South of the Phase 2 trench was a layer of reddish clay (N05:31). Both these features are probably elements of the demolition of the Sub-Phase 1 partitions.

Worn broken flagstones (N04:27) occurred over the north-east corner of the *contubernium*, probably forming the threshold of the Sub-Phase 2 entrance.

Contubernium 5

As a result of the clay puddling pit, only small areas in the north-west and south-east corners of the *contubernium* were available for investigation.

SUB-PHASE 1

Five small upright stones (M05:40), possibly chocking stones for a post, were found in the south east corner of the *contubernium*. This may have been a support for the partition between *Contubernia* 4 and 5, but no evidence of a slot remained near it. The slot for the original partition between *Contubernia* 5 and 6 was probably on the same line as that in Sub-Phase 2.

None of the primary floors were uncovered, but the later foundation of the Phase 2 north wall cut through a layer of orange clay and daub (M04:10, 11), 0.12m thick, presumably a combination of floors and demolition material of both sub-phases. Patches of coal (M04:35, 36) occurred north and south of the later foundation and extended slightly into *Contubernium* 6. These are probably evidence of the burning of the original partition, especially as they appeared in some places to have been cut by the later partition slot (M04:31) and room divider (M05:37).

SUB-PHASE 2

The Sub-Phase 2 partition slot (M04:31, M05:36) between *Contubernia* 5 and 6 was found on both sides of the later foundation. It was filled with mainly reddish clay, probably daub from the demolition of the earlier partition. The slot of a room divider (M05:37) ran east from this and contained the same fill. Another slot (M04:32), parallel with the west partition, and 0.65m inside the room, ran north for 0.35m from the room divider, where it was cut by the Phase 2 foundation and was not found to the north of it. This may mark the line of a partition screening off a passageway running along the west side of the *contubernium*. A doorway at the southern end of the passage would have lead into the rear room of the *contubernium* (the *papilio*). This is the opposite of the normal arrangement in this block, whereby the passageway was positioned on the east side of the front room. The validity of the abnormal layout is confirmed in this case, however, by the presence of an area of stone flagging, immediately to the north, which probably represented the passageway floor. On its east side the flagging formed a straight edge which appeared to respect the projected line of partition M04:32. Fragments of a stone flagged floor (M05:08) were also found over parts of the south room.

Contubernium 6 (Fig. 13.05)

SUB-PHASE 1

The dividing partition slot between *Contubernia* 6 and 7 is probably indicated by the east edge of Sub-Phase 2 flooring M04:27 and hearth M05:29 in *Contubernium* 7. This would make *Contubernium* 6 rather narrower

than usual at 3.15m. Only a small area at the north end of the room was investigated to the original levels. No evidence of a north-east or central entrance survived and the only traces of Sub-Phase 1 floor were a patch of yellow gravel (M04:20), possibly constructional, and an area of dirty trodden grey clay (M05:18).

SUB-PHASE 2

In Sub-Phase 2 a substantial flagged floor (M05:08) 0.09m thick was laid over the southern room. Four upright stones (M04:18), laid end-to-end on the west edge of this floor suggested a north-south partition to the east of that denoted by the features in *Contubernium* 7. If the upright stones were a support for a partition between the *contubernia*, the width of *Contubernium* 6 would have been reduced to 2.60m. However, it is perhaps more likely that they represent one side wall of a drain or urine sump belonging to the subsequent Phase 2 (Period 4) stable building (see below Chapter 14).

Contubernium 7

SUB-PHASE 1

The original width of this room, like all of the others, is indicated by the slots left by the partitions of Sub-Phase 2, giving a width of 3.80m. A small area of sandy yellow clay (M05:30), possibly primary floor, was uncovered in the south-east. Demolition materials were found below the level of the Sub-Phase 2 floors in the form of coal spreads (L04:29) over the south room and reddish-brown clay, probably partition daub (M04:28), over the north.

SUB-PHASE 2

Fragments of a flagged floor (M04:27) were located over the north-east entrance to the *contubernium* and over the south room (M04:21) in Sub-Phase 2. A hearth (M05:29), 0.11m thick, composed of two burnt and shattered layers of shallow bricks in a rectangular shaped platform, had been built in the south east. On the hearth and spreading west of it was a layer of coal (M05:35). The east edge of the flagged entrance and the hearth neatly coincide and must indicate the position of the partition separating *Contubernia* 6 and 7.

The west wall of the room could be seen clearly where 2.00m of the slot (L04:33) had cut the coal and charcoal (L04:29) from the burning of the previous partition. It was filled with yellow clay and fine iron-stained gravel. This line, although not revealed in the north, was respected by the east edge of the stone entrance to *Contubernium* 8.

Contubernium 8

SUB-PHASE 1

The width of this room could be estimated from the distance between the later partition slots (L04:32, 33) to be on average 3.30m. Most of the southern part

of the room was covered with a dirty-grey trodden clay containing patches of sandy gravel (L04:26a) and was clearly cut by the partition slot, L04:32. This material was very similar to those over *Contubernia* 7 and 9 (M05:30, L04:26) and probably represents the original floor surface.

SUB-PHASE 2

Evidence of the Sub-Phase 2 slot (L04:32) between *Contubernia* 8 and 9 could be seen in several places where the fill was a mixture of yellow sandy clay and gravel. This lined up fairly well with the east edge of the flagging (L04:21) over the north room of *Contubernium* 9. Fragments of a flagged floor (L04:21a) were found over the northern part of the south room. The northern edges of several large flags of this surface suggested an east-west room divider on a similar line to that in *Contubernium* 2. A flag at the east end of this group lay across the line, probably indicating the doorway between the two rooms. Another small group of flagstone pieces survived in the south-east of the south room, respecting the line of the slot L04:33. It is notable that this small group of stones is in the same position as the hearth (M05:29) in *Contubernium* 7 and the stone box (L04:34) in *Contubernium* 9, and it may also therefore represent some kind of platform.

A small area of small worn fragments of flagging over the north-east corner of the *contubernium* indicated the entrance.

Contubernium 9

SUB-PHASE 1

Using the Sub-Phase 2 partition, this *contubernium* measured 3.75m wide. Most of the area of the south room was covered by dirty trodden clay (L04:26), probably the primary surface.

SUB-PHASE 2

A substantial flagged floor (L04:21) was laid over the north end of the room, and, as usual, survived particularly well over the area of the north-east entrance. Fragments of a stone box (L04:34) had survived in the south-east of the room, right up against the partition. Only the north and south sides were still standing, the other sides had collapsed in towards the centre of the box. It was composed of several upright stones standing to a height of 0.12m and which cut the clay surface (L04:26) of the primary floor. Assuming that the floor in the south room was flagged in this phase, the interior of the box would have been below floor level. It is difficult to say what the exact function of this structure may have been, but a similar structure, referred to as a 'winkle box', was found at Housesteads in the Barrack Building XIII, in *Contubernium* 4, and it probably was intended to be used for storage of some kind.

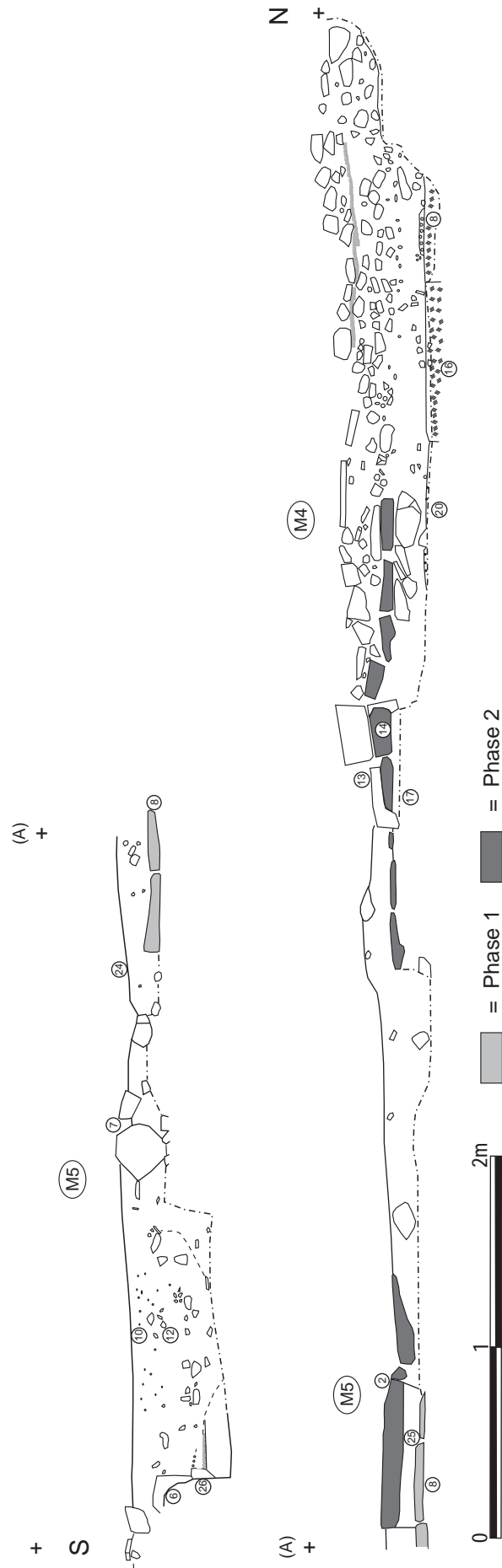

Figure 13.05: East-facing section (S43) across Building 1 in grid squares M04 and M05, at 1:30



Figure 13.06: Drain Q05:03 alongside the east end of Building 1 with the Phase 2 flagging exposed in the SE corner of the building



Figure 13.07: Drain Q05:03 with outflow channel Q05:43 leading from the latrine and drain in Building 1 excavated.

The drains relating to Building 1 in Phase 1

Drains were uncovered to the north, east and west of the building. The drain immediately east of the officer's quarters was very well preserved (Q05:03). In its original form it was composed of two sides of well dressed facers on average 0.25m wide by 0.13m high, three courses deep (Figs 13.06, 13.07). The channel was 0.40m wide. There were traces of broken cover slabs in situ on the west side of the drain. It extended beyond the north wall of the building for 1.00m where it was joined by the east–west drain (Q05:45). The bottom of the channel was covered with a layer of yellowish-green silt (Q05:29) which lay below a layer of soil and rubble (Q05:28), probably backfill from when the drain went out of use at the end of Building 1.

The drain (L04:27, L05:52) to the west of the building also appeared to be primary, being constructed of the same well-dressed masonry. Only one course of this survived however, indicating a channel slightly narrower than that on the east side. This had been deliberately blocked with stone packing (L04:35) at the end of its life.

To the north of Building 1 only slight traces remained of a drain. Probably the best preserved section (Q05:45) occurred at the junction with the east drain (Q05:03), where it appears to be a contemporary feature. At the level of the third course of the east drain a north face extends to the west for 1.00m, forming both the termination to the north end of the east drain and the junction of the east and north drains. The channel for the north drain is at a higher level than that to the east, so the north face is stepped down accordingly. Further west of this the north drain is much rougher in construction and made of larger facers up to 0.40m long. Here one course of both sides survive, but they have been badly damaged and displaced by later activity. In other areas further west (P05:18a, N04:34, M04:08a) the north drain appears to be no more than a gully with a rough north side and with the foundation of the north wall of Building 1 forming the south side. This suggests that the majority of the north drain which was uncovered was not an original feature and that the junction with the east drain was either the only remains of the original drain, or more probably, a short section constructed with the east drain in anticipation of a drain being built along the north side of the building. A section across the drain revealed a layer of grey-brown silty clay (M04:08) below the later backfilling.

The alleyway between Building 1 and 2 in Phase 1 (Alley 1)

The surface of the alleyway was composed of a fairly homogenous level of light-brown clay. This was possibly the material of Phase 1 and Phase 2 of the buildings but no obvious distinction could be seen. An arbitrary distinction was made on grounds of relative heights of the clay within the alleyway. Everything below the level of the bottom of the Phase 2 foundation of the south wall was treated as Phase 1. This clay (L05:31, M05:16, N05:19) lay to a thickness of up to 0.12m above the natural.

The roads relating to Building 1 in Phase 1

North intervallum (Road 4)

This was a heavily worn surface, 0.05m deep, of compacted pebbles (N04:05, P04:10, Q04:13) in a matrix of fine gravel, forming a consistent well laid surface. Only small areas of the road were exposed at this level. Material was taken from the silt found under the primary road in a section across the road (N04:15, 16). The road measured 5.00m wide from the street drain immediately north of Building 1 (N04:34) to the primary rampart kerb (N04:13).

Pit through the north intervallum road (Figs 13.08, 18.06)

Investigation of an area of subsidence in the Phase

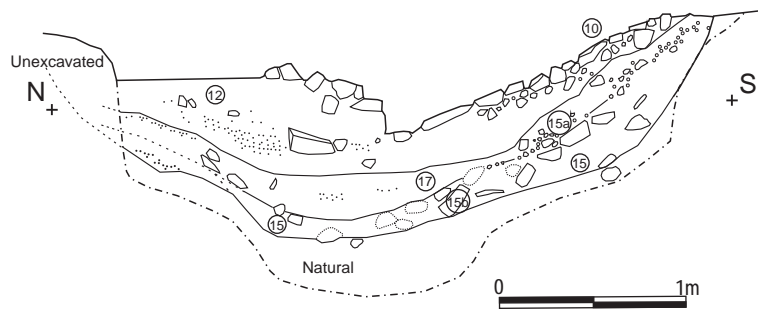

Figure 13 Section (S16) across pit Q04:10 in the north intervallum. Scale 1:10

The surface of the north *intervallum* road revealed a large, roughly oval shaped pit (Q04:10¹). This was cut through the primary road and the southern part of the north rampart. It was situated in the area between the angle tower and the north-east corner of Building 1 and lay on a south-east to north-west alignment. It measured 4.00m (across the main axis) by 3.20m.

A section (S16) down to the natural across the width of the pit, revealed a dish shaped trench, 1.22m deep at the deepest point below the Phase 1 road surface (Q04:13). This measurement was taken using the road surface immediately south of the pit. The fill consisted mainly of three layers of silty-loam, varying slightly in colour and texture and all of which extended the full width of the pit. At the bottom the fill (Q04:15) was sticky, grey, clayey loam varying in depth from 0.05m on the north side of the pit, up to 0.30m at the south side. Also in this layer on the south side were two layers of stone. The lower one (Q04:15b) contained fragments of flagstones, some of which may have originally been thrown into the pit as large complete flagstones. A broken example of one of these was uncovered in situ when the fill of the pit was removed and it measured 1.15m × 0.80m × 0.08m. The upper layer (Q04:15a) consisted of a thin spread of iron stained pebbles and sand, 0.10 m deep, running down from the top of the south-west side of the pit and ending against an upended flagstone of the level below, near the bottom of the pit. Above this was an iron stained layer of light brownish-yellow loam (Q04:17) containing fragments of stone, coal, charcoal, decayed mortar and patches of pink-puddled clay. At its deepest, in the centre of the pit, it measured 0.22m. This lay under a thick layer of silty loam (Q04:12), 0.55 deep on the north side of the pit, which was very similar in consistency but slightly darker in colour. The Phase 2 road of small cobbles (Q04:10) had subsided into this material, especially at a point 1.80m from the south edge of the pit, above the centre, where it dipped sharply to a level 0.60m below the level of the unaffected road. The Phase 3 road (Q04:02) of large cobbles and demolition stone covered the whole of this area including the dip in the subsided road so that none of the pit was discernible at this level.

The purpose of the pit was not ascertained. It was possibly the beginnings of a well or cistern, but if so the work was abandoned and the pit immediately backfilled. More likely, the pit represented a pit dug to obtain and/or puddle clay used in the building of one of the adjacent structures, by analogy with the larger pit which was found to have cut through the northern part of Building 1 at a later stage, although the fill of the *intervallum* road pit contained less clay. The type of materials in the backfilling suggests that the pit was used to dispose of construction debris or demolition rubbish, including broken flagging (Q04:15b), possibly from the alterations to Building 1. After these were thrown in the primary road surface (Q04:13) spilled over into the south side of the pit (Q04:15a). More demolition materials (Q04:12, 17) were thrown in on top of this. The different types of fill (Q04:12, 15, 17) may represent gaps in the backfilling process but they were virtually identical. The Phase 2 road surface (Q04:10) was laid over the top of this and must have subsided into the pit sometime later. As the material in the pit had not subsided before the new road was laid it could be argued that the pit may have been dug and backfilled at the end of Phase 1, immediately prior to the Phase 2 road surface. However, this assumes that subsidence would have occurred very quickly when the pit was backfilled, whereas it could have taken place much later with the weight of the Phase 2 road. The fact that the pit intrudes into the rampart area appears slightly puzzling since this could potentially have threatened the stability of the adjacent rampart levels. Could this be the result of the original sides of the pit collapsing in?

East intervallum (Road 7)

The primary road surface (Q05:26) was composed of the same compacted pebbles as the north *intervallum*. The relationship with the drain (Q05:03) east of Building 1 was not completely investigated but the road appears to have sloped down slightly to meet the upper surface of the east side of the drain. Only 1.50m of the width of the road was uncovered.

FINDS

Building 1 Phase 1*North wall foundation*

Copper alloy: stud (no. 264, M04:04)

Stone: throwing stones (no. 89, Q05:32; lost, L04:22)

North wall robber trench

Roman items plus C17th clay pipes

E–W drain north of wall

Lead seal: no. 3, P05:18

South wall foundation

Coin: Hadrian, 134–8? (no. 78, N05:25)

Copper alloy: stud (no. 316, N05:25)

South wall

Coin: illegible (no. 238, P05:05)

N–S drain east of S Wall

Mortarium stamp: 135–170 (no. 24, Q05:03); 140–170 (no. 33, Q05:03)

Amphora stamp: first to early second century (no. 7, Q05:28)

Graffiti: BB2 bowl (no. 44, Q05:03)

Flint: arrowhead (no. 8, Q05:03)

Stone: throwing stone (no. 7, Q05:28)

Sub-Phase 1 flooring

Iron: stud (no. 60, M04:09)

Sub-Phase 1 demolition material Contubernia 1–4

Iron: ringmail (no. 16, N05:32), stud (no. 43, N05:32), strip (no. 66, P05:17)

Bone: knob (no. 4, N05:32), pin (no. 17, N05:32)

Stone: throwing stone (no. 22, N05:32; no. 60, N05:29; no. 100; N05:29)

Contubernium 5 Sub-Phase 1 clay floor/ demolition

Coin: illegible (no. 245, M04:10)

Copper alloy: collar (no. 57, M04:10), steelyard weight (no. 203, M04:11)

Iron: stud (no. 57, M04:10)

Copper alloy: steelyard weight (no. 203, M04:11)

Contubernium 7, Sub-Phase 2 hearth

Coin: Trajan, 98–117 (no. 43, M05:29)

Contubernium 8, Sub-Phase 1 floor

Stone: throwing stone (lost, L04:26)

Cleaning under Phase 2 flags

Decorated samian: 125–150 (no. D141, Q05:34)

Stone: whetstone (no. 23, Q05:34)

Cleaning of Phase 1 floors/Phase 2 make-up

Iron: ferrule (no. 15, L05:46)

Glass: window (no. 42, L05:46)

Stone: throwing stone (lost, L05:46)

Cleaning of Phase 1 levels (N ends of Contubernia 1–3)

Copper alloy: spoon (no. 105, N04:18)

Iron: stud (no. 54, N04:18)

Stone: whetstone (no. 20, N04:18)

Alley 1 and roads*Alley 1 lowest levels*

Mortarium stamp: 120–60 (no. 4, N05:19)

Flint: flake (no. 3, M05:16)

Copper alloy: brooch (no. 2, M05:16)

North intervallum primary road surface (Road 4, east side)

Mortarium stamp: 120–160 (no. 10, P04:10)

Dating evidence*Phase 1 wall foundations*

The foundations (excluding M04:04) produced approximately 12 sherds of pottery, including a single sherd of samian dated to the Hadrianic or early Antonine period (L04:22, N04:19, N05:25, Q05:08). A single sherd from the rim of a BB2 bowl or dish suggests an Antonine date (L04:22). North wall foundation context M04:04 produced much of a single South-East reduced ware vessel, but also a few sherds of pottery dating to the second half of the third century. This material either relates to later work on the building, or has been wrongly assigned to this context.

Phase 1 walls

An unusually large amount of pottery (over 0.5kg) came from contexts identified as being the barrack walls (L04:13, P05:05, Q05:08). All three contexts produced BB2 and allied fabrics, as well as a Gillam type 151 rim and Nene Valley ware, all of which indicate a third-century date. Context L04:13 also produced calcite-gritted ware and a flanged bowl, probably of late third century, so again this material must relate to later activity or intrusion or it has been wrongly assigned to these contexts.

Phase 1 drains

Over twenty sherds of coarse ware came from the fills of the drains north and east of the building (M04:08, Q05:03), including BB2 and allied fabrics, indicating a late second-century or later date. There were three sherds of samian, all of Hadrianic or early Antonine date, and stamped mortaria dating to 135–70 and 140–70 (nos 24, 33).

The Barrack interior – Phase 1, Sub-Phase 1

Only a small quantity (c. 15 coarse ware sherds) were recovered from Sub-Phase 1 (L04:26, M04:09, M05:18, Q05:33). There was a single sherd of a BB1 dish from the demolition of the primary partition in the officer's quarters (Q05:33). One context from the flooring also included third-century material, such as a sherd from a Nene Valley indented scale beaker (L04:26).

Sub-Phase 1 demolition

The demolition material contained about 20 sherds of coarse wares, and two sherds of Hadrianic or Antonine samian (M04:10, 28, N05:29, 32, P05:17). The material varied according to location; in *Contubernium* 1 the material was mid-second century (P05:17), while in *Contubernium* 7 it was late second in date (M04:28), but the quantities involved are small.

Sub-Phase 2

The flagged floors (M05:08, N04:20, Q05:21) did not produce much material, but about half of it was BB2 or allied fabrics, and a sherd from a Horningsea storage jar, probably of third-century date.

Alley 1 Phase 1 – Lower level

An arbitrary division was made between the 'lower' and 'upper' fills of the alley deposit, reflected in the fact that there are a number of joining sherds from vessels found in both lower fill M05:16 and upper fill M05:12. The lower fill produced only 1.251kg of pottery (76 sherds), and was made up of approximately 77% BB1 and locally produced wares, and 7% BB2, suggesting an Antonine date. There was a stamped mortarium dated 120–60 (no. 4) and a Form 37 dated 125–140 (no. D112).

Demolition debris in Alley 1 of Phase 1 or 2?

The deposit of burnt daub on the south side of the alley (N05:23, N05:24) had cross-joins between sherds from N05:23 of the lower fill, but more from N05:07 of the upper fill, as well as others in the other two contexts from the upper fill, M05:12 and P05:16. It contained a number of near complete locally produced second-century vessels (Fig. 22.12, nos 20–22, 27). Locally produced pottery made up the majority of the coarse wares, but there was also a small quantity of BB2 and south-east reduced ware as well as a few sherds from a Nene Valley indented scale beaker. The samian with the latest production dates were two stamped vessels dated 135–50 and early to mid-Antonine (nos S76, S90). There was also part of the handle of a black sand amphora, dating to after the middle of the third century (Fig. 22.10, no. 5), and two sherds of calcite-gritted ware, which may be contamination from the layers above.

Under Phase 1 north intervallum road surface

The silt under the road surface (N04:15, 16) produced

a quantity of sherds from locally produced vessels of the mid-second century, plus a Form 37 samian bowl dated 135–65 (no. D119) and an Antonine Form 31.

Phase 1 north intervallum road surface

The road surface produced a Hadrianic samian dish, a stamped mortarium dated 120–60 (no. 10) and a body sherd of a second-century Colchester mortarium (P04:10, Q04:13). There were a few BB2 cooking pot body sherds, suggesting an Antonine date.

North intervallum pit fill

The lower fill (Q04:15) of the pit in the north *intervallum* road contained late second-century material. There were three samian sherds, a Hadrianic or Antonine Form 18/31 or 31, and two decorated sherds dated 125–40 and 125–50. The upper fill (Q04:12) contained more pottery, including a sherd of calcite-gritted ware and a body sherd of a Crambeck mortarium, which is presumably intrusive.

Discussion: the dating of the stone barrack block

More contexts associated with Sub-Phase 2 produced dateable material than Sub-Phase 1, but the same overall range in the *termini post quem* provided by the individual pottery groups is evident in both sub-phases, with most contexts producing nothing which need be later in date than the late second-century (BB2 wares), though a few contained third-century Nene Valley material. This pattern would be consistent with both levels being associated with an Antonine barrack block, but is not conclusive evidence. The limited quantity of material found in the Sub-Phase 1 levels does not provide a *terminus post quem* for the building's initial construction (whether or not that represents a timber barrack or an earlier version of the stone one). Instead it probably reflects the occupation and even the demolition of this structural phase. Moreover it is difficult to regard the Nene valley material from context L04:26 as anything other than intrusive. In fact it is difficult to identify any significant group of contexts excavated in 1975–6 which could be regarded as sealed so there is considerable potential for intrusive material. Removal of the flagged floors associated with Sub-Phase 2 and the subsequent Phase 2 building might have revealed such contexts, but these surfaces were generally left *in situ*. The same problem also applies to the pottery found in association with the outer walls and the other principal structural features. The material recorded deriving from the foundations of the north wall, for example, may reflect the demolition and robbing of that structure rather than its construction.

Sealed groups were provided by two sets of deposits in the north *intervallum* road. The silts (N04:15–16) underlying the primary *intervallum* road

surface provided a mid-second-century *terminus post quem* for that road level. The deposits filling the pit which was cut through that road surface and then covered by the metalling of the second road surface should also ostensibly contain a sealed pottery group providing a *terminus post quem* for laying of the Phase 2 *intervallum* road. The lower fills contained nothing which need be later in date than the late second century (BB2). However the presence of a body sherd of Crambeck mortarium and a sherd of calcite-gritted ware in the upper fill (Q04:12) should imply that the Phase 2 *intervallum* road surface was laid no earlier than c. 280. It is questionable whether the primary road surface could have lasted so long before being relaid, giving rise to the suspicion that the integrity of the upper level of the pit, at least, may have been compromised, perhaps as result of later subsidence, with material possibly intruding from the makeup of the Phase 3 road surface above. More fundamentally, if the digging of the pit is associated with a construction event, as suggested above, which particular event would this represent? Candidates include the reconstruction of Building 1 as a stable (Stone Phase 2) or perhaps the earlier replacement of a timber barrack by a stone-walled one or conceivably some modification to the defences.

Building 2

Grid squares: L5, M5, N5, P5

Summary

Building 2 was the second most northerly building on the east side of the *praetentura*. It was separated from Building 1 by the 1.70m wide Alley 1. As Buddle Street ran diagonally across its line, only a small area of the building was available for investigation in 1975–6. This area comprised the north-west corner of the building, tapering to a point roughly in the centre of the north wall. Thus none of its south wall, which formed the frontage, nor its east end, was exposed.

The initial form of the building was that of a rectangular barrack block with clay-floored *contubernia* divided by timber partitions, probably very much like Building 1.

Stone Phase 1 (Fig. 13.09)

The details of the construction are the same as those in Building 1.

Very little of the north wall (L05:30, M05:06, N05:51) survived, but two courses, including the offset, were uncovered at the north-west corner and several stretches, a single course high, further east. The line of the wall could be seen clearly by a robber trench (L05:37, M05:31, N05:17, P05:15) in those areas where the wall was absent. Virtually the whole length of the

west wall could be seen (K05:16, L05:26). Both walls measured 0.70m wide, had rubble core and were bonded with grey clay.

Only small exploratory trenches were made inside the building to the level of the primary floors and subsoil. These revealed the northern limits of a series of partition slots on roughly the same spacing as those in Building 1 in Phase 1, providing space for six out of an estimated nine *contubernia*. The sequence of floor types probably also reflects the changes in Building 1, with flagging replacing clay floors before the building was rebuilt in Phase 2 (Period 4) with stone partition walls and new flagged floors, but the small areas uncovered did not really provide sufficient evidence of the early flooring to establish this conclusively. In particular, without a full sequence of floors recorded in section or clear relationships with the successive partition slots and walls it was difficult to allocate areas of flagging to a particular phase or sub-phase with absolute certainty.

The entrances would have been on the south side of the building opposite Building 3, unfortunately the excavation trench was limited to an area north of the south wall of Building 2.

Contubernium 3

A fragmentary flagged surface (M05:48 – actually located in grid square N05) was identified in the area of *Contubernium 3*, underlying a further level of flagging (M05:47) which may have been contemporary with the Phase 2 building (by analogy with the sequence observed elsewhere). This was not necessarily the primary floor of this *contubernium*.

Contubernium 4

The partition slot (M05:43) between *Contubernia 4* and 5 could be seen clearly in the natural subsoil. A rough line 1.20m long was exposed running into the north wall foundation. It measured 0.25m wide and contained dirty grey loam.

Contubernium 5

Between *Contubernia 5* and 6, the slot (M05:42) was only 0.12m wide but contained the same grey loam as the partition slot to the east. It was traced from the north wall foundation for 1.20m. The room measured 3.70m wide. The section through the floors revealed a series of deposits of clay and daub 0.12m deep, below later flagged flooring. The lowest of a series of flagged surfaces revealed in this area (M05:45) underlay the stone partition wall (M05:44) which separated *Contubernia 4* and 5 in the subsequent Phase 2 barrack block, implying that M05:45 floored *Contubernium 5* in the final stages of the preceding Phase 1 building, although it was clearly not the primary floor level.

Contubernium 6

Only 0.80m was uncovered of the partition slot

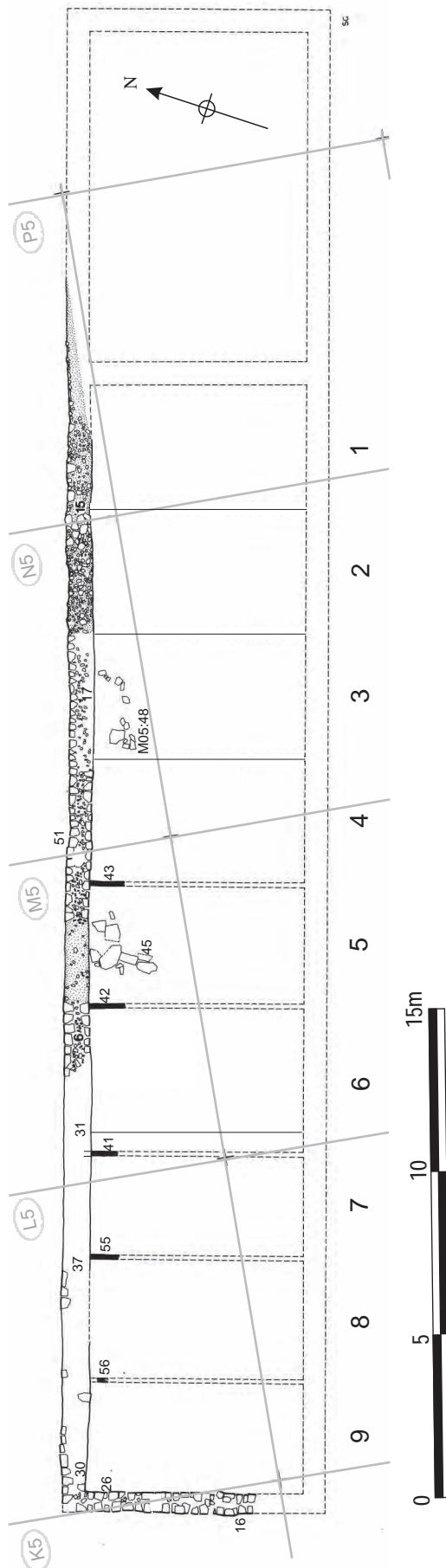

Figure 13.09: Building 2, Phase 1, including partition slot M05:41 possibly belonging to a Period 1 timber barrack. Scale 1:200.

(M05:41) between *Contubernia* 6 and 7. The line was very clear when the area was taken down to the natural sub-soil. It measured 0.14m wide and had a fill of dirty grey silt. Four small stake-holes were also found, two on either side of the trench, touching the sides. These were 0.06m in diameter and contained the same grey fill. The slot was situated 4.50m from partition M05:42, far more than the usual *contubernium* width, and probably therefore did not form part of the same sequence as the others uncovered in Building 2. Moreover plan P216 suggests that this partition continued northwards under the line of the north wall of the building, being visible at the base of robber trench M05:31. This would imply that it was not associated with the stone barrack building at all, but rather may represent one surviving element of a Hadrianic timber barrack building.

Contubernium 7

The partition slot (L05:55) between *Contubernia* 7 and 8 occurred 3.10m west of M05:41, but 7.70m from slot M05:42 which is probably from the same sub-phase. As the later floor was left intact here, only 1.00m of the slot was exposed at sub-soil level. It was 0.15m wide and contained grey silt and small fragments of stone.

Contubernium 8

A small section of the Phase 2 dividing wall (L05:09) was removed to uncover the slot (L05:56) between *Contubernia* 8 and 9. The slot was 0.15m wide and occurred 3.70m from the east partition. It was filled with the same grey silt as the others and contained fragments of sandstone. A modern pit (L05:27) dug through the floors at the north end of the room exposed in section (S47) successive layers of floors and make-up material in this part of Building 2. The lowest of those which could be recorded in the partially flooded pit was a makeup layer of grey-brown loam (L05:43), 0.10m deep, containing small fragments of stone. Immediately above this was a thin band of orange-buff clay (L05:42) 0.04m deep, which probably formed the first floor surface. This was in turn overlain by a further level of grey-brown loam (L05:40), on average 0.08m deep, which provided the bedding for a floor of small flagstones (L05:53) associated with the second main phase of the barrack block (see Phase 2 below).

Contubernium 9

The most westerly room measured 3.40m wide from the east partition (L05:56) to the west wall (K05:16, L05:26) of the building, slightly smaller than the average *contubernium* width, but probably still part of the same sequence.

FINDS

Stone Phase 1*North wall*

Bone: antler offcut (no. 64, M05:06)

North wall robber trench

Metalworking casting waste (no. 9, N05:17)

Dating evidence*Phase 1 wall*

The early phases of Building 2 produced relatively little datable material. One stone barrack Phase 1 feature, the north wall (M05:06), did yield over 20 sherds of pottery, however, including a sherd of East Gaulish samian of the Hadrianic-Antonine period. Over 50% of the coarse wares were BB2 and allied fabrics, and there was a sherd of Nene Valley ware, suggesting a third-century date. It is unclear whether this signifies that the north wall was rebuilt at that stage, perhaps contemporary with the Phase 2 remodelling of the barrack (see Chapter 14 below), no structural evidence for such rebuilding having been noted. It may simply be the result of later contamination of the extant walling.

Building 3

Grid squares: M7, N7, N8, P7, P8, Q7, Q8

Summary

Building 3 was the most southerly of the three barrack blocks on the east side of the *praetentura*. As was the case with Building 2, the majority of its area was covered by the course of Buddle Street, which ran diagonally across the line of the building. This left only a relatively small segment of the block available for investigation in 1983–4, which encompassed its south-east corner and progressively narrowed to a point just over two-thirds of the way along the south wall. As a result, neither the full length nor width of this building were revealed and its overall dimensions can be restored, at c 46m by c 8m, only by analogy with Building 1 and the other barracks of the *praetentura*.

The building evidently faced northwards, across an intervening street, towards Building 2. However this entire area, including the frontages of both Buildings 2 and 3, plus the street itself, lay hidden beneath Buddle Street. To the south it was separated from Building 16 by a narrow alleyway, no more than 0.60–0.90m wide (Alley 2). As revealed, the building took the form of a stone-walled barrack block with two principal structural phases. Its overall history was probably very similar to that of Building 2, but in this case, the exposed remains included part of the centurion's quarters, as well as a section of the *contubernia*.

The structural phasing is essentially that set out in the Daniels research archive and consists of a total of four phases, two of which were associated with the second-century stone barrack, the other two belonging to the remodelled barrack block of the third century. It should be recognised that in interpreting the building's remains in this way the excavators' were undoubtedly influenced by the overall phasing which the Daniels excavations had previously established in relation to the fort's occupation, itself influenced by the then prevailing Wall-period chronology. In practice it is difficult to identify two distinct structural phases in relation to the second-century stone barrack, and such alterations as can be substantiated are better classified as occupational sub-phases. It should also be noted that excavation was not taken down to natural subsoil or even to the pre-fort ground surface, except in small sondages designed to expose the primary timber partition slots belonging to the stone barrack. Consequently it is not clear that the full surviving Roman sequence was examined everywhere, particularly in the officer's quarters.

Stone Phase 1 (Fig. 13.10)

If the evidence for a Period 1 timber barrack, described in Chapter 12, was extremely slender, the next phase (Building 3 Stone Phase 1) was clearly represented. It took the form of a long, rectangular barrack block with external stone walls. A range of *contubernia*, took up most of the building. Although the full length of this range was not uncovered, the spacing of the timber and wattle-and-daub partitions, which separated the *contubernia* one from another, would indicate that it comprised nine *contubernia*, as was the case with the other *praetentura* barracks. An officer's house occupied the east end of the block and was divided off from the rest of the building by a stone wall.

External walls

The construction details of the main external walls were similar to those in Building 1. A 26.8m length of the south wall (M07:05, N07:03, N08:18, P08:11) and 4.75m of the east wall (Q07:04, Q08:10) were exposed in 1983–4, although the south-east corner itself had been destroyed by a modern brick wall (P08:04, Q08:04). The walls were constructed with dressed sandstone facing stones, bonded with a clay and rubble core, and generally ranged in width between 0.55m and 0.75m, with two and even three courses of the south wall's masonry remaining in places. The south wall was observed to sit on rubble foundations (N07:24), set in a construction trench which extended c. 0.15–0.20m beyond the wall's northern edge. In the context database listing the description of the east wall contexts is qualified with the comment 'poss later rebuild?' but no evidence to substantiate this is offered, either on the actual context sheets or

the site plans, and the contexts are still assigned to Phase 1 in the database itself. A neatly constructed, stone-lined drain (Q07:15, Q08:18) ran alongside the east end of the block

The contubernia

The survival of three internal partition slots (M07:20, N07:19, 22) provided the clearest evidence for the *contubernia* of the Phase 1 stone barrack. The slots were c. 0.20m wide and had been backfilled with a mixture of dark clay, redeposited yellow clay and stone chippings. They separated the four easternmost *contubernia* of the block, being fairly evenly spaced along its length at intervals appropriate for the nine *contubernia* layout typical of the Wallsend barracks, giving *Contubernia* 1, 2 and 3 internal widths of 3.8m, 3.4m and 3.6m respectively. Curiously, all three slots appeared to terminate between 0.4m and 0.5m short of the south wall. They thus resembled the three partitions identified in the earlier Phase 1 levels of Building 1 (N05:49, P05:34, 48) which all terminated 0.20–0.40m to the south of the stone barrack's north wall and have been interpreted as forming part of an earlier timber barrack block. However the spacing of slots M07:20, N07:19 and N07:22 fitted into the stone barrack perfectly and there was no slot for a timber south wall in association with them so they are most plausibly assigned to the initial stone barrack phase rather than an earlier timber-built barrack. Two post settings (N07:20–21) were uncovered just 0.05–0.35m west of slot N07:22 and at the same level implying they might also belong to the initial occupation of the stone barrack. N07:21 was positioned next to the south wall foundations whilst N07:20 lay 1.25m north of that wall, both posts presumably performing some structural function within *Contubernium* 2.

The three partition slots were revealed in small sondages dug precisely to locate such features. The nature of the original floor surfaces which were associated with these partitions is unclear, however. A 'soil layer' (N07:15), otherwise undescribed, was identified beneath secondary flagging N07:14, and this might represent the original floor level, but equally it might have formed a bedding layer for the secondary flagged floor. This uncertainty is amplified by the paucity of stratigraphic relationships which were recorded, either with regard to the soil layer or the Phase 1 partition slots themselves. Indeed these relationships are limited to slot N07:22 reportedly cutting the 'natural', whilst N07:19 was *perhaps* abutted by flags N07:14 and underlying soil N07:15. In the latter case, however, there is some reason to believe that the slot remained in use after the secondary reflooring of the *contubernia* (see below) and this could account for the nature of the recorded relationship there.

PHASE 2

A secondary phase or sub-phase was marked by the laying of flagged flooring in the *contubernia*. This flagging survived quite extensively in *Contubernia* 2, 3 (N07:14) and 4 (M07:15). In *Contubernium* 1, a large 0.80m by 0.70m slab next to wall P07:23 and an adjoining line of seven small oblong flags (N07:18), totalling 2.00m in length, may represent the fragmentary remains of a similar flagged floor. The line of small flagstones was aligned east–west and lay some 1.65m from the south wall of the building and might also mark the edge of an internal partition, screen or other furnishing.

Flagging N07:14 appeared to respect the line of the slot separating *Contubernia* 2 and 3 (N07:19) suggesting that particular partition wall remained in use, but the other slots appeared to have been overlain at least partially by the flagged floors and may have been replaced at this stage. One of the replacement partitions was probably marked by post setting M07:21, located next to slot M07:20, but evident at a higher level, amidst flagging M07:15, and perhaps impinging upon the slot.

The centurion's quarters

The officer's house measured 10.20m in length internally, being separated from the remainder of the range by a 0.65m wide stone partition wall (P07:23) which was set on rubble foundations (P07:22), varying in width between 0.70m and 0.90m, and was bonded to the south wall of the barrack (P08:11).

Only in the south-west part of the officer's quarters, where investigation was perhaps most intensive, were levels identified which were attributed to the second-century barrack. An earth floor (P07:21, P08:31), described simply as the lowest earth floor in the barrack, was uncovered here and was 'abutted' or, more plausibly, overlain by a sporadic scatter of flagstones (P07:20). These comprised two larger slabs, 0.85–1.00m in length, and around 20 smaller flagstones. Despite its description, however, there is no indication that earth floor P07:21/P08:31 was removed to determine whether an earlier floor or a pre-fort level lay beneath. A post setting (P07:24) was located amongst the flagstones and cut the earth floor. It was revealed by two substantial upright packing stones, each c.0.35m in length, set at a right-angle to one another. The relationship of the post-hole and the flags was unclear, but both were regarded as belonging to a secondary phase of activity like the flagged floors in the *contubernia*.

East intervallum road

A neatly constructed stone drain (Q07:15, Q08:18) ran alongside the east wall of Building 3, perhaps a continuation of the drain investigated in more detail at the east end of Building 1 (Q05:03). Only a single course of side walling survived, or perhaps

sherds of pottery, but this included a rim sherd of a Nene Valley ware Castor box and body sherd of BB1 with obtuse angle lattice (Q07:15), indicating a date from the second quarter of the third century or later.

Phase 2, Contubernium 2 flagged floor

The floor (M07:15, N07:14) produced little pottery, with a Hadrianic Form 18/31 and a stamped Form 81 dated 125–50 (no. S17) plus a few sherds of second-century coarse wares.

The barracks in the west praetentura

Four buildings were uncovered to the west of the *via praetoria*. Three of these, which were assigned building numbers 4–6, were excavated in 1975–6 and were probably barrack blocks, although only the extreme north-west corner of Building 6 was revealed and it was reconstructed as such by analogy with the arrangements in the eastern half of the *praetentura*.

It should be noted that the preservation of deposits in the north-west part of the fort was significantly poorer than that encountered in Buildings 1 and 2 in the north-east *praetentura*. Indeed Buildings 4–6 were amongst the worst preserved in the entire fort, aside from those parts of the commanding officer's house damaged by the cellars of Simpson's Hotel.

Building 4

Grid squares: E4, F3, F4, G4, H4, J4, K4

Introduction

Building 4 was the most northerly building on the west side of the *Praetentura*. The building probably faced onto the north *intervallum* street (Road 4), with a rear alleyway (Alley 3), 1.50m wide, separating it from Building 5 to the south. The back lane of Winifred Gardens, connecting Carville Road and Leslie Gardens, was still functioning during the excavations and restricted the area available for investigation. The lane ran diagonally, from north-east to south-west, across the line of Building 4, preventing examination of virtually all of the officer's quarters at the west end, but avoiding most of the eastern end. On the north side of the lane, the north-west corner of the building was uncovered, along with adjacent stretches of the north and west *intervallum* roads and parts of the north-west defences, including the angle tower.

Two main phases or sub-phases of occupation were established. In both phases the building functioned as a barracks with an officer's quarters at the west end and the remainder of the building divided into nine *contubernia*. The phasing was based on structural alterations to the building, specifically the replacement of the partitions dividing the *contubernia*.

These alterations may reflect the changes which took place in Building 1 in Phase 1 Sub-Phase 2, but there was no way of demonstrating this. Very little of the *contubernia* floors survived in Building 4, and there was no real evidence of the kind of occupation and demolition material encountered in the floors of Building 1. In addition, certain features were identified in the eastern half of the building which did not appear compatible with its functioning as a barrack block. These might relate to a third structural phase, involving the building's adaption for another use.

A complicating factor in the analysis of this building is the possibility that a timber barrack preceded construction of the stone barrack block, as discussed in the preceding chapter. Most of the timber partition slots identified as belonging to Building 4 Phase 1 could quite comfortably be accommodated within the plan of the stone barrack block. However, a number of slots located towards the eastern end of the building did not conform to the expected pattern and could therefore conceivably relate to an earlier timber block, although it is difficult to discern a coherent pattern in the anomalous slots. Accordingly, the location of anomalous slots in relation to the other features of the stone barrack's *contubernia* is noted in this chapter.

Stone barrack – outer walls (Fig. 13.11)

The building measured 45.60m by 8.00m externally. The best surviving fragment of wall occurred at the north-west corner of the building, where both the north and west walls stood two courses high above an offset which projected outwards to the north and west (see Fig. 13.12). The wall measured 0.65m wide while the offset extended an additional 0.10m. It was constructed with squared, keyed blocks on average 0.12m high × 0.22m wide × 0.20m deep. The core consisted of small sandstone fragments and the bonding material was grey clay. This lay on a foundation of hard pink puddled clay 0.20m deep and 0.80m wide.

The north wall (F03:06, J04:08, K04:17) and foundation (F03:16) survived in fragments over a distance of 9.00m at the west end and 14.00m at the eastern end, the area in between lying under the modern lane.

Only 2.00m of the northern end of the west wall (F03:08) remained to the north of the lane. Forming the north-east corner with wall F03:06, a total of three courses still stood there (Fig. 13.12). The whole length of the east wall (K04:16) of Building 4 survived up to three courses high (Fig. 13.13). The north-east corner of the building was intact, with three courses remaining there, but the junction of the east and south walls had been damaged by post-Roman activity, so that only the inner corner survived.

Virtually all the line of the south wall could be traced, but of the actual wall masonry only small sporadic fragments remained. These were composed of two short, disturbed lengths of offset (F04:09, F04:21, K04:11) and two sections of wall standing one course high (G04:11, J04:07) above the south projecting offset (see Fig 13.14). The foundation (F04:06, G04:05, H04:03, J04:21, K04:24) marked most of the line of the wall in those areas where it had been robbed away. The junction with the west wall was lost under the modern lane.

One small alteration to the fabric of the building was noted, the addition of four squared sandstone blocks (K04:22) 0.18m × 0.30m, laid end to end on the offset of the north wall, butting up against the second course. The east end was one stone away from the north-east corner of the building and the total length of the alignment was 1.30m. The function of this feature was not definitely ascertained.

The contubernia (Figs 13.15, 13.16)

Construction material consisting of a deposit of yellow and orange sand and decayed sandstone (G04:35), including a small patch of sandstone flakes, was uncovered under the west side of *Contubernium* 1. This deposit lay to a depth of 0.05m over the natural. More material of this nature may have covered the remainder of the building, but there was insufficient time to excavate to this level in the other areas.

Over this level and covering the whole of the interior of the building was a layer, 0.20m deep, of greyish clay soil (G04:07, H04:07, J04:25, K04:20). In this were fragments of charcoal, sandstone and patches of coal. Whether this was simply levelling material or a clay floor surface proper, it was not possible to say. However, all of the partition slots which divided the *contubernia* cut through this material, which suggests that it was a make-up deposit put down by the builders before the floor surfaces were laid.

Contubernium 1

PHASE 1

A slot (G04:39) for a timber partition separated *Contubernia* 1 and 2. This was not clearly visible on the surface of the levelling deposit (G04:07), but was revealed in the section under the south side of the modern lane. It was a fairly shallow flat bottomed trench about 0.10m deep. The fill consisted of a homogenous mass of yellow clay. The trench was situated 3.80m from the east wall of the officer's block.

No floor levels survived in this *contubernium*.

PHASE 2

A slot (G04:32) for a new partition was dug 3.60m from the west wall of the room, cutting the west side of the original slot. The new trench had a much

steeper, bowl shaped profile. It measured 0.50m wide × 0.25m deep. The fill consisted of grit, especially at the level of the ground surface, yellow clay, orange sand and flecks of charcoal.

Contubernium 2

PHASE 1

Contubernia 2 and 3 were divided by a slot (G04:31) for a partition 3.40m from the line (G04:39) of the west wall of the room. Over 2.50m of the southern end of the slot was uncovered. This measured 0.45m wide × 0.15m deep and had a rounded, dish-shaped profile. The trench first appeared on the surface of the clay make-up (G04:07) as a smear of pink clay. Further investigations revealed a slot containing redeposited clay, grey loam and sixteen throwing stones or *ballista* balls (SF 458–473 – lost). The occurrence of *ballista* balls in the fill of partition slots was not uncommon on the site, but this was by far the largest number recovered from any one slot (Fig. 13.17).

In the surface of the levelling material in this area were six more throwing stones (SF 143, 399–401), three of which were inscribed with numerals. There had obviously been a large group of these over the west side of the room when the original partition had been removed and they had either rolled, or been pushed, into the open slot.

PHASE 2

The old partition was removed and replaced with a new one on almost the same line. The slot (G04:34) for this cut through the west side of the original partition slot (G04:31) and the clay make-up material (G04:07) to the natural. It was bowl-shaped and steep sided in profile and measured 0.30m wide × 0.30m deep. The fill consisted of light-grey soil containing small stones and fragments of coal. It was situated 3.30m from slot G04:32.

Fragments of a substantial, well laid, flagged floor (G04:22, 29) were uncovered lying directly over the levelling material and could represent either phase of the building. These flags measured up to 0.60m × 0.50m × 0.07m thick.

Contubernium 3

PHASE 1

The partition slot (H04:11) between *Contubernia* 3 and 4 was located 3.00m from the original partition slot of the west wall of the room (G04:31). As the west side of the slot had been cut away by the later slot, the width could only be estimated, but it must have been roughly 0.35m. The slot was shallow, only 0.13m deep with a dish-shaped profile. Over 3.40m of the south end of the trench was uncovered. The fill consisted of dark-grey clayey soil packed with coal and a few sandstone fragments.

An east–west aligned slot (H04:12), which was probably associated with a partition dividing the

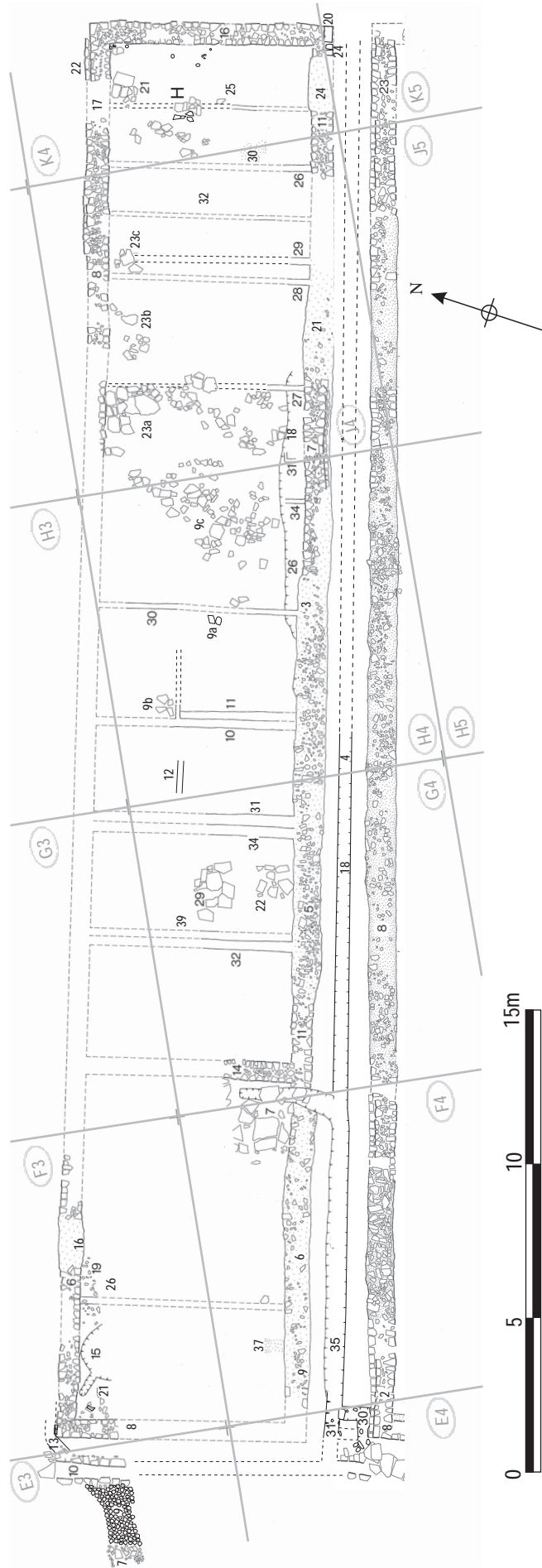

Figure 13.11: Building 4, all features. Scale 1:200.



Figure 13.12: The north-west corner of Building 4 showing the north and west walls surviving up to three courses high looking west.



Figure 13.13: The east end of Building 4, looking south. Note the survival of three courses at the NE corner in the foreground.

contubernium into two rooms, was uncovered for 1.40m in the centre of the room. It was situated 3.30m from the foundation of the south wall. It measured 0.20m wide × 0.10m deep. The fill was similar to that in the slot of the east partition. The two rooms defined by the partition were unequal sizes, with the front room (*arma*) to the north measuring only c. 2.50m (N-S) by 3.00m (E-W) internally, whilst the corresponding dimensions of the inner room (*papilio*) to the south were c. 3.60m by 3.00m.

PHASE 2

A new east wall partition was constructed. The slot (H04:10), as in *Contubernia* 1 and 2, cut the west side of the original trench. It had a steeply cut bowl-shaped profile and measured 0.25m wide × 0.20m deep. The fill consisted of grey-clayey soil with deposits of orange and yellow clay, and small fragments of stone and charcoal. It was situated 3.10m from the phase 2 slot of the west wall of the room.

Two small areas of flagging (H04:09a), possibly evidence of a laid floor, were uncovered over the



Figure 13.14: The south wall of Building 4 (right) showing the surviving stonework including the offset course, with the north wall of Building 5 to the left, looking west.

centre of the room. One area lay over the line of the earlier east-west room divider. The flags consisted of small fragments of worn stone up to 0.40m long × 0.08m thick.

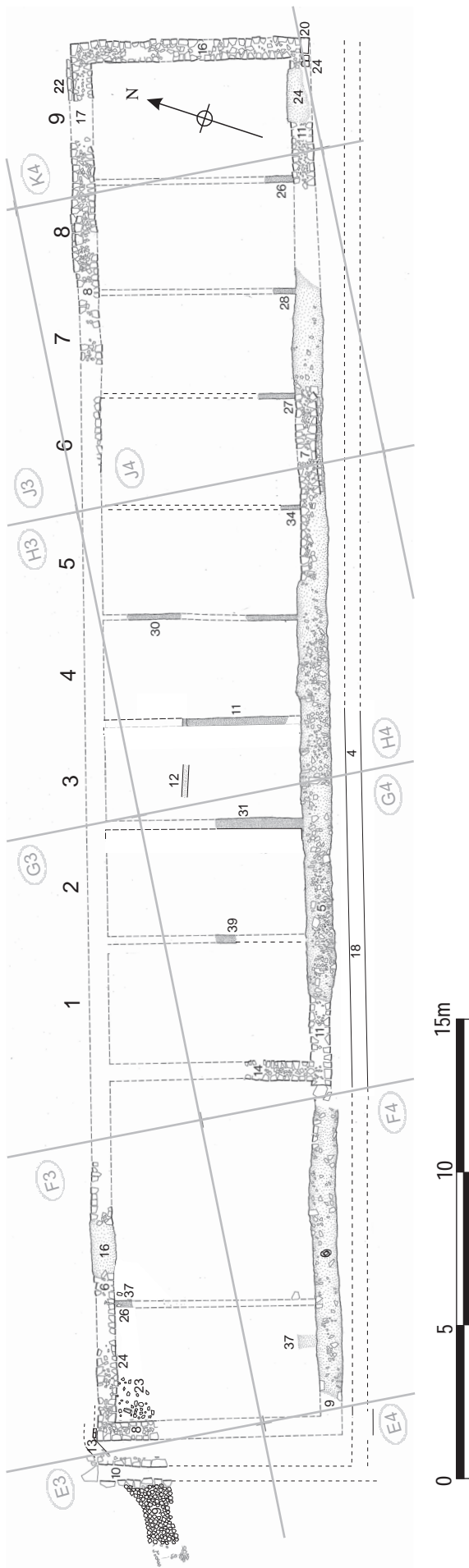

Figure 13.15: Building 4, Stone Phase 1 at 1:200.

Contubernium 4

PHASE 1

The partition slot between *Contubernia* 4 and 5 was not as convincing as the others in the building. Traces of the possible line of a slot were found in two places consisting of a smear of yellow clay (H04:30) up to 0.15m wide. These were 3.20m from the line of the original slot for the west wall. A section through the slot towards the north end of the room revealed only a poorly defined localised area of mottled clay.

PHASE 2

No replacement for the east wall slot was uncovered for this phase, but some small fragments of flagging (H04:09b) were found next to the partition slot for the west wall of the *contubernium* (H04:10) and overlying the line of the original partition slot (H04:11). The southern edge of the patch of flagging was marked by an east–west aligned slot which was connected to the secondary west wall and apparently cut through the line of the original west partition. The course of this east–west aligned partition was traced eastward for c. 0.50m and divided the *contubernium* into front and rear rooms, the front (north) room being the smaller, measuring 2.40m (N–S) by 3.40m (E–W) internally, whilst the corresponding internal dimensions of the southern room were c. 3.60m by 3.40m. These relative proportions were similar to those of the Phase 1 rooms in *Contubernium* 4. In the southern room another two small fragments of flagging (H04:09a) were noted on either side of the line of the east partition (H04:30).

Contubernium 5

PHASES 1 AND 2

The slot (H04:34) for the partition between *Contubernia* 5 and 6 was uncovered for 1.00m at the south end of the room, and was indicated by a clear line of pink and yellow clay on the surface of the levelling material (H04:07). This gave the *contubernium* a width of c. 3.40m. Partition trench H04:34 was not excavated, but the width of the clay together was recorded at 0.40m in the site notebook, suggesting it may have represented the line of two slots side by side. Site plan P62a, on the other hand, shows the main linear band of clay as no more than 0.10–0.15m wide, with a possible additional, very thin parallel strip to the east, giving the whole a width of no more than 0.25–0.30m. It is not clear which – plan or notebook context description – provides the more accurate record.

PHASE 3 ?

A large area of flagging (H04:09c) was found over the *contubernium*, but there was not sufficient time to examine it carefully. However, some of the flooring extended over the line of the partition(s) of the east wall of the room. Whether this represents merely an alteration to *Contubernium* 5, or a major change within the building as a whole, it is not possible to

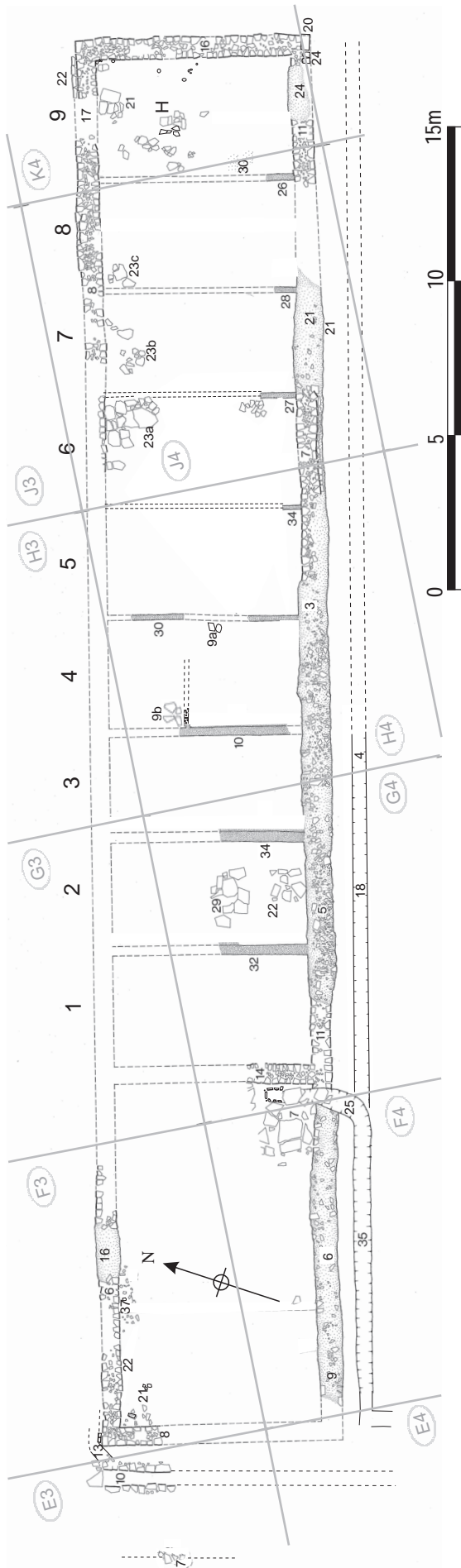

Figure 13.16: Building 4, Stone Phase 2 at 1:200.

say. The floor generally consisted of small fragments of flagging up to 0.55m long \times 0.07m deep.

Contubernium 6

At the southern end of the *Contubernium* 6 a 2.00m length of the slot for the east wall (J04:27) was uncovered giving the chamber a total width of 3.40m. This appeared as a smear of pink and yellow clay 0.15m wide. It was not excavated.

(For internal slot J04:31, uncovered c. 1.10m from west wall and 2.10m from the east wall of the *contubernium* and perhaps associated with an earlier barrack, see Chapter 12.)

Fragments of a flagstone surface (J04:23a) survived over parts of the room, especially at the north end, probably near the entrance. Again insufficient time meant the flooring could not be thoroughly investigated, but it could easily have represented more than one phase. All of the flagging on the east side of the room appeared to respect the estimated line of the east partition, projected from the length of exposed slot J04:27, apart from one small area midway along the slot's projected course. The flags consisted of large pieces of stone up to 0.75m \times 0.60m \times 0.08m thick. The floor over the northern part of the room was similar to the type of flagged surfaces encountered in much the same position, presumably near the entrances, of the *contubernia* of Building 1 in sub-phase 2.

Contubernium 7

Only 0.70m of the southern end of the slot (J04:28) between *Contubernia* 7 and 8 was uncovered. The *contubernium* measured 3.20m wide. It consisted of a line, 0.20m wide, of grit in grey clay with flecks of orange and grey soil.

There were only two small areas of flagging, one of them (J04:23a) to the west side, already noted, lying over the line of the west partition of the room. The other (J04:23b) occurred over the north of the room and was made up of small unconnected fragments.

Contubernium 8

The division between *Contubernia* 8 and 9 was not very clear. An area of a possible slot (J04:26) was revealed for 0.90m immediately north of the south wall foundation. This was not excavated and appeared only as a line, 0.25m wide, of amphora fragments and stone, possibly packing material.

(For slots J04:29 and J04:32 uncovered in anomalous positions in the interior of this *contubernium* and possibly associated with a preceding timber barrack see Chapter 12.)

Several small pieces of flagging (J04:23c) were found over the north-west corner of the room. These respected the estimated line of the west wall partition.

Contubernium 9

Using partition slot J04:26 as the west wall of the room,

Contubernium 9 measured 3.80m wide. A north–south slot (K04:25), located some 2.00m from the east wall of the building, may have been associated with an earlier timber barrack block rather representing an internal dividing partition in this stone barrack *contubernium* (see Chapter 12).

In the surface of the levelling material (K04:20) over this area of the building were seven *ballista* (SF 942a, b, c, 943, 944a, b, c). These may have been part of the surface with the flagged floor K04:21.

Overlying the levelling material and the line of the earlier internal partition K04:25 in the northern half of the *contubernium* was the remains of a flagged floor (K04:21). The larger fragments of flagging measured up to 0.70m long. Roughly in the centre of the room and on the same level as the flagging, was a squared brick and stone alignment 0.55m across, probably the remains of a hearth. This feature was located just far enough north to indicate it probably lay in the front room of the *contubernium*, perhaps set right up against the partition separating the two rooms. In the southern part of the *contubernium* an irregular patch of pink clay (J04:30), measuring roughly 0.80m by 1.30m, was revealed next to the west partition wall (J04:26) and perhaps represented the fragmentary remains of a floor surface.

Later (Phase 3?) features in the *contubernia*

CONTUBERNIA 4–7

A gully (H04:06, 26, J04:18) was traced in the area of *Contubernia* 4–7 alongside the inner face of the building's south wall. It was packed with rounded stones and pebbles, and extended over a distance of at least 8.50m, being cut away to the east by a north–south aligned band of post-Roman disturbance interpreted as a colliery era trackway (J04:13), so its full length could not be gauged. The gully's width varied considerably, reaching as much as 0.90m in *Contubernium* 6, but was generally around 0.50–0.60m and narrowed to some 0.40m to the west, in *Contubernium* 5 before petering out altogether just



Figure 13.17: *Ballista* balls filling partition slot G04:31 in Building 4 *Contubernium* 2

inside *Contubernium* 4. The feature was interpreted as a drain, similar to the internal drain which ran alongside the south wall of Building 1 during its third-century stable phase. This interpretation is not without its problems, however, and it is evaluated in greater detail below (p 000), along with the other suggested evidence for the third phase of Building 4.

The officer's quarters

The officer's quarters were separated from the other rooms in the barracks by a stone partition (G04:14), 0.65m wide. Internally the quarters measured 11.00m in length (E-W). Only the southern 2.10 m of the wall could be uncovered. It consisted, at its highest, of two or three courses of keyed stones, some of which had been removed by the insertion of a modern drain. The rubble core was composed of slightly larger stones than were used in the exterior walls of the building, measuring up to 0.15m long. The wall sat on a foundation of pink puddled clay (G04:33).

At the level of the first course the most southerly facers extended for half their length into the line of the north face of the south wall (G04:11) of the building, bonding the two walls together. The east face of the base course was partly composed of a line of six stones pitched on their sides, possibly evidence of alteration.

As the modern lane ran diagonally across the officer's quarters, only the north-west corner of the room and a narrow area across the south side were available for examination. The sequence of deposits in each area could not be related to the other, or to those in the *contubernia*.

North-west corner of the building (Figs 13.18, 13.19)

A large pit (F03:15), which perhaps functioned as a soakaway, had been dug right through to the natural in the north-east corner of the room during the later occupation of the officer's quarters. This removed a substantial amount of the stratigraphy in an area already limited by the modern lane and created problems in tracing the true extent of the floors. Most of the following description is taken from the section which lay under the north side of the lane (see Fig 13.18: section S49).

CONSTRUCTION

Cut into the natural (F03:35) were the construction trenches for the north and west walls. The trenches were on average 0.85m wide, just slightly wider than the foundations. The west wall trench (F03:33) appeared to have been backfilled first as the fill of dark grey-brown silt was cut across by slightly lighter fill of the north wall trench (F03:31). Also cut into natural was the north side of a roughly rectangular pit (F03:34). This measured 2.70m east–west and was on the same alignment as the building. The northern

lip of the pit slightly impinged on the southern edge of the construction trench and foundation clay for the north wall whilst its western edge was located 0.65m from the west wall trench. The full depth of the pit was not established. It had been backfilled with mixed yellow sand containing yellow and pink clay, grey silt and slight traces of charcoal. Only the first 0.08m of the fill was removed. The purpose of the pit was not ascertained, but it could have functioned as a slurry or clay-puddling pit, or even as a soakaway as it lay in the same position as a soakaway pit (F03:15) from a later period of occupation.

On site plan P72, which recorded the earliest levels excavated in this part of the building, a possible partition slot was shown cutting through the clay foundations of the building's north wall and the natural clay subsoil some 0.40m to the east of the rectangular pit. The slot was aligned north-south and was c. 0.10m wide. On its east side, a single upright stone (F03:37) perhaps served as a chocking stone.

A deposit of mottled grey and yellow silty clay (F03:25), up to 0.15m deep was laid over the room, covering the former soakaway pit and the construction trenches and foundations of the north and west walls. This was also most likely to have been constructional in purpose, probably representing levelling material. It lay up to the middle of the first course above the offset of the north wall. Cut into this were a succession of gulleys, possibly drainage channels. The earliest (F03:29) lay on a north-west south-east alignment, 1.20m from the inner face of the west wall. It measured 0.17m wide × 0.12m deep and the north end lay 0.03m south of the north wall. The fill consisted of pink clay and grey clayey silt with fragments of stone and charcoal. Another gully was dug further west (F03:24) on a north-east south-west alignment 2.10m from the west wall. Very little of it could be seen as the later soakaway pit (F03:15) had removed most of the east side. It measured 0.20m wide × 0.06m deep and contained a fill of yellowish-pinkish clay becoming silty towards the north end which occurred just short of the north wall. The third and much deeper gully (F03:28) lay immediately west of F03:24, on the same alignment and cut both the earlier gulleys. It sloped gently down from the north side, deepening towards the south. It measured 0.35m wide × 0.20 deep and in section the bottom was dish shaped. The fill consisted of fairly homogenous grey clay. The north end had a rounded appearance and lay 0.15m from the inner face of the north wall.

Over the levelling clay right in the north-west corner of the room was a small area of light yellowy-brown clay (F03:30), probably daub from the construction. It lay 0.03m deep against the first course of the north and west walls. The southern edge of the yellowy-brown clay was cut by an almost square post hole measuring 0.25m by 0.22m (F03:27). This was filled by a grey- and orange-flecked silt and a single facing

stone. The latter was described as 'beautifully cut with lines and tooling fairly clear'. It was wedged face up in one side of the post hole and presumably served as a packing stone, but it protruded up through through all the surviving overlying floor surfaces so may subsequently have performed some other function.

FIRST FLOOR SURFACE

A slot (F03:26) for a timber partition was dug 3.70m from the west wall. Only 0.35m of the north end was uncovered. It measured 0.15 × 0.10m deep and appeared as a strip of charcoal in a matrix of grey clay overlying bright yellow sand, probably crushed sandstone. This may have been a replacement for the possible earlier slot associated with the single upright stone (F03:37) found 0.10–0.15m to the east.

A compacted surface of small fragments of sandstone (F03:23) were found over the north-west corner of the room, overlying the clay material. This surface did not appear to extend as far east as the later soakaway pit (F03:15), but did cover clay patch F03:30, post hole F03:27 (apart from the protruding packing stone) and slots F03:28 and F03:29. It may represent a localised area of resurfacing.

SECOND FLOOR SURFACE

The whole of the north-west corner of the Quarters was covered with a layer forming either a new surface or, more probably, the makeup layer for a surface. This consisted of a deposit of yellowish-brown clayey silt (F03:22) containing fragments of stone and burnt daub, possibly the remnants of demolition material. It lay up to 0.11m deep, covering the former partition slot (F03:26), the resurfacing of sandstone fragments and the previous clay floor.

A floor surface of scattered small stones (F03:19, 21) was laid over the clayey silt. This surface was not very compacted but the floor did appear to have been deliberately laid. The surface was up to 0.12m deep and the stones measured on average 0.18 × 0.14m. It lay against the top of the first course above the offset of the north wall.

Over this floor was a substantial layer of occupational material (F03:18) up to 0.14m deep. It consisted of dark-grey clay silt, with a slight tinge of green and black and traces of orange and yellow streaking, and also contained a few small stones. The deposit lay up to the middle of the second course above the offset of the north wall. It was covered in turn by a layer of rubble interpreted as demolition debris (F03:10), which also extended northward (as F03:12) over the uppermost surviving *intervallum* road surface (F03:05). In the F03 site notebook it was suggested that a few small, flat stones (F03:17), covering an area no more than 0.75m square right in the north-west corner, might have been the remnants of a stone floor, overlying occupation layer F03:18. However, it was not sufficiently extensive to appear

as a distinct level in section S49 and was considered equally likely to have formed part of the overlying rubble.

THE SOAKAWAY PIT

A bowl shaped soakaway pit (F03:15) was dug through the occupation material and all of the floors and construction material below it to the natural. Only the top 0.60m of the pit was excavated. The area of the pit uncovered measured 1.80m in diameter but this was not the full extent as most of the pit lay under the section side. The west edge was situated 1.20m from the west wall and the north edge was cut immediately south of the north wall. A narrow round ended channel (F03:20) 0.20m wide ran into the pit from the north-west. It sloped down towards the pit where it became deeper, up to 0.25m. The fill consisted of two fairly distinct layers of material. Covering the sides of the pit and filling the channel was 0.13m of dirty-grey silt with a slight tinge of green plus orange or yellow streaks (F03:15.2), probably slippage from the occupational material (F03:18) and representing the period when the pit was open. Above the silt was up to 0.50m of stone and cobbles (F03:15.1), mostly 0.10m to 0.15m in size and fairly close together, but not tightly packed. The interstices were filled with iron-stained dark-grey and black loam. This material was indistinguishable from the demolition rubble (F03:10, 17) which lay over the pit and this part of the site generally, suggesting that the pit was dug while the building was still standing, if not necessarily occupied.

South-east corner of the officer's quarters

FIRST FLOOR SURFACE

Very little survived of the early floors over the south side of the officer's quarters. The stratigraphy here had been severely truncated, resulting in the exposure of the pre-fort ground surface of slightly clayey, olive green or grey loam (F04:08) across most of the area. This material was clearly cut by the cultivation furrows which predated the fort as well as later, barrack-period features. Only a relatively small part of this level (distinguished as F04:35), right in the south-east corner of the room, was sealed beneath a flagged floor (F04:07, G04:17), which the excavators interpreted as belonging to a secondary barrack phase. This was not fully investigated due to the shortage of time, but some flags were removed alongside the east wall of the officer's quarters (G04:14) to investigate the later latrine (F04:25 – see below). Although the underlying material context (F04:35) was recorded as equivalent to F04:08 the latrine site plan (P38) also shows a narrow strip of sandy soil with yellowish patches along the west side of the wall. This may have been equivalent to the 2m wide band of yellow and orange sand and decayed sandstone (G04:35) in *Contubernium* 1, on the other

side of wall G04:14, which was interpreted as a deposit of construction material.

Elsewhere, a tiny patch of the original floor (F04:37) 0.08m deep was found 2.00m from the estimated south-west corner of the building, immediately north of the south wall foundation. It consisted of dirty-yellow clay.

LATER FLOOR SURFACE

The room was re-surfaced with a flagged floor and a latrine inserted into the south-east corner (Fig. 13.20). The latrine (F04:25) consisted of a box-like structure, located 1.25m from the south wall (F04:21) and immediately west of the officer's quarters east wall (G04:14), plus a trench running from this, through the south wall and into the eaves drip trench (F04:33) along the centre of the alleyway. Both 'box' and trench had been cut through the former clay floor (F04:35). Three upright flags, 0.35m square, formed the east, north and west sides of the box, with the west side collapsed over the fill. Internally it measured 0.40m square. The trench measured 0.30m wide and varied in depth from 0.25m at the north end where it left the box to 0.40m immediately north of the south wall. Small stones were used to form the bottom but the sides do not appear to have been lined. Where the trench cut through the south wall it was considerably wider, measuring up to 0.55m at the point where it left the south wall and entered the alleyway between Buildings 4 and 5. The trench turns south-west to enter the eaves-drip which was obviously re-dug in the direction of the flow to the west of this. Here it was 0.34m deeper than the eaves drip to the east. The fill of the latrine consisted of grey gritty soil containing flagstones and several dressed stone blocks. This suggests that the latrine was probably still functioning until the end of the building when the flagged floor and the east wall of the officer's quarters collapsed into it.

The floor consisted of substantial, well laid flags (F04:07, G04:17) up to 0.75m × 0.60m in size and on average 0.07m thick. One of the flags still lay over the latrine trench immediately south of the stone box. The top of the box was roughly level with the bottom of the flags. Several flags had collapsed into the southern end of the latrine.

Drains relating to Building 4

No drains were uncovered north or east of the building. The north end of the drain (E03:10) immediately west of Building 4 was uncovered for 2.50m before it disappeared under the modern lane, being exposed in a small trench cut across the west *intervallum* road next to the north-west corner of the building. It was composed of three courses of neatly dressed sandstone blocks of various size, but on the whole they were slightly larger than those used for the walls

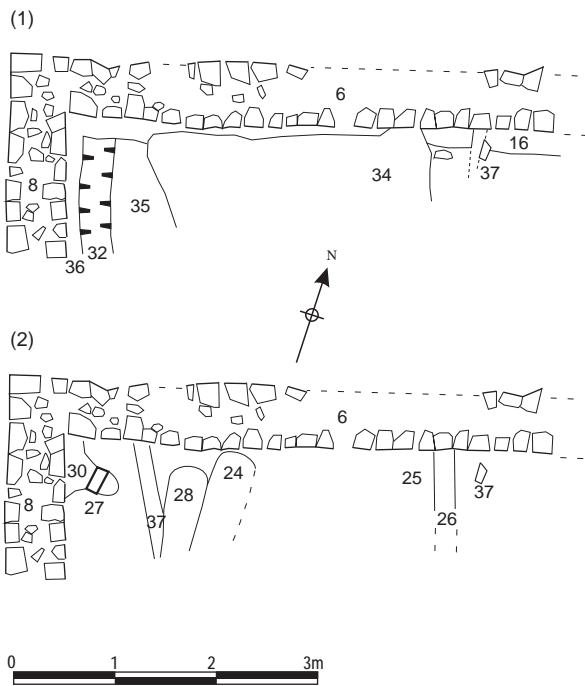

Figure 9 The north west corner of Building 4 sub wing 1 The earliest features cut into natural clay subsoil including cultivation furrow including leveling deposits at

of the building. The channel measured 0.40m wide × 0.40m deep. There was no reason to assume that this was not the full original size and the level of the corresponding street (E03:09) suggested it was intact except for the covering slabs. The street surface sat directly over the pre-fort ground level of grey clay silt (E03:15) and a cultivation furrow (E03:16). The metalling contained some large cobbles and stones and had a brown-red colouration overall. It was well-packed and noticeably worn. At the very north end on the western side, the drain subsided dramatically into an underlying feature. There was not sufficient time to investigate this. There were foundation trenches (E03:11) for both sides of the channel. That for the east side was much more substantial, measuring up to 0.30m at the widest point. The fill was a mixture of yellow and pink clay and small stones. On the bottom of the drain were deposits (E03:12) of light green silt and of orangey gravel, the latter being left in situ.

Between the foundation trench for the drain and the west wall of Building 4 was a gap 0.33m wide covered with greenish silt (E03:14).

Curving around the north-west corner of Building 4 was a gully (E03:13) 0.35m wide which entered the east side of the west drain at the level of the top course where two stones had been removed. Apparently this was a drainage channel, probably for directing water from the roof into the drain.

During Period 2 of the Fort, while Building 4 was still functioning, the drain was abandoned, parts of

it demolished and the channel packed with the side stones. The new west-intervallum road surface (E03:08) was laid over the top of this. This consisted of small to medium-sized cobbles, not as well packed as the earlier street surface and showing only a moderate amount of wear. The metalling was c. 0.10m thick and the carriageway was 3.10m wide.

FINDS

Phase 1 make up material

Decorated samian: 125–145 (no. D71, H04:07)

Samian stamp: 75–100 (no. S103, H04:07)

Amphora stamp: middle second century (no. 5, G04:07)

Graffito: (no. 67, G04:07)

Copper alloy: enamelled mount (no. 223, J04:25), loop (no. 343, G04:07)

Stone: throwing stones (nos 7, 18, 19, 23, all flagging K04:21)

Centurion's quarters Phase 2 NW room

Copper alloy: loop (no. 348, F03:22)

Centurion's quarters Phase 2 SE room

Architectural stone: flagstone with image of figure (no. 4, F04:07)

Iron: paring chisel (no. 24, F04:25)

For F04:33 see under Alley 3

Phase 3 gully

Stone: throwing stone (no. 57, J04:18)

Dating evidence

Phase 1 foundations

The construction trench for the north wall (F03:31) contained 0.119kg of coarse wares, all but 0.003kg of which was BB2 or allied fabrics. There were two sherds of samian, one of which was Hadrianic or Antonine, and the other one Antonine. The foundations of the south wall (G04:05) contained a single sherd from a late Antonine Form 45(?).

Phase 1 make-up layers

G04:07 contained an amphora stamp dated to the middle of the second century (no. 5). The make up layers (H04:07, J04:25) in general contained pottery which could be mid-second in date, with only a few later pieces, such as a sherd of Nene Valley ware and one from a BB2 cooking pot. The six sherds of samian included three of Hadrianic or Antonine date.

Phase 1 officer's quarters

The ground surface (F04:08) under the south-east corner of the officer's quarters produced only two pieces of pottery, one of which was a sherd of a BB2 bowl or dish (but see also F04:35 below). The compacted sandstone surface (F03:23), overlying the

silty clay levelling deposit (F03:25) in the north-west corner of the officer's quarters, contained more BB2, but the overall quantity was small.

Phase 1 contubernia

The partitions associated with *Contubernia* 2 and 3 (G04:31, H04:12) produced only two sherds of residual pottery, the flange of a Trajanic-Hadrianic local mortarium and a sherd of Trajanic or early Hadrianic samian.

The anomalously positioned north-south slot in the centre of *Contubernium* 9 (K04:25) contained the greater part of a decorated Form 37 Central Gaulish samian bowl (D90), dated to c. 125–140, which had been repaired with lead rivets, and a sherd from a second possibly Antonine, Form 37.

Phase 2 officer's quarters

The flagged floor in the south-east corner produced only two sherds of BB1 and one sherd of an Antonine Form 37 samian bowl (F04:07). The BB1 joins sherds in the latrine (F04:25), which also included some BB2 and a sherd of a Hadrianic or Antonine Ebor red-painted bowl. However the clayey loam (F04:35) sealed beneath the flags – equivalent to F04:08 elsewhere in the south-east corner (see above – Phase 1 officer's quarters) – yielded sherds from at least four BB2 vessels, including rounded-rimmed bowls or dishes.

The clayey-silt makeup (?) deposit (F03:22) overlying the earlier compacted sandstone floor surface (F03:23) in the north-west corner of the officer's quarters contained a higher proportion of BB2, but the overall quantity was small. The final layer of occupational material (F03:18) in the north-west corner yielded almost exclusively BB2 and allied fabrics, with only a few sherds of other pottery.

Phase 3?: the soakaway and internal gully (Contubernia 4–7)

The rubble and loam fill (H04:06, J04:18) of the drain or gully (H04:26) along the inside of the south wall produced only a few sherds of pottery, most of which was BB2.

The soakaway (F03:15) in the north-west corner of the officer's quarters contained a sherd of Nene Valley ware, and a body sherd of late third- or fourth-century Crambeck mortarium, which is presumably contamination.

Discussion

The date of the stone barrack's construction

The dating evidence from Building 4, outlined above, is rather contradictory and the picture is further complicated by the possibility that some of the features might conceivably have belonged to a timber barrack preceding the stone one, as discussed in Chapter 12. The material from the wall

foundations contained a high proportion of BB2 and allied fabrics which would normally imply a third-century date, and is unlikely to be earlier than late second-century. The bulk of this material derived from a single context – the construction trench for the north wall of the officer's quarters (F03:31). This trench was clearly overlain by the levelling deposits, makeup and floor levels in the north-west corner of the building, implying that all the Roman activity recognised in that part of the building must have been later in date. If the pottery in the construction trench does accurately reflect the date when the stone barrack was first erected this would imply the building was only occupied for a relatively short period since the three barracks in the west *praetentura* appear to have been replaced by two new blocks, which occupied different footprints, probably at some stage in the first half of the third century. However, the pottery from other Building 4 Phase 1 deposits and features points to the barrack being constructed significantly earlier. Thus the material in the greyish clay makeup deposits covering the interior of the *contubernia* would be consistent with a mid-second-century date, with only single possibly intrusive sherds of BB2 and third-century Nene Valley ware, whilst the few vessels associated with the various early partitions could even form a Hadrianic assemblage, although the fact that these partitions apparently cut the makeup deposits ought to signify that this pottery was residual.

The contradictory dates of these assemblages can be reconciled if the pottery attributed to the trench is interpreted as intrusive material, found at the interface between the trench and the much later soakaway pit (F03:15), which certainly cut into the construction trench. The F03:31 assemblage would then reflect the date when the pit was dug or perhaps when the final occupation layer was deposited, rather than when the backfilling of the construction trench occurred. It is noteworthy that the final occupation material (F03:18) in the north-west corner, which also spilled down the

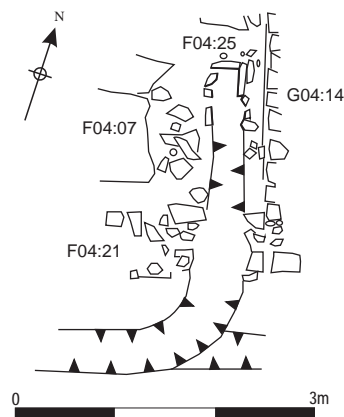

Fig. 10 Plan of latrine F04:25 in the south east corner of the Building 4 officer's quarters. Scale 1:75.

sides of the pit, yielded a pottery assemblage which was very similar to that from the construction trench, being composed almost exclusively BB2 and allied fabrics, with only a few other sherds.

The only other pottery associated with the external walls – the single sherd of late Antonine samian from the south wall foundations (G04:05) – is not sufficient on its own to date the construction of Building 4 and might conceivably also be intrusive since the clay foundation deposits were exposed only where the overlying wall masonry had been robbed out. This would mean the most reliable date for the initial construction of the building would be that provided by the *contubernia* makeup soil (G04:07, H04:07, J04:25, K04:20). The records in the site notebooks suggest this was a complex deposit. It was not fully investigated or removed, although small sondages were dug into it in places to try to expose partition slots in section. Deposits G04:07 and J04:25 were said to be cut by the foundation trenches for the south wall (G04:05, J04:21), which would imply it was laid before the walls were constructed, whilst K04:20 on the other hand was recorded as abutting the external walls (K04:11, 16, 17) and in the context entry for J04:25 it was noted that ‘some of 25 must in fact overlie 21’, but this appears to have been a deductive inference rather than a direct observation.

The suggested Phase 3 features

Building 4 contained two late features the function of which was not clearly apparent within the context of a barrack block. In the north-west corner of the officer’s quarters a bowl-shaped pit (F03:15), with associated narrow channel (F03:20), was tentatively interpreted as a soakaway. A stone-packed gully (H04:06, 26, J04:18) was also traced in the area of *Contubernia* 4–7, extending for at least 8.50m along the inner face of the building’s south wall. To the east this feature was cut by extensive post-Roman disturbance, so its full length could not be gauged, but to the west the gully simply petered out just inside *Contubernium* 4. This gully it was tentatively interpreted as a drain, perhaps comparable with the internal drain alongside the south wall of Stable Building 1, since it extended through several *contubernia* and did not respect the limits of any individual *contubernium*. The possibility that the gully and soakaway might together constitute a distinct, third phase of Building 4 was hinted at in the research archive, but no clear interpretation of the building’s function in that putative phase was offered. It is clear, however, that H04:06/26/J04:18 could not have functioned in conjunction with the central *contubernia* if it did represent a drain.

One possible explanation is that the block was converted into a stable, like Building 1. This might conceivably have been a relatively short-lived episode towards the end of the life of Building 4, providing stable accommodation in this part of the fort, perhaps

directly preceding the reconstruction of Building 1 as a fully functioning stable in the third century, at which point 4 presumably became redundant and was demolished along with Buildings 5 and 6 to be replaced by two new barrack blocks. The spreads of flagging in *Contubernia* 5 and 6 (H04:09c, J04:23a), which apparently overlay the partitions separating *Contubernia* 5, 6 and 7, could conceivably have formed the floor of the converted building, although there was no other intrinsic difference between this flagging and that assigned to the Phase 2 *contubernia* to the east and west (e.g. H04:09a-b, J04:23b-c). The suggested soakaway pit might likewise have potentially played some role in a stable.

On balance, however, the evidence regarding these features was too uncertain for this hypothesis to be treated with anything other than the greatest caution. Gully H04:06/26/J04:18 was not altogether convincing as a drain. It did not appear to run the full length of building, instead petering out in *Contubernium* 4. Nor was there any indication of a drain outlet either passing through the east wall of the building (as was noted in the case of Building 1) or through the wall separating the *contubernia* and officer’s quarters, and there was no trace of stone lining along the north side of the feature at any point along its length, again in direct contrast to the drain in Building 1. Indeed the gully could be a much later feature. It was cut down from mixed loamy rubble spread (H04:19, J04:05) overlying the building interior, which represented the disturbance at the interface between the surviving stratified Roman levels and the heavy clay post-Roman ploughsoil (H04:01.3, J04:03) directly above. The rubble disturbance was recorded as overlying the gully’s fill, but the latter was evidently very similar in its composition, though stated to be more closely packed, and it is not clear that the two should really be distinguished, that is to say H04:06/26/J04:18 might simply represent that part of H04:19/J04:05 which filled the gully-like depression along the inner face of the south wall. It might simply represent a later intrusion, of indeterminate function, into the Building 4 levels. Similarly the so-called soakaway pit might in fact have been a clay quarry pit, cut into the north-west corner of 4 after the latter had been abandoned, with the aim of providing bonding material for the pair of third-century barracks to the south. In this case the suggested third phase of the stone building could be discarded altogether.

Building 5

Grid squares: E4, E5, F4, F5, G4, G5, H4, H5, J5, K5

Introduction

Much of the *contubernium* area of Building 5 had been completely destroyed by a colliery trackway which

passed across the structure from north-west to south-east. Nevertheless a structural sequence not dissimilar to that of Building 4 could be established, with the *contubernia* being floored with stone flags in Phase 2. Some of these flags were obvious, others looked reused and random. The end of Phase 2 was marked by the demolition of the barrack and its replacement by a somewhat larger barrack block (17) with stone-walled internal partitions. This occupied a more northerly footprint than Building 5 and incorporated the north wall of the earlier barrack as its medial wall.

Stone barrack – outer walls (Figs 13.21–13.23)

The overall external measurements of the building were 44.9m by 7.5m, fragments of the wall surviving in places on the northern side and in the north-east and north-west corners. An offset of 0.15m was employed, most noticeably at the north-west corner. Elsewhere, the line of the wall could be followed with the help of the clay foundations. The wall varied between 0.55m and 0.75m in width where it survived, and was constructed of sandstone blocks with a rubble core. It was founded upon grey clay containing pitched stones (at about 45 degrees).

The north wall was 0.65m wide at the western end (E04:08) with an offset to the north. It was constructed on pitched (from west to east) stone foundations 0.8m wide set in grey clay (F04:17). The wall itself only survived in the north-east (2.75m) and north-west (2m) corners of the officer's quarters, and at the north-eastern end of the building (K05:23 – 5.5m).

The south wall was the most poorly preserved of all the main exterior walls of Building 5, with only foundations present for most of its excavated length. Near the south-west corner, four stones (E05:14) of the inner (northern) face of the wall were found, but elsewhere there were only the grey clay and stone foundations (E05:23, F05:20, G05:21, G05:10, H05:08), c.0.9m wide. Some but by no means all of the stone in these foundations was pitched (from east to west).

The northernmost 2.5m of the east wall (K05:19) survived, but the remainder had been robbed away. The west wall (E04:09) was only preserved at the north-western corner of the building. It was 0.65m wide and the surviving section only 1.5m long from the corner of the structure. The wall was set on the western side of its 1m wide grey clay and stone foundations (E04:22), even projecting beyond them in places.

The contubernia (Fig. 13.24)

The barrack can be restored as having a total of nine *contubernia*, mirroring Building 4, as might be expected. Again, the *contubernia* were delineated by timber partitions, surviving as slots, whilst the officer's quarters were demarcated by a stone wall.

All of the *contubernia* measured 6m internally from front to rear, with a distance of 3m to 3.5m between the main north–south oriented partitions. The east–west oriented partition in *Contubernium* 1 suggests that the internal dimensions of the *arma* and *papilio* were 2.25m × 3–3.5m and 3m × 3–3.5m respectively.

Contubernium 1

PHASE 1

Only the north–south slot (G05:27a) survives from the first phase of this part of the building and this was 0.4m wide, 0.1m deep, and traced for a length of 1.75m.

PHASE 2

In this second phase, a replacement north–south partition (G05:27b) was identified, slightly to the east of the primary example. The north–south partition was 0.23m wide, 0.15m deep, but could only be followed for 1.75m. An east–west slot (G05:29) was also identified and attributed to this phase by the excavators. It was mainly defined as a line of stone on the surface (and did not show up clearly in section), and survived for 1.75m of its probable 3m length. It should, however, be noted that this slot continued the same line as the Phase 1 partition in the officer's quarters immediately to the west (see Chapter 12 for further discussion of the potential significance of this slot relation to the evidence for a timber barrack block).

A floor surface (G05:11a) was also identified within the *contubernium* to the south of the east–west partition, consisting of irregular building stone and small flags. This was overlain by a patch of charcoal, grey soil and upright stones (G05:26), which may have filled a depression or a cut through the stone floor, but the record is not clear.

In the north-east part of the *contubernium* a sub-circular stone-lined cist or box (G04:28) was revealed, set into the floor against the secondary north–south partition. It measured 0.60m in diameter, internally, and was 0.30m deep, being filled by dark grey soil containing charcoal and many small stones overlying a shallower layer of light grey-green sticky soil. The stones lining the pit were upright or pitched at a sloping angle. Its function and even its attribution to the Roman period is uncertain (see below for further discussion).

Contubernium 2

PHASE 1

A short length of the north–south partition between *Contubernia* 2 and 3 (G05:32) was found and this was 0.7m wide. Upright stones positioned adjacent to the partition marked the location of a hearth (G05:31), which was associated with patches of burnt clay and coal (G05:35). A second north–south partition slot

(G05:34) was located 1.15m west of that separating *Contubernium* 2 from 3. This may have screened off an entrance corridor leading from a doorway positioned in the south wall to the east side of the *contubernium* facade, following the common pattern, recognised at neighbouring South Shields, for example (cf. Hodgson and Bidwell 2004, 137–9 for discussion of these features).

PHASE 2

A similar surface (G05:11b) to that found in *Contubernium* 1 was identified and a further section of flagging (G04:40) was noted in the north-west corner of the *contubernium*. Another stone-lined box (G05:25), also of uncertain function and date, was set into the floor in this *contubernium*. The cist was oval in plan, measuring 0.60m × 0.80m, with a maximum depth of c. 0.30m, and contained fill deposits similar to those in G04:28 – a medium-dark grey soil over a thin layer of grey-green clayey soil which was streaked with yellow clay and lined the bottom and sides of the box. It was situated on the west side of the *contubernium*, roughly midway between the north and south walls.

Contubernium 3

A similar surface to that noted in *Contubernia* 1 and 2 was found in this *contubernium* (G05:11c). This probably belonged to the second phase of this building. It overlay a spread of charcoal (G05:23) and a depression (G05:30) cut into the natural.

Contubernium 4

Within *Contubernium* 4, a pocket of small flags (H05:07) 1.0m by 0.5m were all that remained of the flooring within this area. This likewise probably belonged to the second phase of this building.

Contubernium 7

Sandstone flagging (J05:27) occurred in patches within the area of this *contubernium* which may represent the second phase of flooring within the building. There are hints of an underlying stone surface (J05:23) which may be the first floor. A pivot stone was noted amongst flagging J05:27 and may have been *in situ* since it was located midway between the north and south walls of the *contubernium* only c. 0.80m from the estimated position of its west partition wall. The pivot was perhaps associated with a doorway in the medial partition between the north and south rooms located in the usual position over to one side of the *contubernium*.

The stone boxes (Figs 13.25, 13.26)

The date and function of the two stone-lined boxes or pits uncovered in *Contubernia* 1 and 2 was uncertain. Various comments in the site notebooks suggest the excavators were divided as to whether these were

Roman or colliery period features, with the latter viewpoint perhaps gaining most support. Similar features, which were clearly Roman in date, but much more rectangular and box-like in form, were discovered in *Contubernia* 4 and 8 of Building XIII at Housesteads (see Rushworth 2009, 86–9). On the other hand, a demonstrably recent parallel can be found at Wallsend itself, in the shape of L05:21, a stone-lined pit set in a larger oblong pit (L05:27) towards the western end of Building 2. This was probably nineteenth-century in date, the larger pit having been floored with a wooden plank and probably lined with pantiles before being reduced in size and lined with stone. The fills contained much pantile, plus wood, clay pipe fragments and post-medieval pottery. No obviously modern material of this kind was recorded in the fills of G04:28 and G05:25, however. Indeed the Roman pottery assemblages in the fill deposits – particularly that from G04:28 which produced a fair quantity of material – appear to be coherent late second/third-century groups which could perhaps reflect backfilling of the pits when Barrack 5 was demolished, along with 4 and 6, in the earlier part of the third century. However their composition might also be compatible with the occupation of Building 17, one of the Period 3 barracks which replaced Building 5.

If the character of the pit fills is convincing with regard to a Roman date, the positioning of the oval boxes raises more serious reservations. They were located only 1.20m apart on either side of the partition slot separating *Contubernia* 1 and 2 (G05:27). Indeed G04:28 would appear to impinge on the line of one phase of the slot, though perhaps not the other phase. Moreover the two boxes did not occupy directly corresponding positions within the *contubernia*. Whereas G04:28 can only have been situated the rear room of *Contubernium* 1, G05:25 was located further south and could conceivably have lain in the front room of *Contubernium* 2, notwithstanding the uncertainty regarding the positioning of the partition separating the two rooms here. The close proximity of the stone-lined boxes, their apparent lack of correspondance with regard to the likely internal arrangements of *Contubernia* 1 and 2, plus the absence of equivalent features from any other *contubernia* supports, though it does not prove, the idea that these may have been later features, which either belonged to the subsequent Period 3 barracks or were post-Roman in date and intruded down into the Roman levels. Certainly the boxes cut down from the very top of the sequence of stratified Roman levels – albeit a sequence that was severely truncated – and were reportedly overlain only by an extensive spread of disturbed rubble (G04:16, G05:17), forming the interface of disturbance at the bottom of the post-Roman plough soil. Moreover comments in the site notebooks make it clear that the excavators were not even sure whether

the boxes actually underlay the rubble level – which they believed formed the disturbed remnants of a late Roman cobbled surface – or cut through it as well, adding yet further uncertainty to the interpretation and dating of these features.

Officer's quarters

Phase 1

The officer's quarters were separated from *Contubernium* 1 by a north–south stone partition. The wall itself did not survive, but the foundations of light grey clay and pitched stone (F04:31, G04:27, F05:26, G05:24) remained. This was about 0.85m wide and produced an internal area of 6m by 10.75m for the officer's quarters.

Two rooms were defined to the south by an east–west timber partition, indicated by a slot (E04:27, F04:37, F05:59), c.0.30m wide, filled with clay and sand, together with a north–south slot (F05:58) 0.30m wide. Together, the two rooms thus formed measured 6.5m × 2m (south–west room) and 4m × 2m (south–east room). Another east–west partition slot (E04:25), which was situated 0.70m south of and parallel to slot E04:27, may have defined a narrow corridor leading to a doorway in the west wall of the building. Only 1.20m of this second slot were traced. In the north–east corner of the officer's quarters, a small room, measuring 2m × 1.9m, was apparently partitioned off by two further slots running north–south (F04:45) and east–west (F04:28).

A 0.02–0.03m thick spread of pink clay (E04:20, F04:24), containing patches of mortar, daub and charcoal, covered an area extending some 3m (E–W) by 2m (N–S) in the north–west corner of the officer's quarters. The excavators suggested this layer represented daub resulting from the demolition of the building at the end of Phase 2. However the clay was described as puddled and the description appears more consistent with a clay floor level or a makeup layer. It directly overlay the grey clayey loam (E04:26, E05:26, F04:22, F05:31, G04:20, G05:23) which formed the pre-fort ploughsoil.

Phase 2

The main feature attributed by the excavators to the second phase of the officer's quarters was a large, irregularly-shaped, sub-oval pit (F04:32, F05:36), which was interpreted as a latrine. Staining of the natural was noted. The pit was 0.4m deep and 3m (north–south) by c.3.5m (east–west). The fill included small stones, charcoal, and coal. A channel (F04:05) c.0.6m wide by 0.2m and covered by three flagstones appeared to lead southwards (and downhill) into the pit from the eavesdrip between Buildings 4 and 5, although logically this would make more sense as a drain from the pit into the external east–west channel

The internal flooring of this phase is represented by a patch of flagging (F05:60) measuring 1m by 0.75m. The function of a large stone block (F05:56), 0.25m square and pierced by a 10cm hole, which overlay the surface is unclear.

Discussion

The irregularly-shaped pit in the officer's quarters (F04:32/F05:36) is a puzzling feature for which it is difficult to provide a satisfactory explanation. It was initially regarded as a latrine pit and then as a water storage feature, as it was noted that the bottom of the pit was well below the level of the channel (F04:05) leading to it from the north, which ought therefore to represent a conduit supplying water to the pit rather than a drain discharging effluent from it. However, the large size of the pit and its highly irregular form combined with the lack of evidence for any kind of lining seem to militate against either interpretation. In its extant form it would have taken up a substantial portion of the officer's house and, because of its irregular shape, would appear to have rendered an even larger area unusable. It is conceivable that the pit was originally more regular and perhaps slightly smaller, with its final shape being a result of robbing which had removed all trace of a stone lining, but if so the robbers displayed unusual thoroughness in removing all traces of the stone revetting.

Such difficulties would be resolved if the two components – the pit and the channel – are divorced from one another and no longer regarded as part of a same structural feature. Channel F04:05 occupied a position broadly corresponding to that of the box-like latrine in the south–east corner of Building 4, which was clearly not associated with a pit, and it may likewise have represented a latrine feeding into the gully in the alley between the two buildings. The channel clearly extended as far as the pit but that need not mean that the two were associated. The southern end of the channel could merely have been clipped or truncated by the pit at a later stage, after the latrine had gone out of use, giving the excavators the false impression that the two were connected. The irregular pit may simply have served as a quarry, providing clay for the construction of the buildings which replaced Barracks 4, 5 and 6 in this part of the fort, and might be analogous to pit F03:15 in the north–west corner of Building 4, which was similarly one of the latest features in the stratigraphic sequence there, potentially postdating the life of the building itself. After digging the pit may conceivably have lain open for some time and collected water (giving rise to the staining of the natural and the slight undercutting of the lips of the pit noted by the excavators) before backfilling to allow construction of Building 17 over the top.

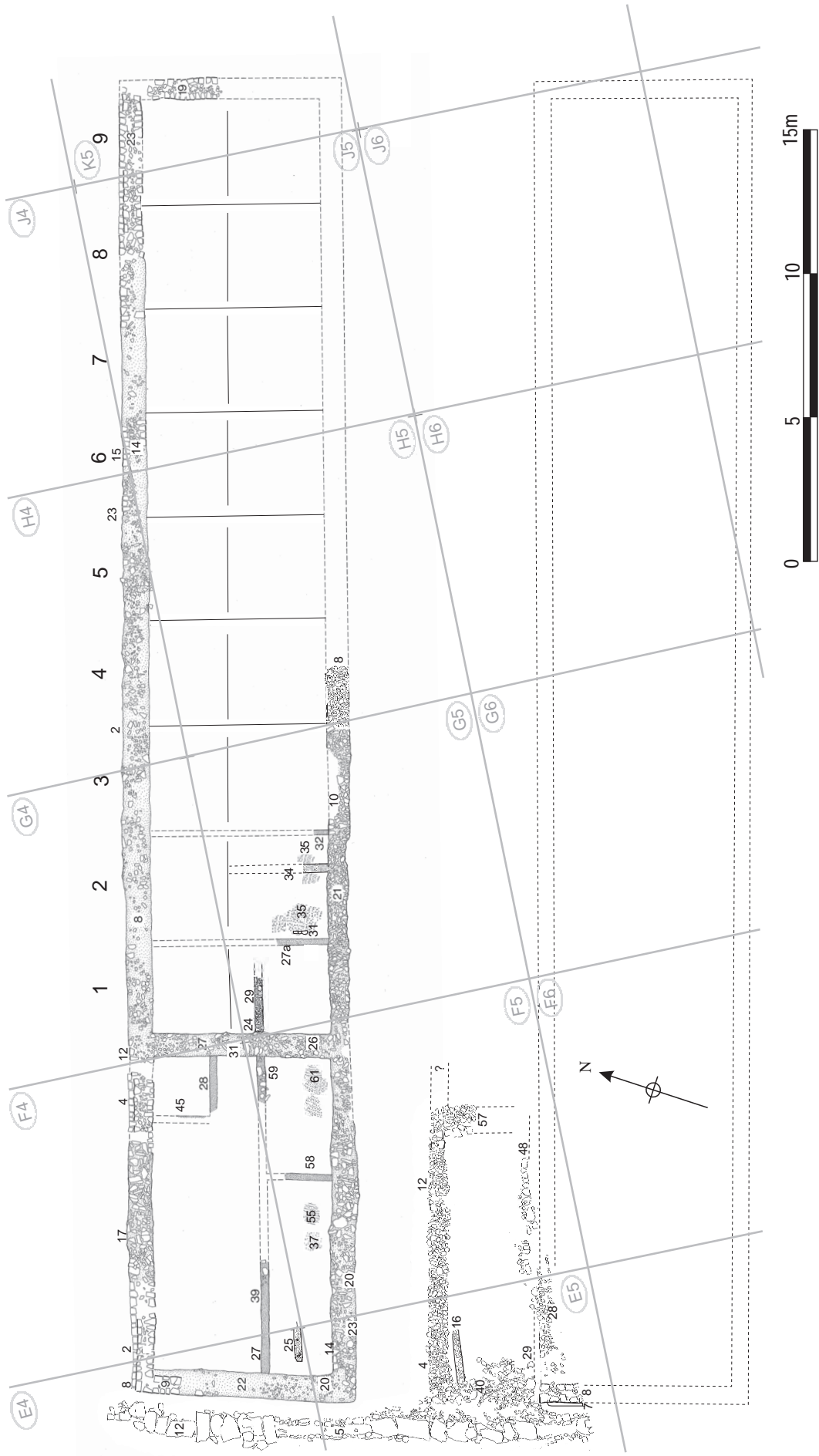

Figure 13.21: Buildings 5 and 6, Phase 1, all features. Scale 1:200



Figure 13.22: 1975 excavation Site 2 looking west mainly showing the west end of Building 5 – foundations and wall footing of Stone Phase 1 (Period 2). Fragments of the third-century barrack phase can be seen surviving over the former street to the south (left).



Figure 3 West end of Building 5 with the stone-capped intervallum street drain in the foreground and the north-west corner of the building visible behind.

FINDS

Building 5

Ground level below building (grey clayey soil)

Decorated samian: 125–145 (no. D6, F05:31)

Iron: spearhead (no. 4, G04:20), bell (no. 38, G04:20)

Lead: sheet (no. 18, G05:23)

Bone: pierced (no. 56, G05:23)

Quern: (no. 47, G05:23)

Ground surface between intervallum drain and Building 5:

Stone: whetstone (no. 22, E04:23)

Slot beneath Phase 1 officer's quarters

Iron: lift key (no. 29, E04:25)

Phase 1 intervallum road drain construction trench

Copper alloy: brooch (no. 9, E05:22)

Intervallum drain fill (beneath cover slabs E05:05)

Copper alloy: pin (no. 118, E05:38)

Bone: bobbin (no. 33, E05:38)

Contubernium 2 – stone-lined box (possibly post-Roman)

Decorated samian: 150–80 (no. D55, G05:25)

Dating evidence

Phase 1 wall foundations

The largest group of pottery, from the foundations of the north wall (G04:08), was contaminated with post-medieval material. The foundations of the south wall (G05:10, 21) produced ten sherds of samian, but only one small scrap of coarse ware. There were two Form 33s, a Form 31, a bowl and a scrap all dating to the Antonine period.

Phase 1 walls

The north wall (F04:02) was contaminated with later material, including a late fourth-century Huntcliff-type rim.

Phase 1 intervallum drain

The covered section (E05:38) of intervallum drain E05:05 produced sherds of BB2, a sherd from an Antonine Form 37, and one sherd of black sand amphora of the second half of the third century. The uncovered section produced only a few sherds of a flagon (E05:39).

Phase 1 partitions

Pottery from the slot in the officer's quarters (E04:25) consisted of one sherd of BB1, one sherd of locally produced grey ware and a sherd from a Hadrianic or Antonine Form 33 samian cup. The partition between Contubernium 1 and 2 (G05:27) produced two sherds of locally produced grey ware and the depression in Contubernium 3 (G05:30) a few sherds of locally produced grey ware.

Phase 1 officer's quarters floor

The pink clay spread in the north-west corner of the officer's quarters (E04:20) produced only a few sherds of BB1 and locally produced oxidised ware.

Later features

The large pit in the officer's quarters contained only a scrap and a sherd of repaired, locally produced grey ware (F04:32),

The stone-lined cist in Contubernium 1 produced a fair quantity of pottery (0.882kg excluding samian), 90% of which was BB2 and allied fabrics, including

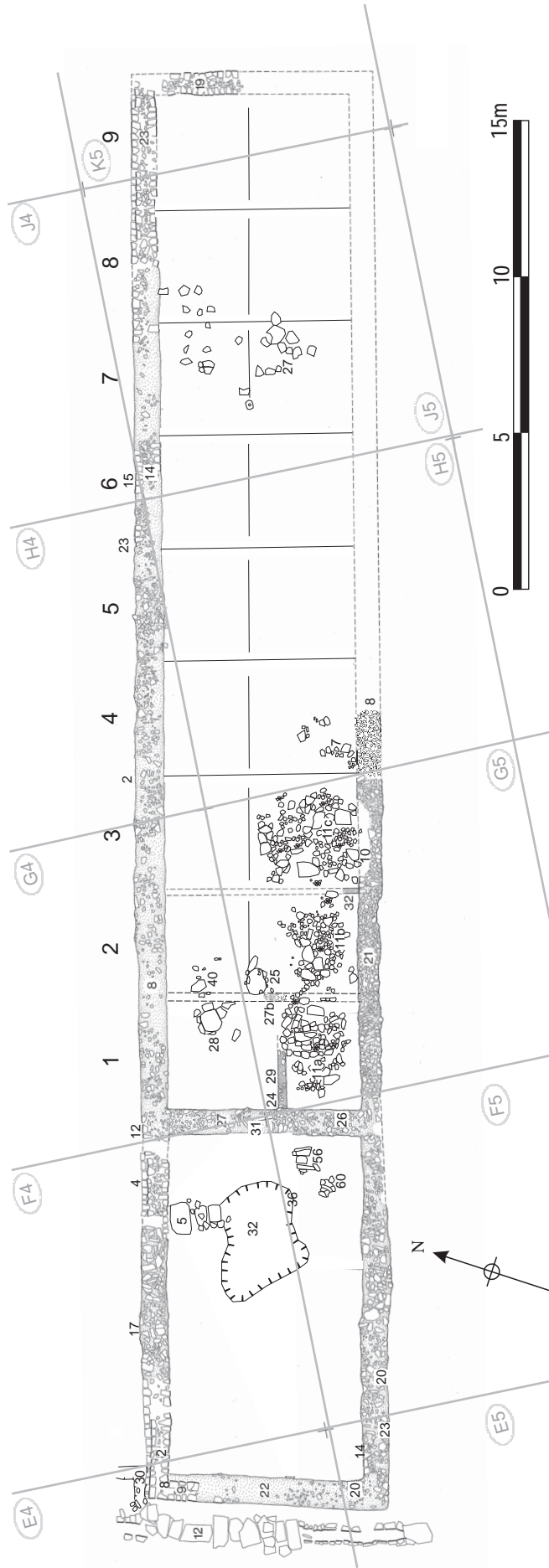

Figure 13.24: Building 5, Phase 2 and possible later features. Scale 1:200.



Figure 13.25: Stone box G05:25 in Building 5.

three Gillam 151 rims dating to the third century (G04:28). There was a single sherd of samian, from a Curle 21 dating from the late second or first half of the third century. The cist in *Contubernium* 2 produced only a body sherd of BB2 and two sherds from a Form 30 dated 150–80 (G05:25). These assemblages may reflect the backfilling of the stone boxes, perhaps at the end of the barrack's life.

Building 6

Grid squares: E5, F5

Introduction

Most of Building 6 lies beneath Buddle Street so that only a very small part of this building – its north-west corner – could be excavated in 1975. As a result little can be said regarding the function and phasing of this structure, though it may be presumed to represent another barrack block like Building 3 which lay in the corresponding position on the east side of the *via praetoria*. The building was probably demolished at the same time as the other barracks in the western half of the *praetentura*, perhaps during Fort Period 3 or at the beginning of Period 4.

Earlier wall foundations (Fig. 13.27)

At the west end of the building a series of wall foundations consisting of clay and cobbles projected northwards 3.90m onto the area of the street. Varying



Figure 13.26: Stone box G04:28 in Building 5.



Figure 13.27: The unfinished foundation of Building 6 in the foreground with Barrack 5 beyond, looking north.

in width from 0.80m–0.85m, these comprised a west foundation (E05:40) corresponding to the western end of the building, a north foundation (E05:11, F05:12), which ran 10.10m eastwards to join up with another north–south aligned foundation trench (F05:57). There was no trace of the north foundation to the east of E05:57, giving the assemblage the appearance of a wing, projecting north of Building 6. The foundations were clearly overlain by the lower (E05:12) of the two metallised surfaces covering the street between Buildings 5 and 6 (Alley 4) and must therefore be early in the life of the fort.

Discussion

These redundant foundation trenches presumably represent a scheme for the block or the officer's quarters at any rate, which preceded the stone barrack ultimately constructed further to the south. Their precise significance is unclear however. On the one hand their existence may indicate that Building 6 was originally intended to occupy a more northerly position and, by implication, that the disposition of the other buildings in the *praetentura*, as initially

planned, differed from that finally realised. The corresponding area of the eastern *praetentura* is covered by Buddle Street so it is unclear as to whether this layout was replicated on that side of the fort as well. The foundations may have been constructed to support a stone-walled officer's quarters associated with a range of timber *contubernia*, either as part of the primary layout of a predominantly timber block or a secondary partial rebuild in stone. However, no timber beam slots for the remainder of the block were actually identified to the east of the foundations. On the other hand it does not seem very likely that the foundations can be explained as part of an initial L-shaped barrack plan which entailed the officer's quarters projecting forward of the *contubernia* and the line of the officer's quarters north wall being continued by a colonnade along the front of the *contubernia*. This type of barrack is found at forts elsewhere on Hadrian's Wall, such as Housesteads, Chesters and Benwell, but in this case would have resulted in a very deep colonnaded veranda, at 3.90m roughly twice the width of those at Housesteads for example. Whatever the precise form of the intended building, there is no indication that any walls were ever erected on the foundations, suggesting that the scheme was probably abandoned before completion.

Building 6

As finally constructed Building 6 took the form of a straightforward rectangular barrack of similar form to the others at Wallsend. The north wall of the building had largely been removed, all that remained being some medium-sized stones set in pink clay (E05:28). It had evidently been 0.7m in width. The basal course of the west wall (E05:08) survived in better condition than the northern. It was 0.65m wide and a length of 1.6m was excavated. Two stones of the first course survived *in situ*, slightly smaller than those below. There was an east–west drain or eavesdrip (E05:29, F05:48) c.0.2m wide, immediately north of the line of the north wall and contemporary with the lower street surface (E05:12). This fed into the main covered north–south drain (E05:05) that ran to the west of Buildings 4, 5, and 6. It was subsequently filled with grey soil and stones (E05:34, F05:47), assumed to be a mixture of natural fill and packing.

FINDS

Pottery: counter (no. 89, F05:47 – silt fill of drain F05:48)

Dating evidence

Unused foundations

The unused west wall foundations (E05:40) held a few sherds of BB2.

Phase 1 drain fill

The fill of the drain (E05:34, F05:47) contained third-century material, such as a sherd from a Nene Valley ware beaker and BB2 and allied fabrics, as well as sherds from two East Gaulish samian vessels dating to the late second or first half of the third century.

Only a small amount of datable material was recovered from Building 6, as might be expected given the limited area available for investigation. This was sufficient to show that the drain to the north of the building was not taken out of use and filled with packing material before the beginning of the third century. The BB2 in the unused foundations may however have been intruded when that area formed part of the street between Barracks 5 and 6, as the foundations were only very sparsely overlain by surviving cobbling of the secondary street surface (E05:32).

Roads in the north-western part of the fort

Introduction

Various stretches of road metalling were exposed around the Period 2 stone barrack blocks in the north-west *praetentura*. These included parts of the *intervallum* road, the narrow back alleyway between Buildings 4 and 5, the broader street between Buildings 5 and 6, and the *via praetoria*.

The north *int*e *v*h *l*um street (Road 4)

Only the stretches of the north *intervallum* road in front of the east end and western half of Building 4, located in grid squares K03 and F03-G03-H03 respectively, were examined. The intervening east-central part of the street, extending across much of H03 and virtually the full length of J03, was covered by the modern back lane between the terraced houses of Buddle Street and Winifred Gardens, which was not excavated. Moreover the surfaces uncovered in grid squares G03, H03 and K03 were not exposed right up to the north wall of Building 4, because of the limits of the excavation site, and so the precise relationship between the barrack and the successive road surfaces could not be determined. Furthermore this area was not excavated right down to the natural subsoil and there is therefore no definite guarantee that the lowest layer of metalling exposed was indeed the primary road surface. There was also a degree of apparent confusion in the recording of equivalences between the road surfaces in G03 and H03, with some contexts being described in such an identical manner as to suggest that they represented the very same level, but these did not match the reported equivalences. Consequently, the correlation of road levels in the two areas investigated is somewhat hypothetical.

Road level 1

The earliest layer identified towards the west was represented by a gravel surface (G03:16). The exact location of this metalling was not shown on the sketch plans for G03, but its approximate position can be estimated by reference to the subsequent gravel surface, G03:15, which directly overlay G03:16 and is shown on a sketch plan. G03:16 contained less sand and was composed of slightly larger stones than G03:15 and was probably equivalent to H03:10, which was described in exactly the same terms in relation to overlying surface H03:09, despite the fact that H03:10 was listed as equivalent to G03:15. It was also noted that towards the west G03:16 began to resemble the cobbled surface (G03:17) in the entranceway of the north-west interval tower (Tower 1).

To the north-east of Building 4, the earliest level revealed (K03:36) was made of small cobbles. This was revealed next to the south wall of the north gate's western guardchamber (marked by robber trench K03:32 and a residue of surviving pink foundation clay). As was also the case in G03/H03, excavation was not taken deeper here to find natural subsoil so it is uncertain whether this was indeed the primary road level, as supposed, and the equation of G03:16/H03:10 and K03:36 is somewhat arbitrary.

Road level 2

The second recorded level of the *intervallum* road in grid squares G03/H03 was described as a compact surface of sand and gravel (G03:15, H03:09). This reportedly lay at the same level as the cobbled surface in the entrance passageway of the interval tower (G03:17, H03:08), immediately to the north, although the composition of that cobbling was somewhat different, taking the form of a compact spread of small angular stones, 0.05–0.10m in length.

Further to the east, the level of small cobbles K03:36 was succeeded by another cobbled surface (K03:11, K03:35). This ran up to a very rough line of five irregularly-shaped flags (K03:34), which extended for about 1m alongside the south wall of the gatetower and appeared to form an edge to the road. The flags each measured c. 0.25m by 0.30m and were c. 0.05m thick. They appeared to sit on two levels, with two set somewhat lower than the other three, but both levels were recorded as abutting and therefore associated with cobbling K03:35 rather than the underlying K03:36.

Road level 3

Covering G03:15 was a further surface composed mainly of medium-sized river-washed cobbles, but incorporating some dressed stones (G03:14). No correspondence with any context in H03 can be established – it was variously stated to be equivalent to H03:09 and H03:10, which however more clearly relate to G03:15 and G03:16 respectively – but it may

conceivably have extended into that grid square. G03:14 may have been equivalent to the rubble surface (F03:05) exposed further to the west, next to the north-west corner of Building 4. This was the only road level uncovered in F03, but – in contrast to the all the layers described above – was traced as far as the north wall of the building, where it was seen to overlie the wall's offset course. It was not, however, recorded as extending further south over the remains of the barrack block. The context was described as a rough cobble surface with some small angular stones and small river-washed cobbles, 0.10–0.15m in length. Fallen building stones were also noted lying on this road level.

No further *intervallum* road surfaces were noted in the area approaching the north gate. Here the second level (K03:11/35) was overlain by rubble disturbance (K03:21) which also covered the robbed remains of the west guardchamber, implying stratigraphy was considerably truncated here.

Discussion

The first three levels of the north *intervallum* road in grid squares G03 and H03 have been assumed to be contemporary with the stone barrack (4) of Periods 2–3 (and perhaps any timber predecessor). However no finds were recorded from any of the levels described above to provide confirmation of this or any indication of the date of each successive surface. Moreover the relationship of the street levels to Building 4 was unclear except at the north-west corner where F03:05 overlay the building's offset course but did not extend further south over the interior.

The west *intervallum* street (Road 5)

Two stretches of the west *intervallum* road were examined in the *praetentura*, next to the north-west corner of Building 4 (in grid square E03) and extending from the south-west corner of 4 to the north-west corner of Building 6 (E04-E05).

The pre-fort ground surface was identified in several areas on removal of parts of the *intervallum* road surfaces. Thus excavation of a narrow strip across the *intervallum* street in E04 revealed a deposit of very clayey, grey soil (E04:33), some 0.10–0.20m deep, underlying the road levels. This incorporated flecks of iron-panning and most likely formed the remnants of ploughsoil pre-dating the military presence. It might represent the same material as the slightly mottled, grey clay-silt (E03:15) uncovered beneath the earliest road metalling in E03, which was clearly cut by a pre-Roman cultivation furrow (E03:16). E03:15 itself was not removed, but E04:33 was seen to lie directly over the natural subsoil which consisted of orange-pink clay and yellow-orange sand with traces of cross-ploughing marks cut into it.

The pre-fort ground surface was also uncovered in the narrow strip between Buildings 5 and 6 and the *intervallum* drain, some 0.35–0.40m to the west, where it was described as an olive grey or light green-brown loam with a slightly clayey texture, incorporating flecks of yellow-pink clay and orange-red iron pan, plus coal, charcoal and some small angular stones (E04:23, E05:21). Here too it was cut by a probable cultivation furrow (E05:07).

Phase 1

Beside the north-west corner of Building 4 the earliest street surface consisted of an iron-stained, worn surface of pebbles containing a few large cobbles and stones (E03:09). It was exposed for 2.50m to the west of drain E03:10 which it met on the west side, overlying the foundation trench. Presumably the drain covers would have abutted this surface.

Further south a primary *via sagularis* surface composed of a mixture of medium-large and very small cobbles (E04:11, E05:06) was also recognised immediately west of Buildings 5 and 6, set on a base of redeposited natural clay, yellow sand and crushed sandstone (E04:13) some 0.05m deep.

A substantial north–south aligned *intervallum* drain (E03:10, E04:12, E05:05), which ran alongside the west walls of Buildings 5 and 6, seemed to be contemporary with the primary road surfaces described above. The channel was 0.35–0.40m wide and lined either side with walls up to 0.40m high generally composed of three courses of dressed rubble. In E03 these walls were described as neatly-faced with sandstone ashlar (by which squared rubble is usually meant in the site archive), but further south, in E04–E05, they were reportedly very poorly built, with irregular coursing, the stones mostly, but not invariably, worked to a flat face. At the north end of the drain the west side wall was clearly subsiding into some underlying feature which was not investigated. There were also signs of collapse or subsidence in E04–E05. The walls were set in a construction trench (E03:11, E05:22), 1.15–1.20m wide overall. The drain's western side wall was set right up against the edge of the trench, with very little packing required, whereas there was a gap c. 0.25m wide behind the other wall, which was backfilled with mixed yellow/pink clay, grey soil and many small stones. No cover slabs survived along the 2.50m stretch in E03 but they did survive over three stretches of the drain in E04 and E05, the longest of these (in E05) being some 5.6m in length. The slabs were c. 0.70m wide on average and up to 1m in length, ranging in thickness from 0.05m to 0.11m, and lay flush with the surface of the *intervallum* street.

In E04 the bottom of the drain was seen to be lined with pink clay (E04:36) which also came up side of the lowest course of stones. The clay didn't appear to have been puddled and gave the impression of having been spread out, with spade cuts in it. Various silty

fills were noted in the bottom of the drain where the capstones were absent, ranging from a light green silt (E03:12) overlying a deposit of orangey gravel in E03 to a medium grey-brown silt and a few small stones (E04:18, E05:37, 39) further south. Where the capstones remained in situ the fill sealed beneath comprised a dark brown clayey loam (E04:34, E05:38) containing much charcoal and small stones, the top being stained a black colour and having a powdery consistency immediately beneath the flagstones, probably as a result of water action, becoming much more silty and a little lighter in colour lower down.

A gully (E03:13), some 0.35m wide, ran around the north-west corner of Building 4 and connected with E03:10 where there was gap in the side wall with one or two facing stones missing. This contained green-grey silt and small stones. It perhaps formed the end of an eaves drip gutter running along the north side of the barrack and designed to channel runoff flowing from the roof of the building into the drain. No other trace of this gutter was identified further east, but the road levels here were not excavated to a sufficient depth to expose the primary surface and any associated gutter channel.

A short length of drain (E04:30) fed the runoff from the drip trench between Buildings 4 and 5 (and later the latrine in the officer's quarters of Building 4) into the north–south drain

This stretch of drain beside Building 5 appears to have remained in use right up to the end of the fort's life.

Phase 2

A new surface (E03:08) was laid over the northern end of the western *intervallum* street. It was composed of a single layer, 0.10m deep, of small to medium sized cobbles. This surface was not very well packed and showed only a moderate amount of wear. It ran over drain E03:10, which was dismantled and backfilled with rubble, and abutted a newly constructed kerb (E03:07) of the west rampart, which sat on top of the earlier metalling.

No equivalent secondary surface was noted further south in E04 and E05. Here the primary road surface was overlain only by a 0.40–0.60m depth of rubble (E04:07, E05:04), including cobbles facing stones and flagstones, set in a loose matrix of dark grey soil and, lower down, a black clayey soil with much orange/red iron staining. This rubble also filled the *intervallum* drain channel where the cover slabs were absent.

The *via praetoria* (Road 2)

The road was not excavated to the earliest levels in the area east of Buildings 4 and 5 and only the uppermost layer of cobbling (K04:04, K05:14), immediately below a modern layer, was explored.

Further north, the cobbled surface of this street (K03:12) was located running through the east

carriageway of the North Gate. Two surfaces, an upper (L03:48) of well-packed medium-sized cobbles, and a lower gravel surface (L03:50), were noted in the east carriageway. The lower surface seemed to overlie a dark soil layer (L03:51), whilst the upper was seen by the excavators as repairs to the lower. (See Chapter 18 below – North Gate, for full discussion)

The alleyway between Building 4 and 5 (Alley B)

The alleyway between the south wall of Building 4 and the north wall of Building 5 was 1.50m wide and was not metalled. A homogenous deposit of grey silty clay (E04:21, F04:12, G04:18a, H04:25, J04:19) up to 0.15m deep lay over the natural ground surface. A drip trench (E04:31, F04:33, G04:18, H04:04), 0.55m wide, ran down the centre of the alley, cutting the grey clay deposit and the natural. Originally it was 0.16m deep with a shallow dish-shaped profile. The fill was similar to the clay through which it was cut, but slightly darker and iron-stained. The trench would have emptied into the drain which ran down the east side of the west-intervallum street, but the junction of the two features had been removed by a modern pit (E04:06).

The trench was later re-dug (F04:33) in the direction of the flow west from the point where the channel from the Building 4 officer's quarters latrine (F04:25) entered it. This measure was presumably associated with the construction of the latrine. The new trench was the same width but 0.50m deep. Alterations were made to the course of the channel at its west end which may also be linked to this recutting. A 0.90m long branch (E04:30) was dug at a right angle to the original course to meet the north wall of Building 5. It then turned sharply again to run around the north-west corner of the barrack to connect with the *intervallum* drain a little to the south. The rerouted channel thus took the L-shaped dogleg (Figs 13.28, 13.29). The original channel to the west of the new branch may now have gone out of use, but there is no definite evidence.

The street between Building 5 and 6 (Alley A)

Two distinct phases of metalled surface (6.2m wide) were identified between Buildings 5 and 6.

Phase 1

The earlier level (E05:12, E05:36, F05:46, G05:07, H05:03) took the form of a very well laid surface mostly made of closely packed small cobbles with a few larger stones, plus the occasional spread of more angular, sandstone rubble fragments (E05:36). This was set directly on the natural subsoil or a thin layer of grey clayey soil. The recorded depth varied from 0.05m at the west end of the street to 0.15–0.20m in the case of the most easterly stretches exposed

(G05:07, H05:03) and for the most part no distinct foundation level was identified although towards the east, where the depth of metalling was greatest, the possible existence of a stone foundation levelled off with small cobbles (cf. G05:07) was noted.

Phase 2

The succeeding surface (E05:32, F05:14, F05:54, G05:19, H05:02, H05:30, J05:21) was composed of larger cobbles than the primary metalling, averaging 0.10–0.20m in length, though areas of smaller cobbling were also recorded (e.g. H05:30/J05:21 and within G05:19). The patch of metalling exposed at the very east end of the area available for investigation (H05:30/J05:21), in particular, more closely resembled the primary surface – fine cobble surface of small packed stones up to 0.05m in length, worn smooth. The road level was 0.10–0.12m in depth.

FINDS

West intervallum street Phase 2

Stone: throwing stone (no. 26, E03:08)

Alleyway between Buildings 4 and 5

Samian stamps: 155–85 (no. S4, F04:33), 125–150 (no. S18, F04:12), 125–50 (no. S21, F04:33)

Decorated samian: 125–140 (no. D35, F04:33), 125–140 (no. D36, F04:33), 130–150 (no. D37, F04:33)

Glass: beaker, late second, early third (no. 38, F04:33)

Stone: whetstone (no. 10, F04:33)

The lower street metalling between Buildings 5 and 6 (Alley A)

Decorated samian: 135–160 (no. D53, G05:07)

Quern: (no. 61, G05:07)

Dating evidence

West intervallum street

ORIGINAL GROUND SURFACE

The only pottery from the original ground surface beneath the street (E04:33) comprised two sherds from the rim of a Colchester or Kent mortarium dated 140–70.

ROAD SURFACES

The surfaces of the street (E04:11, E03:08) produced Hadrianic or early Antonine samian, and a few sherds of coarse wares including the complete base of a BB2 cooking pot from the secondary road surface (E03:08). The silt in north–south drain E04:12 contained five sherds, all probably of mid-second century date (E04:18).

Alleyway between Buildings 4 and 5

SILTY CLAY

There were the larger parts of two locally produced

grey wares, and a sherd from a BB1 flat-rimmed dish, as well as a stamped Form 18/31 dated 125–50 in F04:12. There was a flange fragment from a Hadrianic or Antonine mortarium and a probable Antonine samian bowl in H04:25, and an Antonine samian jar in J04:19. This context also produced a small amount of third-century pottery, including a sherd of Nene Valley ware, a scrap of calcite-gritted ware, and a sherd of black sand amphora (H04:25, J04:19).

DRIP TRENCH

The recut drip trench (F04:33) produced a large quantity of pottery (over 60 sherds, 6.303kg, excluding samian), including a number of nearly complete vessels in locally produced wares of the mid-second century (Fig. 22.14, nos 52–54). Much of the coarse ware was BB1, including six flat-rimmed bowls and dishes (Fig. 22.14, nos 55–58), and cooking pots with acute angle lattice. There were sherds from two local north-eastern mortaria and from 13 samian vessels: three Form 37s (nos D35–7) dated 125–40, 125–40 and 130–150, seven Hadrianic or early Antonine vessels, two Hadrianic or Antonine and a stamped Form 18/31R–31R dated 155–180 (no. S4). There were only a few sherds of BB2, making up less than 0.5% of the group. Sherds from vessels in this context were also found in E04:31, which contained much of a single vessel of a mid-second century locally produced grey ware cooking pot, as well as sherds of BB1 and a second-century rough-cast beaker. The pottery from G04:18 was a much smaller group of pottery (approximately 17 sherds), but contained a few more sherds of BB2 (N.B. It was difficult to distinguish the

upper fill of the drip trench from the ground surface on either side, but finds mostly derived from the course of the channel).

Street between Buildings 5 and 6

ORIGINAL SURFACE

The original ground surface (H05:09) contained a few sherds of possibly second-century material, and a sherd of Hadrianic or early Antonine samian.

LOWER SURFACE

The lower road surface included BB2 and allied fabrics (E05:12, F05:46) and a sherd of Antonine samian (E05:36). There were a couple of sherds of late third century Crambeck reduced ware (G05:07, H05:03), but later material is often found pressed into earlier surfaces on roads.

UPPER SURFACE

The upper surface also contained BB2 and allied fabrics (F05:14, F05:54, G05:19), and a sherd of a mid to late Antonine Form 37 samian bowl (G05:19).

Discussion: the second-century infantry barracks

The six stone buildings which were erected the northern part of the fort in Period 2 clearly represented barrack blocks, each probably intended to house one century forming part of the infantry component of a quingenary equitate cohort. All the barracks were composed of an officer's house, located at the end of the building next to the east or west *intervallum* road, plus an attached row of nine *contubernia*, one short of the normal complement of ten *contubernia* traditionally supposed to make up a cohort. Where two structural sub-phases were identified nine *contubernia* were present in both sub-phases, but too little evidence survived to determine whether this was a feature inherited from the suspected timber

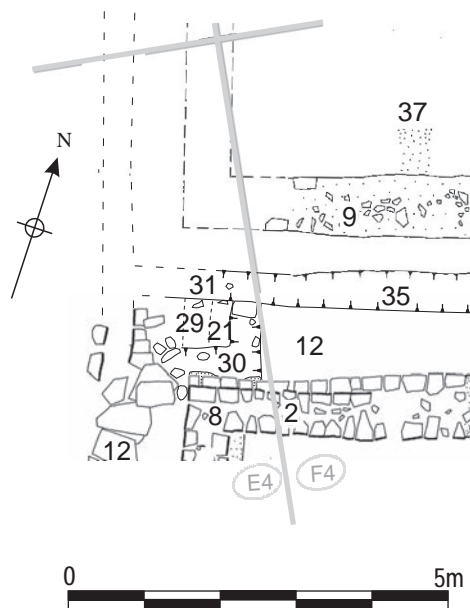

Figure 13.28: Plan showing arrangement of eaves drip channels and intervallum drain at the west end of Alley 3 between Building 4 and 5. Scale 0



Figure 13.29: Eaves drip and gutter channels at west end of Alley 3

barracks of Period 1. This apparent discrepancy may simply reflect the internal composition of the garrison unit at the time of construction, the regiment perhaps being slightly understrength in infantry. It is also conceivable that there was no absolute standardisation on the figure of ten *contubernia* per *centuria*, even in theory, never mind in practice.

In outline, the buildings each formed simple rectangle, a characteristic they share with the barracks in the *retentura* and with those belonging to the third- and fourth-century phases at neighbouring South Shields, but quite different from the familiar L-shaped barracks revealed in the forts further to the west on Hadrian's Wall (Fig. 13.30). In the latter the front walls of the *contubernia* were recessed in relation to the officer's house with the area in front of the *contubernia* being covered by a colonnaded portico. This would have provided some shelter for the doorways. This arrangement is found both in barracks interpreted as housing infantry, as at Housesteads (Rushworth 2009, 42–51) and Birdoswald (Wilmott *et al* 2009, 220–7), and in those presumed to have held cavalry, notably Benwell (Simpson and Richmond 1941, 25–30) and Chesters (1889 AA 2 ser, xiii, 374–9; Johnson 1990, 21–2).

In analysing the internal arrangements of these buildings we are largely reliant on Building 1. It was one of only two to be fully exposed (along with Building 5) and by far the best preserved and most thoroughly investigated. Although the Period 2 (Stone Phase 1) levels did not survive intact in any of the *contubernia* in Building 1, sufficient features survived across the block as a whole to reconstruct the layout of the barrack in some detail, at any rate in Sub-Phase 2. The *contubernia* were separated one from another by timber and wattle-and-daub partition walls and were each further sub-divided by similar partitions into front and rear rooms (*arma* and *papilio*). The rear (south) room generally seems to have been approached by a side passageway which was screened off from the front (north) room by a further partition wall. In Building 1, this passageway generally ran along the east side of each *contubernium*, in the cases where it could be substantiated, apart from *Contubernium* 5 where it seems to have run along the west side. The thresholds of the main doorway through the north wall into the *contubernium*, the adjacent doorway leading off the passageway into the front room and the doorway into the rear room at the southern end of the passageway survived in several instances, complete with pivot holes for the doors, raised door thresholds and threshold slabs immediately inside the internal doorways. This overall arrangement of front and back rooms and side-passage is found in barrack blocks at neighbouring forts, notably the Period 5 and 6 barracks at South Shields (cf. Bidwell and Speak 1994, 24–5; Hodgson 2003, 38–40; Hodgson and Bidwell 2004, 137–9), and

was doubtless a very common layout. In *Contubernia* 7 and 9, however, the flagging immediately inside their respective main doorways (M04:27 and L04:21) bore no indication of side passageways or adjacent internal doorways. In the case of the end *contubernium* (9) this absence of a side passage can be paralleled in other barrack plans and may signify that end *contubernia* often had a special function (storage or specialised accommodation perhaps?), but the layout of *Contubernium* 7 is less readily explicable.

The use of timber internal partitions is another thing which sets the Wallsend barracks apart from the L-shaped blocks noted above. Stone walls – whether full height or sleeper walls providing a base for a timber-framed superstructure – were used in the barracks at Housesteads and Birdoswald to separate the *contubernia* from their initial Hadrianic construction and at least some of the *contubernia* in Barrack XIII were furnished with stone walls dividing them into front and rear rooms, generally right from the start. There was also a marked tendency there for the front room to be smaller than the rear one. At Birdoswald no equivalent room divider survived in association with the second-century phase of barracks in the *praetentura*, but one was revealed in the similar third-century barracks. Stone walls do not appear to have been used to define the side passages at either site, however. Presumably this would have absorbed too much internal space. If side passages were commonly used the screen walls must have been entirely of timber and have left very little trace. Barrack XIV at Housesteads did provide possible evidence of a passage wall or side doorway in the form of two holes cut into the flagging of the north room, possibly to fix timber uprights or a sleeper beam for a wattle and daub panel (Rushworth 2009, 48). It is possible that in many cases timber partitions were set on sleeper beams simply resting on the floor surface in which case they would not be easy to detect.

It is noteworthy that side passageways were not a feature of the cavalry 'stable-barracks' found in the southern part of the fort and could not practically form part of a stable-barrack plan, if it is assumed that up to three horses were intended to be accommodated in each front room. Together with the lack of large latrine pits in their *arma*, this demonstrates that the *praetentura* barracks were intended to house infantry *centuriae*. The stone-lined drains found in the rear rooms of a couple of the *contubernia*, and attributed to the second-century stone barrack by the excavators, most probably belong to the subsequent, third-century stable block.

A number of spreads of coal and charcoal were found in the Sub-Phase 1 levels of Building 1. Some of these spreads clearly respect the line of partitions recorded in Sub-Phase 2, with a different type of floor material, such as a clay spread, being present on the opposite side of the partition line, confirming that two

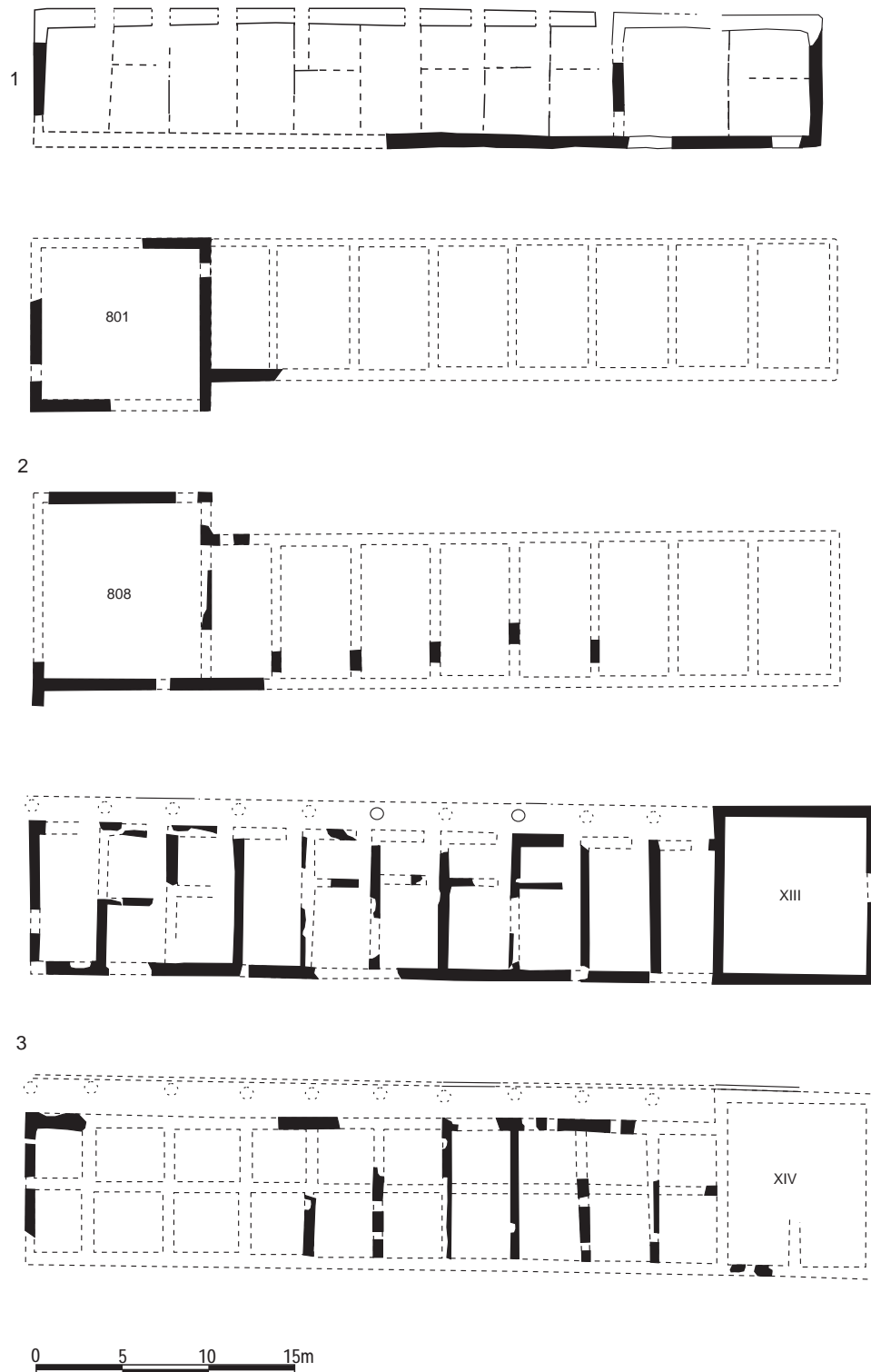

Figure 13.30: Second-century infantry barracks: 1. Wallsend Building 1 Phase 1.2, 2. Birdoswald Buildings 801 and 808, 3. Housesteads Building XIII and XIV (©)

sub-phases were associated with the same layout of *contubernia*. In other cases, however, the coal/charcoal spreads lay on either side of a Sub-Phase 2 partition, which appeared to cut through them. Taken at face value this would imply that the spreads in question

preceded those partitions. The excavators interpreted the coal/charcoal as evidence of the burning and demolition of Sub-Phase 1 partitions which lay on the same line as the subsequent ones, thereby providing an explanation as to why these layers were present



Figure 3 Latrines in the corner of the centurion's quarters: left – Building 4 right – Building 1

on both sides of the later Sub-Phase 2 partitions. If, on the other hand, the spreads derived from the occupation of the block, perhaps a result of the storage and use of coal to heat the *contubernia*, for instance, then these particular levels might indeed be associated with an altogether earlier phase of barrack, perhaps a timber-built one incorporating the three surviving slots (N05:49, P05:34, 48) which clearly form a different pattern.

One curious aspect of Building 4 was the number of ballista balls or throwing stones associated with it. These were found incorporated in levelling material in *Contubernia* 2 and 9 and in one of the partition slots associated with the initial phase of *Contubernium* 2. In the latter case they had presumably, either deliberately or accidentally, ended up as packing in the redundant slot after the partition had been dismantled.

The centurion's houses were clearly subdivided into several rooms but it is not possible to determine the function of any of these other than to note that latrines were provided, at least as a secondary feature.

These took the form of a stone-lined channel or box and were identified not only in Building 1 but also in Building 4 and perhaps Building 5 (Fig. 13.31). These always occupied a position in or close to one of the corners of the house next to the narrow rear alley so that effluent from the latrine could be discharged through the rear wall into the drip channel running along the alley and then flow into the *intervallum* storm drain running alongside the ends of the barracks.

Note

- 1 Context no. Q04:10 was assigned to both the Phase 2 north *intervallum* road surface and, as a general feature number, to the pit as a whole. The separate fill layers of the pit were also given individual context numbers however. It is likely the Q04:10 finds relate to the top only of the pit fill, plus the road surface, but the material from the two distinct features cannot now be differentiated.

14. THE THIRD-CENTURY AND LATER BUILDINGS IN THE PRAETENTURA

Introduction

The six Period 2 stone barrack blocks in the northern part of the fort all underwent either substantial remodelling or complete demolition and replacement, probably at some point during the earlier part of the third century. The resultant, remodelled layout of the *praetentura* cannot be fully restored, in some measure because part of the area lay beneath Buddle Street and was therefore left unexcavated, but principally because of the poor preservation of the third-century and later remains in this part of the fort. This was particularly true of the western half of the *praetentura*, where the devastation wrought by post-Roman ploughing and colliery period activity had left only small, isolated pockets of stratigraphy and occasional fragmentary structures. Nevertheless the broad outlines of the scheme can be established. The pattern of rebuilding and occupation set out below differs significantly from that presented by Daniels. It amalgamates some parts of his Fort Phase 2 (specifically in the north-east area) with Fort Phases 3 and 4, this combined structural period covering a much shorter timespan than Daniels had envisaged, and, with the benefit of much clearer understanding of the extent of post-Roman destruction than he possessed, reinterprets the whole in a more coherent form.

Daniels structural phasing and interpretation

As envisaged by Daniels and set out on his overall plan of Fort Phase 2, the *praetentura* contained five barracks (Buildings 2–6) in the early third-century, whilst Building 1 was rebuilt as a narrower block (Daniels' Building 1 Phase 2), interpreted as a stable. It was thought that the *contubernia* were still separated by timber partitions in most of the barracks (Phase 2 of Buildings 3–6), but in Building 2 these were replaced by stone walls, the latter's extra width resulting in a slight reduction in the number of *contubernia* from

nine to no more than eight. Along the southern edge of the *praetentura* the long narrow workshop, Building 16, was believed to have remained in use, with a number of internal modifications, until the end of the Roman period, its counterpart on the west side (Building 15) having already been demolished during the second century (*see* Chapters 10–11).

This set of arrangements was thought to have persisted until the end of the third century or beginning of the fourth when it was largely swept away to make way for a new and much less intensive pattern of occupation (Daniels' Fort Phase 3). The stable in the north-east corner (1) was demolished and not built over, whilst Barracks 2 and 4–6 were replaced by rows of small, flimsily constructed buildings, labelled 'shacks' – B, K and M in the eastern *praetentura* and C, D, E, F, G, H, J and L in the western. Building 3, however, continued in use until the end of the Roman period, receiving stone partition walls like the third-century Barrack 2 (Building 3 Phases 3–4). Its western end was presumed to have been truncated to bring it in line with Shack B.

The shacks were square or rectangular and of varying size. Most were stone-built, but J appeared to represent a rectangular post hole building whilst the very small E employed wooden sill-beams set in stone-lined slots. B, K and M formed a single conjoined row and all fell within the northern half of Building 2, largely conforming to pre-existing *contubernium* plots and the reusing some of the walls of the former barrack block. In contrast, the structures in the western *praetentura* did not fully respect the footprint of the three earlier barrack blocks (4–6) there, although some sections of the barrack walling did appear to have been reused. These structures were organised in two rows, laid out on either side of a newly constructed east-west aligned street, with F, C, D and E to the south and J, G and H to the north. However only one, partially excavated

building (L), located to the north-west of posthole building J, was identified as overlying the interior of Building 4, which otherwise was assumed to have been completely demolished, and its site left vacant for the remainder of the Roman period like that of Building 1. This pattern of occupation continued until the end of the fourth century, although the shacks were much reduced in number by its later stages, with only B and M and C, D, E and possibly L being shown on plans of Fort Phase 4, c. 370.

The third-century layout

Daniels' interpretation was underpinned by his belief that the full span of Roman activity was represented by the surviving remains and that the structures exposed when the overburden was removed were, to a large extent, all that been constructed. Although aware that the site had been damaged by post-Roman disturbance he still underestimated its impact on the later Roman levels, the fourth-century remains having been almost entirely removed, whilst the third-century structures in the western *praetentura*, in particular, were also badly damaged. Re-excavation of the fort in 1997–8, particularly the successive phases of cavalry barracks in the *retentura*, coupled with analysis of the pottery assemblages from the Daniels excavations, have made it apparent that only a portion of the Roman sequence was preserved, essentially corresponding to the second- and third-century phases of occupation. With this in mind it is possible to interpret the later buildings in the *praetentura* as the fragmentary remains of a more extensive, coherent third-century rebuilding, rather than as evidence for a series of fairly ephemeral structures in the essentially minimalist restoration of their form adopted by Daniels.

The layout is clearest in the eastern half of the *praetentura*. Here much of Daniels' third-century plan – Fort Phase 2 – can be accepted as it stands, including the remodelling of Building 1 as a narrower structure, presumed to be a stable, and the substitution of stone partition walls for timber in Building 2, with resultant reduction in the number of *contubernia*. However, with respect to Building 3, it is Daniels' Phase 3, which was likewise marked by the introduction of stone partitions, rather than the building's insubstantial Phase 2, that should be attributed to this period. Furthermore, rather than representing distinct overlying structures or even later reuse of the parts of Building 2, the three 'shacks', B, K and M, associated with Daniels' Fort Phases 3 and 4, simply represent the secondary floor levels and other third-century occupation features preserved within the remodelled Building 2. It is noteworthy that all three respected the footprint of Building 2 and its constituent *contubernia*, for the most part employing walls already attributed to that building. However, unlike the remains of

Building 1, for example, these walls and internal floor surfaces were not entirely obscured by spreads of rubble when this part of the fort was first exposed in 1975–6, leading to their interpretation as distinct buildings, which could in turn be assigned to Wall Periods 3 and 4, as demanded by the then dominant interpretive paradigm in Hadrian's Wall studies.

In the western half of the *praetentura* the picture differs somewhat. The shacks (C, D, E, F, G, H, J, L) cannot be fully integrated into the three pre-existing barrack blocks (4–6) in the same way that B, K and M can be seen to relate to Building 2. Although there was some reuse of earlier wall footings there was also considerable new construction, plus the creation of a new street (Alley 10). It would appear that the life of the timber-partitioned barracks, 4, 5 and 6, did not extend beyond the earlier part of the third-century when they were demolished and replaced by two new barrack blocks, Buildings 17 and 18, which occupied different footprints from their predecessors and were furnished with stone partition walls separating their *contubernia*. They were also probably somewhat wider than the second-century barracks. The stone-built shacks, C, D, F, G, H and L, represent the fragmentary remains of these two blocks laid out to the north and south of Alley 10. Of these the southern barrack, 18, can be restored with the most confidence, although the southern and easternmost parts of the building lay beneath Buddle Street and were consequently unavailable for excavation. It is represented by Daniels' Buildings F, C and D and was erected immediately to the south of Building 5, its north wall running alongside the line of the former barrack's south wall, and overlay the earlier street, Alley 4, and the northern part of Building 6. Only the north-west corner (F), northern half of *Contubernium* 1 (C) and north-east corner of *Contubernium* 4 (D) were preserved, with evidence for multiple phases of occupation in the *contubernia*. The fragmentary nature of the surviving remains reflects the degree of post-Roman disturbance, with particularly severe damage caused by three broad, parallel furrows aligned roughly north-south, probably the result of medieval or early modern ploughing, as well as the fact that much of the building was not actually exposed. The eastern part of the block, beyond *Contubernium* 4, may have been demolished later in the century, perhaps replaced by timber structures of which the tiny sill-beamed Building E was the sole example uncovered. This indicates that Daniels' shacks may represent a palimpsest of more than one phase in this half of the *praetentura*.

The evidence relating to the northern barrack, Building 17, was even more fragmentary and difficult to interpret. Based on the position of shacks L, G and H, the barrack appears to have overlain the northern half of Building 5, Alley 3 and the southern part of Building 4, with a stretch of new walling running

lengthwise through the latter marking the probable north wall of 17. It is possible, however, that the sequence with regard to the northern barrack could be more complex. An enlarged Building 4, incorporating the area of the former Alley 3, with the north wall of Building 5 forming the new south wall of the block, and featuring a stone medial wall running the length of the *contubernia* range, would have dimensions equivalent to those of the two blocks, 17 and 18, described above. This would not incorporate the side walls of Buildings G and H, but might form part of an initial phase of the remodelled barrack layout on this side of the fort, which would help to explain why there was a broad expanse of cobbling extending well to the north of the main strip of Alley 10 street metalling, as far as the north wall of Building 5, in what would otherwise be the interior of Building 17.

Other elements certainly suggest there were subsequent alterations to Building 17, most notably the post hole structure, J, which could either form part of a secondary rebuilding of 17, featuring greater use of timber, or simply represent a later rectangular timber building overlying 17 and constituting an entirely separate phase.

It is worth emphasising that in neither half of the *praetentura* is there any definite indication that the third-century rebuilding gave rise to chalet-barrack ranges. Instead, it appears to have involved the construction or remodelling of conventional stone barrack blocks. Admittedly the evidence in the western *praetentura* is so fragmentary that the possibility of a chalet-range layout cannot be decisively ruled out, but it is clear in the case of the two eastern *praetentura* barracks, which are markedly different from the chalet-barracks used to house the cavalry in the *retentura*. With the possible exception of post hole building J, evidence for a later, potentially fourth-century rebuilding was found only in the north-east corner, overlying the demolished remains of the stable block. These traces, which are discussed at the end of this chapter, were too fragmentary to be able to make any determination of the type of structure involved, however.

Building 1: Stone Phase 2

The second, main, stone-built phase in Building 1 involved the demolition of the former barrack block and the erection of a narrower building over the site. The new building appears to have formed one, long, open building or hall, with no obvious partitions or dividing walls (Fig. 14.01). A new flagged floor replaced that of Sub-Phase 2, in some areas directly overlying the former slots of the dividing partitions. A drain ran along the south side of the interior for the complete length of the building, probably using the former flagged floor as the drain bottom. To the north of the building a timber supported verandah

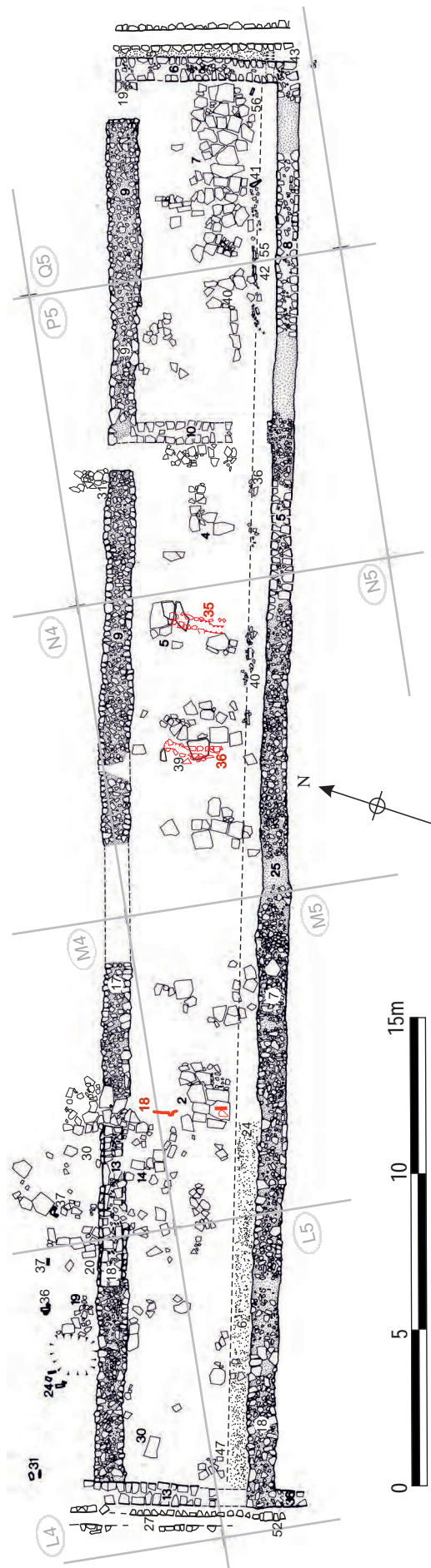

Figure 14.01: Building 1, Phase 2 stable at 1:200.

was constructed over the demolition deposits of the barracks. The combination of stone flooring, internal drain and an absence of internal partitions suggested the building may have functioned as a stable.

External walls

Sections of the barrack's east and west walls were retained, but where the west wall was simply shortened and the new north and south walls butted onto the existing structure, the east wall had been altered and capped at the northern end (Q05:19) to allow for an entrance at the east end of the building. From the west wall 19.00m of the south wall was rebuilt, including the corner with the west wall, but only the foundation (L05:18, M05:07) remained. This measured 1.00m wide and lay on the line of the former foundation. It was composed of well packed large river cobbles and fragments of sandstone, on average 0.20m × 0.10m, in a matrix of grey clay. In the best surviving examples it stood to a depth of 0.17m. As the new foundation was in an elevated position, lying directly on the old, it met the retained west wall at the level of the first course. The same probably applied where the new foundation met the stretch of south wall masonry that was retained from the previous phase.

The north wall of the barrack block was demolished and at least partially robbed out (e.g. M04:05), providing material for a new north wall, which was constructed 1.25m south of the line of the earlier one to give a narrower building 6.00m wide. Three sections of this north wall survived. The best example occurred towards the west end of the building. It consisted of a single course of well-finished, faced sandstone blocks, bonded with grey clay and angular stone chippings. This sat on a foundation (L04:18a, M04:17), 0.40m deep, of two layers of closely packed boulders and fragments of sandstone up to 0.25m in size, with the lower layer in a trench and the upper one almost on the ground surface. The foundation was traced for the length of the building (N05:09, P05:09, Q05:09) apart from 3.70m which was removed by the later clay-puddling pit. The upper layer of the foundation butted against the east face of the first course of the west wall (Fig. 14.02). Another fragment of north wall, consisting of two stones from the north face, was uncovered over the line of the wall which formerly divided the officer's quarters from the rest of the building. The third section (Q05:19) formed the new junction with the east wall, but no new foundation had been constructed here, it merely sat on the first course of the east wall and the daub from the demolition of the previous building.

There were traces of several entrances through the north wall of the building. The most definite occurred at the east end where the new foundation (Q05:09)



Figure 14.02: The Phase 2 stable foundations overlying barrack period flagging.



Figure 14.03: The north wall of the third-century stable, looking west with successive levels of flagged flooring evident, including an earlier barrack floor (Stone Phase 1) in the foreground. A threshold stone with a pivot hole, belonging to a doorway in the stable wall is visible in the foreground.

abruptly ended 1.00m short of the east wall. The west side of the new section of north wall (Q05:19) had been damaged or robbed so the width of the doorway could only be estimated. Another could be seen 11.00m from the west end of the building, immediately east of the section of north wall (M04:13) which had survived. The east end of the wall had been squared off at this point and several large flags, a continuation of the floor (M04:14) over the interior, extended across the cobble foundation east of this, giving a doorway 1.30m wide. A possible pivot hole visible in surface of the largest slab (Fig. 14.03) might, however, imply a doorway no more than 0.60m wide, but the slab may have been recycled from an earlier *contubernium* doorway. A third entrance was suggested immediately west of the former dividing wall where a 0.90m gap had been left between the foundation and the fragment of new north wall.



Figure 14.04: Phase 2 stable flagging (M05:02) overlying the Phase 1.2 flagged floor (M05:08) in the south room of Contubernium 6 from the east



Figure 14.05: Building 1 looking west in the Phase 2 stable flagging is exposed in the SE corner with the Phase 1.2 flagging of the centurion's quarters visible to the right, cut by the cobble foundation of the Phase 2 building's north wall.

The interior

The former timber partitions and perhaps similarly constructed of upper works of the Phase 1 building were demolished and in the process the daub infilling of the wattle sections had covered the floor of the building. This was a similar material to that found under the Phase 1 Sub-Phase 2 floors from the demolition of the original partitions, consisting of reddish-brown, charcoal flecked, iron-stained clay. In some areas, especially under the verandah and road north of the building, the deposit (Q05:25, P05:12, 13, N04:12, N05:18, M04:29) lay 0.17m deep. It covered much of the area of the former *contubernia* (N05:12, 21, M05:03, 9, 15, 17, L04–25) and was clearly cut by the foundation of the new north wall, but was noticeably absent from much of the area contained by the previous officer's quarters.

Fragments of a flagged floor were uncovered over various parts of the interior (L04:30, L05:47, M04:14, M05:02, N05:05, 39, P05:04, 40, Q05:07). The most substantial surface survived over the southern part of the former officer's quarters. It consisted of well laid flagstones (P05:40, Q05:07) measuring on average 0.40m square × 0.08m thick, which were more regular and slightly smaller than the flags of the earlier floor. The floor sat directly on the earlier flags with no visible evidence of the demolition material which occurred under some of the other fragments of the Phase 2 floor (N05:05, M05:02) further west (Figs 14.04, 14.05). The remains of the former west wall of the officer's quarters (P05:10) were probably incorporated in the flagged floor. The wall was not completely robbed away, but it does seem to have been cut through by the drain running along the south side of the interior and was probably demolished down to its bottom course, which was all that survived on excavation.

A small area of fairly worn flagging located towards the west of the building extended across the

doorway through the north wall. The flags that lay directly over the entrance were slightly larger than those over the interior, but were unmistakably part of the same surface (M04:14).

Along the south side of the interior fragments of a drain were found which probably ran along the whole length of the building. It consisted of a channel 0.50m wide with a north side of small flags (N05:40, P05:36, 42, Q05:41, 55, 56) set on edge, measuring between 0.12m to 0.20m high. The north face of the south wall functioned as the south side of the channel. The channel was not investigated, but it is likely that the southern parts of the flagged floors of the earlier *contubernia* provided the drain bottom. Although none of the structure had survived at the west end of the building, the location of the channel was clearly marked by a narrow band of yellowish-brown loam (L05:06, M05:24) against the south wall foundation.

The relationship between the new drain and the former latrine channel (Q05:46) in the south-east corner of the building was obscured by later blocking and alterations to the east wall at this point. However, the northern part of the latrine seems to have been backfilled with loam (Q05:36) while the southern end continued in use with the Phase 2 channel, reusing the unlined outlet (Q05:43) which ran under the east wall, into the road drain east of the building.

Three narrower stone-lined channels (N05:35, N05:36, M04:18), aligned north-south, were found in the centre of the building. The most easterly of the three (N05:35) survived over a length of 2.00m. Its sides consisted mainly of a single course of small flags laid on edge, on average 0.25m long and 0.20m deep and the southern limit had either never been lined or had subsequently been robbed away. The bottom appeared to be made of flags also, although only several had survived. Some 3.60 to the west, the second drain (N05:36) was also constructed of

small flags on edge and irregular sandstone blocks. It measured 2.20m long, 0.35m wide and was on average 0.25m deep. Some 10.50m further west, one surviving side wall of a third drain may be represented by a line of upright slabs (M04:18) initially interpreted as a partition of Phase 1 Sub Phase 2.

These three stone-lined drains were assigned by the excavators to Sub-Phase 1 or 2 of the Phase 1 barrack, because of the depth at which they sat, in which case the first two would have been centrally positioned within the south (rear) rooms of *Contubernia* 2 and 3. However it is difficult to determine what function they would have performed in the second-century infantry barracks. They do not appear to have been designed to remove troublesome ground water from the interior of the *contubernia* since they did not extend far enough to exit the building either to the north or south. They bear some resemblance to the drains or latrine pits invariably located in the front rooms (*arma*) of cavalry barrack *contubernia* identified in the south part of the fort in 1997–8 (Buildings 9–12 – see Chapter 15 and Hodgson 2003, 37–90). The drains and latrine pits were associated with the stabling of horses in the front rooms and this suggests that, in functional terms, the drains in Building 1 would more appropriately relate to the Phase 2 stable block. The drains appear to be set below the flagged floor of the stable, with a couple of the slabs belonging to that floor extending over the channels. They probably cut through the flagging of the underlying Phase 1 barrack – certainly no flagging belonging to either of the barrack sub-phases extended over the line of the channels. The fact that parts of the channels were covered by stable floor slabs does not necessarily mean they could not be associated since the same was often true of the drains/urine pits and flagged floors in the cavalry barracks.

The verandah

Fragments of a paved verandah (L04:19, 20, M04:30, P05:31), 2.00m wide, were uncovered to the north of the building. This lay over a thick deposit of demolition material up to 0.17m deep in places. At the northern limit of the flags a series of post-holes were indicated by groups of upright chocking stones (L04:24, 31, 36, 37, M04:37). The best surviving example (L04:24) was composed of three vertically placed slabs at right angles to one another forming a rectangular slot 0.20m × 0.23m. The post-holes were spaced between 1.50m and 3.00m apart and probably represent a timber colonnade supporting an overhanging roof along the front of the building.

Alterations to the building during Phase 2

During the life of the building the east wall (Q05:06)

was dismantled above the outlet (Q05:43) from the internal drain, the drain and outlet blocked (Q05:30, 35) and the wall above it rebuilt, possibly as a result of subsidence in this area. A section of wall and foundation 2.20m long was removed, then the east end of the drain and the outlet channel were blocked with small angular pieces of sandstone in a matrix of grey clay. A new foundation, 0.30m deep was laid on top of this. It consisted of fragments of stone up to 0.15m × 0.10m in size roughly packed in grey clay. The top of this was level with the first course of the sections of east wall which had not been altered. A course of clay bonded facing stones, some of which were slightly smaller and rougher than those of the original wall, stood on the new foundation.

Probably at the same time, the street drain (L04:27, L05:52) to the west of Building 1 went out of use, suggesting with the blocking at the east end of the drain, that the internal drain along the south side of the building had been abandoned. The street drain to the west had been partially dismantled and the channel blocked by fragments of stone (L04:35) packed into position.

Fragments of two courses of a blocking wall (L05:36), 0.50m wide, were uncovered across the west end of the alleyway between Buildings 1 and 2. The southern end had been robbed away, but the north end abutted the Phase 2 boulder foundation (L05:18) of the south wall of Building 1. It was composed of a mixture of stones, including fragments of flagstones, rough pieces of sandstone, and well dressed facers up to 0.25m long and 0.12m high. These were bonded with a dirty grey clay to form two faces without any obvious core. The wall sat on a layer of buff-grey clay (L05:35), possibly from the dismantling of the west end of the south wall at the beginning of Phase 2, which also abutted the foundation of Building 1 and partially extended over the lip of the offset and into the crevices of the first course of the north wall of Building 2.

The drains relating to Building 1 in Phase 2

On construction of the Phase 2 building the former north drain was dismantled and backfilled with loam and rubble (P05:18, Q05:24), and the new surface of the *intervallum* road extended over the top.

The drain east of the building (Q05:03) continued in use. A deposit of thick pink puddled clay (Q05:05) up to 0.30m deep was added to the top of the west side of the drain probably to elevate the drain to the same height as the new road (Q05:27) and also to increase its depth.

To the west of the building the drain (L04:27, L05:52) continued in use, presumably to function with the internal drain.

The alleyway between Building 1 and 2 (Alley 1)

The distinction between the various surfaces or levels in the alley was really one of relative depths rather than different characteristics. The upper level of clay (L05:29, M05:12, N05:07, P05:16) above the level of the bottom of the new boulder foundation of the south wall of Building 1, was attributed to Phase 2. It consisted of light-brown clay, roughly 0.16m deep and contained fragments of stone including facers, probably from the alterations to the south wall at the beginning of Phase 2. At one point on the south side of the alleyway there was a deposit of slightly burnt daub and charcoal (N05:23, 24), possibly from the alterations to Building 1 in Phase 1, or even from the demolition at the end of Phase 2.

The roads relating to Building 1 in Phase 2***North intervallum***

The Phase 2 road surface was uncovered in a number of areas. It consisted of an extensively worn, single layer of cobbles (N04:07, P04:08), which were 0.04m to 0.08m in diameter, well packed and formed a definite horizon below the patches of rubble and stone scatter representing the re-surfacing of Phase 3. It was difficult to define the southern edge of the road as the north edge of the verandah occurred on much the same line as the north edge of the foundation of the Phase 1 north wall. Nevertheless there was evidence in the area to the north of the west entrance to the building, of the new road extending over the line of the former east-west street drain, 2.40m north of the Phase 2 north wall. This would increase the width of the road to 5.50m, from the verandah to the kerb of the rampart. Another area attributable to this phase occurred immediately south of the north-east interval tower, where the road surface (N04:11, P04:09) ran under the kerb which blocked off the tower at the beginning of Phase 3.

East intervallum

A surface of large river cobbles (Q05:27) was laid over the earlier *intervallum* road (Q05:26) with a layer of soil 0.03–0.04m deep separating them. This was a single layer of stone up to 0.20m deep. A kerb of flagstones (probably re-used drain covers) and large boulders, up to 0.30m in length, formed the western edge to the new road surface. This was set back 0.25m from the inner face of the drain (Q05:03) immediately east of Building 1, and lay on top of a thin layer of silt which covered the upper surface of the drain's east side. The height of the kerb corresponded roughly to the height of the clay pack (Q05:05) added to the west side of the drain and would have increased the overall depth of the drain to 0.80m.

The via praetoria

No surfaces of this road contemporary with Building 1 Phase 2 were exposed in the area immediately west of the building.

FINDS

Building 1 Phase 2***Demolition material/make-up over Phase 1 Building 1***

Samian stamp: 125–145 (no. S37, P05:08)

Coin: Trajan, 98–117 (no. 39, M05:15), Herennia Etruscilla, 249–51 (no. 138, L04:25)

Copper alloy: buckle (no. 153, M05:09)

Iron: stud (no. 59, L04:25), stud (no. 55, P05:08)

Phase 1 demolition material under verandah paving

Decorated samian: 125–140 (no. D140, Q05:25)

Copper alloy: rod (no. 131, P05:13), button-and-loop fastener (no. 192, M04:29)

Iron: slide key (no. 32, N05:18)

Bone: knife handle (no. 11, Q05:25), loop (no. 59, N05:18)

N–S drain east of East wall

Coin: Hadrian, 119 (no. 69, Q05:05)

Verandah paving

Mortarium stamp: 140–170 (no. 30, L04:20)

Glass: jug (no. 9, L04:20), window (no. 42, L04:20)

Graffiti: (no. 65, L04:20)

Stone: throwing stone (no. 102, L04:20)

East end – silt/cobble bedding layer

Decorated samian: 125–150 (no. D139, Q05:17)

Stone: whetstone (no. 14, Q05:17)

Interior clay surface

Copper alloy: junction loop (no. 181, N05:12)

Interior flagged floor

Iron: spearhead (no. 1, N05:05)

Later Phase 2 flooring cleaning, some unsealed

Samian stamp: (no. S48, M05:25)

Graffiti: (no. 14, M05:25)

Coin: Hadrian (no. 67, M05:28)

Copper alloy: bowl (no. 87, M05:28), loop (no. 352, M05:28)

Alley 1***Dump of demolition material (N05:23)***

Decorated samian: 125–140 (no. D122), 130–155 (no. D123)

Samian stamp: 135–50 (no. S76), early to mid Antonine (no. S90)

Mortarium stamp: 120–60 (no. 4), 120–60 (nos 9–10)

Graffiti: nos 1, 35, 55
 Glass: beaker/bowl (no. 3)
 Stone: throwing stone (lost)

Upper layers

Decorated samian: 150–80 (no. D111, M05:12)
 Samian stamp: 135–50 (no. S76, N05:07), Antonine (no. S126, N05:07)
 Mortarium stamp: 120–60 (no. 9, N05:07)
 Coin: Trajan, 114–7 (no. 62, P05:16)
 Iron: stud with copper alloy plate (nos 47, 48 (M05:12)
 Lead: strip (no. 15, M05:12)
 Stone: throwing stone (no. 120, P05:16)

North inte vā lum road

Phase 2 surface

Mortarium stamp: 140–180 (no. 27, N04:11)
 Coin: Vespasian, 67–79 (no. 9, N04:07)
 Stone: throwing stone (lost, N04:07)

Dating evidence

Phase 1 demolition/make-up for Phase 2

Two large groups from the interior, deriving from layers associated with the demolition of the barrack partitions and upper works, included a high proportion of BB2 and allied fabrics (up to two thirds of the coarse ware), Nene Valley ware and BB1 with obtuse-angle lattice (L04:25, M05:03). The presence of black sand amphora suggests a date after the middle of the third century (there was also a slightly worn coin of 249–51). Contexts identified as demolition and/or make-up contained samian of the late second or early third century, Horningsea and BB2 and allied fabrics, but also a sherd from a BB1 cooking pot with a groove above obtuse angle lattice, a few sherds of late gritty grey ware and at least three calcite-gritted ware vessels, providing a late third-century date (M05:09, P05:14).

Phase 2 walls

The foundations of the north wall produced a body sherd of Lower Nene Valley mortarium (third century or later), Nene Valley fine ware, BB2 and allied fabrics and a sherd from a BB1 cooking pot with a groove above obtuse angle lattice, providing a date in the second half of the third century (P05:09, Q05:09). Pottery from the south wall foundations consisted of a sherd of BB1 and a sherd of Hadrianic samian, while from the wall itself there were 11 sherds dating to the late second century (M05:07, N05:08).

Phase 2 flooring

The pottery from the silt/cobble bedding level in the north-east corner of the former officer's quarters

was made up of almost 85% BB2 and allied fabrics (Q05:17). This high proportion, and a Nene Valley ware sherd, indicate a third-century date. The large group from the verandah flagging (L04:20) produced a stamped mortarium of 140–70, and nine sherds of samian, including a burnt Form 37 dated 160–95 and an Argonne bowl or dish dated 150–200. There was a high proportion of BB2 and allied fabrics and a wide-mouthed bowl, possibly from Norton (which would indicate a third-century date). The pottery from the flagged floors in the interior was later in date, including a Lower Nene Valley incomplete mortarium rim dating after 230, a BB1 cooking pot with a groove above obtuse angle lattice, and a small quantity of late third-century material, including a sherd of Crambeck reduced ware, a sherd of calcite-gritted ware, and a flanged bowl in an unidentified reduced ware (M04:14, P05:04, N05:12).

Later Phase 2 alterations

This produced only nine sherds of pottery, of the late second century or later.

Alley 1 Phase 2 (upper level)

The upper layers of the alley fill (M05:12, N05:07 and P05:16) produced a large quantity of pottery (21.672kg excluding samian), much of it second-century in date. The locally produced wares make up 23.5% of the coarse wares. Out of 33 samian vessels, there were eight Antonine, two mid to late Antonine and only two of the late second or first half of the third century. BB2 makes up approximately 16% and south-east reduced ware 10% of the coarse wares. Other pottery of the third century include a Lower Nene Valley mortarium rim of the first half of the third century, Nene Valley ware and BB1 with obtuse angle lattice but no groove, and black sand amphora of the second half of the third century or later. All three contexts did include small quantities of late third- or fourth-century material; N05:07 in particular contained a number of calcite-gritted ware sherds, which included a Huntcliff-type rim. As the proportion of late third- and fourth-century material is so low, the late fourth-century Huntcliff-type rim almost certainly indicates contamination from the dereliction material that covered the alley. The other late third- or fourth-century material may therefore also belong to the late fourth-century assemblage.

North intervallum road Phase 2 (M04:06, N04:11, N04:21, P04:09)

Only two contexts associated with the Phase 2 north intervallum road surface had more than 15 sherds of pottery. Both had little BB2, suggesting a late second-century date, but N04:11 did have a few sherds of a third-century Nene Valley ware vessel.

Discussion: The function of Building 1 in Phase 2 (Fig. 14.06)

The interpretation of the Phase 2 Building 1 as a stable provides a sharp contrast to the 'stable-barracks' recently identified in the *retentura* and presumed to represent the accommodation for the cavalry component of an equitate cohort. Yet the evidence from Building 1 is unambiguous. The combination of a flagged floor to provide a hard-standing, a drain running the full length of the building and the lack of internal partitions would seem to suit no other function. The backfilling of the latrine at the east end of the building would suggest that area was no longer providing accommodation for an officer. Indeed, in all likelihood the area of former officer's quarters was not even partitioned off from the remainder of the interior. The internal drain along the south wall seems to have continued through without interruption and the partition wall (P05:10), which survived only a single course high when excavated, had probably been reduced down to its footings to form part of the building's flagged floor.

In any case, the existence of stable-barracks does not preclude the possibility that the Roman army also erected other types of stable buildings dedicated to that function alone. Not only was the space in the Wallsend stable-barracks strictly limited, with no room to accommodate remounts, but, perhaps more relevant in this context given the location of the building, infantry also needed stables to house baggage animals – doubtless oxen, mules and donkeys as much as horses – of which there must have been a large and varying population in all Roman forts. Officer's horses might also have required accommodation,

if these were not stabled in the centurions' houses. Building 1 was probably intended to perform such a role. A useful comparison is provided by the stable identified at Housesteads, Building XV Phase 3 (also a third-century building), which was located in a fort housing a peditate infantry cohort (though reinforced by a unit of Frisians which may have included cavalry). This was a broadly similar structure – a rectangular, undivided hall with a flagged floor, but featuring two parallel, capped drains running along its full length (Fig. 14.06). Building XV was double the width of Wallsend Building 1 and could probably accommodate two facing rows of animals. Another building furnished with a lateral drain which has been interpreted as a possible stable was located in the east rampart space at Vindolanda (Bidwell 1985, 72–4). It took the form of a rectangular building, 4.15m wide internally and in excess of 11.7m in length, set against the inner face of the curtain wall and this too was probably intended as general provision for pack animals rather than specifically for the cavalry mounts of the equitate cohort stationed there (Hodgson and Bidwell 2004, 128).

Building 2: Stone Phase 2 (Figs 14.07, 14.08)

Introduction

A substantial remodelling, evident right across the interior of Barrack 2, represented Stone Phase 2 in that building. This involved the demolition of the wooden partitions between the *contubernia* and the construction of stone walls instead, which probably

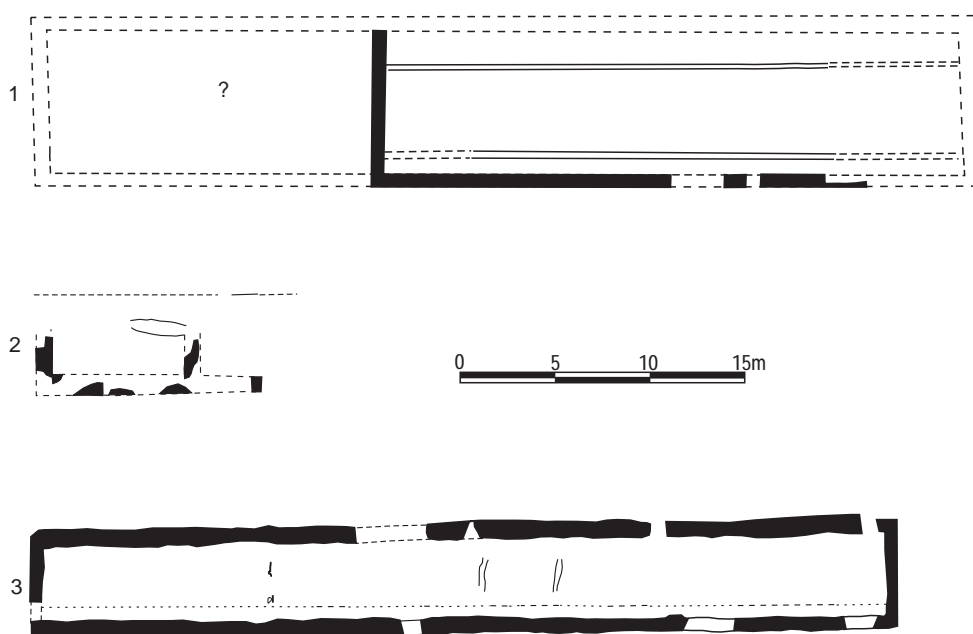

Figure 14.06: Stables at 1. Housesteads Building XV Phase 3, 2. Vindolanda, 3. Wallsend Building 1 Stone Phase 2. Scale 1:400



Figure 14.07: Building 2, Phase 2 at 1:200.



Figure 14.08: Building 2, looking from the west end of the block showing the third-century barrack levels.

separated one fewer *contubernia* than previously, whilst the floors were covered with a further level of stone flagging. The spacing of the walls was not very regular, varying between 3.30m and 4.30m. Considering the extra space taken up by the stone walls, by comparison with timber partitions, and even using the minimum *contubernium* width as an average for those *contubernia* which were not uncovered, the maximum possible number of *contubernia* that could be fitted into the estimated space in Phase 2 would be eight. The lack of a cross-wall in the most westerly *contubernium* might imply that this performed a specialised function – equipment storage for instance – which would further reduce the potential size of the *centuria* occupying the Phase 2 barrack block.

The four westerly *contubernia* were investigated in most detail, the wider area available for excavation there enabling a structural sequence to be established which could also be applied to the eastern *contubernia*, where fewer features were recorded. No part of the centurion's house, which lay beneath Buddle Street, could be exposed so the extent of any contemporary changes there is unknown.

The Phase 2 *contubernia*

Contubernia 1 and 2

The very north end of the partition wall (M05:46) separating *Contubernia 1* and *2* was revealed. The wall was 0.70m wide and composed of sandstone facing stones bonded with clay, but lacking any obvious core material.

Contubernium 3

Fragments of a stone flagged floor (M05:47) attributable to this phase were found over the area corresponding to *Contubernium 3*, overlying an earlier phase of flags (M05:48).

Contubernium 5

Two courses of the dividing wall (M05:21) between *Contubernia 5* and *6* survived intact. This was 0.65m wide and composed of keyed sandstone facing stones, on average 0.20m wide × 0.15m deep, bonded with grey clay and with a rubble core. Over 2.50m of the wall was exposed. The northern end of the wall was indicated by a rubble-filled robber trench (M05:22). Fragments of a stone-flagged floor (M05:13), 0.10m deep, were found over some of the room. The levels of flagging in this area were complex and never fully disentangled, but this context probably embraced at least two and possibly three sub-phases of flagging. The lowest layer, designated M05:45, was overlain by the stone partition wall (M05:44) which separated *Contubernia 4* and *5*. The higher flags were, in part at least, contemporary with the partition wall, as some of the flags appeared to respect it, whilst others were, less certainly, recorded as extending over the wall line and may represent a later modification.

Partition wall M05:44 was somewhat irregularly constructed and some uncertainty was expressed in the excavation and post-excavation records as to whether it belonged to the initial Phase 2 reconstruction of Building 2 or a later modification ('Building K'). A 2.00m length of the wall was recorded, which varied in width between c. 0.60m at its north end, where it comprised two faces of keyed sandstone blocks with a clay and rubble core, narrowing to 0.45m further south, where it was constructed solely of large facing blocks, 0.15m to 0.35m wide and 0.15m deep, one stretching right through the wall. The partition has been assigned to Phase 2 here, as its spacing would give *Contubernium 5* a width (3.50m) in the same range as *Contubernia 7* and *8* (3.60m and 3.20m), whilst its construction was not that dissimilar to stone partition M05:46 further east. Moreover, the analogy with neighbouring Building 1, where flagged floors were clearly present in Sub-Phase 2 of the Phase 1 stone barrack, demonstrates that the underlying flagged floor M05:45 need not belong to Phase 2 as was initially assumed.

Contubernium 6

A robber trench (L05:49), 0.60m wide and 4.30m from the east wall (M05:21) of the room, indicated the dividing wall between *Contubernia 6* and *7*. This trench and the internal wall (M05:21) were respected by the flagged floor of the room (L05:24). The floor was mostly worn small fragments of stone interspersed with large complete flags on average 0.08m deep.

Contubernium 7

The wall (L05:09) dividing *Contubernia 7* and *8* survived for 3.00m from the robber trench of the north wall of the building. It took the same form of construction as M05:21. Two courses, including the

offset, were uncovered at the north end. It was situated 3.60m from the robber trench (L05:49) marking the line of the east wall of the *contubernium*. Several small fragments of flagging (L05:53), representing the floor of the Phase 2 *contubernium*, could be seen underlying the later clay makeup or floor (L05:33) in the section (S47) across the north part of the room. The flags were bedded on and interspersed with a layer of grey-brown loam (L05:40), on average 0.08m deep. Lenses of coal were intermixed in the surface of this loam where the flagging was absent and presumably also reflect occupational activity associated with this phase of the *contubernium*.

A cross wall (L05:08), located some 2.80m from the north wall, may have been erected in this phase, dividing the *contubernium* into two rooms in the manner typical of Roman barracks. The wall was constructed with regular dressed blocks, on average 0.30m wide × 0.16m deep, and bonded with grey clay. Apart from a solitary block of the second course, the wall survived as a single course of masonry. The west end of the wall butted up against the east face of wall L05:09, whilst a gap, 1.00m wide, at the east end of the cross wall probably represented a doorway between the north and south rooms. This construction of this wall was considered by the excavators to have belonged to the subsequent structural phase ('Building B Phase 1' – see below). However, the cross wall's relationship to the initial flagged floor in the Phase 2 *contubernium* (L05:53) is not recorded in site notebook and there are no definite stratigraphic grounds for allocating it to the next sub-phase, rather than the initial stages of the Phase 2 building, as suggested here, though either is possible. These arrangements are not paralleled in any of the other *contubernia* of Building 2 Phase 2, but, given the area that was available for study, clear evidence would only be anticipated in *Contubernia* 8 and 6.

Contubernium 8

This *contubernium* measured 3.20m wide from the west wall (K05:16, L05:26) of the building to the east wall (L05:09) of the room. A substantial flagged floor (L05:45) covered most of the room, forming a flat, uniform surface, respecting the west edge of the partition wall. It consisted of fairly regular small flagstones, well laid, slightly worn and on average 0.08m deep. There was no trace of a cross wall associated with flagged floor or overlying it, and it does not therefore appear that this *contubernium* was divided into front and back rooms in the normal manner. This pattern is repeated in barrack plans elsewhere and may imply that *Contubernium* 8 was used for storage or some kind of specialised accommodation, rather than housing a squad of soldiers.



Figure 9 The latest surviving levels in the rear room of the 3rd-century Barrack 2 Contubernium 7 (Daniels Building B), looking north.

Later alterations to Building 2 ('Building B, K and M')

Introduction

The reconstructed barrack subsequently underwent a series of modifications during the course of the third century comprising the laying of new floors and alterations to the internal partition walls. These modifications can be traced most clearly in the western half of the block, where a greater area was available for investigation, particularly in *Contubernia* 5–7 and, to a lesser extent, in *Contubernium* 8 (Figs 14.09, 14.10).

The excavators in 1975–6 had interpreted these alterations in a very different fashion, as constituting a distinct phase involving the demolition of most of Building 2 and the erection of three small, irregular 'shack'-like buildings over the site (See Chapter 1: Figs 1.07, 1.08). These 'shacks', labelled 'Buildings B, K and M', were thought to re-use the north wall and the former *contubernia* dividing walls of Building 2, whilst the west wall of Building 2 was demolished to the level of the lowest course and incorporated into the new road surface. Three phases in the occupation of these structures were defined by the excavators on the basis of floor types, which in turn were attributed to Periods 3 and 4 of the fort, corresponding to the early and mid-late fourth century respectively.

However, analysis of the datable material evidence from the floors and features associated with B, K and M (see below) indicates that these structures probably did not outlast the third century – and in fact probably had no greater lifespan than Building 1 to the north – and in turn necessitates a re-examination of the structural evidence regarding north-eastern shacks. Daniels' own interpretation makes it clear that B, K and M were not freestanding structures but formed part of a single range, reusing the north wall of Building 2. Moreover, it was also recognised that there were probably more structures related to



Contubernium 7, Phase 2.3

Figure 14.10: Building 2, later modifications to the Phase 2 barrack at 1:200.

this group to the east of Building M, as evinced by the 'fragments of late walls and floors' uncovered there (actually the partitions and floors of *Contubernia* 1–3 in Building 2 Phase 2 – see above). Although Daniels suggested that the south wall of Building 2 might have been demolished, there was no direct evidence as the wall lay to the south of the limit of excavation, underneath Buddle Street. The evidence with regard to the west end and south-west corner of Building 2 was less clear-cut and is analysed in detail below, but it may be as readily interpreted to indicate continuing occupation of this end of the range as to suggest abandonment. In effect all the structural activity recorded under the heading of Buildings B, K and M may simply represent the latest phases of the western *contubernia* of Building 2, with B, K and M corresponding, respectively, to *Contubernia* 7, 6 and 5, and need imply no truncation of the range whatsoever, either to the east, west or south.

The initial perception of these structures as late-Roman buildings may be blamed on the rigid framework imposed by the four-period Wall chronology prevailing at the time of excavation (1975–6), which conditioned the excavators to expect Diocletianic and Theodosian construction phases and interpret the surviving remains in that light. Consequently, it was considered highly significant that, following the removal of the post-Roman overburden, the western *contubernia* of Building 2, and 'Building B' in particular, were apparently not covered by the demolition rubble which overlay Building 1 and much of the rest of Building 2 (but note rubble L05:07 over much of 'B' as well as *Contubernium* 8 to the west). Rather than this simply being treated as the reflection of depositional survival, it was regarded as evidence that 'B, K and M' belonged to a later period after the dismantling of the Phase 1/2 barracks and stables in the *praetentura*. Moreover, their apparent irregularity and flimsy character, as surviving, seemed appropriate to the peasant militia of farmer-soldiers, which the late Roman *limitanei* were then thought to represent.

Three sub-phases were defined within the rooms on the basis of floor types, labelled 'Building B, K and M, Sub-Phases 1A, 1B and 1C'. These multiple sub-phases can be reformulated as Stone Phase 2, Sub-Phase 2 of Building 2.

Contubernium 8

The excavators did not consider *Contubernium* 8, the westernmost component of Building 2, as one of the Period 3 and 4 structures, like B, K and M immediately to the east. It was thought that the west end of the range had been truncated as a result of the widening of the *via praetoria*. However there is clear evidence for a further phase in this westernmost *contubernium* which possessed the same characteristics as those encountered in the neighbouring *contubernia* and

attributed to Periods 3 and 4 by Daniels. The original Stone Phase 2 flagged floor (L05:45) was covered by a dirty loam layer (L05:44), perhaps a combination of occupation trample and makeup material. This layer was in turn overlain by a flagged surface (L05:28), which survived only sporadically. All these features and deposits were covered by rubble probably deriving from the demolition of the building (L05:25). Flagging L05:28 and makeup L05:44 were recorded as abutting the secondary west face of the rebuilt dividing wall between *Contubernia* 8 and 7 (L05:10), which clearly overlaid the earlier flagging, L05:45, and reduced the internal width of 8 to c. 2.70m. Again no evidence was found for a cross wall sub-dividing the *contubernium* into front and back rooms in this phase.

Contubernium 7 ('Building B') (Figs 14.09, 14.10 inset, 14.11)

The west wall of *Contubernium* 7 was rebuilt using the west face of the previous dividing wall (L05:09) to form the new east face, while a new west face (L05:10) was constructed over the earlier flagged floor of *Contubernium* 8 of Phase 2. Very little of the new west face had survived whilst the north and south ends of the wall had also been completely robbed away. The dividing wall between *Contubernia* 6 and 7 remained in use in this sub-phase. Only the robber trench (L05:49) remained to mark this line. This was 4.00m from the altered west wall. The cross wall (L05:08) separating *Contubernium* 7 into front and back rooms also remained in use in this phase, if indeed it was not actually built new at this time. It was interpreted by the excavators as the south wall of Building B, but is much more likely to represent the base of a partition wall of the kind commonly found sub-dividing barrack *contubernia*. The south-east corner of the north room had been damaged by post-Roman activity and robbing, removing the junction of the south and east walls. Later robbing (L05:37, M05:31) had also removed the junction of the north and west walls of *Contubernium* 7.

Modern pits (L05:05, 27) had damaged the interior of the *contubernium*, but a layer of grey-buff clay (L05:33), on average 0.08m deep, was uncovered over most of the room (Fig. 14.11). Lenses of coal were found in the upper surface of the clay (L05:14). The clay respected the edges of the south and west walls and extended across the entrance in the south east corner of the room. It overlay the earlier flagging (L05:53) and loam floors (L05:40) of Building 2 and also the former east face of the dividing wall (L05:09). This was interpreted as a floor surface in its own right but may simply represent make up for the flagged floor laid on top (L05:23). Fragmentary remains of this flagging (L05:23) were found over the clay layer and extended over the south-east entrance into the room. One large shattered flagstone on the east side of the room may have been used as

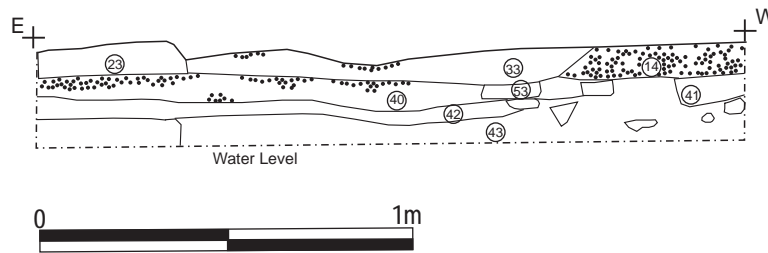

Figure 14.11: Section (S47) across the south face of modern pit L05:27 in Building 2, Contubernium 7, Scale 1:20.

a hearth as the upper surface appeared to be coal blackened. Three small circular pits (L05:39a, b, c) had been dug into the clay layer below. They varied from 0.10m to 0.25m in diameter and had probably all contained pots originally, as one still retained the entire lower part of a BB2 cooking pot (L05:38). The upper portions of this had been burnt by a hearth (L05:12) from the subsequent phase. Several large flags (L05:13) occurred in the area immediately south of the cross wall. These were interpreted as part of a street resurfacing south of the range. However it is more likely that these flags represent the floor in the southern half of the *contubernium*, the front room or *arma*.

A north-south partition, indicated by a 1.50m long line of small upright flags and stones (L05:22), was erected 3.00m east of the west wall of the *contubernium*. This was interpreted as a further alteration to this part of the building, involving the dismantling of the previous east wall of the *contubernium* and its replacement by the new partition. However it is also possible that the partition simply defined a 0.90m wide passageway running along the east side of the north room, screening off that room, and might therefore belong to same overall phase as secondary floor. Access into the room may have been at the north end of the partition where there is a gap between the end of the upright stones and the north wall of the building. A layer of coal and ash (L05:14) 0.03m deep lay over the flagged floor of the interior (L05:23). This respected the west and south walls of the north room (*papilio*) and was limited to the east by the line of partition uprights (L05:22). A small hearth of burnt clay (L05:12) was uncovered towards the south-east corner of the room on the edge of the coal spread. No equivalent changes were recorded the other *contubernia*.

Contubernium 6 ('Building K')

The previous flagged floor of Contubernium 6 (L05:24) was covered with the same kind of dirty buff-grey clay (L05:34, M05:33), that overlay the interiors of Contubernia 7 (L05:33) and 5 (M05:11). This lay over the whole floor and respected the edge of the east wall of the room (M05:21) and was cut by the robber trench (L05:49) of the west wall. There was no evidence for an east-west partition dividing

Contubernium 6 into front and rear rooms, as the clay layer extended beyond the line of partition wall L05:08 in the adjacent Contubernium 7 and continued right up to southern limit of the excavation trench. The clay was interpreted by the excavators as a distinct floor surface ('Building K Phase 1A'), as was the case with regard to the neighbouring *contubernia*. However it is probably better understood as a makeup layer for another flagged floor (L05:50, M05:32) which survived only in small patches in this *contubernium*, apart from an area of very small shattered pieces over the south-west side of the room (Daniels' Building K Phase 1B).

Contubernium 5 ('Building M')

The north-west corner of the room was covered with a clay layer (M05:11) similar to those in Contubernia 6, 7 and 8. It respected the party wall (M05:21) and was cut by the robber trench of the north wall (M05:31).

The roughly constructed north-south wall (M05:44), found 3.50m east of the party wall (M05:21) between Contubernia 5 and 6, was initially assigned to this phase and interpreted as the east wall of Building M. However, as discussed above, this wall could more readily be attributed to the initial layout of Stone Phase 2 of Building 2. Subsequently the wall may have been dismantled to the level of the first course and a flagged floor (M05:13) extended over the top. As noted previously, the context number M05:13 seems to have been applied to perhaps as many as three distinct layers of flagging superimposed one over the other, forming an area of substantial flooring 0.10m deep across the northern part of the room. Whilst the intermediate layer respected M05:44 and can therefore be assigned to the beginning of Phase 2, the uppermost layer (to which the context number M05:14 could also possibly be applied) appeared to extend over the *contubernium* wall, although this is not altogether certain. A new east wall which should be associated with this upper flagging was not located.

In the area east of Contubernium 5, where a progressively smaller slice of the building was investigated, no levels attributable to this phase were identified.

Roads and drains related to Building 2

None of the drains which functioned with Building 2

were uncovered. The only area of roadway available for examination near Building 2 was the *via praetoria*. Unfortunately, due to insufficient time the road surface could not be investigated below the surfaces related to the period following the demolition of Building 2.

FINDS

Contubernium 6, *Three levels of flagged floor-several sub-phases*

Copper alloy: stud (no. 259, M05:13)

Contubernium 5, *Sub-phase 2 clay floor (M05:11)*

Coin: Caracalla, 198–211 (no. 124)

Copper alloy: brooch (no. 27), nail (no. 137), stud (no. 286), loop (no. 368)

Iron: spearhead (no. 6), loop (no. 68)

Glass: bead (no. 26)

Pottery: south-east reduced ware perforated disc (no. 14)

Contubernium 6, *Sub-phase 2 clay make-up or floor*

Lead: pierced disc (no. 23, L05:34)

Contubernium 8, *Sub-phase 2, east wall*

Stone: palette (no. 4, L05:54)

Contubernium 8, *Sub-phase 2, soil make-up over flags (L05:44)*

Copper alloy: belt plate (no. 147)

Iron: hobnails (no. 76)

Contubernium 8, *Sub-phase 2, demolition rubble (L05:25)*

Samian stamp: 140–170 (no. S22)

Copper alloy: rod (no. 135), bell-shaped stud (no. 273)

Pottery: grey ware counter (no. 71)

Stone level (unphased) on S side of Barrack N wall (N05:16)

Flint: flake (no. 5, N05:16)

Iron: spear (no. 3, N05:16), ferrule (no. 14, N05:16)

Copper alloy: fitting (no. 173, N05:16)

Dating evidence

Phase 2 flooring

The flagged flooring in *Contubernium 5* (M05:13) produced only seven sherds of pottery, including a few sherds of BB2, providing an Antonine *terminus post quem*. Some of this material may have been contemporary with the building's Phase 2 reconstruction, but this could not be confirmed as context M05:13 was found to consist of up to three layers of flagging. The lowest of these (renumbered M05:45) probably related to the Stone Phase 1 barrack, whilst the intermediate layer was associated with the

Phase 2 reconstruction and the uppermost layer may have represented a later alteration to the *contubernium*.

Later modifications

Much of the pottery associated with the later modifications to Building 2 was of a similar date to that connected with the beginning of Phase 2. A single sherd from a south-east reduced ware cooking pot (L05:54) was found in the core of the rebuilt wall between *Contubernia 7* and 8. A layer of floor-make-up in *Contubernium 6* (K) contained an Antonine Form 33, local grey wares and a single BB2 bowl/dish (L05:34). Later pottery came from the soil make-up layer (L05:44) which overlay the earlier Phase 2 flagging in *Contubernium 8* (L05:45) and produced a large group of pottery (1.386kg, excluding samian). As well as material dating from after the mid-third century, such as black sand amphora, it also included a number of sherds of Crambeck reduced ware and calcite-gritted ware of late third-century date (L05:44). The floor L05:33 in *Contubernium 7* had had a BB2 cooking pot set into it (L05:38), although only the lower half of the vessel has survived.

The presence of the later third-century wares in the makeup layer for *Contubernium 8* (L05:44) may be significant. The layer was certainly not completely sealed beneath the very patchy flagging above (L05:28), so the later third-century material it yielded could conceivably be intrusive. However a small quantity of similar material was found in association with the Phase 2 flagged floor in Building 1 and it is therefore quite possible that the life of the Phase 2 barrack continued into the late third century or very early fourth century, when Crambeck reduced ware and calcite-gritted ware was first appearing on the northern frontier.

Building 3

Introduction: Daniels' Phases 3 and 4

The most southerly barrack block in the *praetentura*, Building 3, was also rebuilt with stone partition walls like Building 2. This period of activity equated to Daniels' Building 3 Phases 3 and 4, which were assigned dates of c. 300 and 370 respectively. Phase 4 was differentiated from Phase 3 by a replacement stone floor and rebuilt partition wall, for example, but does not appear to have represented a radical alteration to the layout of the Phase 3 building. Four partition walls attributed to Phase 3 were identified along the 29m exposed length of the building. The excavators interpreted these as dividing that part of the building into four rooms, labelled, from west to east, BE, BF, BG and BH (see Chapter 1: Figs 1.07–1.08), with the easternmost BH being significantly narrower than BF and BG (too little remained of BE for any reliable judgement of its extent). These

rooms were initially termed chalets by the 1983/84 excavation team, apparently because they were the latest structures evident in this area and it was accepted that fourth-century frontier troops were accommodated in chalets. It is clear, however, that BE-BH did not represent chalets – they lacked the separate side walls with intervening alleys, which form the distinguishing feature of chalet-*contubernia*, and were never restored as having such features by the excavators. The rooms were only ever shown as separated by common party walls and forming a single conjoined rectangular block. Indeed, during the later stages of the Daniels post-excavation programme, the interpretation of these rooms as a range of chalets was abandoned and the building codes BE-BH were not used to categorise contexts in the final database, for example.

The layout of the remodelled barrack

Instead of a range of chalets what was actually revealed were two rooms of the rebuilt centurion's house (BG and BH), plus a narrow tapering slice at the rear of several *contubernia* (BE and BF), all forming part of a conjoined barrack block (Fig.14.12). Only one partition wall was identified in the exposed area of the *contubernia*. Others may have been removed by later robbing. This, together with the very limited area uncovered, made it more difficult to understand the layout of the stone *contubernia*. The surviving partition wall was located c. 6.30m from the west wall of the officer's quarters. This would appear abnormally wide for a single *contubernium*, by comparison with those recorded in the better preserved of the third-century *praetentura* barracks such as Building 2 and parts of Building 18, although this is how it was interpreted in the final stage of Daniels post-excavation work, with BF being relabelled *Contubernium* 1 and BE *Contubernium* 2. Based on that spacing, five of these enlarged *contubernia* would fit into the available length of the barrack, allowing for a little minor variation. Alternatively it is possible that an intervening partition wall had been removed leaving no trace. 'Building BF' would then equate to the two easternmost *contubernia*. However these would be uncharacteristically narrow with internal widths of perhaps 2.85m each. If that spacing was replicated in the rest of the block a total of ten *contubernia* could have been squeezed into the available length, one more than in the preceding Phase 1/2 stone barrack, whereas the arrangements exhibited in the better preserved of the rebuilt stone barracks generally seem to imply a reduction in the number of *contubernia* to no more than eight. This contradiction might be resolved if there were smaller rooms at either end of the range which performed functions other than accommodating troops, such as storage or a service area for the officer's house. The Daniels scheme would

thus certainly fit the available evidence, but, in view of its anomalous nature, the presence of a second partition wall at the same spacing would be required to provide confirmation of its validity. The alternative layout would conform better to the arrangement of *contubernia* found in other barracks, but requires more extensive restoration of lost structural elements and again definitive proof is lacking.

External walling

The south wall of the building may have been partially rebuilt as part of this remodelling (Fig. 14.13). Certainly there is clear evidence that the wall underwent at least partial reconstruction at some stage. At four points the wall had been demolished down to its foundations or lowest course and then rebuilt using cobbles and boulders set in yellow clay (M07:18, N07:17, N08:47 and *see* unnumbered stretch on P421). These sections were respectively at least 2.25–3.00m, 3.50m, 1.00m and 1.25m in length and appeared too wide and too ragged to represent doorways, created and then later blocked up, which in any case would only have given access to the narrow alley between the barrack block and Workshop Building 16. The character of the rebuild admittedly does appear rather crude by comparison with the new partition walls (see Fig. 14.14) so might represent a later repair, unless the surviving repair fabric was only the equivalent of a foundation level – perhaps similar to the cobble footing of the rebuilt south wall of Building 1 – with better quality masonry erected above which has not survived.

The centurion's quarters

The partition wall separating the officer's house from the range of *contubernia* was rebuilt slightly to the west of its predecessor. Only the east face of this wall remained (P07:15), 0.30m west of the equivalent face of earlier wall P07:23. It was composed of oblong blocks up to 0.50m in length, laid along the line of the wall.

The house was now divided into two rooms by a north-south oriented partition wall (P07:14, P08:23.1). A 2.40m long section of that wall's east face survived and at one point the full width of the partition could be measured at 0.55m. A further stub of masonry, only 0.50m wide, remained at the wall's junction with the south wall and clearly butted up against the south wall of the building rather than being bonded into it like the primary west wall of the centurion's quarters (Fig. 14.15).

The east room

The east room was the smaller of the two rooms measuring 3.50m wide internally, from east-west. Its north-south internal dimensions are likely to have

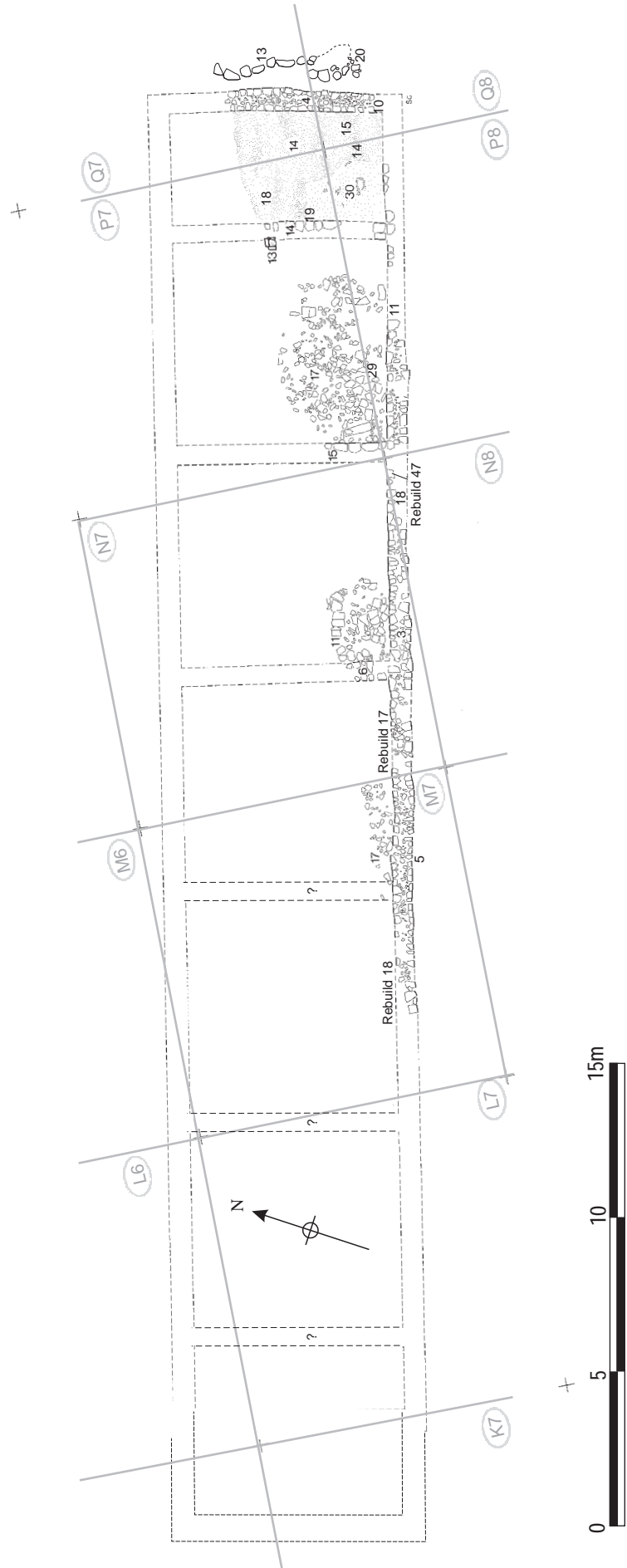

Figure 14.12: North Barracks, Building 3, Phase 3 at 1:200.

been c. 6.70m. In the south-west corner of the room, a floor horizon of dark silty clay and carbon (P07:19, P08:30) was exposed and was found to contain bronze working debris. This was the lowest level examined in this part of the officer's quarters. To the north and east a mid-brown earth floor (P07:18, P08:14, Q07:14, Q08:15) was present across the remainder of the room's interior. The precise relationship between these two levels was unclear, with the mid-brown soil layer being variously recorded as abutting, overlying and/or containing P07:19/P08:30. Comparison of site plans P415 and P421 implies that P07:18/P08:14/Q07:14/Q08:15 did indeed originally extend over P07:19/P08:30 in the south-west corner before further excavation revealed the latter. However it is uncertain whether P07:19/P08:30 was a distinct floor present across the whole room or simply formed part of the same overall floor level as the mid-brown soil, since the remainder of that soil, further north and east, was not removed.

A large, roughly rectangular, flagged hearth (P07:12, Q07:11), measuring c. 1.20m (E–W) by 1.80m (N–S), was constructed towards the centre of the east room, set on the mid-brown earth floor, P07:18/P08:14/Q07:14/Q08:15. Overlying the flags, a small, oval patch of burnt clay (P07:06), 0.55m by 0.35m, was presumably associated. This hearth was attributed to a separate phase (Phase 4) in the original post-excavation records, but it could easily be associated with the earth floor and form part of the same structural episode.

The west room

The larger west room measured c. 6.35m internally, from east to west. A stone layer, composed of a mixture of flags and smaller rubble (P07:17, P08:29), covered the interior of the room, becoming sparser to the east, next to partition wall P07:14/P08:23.1, and was interpreted as a possible floor level. A post setting (P07:13), perhaps for a door post, was set against the west face of the internal partition wall (P07:14) and took the form of a roughly square arrangement of packing stones measuring c. 0.40–0.50m on each side.

Later alterations (Fig. 14.16)

The internal partition wall dividing the house into east and west rooms was rebuilt slightly further to the west (P08:23.2). As excavated this was c.0.75m

wide and composed of small narrow dressed rubble facing stones, but it the stones appeared to have been displaced and spread, presumably as a result of post-Roman disturbance, so the wall's original width cannot be accurately estimated. The relocated wall appeared to fall in line with post-setting P07:13.

A second stone level composed of large flagstones and rubble was laid in the west room (P07:11, P08:26). The largest of the flagstones were c. 0.65–0.85m long and 0.35–0.60m wide.

A layer of light yellow clayey soil incorporating a few dispersed flags (P07:10, P08:13, 28, Q07:08, 12, Q08:09) was present right across the interior of the east room and extended over the line of wall P08;23.2 into the west room. This was tentatively interpreted as a proper floor level by the excavators, but subsequently



Figure 14.13: South wall of Barrack 3 in grid square M07.



Figure 14.14: Elevation showing the north face of the blocking N07:17 in the south wall of Building 3 (N7:03). Scale 1:40.



Figure 3 The south east corner of Building 3 the area of the centurion's quarters, looking east.

more cautiously appraised during post-excavation as perhaps associated with the abandonment of the building, presumably in view of the deposit's wide extent which did not appear bounded by the limits of any one room. To the west, there was a mixture of flags and rubble in a dark soil matrix (P07:08, P08:12), again not forming any kind of proper surface, and, like the light clayey soil, partially overlain by a further spread of disturbed rubble (P07:07), representing post-Roman disturbance.

The contubernia

Only one of the stone partition walls separating the *contubernia* survived (N07:06), the remainder probably having been robbed out. A 0.90m length of the wall was exposed some 3.20m west of the officer's quarters. This butted up against the south wall of the building and was 0.60m wide, with stretches of both faces and the rubble core being preserved.

Areas of flagged flooring survived in two parts of the *contubernia* range. The better preserved (N07:11) was found on the east side of wall N07:06, an area corresponding to the south-east corner of *Contubernium* 1 (BF) under the Daniels schema and the southern end of the first full-size *contubernium*

under the alternative interpretation. Further west, in Daniels *Contubernium* 2 (BE), a more disturbed stone level was recorded which probably represented the fragmentary remains of a flagged surface intermixed with post-Roman rubble disturbance (M07:17).

To the east of flagging N07:11, extending towards the west wall of the centurion's quarters, only a dark soil layer (N07:13) was noted, which may reflect later disturbance rather than constituting a discrete, stratified Roman level. Overlying this soil and flagging N07:11 was a rubble spread in a dark soil matrix (N07:08), extending west of wall N07:06 (as N07:07) where it incorporated flags like M07:17, but in this case there was no suggestion that any remains of a distinct surface survived, however fragmentary.

Roads associated with Building 3

Alleyway between Buildings 3 and 16 (Alley 2)

The narrow alley between Buildings 3 and 16 was only investigated to a limited degree. The lowest level exposed comprised was a rubble and earth deposit (M07:16, N07:12/16, N08:44) filling the alley which included loose pitched stones and appeared to represent the tumbled remains of the south wall of Building 3. This was overlain by an extensive spread of disturbed rubble and flags (M07:07, M08:09/13, N07:09, N08:15/17, P08:21, Q08:17) which covered much of Building 16, including the robber trench for its north wall (L07:08, 23, M07:13, N08:41, P08:27), as well as Alley 2 itself (see Chapter 11: Workshop Building 16).

East intervallum (Road 7)

A layer of soil (Q07:10, Q08:17.1) extended over the remains of the original *intervallum* drain (Q07:15, Q08:18) alongside the east wall of the barrack. This was interpreted as the possible remains of a midden. An irregular drain channel (Q07:13, Q08:20) was cut into this soil replacing the earlier drain. The northern half of this drain used the end wall of the barrack as its west side whilst a single line of large blocks of rubble and oblong boulders formed the east side wall (Q07:13), with some of the stones being set on edge. The channel gradually widened from 0.20m at its narrowest point to the north to as much as 0.85m to the south where it then either abruptly narrowed again to 0.25–0.45m if stone alignment Q08:20 still formed the east side wall or perhaps diverged away from the end of the barrack (if Q08:20 formed the west side with the east side having been robbed out). The surviving evidence is ambiguous, but it is possible that this drain was realigned at some stage in its history.

On the east side of the drain, some 2.80m from the end wall of the barrack, a line of three large stones was preserved (Q08:08). These totalled 1.60m in length, forming a straight edge on their west side,

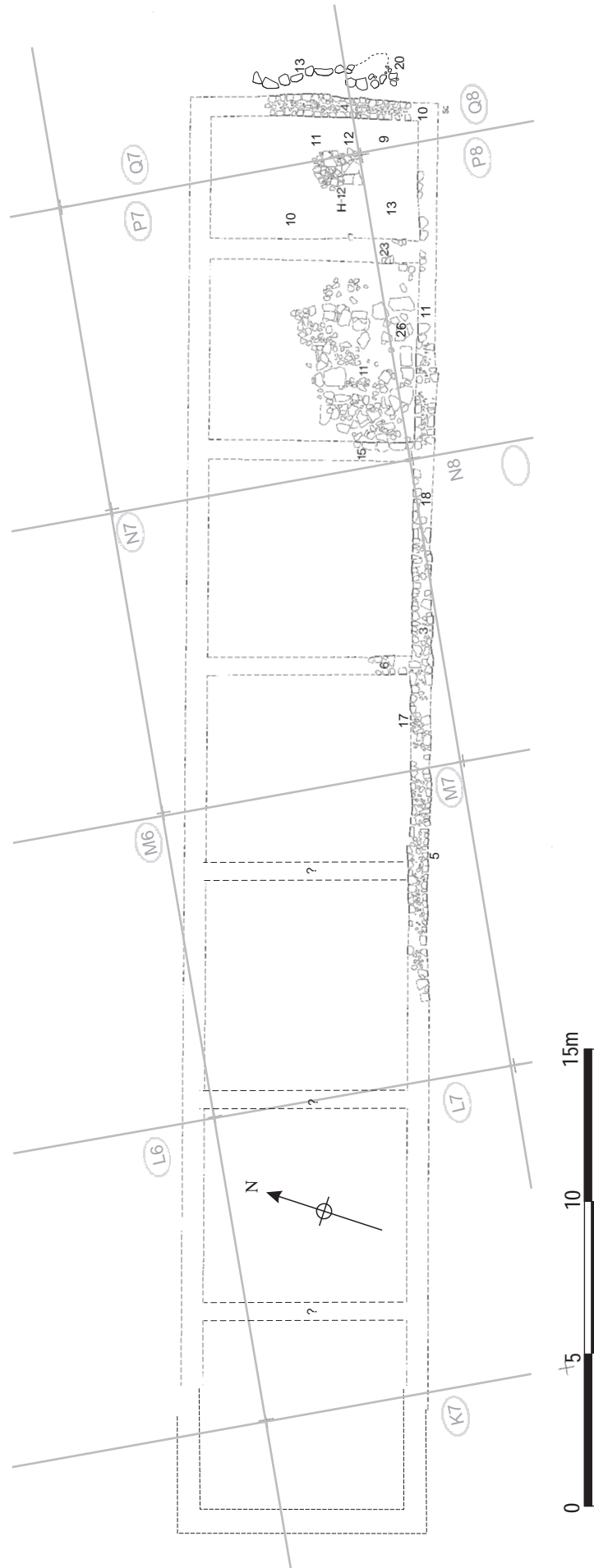

Figure 14.16: North Barracks, Building 3, Phase 4 at 1:200.

and may represent the fragmentary remains of a late kerb for road.

Finally, covering most of the remains of the *intervallum* road and extending over part of the rampart area, was a rubble spread in a dark soil matrix (Q07:07, Q08:11) which probably reflected the impact of post-Roman plough disturbance on the latest levels of the street.

FINDS

Dividing wall between Contubernia 1 and 2

Copper alloy: stud (no. 293, N07:06)

Centurion's quarters east room – possible earth floor

Coin: Hadrian, 119 (no. 70, Q08:15)

Lead: disc (no. 31, P08:14)

Glass: counter (no. 7, P08:14)

Phase 3 soil over N–S drain east of building

Graffiti: (no. 19, Q07:10)

Copper alloy: brooch (no. 38, Q07:10)

Pottery: statuette (no. 1, Q07:10)

Stone: mould (no. 50, Q07:10)

Overlying rubble disturbance

Coin: Vespasian, 70–3 (no. 13, P07:10), Trajan (no. 31, P07:07), Lucilla (no. 112, P07:07)

Copper alloy: brooches (nos 13, P07:07; 19, P07:10), key handle (no. 95, P07:08), stud (no. 250, P07:10), loop (no. 334, N07:08)

Iron: strip (no. 74, P07:07)

Stone: palette (no. 3, P07:07)

Flint: gaming counter? (no. 19, P08:13)

Quern: lava (no. 40, P07:08)

Tumbled rubble and earth in the alley

Samian stamp: 130–40 (no. S60, N08:44)

Rubble disturbance over the east intervallum road and rampart

Amphora stamp: 120–160 (no. 3, Q07:07)

Coin: illegible (no. 247, Q07:07)

Copper alloy: rod (no. 329, Q07:07)

Pottery: spindlewhorl (no. 15, Q07:07)

Decorated samian: 130–60 (no. D143, Q08:11)

Samian stamps: 160–200 (no. S47, Q08:11), 100–20 (no. S62, Q08:11)

Dating evidence

Very little securely stratified datable material was recovered from the later phases of Building 3, but such as there was, notably sherds of BB2 from the dividing wall between *Contubernia* 1 and 2 (N07:06), is compatible with a third-century date, however this context was also contaminated with modern pottery.

Phase 3 midden over the Phase 1 N–S drain east of Building 3

The soil/midden deposit (Q07:10) over the drain contained 1.293kg of pottery (excluding samian), made up of approximately 56% BB2 and allied fabrics. There was also a Mancetter-Hartshill multi-reebed rimmed hammerhead mortarium dated 230–340.

Rubble disturbance

The pottery was not catalogued in detail, but the rubble over the officer's room produced a BB1 flanged bowl and a Crambeck reduced ware beaker of the late third century or later, a calcite-gritted ware proto-Huntcliff rim and a fourth-century l'éponge bowl (P07:07, P07:08; Fig. 22.16, no. 112). A genuine Huntcliff-type rim was found in the rubble over *Contubernium* 2 and possibly also in the rubble over the officer's quarters (N07:07, P07:07, P07:08). The rubble also contained a sherd of seventeenth-century English Red ware and another of possible early Black ware of late sixteenth/early seventeenth-century date (P07:08).

Alley 2

The rubble in the alley (M07:16, N07:12, N08:44) contained a sherd of Nene Valley ware (in M07:16), but much of the other material could be second-century in date.

The date of Stone Phase 2 in Buildings 1, 2 and 3

It is reasonable to suppose that the reconstruction of the Building 2 as a barrack block with stone-walled internal partitions, instead of timber/wattle-and-daub panelled ones, was broadly contemporary with the very similar rebuilding of Building 3, and perhaps with the transformation of Building 1 from a barrack to a stable. This overall remodelling of the north east part of the fort, labelled Stone Phase 2 in Buildings 1 and 2, would in turn probably correspond to the Period 4 identified by the 1997–8 excavations undertaken by Tyne and Wear Museums (Hodgson 2003, 15–16), which was considered to extend from c. 225–35 to the late third or early fourth century.

In the north-east *praetentura*, the most substantial assemblage of dateable material relating to the Stone Phase 2 remodelling derived from the clay/daub layers associated with the demolition of the Stone Phase 1 partitions in Building 1 and the possible make-up for the Phase 2 flagged floor. The pottery and coinage contained within these layers provides an ostensible *terminus post quem* for the construction of the Phase 2 building. As described above, the latest material in these layers comprised black sand amphora suggesting a date after the middle of the third century (M05:03), a slightly worn coin of 249–51 (L04:25), a sherd from a BB1 cooking pot with a groove above obtuse angle lattice, a few sherds of late

gritty grey ware and at least three calcite-gritted ware vessels, providing a late third-century date (M05:09, P05:14). This is quite a significant quantity of mid- to late third century material, although the bulk of the assemblage from the demolition/makeup levels was comprised of BB2 and allied fabrics (2/3 of the total).

There is nothing inherently implausible about such rebuilding work being undertaken during the mid- to late third century. An inscription from Caerleon (RIB 334) records the restoration of barracks from ground level around 255–60 (*cohorti VII centurias a solo restituerunt*), showing that the army was undertaking this kind of rebuilding during this period and the epigraphic evidence relating to construction work on the northern frontier during the Tetrarchy is of course well-known. However, it is significantly later than the date of 225–35 proposed as marking the beginning of Period 4 on the basis of the 1997–8 work in the southern part of the fort. More specifically, it poses a problem in that the pottery associated with the occupation of the building extends no later than that which provides the putative *terminus post quem* for its construction, implying that the period of occupation was relatively short if all the dating evidence is accepted at face value. Thus only a small quantity of late third-century material was found in association with the flagged floors in the interior of Building 1 (M04:14, P05:04, N05:12). The same is also true of the occupation layers in Phase 2 of Building 2, which included a number of sherds of Crambeck reduced ware and calcite-gritted ware of late third-century date (L05:44), and the equivalent levels of Building 3, which yielded no late third-century coarseware whatsoever. Given the degree of internal modifications relating to this phase evident in Building 2, for example, such a short period of occupation seems inherently unlikely. Furthermore, and most crucially, there is a significant questionmark over the integrity of these deposits. None of the Phase 1 demolition levels, which yielded dateable material in Building 1, was fully sealed. The preservation of the Phase 2 flagged flooring in Building 1 was very patchy and, as a result, extensive areas of the underlying Phase 1 demolition/Phase 2 makeup deposits actually lay directly below the demolition rubble associated with the end of these buildings. The same is for that matter also true of the makeup layer (L05:44) for the secondary flagged floor (L05:28) in Building 2, *Contubernium* 8. On the other hand it is noteworthy that there was no material later in date than the mid-third century in the deposits filling the ‘clay puddling pit’ in Building 1, which is associated with the demolition of the Phase 2 structure (see below). These fills represent one group of deposits, the stratigraphic integrity of which is relatively assured.

In these circumstances the date of the Stone Phase 2 remodelling remains uncertain. Material associated with the internal occupation of the Phase 1 barrack

extended into the third century and this, together with the size of the BB2 assemblage in the Phase 1 demolition layers (which cannot all be intrusive), demonstrates that the remodelling can have occurred no earlier than the early third century. Otherwise if the late third-century material is treated as potentially intrusive and excluded from the analysis, the coin of Herennia Etruscilla would provide the next *terminus post quem* of 249, but if the late third-century pottery can be rejected so, it might be argued, can the relatively small assemblage of mid-third century dating evidence. On this basis, the remodelling may have been initiated as early as the first third of the of the third century, perhaps in the 230s in line with the date proposed for Period 4, but could conceivably have occurred as late as the late third century. It seems clear, however, that these buildings did not long outlast the third century.

The end of Buildings 1 and 2

The end of Building 1

Building 1 was demolished at the end of Period 4 of the fort. The material from the demolition was spread over the area of the building (L04:14, N05:04, P05:03, Q05:16), the verandah (L04:15, 17, M04:03, 06, Q05:15) and the alleyway between Buildings 1 and 2 (L05:29). It was also used to backfill the clay-puddling pit (N05:13, 14, 15) and probably provided the material used to resurface the adjacent road surfaces. It was composed of fragments of sandstone, with some boulders, cobbles, pieces of flagging and the occasional facing stone, in a matrix of mainly grey, charcoal-flecked clay. Fragments of the walls, the foundations, and the flagged floors survived in places as part of the surface. The rubble was noticeably denser over the area of the verandah, but was not consistent enough to indicate a widening of the north-*intervallum* road at this time. The edges of the clay-puddling pit could also clearly be seen at the level of this surface.

The clay puddling pit

During the demolition of the Phase 2 building, a large, roughly oval-shaped pit (M04:33, M05:39, N04:22, N05:13) was dug 17.20m from the west end. It cut through the floors, the north wall and the verandah. It measured 4.20m long (north-south) × 3.25m wide × 1.05m deep. The sides were steep, especially the south, and the bottom slightly dished. The fill was composed mainly of orangey-pink, puddled clay, 0.85m deep, with small pockets of grey silty soil (N05:14) and the occasional flagstone fragment. Above this, and around the pit, was the general spread of stone (N05:15) from the demolition. Evidently the backfilling of the pit was not given sufficient time to settle as the later surface

had subsided into the centre of the pit where it was overlain by a gravel deposit (N05:13).

The size and shape of the pit, and the quantity of clay uncovered in the fill, suggest that it was probably used as a clay puddling pit. This was an unlined tank into which clay was thrown and mixed to obtain material of the correct consistency. If this interpretation is correct, the pit's usage must follow the end of Building 1, since it cuts through the building's north wall, but must predate the erection of any subsequent structures on this site, as the upper fills contained demolition debris probably associated with the end of Period 4 in the northern part of the fort.

The end of Building 2

A layer of rubble and cobbles extended over much of Building 2 (L05:07, 25, M05:11) and the alley to the north (L05:29, M05:10), although the manner in which some of the *contubernia* walls remained exposed lead the excavators to believe that the range of supposed shacks ('B, K and M') continued in use until the end of the life of the fort. Parts of the north wall of the building, and the entire exposed length of the wall separating *Contubernia* 6 (K) and 7 (B) had been robbed out, probably during the post-Roman period.

FINDS

Demolition of Building 1

Decorated samian: 160–200 (no. D21, N05:04); 125–140 (no. D120, N05:04); 130–160 (no. D121, N05:04); 90–100 (no. D134, N05:04)

Samian stamp: Hadrianic or early Antonine (no. S107, P05:03), Antonine (no. S120, P05:03)

Mortarium stamp: 150–170 (no. 18, Q04:02), 120–170 (no. 36, M04:06)

Amphora stamp: unknown (no. 11, M04:06)

Graffiti: (no. 23, N05:04)

Coin: Vespasian, 69–79 (no. 8, M04:03), Nerva? 96–98? (no. 27, N05:04)

Pottery: BB2 spindlewhorl (no. 33, Q04:02), BB2 counter (nos 58, N05:04; 72, Q04:02)

Copper alloy: brooch (no. 20, P05:03)

Copper alloy: stud (no. 268, M04:03)

Iron: holdfast (no. 41, N05:04), hobnails (no. 76, N05:04)

Glass: two pieces of window (no. 42, N05:04)

Quern: lava (no. 13, P05:03)

Upper clay fill and rubble dereliction over Alley 1 (L05:29)

Samian stamp: 125–50 (no. S42)

Graffito: (no. 28)

Glass: armlet (no. 1)

Clay puddling pit

Coin: Trajan, 98–117 (no. 41, N05:13)

Copper alloy: trumpet brooch (no. 4, N05:15); harness

mount (no. 184, N05:14), handle (no. 215, N05:13)

Iron: hobnail (no. 76, N05:14)

Pottery: samian counter (no. 85, N05:14)

Stone: throwing stones (two lost, N05:13)

Dating evidence

Clay puddling pit

The fill of the clay puddling pit (N05:13, 14) contained three sherds from at least two Lower Nene Valley mortaria dated after 240, including an incomplete multi-reeded hammerhead rim, and three body sherds of black sand amphora of the second half of the third century.

The demolition/dereliction rubble over Building 1 contained a very large group of pottery with late fourth-century material in, including two Huntcliff-type rims and Crambeck parchment ware of 370+, plus a little post-medieval pottery (N05:04). The material from other contexts of cobble, clay and stone spreads over the north-east area was not catalogued in full, but included at least one Huntcliff-type rim of the late fourth century (P05:03).

Demolition over the verandah of Building 1

The material over verandah and the *intervallum* road to the north was consistently made up of over 70% BB2 and allied fabrics (e.g. L04:17, M04:03). Sherds of black sand amphora would indicate a date in the second half of the third century.

Dereliction over Alley 1

The dereliction material over the alley contained a lot of residual mid-second century material, BB2 and allied fabrics and only three sherds dating to the late third century (Crambeck reduced ware and a flanged bowl in an unidentified reduced ware).

Discussion

The puddling pit and its clay backfill provided a useful pottery assemblage which points towards a date around the middle decades of third century for the demolition of Building 1 and one probably before the end of the third century given the absence of East Yorkshire grey wares and calcite-gritted wares from these deposits. If the pit was associated with the preparation of clay for the floors of the structures which succeeded Buildings 1 and 2 in the north-east *praetentura*, as suggested above, it was probably open for a relatively short period and was covered by the general spread of demolition material laid over Building 1. Sherds of later third-century wares were recovered from a few contexts in the interior of Building 1 – although some of this material may have been intrusive (e.g. P05:14) – and from the upper levels of clay in the alley (e.g. L05:29, N05:07), but none of these contexts was demonstrably sealed.

The inclusion of post-medieval pottery and a significant quantity of later fourth-century coarseware in the rubble over Building 1 might imply that these levels actually resulted from the destruction of the later Roman layers by post-Roman ploughing, rather than representing a discrete demolition episode which could be assigned to a specific date, such as the end of Period 4. In other words it probably represented the interface of disturbance between post-Roman activity and the stratified Roman levels.

The Buildings in the west *praetentura* – 17 and 18

Introduction (Figs 14.17, 14.18)

The layout of the buildings in the west *praetentura* was also substantially reconfigured during the third century. Although many of the details are uncertain because of the very fragmentary survival of the late Roman remains in this part of the fort, it is clear that the new layout took a different form to that observed in the north-east part of the fort. Instead of a straightforward rebuilding and internal remodelling of the three earlier stone barracks (4, 5 and 6), comparable with that undergone by Buildings 1, 2 and 3, the former were replaced by a pair of entirely new barracks, which are designated Buildings 17 and 18 here. These were disposed on either side of a newly constructed east-west street (Alley 10), which overlay the southern part of Building 5. Their remains correspond to the two rows of ‘shacks’ (C, D, E, F and G, H, J, L respectively) which Daniels envisaged as representing the fourth-century pattern of occupation in this area (see Fig. 14.17; Chapter 1: Figs 1.07–1.08). Fig 14.18 demonstrates that these surviving fragments could in most cases form part of a more coherent restored layout comprising two conventional barrack blocks, like Building 2 to the east, with stone partition walls separating the *contubernia* and dividing the latter into front and back rooms. The officer’s quarters were probably located at the end next to the *intervallum* road (here the west end), as was the case with all the barracks at Wallsend, and there may have been as many as eight *contubernia* in each block, but probably no more. The cobbled street separating the two buildings was probably 3.00–3.50m wide, though there are problems in estimating its exact width, as there are in gauging the width of the new barrack blocks, though it is likely these were somewhat wider than the earlier barracks, including those still use on the other side of the *praetentura*.

Problems of the evidence

However Fig 14.18 also highlights how small was the proportion of the barrack plan which actually survived, meaning that the remains could quite

conceivably be restored in other ways – perhaps even as a pair of chalet-barracks for instance. Furthermore some of the features, such as the small timber structure, E, and the post-holes associated with Daniels Building J, can only be convincingly integrated into the suggested scheme if it is assumed they belong to a later phase, representing alterations to or replacements for the original barrack blocks. In other words the surviving evidence appears to represent a fragmentary palimpsest of multiple, badly damaged phases of activity.

An awareness of the scale of post-Roman disturbance is thus essential to appreciate the difficulties associated with any attempt to understand the third-century and later occupation of this part of the fort. The Roman levels here had been heavily truncated, with particularly severe damage being evident in three, parallel linear strips, varying in width between 3.5m and 9.0m. These were interpreted by the excavators as a series of eighteenth/nineteenth-century colliery trackways, but it is not easy to envisage why three trackways would have lain so close together and they can be more plausibly explained as broad plough furrows associated with medieval or early modern cultivation. The furrows traversed the area from north-west to south-east, in effect cutting up the third-century and later levels into a series of islands and, inevitably, making it more difficult to reconstruct the layout of the north-west *praetentura*.

The assorted wall footings and foundation deposits which made up the identified structures were variously composed of occasional lengths of newly constructed walling and stretches of the preceding barrack block walls which appeared to protrude through the surrounding cobbled surfaces and rubble spreads and were therefore considered to have been reused in this phase (Figs 14.19–14.21). Most of the newly constructed walls were set directly on top of the previous Roman ground surface with no discernable foundations and certainly lacked any foundation trench (as made explicit in the context record for wall G04:10, for example), a practice paralleled in the Severan and later barracks at South Shields (cf. Hodgson and Bidwell 2004, 145–6). Hodgson and Bidwell (*ibid.*) have emphasised how easily walls constructed in this manner could have been robbed out without leaving any trace, particularly if any contemporary floor surfaces laid up against the edge of the lowest course were also destroyed. Furthermore, with regard to Building 17, it is often uncertain which if any of the surviving traces of walling from the previous phase were actually reused rather than merely incorporated in the cobbled surfaces.

With such a degree of uncertainty, as a consequence of the fragmentary nature of the surviving evidence, it is the analogy with the better preserved third-century barracks in the east *praetentura* which ultimately underpins the reconstructed scheme presented here.

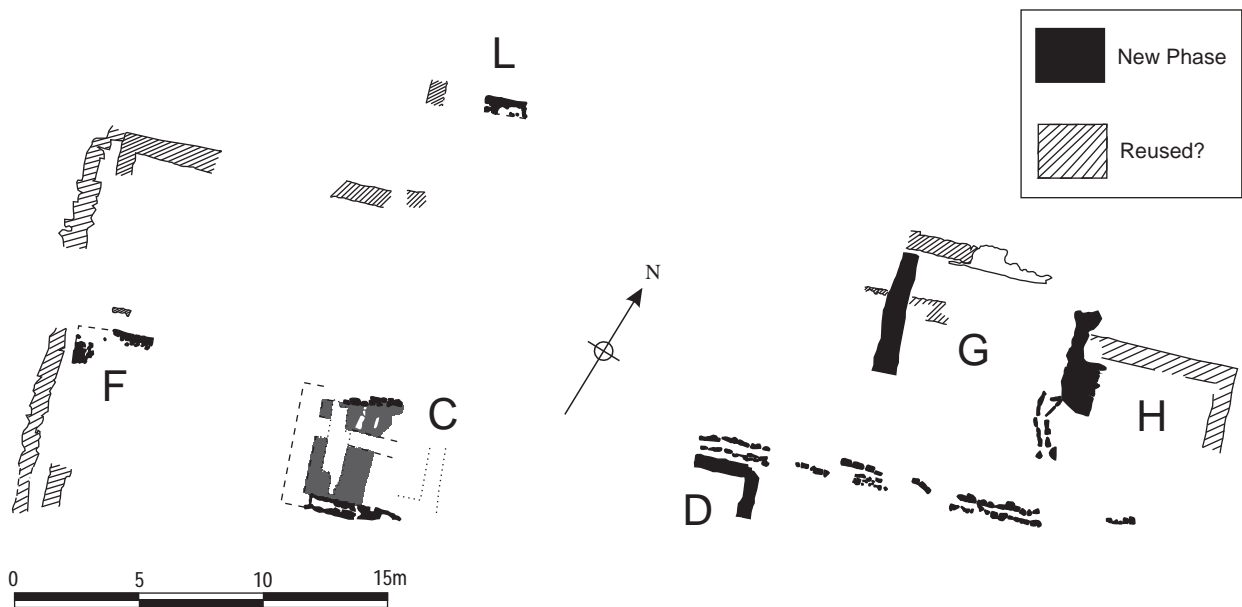

Figure 14.17: Surviving third-century structures in the north-west praetentura, showing walling possibly retained from the previous phase and newly built. Scale 1:300.

Even so, as newly constructed blocks, 17 and 18 were clearly not identical to their eastern counterparts, which were adapted versions of earlier buildings, and many aspects therefore remain unclear, in particular, the width and orientation of the blocks.

Nevertheless, despite the uncertainties one crucial point appears certain. Only two barracks, whatever their form, can be accommodated in the revised layout of the west praetentura. The locations of Building 18 and Alley 10, which are clear, are decisive in this regard as they leave insufficient room for two barracks further north, whatever the precise width of the street. Nor was there sufficient room for another street and a full block to the south of 18, where much of the room seems to have been taken up by a large square pit ('Cistern 2' – see Chapter 10). This has important implications for the size of the garrison in the third century.

The surviving components of the two barracks are described below with cross referencing to the building designations of the individual structures envisaged by the 1975–6 excavators. Building 18 is treated first because its remains, although far from complete, survived better than those of 17 and can be used to inform the interpretation of the latter barrack's more ephemeral traces.

Building 18 – the south barrack block

Grid squares: E5, F5, G5, H5, J5, K5

Although Building 18 was the better preserved of the two barracks, its analysis still poses a severe challenge. Only isolated pockets of stratigraphy and short lengths of walling survived, whilst much of the building lay beyond the southern edge of

the excavation. The extant remains comprised the exterior wall at the north-west corner (corresponding to Daniels Building F) and a short section of the west wall further south, the north room of *Contubernium* 1 (Daniels Building C) and the north-east corner of *Contubernium* 4 (Building D).

Dimensions and orientation

The estimated length of the building, based on its restored plan, was c. 45.40m. However the east wall lay entirely outside the excavated area and its position could only be determined by comparison with that of Building 17. The overall length of the officer's quarters, from east to west, could be gauged at c. 10m (8.5m internally), based on the position of the west wall of *Contubernium* 1, which was evident as a distinct robber trench (F05:18), with the remainder of the block taken up by an estimated eight *contubernia*.

No part of the south wall was available for examination, either, and the overall width of the block is therefore uncertain, particularly as such evidence as does exist is rather contradictory. The north-south length of the northern room of *Contubernium* 1 in its primary phase was c. 5.50m, including the north wall and the block's 0.70m wide medial partition. If the southern room was of equivalent size the overall width of the block would therefore have been around 10.30m. However Building 17 would appear to have been rather narrower than that (see below). The location of the edge traced between the surfaces of the new street and the internal levels of Building 17, although somewhat irregular, would imply that barrack was no more than 9m wide. Similarly, in its second phase the north room of *Contubernium*



Figure 14.18: Third-century Barracks 17 and 18, with two alternative restorations of the contubernia of 18 with smaller southern front rooms like 17, and with front and rear rooms of equal dimensions. The Daniels building codes are shown in brackets. Scale 1:200



Figure 14.19: The intervallum drain, fragments of the third-century barracks next to the south wall of Building 5 and overlying the unfinished foundations of Building 6 (right), looking east.



Figure 14.21: North wall of Building 17 (G04:10) from the north east.



Figure 14.20: Detail showing the north wall (E05:13) of third-century Barrack 18 (right) next to the south wall of second-century Barrack 5 (E05:14) at a lower level.

1 was reduced in size, its north-south length being shortened to between 4.50m and 4.70m, including the medial partition wall (the width and precise alignment of the north wall were difficult to gauge exactly), which would in turn suggest the block was c. 8.30–8.50m wide overall, assuming the south room was equal in size to the north one. Thus it is possible that the north room, which probably formed the inner living quarters to the rear of the *contubernium*, was initially larger than the south room and, rather than marking a reduction in the width of the barrack, the Phase 2 remodelling evident in *Contubernium* 1 may simply have made both rooms the same size.

Although not conclusive such evidence as existed, notably the presence of clay floors rather than stone surfaces in the north rooms of *Contubernia* 1 and 4 during their initial phases, may point towards the block being south-facing.

Exterior walls

The exterior walls of the barrack survived best at the building's north-west corner where short stretches of the outer facing survived (north wall: E05:13, F05:13; west wall: E05:15, 1.70m and 0.80m in length respectively), with a very thin line of the dark grey black soil connecting them and forming the remnants of a robber trench (E05:18). The facing stones appeared to sit on angular cobble foundations (E05:36), but these may simply represent surviving fragments of the earlier street surface (equivalent to E05:12). Daniels restored this as a distinct structure (F) measuring at least 3m east to west (and perhaps up to 9m) and 7.5m north to south. To the south a stretch of the west wall of Building 6 may have been reused (E05:08) as the base of the new wall. A 1.50m length of this wall was exposed at the southern edge of the excavation site and originally formed the north-west angle of 6, but was clearly extended northward subsequently. The angle of the earlier building was abutted by a further surviving fragment of masonry, some 0.65m long, which represented part of that northward continuation and incorporated two stones set upright to block the eavesdrip gutter (E05:29) running along the north side of 6.

Away from the north-west corner, most traces of the north wall of 18 had been removed with the exception of the stretches associated with *Contubernia* 1 and 4. In the former case the remains had been greatly disturbed with only the inner face surviving (F05:11), its stones perhaps somewhat displaced, and two small underlying patches of possible yellow-pink foundation clay (F05:23/62). (The excavators considered this stretch of wall was a secondary rebuild – see below Building 18 Phase 2.) At the north-east corner of *Contubernium* 4 the north wall (H05:18) was 0.60m wide and composed of two lines of facing stones only, with no apparent rubble core. Many of the roughly dressed rubble blocks making up the wall were relatively long and narrow in proportion

and were either laid lengthways along the face or tied back into the thickness of the wall. It may have been bonded with clay but this is not made explicit in the context record. The wall here lay c. 0.30m south of the stone-lined drain which ran along the southern edge of the street separating Buildings 17 and 18, but some 8m further east, where the drain adopted a slightly more southerly alignment (J05:10), the latter's southern side wall may also have functioned as the footing course for the outer face of the barrack north wall.

Officer's quarters

No demonstrably intact floor levels or other internal features survived in the officer's quarters. Only a light pink/orange-brown clayey soil layer (F05:08) containing a number of stones was recorded to the west of the robber trench for the Phase 1 west wall of *Contubernium* 1 (F05:18). The interpretation of this layer is unclear. It was not plotted precisely on the any site plan, but is shown, rather schematically, extending north of the limits of Building 18 on a site notebook sketch plan (F5 p.12) and was reported to 'cut' the successive cobbled surfaces of the street separating Buildings 17 and 18 in this area (F05:25, F05:06). It was cut by robber trench F05:18, but it is unclear whether that robber trench was associated with the demolition and replacement of the Phase 1 wall or occurred at a much later date and simply removed the footings of the already demolished wall.

Contubernium 1 (Building C) (Fig. 14.22)

Phase 1 (Figs 14.23, 14.24)

The westernmost *contubernium* represented the best-preserved part of the barrack. Only the north room of the *contubernium* was available for investigation, as the edge of the excavation ran obliquely along the line of the medial partition wall which separated the two rooms, and Daniels interpreted this as representing the full extent of a small rectangular stone structure (Building C), measuring around 6m by 5m. The room was most clearly defined by the 0.70–0.75m wide robber trench (F05:18) marking the position of the west wall (see Fig. 14.28 below), by the remains of the east-west aligned medial partition wall (F05:09, G05:16) and by the extent of the internal floor surfaces and occupation deposits in the western and central parts of the room. The east wall had been robbed out in the course of the Phase 2 remodelling which also resulted in the removal of the Phase 1 floor levels along the east side of the room, its position being estimated on the basis of the likely *contubernium* spacing. The resultant internal dimensions of the room are estimated at 4m (N-S) by 4m (E-W). The robber trench for the west wall was apparent as a

dark grey soil filled linear feature, containing small-medium sized stones, which cut through the floor levels and deposits originally laid up against the wall to a depth of 0.10m. To the south, the medial partition wall survived over a length of 3.80m and was 0.70m wide, but the stratigraphical relationship between this and F05:18 had been lost as a result of later intrusion. The surviving footing course was carried across the full width of the *contubernium* with no indication of the position of the threshold.

It was possible to record a fuller sequence of internal floors levels and associated deposits and features here than elsewhere in the two barracks, although all deposits in the north-east corner of the room had been removed by later intrusion. The secondary cobbled surface (F05:14) of the street separating Buildings 5 and 6 was covered by a layer of light grey-green clayey soil (F05:52), incorporating many lumps of charcoal and some small stones, which might be interpreted as a build up of trampled debris over the street surface or a makeup deposit. This was overlain by a 10–30mm thick spread of orange sand and grit (F05:51), which was not, however, noted in the north-west corner of the room. On the west edge of the room these levels had been intermixed (as F05:53), perhaps as a result of disturbance resulting from the subsequent remodelling of the barrack and this disturbance apparently extended to the underlying street metalling (disturbed cobble layer F05:54, part of F05:14). The sand and grit layer was very tentatively interpreted by the excavators as 'decayed wall plaster' but was perhaps actually a bedding layer for a flagged floor which survived in a very fragmentary condition in the south-east corner of the room (F05:44). At the northern end of the room a stone-flagged hearth (F05:50), measuring 0.80m by 0.50m, sat on clayey soil F05:52 about midway along the length of the north wall (Fig. 14.23). The hearth was composed two yellow sandstone slabs and three flat white stones, all some 30–50mm thick and showing signs of burning at the edges. It was associated with an extensive deposit of grey-black ashy soil (F05:38), containing much charcoal and coal and flecks of orange iron pan, which stretched right the way to the medial wall, reducing in thickness from c. 50mm around the hearthstones to 10mm at its southern edge, with thin but distinct lenses of burnt material where it was thickest.

PHASE 1 SUB-PHASE 2

A second sub-phase in the *contubernium* was marked by a pink clay floor (F05:39, 40) which survived over an area 4m × 3m (Figs 14.25, 14.26). The earlier hearth (F05:50) was replaced by another occupying the same position (F05:45). This was represented by an oval patch of fire reddened clay and dull yellow sand, 0.45m × 0.35m in extent and surrounded by a ring of blue charcoal. A row of three small flagstones, 1m long in total, was present on the west side of the

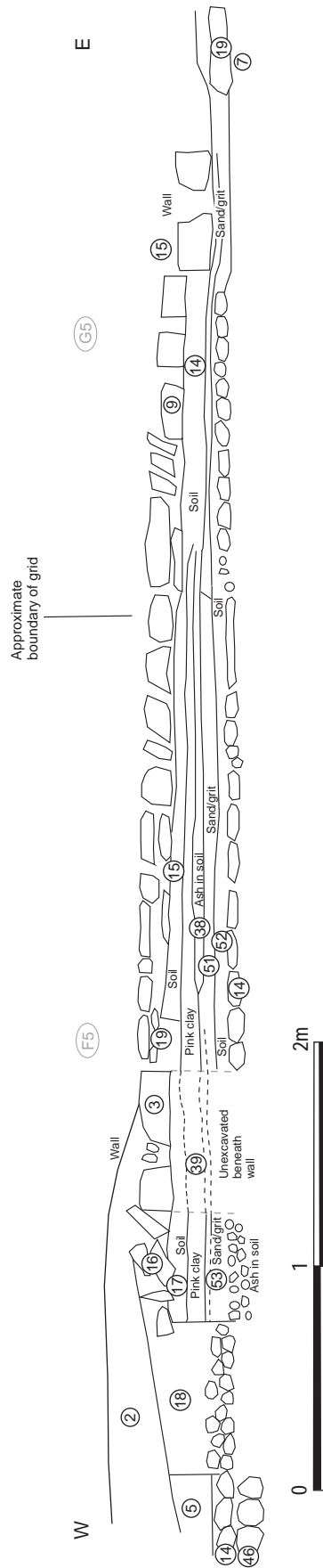

Figure 14.22: Section Drawing S11: Reconstruction of the SW-NE section through Building 18 Contubernium 1 (Daniels 'Building C'). Scale 1:30.



Figure 14.23: Phase 1 hearth F05:50 (the flagged setting at the top of the view) in Building 18 Contubernium 1 looking north

hearth with a single flag on the opposite side. It is not clear if these were related to the hearth's functioning in any way. The excavators suggested the hearth had not been much used as there was no ash layer associated with the burnt clay.

The excavators also considered that the room was subdivided at this stage by an east-west partition wall (F05:42, 43) which cut through this floor, although all other trace of the partition had subsequently removed. The function of such a wall is by no means clear, however, and the plans do not suggest there was a distinct linear robber trench cutting through the pink clay, simply an irregular gap in the northern half of the room where the clay was absent. It seems more plausible to interpret this 'wall' as simply a false impression conveyed by the patchy survival of the clay floor.

Use of the *contubernium* in this sub-phase may be represented by a dark grey/black deposit (F05:15, 17, 41, G05:14), up to 0.1m thick and comparatively rich in finds, which directly overlay the pink clay floor and other surviving Phase 1 levels plus the cobbled surface of the earlier street and was sealed in places by walls F05:03 (as F05:41) and F05:10 belonging to the next phase. The deposit had a greasy texture and contained concentrations of heavy pinkish clay and areas of slightly lighter brown soil. It may comprise a mixture of occupation debris and makeup or other material deposited when the barrack was remodelled in Phase 2.

Phase 2 (Figs 14.26–14.28)

The second phase of Building 18 involved a substantial remodelling of *Contubernium* 1 which was shifted 1.20m to the east with the construction of new west (F05:03) and east (G05:15) walls. These walls were c. 0.65m wide and were constructed with two lines of roughly dressed, sandstone facing stones with a thin rubble core. They survived only course high, with the exception of one block apparently belonging

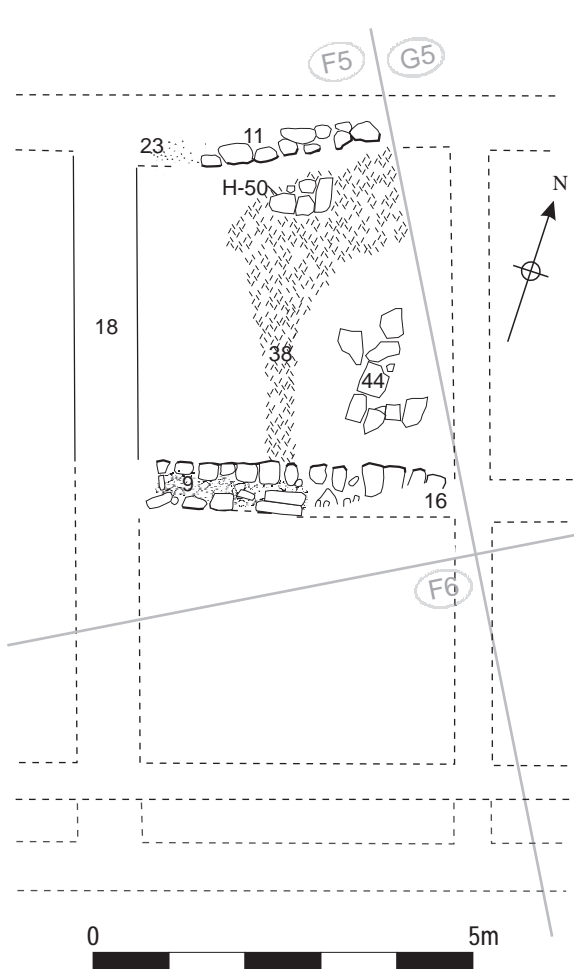

Figure 14.24: Building 18, Contubernium 1 (Daniels 'Building C') Phase 1, Sub-Phase 1, 1:100.

to a second course at the southern end of east wall G05:15. A 0.20m wide and 0.10 thick deposit of fairly clean and firm orange-pink clay (F05:19) was packed along the east side of wall F05:03, the purpose of which was unclear. The north wall (F05:11) may have been rebuilt at this stage as well, as supposed by the excavators, since the surviving remains were reported to lie over the edge of the deposit of grey-green soil (F05:15) marking the end of Phase 1. The original medial partition wall, F05:09, was also replaced by a new one, some 0.7m wide, located immediately to the north (F05:10, G5:08). This reduced the size of the north room, which now measured 4m × 3.5m internally. An entrance through the medial wall was apparent in the south-west corner of the room and was some 1.35m wide (assuming the full length of the wall was preserved). In the interior, a floor surface (F05:24, G05:22), composed of small flagstones and flat stones, and including a tile and an amphora sherd, was present, though it survived only sparsely, mainly in the centre of the room. A few flagstones (F05:49) overlying earlier medial wall F05:09 may represent the sparse remnants of a floor in the south room.

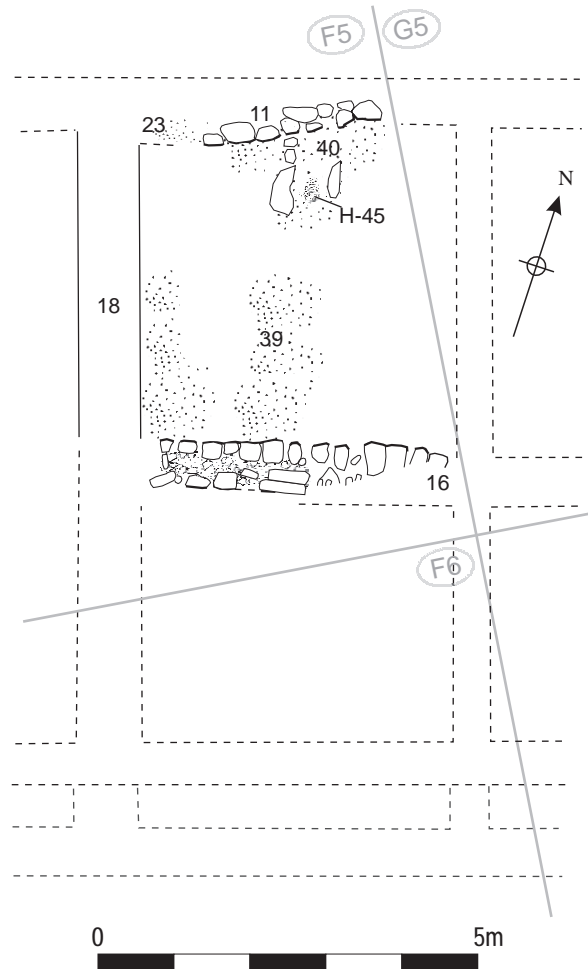

Figure 14.25: Building 18, Contubernium 1 (Daniels 'Building C') Phase 1, Sub-Phase 2, 1:100.

As remodelled, the north room would now have been roughly equivalent in size to the south room, assuming that the block was roughly similar in overall width to that estimated for Building 17. By moving the west wall of *Contubernium* 1 eastwards the alterations would also have enabled an increase in the size of the officer's quarters and these may have been the aims the rebuilding was designed to satisfy.

Phase 3 (Figs 14.26, 14.29)

The final activity recognised within the north room of *Contubernium* 1 was represented by stone packing (F05:07, G05:09), some 0.10–0.15m deep, composed of a mixture of smallish stones, large cobbles and building rubble in a matrix of dark clayey soil, which filled most of the interior. In the north-west corner of the room a layer of yellow sand mixed with brown soil (F05:04), 0.05m thick, was present instead and overlay the edge of the stone packing. The stone layer was also present on the east side of wall G05:15, overlying the cobble surface (G05:19) in *Contubernium* 2. The excavators considered this stone layer to be a deliberate pack perhaps to create some



Figure 14.27 Views of successive phases of the north room of Building 18 Contubernium 1 from the east. 1 Phase 1 Sub-phase 2 (with later east wall G05:15 visible); 2. Phase 2; 3. Phase 3.

form of platform or conceivably a replacement stone floor. Some of the smaller, flatter stones were pitched vertically, as is evident in the site photographs, which might imply they simply represented structural collapse, but these may have overlain the main pack or had conceivably been dislodged by post-Roman ploughing.

Contubernium 2

Levels directly equivalent to the Phase 1 and 2 floors in Contubernium 1 were not present in the area of Contubernium 2 immediately to the east. The Phase 2 wall separating Contubernia 1 and 2 (G05:15) appeared to sit more or less directly on top of the surface of large cobbles (G05:19) forming the secondary metalling of the street which occupied this area before the construction of Building 18. It is possible this surface was reused as a stone floor in the Phase 2 contubernium, with any Phase 1 floor levels here perhaps having been truncated by the Phase 2 reconstruction works. One large roughly squared boulder rose proud of the rest of road cobbles G05:19 and could conceivably have formed part of a Phase 2 medial partition wall since it lay on the same alignment as the equivalent medial partition in Contubernium 1. Any trace of the Phase 1 medial partition would, however, have lain beyond the southern limit of the excavation.

Contubernium 4 (Building D)

The north-east corner of Contubernium 4 also survived the widespread destruction of the third-century levels (Figs 14.30, 14.31) and was interpreted by Daniels as part of another freestanding stone structure (Building D). In addition to a 2m long stretch of the north wall (H05:18 – see above), a 1.6m length of the east wall (H05:15) survived here. This wall was 0.60m wide and was bonded with the north wall. The excavators regarded this junction as marking the intact corner

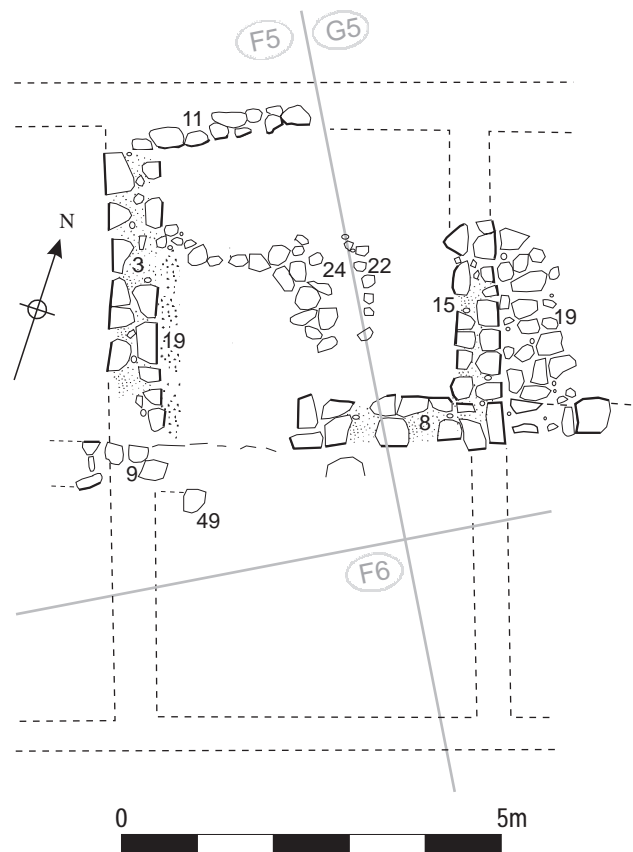

Figure 14.27: Building 18, Contubernium 1 Phase 2



Figure 14.28: The robber trench for Phase 1 west wall F05:18 Contubernium 1 with later wall F05:03 beyond, from the SW.

of a distinct building, but the surviving remains of the two walls did not form a properly finished angle, suggesting the north wall originally continued further east and had simply been robbed away at a later stage.

A succession of floor surfaces were recognised inside the contubernium. The lowest level was apparently a deposit of grey-blue ashy soil, charcoal, and mortar (H05:47), 20–30mm thick, which sat directly on the upper cobbled surface (H05:02) of the former street between Buildings 5 and 6. This deposit may have been associated with a possible hearth

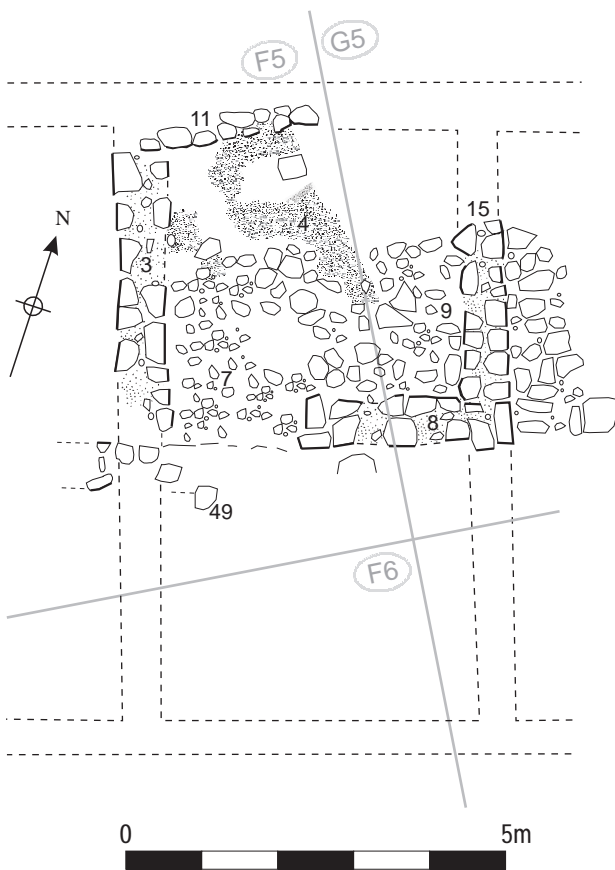

Figure 14.29: Building 18, Contubernium 1 Ph se 3 0



Figure 14.30: NE corner of 18 Contubernium 4 (Daniels Building D) from the west with the street drain to left and Building E beyond.

(H05:46) which took the form of a stone slab, 0.50m square, set against the north wall and surrounded by a scatter of other smaller flat stones in the corner. However the ashy deposit was recorded as underlying the flags and may therefore have been associated with an earlier version of the hearth. To the west, a patch of pink clay (H05:45), c. 0.75m square and also reportedly overlying ashy soil H05:47, may represent the remains of a more extensive floor in the western half of the room. A small spread of rubble including

one facing stone (H05:48) was also recorded over H05:47 to the south of the possible hearth slab. It is not clear whether this was part of the same floor as the flags of H05:46 or perhaps more likely represented debris connected with the end of Phase 1 and was incorporated in the subsequent stone surface.

All the features belonging to this floor level were overlain by a dark grey soil (H05:39), perhaps part of an occupation deposit or conceivably a makeup level for the next phase of flooring, which comprised a rather rough surface of shattered flagging (H05:38). It is possible this secondary stone floor was contemporary with the Phase 2 remodelling of *Contubernium* 1, but the stratigraphic separation and limited amount of datable material from *Contubernium* 4 means there is no way of confirming this.

The eastern part of the barrack

Only a small area of Building 18 was excavated to the east of *Contubernium* 4, but it is clear that no definite traces of further *contubernia* were exposed there. Instead the remains of a small timber structure labelled Building E by Daniels were exposed. This may relate to a later phase of the building and perhaps reflects the replacement of the block's four easternmost *contubernia* by a series of timber buildings, the remainder of which lay beyond the edge of the excavation (Fig. 14.32).

Building E (Figs 14.30–14.32)

Phase 1

A gap of 1.30m separated Building E from the east side of *Contubernium* 4. The small structure was constructed on wooden sill-beams which were laid in stone-lined slots. Traces of these beam-slots (of about 0.2m width) were recognised on the west (H05:19) and north (H05:44) sides, in the form of parallel lines of thin vertically set slabs or small facing stones marking the edges of the beam settings. The east slot (H05:20) was less obvious, however, consisting of only one or two vertically set slabs plus some other stones on the same alignment, which appeared to form the west side of a possible slot. The three slots enclosed a floor of pink clay (H05:42) which was cut by a circular posthole (H05:43), 0.35m in diameter, containing two pitched packing stones towards its western edge. The building measured 1.5m east to west by at least 2m north to south, and evidently continued southward beyond the excavation area.

Phase 2

The laying of a stone floor (H05:22) in the interior represented a second phase of Building E. This was composed of small shattered flagging, including several large pieces of tile, laid on top of a 50mm deep layer of fine, dirty grey soil (H05:23, 41) which covered the earlier clay floor.

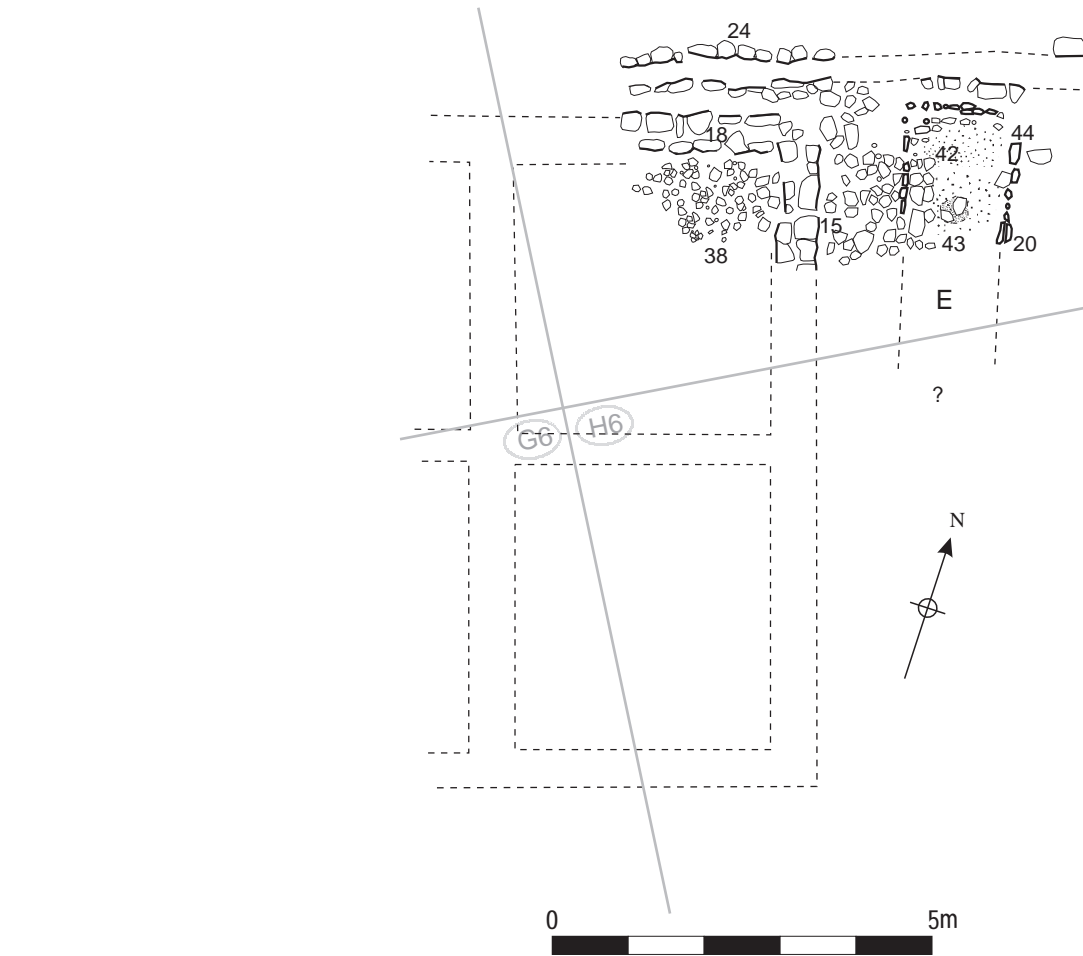

Figure 14.31: Building 18, Contubernium 4 (Daniels 'Building D') Phase 2 and adjacent Building E, 1:100

Immediately to the west and east of E there were only deposits of dark earth and rubble (H05:21, 29), which clearly represented modern disturbance, overlying the metalling of the earlier street.

Interpretation

The excavators noted the similarity between pink clay floor H05:42 inside Building E and clay floor H05:45 inside Building D (i.e. *Contubernium* 4). A similar floor was also present in the north room of *Contubernium* 1 in Phase 1 Sub-Phase 2 (F05:39–40). It is possible that clay H05:42 actually represents the surviving remnant of a more extensive floor which formerly covered the interior of the north room of *Contubernium* 5, and which was protected by the stone floor of Building E that was more resistant to plough disturbance. However the clay did appear to encroach on the projected line of the north wall of Building 18 so its interpretation as the Phase 1 floor of E is retained here.

Building E, as restored above, is a rather peculiar structure resembling a very small timber-built chalet with an internal space no more than 1m wide. An alternative way of interpreting these remains would be to envisage them as forming part of a

rebuilding of the eastern end of the block, involving the reorientation of the block to face north (assuming it originally faced south) and the provision of a timber frontage and internal partitions. In this case slot H05:44 would form part of the new façade of *Contubernium* 5, with an opening for a doorway to the west next to *Contubernium* 4. The west slot (H05:19) would represent the wall of a side passageway leading from the doorway to the rear of the *contubernium*, with the earlier street cobbling of Alley 4 (H05:02) being adapted to serve as the floor of the passage, any previous floor levels having been stripped away. It is, however, more difficult to integrate slot H05:20, to the east, into this hypothetical scheme. If it formed the east wall of the *Contubernium* 5 the latter would have an internal width of no more than 2.50m, whereas *contubernia* at Wallsend were generally in excess of 3m. It was described as a very scanty remnant and perhaps could have been associated with an internal bench or screen in the front room rather than a timber wall slot, but, from that point eastwards, all contemporary levels had been destroyed so the exact form and function of H05:20 is impossible to confirm. Such remodelling could conceivably be associated with the later phases of *Contubernia* 1 and 4, which

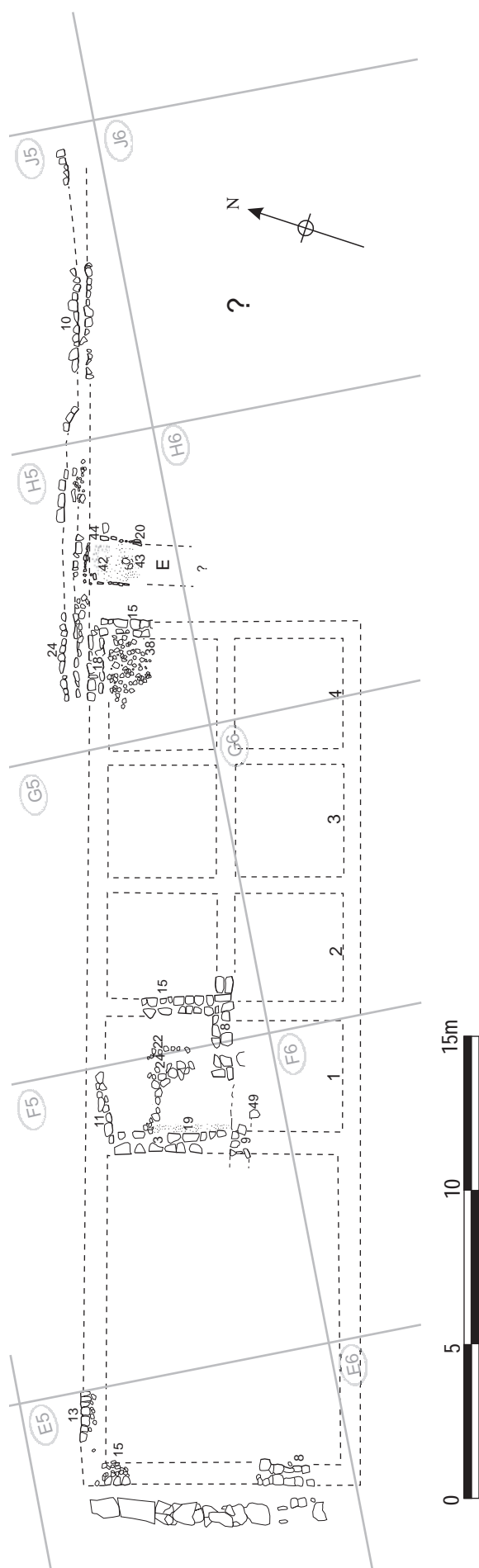

Figure 14.32: Secondary phase of third-century Barrack 18, showing possible reduction in length of block, 1:200.

saw the laying of rough stone floors in their north rooms and, in the case of 1 at least, a reduction in the area of that room, all perhaps consistent with the reorientation of the barrack to face northwards.

Building 17 – the north barrack

Grid squares: E4, F4, F5, G4, G5, H4, H5, J4, J5, K4, K5

Introduction

The remains of Building 17 were regarded by Daniels as forming three small distinct structures, which he labelled, from east to west, H, G and L (see Fig. 14.17 above; cf. Fig. 1.07). As restored by Daniels, Building H was a rectangular structure, measuring 4m by 5.5m, which reused the east and north walls of Building 5, along with a newly constructed west wall of which only the external face survived, and was open-fronted to the south. Directly adjoining H on its west side, G was envisaged as a larger structure, some 8.5m (E-W) by 6.7m (N-S), again rectangular and open-fronted, which reused the south wall of Building 4 as its north wall and featured newly constructed east and west walls represented only by strips of rubble marking the position of their foundations. To the north-west, L lay on the edge of the excavated area, with a fragmentary length of newly constructed walling forming its south wall (G04:10) whilst its west wall was apparently represented by the wall which had separated the *contubernia* and officer's quarters of Building 4 (G04:14). A cobbled floor surface was identified inside the building (G04:23), but most of the putative structure would have lain beyond the northern edge of the excavated area, beneath the back alley of Buddle Street and Winifred Gardens, whilst to the east it was destroyed by a broad plough furrow, and hence no clear estimate of its overall size or form was advanced. Some 3m to the west of G, lines of post holes were interpreted as forming the remains of an east-west aligned, rectangular timber building (J), measuring perhaps 14m by 6m. The south and east walls of this structure were well-represented, the north wall less so and the west wall not at all. Daniels suggested this building was a secondary addition to the stone structures in this area.

Daniels considered that the plan of this phase was substantially intact and therefore reconstructed a series of structures more or less solely made up of the visible remains. If, on the other hand, it is assumed that a great deal of the original layout has been obliterated by post-Roman destruction then the plan of a rectangular barrack block, composed of many of the very same structural components that figure in Daniels' buildings L, G and H, can be recognised on the north side of the new east-west street (see Fig. 14.18). Some other walls which Daniels thought were reused at this stage, notably sections of the south wall of Building 4 and the wall dividing the

officer's quarters from the remainder of that block, are likely to have been redundant. They had probably been demolished down to their footings at the end of the life of Building 4, but were not yet robbed away completely. The remaining features, such as the post holes of Building J and the east wall of G, can also be accommodated if it is assumed that more than one phase of activity is represented. The north-west corner of the block (corresponding to the south-west corner of 4) lay outside the excavation area altogether. The layout and likely development of the barrack block are set out in detail below with reference to the surviving features uncovered in 1975–6.

Overall dimensions and orientation

The block was probably c. 45m long, like Building 18 and the earlier barracks in this part of the fort (the length of Building 5 was 44.90m and Building 4: 45.60m). The width of the block could not be determined precisely owing to the complete removal of the south wall. However, based on the position of the suggested robber trench for the south wall (K05:27), the extent of partition wall foundation H04:31–32/H05:28 and the northern edge of the metalling of Alley 10, the building's overall width can be estimated at roughly 9m.

On this basis, the distance between the estimated position of the south wall and the building's medial partition – the reused north wall of Building 5 – was about 3m, whereas the distance between medial wall and the north wall was 4m, implying that the southern rooms of the barrack's *contubernia* were significantly smaller internally than the northern ones. The apparent smaller size of the rooms on the southern side of the block combined with the presence of utilitarian stone floor or makeup deposits there (see below: Interior floors) might in turn indicate that this area was occupied by the storage and utility rooms located at the front of each *contubernium*, in which case the block would have been south-facing.

Exterior walls

The north and south outer walls of the block were newly constructed, but the east wall and probably the west wall appear to have reused parts of the corresponding end walls of Barracks 4 and 5. Presumably the reused walls were demolished down to their bottom few courses with new masonry being erected on these footings and tied in with the new north and south walls. The limited preservation means this arrangement could not be definitively substantiated, but a 2.20m long linking wall (K05:25) was constructed across the former narrow back alley to connect the reused east walls of 4 and 5 (K04:16/K05:20 and K05:19). This was originally attributed by the excavators to Phase 2 of Buildings 4 and 5 and

interpreted as a blocking wall designed to close off the east end of the narrow back alley (Alley 3) separating those two buildings. Up to two courses remained of the connecting wall, which was 0.55m wide (narrower than the earlier barrack wall footings it was joining) and was composed of fairly regular, faced, keyed sandstone blocks, on average 0.23m wide × 0.18m deep. The core was grey clay and small fragments of sandstone. It butted up against the wall footings at the respective corners of the earlier blocks and appeared to have subsided slightly, midway along its course, as a result of the looser fill of the alley drip trench compressing beneath the weight of the wall. No trace of a equivalent connecting wall survived at the west end of the block, but it is noteworthy that a similar wall (L05:36) was erected across the alley between Buildings 1 and 2, and abutted the Phase 2 rebuild of the south wall of Building 1.

The north wall was most clearly represented by a 2.40m length of masonry (G04:10) which survived some 13m from the west end of the block and was interpreted by Daniels as the south wall of Building L. This was 0.65m wide and composed of coarse-grained sandstone rubble blocks. Its roughly worked facing stones were small to medium-sized, some tapering inwards to key into the rubble core whilst others were more rectangular in shape. The north face survived better than the south face. The context records explicitly state there was no construction trench or foundation deposits, the wall simply being laid on top of the earlier Roman surfaces, however the site photographs (B8/12–15) show that the masonry of G04:10 was set on a base of small rubble. Rather than being a discrete foundation deposit however this seems to have been a continuation of the street surface (G04:23) immediately to the north, implying that the road surfaces were laid before the barrack blocks were constructed. A little further east a linear spread of small flat stones (G04:06) on the same alignment might represent the very disturbed remains of a thin footing course. These stones clearly extended over *contubernium* partition slots associated with both phases of Building 4 (G04:31, 34) so probably do not form part of the flagged flooring of the earlier barrack (G04:22, 29). No other traces of this wall were identified by the excavators, but possible evidence for its presence may perhaps be detected still further to the east on site plans P62a-b, where a 5m long band of small rubble stonework is apparent on the same alignment as G04:10. The rubble is noticeably smaller than the adjacent flagstones which formed the *contubernia* flooring in Barrack 4 (H04:09, J04:23) and may mark either the intrusion of material from the later wall into the level of the earlier barrack floor or perhaps the disturbance caused to the flagging by the construction of the wall over the top.

No definite remains of the south wall were found, suggesting it had been completely removed at a

later stage. A distinct strip of smallish, angular stone tumble (K05:27), 0.90m wide, which might possibly represent a robber trench for the south wall, was recognised at the east end of the block. The southern edge of this strip lay 3.60–4.00m from the southern face of medial wall J05:14/K05:23. Otherwise the best guide to the south wall's location was the distinct edge which could be traced between the successive surfaces of the street to the south (H05:26/J05:19/K05:21 and H05:27/J05:20) and the internal rubble flooring (J05:25, K05:26) of the front rooms in the easternmost *contubernia*, with the wall probably being laid on or immediately alongside this edge of the cobbled road metalling.

Internal partition walls

The north wall of Building 5 was probably reused to form the base of the medial partition between the north and south rooms of the *contubernia* throughout the block. Several lengths of this wall had survived later robbing and plough disturbance to be exposed by the excavators (E04:08, F04:02, 04, G04:12, H04:23, J04:15, J05:14, K05:23). At its west end (E04:08, F04:02, 04) this wall may have functioned as an internal partition within the officer's quarters.

Fragmentary remains of two of the internal, north-south aligned walls which separated the *contubernia* were apparent towards the east end of the block (H04:31–32/H05:28, J05:17). Their spacing is consistent with the comparable walls associated with *Contubernium* 1 and 4 in Building 18 and suggests the barrack contained eight *contubernia* in its initial phase. The wall dividing *Contubernium* 7 from 8 (corresponding to the west wall of Daniels Building H) was marked by a 2.15m length of its west face (J05:17) to the south of medial wall J05:14. Traces of underlying rubble foundations were also identified amidst the surrounding rubble flooring or levelling deposits and the width of the wall was thereby estimated at 0.60m. This gave *Contubernium* 8 and internal width of 4m.

No trace of the wall between *Contubernia* 6 and 7 was found but a rectangular post setting (J05:26), surrounded by upright slabs and measuring 0.35m by 0.45m, which was situated next to the presumed line of the wall may conceivably have been associated with a doorway between the front and rear rooms of *Contubernium* 7.

The partition between *Contubernia* 5 and 6 was represented only by a 0.90–1.10m wide strip of rubble foundations (H04:31–32/H05:28) distinguishable from adjacent and road surface (H05:26) and rubble floor or makeup level (H05:36) in being composed of larger material and less well-packed. The rubble foundations extended for 6m as far as the south wall of Building 4 (J04:07). The final stretch had probably removed by the disturbance (H04:20, J04:18) recorded along the

north side of J04:07. There was evidence for a possible entrance at the south-west corner of *Contubernium* 6, where street cobbling H05:26 continued around southern end of rubble foundations H05:28 and along their east side as though forming the surface of an entrance passage. A roughly linear spread of very large, worn cobbles and slabs (H05:33), each up to 0.50m in diameter, extended for c. 4m along the suggested line of the partition wall between *Contubernia* 4 and 5 and might have been intended to provide a solid base for the wall, though it was interpreted by the excavators as a surface rather than a wall foundation. No further evidence was recovered for partition walls associated with the initial phase of the barrack. Daniels considered that the northern part of the earlier wall separating the officers quarters and *contubernia* of Building 4 was reused as the west wall (G04:14) of Building L, but the position of this wall does not conform to the spacing of the other *contubernia* in either Barrack 17 or 18. It is more likely that this wall was demolished down to its lowest courses like the south wall of Building 4, but not actually robbed out, with the north wall of 17 cutting through or riding over its remains (the actual relationship between the walls was not preserved as the surviving masonry of wall G04:10 did not extend sufficiently far west).

Interior floors

From the medial wall southwards the interior of the block was covered with stone deposits variously composed of cobbles, flags and rubble, which appeared to form a continuation of the road surface to the south (Alley 10). However a distinction was noted between the cobbled street surfaces proper and the deposits to the north, which were perhaps laid down immediately following the demolition of Building 5. This distinction was most apparent to the east, which was the best-preserved area. Here the suggested internal levels incorporated a variety of sizes of cobbled stone and flags (H04:29, H05:33, 34, 36, J05:24, 25, 27, K05:26). Further west, the rubble deposits in the equivalent internal area were more disturbed, but did appear distinct from the street metalling proper (F05:25, G05:20). They were recorded as being composed of rounded stones of all sizes, set in a dark grey clayey loam matrix on a base of very small stones (F04:19, F05:21, G04:16, G05:17), the whole level being some 0.10–0.30m thick overall. At the west end of the block the context records treat the rubble over the street and the building interior as a single level (E04:10, E05:19, F04:23), but they do provide clear indications of multiple layers which may represent successive phase of street surfaces, whilst to the north only one layer was recognised, perhaps again an internal level.

It is unclear whether the cobbled layers in the

southern half of Building 17 served as floor surfaces or just represented makeup levels with the actual floors having been destroyed by post-Roman disturbance. The former is possible, particularly if the block was south facing. This would make the southern room in each *contubernium* the front room, or *arma*, which is generally considered to have been used for storage and perhaps food preparation and other processes, for which a rough but hard wearing stone floor might be appropriate, rather than for accommodation (but cf. Hodgson and Bidwell 2004, 140, noting the presence of hearths in the front rooms of barracks at South Shields and Lorch). No trace of any contemporary floor deposits were found in the northern half of Building 17 and these may simply have been destroyed by post-Roman activity. However, if the north rooms represented the inner room (*papilio*) in the *contubernium*, and were consequently furnished with less utilitarian flooring than the southern front rooms, it is possible that they may have had raised wooden floors consisting of planks and perhaps joists laid across and perhaps resting on demolished and apparently redundant walls, in particular the south wall of Building 4. Such a method of flooring would not necessarily leave much archaeological trace, particularly if the walls were demolished below the level of any joist sockets, as it would obviate the need for clay or stone floor surfaces and would minimise the potential for survival of any occupation deposits.

Later alterations to Building 17 (Fig.14.33)

There is evidence that Building 17 underwent some degree of remodelling at a subsequent stage although the remains were too fragmentary to allow any coherent overall pattern to be discerned. A 4m length of rubble foundation (J05:18) was traced on the west side of partition wall J05:17, cutting through the line of the north wall of Building 5 and extending across the width of the former Alley 3. This resembled the rubble foundation for the possible partition between *Contubernia* 5 and 6 (H04:31–32/H05:28) and was interpreted by Daniels as the east wall of Building G. It might represent a replacement for wall J05:17 and signify that *Contubernium* 8 had been enlarged at the expense of *Contubernium* 7 or form part of a more substantial remodelling.

A channel lined with sandstone slabs (J05:22), aligned roughly north-south, was 1.7m long and 0.5m wide was located in the southern part of *Contubernium* 7, close to the line of wall foundation J05:18. It was filled with rubble and dirty soil and resembled the stone-lined drains present in the front rooms of the cavalry barracks in the *retentura*, which could imply that horses were stabled in this part of the barrack at some stage in its life.

Post-hole Building J

Grid squares: G4, G5, H4, H5

The most substantial structural alteration was represented by the group of postholes designated Building J by Daniels. Constructed mainly in the post-in-pit fashion, this was located in the central third of Barrack 17. Most of the surviving postholes lay on the southern side where ten postholes were identified (G05:36–41 and H05:50–53), some clearly set in a c. 0.35m wide trench (H05:32), and on eastern side, with three more postholes (H05:54–56). In addition, occasional outliers (H04:35 and G04:41–42) may have belonged to a northern side of the building, although only two of these (G04:42, H04:35) lay directly in line. Alternatively the medial wall of Building 17 might have provided the base for a sleeper beam. The posts were placed between about 0.8m and 1.2m apart and averaged 0.3m in diameter. The minimum dimensions of the structure were 14m east to west and 4m north to south, although this last measurement may actually have been 6m if the outliers did indeed belong to a north wall. The line of the south wall trench and post holes ran along the edge between the surface metalling of Alley 10 (H05:26 etc) and rubble deposits identified as the interior floors or levelling up deposits of Building 17 (H05:33–34).

Interpretation

Daniels interpreted these post holes as forming a rectangular timber building around 14m in length (E-W) and 6m wide (N-S), regarding it as a secondary feature of the late Roman layout in the west *praetentura*. This remains the most straightforward interpretation of the evidence – a post-in-pit building erected over the central third of Building 17 (perhaps in the fourth century?) after that structure had gone out of use and been demolished. Any floor levels and occupation deposits associated with the timber building would presumably have been destroyed by later activity.

Nevertheless there is an alternative possibility, namely that the post holes marked the remodelling of Building 17 as a hybrid timber and stone-built barrack block. Such hybrid construction is apparent in the case of Building 12, one of the earlier cavalry barracks in the *retentura*, where the frontage of the *contubernia* range as well as its internal partitions was built of timber (see Chapter 16 below). A similar mixture of stone and timber construction was also encountered in some of third-century phases of barrack block at South Shields (cf. Hodgson and Bidwell 2004, 125–8), extending so far as to include the end wall of the *contubernia* in some instances. It could be argued that something similar obtained in the case of Building 17, with the main east-west row of posts which Daniels assigned to Building J potentially forming part of a timber frontage and the east wall representing an internal partition. It seems unlikely that any such arrangement formed part of

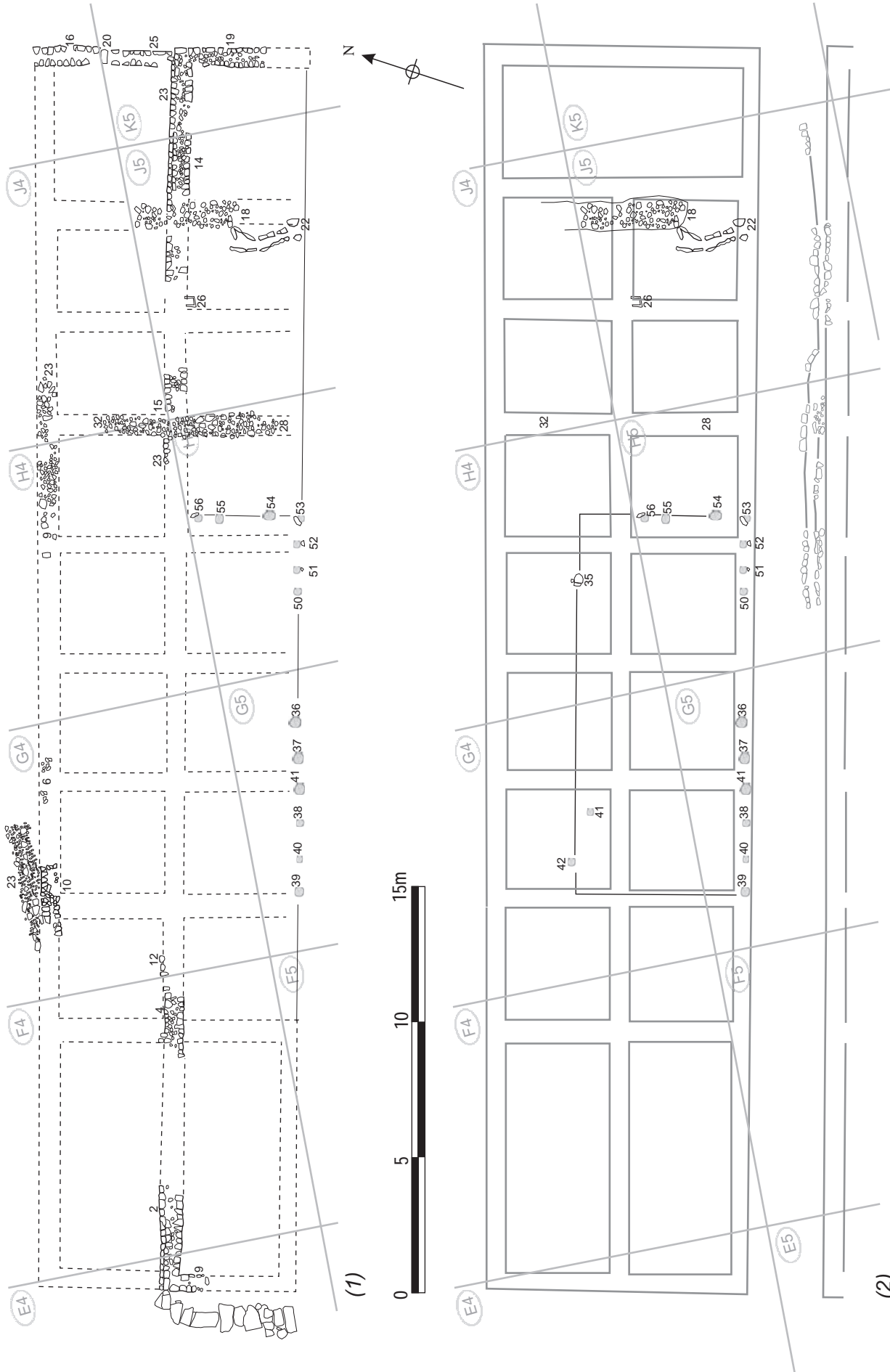

Figure 14.33: Two alternative restorations of the latest features in Building 17, (1) with the posts of 'Building J' interpreted as part of the south façade of Barrack 17, (2) with Building J restored as a separate rectangular timber building, replacing part of 17. Scale 1:200.

the primary layout of Building 17 since the very fact that the internal partition walls both in Building 17 and in 18 were all built of stone, including those used to divide front rooms from rear, as well as those separating the individual *contubernia* one from another, would imply that the use of stone walling was the defining characteristic of the third-century barracks in the *praetentura*, at least as initially laid out. The outer walls would surely therefore all have initially been built of stone, as sleeper walls at the very least, if not to their full height, as substantiated at South Shields with regard to one phase of barrack in this general period (Hodgson and Bidwell 2004, 144, fig 11). However, a later rebuilding which incorporated a timber frontage in the central third of the block cannot be ruled out. It is, admittedly, less easy to fit the three isolated posts attributed to the north wall of Building J into any such pattern, unless they were unconnected, perhaps belonging to an earlier phase of Building 17, but this north wall was too uncertain for this to be a decisive factor either way. Unfortunately only one of the Building J post holes (G05:39) produced a few sherds of pottery and these may well have been residual.

Roads associated with Buildings 17 and 18

The new east-west street (Alley 10)

The demolition of Buildings 4, 5, and 6, and the construction of the two new barrack blocks in the western *praetentura* was accompanied by a revision of the internal road system, with a new east-west street passing between Buildings 17 and 18 (labelled Alley 10 here). The street was laid over the southern half of Building 5. It was divided into three separate sections by the broad post-Roman cultivation furrows and was best preserved towards the east, in grid squares H05, J05 and K05, where a clear distinction was noted between the street metalling and the cobbled stone floors inside Building 17.

Phase 1

The first surface covering the easternmost stretch of the new street (H05:26, J05:19, K05:21) contained many large, worn cobbles, though the size was more variable in H05, and formed a good, well-packed layer. This was associated with a newly constructed stone-lined drain (H05:24, J05:10) which ran along the south side of the street next to the north wall of Building 18, having been built on top of the remains of the south wall of Building 5. Although its northern limit was somewhat irregular, the overall width of the street, including the drain, can be estimated at 3.00–3.50m from the north wall of Building 18 to the edge of the stone surfaces associated with the interior of 17. The latter were marked by clear signs

of differential wear (H04:29, H05:33, 34, 36, J05:24, 25, 27, K05:26 – see above). To the east the large cobbles of street surface J05:19/K05:21 appeared to terminate in a north-south oriented line of similarly sized stones (K05:18) which may have formed the west sidewall of a drain running along the western edge of the *via praetoria*. Five of these stones remained *in situ* and did seem to form a distinct face, extending for 1.90m.

In the central section of the road there remained one clearly undisturbed strip of the initial street surface (F05:25, G05:20) comprising medium sized cobbles resting on a base of small pieces of rubble. This area of intact primary and secondary levels was not clearly differentiated from the surrounding disturbed levels on the site plans, only in the context records and associated sketch plans, and its dimensions cannot be accurately estimated. To the north lay an extensive rubble spread (F04:19, F05:21, G04:16, G05:17) which was interpreted as a disturbed area of the road surface, but appears to correspond to the interior of Building 17 and may therefore represent disturbed floor levels of the building comparable with those identified further east. To the south there was only a band of rubble disturbance (F05:22, G05:18), c. 1.50m wide, composed of a mixture of small angular stones and some very large stones lying between the intact layers of street metalling and Building 18 *Contubernium* 1. This probably marked the course of a later robber trench responsible for removing the stone-lined drain on the south side of the street and/or the north wall of 18, which was largely absent here except for the few possibly displaced facing stones of F05:11.

To the west only one level was identified (E04:10, E05:19, F04:23), extending over the area of the demolished Building 5 and thus encompassing the southern part of 17 as well as the street south of Building 17. It reportedly also overlay those stretches of Building 5 walling which had been removed with no sign of robber trench. The level was composed of small and medium-sized cobbles, many sub-rectangular in form, in a grey soil matrix. The context descriptions do imply that this was a deliberately laid surface, albeit somewhat rough, and make clear reference to there being more than one layer of cobbling, though only one layer was present at the north end (F04:23). Thus the sequence here may be more complex than the use of a single context number in each grid square would suggest, with the possible presence of successive levels of street metalling and conceivably even an internal cobbled floor base at the west end of 17. Beyond this the north-south drain (E04:12, E05:05) on the east *intervallum* road apparently continued in use during this phase.

Phase 2

A second surface was subsequently laid over the street (perhaps corresponding with the construction of Building J), although the existing drains from Phase

1 were retained. Again this resurfacing was clearest towards the eastern end of the street, where it was composed of worn small cobbles in crumbly, sandy loam, which was a mixture of light yellow and dark brown in colour (H05:27, J05:20), but even here it did not survive over the full extent of the earlier cobbling, being absent over K05:18/21.

A second street level (F05:06, G05:06) was also recorded further west, overlying the earlier metalling there (F05:25, G05:20). The new level was c. 0.10m thick and made up of cobbles of all sizes, which formed a fairly good surface, but did not appear to be heavily worn.

The street north of Building 17 (L)

A rubble street surface (G04:23), was identified immediately to the north of Building 17, in 1975, in a narrow tapering area, some 8m in length, between the building's north wall and the northern edge of the excavation area. This was interpreted by Daniels as the internal floor of Building L. The surface was composed mainly of small rubble stones with some larger ones, all set in a firm, dark grey clay (perhaps in fact pressed into the underlying clay floor levels of the redundant Barrack 4). The site plans and photographs suggest the rubble perhaps continued beneath the north wall of Building 17 (G04:10), forming a solid base for that wall.

A subsequent possible surface (G04:09), predominantly made up of very small, tightly packed cobbles, but also incorporating several large, reused building stones, covered G04:23 and abutted wall G04:10. This may be Roman, and contemporary with the last phases of Building 17, but it might equally be later, as it included modern brick and coal in close association. The surface was 50mm thick and was overlain by a thin lens of hard dark clay.

The via praetoria

The latest surviving level of the *via praetoria* consisted of a 3.50m wide carriageway (K04:04, K05:14) located towards the east side of the original broader roadway and running northward towards the *porta praetoria*. It was composed of medium-sized cobbles, averaging 0.10–0.20m in length, and was clearly distinguished from the rubble spreads to the west and east (K04:13/K05:07 and K05:15 respectively) in the site records. Its relationship to these levels was not clearly defined.

North into vallum road levels

Two further levels of the north *intervallum* street were recorded in grid squares G03 and H03, at least one of which was probably of Roman date. These could not be related to road levels to the west or south with any certainty although some possible equivalences

can be suggested. The sequence was clearest in G03 where the third road level (G03:14) was partially overlain by a surface composed of fairly large cobbles (0.10–0.30m in length) and some building rubble (G03:20). For the most part this did not extend as far as the northern edge of G03:14. It was regarded as equivalent to context H03:05, immediately to the east, described as medium-sized, river-washed cobbles and small angular stone intermingled with colliery waste. As a result of the presence of that waste H03:05 was initially interpreted as a road associated with colliery activity, but no such contamination is referred to with respect to G03:20 and the context record was later revised to acknowledge the possibility that the surface was associated with the *intervallum* road. The colliery waste may have intruded into the cobbling when the modern overburden was machined off, as suggested in the context record, or perhaps the overlying deposits were removed by colliery period activity, resulting in the renewed exposure of surface G03:20/H03:05 at that stage.

The extent of G03:20 shown on the relevant sketch plan (G03 p 22) implies there should have been an equivalent layer in grid square F03 to the west. No such layer was recorded however, unless F03:05 (the only street surface examined in F03) was equivalent to surface G03:20, rather than the underlying third phase of street metalling (G03:14) as stated in the context records. F03:05 was partially overlain by a spread of angular rubble (F03:12) which also extended over the remains of Building 4 (as F03:10), but the description of these contexts does not particularly resemble that of G03:20 and the rubble does not appear to have formed a deliberately laid surface.

A very hard, compact cobble surface (G03:05, H03:06) overlies much of G03:20/H03:05, incorporating a number of large sandstone blocks, particularly towards the west where the cobbling survived more extensively. The blocks were interpreted as reused Roman stonework. Modern material (pan tiles, clay pipe stems, cinder and relatively modern ironwork), as well as Roman period finds, were found in association with this surface, although it was not clear from the context record whether this was actually sealed by the metalling or simply pressed into the surface by later activity. However G03:05/H03:06 was certainly interpreted as a colliery period surface by the excavators with G03:05 said to cut the post-Roman ploughsoil.

To the north of the *intervallum* surfaces G03:14 and G03:20 there was a linear spread of sparse rubble and cobbles intermingled with colliery waste (G03:04), which followed a broadly similar alignment to that of the street. Towards the west a smaller patch (G03:08), similar in composition – river-washed cobbles and small angular rubble – but perhaps less disturbed, was recorded as overlying G03:04. Both G03:04 and G03:08 were recorded as underlying the

post-Roman ploughsoil layer (G03:13) extending to the north. Compact surface G03:05 was also recorded as overlying G03:04, but the latter's relationship to adjacent levels, such as G03:14 or G03:20, is not clearly expressed in the context record and associated sketch plans.

Discussion

Interpretation of the later levels of the north *intervallum* street is complicated by the lack of a clear horizon between the Roman levels and those associated with 18th and 19th-century colliery activity. The post-Roman ploughsoil layer encountered across parts of the site was not present over much of the *intervallum* street (although it did survive – as G02:11, G03:13, H02:03, H03:03 – over the rampart deposits immediately to the north). Presumably this reflects the truncation of the deposits overlying the Roman levels resulting from colliery era disturbance. Moreover finds were absent or not recovered from all but the uppermost surfaces (including an eighth- or ninth-century strap end from sparse cobbling G03:04 – see Chapter 25, no. 2). The very hard, compact cobble surface (G03:05/H03:06), which formed the uppermost layer of cobbling exposed by the excavations, was associated with modern material and was consistently interpreted as a colliery era surface rather than part of the *intervallum* metalling. This remains the most plausible interpretation but it is possible that a Roman period surface was reused during the colliery era, with modern material being pressed into the surface through constant wear.

The description of the uppermost hard compact surface, G03:05/H03:06, is similar to that given to the upper of the two cobbled layers recorded on the north side of Building 17 (G04:09) a little further to the south. It is possible therefore that these represented the same surface which extended continuously over the former area of Building 4 between Building 17 and the original *intervallum* road. However further to the west, F03:05 was not seen extend over interior of Building 4.

Rubble spreads

An extensive stone spread, comprising cobbles and building stones (E04:07, E05:04, F04:03, F05:02, G04:03, G05:03, 05, H04:18, 19, 28, H05:12 J04:05, 06, J05:07, K04:13, K05:07) was present over Building 17, the western part of 18 and the intervening Alley 10. The excavators thought this represented a third distinct phase of deliberately laid road metalling and that it was associated with the demolition of Buildings G, H, and J. The east-west drain along the eastern part of the road was believed to have remained in use at this stage, with occupation also continuing in the buildings on the south side of the street (C, D, E).

The excavators' interpretation of the rubble spreads

as a metalled road level is very much open to question in view of their great extent – covering virtually the entirety of Sites 2 and 3 – and relative lack of wear. Variations were noted in the rubble, but none appear to represent significant functional distinctions. The rubble lies at the interface between the Roman levels and the overlying ploughsoil (E04:03, E05:03, F04:01.3–4, F05:01.5, G04:02, G05:02, H04:01.3, H05:01.3, J04:03, J05:03, K04:02, K05:03), and must instead, in large measure, simply reflect the impact of the ploughing on the later Roman archaeological remains. It is matched by the broad band of similar rubble encountered beneath the ploughsoil (F03:03) in Site 4, covering the north-west corner of Building 4 (F03:10) and extending northward across the north *intervallum* road (as F03:12). The deposits of tumbled angular stone in the alley between Buildings 4 and 5 (E04:15, F04:10, 11, G04:15, H04:24, J04:16, J05:15, K05:22) should likewise be grouped with the overall rubble spread. Only the reference to 'worn cobbles and shattered flagging', making up part of deposits H04:24 and J04:16, hint at any kind of surface over the alley, but such an interpretation was largely dismissed in the context record. Furthermore the rubble spread was cut by a series of three broad deep furrows running roughly north-south (west: E05:31, F04:18, F05:27; central: H04:21, H05:16; east: J04:13, 17, J05:15, 23, K04:10), probably resulting from ridge and furrow ploughing, with further loose rubble deposits being encountered at a lower level in the base of the furrows (e.g. central plough furrow: G05:12, H05:04). The rubble was less dense along the southern edge of the excavation site, overlying Building 18 (clay soil and rubble deposit H05:13), and particularly so to the east of *Contubernium* 4 ('Building D') where the clay soil contained relatively little rubble (H05:14, 29, J05:16) and was clearly disturbed with modern pottery and clay pipe recorded in H05:29 and in the dirty black earth layer, H05:21, which underlay H05:14. The reduced density of rubble here may simply be a result of the eastern *contubernia* of Building 17 having been demolished and their remains entirely removed during the Roman period to be replaced by timber structures such as Building E, which meant there was less stonework present here to be converted into rubble spreads by the action of the plough.

The end of the third-century barracks, whenever that occurred, may have been followed by their demolition and the deposition of a rubble levelling deposit to provide a base for the next phase of construction. It is conceivable that the rubble deposits encountered across the west *praetentura* may derive from and some way reflect such a levelling deposit, but even so the rubble was without doubt substantially impacted by later ploughing which must have compromised its integrity as a level representing a deliberate structural action undertaken at a particular point in time. It is clearly safer to treat it as plough

disturbance and the material associated with it cannot be regarded as securely stratified.

FINDS

Building 17

North wall

Coin: Antoninus Pius, 152–5 (no. 92, G04:10)

Building 18

Contubernium 1, Phase 1 Sub-Phase 2 floor

Iron: handle (no. 22, F05:39)

Stone: palette (no. 1, F05:39)

*Contubernium 1, end of Phase 1 deposit (F05:15)
(possible makeup for Phase 2)*

Copper alloy: loops (nos 350, 360)

Stone: whetstone (no. 32)

Contubernium 1, Phase 3 stone packing

Quern: (no. 16, F05:07)

Roads

Phase 1/2 surfaces Alley 10/Building 17 (west end)

Samian stamp: mid to late Antonine (no. S36, E04:10)

Mortarium stamp: 150–70 (no. 28, E04:10)

Phase 2 road surface

Mortarium stamp: 120–60 (no. 13, G05:06)

Copper alloy: strip (no. 303, J05:20)

Glass: window (no. 42, G05:06)

Alley 10/Building 17 – disturbed cobble/rubble surface inside building?

Graffiti: (no. 48, G04:16)

Copper alloy: handle (no. 216, G04:16)

Pottery: lamp (no. 10, G04:16), spindlewhorl (no. 32, G04:16)

Quern: (no. 59, G05:17)

Stone: throwing stone (no. 86, F04:19)

Road surfaces north of Building 17

Copper alloy: pendant (no. 169, G04:09 – later street surface N of Building 17)

Latest surviving via praetoria surface

Coin: 'Elagabalus', '219' (no. 131, K04:04), illegible, c. 202–35 (no. 262, K04:04)

Bone: shell (no. 57, K04:04)

Rubble in Building 17 (under G04:03)

Coin: Titus and Divus Vespasian, 80–1 (no. 16, G04:19),

Rubble spreads and other disturbed levels

Robbing of the street drain or north wall of 18

Decorated samian: 125–45 (no. D54, G05:18)

Rubble tumble between north wall of 18 (D) and street drain H05:24

Samian stamp: 85–110 (no. S145, H05:25)

Quern: (no. 49, H05:25)

Rubble over the west praetentura

Stamped samian: 160–85 (no. S3, H04:18), 150–80 (no. S69, H04:19)

Coins: Vespasian, 69–79 (no. 11, H04:19), Trajan, 98–117 (no. 33, H04:19), Septimius Severus, 202–10 (no. 118, E05:04), Julia Domna, 193–6 (no. 122, H05:12), Magnentius, 350–1 (no. 221, K05:07), Valens, 376–75 (no. 228, J05:07)

Copper alloy: brooches (nos 10, 18, both E05:04), bead (no. 60, H05:12), pendant (no. 170, H04:19), mount (no. 237, E05:04), loop (no. 335, J04:05)

Iron: ringmail (no. 17, J04:05), stud with copper alloy plate (no. 51, E05:04), double spiked loop (no. 69, H04:19), escutcheon (no. 73, H04:19), stud (no. 263, G04:03)

Lead: cramp (no. 7, H04:19), counter? (no. 21, H04:19), weight (no. 22, J04:05)

Glass: inset (no. 6, G04:03), bead (no. 28, G04:03), window (no. 42, J05:07)

Pottery: counter (no. 68, J05:07)

Stone: disc (no. 36, H04:19), throwing stones SF812, WSS167, WSS155, WSS163 (all J04:05), WSS148, WSS169, WSS215 (all J05:07)

Quern: (no. 15, E05:04)

Metalworking debris (no. 5, E05:04)

Clay pipe (E05:04, J04:05)

Wall tumble over Alley 3

Decorated samian: 125–40 (no. D36, F04:11)

Coin: illegible (no. 287, G04:15)

Rubble at the base of the plough furrow

Graffito: no. 57, H05:04

Stamped samian: Antonine (no. S117, G05:12)

Glass: counter (no. 9, G05:12),

Fill of the plough furrow

Coin: Commodus, 190–1 (no. 114, J05:15)

Soil layer west of Building 18 Contubernium 1 (F05:08)

Decorated samian: 125–45 (no. D6)

Stone: throwing stone (no. 34)

Pottery: statuette (no. 2), model lamp (no. 12)

Clay soil & heavy rubble over the east end of Building 18 (D)

Mortarium stamp: 150–80 (no. 39, H05:13)

Coins: Commodus, 180–92 (no. 113, H05:13), Claudius II?, 268–70 (no. 150, H05:13)
Copper alloy: knob (no. 205, H05:13), mount (no. 235, H05:13)

Clay soil & light rubble over the east end of Building 18 (east of D)

Copper alloy: bell-shaped stud (no. 272, J05:16)
Pottery: spindlewhorl (no. 16, H05:14)

Dirty black earth below H04:14 (with modern pottery)

Graffiti: (no. 37, H05:21)
Glass: window (no. 42, H05:21)

Dating evidence

Demolition/robbing of Building 5

The robber trench for the south wall of Building 5 produced three sherds of BB2 (G05:13, H05:06) and a scrap of late second or first half of the third-century samian (H05:06).

Building 17 (L, G and H)

Very little pottery was found in association with the remains of Building 17. Some material including second-century grey ware and Antonine Central Gaulish Samian, plus a coin of Antoninus Pius dated to 152–5, derived from the north wall (G04:10). Three sherds of pottery were recovered from the rubble foundations of the wall between *Contubernia* 5 and 6 (J05:18) – a third-century south-east reduced ware Gillam 151 rim and two south-east reduced ware body sherds – and a single sherd of south-east reduced ware cooking pot from the possible south wall robber trench at the southern edge of *Contubernium* 8 (K05:27).

Building 18

Significantly more pottery was found in Building 18, particularly in the various levels and features associated with *Contubernium* 1

CONTUBERNIUM 1 (C), PHASE 1 CONSTRUCTION

The make up deposits for Building C produced only about 15 sherds of pottery, almost all of which was BB2 (F05:51–53). The medial partition wall produced a sherd of south-east reduced ware (F05:09).

CONTUBERNIUM 1 (C), OCCUPATION

The initial occupation deposit (F05:38) produced little pottery, but included BB2.

CONTUBERNIUM 1 (C), PHASE 1 SUB-PHASE 2 OCCUPATION/ PHASE 2 REMODELLING

The thick deposit of debris (F05:15) overlying the pink clay floor and other Phase 1 levels in *Contubernium* 1 produced 0.569kg (c. 20 sherds) of pottery, including a third-century Gillam 151 rim and the rim and handle

of a countersunk lug-handled jar, probably from Yorkshire (F05:15).

The equivalent deposit along the west edge of the *contubernium* (F05:17) and sealed beneath Phase 2 wall F05:03 (F05:41) produced little pottery, the majority of which was BB2 and allied fabrics.

CONTUBERNIUM 1 (C), PHASE 2 WALLS

The secondary walls (F05:11, G05:15) produced very little pottery, but included BB2 and a sherd of Antonine samian.

CONTUBERNIUM 1 (C), PHASE 3 STONE PACKING

The stone packing (F05:07, G05:09) produced a few large sherds of Dressel 20 amphora (3.450kg) and 0.614 (c. 25 sherds) of other coarse wares, including some of third-century Nene Valley ware. BB2 and allied fabrics made up approximately 98% of the coarse wares. There was a single sherd of samian, of Antonine date.

CONTUBERNIUM 1 (C), ROBBER TRENCH OF THE PHASE 1 WEST WALL

The pottery from the west wall robber trench included Nene Valley ware and a high percentage of BB2 and allied fabrics, as well as a sherd of calcite gritted ware (F05:18).

CONTUBERNIUM 4 (D)

Little pottery was recovered from *Contubernium* 4. It included a rim, possibly a waster, of a second-century mortarium from secondary stone surface H05:38 and a high proportion of BB2 and allied fabrics from the underlying dark grey layer (H05:39).

PHASE 2 – ‘BUILDING E’

The little pottery recovered from the building derived from the soil makeup (H05:41) beneath secondary (?) stone floor H05:22. Most of the coarse ware was BB2, and there was one sherd of Hadrianic to mid-Antonine samian.

Building J

The post hole at the south-west corner of J (G05:39) produced a few sherds of pottery, including a scrap of Hadrianic or Antonine samian, some BB1 cooking pot body sherds and a scrap of BB2.

Roads

STREET NORTH OF BUILDING 17 (L)

The rubble road surface north of 17 produced a sizeable group of pottery (G04:23). It contained BB1 with obtuse angle lattice, a Lower Nene Valley mortarium rim of 230–400 and a third- or fourth-century mortarium body sherd. There was also a Nene Valley ware beaded-rimmed funnel-necked beaker, dating from the late third or fourth century.

The later surface in this area (G04:09) had almost

equal quantities of BB1 and BB2, including a BB1 flanged bowl of the late third century.

ALLEY 3

Context J05:15, probably representing Building 4/5 demolition rubble over Alley 3, produced mainly second century material, both locally produced wares from the middle of the century and later BB2, probably residual material from the alley. K05:22, on the other hand, produced a Huntcliff-type rim of the late fourth century or later.

EAST-WEST STREET (ALLEY 10)

The initial surface metalling of the east-west street (E04:10, E05:19, F04:10, 19, F05:25, G04:16, G05:17) produced three East Gaulish vessels of the late second or first half of the third century (E04:10, E05:19, F04:19, G04:16), four third-century Gillam 151 rims (F04:10, 19, G04:16, G05:17), a sherd of Campanian amphora (E04:10), a body sherd of third or fourth century Mancetter-Hartshill mortarium (E04:10) and the base of a Crambeck mortarium of the late third century or later (G04:16).

Most of the coarse wares from the Phase 2 street surface (F04:23, F05:06, G05:06, H05:27) were BB2 and allied fabrics. There were also four sherds of mid- to late Antonine samian.

The large group of pottery from the rubble/cobble spread over the alley produced four sherds of late second or first half of the third century samian sherds, three third-century Gillam 151 rims and large quantities of BB2 and allied fabrics. Context G04:03 also included some later third or fourth century material, with flanged bowls in Crambeck reduced ware and an unidentified reduced ware, and a proto-Huntcliff calcite-gritted ware rim.

The tumble produced a large quantity of pottery, with a lot of BB1 and a smaller quantity of BB2 and allied fabrics (F04:11). Although there was no Crambeck reduced ware, there were a few sherds of late third century gritty grey ware and two sherds of calcite-gritted ware, although the one Huntcliff-type rim is presumably contamination.

RUBBLE IN ALLEY 3

The rubble in the former alley between Buildings 4 and 5 (H04:24) contained third-century material, with BB1 and allied fabrics and sherds of an indented Nene Valley beaker.

RUBBLE OVER BUILDINGS

The loam/rubble over Building 4 (J04:05) produced a number of sherds of Crambeck reduced ware of the late third century or later, and a Nene Valley bead rim in the orange fabric more typical of the fourth century.

ROBBER TRENCH

The robber trench of the south wall of Building 4

(K04:14) produced only seven sherds of pottery, including a body sherd of third or fourth century Lower Nene Valley mortarium, and a Huntcliff-type rim of 370+.

STONE SPREAD

Context H05:12 produced over 100 sherds of pottery (3.77kg excluding samian), which included some residual material, such as sherds from six second century mortaria. Material that could be dated to the late third century or later made up approximately 10% of the coarse wares. There was one sherd from a possible late fourth century Crambeck parchment ware vessel, but it was in poor state.

RUBBLE OVER BUILDINGS (SURFACE??)

Material dating to the late third century and later made up about 22% of the coarse wares in context J05:07; three Huntcliff-type rims and a Crambeck parchment ware vessel indicate a date after 370+. Context K05:07 had a Nene Valley ware colour coated flanged bowl, a Huntcliff-type rim and a painted Crambeck parchment ware Corder type 9, also indicating a date after 370, plus a coin of Magnentius (350–51).

COBBLE SURFACE NORTH OF 18 *CONTUBERNIUM* 1 (C)

Although this produced over 50 sherds of pottery, much of this was BB2 and allied fabrics, and there was only one sherd of a later third century or later Crambeck reduced ware flanged bowl (G05:12).

DERELICTION?

The assemblage in J05:16 consisted of over 25 sherds, but included only one sherd of Crambeck reduced ware and two of calcite-gritted ware, although one of these was a Huntcliff-type rim.

Aspects of the third-century infantry barracks

It is an unfortunate consequence of the position of Buddle Street that the Daniels excavations were unable to reveal a complete barrack block belonging to this period. The road covered the frontages of both of the barracks blocks – 2 and 3 – in the better preserved, eastern part of the fort, whilst Building 1, which provided the best evidence relating to the second-century infantry barracks, was converted into a stable at this stage. The equivalent buildings in the western *praetentura* probably took a similar form, but their preservation was so patchy that they can only be restored by analogy with blocks on the other side of the *via praetoria* (Fig. 14.34). They were however clearly built on different footprints from the Period 2 barracks unlike those in the eastern *praetentura* which adapted the pre-existing structures.

The distinguishing feature of these barracks by comparison with their second-century counterparts is the use of stone walls to form the internal partitions separating the *contubernia* and dividing the latter into front and rear rooms. This increased use of stone is not necessarily a third-century trend. Barracks incorporating stone internal partitions were already in existence at many other sites, as noted previously, whilst contemporary infantry blocks at South Shields retain timber internal partitions throughout the life of the third-century supply base (Periods 5 and 6: c. 210–286/312). It is not until the Period 7 rebuild dated to 286/312 that the barracks there feature stone partitions (Hodgson and Bidwell 2004). However, the third-century infantry barracks at Wallsend, like their third and fourth-century counterparts at South Shields, retain simple rectangular plan form of their second-century predecessors, with no trace of the attached colonnaded verandahs which were a common element of barrack blocks further west (Fig. 14.35). Again this would appear to reflect localised regimental tradition rather than contemporary fashion. The third-century (Period 3) rebuild of the barracks in the north-west quadrant at Birdoswald retained the L-shaped form of the previous second-century barracks, although the officer's house was now detached from the *contubernia* and a wall was erected along the edge of the verandah of one of the barracks, probably a low stylobate wall supporting

the columns or posts of the verandah (Wilmott *et al* 2009, 227–36).

Where they survived (in Building 2 *Contubernium* 7, Building 18, *Contubernia* 1–2), the partitions separating the front and rear rooms of their respective *contubernia* took the form of simple cross walls like those in use in infantry barracks at Housesteads and Birdoswald. There was no indication that any of these cross walls were attached to a side passage wall in an L-shaped arrangement, like that prevailing in the fourth-century barracks at South Shields (Bidwell and Speak 1994, 35; Hodgson and Bidwell 2004, 131, fig 7, no 9), which replicated the layout of the timber partitions in the third-century barracks at that site (*ibid.*, 125–8, figs 2–4, nos 3–4) or the second-century infantry barracks at Wallsend. So little survived of the front rooms that it is impossible to be certain whether or not they were furnished with timber partitions to divide a passage off from the front room, but none was traced, where part of that room was exposed, as in Building 2 *Contubernium* 7, for example. Curiously, a possible partition or screen was noted in the rear room of that same *contubernium*, apparently defining a passage along the side of that room with access to the main area of the room being gained at the far end. This may have functioned in association with a hearth next to the doorway into the room, perhaps screening it.

If the use of stone walling – internal as well as

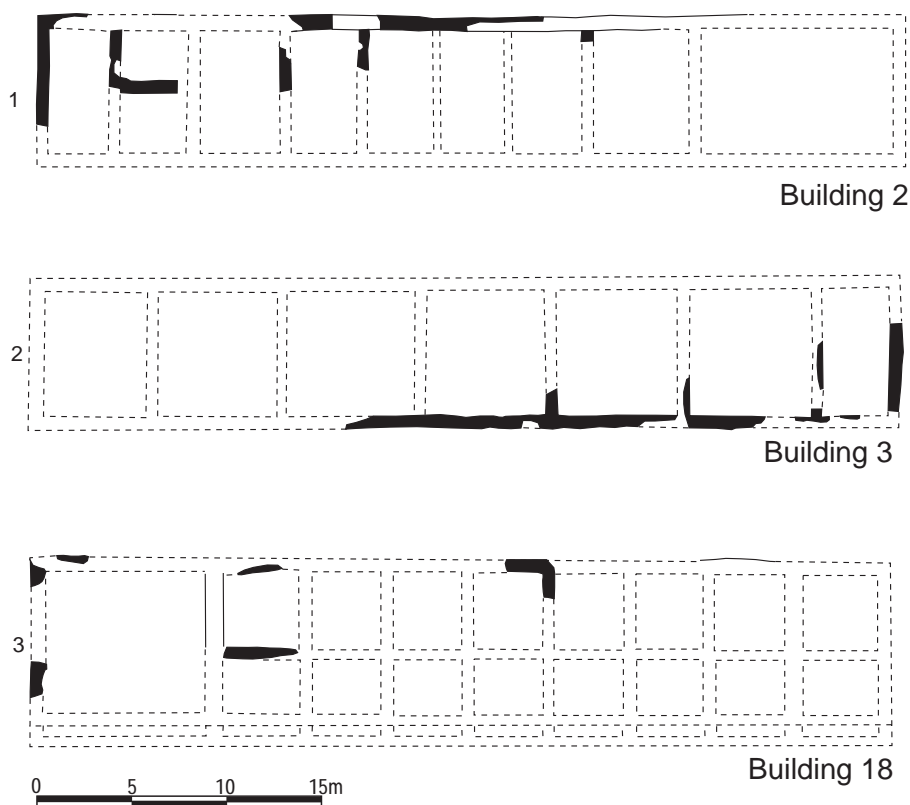

Figure 14.34: Third-century infantry barracks at Wallsend. Scale 1:400.

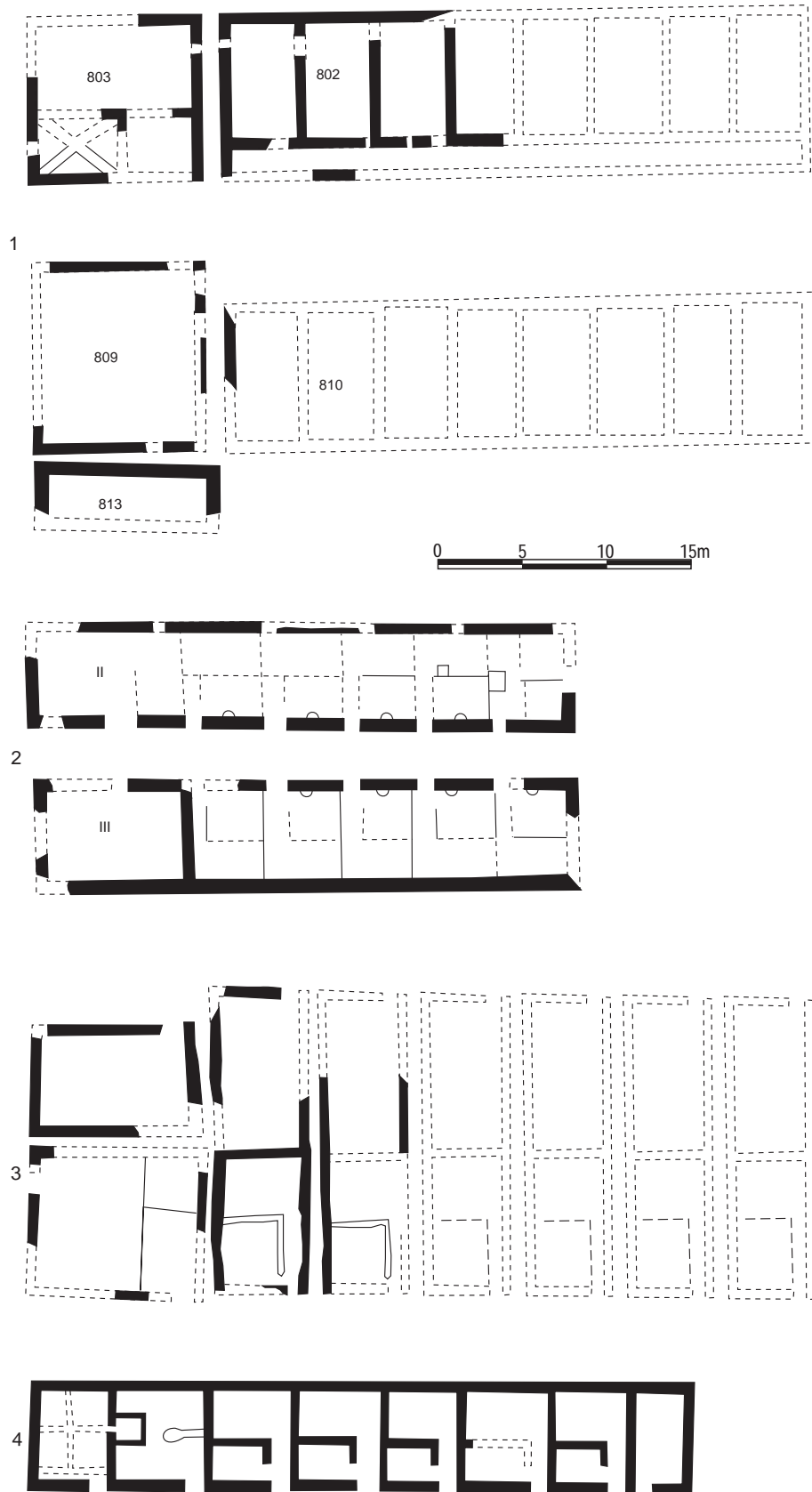

Figure 14.35: Third-century infantry barracks: 1. Birdoswald (after Wilmott et al 2009), 2. South Shields Barracks II and III c. AD 225/35–300 (after Hodgson and Bidwell 2003), 3. Vindolanda (after Bidwell 1985), 4. South Shields Period 7 barrack c. AD 286/312–c. 350 (after Hodgson and Bidwell 2003). Scale 1:400.

external – was the distinguishing characteristic of this phase of barracks the question remains as to what this actually signified in practice. The generally accepted view has been that Roman barracks were actually constructed with sill walls supporting a timber-framed superstructure. The discovery of the collapsed front wall belonging one of the third-century barracks at South Shields (dated 225/235–286/312) has prompted Hodgson and Bidwell to review this issue (2004, 144–5, fig 11). They argue convincingly that many of the phases of barrack examined at South Shields and Wallsend were probably constructed with external walls, at least, which were built entirely of stone. Of course, even if the external walls were carried up in stone to their full height, the internal partitions may have been built of timber and wattle-and-daub panelling above stone wall footings, which would have increased the available interior space by comparison with comparable full height stone partitions. In Building 17, the former north wall of Building 5 would appear to have been used as a longitudinal spine wall and in this case it is quite likely that the wall was demolished down to its footings and then used as a base for timber cross-wall superstructures separating the front and rear rooms of the *contubernia*. However there is no certainty that this was always the case. Stone partitions had compensatory benefits, being more fire proof, for example, a significant factor when hearths were set right against the internal walls.

As regards hearths, few were identified in the four barracks. In Building 18 two successive stone-flagged and clay hearths, associated with ashy deposits, were placed midway along the north wall of *Contubernium* 1, whilst another possible example was found in the north-east corner of *Contubernium* 4, in the form of a flagstone over an ashy spread. Only one hearth was revealed in Building 2, located in the rear room of *Contubernium* 7, at the end of the partition cross wall next to the doorway between the two rooms. The latter matches the positioning of many of the hearths in the third-century barracks at South Shields (*ibid.*, 140).

One of the most important questions concerning the third-century blocks at Wallsend is the number of *contubernia* they contained. This is surprisingly difficult to establish, the evidence being somewhat contradictory, but it was clearly less than the nine found in the second-century blocks. Neither Building 2 nor 3 could be examined in its full length, as a result of the oblique course of Buddle Street, and all trace of the barrack frontages has been lost. The clearest picture is presented by Building 2, where traces of five partition walls were recognised and a fairly uniform spacing can be restored. Assuming the officer's quarters – entirely obscured by Buddle Street – occupied the same area as its equivalent in Building 3 and the Period 2 Building 1, eight *contubernium*-sized suites could be fitted into the available space

with one next to the officer's house perhaps being rather wider (c. 5m wide internally) and the end unit narrower (3.20m) than the remainder, which ranged in width internally between an estimated 3.30m and 4.20m, with most c. 3.40–3.60m. A similar number of *contubernia* could be restored in the case of Building 18, although only three *contubernia* were partially uncovered there. The fragmentary remains of Building 17 could also be compatible with that figure, but in that case the evidence is even more tenuous. Most problematic, however, is Building 3 where the position of the sole surviving *contubernium* wall does not correlate with any of those plotted towards the east end of Building 2. If the wall formed part of a fairly uniform spacing the block would contain only five large *contubernia*. With only one such wall remaining there is no guarantee this was the case, however. The first *contubernium* or suite may have been abnormally large, or perhaps there was an exceptionally narrow chamber then a normal width *contubernium*, the two separated by a wall which has not survived. In the rest of the block, beyond the existing partition, there was room for six *contubernia* of average internal width (c. 3.40–3.60m) with a half width to spare, but seven 3.30m wide suites could have fitted neatly into the available length. What is clear in this barrack is that the officer's quarters did take up the anticipated proportion of the block, being some 11.60m in overall length (10.50 internally) divided into two unevenly sized rooms by a stone wall. This is of relevance to any restoration of the arrangements in Building 2, as noted above.

A reduction in the number of *contubernia* per barrack can be observed elsewhere, implying its occurrence at Wallsend is a real phenomenon and not simply a problem of interpretation caused by the inferior preservation there. At South Shields the number of *contubernia* in each block decreased to five from 225/235 onwards. These Period 6 barracks, which were excavated in the east quadrant of the fort, replaced an early third-century layout of six half barracks arranged in pairs to form three complete barracks are much shorter than normal blocks, perhaps in part because of the confined area they were occupying to the south of the supply base granaries (Hodgson and Bidwell 2004, 125–7). However the reduced complement of five *contubernia* was maintained in the fourth-century Period 7 barracks, even though these blocks are full length. The best-preserved example can be seen to have contained a large undivided room next to the officer's quarters and a smaller room at the opposite end again devoid of internal partitioning. The large room housed a stoking pit serving the channelled hypocaust in the adjoining officer's house and a hearth for ironworking and probably functioned as a workshop (*ibid.*, 131–2). The small room at the other end of the block may be comparable with the equivalent end room in Building 2, which was furnished with a flagged floor, extending

across the entire chamber, and also lacked any trace of internal subdivision. At 3.20m wide internally (but later reduced to *c.* 2.70m), the end room in Building 2, like its counterpart at South Shields, was slightly narrower than the *contubernia* in the rest of the block and this together with the lack of a partition dividing it into front and rear rooms suggests it may have performed a specialised function within the block, such as storage. This would further reduce the number of proper *contubernia*, designed to accommodate troops, down to a maximum of seven in the case of Building 2. There is as yet no definite evidence at Wallsend for the presence of a workshop and service room next to the centurion's house and these were not a feature of the third-century barracks at South Shields either.

The later Roman structures in the east praetentura ('Building A')

Grid squares: K04, K05, L04, L05, N04, N05

Most of the stratigraphic evidence for the late Roman period in the *praetentura* had been removed by medieval ploughing and colliery-related activity, but traces of structures belonging to this period did survive in one area. Overlying the demolished remains of the third-century stable block (Building 1 Phase 2), in the north-east corner of the fort, were the very fragmentary remains of a completely separate group of structures, recorded in the 1975–6 site notebooks (Fig. 14.36). These were initially interpreted as late Roman features (labelled Building A), then reinterpreted as colliery period features. Crucially, however, they were overlain by a deep ploughsoil deposit which covered this part of the fort and which must relate to the prolonged medieval and early-modern agricultural cultivation carried out over the site. The ploughsoil took the form of a heavy clay loam (K04:02, K05:03, L04:03, L05:03), grey-brown in colour and ranging in depth from 0.10m to 0.25m. The underlying series of walls probably do therefore represent the remnants of a late third- or fourth-century structural phase after all, rather than colliery-period features. These remains for the most part followed broadly the same orientations and alignments as the earlier Roman buildings, implying that the previous building plots were still in use when the new structures were erected. However the surviving walls were too few and too widely dispersed to enable any coherent pattern of a barrack block or chalet range to be discerned.

These structures appeared to be associated with the late road surface on the *via praetoria* (K04:04, K05:14) which, like the surviving walling, was covered by the post-Roman ploughsoil.

Four stretches of walling were identified, each aligned roughly north-south and surviving no more than a single course in height (see Fig. 14.37). The most westerly of these (K05:17, L04:12) was *c.* 7.0m in

length and was composed of very large, roughly-faced blocks which may have been reused. It was located just beyond the west end of the former Building 1 and was lined on its west side by a stone-faced drain or gutter, again one course deep, which was traced over a distance of 15m along the east edge of the *via praetoria*. The gutter made a 90 degree turn towards the east (L04:23) at the north end of the wall, suggesting this represented the northern limit of any building associated with the wall, but there was no firm evidence for any walling running alongside this stretch of guttering, which extended for a further 5.0m. Although the alignment of the new wall did not correspond exactly with that of the west gable wall of Building 1, the two were broadly similar and K05:17/L04:12 could therefore represent the end wall of a building or range of buildings occupying broadly the same plot as the earlier Building 1 (see Fig. 14.38).

A much shorter stretch (L05:11), no more than 1.0m long and 0.40m wide, survived some 12m to the south-east of K05:17/L04:12. It sat on a layer of loose, dark grey-blue loam which in turn extended westward over the line of the robbed out wall (L05:49) which had separated *Contubernia* 7 and 8 of the previous Building 2, implying that particular partition wall had been robbed out at some point prior to the erection of the later Roman structures. No detailed plan exists for the third of these walls (M04:15, M05:20), apart from its northern end, though its approximate position can be estimated. The fourth and final stretch of walling (N05:10) was more substantial at 7.0m long and 1.0m wide, and was located 24.0m to the east of west wall, K05:17/L04:12. The easternmost wall comprised large, roughly faced blocks with a rubble core (Figs 14.39, 14.40). A dark earth layer (N05:20) formed a matrix between and beneath the wall's stones.

The orientation of these different structures is not identical. The short stretch of walling, L05:11, followed virtually the same orientation as wall and drain K05:17/L04:12. These features did not quite run parallel to the easternmost wall (N05:10), but their respective orientations were sufficiently similar to suggest that all three walls may have formed part of the same structural phase. However wall M04:15/M05:20 followed a very different alignment and extended across the *intervallum* road, implying that it belonged to a later phase of activity. Moreover the crucial relationship of this last wall to the post-Roman ploughsoil is not defined in the relevant site notebooks so this feature could conceivably represent a colliery period feature, as supposed by the excavators.

FINDS

Building A

N-S wall

Mortarium stamp: 155–180 (no. 26, N05:10)

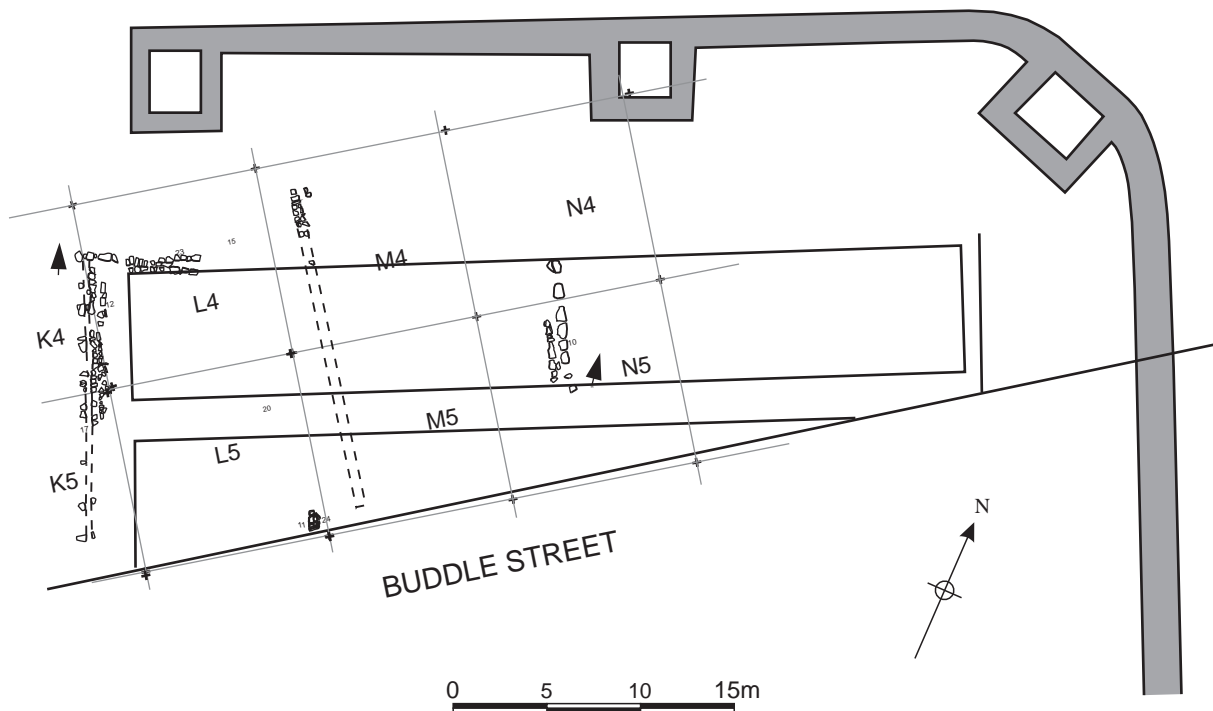

Figure 14.36: Late structures in the north-east part of the fort shown in relation to the earlier buildings. Scale 1:400.

Post-Roman ploughsoil

Lots of Roman objects, plus Charles I coin and clay pipe.

PLOUGHSOIL L05:03 (ROMAN FINDS)

Coin: Constans

Iron hobnail

Pottery counters

Two glass beads, one (no. 25) of 'late Roman' date

Copper alloy loop, terret

Window, bottle, cup glass

Decorated samian

Amphora stamp

Mortarium stamp

Quern

(POST MEDIEVAL FINDS (AS KEPT))

Coin: Charles I, 1625–49

Bone button, C18 or later

Clay pipe bowl, C18 or C19

Dating evidence

The only pottery associated with the walls came from the soil under and between the stones of the eastern section of north-south wall (N05:20). This produced 0.3kg of pottery, of third-century material, with only a single flanged bowl probably dating to after 270. The possibly later wall M04:15/M05:20, produced only a few sherds of undiagnostic pottery (0.019kg).

Two contexts from the post Roman ploughsoil produced pottery of third century date, although

nothing certainly of the late third century (K04:02, L04:03). The only context to produce fourth-century material, including a coin of Constans dated 346–8 (cat. no. 196) and a late fourth-century Crambeck mortarium, was L05:03, which also produced post-medieval material.

The later Roman road surfaces

The *via praetoria*

A new surface of small cobble rubble (K05:15) was present over the east side of the *via praetoria*. This overlapped the remains of the west wall of Building 2, and merged with the demolition rubble which extended eastward over the building (L05:07, 25). In these areas it included broken fragments of stone and flagging from the demolition. However no clear distinction between the cobble/rubble over the *via praetoria* and the demolition rubble overlying the building was defined leading the excavator to suppose that the road had been widened by 3.50m, extending over the area of the westernmost *contubernium* of Building 2 (8). This was regarded as contemporary with the occupation of Shacks B, K and M over the remainder of Building 2 (which, as argued above, actually just represent the latest occupation levels in that building). The same widening of the *via praetoria* was also suggested in relation to the final phases of Building 16, which was interpreted as having been reduced in length to accommodate the broader road. However a layer of cobbles and rubble, very

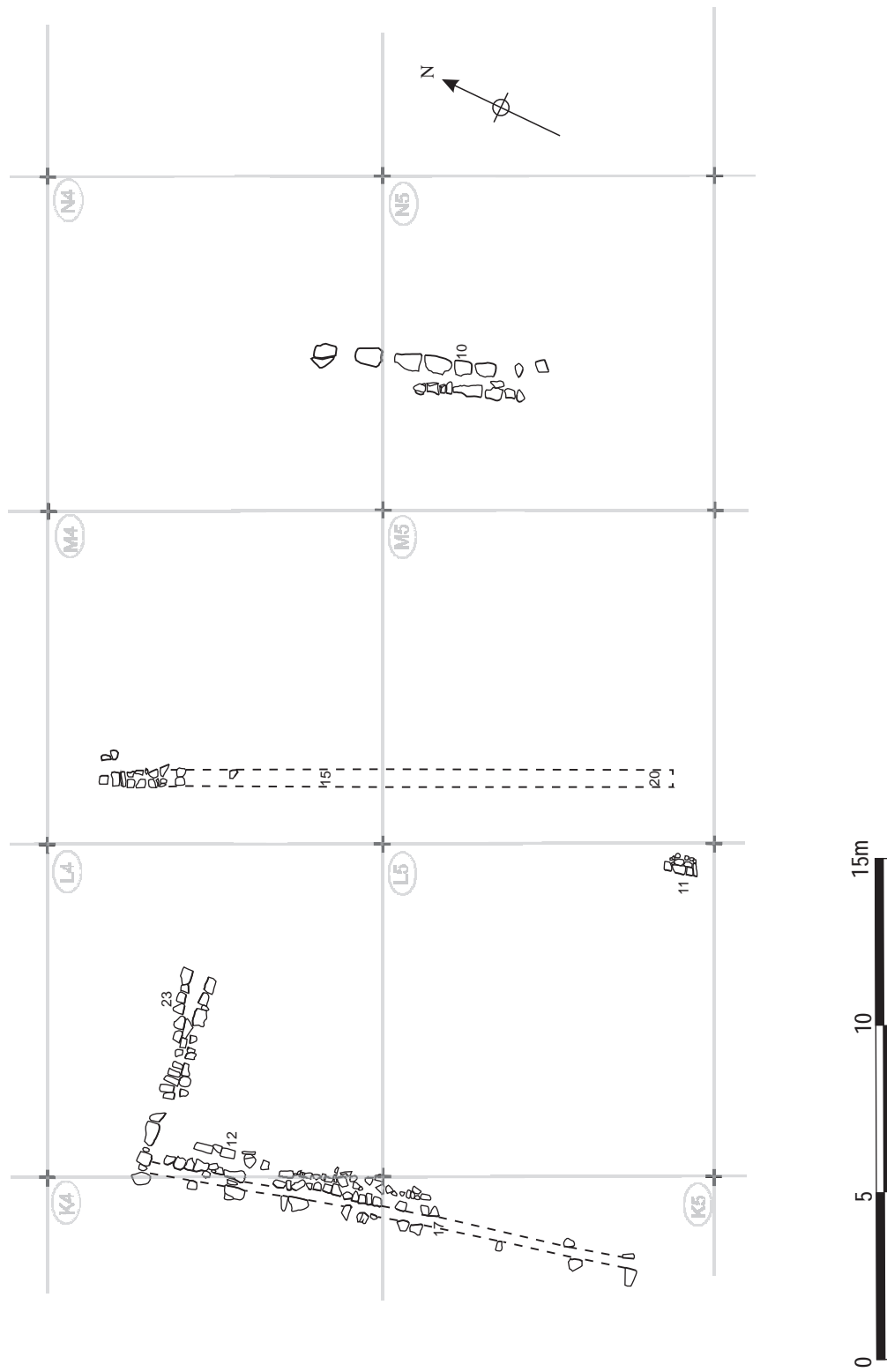

Figure 14.37: Later Roman structures in the north-east part of the fort at 1:200.



Figure 14.38: The north-west corner of Building 1 showing the later north-south wall (L04:12) and east-west gutter and possible walls (L04:23), looking east.

similar in character to K05:15 etc., was also present along the west side of the *via praetoria* (K05:07) and extended without any evident differentiation over the area of Buildings 4 and 5 in the north-west part of the *praetentura* (as K05:07, K04:13, J05:07, J04:05, 06, H04:18, 19). A very similar rubble level (L04:11, L05:32) was found over the drain (L04:27, L05:52) immediately west of Building 1 and extended eastwards across the demolished remains of Building 1, as described above. The cobble and rubble layers on either side of the *via praetoria* were separated by a cobbled road surface (K04:04, K05:14), c. 3.5m wide, composed of medium sized cobbles, which ran down the centre of the earlier *via praetoria*, leading from the north gateway. This road surface was interpreted as a cobbled track of eighteenth- or nineteenth-century date by the excavators. However, it underlay the thick clay-loam deposit which extended across the entire site and which, as noted above, is most plausibly interpreted as the agricultural soil associated with the post-Roman use of the fort as arable and meadowland. Furthermore, no road, lane or track can be identified on the line of the *via praetoria* on any of the eighteenth- or nineteenth-century historic maps. Road surface



Figure 14.39: Late wall N05:10 from the north.



Figure 14.40: Central section of Building 1 viewed from Simpson's Hotel in 1975. Late wall N05:10 can be seen in the centre of the building.

K04:04/K05:14 was, therefore, probably the latest Roman road level laid over the demolition rubble in the north part of the fort.

One problem with this reinterpretation is that further to the north, where it passed through the north gateway, the *via praetoria* cobbling appeared to extend over the area of the gate's east guardtower (see

below: *north gate*). This relationship is not certain – the cobbling over the tower remains is separated by 1920s excavation trenches from that in the passageway, which is definitely associated with the late road. However, the two cobbled layers do lie at the same level and have very similar characteristics. If they are equivalent this would imply that the road is either post-Roman (medieval?) or that the east tower went out of use and was raised to the ground during the later Roman period, before this phase of the *via praetoria* was laid.

At any rate, whether or not K04:04/K05:14 does represent a late Roman road surface, there is no evidence that the *via praetoria* was widened at any stage nor that the buildings in the north-east part of the fort were reduced in length. Indeed position of the stone-lined drain or gutter (K05:17), which extended along the east side of the *via praetoria* carriageway and was closely associated with the west wall of 'Building A' (L04:12), suggests the carriageway was slightly narrower in this phase. A 2.0m length of similar stone kerbing (K05:18) was identified on the west side of the *via praetoria* and might form part of a corresponding gutter on that side of the road.

North inte vallum (Road 4)

This consisted of large areas of irregular cobbles (L04:07, P04:02, P05:11, Q04:11, Q05:13) and stone fragments, presumably from the demolition of Building 1. Although this surface was badly disturbed by post-Roman activity and did not show the kind of wear encountered on the earlier roads, it did appear to be a consistent, well packed, deliberately laid surface. The north side of the road ran up to the face of the new kerb (N04:02, P04:03) of the rampart and to the south

extended over the former verandah of Building 1. The south edge was not clearly defined as the road merged with the general spread of demolition material.

East inte vā lum (Road 7)

General demolition material including clay and fragments of flagging (Q05:04) were found in and over the street drain east of Building 1, but there was no evidence of a Phase 3 re-surfacing of the type which occurred over the north *intervallum* street. The Phase 2 surface must have continued in use.

FINDS

North intervallum road Phase 3 surface

Coin: M. Antonius, 32–1 BC (no. 3, P04:02)

Metalworking debris: casting waste (no. 8, P04:02)

Demolition over the Phase 2 east intervallum street

Copper alloy: tripod support (no. 84, Q05:04)

Dating evidence

North intervallum road Phase 3

Most of the pottery came from context P04:02. The high proportion of BB2 and allied fabrics (approximately two-thirds) suggest a date round the middle of the third century.

Ploughsoil over the north intervallum road

Context Q04:02 contained a possible late third-century Crambeck reduced ware flanged bowl and some sherds of calcite-gritted ware, but most of the coarse wares were made up of BB1 and BB2.

PART 4

THE BUILDINGS IN THE SOUTHERN PART OF THE FORT

15. THE EARLIER CAVALRY BARRACKS IN THE *RETENTURA*

All four barracks in the *retentura*, Buildings 9–12, were investigated by Daniels in 1977–9, with Building 12 in the north-east quarter being interpreted as a stable block whilst 9, 10 and 11 were envisaged as barracks for the soldiers. The northern pair, 9 and 12, were re-examined by Tyne and Wear Museums in 1997–8, which resulted in a significant shift in our understanding not only of those two structures, but, by analogy, of all four *retentura* buildings, which are now interpreted as stable-barracks, a type not previously recognised on the British frontier.

The account presented below provides only an outline summary of the earliest timber and stone phases of the barracks 9 and 12, focussing on the associated features which were identified in the 1978 and 1979 seasons, along with full treatment of the Daniels evidence relating to 10 and 11. For a fuller description of the layout of barracks 9 and 12 the report on the excavations conducted by Tyne and Wear Museums should be consulted (Hodgson 2003, 37–90).

Building 9

Grid squares: D12, D13, E12, E13, F13, F14, G13, G14, H13, H14

Introduction

Excavation of Building 9, the most north-westerly of the four *retentura* barracks, was initiated in 1977, but mostly undertaken during the 1978 season. Much of the building had been removed by post-Roman disturbance and robbing. Nevertheless a complex structural sequence was apparent, with multiple phases, many surviving only fragmentarily. As a consequence of this fragmentary survival, the structural evidence posed the kind of interpretative problems more commonly faced when examining the

results of nineteenth-century excavations, for example multiple intersecting walls which were difficult to form into a coherent pattern and which were rarely relatable to a clear sequence of extensive or well-preserved floor surfaces. These problems are reflected in the research archive with successive redrafts of the phase plans, sometimes involving radical shifts in thinking.

Re-excavation by Tyne and Wear Museums in 1997–8, as part of the Segedunum Project, has substantially revised our understanding of this structure. Like its three counterparts in the *retentura*, 10, 11 and 12, Building 9 is now interpreted as a cavalry barrack block of a type first proposed by Sebastian Sommer (1995), designed to house a full *turma* of around 30 men and their horses. The four blocks would thus have been able to accommodate an equitate cohort's full complement of c. 120 cavalry.

Phase 1 – the timber-built barrack (Fig. 10)

In its primary, Hadrianic, form Building 9 was built entirely of timber. No sectioning to find timber-beam slots underneath the main external walls was undertaken in this building in 1978 (in contrast to Building 12 where such features were identified), but slots for external timber walls were located in 1997–8. Together with the evidence from Building 12, this suggests that all the barracks in the *retentura*, and probably in the fort as whole, were built of timber originally.

As many as nine slots for the internal timber partitions separating one *contubernium* from another were uncovered by Daniels, mostly by means of small spits excavated at the end of the 1978 season. It is difficult to determine whether the individual partitions were associated with the timber barrack or its stone successor as it is apparent that the footprints of the two ranges were very similar. Together,

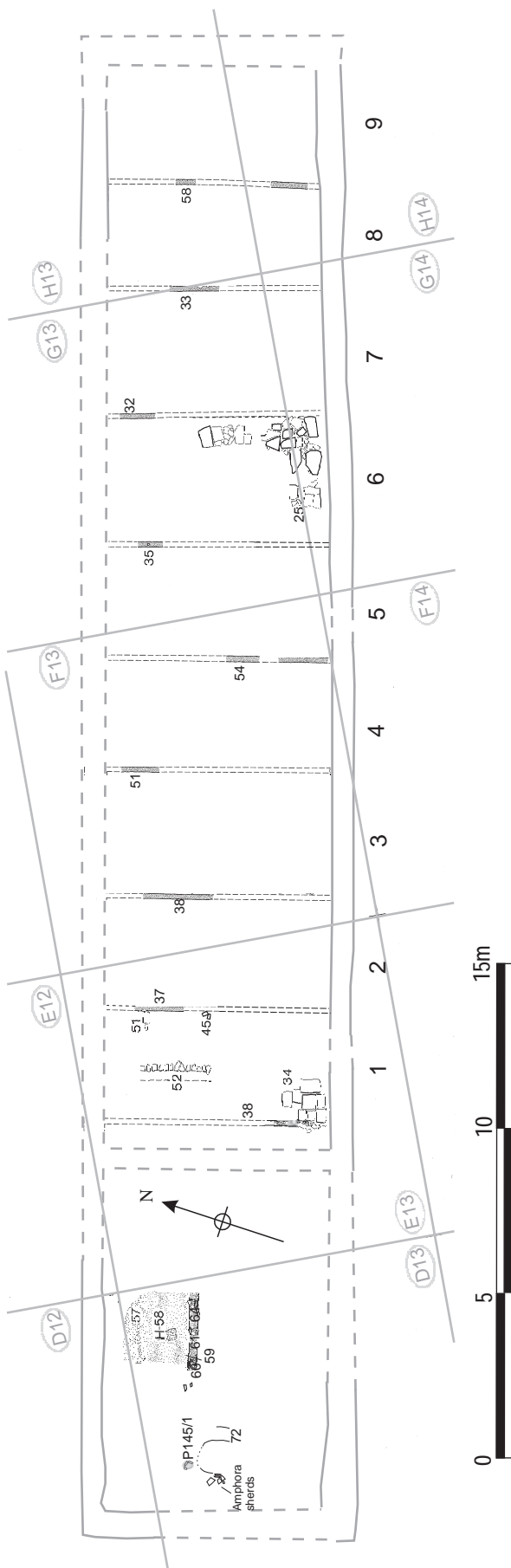

Figure 15.01: Building 9, Period 1 at 1:200.

however, these partition slots give nine *contubernia*, plus the officer's quarters situated at the west end of building. The *contubernia* were each divided into front and rear rooms (clearly demarcated by a surviving partition slot in the most westerly *contubernium*, as recorded in 1997–8), the former floored with flagstones and the latter with beaten clay, and opened to the south, facing the parallel block, Building 10, across a 4.00m wide street (Alley 5). A centrally-placed, elongated pit was recognised in the southern half of each *contubernium* during 1997–8, leading to the reinterpretation of Building 9 as a cavalry barrack block. The pits, it is argued, were intended to collect waste from stalled horses. The block accommodated a full *turma*. Each *contubernium* would have housed three troopers, with their horses stabled in the front (southerly) rooms of the *contubernia* and the men plus most of their equipment in the rear rooms. It is significant that the cavalry *contubernia* in the *retentura* barracks all lacked the distinctive type of internal partition that separated the front room from a side access corridor leading from the front entrance to the back room, which were recognised in the infantry barracks in the northern part of the fort and at South Shields. In a cavalry barrack such partitions would simply have impeded access for the horses into the front room.

Only a few features associated with the timber barrack were uncovered during the Daniels excavations. These can be identified by reference to the phase plans and description presented in the 1997–8 excavation report. The clearest evidence was seen in *Contubernium* 1 and 2 where successive floor levels were preserved. A sequence of three stone floors was revealed in the south room of *Contubernium* 1. Only a very small area of the lowest flagging was seen, consisting of fairly small irregular slabs (E13:35), and it is questionable whether this represented an actual floor surface or simply a construction level. A more extensive area of the next level was revealed, comprising regular, rectangular flagstones up to 0.70m × 0.40m in size (E13:34), very similar to some of those used in the floor belonging to the subsequent phase of *Contubernium* 2 (E13:14). The western edge of this flagging clearly respected a north-south aligned wall slot (E13:38, TWM 8534) which was positioned only 0.70m from the stone wall (E13:17) that separated the officer's quarters from the *contubernia* after the barrack block was rebuilt in stone, too close for the wall and slot to have functioned at the same time. Both the slot and, by association, the flagging must therefore have belonged to the preceding timber phase. They were overlain by a further surface of more irregularly shaped stones (E13:23) which evidently represented the floor of the subsequent stone barrack. Similarly, two successive clay layers were recorded in the north room of *Contubernium* 1, the lower of which (E13:48) probably represented the

floor level associated with the timber barrack phase. Up to three clay levels were noted in the north room of *Contubernium* 2 (E13:47/F13:49, E13:41/F13:36, E13:13). The lowest (E13:47, F13:49), again, must relate to the primary timber barrack. In *Contubernium* 3, the lowest clay surface (F13:50) was covered by a layer of daub (F13:45), which probably derived from the demolition of the timber barrack. This was in turn overlain by another clay floor (F13:35), presumably associated with the replacement stone block. Further east, a flagged floor (G13:25, TWM 7779) in the southern part of *Contubernium* 6 was also primary as was the associated clay level to the north (G13:26). Re-excavation in 1997–8 showed that this flagging respected the edges of 2.20m long waste pit (7795). It was cut through by pitched stones (G13:36, 8542) which lined the replacement sump in the subsequent stone barrack phase, and overlain by secondary flags probably associated with the stone barrack block (G13:37).

Two features in the north room of *Contubernium* 1 were overlain by the secondary clay floor surface (E13:42) and should therefore be primary. A stone setting (E13:51) occupied a position against the east side wall characteristic of hearths. Like similar features in the hospital building and Building 1, this was interpreted by the excavators as a coal scuttle. These structures are perhaps more plausibly viewed as a brazier stands. The stratigraphic position of this feature beneath the secondary floor but set right next to partition E13:37 would suggest the latter too belonged to Phase 1. In the centre of the north room, a line of small stones (E13:52), some of which were tipped downwards, was initially interpreted as one side of a possible drain, but the actual structural significance of this feature remains very uncertain. It was 2.10m in length and was recorded as cutting the Phase 1 clay floor.

In the officer's quarters, the position of an east-west partition was indicated by a trench (D13:59) and three post-holes (D13:60, 61 and 64), and was shown to extend further westward in 1997–8 (a post hole was marked on site plan P145 here, but not allocated a context in the Site Notebook). This defined the southern edge of a clay floored room (D13:57) which was furnished with a hearth marked by a rectangular patch of burnt red clay (D13:58). The floor was composed of rather patchy pink clay with much grey, sticky, silty material.

On the south side of the partition line, further to the west, an irregular U-shaped feature (D13:72) may also belong to this phase. It was formed by shallow gulleys cut into the clay beneath the stone floor of the Phase 2 barrack (D13:65, 71). The full extent of this feature had been truncated by the later stone partition wall (D13:04) to the south. Its purpose is unclear. A Dressel 20 amphora base uncovered in 1997–8 was set in a circular cut, apparently positioned within

the western gully and might be associated with this feature although this cannot be confirmed as its positioning could be coincidental (base: TWM 8266; cut: 8273; cf. Hodgson 2003, 100 & fig. 67, where it is assigned to the chalet period – TWM Period 4). The amphora was not specifically identified in the 1978 context records though sherds belonging to the vessel were clearly shown on site plans P154 and P157, incorporated in and beneath stone floor D13:65/71. The vessel was sealed beneath the chalet period floor (D13:48) and must predate that period. The green silt contained in the amphora base indicated the vessel may have been used as a urinal.

FINDS

Clay level between Contubernium 1 and the decurion's house

Decorated samian: Flavian-Trajanic (no. D31; E13:20)

Contubernium 1 partition slot

Stone: throwing stone (nos 12, 113, E13:38)

Contubernium 1 floor

Stone: throwing stone (no. 71, E13:34)

Dating evidence

The make-up layer in the gap between *Contubernium* 1 and the officer's house (E13:20) produced only a single sherd of pottery, from a Flavian or Trajanic samian bowl. The clay floors in *Contubernia* 1 and 3 produced four sherds, consisting of a second-century mortarium, two second-century BB1 flat-rimmed bowls and a sherd of Flavian or Flavian-Trajanic samian (E13:48, F13:50). The clay floor in *Contubernium* 6 produced a sherd of samian and a sherd of BB2, both of Antonine or later date (G13:26).

The material in the levels associated with the timber barrack block is for the most part consistent with a Hadrianic construction date. The BB2 and Antonine samian in clay floor G13:26 may represent material trampled into the floor before its replacement.

Phase 2 – Stone rebuilding (Fig. 8)

Introduction

The external walls of the barrack were rebuilt in stone, probably in the mid-late second century. Their state of preservation when revealed in 1978 was poor. Most of the north wall of the building was destroyed by modern disturbance, especially by modern sewage pipe trenches. Only fragmentary remains of the foundations of the east wall survive. Slightly more of the west wall was intact. The south wall was the best preserved of the four, surviving several courses high in places. It was 0.65m–0.70m wide and constructed with fine grained, orange-grey, sandstone blocks

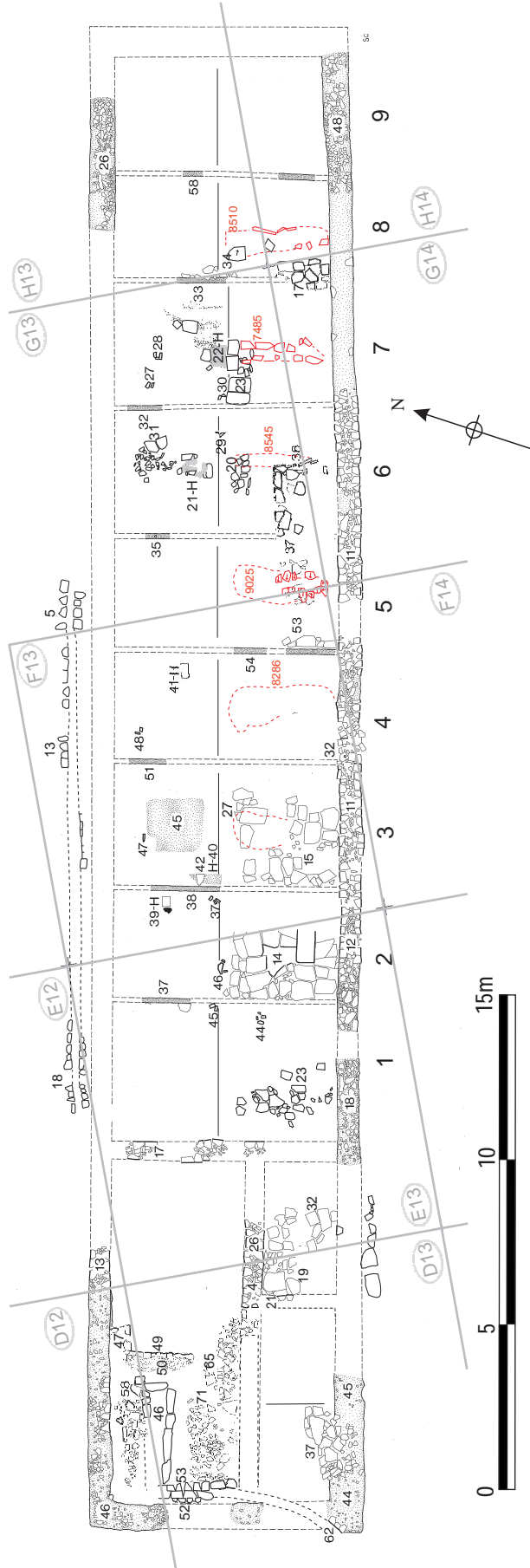

Figure 15.02: Building 9, Period 2/3 at 1:200

facing a rubble core, probably originally clay-bonded. The clay and rubble foundations varied in width from 0.70m (e.g. E13:18) to 1.10m at the south-west angle of the building (D13:44). Certain parts of the wall appear to have been rebuilt, i.e. E13:12. The stone barrack was 46.00m in length and was wider at the west end (8.20m), where the officer's quarters were located, than at the east end (7.80m). The range of nine *contubernia* occupied 34m of the total length and their internal dimensions from front to back wall ranged from c. 6.20m (east end) to 6.80m (west).

The contubernia

It is not always possible to determine whether the internal features identified in 1978 belonged to the primary timber phase, which Daniels' team were unaware of, or to the subsequent stone rebuild. The internal arrangements initially remained very similar, with timber partitions continuing to divide nine *contubernia* one from another after the rebuilding. Moreover the footprint of the successive *contubernia* ranges was so similar that, with one or two exceptions it was very difficult to determine which of the two phases the individual partition slots should be assigned to.

The evidence for these partition slots was fairly fragmentary, the slots being identified in frantic last minute digging of small spits at estimated *contubernia* distances. They vary from changes in the colour or texture of the clay, to stones on edge (presumably to support a partition), to the edge of a flagged area and even a ballista ball/throwing stone (G13:35). It was suggested by the excavators that this stone had perhaps rolled into the slot left when the partition was removed, but three were found in slot E13:38 and others were revealed in similar contexts in other barrack blocks which implies their presence was the result of a deliberate action, though its purpose – structural, backfilling or otherwise – is unclear.

Each *contubernium* was divided into north and south rooms. As in the primary timber phase, the southern rooms were floored with stone flagging, whilst only beaten clay floors were uncovered in the northern ones (although it is conceivable that the clay served as a bedding for wooden floorboards with holes cut in them for the hearths). In some places traces of post holes were identified (e.g. E13:45, 46, F13:37 and G13:29, 30), roughly at the northern limit of the stone floors, which possibly formed part of the east-west partitions separating the two rooms (such east-west partitions were found in Building 1 Phase 1 and also in Barracks XIII at Housesteads and at South Shields). The allocation of these post settings to the stone barrack rather than its timber predecessor is based on the recorded observation that they cut the uppermost clay floor levels. In *Contubernium* 2, flagging E13:34 – more of which was uncovered in 1997–8 (as TWM 7513) – apparently terminated some



Figure 15.03: Building 9 viewed from the west showing flagged floors – E13:34 in *Contubernium* 1 (Period 1), E13:35 in 2 and F13:37 in 3 (Period 2 & 3).



Figure 15.04: View from the south of Period 1 flagged floor G13:25 in the south room of *Contubernium* 6 and the protruding slab wall of the Period 2/3 urine sump (G13:35) at the extreme left foreground. In the background, beyond the Period 4 spine wall, can be seen at top left hearth flag G13:21 sitting on Period 2/3 clay floor, with flags G13:23 belonging to the Period 2/3 floor of *Contubernium* 7 to the right.

0.70m–0.80m before the line of the east partition wall (F13:38), suggesting the existence of a side walkway, perhaps floored with timber boarding, leading from the front entrance in the south wall to the back room. The restriction of the flagged floors to the south part of the *contubernia* and location of the hearths only in the north rooms confirms that the two rooms had different functions, with the north rooms forming living areas for the troops whilst their mounts were stabled in the south rooms.

In *Contubernia* 1, 2, 3 and 6, the floor levels which were associated with the stone barrack could be identified on the basis of their relative position in the sequences of floors revealed here (Figs 15.03, 15.04). The upper flagging in the south half of *Contubernium* 1 (E13:23), ran over the top of the earlier flagging (E13:34) and the slot which formed the west wall of

the primary *contubernia* range, and extended towards the stone wall which separated the officer's quarters from the *contubernia*, indicating that *Contubernium* 1 was enlarged to the west when the barrack was rebuilt in stone. This flagging was presumably contemporary with the uppermost (E13:42) of the two successive clay floors recorded in the north room. Similarly the upper clay levels encountered in the north rooms of *Contubernium* 2 (E13:41/F13:36, E13:13) and *Contubernium* 3 (F13:35) should relate to the stone barrack block not its predecessor, with the clay floor in *Contubernium* 3 seen to be covering a spread of daub (F13:45) which probably derived from the demolition of the primary partition walls. The flagging in this *contubernium* (F13:15/27) had subsequently subsided into the underlying urine sump. Two levels of clay flooring were identified in *Contubernium* 2. In *Contubernium* 6, the primary flagged surface (G13:25) was overlain by a stone floor (G13:20, 37) associated with the secondary barrack and cut by the upright slabs (G13:36) lining the west side of the urine sump associated with this phase (Fig. 15.04). To the north, the corresponding clay floor (G13:24) was noted, again overlying its primary counterpart (G13:26). A further sandy clay layer (G13:19) covered all of these surfaces and probably represented makeup or a floor level for the subsequent chalet range.

The surviving evidence for the internal furnishings of the *contubernia* was limited. Hearths were revealed in the northern rooms of *Contubernia* 2, 3, 4, 6 and 7 (F13:39, 40, 41, G13:21, 22) comprising small patches of burnt red clay and/or single flagstones sometimes surround by spreads of coal. These were often set against the side or medial partition walls of the *contubernium*. One of the hearths (F13:40) comprised a single flagstone (F13:42) overlain by a spread of coal, rather than burnt clay or ash. This suggests the fire was not set directly on the ground and the feature might therefore conceivably be interpreted as a brazier stand rather than a hearth proper. Several post holes towards the north ends of the *contubernia* (e.g. F13:47–48, G13:27–8) may also relate to the internal arrangements of the early barracks in some way (F13:47 cuts upper clay floor F13:35 in *Contubernium* 3; relationship of F13:48 to equivalent clay floor F13:44 in *Contubernium* 4 is uncertain, but G13:27–8 also cut upper clay levels).

There was evidence for the location of a doorway through the front wall of *Contubernium* 4, in the form of a 0.90m wide section where only a single heavily worn course of the wall footings was present (F13:43). One of these stones, though displaced, preserved a pivot hole and a groove perhaps worn by the door leaf. The doorway was positioned at the western edge of the *contubernium* frontage.

The officer's quarters

The officer's house measured 11.80m by 8.20m and

was separated from the range of *contubernia* by a 0.70m wide stone wall (E13:17). Two possible entrances to the officer's quarters were identified, one in the south wall near the building's south-west angle and one in the middle of the north side (D13:47). An east-west medial wall (D13:04, E13:26) divided the house into two unequal parts, the northern room being the larger. The western half of this wall had later been entirely robbed out (D13:16). When it was first excavated in 1978 Daniels was uncertain whether the medial wall was an original component of the stone-built quarters. Internal stone walls of this kind were not a feature of officer's quarters in other barrack blocks of this period in the fort, timber partitions generally being used instead. The 1997–8 excavators assigned the wall to the following chalet-barrack phase (Fort Period 4) and restored a timber partition in the initial stone barrack phase (Period 2/3), which was represented by a single surviving post hole (TWM 8237, cf. Hodgson 2003, 51 fig. 37, 58, 98–9). However, the relationship of the wall to the lowest stone surface (D13:65, 71) in the north-western room suggests that it did belong to this overall period of the stone barrack (see below). The junctions between this wall and the east and west walls of the officer's house have not survived so the possibility that it represented a secondary insertion or sub-phase rather than an original feature, cannot be ruled out.

The northern room was divided by a north-south aligned wall. Only a single course of the east face of this wall survived (D12:51, D13:49), backed by a clay deposit (D12:52, D13:50), giving the surviving remains a rather unusual aspect, similar to the side of a water tank. At the north end of the wall, a line of three blocks immediately to the east may have represented some form of stepped threshold (D13:47), though set well inside the line of the building's north wall.

A large stone-lined urine-pit (D13:46), measuring internally 2.45m by 0.45m–0.50m, was constructed in the north-west room. This pit is probably a more elaborate version of those recently found in the front rooms of the *contubernia*, appropriate to an officer's accommodation, and was presumably designed to hold the waste from the decurion's horses. The sides consisted of large slabs set on edge sloping down into the bottom of the pit (see Fig. 15.05), giving an overall depth of 0.50m–0.60m. The pit's construction trench (D12:59) was observed on its north side, cutting into a grey clay spread (D12:60, D13:66 – a timber barrack level?), which in turn covered a grey clayey silt layer (D12:61) interpreted as the 'old ground surface' (pre-barrack?), overlying the natural subsoil. An overflow drain (D13:52/53) ran from the west end of the latrine southward along the inner face of the west wall (see Fig. 15.06), exiting at the south-west angle of the building (D13:62). This was found to contain a green-grey sandy silt (D13:70) including much pottery and glass. The remains of a stone surface survived to the



Figure 15.05: The flag lined urine sump (D13:46) in the officer's quarters from the east.

north and south of the pit (D12:58, D13:65, 71). This was composed of small rough sandstones (D12:58, D13:71) and was suggested this might represent the sub-floor for timber boarding. On the north side of the urine pit the stone surface was observed to directly overlie the fill of the pit's construction trench. Further east this floor level took the form of very worn and cracked flagstones (D13:65, TWM 7895), which incorporated three facing stones belonging to the lowest course of the medial wall (D13:04). The facing stones exhibited the same wear pattern as the flagging (D13:65) and lay at virtually the same level, demonstrating there must have been a doorway through the wall at this point which was in use at the same time as the flagstone surface.

The Dressel 20 amphora base set in a circular cut in the north-west room may belong to this phase rather than the primary timber barrack. The amphora base was uncovered during the 1997–8 excavations (base: 8266; cut: 8273; cf. Hodgson 2003, 100 & fig. 67, where it is assigned to the chalet period – TWM Period 4). The amphora was not specifically identified as a feature in 1978 though sherds belonging to vessel were clearly marked on site plans P154 and P157, in and beneath stone floor D13:65/71. The amphora setting and sherds were all sealed beneath the chalet period floor (D13:48) and must predate that period.

The south side of the officer's house was divided into a range of three rooms. In the south-west corner, a flagstone surface (D13:37) was observed to spread directly over the pink clay foundations of the building's south wall (D13:44/45), suggesting there was another entrance at this point. This surface was shown to extend further northward in 1997–8 (TWM 7701), forming a flagged lobby which encompassed the entire south-west corner of the building and was bounded on the east side by a timber partition slot (8234, cf. Hodgson 2003, 51 fig. 37, 58).

The central room of the south range was divided off from the next room by a stone wall (D13:21) extending south from doorway into the northern part of the



Figure 15.06: Stone channel D13:52/53 leading away from the west end of the urine sump from the north

house. The dimensions of the central room were c 3.00m (east-west) by 2.20m (north-south). The room occupying the south-east corner measured 4.00m by 2.20m and was floored with stone flags (D13:19, E13:32) which abutted the two surviving facing stones of wall D13:21. Just outside the south wall of the building a further line of flagging shown on site plan P145 was re-exposed in 1997–8 (TWM 7561).

Via quintana drain

Along the north side of the building parallel to the wall of the later stone barrack, lay a stone-lined drain or gutter (E12:18, F13:13, G13:05). Originally this probably ran the full length of the building, but, like the north wall, it had been badly damaged by modern sewer trenches and only a few fragments of its central section, spanning a distance of 16m, were revealed. The channel varied between 0.20m and 0.25m in width and was filled with a light brown sandy silt, whilst the side walls were composed of at least two courses of sandstone blocks, although in places only one course survived. The drain was set into the lowest cobbling of the *via quintana* revealed in 1977–8, which was composed of orange gravel, crushed sandstone and clay (E12:21, F13:24, G13:04). It should therefore

be contemporary with the occupation of the stone barrack and may even initially have been constructed at the same time as the primary timber block.

FINDS

Contubernium 1

Coin: Domitian, 81–96 (no. 20, E13:23)

Iron: chain (no. 36, E13:42), stud with copper alloy sheet (no. 53, E13:24)

Contubernium 2

Samian stamp: c.125–50 (no. S35, E13:13)

Copper alloy: chape (no. 220, F13:36), stud (no. 231, E13:41), mounts (no. 240, F13:36)

Iron: spearhead (no. 10, E13:41)

Pottery: disc (no. 51, E13:13)

Contubernium 3

Iron: studs (nos 45–6, F13:50)

Contubernium 4

Iron: clamp (no. 42, F13:44)

Contubernium 5/6 *partition slot*

Stone: throwing stone (no. 36, G13:35)

Contubernium 6

Copper alloy: plate (no. 307, G13:24)

Contubernium 8

Decorated samian: c.125–40 (no. D67, G14:17)

Glass: bead (no. 45, G14:17)

Officer's quarters

Mortarium stamp: 110–40 (no. 19, D13:71)

Glass: cup (no. 32, D13:70), bowl (no. 41, D13:70), window (no. 42, D13:50)

Coin: Crispina, 180–3 (no. 115, D13:71)

Via quintana drain

Bone: pin rough-out (no. 23, E12:18)

Dating evidence

The walls produced only four sherds of pottery, including a sherd of late second-century samian (F14:19) and one sherd of late second-century or later BB2 (E12:13).

The clay floors in both the officer's house and the *contubernia* produced BB2 and a small amount of allied fabrics of the late second-century or later. The stone floor in *Contubernium* 1 produced only about 15 sherds, mainly BB1 and locally produced grey wares plus a sherd of Hadrianic or Antonine samian (E13:23). The occupation material over this floor was different in composition, being made up of almost equal quantities of second-century locally produced

grey wares and BB2 of the late second century or later and only a single sherd of BB1 (E13:24).

The intermediate clay floor in *Contubernium* 2 was dominated by sherds of BB1 cooking pots (F13:36), and there was another BB1 vessel, a flat-rimmed bowl, in the upper clay floor. However, the upper layer also contained the remains of two Nene Valley indented scale beakers, each almost one-third complete, dating to the third century. (E13:13, fig. 22.15, nos 77–8). The amount of pottery from the floors in the other *contubernia* was small, mostly consisting of late second-century or later material, but with a few sherds of third-century Nene Valley ware in the flagged surface in *Contubernium* 3 (F13:15) and the clay floor of *Contubernium* 6 (G13:24).

Via quintana drain

There was a single sherd of Trajanic or early Hadrianic samian alongside sherds from two Lower Nene Valley mortaria dating after 230 and one dating to the late third or fourth century (E12:18). There were no surviving coarse wares.

Discussion

The use of stone dividing walls in the officer's house of Barrack 9 Phase 2 is anomalous. Nothing similar was encountered in the equivalent phase of the other officer's quarters investigated at Wallsend. Yet the stratigraphic evidence provided by the Daniels excavations to support this association appears convincing. Most crucial is the close relationship recorded between the worn threshold through the main, east-west aligned, partition wall and the Phase 2 stone floor to the north (D13:65/71, D12:58). This floor must have been associated with the initial phase of the stone-lined latrine sump (D13:46) and its outlet (D13:52/52). It was clearly too low to have been associated with the chalet period, when the height of the sump's side walls was raised well above the level of D13:65/71 and a new floor was laid (D12:39, D13:48). Secondly the lower flagged floor (D13:19/E13:32) in the south-east room of the house abutted the south side of the wall and was evidently broadly contemporary with it. This flagged surface extended as far south as the line of the south wall of the house, but did not extend over the robber trench for that wall (D13:35), unlike the chalet period flagged floor above (D13:20/E13:31), which obviously post-dated the demolition and removal of the redundant south wall.

Street between Buildings 9 and 10 (Alley 5)

Buildings 9 and 10 were separated by a 4.00m wide street (Alley 5). Two phases of metallated surface were recognised here (see Table 15.01). The lower surface, which was exposed along the full length of the alley,

Table 8 The cobbled street surfaces of Alley 5 between Building 9 and 10

Description	D13	D14	E13	E14	F13	F14	G14	H14
Post-Roman debris over the alley surface						13	08	21
Alley 5 surface 2			21	45				
Alley 5 surface 1			22	08	28	14	09	22

consisted of small, well-laid sandstone cobbles, generally worn smooth (E13:22, E14:08, F13:28, F14:14, G14:09, H14:22). Quantities of broken amphora were found on this surface in one area (E14:08). The cobbling dipped slightly along the north side of Building 10, the small stones here showing less sign of wear (E14:15=F14:30). The excavators were unsure whether this 0.35m wide depression formed some kind of gutter or a construction trench for the north wall of Building 10 and whether the cobbles exposed in the bottom represented an earlier road surface. A second layer of metalling was recorded in one small area and comprised worn small-medium sized cobbles (E13:21, E14:45). Elsewhere the lower cobbling was directly overlain by the walls of Chalet Range 9 (for example the walls of Chalet U sat on top of F13:28 and F14:14). No surfaces survived which post-dated the construction of the chalets and belonged to Fort Period 4 or later.

FINDS

Samian stamp: 125–50 (no. S7, F14:14)

Dating evidence

A total of 52 Dressel 20 amphora sherds, and two samian sherds of Hadrianic and Hadrianic or Antonine date were found on the lower road surface (E14:08, F13:28, F14:14). All but one of the Dressel 20 sherds derived from E14:08 and this may represent a single amphora smashed on the road.

Building 10

Grid squares: D14, E14, E15, F14, F15, G14, G15, H14, H15

Introduction

Very little of Building 10 survived (see Fig. 15.07), even by comparison with Building 9 its neighbour to the north, when it was excavated by Daniels in 1978 (as with Building 9, initial clearance of overburden took place in 1977). The south-west corner in particular, including much of the officer's quarters, had been entirely removed by modern cellars. Of the outer walls not more than two courses of the

superstructure, including the wide plinth course, remained at any point. However their foundations survived sufficiently extensively to establish clearly the outline of the second-century barrack. Building 10 was not included in the area re-excavated by Tyne and Wear Museums for the Segedunum Project in 1997–8, but the overall conclusions with regard to the *retentura* barracks derived from that programme nevertheless have important implications for our understanding of this barrack block's development as well.

Phase 1: the timber barrack block (Fig. 15.08)

The primary building was initially interpreted by Daniels as a stone walled barrack block with nine *contubernia* separated by timber and wattle and daub partitions. However, the 1997–8 excavations of Buildings 9 and 12, demonstrated that these two barracks were both constructed entirely of timber in their initial phase and each comprised a row of nine *contubernia* designed to accommodate a cavalry *turma*, with a separate officer's house standing at one end. It is inherently probable that the same was true of Building 10 and that it was only later rebuilt with stone outer walls and a stone dividing wall separating the officer's quarters from the row of *contubernia*. Indeed, the surviving remains provided clear evidence that such was the case. Traces of eleven or twelve timber partitions were uncovered by Daniels in the *contubernia*, many of which could not be fitted comfortably into the layout of the stone barrack block and must instead have been associated with an earlier timber-built phase.

The timber or wattle partitions separating the *contubernia* were represented by a series of eleven linear slots, distinguished by fills of gravel chippings or differently-coloured clay. These fills probably represent construction debris deposited when the timber partition panels were dismantled and removed. One pronounced soil change (F14:56) was also interpreted as the edge of a partition, although this may now be questioned. Most of the slots were found during last minute excavation of small spits at likely intervals and they were numbered from 1 to 12, running from west to east. They were planned (cf. archive plan P162) and assigned context numbers, but those examples in the western and central parts of the block were not recorded in detail in the site notebooks,

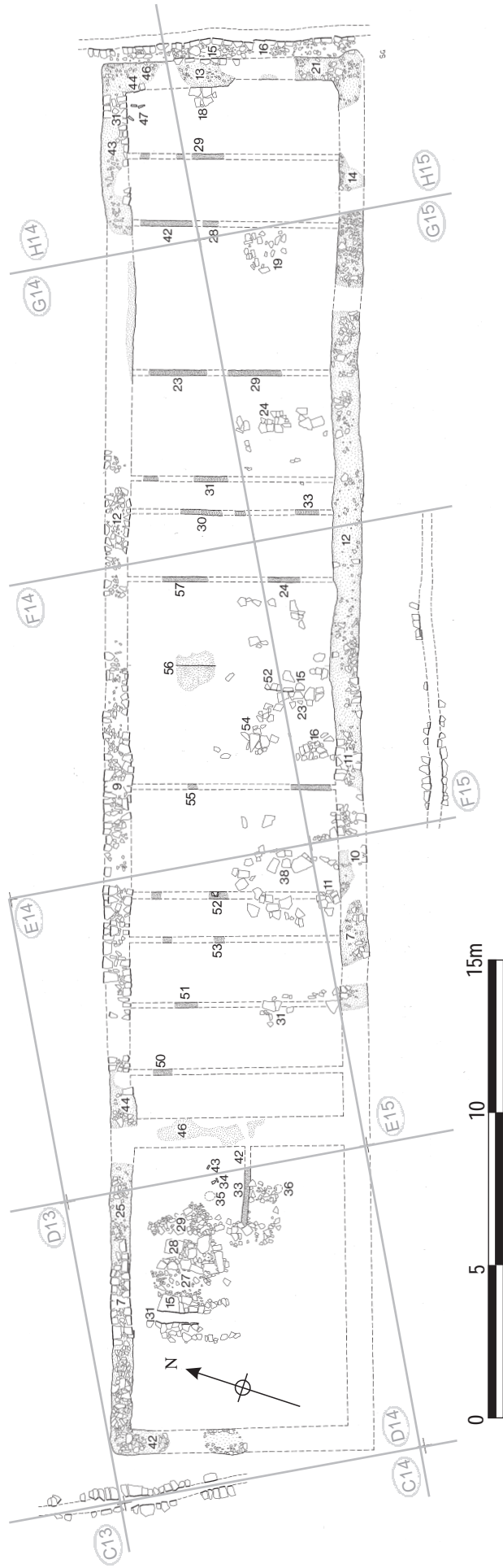

Figure 15.07: Building 10, All features associated with the Period 1 and 2 barracks at 1:200.

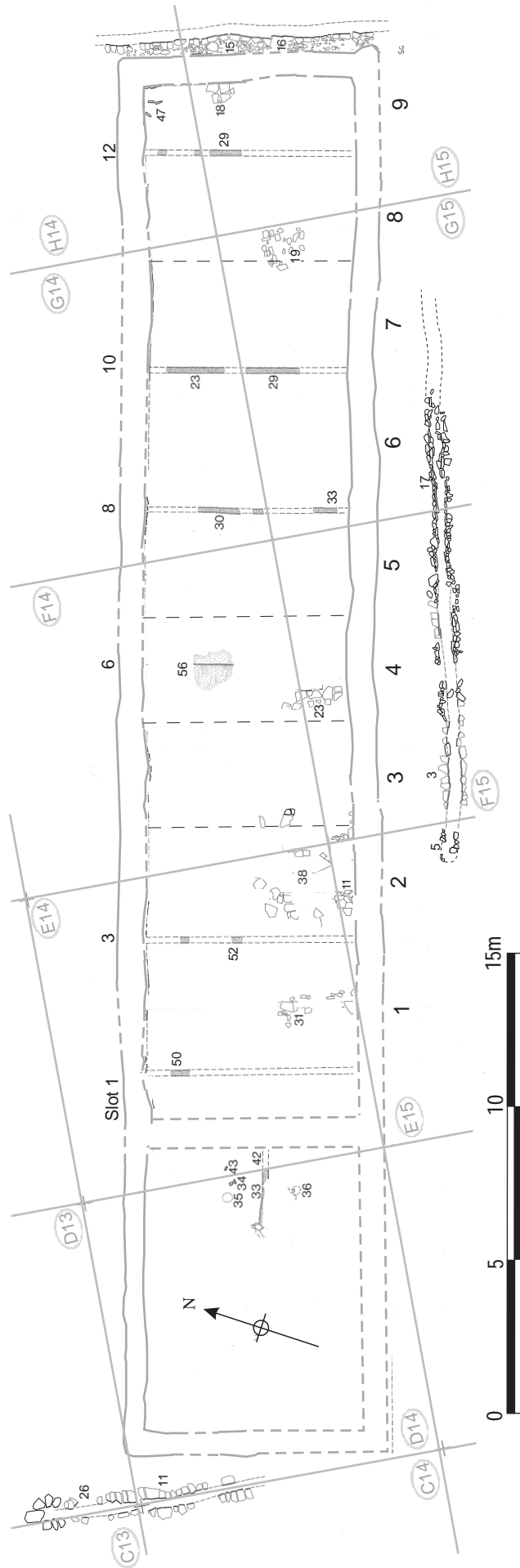

Figure 15.08: Building 10, Period 1 with the outline of the later stone barrack shown for reference at 1:200.

so their stratigraphic relationship with the successive clay floors or make up levels is often uncertain. Despite the predictive nature of the investigative methodology, too many slots were discovered at too close a spacing to fall into a simple, single-phase, if it is assumed that each example divided one *contubernium* from another. The partitions must have related to at least two phases of barrack *contubernia* which evidently had significantly different footprints along their east-west axis. This forms a marked contrast with Building 9 where it is clear that the two phases of *contubernia* occupied virtually identical plots and it was correspondingly difficult to distinguish one phase from another.

Initially two groups of slots were differentiated in Building 10, based on the depth that they cut into the underlying deposits, with Slots 1, 3, 5, 8, 12 falling in one group and 2, 4, 6, 7, 9, 10, 11 in the other, the second group cutting much deeper than the first. It would be logical to interpret the deeper slots as representing an earlier phase than the shallower examples, with the former representing part of a primary timber barrack whilst the shallower slots were associated with the stone rebuild. However, this was evidently not the case. Slot 1 (E14:50), one of the shallower examples, was only c. 1.40m from the stone wall separating the officer's quarters from the *contubernia*, too near to be contemporary with it, whereas the much deeper Slot 2 (E14:52) is positioned at about a *contubernium's* width away from the stone wall.

A more reliable method of determining which partitions were associated with which phase is to examine the spacing of the slots. On this basis, slots 1, 3, 8, 10 and 12 could belong to the earlier timber phase. As noted above, there is only a narrow gap between Slot 1 and the east wall of the officer's quarters, whilst Slot 12 (H15:29) is too close (2.40m) to the line of east wall of the stone barrack block to create a full-sized *contubernium*. Several missing partitions must be restored in the centre and east end of the range to complete the series. A second series, comprising slots 2, 4, 5, 7, 9 and 11, fitted reasonably comfortably within the footprint of the later stone-walled barrack block, their spacing beginning with the wall separating the officer's quarters from the *contubernia* (E14:46) and ending neatly at the east wall of the building (H14:46, H15:21). They should therefore belong together in association with this phase. In contrast, Slot 6 (F14:56), which was represented by a change in the colour of the clay flooring with chippings on the east side, doesn't fit with either layout and may well represent the trace of some other type of internal arrangement.

Some degree of confirmation for this two phase interpretation of the partition slots is provided by the relationship of Slots 3 and 4 (E14:52, 53) with the flagging in the southern part of the barrack (E14:38). Although it was not recorded as such in the site

notebook, the flagged floor appeared to be made up of an upper and lower level of flags (cf. archive plan P147), presumably reflecting a later repair. Both levels were very patchy, but the lower ones did appear to respect the edge of the Phase 1 slot (no. 3) whilst the upper flags respected the later slot (4).

Slot 1 (E14:50) was shallow, with no depth to the chipping fill and no discernable difference between the colour of the clay in the fill and that of the adjacent clay floor. Slot 3 (E14:52) was shallower with a saucer-shaped cross-section. It lay 3.75m from slot no. 1, probably about the right distance for a *contubernium's* width. Slot 8 (G14:30, G15:33) comprised a shallow, 0.30m wide strip of gravel chips containing some mortar. This may have marked the west wall of *Contubernium* 8. Slot 10 (G14:23, G15:29) was another deeper slot consisting of a visibly different-coloured strip of clay, but no gravel or chippings. Slot 12 (H15:29) was slight, shallow and gravel-filled. It is unclear how footprint of the Phase 1 *contubernia* range corresponded with that of Phase 2. If the officer's house was a freestanding structure, as was the case in other barracks of this phase in the *retentura*, which were revealed more fully in 1997–8, Slot 1 might represent the west wall of *Contubernium* 1, the east wall of the officer's house or, conceivably, the west wall of *Contubernium* 2, although one of the first two options is more likely.

An east-west partition slot (D14:33, E14:42) was uncovered towards the eastern end of the later Phase 2 officer's house, along with three or possibly four post-holes for some kind of room divider (D14:34–35, E14:43). A fourth post hole (D14:36) was found to the south of the slot. All these features were cut into a layer of orange silty clay (D14:32, E14:37), which was the lowest level investigated in this area, and they could conceivably relate to the officer's accommodation associated with the primary timber barrack, but too little evidence was recovered to form a coherent, overall picture in that regard and the possibility that they formed part of the initial arrangements in the stone officer's quarters, instead, cannot therefore be excluded.

FINDS

Contubernium 8 flag floor

Coin: Crispus, 321–4 (no. 182, G15:19)

Contubernium 5/6 clay floor (Phase 1 or 2)

Stone: throwing stone (no. 87, G14:29)

Contubernium 7 clay floor (Phase 1 or 2)

Copper alloy: ear-ring (no. 42, G15:20)

Dating evidence

There were only two sherds of pottery from this phase,

both from a second-century flagon in the clay floor of *Contubernium* 2 (E14:48).

Phase 2: the stone barrack (Fig. 8)

Building 10 was rebuilt with stone outer walls and a stone dividing wall (E14:46) separating the officer's quarters from the *contubernia*. At 45.00m in length the barrack was about a metre shorter than Building 9, and as a result did not extend quite as far west, whilst the full length of the *contubernia* range was 34.40m. The building's width varied between 8.50 and 8.60m.

Outer walls

Although severely damaged, sufficient survived of the north wall to show it was of unusual construction (cf. F14:09 and G14:12). The core of the lowest course above the foundation was composed of small flat slabs to create a flat base, 0.85m wide, for the wall superstructure. The latter was noticeably inset, particularly on the outer face, and measured 0.75m in width (see Figs 15.10 and 15.11). At its east end several faced stones (H14:31) were linked to the east wall (H14:45) and its foundations were continuous with those of the east wall (H14:44). The construction of the latter was similar to that in the north wall with traces of a flat, thin base course between the clay and rubble foundation and the wall proper. Some trace of later, possibly chalet-period reconstruction was discernible midway along the east wall (see Chapter 16 below). The actual foundation measured between 1.00 and 1.05m in width.

Significantly, a narrower band of foundation material (H14:46, H15:21), apparently underlying H14:44, was seen particularly towards the south end of the east wall and in the bottom of modern drain trenches which cut its line. This was interpreted as the foundation of an earlier stone-walled phase of Building 10 and if so would imply that the flat plinth course belonged to a later reconstruction, the chalet phase being the favoured candidate. A degree of uncertainty existed over this interpretation, however. It is conceivable that the 'earlier' foundation simply represented the bottom of upper foundation H14:44, as suggested by one of the excavators (IDC). Furthermore the style of the north wall, with its good, clay-packed rubble foundation and its wide (i.e. off-set), well-laid base course was quite distinct from the east and west side walls of all the chalets in this area which, while quite functional, were simple. None had any depth of construction let alone foundations. Two of these walls, F14:27, the east wall of Chalet AA, and F14:43, the west wall of Chalet Z, were said to have been bonded with the north wall, which would have made that wall contemporary with the chalets (Site Notebook entries F14:09 and G14:12), but examination of the site plan (P136) and photographs suggests this is far

from conclusive and if anything would contradict this with the chalet walls apparently overriding the plinth course, but butting up against one surviving facing stone of the north wall. Accordingly it is more likely that the chalet side walls were simply keyed into the pre-existing masonry of the north wall, with rebuilding perhaps limited to that required to break the north wall of Building 10 into a series of separate chalet walls (Research Archive – Building Y Summary). Furthermore, if the narrower foundation H14:46 was indeed distinct from foundation H14:44 and therefore represented the initial stone phase, the flat plinth course must have represented a secondary reconstruction of the barrack prior to chalet phase.

The north wall of the officer's quarters (D14:07) did show signs of rebuilding over part of its length, to form the north wall of Chalet AB and perhaps on more than one occasion (see below Chapter 16: Chalet AB). Significantly, the wall here lacked the flat plinth course noted elsewhere and the excavators distinguished two levels of foundation, though on what basis was not made explicit in the records. The upper layer, directly beneath the wall masonry, was described simply as angular rubble (D14:21), whilst the lower and presumably original foundations were said to have comprised angular rubble firmly set and packed with grey clay (D14:25). The south wall of the building, which was even less well preserved, probably experienced a similar history, though it is unclear whether it was retained in use during the chalet phase.

The contubernia

PARTITION WALLS

Six of the slots identified in 1978 (nos. 2, 4, 5, 7, 9 and 11) were distributed at sufficiently convincing intervals between the east wall of the officer's quarters (E14:46) and the east wall of the building as a whole (H14:46, H15:21) for them to have represented partitions separating the various *contubernia* of the Phase 2 stone barrack block. Two missing partitions must be restored to complete the series, one c.0.40m west of soil change no. 6 to divide *Contubernium* 4 from 5, and a second c. 1.20m west of partition 11 to separate *Contubernia* 7 and 8.

The normal *contubernium* width was c. 3.20m, although there was considerable variation. In particular two or three *contubernia* at the east end of the building were significantly wider than the other six rooms (the width of *Contubernium* 9 varied between 4.20m and 4.40m, whilst 7 and 8 were perhaps around 3.90m wide internally, although 7 could have been closer to the normal range and 8 similar in width to 9 for instance). One possible explanation for the larger size of these *contubernia* could be that they included junior officers of the *turma* – the *duplicarius* and *sesquiplicarius* – amongst their complement.

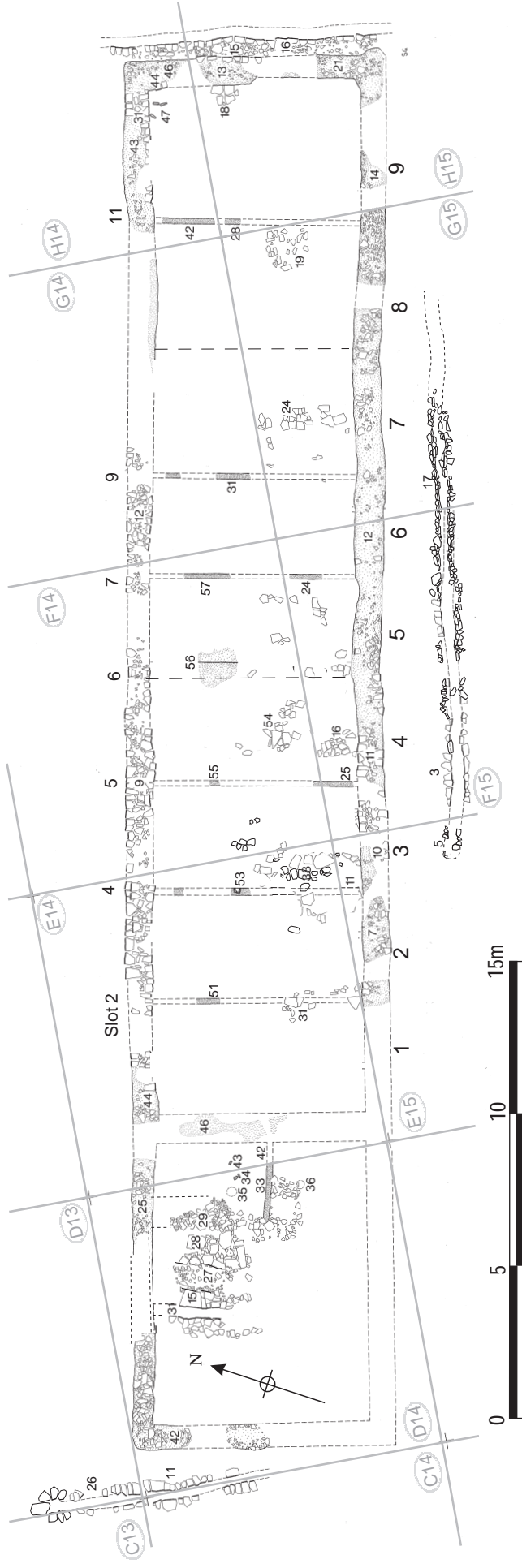

Figure 15.09: Building 10, Period 2 at 1:200.



Fig re 2 View along th north wall of Barrack 10 from th west.



Fig re 3 View of th north wall of Barrack 10 looking south, showing the pronounced offset.

Slot 2 (E14:51), which probably separated *Contubernia* 1 and 2, was deep and definite with differently-coloured clay and chippings right down through the fill. It possibly ran down the east side of flags E14:31. This would give *Contubernium* 1 an internal width of 3.60m. Slot 4 (E14:53), between *Contubernia* 2 and 3, was again deeper and was recognised in two separate sondages. The northern length was filled with chippings in a dark matrix. The surface to the east was light-coloured, whilst that on the west side had a lot of plaster in it as though the partition had been rendered. The more southerly had darker clay on each side and a lighter fill with chippings and upright stones for a socket or post-hole. With Slot 2 this was appropriately spaced (3.20m) to define another *contubernium* (2). Two separate lengths of Slot 5 were revealed some 3.30m further east. The northern section (F14:55) was very slight, with again decayed mortar to the west. More of this slot survived to the south (F15:25), containing a lot of chippings, but it was narrower than its northern counterpart. Two possible strips were also identified in the case of Slot 7, which must have separated *Contubernia* 5 and 6, the northern (F14:57) being 0.19m wide with dark coloured clay on either side and mixed clay, but not many chippings, along its line. This possibly lined up with F15:24 to the south (recorded in the Site Notebook, but not on the plan), which underlay the later clay floor F15:17. The ninth slot (G14:31) was also filled with gravel chippings and was 0.30m wide, but of some depth. It was appropriately situated to represent the partition between *Contubernia* 6 and 7 and would make 6 some 3.10m wide. Slot 11 (H14:42), which probably marked the west wall of *Contubernium* 9, was also relatively deep, and contained the usual gravel fill.

URINE SUMP

No definite examples of the kind of urine sumps recognised in Building 9 were identified in this block, either in association with this phase or with

the preceding timber barrack. The only possible instance was to be found in the fourth *contubernium* from the west where an oval pit (F14:51, F15:07), faced by stone blocks along its east side (F14:52, F15:15), was revealed, the western side wall having presumably been robbed out. Flagstones associated the Phase 1 floor (F15:23) were exposed in the bottom of the feature. However the urine sumps identified in Buildings 9 and 12 were invariably positioned on or close to the medial line of their respective *contubernia*, whereas this drain was located very close to the estimated eastern edge of *Contubernium* 4. It is therefore more likely to have been associated with the subsequent chalet phase instead, since it did occupy the medial line of Chalet Z (see Fig. 16.14 below).

FLOOR LEVELS

The fullest sequence of floors was encountered in E14 and E15, where the lowest level comprised areas of flagging (E14:31, 38, E15:11) in the southern part of the barrack block (see Figs 15.09, 15.12), as noted above, and corresponding clay floors to the north (E14:48, 49, overlain by a layer of possible occupation material E14:47). Both the clay and flagstone layers were covered by another clay level which was subdivided into many separate contexts, but appeared to extend the full length of the block. In F14 and F15 areas of flagging were noted to the south, but the corresponding clay floor in the north was not identified. The same overlying clay level was present, however. No relationships were noted between either of these clay levels and the partition slots in E14 and F14/15, with the exception of slot F15:24 (no. 7) which was recorded as being underneath clay level F15:17.

In the eastern third of the building, probably corresponding to *Contubernia* 6–9, only a few fragments of flagged flooring survived (G15:19, H15:18). A single clay level was also recorded across this end of the barrack (G14:25–9, G15:20, 26–8, 30, H14:41, H15:25, 27), which apparently overlaid the flagging (G15:20 over G15:19). Conversely, however,



Figure 15.12: Successive phases of flagging in the southern ends of Contubernia 1, 2 and 3 overlain by chert walling

some of the primary partitions (G14:30/G15:33 and G14:23/G15:29 – no record in the case of H15:29) were recorded as cutting this clay level, which should imply that the clay level belonged to Phase 1 as well. It is possible that two phases of clay floor surface have been conflated into a single recorded level or that some of material associated with Phase 2 was removed during cleaning (G14:19, 20, G15:11) of the clay.

These contradictory records underline the problems faced in trying to analyse the earliest phases of Building 10. It is tempting to assign the upper clay levels to the stone barrack and the lower to the timber barrack phase, however, in *Contubernium* 3, two levels of flagging (E14:38/E15:11) were noted, the lower of which may be assigned to the primary timber barrack and the upper to its stone replacement, as described above, but *both* levels were overlain by the upper clay layer (E14:24/E15:09). The upper clay level might therefore represent either a replacement clay floor of Period 2/3, associated with the later stages of the conventional stone barrack block, or conceivably, makeup levels for the subsequent chalet range (TWM Period 4). The actual sequence was probably fairly straightforward and similar to that encountered in Building 9, but the excavation records do not enable specific contexts and the dateable material contained therein to be confidently ascribed to a particular phase.

The distribution of the flagging and clay associated with the lowest surfaces suggests that each *contubernium* was divided into two rooms, a clay-floored north room and flagged south room, like Building 9. It is noteworthy that the traces of flagged floors were again confined to the southern part of the *contubernia*, as in Building 9. However this poses a problem regarding the orientation of block. If the two barracks faced one another, as was commonly the case, the flagging, which presumably floored the front rooms, should have been restricted

to the northern halves of the *contubernia*. Instead the location of the flagging suggests that 10 faced south towards the *intervallum* road and the rampart. This is not unparalleled; at Housesteads, Building XIII, in the north-east quarter of the fort, faces north onto the rampart and *intervallum* road rather than south towards the neighbouring barrack, XIV, though in this case the layout was probably influenced by topographic considerations. In this case, the face to back layout of Buildings 9 and 10 may reflect the difficulties that would have been experienced if two opposing *turmae* had both attempted to issue from their barrack with their horses and mount up at the same time in the relatively restricted space of the intervening street (Alley 5), which was no more than 4.00m wide. It was perhaps judged more efficient if each *turma* had its own space to assemble, with the *turma* from Building 9 drawing up on Alley 5 whilst that occupying Building 10 used the *intervallum* road. The fragmentary evidence from Building 11 suggests that it too followed the same pattern, the drains or urine sumps associated with the Period 2/3 stone barrack block being located in the southern half of the *contubernia*.

The officer's house

Much of the area of the officer's quarters had been removed by the construction of a modern cellar (D14:09), leaving only the northern part of the house available for examination, whilst the north-east corner was concealed by later road surfaces and chalet period structures which were largely left *in situ*, though the sandstone and grey/pink clay exterior wall foundations (D14:42, 44) were traced. The wall dividing the officer's quarters from the *contubernia* remained only as a very patchy foundation of pinkish and orange clay (E14:46) which had no clear line. No trace of an earlier timber partition was recognised in this area.

As a result of the limited extent of the area examined, no clear impression of the overall development of the house could be gained, though a number of features were identified. Within the officer's quarters, a drain (D14:15/31) and parts of the flagged floor (D14:15, 28) were revealed and assigned to the stone barrack by the excavators (Figs 15.13, 15.14). All these features overlaid or cut into a layer of orange silty clay (D14:32, E14:37). The drain was 0.33–0.35m wide, with side walls constructed of neatly coursed stone blocks (Fig. 15.13), and was filled with a mid-grey silty soil with small stone and coal inclusions (D14:26). A 1.30m length of the drain survived, but could be seen, in the bottom of a modern drain cut (D14:03), to extend further northward and may have continued via an outlet through the north wall of the building, though this was not traced. The flagged floor was separated into two distinct areas by a 0.80m wide spread of small, close-set stones (D14:27), mostly consisting of



Figure 15.13: The stone-lined drain in the decurion's quarters of Barrack 0 (Stone Phase 1, from the north)



Figure 15.14: Period 2 stone surfaces in the decurion's quarters of Barrack 0 partially reused in the chalet barrack.

rubble, but with a few small flags. The flagstones on either side formed a clear edge (Fig. 15.14). In plan, the feature is reminiscent of the urine sumps found in Building 9 and 12, but analysis of the site photographs demonstrates that no pitched stones defining such a pit were evident in section, and nor was any staining apparent in the bottom of the modern drain cut to the north. It seems likely that flagging was respecting the edges of an internal structure, perhaps of timber construction, which sat on the stone spread. Such a structure may have been associated with the stabling of the officer's horses. To the east of the flagging an area of rounded cobbles stones (D14:29) was recorded, running north-south, though evidently partially removed by later activity so its full extent could not be determined. Some of the stones appeared to be worn so the feature was interpreted by the excavators as a possible surface. However the site photographs suggest the band of was of some depth and it might therefore represent the foundations for a north-south partition wall, perhaps defining a passageway at the eastern end of the house. At its south end some of the flagstones of D14:28 apparently extended across the wall's line.

A number of timber features, including an east-west partition slot (D14:33, E14:42) and three or possibly four post-holes (D14:34–36, E14:43), uncovered in the eastern part of the officer's house, might relate to the earlier timber barrack (see above), but there was too little evidence to present a coherent sequence of developments in this part of the block. The external dimensions of the officer's quarters in this period were 10.80m × 8.40m.

Drains and street surfaces

Three drains were noted in the road surfaces adjacent to the building. Immediately to the east of the building, lay a north-south drain (H15:16), which was characteristic of the primary drains noted at the



Figure 15.15 View of Building 10 from the east showing the east wall. The drain side-wall and the flagstones of the secondary drain lining can just be seen along side.

ends of several barracks, e.g. Buildings 1, 3, 4, 5 and 11. Only the west side of this drain remained, with up to three courses surviving (Fig. 15.15). The east side had been removed by a modern drain trench. The gap between the north-south drain and the east wall of the building was packed with rubble including some facing stones (H15:15). This was thought to be secondary to the drain, but to pre-date Chalet X. It may therefore have been packed in when the barrack was rebuilt in stone. In a subsequent phase the drain was reconstructed using upright slabs to reline the sides (Fig.15.15). Elements of both of the slab side-walls survived, though several stones were displaced by the modern drain. This method of construction is typical of some of the later drains in the fort, notably that running south eastward from the south end of the granary past the south-west corner of the *principia* (G11:04). It may even form another stretch of the latter drain, perhaps connecting up with the similarly constructed length observed in the east carriageway of the south gate (H16:06). This latter phase of the

drain may be contemporary with the construction of the chalets.

A second stone-walled drain (E15:05, F15:03, G15:17) was noted set into the *intervallum* road surface south of the barrack. The drain's slightly sinuous course ran parallel to the building, its distance varying between 1.40m and 2.20m from the south wall of the block. It was filled with a mixture of dark grey clayey silt and brown sandy silt and stone (E15:06, F15:04, G15:18). This drain was tentatively attributed to the chalet phase (i.e. Period 4) by the excavators, although the stratigraphic evidence is inconclusive.

The road surface into which the drain was set was composed of orange gravel and small cobbles (E15:04, F15:05, G15:07) which covered the area between Building 10 and the drain (the area south of the drain was not cleared of overburden). This was the only extensive level of the *via sagularis* recognised south of Building 10 in 1978 and was thought to represent the primary road metalling. However the full sequence of levels in the south *intervallum* road was not investigated so the attribution of this surface to Period 1 cannot be confirmed, although the orange gravel composition and small size of the metalling is consistent with the earlier road surfaces recognised elsewhere in the fort (cf. the west *via quintana* for example).

The drain running along the *intervallum* road to the west of the barrack block was also exposed for a length of 8.00m (D13:26, D14:11). This formed a continuation of the drain traced alongside the west wall of the hospital in 1977 and 1983.

FINDS

Contubernium 1/2

Mortarium stamp: 125–45 (no.15, E14:28)

Contubernium 2

Coin: Trajan, 103–17 (no. 57, E14:24)

Bone: die (no. 36, E14:24)

Contubernium 3?

Mortarium stamp: second century, before 180 (no. 38, F14:44)

Copper alloy: brooch (no.30, F14:44)

Contubernium 3/4/5

Pottery: lamp (no. 8, F15:20)

Contubernium 6

Stone: throwing stone (no. 66, G14:31)

Dating evidence

Foundations

The east wall foundation contained two sherds of mid to late Antonine samian (H15:21). The foundation for the north-south internal wall contained a number

of sherds from a single locally produced grey ware cooking pot and a sherd from a flat-rimmed BB1 bowl/dish, both second-century in date (E14:46).

Floors

Most of the *contubernia* produced only one or two sherds of pottery, second-century in date, from the clay floors. The exception was *Contubernium 2*, where much of the pottery came from the lower part of a single BB2 cooking pot (F14:41). There were also sherds of BB1 and locally produced wares, a sherd of mid to late Antonine samian, and a single sherd of third-century Nene Valley ware (E14:24).

Building 11

Grid squares: J15, K15, L15, M15, M16, N16

Introduction

Most of Building 11 had been destroyed by an eighteenth-century trackway (probably a waggonway) which cut a 6.00–7.00m wide diagonal strip the length of the building from south-west to north-east. This had removed most of the south side of the building and the entire north-east corner comprising virtually all the structural remains and deposits associated with the officer's quarters. Only the north side of the *contubernia* (diminishing from west to east) and the south-east and south-west corners of the officer's quarters remained. These areas were largely excavated in the 1978 season with investigation of the south-west part of the building being completed in the late summer/autumn of 1979.

Pre-fort agriculture and preparatory construction works

The structure was built directly on what had previously been farmland. A series of cultivation furrows, or 'cord rig' (M16:14–15, 25–7, N16:08, 09, 19–21), were found cut into the original, grey, clay-loam ground surface (N16:10), beneath the south-east corner of the building and the *via sagularis*, where excavation was taken down to natural subsoil. The site was levelled by filling the furrows were filled with deposits of construction debris, a mixture of masons chippings, gravel and the pink clay used in the foundations of the early fort buildings (see Chapter 3). Burnt clay deposits, presumably resulting from firing the vegetation to clear the site were also encountered in the area of the officer's quarters (N16:10). A strip of small cobbles (M16:19), forming a worn surface, was uncovered alongside the west wall of the officer's house. These deposits were overlaid by a layer of rubble composed of orange, coarse-grained sandstone (M16:13, N16:07), up to 0.35m in depth. This was evidently a levelling deposit and covered

most of the area exposed within the south-east corner of the stone-built officer's quarters. It was at the same level as or below the top of the stone foundations of the Period 2/3 barrack (M16:09, N16:16–17). If this deposit was associated with the stone barrack, rather than a suspected primary timber barrack, then all the deposits associated with the Period 1 building in this area must have been truncated by construction of the secondary building. No floor surfaces or features of either period survived over the rubble.

Phase 1 – the timber barracks (Figs 5

6

Based on their investigations in 9 the excavators concluded that the building was a stone walled, rectangular barrack block in its primary phase. Although Charles Daniels and his team were conscious of the possibility that, in its initial form, the building was constructed entirely of timber, several small trial trenches, dug beneath the stone foundations of the north wall and the north-west and south-east corners of the barrack to test this hypothesis, found no trace of timber sleeper-beam slots, apparently confirming that the stone phase was primary.

The re-investigation of two of the buildings in the southern part of the fort by Tyne and Wear Museums during 1997–8 has, however, cast considerable doubt on Daniels' conclusions. The 1997–8 excavations demonstrated that the primary phases of Buildings 9 and 12 were indeed timber structures. It now appears inherently likely that Building 11, like 9, 12 and probably 10, began life as a timber stable-barrack.

Certain evidence recovered in 1978 would support this reconstruction. A total of 12 narrow, gravel- and clay-filled slots, running north south, were identified (see Fig. 15.16), representing the remains of timber and wattle-and-daub partitions which divided the barrack internally into a series of *contubernia*. All but one of the slots (J15:28) was located at the very end of the 1978 excavation season in digging specifically aimed at locating such features and they were principally recorded, with accompanying annotations by Charles Daniels, on one site plan (P161). Context numbers were assigned, but these context records provide no additional description nor any indication of stratigraphic relationships.

The spacing and the varying depth of the 12 slots would suggest that the partitions belonged to at least two and probably three distinct phases. Thus slots M15:33 and L15:38 were much too close together to belong to the same phase. The spacing between two pairs of slots (K15:29 and K15:30, L15:35 and L15:36) would be compatible with their interpretation as partitions defining access passageways along one side of the front room. However, although such side passages are common features of *contubernia* in barrack blocks designed to accommodate infantry,

they are not found in cavalry stable-barracks where they would have reduced the space available for stabling and hindered the task of leading horses in and out. Moreover, if it assumed that the barrack was divided into nine *contubernia*, as was seen to be the case in the other three blocks in the *retentura*, only six of the slots can be associated on spacing grounds with the stone barrack block (K15:27, 28, 30, L15:36, 37, 38). Three of the slots (J15:28, 34, M15:34), located at either end of the series, were in any case too close to the east and west walls of the *contubernia* range (c. 1.50m, 2.60m and 2.30m respectively) to have been associated with the stone building, whatever the number of *contubernia* in the block, since the end *contubernia* they would define would have been unfeasibly narrow. These three slots, plus another trio (K15:29, L15:35, M15:33) could be associated with an earlier timber barrack block (although J15:28 and J15:34 were also evidently too closely spaced to have belonged to the same phase). As reconstructed the internal width of the two *contubernia* bounded by surviving partitions (2 and 6?) was c. 3.50m in both cases, whilst to fit into the available space the other *contubernia* must have averaged around 3.10m–3.30m, all reasonable figures for Roman barracks (See Fig. 15.17). The failure to find any trace of timber external walls might be explicable if the footprint of the stone barrack was slightly different from that of its timber predecessor with the result that the stone walls did not directly overlie the slots for the timber walls.

The depth of the slots varied, and this was treated by the excavators as a clue to phasing, with the deeper, gravel-filled ones (e.g. L15:36) presumed to be earlier and the shallower (e.g. L15:35) to be later. Partitions M15:33 and L15:38, which were so close together that one must be a replacement for the other, were assigned to the primary and secondary phases, respectively, on the same grounds. However, in both instances, the scheme restored on the basis of the slots' spacing would suggest that the deeper slot should belong to the secondary phase and the shallower to the primary. This might conceivably indicate that the levels associated with the Phase 1 barrack had subsequently been truncated during construction of the secondary, stone block.

A flagged floor (J15:29, 33) uncovered towards the western end of the building (in *Contubernium* 9?) was clearly primary being overlain by the Phase 2 drain (J15:32) and clay floor (J15:19). In the neighbouring *contubernia* (6–8), a clay level composed of orange and grey sandy, silty clay (K15:12, 23) was present. This was observed to overlie clean grey silty clay (K15:25) which was interpreted as the original ground surface. The clay floor was in turn associated with a flagged hearth (K15:19) and spreads of charcoal (K15:22). Further east, two areas of worn flagstones (L15:21, 30) were found in the northern half of the block, which probably represented the Phase 1 floors of *Contubernia*

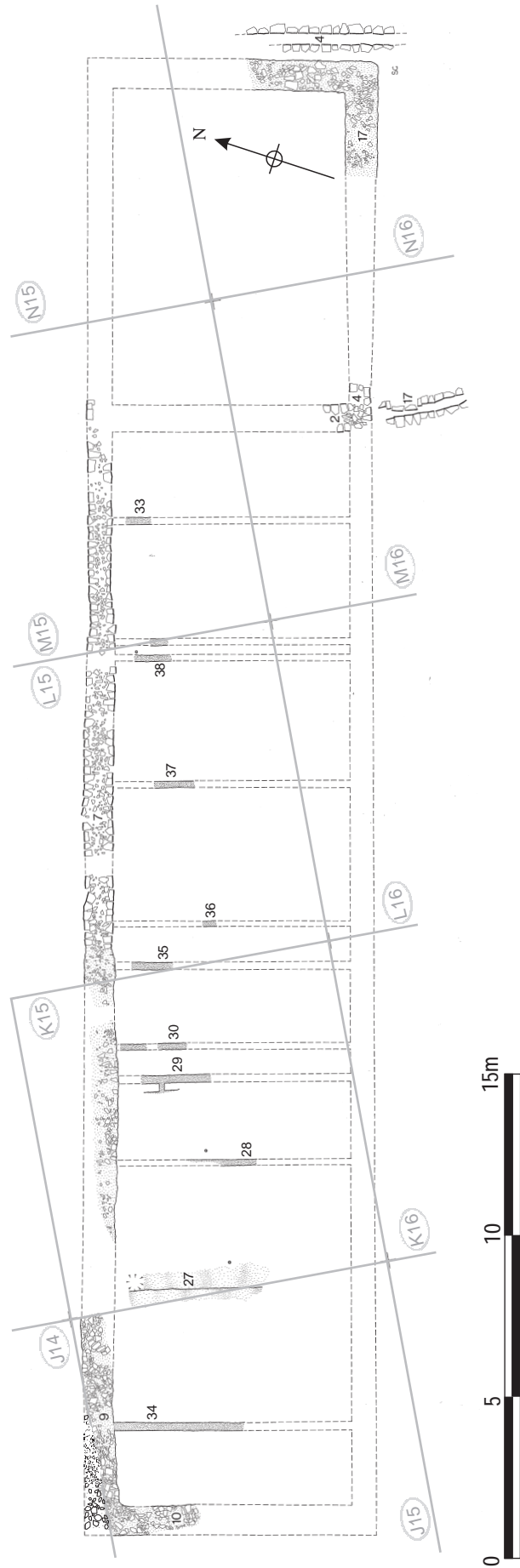

Figure 15.16: Building 11, all partitions at 1:200.

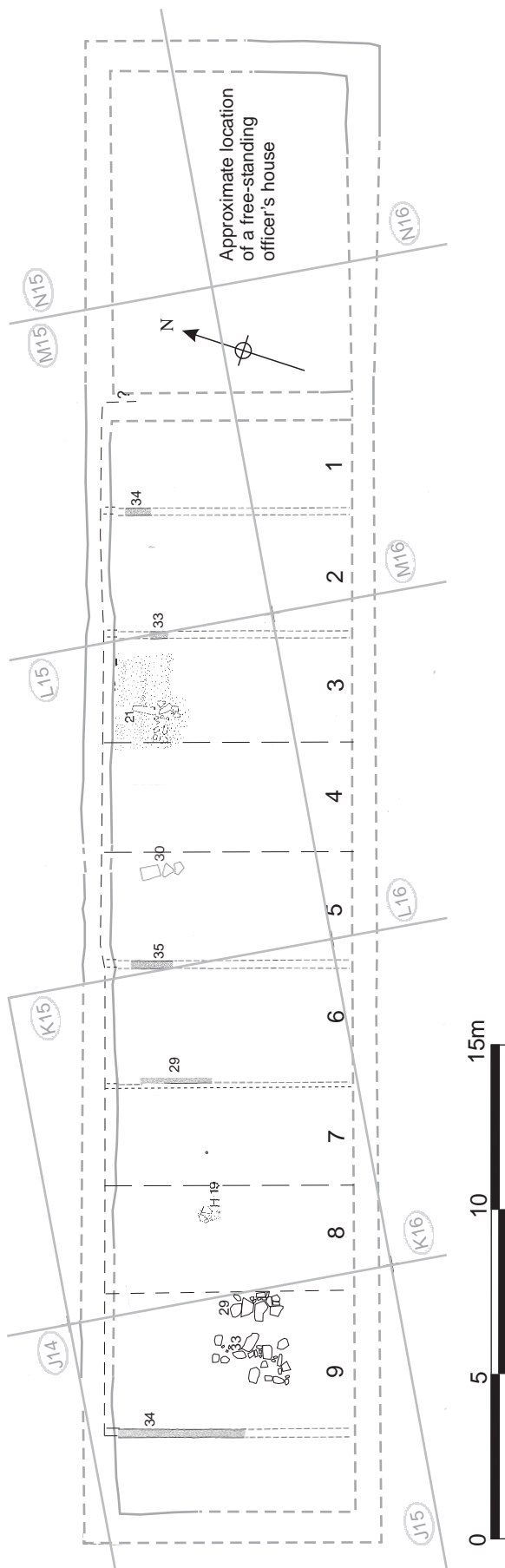

Figure 15.17: Building 11, Period 1 at 1:200.

3 and 5 respectively, whilst a series of silty clay levels (L15:25, 27) with charcoal and small stone and rubble (L15:26), which were cut by the foundations of the stone barrack block's north wall, may represent the corresponding floor level in *Contubernium* 4.

FINDS

Phase 1

Contubernium 4

Copper alloy: buckle (no. 155, L15:29)

Iron: chain (no. 37, L15:29)

Lead: plugs (nos 12–3, L15:25)

Contubernium 6

Coin: Republican, first or second century BC (no. 4, K15:12)

Dating evidence

This phase produced less than 20 sherds of pottery, second-century in date, consisting mainly of local grey wares and BB1 (K15:23, L15:25, 29, 31, N16:15, 22). There was also a single sherd of late second-century or later BB2 (K15:21).

Phase 2: the stone barrack block (Fig. 5)

The barrack block was rebuilt with stone external walls in the mid to late second century. Only the masonry of the north wall (L15:07, M15:03) survived to any significant extent. Here a 17m length of the offset plinth course and shorter stretches of the first main course remained (Fig. 15.19). The width of the offset course was 0.90m–0.95m, whilst that of the first main course was 0.68m, being inset on both sides. The wall was constructed of a mixture of fine- and course-grained sandstone of yellow-white appearance and was bonded with orange clay. Elsewhere only the rubble foundations set in orange-pink clay were present (J15:09, K15:04, L15:24). At the north-west angle, the foundations of the north and west walls (J15:09, 10) were observed to sit at the same level as the later chalet side walls. This was higher than the internal flagging of the westernmost *contubernia* of Building 11 and the foundations apparently cut the Phase 2 floor clay level (J15:19). It was assumed this reflected much later rebuilding during the chalet phase. The external wall foundations also survived at the south-east angle of the building (M16:09, N16:16–17), along with short lengths (1.30m and 0.80m respectively) of actual masonry at the junction between the south wall of the barrack (M16:04) and the dividing wall (M16:02) separating the officer's quarters from the *contubernia*. At 0.85m, the width of the dividing wall exceeded that of the south wall, which was only 0.70m at this point. Together, these fragments of masonry and foundations demonstrated

that the overall dimensions of the barrack block were 45.20m × 9.00m. Virtually nothing remained of the interior of the officer's quarters, however, except for a layer of rubble composed of orange, coarse-grained sandstone (M16:13, N16:07), up to 0.35m in depth, which was evidently a levelling deposit. This covered most of the area exposed within the south-east corner of the building and lay at the same level as or below the top of the stone foundations of the Period 2/3 barrack, implying that it was contemporary with the latter rather than the suspected primary timber barrack.

The barrack was probably divided into nine *contubernia*, as was seen to be the case in the other three blocks in the *retentura*, during Periods 1 and 2. However only six out of potentially eight the slots which represented the timber/wattle-and-daub partitions separating one *contubernium* of the stone barrack block from another, were actually identified (K15:27, 28, 30, L15:36, 37, 38). The *contubernia* were probably each divided into front and back rooms, the front (southern) rooms containing north-south aligned drains with associated flagged floors, whilst hearths and probably clay floors were laid in the northern rooms. These features survived only fragmentarily, however, with most of the drains, in particular, having been removed by the eighteenth/nineteenth century waggonway.

In the north room of the westernmost *contubernium* (9), several features cut into the layer of clay (J15:19), which covered the earlier flagged floor (J15:29/33) probably associated with Phase 1, and hence were regarded by the excavators as belonging to Phase 2. These included a square pit (J15:26) c. 0.05m deep with two stones set along the west side and filled with clay, another square feature composed of gravel edged with stones on all four sides which was interpreted as a possible coal scuttle (J15:27), and a north-south aligned slot (J15:28), 0.15m wide and filled with orange gravel and coarse set chippings. The function of the slot was unclear as it lay far too close to the west wall of the block to have separated two *contubernia* and roughly bisected *Contubernium* 9 into east and west halves. On the basis of its position it would most plausibly be interpreted as a sub-phase of the primary timber barrack, but this would also imply that clay floor J15:19 also belonged to that sub-phase.

The south room of *Contubernium* 9 contained a drain (J15:20), which was offset slightly to the east of the room's central axis. It comprised a double line of faced and squared sandstone blocks, which survived over a length of 2.20m (Fig. 15.20). Its channel was 0.12m wide with slabs on the bottom and cut the underlying clay makeup (J15:19). It was filled by a clean, sticky grey clay covered by small rubble which probably formed part of the overall layer of demolition disturbance. The drain was associated with flagging (J15:25), which represented the floor

of the south room. A stone-faced drain (J15:32) was also revealed in south room of *Contubernium* 8, though a shorter length survived here, consisting of no more than three facing stones on either side, set over the flags of the Period 1 floor (J15:33). This too was offset towards the east side of the room. A large south-east reduced ware storage vessel (J15:18) was set into the clay level in this room (J15:19). Another drain (K15:14), lined with sloping stone slabs, two of which survived, was uncovered in the south room of *Contubernium* 7 and was associated with a flagged floor (K15:21). A hearth (K15:15), measuring 0.70m north-south by 0.50m east-west, and composed of pink clay burnt red with several blackened flags, surrounded by a spread of coal (K15:16), was found in the north room of *Contubernium* 6.

A layer of clay (L15:18–20, equivalent to K15:13 and perhaps J15:19 further west) was observed to overlay the foundations of the north wall of Building 11 in both *Contubernia* 3 and 4 and hence probably represented the Phase 2 floor surface here. Similarly the pink clay layer L15:33 was separated from grey silty clay L15:34 by a Phase 2 partition (L15:36) and these presumably therefore constituted the corresponding floor levels associated with that phase in *Contubernia* 4 and 5 respectively. The clay floor in *Contubernium* 5 was overlain by flagging (L15:32), which was in turn covered by a mixed layer of coal, pink clay and orange-brown and grey silty clay (L15:28), perhaps an occupation deposit.

Drains

A 4.60m length of stone drain (N16:04) was revealed immediately parallel to the east wall of the building, and measured between 0.30–0.35m wide internally (up to 0.85m including the side walls) and 0.16m deep. Its position and its carefully-constructed side walls of sandstone blocks, only one course of which survived in this case, are typical of the early drains in the fort associated with the first phase of stone barrack blocks (Fort Period 2), several of which ran right alongside the end walls of barracks adjoining the *via sagularis*, e.g. Buildings 1, 3, 4 and 5. The drain contained a yellow sandy silt fill (N16:05).

Another drain (M16:17) was recognised running for 2.90m southwards across the *intervallum* road and away from the southern terminal of the wall separating the officer's quarters and the *contubernia*. The drain comprised a single (surviving) course of facing stones on either side, set 0.23m apart in a 1.20m wide construction trench which clearly cut the secondary road surface (M16:16, 18). The overall width of the drain including its side walls was c. 0.75m. This contained a layer of silt comprising a brown sandy clay loam containing a lot of stones (M16:23), overlain by rubble and grey loam (M16:21) which represented later deliberate backfilling. The location of this drain is rather curious since it seems

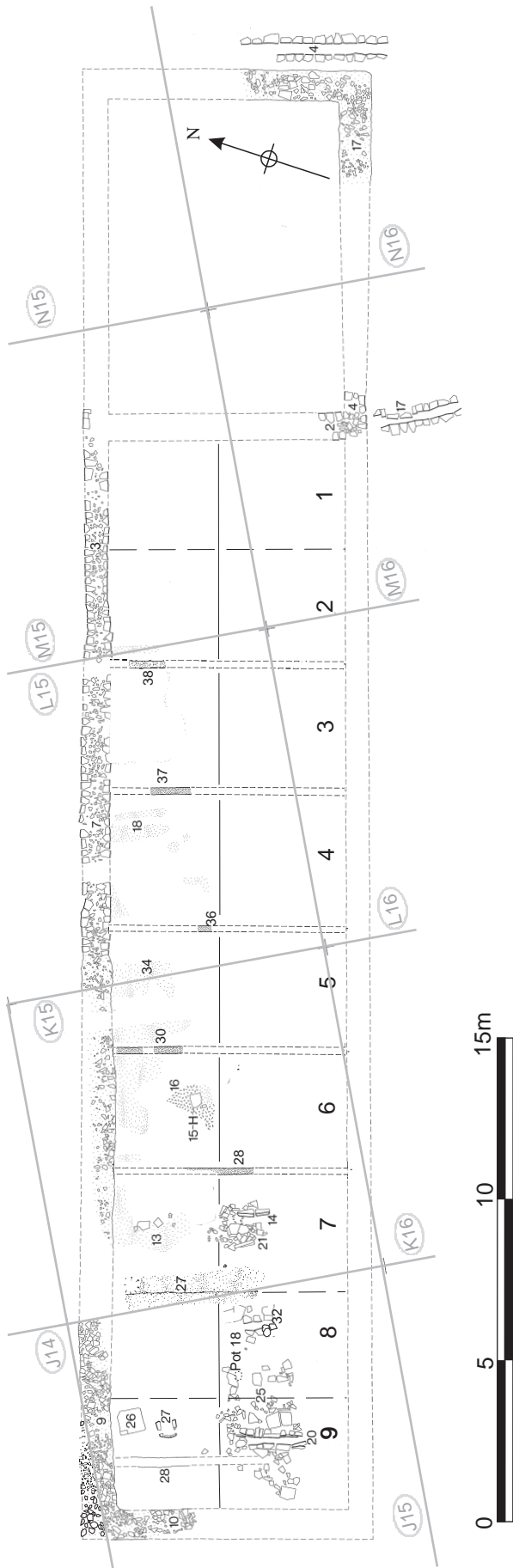

Figure 15.18: Building 11, Period 2 at 1:200.

designed to take water away from a particular point and feed it into the *intervallum* road drain just over 3.00m south of the building, rather forming a gutter alongside the barrack footings as more commonly encountered. This might suggest the roofs over the decurion's house and *contubernia* range were separate in some way, with that over the officer's perhaps rising higher (to incorporate a second storey or mezzanine level?). This may have resulted in a more concentrated volume of water flowing off the roof onto onto the road at the southern end of the dividing wall. The fact that the drain was clearly associated with the secondary *intervallum* road surface (M16:16, 18) and sat on the primary surface (M16:20, 24), would appear to rule out the alternative possibility that the drain was related to an earlier timber barrack phase, when the officer's quarters and *contubernia* range may have formed independent freestanding structures, as established in the case of Buildings 9 and 12 by the 1997–8 excavations.

FINDS

Phase 2

South wall

Glass: window (no. 42, M16:04)

Contubernium 3/4

Decorated samian: c.160–95 (no. D109, L15:18)

Coin: Trajan, 98–117 (no. 40, L15:20)

Copper alloy: amulet (no. 75, L15:23), scabbard runner (no. 145, L15:18), harness mount (no. 182, L15:23), rod (no. 328, L15:19)

Iron: spearhead (no. 7, L15:18), padlock (no. 34, L15:19)

Pottery: counter (no. 66, L15:23)

Contubernium 4

Copper alloy: loop (no. 358, L15:33)

Dating evidence – Phase 2

The south wall produced a sherd of samian jar of the late second or first half of the third century (M16:04), and there was Antonine samian in the fill of the drain and the levelling deposit (N16:05 and 07) as well as in the clay floor (L15:18, L15:20). The clay floor contained the lower part of a large south-east reduced ware storage jar, probably of the third century, deliberately set into it (J15:18), while the material of the floor itself contained two Nene Valley sherds of third century date amongst the plentiful BB2 typical of third-century groups (L15:18; L15:20).

The presence of this material in the clay floor levels suggests that the life of the barrack continued into the third century.



Figure 9 North wall of Barrack 1 with the later chert side walls butting up against it to the south, looking west.

Street between Buildings 11 and 12 (Alley 6)

Two phases of cobbled surfaces were recognised in the street between Buildings 11 and 12. This was the case both at the east and west ends though no direct association between the two halves was seen (i.e. between the surfaces in grid squares L14 and L15 on the one hand and M14 and M15 on the other). To the west two successive levels were only identified in grid square K14 (upper: K14:05, lower: K14:20) and there was some confusion as to which of two the single levels identified in J14, K15, L14 and L15 equated. To the east two levels were identified in M15 and N15. In all cases where two definite levels were identified the upper level was composed of small pebbles or cobbles whilst the lower level contained large or medium sized cobbles. It seems likely that the upper level was not universally present elsewhere leading to the upper level of smaller material being identified in some grid squares but elsewhere the excavation



Figure 15.20: Stone drain J15:20 in Contubernium 9, looking north

came straight down on to the lower level of larger material. The surfaces have been differentiated by phase on this basis.

Excavation was not taken down to natural at any point along the street in 1978–9 so it is not certain that the full surviving sequence was recorded at that stage. It is conceivable that the larger material represented the base for the road whilst the smaller cobbles and pebbles represented the surface metalling in which case the two layers could belong to the same phase, but both levels were described as worn so they are presented as two separate phases here.

Phase 1

The lower level was evident at the east end where it consisted of medium-sized, very worn and compacted river cobbles (N15:06) and a mixture of large and small worn cobbles (M15:32). Some very large cobbles were also noted in parts of M14:49 where two levels may have been conflated into a single context. Further west, the surface was composed of large worn cobbles, up to 0.30m in length (K14:20, L14:08, J14:09).

Phase 2

The second phase of metalling, again well-packed and very worn, was evident over most of the street (K14:05, K15:03, L15:06, M14:49, M15:27, N15:06). This was generally composed of very small cobbles and compacted fine river pebbles ranging in length/diameter from 50–80mm (K14:05) to as little as 30mm in diameter (M14:49, L15:06).

This layer was overlain by walls associated with the chalet phase (Period 4). No dateable material was recovered from any of these levels.

Building 12

Grid squares: J13, J14, K13, K14, L14, M14, M15, N14, N15

Introduction

Building 12 was the north-easterly of the four long rectangular barrack/stable blocks in the southern part of the fort. This building was interpreted by Daniels as a stable, rather than a barrack block, built entirely of timber in its initial phase and featuring internal drains, but no internal partitions, save one towards the east end which, it was suggested, might have separated off grooms' quarters from the rest of the stable accommodation (Phase 1). The building was subsequently reconstructed in stone in two stages. The separate 'grooms' quarters', at the east end of the block, was rebuilt in stone first (Phase 2), whilst the remainder of the building was left in timber, only later being reconstructed with stone external walls (Phase 3).

Three main factors appear to have led Daniels to reach these conclusions regarding the likely layout of Building 12, which differed from his interpretation of the other three buildings in the *retentura*. Firstly, construction slots for timber sleeper beams were discovered beneath the later, external stone walls of this building, demonstrating that it was a timber structure in its first phase. This was the only case where such construction slots for external walls were recognised, although attempts were made to uncover equivalent construction slots beneath the walls of the other barracks of the *retentura*, but with no success. Conversely and somewhat ironically, in this case alone, the internal timber partitions, which divided the block into separate *contubernia*, were not found in 1978–9. In addition, internal stone drains, which, in actuality, were probably associated with the subsequent chalet range, were attributed to the earlier phases (1–3) of 12 by Daniels. The failure to find any trace of internal partition slots doubtless appeared to confirm the anomalous character of this structure with respect to the other buildings of the *retentura*, encouraging the belief that the entirely timber construction of its primary phase could be explained by its being a stable rather barracks like the other blocks. It is perhaps particularly unfortunate with regard to the formulation of Daniels' ideas regarding the development of the barracks since identification of such partition slots in 1978–9, might also have prompted renewed consideration of the primary form of the other barrack blocks. However it is probably also true to say that the then generally accepted belief that cavalry horses must have been accommodated separately from their riders, coupled with the knowledge that the fort was garrisoned by an equitate cohort throughout much if not all its life, predisposed the 1978–9 excavators to seek building

ranges which incorporated apparently anomalous features and might be interpreted as stables.

Re-excavation by Tyne and Wear Museums in 1997–8 showed that this building was in fact another stable-barrack block. Internal partitions dividing the block into separate *contubernia*, with urine-pits in the front room of each *contubernium*, were identified in relation to all three phases of the stable-barracks. However, in other respects re-examination confirmed that the development of the building was broadly as outlined by Daniels. In its primary phase the block built was entirely of timber and comprised a row of *contubernia* with quarters for the decurion at the east end. The latter perhaps took the form of an adjacent freestanding house rather than being attached to the range of *contubernia*. The officer's house was later rebuilt in stone whilst the remainder of the barrack was apparently left unaltered. Subsequently the *contubernia* were also reconstructed in stone, with the range now directly adjoining the west wall of the officer's quarters. However no evidence for a stone-built south wall was found, either in 1978–9 or 1997–8, and the barrack probably retained a timber frontage even at this stage.

Phase 1 (Fig. 3)

Relatively few features revealed by Daniels could be firmly attributed to the primary timber phase of the stable-barrack block. Construction slots, which had probably held sleeper beams supporting the outer walls of the block (or conceivably individual post holes though none were recognised), were revealed under all the stone walls of the later barrack. The excavated lengths of slot ranged from 0.15m to 0.35m in width and were filled with material variously described as grey silt and pink clay (J14:29 – west wall), pink clay (K14:32 – south wall), patchy pink and grey clayey loam (alternatively described as a narrow band of yellow clay) (M14:67 – south wall), grey loamy clay (M14:68 – north wall) and 'grey sticky material with odd stones, tile' (J13:14 – north wall – see Figs 15.22, 15.23). All this material presumably related to the backfilling of the wall trenches when the timber building was demolished. At its western end the south wall trench (J14:30) was seen to cut a layer of grey clayey silt interpreted as the former ground surface (J14:31) and the natural clay subsoil. Packing stones were recorded in some of the slots (M14:68 – north wall; N15:14 – south wall). Although the lengths of slot uncovered were all relatively short (the longest extended no more than 2.60m), they included the south-east angle (N15:14–15) and stretches of all three external walls at the west end of the block (slots J13:14, J14:29–30), which were sufficient to establish the overall length of the building as 44.50m, whilst its maximum width at its west end was 7.50m, narrowing to only c. 7.00m further east.

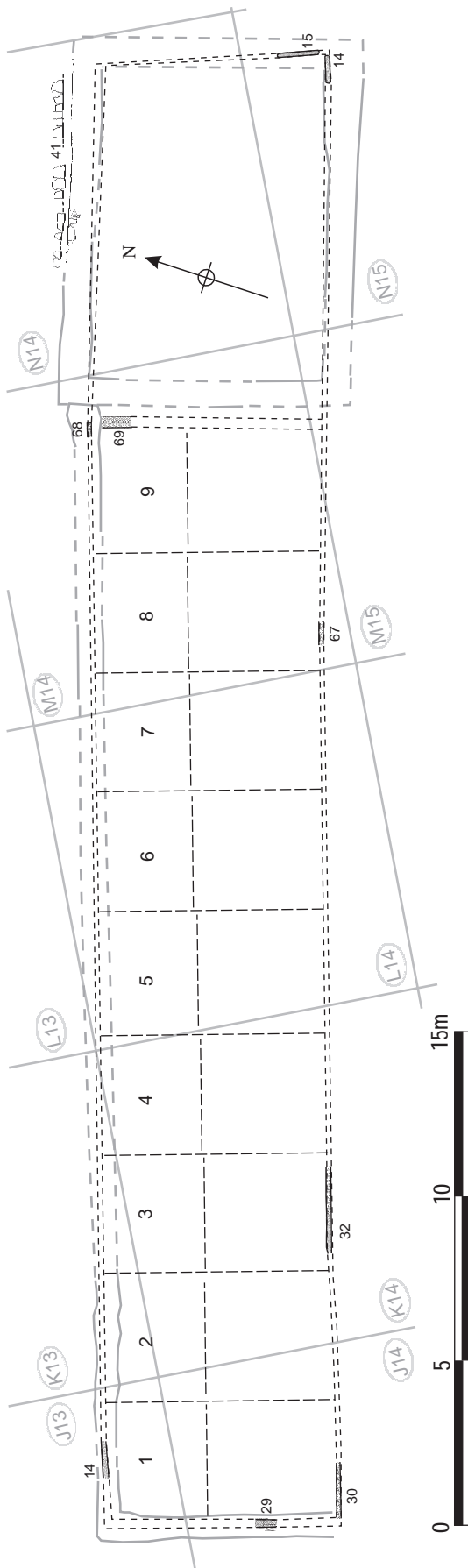

Figure 15.21: Building 12, Phase 1 with the outline of the later stone barrack shown for reference (at 1:200).

Analogy with the subsequent stone-built stable-barracks would suggest that the decurion's quarters were located at the east end of the block and there was some evidence to suggest that these stood independently of the rest of the barrack. Some 11m from the east end of the building the slot uncovered beneath the later north wall of the stone barrack (M14:68) was seen to terminate rather than continuing eastward. Running south from the rounded terminal, and forming a right-angle junction with it, was a band of compacted gravel (M14:69), 0.25–0.30m wide, which might represent the fill of another slot, marking the end of range of *contubernia*. On this basis the length of the officer's house must therefore have been under 11.00m, whilst the length of the *contubernium* range was 33.40m. No internal partitions separating one *contubernium* from another were recognised in 1978–9, as noted above, but such partitions were uncovered during the 1997–8 excavations as were latrine pits in the southern part of the barrack and further partitions dividing the *contubernia* into front (south) and back (north) rooms. A number of postholes were revealed inside the *contubernia* in 1978–9, four of which (J14:28, J14:32, J14:33, J14:34) might have been associated with partitions separating the front and back rooms. The 1978–9 excavation team tentatively attributed these to the primary timber phase, but, following re-excavation of the block in 1997–8, these have been assigned to the later Period 2/3 remodelling of the stable-barrack, which involved the rebuilding of outer walls in stone.

A drain or gutter (M14:71, N14:41, equivalent to TWM 9264) ran east-west along the north side of the building. This was uncovered only towards the eastern end of the building where small fragments of it remained. Only one course of the stone side walls remained. The southern side wall of the drain formed the north face of the stone wall of the later decurion's house and the drain could have been contemporary with that structure rather than the earlier timber phase. However, the north-west corner of the officer's quarters appeared to extend across the line of the drain, here represented by only two stones. Thus it is more likely that construction of the drain was associated with the all timber phase of the stable-barrack – as Daniels suggested in notes contained in the 1975–84 excavation archive – and its south face was subsequently reused as part of the footings of the later stone-built decurion's house. Additional stretches (M14:72, 9249), some 2m and 4m in length, were identified on the same alignment further to the west in 1978–9 and 1997–8. These were located to the north of *Contubernia* 7 (M14:72) and 4 and 5 (9249), the more westerly being assigned to Period 2/3 by the 1997–8 excavators. However the drain may well have continued to function throughout the life of the stable-barrack block. Another stone-lined drain (J13:09, J14:25), located 1.0m to the west of the



Fig re 1 Slot (J1) for north wall of timber barrack 2 looking south



Fig re 2 The west end of Building 2 looking south west with drain J1 visible and slot J2 at extreme right.

building, ran parallel with the end wall, along the edge of the *via decumana*, and might also be associated with this phase although it is equally possible that the drain was associated with the later stone rebuild of Phases 2/3. There may originally have been an equivalent drain running parallel with the east wall of the barrack, as there was in the case of Building 11, for example, but any trace of this had been removed by extensive modern disturbance at that end of the building.

FINDS

Construction? material – Phase 1

Iron: adze hammer (no. 27, K14:26)

Dating evidence – Phase 1

No datable material was found in contexts which could definitely be assigned to Phase 1 (but there is one sherd of second-century grey ware pottery in K14:26 if that is a Phase 1 context).

Phase 2 (Fig. 1)

The second phase of Building 12 is marked by the replacement of the original timber-built decurion's quarters by a stone house (Fig. 15.24). This was erected on the same site as its predecessor, at the east end of the barrack. The full length of the west wall (N14:25, M14:50) and fragments of the north (N14:24) and south (N15:13) walls remained and measured 0.80–0.85m in width. Where the masonry of the north and south walls had been robbed away the clay foundations still survived. No trace of the east wall was found owing to the modern disturbance at that end of the building. The surviving walls showed that the officer's house was 8.90m wide externally (from north to south) and over 10m long. Although its full external length could not be determined conclusively, but it can be estimated based on the presumed course

of the drain which ran along the west edge of the east *intervallum* road and is unlikely to have significantly exceeded 11m. (The drain conduit is one of the principal early – Period 1 or 2 – storm drains in the fort and probably continued for the full length of the east *intervallum* road, having been traced beside the east ends of Buildings 1, 3 and 11, along the east side of the *praetorium*, where it was also seen to extend southwards across the *via quintana*, and towards the southern edge of that same road opposite Interval Tower 5.) The house was clearly built before the rest of the stone barrack since the north wall foundation (M14:59) of the stone *contubernium* range butted up against the west wall (N14:25) of the officer's house and lay slightly to the south of the north wall (N14:24) of the house, rather than following exactly the same alignment as was the case with the other stone barrack blocks. The north wall was built over the southern edge of the earlier east-west drain. Near the north-west corner of the building an area of pitched stones (N14:42) present at the point where an internal stone drain exited through the north wall (see below) was perhaps associated with the removal and packing of the former east-west drain channel.

In north-west corner of the house a complex of latrine channels was evident. This was initially interpreted as a channel hypocaust by the excavators and, in its ultimate cruciform layout, the complex of channels does indeed resemble such a structure, in plan at least. However there was no sign of burning on any of the stones and this preliminary interpretation, which is reflected in the context records, had already been abandoned by the time the draft structural summary was compiled. The latrine underwent later modification which has partially obscured its original form. Daniels believed that initially it had a T-shaped arrangement, comprising a main north-south channel (N14:27) with an offshoot to the west (N14:26). A subsequent phase involved the extension of the west channel towards the east and the realignment and southwards extension of the southern part of the

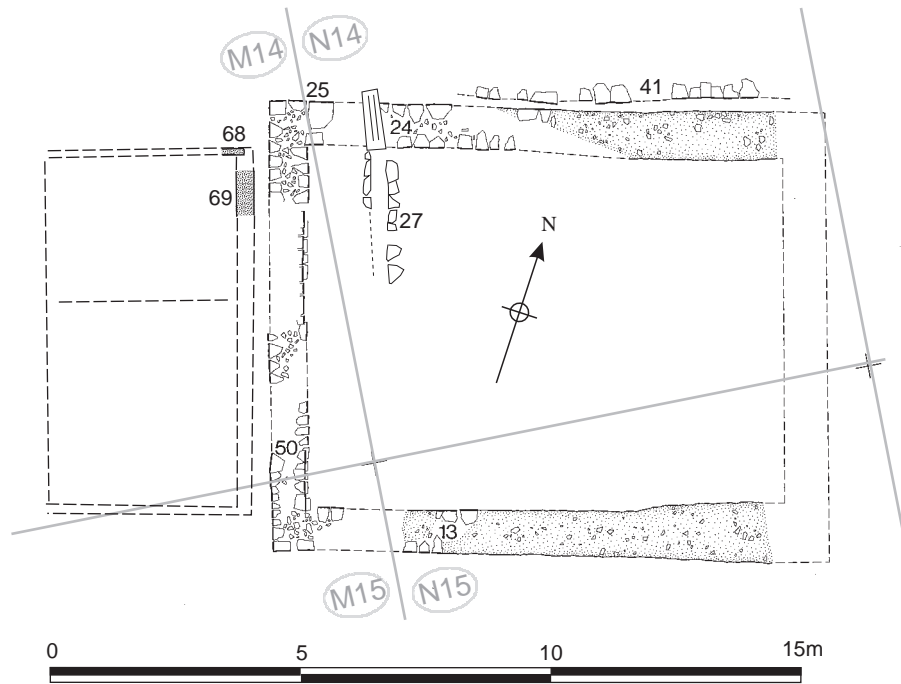

Figure 15.24: Building 12, Phase 2 plan showing the addition of the officer's stone house at 1:150.

north-south channel, the combined changes resulting in an overall cruciform arrangement of channels, all of which were surrounded by a packing of clay and stone (N14:33–36) which extended as far as the earlier flagging in the south-west part of the the house. Re-excavation in 1997–8 has suggested that the initial form of the latrine was simpler than proposed by Daniels with just the north-south channel belonging to this phase. One stone forming part this channel can be seen in the bottom of the western offshoot channel, implying that the latter must have been a later construction which interrupted the original line of the north-south channel, rather than a contemporary element as Daniels believed. Daniels also considered that some of the stones incorporated in the clay and stone packing defined the southern and eastern limits of the initial latrine and were presumably earlier than the main packing. On site plan P199 three or four stones do appear to mark a straight edge on the same alignment as the southern end of the north-south drain. However, no differentiation was evident in the stone/clay to the north and south of this line, which was recorded as two single contexts on either side of the drain (N14:35 (west), 36 (east)). The eastern edge is even less clear on the site plan (P199) and the overall evidence is not conclusive.

The north-south latrine channel issued through the north wall by means of a carved gutter stone, evidently reused from elsewhere. Such guttering is used in the courtyards of the stone hospital (Building 8), and the headquarters (Building 14). In both cases some of guttering is missing as a result of later

modifications. However it is now recognised that the stone hospital was not constructed until Period 2 (probably coinciding with the Antonine era) and the modifications which result in the removal of the western side of the guttering did not occur until even later, in Period 3. In contrast, the guttering along the east side of the *principia* courtyard became redundant and was largely removed during Phase 2 of that building, so might well represent the most plausible candidate for the source of the gutter stone recorded here.

Flagging was present in the south-west corner of the officer's house (N14:40, N15:16) and appeared both to respect the position of the external walls and sit at same level as their lowest course, suggesting that the floor was laid in this period. Little remained of the interior levels in the eastern part of the building, but a possible surface composed of hard, relatively clean, yellow-grey clay (N14:38) was recorded to the east of the drain complex, apparently underlying the clay/stone packing (N14:34, 36) and abutting the north wall, and might belong to this phase or conceivably to the primary, timber officer's quarters. In addition a north-south aligned partition slot (9159) was identified in 1997–8, some 2m to the east of the latrine channel. On this basis the 1997–8 excavators suggested that the layout of the decurion's house comprised a paved lobby in the south-west part of the building, stabling for the officer's horses in the north-west quarter and domestic accommodation to the east, similar to the equivalent officer's quarters at the west end of Building 9 (Hodgson 2003, 47).

FINDS

Phase 2 officer's house

Bone: spindle-whorl (no. 31, N14:38)

Dating evidence – Phase 2

Less than 10 sherds survived from this phase. They included BB1 and second-century locally produced wares (clay floor N14:38).

Phase 3 (Fig. 15)

The third phase of the building involved the rebuilding of the stable-barrack *contubernia* in stone. As with the other barracks of Period 2 only the outer walls were rebuilt in this manner. Timber and wattle-and-daub construction was retained for the internal partitions separating the individual *contubernia* and these must have been rebuilt at the same time.

Outer walls

The north wall of *contubernium* range was set on a line slightly to the south of that taken by the north wall of the officer's quarters, as noted above. The foundations of the north wall (J13:13, K13:23, M14:59) could be seen in several places and the position of the west wall was also revealed by remains of the foundations (J13:11, J14:13). These were composed of large, rounded river cobbles up to 0.40m long, closely set. No bonding clay evident in the stretches of west, but clay loam packing was recognised in the rubble foundations nearer the east end and an underlying pink-yellow streaked bedding clay was revealed here too (shown on site plan P199). A line of squared blocks sitting on the foundations of the west wall might represent the outer face of a footing course whilst a few possible facing stones remained *in situ* at a couple of points near the junction of the north wall with the decurion's quarters (north of *Contubernia* 8 and 9), showing that the wall was c. 0.80m wide and the clay foundations were 0.90m wide. Another stretch incorporating some facing stones was exposed further to the west in 1997–8, in Grid Square L14, an area where the pre-chalet period levels were not investigated in 1978–9. In contrast no trace of a stone south wall remained and there is some evidence to suggest that the barrack retained a timber frontage. Over the Phase 1 slot (M14:67) there was a linear gap between the flags in the south room of *Contubernium* 8 (M14:64) and the road surface to the south. This was interpreted as the linear slot for a second phase of timber wall (M14:65).

Only a 1.10m length of the slot was revealed in 1979, but immediately to the west, an upright threshold stone (M14:66), 0.70m long and 0.13m wide, was set vertically on the same line. (In addition the excavations fully exposed a pivot stone incorporated in flagging

M14:64 at the western end of the threshold, confirming that this was the location of the entrance into the *contubernium*.) Such an arrangement is paralleled in barracks of various periods at South Shields fort (Hodgson & Bidwell & Speak fig 2.9) though none of the other conventional stone barracks at Wallsend have provided any definite evidence of similar timber frontages, even as an interim phase. On this basis the external length of the stone *contubernium* range (excluding the west wall of the decurion's quarters) was established as being , whilst its width was c. .

Internal features – the contubernia

The overall layout of the stable-barrack was established by the 1997–8 excavations. The block faced south across the street towards the back wall of Building 11. Each of the nine *contubernia* was subdivided into a front and back room, the front room being given over to stabling the *contubernales'* horses and furnished with an oblong, stone-lined urine pit, whilst the rear room provided living accommodation for the soldiers themselves (nominally three cavalry troopers) and often contained the remains of a hearth. No partitions were found in 1978–9 so the subdivision of the barrack set out below, with its attribution of particular internal features to specific *contubernia*, is based on the results of the 1997–8 excavations and, accordingly, the numbering of the *contubernia* follows that provided in the 1997–8 report (Hodgson 2003). It has been assumed that most of the flagged floors and drains in the *contubernium* range which Daniels attributed to the conventional barrack phases actually belonged to this phase rather than the primary timber barrack and this is supported by the results of the 1997–8 excavations. The principal features identified in interior were flagged floors, which were present in both front and back rooms. These were best preserved towards the east end of the building (*Contubernia* 8 and 9), though these were more extensively revealed in 1997–8. The picture is complicated at the west end of the range in *Contubernia* 1 and 2 where some elements may have been adapted and reused in the subsequent chalet phase (Period 4).

A total of nine post holes were identified towards the western end of Building 12 in 1978, betrayed by fills of grey silt, grey clay and pitched packing stones. Additional examples were uncovered in 1997–8 (Hodgson 2003, 61–2 & fig 47). These post holes which mostly fell within *Contubernium* 1 were attributed to the primary timber phase by Daniels, but were assigned to the Period 2/3 stone barrack by the Tyne and Wear Museums team in 1997–8. Four of the post holes (from west to east: J14:32, 33, 28, 34, cf. TWM 8150, 8163), arranged in a line in the centre of *Contubernium* 1 (and perhaps extending into *Contubernium* 2), may have been associated with a partition separating the *contubernium* into front and

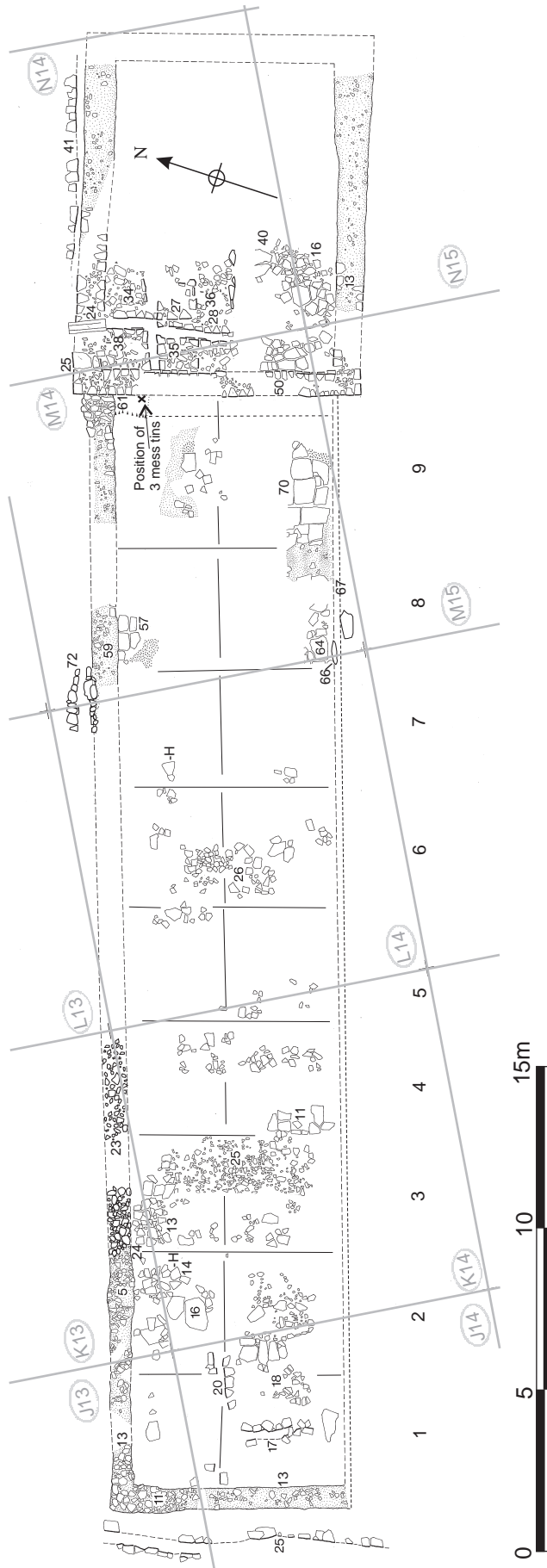

Figure 15.25: Building 12, Phase 3 at 1:200.

back rooms. These post holes ranged from 0.20m to 0.40m in diameter, the internal post pipe (where it could be estimated) was 0.08m across (J14:34) and 0.07–0.08m by 0.10m (J14:28). More difficult to interpret was the function of the two timber posts implied by post holes uncovered towards western edge of the front (south) room of *Contubernium* 1 (J14:15–16, corresponding to TWM 8144, 8143 respectively), some 0.60m apart. They were positioned some 0.30–0.40m from the foundations of the stable-barrack's west wall and were also in line with the westernmost of the four central postholes (J14:32 – TWM 8150). They may conceivably have served as tethering posts, but, as was noted in the report on the 1997–8 excavations, their location would surely have made the manoeuvring of horses in and out of the front portion of the *contubernium* more difficult. Another post hole lay right in the middle of the north room (J14:35), whilst a further couple were located in the southern room of *Contubernium* 2 (K14:28, 29 – TWM 9173, 9115). Again, the positioning of these last two would have been awkward in terms of the functioning of the stable quarters in that *contubernium*, but a number of post holes in locations roughly corresponding to that of J14:35 were revealed in the back rooms of other *contubernia* in 1997–8, suggesting it represented a common feature in the barrack's internal layout.

In the southern part of *Contubernium* 1, a stone-lined drain (J14:17), aligned north-south, was uncovered and was attributed to this phase both by Daniels and the 1997–8 excavators (cf. Fig. 15.23). The drain took the form of a channel, some 0.15–0.25m wide and c. 2.50m in length, filled by a grey clay silt (J14:24), with side-walls constructed principally of roughly dressed facing stones, although vertically set slabs also appear to have been incorporated along the east side as an additional lining. Thus, with its relatively narrow channel and stone-walled construction, it more closely resembled the drains encountered in the front parts of the Period 4 chalet-*contubernia* – the subsequent phase of stable-barrack – rather than the urine pits found in the stable barrack *contubernia* of Periods 1–3, which mostly took the form of slab-lined oblong pits. Furthermore, although Stable-Barrack 12 was orientated to face south in Periods 1–3, whereas its successor, Chalet-Barrack 12, faced north, the frontages of the individual chalet-*contubernia* were staggered from east to west, each one being recessed slightly in relation to its neighbour to the east. As a result the westernmost chalet-*contubernium* (AG I) was recessed so far that a drain located in its front (northern) room could have occupied the same position as one in the front (southern) room of the preceding Period 3 *Contubernium* 1. Drain J14:17 could therefore represent a chalet-phase remodelling, involving the construction of a new stone-walled drain within an earlier urine pit, which would explain its somewhat anomalous form.

Immediately to the north of drain J14:17 was what appeared to be a stone-lined channel one course high and 0.25m wide (J14:20). This was aligned east-west and was filled with a deposit of sticky grey soil and some pitched stones (J14:22). It was interpreted by Daniels as another drain channel, perhaps connected with the north-south drain (J14:17). The east-west channel was clearest to the east of drain J14:17, but some stonework to the west (J14:26) was thought to represent a westward extension of this feature although this was much more fragmentary. However there are grounds to question Daniels interpretation in this case. No definite link between drain J14:17 and channel J14:20 was recorded and elaborate L- or T-shaped arrangements of drains are not otherwise known in the stable-barrack *contubernia* either in the earlier blocks of Periods 1–3 or the later freestanding chalet-*contubernia*. An alternative interpretation of the east-west 'channel' would be as a stone-lined slot for a medial partition (or perhaps more accurately the edge of stone surfaces which ran up to a timber partition wall). The feature was certainly in an appropriate position to form a medial partition in the Phase 3 stable-barrack, although, positionally, it could equally have been associated with a later timber frontage of Chalet-*Contubernium* AG I. To the south and south-east of the slot, an area of flagging (J14:18) appeared to occupy the same level as the slot's edge stones and may have been broadly contemporary. On the basis of its location, however, much of this flagging should fall within *Contubernium* 2 rather than 1, otherwise it would imply that *Contubernium* 1 was wider than the other *contubernia* (4.50m internally rather than c. 3.50m), which would not be consistent with the overall layout uncovered by the 1997–8 excavations.

Discussion: The stratigraphic position of the slot J14:20 and flagging J14:18 provide strong grounds for assigning these features to the Stable-Barrack 12, most probably the Phase 3 stone building. No earlier, flagged surface was recognised beneath J14:18. However this interpretation is not without its problems. In particular no interruption for a north-south partition separating *Contubernia* 1 and 2 is apparent at the point where the later discoveries in 1997–8 indicates there should have been one (cf. Hodgson 2003, 60, fig 47). Instead the stone side walls of slot J14:20 continued over the top of the partition slot between the two *contubernia*. Moreover flagging J14:18 formed a very neat edge with the west side of chalet phase wall foundations (K14:23) hinting that the two might be contemporary. Such evidence is far from conclusive. The apparent eastern edge of flagging J14:18 was most probably simply the result of flags further to the east having been removed when the foundations of the east wall of Chalet AG I were laid. Nevertheless, it is quite plausible that slot J14:20 represents an earlier feature adapted to form part of the frontage of Chalet-*Contubernium* AG I during Period 4, like internal drain J14:17. The use of pitched

stones, of the kind packed into the slot in a couple of places, for example, is characteristic of the chalet frontages in Chalet-Barrack 12.

Two layers of flagging were evident in places in the northern part of *Contubernium* 2 (flags K14:16 and K14:14, but note the two levels are not differentiated by context number). A few scattered flagstones towards the northern end of *Contubernium* 1 also appeared to lie on the same level as the lower flagstones in *Contubernium* 2. It is not clear whether the lower flagging should be assigned to the primary timber stable-barrack range or whether this indicates that *Contubernium* 2 was resurfaced during Phase 3. Traces of burning on flags K14:14 mark the location of a hearth in the north room of *Contubernium* 2.

In the northern part of *Contubernium* 3 a flagged surface (K13:24, K14:13) was present, composed of angular, light-coloured, fine-grained sandstone slabs, ranging in size from 0.1m to 0.2m across and averaging 0.1m thick. The remainder of the *contubernium* to the south was covered by band of small stones and very small flags (K14:25), up to 1.70m wide, which was interpreted as a floor surface. The excavators noted that the western edge of K14:25 formed a rough line, and suggested this represented the line of a partition (K14-27). However this would not fit with the arrangement of *contubernia* established by the 1997-8 excavations and may therefore not be significant. The eastern limit of the *contubernium* could be distinguished in the form of a clear edge between K14:25 and the worn flags in the south-west corner of *Contubernium* 4 (K14:11). A post hole (K14:33) apparently cut through flagging K14:11, being revealed as patch of broken rubble disturbance. The function and phasing of this post hole were not altogether clear, but it seemed to be partially overlain by the foundations of the east wall of Chalet AG II (K14:08), suggesting that it represented an alteration to the internal arrangements in the Phase 3 stable-barrack. Other scattered patches of small flagstones were evident in *Contubernium* 4, some of which were shown to form part of demolition material (TWM 9188) infilling a urine pit in 1997-8. Like the other urine pits revealed by the later excavations, the latter was laid out on a north-south alignment along the central axis of the front room and was perhaps 3.00m long. Only a few scattered flagstones were exposed in *Contubernium* 5 in 1997-8, but a more extensive spread of cobbles and flags (L14:26), the latter averaging 0.25m in diameter, was uncovered in *Contubernium* 6 particularly towards its western side. In the north-west corner of *Contubernium* 7 one flagstone (recorded as part of L14:26) was revealed which had been extensively cracked by heat and had evidently been used as a hearth. The positioning of this hearthstone, like the similar evidence of burning on flagging K14:14 in *Contubernium* 2 noted above, reflected the function of the rear room in providing living quarters for the troops.

Flagged floors were present at both north and south ends of *Contubernium* 8 (M14:57, 64). These floors were less disturbed than those further west and were composed of neat, roughly dressed, squarish or oblong slabs. The patch of flagstones at the north end of the *contubernium* (M14:57) butted neatly up against the line of robbed north wall. A more extensive area of the southern flagstones was uncovered in 1997-8 (M14:64, 8418), but it was already clear that this represented the site of a doorway as the upright threshold stone discussed above (M14:66, 8432) was found on the southern edge of the flagstones in 1979. In 1997-8 the flagging was seen to incorporate a pivot stone next to the western end of the threshold and the doorway was evidently located at the western edge of the *contubernium* frontage, which seems to have been the normal position for *contubernium* entrances. A very similar flagged floor (M14:70) was seen at the southern end of *Contubernium* 9, although some of the individual flagstones were larger than their counterparts in 8. Again, no traces of an adjoining masonry wall were observed along the southern edge of this flagging which instead was presumably respecting the line of a timber front wall, whilst the western edge of the flags marked the position of the partition wall separating *Contubernia* 8 and 9. A scatter of flagstones which may relate to this phase was also seen in the centre of the *contubernium*.

The decurion's house

There is evidence that the decurion's stone house was substantially rebuilt at some stage after its initial construction. This involved rebuilding the house's west wall (M14:50, N14:25) from the second course upwards (insufficient remained of the other walls to determine whether they were also affected by this reconstruction). A number of alterations to the drain in the north-west corner were also apparent and these might also have been associated with this rebuilding phase, which may in turn have been contemporary with the construction of the stone *contubernium* range. However, an alternative possibility, namely that some or all of these changes formed part of the Period 4 remodelling of the barracks into ranges of free-standing chalet-*contubernia*, cannot be excluded either.

Three phases were evident in the west wall of the decurion's quarters. The lowest course which belonged to the initial phase of the house (Building 12 Phase 2) was overlain by a second which was inset c. 0.08m on its eastern edge, but also overlapped beyond the western edge of the lowest course. This implies that the second course must have belonged to a later rebuild which involved dismantling the wall down to its footing course. The second course was in turn overlain by two further surviving courses (M14:18), inset on their west side, which belonged to yet another remodelling, probably associated with the secondary chalet phase (Chalet AM2).

A set of modifications to the drain serving the

stable area in the north-west corner of the building involved the addition of a western offshoot (N14:26W) roughly midway along the original channel. To the south of this offshoot, the original channel (N14:27) was rebuilt on a line (N14:28) slightly to the west of its original course and extended. Also a new east channel (N14:26E) was inserted in line with the west channel. The stones on the north side of the east-west channel were set upright in a manner different to the other drain walls in this area. This may imply that both halves of the east-west channel were constructed at the same time. The clay and stone packing (N14:33–36) around the channels extended as far south as the edge of the flagging in the south-west part of the house (N14:40, N15:16).

N.B. In photographs of the surviving remains exposed in 1997–8 a stone can clearly be seen apparently blocking the northern end of branch N14:26E implying that this southern branch was taken out of service whilst the east-west channel (N14:26) and possibly the northern half of the original channel (N14:27) continued in use. However no such stone can be seen on any of the photographs taken in 1978–9 (see Fig. 15.26) or on site plan P199, all of which appear to show the channel open. It is possible therefore that this stone was inadvertently inserted during backfilling operations at the end of the 1979 season and its presence is potentially misleading with regard to the developmental sequence of the drain channels.

FINDS

Phase 3

Contubernium 1: fill of stone-lined slot for a medial partition

Copper alloy: harness lead (no. 178, J14:22)

Contubernium 6: flagged floor

Copper alloy: mount (no. 244, L14:26)

Dating evidence – Phase 3

This phase produced only about 25 sherds of coarse wares, with no samian, mortaria or fine wares. There were three sherds of BB2 and allied fabrics in the wall foundations and slots (M14:59, N14:65). The other sherds consisted of more BB2 and allied fabrics, BB1, second-century locally produced wares, and Dressel 20 amphora.

Demolition and robbing

Overlying the floor surfaces in *Contubernia* 8 and 9 was a distinct layer of debris associated with the demolition of the stable-barrack. This was recorded at various points and varied a little in composition although the overall character was very similar. In

Contubernium 9 it was recorded as a loose and friable, light to mid-brown sandy clay loam, including some greyer ashier silts, with rubble in places (M14:54), and becoming darker and less sandy further south (M14:55), where a layer of 'coal/silt' was present at bottom of the deposit, sitting on flagging M14:70. The deposit ranged in thickness from 0.03m at the northern end of the *contubernium*, increasing to 0.10–0.15 in the central part and thinning again to c. 0.04m at the southern end. The lowest silty levels might represent final occupation debris on the floor surfaces. In *Contubernium* 8 the demolition layer was described as a slightly stony, light grey or orange-grey silty clay loam (M14:56, 63), c. 0.05–0.08m thick. These deposits were seen to extend across the line of the north wall, filling (M14:60) the robbing trench and covering the surviving clay foundations, indicating that the barrack walls were robbed out at the end of the life of the stable-barracks, but before the succeeding chalet-barrack structures, which overlay these levels, were erected.

FINDS

Robbing of the east end of the contubernia

Copper alloy: buckets (nos 79–81, M14:61 – see Fig. 15.27)

Demolition material

Copper alloy: belt plate (no. 146, M14:54), mount (no. 247, M14:63)

Stone: throwing stone (no 117, M14:63)

Dating evidence

Six contexts produced pottery (M14:54–56, 60–61, 63), all of which included BB2 or its allied fabrics. There were two East Gaulish form 37s dating to the late second century or the first half of the third century (M14:54). There was a sherd from a Nene Valley colour-coated ware funnel-necked beaker, a type introduced during the second quarter of the third century (M14:63), suggesting the demolition occurred after c.225.

South *intervallum* road (Road 6) – east (Fig. 15.28)

Grid squares: L16, M16, N16

Primary street levels

Three distinct layers of metalling were identified within the context designated by the excavators as the primary road level (M16:20, 24). The first of these was composed of cobbles and grey clay loam. This was said to be equivalent to the strip of worn cobbling uncovered alongside the west wall of the



Figure 15.26: Cruciform arrangement of channels in the officer's quarters.



Figure 15.27: Barrack 2 mess tins next to west wall of the officer's quarters.

officer's house (M16:19), which may have surfaced an alley between the range of *contubernia* and a detached decurion's house, the typical components of the primary timber stable-barracks found in the *retentura*. The lowest surface was overlain by two further layers of worn cobbles, the uppermost of which had a greyish appearance. The relevant site plan (P185 – it is not clear which of the three layers is depicted) indicates that most of the cobble stones were very small, but some larger squarish or angular blocks measuring up to $0.40 \times 0.25\text{m}$ were also incorporated, particularly to the west of the later drain M16:17. It is unclear why the excavators chose to designate these three surfaces as a single level rather than assigning them each a separate context number.

Phase 2 road level

The secondary road level took the form of a very worn cobble surface (M16:16, 18), c. 0.05m in thickness, described as being 'a clean colour with little dirty grey silt on or in the surface'. At one spot a concentration of ballista balls was incorporated in the cobbling. Set into this surface was a stone-lined drain (M16:17), which extended southward for some 2.20m from the end of the wall separating the *contubernia* from the decurion's house. Its sidewalls each comprised a single course of facing stones which lined a 0.23m wide channel, filled with a brown sandy clay loam containing a lot of stones (M16:23). The drain's overall width including both sidewalls was 0.75m and it was set in a 1.20m wide construction trench indicating that whilst its use was clearly broadly contemporary with secondary road level its construction was secondary to that of the metalling.

Drain M16:17 probably fed rainwater into another, more substantial storm drain (M16:07), which ran along the south side of the *intervallum* road (the actual junction between lay just beyond the limit of the excavation). This east-west aligned drain was capped by large yellow sandstone flags which had cracked

as a result of wear. The largest must originally have measured c. 1.20m by 1.00m. These capstones were not lifted, the side walls only being exposed where the drain's course was intersected by a colliery-era trench (M16:08). The site plans (P167, P185) indicate that one or perhaps two courses of the north wall were uncovered on either side of the intrusion, but these were not mentioned in the context description, which essentially referred to the capstones, and it is not clear that even here the drain fill – a grey sandy silt (L16:02) – was fully excavated to reach the bottom of the wall. The plans suggest the channel was at least 0.40m wide. Although its capstones were visible in the road surface associated with the subsequent phase (M16:06, 11), lying apparently flush with the top of the metalling to judge from site plan P167, this *intervallum* drain may be attributed to the secondary phase on the basis of its apparent functional relationship to drain M16:17. It is difficult to see how the latter could have functioned effectively without envisaging the prior existence of M16:07. The capstones certainly lay over the primary metalling (as evinced by site plan P185).

Phase 3 road level

The uppermost surviving road level (M16:06, 11) was composed of yellow sandstone cobbles, described as 'closely set with a worn surface' and 'very clean' with a sandy layer to the bottom over the previous road surface (M16:18). This included a number of larger angular stones averaging 0.15–0.25m in length. To the west, a layer of orange sandstone cobbles (M16:12), which formed a very smooth surface, may have constituted part of the same level. Like M16:06/11 this lay directly beneath the modern overburden and any higher road levels over these surfaces must have been removed as a result of truncation of the Roman deposits.

Two further drains (M16:03, N16:12) were set into this cobbling. One of these (M16:03) extended southward from Building 11 for 2.20m towards the

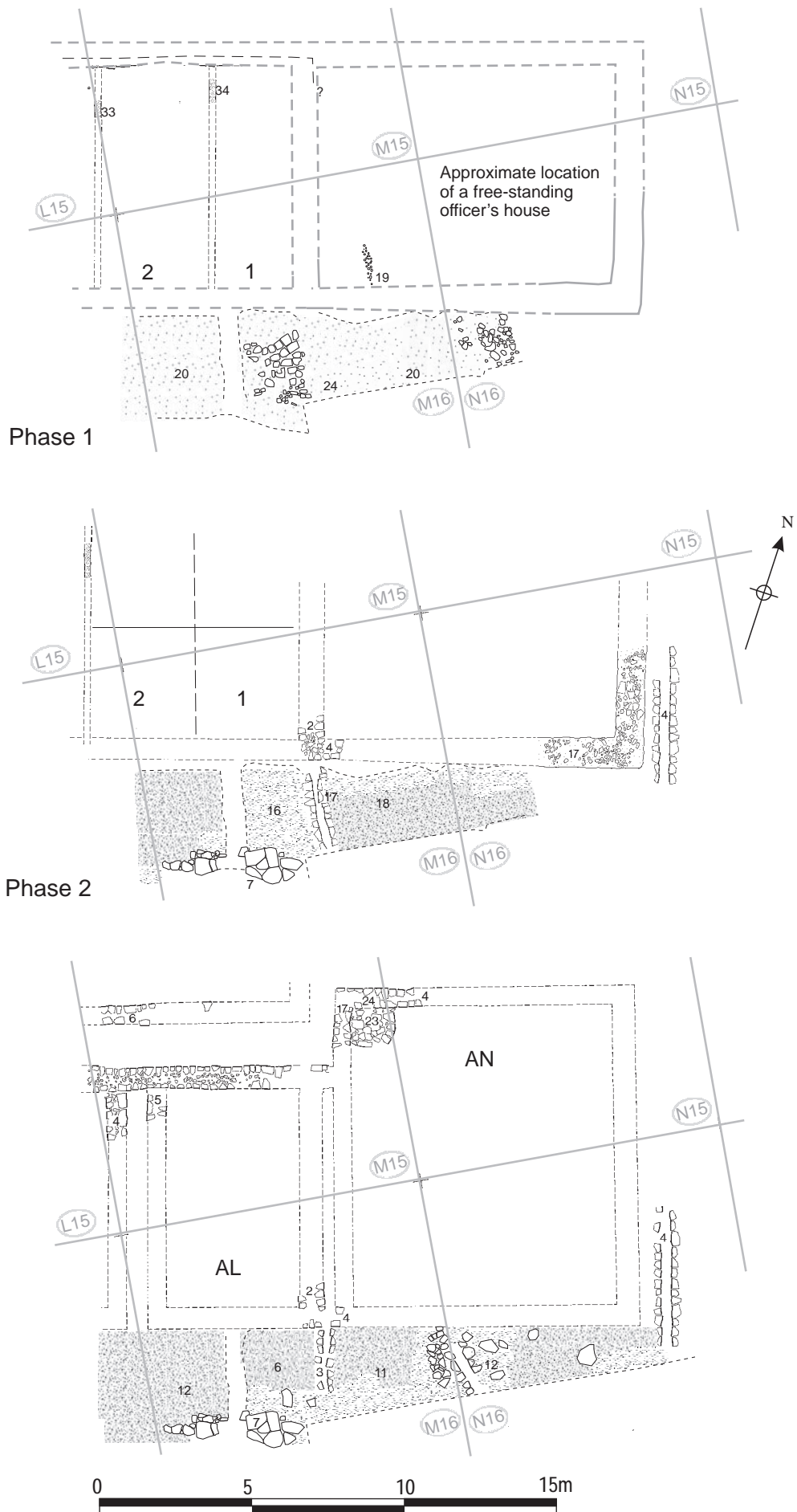

Figure 8 Location of the intervallum road surfaces south of Building 1 and Ch let Rang 1 (AL & AN) at 0

main east-west aligned *intervallum* drain conduit (M16:07). It partially overlaid the earlier north-south drain (M16:17), but was offset marginally to the east and was oriented perpendicular to the line of Building 11 whereas its predecessor had lain at a slightly oblique angle. The side walls again survived one course high and lined a channel, 0.20m wide and 0.15m deep, filled with rubble and grey loam (M16:21). The overall width of the drain including the side walls was c. 0.65m. The excavators in 1978–9 assigned this feature to the chalet period on the basis that it appeared to continue the line of a possible alley between Chalet AI and decurion's quarters (Building AN), which was defined by walls M15:17 and M16:02. A second drain (N16:12), c. 1.50m in length, was located some 4.50m further east. It followed a somewhat different NW to SE orientation, running at an oblique angle to Building 11. The side walls were each composed of a single course of angular facing stones and large river cobbles, c. 0.40m in length, which defined a channel 0.30m wide and 0.20m deep. This was filled to a depth of between 0.05m and 0.10m by an olive grey-brown silty clay loam (N16:14) containing some stone, particularly towards the bottom of the drain, overlain in turn by a c. 0.10m deep deposit of rubble (N16:13), which may represent later demolition or disturbance. To the east of the drain, a layer of sandstone rubble (N16:18) was present which may have represented the heavily disturbed remains of the road surface.

FINDS

Primary street level

Copper alloy: phallus mount (no. 228, M16:20)

Stone: throwing stones (nos 80, 108–10, 119, 122, M16:20)

Quern: lava (no. 33, M16:20)

Phase 2 street surface

Stone: throwing stones (nos 2, 3, 25, 106, M16:16)

Phase 3 drain fill

Glass: window (no. 42, M16:21)

Dating evidence

The primary road levels produced about ten sherds

(M16:20, 24), including BB1, locally produced wares and mortaria made by Anaus (120–160). The Phase 2 metalling and drain fills produced about twice as many sherds, although most of these were sherds of Dr 20 amphora and sherds from another Anaus mortarium (M16:17; M16:18). The only samian sherd was a Hadrianic or Antonine form 18/31 or 31 (L16:02). The equally small number of sherds from the Phase 3 road surface and drains included a few sherds of BB2 of the late second century or later (M16:06, 11, 21, N16:14).

Discussion

Three main levels were identified by the 1978–9 excavators on the south *intervallum* road, but five distinct surfaces were actually listed and it may be preferable to think of the road in those terms. However, for dating purposes, the material associated with the layers of metalling was somewhat disappointing, displaying a relatively limited chronological span including nothing which need be later than the second century.

The primary level produced a number of finds which derived predominantly from the lower layers, including a brooch from the second layer and bone mainly from the bottom layer. The coarseware from that part of the road level which lay beneath the later drain M16:17 came from the second layer (M16:24).

The lowest surface presumably relates to the initial construction of the fort, whilst it is reasonable to suppose that the second and perhaps the third layers reflect the occupation of the primary timber stable barracks (Period 1), although the third surface could conceivably be connected with the establishment of the succeeding stone barrack instead. The Phase 2 level might then be associated with the life of the stone stable-barrack (Period 2/3), as implied by the presence of late second-century coarsewares, whilst the uppermost level could be contemporary with the chalet range (Period 4), as suggested by Daniels. In these circumstances the drains set in the road metalling might provide clues to the internal layout of the range. The associated dating evidence would not contradict such a hypothetical periodisation of the *intervallum* road levels, even if it does not provide definite confirmation either.

16. THE CHALET-BARRACKS IN THE *RETENTURA*

The four stable-barrack blocks in the *retentura* were all rebuilt at some point, probably in the second quarter of the third century (Period 4). The new barracks took a markedly different form from their predecessors, comprising ranges of freestanding structures, which for convenience are labelled chalets. However, the basic characteristics of the block were not so different from their predecessors as first appearances might suggest, implying a broadly similar function. Most significantly, the survival of drains in the front of several chalet-*contubernia* implies these were still barracks intended to house cavalry *turmae*. An officer's house was also still found at outer end of each range, next to the east or west *intervallum* road, as was the case in the earlier barrack blocks, but the number of *contubernia* does appear to have been reduced to five or six in each range.

This chapter includes detailed description and analysis of the 1978–9 Daniels excavation data relating to the four later barracks, which was more extensive and informative than that surviving when Chalet Ranges 9 and 12 were re-examined in 1997–8. It includes full discussion of the interpretive *schema* proposed by Daniels and TWM. The improved conceptual understanding of these buildings as cavalry barracks, which has resulted from the more recent work, is applied to the detailed evidence of the Daniels excavations, and, where these appear to conflict, revised interpretations of the barrack layout are presented, which can be more easily reconciled with the excavation data.

Chalet Range 9 (W, V, U, ET, AK)

Grid squares: D12, D13, D14, E13, E14, F13, F14, G13, G14, H13, H14

Introduction

Daniels considered that Building 9 underwent a further phase of modification, prior to its replacement by a row of free-standing chalets (Chalet Range 9 comprising Chalets U, V, W and AK) in Fort Phase 3. Under Daniels scheme, which was unaware of the primary timber barrack phase, this represented the second overall phase of the structure – Building 9 Phase 2 – and was assigned a third-century date, corresponding with his Fort Phase 2. The defining feature of this phase is the construction of a long cross-wall (F13:10, G13:10) running through the eastern half of the building. Over the course of the 1978 excavation and subsequent post-excavation analysis two divergent hypotheses were developed to explain this enigmatic structure. Subsequent re-excavation by Tyne and Wear Museums in 1997–8 has substantially clarified the function of the cross wall, integrating it into the layout of the chalet range. However, the resultant plan possesses a number of anomalous characteristics by comparison with other chalet barrack plans, which suggest the significance of Chalet Range 9 and its medial wall as evidence for changing ideas regarding the preferred form of barrack layouts has not hitherto been fully appreciated.

Daniels' Building 9 Phase 2a-c (original version) (Figs 16.01–16.02)

Initially, the medial wall was seen as part of a modification to the barracks reducing the number of *contubernia* in the central portion of the block from four to two and providing a corridor in front of the main rooms of the enlarged *contubernia*. The two *contubernia* were defined by surviving partitions F13:38 (west end), and G13:32 (east end) and possibly a north-south stone dividing wall, F13:06. The latter wall apparently separated the two *contubernia* from one another (with Phase 1 partition F13:54 immediately to the west

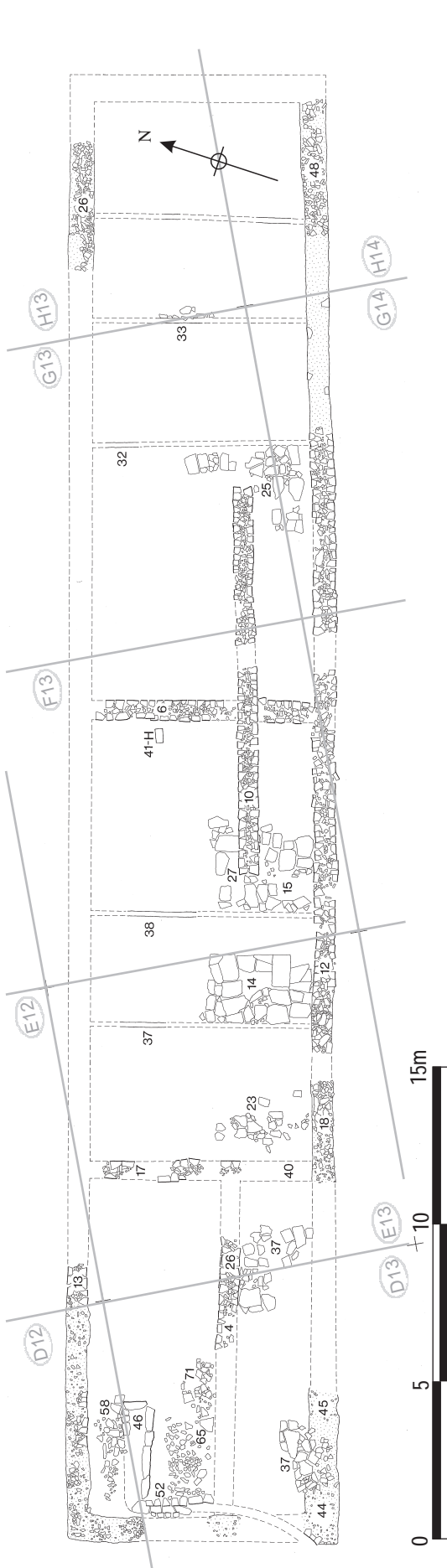

Figure 16.01: Building 9, Daniels Phase 2a, initial interpretation at 1:200.

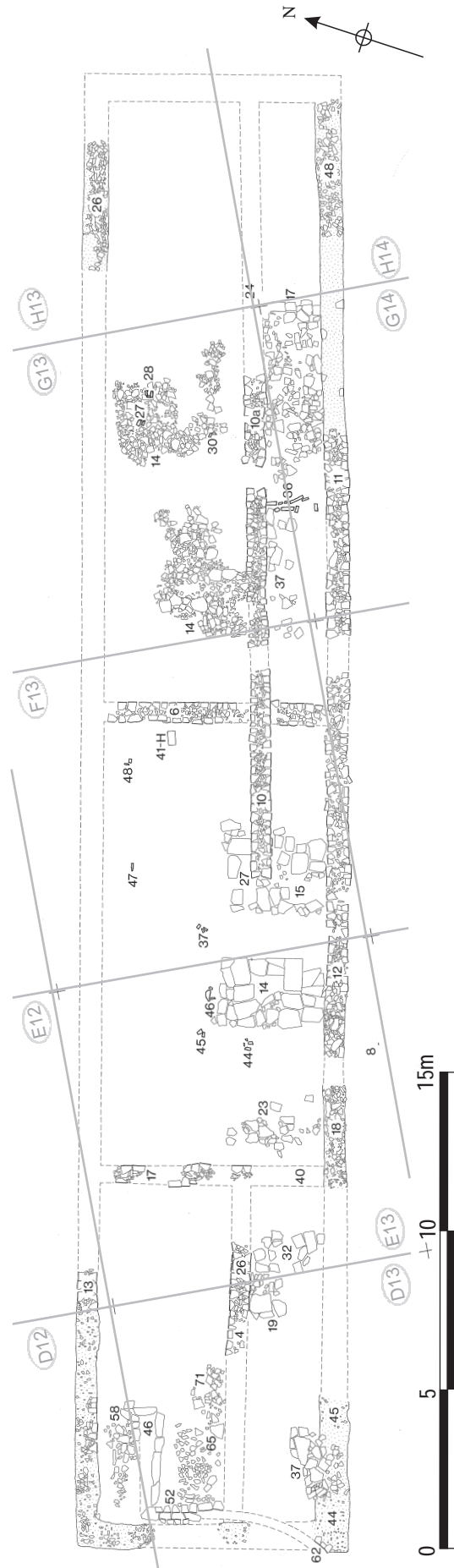

Figure 16.02: Building 9, Daniels Phase 2 sub phases b-c, initial interpretation at 1:200.

going out of use), but also divided the front corridor in two, although the incongruity of this arrangement was recognised. Gaps between the timber partitions and the east and west ends of the cross wall were thought to represent doorways giving access from the *contubernia* into the new corridor. The flagged floors laid during earlier phases in the southern half of the *contubernia* were retained in use, as were some of the timber partitions, notably the pair separating *Contubernia* 1, 2 and 3 (E13:37, F13:38). This scheme restored two *contubernia* west of the central rooms and, tentatively, three *contubernia* east of them, but the east end of the building was so badly damaged that the arrangements here were regarded as obscure. Moreover the stratigraphic evidence for the layout as a whole was acknowledged to be somewhat problematic. A second structural sub-phase (2.2 or 2b) was envisaged involving the extension of the medial wall to the east end of the building and the removal of the partitions at that end. The extension (G13:10a and foundation/robber trench H13:24, H14:37?) was recorded as being of rougher construction than the original length. Flags G13–14/37, north and south of the cross wall, were assigned to this sub phase. A further sub-phase (2.3 or 2c) was postulated on the basis of a series of post holes (E13:37, 44–46, F13:47–48, G13:27–30) thought to represent the screening off of areas within the rooms and presumably replacing the earlier partitions.

Daniels' Building 9 Phase 2 (revised version)
(Fig.16.03)

A reassessment of Phase 2 was prompted by the recognition that cross wall F13–10 almost lines up with the medial wall, D13:04, constructed across the officer's quarters at some stage (see above). It was suggested that this medial wall might have been designed from the outset to serve along with cross wall F13:10/G13:10 as the south wall of the building, rather than forming a medial east-west partition, with the whole building being foreshortened on the south side, possibly to function as a stable, paralleling the change which takes place in Building 1 in Phase 2. Although the interim structural report stated that the stratigraphic evidence in Building 9 did not support this interpretation (but without any further explanation), it was ultimately adopted as the favoured version, incorporated in interim summary reports (cf. Daniels 1989, 79–80), in the context phasing and depicted amongst the most recent series of inked plans, catalogued when post-excavation analysis resumed in 1997–8. As reconstructed, the building comprised a long, narrow, open room, measuring 33.10m by 4.10m–4.50m internally and stretching the full length of the former *contubernia*. The room was somewhat irregular, being wider in the middle (5.85m externally) than at either end (5.40m–5.50m). Only the area of the former officer's quarters at the

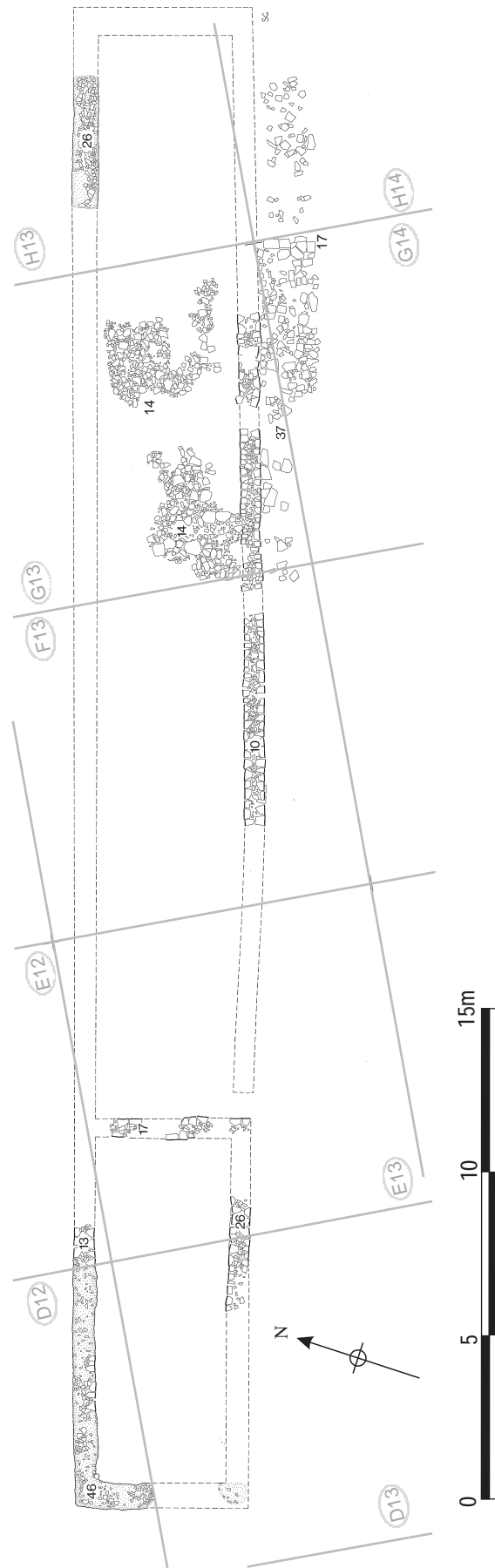

Figure 16.03: Building 9, Phase 2, final Daniels interpretation at 1:200.

west end remained separated from the rest of the building. The main room was floored with a flagged surface (G13:20), observed towards the east end of the building. Two flagstone and clay hearths were recorded in this area (G13:21, 22). The flagging was covered by yellow, sandy clay (G13:19), interpreted as an occupation deposit or conceivably a later makeup layer. An overlying floor of mixed cobbles and flags (G13:14) presumably marked a later sub-phase, similar flagging being present immediately outside the building on the south side (G13:37). Two rows of post holes (E13:37, 45–46, F13:47–48, G13:27–30), inset roughly 1.00m from the main longitudinal walls, were also attributed to this phase rather than the preceding barrack, giving the structure the apparent form of an aisled hall in its latest phase. No internal drains were identified in association with Phase 2, however, though these would have been expected if the excavator's interpretation of the building's function as a stable was correct.

The 1997–8 excavation results: Barrack 9 Period 4
Both Daniels' hypotheses contained serious flaws. The initial scheme was actually an assortment of features from different phases and the resultant layout had no clear parallels. It was ultimately rejected by the excavators themselves. The alternative 'stable' was a more coherent structure, this interpretation being based on the better preserved Building 1 Phase 2. However, the two surviving stretches of its suggested south wall, D13:04 at the west end of the building and F13:10/G13:10 to the east, clearly do not line up particularly well implying these were separate structures rather than fragments of a single feature. Indeed the west end of the building seems to have served as officer's quarters in both the stone barrack and chalet range phases with no evident interruption in function. Many of the other features attributed to Daniel's stable, such as the flagstone and clay hearths (G13:21, 22), the lower flagging (G13:20) and even the post settings (G13:27–30), fit comfortably into the internal layout of the *contubernia* at the east end of the stone barrack (see above *Building 9 Phase 2*). The remaining elements such as the long wall, F13:10/G13:10, and the cobble and flagstone floor (G13:14) can be allocated to the succeeding chalet phase, effectively eliminating Daniels' Phase 2 building altogether.

This was essentially the interpretation presented by Tyne and Wear Museums following re-excavation of Building 9 in 1997–8 (Hodgson 2003, 91–121). Wall F13:10/G13:10 was examined in detail and reinterpreted as an integral part of Daniels' chalet range, a spine wall running through much of the length of an enlarged barrack range. This remodelling was assigned to Period 4 beginning in c. 225–235 and extending up to the late third or early fourth century. As re-imagined, the Period 4 barrack was widened and

reorientated to face north, rather than south as before. It was composed of five enlarged *contubernia*, with the officer's house located at the west end of the range, as previously. The spine wall formed a medial partition separating the front and back rooms in the four easternmost *contubernia*. Three of these, which occupied the same area as Daniels' Building AK and an undesignated chalet here labelled ET¹, were restored as adjoining *contubernia* numbered 1–3, whilst the fourth *contubernium*, located in the centre of the range and equivalent to Daniels' Building U, was a freestanding structure of typical chalet form save that it was connected to the remainder of the range by the spine wall. The remaining *contubernium* (5, equivalent to Daniels' Chalet V) was entirely freestanding. The officer's quarters at the west end of the range was also remodelled and now probably faced westwards.

The overall layout of barrack rang (Fig. 16.04)

The 1997–8 excavations resulted in a much improved understanding of the third-century arrangements in Building 9. Daniels' Phase 2 has essentially been eliminated, key elements being combined with the chalet phase layout (Daniels' overall Phase 3, dated to c. 300, but now shifted considerably earlier to correspond to TWM Period 4). This interpretation is largely followed here. Where the Daniels' excavation record suggests an alternative interpretation this is highlighted below.

Owing to later disturbance there was considerable variation in the degree to which the remains of this phase survived. However sufficient remained to show that the extent of the reconstruction undergone by Building 9 in this phase was substantial. The east wall was retained and the north wall may conceivably have been, though this is by no means certain as very little of it has survived and the *contubernia*, or 'chalets', may have been timber-fronted along this side. There was also a degree of continuity in the arrangements in the officer's quarters. In contrast the south wall, which had previously formed the barrack's frontage, was demolished and the building extended over the street to the south, increasing the width of the building, perhaps to well over 9.00m internally. This enlargement reduced the street between Buildings 9 and 10 to a narrow alley, no more than 1.10m in width, and must therefore have been associated with a reorientation of the barrack range to face northwards onto the *via quintana*. A wall was built down the approximate centreline of this widened building extending for a distance of 24.60m from the eastern end into the middle of the range. It did not however continue for the full length of Building 9. The east-west aligned partition wall in the officer's quarters (D13:04, E13:26) was treated as part of the same wall in the Daniels revised Phase 2 scheme and as a contemporary and related structural component

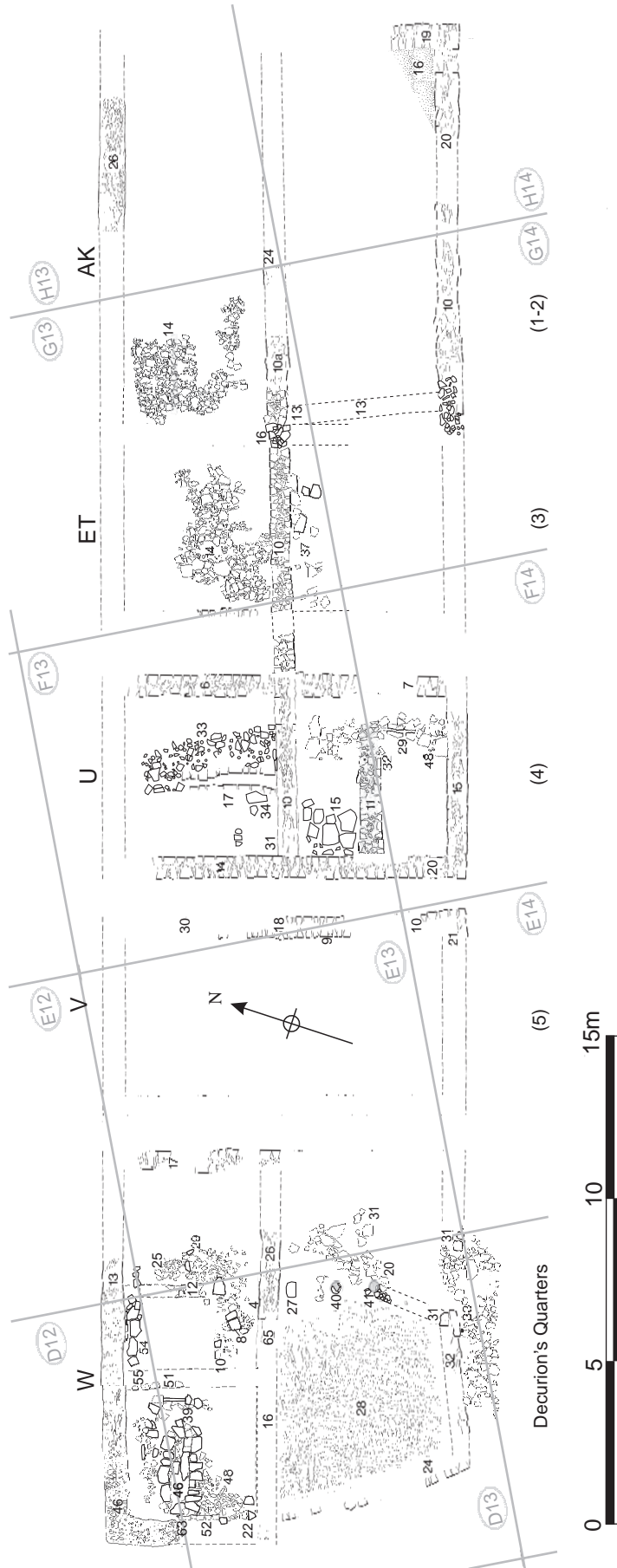

Figure 16.04: Chalet Range 9 at 1:200.

in the 1997–8 interpretation. However, the evidence of the Daniels excavation record would suggest that this was erected as part of the earlier Period 2/3 officer's quarters. Where it did exist the spine wall divided the barrack *contubernia* into front and back rooms. The wall was studied in detail in 1997–8 and was shown to have been built in discrete sections which displayed slight structural variations (Hodgson 2003, 92), a not uncommon feature of Roman barrack construction. The 1978 excavators had noted the same point, though in a less thorough fashion. The context number G13:10a was used to distinguish the surviving fragment of the wall in the easternmost pair of *contubernia*, which displayed rougher construction using 'inadequately squared off stones', from the stretch further west (G13:10) in the same grid square, which was faced with care. The excavators suggested that G13:10a might be a later addition, but there is no need to accept this supposition.

The layout comprised five *contubernia* and an officer's house. The three *contubernia* in the centre of the range (1978 Buildings ET, U and V; 1997–8: *Contubernia* 3–5), certainly faced north on to the *via quintana* and measured externally up to 11.30m north-south by 6.20m east-west. V and U were essentially freestanding structures separated from each other and the remainder of the range by alleys, U being connected to the *contubernia* to the east only by the spine wall which partitioned it into two rooms. At the east end of the range, arrangements were more obscure due to the greater degree of post-Roman destruction here. Daniels considered that ET was another freestanding *contubernium*, or 'chalet', independent of the remaining *contubernia* to the east, whereas the 1997–8 excavators argued that ET/*Contubernium* 3 adjoined them, forming a block of three *contubernia* (1–3), all of which faced north. Daniels, on the other hand, envisaged the two easternmost *contubernia* (which he labelled Building AK) as a conjoining pair that faced eastwards on to the *via decumana*, being separated by the spine wall (G13:10a, foundation/robber trench H13:24) rather than by a north-south aligned partition wall.

The evidence is examined in detail below, the suggested partitions being represented by fragmentary remains of possible walling and robber trenching. However the spread of rubble representing the south wall did appear to extend right up to ET/*Contubernium* 3, implying that the three eastern *contubernia* did indeed form a single block. At the western end of the range, the officer's house (labelled Building W by Daniels) was remodelled internally, but retained many structural elements from the previous phase including the north and east walls, the latter having previously functioned as the partition wall separating the house from the *contubernia* in the Period 2/3 barrack. The remodelled building may have been L-shaped in plan, with a stone walled, cobbled yard

occupying the remaining south-west corner. These quarters appear to have faced westward onto the *intervallum* road and probably continued to perform the same function as their Period 2/3 predecessor.

Thus the building had a peculiar hybrid layout incorporating elements of a traditional barrack with what appeared to be adjoining *contubernia* at the east end of the range, and two structurally independent, or largely independent 'chalet' *contubernia* in the centre. The spine wall not only ran through the three adjoining *contubernia*, but also one of the otherwise freestanding chalets. Nevertheless there were elements of pronounced regularity in the range, nowhere more evident than in the standard module size apparently adopted for at least some of the *contubernia*. The exemplar for this was provided by the best preserved chalet, U (Figs 16.05, 16.06). This was the only case where substantial lengths of both the east and west side walls were reasonably preserved, providing clear evidence for the width of the *contubernium*, at 6.20m externally (4.80m internally). Much of the south wall



Figure 16.05 Rang 9 Chalet U from the north with the central drain and both east and west walls visible and the west wall of ET just in shadow on left.



Figure 16.06 Chalet U from the east. Note the earlier south wall of Building 9 (left) probably incorporated in the floor along with flagging, but perhaps still used here as a room divider.

remained, but no trace of the north wall survived. If the latter existed it may be assumed to have lain on the same line as the stone north wall of Building 9 and like that structure to have been removed by modern drain trenches. However it quite possible that the chalet was open-fronted like the examples at Housesteads, Vindolanda and elsewhere, in which case the north end may simply have been closed off by some form of timber shuttering.

The alley separating Chalet U from the east wall of Chalet V (E13:08), which, crucially, also survived, was 1.30m wide. The west wall of Chalet V did not survive, but, if the same dimensions are applied to the width of Chalet V and the alley to its west as held true for Chalet U and the intervening alley, we arrive precisely at north-south wall E:13:17, which had formed the dividing wall separating the officer's quarters and the *contubernia* in the Building 9 Phase 2, and was retained as the east wall of Chalet W. Similarly the surviving east face of Chalet ET's west wall (no Daniels' context no. assigned) was found to be in precisely the correct position, assuming the same alley width of 1.30m and a wall width of approximately 0.65m. The east wall of Chalet ET had largely been robbed out, but its position can be determined by the point where the robbed wall crossed the earlier spine wall F13:10. A few facing stones of the wall (G13:16) survived at this point, just sufficient to show clearly that the chalet wall intersected with the spine wall. The internal width of this *contubernium* was again 4.80m, the same as that of U. The chalet east wall again occupied the precise line which would be expected, assuming a standard chalet width of c. 6.20m.

The two remaining *contubernia* (1-2/AK) to the east cannot be fitted so readily into this standard size format, whether they were orientated facing north as suggested by the 1997-8 excavators or east onto the *via decumana*, and whichever of the possible wall lines in this area is valid. It is clear that this part of the building was laid out according to slightly different principles, although there seems no reason to doubt the essential point that it accommodated two *contubernia* of broadly similar size to those in the rest of the range.

In the following detailed descriptions the Daniels codes are used with the TWM *contubernium* designations in brackets.

Building W (the officer's house) (Figs 16.07-16.09)

The officer's house was remodelled internally, but much of the basic structure was retained from the previous phase of Barrack 9. The north range was largely preserved including the pre-existing north wall (D12:46, E12:13), part of west wall and the east wall (E13:17), which was probably extended to the south. The east-west medial partition wall (D13:04,



Figure 16.07: General view of chalet base (Period 4 levels in the decurion's quarters (W and AB) of Rang 9 and 10 viewed from the south



Figure 16.08: The shortened urine pit in the decurion's quarters (Chalet W) of Chalet Rang 9 viewed from the north



Figure 16.09: Flagged access and cobbled yard south of Rang 9 decurion's quarters (Chalet W) extending towards the north wall of Rang 10 (AK), looking west.

E13:26) also remained in use as the south wall of this range. The east end of the building may have extended southwards incorporating another room as a south-east wing, perhaps giving the building an L-shaped

plan, whilst the south-west corner was occupied by a cobbled yard.

The north range was divided into three rooms. In the western room, which measured 4.00m by 4.00m internally, the urine sump (D12:49, D13:46) continued in use, but was reduced in length to 2.35m and narrowed to a width of 0.60m (Fig. 16.08). The outlet drain (D13:52/53) was also taken out of use and backfilled (D13:69). The side walls of the sump were raised by the addition of an extra course of stone blocks, bring the top of the sump up to the level of a new stone floor (D12:50, D13:39, 48) which was laid in the room. The west side wall of the outlet drain was incorporated in this surface and the fill of this drain (D13:69) was identical in composition to the overlying surface (D13:48). There may have been an entrance in the middle of the west wall of this room, the evidence for which was a pivot setting (D13:63, recorded in a site notebook sketch plan) and an apparent gap (D13:54) in the robber trenches (D13:22) of the west wall. The central room was separated from the western room by a north-south wall, one face of which survived (D12:55, D13:51), and which probably occupied a similar position to the Phase 2 partition. To the east the room was closed off by another stone wall (D13:12, E13:25), giving it internal dimensions of 4.00m (north-south) by c. 2.20m (east-west). The relatively narrow proportions of this chamber suggest that this room functioned as an entrance passageway, with opposing doorways in the south and north walls. This supposition was supported by the pronounced pattern of wear identified by the 1997–8 excavators over a 1m wide area of the *via quintana* street surface immediately outside the north wall (TWM 7973, cf. Hodgson 2003, 99). A line of flagstones (D12:54) in the corresponding position just inside the north wall, at the north end of the passageway, may have formed part of the threshold with the flagging having presumably continued through the doorway before the north wall was robbed out. The only possible floor recorded in the passageway was a rubble level (D13:11) over a layer of soil and stone (D13:55). This was bounded to the south by a distinct line of flagstones (D13:10), that appeared to mark the edge of a flagged surface (D13:08) extending between the entrances to the east and west rooms and through the pre-existing doorway in the south wall, which lay directly opposite the doorway at the north end of the passageway. The east room had internal dimensions of 4.00m north-south by 3.45m and was furnished with a flagged floor (E13:29). Access to the room from the central passageway was in the south-west corner. The entrance to the western room occupied the corresponding position on the west side of the passageway.

The south-west corner of the house was covered by a grey-black, slightly stony, sandy soil which covered the remains of the south-west room of the Period

2/3 officer's quarters (including the robber trench for the earlier west wall – D13:35) and was initially interpreted by the 1978 excavators as a garden soil. It is unclear whether this represented a dereliction level associated with the demolition of the previous phase. This was in turn covered by a cobbled surface (D13:28) which was enclosed by a wall along its west (D13:24) and south (D13:32) sides, possibly of drystone construction. For the most part only a single face of this wall survived, but the two sides of what was interpreted as a gateway (D13:31) through the south wall were also identified. To the east of the cobbling, a flagged floor (D13:20) was laid over the earlier flagged room of the Period 2/3 building and extended over the robbed out remains of the former south wall of the officer's house (Fig. 16.09). This flagging continued southwards through the gateway (D13:31) without any evident interruption and thence westwards, covering the alley (D13:33, D14:40) between the walled yard and the presumed officer's quarters of Chalet Range 10 (Chalet AB). The presence of flagging here could imply that this area still formed part of a room interior, but no trace was uncovered of a masonry wall dividing such a room off from the yard. The north-south wall belonging to the previous phase (D13:21) was probably demolished. Facing stones which probably derived from this wall were spread over the earlier flagged floor (D13:19/ E13:32) to the east, apparently incorporated in the new floor (D13:20). A very large oblong stone (D13:27), flattened on top, which probably functioned as a post-pad, was set directly on the flagstones of the earlier floor. This was directly in line with two of the post holes identified in this area in 1978 and 1997–8 (D13:40, 41, the latter equivalent to TWM 7722). Together these posts may have formed part of a timber wall screening the area off from the yard, as the 1978 excavators suggested. The presence of large, somewhat irregular stones, immediately to the south of posthole D13:41, suggests that the yard wall did not terminate at gateway D13:31, but instead turned the corner and continued northward along the west side of the flagging to meet the line of postholes. The existence of this continuous flagged passage between W and AB suggests the two chalets, which both probably functioned as officer's houses, were intimately linked.

Later alterations (Fig. 16.10)

The yard walls were subsequently demolished and the remains incorporated in a new cobbled surface (D13:25) laid over the south-west corner. These cobbles were close set and noticeably worn.

Four post holes (D13:40, 41, 42, 67) were identified in 1978, three of which followed a north-south alignment. Several more were revealed when the area was re-excavated in 1997–8. Unfortunately the relationship of these post holes to the latest levels was

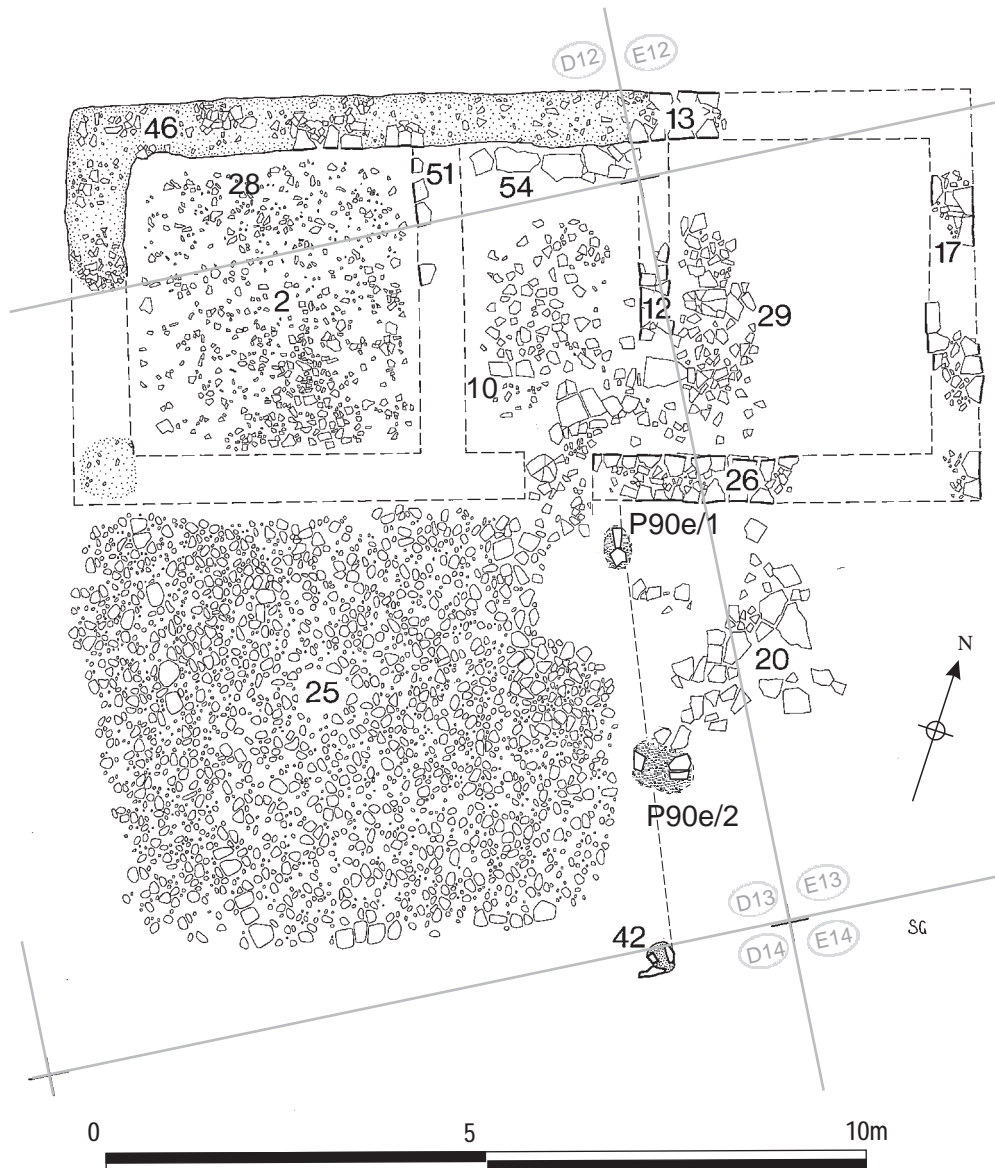

Figure 16.10: Chalet Range 9: later modifications to the officer's quarters (W) at 1:100.

not clearly defined in 1978, with some lying beneath modern intrusions (D13:14, 17) which obscured the stratigraphic relationship. The context records, however, confidently associated the post settings with flagged floor D13:20, and there were reasons to believe this judgement valid in the case of two of the post holes (D13:40, 41) and the post pad stone discussed above (D13:27). Three clusters of upright stones, marked on site plans P90e and P90g, may represent a line of post settings which cut through the late cobble/rubble dereliction levels recorded by those plans. The most southerly of these settings was equivalent to post hole D13:42, but the other two were not assigned context numbers and do not correspond to D13:40–41 or 67, which were not evident at this level. The 1997–8 excavators concluded that the post settings identified in 1978 and 1997–8 represented a substantial timber rebuild, which probably replaced

the southern part of the officer's house, but noted that these features need not all belong to the same phase (cf. Hodgson 2003, 101, & fig 68 for full discussion). Thus some might be associated with the flagged surface in the south-east corner (D13:20) and relate to the initial phase of the Period 4 officer's house, as outlined above, whilst others may postdate the demolition of much of the house.

Final modifications and dereliction

The excavators were unsure whether the remains first exposed on clearing the site, represented a final phase of occupation in Building W or its demolition and covering over with layers of rubble and cobbles. Two alternative versions were presented in the archive text. The rubble over the southern part of the building was interpreted by the excavators as a disturbed street level (D13:06, D14:06, E13:27). The

stone floor in the north-west room was covered by a layer of grey-black sandy soil (D12:53, D13:34), which in turn was overlain by a spread of very small, worn sandstone slabs (D12:28, D13:02). The latter was interpreted as a floor level and this might have been associated initially with the secondary cobbled surface over the yard to the south (D13:25), with the overlying layer (D13:06) forming part of a further, much disturbed, remetalling. The line of three post settings shown on site plan P90e (including D13:42) might also be associated with just such a structural phase. The sandstone rubble (D12:11), which covered the latest surviving road surface on the *via quintana*, subsequently extended over the worn stone floor in the north-west room. The chalet's walls (for example D13:04, D12:46/E12:13) must still have protruded through into these levels, since their robber trenches (e.g. D13:16, 22, D12:18, 57) cut through the rubble and cobbles, indicating that prior to robbing the walls must still have been visible, even if only at footing level, and they may indeed still have been part of a functioning building.

Building V (Contubernium 5)

Description

This building was very largely destroyed, with only the east wall and south-east corner remaining, so that its dimensions must be estimated by reference to those of Building U. The north wall had disappeared in the same disturbance that took away the north wall of Building U. The east wall (E13:09, E14:10, F13:18) was about 0.85m wide and only survived one course deep in its southern part. The remaining length was marked by traces of the rubble core though there was no sign of a robber trench (E13:10, F13:30). Enough of the south wall was intact to show the position of the south-east corner. The 1997–8 excavators suggested that a further stretch of the south wall was marked by a very slight depression in the earlier street surface on which it sat (Hodgson 2003, 98, cf. 96, fig 67). A similar suggestion was made in relation to the west wall. The groove identified in this area lay no more than 0.40 m from the east wall of the officer's house (W), implying a much narrower space on this side of the building than on the east side where V was separated from U by an 1.30m wide alley. However Daniels site plan P122 shows that shallow modern drain trenches ran on the same alignment as the suggested west wall and it may well be the bottom of these which was recorded here. As outlined above there is reason to suppose that the alley on the west side of V may have been the same width as that on the east side which would give the *contubernium* practically the same dimensions as the better preserved chalet, U, which had an internal width of c. 4.80m. None of the wall locations were marked by distinct robber trenches. In view of the extensive damage to the west side of the

building it would not be at all surprising that shallow-founded chalet-phase walls could have disappeared without trace. No interior floors attributable to this phase were found.

Building U (Contubernium 4)

Building U was the best preserved of the chalet *contubernia* belonging to this phase of Barrack 9. The chalet was oriented to face north. Its northern limit was considered by Daniels to have probably lain on the line of the earlier north wall, which had been completely removed by modern disturbance. Its frontage may have been closed off by timber shuttering, rather than masonry walling. The 1997–8 excavators considered that the frontage may have lain further south, noting the position of two postholes (F13:47–8; TWM 7754, 7800) towards the northern end of surviving remains. However these post settings might be associated with the internal arrangements in the previous phase of the stone barrack block. At the other end, the chalet extended well beyond the south wall of the Phase 2 block, over the earlier road surface. The new south wall (F14:15) was 0.60–0.65m wide and rested directly on the road surface (F14:14), with up to two courses surviving. It was bonded with the west wall (F13:14, F14:20), also 0.65m wide. This too was set directly on the earlier road surface, continuing over the remains of the earlier south wall (F13:11) and a flagged floor belonging to the Phase 2 barrack (F13:15, 27). Its interior face was abutted by the west end of the spine wall (F13:10) which formed the main internal partition dividing the *contubernium* into north and south rooms. The east wall (F13:06, F14:07) had no surviving link with the south wall due to modern disturbance, but there is no reason to doubt that it was built at the same time. Where it survived, it consisted of a single course resting on the cobble street, continuing to the north of the former south wall of Building 9 often three courses deep and embedded well below the clay loam spreads which comprise the interior levels of the barrack (e.g. F13:44, 52). There was no sign of a construction trench for the wall which abutted the east-west spine wall (F13:10) on both sides.

The north room

A possible doorway through the spine wall into the south room was identified hard by the west wall (F13:31) on the basis of the wear on the surface of the spine wall's surviving masonry. This doorway was about 0.65m wide and to the east was a facing stone with a socket 0.06 by 0.07 m. A stone-lined drain (F13:17) ran down the centreline of the north room (Fig. 16.11). This feature was c. 0.90m wide overall, the channel being wider at its southern end (c. 0.40m) where it was best preserved. There the drain was 0.20m deep, with a rough stone bottom,



Figure 16.11: The stone-lined drain in the north (stable) half of Chalet U from the south, with the spine wall in the foreground.

edged on either side by one or two courses of facing stones. To the north it narrowed to about half the width and its side walls were badly disturbed. To the east of this drain a very disturbed stone floor level (F13:33) was evident, which contained quite a lot of reused building stones. This had been cut away by a modern drain channel along the east side of the room. A deposit of stone and clay loam (F13:34) edged by a line of stones, filled the depression where the earlier flagged floor had subsided into the urine sump, on the north side of the spine wall immediately in front of the suggested doorway (F13:31). Internally, the room measured at least 4.50m north-south by 4.90m east-west.

The south room

The south room was at least 4.60m north-south by 4.90m east-west and may have been further partitioned into two smaller chambers. Traces of a timber partition were identified, which divided off a passageway along the east side of this room (Fig. 16.12). The evidence took the form of a line of packing stones (F14:29), with what appeared to be flagged thresholds at both the northern and southern (F14:48) ends. The presence of two such possible thresholds suggested that the remainder of the south room may have been divided into two smaller chambers, each with its own entrance. The demolished remains of the earlier south wall of Building 9 (F13:11/F14:08) perhaps served as the base of an east-west partition separating these two smaller chambers. At the north end of the passageway, right next to the east wall, the 1997–8 excavators identified a possible blocked doorway (TWM 8554) through the spine wall which probably provided access from the north room. Here, a 0.90m long section of the spine wall comprised just a single course, worn on its upper surface. Where the second course began it presented a neatly dressed face, whilst a single sandstone block prolonged the alignment of that face into the north room, perhaps acting as a jamb of some kind (Hodgson 2003, 98).



Figure 16.12: The possible stone-packed partition slot (F14:29) running north-south in the rear room of Chalet U, looking north.

One note of caution should be expressed with regard to this interpretation, however, as a modern drain cut through the spine wall at precisely this point. Part of the Phase 2 flagged floor (F13:15) may have remained in use in the northerly of the two smaller rooms. In the southernmost room there was a thin deposit of yellow-orange sandy clay loam (F14:45, 46) directly on top of the earlier street surface. This yellow-orange material was interpreted as daub collapsed from the walls of the building, but it could represent makeup for a floor constructed of some perishable material such as wood. Post-Roman robbing of a stone flagged floor is unlikely in view of the survival of the walls.

Building ET (Contubernium 3)

Most of the walls of this *contubernium* had been destroyed by modern drain cuts. The north wall on the line of the north wall of Building 9 had been entirely lost. The course of the south wall was followed with remarkable diligence by a modern drain running east-west. The west wall had likewise largely been removed by a north-south drain, but one stretch of its east face did survive in F13 (no context no. assigned).

in 1978; TWM 7525), in the form of a 1.90m length to the north of the spine wall. This lay just under two metres from the east wall of Chalet U, which would accord with an alley width of 1.30m and a wall width of approximately 0.65m. The east wall of Chalet ET had largely been robbed out, but its course was indicated by the disturbed masonry of the spine wall (G13:10) at the point where this robbing intersected with the latter. A few facing stones of the chalet wall (G13:16) still survived *in situ* at this junction. In addition, the 1997–8 excavators noted a slight trench (8507) through the earlier Alley 5 surface, which may have marked the southern end of this wall and part of the south wall. In contrast, the full length of the east-west spine wall survived, bisecting the *contubernium* into front and back rooms. Thus restored, the chalet was c. 6.20m wide like the other central chalet-*contubernia* in Range 9. A worn cobble and flagstone floor (G13:14) similar to that found in the north-west corner of AK survived on the north side of the spine wall, covering much of the interior of the *contubernium* here. This overlaid a yellow sandy clay layer (G13:17/19) which covered the Period 2/3 barrack levels and might represent a makeup layer for this phase of Building 9. There was a 0.25m wide gap between the western edge of this surface and the face of the west wall, which was interpreted by the 1997–8 excavators as the remains of a drain (7717) running along the west side of the north room. On the south side of the spine wall, the surface was composed of coarse flagging (G13:37), including facing stones, which was laid on a clay and rubble base, the floor level together totalling up to 0.25m in depth. This might represent the reuse of an earlier barrack floor. No floor surface survived at the southern end of this room where the *contubernium* extended over the former road surface (G14:09, H14:22).

Later alterations (Figs 16.13, 16.14)

A group of structures overlying ET provided evidence that the layout of this part of Barrack Range 9 was later substantially remodelled. The remains of two parallel walls were noted, set on the earlier cobble and flagstone floor (G13:14, G13:37). Both survived fragmentarily on either side of the spine wall, implying that they extended across the full width of the barrack range, and followed the same, roughly north-south orientation as the side walls of *contubernium* (see Fig. 16.14, cf. Hodgson 2003, 97, fig. 70). The more westerly wall (G13:12, G14:14) had a heavily worn surface. Its stones were very large and irregular and it did not survive well enough to measure its width. Just to the east was a second wall (G13:11, G14:15) about 0.70m wide. It butted on to G13:10 on both sides. To the west of G13:11 a new surface of flagstones (G13:18) was laid, mainly on the south side of the spine wall G13:10, but also extending over the surviving remains of that wall, which exhibited similar wear on the surface of its uppermost course, demonstrating it had

now gone out of use and been demolished. The earlier cobble surface (G13:14) ran up to the spine wall on its north side and probably remained in use here. The wear on top of the facing stones of the westerly wall G13:12/G14:14 suggests its demolished remains were subsequently incorporated into floor surface G13:18.

It is uncertain whether both these walls were initially constructed at the same time, with the western example going out of use before the eastern and being incorporated in the new flagged surface, or whether the eastern wall replaced the western.

Still less clear is the significance of these structural alterations for the overall layout of the barrack range, other than the obvious implication that they reflect a substantial remodelling affecting at least the central parts of the barrack. Daniels interpreted this structural evidence as signifying that double chalet, AK, at the east end of the range was extended westwards by the construction of a new west wall (G13:12/G14:14) to enclose an additional chamber, aligned north-south, which occupied part of the area of the former chalet-*contubernium*, ET. The width of the new room would have been something between 3.50m and 4.00m. A further phase was envisaged involving a reduction in the width of the additional chamber to no more than 3.00m by the construction of a new end wall (G13:11/G14:15) a little to the east of the previous one, with wall G13:12/G14:14 being demolished and its remains incorporated in a new flagged surface (G13:18) laid in the area between the enlarged AK and Chalet U. Daniels considered that the area between AK and U was left empty in both of these phases.

The 1997–8 excavators suggested that the new walls may have represented a rearrangement of partitions in a generally persisting building. The western wall (G13:12/G14:14, TWM 7519) perhaps formed the eastern side wall of a *contubernium* replacing ET and the east wall of U provided the other side wall. Wall G13:11/G14:15 (7520) could have formed the west side of a free-standing *contubernium*, which would have enabled three such *contubernia* to be fitted into the space between there and the eastern end of the range (Hodgson 2003, 101). This is entirely possible, but the pocket of surviving stratigraphy is too small to enable any definitive reconstruction of the possible arrangements. However, the general point regarding the likely persistence of a coherently organised barrack is surely valid.

Building AK (Contubernia 1 and 2)

The east end of Building 9 had suffered greatly from post-Roman robbing and disturbance, which made interpretation of this structure very problematic as only very fragmentary traces of walling from this period survived. This is reflected in the differing interpretations of its layout that were presented by the 1978 and 1997–8 excavation teams. The building

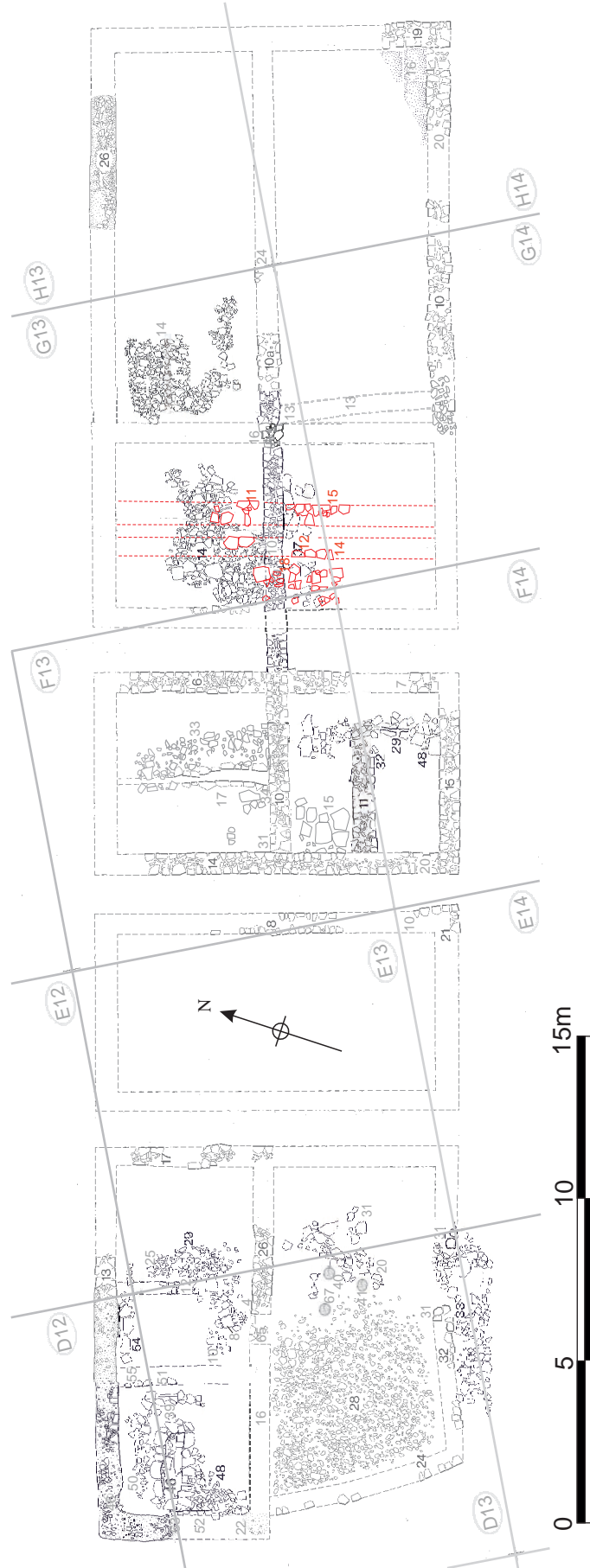

Figure 16.13: Chalet Range 9 later modifications (shown in red) at 1:200.



Figure 16.14: View of the later walls G13:12/G14:14 and G13:11/G14:15 and flagged surface G13:18 in the centre of Chalet Rang 9 from the east.

was restored by Daniels as a double chalet (AK), the two *contubernia* being separated by the spine wall (G13:10a), with their long axes aligned east-west. In contrast the 1997–8 excavators interpreted this end of the building as comprising two north-facing *contubernia* (1 and 2).

As envisaged by Daniels, the north wall of AK reused that of Building 9, or at any rate followed the same line. This had largely been destroyed by the construction of modern field drains with only a length of rubble foundation surviving intact towards the east end (H13:26). The east wall of 9 certainly continued in use (H14:19, foundations H13:25/H14:26) and was extended southward over the early road (H14:19). The wall was 0.75–0.80m wide with a foundation cut into the road cobbles. A new south wall (G14:10/H14:20, foundations H14:27), constructed in a similar manner, ran west from the south-east corner about a metre from Chalet Range 10. A doorway into the building was identified at this corner on the basis of the heavy wear evident on their surface of the foundations here, although, at 0.60m, it was admittedly rather narrow.

Daniels considered that AK did not directly adjoin ET to the west, believing instead that the west wall of the combined *contubernia* was independent of the neighbouring chalet. What was thought to have been the corner stone of south wall was identified, plus the remains of the west wall extending north from that point as far as the spine wall. These remains took the form of a yellow-brown band of silty clay with crushed stones (G13:13, G14:13), interpreted as the remains of a robber trench or perhaps more precisely the remains left by the removal of wall footings. However this proposed wall line was separated from the east wall of ET (G13:16) by the narrowest of gaps, perhaps as little as c. 0.15m to judge from site plan P141, and no trace of it was recorded with any certainty to the north of the spine wall (G13:10a). An apparent continuation of the yellow clayey strip into this area shown on a site notebook sketch plan

was dismissed in the context entry for G13:13 and may simply represent a strip of the sandy clay layer (G13:19) underlying the stone floor G13:14, which had been exposed by the excavation. The worn cobble surface (G13:14) survived covering a fairly extensive area north of the spine wall in the north-west corner of AK and in ET. The underlying yellow sandy clay level (G13:19), which might represent a makeup level, was also present in both buildings. The stone surface respected the line of the east wall of ET (G13:16), but extended over the projected line of 'robber trench' G13:13. A small pocket of yellow clay (H14:16) also remained in the south-east corner, overlying the earlier street surface (H14:22), and presumably formed a clay floor or makeup layer.

As restored, the north-south dimensions of the two *contubernia*, including the spine wall, were 6.10m in the case of the southern one and 5.80m in the case of the northern, i.e. they were broadly comparable in width to the central trio, V, U and ET (the irregularity between the two being accounted for by the slightly eccentric position of the spine wall).

There were a number of differences in the way the 1997–8 excavators reconstructed the easternmost *contubernia* of the barrack in this phase. Principally they restored this area as two north-facing *contubernia* which adjoined *Contubernium* 3/ET to the west to form a block of three conjoining units. The best evidence that the two *contubernia* of AK adjoined ET is provided by the remains of the south wall. There is no evidence that the supposed corner stone revealed here was anything other than an ordinary facing stone, other than the presence of the suggested robber trench G13:13/G14:13. Indeed the 1978 site plan P122 shows a band of rubble, which may have formed part of the foundations or disturbed remains of the south wall, continuing beyond the 'corner stone' as far as the line of the robbed out east wall of ET (G13:16). This would certainly support the 1997–8 excavators' case and calls into question Daniels' interpretation of silty clay band G14:13/G13:13. As noted above this was not traced with any certainty to the north of the spine wall and the 1978 excavators themselves suggested an alternative interpretation in the relevant context entries – 'debris fallen beside lost wall' (presumably referring to the adjacent G13:16 though this is not explicitly stated).

The 1997–8 excavators restored a north-south partition wall some 6.20m from the east end of the block (8515, 7585, foundations 7586), which they interpreted as separating the two north-facing *contubernia*, 1 and 2, giving them internal widths of 6.20m and 4.60m respectively. These features are evident on Daniels' site plans and photographs but were not interpreted as the remains of a wall. The suggested masonry north of the spine wall (G13:34 = 7585) was treated as flagging belonging to an earlier barrack floor (perhaps Phase 1), butting against partition slot G13:33 which was traced along its western edge (G13:33 was said

to cut the primary clay floor G13:26, but was possibly under the secondary clay floor G13:24).

As with the rest of the range (except the officer's house at the west end) the 1997–8 excavators suggested that the north frontage may have been retracted southwards. This was based on the position of two post holes at the northern end of U/*Contubernium* 4 and one in *Contubernium* 2 (G13:28, TWM 8549; cf. G13:27) which were thought to have been associated with a timber frontage. All these post settings were recognised by Daniels, along with another example 0.7m west of G13:28 (G13:27). They have been attributed here to the Phase 2 stone barrack. They clearly cut the clay floor associated with that phase of the barrack (G13:24), but not the stone floor G13:14. They are also recorded as cutting the sandy clay level G13:19 which may represent a makeup (or floor?) level for the chalet phase. However the same is true of post holes G13:29 and 30 to the south, which coincided with the partition line between the front and rear rooms of the Phase 2 *Contubernia* 6 and 7. It is noteworthy that the context entries for all four post holes originally recorded that they cut clay floor G13:24, but this was later crossed out and replaced with overlying layer G13:19, and it is unclear whether this emendation was made on the basis of firm observation or some degree of inference.

On balance the 1997–8 excavators restoration of as a conjoining block of three *contubernia* appears more convincing than Daniels' interpretation that AK and ET were separate single and double chalet-*contubernia*. The orientation of the *contubernia* is more difficult to determine, however. The destruction of the north wall and much of the east wall makes it renders it impossible to determine where doorways were located or whether the wall was replaced by a timber frontage. This applies irrespective of whether partition wall 7585/8515 is accepted as a genuine feature since it could either separate two north-facing *contubernia* similar to ET or divide two east-facing ones into front and back rooms as appears to have been the case in Chalet X at the east end of Barrack Range 10 (see below).

FINDS

Make-up layer

Copper alloy: enamelled stud (no. 224, G13:19)

Building W: Phase 1 features

Samian stamp: Mid to late Antonine (no. S130, D13:24)

Copper alloy: brooch (no. 3, D13:28)

Building W: later features

Decorated samian: c.160–90 (no. D4, D13:55).

Glass: window (no. 42, D13:55)

Coin: Antoninus Pius, 153–5 (no. 94, D13:06), late second century, illegible (no. 252, D13:06)

Copper alloy: brooch (no. 37, D13:06), rod (no. 39,

D13:06), skillet (no. 78, D13:34)

Iron: spearhead (no. 11, D13:34), lift key (no. 30, D13:34)

Quern: (nos 52–3, D13:47, D13:11, D13:39)

Building U

Samian stamp: 125–50 (no. S7, F14:14)

Building ET

Copper alloy: medical implement (no. 103, G13:14); button-and-loop fastener (no. 197, G13:14); strip (no. 302, G13:14)

Iron: stud (no. 50, G13:14)

Post-Roman

Samian stamp: c.160–200 (no. S10, G13:03), c.145–75 (no. S106, F13:12)

Decorated samian: c.125–50 (no. D50, F13:16), c.70–85 (no. D64, G13:03), c.130–60 (no. D65, G13:03), c.130–60 (no. D75, H13:09)

Graffito: (no. 7, G13:03), (no. 22, F13:16)

Coin: Vespasian, 72–3 (no. 15, F13:16), Antoninus Pius, 139–61 (no. 86, G13:03), Antoninus Pius 153–4 (no. 93, F14:24), Faustina I (posthumous), 141–61 (no. 99, H14:38), Constantius II, 355–61 (no. 203, G13:03)

Copper alloy: bead or collar (no. 58, F13:16), collars (no. 67, G13:03; no. 70, H13:08), stud (no. 288, F13:16)

Iron: chisel (no. 25, G14:13), sheet (no. 71, G13:03)

Bone: handle (no. 6, F13:12)

Glass: bead (no. 15, G13:03), bead (no. 16, D12:18), bead (no. 17, G14:16)

Stone: whetstone (no. 8, G13:03), throwing stone (no. 111, H13:08)

Dating evidence

The possible make-up layer of clay under the cobbles and flagstones (G13:19) contained pottery dating to the late second century or third century, with only a single sherd of Nene Valley ware certainly dating to the third century. The pottery from the cobble and flagged surface (G13:14) was very similar in make-up to the clay below it. The wall robber trenches produced little pottery, but what there was was all late second century or later in date. The spine wall in ET (G13:10) apparently produced only a single sherd of pottery, which was a late fourth-century Crambeck mortarium, but this is very different in character to the rest of the assemblage.

The small quantities of pottery from Chalet U, the alley between U and ET and the later wall in ET could again be dated to either the late second or third century, with only an occasional piece of third-century Nene Valley ware.

Chalet W: Phase 1

Most of the small assemblage of pottery from the Phase 1 features can be dated only generally to the late

second century or later, apart from a sherd of third-century Nene Valley ware in the stone floor D13:48. The cobbled surface of the yard had a third-century Dales-type rim and also a Nene Valley bead-rimmed funnel neck beaker, probably of the late third century or later (D13:28).

Chalet W: later features

The make-up for the new flooring produced a large group of pottery. It included a large part of the lower section of a thick-walled Crambeck reduced ware jar of the later third century or later (D13:09), a sherd of another Crambeck reduced ware vessel, a sherd of calcite-gritted ware and a Lower Nene Valley mortarium rim dated to the late third or fourth century (D13:34). The new floors themselves contained a small amount of mainly third-century material, including a sherd of Campanian amphora of the second half of the century or later, and only two sherds of calcite-gritted ware likely to be of the late third century or later. The later cobbled surface in the yard contained a BB1 flanged bowl of the late third century or later (D13:25), and the cobbled surface west of the chalet produced another sherd of calcite-gritted ware (D13:29).

Post-chalet robbing and dereliction

The post Roman robbing and dereliction produced a large quantity of pottery including late third-century or later material such as a Nene Valley bead-rimmed beaker, Crambeck reduced ware and calcite-gritted ware (G13:03, D13:06), late gritty grey ware and a proto-Huntcliff type rim (H13:09, H13:07). Context D13:06 also produced a late fourth-century Huntcliff type rim. The robber trench of the north wall of chalet W contained sherds from a Crambeck reduced ware dish, and six Huntcliff type rims of the late fourth century (D12:18).

These contexts also produced a little post-Roman pottery. G13:03 and H13:24 each had one sherd of C17+ English redware. D13:06 had two sherds of post-medieval pottery, and D14:06 also had a possible sherd of post-medieval pottery.

Discussion

As reconstructed, this phase of Building 9 represents a curious hybrid structure, partly a barrack of traditional form rebuilt with stone partition walls similar to the blocks in the *praetentura*, though of greater width, and partly a range of freestanding chalets comparable to the remainder of the Period 4 *retentura* barracks. Particularly puzzling is the continuation of the spine wall through Chalet U. Here, the unity implied by a common spine wall seems completely at odds with the structural independence demonstrated by the *contubernium* in all other respects. Such structural autonomy was in all probability the whole

point of chalet construction, enabling each squad of *contubernales* to maintain and adapt its own quarters without disruption to its neighbours. In the eastern part of the barrack, the spine wall may have helped to support a shared east-west roof-line, extending unbroken over *Contubernia* 1–3 (ET-AK). In Chalet-*Contubernium* 4/U, by contrast, the ridgeline of the roof is likely to have been aligned north south and the only function the spine wall could have performed here would have been that of an internal partition.

One possible explanation may be derived from a comparison with the third-century barracks in the northern part of the fort. Here the infantry barracks were also rebuilt in stone, but in a more traditional form as barrack blocks rather than ranges of free-standing *contubernia*. Stone partition walls replaced timber/wattle-and-daub examples, the extra space taken up by the stone walls generally resulting in a slight reduction in the number of *contubernia*. In the east *praetentura* two barrack blocks of this type (Buildings 2 and 3) were laid out, plus a stable building (Building 1), all of which stood independently of their neighbours. In the west *praetentura*, there is evidence – albeit fragmentary because of the extent of post-Roman destruction in this part of the fort – for further, slightly wider blocks of similar form.

It is conceivable that something similar was initially planned for the third-century barracks in the *retentura*. It is noteworthy that the character of the four ranges differs. For example there are elements of pronounced regularity in the plan of Barrack Range 9 and it may conceivably have been the first of the four to be constructed, whilst Chalet Range 10 appears quite regular but its individual chalets were considerably smaller than those in Building 9. The layout of 11 and 12 differed again, possibly including back-to-back chalets. All this may signify that ideas regarding the appropriate form of barrack accommodation were changing as construction progressed or were viewed differently by the *turmae* of the four buildings. The remodelling of Building 9 involved reorientating the barrack to face north and extending it southward partway over the street lying between it and Building 10. It may have been the intention to similarly extend Building 10 northward over the remainder of the street to back onto Building 9. The new south wall of Building 9 would thus have formed a party wall separating the two enlarged blocks, providing more ample accommodation for their respective cavalry *turmae*.

The hybrid layout which finally emerged, however, suggests there was a change plan during construction. After completion of *Contubernia* 1–3, at the eastern end of Barrack 9, the scheme for blocks of conjoining *contubernia* was apparently abandoned in favour of ranges of free-standing rooms. Construction of the spine wall, which was evidently intended to form the medial partition in all the *contubernia*, had presumably

progressed further than the other principal structural elements and so was incorporated in the Chalet-*Contubernium* 4/U, which was otherwise entirely freestanding. The range was completed to the more ample dimensions initially envisaged for the enlarged block, with *Contubernia* 3–5 perhaps laid out according to a uniform module. When reconstruction of Building 10 commenced, however, it was remodelled as a straightforward chalet range, and retained the more restricted dimensions of the original block.

Chalet Range 10 (AB, AA, Z, Y, X)

Grid squares: D14, E14, E15, F14, F15, G14, G15, H14, H15

Summary (Fig. 16.15)

In common with other barracks in the southern part of the fort, Building 10 was reconstructed as a range of free-standing *contubernia* or 'chalets'. The individual structures were smaller than those of Chalet Range 9, but the overall layout and proportions were very similar. The range comprised three central chalets orientated north-south (AA, Z, Y), of which very little was left apart from the outside walls, and, at either end, a larger structure orientated east-west (AB, X). The eastern building (X) comprised a pair of east-facing chalets sharing a common party wall, possibly of timber, and each possessing a small rear room again closed off by a timber partition. The western example (AB) overlay the former officer's quarters and, like Chalet W in Range 9, probably maintained that function.

The south ends of the chalets overlying Building 9 extended over the early road between Buildings 9 and 10, leaving a gap of as little as 1.00m between the two new ranges of late buildings. This alley was now too narrow to have provided the main access to the chalets, with the implication that the central trio of Chalet Range 10 must therefore have faced southward onto the *via sagularis*, as, in all probability, did the earlier *contubernia* (see Chapter 15). The end buildings, AB and X, probably faced onto the west *intervallum* road and the *via decumana* respectively.

Although very similar in layout to Chalet Range 9, this phase of Building 10 was notably smaller, being confined within the limits of the earlier barrack block. Both the north and south walls of the barrack were re-used, though probably only after they had been substantially rebuilt. The way that the east wall of Chalet AA (F14:27) and the west wall of Chalet Z (F14:43) apparently butt up against the north wall of Building 10 confirms that the latter wall continued in use in some form, functioning as the northern limit of Chalet Range 10 (archive: Plan P136; Photos B36/18, 24). Similarly, there was no firm evidence that the chalets extended beyond the south wall of Building

10 on to the *intervallum* roadway, in the way that Chalet Range 9 encroached on to the road between 9 and 10, although such a southward extension would have been quite feasible and would have increased the size of the individual chalets. The only possible indication that this might have been the case was represented by a 1.70m length of large cobbles, some of them pitched, set in clean orange clay (G15:03) and running parallel to the south wall of Building 10 some 1.50m south of the building (archive: Plan P116; Photo B36/3). This was initially, tentatively, interpreted as a possible chalet-phase wall foundation, although this idea was subsequently discarded.

Building AB (the officer's house) – Phase 1

Lying mainly over the officer's end of Building 10, this building had suffered very badly from modern disturbance including cellars and drains as well as the robbing of the east wall.

The north wall of AB was the old north wall of Building 10 which survived mainly as a flagged base course over the foundation. At the north-west corner the early wall had been shortened and the old west wall completely demolished (Fig. 16.16). Some of the north wall actually survived (D14:07), and showed evidence of having been rebuilt, being very different in character to the rest of the Building 10 north wall. The 3.50m surviving stretch of walling was composed of large, roughly square or oblong blocks, with relatively little wall core, and lacked the flat plinth course, which characterised the north wall of Building 10 to the east. In addition it sat on a distinct secondary foundation layer of angular rubble (D14:21), over the original clay and rubble foundations (D14:25). The position of the new west wall was marked by the sharp edge to the new *intervallum* street cobbling (D14:13), and a line of dark grey soil 0.10m-0.15m wide (D14:37) between the street and the flagged floor of the interior. This would be consistent with the slot for some kind of timber wall or shuttering, rather than a robber trench for a stone wall. The use of timber frontage was a common feature of chalet barracks and suggests that the officer's house now faced westwards onto the *intervallum* road. The east wall of the officer's quarters was removed presumably in conjunction with the erection of the new building and the clay loam filling of the trench provided a valuable group of pottery (E14:39). The east wall of AB itself was seen in a short length of robber trench up to 0.65m wide where the impressions of four or five stones survived (E14:35) towards its north end. The rest was lost in modern disturbances, as was the whole of the south wall. As with the other chalets of the range, X, Y, Z and AA, it was assumed that the south wall of Building 10 was re-used to form the south wall of AB.

The overall dimensions of AB in its first phase

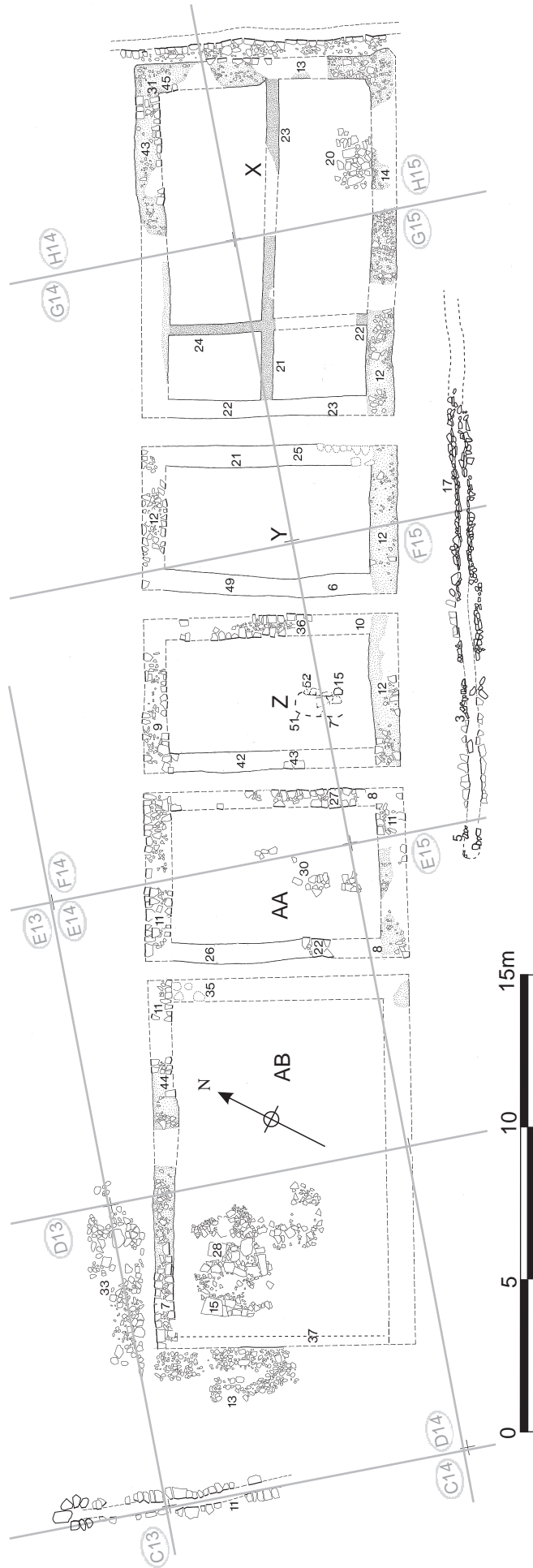

Figure 16.15: Chalet Range 10, Phase 1 at 1:200.



Figure 16.16: Range 10, the north-west corner of the decurion's quarters (Chalet AK), showing the rebuilt stretch of north wall (left) and successive west frontages, looking east.

were 12.00m (east-west) by 8.50m (north-south). No floors could be confidently attributed to the building, unless the Building 10 floor D14:15/27 remained in use. The likelihood of this occurring was questioned by one of the excavators (IDC), but the uppermost stone flags incorporated in floor D14:15/27 were at a similar level to those which formed part of a later phase of AB (D14:17). The continuation in use of floor surfaces from the Phase 2 barrack to the chalet phase, in this way, is, admittedly, not certainly established in any other case, though it does appear likely that part of the earlier flagging (F13:15) in Barrack 9 *Contubernium* 3 was reused in Chalet U. To the north of the chalet, surface D14:40 corresponded to D13:33 (the successive phases of AB possibly correspond with those of Building W). The north-south drain (D14:11) in the *intervallum* road to the west continued in use.

Chalet AA (*Contubernium* 1)

Traces of all four walls of this chalet were extant. The south wall seemed to be the south wall of Building 10. Of the west wall only a 1.05m length of the foundation and a few stones of a flagged base course survived (E14:22), the remainder of the wall to the north being marked by a shallow robber trench (E14:26). To the south, the wall line was removed by modern pitting. The east wall (F14:27, F15:08), also 0.60m wide, was substantially intact to a height of one course over the southern half of the building. Its robber trench to the north (F14:28) was also clear though very shallow. One side of the north end apparently overlay the plinth course of the north wall of Building 10. The superstructure of the latter wall was probably reused or rebuilt to form the north wall of Building AA.

Little survived of the interior of the building but a scattered level of flagging may have formed part of the floor (E14:30). The overall dimensions of the building were 8.50m (north-south) by 5.40m (east-west). It was separated from Building AB by a narrow alley only



Figure 16.17: Chalet Z in Range 10 from the south with the east wall of AA (F14:27) to the left and the robbed west wall of Y on the right.

0.60m in width and from Chalet Z by another alley 0.70m wide.

Chalet Z (*Contubernium* 2) (Fig. 16.17)

The west wall (F14:43) was virtually destroyed by modern robbing of its stones. In much of its length even the shallow robber trench found elsewhere over Building 10 was indistinct (F14:42, F15:18). However, two stones were found abutting and partially overlying the base course of the north wall of Building 10. A considerable amount of the east wall (ca. 0.70m wide) was intact though only one course high (F14:36, F15:09; robber trench: F14:37, F15:10). The south wall was almost entirely robbed though the foundation (i.e. of the south wall of Building 10) was found clearly (F15:12).

The overall dimensions of Z were c. 8.50m north-south by 5.00m east-west. It was separated from Building Y to the east by an alley which varied in width between 0.50m and 0.90m. An oval pit (F14:51, F15:07), faced by stone blocks along its east side (F14:52, F15:15), was revealed the medial line of this chalet, the western side wall having presumably been robbed out. Flagstones associated the Phase 1 floor (F15:23) were exposed in the bottom of the feature. The drain was attributed to this phase because it occupied the medial line of the chalet whereas it would have been well to one side of the relevant *contubernium* in the earlier Period 2/3 barrack. The use of narrow drains, with side walls constructed of stone blocks, as a means of dealing with the waste from the cavalry horses stabled in front of the *contubernia*, was more typical of the chalet period rather than the Period 2/3 cavalry barracks, when slab-sided urine pits tended to be employed instead.

Chalet Y (*Contubernium* 3)

The area covered by this building was heavily robbed

in modern times and overlain by huge spreads of clay and coal which may have originated in the disturbance which took away the *intervallum* street. This cut away the deposits to the south of the building and ran slightly to the north east of the Roman building alignment and gradually removed more of the Roman levels as it ran eastward. South of Y only the south half of the *intervallum* street was lost. However, all the stone from the walls of Y had gone. The north and south wall foundations of Building 10 were intact (F14:12, G14:12; G15:12). Shallow robber trenches marked the east (G14:21, G15:25) and west (F14:49, F15:06) walls. They were generally no more than 0.05m deep and about 0.70m wide. The east wall in particular was very clear with the impression of many stones left in the underlying clay-loam (G15:25). No definite interior floor levels survived, but a layer of grey clay soil (G14:19, 20, G15:11) overlying the structural features of Building 10 was considered to be a transitional deposit between that building and Chalet Y. The overall dimensions were 8.40m (north-south) by 4.65–5.00m (east-west). The alley separating Y and X was 0.95m wide.

Chalet X (Contubernia 4 and 5)

Building X comprised a large, double chalet with its long axis aligned east to west, measuring 11.70m (east-west) by 8.25–8.50m (north-south) overall. Very little remained of the building, with almost none of the superstructure surviving, other than at the east end. Its north, south and east walls followed the same lines as the corresponding walls of Barrack 10, but probably with some rebuilding. Only the west wall, indicated by a robber trench, was totally new.

The north wall was represented mainly by the foundations (G14:12, H14:43) and characteristic flat, thin base course of Building 10's north wall. At the north-east angle several of the inner facing stones of the base course survived (H14:31; H14:45), linking the north and east walls. Midway along the east wall, however, a short length (0.85m) of the outer face was observed which stood two courses high and may represent chalet-phase rebuilding (archive B36/4–6, 33–4). It was distinguished by a much taller base course and a very narrow offset, whilst an awkward junction with the southward continuation of the thin base course and foundation was evident.

The foundations of the south wall were partially removed by the modern disturbance south of the building. However, damage was limited and there was no doubt about the line of the wall and the position of the corner (G15:12, H15:14). The west wall was entirely robbed, but there was little problem in fixing the position of the wall although the robber trench was less marked than in other cases (G14:22, G15:23).

Internally, there were traces of foundations for partition walls dividing the building into four

unequally-sized rooms; two small rooms, measuring 2.00–2.20m by 3.00m (north-east room) and 2.25m by 3.00m to the west and, to the east, two larger rooms, aligned east to west and measuring 7.50–7.70m by 3.00–3.50m (north-east) and 7.60–7.80m by 3.00m (south-east). The north-south foundation (G14:24), situated rather west of the centre, was 0.50m wide and consisted mainly of yellow and pink clay though it was not completely uniform. The east-west foundation was also composed of clay to the west (G15:21) but further east this was overlaid by small stones, quite clearly laid down with care (H15:23). This also was 0.50m wide. These foundations were rather narrow for stone walls, but wide for partition slots; they may represent the full width of timber plastered walls. The most plausible interpretation of this arrangement, as noted above, is that Building X comprised two adjoining, east-facing chalets, separated by a timber partition. These chalets were in turn each divided by the north-south partition into two rooms, a small one to the rear and a larger area to the fore. The function of the small rear rooms is unclear.

In the two eastern rooms there was quite a lot of stone, some slightly worn but rather haphazardly set, which may have been part of a contemporary floor level, though not certainly so (H14:40; H15:24; H15:26 – not shown on Fig. 16.15). There was some uncertainty in the archive as to which phase this flagging should be attributed to. In context list phasing it is assigned to a secondary phase of the preceding barrack *contubernia*, though the possibility of it belonging to the chalet phase is admitted. However site plan P126 clearly shows some of the stones (H15:24) running over the east-west partition slot, suggesting the whole layer may simply represent later spreads of rubble. More definitely part of the interior was a rectangular patch of heavily-worn stone and flagging, 1.30m (north-south) by 1.70m (east-west), in the south-east part of the building (H15:20), next to the south wall. Again however there is some dispute in the archive over the phasing of this flagging with the context listing attributing it to a secondary phase of Building 10.

FINDS

Chalet AB

Copper alloy: mount loop (no. 232, D14:12)

Chalet X

Decorated samian: mid to late Antonine (no. D68, G15:16)

Pottery: (no. 81, G15:16)

Lead: rod (no. 5, G15:11)

Post Roman

Samian stamp: late second to first half of third century (no. S43, F15:06)

Coin: Constantius II/Constans, 346–8 (no. 217, E14:09)

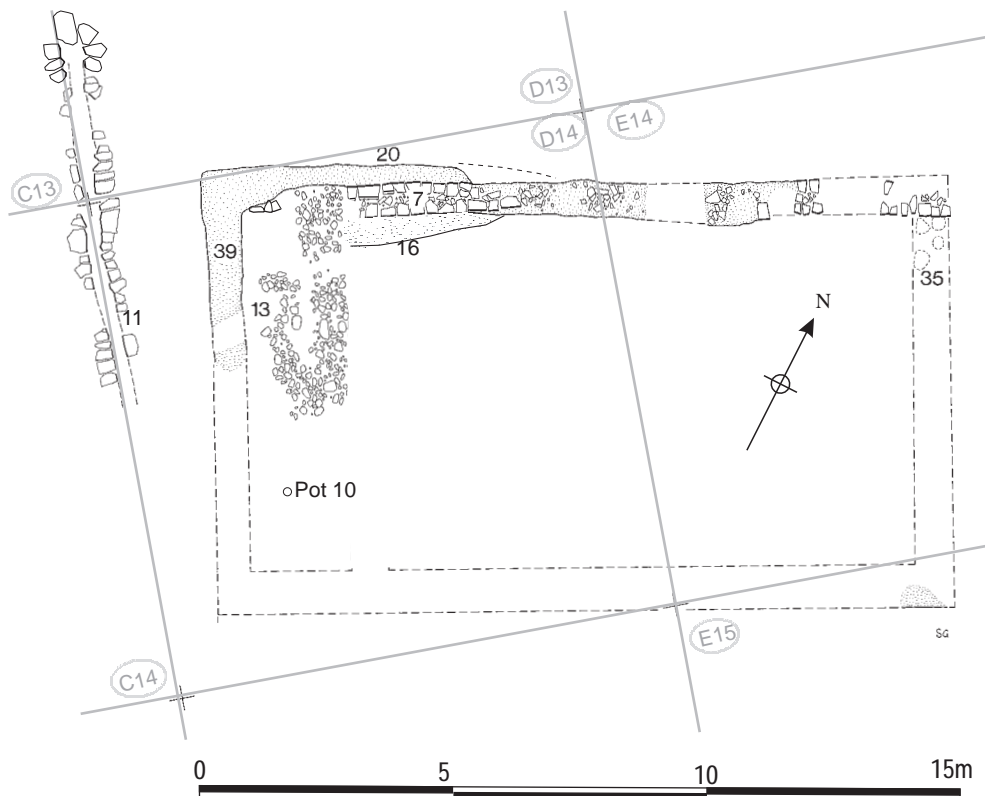

Fig. 16.18 Chalet AB (Rang 0) decurion's quarters) Phase 2 at 10

Dating evidence

The pottery from Chalets X, Y and Z (F14:36, G14:19–20, G15:11, 16, H15:23) is almost all material that could date to any time after the late second century, with a single sherd of third-century Nene Valley ware (G15:11). There is also an intrusive late fourth-century Huntcliff-type rim (G14:19). The pottery from Phase 1 of Chalet AB consisted of more third-century material, consisting of a high proportion of BB2 and allied fabrics, as well as Nene Valley colour-coated ware (D14:13, D14:22, E14:39). Context E14:39 in particular – robber trench fill relating to removal of original east wall of the (Period 2/3) officer's house – represents a good sealed context.

Chalet AB – Phase 2 (Fig. 16.18)

Two successive modifications to the west end of Building AB were noted. The first was represented by a strip of sticky pink clay, 0.15m–0.20m wide and up to 0.15m deep (D14:20), along the north side of the pre-existing north wall (D14:07). This continued 2.60m beyond the original west frontage and turned south as a band of clay about 0.50m wide (D14:39), increasing the overall length of the chalet to 14.60m. Both clay-filled trenches cut the existing road surfaces. Similar material was packed along the southern side of wall D14:07 (D14:16). The excavators considered

that the clay-filled trenches might only represent the foundations for a timber lean-to extension to the existing structure. However the previous frontage was probably formed by a timber wall or shuttering, which required far less substantial structural arrangements (a simple slot E14:37) than those represented by the clay foundations. Three facing stones adjacent to the northern trench may form the remnant of a stone wall which sat on the clay. These stones were evidently part of the south face, but they were in line with the north face of pre-existing north wall D14:07, and it is possible that the latter was rebuilt at this stage, being widened on the north side, with the previous north face now being reused as the south face of the rebuilt wall. A pot was set into that part of the road surface now enclosed by the clay-founded walls (D14:10). The former road surface D14:13 was apparently used as the floor of the extension. No other floors associated with this phase survived.

Dating evidence

The clay fill of trenches D14:16, 20, 39 was very similar and pottery from this material essentially formed a single group. The fill from the section of the trench (D14:16) along the south side of the pre-existing north wall (D14:07) contained one sherd of Antonine samian, two sherds of late-second century or later BB2 and allied fabrics, and a sherd of third-century Nene

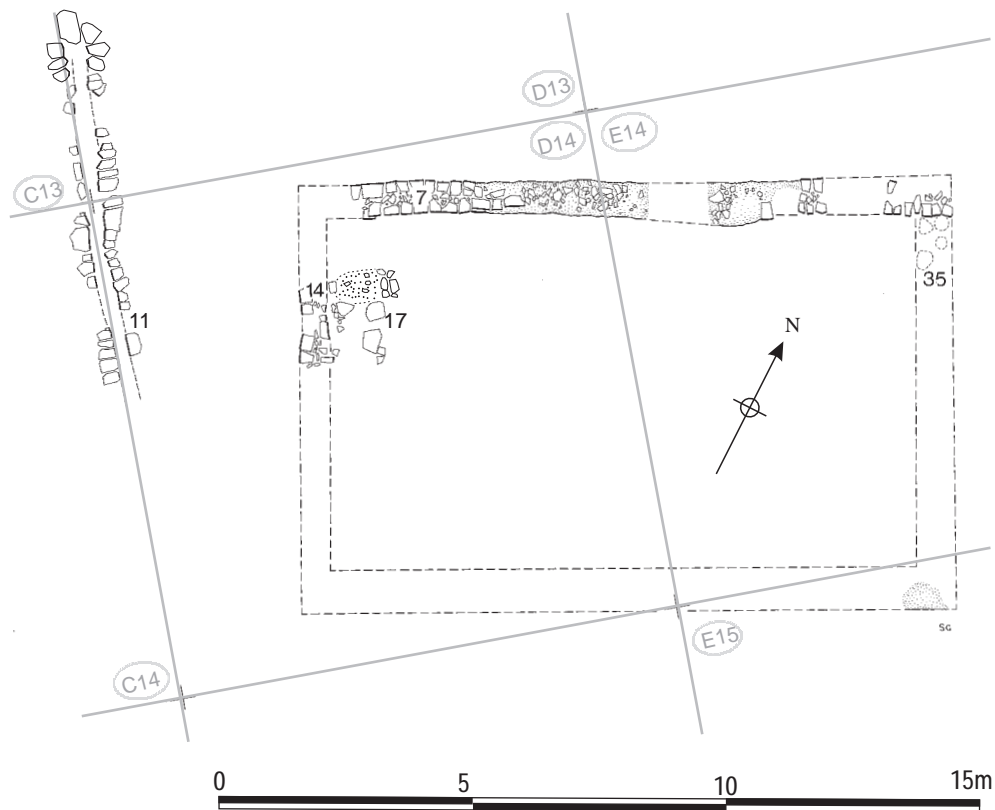

Figure 16.19 Chalet AB Phase 3 at Daniels' Fort

Valley ware. The equivalent fill on the north side also contained third-century Nene Valley ware and a sherd from a samian bowl dating to the late second or first half of the third century (D14:20).

Chalet AB – Phase 3 (Fig. 16.19)

Further modification to the west end of AB reduced the chalet's size again. The Phase 2 walls were demolished and a third west wall (D14:14), 0.60m wide, was laid slightly to the west of the first wall, but well within the earlier clay foundation, reducing the overall length of the building to 13.00m. The main surviving large stone on the east face of this wall had a shallow rectangular recess cut into that face, perhaps to receive a timber screen or shuttering. The wall was laid straight on to the *intervallum* street surface (D14:13) and a new surface of cobbles (D14:12) laid against the external face of the wall. This surface had a centrally placed drain of large faced stones (D14:11). A floor associated with this phase, consisting of a mixture of flagstones and orange grit and small pebbles (D14:17), survived on the east side of the new wall.

Dating evidence

Phase 3 produced third-century pottery (D14:02, 07, 17), with the only later pottery, two sherds of calcite-gritted ware probably of the late third century, coming from the filling of the *intervallum* drain (D14:38).

South *intervallum* road (Road 6) – west

Opposite the eastern part of Chalet Range 10 the earlier orange gravel and small cobble surface of the *intervallum* road (E15:04, F15:05, G15:07) was replaced by medium- to large-sized stones (of fine-grained sandstone), some of them faced, to form a well-laid but not heavily-worn surface, which may represent a later repair (G15:08). Nene Valley ware was associated with this secondary surface, suggesting a third-century date. Elsewhere any upper road surfaces had presumably all been destroyed by post-Roman activity.

Roughly along its centreline, some 2m south of Building 10, the earlier road surface was cut by a stone-lined drain (E15:05, F15:03, G15:07 – no direct relationship with later patching G15:08 survived). This was traced over a distance of 15m opposite the central section of Building 10 and probably ran the full length of the building but had been destroyed to the west and east, in the latter case by an eighteenth-century waggonway which pursued a north-easterly course continuing towards Building 11. This was attributed to Daniels' Fort Phase 3 (i.e. the chalet phase) by the excavators, which would imply it belonged to Period 4 like the chalet ranges. Its side walls were up to 4 courses high in grid G15, where the drain was fully emptied, and its width ranged from 0.20m-0.30m (bottom) to 0.50m-0.60m (top).

The uppermost course of the sidewalls was worn on top, implying there were no cover slabs over the drain. The presence of one vertically set slab against the north sidewall may suggest that the drain was subsequently repaired in the manner characteristic of the later drains in the fort (cf. G11:04, H15:16). Where it was fully emptied a lower fill of mixed pale grey and yellow clay and silt (G15:32) was noted beneath an upper fill of dark, slightly blue-grey clayey silt, brown sandy silt and stone (E15:06, F15:04, G15:18).

FINDS

South intervallum drain fill

Decorated samian: 130–60 (no. D52, F15:04)

Dating evidence

The resurfaced patch of the south *intervallum* road produced a sherd of third-century Nene Valley ware (G15:08). The fill of the drain (F15:04) contained a probably third-century Mancetter-Hartshill mortarium rim, two third-century Gillam type 151 rims and a sherd of BB1 with obtuse angle lattice, dating to after c.225.

Chalet Ranges 11 & 12

Introduction (Fig. 16.20)

In Period 4, Buildings 11 and 12 were transformed from conventional stable-barrack blocks into ranges of free-standing chalet-*contubernia* and officer's quarters, like the other *retentura* barrack accommodation. As these closely linked if not actually conjoined they are discussed together.

Daniels interpretation

As initially reconstructed by the 1978–9 excavators in their summaries of the structural sequence, Range 11 comprised six *contubernium*-sized structures (AC(W), AC(E), AD, AE, AF, AI), plus a larger, roughly-square, block at the east end (AN). Two of the *contubernia* formed an adjoining pair (AC(W), AC(E)), whilst the remainder were freestanding, with independent sidewalls separated from the neighbouring *contubernia* by narrow alleys in the typical manner of chalet-barracks (see Chapter 1: Fig. 1.07). The larger Building AN, at the east end of the range, probably represented the officer's quarters. The earlier barrack north wall survived quite well in grid squares L15 and M15, and was thought to have been retained in use as the north wall of the new chalet-*contubernia*, with the probable exception of AN which clearly did project north of the earlier wall at some stage in its life (the earlier north wall had been removed by modern disturbance in this area). However two curious annexes, extending just over a metre north of the earlier north wall,

were restored by the excavators, one spanning an area 5.00m wide, internally (east-west), to the north of AE and part of AF and the other encompassing a 5.60m wide area on the north side of AI and the alley between AI and AF. As thus conceived, these annexes did not exactly correspond to the chalets immediately to the south and were not therefore simply northward extensions of Chalets AE and AI. All traces of the southern part of the chalets had been destroyed by an eighteenth/nineteenth-century waggonway, the disturbance having removed progressively more of the range from west to east. However, despite this, it was clear that the range faced south (as the conventional Barrack 11 had done), since the contemporary remodelling of Barrack 12 effectively shifted the new chalet-*contubernia* southward, with respect to the earlier barrack block, narrowing the street between Ranges 11 and 12 (Alley 6) to such a degree that any entrance on this side would have been obstructed. All the evidence for the entrances to the chalets of this range has thus been lost. Nevertheless its south face was presumed to lie on the same line as the south wall of Building 11, as the surviving remains of the building's south-east corner and adjacent south *intervallum* road provided no indication that the chalet-barrack extended further south than its predecessor, over the *via sagularis*, (just as there was no firm evidence that Chalet Range 10 in the western *retentura* extended southward beyond the limits of the earlier Barrack 10, over the *intervallum* street).

A similar range of freestanding *contubernia* was restored in the case of Building 12. In this case there were five free-standing, chalet-*contubernia* (AG (I & II), AH, AJ, AL), which occupied a more southerly footprint than the former barrack block, as noted above, plus a larger, more squarely proportioned, structure at the east end (AM). This latter, which probably represented the officer's house for the remodelled barrack, occupied the same area as its counterpart in the earlier barrack and was thus positioned a little further north than the chalet-*contubernia*. It had an attached yard on its west side. No firm evidence for the position of the south end walls of the chalet-*contubernia* was recovered but they were considered to lie immediately adjacent to the north walls of the annexes attached to Building 11. The alley between 11 and 12 was thus reduced to a narrow alley, little more than 2m in width, and in some places was completely blocked.

The 1997–8 alternative scheme

Following re-excavation of Chalet Range 12 by Tyne and Wear Museums in 1997–8, a somewhat different interpretive scheme was proposed for the two barrack ranges (Hodgson 2003, 101–14). The principal difference involved reinterpreting the north walls (L15:04, M15:06) of the two supposed annexes attached to Chalet Range 11, together with the north

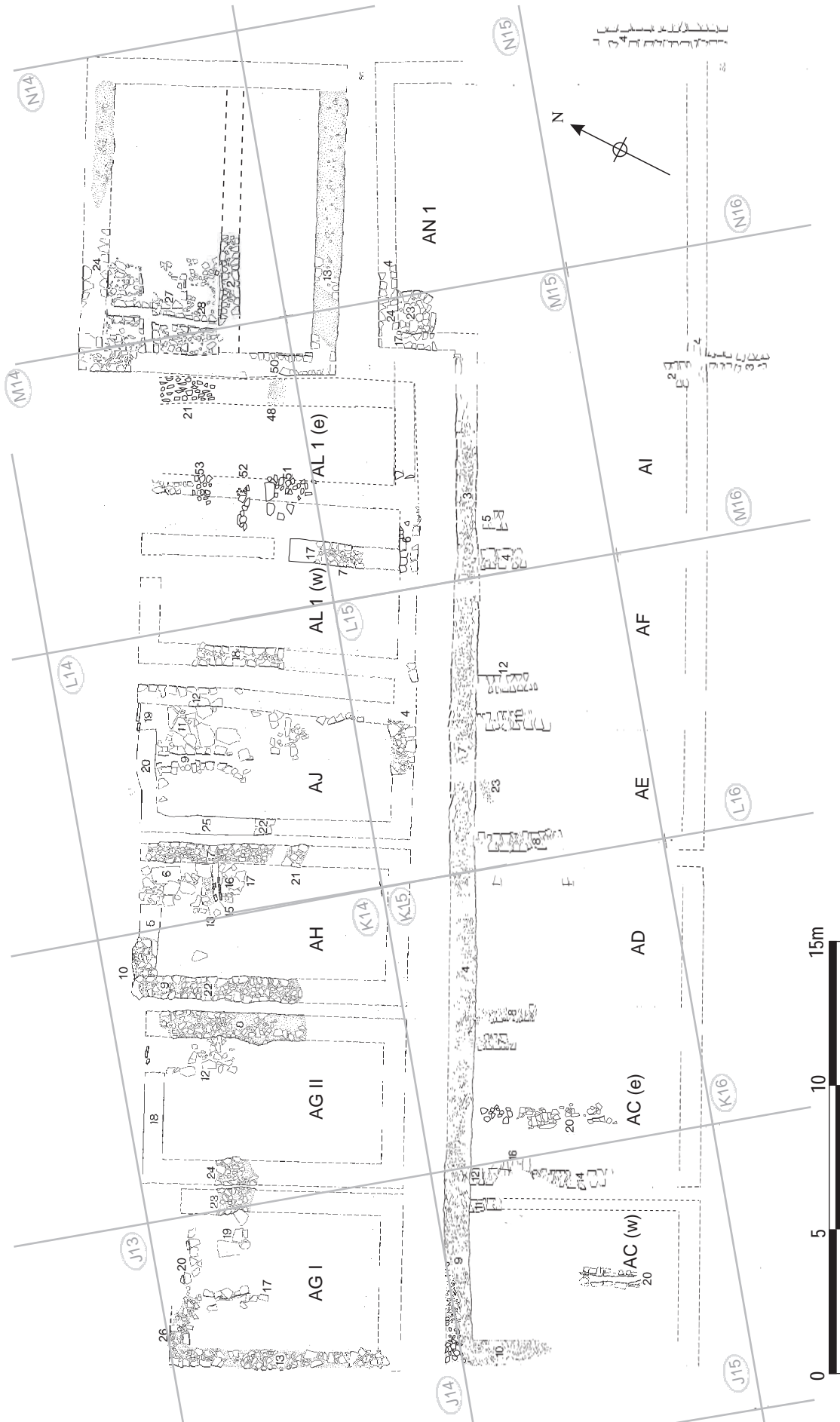

Figure 16.20: Chalet Range 11 and 12 initial layout at 1:20.

wall of AN, as the surviving fragments of a single continuous structure, which formed a common rear wall shared by both ranges. This spine wall ran the full length of the barrack ranges which effectively formed rows of back-to-back chalets, like the third-century infantry barracks recorded at Vindolanda (Bidwell 1985). The proposed layout also envisaged enlarged officer's quarters of roughly similar size at the east ends of both barrack ranges. According to this interpretation, Daniels' Chalet AI formed part of the officer's house of Range 11, along with AN, and both ranges would thus have been comprised five chalet-*contubernia* and an officer's house. A further feature of the suggested layout of Range 11 was the retraction of the chalet-*contubernia* frontage further to the north to match the length of the chalet-*contubernia* of Range 12, although no evidence survived to substantiate this, whilst, conversely, it was envisaged the officer's house was extended southward over part of the *intervallum* road.

Discussion

If the arrangement proposed by the 1997–8 excavators is correct the chalet side walls associated with Range 11 must have originally ridden over the top of the north wall of the earlier Barrack 11. Unfortunately no chalet wall survived to a sufficient height to demonstrate whether this was definitely the case or not and the only clear example – L15:10 – where a chalet wall was seen to continue beyond the former north wall of Building 11 towards the south wall of Range 12 probably formed part of a later remodelling of Chalet Range 11.

In fact Daniels' assumption that the north wall of Building 11 was retained in use as part of the succeeding chalet range was not unreasonable, given the state of the remains as they appeared when uncovered in 1978, and is paralleled in the similar reuse of the south wall of Barrack XIII at Housesteads as the rear wall of the subsequent chalet range around the end of the third or beginning of the fourth century (Rushworth 2009a). The north wall of Building 11 survived best towards the east, where a 17.70m length of masonry was revealed standing up to two courses high (L15:07, M15:03), although the easternmost stretch, in the area of Chalet AN – the putative officer's house – had been destroyed by the course of the waggonway. The lowest courses of the chalet side walls – all that remained of these walls – butted up against the masonry footings of the north wall L15:07/M15:03 and the state of preservation of all these structures appeared to be very similar (Figs 16.21, 16.22). Further west, only foundations of the north (J15:09, K15:04) and west (J15:10) walls remained. These were composed of angular rubble set in orange clay and were 0.95m wide. The excavators' observations with regard to these less well-preserved



Figure 11 Chalet Rang 1 th side walls of Ch lets AE and AF running up to th north wall of earlier Barrack 1



Figure 12 Th south wall of Ch let Rang 2 (p ssible ch let sp ne wall) to th left and Barrack 1 north wall to th right with later alterations beg nd, looking east.

stretches, set out in the context records for J15:09 and J15:10, seem to provide explicit evidence that these walls were rebuilt as part of the chalet phase remodelling (which at that stage was considered to be fourth-century in date). The foundations appeared to cut the clay floor associated with the Phase 2 barrack block (J15:19), sat at a relatively high level in relation to the internal flagging of the early barrack and the street to the north (J14:09), and were abutted by the lowest courses of chalet side walls (J15:11, 12). Fragmentary surfaces survived in the north-east and north-west corners of Chalets AC (w) and AC (e), respectively, apparently associated with the secondary phases of these structures. These not only abutted the chalet side walls but also appeared to sit at the same level as the north wall foundations J15:09/K15:04, suggesting the latter wall was still functioning.

However, the positioning of two, north-south aligned features in Range 11, identified as possible drains by Daniels, could imply that the chalets of this range extended further north than their predecessors, the barrack block *contubernia*, and

thereby support the 1997–8 excavators' suggested layout. The two drains (K15:17, 20), which survived only fragmentarily, were located on or close to the centreline of their respective chalets and sat relatively high in the stratigraphic sequence, indicating they must have belonged to the chalet period. It is clear that the south rooms in the Period 2/3 Barrack 11 represented the front rooms (*arma*) of their respective *contubernia* and accommodated the horses of the resident cavalry troop. The same must have been true of the succeeding chalet range, since the alley to the north, even if not eliminated altogether as suggested by the 1997–8 excavators, would certainly have been narrowed by the southward shift of Chalet Range 12 to such an degree that it could not have served as the mustering point for cavalry emerging from either range. Yet the two drains were apparently positioned further north than the urine channels in the *contubernia* of the preceding barrack block, restricting the space for an inner north room (*papilio*) if the north wall of Building 11 had continued to function as the north wall of the chalet range.

In actuality the interpretation of both of these features is problematic once subjected to more intensive scrutiny. Thus K15:17 lay on the same line as a very poorly preserved, secondary chalet side wall (K15:09) and it is unclear whether it really did represent a drain or just masonry belonging to the wall and fragments of a stone floor abutting the latter. Site plan P127 suggests that K15:20 formed part of an almost continuous spread of stone extending right up to the north wall. To the west the spread appears to terminate abruptly, creating one of the apparent drain edges, but this appears to be the result of a modern linear intrusion K15:02 running down the west side of the chalet. Beyond the intrusion more stone (J15:16) can be seen abutting the inner face of side wall. It seems likely that K15:20 and J15:16 represent parts of the same floor which extended continuously from the western edge of the chalet-*contubernium*. Only at its southern end can two drain side walls be discerned and this might represent the north end of a drain or urine pit in the southern room. Both features are analysed in detail below but on balance their interpretation is too uncertain to sustain any broader hypothesis regarding the chalet layout.

Chalet Range 12 was the only one of the late barracks in the *retentura* to preserve significant details regarding the front (north) walls and doorways of its constituent chalet-*contubernia* (Fig. 16.20, cf. Figs 16.27–16.29 below). The staggered nature of this combined frontage, with each individual *contubernium* recessed slightly in relation to its neighbour to the east, would suggest that the course of the eastern *v a quintana* had been altered slightly, making it an easier turn for traffic between that street and the *v a decumana*. There is no indication that a similar pattern prevailed in the western *retentura*. The frontage of Chalet Range 9 had

been largely destroyed by a modern sewer trench and Range 10 was poorly preserved in general, but both appear to have displayed more regular, rectangular layouts, their frontages probably lying on the same line as the north and south walls respectively of the earlier stable-barracks, 9 and 10. Similarly, virtually all trace of the actual frontage of the south-facing Range 11 had been removed by the eighteenth-century waggonway. The only potential evidence for the position of the frontage was represented by a drain (M16:03), set in the uppermost south *intervallum* surface towards the eastern end of the range, which might represent the continuation of a channel formed by a narrow alley between the easternmost chalet-*contubernium*, AI, and the decurions's quarters (AN). This could therefore indicate that the frontage of the chalet-barrack remained on essentially the same line as its predecessor, but the phasing and interpretation of this structure are too uncertain for any definite conclusion.

Whether or not the two chalet-barracks in the eastern *retentura* were laid out in a back-to-back arrangement or as separate ranges it is evident that there were significant differences in the construction techniques employed in the two barracks. In Range 12, the side walls of several of the chalet-*contubernia* were set on foundations composed of river-washed cobbles and sandstone rubble, whereas the chalet side walls in Range 11 were constructed of squared blocks from footings upwards with nothing resembling a distinct foundation level. Such variations seem characteristic of chalet-barracks. The evident differences in size and plan between Chalet Ranges 9 and 10 have already been noted above. Together these seem to demonstrate that although the chalet-barracks were constructed according to certain common principles there was no single rigid blueprint which might have resulted in a series of identical structures and suggests that in each case construction work was undertaken by the particular *turma* destined to occupy the barrack in question.

At the east end of the two ranges, the 1997–8 excavators restored large, roughly square officer's houses, as noted above, whereas Daniels envisaged somewhat smaller buildings (AM and AN), similar in size to the earlier decurions' houses. In Range 11 he also added another chalet-*contubernium* (AI), immediately to the west of AN, within the area interpreted as part of the large officer's quarters in 1997–8. Most of the remains at the east end of 11 had been removed by the colliery-era waggonway, and as a result the evidence there was inconclusive, whilst the corresponding part of Range 12 was largely masked by the later substantial remodelling of the chalet layout in that area (AL). However examination of the Daniels excavation records does reveal the existence of features in the area immediately to the west of AM which cast doubt on the large officer's houses proposed in 1997–8. Specifically, a

series of foundation deposits were exposed there in 1979, comprising pitched stones (M14:21), pink clay (M14:48) and cobble and rubble (M14:51–53), the latter being characteristic of the chalet side walls in that range. These clearly post-dated the dereliction deposits associated with the end of the Period 2/3 stable-barrack (M14) and could represent the remains of another chalet of conventional size and proportions which had largely been removed when the initial chalet-phase structures in this area were later substantially remodelled. Its position in Range 12 corresponded to that occupied by Daniels' Chalet AI, next to the officer's house (AN), in Range 11. Furthermore, the officer's houses envisaged by the 1997–8 excavators were not only considerably larger than the earlier examples associated with Stable-Barracks 11 and 12, but also the equivalent chalet-phase houses at the west end of Ranges 9 and 10. It is unclear why such larger houses should be necessary in the two eastern barrack ranges.

The 1997–8 layout would mean that Ranges 11 and 12 each contained five *contubernia* just like the chalet-barracks in the western *retentura*, whereas the modified Daniels scheme would entail six chalet-*contubernia* in each of the two eastern ranges. However such differences could be explained simply by slight variations in the strength of the *turmae* of the Wallsend garrison. In any case, regardless of whether there were five or six chalet-*contubernia* in each range, this marks a significant reduction on nine *contubernia*, the number encountered in the earlier stable-barrack blocks. The implications of this change for the overall size of the third-century garrison's cavalry component were considered in Chapter 2.

Chalet Range 11 (AC–AF, AI, AN)

Grid squares: J15, K15, L15, M15–16, N15–16

Two different systems were used following the 1978–9 and 1997–8 excavation campaigns to designate the individual chalet-*contubernia* of Range 11. The 1997–8 excavators treated them as a straightforward series of *contubernia* numbered from 1 to 5 (the sequence beginning at the west end of the range), with a decurion's house to the east of these. This better reflects their interpretation of the chalet range as an integrated barrack, housing a distinct cavalry *turma* under the command of a decurion, a view which is accepted here. Daniels, by contrast, used a series of lettered building codes (AC (w) and AC (e), AD etc.). He considered that the chalets accommodated individual military households, with the degree of overall integration being uncertain. Cross-referencing to both systems is provided here.

Chalets AC (w) and (e)

The two westernmost chalet-*contubernia* of Range 11

were treated as a single building by the excavators of 1978, which they labelled AC, the extant remains being restored as a double-width chalet separated into east and west rooms by a medial wall. However the survival of certain features – notably a stub wall parallel to the medial wall – suggest that, initially at least, 'AC' actually represented a pair of normally proportioned chalet-*contubernia* separated from one another by an intervening alley, like Chalets AD, AE and AF. The two chalets have been relabelled AC (w) and AC (e) for convenience. At least two subsequent phases of alterations saw the two structures combined to form a single double-width chalet with a linking doorway.

Chalet AC (w) – Contubernium 1

The west wall of Chalet AC (w) probably occupied the same position as the former west wall of Building 11. Only a stone foundation (J15:10) survived at this point, and it appeared to be of one build with the adjacent stretch of the north wall foundation (J15:09). Daniels interpreted these as a chalet phase rebuild on the basis of their apparent relationship to the earlier barrack floor levels. Only the northernmost stub (J15:11) of the east wall remained, the rest having been removed when the two chalets were subsequently united. The wall was 0.50m wide and overlay a small area of rubble (J15:30). Thus reconstructed, Chalet AC (w) would have an internal width of c. 4.70m (c. 5.70m overall). If the north and south walls of the building were in the same position as those of Building 11 the chalet-*contubernium* would have an overall length in the order of 9.00m, but if it extended further north as argued by the 1997–8 excavators it could have been as much as 11m in length.

It is noteworthy that the well-preserved, stone-lined drain (J15:20) associated with the south room of Building 11 *Contubernium* 9 was conveniently positioned in relation to Chalet AC (w) as well, lying in the southern part of the chalet on its central axis. This raises the possibility that the drain might have been retained in use in the new chalet-*contubernium*, although such reuse of stable drains is not normal.

Chalet AC (e) – Contubernium 2

A 3.00m length of the west wall of AC (e) survived, divided into two parts (J15:12, 14) by a later doorway, where only a single course of the east face was retained as a threshold (J15:13). At the south end of this surviving stretch, where it had been robbed away, it was clear that wall must have overlain the earlier drain (J15:32). Of the east wall only a 1.30m stub (K15:07) survived towards its north end, the remainder to the south having been removed by robbing or destroyed by the colliery-era waggonway. This would give Chalet AC (e) an internal width of 4.00–4.20m (5.25m

overall). It was separated from Chalet AC (w) by an alley 0.40–0.50m wide. The north-south length of the chalet was uncertain. Daniels considered that the north wall of Building 11 was reused or rebuilt to form the north wall of the chalet, whereas the 1997–8 excavators argued that the chalet shared a common rear wall with its counterpart in Range 12 to the north, Chalet AG II. In any case, the exact position of the chalet's southern frontage is unclear.

Alongside the inner face of the west wall, six large stones (J15:16) probably formed the remnant of a much more extensive stone floor in AC (e) which had been cut away immediately to the east by a band of modern soil- and mortar-filled disturbance (K15:02), which did not however appear to form a distinct robber trench. The floor was present on the east side of K15:02 in a more disturbed condition as a strip of sandstone rubble (K15:20) extending from the chalet's north wall along its central north-south axis. This was initially interpreted as a drain, but two actual side walls could only be discerned at the southern end of the spread. They can be traced on site plan P127 over a distance of 0.60m and might indeed represent the north end of a drain or urine pit in the southern room. Further north, however, the apparent 'side wall' was more probably a false edge created by the modern intrusion.

Chalet AD – Contubernium 3

In its initial phase, AD can be restored as a rectangular, south-facing chalet-*contubernium* of similar width to the others in the range. Part of the west wall survived as a line of rubble (K15:08), but the rest had been robbed and the southernmost stretch totally destroyed. The surviving length was located immediately to the south of the former north wall of Building 11. Even less remained of the primary east wall, as this had probably been removed during the chalet's secondary phase, and its course was not recognised during excavation. The 1978–9 excavators instead interpreted wall L15:08 as the east wall of Chalet AD, although, at 5.30m internally (6.50m overall), this made AD abnormally wide in relation to the other chalet-*contubernia* of the range (e.g. AF, AI, AC (w & e)). However, examination of site plan P127 reveals a line of three facing stones appropriately positioned to form part of the chalet's east wall if the normal spacing applied (all would have belonged to the wall's west face). The remainder of the wall was probably removed during later remodelling of the range. On this basis AD was c. 5.30m wide over the walls (4.10m wide internally). The west wall was 0.40–0.50m from Chalet AC to the west.

Daniels considered that the chalet's north wall lay on the same line as the former north wall of Building 11 (K15:04). However two more facing stones to the north of that wall might have formed part of the

chalet's east wall, which would imply that the chalet extended further northward, backing up against the rear wall of Chalet Range 12, which may have served as a common spine wall for the two ranges, as suggested by the 1997–8 excavators. However the two stones, which probably belonged to the wall's east face, are not quite on line and may have been slightly displaced.

No floor surfaces were preserved and the only possible internal feature associated with this phase of the chalet-*contubernium* was a short length of stonework interpreted as a drain (K15:17), positioned roughly on the centreline of the building. However, it is more likely that this structure was associated with a wall belonging to the secondary chalet phase (K15:09) and the remains are accordingly discussed in connection with the later modifications to the chalet range.

Chalet AE – Contubernium 4

As restored by Daniels, Chalet AE was somewhat narrower than the other chalets of Range 11, an interpretation which was subsequently accepted by the 1997–8 excavators. This was based on the assumption in 1978–9 that wall L15:08 marked the east side of Chalet AD, whilst L15:09, immediately adjacent, represented the west wall of AE. However in this case AE would have been abnormally narrow (2.80–2.90m internally, 4.00–4.20m overall), just as AD would have been correspondingly wider than the standard primary chalets in this range. This problem is resolved by the evidence noted above for the primary east wall of AD, which occupied a position more consistent with typical chalet spacing. This in turn implies that wall L15:08 could plausibly have functioned as the initial west wall of Chalet AE, whilst L15:09 was associated with a later remodelling of the chalet.

Up to two courses of wall L15:08 were found. It was about 0.63m wide with a narrow gap at its junction with the footings of the north wall of Building 11. A further series of stone blocks located beyond north wall of Building 11 (L15:07) might represent the continuation of wall L15:08. This would imply that the chalet extended northward beyond the footprint of the earlier stable-barrack and backed up against the rear of Chalet Range 12, as suggested by the 1997–8 excavators, whereas Daniels considered the north wall of the chalet occupied the same line as the north wall of the earlier Building 11. However the stonework in question appeared disturbed and did not provide conclusive evidence.

Three courses of the chalet's east wall (L15:11) survived with their width varying from 0.60m at the top to 0.68m at the bottom. Again there was a small gap between its surviving remains and the north wall, but it clearly cut the latter's foundations.

The resultant internal width of the chalet was 4.80m (6.00m overall). The depth of wall L15:11 suggested to the excavators that it may have originated as a partition wall in the earlier stone barrack block which was subsequently re-used in Chalet AE. However this appears improbable as no other stone partition walls were associated with *contubernia* of Stable-Barrack 11. A patch of brown and grey sandy soil containing much grey ash (L15:23) in the northern part of the chalet was interpreted as debris belonging to a possible hearth associated with this phase.

Chalet AF – Contubernium 5

Parts of the east and west walls remained of Chalet AF. The west wall was of neat construction 0.63m wide (L15:12); the east wall at 0.70m was slightly wider (M15:04). Both abutted the remains of the north wall of Building 11 fairly closely. The building was 3.60m wide internally (c. 4.90m overall). There was a gap of 0.65m to the west between AE and AF. No interior levels survived.

There was no trace whatsoever of the chalet side walls continuing beyond the north wall of 11, which was consequently interpreted by Daniels as the north wall of the chalet itself. If the chalets extended as far as the rear wall of Range 12, as suggested by the 1997–8 excavators, this differential survival which is also repeated in Chalet AI, is slightly puzzling (see Figs. 15.19, 16.21–22).

The eastern end of the range

Very little remained of the structures at the eastern end of the range. Daniels considered this area was divided into another rectangular, south-facing chalet of conventional size and proportions (which he labelled Chalet AI), and a larger almost square building equivalent in size to the earlier decurion's quarters (Building AN). The 1997–8 excavators suggested there was only a single structure at this end of the range, a very large roughly square building which they argued functioned as the decurion's house for the chalet-barrack, replacing the earlier example attached to the east end of the Period 2/3 stable-barrack. For the reasons outlined in the discussion above the layout preferred here comprises a standard chalet-*contubernium* and an officer's house of broadly similar size to those associated with the earlier, Period 2/3 stable-barracks, broadly along the lines proposed by Daniels.

Chalet AI – Contubernium 6

The firmest piece of evidence was represented by the structure's west wall (M15:05), a 0.90m stretch of which survived immediately south of the north wall of Building 11. Daniels considered that this represented

the west wall of a rectangular chalet-*contubernium*, AI, which he restored at this spot, whereas the 1997–8 excavators treated it as the west wall of the late decurion's quarters. Daniels also suggested that the west wall (M16:02) of the former decurion's quarters was reused to form the chalet's east wall. Only a very short length (0.80m) of this survived, adjoining the south wall of the stable barrack (M16:04), which it was argued may also have been reused as the line of the chalet's southern frontage. The position of the chalet's north wall is also problematic. Daniels argued that the north wall of Building 11 remained in use (it survived two courses high at this point). Conversely, acceptance of the 1997–8 excavators' overall scheme of back-to-back ranges would imply that the chalet extended further north, sharing a rear wall with Chalet AL1 (e), identified immediately to the west of the Range 12 decurion's quarters. As was the case with Chalet AF, however, no fragment of surviving chalet side-walling continued beyond the north wall of 11 to provide firm evidence of such an arrangement. No interior floor levels or features remained.

Although Daniels scheme appears coherent in plan the evidence is tenuous. Neither of the earlier stable-barrack wall fragments (M16:02, 04) on the south side of the building survived more than one course high, a reflection of the degree of modern destruction in this area, and consequently any indication of later rebuilding which might have existed had been destroyed too. However the adjacent *intervallum* road levels did preserve features that might be contemporary with the chalet range, notably a stone-lined drain (M16:03), set into the uppermost surviving surface of the south *intervallum* road (M16:06, 11). This drain extended southward for 2.20m across the road towards the main east-west aligned *intervallum* drain conduit (M16:07) and appeared to prolong the line of the narrow alley which Daniels had restored between wall M16:02 and the west wall of AN (M15:17) as part of his scheme. However it was far from certain whether the drain and the road level in which it was set should be attributed to the chalet period, as opposed to the latter stages of the previous stable barrack, for instance, with the associated dateable material providing little guidance (see Chapter 15 – south *intervallum* road).

Chalet AN – the decurion's quarters

The easternmost building in the range, which Daniels labelled AN, may be interpreted as the decurion's house associated with the Chalet Barrack 11. According to the interpretation presented here, this structure was not dissimilar in overall size to the officer's quarters in the preceding stable-barrack. The 1997–8 excavators restored the house as a much larger structure also incorporating the structural features of AI.

Only the north-west corner survived of the building, comprising short lengths of the north (M15:24, N15:04) and west (M15:17) walls, although the actual junction between the two had been robbed away along with the rest of these structures to the south and east. Both walls were some 0.55m to 0.60 m wide, clay-bonded with a rubble core. Positioned right in the corner was a roughly semi-circular structure (M15:23), measuring 1.50m by 1.30m and composed of stone blocks with facing stones around the south and east edge. This was interpreted as the base of an oven or hearth, as there were traces of burning around it (M15:25–26) and on the structure. It was overlain by flagging (M15:22) which might however relate to subsequent phase. It was evident that the building extended 2.60m northward, beyond the footprint of the earlier officer's quarters of Stable-Barrack 11. The west wall was situated slightly to the east of the line of the equivalent earlier wall separating the *contubernia* and decurion's house of Stable-Barrack 11 (M16:02), which *may* have been reused as the east wall of Chalet AI, with the gap between the two walls being taken up by an alley no more than 0.40m wide. Whilst the west and north walls clearly occupied different locations from their predecessors, Daniels presumed that the south and east walls of the house were on the lines of the former south and east walls of Building 11, although there was no direct evidence to support this. It is reasonable to suppose that the east wall would have respected the carriageway of the east *intervallum* road and in particular the substantial stone-walled drain (N16:04) which lay alongside the east wall of the Stable-Barrack 11, but it is unclear whether the chalet period decurion's house extended as far south as the earlier block. The possibility that the southern frontage of the chalet range was slightly staggered, like the frontage of Chalet Range 12, was discussed above, but firm evidence is lacking, with any structures belonging to the chalet period in this area having been removed by post-Roman activity. One feature which might be relevant was a stone-lined drain (N16:12, fill: N16:14), which was set into the uppermost surviving metalling on the south *intervallum* road (M16:06/11) and followed a NW to SE orientation (see Chapter 15 above – south *intervallum* road). This might conceivably relate to the internal arrangements of the late decurion's house in some way (taking the outflow from a stable drain?). However, as noted above, the phasing of the road surface in question and the drains associated with it was uncertain.

FINDS

AF, initial phase

Glass: bead (no. 41, L15:12)

Clay packing in alley between AF and AI

Copper alloy: buckle (no. 159, M15:12)

Dating evidence

This phase produced under 30 sherds of coarse and fine wares and a single samian sherd (J15:16, M15:04).

Later remodelling of Chalet Range 11 (Fig. 16.23)

Summary

It is clear that Chalet Range 11 underwent substantial remodelling at later stage in its history. This apparently resulted in alterations to the footprint of several of the chalet-*contubernia*. As with the previous phase, the surviving evidence was patchy and it is far from certain that it provided a full picture of the layout of the range. Some of the chalet-*contubernia* appear to have been widened (AC (w), AF??), but others appear to have been narrowed (AD, AE), which makes the underlying rationale behind the reorganisation unclear. It is possible that the narrowing of certain chalets was related to the widening of the adjacent alleys (specifically those between AC (e) and AD and AF and AI). This may have been intended to permit those alleys to function as side passages with doorways allowing direct access from these alley-passages into the rear rooms of the chalets. On the other hand AC (w) and AC (e) appear to have been joined together, the intervening alley being absorbed into AC (w) and a connecting doorway being provided between the two (Fig. 16.24). The number of chalet-*contubernia* probably remained the same at six, but the overall length of the range may have increased a little, expanding eastwards to provide sufficient room for the wider alleys, but the degree of post-Roman destruction at the east end of the range makes arrangements here obscure. Finally, whatever the case earlier, the range certainly appears to have extended northwards beyond the footprint of the earlier stable-barrack block by this stage, backing up against the rear of Range 12 to form a back-to-back layout.

The detailed evidence relating to each individual chalet is set out below.

Chalet AC (w) (Fig. 16.24)

Phase 2

Chalet AC (w) was slightly widened at this stage absorbing the area of the former alley between AC (w) and AC (e). Most of the east wall of AC (w) was demolished, leaving only a 1.20m length towards its north end (J15:11), and the former west wall (J15:12/14) of Chalet AC (e) was reused as the new east wall of the chalet giving the latter an internal width of 5.70m. A 0.95m wide door passage connecting with AC (e) was inserted in the northern half of this wall (located some 1.50m from the north wall and perhaps 3.30m from the suggested spine wall of the two ranges). In the area of the doorway itself a single

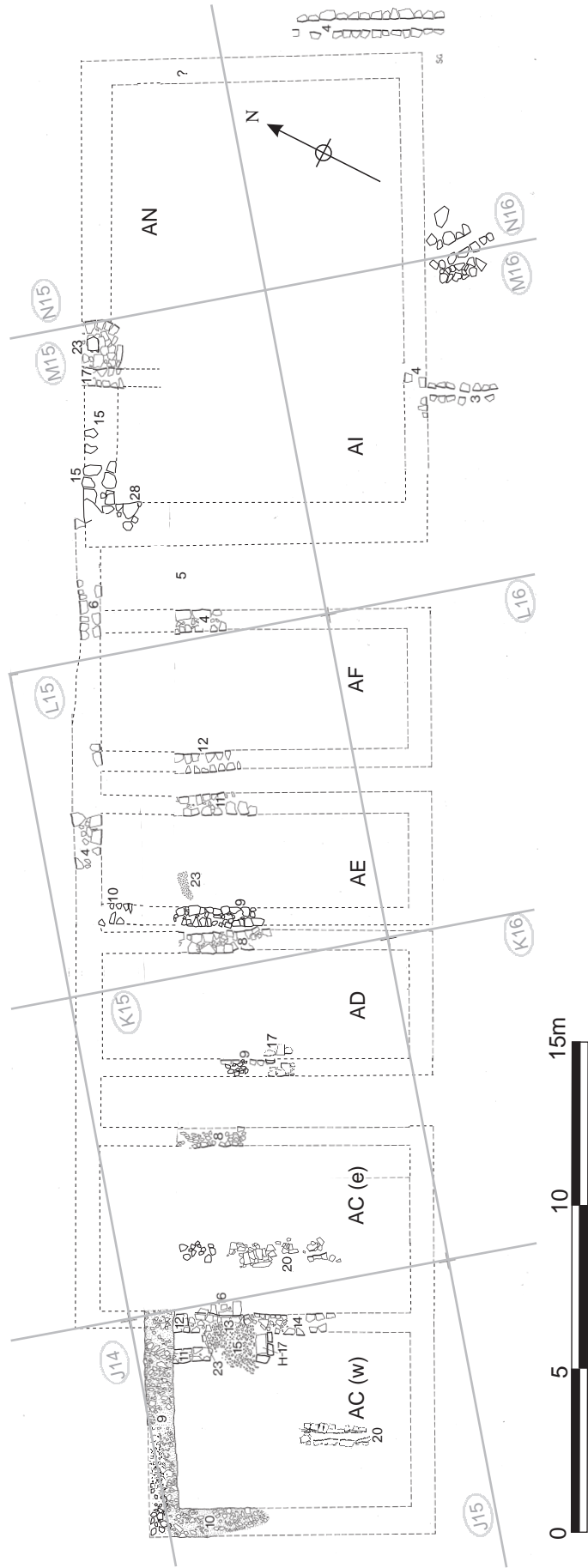

Figure 16.23: Secondary alteration to Châlet Range 11 at 1:200.

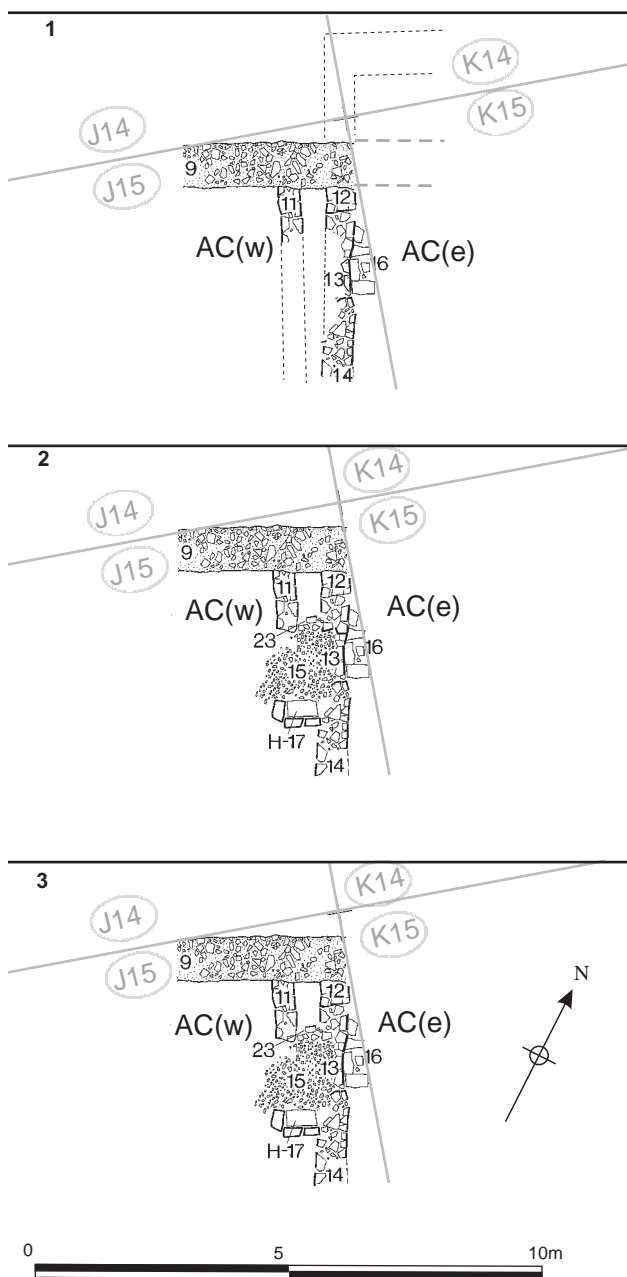

Figure 16 2 Plan showing successive phases in the area of the doorway between AC (w) and AC (e). Scale 1:100

course of the wall's east face was retained to serve as a threshold (J15:13), the upper surfaces of these stones being heavily worn. The remaining stub of east wall of AC (w) (J15:11) appeared to form a sort of alcove with wall J15:12. South of the alcove and west of the new doorway was a small area of gravel flooring (J15:31), bounded to the north by a stone kerb (J15:23) which extended between walls J15:11 and J15:12 forming the southern limit of the alcove. On the south edge of the gravel a hearth with a large stone base and upright stones on two or three sides (J15:17) was constructed, abutting the west side of wall J15:14. The alcove was filled with a layer of grey and orange clay-loam which contained a lot of,

charcoal, ash and tile flecks (J15:24) and may have derived from the hearth.

Phase 3

The doorway between the east and west rooms was subsequently widened by shortening the north portion of the dividing wall (J15:12). The new door passage was 1.70m wide. A protruding stone from the south-west corner of foreshortened J15:12 may represent part of a door jamb or a door stop. The threshold between the reveals of the doorway comprised a line of small facing stones which were heavily worn on their upper surface (J15:13). To the west a second gravel surface (J15:15) was laid, which came right up to the threshold and was revetted on the north side by some of the stones of kerb J15:23 like the preceding gravel surface (see Phase 2). The alcove to the north of the kerb contained a level of grey and orange clay loam with coal, charcoal and tile flecks (J15:24). The hearth (J15:17) probably continued to function.

Chalet AC (e)

On the east side of the threshold, six large stones (J15:16), together covered the full width of the doorway and gave the appearance of a step leading down into the east room. It is probable however that these were simply the remnant of a much more extensive stone floor in AC (e) (including K15:20) which had been cut away immediately to the east by post-Roman disturbance (K15:02). The former west wall of Chalet AD (K15:08) may now have been reused as the east wall of AC (e), which would make the chalet c. 5.00m wide internally.

Chalets AC (w) and (e) – discussion

Daniels envisaged the doorway in wall J15:12/14 as an initial feature of the chalet layout, which linked the two rooms of a single double-width chalet (AC), whereas there are strong arguments for seeing these as forming two separate chalet-contubernia in the first instance. Nevertheless Daniels' proposed layout can be envisaged as a secondary remodelling which involved connecting the two separate chalets of the initial chalet phase, AC (w) and AC (e), via a doorway. This would largely follow the structural layout set out as AC Phase 1 in Daniels post-excavation summaries although AC (e) may also have been extended eastward. The arrangement would subsequently have undergone a number of relatively minor subsequent modifications involving widening the connecting doorway and laying a new gravel surface (Daniels' AC Phase 2).

Chalet AD

AD was extended to the east, at the expense of AE, as

part of a coordinated rebuilding of the two chalets. Its former east wall was demolished and the previous west wall of AE (L15:08) reused to form its replacement. A new west wall was also built c. 1.50m east of the previous one (which may now have functioned as the east wall of AC (e) as suggested above). The position of the new wall was indicated by a 1.70m long row of dressed stones belonging its east face (K15:09), plus a fragment of the wall's core immediately to the west. To the south where the facing had subsided the remains were interpreted as a drain (K15:17), perhaps preceding the wall. However examination of the site plans and photographs suggests the west side of the suggested drain might simply represent additional wall core and part of the wall's west face, whilst the east side could comprise fragments of a stone surface abutting the wall's east face. Much of the base of a second-century Cologne ware beaker (K15:18) was associated with K15:17. The width of the wall was around 0.65m. This would give the chalet an internal width of 3.30m (4.60m overall including both sidewalls). The alley between AC (e) and AD was widened to perhaps c. 1.40m which would have been adequate to function as a side passage and would imply the existence of a doorway from the alley into the rear room of the chalet, though this has not survived. By contrast the chalet's eastern sidewall (L15:08) virtually adjoined the newly built west wall (L15:09/10) of the neighbouring chalet, AE, indicating that there was no passage on this side of the chalet.

Chalet AE

The remodelling of Chalet AE entailed a slight reduction in its width. A new west wall (L15:09), 0.63m wide, was built slightly to the east of, but virtually touching, the former west wall (L15:08), which now became the east wall of Chalet AD, as described above. The chalet's east wall remained unchanged and consequently its internal width was reduced to 2.80–2.90m (4.00–4.20m overall). There was clear evidence, in the form of a 0.70m long stretch (L15:10), that the west wall continued beyond the north wall of the former Building 11 (L15:07), which Daniels had presumed was reused as the north wall of the chalet range, and probably butted up against the south wall of Chalet AJ (L15:04) belonging to Range 12. This demonstrates that – whatever was the case in the initial chalet phase – by this stage Chalet AE and presumably at least some of the others in the range extended northward beyond the earlier footprint of the Period 2/3 Stable-Barrack 11, with the south wall of Range 12 (L15:04, M15:06) also serving as the north wall of Range 11, forming a spine between the two. In the case of AE, therefore, it formed a kind of back-to-back chalet with its counterpart to the north, AJ, with wall L15:04 acting as a rear party wall between the two chalet-*contubernia* and no intervening back

alley. To the east, the width of the side alley between AE and AF was apparently unaltered at 0.70m wide, so there was no potential for the provision of a side entrance into the rear room, which was possible in the case of all the other chalet-*contubernia* in the range. No internal features specifically associated with this phase were recognised.

Chalet AF

This chalet was probably largely unaltered. To the east Chalet AI was substantially rebuilt and shifted eastwards, with the result that its former west wall (M15:05) was now redundant and could have been reused as the new east wall of a widened Chalet AF. It is perhaps more likely, however, that AF retained its pre-existing east wall (M15:04). This would have allowed room for a 2.20m wide side passage between M15:04 and the new west wall of AI (M15:28), which could have given access to a newly inserted doorway into the rear room of AF.

Chalet AI

The clearest evidence for remodelling of the chalet range derived from Chalet AI which was completely rebuilt in this phase, shifting its footprint some 1.50m eastward. Only the northern end the new building remained (Fig. 16.25). The north (M15:15) and west (M15:28) walls were constructed similarly, consisting of a foundation deposit of small rubble on which were set footing courses, as much as 1.00m broad, composed predominantly of flat sandstone slabs or flags dressed to form a flat face along the outer edges, although more conventionally proportioned facing stones were also incorporated. The surviving fabric of the west wall (M15:28) extended only 0.85m southwards to butt up against the remains of the former north wall of Stable Barrack 11 (M15:03). In places two courses of the north wall's inner face survived, the second course being inset some 0.08m. Only one course of the north face remained, but this was level with upper course of the south face and sat on the line of the largely robbed-out south face of the rear wall of Range 12 (M15:06). The latter must have been demolished along this particular stretch during the secondary chalet phase. Although the masonry of the north wall footings had been partially robbed, the rubble foundations extended as far as the former west wall (M15:17) of the decurion's quarters (AN) which was probably reused as the chalet's new east wall. This would give the chalet an internal width of c. 3.60m (c. 5.20m overall).

Overlying hearth/oven M15:23 in the former north-west corner of the decurion's house was a small fragment of a possible floor (M15:22) composed of flagstones and rubble (see Fig. 16.26). This might represent part of a secondary floor associated

with the previous phase of the decurion's quarters (AN), overlying the hearth/oven, but predating the remodelling and eastward shift of AI. However it could also conceivably have formed part of a surface in a newly established alley between the rebuilt AI and AN.

The decurion's house (AN)

Nothing survived of the decurion's house (AN) associated with this phase. It may have been shifted slightly to the east, presumably being furnished with a new west wall to replace M15:17 now incorporated in AI. The north wall was probably also rebuilt at the same time. The east end of Range 12, to the north, underwent very substantial secondary remodelling which probably coincided with this phase of Range 11. This saw Chalet AL refashioned as an L-shaped building (AL2) which encroached over the line of the earlier north wall of AN (M15:24, N15:04), indicating that the latter must have been demolished by this stage. Its replacement probably followed the same, slightly more southerly, alignment as the north wall of AI (M15:15), but no chalet period remains survived in the area beyond features M15:22 and M15:23.

Dating evidence

The remodelling of the chalet range produced very little pottery, mainly BB2 and allied fabrics (J15:24, M15:22), plus much of the base of a second-century Cologne ware beaker (K15:18).

Chalet Range 12 (AG, AH, AJ, AL, AM) (Fig. 16.20)

Grid squares: J14, K14, L14, M14, M15, N14, N15
Chalet Range 12 was the only one which preserved any detailed evidence regarding the frontage and entrances of chalet-*contubernia* (see Figs 16.27–16.29), since all the evidence for the frontages of Ranges 9 and 11 had been lost as a result of modern intrusions and the overall preservation of Range 10 was very poor. It is also clear that the chalet-range occupied a more southerly footprint than its predecessor Stable-Barrack 12, extending over part of the early street between 11 and 12 (Alley 6). The chalets in the range were all provided with separate side walls so that they stood independently of the neighbouring *contubernia* on either side.

The western end of the range

Very little remained of the two chalets at the western end of Range 12. Post-Roman activity here had produced a mass of jumbled cobble and flagging in grey loam with the shape of any possible robbing trenches obliterated. The structures were initially



Figure 16.25: Later modifications to the north end of Chalet AI.



Figure 16.26: The north-west corner of the decurion's quarters (AN 1 in Rang 1) looking west.

thought to represent one large double chalet, labelled AG, with flags J14:19 perhaps forming part of a threshold from one room to another. This would have conformed (in reverse) to the pattern apparent in the chalet barracks of the western *retentura* where the eastern end of Ranges 9 and 10 comprised two adjoining *contubernia*, which faced east onto the *via decumana* and were separated by a party wall, whilst several standard rectangular chalets occupied the

centre of the line, facing north or south onto the *via quintana* or *intervallum* road, and substantial officer's houses were located at the west end of the range. The evidence was later reassessed and AG convincingly reinterpreted as two standard chalet-*contubernia*, AG I and AG II, which faced north and were separated from one another by a narrow alley like their neighbours to the east, AH and AJ, and on the same model as AC (w) and AC (e) at the west end of Range 11, immediately to the south.

Chalet AG I – Contubernium 1

The westernmost chalet (AG I) probably re-used the line of west wall of Building 12 for its own west wall, the foundations of which survived (J14:15). The line of the east wall is indicated by a short stretch of cobble foundation (K14:23) up to 1.15m long and 0.95m broad. Some of the south wall foundations possibly also remained, though this can only be guessed at from site plan P131b. On the assumption that this formed part of a single, continuous rear wall for all the chalet-*contubernia* of Range 12 (and possibly for Range 11 as well), its probable line is indicated by the more obvious fragments of masonry farther east (L15:04, M15:06). The northern frontage of AG I appears to have been set back quite markedly in relation to the frontages of the neighbouring chalets. The evidence took the form of what appeared to be a stone-lined channel or slot one course high and 0.25m wide (J14:20) on the eastern half of the frontage, which probably held a timber shuttering of some kind. On the western half of the frontage the rubble foundations of a wall (J14:26) were present, extending for 1.80m. The stone-lined slot was assigned to the preceding phase of Building 12 by Daniels and interpreted as part of a drain, although, in view of the building's reinterpretation as a stable-barrack (rather than a dedicated stable block as supposed by Daniels), a slot for a medial timber partition wall in the westernmost *contubernium* (1) of the Phase 3 stable-barrack seems more plausible, if the attribution to phase is correct. However there are significant grounds for believing that this feature was associated with a later timber frontage of Chalet-*Contubernium* AG I instead. Positionally this would make equal sense and the extent of the slot would fit the width of the chalet better than the preceding Period 3 *contubernium*. It might even represent an earlier feature adapted to form part of the frontage of Chalet-*Contubernium* AG I during Period 4, like internal drain J14:17. The use of pitched stones, of the kind packed into the slot in a couple of places, for example, is characteristic of the chalet frontages in Chalet-Barrack 12.

The resultant dimensions of Chalet AG I can be estimated at c. 4.70m wide internally (c. 6.25m overall) and perhaps 5.30m long internally and (c. 7.10m overall).

In the interior of the chalet a stone floor survived in the north-east corner. It was composed of several large, worn flagstones (J14:19), one of which abutted the cobble foundations of the east wall. Also located in the northern half of the chalet, close to its central north-south axis, was a stone-lined drain channel (J14:17), some 2.50m in length and 0.15–0.25m wide, filled by a grey clay silt (J14:24). Its side-walls constructed principally of roughly dressed facing stones, although vertically set slabs also appear to have been incorporated along the east side as an additional lining. This was attributed to the earlier building phase, both by Daniels and the 1997–8 excavators (Phase 2 and Period 3 respectively). The position the drain occupied along the central axis of the south room of *Contubernium* 1, would certainly accord with such an interpretation. However, with its relatively narrow channel and stone-walled construction, it more closely resembled the drains encountered in the front parts of the Period 4 chalet-*contubernia* – rather than the urine pits found in the stable barrack *contubernia* of Periods 1–3, which mostly took the form of slab-lined oblong pits. The drain channel might therefore represent a chalet-phase remodelling, involving the construction of a new stone-walled drain within an earlier urine pit, which would explain its somewhat anomalous form. This would certainly not be the only chalet drain attributed by Daniels to an earlier phase, (cf. drain L14:09/29 in Chalet AJ – see below).

Chalet AG II – Contubernium 2

Even less remained of the next chalet to the east, labelled AG II. The line of the east wall was marked by a 0.75–0.80m wide foundation (K14:08), only the northernmost 5.00m of which survived. This was composed of river cobbles and sandstone pieces, like the equivalent side wall foundations in AH and AG I, and rested directly over flagging of the earlier stable-barrack. A short fragment of the 1.00m wide west wall foundation also survived, being of similar composition. The latter was exactly adjacent to the equivalent remnant of east wall foundation of the Chalet AG I, the two fragments presumably having survived because they lay at a slightly lower level than the rest of those walls to the north and south, perhaps as a result of later settling or subsidence. Indeed, so singular was the pattern of survival that the excavators were initially unsure whether these represented two foundations running north-south, indicating two narrow buildings side-by-side, or formed part of the foundation of an east-west aligned internal wall.

The position of the north wall was marked by a slight robber trench (K14:18), c. 0.70m wide, whilst two upright slabs with a combined length of 0.60m, in the north-east corner of the chalet, probably formed

the threshold for a doorway (K14:17). The entrance was perhaps 1.20m wide and its position in the north east corner was repeated in Chalets AH and AJ. To the north, some of the contemporary surface of the *via quintana* (K14:15) was also intact. To the south of the doorway, a patch of flagging (K14:12), consisting of a variety of different stones averaging only about 0.20m across, probably formed part of associated stone floor. This came up to the top of the adjacent wall foundation and likewise rested on the earlier, stable-barrack floor. The facade of AG II, thus revealed, was set slightly further back from the *via quintana* than AH and AJ, but perhaps c.1.20m forward of the frontage of Chalet AG I. No trace of the south wall remained, but its course can be reconstructed by reference to the surviving stretches further east (L15:04, M15:06). On this basis AG II was c. 4.00m wide and perhaps 7.40m long internally and c. 5.90m wide and 8.80m in length overall. Assuming that the masonry walls resting on the adjacent sidewall foundations of AG I and AG II (K14:23, 24) were inset slightly, the two chalets will have been separated by the narrowest of alleys.

Chalet AH – Contubernium 3 (Figs 16.27, 16.28)

The third chalet comprised another rectangular *contubernium* with its long axis aligned north-south. Substantial parts of the northern half of the building survived, including much of east (L14:07, 21) and west (K14:09) wall foundations, plus part of the north wall (K14:10). These foundations were 0.70–0.80m wide and composed of river cobbles with some sandstone building stone mixed in (including a total of three quernstones), like the foundations of the other chalet walls in the eastern part of the range. A few large sandstone facing blocks were left in situ on the west foundation (K14:22). Only a 1.20m length of the north wall foundation survived (K14:10), and this appeared to butt against the side of the west wall foundation suggesting the latter was laid first. The remaining course of the north wall was marked by a robber trench (L14:05), which extended another 1.20m towards the flagged doorway into the chalet at the north-east corner. The line of the south wall must be reconstructed on the basis of surviving stretches further east (L15:04, M15:06). The entrance lay at the east end of the north wall where a 1.50m wide strip of the internal flagging (L14:06) extended across the line of the north wall up to the street surface. The *via quintana* was resurfaced in conjunction with the construction of the new barrack (L13:02; L14:04). One of the flag stones had pivot holes cut in it. It may have been reused but was perhaps deliberately positioned to hold a door pivot.

On this evidence the internal width of AH was c. 3.85m and its length 7.80m (measured from the inner edge of the foundations), and its overall dimensions,

including the walls, were c. 5.40m by 9.00m. The building was separated from AG II by a narrow alley only 0.40–0.50m in width.

The interior levels only survived in the north-east part of the chalet where two phases were recognised. The initial phase comprised a continuous flagged floor extending southward from the doorway (L14:06; L14:17; L14:43). This floor was overlain by a series of soil and stone debris levels (L14:33–37, 40–41).

Phase 2

A deposit of pink, plastic clay was laid over the Phase 1 levels (L14:14, 32). This was tentatively interpreted as the foundation for a possible cross-wall. However the edge of the clay lay only 2.00m from the entrance which would imply that any wall associated with it must have functioned as some sort of screen for the entrance, rather than a cross-wall partitioning the chalet into front and back rooms. Even more problematic was the width of the clay 'foundation', which reached as much as 1.20m, that is to say substantially wider than the foundations of the chalet's external walls. The alternative interpretation of this deposit as the remnant of a once more extensive makeup layer for the second flagged floor seems more plausible, therefore. Set into the clay was a slot for a timber partition at least 1.25m in length. This feature ran east-west from the east wall opposite the entrance and about 2.30m from it (L14:15, 23, 39). It was constructed of a double line of upright stones (L14:15), some 0.25m wide overall, packed with gravelly sandstone pieces in dark soil matrix (L14:23, 39), and presumably held a timber partition. Alternatively the stone lined feature could be interpreted as a narrow drain, though its east-west orientation would be otherwise unparalleled for the chalet drains. To the south successive fragmentary patches of flagging (L14:35, 40) were noted, culminating in a more extensive level of larger flagging (L14:16). To the north of the slot one large flag (L14:38) and the presence of the pink clay suggested that there may have been a comparable re-surfacing of the floor up to the entrance.

Chalet AJ – Contubernium 4 (Figs 16.27, 16.29)

The walls of AJ varied between 0.60m and 0.90m wide and their construction differed from those of Chalets AG I and II and AH to the west, lacking the river cobble and rubble foundations which distinguished the walls of those chalet-*contubernia*. Instead the footings were built of large faced sandstone blocks. The northernmost 3.60m of the east wall was partially intact (L14:12), along with a 1.30m section of the wall's west face, further south, which had been slightly displaced. One small fragment of the west wall was found (L14:22), its line being continued northward by a robber trench (L14:25), whilst the course of the north wall was indicated by its robber trench alone (L14:20).

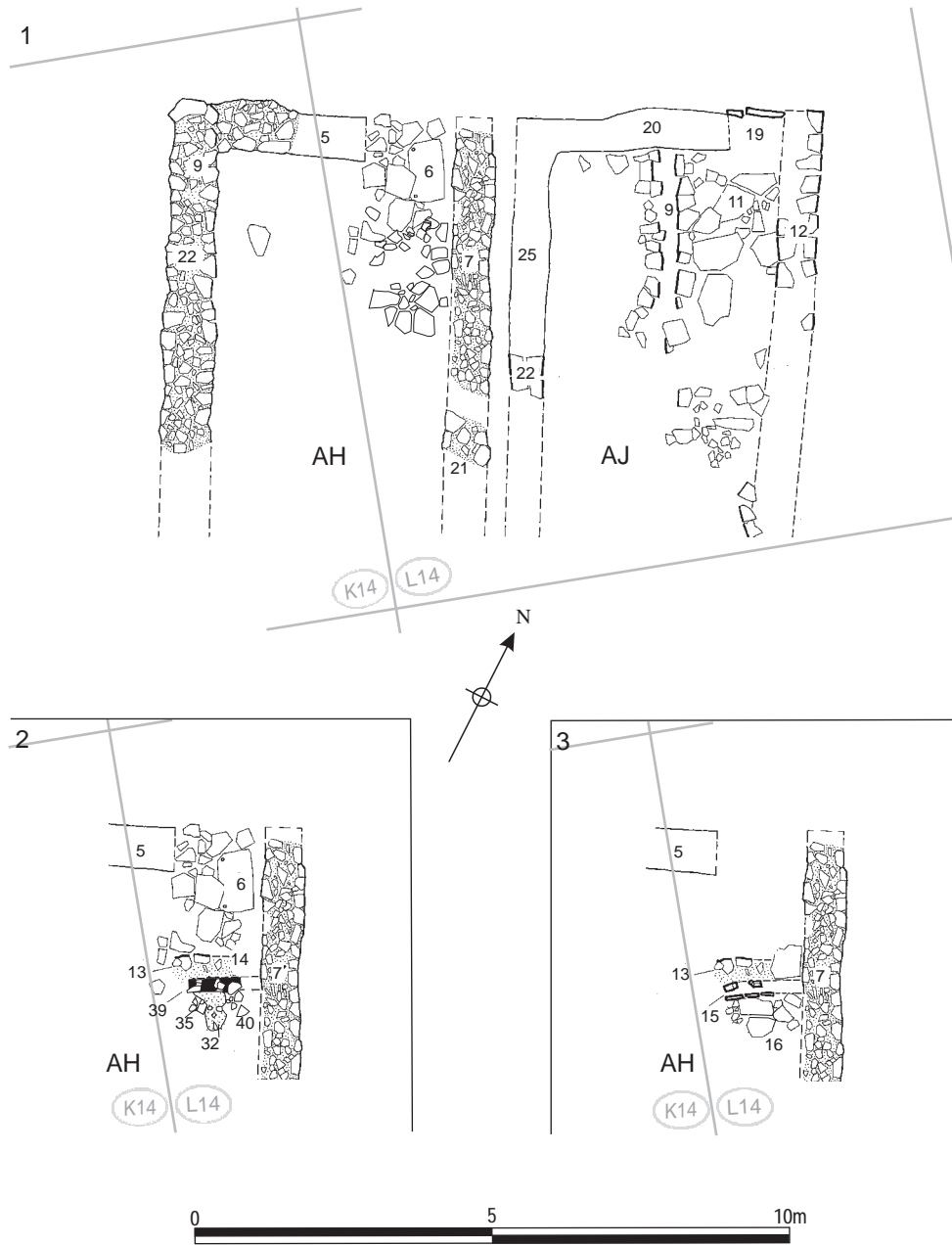

Fig re 1 Successive p ses of th frontag s of Ch lets AH-AJ, at 2



Fig re 2 Ch let AH frontag , looking south



Fig re 3 Ch let AJ frontag looking south with drain L v sible in th centre.

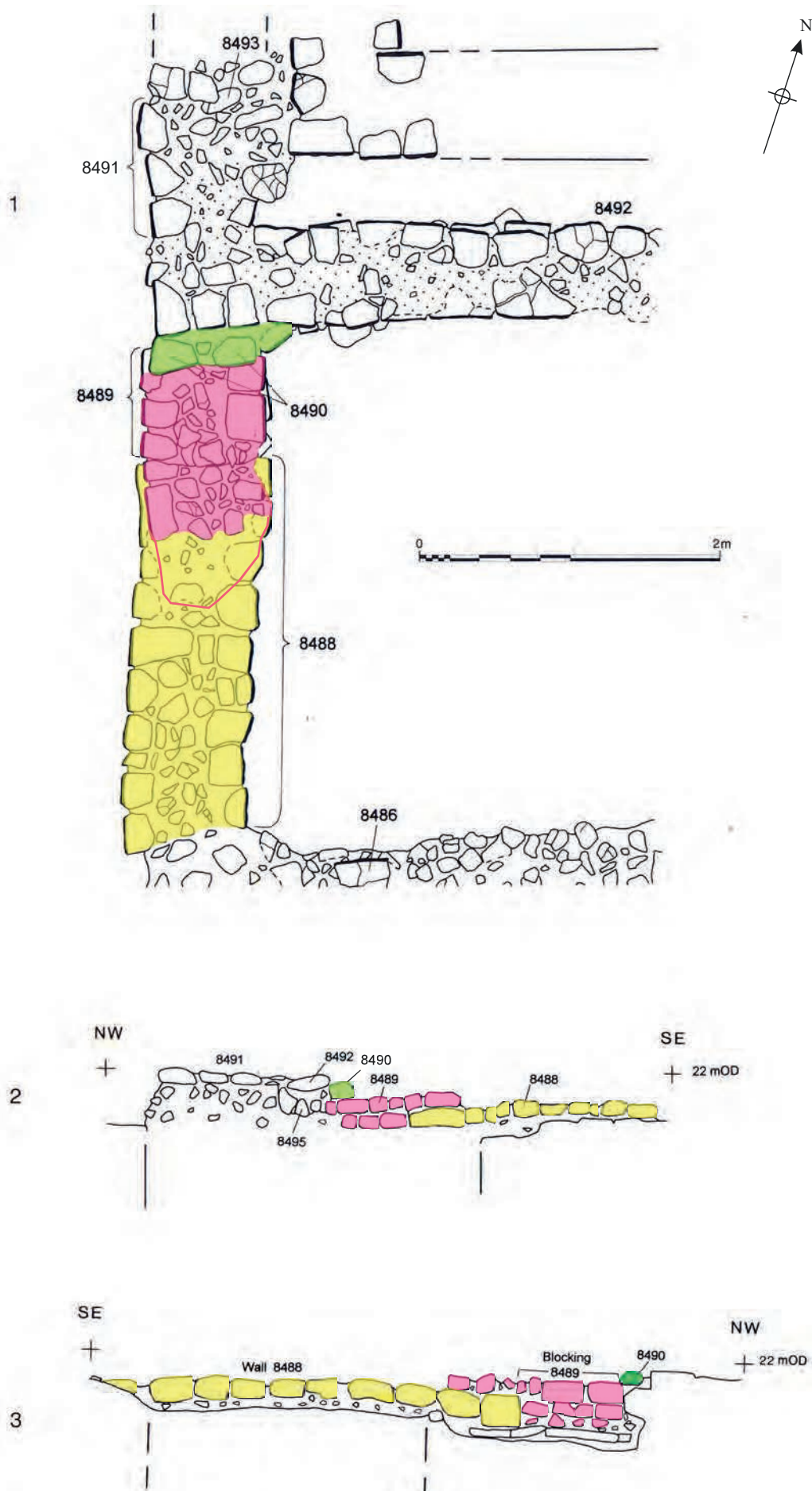

Figure 16.30: Details of east wall of Room AL II of the modified officer's house of Period 4 Barrack XII at 1:40 (adapting Hodgson 2003, 111, fig. 81, with additional colour coding to distinguish the different phases – see Fig. 16.31 for key): 1. Plan; 2. West-facing elevation; 3. East-facing elevation. The red outline marks the portion of masonry seen in the 1979 excavation but not *surv* *in situ* in the 2003 excavation.

A 1.80m long stretch of wall (L15:04), found resting on the early road surface between Buildings 11 and 12 and noted to be of similar construction to the east wall, probably formed the south wall of AJ. Its stones were reportedly similar to those in the other walls of AJ and slightly larger than those of Chalets AE and AF to the south of it. The 1978 excavation team was divided on whether this belonged to Chalet AJ, with Caruana in favour, but Moffat more sceptical, as reflected in the post-excavation structural 'summary' and 'notes' which they respectively compiled. The 1997–8 excavators not only took the same view as Caruana, but pursued the argument further, proposing that along with couple of other surviving fragments further east (M15:06), this formed part of a continuous rear wall for all the chalet-*contubernia* of Range 12 and indeed those of Range 11 as well.

An entrance was located at the east end of the north wall as in AG and AH. It was marked by two large, vertically set flagstones on the south edge of the *via quintana*, which probably served as a threshold (L14:19). The same arrangement was found in AG II and perhaps AG I. In AJ, however, the robber trench for the north wall continued across the entrance unlike the situation in AG and AH where the floor surfaces came up to the road.

In the northern part of the interior, a drain was laid out on the chalet's central, north-south axis. This appeared to be of two phases, the earlier of which was assumed by the 1978 excavators to relate to the pre-chalet block (which they interpreted as a stable). It is now evident that this initial phase (L14:29) cannot belong to the earlier block – recognised to be a stable-barrack – as it would have lain right in the middle of *Contubernium* 6 (offset slightly to the east) rather than occupying the front (south) room as was the norm for stable-barrack urine pits. Its form – a narrow channel lined by side walls constructed of faced blocks – was also more typical of the chalet period structures rather than the stable barracks of Periods 1–3, which tended to employ wider oblong pits, lined with sloping stone slabs. The initial drain had been partially demolished and some of its flagstone capping lay in and over its channel. Subsequently an extra course of stones had been added to the sides. Some of these stones rested over the displaced early capstones. They were the larger type of facing stones characteristic of the walls of AJ and noticeably more substantial and less neatly shaped than those forming the original drain sides. This phase of the drain appeared to continue further south than the original. The new drain (L14:09), with a channel 0.35m wide and 0.15m deep, was filled with grey soil and rubble indistinguishable from the overlying debris (L14:10). Its finds cannot therefore be regarded as a safely sealed group. From the edge of the drain there was a decent flagged surface (L14:11) over most of the eastern half of the *contubernium*. In the western half of the structure the earlier flagged

floor (L14:26) may conceivably have continued in use with the initial phase of the drain (L14:29). The upper level there, equivalent to L14:11, was mostly disturbed.

The width of the building was 3.80m internally (5.00m over the walls) and its length, north to south, was 8.00m (9.60m). The alley separating the chalet from AH was 0.30–0.40m wide.

The eastern end of the range

The eastern end of Chalet Range 12 was later subject to particularly extensive remodelling which has obscured its initial layout. Nevertheless the basic layout can be restored, comprising two chalet-*contubernia* of generally typical dimensions but fractionally narrower than the norm apparently to provide space for an intervening alley which was wide enough to permit access to the rear part of the chalets through doorways in the sidewalls (similar to the later arrangements in Range 11). To the east, the pre-existing decurion's house was probably retained and partially rebuilt on the same footprint as before.

Chalet AL1 (w) – Contubernium 5

A series of deposits which could be interpreted as debris from demolition of the Period 2/3 stable-barrack were present across this part of the range, as described previously (see above *Building 12: Demolition and robbing*). Over the entire area of Chalet AL1 (w), these deposits were covered by a layer of angular rubble (M14:42), composed of substantial pieces of sandstone c. 0.30m across, which showed no significant trace of wear but certainly represented a deposit created with deliberate intent, perhaps to form a levelling platform for the new building. The walls of the chalet-*contubernium* were erected on top of this rubble level, which was also overlapped by the contemporary *via quintana* metalling (M14:41).

AL1 (w) took the form of another rectangular chalet-*contubernium*. Only a 3.15m long central section of the west wall (L14:18) and a 2.40m length towards the southern end of the east wall (M15:07, TWM 8488) remained. The west wall was c. 0.70m in width and faced with large blocks up to 0.40m broad whilst the east wall was 0.80m wide and used slightly smaller stones measuring 0.15–0.35m across their faces. The latter was recorded in further detail in 1997–8 (Hodgson 2003, 111, fig. 81). Any trace of this wall further north had been removed during the subsequent phase when a new foundation for the Phase 2 wall was erected on the same line. The southern stretch was demolished down to the level of its lowest course and partially rebuilt at the same time, but despite the later alterations it is clear that the northern end of the surviving length of original masonry actually formed a neatly squared-off terminal, representing the one jamb of a side

doorway. This presumably allowed entry into a rear room (*papilio*) from a side alley, providing direct access to the chalet's living quarters. The existence of a side doorway suggests that this and probably the other chalet-*contubernia* were each divided into front and back rooms but the Daniels archive provides no clear evidence for the partition walls which must have divided the chalets. The doorway was later blocked (M14:17) when the wall was rebuilt and the north side of the doorway removed by the new construction work.

No trace of the chalet's north wall remained, but it was assumed to lie on roughly the same line as those of AJ and AH, as suggested by the edge of *via quintana* road surface (M14:41). Fragments of the south wall (M15:06) did remain, however, on the same line as the south wall of AJ (L15:04). Like those of the neighbouring chalet, AJ, the walls of AL1 (w) were constructed with neatly dressed facing stones from the footings upwards, with no distinct foundation course, although in this case the presence of the extensive rubble platform (M14:42) would have made such foundations largely superfluous. However a clay foundation layer (M15:13) was recorded in association with the south wall. None of the interior flooring or other features survived over the rubble levelling deposit. This would result in a chalet with an internal width of 3.00m (4.45m overall) and a maximum overall length of perhaps 9.60m (7.20m? internally).

Chalet AL1 (e) – Contubernium 6

The area immediately to the east of AL1 (w) posed many problems of interpretation which have given rise to differing restorations of the initial layout. Following excavation in 1979, Daniels' team envisaged a south-facing, open-fronted structure attached to the west side of the earlier decurion's house, perhaps a lean-to. The components of this scheme included two walls incorporated in the later phase, which were presumed to have been reused or rebuilt, plus floor surfaces which could not be attributed to any other phase. The 1997–8 excavators, by contrast, viewed this area as being incorporated in an enlarged house for the decurion. However, the Daniels archive contains evidence which clearly perplexed the excavators and caused them to question their favoured interpretation in the detailed post-excavation notes. Several of these features could be restored as elements of another chalet-*contubernium* of similar proportions to the other five in the range and forming part of the same row. Conversely certain other remains fitted much better with Daniels' original interpretation, perhaps implying that the structural phasing in this area was more complex than previously envisaged, with an additional phase or sub-phase to be slotted into the sequence.

Phase 1

Evidence for the east and west walls of a chalet-*contubernium* survived. The west wall took the form of three spreads of rubble foundation deposits, consisting of cobbles and building stones in a mid-brown clay loam matrix (M14:51–53), revealed beneath the remains of the secondary chalet phase. Some of the rubble in the central (M14:52) of the three spreads appeared to have been displaced westwards, probably as a result of the construction of later walling. The rubble foundations extended over a distance of 4.30m from north to south and rested on what appeared to be the eastern edge of rubble platform M14:42. Immediately to the north, the line of the foundations was continued by the possible remains of masonry which may have formed the northern end of the west sidewall. This was preserved in a later floor surface (M14:11), its west face being reused as the sidewall of part of a hypocaust channel (M14:07). The northern end of the corresponding east wall was represented by another stretch of rubble foundation pitched in a clay loam (M14:21), 1.00m wide and 1.60m in length, which were also incorporated in the later floor. Some 1.80m further south, a 1 metre wide patch of pink clay (M14:48) may have formed a short section of surviving bedding clay for the foundations. There was no trace of the north wall, but it may have lain on the same line as the later east-west orientated channel M14:10 which followed roughly the same alignment as the north walls of Chalets AH, AJ and that inferred for AL1 (w). The south wall was probably formed by a continuation of the south wall of AL (w) and AJ, with fragments of this stretch still remaining. As thus restored, the chalet would have dimensions of c. 3.00m wide internally (perhaps just over 4.00m overall) and roughly 9.20m long overall from north to south and was separated from AL1 (w) by a 1.30m wide alley which would have allowed access to the side doorway identified in the east wall of AL (w). There may conceivably have been an equivalent doorway in the west wall of AL (e) itself.

The decurion's house (Building AM1)

The decurion's house associated with Stable-Barrack 12 probably continued in use during the initial chalet phase, possibly with its system of internal stable drains still functioning as well. This is entirely feasible since, although the row of *contubernia* was attached to the house, the latter was effectively structurally independent of the rest of the barrack and could have remained standing after the *contubernia* were demolished at the end of Period 3. As was noted in Chapter 15 the west wall of the house was rebuilt on two occasions. The first instance involved rebuilding the wall (M14:50, N14:25) from the second course upwards. This was evident in the way that the second course was inset c. 0.08m on its eastern edge,

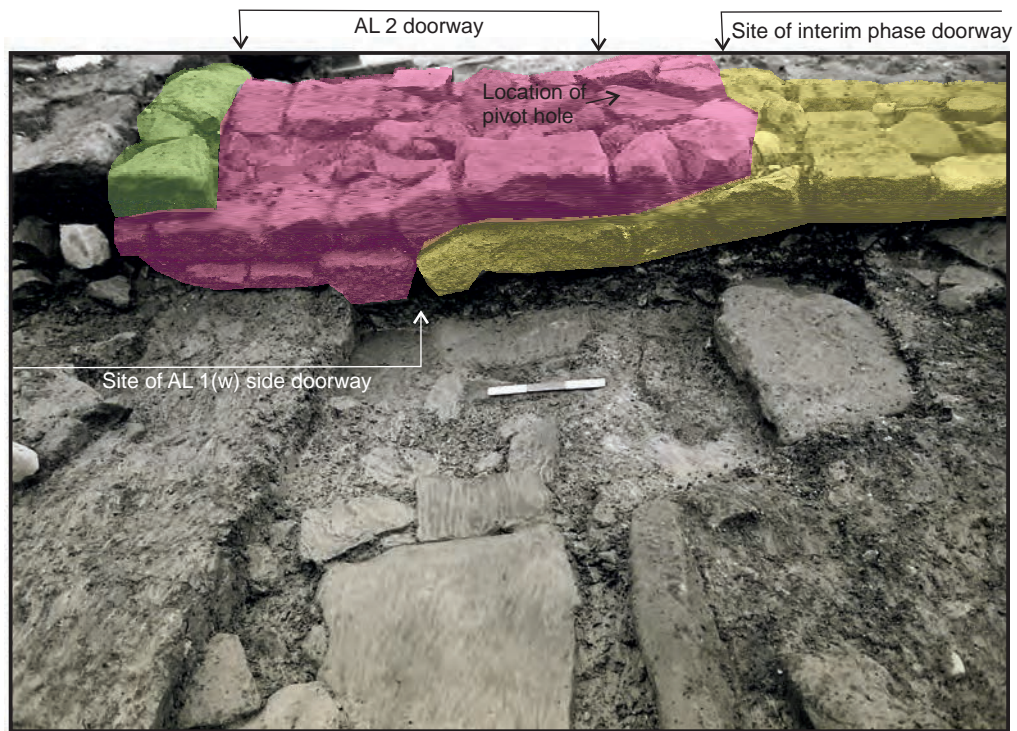
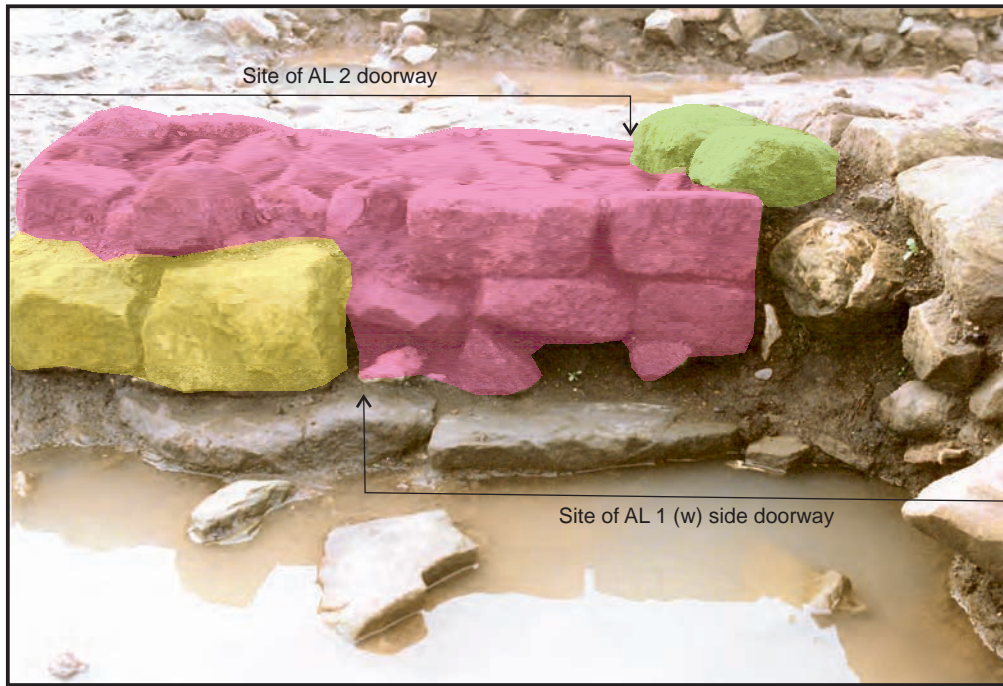

- Chalet AL (w) Phase 1 wall
M15:07/8488
- AL interim remodelling
(blocking earlier doorway)
wall M14:17/8489
- Chalet AL2 door jamb 8490

Figure 16.31: Successive structural phases embodied in north-south wall M14:17/M15:07 in Chalet AL, viewed from the east (top) and west (below). Photograph taken during the 2010 excavations.

but overlapped the western edge of the footing course (which belonged to the initial phase of the stone house – Building 12 Phase 2). Insufficient remained of the other walls to determine whether they were similarly reconstructed at this stage, but there was evidence that the internal drain system in the north-west corner of the house was substantially altered, perhaps contemporaneously, resulting in a cruciform pattern of drains (see Chapter 15 for detailed description). As was noted in Chapter 15, it is uncertain whether this first rebuild of the west wall occurred during the life of the earlier, Period 2/3 stable-barrack, as suggested by the 1997–8 excavators (Hodgson 2003, 66), or was contemporary with the Period 4 remodelling of the barracks into ranges of free-standing chalet-*contubernia*. Certainly, the west and north walls of the decurion's house must have remained in use during the initial chalet phase since the north wall (M14:09) and medial partition wall (M14:18) of the later reorientated chalet, AM2, clearly followed exactly the same respective lines (see below).

AL/AM Sub-Phase 2 (Figs 16.30–16.32)

A number of surviving features recorded by Daniels in the area of Buildings AL and AM could not be readily accommodated in Chalet-*Contubernium* AL1 (e) described above, indicating that his proposed interpretation of the initial arrangement of AL and AM cannot be simply discarded. Instead the problematic elements might relate to a subsequent interim remodelling of this area, perhaps involving an enlargement of the officer's house (labelled AM1 (w) here) at the expense of the easternmost chalet-*contubernium*, AL1 (e), and the northward extension of the adjacent Chalet AL1 (w).

AM1 (w)

The most tangible trace of an extension to the decurion's house was represented by one course of walling (M14:58) which continued the line of north wall of that building westwards for 5.30m. This lay some 2.00m to the north of the probable northern limit of AL1 (w) and (e) and extended beyond the west wall of AL1 (e), implying that M14:58 could not simply have represented the north wall of a longer than normal chalet-*contubernium*. It was directly overlain by the later north wall of AM2 (M14:09), which was assigned to Daniels Phase 2, but M14:58 clearly belonged to an earlier phase since the north face of M14:09 was slightly inset to the south of the equivalent face of M14:58, whilst the southern edge of M14:09 correspondingly overlapped the south face of M14:58. At the western end of this wall a number of river-worn boulders were present in the *via quintana* street, one overlying the offset face of M14:58, but two others underlying the north wall of

the later L-shaped building, AL2, immediately to the west, confirming that M14:58 belonged to an earlier phase. The west wall presumably lay on the same line as west wall of AM2 (M14:02) and had probably later been demolished and completely rebuilt when AM2 was constructed. It certainly does not appear to have reused the west wall of AL1 (e) since north wall M14:58 continued westward beyond the line of the rubble foundation (M14:51–53). No trace of the south wall remained either. Daniels considered the building was open to the south, but if the west wall was removed without trace so too could the south wall have been. The southern limits of the building were thought to be indicated by the extent of interior clay floors (M14:46, 47). These were composed of a 0.03m thick layer of pink clay covered by patches of fine orange gravel or grey silt (M14:46) becoming thinner and less uniform to the south where the yellow sandy clay predominated with patches of coal, charcoal and silt but very little gravel (M14:47). The clay floor extended no further south than did the adjacent decurion's house (south wall – M15:31). To the south, beneath layers associated with the later Chalet AL2 (M14:13, M15:21), excavation exposed only the uppermost surface of Alley 6 (M14:49: M15:27), which may have been laid towards the end of the life of the Period 2/3 stable barracks, 11 and 12. Thus the clay floor surface did not match the inferred footprint of AL1(e), extending beyond the latter's presumed northern limit but stopping between 2.10m and 2.50m short of the south wall of the chalet-*contubernium*. It is this which suggests that AM1 (w) represented a western extension to the pre-existing decurion's quarters, supplanting the easternmost chalet-*contubernium* of Range 12. The pre-existing west wall of the decurion's quarters of Building 12 (M14:50, N14:25, M15:30) probably continued in use as a partition wall between the original house and the extension. On this basis the dimensions of AM1 (w) would have been around 8.90m by 5.25m externally (excluding the pre-existing west wall of AM1), and perhaps c. 7.35m by 4.75m internally.

The relationship between the clay floors and the rubble wall footings associated with AL1 (e) is problematic. Daniels interpreted the rubble as debris deriving from the demolition of the west wall of AM1 (w), though not with any great conviction as the doubts expressed in the structural *Notes* demonstrate. Indeed the rubble deposits, M14:51, 53, were reported to cut the clay floors rather than lying on the floor surfaces, as might be expected if they simply represented demolition debris. If the foundations were in fact cut into the clay floor it would imply that they belonged to a later phase, but there was a significant degree of uncertainty in the context records as to whether this was the actual stratigraphic relationship. The structural sequence presented above, involving the replacement of a chalet-*contubernium* (AL1 (e)) by an extension to the

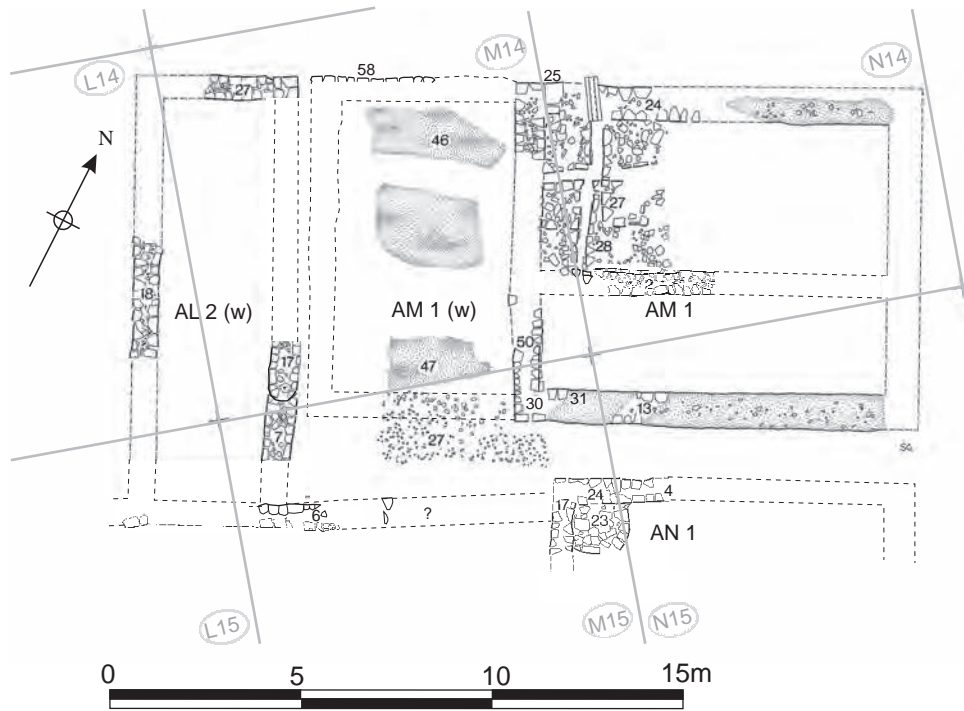

Figure 16.33 Interim remodeling of Building AL (w) and AM, Phase 1 (at 0)

decurion's house (AM1 (w)), would suggest that the clay floors of AM1 (w) must instead have been laid up against pre-existing cobble and rubble wall footings of AL1 (e). In such circumstances the foundations might appear to cut the floor level, and this could perhaps explain the apparently contradictory record.

AL2 (w)

It is possible that Chalet AL1 (w) was extended northward at the same time as the decurion's house was enlarged immediately to the east. A new north wall (M14:27) was built on the same line as the north wall of the adjacent officer's house (AM1). Only the eastern half of this new wall survived. It was clay-bonded like the other extant walls of AL1. The east and west side walls were both extended northward to join the new north wall. The position of extended west wall was indicated only by a line of later robbing debris, composed of cobbles and rubble in a soil matrix (L14:44), but there was clearer evidence for the demolition and rebuilding of the east wall. The masonry of the rebuilt wall (M14:17) blocked the original side doorway of AL1 (w) and extended 1.00m further south over the one surviving course of the original wall (M15:07), finishing with a rounded terminal some 2.70m short of the line of the south wall (Figs 16.30, 16.31). This suggests that the position of the side doorway was shifted towards the southern end of the east wall with that section of the latter's original masonry which was not built over presumably forming a new threshold. Access to the

original doorway would have been closed off by the construction of the extension to the decurion's house, and relocating the doorway would have permitted continued access via remaining section of the alley between Ranges 11 and 12, which was open once more after the demolition of Chalet AL1 (e). As a result of these alterations, the overall length of AL (w) would have increased to 11.80m (10.65m internally). The enlargement of Chalet AL1 (w) to form AL2 (w) may have been intended to at least partially compensate for the loss of the accommodation provided by Chalet AL1 (e).

Later remodelling of Chalet-Range 12 (Figs 16.33–16.35)

The eastern end of Range 12 evidently underwent a further substantial remodelling which saw the decurion's house replaced two parallel chalet-*contubernia* like buildings that probably faced east, rather than north like the remainder of the range. The southern chalet (AL2 (e)) was attached to AL2 (w), to the west, creating an L-shaped building, whilst its neighbour to the north, Chalet AM2, featured an elaborate system of stone-lined channels, probably representing a hypocaust system.

AL Phase 2

Chalet-*Contubernium* AL (w) had probably already been extended northwards during the preceding sub-phase (see above Sub-Phase 2). The clay-bonded

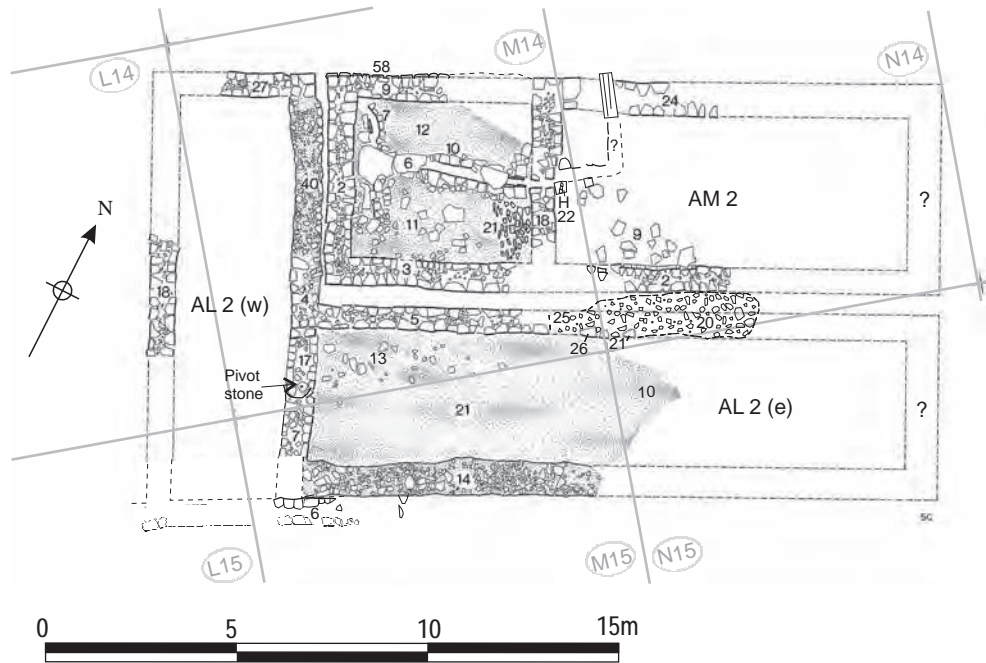

Fig. 8 Final remodeling of east end of Chalet Rang 2 (AL and AM Phase 2 (at 0 0))

east wall was now demolished and its northern half replaced by a mortar-bonded wall (M14:04). Only a short stretch of actual wall masonry (1.80m) survived, but its line was continued northwards by the remains of its associated rough cobble foundation (M14:40). The latter clearly belonged to this phase since the context records indicate that it was not present further south, beneath the stretch of the east wall (M14:17) which was retained from the preceding sub-phase to serve as an internal partition. Attached to the southern half of the AL2 (w) was an east-west aligned chalet (labelled AL2 (e)). The north wall (M14:05) of this east wing featured a mortar-bonded core and was of one build with wall M14:04, both being 0.65m wide. Further east, only fragments of the south face survived (M14:26, N14:21), but the wall's line was prolonged by the remains of its foundations (M14:25, N14:20). These consisted of a compact packing of small angular sandstone rubble fragments and cobbles, each averaging 0.10–0.15m across and incorporating a lot of bone and pottery, including an entire gritty ware vessel (N14:19). The overall width of the foundations was up to 1.25m, though they may have been spread by later disturbance. The resultant surviving length of the wall was 12.50m, extending across the southern part of the former decurion's house (AM1). The parallel south wall was represented by a 0.80–0.90m wide rubble foundation (M15:14) and a couple of stones belonging to the north face. The foundations were composed of pieces of sandstone rubble and large river cobbles in a dark grey clay soil matrix. They extended 8.50m from the east wall of the west room across the former alley surface overlapping the remains of the north wall of Building AN, which

must therefore have been demolished by this stage. However the wall did not appear to continue farther westward, across the southern end of AL2 (w). Either it had been robbed out completely in this area or, perhaps more likely, the south wall of Chalet Range 12 still formed the south wall of AL2 (w).

No interior surfaces survived in AL2 (w). Remnants of a floor or make-up layer (M14:13–14, M15:21, N15:10, 12) consisting of grey clay, small compacted pebbles and pieces of rubble, with patches of decayed mortar/lime and coal or charcoal were present over much of the interior of AL2 (e), covering the southern end of AM1 (e) and the south-west corner of the former decurion's house (AM1). Separating the two parts of AL2 was the former east wall of AL2 (w). The pre-existing masonry (M14:17) south of the angle of the new walls, M14:04 and M14:05, was probably demolished down to its extant level and the position of the side doorway shifted northwards a little – more or less back to the position it originally occupied in the east wall of Chalet AL1 (w)) – to provide access between the two rooms. The evidence for this repositioned doorway was represented by a masonry jamb attached to the south face of M14:04/05 and a pivot stone some 1.25m further south, with the surviving masonry of wall M14:17 forming the threshold. No trace of a jamb or rebuilt wall masonry was preserved on the south side of the doorway and it is possible that here the extant remains of the wall (M15:07) simply provided a solid footing for a timber partition.

The internal width of AL2 (e) was 3.60m, implying the building was probably c. 4.90m wide overall, assuming the masonry of its south wall was the same



Figure 16.34: The east ends of Chalet Ranges 11 and 12 showing later chalet remodeling (AL2 (e) and AM/AN).

width as its north wall. The eastward extent of both the north and south walls was limited by modern disturbance and no trace of an eastern frontage was uncovered. Nevertheless the maximum surviving length of 12.30m, recorded in relation to AL2 (e), is a perfectly respectable overall length for any chalet, comparable to that from north to south of AL2 (w) (11.85m overall, 10.65m internally) or the east-west length of Building W at the west end of Range 9 (c. 12.00m overall, 10.60m internally), which functioned as the decurion's house in that chalet-barrack. This could signify that AL2 (e) did not extend much if any further east. If the building continued eastwards as far as the estimated east wall of the former decurion's quarters, AM1, its east-west length would have been as much as 16–17m and in excess of 20m when the width of AL2 (w) is added. A reduction of the footprint of Range 12 in this phase would certainly make the east room of AL 2 a more reasonable size, but given the uncertainty over the function of the structures at this end of the range and very extensive post-Roman disturbance the possibility that AL2 and AM2 did stretch further eastwards cannot be excluded.

AM Phase 2

The remaining area of the Building AM1 was also substantially remodelled, creating an east-west aligned building of conventional chalet proportions, here labelled AM2. This was laid out to the north of and parallel to AL2 (e) and extended across the northern and central sections of AM1 and its western annexe (AM1 (w)), reusing or reconstructing many of the pre-existing structural components of the earlier building. The arrangements in the eastern part of the new building were obscured by the very considerable disturbance to the Roman levels caused by a colliery-era trackway (M14:08, 30–34, N14:11–17) which ran diagonally across the north and east parts of the chalet.



Figure 16.35: Spine wall M14:09 (foreground) north-south wall M14:02, M14:03 separating AL2 (w and e) and rubble foundation of AL2 (e) south wall M14:03 looking east.

The north wall of AM1 (w) was dismantled down to its lowest course (M14:58) and rebuilt on the same line (M14:09). Up to two courses of the rebuilt wall survived and clearly belonged to a later phase than the footing course, M14:58, since their south face overlapped the corresponding face of the M14:58, rather than being flush with it or inset like their north face, the whole wall being some 0.55–0.65m wide. Although only a 3.15m length was still standing when excavated in 1979, the wall may have been rebuilt further east as well, but only the original footing course of the north wall of the decurion's house (N14:24) remained here, as a result of the damage caused by the colliery trackway. The west wall (M14:02) was bonded to the north wall and survived over its full 5.50m length. It was 0.70–0.75m wide and was probably erected on the same line as the west wall of AM1 (w), although no trace of the earlier wall was preserved. The adjoining south wall (M14:03, N14:02) followed a new course some 2.50m north of the line of the south wall of AM1 and was traced over a total distance of 10.65m, which gives a minimum length for the building. The new wall was of similar width to the west wall with two courses surviving in places,

the upper course clearly inset on its north side along the eastern half of its length (N14:02). All these walls were clay-bonded in contrast to those belonging to the same phase of AL2. The building was separated from AL2 (e) to the south by a 0.40–0.50m wide alley filled with rubble, broken flags and dark soil (M14:15). An even narrower space, no more than 0.30m across, lay between the chalet and AL2 (w) to the west.

The external width of the building was clear at 5.50m, but its extent to the east and therefore its length could not be established. It is reasonable to suppose that the eastern frontages of AL2 and AM2 were in line, which, based on the surviving length of the foundations of the north wall of AL2 (N14:20), would imply that AM2 extended at least another metre or so beyond the recorded 10.65m length of its south wall. Even this is not certain, given that the *via quintana* frontages of the chalet-*contubernia* belonging to this range were clearly staggered.

The building was divided into two rooms by a partition wall (M14:18), built on the same line as the west wall of the decurion's house (M14:50, N14:25). Internally, the west room measured 4.20m by 4.75m and the east room c. 4.20m by at least 4.60m. The partition actually represented the second rebuilding of the original west wall of the officer's quarters, comprising its two uppermost surviving courses. Towards the south end the highest course could be seen to be inset on its west side (see Fig. 16.36) though further north it appeared flush with the course below. The rebuild clearly belonged to this phase as it did not survive beyond the south wall of AM2 and incorporated a vent or slot through its masonry associated with the stone-lined channels in the west room. This opening was neatly constructed, being 0.20m or one facing stone's length wide and gave every appearance of being part of the original fabric of the wall (Fig. 16.37). It was connected to a channel extending east-west across the centre of the west room (M14:10), which linked in turn to another one running down the west side of the room (M14:07), forming a T-shaped arrangement in plan (Fig. 16.38). There were no openings through any of the other walls of AM2 (w) (contra Hodgson 2003, 106, fig. 77.2). The side walls were composed of faced sandstone blocks, averaging 0.30m in length and 0.12m in width, creating a 0.20m wide channel, and lined with grey clay and upright flags at certain points (notably immediately west of the outlet). In places cover flags (M14:06) were still *in situ* over the channels, but there was no indication that a comparable flagged surface extended across the remainder of the room. Instead the floor on either side of the central channel was composed of grey clay (M14:11–12), with some building debris mixed in, perhaps deriving from the demolition of the previous phase. In the south-east corner of the room a band of pitched stones and rubble packed into a clay loam (M14:21) ran on a north-south axis alongside

the partition wall. This pack resembled a rubble foundation and may represent the base of the east wall of Chalet AL1 (e), as suggested above, although it did appear to be packed right against the west face of the medial wall over the wall's offset course.

N.B. Little remained of the two upper courses of the partition wall (M14:18) when the area was re-excavated in 1997–8. Presumably they had been removed during the later stages of excavation or backfilling in 1979, along with virtually all trace of the outlet for drain M14:07/10. The loss of these features inevitably affected the 1997–8 excavators' understanding of AM2 which is reflected in the differences between their published plans and the interpretation of the building proposed here (cf. Hodgson 2003, 109–112).

Arrangements in the east room were more obscure because so much of the later levels had been removed by post-Roman disturbance, but it is clear that the floor level here stepped down from that in the west room and was roughly level with the bottom of the opening in wall M14:18. In the south-west corner of the room the fragmentary remnants of a flagged floor did survive (N14:09), and included the apparent remains of a hearth (M14:22, N14:07) situated beside the partition wall, opposite the vent. The hearth was made up of scorched flags, burnt and shattered tiles and burnt earth, with the east side of the partition wall also showing signs of scorching. In the context record (N14:07) it was suggested that the tiles might represent an earlier phase of the hearth which was subsequently replaced by the flags. The flagging and hearth sat on a layer of mid-brown/grey soil, containing much silt, ash, charcoal staining and coal (N14:22–23, M14:37?), which was interpreted by the excavators as suggesting a period of abandonment between this phase and the previous one. This layer extended over the southern arm of the earlier cruciform arrangement of stable drains associated with the decurion's quarters of Period 3 and/or 4 (AM1).

The T-shaped arrangement of channels in the west room of AM2 was initially interpreted in the context record as a network of drains, however Moffat considered that they represented the remains of a channel hypocaust. This debate persisted in the written summary in 1984–9 research archive. Interpretation as a system of drains would be consistent with the general pattern in the *retentura* cavalry barracks, with a sump being retained in the decurion's quarters of the Chalet barrack 9 (Chalet W), for example, but there are a number of strong objections to its acceptance in this case. The only outlet for a system of drains is the opening midway along partition wall M14:18 which would have discharged the effluent from the west room into the east room. It is unclear how the effluent would have been dealt with thereafter. The most logical course would have been to release it



Figure 16.36: Successive phases of the west wall of the officer's quarters with final chalet period rebuilding evident (AM2), looking south

via the channels of the earlier cruciform network of drains in AM1 – probably the western and northern arms. However channel M14:10 and the associated opening in wall M14:18 were not actually in line with the western branch of the earlier cruciform drains, being offset to the south, which would obviously have complicated any continuous flow through the outlet and down into the channel in the east room. Moreover it is not clear that the drains in the west room were still in use at all. Site plan P186 hints that they may have been backfilled and overlain by flagged floor N14:09, but the destruction wrought by the colliery trackway makes certainty impossible.

Most compelling of all, however, is the position of hearth M14:22/N14:07 right beside the opening in wall M14:18. This would appear to be incompatible with the interpretation of the opening as a drain outlet and it was presumably this which convinced Moffat that the various stone-lined channels in AM and the earlier Building 12 decurion's quarters were actually components of a channel hypocaust rather than a system of stable drains or latrines. In this case the outlet would actually represent a stokehole and flue for the hypocaust and the hearth and other traces of burning could be explained as the residue



Figure 16.37: Chalet Range 12 officer's quarters (AM2) with the opening for the hypocaust flue visible in rebuilt wall M14:18



Figure 16.38: The T-shaped channel hypocaust in the western half of AM2 looking south west.

of a firing area. The research archive summary notes make reference to Moffat's recollection of areas of burning and burnt stones running through the medial wall plus the discovery of hypocaust-type construction materials (i.e. bricks and box tiles) in this area, though there is no explicit record of this in the context records, other than the burnt flagstones and hearth materials noted above and the reference to scorching on wall M14:18. It is noteworthy that hypocaust heating systems are introduced into the officer's quarters in later barracks at some northern frontier forts. Cruciform channel hypocausts fired from an adjoining room figure in the officer's quarters of the Period 7 barracks at South Shields, probably erected between c. AD 286 and AD 312 (Hodgson 2009, 69–70; Hodgson and Bidwell 2004, 131–2, fig. 7), and a pillared hypocaust chamber was recognised in the centurion's quarters of the fourth-century Chalet barrack XIII at Housesteads (Rushworth 2009a, 151, fig. 6.7). The system of channels in AM2 may therefore form part of that trend.

The interpretation of these channels is clearly critical to understanding the function of the rooms

in AM2. If the channels in the west room were in fact drains, the position of the outlet in the medial wall should mean that at least some of the earlier channels remained in use in the east room as well, implying that both rooms of AM2 were used as stable accommodation. Thus the construction of AL2 and AM2 might have been intended to separate off the officer's living accommodation (AL2?) from the stable (AM2). Conversely, if the channels functioned as a hypocaust, as appears more likely, the inclusion of such an elaborate domestic feature would represent confirmation of the continued presence of the decurion at this end of the barrack range. Moreover the existence of a hearth in the east room would appear to rule out the presence of horses there as well. It must be admitted, however, that nothing is known regarding arrangements at the east end of AM2, all contemporary levels having been destroyed and it is possible that this area could have been partitioned off for stabling.

FINDS

Chalet Range 12 – initial phase

AH, initial phase

Copper alloy: belt plate (no. 149, L14:07)

Quern: beehive (no. 10, L14:07)

AJ, initial phase

Decorated samian: c.150–80 (no. D107, L14:10)

Quern: (no. 11, L14:09)

AL1, initial phase

Decorated samian: c.160–90 (no. D117, M14:39)

Samian stamp: mid to late Antonine (no. S131, M14:38)

Copper alloy: plumb-bob (no. 202, M14:39), loop (no. 372, M14:42)

Iron: pattern-welded blade (no. 18, M14:39)

AM1, initial phase

Decorated samian: c.160–90 (no. D129/S31, N14:02)

Samian stamp: see above (no. S31/D129, N14:02)

AL/AM – first alterations

AM1, first alterations

Bone: pin (no. 15, M14:46)

Later remodelling of the east end of Range 12

AL2, later remodelling

Decorated samian: c.150–80 (no. D131, N15:12)

Samian stamp: illegible (no. S143, N14:37)

Graffito: samian (no. 68, N14:37)

Copper alloy: pin (no. 119, M15:21)

Iron: hobnails (no. 76, M14:04)

Pottery: spindle-whorl (no. 47, M15:21)

Stone: whetstone (no. 25, M15:21)

AM2, later remodelling

Decorated samian: c.125–45 (no. D122, N14:23), c.160–90 (no. D129/S31, N14:02)

Samian stamp: c.170–200 (no. S5, M14:45), see above (no. S31/D129, N14:02)

Glass: vessel (no. 40, M14:11)

Coin: M. Aurelius/Commodus?, 160–92 (no. 289, N14:22)

Copper alloy: mount (no. 238, M14:11), sheet (no. 308, M14:11)

Bone: counter (no. 55, M14:11)

Glass: bead (no. 14, M14:12)

Stone: spindle-whorl (no. 34, M14:11)

Post-Roman?

AJ, robber trench

Copper alloy: stud (no. 230, L14:20)

Dating evidence

Initial chalet phase

Some of the pottery groups from these contexts are no longer complete, with only the rims surviving for some or all fabrics. It is unclear how much has been lost. The most common type of pottery is BB2 and south-east reduced ware, including two G151 rims of third-century date. The loam layer in AL1 contained a Lower Nene Valley mortarium rim drilled for repair, dating to after 250 (M14:39) (unsealed context). The same room produced half a stamped form 31R bowl of mid to late Antonine date placed next to one wall (M14:38; see samian stamps no S131). One of the largest groups of pottery (0.240kg) came from the clay foundation of the south wall (M15:13). Most of this was BB2, with only one sherd of south-east reduced ware, and two sherds of third-century Nene Valley colour-coated ware.

AL/AM first alterations

The alterations produced only a small group of pottery (M14:44, 46–47), no later in date than the initial phase.

Later remodelling of the east end of Range 12

AM2

The pottery included BB2 and a smaller quantity of south-east reduced ware, but nothing later in date than in the initial phase. The largest group (M14:11) was made up of 50% BB2, and contained a Nene Valley colour-coated ware funnel-necked beaker of the second quarter of the third century or later.

AL2

Pottery from make-up layer M14:13 consisted of 60% BB2 and allied fabrics, and included a third-century cupped jar rim from one of the Yorkshire industries. The coarse wares of M15:21, part of the same layer,

were made up of 70% BB2 and a little south-east reduced ware, plus a sherd of a BB1 cooking pot with obtuse-angled lattice with a groove above, dating to after the middle of the third century. There was a possible Catterick mortarium rim of the third century in N14:20 (but just a flake, and hence unreliable for dating purposes), and an incomplete Mancetter-Hartshill mortarium rim dated 250–320 (M15:21). The pottery from context N14:20 (0.419kg), the north wall foundation of AL2, was made up of 77% BB2 and allied fabrics, and included a single rim sherd of a Crambeck reduced ware jar dated to the late third century or later as well as the possible Catterick mortarium. In or over this wall foundation were a large number of sherds from the lower half of a cooking pot in late gritty grey ware, probably also late third century or later in date (N14:19).

Discussion

The dateable material suggests a third-century date for the construction of Chalet Range 12, like the other chalet barracks in the *retentura*. The very limited amount of diagnostic pottery which might imply a mid-third-century date derived from an unsealed context.

Crambeck reduced ware was found in the foundations of the north wall of AL2 (e) (N14:20) whilst Mancetter-Hartshill mortaria, which could be no earlier in date than c. 250, was recovered from the clay floor of the same chalet (M15:21). This could provide a later *terminus post quem* for the final modifications to the buildings at the east end of the range – AL2 and AM2 – but again neither context was sealed.

The *via quintana* (Road 3)

The construction of Chalet Range 12 was contemporary with a resurfacing of the *via quintana* to the north. The new surface was composed of small worn cobbles (K13:22, K14:15, L13:02, L14:04, M14:41), ranging between 0.03m and 0.20m in diameter, but averaging 0.05m to 0.10m in diameter. This was bedded on a makeup level of rubble and yellow-grey clay. The road surface uncovered north of AM 1 (w), described as a 'rough stone surface' (M14:62), should also be the equivalent level to M14:41, but no actual stratigraphic proof was observed.

A further possible road level (M14:28) was recorded over the surface described above. This was present to the north and west of the chalets belonging to the subsequent phase (AL 2 (w), AM 2) and consisted of irregular sandstone fragments and river cobbles in a mixed dark brown/grey soil. It was initially considered to represent debris over the previous road surface, but was later reinterpreted as the probable remains of an actual street surface.

FINDS

Road 3 – *via quintana* a

Architectural stone: phallic symbol (no. 5, K14:15)
Copper alloy: hinge (no. 164, K14:15), fitting (no. 249, M14:41), six tiny studs (no. 287, K14:15)

Dating evidence

The road produced less than 25 sherds of pottery (contexts K14:15, M14:41, 62). BB2 and allied fabrics make up 69% of the coarse wares, indicative of a third-century date.

The third-century cavalry barracks in context

The four third-century barrack ranges at in the *retentura* at Wallsend are currently unique, as cavalry chalet-barracks, that is to say cavalry accommodation taking the form of ranges of structurally independent components – *contubernia* and officer's quarters. The chalet-barracks examined by other recently published, modern excavations, notably Buildings XIII and XIV at Housesteads (Rushworth 2009, 114–33, 149–71) and perhaps the final barrack phases in the north-west quadrant at Birdoswald (Wilmott *et al* 2009, 241–50), were clearly designed to accommodate infantry. Similarly the back-to-back chalets investigated at Vindolanda in 1980 (Bidwell 1985), which form the clearest parallel for the back-to-back arrangement proposed by Hodgson in relation to Chalet Ranges 11 and 12, probably housed infantry *centuriae*. The parallel with third-century cavalry barracks identified at Haltonchesters has been highlighted (Hodgson 2003, 119–20; Hodgson and Bidwell 2004, 151–3), but these were clearly blocks composed of *contubernia* conjoined in the traditional manner with two of the four blocks arranged back-to-back (Fig. 16.39). The urine channels or sumps in their front rooms have been convincingly identified and the Haltonchesters barracks probably featured a reduced number of *contubernia* (perhaps between six and eight), but they may eventually prove to be relatively little different from the earlier/second-century barrack blocks – again commonly laid out back-to-back – known in forts presumed to have held cavalry, such as Benwell or Chesters. Walls belonging to a secondary phase in the most southerly of the barrack blocks in the north-east quadrant at Chesters could conceivably represent part of a chalet-barrack range, but the layout is too incomplete and uncertain to enable even a hypothetical restoration of the plan.

Differences of interpretation regarding the detailed layout of the Wallsend chalet ranges, particularly in relation to 11 and 12, were proposed in the foregoing description and analysis of the remains (Fig. 16.40). However these don't materially affect the overall interpretation of the structures as cavalry barracks,

designed to house *turmae* of regular cavalrymen, proposed by Hodgson in the 1997–8 excavation report (2003, 115–18). The basic similarity between the internal features of the chalet-*contubernia* and those of the second-century stable-barrack *contubernia* – the two room layout with the drain in the front room – are compelling in this regard and there is no reason to identify freestanding chalet-*contubernia* as the homes of individual soldiers and their families, as originally suggested by Daniels (1980). The decision to adopt this form must have been influenced by other factors, perhaps a desire to make the individual components of barracks as independent as possible in order to facilitate the construction and repair of each individual *contubernium* by its own resident group of *contubernales*. This would be an extension of the trend for communal facilities within forts to be abandoned, with rampart back-ovens each serving an entire *centuria* being replaced by cooking facilities within the individual *contubernia* for example. Chalet-barracks, which lack a common overall roof might also have been more fireproof, at least in terms of better enabling the containment of a blaze within one *contubernium*. Whatever the perceived advantages of this building type, its adoption would tend to foster a process of minor *ad hoc* alterations within individual chalet-*contubernia* as each group of *contubernales* managed its living space.

Despite the impetus for autonomous structural alterations which the adoption of the chalet form may have provided, there is evidence that the ranges were subject to substantial replanning, perhaps later in the third century, which demonstrates that these barracks were still subject to a considerable measure of overall control and direction. This is clearest at the east end of 12, but occasional traces over 11 and the central section of 9 suggests rebuilding affected these ranges as well, in addition to the clear evidence for repeated alterations to the officers quarters in 9 and 10. The later arrangements at the east end of 12 are remarkably complex and different from the initial layout. It is only the superior preservation in this area which allows us to restore it. It is conceivable that the ultimate layout in other parts of the *retentura* – in parts of 9 and 11 for example – was similarly complex, but there the later remains survived as little more than scattered fragments and the remodelled layout cannot be restored to any satisfactory degree.

Finally one issue raised by Hodgson requires further comment. The four chalet ranges were all characterised by a marked reduction in the number of the constituent *contubernia* by comparison with the equivalent barracks of the second century. Whereas the latter each had nine Chalet-Ranges 9 and 10 comprised only five *contubernia* apiece, alongside the decurion's quarters. Ranges 11 and 12 may initially have had six *contubernia* each, although Hodgson (2003, 101–4, 109, 118) argued that there were only five *contubernia* each

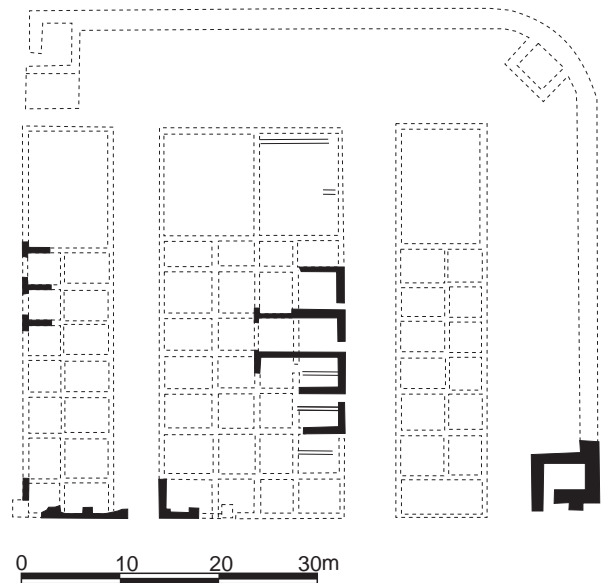

Figure 16.39: Third-century stable-barracks at Haltonchesters (1:750), as interpreted by Hodgson 2003, fig 84.2, revising Simpson and Richard 1937, fig 5.

in Chalet-Ranges 11 and 12 with the area of the sixth absorbed by enlarged decurion's houses. Certainly arrangements at the east end of those two ranges, next to the decurion's houses, are very obscure, due to the impact of later alterations, and, even if it was not the case at the outset, there are indications that their officer's quarters did subsequently extend westwards to incorporate those areas which could initially have been occupied by a sixth *contubernium*. This could imply a marked reduction in the strength of each *turma* by as much as a third or more, to 15–18 men, plus officers, giving a total figure for the cohort's cavalry component of 60–70 *equites* plus perhaps up to a dozen officers.

Hodgson, however, (2003, 119–20) has argued this reduction was more apparent than real, suggesting that a smaller number of *contubernia* could have been compensated for by a corresponding increase in the number of troopers in each individual *contubernium*, perhaps rising to as many as six men and horses per squad. His argument is based on the larger size of the chalet-*contubernia*, with respect to their earlier, barrack block counterparts, and on the appearance of the rank of *hexarchus* or *exarchus* (commander of six) amongst the junior officer ranks of the late Roman army. He further suggests that around 120 men may have been regarded as the minimum size for a tactically effective cavalry unit.

The overall size of the third-century garrison is considered more broadly in Chapter 2. It is worth noting here that this argument must be viewed with just as much caution as former suggestions that the size of the late Roman army in Britain was drastically

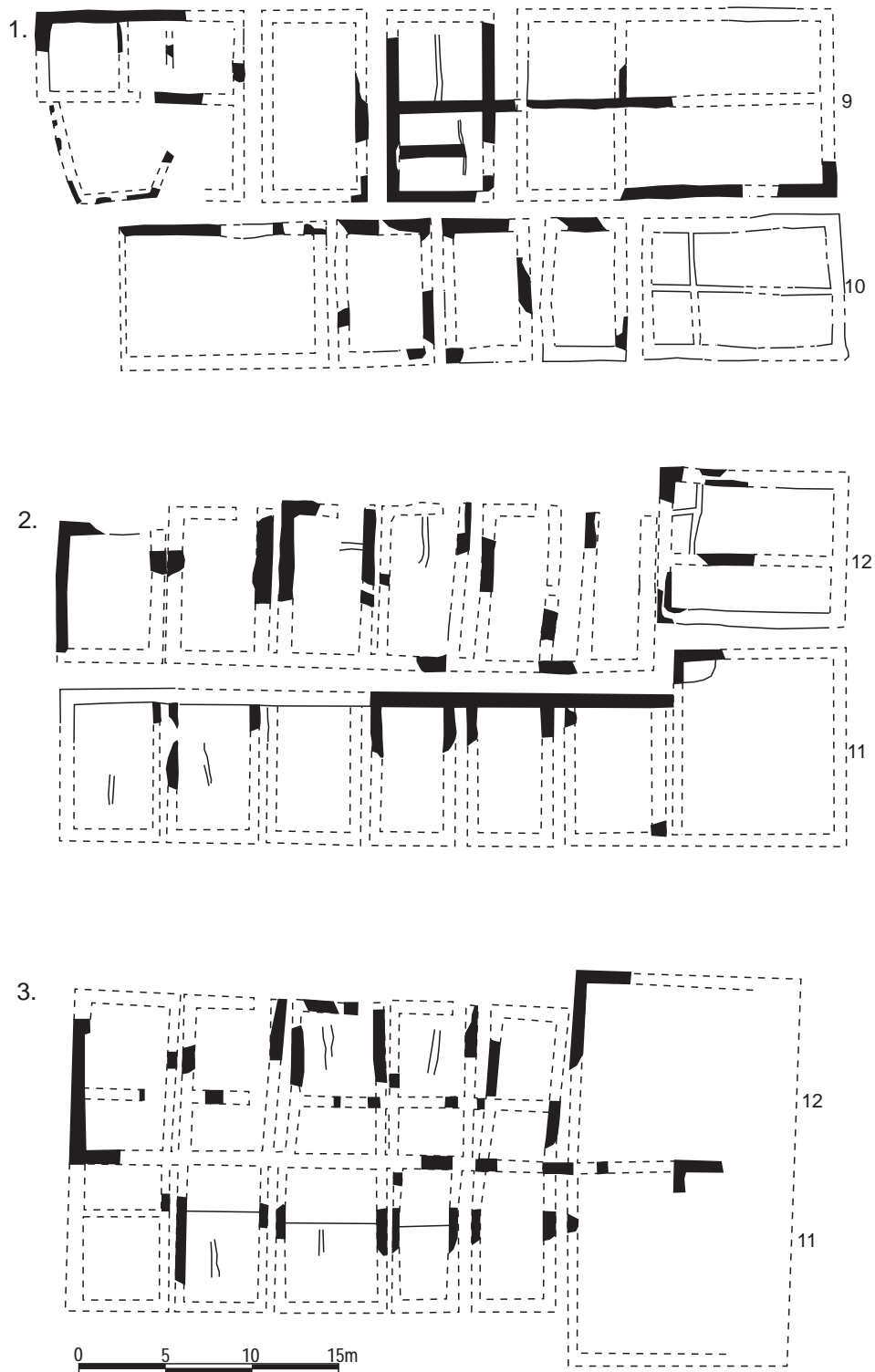

Figure 16.40: Third-century barracks at Wallsend: 1. Chalet-barracks 9 and 10; 2. Chalet-barracks 11 and 12 as restored here; 3. 11 and 12 as restored in Hodgson 2003, fig 77.1. Scale 1:400.

reduced with chalets housing an individual soldier's household. The *contubernia* of Chalet-Range 9 do appear to have significantly greater internal space than their predecessors in Barrack Block 9, this can perhaps be explained by the building's place within

the sequence of reconstruction, as outlined above. The chalet-*contubernia* of Range 10, on the other hand do not appear to have been any longer than those of Barrack Block 10 since, as far as can be gauged, the chalet range occupied the same footprint as the barrack

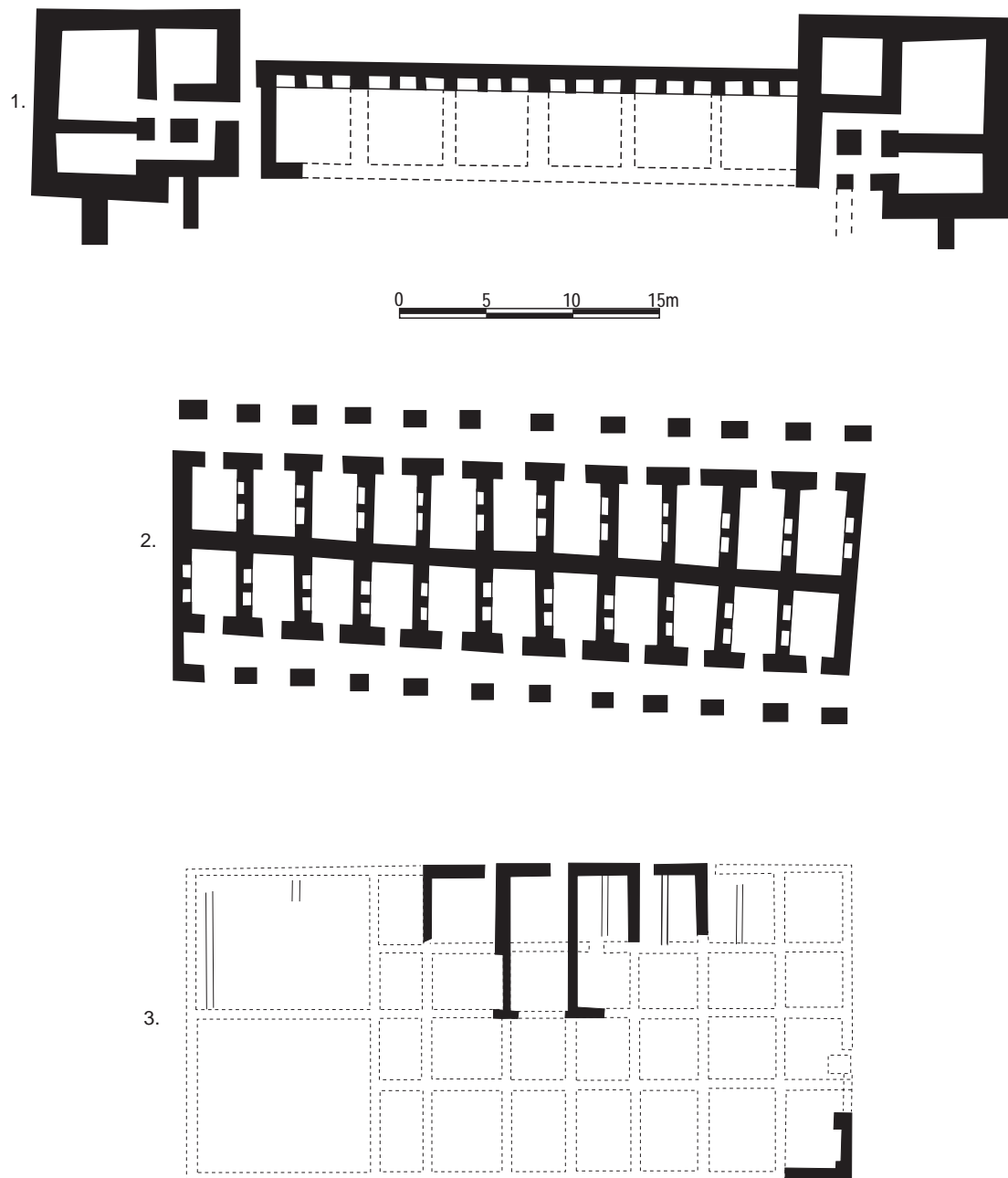

Figure 4 Late Roman cavalry barracks 1 Qasr Bsh r 2 B B – two storey barrack range against the north curtain, 2 Tim d B B back to back, two storey barracks, 3 Haltonchester's single storey back to back barracks. Scale 0

block, nor were they even any wider in some cases. As regards Ranges 11 and 12, no partitions separating the front and rear rooms survived, as is evident from the Daniels excavation record, nor did any of the frontages of Range 11. The chalet-*contubernia* in Range 11 appear to have been a little wider than their barrack block predecessors, but little else can be said without the risk of generating a circular argument, since there are so many uncertainties with regard to the range's overall plan, whilst those in Range 12 were sometimes a little wider, sometimes a little longer, sometimes both. In general, therefore, the *contubernia* in the chalet-barracks appear to have been somewhat

larger than their barrack block predecessors – though not always, as exemplified by the case of Range 10 – but, with the possible exception of Range 9, this does not appear sufficient to permit a doubling of the number of horses stabled. More fundamentally the hypothesis assumes that more space must equate to a larger complement of men and horses. This was not necessarily the case. The size of accommodation provided for the *contubernia* of broadly similar units could vary greatly (cf. Figs 14.34–14.35 above relating to third-century infantry barracks at a variety of sites). Indeed a smaller garrison, with the same overall area available as previously, might simply choose to

furnish itself with more spacious accommodation, particularly where this might yield benefits in terms of improving stabling arrangements for cavalry horses.

Furthermore, it is not clear how relevant the new officer ranks are to this question. There is no evidence that they supplanted the longstanding of officer ranks of the traditional auxiliary cohorts and *alae*. Instead they relate to the new-style regiments, such as the cavalry *vexillationes* which first came into existence during second half of the third century, units which figure on inscriptions of Tetrarchic and later date, with titles such *numerus equitum scutariorum*, *equites Dalmatae* or *equites Stablesiani* (see Hoffmann 1969, 247–279 for general discussion of these late Roman cavalry; cf. AE 1916, 7–8, Sitifis: *Val(erio) Dalmatio exarco equit[um] stablesianorum*; AE 1937, 35, Thamallula: *Dm s . Aurelius Veritus eques stablisanorum (!) ... Aurelius Vitalis exarqus contubernali memoriam fecit*). Moreover if the rank of *exarchus* is recorded so too is that of *biarchus* (commander of two) and it is a substantial leap from official title to *contubernium* strength (cf. AE 1946, 42, Timgad: *Valerius Vincentius biarcus de nu[m(ero)] iscutarior[um]*).

It is conceivable that in late Roman cavalry *vexillationes* each pair of *contubernia* was placed under a *hexarchus*, residing in one of the *contubernia*, with a *biarchus* (commander of two plus himself?) as his subordinate in the other *contubernium*. Alternatively, where two-man cavalry *contubernia* prevailed (see below), the *hexarchus* may have been the senior cavalryman for every three *contubernia* with a subordinate *biarchus* being nominated as senior *equus* in each of the other two *contubernia* in the grouping.

Crucially the structural evidence from newly built late Roman cavalry forts suggests that three- or even two-man *contubernia* prevailed (Fig.16.41). Thus the ground floor stable rooms in the two-storey *contubernia* in the Tetrarchic fort of Qasr Bshir (Praetorium Mobeni) contain three stone feeding troughs per room (Isaac 1990, 203 fig. 12), implying the complement of a *contubernium* was unchanged at this stage. The equivalent rooms in the sixth-century fort at Timgad generally contain only two such mangers

(Lassus 1981, 169–214 esp figs 134–6; Pringle 1981, 85–8, 235–6, 547 fig. 2, pl XIb) which may signify that its strength had actually diminished over the intervening timespan. The ground floor rooms in the east range of Qasr Bshir are 3.40–3.50m wide and 5.30 long internally, whilst those in the north range are squarer in proportion, being both shallower in length from front to rear (4.20m) and wider at 4.20–4.50m. The barrack blocks at Timgad also varied with respect to the internal dimensions of their ground floor (stabling) rooms, 3.60m × 2.60m, 5.00m × 2.60m and 3.90m × 2.60m being typical examples. The generally smaller dimensions of Timgad by comparison with Qasr Bshir may reflect the fact that only two horses were being stabled in each room as opposed to three in the earlier fort. The essential point is that these dimensions are broadly comparable with the front rooms of the cavalry chalet-barracks at Wallsend and there is no need to postulate a reorganisation of the internal composition of the *turmae* to account for their greater size by comparison with the stable-barracks of the second-early third century. Indeed, such is the variability in the size of barrack *contubernia* in different forts, in all periods, that it would appear unwise to base any argument on one group being larger or smaller than another.

Coupled with the evidence for a reduction in the strength of the cohort's infantry component, reflected in the rebuilding of the barracks in the northern part of the fort (see Chapter 14), it is preferable to regard the reduced number of cavalry barrack *contubernia* as a further indication of a general, though not precipitous, decline in the size of the auxiliary garrison.

Note

- 1 This building was not assigned an identifying letter code or number by Daniels. It was given the code ET by the 1997–8 excavators and that designation is retained here for consistency. In their published work (Hodgson 2003), however, the 1997–8 excavators generally referred to the structure as *Contubernium* 3 of Period 4 Barrack IX.

PART 5

THE DEFENCES

17. THE WESTERN DEFENCES, INTERVALLUM ROAD AND HADRIAN'S WALL

The stretch of the western defences incorporating the south tower of the west gate (*porta principalis sinistra*), the junction with Hadrian's Wall to the west, and the adjoining 25m section of curtain wall and rampart to the south, was excavated in 1983 as part of Site 17 (Fig. 17.01). The adjoining levels of the *intervallum* road are described in Chapter 7 along with the open area to the east labelled the Assembly Area, with its large cistern in the centre (Cistern 1), and western stretch of the *via principalis* leading towards the gate.

The degree of structural preservation in this part of the western defences varied considerably. Much of the fort's curtain wall had been robbed out leaving only two sections of surviving masonry, each c. 3m in length, adjoining the gatetower and opposite the north end of the hospital, whilst a large, modern intrusion (D08:11) had cut away the east and south-east sides of the gatetower, removing the tower's internal floor levels and wall masonry and exposing its rubble-filled foundation trenches.

Hadrian's wall and the area outside the fort

Grid squares: C7, D7

Hadrian's Wall

Hadrian's Wall was already known to run up to the west gate and attach itself to the front of the south tower following investigation led by F. G. Simpson on behalf of the North of England Excavation Committee in 1929. This work, undertaken with the collaboration of Wallsend Corporation, remarkably involved tunnelling under the surface of Buddle Street and demonstrated that the north face of the Wall and the north face of the tower formed one continuous line, tower and wall being bonded together (see Spain & Simpson 1930, 488, 493, and fig 7; reproduced below

as Fig. 17.04). The unusual nature of this arrangement was noted, it being more normal for the Wall to meet fort gate facades at about the middle of the south tower. Also noteworthy was the 'exceptionally massive masonry', consisting of very large, neatly squared stone blocks, standing two courses high, which made up the surviving north face of the Wall at this point.

Only a relatively limited stretch of the Wall adjoining the west side of the fort was available for investigation in 1983–4, comprising 5.40m of its south face. The exposed remains were bounded by Buddle Street, to the north, and narrowed from east to west due to the angle at which the street intersected with the line of the Wall. The Wall's north face, still covered by the pavement and carriageway of Buddle Street, was not re-examined, although the east end of F.G. Simpson's tunnel was encountered (D07:04).

The Wall's foundations were exposed at the very end of the excavations, during late March 1984, when the Wall and its junction with the tower was re-examined more thoroughly (work in this area having initially ceased around the beginning of November 1983). This involved undertaking deeper excavation along the 2m stretch of the Wall next to the gatetower in order to fully reveal the cobbled foundations. Unfortunately no photographs would seem to have been taken of the Wall foundations uncovered at this late stage. Certainly none are preserved in the archive, the remains being recorded in plan and context record only (site plan P422). Two main levels appear to be shown on the site plan, comprising a cobbled foundation raft and an overlying footing course (Fig. 17.02). The foundation level (D07:37) shown on the site plan appeared to be composed of large rounded cobbles, up to 0.35m in length and 0.25m wide, packed with clay (as reported in the excavator's summary notes for 1983–4). Based on the known position of the Wall's north face, these foundations must have been



Figure 10. Period 1 and 2 features associated with Hadrian's Wall, the west gate, western defences, and the intervallum at 10. The third-century pits are also shown.

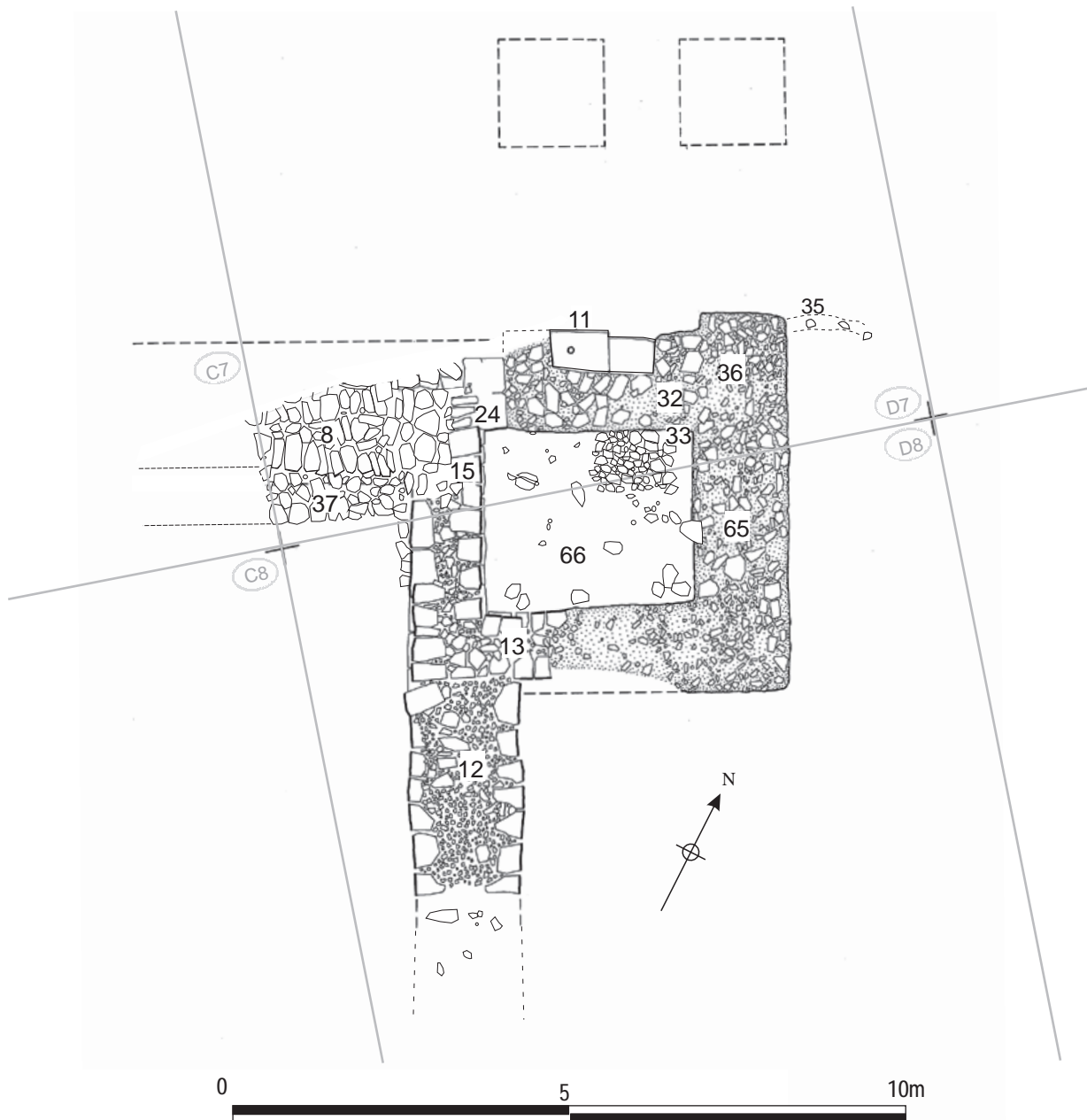

Figure 17.02: West gate south guardchamber primary floor foundation levels at 1:100.

c. 2.70–2.80m or as much as 9 feet or more wide. This course may have been continuous with an equivalent layer beneath the gatetower and fort curtain. A line of similarly sized cobblestones, apparently of one build with the Wall foundations, can be seen on site plan P422, extending southward for 1m along the outer face of the tower's west wall, in the area where the excavations were taken deeper.

Sitting on top of the lower foundation course was a further layer of rubble and cobbles (D07:08). This is designated a footing course here to distinguish it from the underlying foundations. However it was not faced with dressed stones. Instead its exposed southern edge was only roughly faced with narrow, often wedge-shaped stones which were keyed back

into the wall core and at least some of which may have been pitched (perhaps implied by the reference in the 1983–4 summary notes to 'pitching of big stones on clay and cobble (big) foundation'). Some stones are clearly shown overlapping others on site plan P422. Moreover the footing layer was deeply offset along its southern side. This offset was some 0.50m wide next to the gatetower, increasing to as much as 0.80m to the west, where the underlying foundations appeared to spread out further towards the south. The normal width of the footing course, from its north face to the extant southern edge can be estimated at 1.85–2.00m. This layer in turn was capped by firmly packed clay (see Fig. 17.03).

Overlying course D07:08, the tails of five blocks,



Figure 17.03: The line of Hadrian's Wall joining the west gate, from the west. The clay cap is visible over the foundations which are not yet properly exposed.

which probably belonging to the north face of the Wall curtain, were evident, protruding from the section along the northern edge of the site (treated as part of D07:08).

Discussion

The stretch of Wall directly adjoining the west gate, revealed in the 1929 and 1983–4 excavations, displays certain unusual features which require further consideration. The footing course on the south side was characterised by a very wide offset over the cobbled foundations and was only roughly faced, whereas the north side was faced with very substantial, neatly dressed blocks, set on a rubble/cobble footing or foundation which can be seen protruding northward perhaps 0.10–0.15m in F. G. Simpson's photograph of the tunnel excavated beneath Buddle Street (Fig. 17.04). Two courses of the stone blocks survived, the upper being set back slightly. The dimensions of the stone blocks are not recorded in the published description, but the height of each course can be roughly estimated at perhaps 0.45m–0.50m by reference to the shovel appearing in the background of the photograph.



Figure 17.04: Hadrian's Wall curtain at the point where it joins the west gate, looking east. Seen in the tunnel beneath Buddle Street excavated by F. G. Simpson in 1929 (Simpson et al. 1930, fig. 7).

The use of large stone blocks in the north face of the Wall and the positioning of that face in line with the north face of the gatetower presumably reflect a desire to integrate Wall and gate into a single, harmonious scheme, with the massive dressed stonework of the Wall facing simply forming a continuation of the blockwork of the west gate. The broad offset between the foundations (D07:37) and presumed footing course (D07:08) on the south side probably signifies either an alteration to the original plan or a later complete rebuild of the wall from the foundation level upwards with footing course D07:08 representing new foundations. D07:08 was perhaps equivalent to the cobble and rubble footings seen protruding from beneath the stone blocks of the north face in 1929, whilst underlying clay and cobble foundations D07:37 may have followed a different line, with the full width of the foundations perhaps not actually extending as far as the Wall's extant north face.

This last point cannot be proved on the basis of the available evidence. However, the southern edges of the foundation course and the footing course certainly did not run parallel with one another, the south face of the cobbled foundations instead diverging southwards at an oblique angle to the edge of the footing course (see Fig. 17.02), and this too would be consistent with their belonging to two separate schemes for the layout of Wall and gateway.

Outside the fort

A grey silty clay level (C07:04, C08:13) was exposed at the bottom of the stratigraphic sequence outside the fort, in the angle between Hadrian's Wall and the curtain wall and south guardchamber of the west gate. This was identified as the pre-fort ground level the layer universally labelled 'old ground surface'

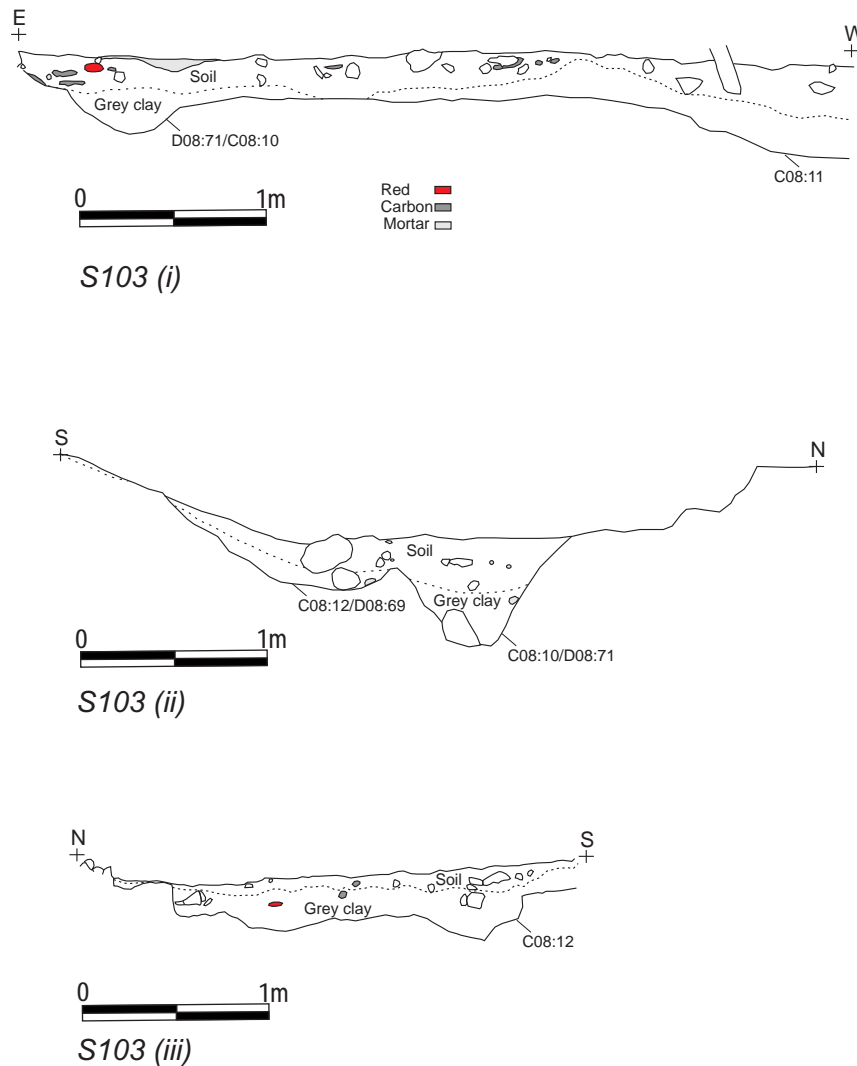

Figure 17.05: Section 103 (i-iii) across the pits outside the fort, in the angle between Hadrian's Wall and the fort curtain, (grid squares C7, C8, D7 and D8). Scale 1:40.

or 'OGS' in the excavation archive. To the south, along the narrow strip of berm exposed next to the remains of the fort curtain wall, the equivalent ground surface was described as a mid-brown loamy surface with patches of grey fine silt and sand (D08:68). This level was also recognised across a wide area inside the fort. Further south still, the surface of the berm reportedly consisted of yellow clay (C09:08), perhaps a boulder clay subsoil, and, beyond that, a mid-grey clay silt (C10:09). This was overlain only by deposits of scattered rubble in dark soil (C09:06, 09, C10:04), the result of modern disturbance. The silty clay in the angle between the fort and the Wall was probably cut by the foundations of Hadrian's Wall (D07:37), although the context records and site plans do not explicitly confirm this.

Two pits (C08:11; C08:10/D08:71) and a possible linear slot or gully (C08:12/D08:69) were situated in a depression on the south side of the Wall, opposite the guardchamber (Fig. 17.01). Pit C08:10/D08:71 was oval in plan, measuring 2.35m by 1.00m and

narrowing very slightly midway along its length. Its long axis was aligned east-west, parallel with Hadrian's Wall and perpendicular to the fort wall. The pit was 0.60m deep, with a V-shaped profile (see Fig. 17.05 – Section 103/2), and was filled by a series of deposits: two large stones, c. 0.25m in diameter, lay at the bottom of the pit in a grey-brown silt with traces of coal (C08:10/D08:59). This was overlain by a layer of redeposited brownish grey clay (C08:09/D08:58), containing scattered stones and small amounts of bone, which in its turn was completely covered by a spread of 'black carbon' (charcoal/coal?) some 40mm thick, with pottery and a few bones intermixed (C08:08/D08:57). The uppermost fill consisted of grey silty clay (C08:07/D08:56) incorporating shell remnants and a few bones.

A linear cut feature (C08:12/D08:69), 2.9m in length, lay immediately to the south of pit C08:10/D08:71, on a parallel alignment. This extended slightly further to the west and was dumbbell-shaped in plan, measuring 0.5m across at its midpoint, widening out

to 0.75m towards the eastern end, where it was some 0.3m deep, and 1.0m in width at the western end, where the depth of the feature was 0.4m (see Fig. 17.05 – Section 103/2–3). On its south side, the ground level was higher, sloping up as much as 0.7m from the base of the slot. The base was lined with yellow clay and the fill, which may have been the same as layer C08:06/D08:45, contained Black Burnished Ware pottery and bones.

Pit C08:11 lay furthest to the west, on the edge of the excavated area, with the result that only its north-east corner was revealed. The outer lip of this ditch traced a roughly square outline in plan, the exposed area measuring c. 1.6m by 1.3m, but the eastern edge was relatively shallow with a rather irregular and deeper cut within it some 0.40–1.10m from the edge. It was filled with a layer of carbonised material (charcoal/coal?) and clay in a dark grey silt and contained Roman pottery, tile and bone (all fill material was treated as C08:11).

The grey silty clay (C08:13) and mid-brown loamy material (D08:68) forming the surface of the berm, alongside the west curtain wall, was covered by a layer of fine, rich, dark brown soil (C08:06/D08:45), resembling a garden soil. This contained traces of yellow-orange or reddy yellow soil, small stones and black and white shell remnants, and was reportedly 'surrounded by' thicker yellow clay with more shell waste (D08:45), though the meaning of this is not altogether clear. The fills of pit/slot features C08:10/D08:71 and C08:12/D08:69 may also have been covered by or in the latter case essentially identical to this dark brown soil, although the records are somewhat contradictory (pit C08:10/D08:71 was recorded as cutting C08:06/D08:45, but the pits upper fills were also said to underlie the dark soil).

The pits and midden deposits were in turn covered by a spread of light brown fine grained loam soil (C08:03/D08:03), containing abundant mortar grains and lenses and interspersed with stones of varying sizes and tile fragments. This layer, which may conceivably have been truncated by later activity, should perhaps be interpreted as the residue of the collapse or demolition of the Roman structures and may also be equivalent to the light yellow sandy soil (C07:03) recorded in grid square C07. This was overlain by an oval spread of black loamy soil (C08:02/D08:06), 2.80m long (E-W) by 1.20m wide (N-S), which contained abundant coal fragments, occasional pebbles and small stones. It is not clear whether these spreads did in fact represent intact Roman levels. Layer C08:03/D08:03 could perhaps be interpreted as the residue of the collapse or demolition of the Roman structures, whilst C08:02/D08:06 might represent a modern deposit, or at any rate have been contaminated by modern material, rather than represent a midden deposit as suggested in the context database. There

are even some indications of a degree of confusion in assigning context numbers to features on site and it is possible that the description provided on context sheets C08:02/D08:06 may actually have related to the robber trench for Hadrian's Wall and the outer face of the fort wall, for which the correct context numbers were C07:02/D07:16/D08:15.

Interpretation

The pits and overlying deposits examined in the area of the berm to the south of Hadrian's Wall were interpreted as features associated with the dumping of rubbish from the fort. The two pits were described in the context database as 'midden pits', that is to say rubbish pits (midden surely implies a mound). There was less certainty with regard to the linear cut (C08:12/D08:69), that is to say whether it should simply be interpreted as another pit or as some kind of post trench or slot. The dumbbell shaped plan of the feature might suggest that it originally contained posts set at either end with smaller timbers or fencing filling the intervening slot, although no packing stones were identified and certainly no trace of in situ post pipes so it remains open to interpretation. However, if this feature originally had some other function, such as defensive, it raises the possibility that the other pits also began life as defensive features and were only later filled with rubbish. Indeed the V-shaped profile of pit C08:10/D08:71 might be consistent with such an interpretation. The backfilling of these features might simply have been a by product of the dumping of rubbish over this area, dumping represented by the fine, dark brown soil layer (C08:06/D08:45) which, as described, apparently resembled a well-composted soil. This material may indeed have formed a midden, though one perhaps levelled later on.

All these features were located on the berm between the west curtain wall of the fort and the defensive ditch. The width of the berm was established in 1929 as being 23 feet (c. 7.01m). Pit C08:11, despite only having been partially revealed at the edge of the excavated area, could not have formed part of that defensive ditch as its eastern edge lay only 4.1m from the fort wall and was in any case rather irregular. Arrangements of pits have been found on the berm of Hadrian's Wall, at Wallsend, Byker and Throckley, in recent years, which clearly formed an integral part of the Wall's defences (cf. Bidwell 2005 for an overview). These pits have been interpreted as *cippi*, designed to hold timber entanglements – roughly the equivalent of rolls of barbed wire, and are generally square or rectangular in plan, arranged in very regular patterns for maximum defensive effect. Thus these systems of obstacles do not greatly resemble the three pits exposed on the fort berm south of Hadrian's Wall, in 1983–4, which were all different one from another, and, hence, do not necessarily elucidate their function, although the possibility that some or all of the three

features originally had a defensive purpose cannot be altogether ruled out.

Robbing of Hadrian's Wall and the gate tower facing

The contexts associated with the robbing of Hadrian's Wall and the facing of the guardchamber are variously described: pebbly rubble in yellow soil (D07:16), also termed 'packing through double course of wall' in a context record supplementary note and 'gravel levelling' in the context database; very light sandy mortar fill with profusion of small stones (D08:15). The fill of trench C07:02 is not described.

FINDS

Pit C08:10/D08:71 (uppermost fill)

Coin: Constantine II, 326–8 (no. 184, C08:07)

Dating evidence

No dateable material was recovered from the stratified contexts associated with Hadrian's Wall. The material from the pits outside the fort implies a third-century date (perhaps late third-century) for their backfilling and the general rubbish dumping in that area.

Ground outside fort

The ground level outside the fort produced seven sherds of pottery (C09:08). One small sherd of a BB1 cooking pot with a groove probably also had obtuse angle lattice, dating it to the second half of the third century or later.

Midden layer?

The midden layer D08:45 produced only a small amount of pottery, most of which was BB2, but with a single sherd of Central Campanian amphora dating to after the mid-third century.

West rubbish pit

The pit produced six sherds of pottery, including a sherd of East Gaulish samian dating to the late second or first half of the third century, and third-century BB2 and allied fabrics (C08:11).

Pit C08:10/D08:71

The lowest fill (D08:59) contained approximately one-third of a grey ware lug-handled jar (of the type often used for collecting water) from Yorkshire, and a large piece of rim from a calcite-gritted ware everted rim cooking pot of the late third century or later. The rest of the fill of the pit contained little pottery (C08:09, D08:56–57), although there was a slightly worn coin of Constantine II dated 326–8 in an upper layer (C08:07).

The west gate and adjoining fort defences

The west gate (porta principalis sinistra)

Grid squares: D7, D8

The north guardchamber and most of the passageways of the fort's west gate (*porta principalis sinistra*) lay beneath Buddle Street. The south guardchamber was available for investigation, however, and was extensively excavated in 1983, the whole structure being labelled Gate 2 in the Daniels building numbering system.

The chamber formed the base of a tower flanking the double passageway and measured c. 5.50m (E-W) by 5.0m (N-S) externally and 3.20m (E-W) by 2.80m (N-S) internally (Figs 17.02, 17.06). The guardchamber had been badly affected by later robbing and disturbance. The internal levels along its east side and particularly in the south-east corner had been cut away by a broad modern intrusion (D08:11), whilst the north, east and south walls had been robbed down to their foundations along most of their length.

The foundation deposits were generally 1.5m wide (those for the south wall being narrower at 1.30–1.40m) and were composed of cobbles, 0.05–0.30m in diameter, set in thick dark brown to red patchy clay (D07:32, D08:65). The clay and cobblestones were covered by a further layer of light brown or red-brown clay (D07:31, D08:64) which was largely devoid of stones and formed a level bed for the masonry walling. The clay bedding was overlain in turn by light yellow crushed sandy mortar (D07:30, D08:63) which may represent the residue of the wall robbing (D07:29).

Two courses of masonry belonging to the tower's west wall and an adjoining 1.25m length of its south wall survived (D07:15, D08:13). The footing course of the west wall was 1.15m wide and was composed



Figure 17.06: The primary floor base and foundations of the west gate's south guard chamber.

of very substantial blocks measuring up to 0.70m in length and 0.40m wide with a mortared rubble core, whilst the second course was 1.0m wide with a narrow offset on either side. The south wall footing course was slightly narrower at 1.0m, whilst the second course was c. 0.90m wide, again with an offset on either side.

Two large well-dressed blocks belonging to the north wall were also still in place (D07:11), and would have formed part of the facing of the gate passageway. The larger block, some 0.90m long and 0.60m wide, featured a 0.20m deep pivot hole in its upper face and projected 0.08m further north than the smaller block surviving to its side which measured 0.60m by 0.50m. Judging from its position and its slight northward projection, the larger block probably formed part of the south respond for the outer (western) arch in the southern gate portal. The excavators suggested the block with the pivot hole may have been reused, but need not have been the case as the pivot hole is located at the appropriate spot. The footing of the arch respond would have probably have had another block to the west, which did not survive. The next courses would have been offset to the south and west of the pivot hole, the arched superstructure of the respond being much narrower than the footing and positioned to the west of the pivot hole so that the leaf of the gate could close against it. The cobble foundations of the corresponding inner (eastern) respond (D07:36) projected 0.30m north of the edge of the main north wall foundations (D07:31–2).

The possible remains of a narrow drain channel (D07:35), robbed and backfilled, were traced in the form of a 0.15–0.25m wide linear feature, filled with light yellow brown clay, which ran from the north-east corner of the gatetower for some 1.25m, part way across the *intervallum* road towards the main north-south aligned drain conduit.

Interior

THE EARLIEST LEVELS (Figs 17.02, 17.06)

Several floor levels were preserved in the interior of the gatetower. Only the lowest of these survived across the entire interior of the chamber, however, all the later levels having been cut away to the east and south east by modern intrusions.

The earliest level was represented by a layer of yellow-brown patchy clay, crushed mortar and sand (D08:66). Set on this was a pack of small-medium sized stones in the north-east part of the chamber, plus a few, scattered flags (D07:33 – see Figs 17.02, 17.06). The pack was roughly 1m square and was overlain by a deposit of yellow crushed mortar, gravel and small stones (D07:22, D08:53), which extended further westward in a band across the northern part of the chamber, but also projected southward into the centre of the room (Figs 17.07, 17.08). This was interpreted as the foundation of a structure of some kind, perhaps an oven (an interpretation influenced by the presence of a

burnt clay deposit (D07:18) immediately to the north, although the T-shaped plan of the deposit does not particularly resemble an oven platform). A deposit of yellower crushed mortar (D07:23), covering part of the stone pack, probably formed part of the same layer, though overlain by D07:22. In the southern and western part of the guardchamber, level D08:66 was overlain by dark grey-brown silty clay (D07:25, D08:52). This overlapped the southern edge of the crushed mortar and gravel D07:22/D08:53 and also extended northward in a narrow strip alongside the west wall and then the north wall where it was interrupted by burnt clay deposit D07:18. In the south-east and eastern part of the room D07:25/D08:52 had been removed by broad modern intrusions. Towards the east, a patch of coal (D08:48) filled a depression or cut in the clay deposit truncated by the later disturbance, whilst a small roughly triangular area of light yellow sand (D08:47), measuring c. 0.50m by 0.40m, also overlay the clay in the southern part of the room.

Interpretation

The lowest level in the gatetower, D08:66, could perhaps represent a construction level rather than a proper floor surface, judging from the description provided in the context record. Similarly, it is not clear that the stone level D07:33 can be differentiated from the overlying mortar, gravel and clay deposits, particularly given the limited extent of the stone pack and sporadic, scattered nature of the other stones. These could all quite conceivably have formed part of the primary floor level, although this may have remained in use up to the mid-Antonine period, if the presence of Central Gaulish samian of that date in clay D08:52 is a reliable indication.

LATER FLOOR LEVELS

The second or perhaps third floor surface in the tower was probably represented a spread of dark clay (D08:41), noted in the southern part of the room, though not recorded in plan. This may have been equivalent to the deposit of light brown/yellow clay (D07:17), shown covering an area, 0.80m (N-S) by 0.40–0.65m (E-W), adjoining the inner face of the west wall in the north-west corner of the room where it overlay mortar/gravel D07:22 and clay D07:25. The difference in the colouration of the D07:17 and D08:41 might be accounted for if the clay in the southern part of the room had been more directly exposed to heat from a hearth or oven.

Clay deposits D08:41 and D07:17 were in turn covered by a very gritty, well-packed light brown soil (D07:12, D08:40) which probably constituted the third floor level of the guardchamber (Figs 17.09, 17.10). This was present across the full extent of the interval tower interior in so far as it survived at this level. Intriguingly, a narrow strip of this gritty soil (surviving width: 0.20–0.40m) is also shown on site

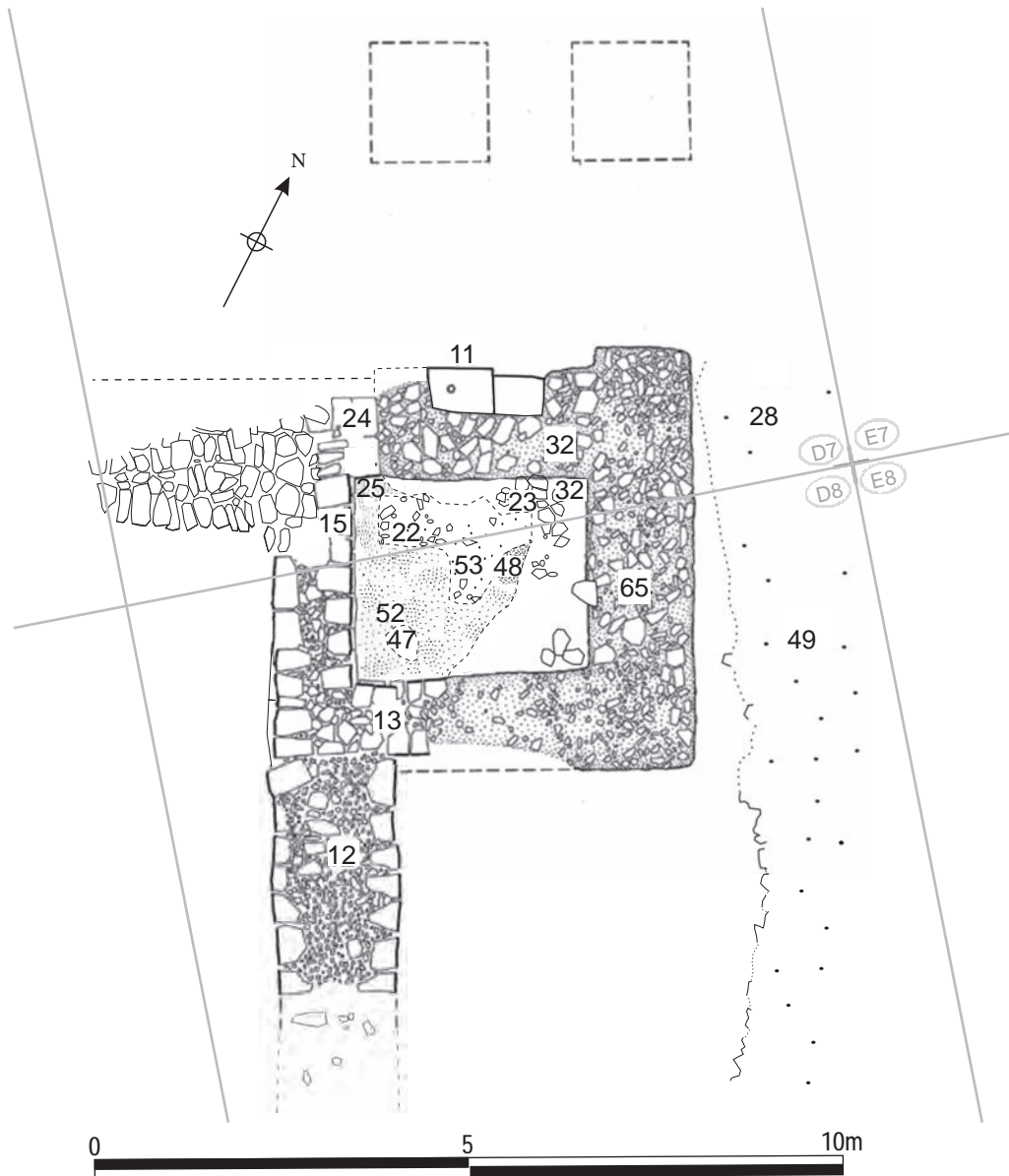

Figure 17.07: West gate, south guardchamber, the second internal level (perhaps the initial floor surface) at 1:100



Figure 17.08: The second level in the guardchamber interior showing the crushed mortar, gravel and stone deposit (D08:53) to the north and dark silty clay (D07:25/D08:52), to the south.



Figure 17.09: West gate, south guardchamber, secondary floor levels (third century, Period 3–4?) at 1:100.



Figure 17.10: The third (third-century?) floor level (gritty soil D07:12/D08:40) in the south guard chamber and reinstated ramp levels to the south

plan P377 as extending northward, from the north-west corner of the chamber, over two large, surviving dressed blocks (D07:24) which belonged to the tower's north wall and were situated at the junction of that wall with the west wall (D07:15, D08:13). If the record of this relationship is reliable (and it appears to be confirmed by the photographs), it should imply the north wall was no longer standing at this point, either

because it had been demolished or perhaps because there was a doorway at this point.

The uppermost surviving floor level consisted of a spread of yellow-pink clay (D07:07, D08:14) containing numerous small stones (Fig 17.11). Resting on or set into the surface of this clay were the possible remains of a very rough flagged floor made up of stones with dimensions of up to 0.40m by 0.60m. These flags may be the same as the 12 stones allocated the context number D08:28, which were described as laid flat and forming part of a possible stone floor and were shown adjoining the west wall of the tower on site plan P330. The northern edge of the yellow-pink clay D07:07/D08:14 is not clearly defined on the relevant site plan (P330), but the corresponding sketch plan for grid square D7 (D7 fig 1) might imply that the yellow-pink clay D07:07/D08:14 had a similar extent to gritty soil D07:12/D08:40 and likewise extended northward over stone blocks D07:24.

Discussion

THE OVEN

A thick layer of burnt clay (D07:18), was present on the northern edge of the guardchamber interior, featuring on successive site plans, but, significantly, it also extended westward, over the line of the tower's



Figure 17.11: West Gate, south guardchamber, latest surface (late third/early fourth century?) at 1:100.

robbed north wall, where it was overlain by a mass of flat stones (D07:06), pitched on edge, burnt red and set in a pink clay matrix (see Figs 17.12, 17.13). The burnt pink spread was reddy brown in colour, with traces of red scorching, and was roughly oval in plan, attaining a maximum extent of 1.65m (E-W) by 0.80m (N-S), its western edge butting up against the surviving stone blocks of the north wall D07:24. The overlying pitched stones were generally relatively small – no more than 0.30m long and 0.10m wide – and covered an area some 1.25m by 0.50m.

The excavators interpreted the burnt clay and pitched stones as the collapsed remains of an oven, suggesting that the pitched stones were not in situ and implying they had perhaps toppled over into the north wall robber trench. On this basis, it is possible that the excavators envisaged that the oven sat within the interior of the guardchamber, perhaps set against the north wall, standing on gravel foundation D07:22–3/ D08:53, and had partially collapsed into the robber trench when that wall was demolished and robbed out.

As thus restored the oven would have been a relatively early feature, part of the overall primary phase. The dark clay layer D08:41 overlying the early levels in the southern part of the guardchamber might be representative of the burnt deposits resulting from the life of the oven, although there is no reference to

traces of burning or to the presence of deposits of charcoal or the like, which might have been produced by repeated raking out of the oven. The excavators may have envisaged that the demolition and robbing of the north wall occurred at some stage after the end of Roman occupation, although there is no direct statement to that effect in the archive. However surface D07:12/D08:40 was recorded as overlapping burnt clay deposit D07:18 (noted on context sheet D07:18 and supported by comparison of site plans P377 and P367/P373) and apparently extended across the line of the north wall. This should signify that the removal of the north wall, and, by association, the destruction of the oven, occurred before the end of the Roman period, prior to the laying of floor D07:12/ D08:40, probably in the third century.

As emphasised by the above, there is nothing resembling a full description of the oven in the archive, outlining its likely form and explaining how its history may be understood from the surviving stratigraphic relationships. Instead any interpretation of the structure has to be reconstructed from the briefest of comments in the supervisor's summary notes, occasional references in the context sheets and database, and in the photographic descriptions. As a result there are a number of details which are very unclear.



Figure 17.12: Robber trench for the north wall of the guardchamber viewed from the north. Note the mass of flat stones pitched on edge, the extant pivot stone and the floor level extending across the line of the north wall in the bottom right corner.



Figure 17.13: Close up view of the pitched flat stones overlying the burnt clay in the robber trench for the north wall of the guardchamber, from the south

The most problematic context to interpret is the burnt clay deposit, D07:18. This was not only encountered in the north wall robber trench, beneath the pitched stones (D07:06), but also extended into the northern part of the chamber interior, where it reportedly cut the mortar and gravel base D07:22/D08:53 and light brown clay D07:25. Since it cuts these early levels it is more difficult to envisage the burnt clay simply as a deposit associated with the collapse of part of the oven into a robber trench, though it must certainly postdate the robbing of the north wall.

Moreover, if D07:18 was overlain by gritty soil layer D07:12/D08:40, as noted above, the deposition of the burnt clay must have occurred before that floor was laid, implying that the removal of the north wall, which must have preceded the deposition of the clay in the robber trench, took place at an even earlier date (later second or early third century?).

Some of the difficulties in understanding the burnt clay deposit might be resolved if it is envisaged as part of an oven built over the site of the north wall rather than inside the guardchamber. It is worth noting that

the site plans indicate that D07:12 only overlay the burnt clay at one point (the maximum margin of overlap being 0.35m). If the clay represented part of the oven lining, for instance, the oven could have been erected after the north wall had been demolished and partially robbed out, with the gritty soil floor (?) perhaps being laid to the south and west immediately afterward, slightly overlying but essentially contemporary with the life of the oven. (In these circumstances gravel foundation D07:22/D08:53 would presumably relate to an earlier structure of uncertain form and function.) At some later stage, the oven would have collapsed or been demolished, its remains perhaps subsequently being largely removed by further robbing or disturbance (e.g. D07:14 or D07:03).

THE LATER FORM OF THE WEST GATE

If much about the oven must remain inconclusive, including its form, precise siting, phasing and even its very existence, there does appear to be convincing evidence for the north wall of the guardchamber having been demolished well before the end of the Roman period, with clear indications that the later floor surfaces (D07:12/D08:40, D07:07/D08:14) extended across its line. This would in turn imply that substantial changes were effected to the layout of the west gate. In addition to separating the guardchamber from the south passageway, the north wall also supported the flanking gatetower. Its removal must surely signify that the tower superstructure had been dismantled at the same time and also suggests that passageway was perhaps no longer functioning as such, but instead now formed part of an extension of the guardchamber. The gateway's south portal may well have been blocked up at this stage, and conceivably even its north portal as well.

There was nothing unusual in such treatment. The original provision of gateways at the forts along Hadrian's Wall was excessive with four double portal gateways, three of them normally to the north of the Wall, plus additional single portal quintan gates supplementing the double portal south gate to the rear of the Wall curtain. As a result, many were blocked up or turned into narrow postern doorways later on. Blocking of the gate would have reduced the need for flanking guardchambers and towers making a substantial alteration to the plan of the gate possible. If the south tower was demolished the north tower might still have been retained as an interval tower, even if both portals of the gateway



Fig re I 4 Th west curtain wall with foundation exposed in grid square C0 from the south

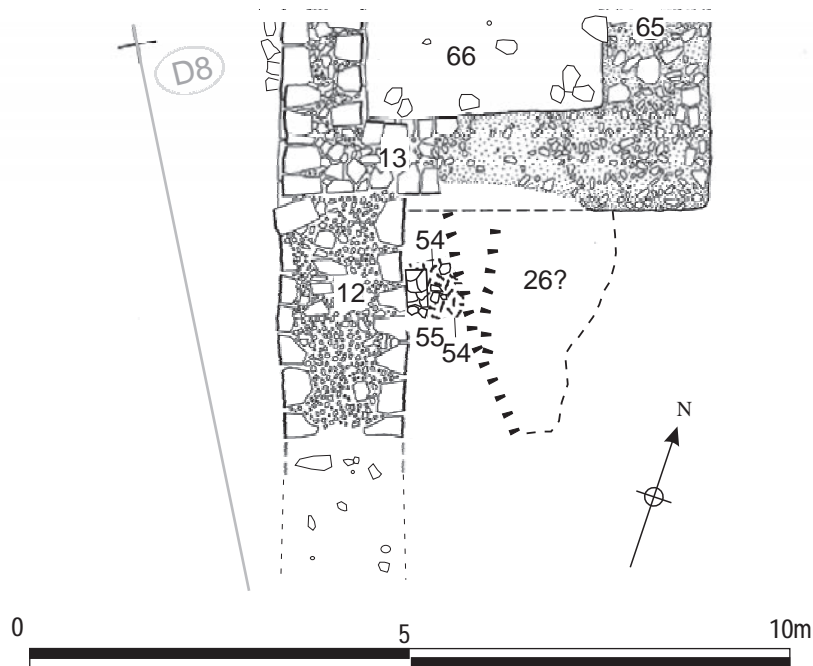

Fig re 3 Features in the ramp area south of the west gate, 0

were blocked up. However, the dismantling of the south tower is somewhat puzzling since that tower probably controlled access to the wall-walk along the top of Hadrian's Wall. If the gatetowers were originally three storeys high, with a roofed first floor gallery level running between the two, directly over the gate passageways, removal of the southern tower's north wall would perhaps only have necessitated demolition of the tower's uppermost storey, whilst its first floor level might now have formed a continuation of the gallery storey and could potentially have continued to control access to Hadrian's Wall.

The west curtain wall and rampart

Grid squares: C8, C9, C10, C11, D8, D9

The fort curtain wall

A 25m length of the defences to the south of the west gate was investigated in 1983. The western curtain wall was found to have been extensively robbed here. Only two stretches of actual masonry survived, comprising a 3.2m length next to the south guardchamber (D08:12) plus a similar length (C10:02) some 16m further to the south (see Fig. 17.01). In between, all trace of in situ dressed stonework had been removed, but an 11m stretch of the curtain wall foundations (D08:70, D09:29, C09:07) was uncovered beneath robber trench fill of rubble and disturbed

facing stones (C09:02, 04, D09:09, 14), continuing into grid squares D09 and C09. These foundations were 1.9m wide and composed of smooth cobbles and small boulders, up to c. 0.40m in length, set in yellow-grey clay. The clay was further described in the additional post-excavation notes as 'stiff puddled clay' and 'stiff dark clay'.

The stretch of wall masonry (D08:12) adjoining the south guardchamber was constructed of large, dressed and mortared blocks facing a rubble core and was of one build with the walls of the guardchamber. For the most part only a single course of the curtain wall survived, some 1.60–1.75m in width, whereas up to two courses of the guardchamber walls were preserved. One block belonging to the second course did remain, next to the south-west angle of the tower, but appeared to have been displaced forward slightly, however, comparison with the walls of the south guardchamber would suggest the second course was inset 0.05–0.075m on either side. The blocks were generally wedge-shaped to key into the core, but varied considerably in proportions, ranging from those with narrow face and long tail (c. 0.30m × 0.55m) to others with a very broad face (0.65m) and a short length (0.35m) into the thickness of the wall, with most somewhere in between.

Another 2.85m length of the footing course (C10:02), survived 16m to the south in grid square C10, to the west of the hospital (Fig. 17.14). This stretch was



Fig. 17.14 Burnt tile D08 set against the curtain wall on the leveled rampart bank.

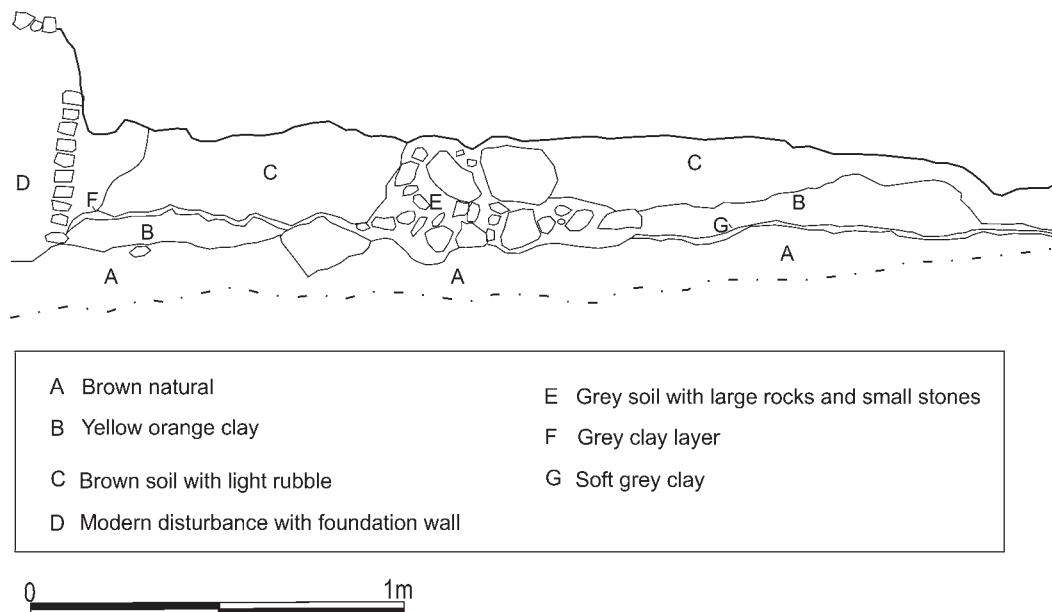

Figure 17.17: S104 across the west rampart in grid squares C9 and D9, at 1:20 (see Fig.17.01) for location).

1.85m wide and was similarly constructed, with large roughly dressed blocks facing a rubble core. Like those recorded on the stretch to the north the facing stones were slightly wedge-shaped and were relatively narrowly proportioned, extending further into the thickness of the wall than they were broad across the face. Those used in the outer face appeared somewhat larger than those along the inner face, the former being 0.40–0.55m broad across the face and 0.45–0.65m long, whilst latter were 0.30–0.50m broad and 0.40–0.50m long. A scatter of rubble belonging to the wall core and foundation cobbles (C10:08) extended for a further 2.5m southward beneath robber trench fill C10:04.

The rampart

Inside the fort, stretches of surviving rampart bank and adjoining *intervallum* road metalling were uncovered behind the curtain wall (Fig. 17.15), where they were deposited over the 'old ground surface' (D07:34, D08:68, D09:32), the lowest level exposed during the excavations. The latter was described as dark loam and sandy gritty silt with some stones (D07:34) and a mid-brown loamy surface with patches of grey fine silt and sand (D08:68), which was seen to extend from the berm beyond the curtain wall, to the west, right across the grid square, being equivalent to E08:68 further east.

A relatively narrow strip of the rampart bank was preserved, tucked into the angle between the south guardchamber and the surviving stretch of fort curtain wall. This pocket of deposits was 1.30 m wide at the north end, next to the tower, narrowing to 0.70m some 4.20m further south, at which point the bank was completely cut away by robbing and other modern intrusions (e.g. D08:25, 30).

However, despite being clearly depicted on the site plans, the context record relating to this strip of rampart bank is very confused. It is usually designated (D08:)55 on the site plans and sketch plans for this area, although in some instances it is not numbered at all. D08:55 refers to a group of heavily burnt and reddened tiles set on or in a surface of burnt black silt (D08:54) and butting up against the inner face of the fort wall in this area. Site plan P384, the only one to show these features in detail, indicates the blackened area and tiles only extended over a small part of the surviving rampart bank, covering roughly 1.15m by 0.95m. Examination of the plan and the site photographs indicates that D08:55 took the form of a neatly cut, but extensively cracked, rectangular slab, perhaps of stone rather than ceramic tile, measuring c. 0.40m by 0.25m and set right against the fort wall, with two additional stones at the southern end extending its length to 0.55m (Figs 17.15, 17.16). The slab resembled the tread of a shallow step and was surrounded by several orangey-pink patches which may represent decayed tiles set in the carbonised surface. The site supervisor's notes state that this feature yielded an archaeo-magnetic date of 390 ± 10 , but there is no other information on this.

Features D08:54–5 only seem to have been recognised relatively late in the course of the Site 17 excavations (during mid October–early November 1983), as their high numbering suggests, although context number D08:55 is marked on much earlier plans. The features do not appear on earlier site photographs, implying that they were revealed after the removal of some of the rampart bank, although whether this represented a distinct layer or was simply the result of vigorous cleaning is uncertain. At any rate the numbering of the entire strip of rampart

as D08:55 is clearly incorrect and indeed there would appear to be a distinct possibility that, apart from the restricted area of the burnt tiles and carbonised surface, the rampart bank was never actually assigned a context number.

The only other context number which could designate this strip of rampart is D08:26, described as a clear (sic – signifying clean?) dark clay, which evidently lay somewhere in this general area, although there was some uncertainty regarding its exact position. This number only marked on one of the sketch plans (D08 fig 3), where it was allocated to a spread at the bottom of a modern intrusion (D08:11), immediately to the east of the strip of rampart bank. The deposit apparently extended over the robber trench for the south wall of the guardchamber, which ought to imply that this material was relatively modern. However the context record sheet indicated that D08:26 abutted the fort curtain (D08:12), which would be appropriate for the strip of rampart bank, but not the deposit identified on the sketch plan, so conceivably the positioning on the sketch plan was either incorrect or perhaps applied to both deposits.

At any rate the presence of the tiles and burnt deposits in the rampart area is clearly significant. They did not resemble an oven, but might conceivably represent the truncated remnant of that kind of activity. Their existence implies that the rampart bank in the area next to the gate was removed at some stage. It may subsequently have been reinstated at some time thereafter, which action would be represented by any material removed to expose tiles and burnt deposits D08:54–5.

Further south, the rampart was laid over clay subsoil (D09:32), which was recorded only where narrow strips were revealed at the base of the curtain wall robber trench and at the bottom of a modern sewer pipe trench (D09:08), but was perhaps equivalent to the yellow clay (C09:08) seen on the berm on the other side of the fort wall (Fig. 17.17). The rampart deposit overlying the clay consisted of brown soil, light clay and small pieces of thinly scattered rubble (D09:12, D10:30), and clay with small stones or stone chips and sand (C10:06, D10:25), which, despite being somewhat differently described, represent the same level, on either side of a modern brick-lined drain (C10:03, D10:03), as the site plans (P331, P332, P339, P356) demonstrate (cf. Fig. 17.01). The rampart deposits extended over an area roughly 3.70–4.40m wide, between the curtain wall and the western edge of the *intervallum* road metalling (D10:09, 28), but no trace of any revetment walling remained to provide a definitive edge.

Discussion – the west curtain and rampart

The sequence very tentatively proposed in grid square D08, involving removal of the primary rampart to make way for an oven or perhaps some form of industrial

hearth, followed by the eventual reinstatement of the rampart bank, would be consistent with that observed in 1997–8 when the adjacent stretch of the western defences was investigated. The 1997–8 excavations extended between the minor west gate (*porta quintana sinistra*) and the southern edge of the 1983 excavations (equivalent to C12, C11-D11 and parts of C10 and D10) and found evidence that the rampart bank here was removed in Period 2 and a timber building employing sleeper-beam construction was erected against the inner face of the curtain wall (Rampart Building II). This building remained in use until Period 4 when it was demolished and the rampart bank reinstated (Hodgson 2003, 157–62). Some form of workshop function for Rampart Building II was hinted at by the presence of much redeposited ash and coal, including clinker-like material and hammer-scale, in the lower part of the reinstated Period 4 rampart (op. cit., 158).

The composition of the pottery found in the rampart deposits in D09, C10 and D10, suggests that only the primary rampart levels survived in this area. Whether this indicates that the primary rampart bank was never removed in this area or simply that all evidence of later activity in this part of the rampart had been removed by post-Roman disturbance is impossible to determine, although the latter appears more likely.

Finally, no clear evidence for the collapse and rebuilding of the curtain wall was found during the 1983 excavations comparable with that revealed in 1997–8 (Hodgson 2003, 167–70). The latter investigations suggested, on the basis of surviving fragments of wall core, that the primary curtain wall was clay-bonded, with any mortar-bonded stretches representing later rebuilds. The walls of the west gate's south tower (D08:12–13) were definitely recorded in 1983 as being constructed of mortared masonry. It seems likely that the gate superstructure, which featured thinner walls that would nevertheless have stood much higher than the curtain wall, might have been treated differently and bonded with mortar rather than clay to ensure their stability. However the context record for D08:12, which applies to both the west wall of the tower and the adjoining 3m stretch of curtain wall, gives no indication that these two were differently constructed. No reference to mortar bonding was made with regard to the stretch of curtain wall further south (C10:02), but the context record is so terse that this need not be significant one way or the other (there is no indication of clay bonding material either).

FINDS

West gate

Soil over earlier floor

Graffito: (no. 58, D08:40)

Copper alloy: loop (no. 365, D08:40)

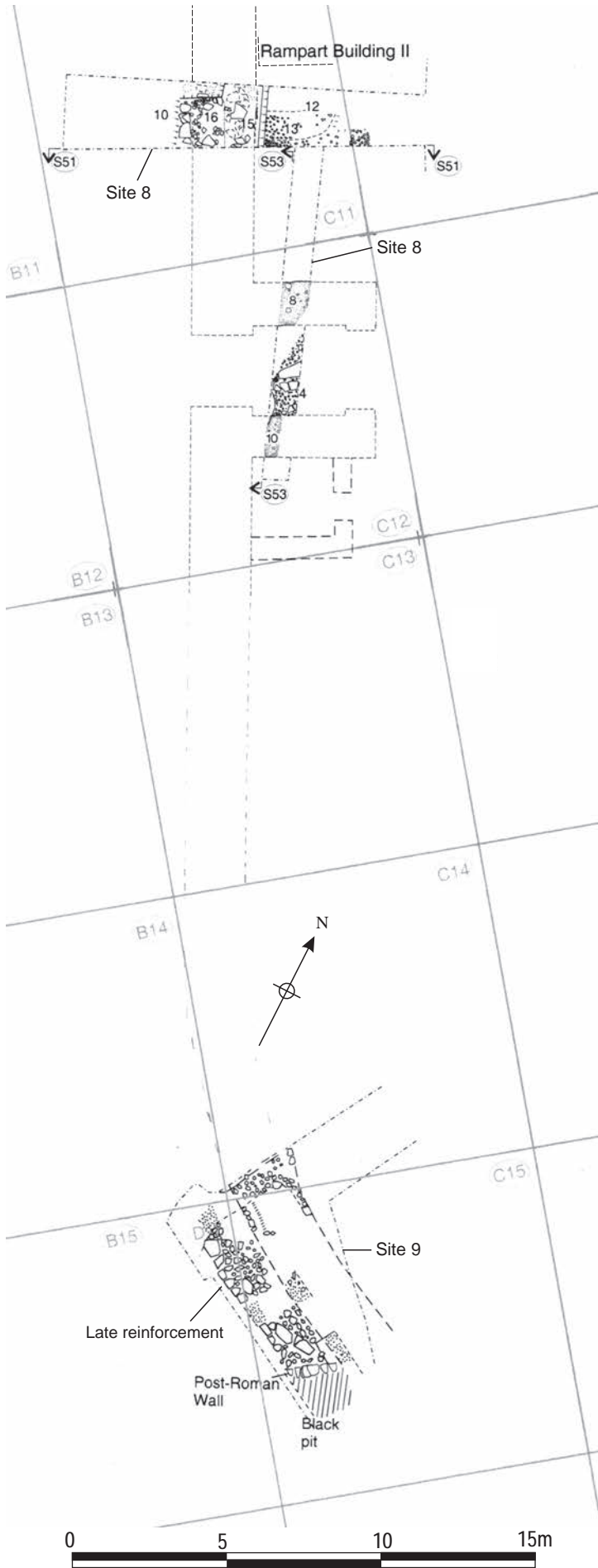

Fig. 1. Plan showing the trench locations (Sites 8–10) in the western defences, examining the porta quintana, curtain wall and rampart, and the SW angle. Scale 0

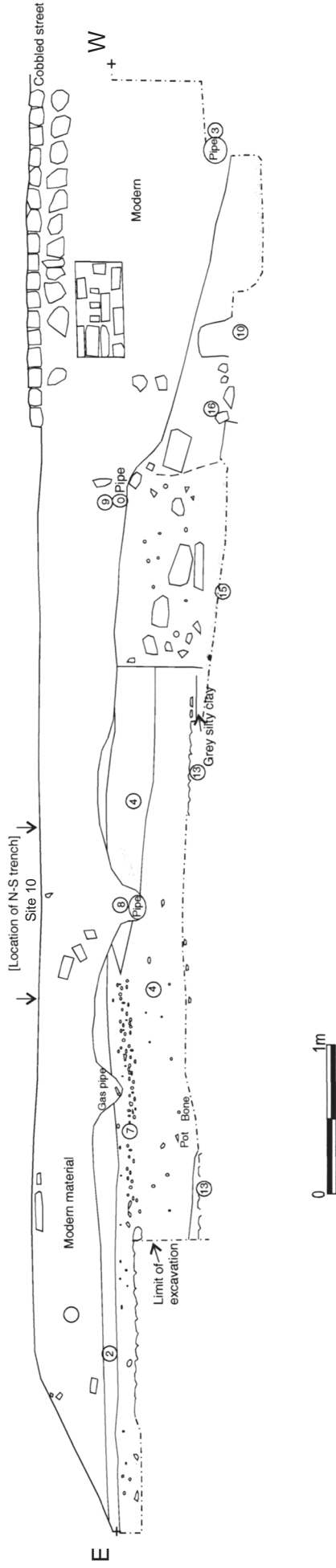

Figure 17.19: Section S51, south section in Site 8 trench across the west rampart and curtain wall, at 1:40.

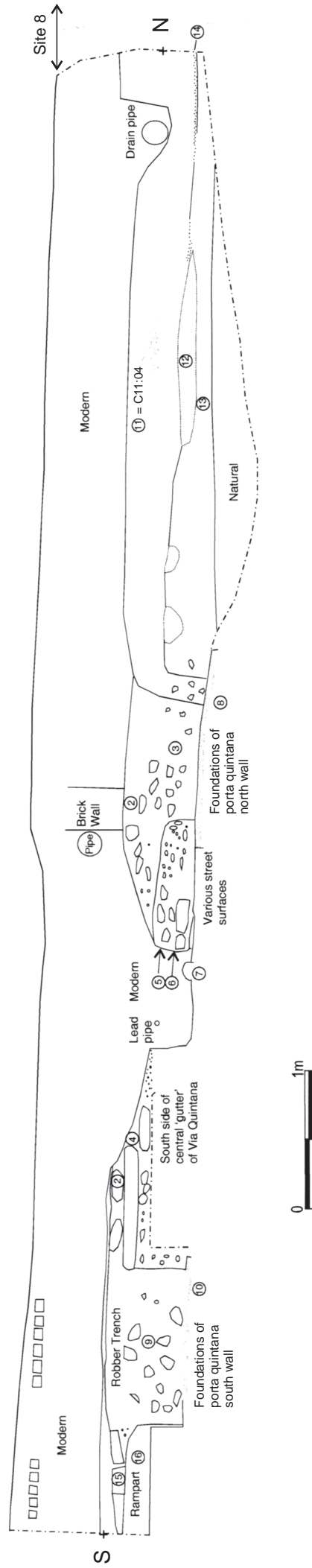

Figure 17.20: Section S53, east-facing section in Site 10 trench across the porta quintana and adjoining rampart, at 1:40.



Figure 17 Via quintana road surfaces and clay foundations of the gate passages walls in the Site 10 trench.

Latest surviving floor

Copper alloy: brooch (no. 1, D08:14)
Pottery: spindlewhorl (no. 20, D07:07)

Post Roman layer

Copper alloy: loop (no. 353, D08:17)

Fort Wall

Copper alloy: stud (no. 255, D10:25)
Stone: whetstone (no. 15, D08:12)

Dating evidence

West gate

The floors in the gate only produced a total of 11 sherds of pottery. The early floor level contained a sherd of a mid-Antonine form 18/31R–31R samian bowl (D08:52), and the gritty soil (D07:12/D08:40) covering this floor produced a sherd of a Central Gaulish Curle 21, dated c.150–200, in D08:40. The latest surviving floor level (D07:07/D08:14) included a single body sherd of a Crambeck reduced ware jar in D08:14.

There appears to be a reasonable seriation of the pottery types in the successive surviving floor levels of the south guardchamber, implying the floor levels continued up to the late third century, with any later levels lost through truncation. When looked at by sherd count, however these are very small groups, and can only be used with caution for dating.

Fort wall

Curtain wall D08:12 and underlying ground

level D08:68 contained a few sherds only, pretty undiagnostic, probably second century

Primary rampart

The primary rampart produced 12 small sherds of pottery, mostly grey wares (D09:12, D10:25, 30).

Late rampart

There was a sherd of Crambeck reduced ware of the late third century or later associated with the burnt tiles in the late rampart (D08:55), as well as a rim from a Lower Nene Valley mortarium dated to the late third or fourth century (D08:26).

The material from the surviving primary rampart levels is consistent with their interpretation as part of the earliest, Hadrianic defences of the fort. The later material deriving from context D08:26 can only be assigned to the later rampart levels with a degree of uncertainty.

The western defences excavated in 1977 (Fig. 17.18)

The porta quinta a sinistra (Gate 4)

Grid square: C12

The *porta quintana sinistra* or minor west gate was subject only to very limited investigation by Daniels. A single, 0.90m wide trench, orientated roughly north-south (Site 10), was excavated in 1977, opening off the east-west trench (Site 8) cut to investigate the west curtain in grid C11 (Figs 17.18–17.20). The gateway was fully explored by Tyne and Wear Museum Service

in 1998, when a small, secondary, rampart building, roughly square in plan, was revealed directly to the south. The results published here should be interpreted in the light of the later work.

Like its counterparts at other forts along Hadrian's Wall, this gateway was required because the main west gate (*porta principalis sinistra*) projected north of Hadrian's Wall necessitating a supplementary gateway to facilitate access and communications behind the Wall curtain, along the Military Way or an earlier service track. However, at Wallsend, there was no need for an equivalent gateway, or *porta quintana dextra*, on the east side of the fort, as the Wall ran from the south-east angle down into the river where it terminated. The main east gate (*porta principalis dextra*) provided all necessary access from this quarter and a simple interval tower took the place of the *porta quintana dextra*.

The gateway took the form of a single portal, with walls on either side linking the front and rear arches and supporting a tower, but lacking flanking guardchambers or towers. The side walls had been completely robbed away (C12:03; C12:09), but the clay foundation deposits remained. On the south, a good, 1.05m wide, red clay foundation (C12:10) was recognised. On the north, a band of stiff, grey-pink puddled clay (C12:08), 1.40m wide, was clearly distinguishable from the natural yellow clay to the north. The two bands of clay were separated by the layers of metalling of the *via quintana*. Responds for arches were revealed in 1997–8 at either end of the passageway, and the width of the road carriageway was shown to have been 3.00m.

Despite being less architecturally elaborate than the four main cardinal gateways, the *porta quintana sinistra* was probably one of the intensively used gateways into the fort, as a result of its position south of Hadrian's Wall. Three successive levels of metalling were recognised on the road through the gateway, in 1977, but as many as six were uncovered in 1997–8, with some evidence for a seventh. The lowest of the three surfaces uncovered in 1977 (C12:06) was not described, but the section drawing (S53 – Fig. 17.20 here) suggests that it was similar in composition to the layer above, though possibly containing slightly larger cobbles. This might be equivalent to the layer of cobbles and sandstone fragments assigned the context numbers 7075=7077=7054 in 1998 and attributed to the late third- or early fourth-century. The second layer was composed of small, worn cobbles (C12:05). This surface in turn might be equated with the first of a series of mid-fourth century levels excavated in 1998 (7053) which was composed of cobbles and sandstone fragments. The uppermost level of metalling (equivalent to TWM 7044) incorporated some very large, heavily worn sandstone slabs (C12:04), which formed the side walls of an east-west oriented drain or gutter (TWM 7036) leading from the

via quintana through the centre of the passageway. The side walls of this central gutter were only one course in height and the north wall continued the same line as the big kerbstones (7911) in the *via quintana* Phase 4 surface (D12:12) south of the hospital (see *via quintana* west, Phase 4). A further layer of metalling (7030), composed of cobbles, sandstone fragments and gravel, was recognised in 1997–8, overlying and infilling the *porta quintana* drain and its associated road surface, and was observed to extend across the full width of the passageway. This uppermost surface was not identified in 1977, but a very large slab which may have formed part of it was recorded protruding from the east-facing section of the excavation trench immediately to the south of, but at a higher level than, the central gutter. (Figs 17.18, 17.20–17.21)

FINDS

Coin: 'Gallienus', 258+ (no. 145, C12:05); Constantius II Caesar, 330–35 (no. 186, C12:04)

Dating evidence

No dateable material was recovered from the foundations of the *porta quintana* side walls in 1977, but the gate was evidently a primary, Hadrianic structure like the other principal elements of the defences (cf. Hodgson 2003, 154, 157). Material recovered from the periodic resurfacing of the carriageway through the gateway included two coins (nos 145, 186) recorded in association with the intermediate and uppermost of the road surfaces excavated. The precise relationship of the two coins to the respective road surfaces – i.e. on top of or embedded within – is not stated, but they may be added to the large number of late Roman coins which were recovered from the *porta quintana* passageway and the immediately adjacent areas of the *via quintana* and *intervallum* road in 1997–8.

The substantial coin assemblage has, plausibly, been interpreted as evidence for the existence of a marketing area in and around the gateway during the fourth century (Hodgson 2003, 166–7). To this group should be added a further six examples (nos 151, 153, 187, 193, 195, 199) found in contexts over the western end of the *via quintana* and *intervallum* road (D11:02, D12:11, E12:11) and ranging in date from 258+ to 348–50. The majority of these (four: 151, 153, 193, 199), plus a further couple of illegible third- or fourth-century coins (273–4), were listed as deriving from the disturbed rubble layer (D12:11) overlying the road surfaces, although the context records make it clear that finds listed under this context included material from the uppermost road surface excavated in this area (D12:12, E12:11). Even though some of these may derive from disturbed contexts, the fact that they were found concentrated over the road surfaces rather than the adjacent building plots is surely significant. These examples may extend this

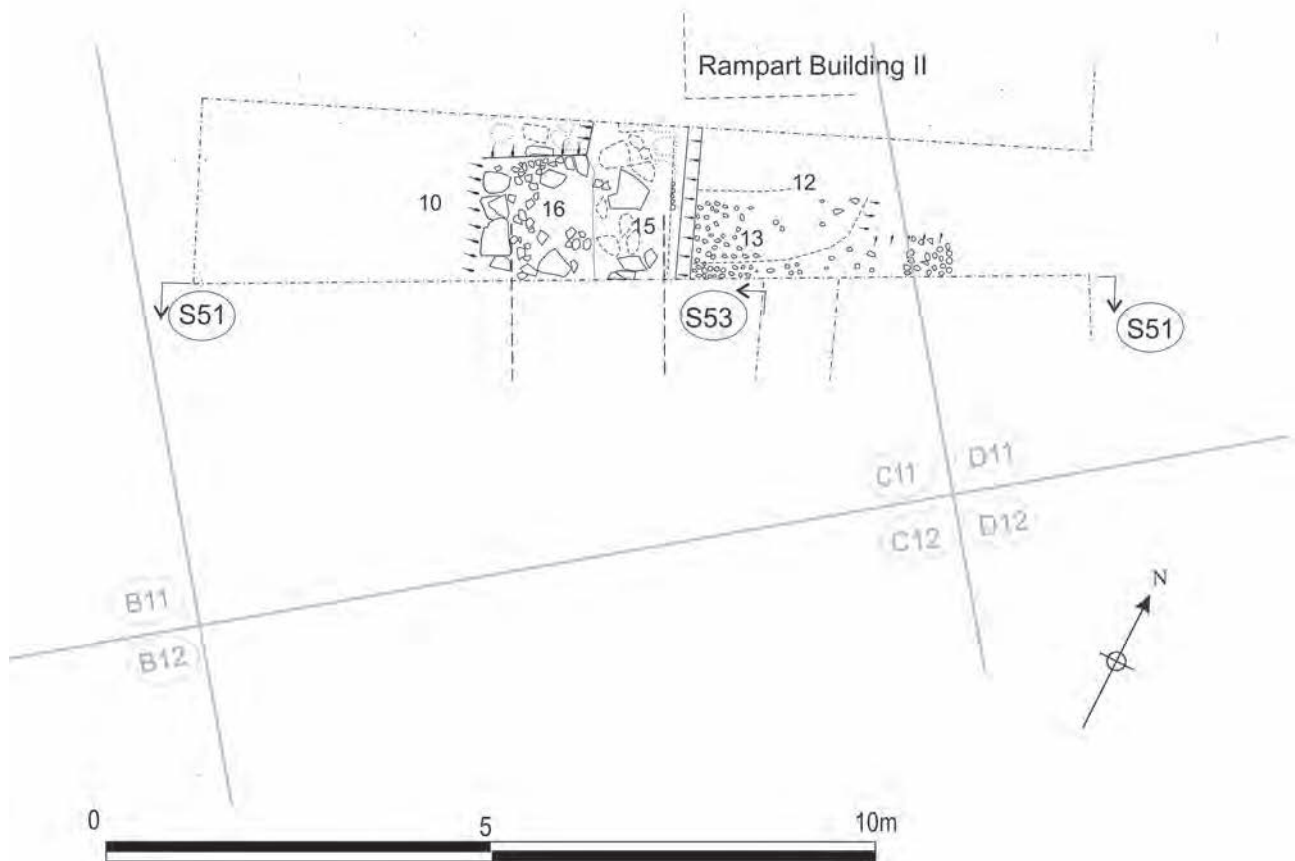

Fig. 17.21 Trench across the west defences north of the porta quintana at Segedunum

spread of late Roman coinage a little further eastwards along the *via quintana* into the fort interior (into grid squares D12 and E12), but they do not markedly alter its interpretation as marking the site of a marketing area, close to the gateway, for itinerant traders visiting the fort garrison.

The western curtain and rampart

Grid squares: C11–12, C14

Curtain wall

Apart from the extensive stretch adjacent to the west gate (see above), the western curtain was examined at only two, restricted points. A 12.00m long and 2.00m wide, east-west trench (Site 8) was cut in grid C11, some 4.20m north of the *porta quintana*, and further L-shaped trench (Site 9) was dug in and around grid C14, close to the south-west angle of the defences, both during 1977 (see Fig. 17.18 above). In both cases the masonry of the circuit wall had been entirely robbed away, but traces of the foundations remained. In the northerly trench this was represented by a band of heavy pink clay (C11:15), up to 2.60m wide (Fig. 17.22). Similarly in grid C14, a dark-brown, clay and cobble foundation layer (C14:07) was recognised, its outer, western edge apparently beginning to curve round to the east, consistent with its identification

as the south-west angle of the curtain. Overlying this was a layer of sandy rubble (C14:04) which probably represented the post-Roman robbing of the wall.

West rampart

The rampart layers immediately north of the *porta quintana* were also uncovered in Sites 8 and 10, which formed a T-shaped arrangement of trenches, cutting through the rampart roughly north-south and east-west. A small pocket of deposits immediately south of the gateway was also revealed at the very end of the Site 10 trench.

PERIOD 1

In the area north of the gateway, a layer of grey, clay loam (C12:13) was recognised over the natural yellow clay subsoil. This was interpreted by the excavators as a buried ground surface, although comparison with the results obtained in 1997–8 might imply that it was actually a primary rampart layer, in which case the original ground surface had presumably been truncated. At one spot, the grey clay was overlain by a spread of pink/yellow clay (C12:12 – see Fig. 17.20: Section S53; Fig. 17.22: plan).

The south side of the *porta quintana* was only marginally impinged upon by the 1977 trenching but excavation of this area by Tyne and Wear Museums Service in 1997–8 unexpectedly uncovered a roughly



Figure 17.23: Remains of the west curtain with the late refurbishment along the outer face in the foreground, in grid square C11 (Site 8 trench).

square building attached to the gatetower (see Hodgson 2003, 154–6 for full description). The excavators noted that although it was not necessarily part of the primary design it does seem likely that the gate annexe came very early in the building programme, as there was no evidence of material belonging to a reduced rampart below, and its construction seemed to have taken place from the pre-fort ground surface (op. cit., 155). It should also be noted that the way that the rampart bank enveloped the south-east corner of the gate annexe, with the revetment wall running neatly up to the south jamb of the doorway, would tend to imply the rampart was constructed around the building, rather than the latter being inserted into a pre-existing bank. The structure's function is uncertain, but it probably functioned as a guardchamber and may also have provided covered access to the first floor level of the gatetower. No similar annexes have been recognised beside the minor gates at other forts along the Wall, but early experience elsewhere may conceivably have resulted in an alteration to the design at Wallsend.

PERIODS 2 AND 3

Partially covering the clay loam and pink/yellow clay deposits north of the gateway were spreads of orange gravel or chippings and small cobbles (C11:13, C12:14), which were quite extensive, but did not survive over the entire area. The presence of this cobble and gravel surface implies that the stretch of rampart bank to the north of the gateway had been removed and the area at least partially cobbled over. This activity was probably associated with the construction of a rampart building ('Rampart Building II'), the remains of which were recognised immediately to the north of the Site 8 trench in 1997–8 (TWM Trench A; see Hodgson 2003, 157–9). This building was represented by two linear slots running east-west and north-south, which probably reflected the extraction of timber sleeper beams, and a clay floor level surfaced with scattered sandstone slabs and fragments. The construction of Rampart Building II and associated removal of the rampart bank is assigned to the beginning of Period 2 (corresponding to the Antonine period, c. 160). Furthermore, there is some evidence to suggest that a similar process also occurred to the south of the gateway with the removal of the earthen bank there, the extension of metalling over the area of the former rampart and the possible construction of a building against the back of curtain wall some 1.60m south of the gate annexe (Hodgson 2003, 159). No further major alterations can be identified in these areas before the end of Period 3 in the mid-third century.

REINSTATEMENT OF THE RAMPART IN PERIOD 4

During the mid-third century the rampart was reinstated, filling in the previously open, cobbled area to the north of the *porta quintana*. The sequence of deposits was seen most clearly during re-excavation in 1997–8 (see Hodgson 2003, 169, fig. 119: Section 13), but the 1977 results from the two Site 8 and 10 trenches can be fitted into the same framework.

Directly overlying the orange gravel (C11:13), a very shallow band of mixed, yellow, pink and grey clay (C11:12), L-shaped in plan and varying between 0.90m and 0.95m in width, ran eastward from the fort wall for c. 2.00m then turned north and ran into the section. The significance of this clay feature was not fully understood by the excavators in 1977. It appeared to enclose a layer of homogenous medium grey clay loam (C11:14) and it was suggested that the feature might have formed the clay foundation for a wall. However, it appears unnecessarily wide for a single-faced revetment and was found to be very shallow so is more plausibly interpreted as a shallow rampart deposit. On the north side of the trench these deposits were in turn covered by a layer of yellowish-grey clay (C11:06) which was apparently similar in composition to C11:14. To the south, a different rampart layer, composed of a grey clay-loam matrix

which contained much occupation debris including many fragments of copper alloy metalwork, other small finds and pottery (C11:04, C12:11; perhaps equivalent to TWM 7043), was deposited over the orange gravel and the remainder of the clay band, C11:12. This extended from the southern limit of C11:06 as far as the north wall of the *porta quintana* and survived to a maximum depth of 0.54m.

The final activity of possible Roman date in the west rampart area was represented by a layer of cobbling, comprising closely-set, small stones (C11:07), partially overlying rampart deposits C11:04 and C11:06 in the east end of the Site 8 trench. This may have formed a late surface of the *via sagularis*, though in the cases of such a small area it is difficult to differentiate between late/sub-Roman surfaces and those of early-modern date.

On the south side of the *porta quintana*, the Site 10 trench was not taken down to natural subsoil, so the sequence of floors within the gate annexe was not exposed. However a layer of grey clay loam (C12:16), 0.2m deep, was uncovered at the end of the trench. This was interpreted by the excavators as a rampart layer, but it may represent to the uppermost floor (TWM 7079) or more probably the demolition layer of dark grey-brown clay loam (7073) which was at the top of the stratigraphic sequence of layers dateable to the Roman period revealed by the 1997–8 excavations (Hodgson 2003, 159–60, 162). The grey clay loam was overlain by some loosely-placed sandstone blocks (C12:15), which were interpreted as the possible remains of a wall, perhaps of modern date. No plan was made of this feature, although two blocks were recorded in section (S53) immediately south of the robbing trench for the southern gate passage wall (Figs 17.20, 17.21).

FINDS

Reinstated rampart – occupation debris rich layer C11:04

Glass: bracelet (no. 2, C11:04)

Copper alloy: medical implements (nos 99–100, C11:04), spoon (no. 108, C11:04), buckle (no. 157, C11:04), loop (no. 373, C11:04)

Stone: whetstone (no. 16, C11:04), counter (no. 46, C11:04)

Dating evidence

No dateable material was recovered from the primary levels or those relating to Periods 2 or 3 in the trenches dug to investigate the western defences next to the minor west gate. Dateable pottery groups were recovered from the rampart layers of Period 4, however these provide little help in dating the reinstatement of the rampart. The grey ware, coarse-pottery group found in layer C11:06 would in fact be consistent with a primary, Hadrianic rampart level, though

deposit C11:04/C12:11 did contain some BB2 as well as mid-late Antonine samian. The mid-third-century date assigned to the reinstatement of the rampart is provided by pottery found in corresponding levels investigated in the 1997–8 excavations. It is not uncommon for individual rampart layers deposited in a single episode to provide a wide range of *termini post quem*, reflecting different origins of the redeposited material.

The later rebuilding of the fort wall

In both the Site 8 and 9 trenches, evidence for a later rebuilding of the curtain was recognised, paralleling the observations made by Tyne and Wear Museums Service in 1997–8, in a trench immediately north of the Site 8, which had suggested that the fort wall, which stood on a west-facing slope, had collapsed and been rebuilt in antiquity (Hodgson 2003, 168–70).

In Site 8 this evidence took the form of a narrow stone facing (C11:10), no more than two stones (c. 0.40m) in breadth and incorporating large rubble blocks as well as squared stones probably deriving from the primary curtain facing (Figs 17.22, 17.23). The narrow facing was backed by and presumably retained a 0.80m wide, dump of rubble in a loose, sandy-brown soil matrix (C11:16), which overlay the western half of the primary clay foundation. Together these would appear to have formed a stone revetted, rubble and soil base or platform, running along the front of the circuit and providing greater support for the outer face of the newly rebuilt fort wall to prevent it collapsing down the slope to the west.

More evidence for reinforcement or refacing was found at the south-west angle. A 1.30m–1.60m wide layer of flattish, faced stones and cobbles in clay loam (C14:05) was revealed, abutting the western edge of the primary foundation deposit C14:07 and extending for at least 5.70m (the feature was cut at either end by modern intrusions including a stone-lined pit and drain or conduit). This was in turn covered by a layer of grey clay (C14:03).

No evidence was recovered to determine the date of these reinforcements, revetments or rebuilding of the west curtain, but the rough character of the work, forming a kind of external revetment, is similar to late refurbishment known at other forts on Hadrian's Wall and environs (*see* Chapter 20 for further discussion).

Robbing

The masonry of the western defences was robbed out in the post-Roman period, these actions being represented by a series of rubble-filled trenches overlying the clay foundation levels of, respectively, the curtain wall (C11:05, C14:04) and the side walls of the *porta quintana* (C12:03, C12:09).

18. THE NORTHERN DEFENCES

The north gate – *porta praetoria* (Gate 1)

Grid squares: K2, K3, L3

Introduction (Fig. 18.01)

The masonry of the north gate had been almost totally robbed out. Only one block of the *spina* had survived and the four blocks of the east guard chamber.

The west guardchamber

All that remained of the west gate tower was the outline of its walls, preserved as robber trenches, within which traces of the original pink clay of the

foundations were noted. This is equally true of the north (K03:37), east (K03:38), south (K03:32), and west (K03:33) walls. Patches of light orange gravel and crushed sandstone (K03:26) in the interior, particularly the north-east corner, were identified as a possible construction deposit creating an even level. No measured plans of this tower were made during the excavations and, for the purposes of this report, its plan has been mirrored from that of the east guardchamber.

The spina

Two square bases formed the *spina* of the gateway, matching the positions of the responds on the sides of

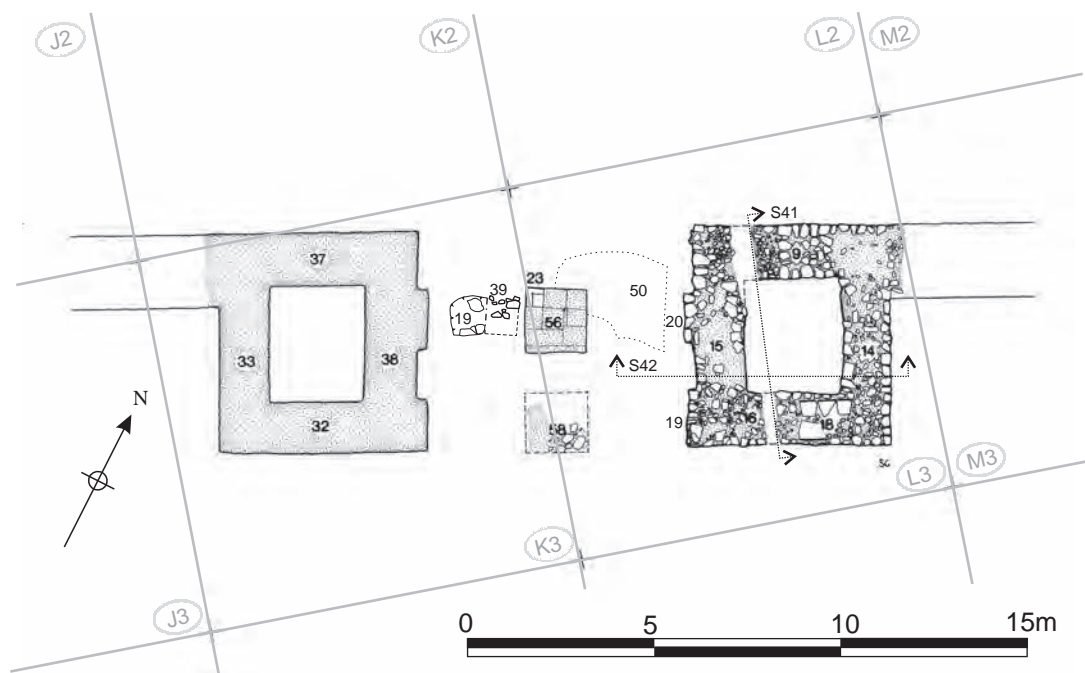

Figure 18.01 The north gate, at 18.01

the guardchambers. The northern pier (L03:56), which measured 1.7m × 1.5m, still retained one stone (L03:23) at its north-western corner, scored to assist with the positioning of the courses above it. The outlines of the other eight blocks could be made out in the pink foundation clay. The remainder of the stonework had been robbed away (K03:13, L03:52, 53). The position of the southern pier (L03:58), just over 1m to the south of its northern partner, was also marked by traces of pink foundation clay, but less well-preserved.

The *spina* defined a carriageway 2.5m wide between it and the responds on the east and presumably the west guardchambers.

The east guardchamber (Figs 18.02–18.05)

The east gate tower was first excavated in 1929 (Spain & Simpson 1930, 489, fig 2), exposing its walls but leaving the interior untouched. The earlier trench was emptied in 1976 (backfill deposits L03:10) and the central area excavated. The gate had been cut by modern housedrain and floodwater pipes (L03:03–06) leading to a manhole to the south (L03:02). The foundation consisted of large boulders and some cut stone in a trench with red clay sometimes two courses deep (L03:09, 14–16). The only blocks *in situ*, which did not form part of the foundation or the levelling up course, were four large facing stones belonging to the south wall (L03:18). These measured 0.35 × 0.40m, 0.40 × 0.54m and 0.42 × 0.73m and ran back 0.40 to 0.48m into the core. Hardly any material from the wall core survived, and what little did apparently remain (L03:24) may have been redeposited during backfilling in 1929.

Within the tower the original level of masons' chippings (L03:28, 45–47) was uncovered overlying grey-brown clay (L03:29), possibly a levelling layer, which in turn sat on light buff sandy soil and orange clay, both interpreted as natural subsoils (L03:30i–ii). The construction debris included a patch of coal dust



Figure 18.02: The east guardchamber of the north gate showing the tower foundations, looking south

and brick/tile fragments (L03:31–32) and was in turn overlain by a mixed occupation level of clay, coal dust and small stones and including small fragments of bronze and iron (L03:44).

Traces of a gravel surface for an entrance passage through the tower's west wall were also seen in section (L03:42; see S42, Fig. 18.03).

There were two responds on the west face of the tower. The southern example (L03:19) was 1.40m broad north-south and projected 0.25m, whilst the northern one (L03:20) was 1.20m broad and projected 0.27m. The latter was 1.80m from the north face of the tower and the recess between the two measured 1.40m. The interior of the guardchamber measured 2.70m north-south and 3.10m east-west. Where wall stones actually sat on the foundation they were set back c.0.12m.

The gate passageways

A series of possible road surfaces were recognised in the gateway. The fullest sequence was recorded in the east passageway where a full section was cut through these levels (S42; cf. Fig 18.03). The lowest consisted of small stones (L03:34), mostly sandstone and gravel, over layers of grey-brown clay (L03:36, 38) which could represent levelling up. This was overlain by orange-brown clay (L03:37) surfaced by a layer of sand and gravel (L03:35), which presumably formed a second road level in the east carriageway. Overlying level L03:35, in turn, was a further road surface of small cobbles (K03:12, L03:59, 61), which was observed in plan to extend across the full width of the gateway.

Two smaller areas of cobbling appeared to form patches in this road surface. A narrow band of small cobblestones set in grey-brown soil (K03:39) extended across the western carriageway, between the north *spina* and the west tower, filling a trench (K03:19) which ranged between 0.70m and 0.80m in width. A larger area of yellow clay and gravel (L03:50) was located on the east side of the north *spina*. Cobbling K03:39 was tentatively interpreted by the excavators as the fill of a robber trench for the sill blocks. Alternatively it is possible that both could represent cobbling laid to restore the road carriageways after blocking walls had been removed in both carriageways. The latter explanation presumes that the putative blocking walls were removed whilst the road surface, K03:12/L03:59/61, was in use, but they could conceivably predate the laying of that surface.

The final road surface was composed of well-packed, medium-sized cobbles (K03:08, L03:48), overlying a thin layer of dark soil (L03:51). This was considered to represent a post-Roman level, although this is by no means certain. The surface probably corresponds to a cobbled trackway (K04:04, K05:14), interpreted

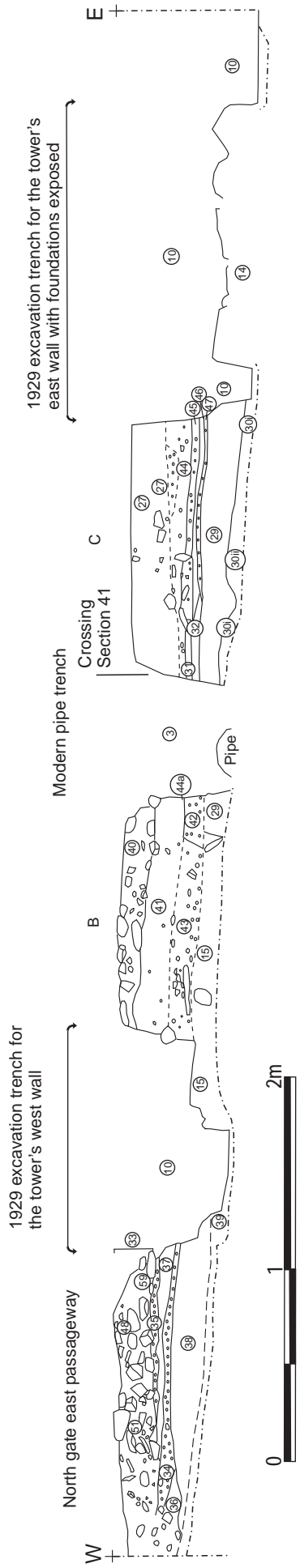

Figure 18.03: Section 42, east-west section across east tower of the north gate, 1:30 (Grid L03).

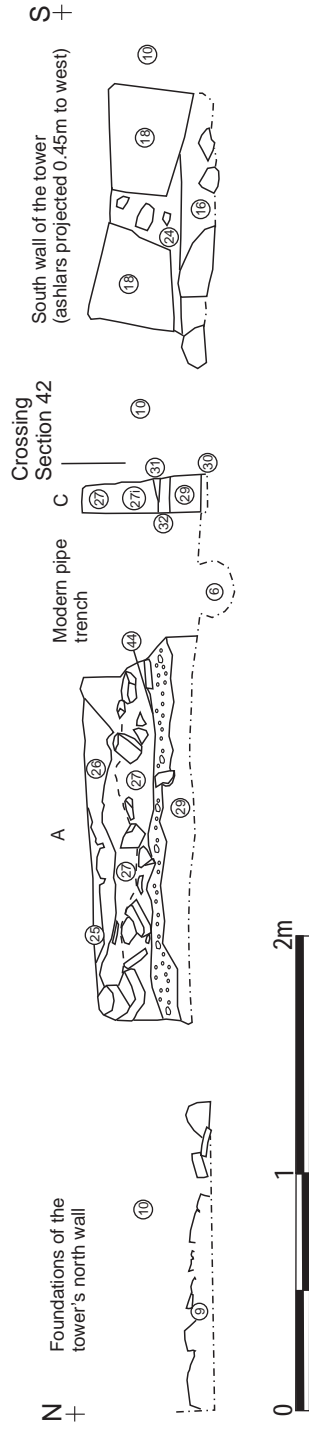

Figure 18.04: Section 41, north-south section across the east tower of the north gate, 1:30 (Grid L03).



Fig. 10 View of the north ramp and north gate from the east with the ramp revetment wall in the foreground.

as being of eighteenth- or nineteenth-century date, which ran down the centre of the *via praetoria* heading towards the gateway. Level K03:08/L03:48 was also equated with a similar stone layer with cobbled surface (L03:40) found over the robber trench for the west wall of the east guardtower (L03:43) and the post-Roman ploughsoil (L03:41 = L03:27) which covered the tower's remains. A layer of dark soil, similar to L03:51, was also recorded beneath this cobbling. If the equation of L03:40 with K03:08/L03:48 is correct, this would indicate that the road surface through the area of the north gateway had grown significantly wider by this stage, covering the remains of part of the east tower as well as the twin carriageways of the original gate. These stratigraphic relationships would strongly imply that the whole surface was laid at some date after the Roman period, following the demolition and robbing of the east tower. However any direct connection between K03:08/L03:48 and L03:40 was severed by the 1929 excavation trench (L03:10) dug to expose the west wall of the east guardchamber (L03:15). In the west passageway the road surface K03:08 dipped down towards its west edge where it was covered by a ploughsoil deposit of orange-brown clay (K03:02) which also covered the robbed remains of the west guardtower. The remainder of this uppermost road surface was covered by a layer of rubble and soil (K03:07, L03:12) which also extended (K03:21) around the south side of the west tower over the final *intervallum* road surface (K03:11, 34–35). This rubble included some relatively modern brick fragments and cobble sets.

FINDS

East tower

Copper alloy: medical implement? (no. 101, L03:32)

East passageway upper road surface

Coin: Claudius II, 268–70 (no. 148, L03:48)

Modern plastic

Dating evidence

West tower foundation

The south wall foundation (K03:32) of the west tower produced sherds of locally produced wares and a flake of Flavian or Flavian-Trajanic South Gaulish samian.

East tower interior

The deposits within the interior produced only a few sherds, but they did include BB2 and allied fabrics (L03:44). The occupation only produced a small quantity of pottery, of mid-second century material (L03:44).

East passageway upper road surface

The upper road surface (L03:48) contained a calcite-gritted Huntcliff type rim dating to after 370.

The pottery associated with the foundation levels of the north gate is consistent with this being a primary, Hadrianic component of the defences.

Discussion

The presence of robber trench K03:19 and the apparent patching (K03:39 and L03:50) of the associated road surface (K03:12, L03:59, 61) through the gateway clearly does not prove that north gate portals were blocked at some stage in their history and subsequently reopened. However such a pattern of events would be consistent with what is known of the history of the gateways (cf. Hodgson 2003, 19, 21, where it is argued that the north gate was open during fourth century).

The date of the final road surface (K03:08/L03:48) through the gateway also requires comment. The date of the final road surface (K03:08/L03:48) through the gateway also requires comment. The excavators attributed this to the eighteenth and nineteenth centuries. This is certainly the case with regard to surface L03:40, to the east, as it clearly did lie above a post-Roman ploughsoil (L03:41) and the east tower robber trench (L03:43). However this was divorced from the latest cobbling in the gate passageway (K03:08/L03:48) by the 1929 excavation trench. Moreover not only was there no ploughsoil deposit beneath the uppermost passageway surface, but ploughsoil K03:02 was observed to overlie the western edge of the surface (K03:08) providing an apparently contradictory relationship. On this basis it is possible that L03:40 represented a later surface (destroyed by modern activity in the area of the passageway), whilst K03:08/L03:48 formed the final Roman surface in the gate passageway. The excavators, however, noted that the relationship between K03:02 and K03:08 was 'tenuous', with the soil not covering the surface uniformly and suggested that the soil had crept back over the margins of the surface while the latter was in use. The continued use of the colliery era trackway may have eroded away any ploughsoil in the central

area of the gateway. Though slightly awkward, this is probably the most convincing explanation for the contradictory relationships in the excavation record, though a Roman date for K03:08/L03:48 cannot be entirely ruled out either.

The north-east defences

Grid squares: M03, M04, N04, P04, Q04

Introduction (Fig. 18.06)

Excavation of the north rampart in the north-east corner of the fort was limited by the back lane which was still functioning between Wooley Street and Lesley Gardens. The area available for investigation included 36.50m of the length of the rampart and rampart kerb, a small section of the fort wall, the southern limits of the interval tower (Tower 7) and the south-west corner of the north-east angle tower (Tower 6). A further 8.50–9.00m length of robbed-out curtain wall and rampart was uncovered immediately to the east of the north gate (grid squares L03 and M03).

The fort curtain

An 8.70m stretch of curtain wall immediately adjacent to the north gate was investigated in 1976. The wall had been robbed out, but the robber trench (M03:06) was clearly visible owing to the small stone pack thrown back into the trench, enabling the line of the curtain to be traced. The wall was set on a heavy boulder-clay foundation (L03:21, M03:10), at least 0.35m deep and 2.00m wide, which was of one build with the east gate tower of the north gate. A layer of gravel and sandstone chippings (M03:11), presumably a construction deposit, overlapped the southern edge of the foundations and was itself overlain by clay rampart (M03:13). The berm north of the curtain was covered by a build up of clay-loam (M03:12), which also overlapped the curtain foundations.

A further small section of the south edge of the north wall of the Fort was located 3.00m west of north-east angle tower. Three ashlar blocks (Q04:03) were uncovered with an average size of 0.40m high × 0.50m wide. They extended beyond the northern limit of the excavation trench, so their depth could not be determined. The south kerb of the lane between Wooley Street and Leslie Gardens sat directly on top of these stones. The foundation of the Fort wall on which the ashlar blocks lay, continued for 1.80m to the east (Q04:04). This consisted of a layer of densely packed rough stones in a trench 0.20m wider than the wall. The construction technique used here was to place the larger stones in a line along the edge of the trench and fill the centre of the trench with smaller material. All of this lay in a matrix of heavy yellow-brown clay.

The rampart (north-east corner) (F2)

The estimated width of the rampart was 5.50m. It could not be established precisely in this area because the only location where the full width could have been indicated, in the area immediately west of the angle tower, the kerb of the rampart had been robbed away and the relationship with the north-*intervallum* road had been destroyed by a large pit (Q04:10) dug through the primary road and the rampart. The rampart consisted of a deposit of fairly homogenous boulder clay, usually dark yellow in colour, surviving to a depth of 0.20m in some places. This was recorded as two separate levels to distinguish the lower sealed material (M03:13, N04:06, P04:13, Q04:06) from any material nearer the surface which may have been contaminated (M03:07, M04:07, N04:03, P04:04, Q04:05), but it is a distinction of relative depth rather than character. The rampart clay sat on a make-up layer (Q04:07), up to 0.25m deep, of medium brown sandy loam containing a large proportion of small angular fragments of sandstone, probably masons-chippings from the construction of the fort wall.

Although there were no obvious indications of major occupation within the rampart, there were traces of possible activity in the area immediately west of the north-east angle tower. Here patches of burnt clay 0.05m deep, containing charcoal, coal and iron slag (Q04:09, 16), lying on a thin deposit of gravel, were uncovered over the sealed rampart clay. These patches were on average 1.10m wide and extended across width of the rampart, running diagonally north-west to south-east and ending opposite the south wall foundation of the angle tower. The largest area occurred immediately south of the north wall of the fort. When this feature was first uncovered it had the appearance of a cinder track and possibly represents a pathway from the entrance of the angle tower to the fort wall, or to something built into the rampart against the fort wall.

Fragments of the primary kerb of the rampart were found to the west and east of the interval tower (Figs 18.06, 18.07; cf. 20.04). Most of the kerb had been robbed away, probably to rebuild it further south during later alterations, perhaps around the end of the third century. To the west of the tower it survived for 3.30m as two courses of pitched stone (N04:13) up to 0.17m × 0.15m in size, with a third course on the top up to 0.38m × 0.16m and going back 0.30m. Most, but not all, were roughly faced. At the east end of this course the kerb turned north forming a neat corner and continued for 1.50m towards the south-west corner of the interval tower. East of the tower, the kerb continued on a rough line for 5.25m (P04:17). It was composed of groups of pitched stones, generally smaller than those of the kerb to the west and possibly representing different periods of repair. This turned north 1.50m west of the south-east corner of the interval tower. The corner in the kerb was much rougher than

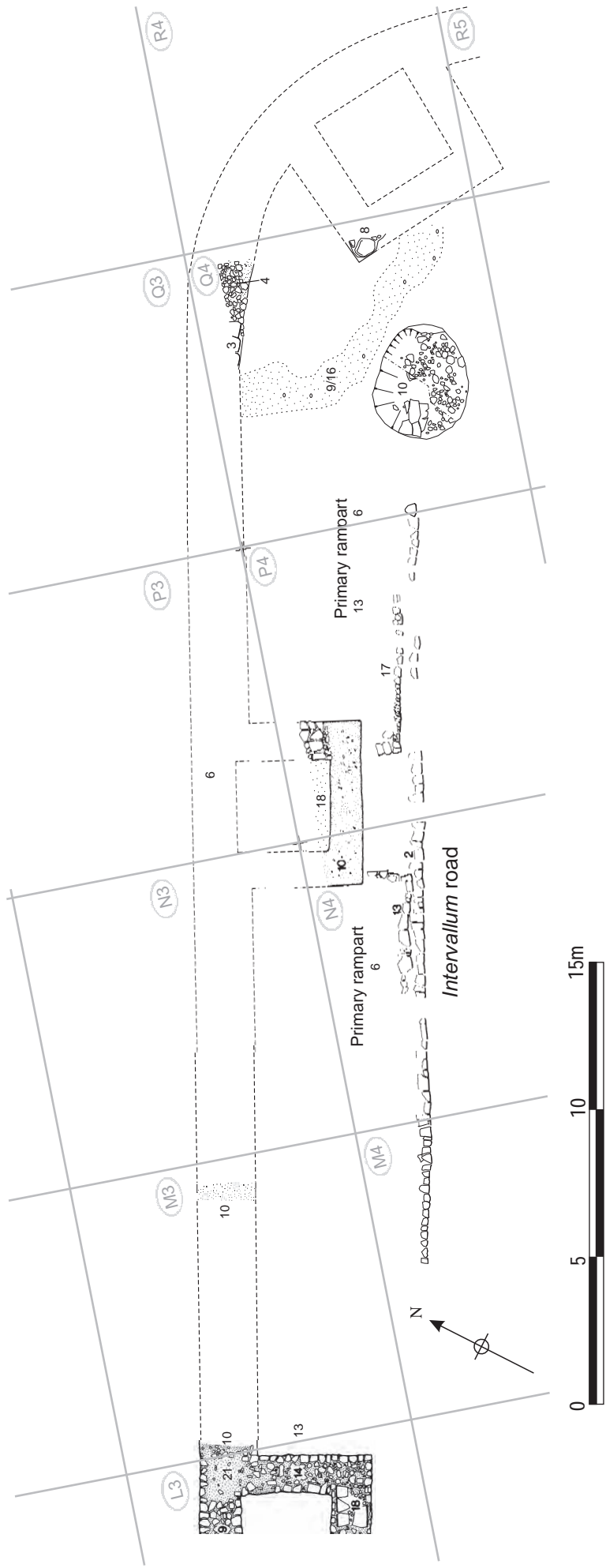

Figure 18.06: Defences to the east of the north gate. Scale 1:200.

the one on the west side and the stonework larger and less regular. The approach to the interval tower between the two kerbs measured 4.00m.

The interval tower (Tower 7)

Only the southern end of the interval tower was available for investigation (Fig. 18.07). It was situated 20.25m from the east tower of the north gate and 15.50m from the north-east angle tower. The line of south wall (P04:15) and parts of the east (P04:16) and west walls (N04:35) were indicated by the foundation of thick, pink, puddled clay. This foundation measured 1.00–1.10m wide and survived to a depth of 0.07m. It lay on a base of large river cobbles (P04:16) in a trench which cut the natural sub-soil. The width of the tower across the foundations was 6.00m. Only a narrow strip of the interior of the tower was uncovered. A thin layer of masons chippings and mortar lay on the surface (P04:18). No occupation levels survived. The walls of the tower were obviously narrower than the width of the clay foundations, as construction material over the interior and the clay of the north rampart both extended a little way across the edges of the foundations.

The approach to the interval tower, was covered with a layer of compacted orange sand (P04:12), probably the original surface. Over this was a layer of occupation material composed of trodden clay containing dirty grey loam, burnt clay, burnt daub and charcoal (N04:08, 09, 14, P04:05).

The north-east angle tower (Tower 6)

The very tip of the south-west corner of the angle tower was uncovered. An area 0.50m square revealed the pink puddled clay and stone fragments of the foundation (Q04:08). This was situated 15.50m from the south-east corner of the interval tower.

FINDS

Sealed north rampart clay

N04:06

Graffiti: (no. 26, N04:06)

Upper unsealed rampart clay

Copper alloy: buckle (no. 154, P04:04), handle (no. 214, P04:04)

Decorated samian: 90–110 (no. D134, Q04:05)

Burnt patches over the rampart clay

Glass: bead (no. 44, Q04:16)

Dating evidence

Rampart

The sealed rampart clay contained BB1 and second-century locally-produced wares, mainly from a single

grey ware vessel (N04:06), and the base of a Hadrianic mortarium (graffito no. 26). The upper, unsealed, rampart clay (M04:07, N04:03, P04:04, Q04:05, 09, 16) contained a large quantity of second-century material, but also a few sherds of third- or fourth-century vessels, including Crambeck reduced ware and a Lower Nene Valley mortarium (N04:03; Q04:05).

Interval Tower 7

The occupation layer over the entrance to the tower contained second-century material, such as locally-produced flat-rimmed bowls in grey and oxidised wares (P04:05, N04:08, 09), but one context also produced some sherds of probable third-century material, including BB2 and calcite-gritted ware, and a burnt sherd that could possibly be fourth-century Crambeck parchment ware (P04:05).

Later modifications

Demolition of the Interval Tower

There was some evidence that the interval tower was



Fig. 18.07 The foundations of the interval tower east of the north gate, looking west. The rampart revetment wall extended across the front of the tower after its demolition; it can be seen across the top left.

demolished towards the end of the third century or the beginning of the fourth. This took the form of a dense layer of sandstone fragments and cobbles (P04:07), 0.20m deep, spread across the approach to the tower and the north *intervallum* road and the extension of the rampart bank across the front of the tower, blocking off access. The walls of the tower had been robbed down to the level of the foundation at some time, but as the fill of the robbing (N04:10, P04:06) was not immediately distinguished from the demolition material, it was difficult to say whether this occurred during the Roman period or later. A clay pipe stem was found amongst the upper fill of the robber trench of the south wall, 0.17m above the foundation, indicating some post-Roman activity in the area. The robber trenches were filled with mixed brown soil, densely packed with large fragments of sandstone.

Replacement of rampart revetment

A new rampart kerb (N04:02, P04:03) was constructed immediately south of the original and extended across the approach to the tower, blocking off the access (Fig. 18.07; cf. Fig 20.03). It was composed of large faced sandstone blocks up to 0.40m × 0.25m × 0.35m set in a slight clay pack. Fragments of the kerb survived as a single course for 26.00m, most of this occurring west of the tower. This sat on a thin bedding of light-brown loam over the demolition rubble from the tower and the earlier road surface. In some places the kerb was keyed into the rampart with brown loam and small fragments of sandstone.

Most of the kerb was left in position, but the excavation of the north *intervallum* road immediately south of the kerb across the approach to the interval tower revealed the position of the kerb in the sequence of events. The two earliest phases of road surface (Phase 1: N04:05, P04:10; Phase 2: (S) N04:07/P04:08, (N) N04:11/21/P04:09) could clearly be seen running under the kerb and some of the demolition rubble (P04:07) on which the late kerb sat. The late surface over the north *intervallum* (N04:04, P04:02), consisting of flags, cobbles and fragments of stone from the demolition of Building 1 around the end of the third century, ran up to the face of the late kerb. On this basis the excavators inferred that the interval-tower had been demolished and the new rampart kerb constructed before the demolition of Building 1 was begun, possibly during Period 4 of the Fort. However, the Phase 2 road surface south of the kerb and the surface which ran beneath it appeared to be one consistent level, so it is more likely that the alterations took place around the end of the third century, probably as part of an overall programme of rebuilding.

Dating evidence

Later modifications

The rampart kerb continued sherds of a BB1 cooking pot with a line above obtuse angle lattice, dating to after c.250 (N04:02). More sherds of the same or a similar vessel came from the fill of the robber trench, which also contained BB2 and Nene Valley colour coated ware. A sherd of calcite-gritted ware suggests a date after c.270 (P04:06).

Note: the demolition of the interval tower

The excavators argued cogently that the interval tower was demolished towards the end of the third or beginning of the fourth century. However, based on comparative analysis of structural sequences in the defences of other northern frontier forts, the evidence recovered from the north-east defences in the 1975 season was not as conclusive as they imagined. A case can be made that the tower was retained, but access to the ground floor level was closed off. This question is considered in more detail in Chapter 20 below.

The north-west defences (Fig. 18.08)

Grid squares: E2, E3, F2, F3, G2, G3, H2

The ramparts and curtain wall

Introduction

A small portion of the western rampart survived to the south of the north-west angle tower. Rather more of the north rampart was located and, at one point, it was possible to examine the foundations of the north curtain wall.

West rampart

An area of the clay of the west rampart (E03:06) was preserved immediately south of the north-west angle tower. Separating it from the *via sagularis* was a stone revetment (E03:07), which was traced for a distance of 1m in the form of a single course of stones, only one stone wide.

North rampart and curtain wall

Material belonging to the north rampart was noted in a number of places as a yellow sandy clay with occasional stones (E02:19, F02:13, F03:14, G02:06, G03:10). This was associated with the base of a revetment wall (F03:11), again only one stone wide and with only the lowest course surviving. The revetment was traced for at least 1.5m from the north-west angle tower (F03:11), and possibly as far as the western interval tower (Tower 1) on the north rampart, albeit intermittently (perhaps incorporated in surface H03:10). An east-west aligned strip of cobble foundation (F02:09), 3.5m in length and 0.95m wide,

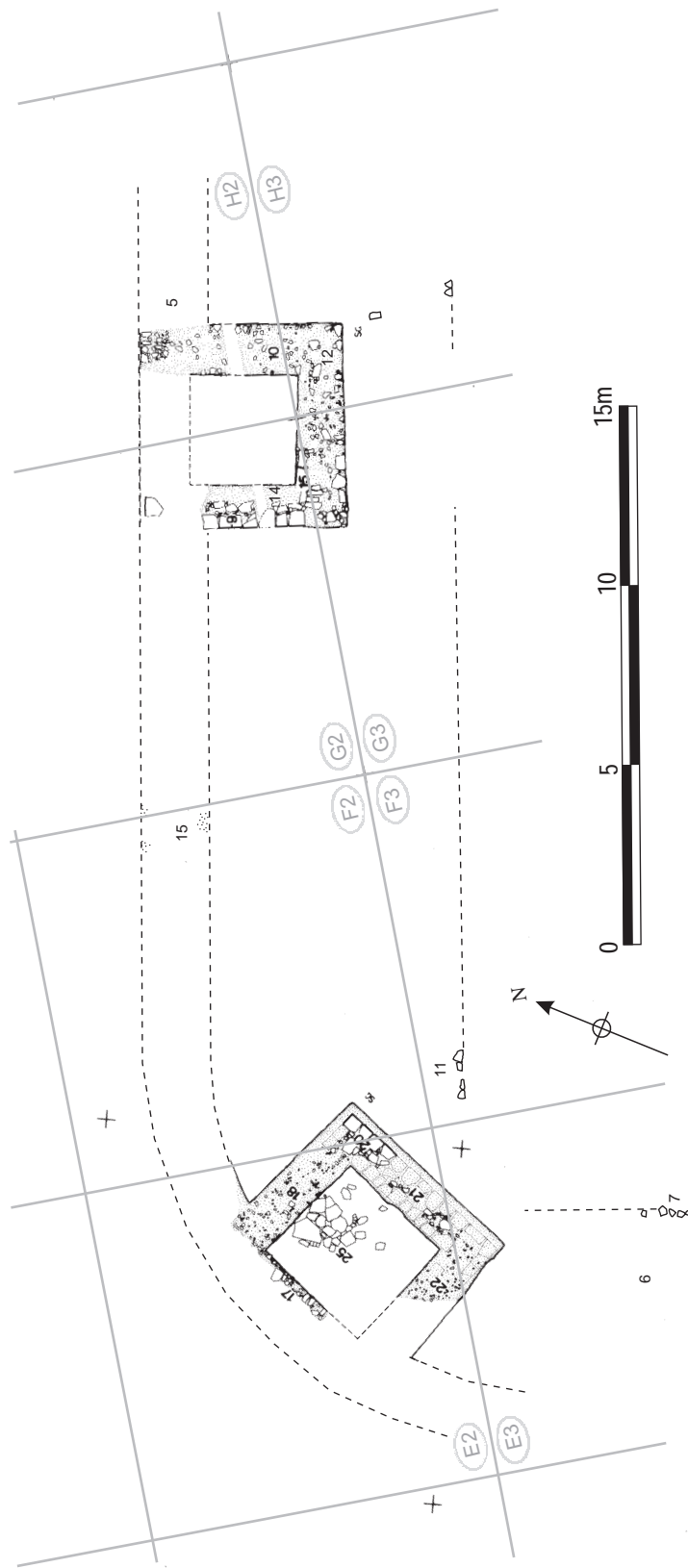

Figure 18.08: Plan of the north-west defences comprising the north west angle tower (2) and north interval tower (1) and surviving stretches of rampart revetment. Scale 1:200

was recognised overlying the rampart clay (F02:13) immediately east of the east corner of the angle tower. Its function was unclear but it appeared to lie beneath the post-Roman agricultural soil (F02:07). The north curtain wall of the fort had been comprehensively robbed (E02:14, F02:10, G02:05, H02:08) and only a couple of sections of the pink foundation clay (F02:15, H02:05), about 2m in width, and one possible facing stone were found. The presumed line of the rear face of the north curtain would make the rampart 7m wide along this section of the defences, projecting 3m further south than the south wall of the interval tower. It was evident that the rampart had been constructed after the angle tower had been at least begun, as the clay butted against the surviving eastern corner stone of the tower (E02:20).

The interval tower west of the north gate (Tower 1)

Only the pink clay and cobble foundations (H02:10, H03:12) survived from the east wall of the interval tower, but there were some flags preserved within it on the line of the south wall (G02:15), whilst 3m of the western facing stones and core were found for the west wall (G02:09, 10) overlying pink clay foundations G02:14. The foundations delineate a tower 5.7m east to west, extending 5.75m south from the northern face of the north curtain wall. The internal space within the tower was 3m wide (but the absence of the rear face of the curtain made it impossible to be certain of the north to south measurement).

A cobbled surface was identified in the entrance passageway of the interval tower (G03:17, H03:08), composed of a compact spread of small angular stones, 0.05–0.10m in length. This reportedly lay at the same level as the second of the layers of metalling recorded on the north *intervallum* road (G03:15, H03:09). A pivot stone (H03:11) was found at the eastern edge of the cobbling.

The remains of the tower were covered by rubble (G02:12, H02:09, H03:07), interpreted as demolition rubble but possibly simply the result of post-Roman disturbance.

The north-west angle tower (Tower 2)

Like most of the other towers this one had suffered severe damage from various causes. Enough remained, however, to show its basic structure and to allow the tower's constructional sequence to be established. On top of the tower was a series of nineteenth century stone cottages which had not damaged the Roman remains. They overlay a large gully (E02:23) on the western edge of the site which had removed all earlier levels. This is probably the same feature which was also noted west of Buildings 4, 5 and 6. The gully cut through extensive robbing of all the walls of the



Figure 18.09: The north-west angle tower from the south west. The impressions of the robbed out facing stones are evident in the surface of the clay foundations.

tower and the curtain wall.

Only four facing stones of the east corner of the tower (E02:20) and some parts of the core had survived the robbing of its stone work (Fig. 18.09). The height of this base course was 0.33m and the stones were about 0.40m long. Impressions of robbed stones in the clay of the foundations (E02:21) showed that the rest of the south-east wall was similarly constructed. In all the outside face had 12 stones and the inside face 10. The widths of the south-west, south-east and north-east walls were established as 1.10m, 1.05m and 1.15m from the impressions in the clay foundations and the size of the robber trenches (E02:15). The foundations themselves were 1.30m wide and were packed with puddled pink clay (E02:18, 21, 22). Presumably the clay sealed large cobbles as elsewhere but this was not tested.

None of the robber trench fill (E02:14) over the curtain wall was removed at this point except in the interior of the angle tower. This showed that the tower foundations were recessed 0.50m into the curtain wall foundations (E02:17).

The overall dimensions of the angle tower were 5.5m (north-east/south-west) and it projected 6.1m from the curtain wall. Internally, it measured 3.7m by 3.5m. As the impressions of robbed stones were continuous along the south-east side it is not clear where the door to the tower was located (if indeed there was one). The rampart bank (E02:19) curved in to the south and east corners of the tower, indicating that the south-east face was free-standing.

Internally, part of a stone flagged floor survived in the east corner (E02:25). On it lay some tumbled facing stones (E02:24) presumably from the superstructure of the tower, but there was nothing to indicate when they arrived there. The flagging was not removed but where it was not present there was a mixed level of sand, clay and dark soil including some ash (E02:26), which went under the flagging and presumably

represented an earlier phase of occupation. Below this again was a layer of small sandstone pieces and mortar (E02:27). It was between 0.03 and 0.10m thick and extended over the clay foundations and under the rampart clay on the north east side. It was at its thickest on this side and its presence probably accounts for the failure of the clay foundations here to show the impressions of the robbed stones. A small test hole showed the stone and mortar to fade away about 0.25m into the rampart. This level was interpreted as construction debris for the fort wall (there was no trace of mortar in the other walls of the tower, which were bonded with grey clay). It allows us to suggest that the construction sequence saw the foundations of the tower being laid first, before the curtain wall was started.

Without the evidence of the relationship of the angle tower walls to the curtain wall it is impossible to say whether the fort wall was finished before the tower was built. However, it seems more probable that work on both continued apace. In the final stage of the sequence, the rampart was thrown up against the walls of the tower. There was definitely no construction trench for the tower cut into the rampart and this is consistent with the construction debris being sealed by the rampart.

The same sequence was met elsewhere on the north side of the fort.

FINDS

North rampart clay

Stone: throwing stone: (no. 82, G02:06)

Dating evidence

North and west ramparts

The west rampart revetment wall (E03:07) produced at least one third-century Gillam 151 rim, and an East Gaulish samian dish of the late second or first half of the third century.

There is no indication in the context record or in the excavators' structural description, presented above, that the remains of the west rampart revealed in 1976 represented a secondary remodelling rather than the primary layout. However the association of late second/third-century pottery with the revetment wall does raise the question as to whether this signifies that the west rampart was reconstructed at this period. If so, the original revetment has still to be traced.

Interval tower (Tower 1)

The demolition rubble over the interval tower (H02:09) did not produce much pottery, and contained none later than the third century.

North-west angle tower (Tower 2)

There were no stratified finds from the angle tower. However, no evidence was found to suggest that it was dismantled in Roman times. The robbing contained clay pipes, and there is little reason to doubt (although it cannot be proved) that the angle tower functioned as long as the fort itself.

19. THE SOUTH AND EAST DEFENCES

The south gate – *porta decumana*

Grid squares: H16, G16, J16

Introduction (Fig. 19.01)

The south gate (*porta decumana*), labelled Gate 3 in Daniels system of building codes, was initially investigated as part of Site 7 in the 1977 season when a trench was dug across the south defences to locate the curtain wall and defensive ditch with an offshoot to determine the position of the gate. More extensive exploration of the south gate's remains was undertaken in 1978 when the structure was incorporated into Site 11. The north-west part of the gate, corresponding to most of the west tower, was never exposed, however, nor was the majority of the western passageway.

The remains of the gate had been extensively robbed and further damaged by modern intrusions. Much of the north side of the west tower had been obliterated by the course of an eighteenth/nineteenth-century waggonway, but traces of the *spina* piers remained. Modern drains cut across the surviving remains which had largely been reduced to their primary foundation levels as a result of stone robbing.

Period 1

The pre-fort ploughsoil was recognised at various points overlying the natural yellow-orange clay subsoil (H16:18), including south of the west guardtower (G16:30), on either side of the curtain wall around 3m further west (G16:34) and next to the south respond in the west passageway (H16:17). It took the form of a grey clay with slight yellow-orange streaking. Evidence for the ground being cleared by fire before construction was also found in a couple of places in the form of fairly extensive patches of orange and black, burnt clay on the surface of G16:34 on the

north side of the curtain wall (G16:33) and over H16:17 at the edge of the western passageway (H16:16).

In plan the *porta decumana* followed the general pattern of the principal gates at Wallsend and the other Hadrian's Wall forts, featuring twin arched passageways separated by two *spina* piers and flanked by a pair of rectangular guardtowers. Arches towards the front and rear of each passageway would have sprung from the *spina* piers and a pair of responds attached to the sides of the towers. Notionally it was the fort's rear gateway, giving direct access to the *via decumana* and the area behind the central range buildings. However, as the only one of the fort's major, double portal gates to lie south of Hadrian's Wall, it may in consequence have played a more significant role in the history of the fort than some of the other gateways.

The east guardtower

All four walls of the east guardtower were traced enabling the dimensions of the tower to be gauged, but the interior was not explored. With the exception a 0.85m length of masonry forming part of the north wall (J16:13) only the foundations remained (J16:21–24). These were composed of cobbles set in pink clay. Most of the north, east and west foundations were exposed, but the south-west corner had been completely removed by a later pit (J16:19) and the edge of north-west corner had also been destroyed, whilst only a narrow strip across the south wall foundations (J16:22) was revealed. The width of the foundation deposits varied from 1.30m in the case of the north and west walls (1.50m including responds), 1.35–1.40m for the east wall, right up to 1.55m for the south wall. The foundations for the north and south responds projected some 0.20m further and were respectively 1.35m and 1.45m wide (N–S). The southern (outer) respond was withdrawn some 1.50m from the outer face of the fort wall, whilst the shallow

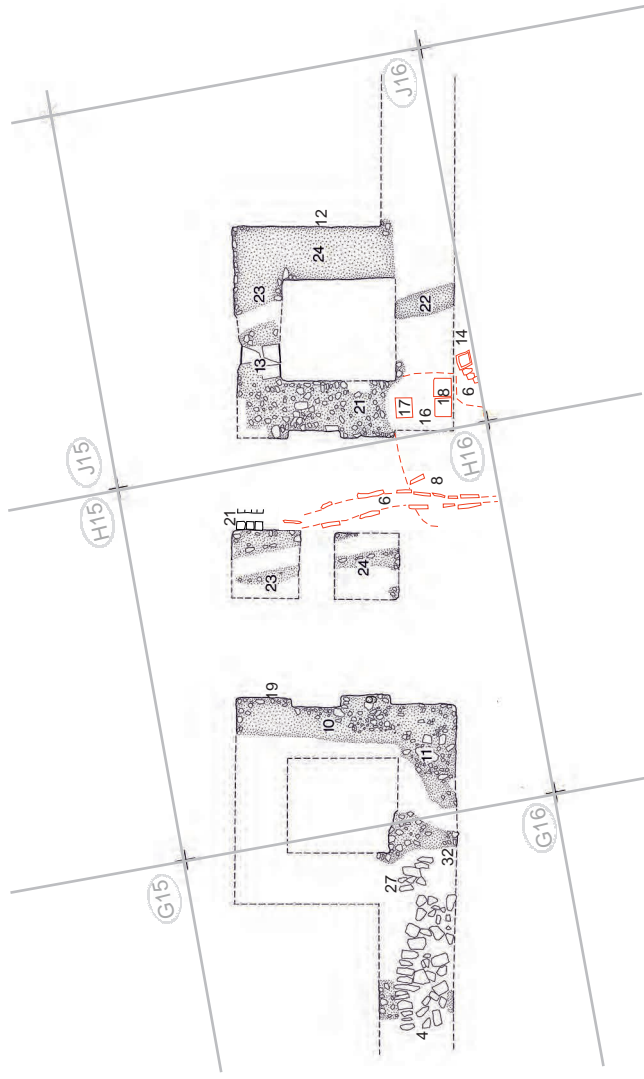

The south gate, at 1:200, with later Roman or post-Roman features marked in red.



East defences: the interval tower north of the south-east angle, at 1:200

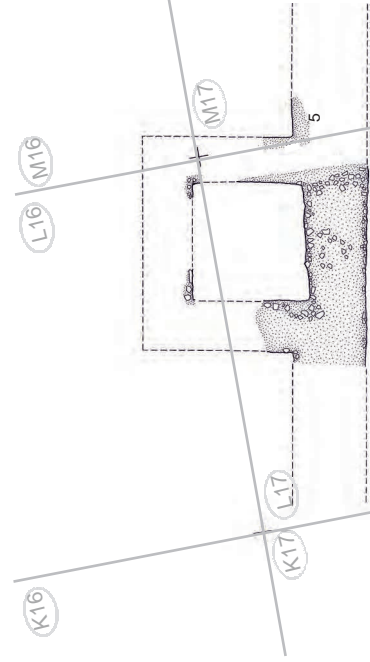

South defences: the interval tower east of the south gate, at 1:200

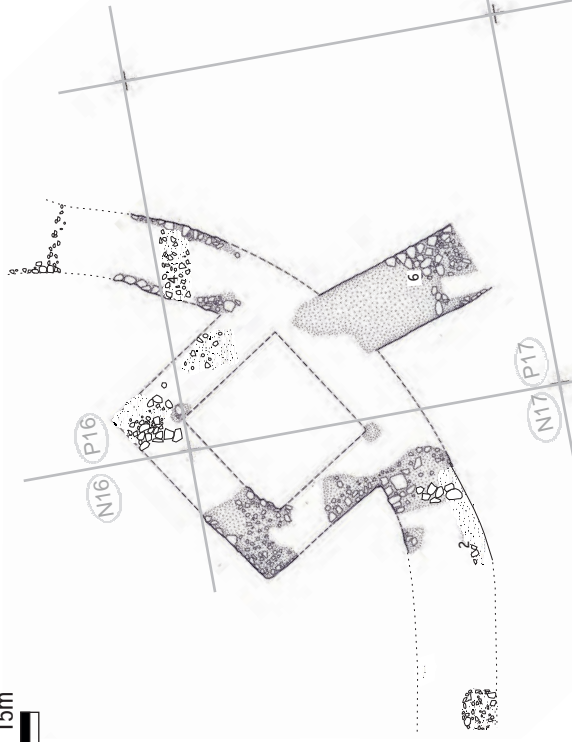

The south-east angle tower, at 1:200

Figure 19.01: South and east defences at 1:200.

recess between the two was 1.35m in length. Based on the extent of the foundations the overall external dimensions of the tower were estimated at 5.70–5.90m (N–S) by 5.35m (E–W), excluding the responds, whilst the interior of the tower measured c. 2.70m (E–W) by 3.00m (N–S). The actual plan dimensions of the standing tower walls would have been somewhat less, however, judging from the surviving north wall masonry, which was set back c. 0.15–0.20m from outer edge of foundation deposits. There may have been a similar offset along the interior face, but this was less clear.

This surviving fragment of the north wall (J16:13) comprised three large, dressed blocks of coarse-grained sandstone, two belonging to the internal face and one to the external, north face. The blocks were 0.30–0.50m wide along the wall faces, c. 0.30m high and extended 0.45–0.55m into the thickness of the wall, generally tapering inwards slightly. The resultant overall width of the wall was 1m. The size of the blocks left little space for wall core but one large piece of sandstone rubble was noted set vertically between the tails of the facing stones. The rest of the wall masonry had been removed, its position being marked by robber trenches filled with brown, grey brown or black sandy soil and sandstone rubble (J16:07–09, 11). Nevertheless the 1.00–1.05m recorded width of the north (J16:07) and east (J16:08) robber trenches implied that all the walls were a similar width and significantly narrower than the foundation deposits (the west wall would presumably have been correspondingly wider where the responds were present). The impression of blocks of masonry was even preserved in the clay foundation (J16:23) at the base of the north wall robber trench.

Next to the east wall foundations a narrow strip of yellow clay (J16:12), some 30mm thick, belonging to the primary rampart base, was exposed.

The gateway (Figs 19.01, 19.02)

Traces of the foundations for the two *spina* piers (H16:23–4) were identified, although in neither case was their full area exposed. They were composed of dark pink puddled clay and largish chippings. The east side of the inner (north) *spina* was revealed including both the north-east and south-east corners, plus a north-south strip roughly midway along (H16:23). In the case of the front *spina* (H16:24), only the north-east corner, another north-south strip and the south-west corner were traced. On this basis the dimensions of the two pier foundations were shown on the plan (P125) as 1.80m square (H16:23) and c.1.75m (E–W) by 1.70m (N–S) (H16:24), though the figures recorded on the context sheets were somewhat greater at respectively c. 2.00m (N–S) and c. 1.95m (N–S) × c. 1.80m (E–W). The two pier foundations were 0.90m apart and the estimated width of the east and west passageways between the foundations and

those of the corresponding responds was respectively c. 2.40–2.50m and perhaps 2.50–2.60m.

A stone-lined drain was noted in the east passageway (H16:21) which might have been primary, or at any rate have belonged relatively early period in the gate's structural history. This was perhaps a continuation of the drain channel (J13:09, J14:25) traced running alongside the west end of Building 12 further north on the *via decumana*. It was located in two places beneath a later, possibly post-Roman drain channel (H16:06). To the north it was neatly positioned on the west side of the passageway, next to the rear *spina*, and was traced over a distance of 1.5m, but further south it appeared to have shifted further to the east. Both side walls survived in the northern section, each composed of a single course of dressed rubble blocks lining a 0.22–0.28m wide channel. The latter still contained an original fill of gravelly, gritty wash including fragments of pottery and a few stones (H16:22) along its west side. Only the east wall of the drain was preserved further south, the other side having been removed by the later drain channel. The height of the stones in the side walls was variously recorded as 0.09–0.10m and 0.13m.

The primary road level through the gateway was not identified, even in places where excavation was taken down to the natural subsoil or the pre-fort ploughsoil and had evidently been removed by later truncation in many areas.

The west guardtower

Only the east and south sides of the west gatetower were examined. The surviving remains there had been reduced to the level of the foundations with the exception of a short section of stonework possibly belonging to the southern end of the west wall (G16:27). The estimated overall dimensions of the tower were 5.80m (N–S) by 5.40m (E–W), including the responds. The primary foundations of the east wall (H16:10) and the south-east corner (H16:11),



Fig re 8 The east passageway and east guardchamber of the porta decumana, looking north west.

uncovered in 1978, consisted of dark pink puddled clay, large cobbles and some cut stone, becoming very stony whilst the clay changed to a much yellower colouration in the northern part of the gatetower. Some traces of flagging were noted over part of the clay in the foundations of the east wall (H16:10) plus a layer of chippings over the south respond in places (H16:09). The full width of the east wall foundations was not exposed so this can only be estimated by analogy with the equivalent part of the east gatetower. Their length from north to south is shown on the plan as c. 5.80m, although the context records and associated sketch plan suggest the northern edge was cut by the coarse of an eighteenth-century waggonway (H16:20). The foundations of the front and rear responds were traced, the former (H16:09) measuring 1.35m in length (N–S) and projecting up to 0.35m eastward into the passageway, whilst the latter (H16:19) were shown as c. 1.45m in length (N–S) and c. 0.20m wide (E–W). The recess between the two was c. 1.30m in length.

The foundations of the tower's south wall were composed of the usual pink, puddled clay and cobbles (G16:32, H16:11). Their width was apparently somewhat irregular, increasing from 1.60m to 1.80m at the junction with the west wall, to judge from the site plan. A robber trench, filled with orange sandy clay and small stones (G16:31), had removed the actual masonry of the south wall. Further west, beyond the tower, the recorded width of the fort curtain wall foundations (G16:32) was 1.95m.

A course of well-laid and firmly set, large blocks (G16:27) was interpreted as forming the southern part of the tower's primary west wall. The stonework was seen to extend 0.60m from the northern edge of the Site 7 offshoot trench to the point where it adjoined or was abutted by an east-west aligned, foundation of pitched stone (G16:04), which extended westward along the line of the primary curtain wall and clearly represented a secondary, if not post-Roman, feature. Stonework G16:27 was shown on site plan P88 in such a way as to suggest that the west face of the wall may have been preserved, but the manner of its depiction on the main site plan (P125) is less compelling in this regard and it may simply have comprised a section of wall core. Its positioning in relation to the secondary, pitched stone foundation suggest a possible association with that feature and it is therefore considered further below.

Later features and modifications (see Fig. 19.01)

Several features which could relate to later modifications to the gate were identified by the excavators. For the most part these were eventually dismissed as being of post-Roman date. However the 1997–8 excavations revealed evidence for later Roman repairs

and refurbishment of the defences and it is worth re-examining the 1977–8 features in this light.

Cobbled road surfaces

A small area of rough but deliberately laid cobbling (J16:14) was exposed on the south side of the east gatetower. This was interpreted as the surface of a Roman road covering the area of the berm between the tower and defensive ditch outside the fort circuit. The cobbles were not removed to reveal the underlying levels so there is no clear indication as to where it fitted in the sequence of Roman structural periods. They were overlain by an obviously modern feature – a rather irregular line of mortared stones, of indeterminate function, sitting on a dirty grey soil flecked with mortar and terminating at its east end in a moulded plinth stone which may have been a reused Roman plinth (J16:06).

Along the east side of the eastern passageway a layer described as a densely packed, possibly laid surface of coarse-grained sandstone cobbles or 'cobble rubble' (J16:20) was the lowest level uncovered. The context sheet includes a comment that this may have been the illusion of a surface created by the densely packed nature of the layer. This was covered by a further layer composed of various sizes of cobble rubble in a matrix of grey-black soil (J16:15), 0.10–0.15m deep. It was noted that in its extant state this did not appear to be an actual surface but could perhaps represent a disturbed road surface. In the context database J16:15 was treated as a possible Roman level whereas the underlying layer, J16:20, was not included and was presumably assigned a post-Roman date. Both contexts were qualified as 'modern' on the actual context sheets, though it was also acknowledged that no modern material was actually found in J16:15.

Foundation (?) pit H16:08/J16:19 (cf. Fig. 20.02)

A large, stone- and clay-filled, sub-rectangular pit (H16:08, J16:19) had cut away the south-west corner of the east gatetower foundations (J16:21–2), and additionally extended southwards, where it cut through cobbled surface J16:14, and westwards into the gate passageway, where it underlay cobbling J16:20. The latter was not removed to expose the full area of the pit, but the pit's stone packing was seen to continue west of J16:20, in the bottom of the cut for a later drain channel (H16:04). The pit contained three large, flattish blocks (J16:17; J16:18), probably reused, the largest measuring 0.68m × 0.62m × 0.35m. These were packed around with and covered by yellow and pink clay, probably a mixture of redeposited natural and foundation clay. The three blocks and the stone and clay fills at the south-west angle of the tower were overlain by a layer consisting of large pieces of sandstone in grey-black clayey soil (J16:16), perhaps representing the fill of a later robbing intrusion or

conceivably the 1929 sondage which located the south-west corner of the east tower (Spain and Simpson 1930, 489, cf. plan facing p. 486).

The pit was generally interpreted as a modern feature by the excavators. Its relationship with cobbles J16:20 was described in greatest detail in the context entry for H16:08. The pit and its fill deposits could be seen to extend underneath the cobbles with a clay band between. Extending from the northern edge into the area below the cobbles there was a band of black, dirty modern fill. This black fill, which was explicitly said to lie below the cobbles, was not regarded as an integral or original part of the feature, but rather as material which had collected on top of the pit fills (and particularly around the edge of the cut for the pit) after they had subsided a little within the pit. The excavator argued this would tend to imply a modern date for the pit since the settlement probably occurred relatively soon after construction. However confirmation of this interpretation is lacking. The description of the dirty black fill as modern was presumably based on the reasonable assumption that it represented colliery debris, but it is not clear whether this was really the case or whether any modern finds were actually recovered from it. Hence the pit and the stone blocks set in it could, alternatively, be envisaged as forming part of a later Roman reinforcement or underpinning of the south-east corner of the gatetower, which would provide a coherent functional explanation for them.

Drain H16:06

Another feature of uncertain periodisation is the secondary phase of the drain through the east passageway (H16:06). This followed essentially the same course as the earlier Roman drain (H16:21), which it must have overlain or removed, and cut the western edge of pit H16:08/J16:19. The side walls were constructed with roughly dressed, sandstone rubble facing stones and survived better on the east side than the west. The channel appeared to have also been relined with vertically set flags and was filled with a mottled grey sandy clay silt (H16:07). The pitched flags were reminiscent of the side walling used in the drain which ran around the south end of the granary and past the south-west corner of the *principia*, although in that case the slabs appeared to have featured from the outset. The course of the drain was overlain by a broad linear spread of dirty, dark grey to black sticky soil, containing coal, brick, mortar fragments and some redeposited clay (H16:04), which appeared to form the fill of a cut through the cobbled layers to the east (J16:15, J16:20).

The drain was initially thought to be Roman in date, its pitched slab lining being added to the inked phase plan of the gate, but was later interpreted as a probable modern feature. In the context database it was listed as an eighteenth-century trench. The

stratigraphic reasoning is convincing. The composition of the uppermost fill material (H16:04) indicates it was colliery era debris which had presumably filled the cut for the drain channel after it had gone out of use later in the eighteenth or early-mid nineteenth century, although it is curious that a colliery drain should so closely follow an earlier, Roman one.

Dating evidence

South Gate

The south gate produced very little pottery; an intrusive (?) incomplete mortarium rim, possibly from a third- or fourth-century Mancetter-Hartshill vessel from the fill of the early drain (H16:22), and some third-century material from the disturbed cobbling (J15:15).

Discussion

Despite extensive robbing and the presence of numerous modern intrusions the outline of the primary *porta decumana* was established with reasonable clarity. However the remains yielded disappointingly little evidence for later alterations such as the blocking of either of the portals or a succession of road levels which might be related to the structural sequence recorded outside the south gate in 1991. The stone foundation pit H16:08/J16:19 – if it is assumed to have been Roman – not only encompassed the south-east corner of the east tower but appears to have extended part way across the east passageway as well. It did not close off the passageway completely, however, and in any case appears more substantial than would be required for a simple blocking wall unless the arch of the portal also needed rebuilding. The two layers of cobbling identified in the east passageway (J16:15, 20), the uppermost (J16:15) evidently disturbed, overlay the pit and were clearly relatively late in the sequence if not post-Roman. Indeed, the most difficult issue with regard to the interpretation of this gate is the uncertainty as to whether secondary features should be assigned to the Roman period at all. Differing opinions were expressed in the context notes at various stages over the course of excavation and thereafter, with most of the features eventually being dismissed as belonging to the colliery period, although the reasoning behind this is not always clear. Much seems to have depended on the character of certain dark deposits, notably that extending over the northern lip of the foundation pit beneath cobbling J16:20.

The sequence of defensive ditches recorded outside the gate by TWM in 1991 provides more substantive clues regarding the gate's likely structural history (Hodgson 2003, 19–21). The implications of this data are analysed in Chapter 20.

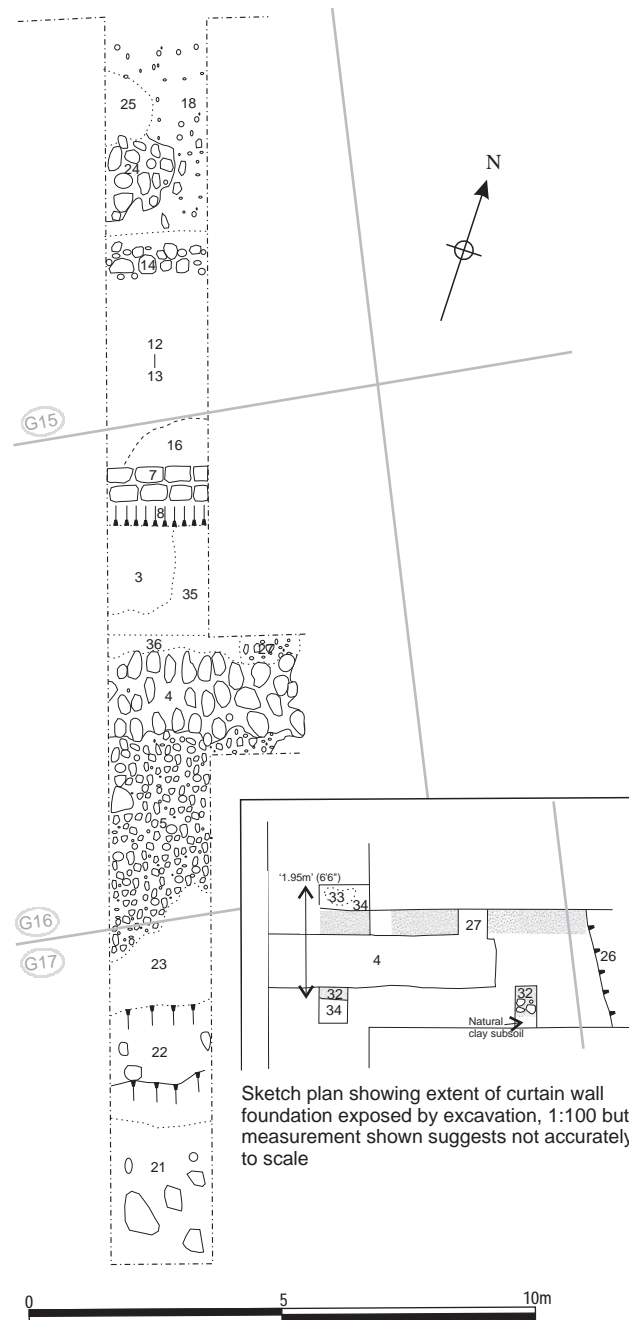

Figure 19.03 Trench across the south defences in grid squares G15-G17 Scale 1:100

South curtain and ditch

Grid squares: G16-17

A trench was excavated across the southern defences a little to the west of the *porta decumana* in 1977. In the same season a branch trench, 6.40m long and 2.35m wide, was extended eastwards from the first trench, along the line of the curtain wall, to reach the nearest tower of the gate (Fig. 19.03). The main, north-south aligned trench was 24.50m in length and 2m wide, and extended southward from the *intervallum* road, traversing the rampart, curtain wall and berm to terminate part way across the innermost

ditch. Once again the Roman levels had been severely truncated by later activity and there was some difficulty in determining whether certain features should be interpreted as potential later Roman modifications to the defences or as colliery period structures.

Period 1

The foundations of the fort curtain wall were traced as a 1.95m wide band of puddled pink clay and cobbles (G16:32) encountered at a point c. 12.15m from the

northern end of the main trench and exposed at various places in the offshoot trench to the east. The foundations cut the pre-fort ploughsoil (G16:34) and underlying natural clay subsoil. The masonry of the curtain wall itself had been removed by a robber trench (G16:36) filled with small stones in a slightly sandy, clayey grey soil matrix, which was uncovered over the northern edge of the foundations in the main trench.

A strip of mixed grey and yellow clay (G16:35), which probably represented the primary rampart, was revealed, overlying the northern edge of the curtain wall foundations, as well as the pre-fort ploughsoil and the clearance deposits (G16:33). It extended c. 2.15m from the northern edge of robber trench G16:36 as far as the construction cut (G16:08) for a stone-founded, brick wall (G16:07) belonging to the colliery period. (To the north of that wall the only other features and levels exposed in the trench were probably modern.)

The ditch (Fig. 19.04)

Beyond the curtain wall foundations, a pink-grey patchy clay incorporating a few stones (G16:23) was uncovered on the surface of the berm immediately to the north of the lip of the inner ditch (which actually lay in grid square G17, though its contexts were still numbered as G16). The distance between the lip of the ditch and the southern edge of the foundations was not specifically recorded, but can be estimated at around 5.20–5.50m. A homogenous pink clay (G16:22) was exposed by the sloping side of the ditch and presumably represented the natural subsoil in this area, although this was not defined as such and apparently differed somewhat from the yellow-orange clay subsoil (H16:18) revealed at various points in the south gateway. The ditch was filled with a very dirty, grey-black, coal-stained clay loam and worked sandstone blocks – both rubble core and facing stones – presumably tumbled from the curtain wall (G16:21). This was overlain further to the south by an orange clay fill (G16:28), up to 0.25m deep. Although the ditch took up the southernmost 5m of the trench, that did not represent its full width, which was not actually determined, but clearly extended beyond the end of the trench. Furthermore, the excavators were unable to fully empty that section of the ditch they did open, due to a powerful flow of groundwater which filled the bottom of the ditch at the south end of the trench, causing it to be abandoned.

It is uncertain whether this ditch formed part of the primary defences of the fort or was a later addition. The fill contained late third-century pottery, but the description of fill G16:21 suggests that the ditch may not have been completely backfilled until the colliery period. Following investigation of the ditches outside the south gate by Tyne and Wear Museums in 1991, it has been argued that this represents the course of

the primary inner ditch as recut and enlarged later in the third century (Hodgson 2003, 19–21).

Later modifications

The most significant of the later features identified in the Site 7 trenches was a substantial, pitched stone foundation (G16:04; cf. H16:14), 1.20m in width, overlying the clay and cobble foundation of the primary curtain wall (Fig. 19.05). The sandstone blocks used were up to 0.50m in length but averaged 0.35m long by 0.20m wide and 0.30m high. They were traced over a total distance of 4.50m running from the western edge of the main trench eastwards towards the south gate as far as the surviving fragment of masonry interpreted as belonging to the west wall of the west guardchamber (G16:27) where they petered out. Masonry G16:27 appeared to adjoin the north side of the foundations, suggesting that they were associated, though they need not have been contemporary. On the south side of foundations G16:04 the berm was covered by a surface of worn cobble stones set in in grey clay (G16:05), up to 3.70m in width (N–S), with a further 1m of more scattered metalling to the south beyond that. This cobbling appeared contemporary with the pitched foundations. Abutting the foundations on the north side was a layer of orange gravel and clay (G16:03), with coarse sand and scraps of sandstone. This



Fig. 19.04 North lip of the south ditch looking north with pitched stone foundation G16:04 visible on the line of the curtain wall in the background.

overlay the primary rampart deposit (G16:35) and, like the latter, extended as far as the cut for the colliery period brick wall (G16:07–08). The layer was interpreted as a possible construction level in the primary rampart, but, whereas level G16:35 was cut by the curtain wall robber trench (G16:36), G16:03 may be judged to have overlain the robber trench, on the basis of the successive sketch and site plans, although there is no explicit record of the relationship between the two contexts. It should therefore be interpreted as a later deposit, probably contemporary with the pitched stone foundations.

The pitched stones were originally interpreted as foundations for the fort curtain wall (and are listed as such in the context database), but it was noted that they cut the robber trench for the primary curtain wall (G16:36) and were therefore quite reasonably reinterpreted as another post-Roman wall foundation in the context notebooks. Nonetheless, in view of the substantial nature of these foundations, their coincidence with the line of the primary curtain wall and the evidence revealed by the 1997–8 excavations for rebuilding work along the west curtain, the possibility that they represent a reconstruction of the south curtain at some stage later in the Roman period cannot be entirely ruled out. This would, however, imply that such a reconstruction involved reducing the primary curtain wall right down to its foundations, removing all the original masonry and even providing new narrower foundations (1.20m

wide instead of 1.95m) composed of large blocks of pitched stone. This might have been associated with the reinstatement of the rampart bank (G16:03) and cobbled surface on the berm.

Two features to the north of the surviving rampart levels also merit a brief note (these lay partly or entirely within grid square G15 but were numbered as G16). Beyond the colliery era brick wall G16:07, a 3.5m broad layer of grey clay and stones (G16:12), badly contaminated by overlying deposits of coal slack, was exposed which was identified as the remnant of eighteenth century topsoil. This in turn covered a layer of stones (G16:13), which included some modern material perhaps intruded into it by plough disturbance. If the stone layer did indeed lie beneath the eighteenth-century soil layer – perhaps the remnant of the pre-colliery ploughsoil – it might represent the destruction of rampart back structures by post-Roman ploughing or other disturbance.

Immediately north of stone layer G16:13, and some 7.20m from the pitched stone foundation, a strip of large and medium-sized sandstone cobbles (G16:14), c. 0.45m in width, ran across the main trench on an east-west alignment, parallel with the line of the curtain wall. The cobbles were set on a 0.80m wide band of homogenous yellow clay (G16:15), similar to the natural subsoil, which extended a little further north. This feature was initially interpreted as the foundation for a rampart revetment but later dismissed as modern like all the other features in this part of the fort. This is quite likely but no material, either ancient or modern, was apparently recovered to assist the dating of the feature and its position would be consistent with that of a rampart revetment. The *intervallum* area immediately beyond, at the northern end of the trench, contained an extensive deposit of grey clay and cobbles (G16:18), and smaller spreads of large cobbles in orange and grey clay (G16:24) and very compact, dark pink-grey clay (G16:25), both located on the west side of the trench. However none of these layers, which all sat at the same level, exhibited any obvious indications of wear and consequently they were not interpreted as *intervallum* road levels and again were considered to be relatively modern in date.

Dating evidence

The grey loam and tumbled sandstone blocks filling the south ditch included sherds of calcite-gritted ware and Crambeck reduced ware, dating to the late third century or later (G16:21).

The interval tower east of the south gate (Tower 3)

Grid squares: L16–17, M 16–17

Most of the excavation of the interval tower to the



Figure 19.05: Pitched stone foundation G16:04, from the south west

east of the south gate took place during 1978 as part of the overall work in the *retentura*. The outer face of the tower's east wall was examined in 1979, being designated Site 14. For the most part the investigation involved the excavation of a series of very small 'keyhole' sondages designed to determine the position of the tower by tracing the edges of the wall foundations or faces (Fig. 19.01). The Roman remains had largely been reduced down to foundation level by post-Roman robbing and modern disturbance, which was especially severe in this part of the fort. In view of the straightforward nature of the remains exposed and the simplicity of the stratigraphic sequence, recording of the tower was principally by means of a single site plan (P133) drawn in 1978 and adapted in 1979. As a result not all the excavated deposits or features were given context numbers.

The site plan shows that the clay and cobble foundations of the curtain wall and tower walls were traced most extensively along the south side of the tower, with both the external and internal faces being uncovered along with parts of the wall core. The internal north-east and north-west angles of the tower were also revealed along with short stretches of the external faces where the tower's side walls joined the fort curtain wall. However only one 0.25m square slot was dug to locate the external face of the tower's north wall. This picked up a clear colour change in the clay, from pink to brown, but it was not absolutely certain that this did represent the edge of the tower. Virtually all of the coursed masonry of the tower and curtain walls had been removed by robber trenches (L17:02–03; M17:03) filled with dark brown sandy and gritty soil, which contained a lot of small sandstone rubble, plus much larger rubble blocks, up to 0.50m in length, in the case of the curtain wall robber trench (L17:03). However neat facing stones were evident on the site plan along the inner face of the west and north walls of the tower. These stones probably formed a kerb defining the edge of the clay and cobble foundation. At the junction of the tower's east side wall and the fort curtain the foundation clay (M17:05) of the two walls was a different colour changing from pink to blue-grey respectively. Impressions of two of the stones forming the north face of the curtain wall were evident in the clay at this point.

The tower was virtually square, measuring c. 5.80m (N–S) by 5.70m (E–W). The side and rear walls were around 1.25–1.30m wide, although the east wall foundations (M17:05) appeared to taper inward towards the north, narrowing from 1.30m to c. 1.15m in the 0.80m excavated length. The curtain wall foundations appeared broader (1.95m) to the east of the tower than to the west (1.75m) and varied between c. 1.45m and 1.70m in front of the tower itself. Internally, the tower measured 3.15m (E–W) by 3m (N–S) and was recessed c. 0.25–0.45m into the curtain wall. Only the natural yellow clay subsoil remained

along the south side of the interior, but undescribed darker material is shown at the north-east and north-west angles suggesting a different level survived there, probably representing an overlying floor or makeup layer.

In the external angle between the curtain wall and the tower's east wall an area of light grey silty clay loam (M17:07) representing the pre-fort ploughsoil was uncovered and recorded in section. This was overlain by orange and purple-black staining (L17:06) perhaps as a result of burning to clear the site prior to construction. Covering the burnt level was a layer of grey silty clay loam with some orange and black flecking (M17:04) which formed the solitary surviving rampart deposit. Patches of soot and charcoal and burnt orange clay were recorded in plan amongst this rampart base deposit and may have formed part of the underlying burnt level protruding through. On the opposite side of the curtain wall a grey silty clay loam indistinguishable from the rampart deposit was uncovered forming the surface of the berm overlying the natural yellow clay subsoil. This was treated as the same context number as the rampart layer (M17:04). Both the M17:04 deposits may have originated as upcast deriving from the digging of the foundation trench for the curtain wall and tower through the pre-fort ploughsoil.

The remains of the interval tower and adjoining features can all be attributed to the primary defences of the fort, with no evidence for any later modifications surviving. There were no significant finds from the tower.

The Branch Wall and south-east angle tower (Tower 4)

Grid squares: N16–17, P16–17

Introduction

The south east angle tower was included within the limits of the 1978 excavation as Site 13, when most of the surviving remains of the tower were planned (P129) though few context numbers were assigned. Further detailed excavation occurred in August–September 1979 when the north end of the spur of Hadrian's Wall, known as the Branch Wall, which led down from the fort to the river, was examined. Narrow trenches and small slots were also dug to trace the course of the adjoining sections of the fort wall north and west of the angle tower. The position of the Branch Wall and the curtain north of the tower had already been traced by trenching in 1929.

As elsewhere along the south-east defences numerous modern intrusions and extensive robbing which had removed all the upstanding masonry and even some of the foundations. Investigation was therefore limited to recording the surviving foundations and differentiating the associated clay

core from natural and re-deposited clays. The 1929 excavation trenches (P17:03, 05, 07) were located and emptied.

The south east angle tower

The south east angle tower could only be partially exposed and traced due to the number of modern intrusions (Fig. 19.01). It survived best along its south-west side and particularly at the west corner where the pink clay and river-washed cobble foundations remained *in situ* and were planned in 1978 (P129). The outer edges of the north-west and south-west wall foundations were both still traceable at these points, round the corner and as far as the junction with the south curtain wall. Some pink clay and cobble deposits were also recorded in the area of the north corner and extending a little way down the northern east side of the tower, where a couple of sizeable stones and the imprints of others may have belonged to the external kerb. In the interior the west corner was correspondingly well-defined, plus to a much lesser extent the north and, even less certainly, south corners. The north-west wall foundations – which alone could be measured accurately – were 1.40–1.55m wide. No internal floor levels survived, however, with the natural yellow clay subsoil being exposed on all sides. On the basis of this data the external dimensions of the tower were estimated at 6.40m from the outer face of the south-east angle curtain to the rear of the tower and 6.00m from east to west. The tower appear to project inwards 4m from the inner face of the curtain. Internally it probably measured 3.50m (E–W) by 3.35m (N–S), though there was a degree of uncertainty with this estimate, and like the other towers was probably recessed c. 0.30–0.40m into the curtain wall.

The Branch Wall

With the exception of a spread of pink clay, up to 2.50m wide, all trace of the Branch Wall foundations had been removed at the point where it joined the south-east angle of the fort (P177). However, 2m south of the curtain wall, the remains of the foundations survived in better condition (P17:06). These were constructed of river-washed cobbles set in pink clay, in the usual fashion, and continued right to the south end of the trench, marked by a modern stone founded garden wall (P17:08) lining the pavement of Camp Road, some 4m from the fort wall. At 2m (6ft 8in) in width, the Branch Wall foundations were relatively narrow, whilst the edges were defined by the use of larger boulders which were c. 0.25–0.30m broad across the face and tapered inward 0.25m–0.35m (Fig. 19.06).

The curtain wall

Several small trenches were excavated to determine the precise course of the fort wall to the west and north of the angle tower. The edges of the curtain

wall's cobble and pink clay foundations (N17:02) were traced up to 6.25m west of the junction with the angle tower, beneath the stoney fill of a robber trench (N17:05). This showed the stone foundations were 1.85m broad next to the tower, but the pink clay could be seen to extend some 0.25–0.30m further south, beyond the line of the depression left by the outer kerb stones of the foundations. Along this outer edge the foundations could be seen to cut the 0.05–0.15m deep layer of grey silty clay loam (N17:03) which formed the pre-fort ploughsoil, overlying the mottled yellow-orange silty clay natural (N17:04). The site plan (P168a) shows “rusty” charcoaly patches’ on the surface of the grey silty clay at one spot, perhaps the residue of site clearance burning.

The curving course of the clay and cobble curtain wall foundations was traced for 6m north of the tower, the stone foundations being generally wider, at 2m, than those to the west. The use of slightly larger boulders or cobbles to form the edges was evident, but again the pink clay extended well beyond these kerbs (perhaps c.0.50m on average), particularly along the outer edge, where it continued beyond the limits of the trench in places, but also along the inner edge, notably near the junction with the tower.

The interval tower south of the east gate (Tower 5)

Grid square: P14

The interval tower (Tower 5) positioned midway between the east gate and the south-east angle, immediately north-east of Building 12, was excavated in July–September 1978. The 9m × 9m excavation trench designated Site 12, formed an adjunct to that season's main area excavation of the *retentura* and encompassed the whole area of the tower, along with short stretches of the adjoining east curtain and rampart (Figs 19.01, 19.07).



Fig. 19.06 The foundation of Branch Wall next to the south east angle of the fort, looking south west.

Nineteenth-century development had taken a particularly severe toll in this part of the fort, reducing the tower and the curtain wall down to the level of their foundations and stripping away virtually all the stratigraphy, both internal and external, above the pre-fort ploughsoil. Only on the north side of the tower did a small pocket of rampart deposits survive. The ploughsoil took the form of a fairly sticky, mid-grey clay, which was 0.10m thick inside the tower (P14:05) and 0.05–0.10m deep to its south and west (P14:03). No trace of turf was preserved, but an irregular, patchy skim of burnt clay was exposed overlying the ploughsoil to the west of the tower, covering an area around 1.50m square. This was orange and black in colour and only 10–20mm deep, and probably reflected the use of burning to clear the site prior to construction. The underlying natural yellow clay subsoil (P14:04) was also revealed where modern intrusions had cut through the ploughsoil. Some 2m to the west of the tower the deep cut of a modern road divorced the tower from the Roman levels of the *via quintana* beyond.

Although the tower's masonry superstructure had been entirely removed, the wall foundations survived surprisingly well. Apart from a number of modern intrusions, notably at the south-west corner, only the north wall foundations (P14:09) had been substantially robbed out, a 1.05–1.25m wide trench (P14:23) having removed the cobbles down to the pink clay base over a distance of more than 3m, leaving only a short stub at the junction with the curtain wall. The robber trench was filled with a mixture of orange-grey clay, stone, brick and coal lenses. The rest of the wall foundations were largely intact and were generally c. 1.25–1.35m wide, although the south foundations appeared a little narrower at 1.15–1.25m to judge from the site plan (P117). Externally the tower measured 5.5m, from north to south, and protruded 3.70–4.00m from the inner face of the curtain wall (the length of the tower's south wall foundations apparently being slightly greater than that of the north wall). Internally, the tower measured 3.00m × 3.00m and was recessed 0.30m into the east curtain wall.

The interval tower's foundations comprised two layers of cobbles packed and sealed into pink clay (P14:06–09), 0.30–0.50m deep overall. The cobbles were mostly water worn boulders but included a few pieces of sandstone rubble. Larger and sometimes squarer stones appear to have been deliberately selected to form the edges of the foundations. In the west wall foundation (P14:06) a difference was noted in size of these edge stones in the two layers: those in the upper layer being up to 0.30m in length, while those edging the lower layer were larger at up to 0.40m in length. However, no difference was noted in the size of the stones marking the edges of the two layers of the south wall foundation (P14:07), these being up to 0.40–0.50m long.

The excavation revealed a 9.10m length of the curtain wall foundations (P14:08) on the east side of the interval tower. These were constructed in the same manner as the tower foundations. The entire east face of wall was cut away by a modern concrete foundation slab for a brick wall (P14:22) which formed the eastern limit of the excavation area, meaning that the width of the curtain wall could not be precisely gauged. However a change in the colour of clay from pink to yellow glimpsed in the bottom of an intrusion to the east of the concrete slab suggests the breadth of the curtain wall foundations was c. 1.80m where they fronted the tower, c. 2.20–2.30m to the south and perhaps 2m to the north.

A small sondage, c. 0.50m square, dug to investigate the strip of rampart on the north side of the tower, showed that a 20–30mm deep layer of grey clay upcast (P14:26), presumably deriving from the foundation trenches, overlay the grey clay silt ploughsoil (P14:28) and the burnt orange clay spread (P14:27) resulting from site clearance. The upcast was covered by a 10mm thick layer of small stones (P14:25). This also extended over the northern edge of the tower wall foundations (P14:09) and might represent a construction level associated with the building of the tower and curtain. This was overlain in turn by the grey clay of the rampart bank (P14:24) which included pieces of coal.

Although no finds were recovered from the tower there is no reason to doubt that all the Roman features and deposits identified in Site 12 were associated with the initial construction of the fort's defences, presumably during the Hadrianic period, based on the clear evidence for site preparation and the cutting of the various wall foundations directly into the original ploughsoil.

The east curtain and rampart

Grid squares: P11, Q7, Q8, Q11, R5, S5, T5

P11Q 11

In 1979, a 2.10m wide trench was extended some 13m eastward from the north-east corner of the main Site 15 excavation area, providing a transect from the east wall of the *praetorium* across the full width of the *intervallum* street, rampart and curtain some 11m south of the east gate. This revealed the width of the *intervallum* road cobbling (P11:11) to have been c. 3.60m and uncovered the clay base of the rampart (P11:12, Q11:03) and the robbed out remains of the curtain wall. The rampart deposit was 4.40m wide and consisted of plastic clay, streaked orange, buff and pink in colour, with pockets of orange ironstone material and charcoal flecks. A small slot, 0.30m × 0.30m, was cut through the eastern edge of this deposit to reveal that it overlay a thin layer

of sandstone dust and gravel chippings (Q11:06), perhaps associated with the construction of the curtain wall, which in turn covered a layer of grey clay loam (Q11:07), tentatively interpreted as upcast from the ditch or the wall foundation trench. The clay loam lay directly on top of the pre-fort ground surface and tapered down towards the curtain wall, being thicker at the west end of the slot. A rubble-filled robber trench (Q11:04), 2.15m wide and 0.35–0.40m deep had completely removed the masonry of the curtain, exposing the wall's underlying pink clay foundations (Q11:05). The foundation clay was 2.10m wide and, along the western edge of the robber trench, it preserved impressions left by the wall's inner facing stones. The clay foundation extended 0.20m beyond the line of the wall's inner face and here was overlain by the rampart deposits (Q11:03, 06–07). The overall width of the curtain wall was difficult to estimate but was perhaps c. 1.7m.

No dateable material was found in any of these deposits, but they may all be assumed to relate to the primary defences of the fort.

Q07 8 (Figs 19.07–19.09)

Further north, the area of the rampart immediately to the east of Building 3 in grid squares, Q07 and Q08, was investigated in 1983–4, whilst a narrow trench was previously excavated across the east *intervallum* road (Road 7) and eastern defences next to Building 1 in 1976 (Site 5).

The location of the rampart bank to the east of Building 3 was marked by a spread of clay (Q07:17.2, Q08:21.2), up to 4.6m wide. Its western edge lay no more than 3.30–3.50m from the end wall of the building (Fig. 19.07). Cutting into the eastern edge of the rampart level was a roughly oval flagged surface (Q07:16), which covered an area 1.75m (N–S) by 0.90m (E–W) and was composed of seven large and medium-sized flags and few smaller ones. This was interpreted as the floor of a possible bread oven. It was overlain by a deposit of yellow clay (Q07:06) which was bounded and reportedly cut to the north by a line of three large stones (Q07:05), 1.15m in length, with two more large blocks of rubble further north perhaps also being associated (Fig. 19.08). These stones may have formed part of the original oven or perhaps the fragmentary remains of a replacement.

Extending over the rampart area and *intervallum* street to the west of Q07:05 and Q07:06 was a rubble spread in a dark soil matrix (Q07:07, Q08:11) probably reflecting the impact of plough disturbance on the Roman levels. No trace of the curtain wall was uncovered. It probably lay just beyond the eastern edge of the site at this point and may well have been destroyed by the east wall of Simpson's Hotel (Q07:03, Q08:19) with its associated construction trenches (Q07:09, Q08:07).

R0 (Figs 19.10, 19.11)

In the 35m long and 2.40m wide trench (Site 5), excavated across the eastern defences next to Building 1 in 1976, the remains of the rampart bank were revealed as a 2.40m wide layer of sandy grey clay (R05:06), flecked with charcoal and incorporating several lenses of gravel. This clay extended beyond the western end of the trench so its full width was not exposed. It was partially overlain by a further thin spread of heavy yellow clay, sand and gravel (R05:07). The sandy grey clay was cut to the east by the rubble and soil-filled robber trench (R05:04) which had entirely removed the stonework of the curtain wall. Only the heavy orange-brown foundation clay (R05:05) for the wall remained at the bottom of the robber trench. This foundation clay was 1.90m wide and included a few stones.

The eastern edge of the curtain wall foundations and robber trench cut through a deposit of light brown sandy clay (R05:08), containing relatively few stones, which was interpreted as the original Roman ground surface. This extended for 0.40–1.50m further east at which point it was cut away by a modern, north-south aligned, linear intrusion (R05:09), perhaps a former drain trench, with vertical sides and a flat bottom, and substantially wider to the north (1.90m) than the south (0.70m/0.85m). Beyond, a thick deposit of clay (R05:12) extended eastwards and was perhaps equivalent to R05:08, though not identified as such by the excavators. In section, its surface was seen to dip down from the level of R08:08, before levelling out, and the deposit appeared to fill a 0.50–0.60m deep depression extending 0.70m from the south side of the trench, perhaps a gully, whilst reportedly overlying a greyish sand/clay. The latter may be essentially the same as the yellow sand seen at the bottom of modern drain trench R05:09, perhaps bands of natural which presumably also extended beneath R05:08.

A layer of black, burnt material (R05:03), 0.12m deep and containing much charcoal and coal, covered



Fig. 19.08 The interval tower between the south east angle and east gate (Tower 5, looking south)

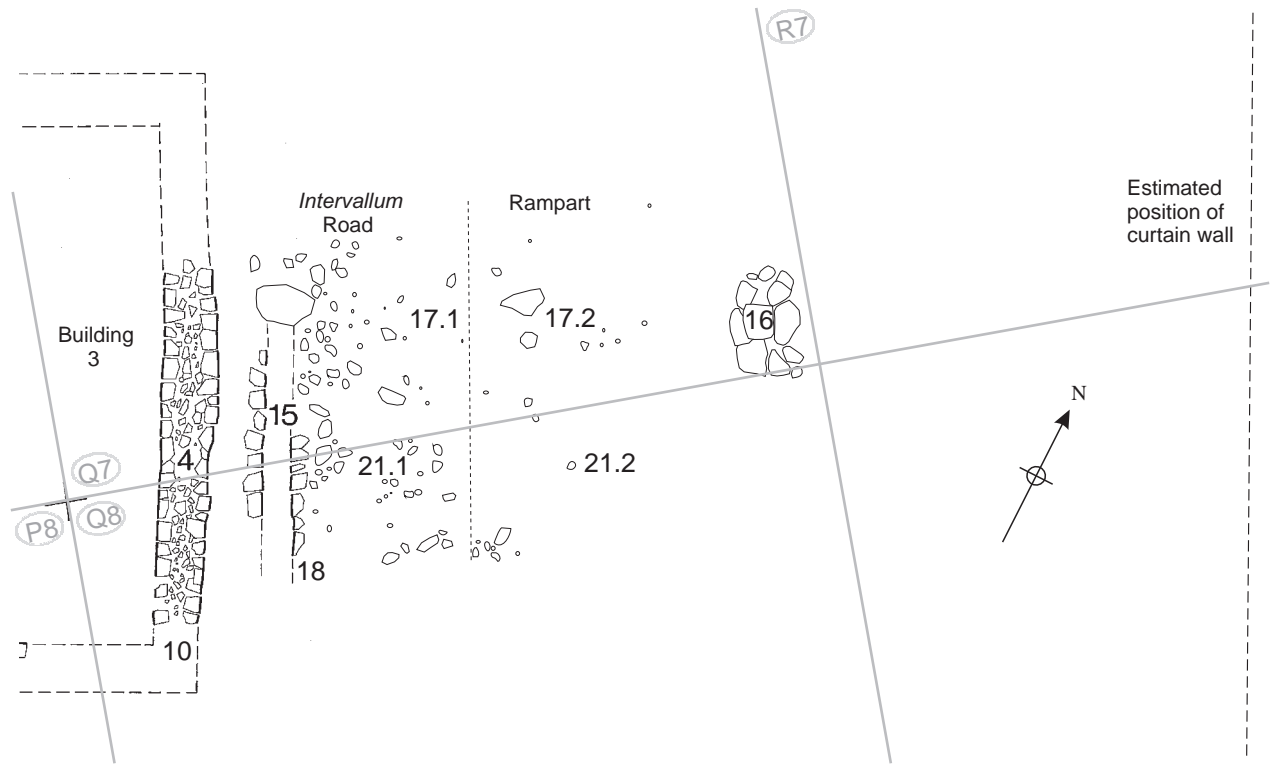

Earlier features

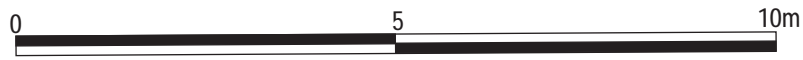

Later features

Figure 10 Eastern intervallum road and defences in Q0 and Q8 showing earlier and later features. Scale 1:10

the full expanse of rampart clay except in the south-west corner of the trench. This was in turn overlain by a deposit of disturbed yellow clay (R05:02), up to 0.30m thick, containing brick, stone and burnt material. Both layers were cut by robber trench R05:04 and lay beneath the modern overburden (R05:01). Although neither was treated as a stratified Roman level in the Daniels post-excitation record, it is conceivable that R05:03 could represent the debris from industrial activity or perhaps bread ovens and imply that the rampart bank was removed at some

stage in this area to make way for such processes, before subsequently being reinstated in the form of R05:02. The remains of the reinstated bank would in turn have been subject to later, post-Roman disturbance with material perhaps being intruded.

Overlying the entire eastern end of the trench were thick deposits of disturbed dirty greyish yellow and dark grey black clay and rubble (R05:10–11, S05:05, T05:02) and relatively recent coal slack (R05:13, S05:03, T05:03). Although the trench extended into grid squares S05 and T05 no stratified Roman levels were revealed there.

FINDS

Rubble disturbance/dereliction over rampart and east intervallum road

- Amphora stamp: 120–160 (no. 3, Q07:07)
- Coin: illegible (no. 247, Q07:07)
- Copper alloy: rod (no. 329, Q07:07)
- Pottery: spindlewhorl (no. 15, Q07:07)
- Decorated samian: 130–60 (no. D143, Q08:11)
- Samian stamps: 160–200 (no. S47, Q08:11), 100–20 (no. S62, Q08:11)

Dating evidence

The second-century grey ware from the lowest intervallum street level and/or the rampart deposit (Q07:17) is consistent with these forming part of the primary layout of the fort.



Figure 19.9 Building 3 east wall Q07:07 with the side wall stones of street drain Q07:17 in the foreground, looking west.

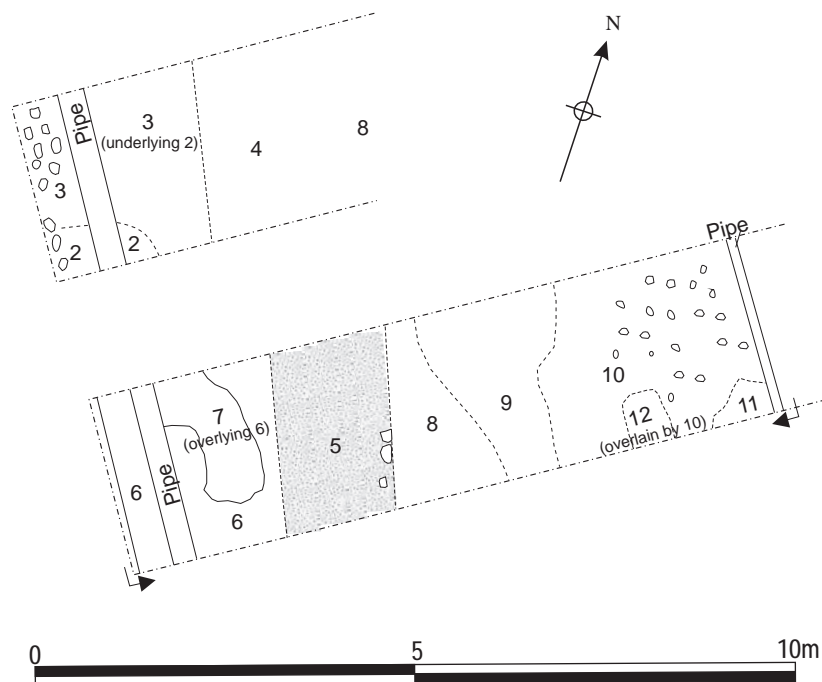

Figure 19.10: The 1976 trench across the east defences in grid square R5, at 1:100, showing upper (top) and lower (bottom) levels of excavation at the east end of the trench

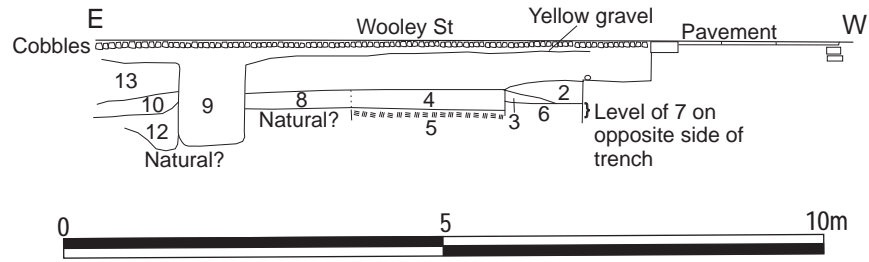

Figure 9 Section across the east defences in grid square R5 at Seg

The rubble overlying the east *intervallum* road and rampart to the east of Building 3 included Crambeck

reduced ware and a fourth-century proto-Huntcliff-type rim in calcite-gritted ware (Q08:11).

20. THE DEFENCES – AN OVERVIEW

Introduction

This chapter is intended to present an overall summary of the history of the fort defences at Wallsend, in so far as it can be teased out from the various pieces of evidence produced by the 1975–84 and 1997–8 excavations, and provide the basis for comparison with the structural history of other similar sites (Fig. 20.1).

Although a substantial proportion of the defences was exposed over the course of the excavations, Wallsend is not the most promising site with regard to understanding the changing form of fort defences over time. The south and east defences, in particular, were amongst the most badly damaged parts of a site, which is nowhere noted for its exceptional preservation. In places post-Roman disturbance had stripped away all the overlying stratigraphy down to the level of the primary foundations and there is nothing to compare with complex, well-preserved structural sequences recorded during the contemporaneous work undertaken by Daniels to examine the north and east ramparts at Housesteads and during the more recent programmes of investigation at Vindolanda, for instance.

There was also a bias, particularly in Daniels' work, towards the investigation of discrete structures – the towers and gates – whilst the adjoining rampart areas were comparatively neglected, though this lacuna was to some degree addressed by the 1997–8 work along the west defences, on either side of the quintan gate.

A further problem in some parts of the defences was the lack of a clear horizon between the Roman and post-Roman levels so that it was difficult to determine whether certain features were actually later Roman modifications or reflected much more recent activity, associated with the eighteenth/nineteenth-century colliery for instance.

The primary layout

A clear understanding of the layout of the primary defences and the initial construction sequence was obtained. The fort was furnished with four principal double portal gates on its cardinal axes, each tower flanked by a pair of towers forming guardchambers. Three of these lay north of Hadrian's Wall, as was commonly the case, presenting an aggressive posture. Only one single portal quintan gate, the minor west gate (*porta quintana sinistra*), was required at Wallsend, however, because the terminal Branch Wall ran down to the river from the south-east angle. An interval tower took the usual place of the *porta quintana dextra* on the east side of the fort. Another four interval towers were provided in addition to the four angle towers, their distribution being restricted to shorter north and south sides of the fort. The most reliable measurements for the width of the primary rampart derived from the north defences where lengths of original revetment walling survived. This indicated that the rampart bank to the west of the north gate was significantly wider than that to the east. The well-preserved primary revetment on either side of the eastern interval tower (7) were associated with a 5m wide rampart whereas the short lengths of surviving walling to the west of the gate, in the vicinity of the north-west angle tower and the western interval tower (1) defined a 7m wide bank. On the other side of the angle tower, however the width of the west rampart reduced to 5m again (but note that some third-century pottery was found in association with the kerb here). Excavation on the south side of the *porta quintana* in 1997–8 demonstrated the Period 1 rampart was only c. 4m wide there, with lines of sandstone blocks which formed a kerb delimiting the rampart tail or the base of a wall retaining the rampart bank being traced adjoining the gate annexe (Hodgson 2003, 157).

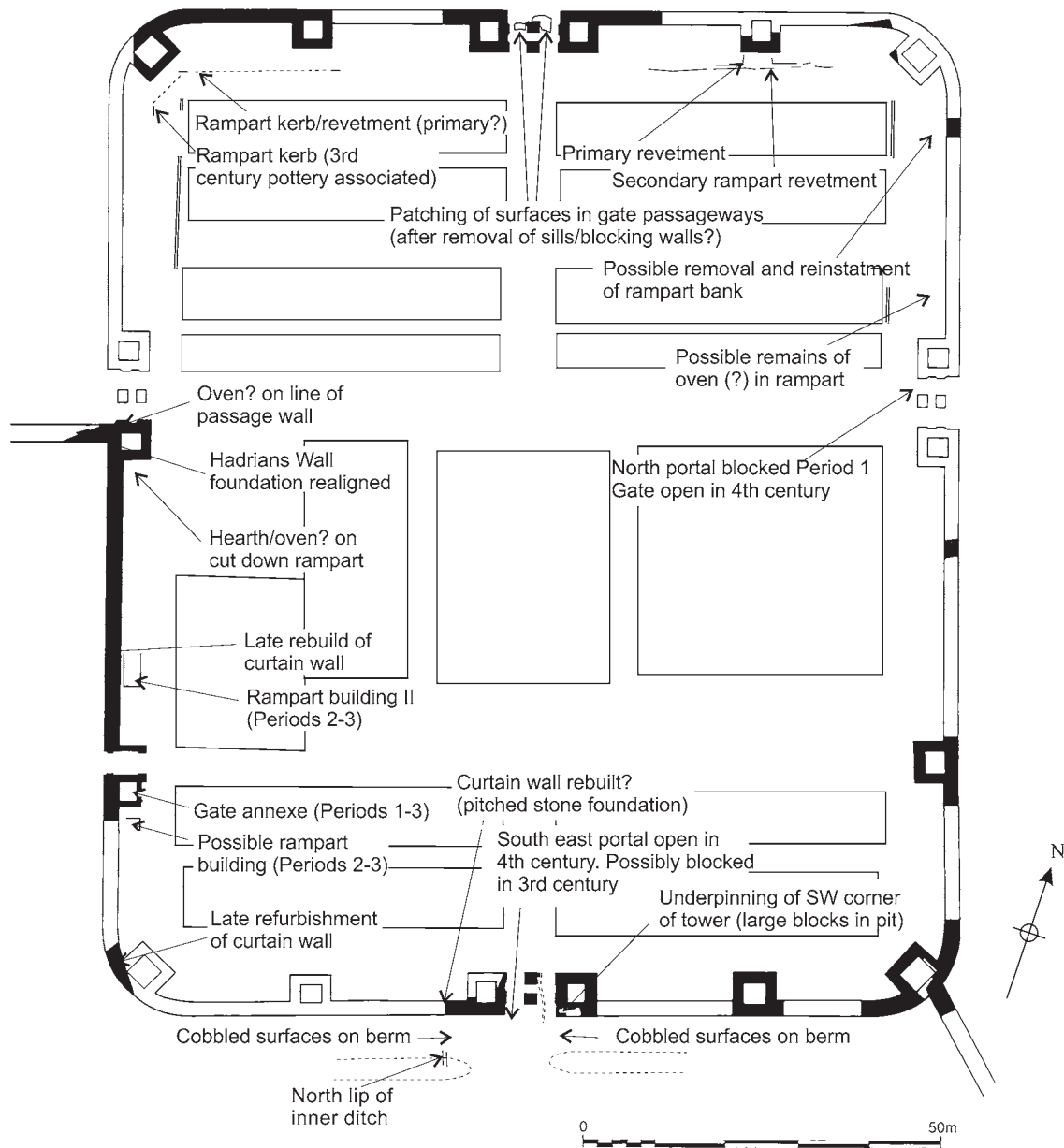

Figure 20.1: Summary plan showing the features and modifications identified in the area of the defences, 1:1000.

Wherever the primary levels of the defences were examined a fairly uniform construction sequence was recorded. Orange and black coloured patches of burning were often encountered covering the surface of the original pre-fort ploughsoil and presumably reflect the burning off of vegetation as part of initial site clearance. The foundation trenches for the defensive structures were dug through this with upcast from the trenches being thrown to either side, onto the berm and rampart area. A layer of construction debris, composed of stone chippings, mortar and sand usually covered the upcast and was evidently associated with actual building of the curtain, gates and towers. This layer was overlain in turn by clay of the rampart bank. The north-west angle yielded evidence that the tower foundations were

constructed before the curtain wall was started as construction debris probably deriving from the latter covered the tower foundations. It was unclear if the wall was completed before the tower superstructure was erected, but more likely the two proceeded more or less in tandem to ensure the tower walls were tied into the curtain properly.

Later modifications

Most interest focuses on the alterations made to the defences over the course of their life and the comparison which may be made with developments at other sites on the northern frontier where extensive work has taken place.

Gates

Four of the fort's five gates were examined at least partially by Daniels. Only the east gate (*porta principalis dextra*) was not investigated, having been recorded in 1912 before it was cleared away to permit the construction of Simpson's Hotel (Corder 1912; Spain and Simpson 1930, 488).

The *porta quintana sinistra*, which Daniels only traced by means of a single north-south-trench in 1977, was fully excavated in 1997–8 and was discussed in detail in the report on that programme (cf. Hodgson 2003, 153–70). The most striking feature revealed by those excavations was the annexe attached to the south side of the gateway. This small structure, measuring c. 3.20m (E–W) by 3.10m (N–S) externally, formed part of the original layout of the fort and remained in use during Periods 2 and 3. It was interpreted as a possible guardchamber and it was also suggested that it may have provided access to the wall-walk by means of wooden ladder, in which case it should perhaps be envisaged as a two-storey structure with a pentice roof sloping down from the side of the tower.

The double portal gates were distinguished by having freestanding *spina* piers like Housesteads, Great Chesters and (originally) Birdoswald. These were probably linked by a lateral arch. Evidence from the north gate suggests that the guardchambers in the base of the flanking towers were entered from the gate passageways, as was commonly the case rather than via a doorway in the rear wall of the towers, as at Birdoswald, Rudchester and South Shields. Traces of a gravel passage floor through the west wall of the gate's eastern guardchamber were noted.

Blocking of the gateways

One of the most common modifications to fort defences was the blocking of some gate portals and indeed the blocking up of some gateways altogether (Breeze and Dobson 1972, 194–7). In some cases this process began straightaway as it was realised there was an over-provision of gateways on the forts of Hadrian's Wall, which typically possessed four double portal and two single portal gates, a total of ten arched passages (nine in the case of Wallsend). Thus both portals of the west gate at Haltonchesters were blocked before its completion as was the east portal of the north gate at Housesteads (*ibid.*, 193–5; Simpson and Richmond 1937, 157–8; Crow 1988, 73), whilst the two *portae quintanae* at Birdoswald were blocked after a very short period of use towards the end of Hadrian's reign (Wilmott 1997, 192). This process continued, though individual gate blockings are often difficult to date, particularly because many were excavated in the nineteenth century. Some gates, such as the two *portae principales* at Chesters, were eventually blocked up entirely. In some cases this was clearly a two stage operation, for example the south

gate at Birdoswald and the north and west gates at Housesteads (both retained postern openings). At the end of its life only four gate portals remained open at Chesters, whilst no more than two were fully open at Housesteads (in the south and east gates with a couple of narrow postern openings in the other two gates). At Birdoswald, aside from the uninvestigated north gate, only two portals remained open, one in each of the two *portae principales*.

It is likely that a similar process occurred at Wallsend, but no definite remains of a blocking wall have yet been found in any of the gateways there. With the exception of the minor west gate, however, where the long sequence of metallised surfaces in the passage demonstrate the gate remained open throughout the history of the fort, providing access from the Military Way, this lack of surviving blocking walls does not constitute firm evidence of their absence, as so much robbing has occurred at the site. Blocking walls, which may have been laid directly on the surface of the metallising in the passage rather than being given proper foundations, could well have been removed with very little trace.

The most intriguing evidence derived from the north gate where two patches of cobbling in the third of the passageway surfaces might conceivably represent traces left by the removal of blocking walls. A narrow band of small cobblestones filled a 0.70–0.80m wide trench in the west passageway, between the north *spina* and the west tower, whilst a larger area of yellow clay and gravel lay on the east side of the same *spina*. However the excavators themselves tentatively interpreted the cobbling in the west passageway as the fill of a trench associated with the robbing of the sill blocks. A further possibility is that both patches could represent cobbling laid to restore the road carriageways after the removal of blocking walls had been removed to reopen the gateway. The discovery of a causeway across the ditches in front of the north gate in 1929 implies that at least one portal in this gate remained open right up to the end of the life of the fort.

Indeed it is the work on the fort's outer defences and approach roads in 1929, 1991 and 1997, summarised by Hodgson (2003, 19–21), which provides the clearest indication of the history of the gates, in view of the poor preservation of their archaeological remains. The alignment of the road issuing from the east gate suggests the north portal was blocked at an early date. This road was lined by at least one building during the second century, implying the civil settlement extended north of the Wall at this stage. A similar strip building, discovered outside the north-west corner of the fort, might well belong to the same period and would have been most conveniently accessed from the west gate (Archaeological Practice 2006). Its alignment suggests the building could have fronted on to a road swinging northward away from that gate. Outside

the south gate, a second-century road was recorded swinging south-west away from both portals, its east edge clearly respected by the intermediate and outer of the three ditches presumed to exist on this side of the fort. The situation at the north gate is unknown.

In the third century the *vicus* extended around the south and south-west flanks of the the fort and received its own system of defences to the west. However, perhaps surprisingly access to the south gate appears to have been closed off at this stage. Two gulleys were extended across the gate approaches to connect the respective terminals of the inner and intermediate ditches. Flimsy *vicus* structures were constructed beyond the ditches and there appears to have been no regular route leading to the gate from the south. This might imply that both portals of the gate were blocked at this stage, and, if not now, perhaps later in the third century when the *vicus* structures were removed and a new outer ditch or gully cut across the approaches. A recut and enlarged inner ditch was also created, either at this stage or somewhat later, running across the front of the gate.

Finally, in the later third or during the first half of the fourth century the ditches in front of the south gate were infilled and a substantial 7m wide road was constructed, leading southwards from the west portal of the gate.

There was little evidence for these changes to be seen in the surviving fabric of the south gate. No road surfaces were recorded in the west passageway, all stratigraphy having been stripped away down to the level of the pre-fort ground surface. Two phases of drain channel ran along the west side of the east passageway. The later of these, lined with pitched stone slabs, was interpreted as post-Roman, associated with the colliery, whilst the earlier, well-constructed from small coursed rubble blockwork, could conceivably be of second-century date. The



Figure 20.2: Possible modifications to the south gate. Stone filled pit H16:08/J16:09 at the south-west corner of the east guardchamber and east passage, overlain by later cobbled surfaces and cut by drain H16:06.

south-west corner of the east tower may have been underpinned at some stage using three large squared blocks set in a pit (Fig. 20.02), though it should be noted that the excavators again considered this to be a colliery-era feature of some kind. The clay and stone-packed pit appeared to extend across the front of the gate portal, though its full extent here was not traced as it was overlain by two layers of cobbling, also regarded as post-Roman, which were not removed. It might therefore conceivably have formed the foundations of a blocking wall, perhaps tied into a repair of the east tower, though it appeared very broad.

There always appears to have been a main road leading out of the east gate except for some time in the mid- or later third century when the causeway across the outer ditch was narrowed to 1.50m. Whether this would have resulted in the blocking or partial blocking of the south portal at this stage is uncertain, but in the fourth century there was a substantial road, at least 12m wide, leading from the gate, implying that at least one portal was fully open by this stage.

The earlier situation at the north gate is unknown, but the presence of a causeway suggests the gate was open in the fourth century, as noted above.

West gate

Only at the west gate is direct evidence regarding the ditches and causeways lacking. Excavation of this gate in 1983–4 showed it was the best preserved of the three major gates investigated by Daniels and it yielded the most complex evidence. Only the south tower and a small part of the southern passageway were available for examination, with the remainder lying beneath Buddle Street, but the junction between Hadrian's Wall and the south tower of the gate was examined by means of a tunnel beneath Buddle Street in 1929 and this yielded further information. The foundation of the west *spina* was found at this stage. There was no mention by Spain and Simpson of a blocking wall in the south portal, nor is one visible in the published photograph of the 1929 tunnel (Spain and Simpson 1930, 488, fig 7) and no trace was noted at the edge of the site in 1983. Considerable stonework survived including very substantial squared facing blocks along the north face of Hadrian's Wall and part of the south respond and the south wall of the passage. Hence it is doubtful that an adjoining blocking wall had simply been robbed away – though that possibility cannot be entirely excluded – and on this basis it would appear likely that the south portal was still open at the end of the gate's life.

The evidence from the excavation of the south tower presents a somewhat different picture, however. A succession of floors was revealed in the interior of the south tower, surviving best on the west side and representing the most extensive sequence recorded in any of the towers at Wallsend. The latest two

internal floor surfaces extended northward part way across the line of the passage wall, implying that the latter wall had been demolished and the south passageway and the south tower perhaps converted into a single large chamber. An oven may have been built over the line of the wall as well, though its remains are incomplete and difficult to interpret. Such arrangements would be easier to comprehend if the south portal was walled up converting the entire space into an enclosed cooking or industrial area. In this case either access to the fort from the west would have been maintained through the north portal, or the entire gate may have been blocked. It is not possible to resolve these contradictions with the available evidence, based as it is on incomplete excavation of an only partially surviving structure and – in the case of the 1929 tunnel – executed under very difficult circumstances. If the passage wall was demolished does that signify the south tower no longer stood to its full height or was a narrower timber-framed wall erected as a replacement on top of the extant footing blocks along the northern edge of the original wall? Nevertheless it is clear that, however difficult its remains are to interpret, this gate is the only one to produce definite evidence for the kind of activities commonly recognised in gates and towers at other forts (compare, for example, the complex sequence of modifications to the *porta principalis sinistra* at Birdoswald and the evidence for industrial activity in the guardchambers and block south portal: Wilmott 1997, 145, 150–4).

HADRIAN'S WALL AND THE WEST GATE

Spain and Simpson noted that north face of the Wall and the north face of the south tower formed one straight face of continuous masonry and argued that the Wall and tower were built at the same time. They didn't comment on the large size of the blocks and relatively quality of the stone dressing, but together all these features appear to have been designed to integrate Wall and gate into a single, harmonious scheme, with the large dressed stonework giving the whole ensemble an impressive aspect.

Another feature of great interest here is the broad offset evident on the south side of the Wall between two levels of cobbled foundations, which may signify there was an alteration to the original plan involving a change in the alignment of the Wall curtain. The upper level was perhaps equivalent to the cobble and rubble footings seen protruding from beneath the stone blocks of the Wall's north face in the 1929 photograph, whilst the underlying clay and cobble foundations may have followed a different line a little further south. The southern edges of the foundation or footing courses certainly did not run parallel with one another, with the south face of the lower foundations instead diverging southwards at an oblique angle to the edge of the footing course, and this too would

be consistent with their belonging to two separate schemes for the layout of Wall and gateway. It is impossible at present to date the change of plan. It may conceivably still have been associated with the primary Hadrianic fort. If it did belong to a later period it very likely involved a rebuild of the west gate as well since the design of the two is so closely integrated.

Towers

Daniels devoted considerable effort to establishing the position of the fort's interval and angle towers. Of the nine towers, five were fully exposed and another two partially examined or at least located, with only the interval tower west of the south gate and the south-west angle tower left completely uninvestigated.

Only in the north-west angle tower was part of a proper flagged floor surface preserved. This lay on top of a mixed sand, clay and dark soil layer, which included some ash and might represent an early occupation level. However the mixed layer was only underlain by construction debris associated with the fort wall so it could simply have formed a levelling deposit providing a base for the flagging which would then be primary. The flagging was overlain only by tumbled facing stones and there was no trace of the types of internal feature commonly found inside or adjacent to towers, such as bread ovens, as for example at Birdoswald (Wilmott 1997, 72 fig. 46, 181, 188–9) and Housesteads (Simpson 1976, 126, 138–9, pl. 12, fig. 46; Rushworth 2009, 221, 227), or latrines, as at Vindolanda (Bidwell 1985, 50–52) and Housesteads (Rushworth 2009, 112–13). A thin layer of masons' chippings was revealed in the interval tower to the east of the north gate (Tower 7), but no occupation levels survived. Elsewhere, virtually all trace of internal levels above the natural subsoil or pre-fort ploughsoil had been removed by post-Roman activity.

The most significant piece of information related to Tower 7. Here the secondary rampart revetment or kerb extended unbroken across the approach to the tower, implying that access to the interval tower had been closed off. The excavators suggested that this was associated with the demolition of the tower immediately preceding the construction of the new rampart. The revetment sat on top of a dense layer of sandstone fragments and cobbles covering the approach to the tower and extending over the *intervallum* road interpreted as demolition rubble deriving from the tower.

There is compelling evidence that many towers became dilapidated over time and required rebuilding. At Housesteads the reuse of decorated string course blocks as flagging and building material in the late third/early fourth-century chalet barracks, for instance, indicates that the superstructure of the towers and gates must have been dismantled to a

fairly low level (Crow 2004, 105–6). However, the complete demolition and suppression of a tower is perhaps more surprising. At Housesteads four additional interval towers were erected around the eastern part of the fort circuit c 300 and when one of these in turn collapsed later in the fourth century a timber replacement was apparently constructed over its remains, so internal towers were clearly regarded as important components of the defences at some sites during the later Roman period. The evidence from Tower 7 is therefore worth interrogating in more detail to assess its significance.

The excavators noted it was difficult to determine whether the robbing of the tower walls occurred during the Roman period contemporary with the deposition of the demolition spread or much later, but the presence of clay pipe in the upper fill of the robber trench did imply at least some activity was later. Moreover, the demolition rubble is an ambiguous deposit. As described its character could also fit a renewal of the surface in the passageway. The new rampart kerb constructed over the rubble, across the approach to the tower, thereby closing off access, would appear to represent the best evidence that the tower was demolished at this stage, but even this is not conclusive. Tower doorways were sometimes completely blocked up indicating that access to the ground floor was not necessarily required. This can be seen at Birdoswald where the doorway of the north-west angle tower was blocked in the early to mid-third century and the entire tower subsequently rebuilt from a level part way up the doorway (Wilmott 1997, 180–82). Indeed Wilmott notes that all the towers at Birdoswald for which evidence is available had their doorways blocked after a bakehouse phase (1997, 193). An early photograph of the north-west angle tower at Housesteads suggests the doorway of that tower was similarly blocked up (NRO C8/117), whilst Hodgson's description of the defences at that site as surviving before Clayton's clearance work implies that in at least some of the towers the ground floor was filled up to transform them into solid platforms (Hodgson 1840, 187, see also Bruce 1863, 123; Rushworth 2009, 9, 227). Furthermore Bidwell *et al* (1988, 190, n 5) have noted that the common presence of ovens and latrines in the tower bases would have made access to the upper floor difficult in any case and it is possible therefore that in general no provision was made for such access, with the upper storeys only being entered via the wall-walk. The use of communal bread ovens declined from the third century onwards, making the ground floor rooms of the towers increasingly redundant which in turn may have prompted the blocking up of their doorways in many cases. In such circumstances there would have been no obstacle to the rampart bank being extended continuously behind the tower, as at Wallsend, so this feature does not necessarily signify that the tower had been dismantled.

Curtain wall

Investigation of a section of the west curtain north of the *porta quintana* in 1998 produced a clear sequence showing the attempted reinforcement of the wall, the ensuing collapse of the wall and its subsequent rebuilding (Hodgson 2003, 167–8). The late rebuilding was represented by a mass of sandstone rubble and sandy loam interpreted as a dump of levelling material to provide a base for the new fort wall, which had itself been robbed away, the dump being terraced into the slope truncating the western edge of the primary curtain foundations. This stratigraphic sequence was recorded just north of Daniels 1977 trench, Site 8, which yielded corroborative information. A 0.80m wide deposit of rubble in a loose sandy-brown soil matrix, overlying the western half of the primary foundations, probably corresponded to the levelling dump recognised in 1998. This was fronted by a narrow stone facing no more than two stones (c. 0.40m) in breadth and incorporating large rubble blocks as well as squared stones which probably deriving from the primary curtain facing. This facing was not present in the 1998 trench, having been robbed away, but a boulder foundation two stones in width was exposed at the base of the robbing intrusion and might represent the base for this narrow wall. The 1998 excavators interpreted the boulder foundation as the remains of a wall designed to retain material revetting the west face of the fort wall – part of an initial and ultimately unsuccessful precautionary measure designed to prevent the wall from actually collapsing. However the narrow wall exposed in 1977 would appear to be backed by and associated with the rubble and sandy loam dump. It was presumably therefore associated with the late rebuilding of the fort wall, retaining the front of the rubble and soil platform on which the outer face of the wall was set.

No evidence for similar rebuilding was found further north, where the west curtain adjoined the *porta principalis sinistra* and Hadriani Wall, but further possible traces of revetment or refacing of the curtain was found at the south-west angle in 1977, in the form of a layer of flattish, faced stones and cobbles in clay loam lining the outer face of the original wall. Less certainly, a pitched stone foundation, which was uncovered immediately to the west of the south gate, overlying the clay and cobble foundations of the primary curtain wall, might conceivably also represent another stretch of late rebuilding. This was associated with the apparent reinstatement of the rampart bank and the laying of a cobbled surface on the berm (cobbled surfaces were also noted on the berm abutting the late rebuild of the west curtain in the 1998 excavation trench). However the pitched foundation blocks cut the robber trench for the primary south wall and, consequently, were ultimately interpreted as a colliery era feature by the excavators.

Comparative evidence

Evidence for multiple phases of curtain wall rebuilding have been identified at other forts along Hadrian's Wall from the third century onwards. The most detailed sequences derive from the stretch of the east curtain at Birdoswald examined in 1992 and the section of north wall excavated at Housesteads in 1984 (Crow 1988).

The earliest of the rebuildings at Birdoswald was distinguished by the use of large squared stone blocks, featuring lewis holes, bar-cramp holes, crowbar holes and dowel holes, which probably derived from Willowford Bridge which was apparently replaced in the early third century (Wilmott 1997, 193–4). A further rebuild, probably dateable to the early fourth century, featured the deliberate inclusion of a band of white coral at the top of the facing (*ibid.*, 185, 194, 202) echoing the decorative banded effect commonly encountered in late Roman fortifications, notably in some Gallic city walls (Johnson 1983, 38–9).

At Housesteads a stretch of the north curtain between the north gate and north-east angle was likewise rebuilt in the early third century, contemporary with the removal of the north rampart bank and its replacement by an inner reinforcing wall expanding the width of the curtain. This wall was again rebuilt in narrower form *c.* 300 when the rampart bank was fully reinstated and other improvements made to the defences. Although these different phases of stonework lacked the distinctive characteristics of the work at Birdoswald, the north wall at Housesteads is of interest because it too was built above a steep slope, which, as at Wallsend, was a major cause of instability, particularly with the pressure of the rampart bank behind the wall and subsidence resulting from compression of the turf base of that bank. The outer face of the curtain wall at Housesteads shows many traces of repair along other stretches as well, notably around the south-east and south-west angles which were also particularly vulnerable to collapse because of the sloping ground. These stretches incorporated many distinctive, long stone blocks, which were dressed somewhat more carefully than the coursed rubble stonework ordinarily used in the wall facing (Crow 1988, 73; 2004, 105, fig 56; Rushworth 2009, 220).

Especially interesting in relation to the remains revealed at Wallsend was the bank built up as a buttress against the front of Birdoswald's west wall at some stage before its final collapse (Wilmott 1997, 187–8, 194). The defences at Vindolanda, were similarly repaired by piling material in front of the curtain wall in order to prevent the facing collapsing forward away from the rampart, perhaps during a phase of sub-Roman occupation (Bidwell 1985, 49, pl III). These banks were apparently designed to buttress the outer face of the curtain wall. The stone-revetted rubble and soil dump at Wallsend could conceivably

have functioned similarly as a buttress, if it was originally battered up the front. When excavated, however, the rubble's upper surface, in front of the robbed wall, was seen to be flat and was covered by two successive layers of cobbled metalling, and its principal purpose always seems to have been to underpin the newly rebuilt curtain wall.

On the other hand there was no trace at Wallsend of the kind of substantial earthen bank encasing the collapsed remains of the curtain wall, with a narrow stone parapet or revetting wall along the outer edge, which represented the final form of the defences along several stretches of the circuit at Birdoswald (Simpson and Richmond 1933, 261–2; Wilmott 1997, 191, 194). The latest alterations to the defences in the north-east corner of Housesteads were similar. The fort wall having largely collapsed, its surviving stub was left in place as the external revetment of an enlarged rampart which itself became unstable and required repeated repairs to contain episodes of slumping to the rear (Crow 2004, 109–10; Rushworth 2009, 137–40). Massive ramparts were also associated with the latest phases of the fort at Malton, where they were dated to the fifth century by excavator (Corder 1930). Their absence at Wallsend is therefore interesting, albeit cautiously so given that so much of the later stratigraphy has been destroyed there.

Rampart areas

A series of highly informative structural sequences have been published in recent years, relating to the ramparts in forts along Hadrian's Wall, notably Housesteads (Rushworth 2009, 218–32), Birdoswald (Wilmott 1997) and Vindolanda (Birley and Blake 2000). These have emphasised how complex the history of this part of a fort can be, which is therefore deserving of examination every bit as careful as that devoted to the major buildings or the barracks.

To summarise the activities known to have occurred in rampart areas, firstly the rampart bank itself was not necessarily a permanent, unchanging feature. Long stretches might be removed altogether, to make way for workshops manufacturing or repairing equipment, for example. This is seen most clearly on the north and east ramparts at Housesteads where a range of metalworking, particularly the manufacture of copper alloy items, was undertaken in small, open-fronted, stone and timber structures set against the inner face of the curtain (Rushworth 2009, 53–60, 65–7, 280–82; Dungworth and Starley 2009). If necessary the curtain wall could be widened and reinforced to the rear to compensate for the loss of the earthen bank (Rushworth 2009, 53, 221, 225–6, 228). These same stretches of rampart might subsequently be restored removing or reducing the extent of workshop or other activity, whilst existing banks might be refurbished and widened in phases

of defensive renewal which could be prolonged and exceptionally complex. Ovens were also commonly located in the rampart back, as well as in the base of the towers. They were often grouped in clusters where a section of the earthen bank had been removed or left uncompleted, sometimes deliberately positioned on 'cooking shelves' set into the rampart as at Birdoswald (Simpson and Richmond 1933, 260–61; Wilmott 1997, 191) or housed in specially constructed bakehouses (Housesteads: Rushworth 2009, 38–40, 55–6, 60–61, 67–8, 226). Multiple phases of oven were sometimes set one on top of the other. Latrines could also be found there, most famously represented by example next to the south-east angle at Housesteads (Smith 1968, reproduced in Simpson 1976; Crow 2004, 41–5). At Vindolanda a possible stable was found inserted into the east rampart space (Bidwell 1985, 72–4; see above Chapter 14). Finally, the recent discovery of a *Dolichenum*, also at Vindolanda, shows that shrines might even be established next to the curtain wall (Birley and Birley 2010). This is as yet a unique find, but the three altar bases found in a neat row near the south-west angle tower at Housesteads in 1898 (HWA 6498; Bosanquet 1904, 271–2) hints at something similar there. Rather than having been collected during earlier excavations then buried and forgotten, as the excavators suggested, it is more likely they were *in situ*, forming a shrine perhaps associated with two altars dedicated to god Huitris or Veteres (RIB 1603, 1604) which were found, probably reused, in the nearest barrack, Building VI (cf. Rushworth 2009, 224).

Unfortunately the evidence from the Wallsend excavations does not fall into the same category as those listed above, due mainly to problems of preservation. Hence it was not possible to build up an overall history of the changes which affected the rampart areas at Wallsend from the results of either the 1975–84 or 1997–8 excavation programmes. Only a relatively few structural episodes can be traced, widely scattered around the defensive circuit, and these are often difficult to date due to the paucity of associated material.

The most extensively investigated area was the west rampart, where the area immediately south of the west gate (grid squares D08–D10) was exposed in 1983–4, whilst the stretch directly to the south of that, extending up to and just beyond the *porta quintana*, was excavated in 1997–8 by Tyne and Wear Museums, clarifying the picture obtained by Daniels in two exploratory trenches in 1977. The stretch between north gate and north-east angle tower was also relatively extensively explored, although the results there were less informative with regard to the history of the rampart area.

The sequences excavated on either side of the *porta quintana* were the most informative. Here the primary rampart was completely removed in Period 2. A timber building (Rampart Building II) was erected 7m

north of the gate, as evinced by a clay floor deposit and two slots (E–W and N–S) dug to extract sleeper beams (Hodgson 2003, 157–9). The area between the gate and this building was partially metalled with spreads of orange gravel and small cobbles. Only the south-west corner of the building was uncovered so no accurate estimate of its width or length could be made, though it was probably in excess of 2m wide and the excavators noted that it would have c. 4m if it filled the area of the rampart. There was no direct evidence for the function of the building although the deposits in the lower part of the rampart overlying it, recognised in 1977 as well as 1997–8, contained much redeposited ash and coal waste, including clinker-like material and hammer-scale, plus many fragments of copper alloy metalwork, other small finds and pottery. On this basis it was suggested that the structure functioned as a workshop (*ibid*, 158), of the kind studied at Housesteads. It should be noted however that if the material was deposited as one of the layers associated with the reinstated rampart, as appears to be implied, rather than an occupation level in the building which was then covered by rampart dumps, it must represent waste which was dumped in one place while the workshop was in use then subsequently redeposited over the building. It could simply have been associated with activity elsewhere and have been dumped directly into the rampart for convenience of disposal. The presence of two medical instruments (copper alloy: nos 99–100) amongst the small finds in this deposit suggests some of it might have originated as rubbish from the hospital directly opposite on the other side of the *intervallum* road.

It has been tentatively inferred that a second building was set against the back of curtain wall some 1.60m south of the gate annexe following the removal of the earthen bank there. An area of metalling was recorded extending over the area of the former rampart and was associated with a large embedded boulder. It was suggested that this boulder was deliberately positioned to protect the north-east corner of an otherwise unrecorded building from damage by cart traffic (*ibid*, 159).

In Period 4, corresponding to the mid-third century, the rampart buildings and gate annexe were demolished and the rampart bank reinstated over their remains (*ibid*, 161–3). To the north of the *porta quintana* the reinstated rampart was only 2.40m wide. No revetment walling or kerb associated with this rampart has been found. To the south of the gate the rampart deposited over the remains of the annexe building was evidently wider, at 4.50m, than the bank to the north of the gate. Here a short stretch of kerb did survive directly in line with the east end of the gate. This is the latest activity for which there was evidence in this stretch of rampart though later phases were evident on the adjoining *intervallum* road levels.

The stretch of rampart immediately south of the



Figure 20.03: The secondary north rampart revetment N04:02/P08 extending across the front of Interval Tower 7 closing off access.



Figure 20.04: The primary north rampart with revetment wall P09 in front.

west gate which was examined in 1983 also produced evidence that the primary rampart was cut down to make way for activity involving burning, perhaps a hearth of some kind or the very truncated remains of a cooking area. The remains took the form of a line of neatly cut, rectangular stone slabs, totalling 0.55m in length, set right against the fort wall. The slabs were extensively cracked and surrounded by several orangey-pink patches, which may represent decayed tiles, and were set on or in a surface of burnt black silt, all indicative of burning. These features were not identified till relatively late in the excavation, suggesting they may have been covered by material which could represent the remains of rampart bank reinstated over them at a later stage, although the excavation records are not explicit.

There was some evidence that the south rampart bank immediately west of the *porta decumana* may have been redeposited in conjunction with the possible rebuilding of the fort wall. However the interpretation of the pitched foundations as indicating rebuilding of the curtain in the later Roman period is itself subject to question. A post-Roman date for that feature was ultimately preferred by the excavators, which would in turn imply a similar date for the supposed rampart level (see Curtain wall above).

Along the north rampart, to the east of the *porta praetoria*, a secondary revetment or kerb was traced over a total distance of 25.40m, continuing without interruption across the approaches to Tower 7, as

described above (Figs 20.03, 20.04). No trace of successive phases of revetment was found elsewhere by Daniels, although the small quantity of third-century pottery associated with the west rampart revetment next to the north-west angle tower might hint that this was not the primary kerb.

All trace of post-primary fort stratigraphy had already been lost wherever the east rampart was examined south of the *porta principalis dextra*, but the possible truncated remnants of bread ovens and/or industrial activity were uncovered in two areas to the north of the gate. A roughly oval flagged surface sitting on the clay of the rampart bank in Q07, directly east of Building 3, was interpreted as the floor of a possible bread oven. Several large blocks of rubble marking the edge of a dump of yellow clay overlying the flagging might have also formed part of the oven or of a replacement structure.

Further north, in grid square R05 opposite the east end of Building 1, a layer of black, burnt material overlying the sandy grey clay of the primary rampart might perhaps represent debris from a bread oven or industrial activity taking place on the cut down rampart. A deposit of disturbed yellow clay overlying the burnt layer could in turn conceivably correspond to a reinstated rampart bank. It should be noted, however, that neither of these deposits was treated as being of Roman date by the excavators in the context database.

SEGEDUNUM

Excavations by Charles Daniels in the Roman Fort
at Wallsend (1975–1984)

VOLUME 2: The Finds



Alan Rushworth and Alexandra Croom

SEGEDUNUM

Published by
Oxbow Books, Oxford, UK

© Oxbow Books and the individual authors 2016

ISBN 978-1-78570-026-2

A CIP record for this book is available from the British Library

*This book is published with the aid of a grant
from English Heritage.*

English Heritage is now Historic England



Historic England

This book is available to download from

<http://books.casematepublishing.com/Segedunum.pdf>

Front cover: Portable lead shrine.

SEGEDUNUM

EXCAVATIONS BY CHARLES DANIELS IN
THE ROMAN FORT AT WALLSEND (1975–1984)

Volume 2: The Finds

Edited by A. T. Croom

With contributions by

L. Allason-Jones, D. Allen, R. Brickstock, P. J. Casey, B. Dickinson, L. J. Gidney, W. B. Griffiths,
K. F. Hartley, M. Henig, R. McBride, J. Tipper, R. S. O. Tomlin, R. G. Willis

Principal illustrator

G. Hodgson

CONTENTS

Volume 2

PART 6 THE FINDS	1
21 Building Material, <i>by A. T. Croom</i>	2
22 The Pottery, <i>by B. Dickinson, A. T. Croom, K. F. Hartley and R. McBride</i>	16
23 The Vessel Glass and Graffiti, <i>by D. Allen and R. S. O. Tomlin</i>	88
24 The Coins, <i>by P. J. Casey and R. Brickstock</i>	98
25 The Small Finds, <i>by L. Allason-Jones, R. Brickstock, A. T. Croom, W. B. Griffiths, M. Henig, J. Tipper, C. Waddington and R. G. Willis</i>	133
26 Metalworking and Environmental Evidence, <i>by L. Allason-Jones and L. J. Gidney</i>	217
Bibliography	233
Abbreviations	233
Bibliography	234
Index	245

PART 6

THE FINDS

Many of the specialist reports were first written in the late 1980s and then revised, where necessary, in the late 1990s. Most have not been updated since. Occasionally extra finds not included in the original reports have turned up after further work on the collection (such as after the processing of the coarse wares) and these finds have been added to the original reports. These are indicated by (AC) after the entry. Some finds have been lost or have deteriorated since their recovery, and where possible these are illustrated by drawings based on the sketches in the original site finds books, although it should be noted these were not always drawn to scale and can only give an approximate idea of the object. The catalogue entries for the finds include, in order, location, period, context number, site small finds number, museum record number, and sometimes also accession number.

21. BUILDING MATERIAL

by A. T. Croom

Architectural fragments and other objects of stone

Prehistoric (Fig. 20)

1. Cup marked stone (L:220mm W:210mm B:90mm). Unstratified, Site 18, 2640, WSS44.

Roughly triangular piece of sandstone with two cup marks on one surface. A portable example of rock art such as this may originally have been used in a burial cairn. Bronze Age.

Sculpture (Figs 21.02–4)

2. Statue (L:130mm W:80mm B:90mm). L08:50, *Via principalis*, 2518, WSS1.

Incomplete head from a sandstone statue of a woman shown with her hair rolled back on either side of

her face wearing a helmet with a peaked front and a central plume. The statue was not large, probably only approximately 0.5m tall. This is most probably Minerva, although a relief from Birrens depicting a goddess with a number of Minerva's attributes was dedicated to Brigantia, the local regional deity (*CSIR I.6*, no. 12). Minerva was one of the three most important state gods, but she would also have appealed to soldiers in her role as goddess of war, and a fragment from a large statue of Minerva has been found to the west of the fort at Wallsend (*CSIR I.I*, no. 208).

3. Bas relief (L:320mm W:140mm B:120mm). Levelling between Buildings Q and R, late third/fourth century, F11:18, 1210, WSS2.

Rectangular sandstone block. Carved in relief on one of the wide surfaces with a T-shaped object below a pendant loop. On one of the adjoining faces is an incised fish.

4. Incised figure (L:370mm W:360mm B:75mm). Building 4, officer's quarters, Period 2, F04:07, WSS4. A large flat sandstone slab with a smooth upper surface, used as a flagstone. To one side is an incomplete incised line figure. It can be interpreted as a standing figure of man holding a long object, but while there are three lines on the right-hand side, all or some of which might be depicting an arm, there is only a single line on the left-hand side, and any head (now missing) was not shown attached to the 'body'. Very simple incised figures are known from a number of sites Roman, including, in the northern frontier zone, Great Chesters (*CSIR I.6*, nos 81, 360), Willowford (*ibid.*, no. 365), South Shields (unpublished, SF no. S407), Newcastle (Ross 1967, pl. 52a), and Maryport (*ibid.*, pl. 63c). On these examples, however, the figure tends to occupy the whole face of the stone, and the Wallsend example may be closer to



Figure 20 Cup marked stone. Scale 1 .

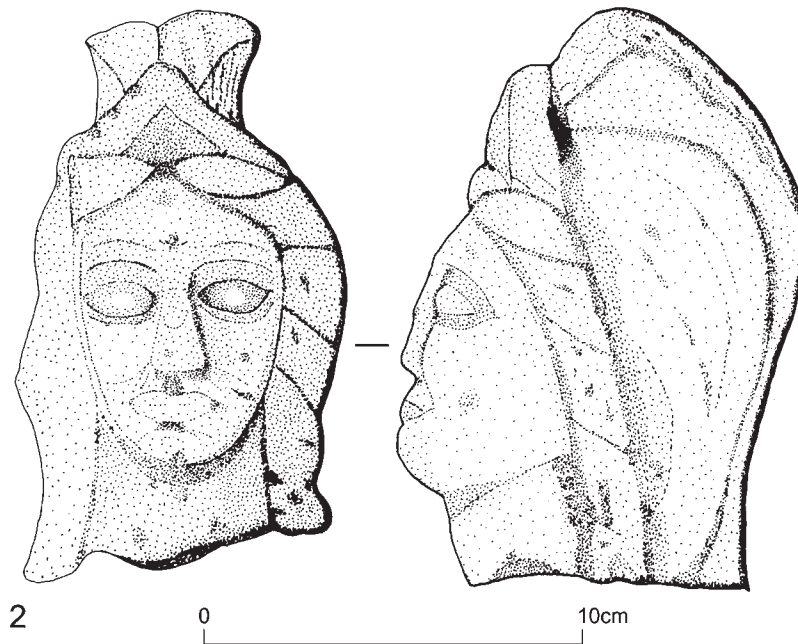

Figure 21.04 Sculpture of female head. Scale 1

the hunting or gladiatorial scenes on the stones from Chesters (*CSIR I.6*, 401–3).

5. Phallic symbol (L:250mm W:160mm B:130mm). Road 3, K14:15, 1584, WSS21. Sandstone block with incised phallic symbol, re-used in a road. On the opposite face there is an incised roughly rectangular shape, perhaps an abortive attempt at a second phallus.

Altar (Fig. 21.04)

6. Altar (H:240mm W:290mm B:150mm). Building 3, south wall, Period 2, P08:11, 2515, WSS5. Incomplete sandstone altar base, showing signs of burning, with a complete width or breadth of 290mm (both of the other measurements are incomplete). This was built into the wall of an Antonine building, and is therefore likely to be Hadrianic in date. The simple base with a moulding wider at the top than the bottom is also found on Antonine altars at Birrens (*CSIR I.4*, nos 3, 15).

Architectural (Figs 21.05–6)

7. Bench leg (H:630mm W:440mm B:100mm). F09:55, Road 8, 2382, WSS40. L-shaped sandstone seat support with concave mouldings on the front of the leg. Flat-topped examples were used as bench legs to support wooden or stone seats (Croom 2007, 112). They are frequently found in bath-houses as changing-rooms were often lined with benches as seating for bathers getting changed. This example is unusual in having an extension above the

seat, which reduces the width of the support available for the seat by half. It may have been intended as a decorative feature for the end of a bench, or to act as a divider in the middle of a long bench.

Parallels (without extension): Mumrills: Macdonald and Curle 1929, 453 and fig. 11b; Pentre Farm, Flint: J. Webster 1989, fig. 32, no. 4; Chesters: *in situ* in bath-house

8. Latrine seat (L(surviving):660mm W:380mm D:120mm). Building 8, room 2, mid-third century?, WSS63.

Incomplete sandstone latrine seat with two key-hole shaped holes set *c.*480mm apart. The top surface is very smooth and slopes down towards the holes which are approximately 130mm in diameter. The interior face of the holes and the front face of the block are only roughly worked. Stone latrine seats, often in marble, were commonly used in Mediterranean-region large multi-seater public toilets, but they are rare in Britain. As stone seats would have been unpleasant to use much of the year (especially for sick patients in a hospital), wooden seating set on stone uprights usually seems to have been preferred. This example was found re-used in the latrine channel in the final phase of remodeling in the hospital, the stone seating of an earlier phase having apparently been replaced by wooden seating.

9. Guttering (L:630mm W:390mm B:190mm channel W:140mm). E08:50, Road 5, 2436, WSS30.

Large sandstone guttering block, tapering slightly to one end. Possibly originally from the headquarter's building.

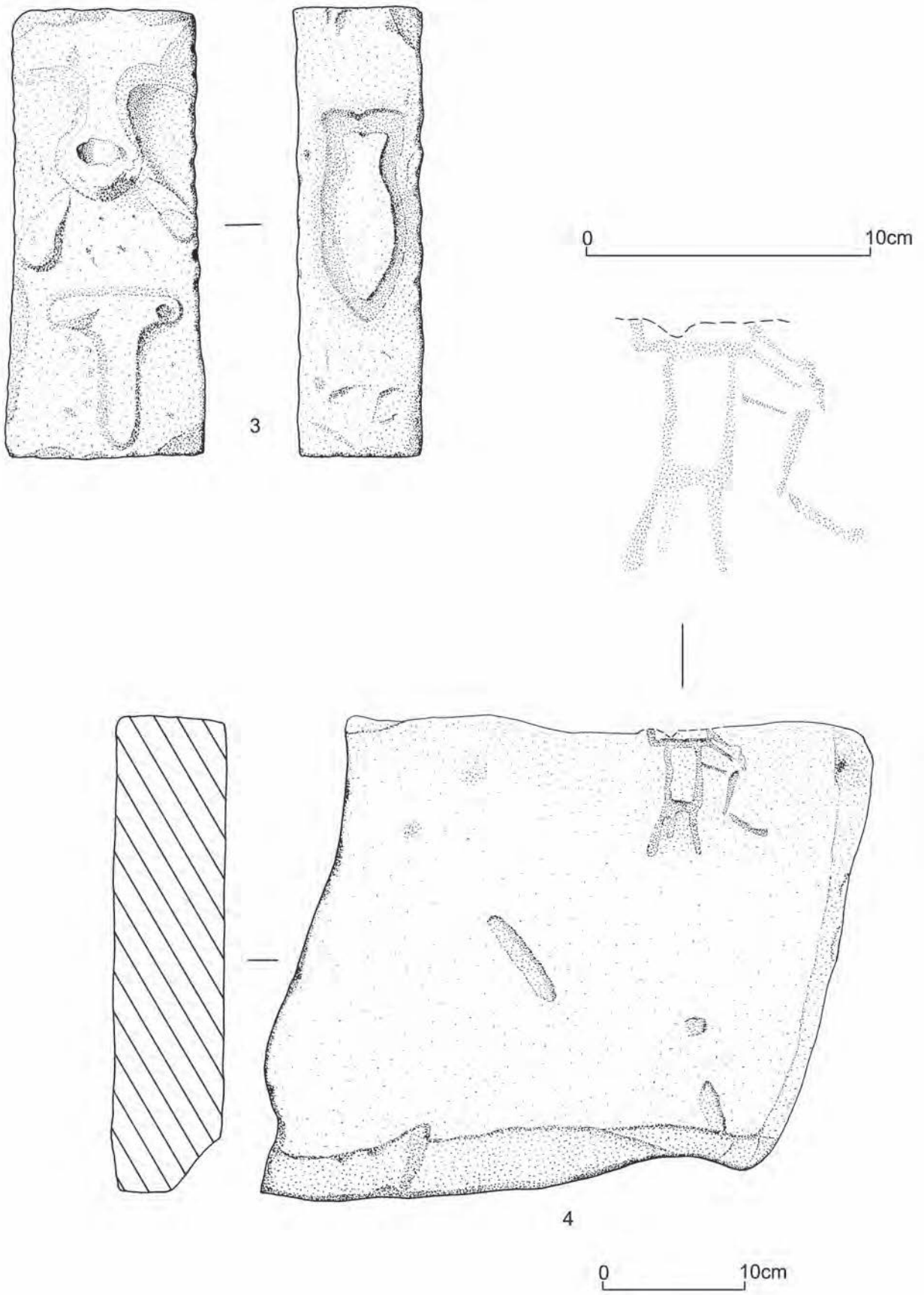

Fig re 0 Decorated stonework nos 3 Scale 1 and 2

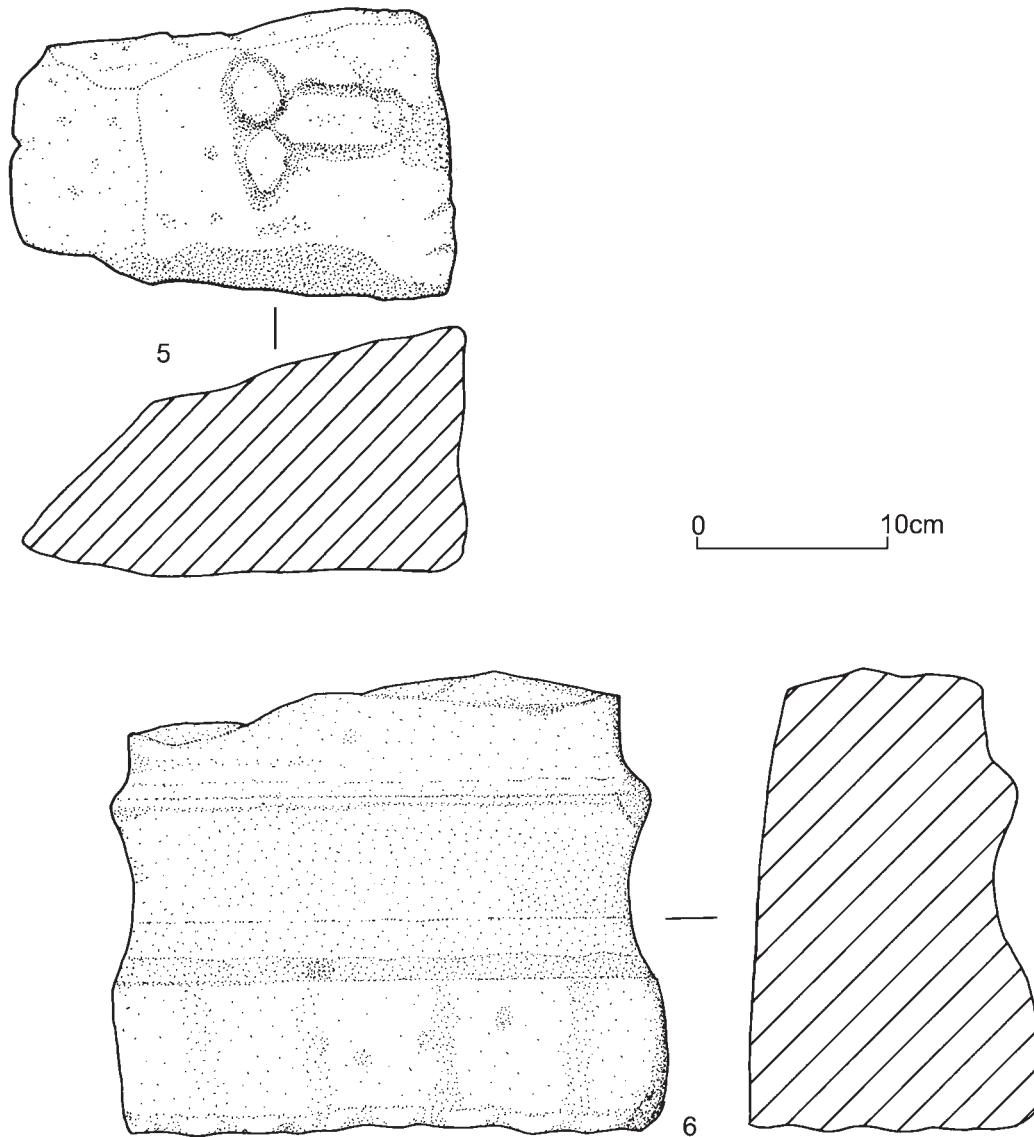

Fig re 2 Architectural stonework nos 5 Scale 1

10. Guttering (L:140mm W:190mm B:130mm channel W:90mm). Surface round Cistern 1, Period 2 or 3, E08:64, 2440, WSS24.

Small sandstone fragment, from a block with a narrower channel than no. 9 above.

The hospital has 14 surviving guttering stones *in situ*. These vary in length, but most are about 0.9–1.0m. The floor of the channel also varies in width from 60–100mm, but generally about 80mm. The guttering in the courtyard of the headquarter's building is generally in poor condition, but complete examples are longer (up to 1.5m) than those from the hospital, slightly wider, and with a much wider channel base (c.170mm).

11. Circular guttering (D:480mm overall L:630mm). *In situ*, hospital courtyard.

Two examples (out of a probable four) were uncovered *in situ* set in the corners of the courtyard of the

hospital. The circular basin itself is 360mm in diameter and 50mm deep, with a small, lower central section 200mm in diameter and 20mm deep. A channel leads off one side to connect to the stone guttering set round the edge of the courtyard. The circular basin would have collected rain water falling from the corner valleys of the portico roof and fed it into the guttering, although this is not a common feature of courtyard gutters (they were not, for example, used in the headquarter's building).

12. Block with clamp holes (L:570mm W:300mm B:180mm). L08:50, *Via principalis*, 2522, WSS39.

Large sandstone block with one surviving flat face, with clamp holes at either end. Block from a substantial building, re-used in a road surface.

13–15. Armchair voussoirs

Sandstone voussoirs, used in hollow roofing for a

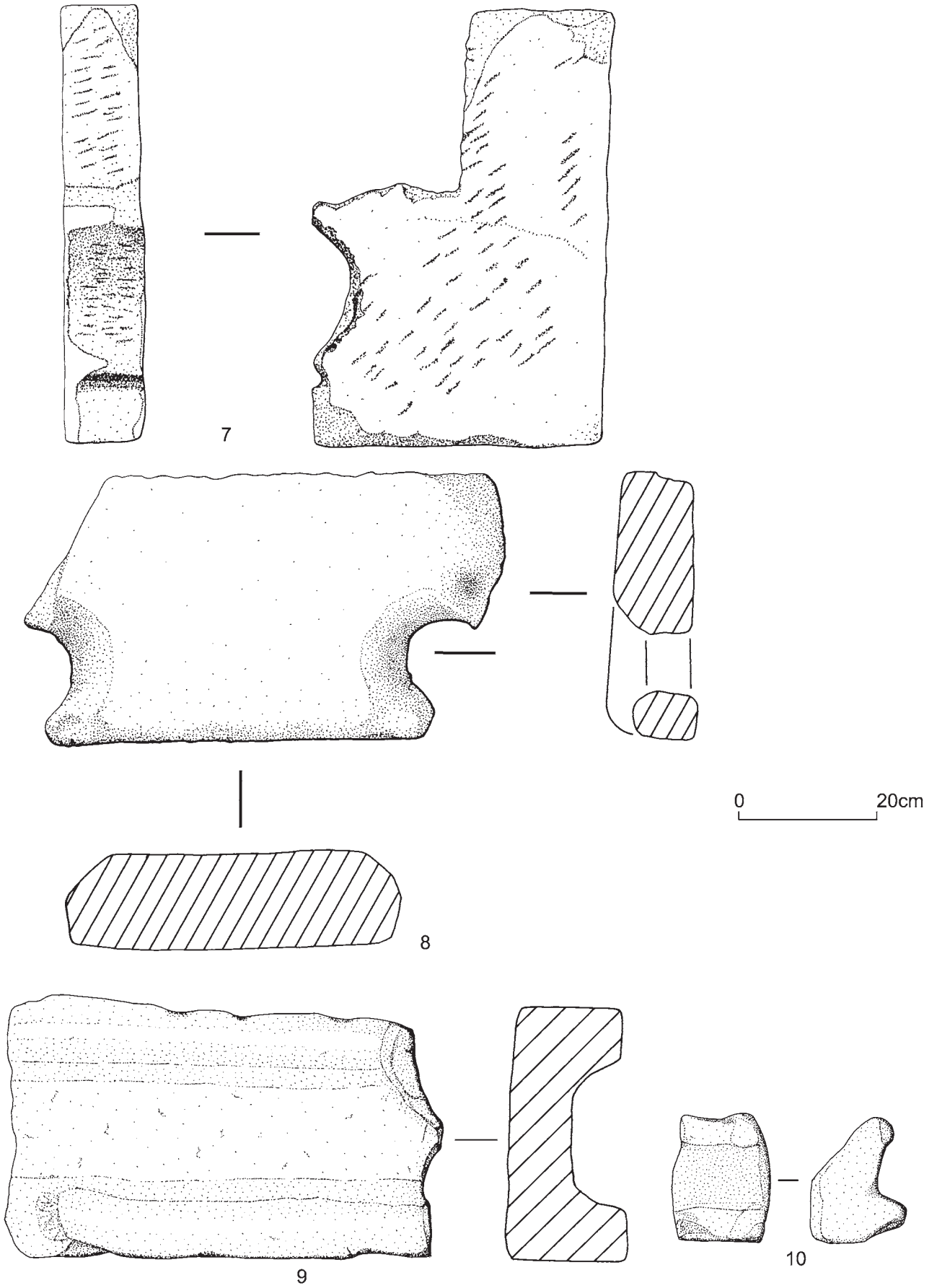

Fig re 7 Architectural stonework nos 7 Scale 3

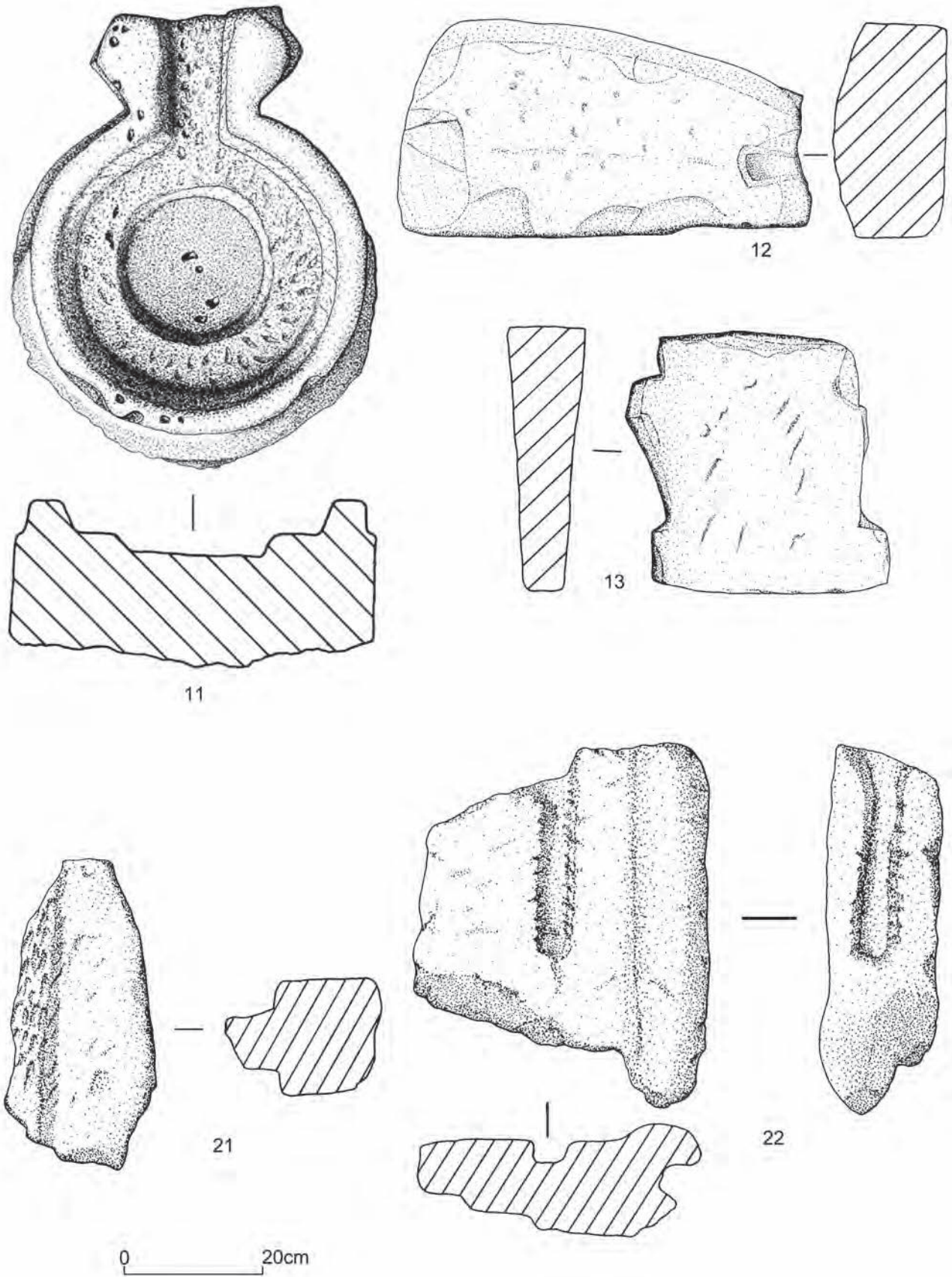

Fig. 10 Architectural stonework nos 11-22 Scale 1:3

bath-house. Other re-used debris from the bath-house found inside the fort includes a fragment from an inscription found near the *porta quintana* (Tomlin 2003, fig. 128), and possibly the bench leg (no. 7 above).

13. (L:390mm W: 350mm B:120mm). Building BK, mid-third century?, N13:04, 1915, WSS37.

14. (L:350mm W: 380mm B: 90mm). Unknown context, 1913, WSS36.

15. (L:380mm W: 290mm B: 70mm). Building BK, mid-third century? N13:04,1914, WSS45.

16–17. Roofing slates

Incomplete examples of sandstone slates.

16. (L:190mm W:180mm B:30mm). Unstratified, WSS14. With nail-hole.

17. (W:230mm B:45mm). Building 13, room 6, Period 4, H12:66, 1916, WSS42. With rounded lower edge.

18–20. Troughs

18. L:410mm W:180mm B:220mm depth:120mm). Lower fill of north-south drain in Alley 9, F10:29, 2282, WSS26. Incomplete.

19. (L:390mm W:300mm B:170mm depth:100mm). Area over *Via principalis*, unstratified, M08:01, 2381, WSS27. An almost complete small rectangular sandstone trough.

20. (L:280mm+ W:290mm B:190mm depth: 90mm). Unstratified, WSS28.

21. Screen (L:450mm W:220mm B:150mm). Area of Cistern 1, unstratified, E08:16, 2294, WSS31.

Fragment of fine sandstone block with a roughly worked tongue 60mm wide on one side. Probably from a flat panel used in a screen or water-tank.

22. Screen (L:540mm W:430mm B:170mm both slots W:50mm DT:30mm). Area of Building 14, unstratified, J12:04, 2469, WSS32.

Incomplete sandstone block with a groove cut into one face c.220mm from one edge. This edge has a thicker ridge running down its length, and a groove cut into its side. Both grooves are of the same dimensions, and presumably one of them belongs to some moderation or alteration of the structure.

23. Pier base (L:300mm W:330mm B:150mm). Granary, north west loading steps robber trench, G08:39, 2616, WSS38.

Weathered pier base, two sides surviving.

Other (Figs 21.07–8)

24. Worked stone (L:370mm W:120mm B:27mm). Building 13, courtyard, Period 3–4, M11:08, 1918, WSS46.

Incomplete flat sandstone block with two projections on one side.

25. Panel and bas-relief (Panel L:800mm W:450mm). Building H, 941, J05:25.

An unusual combination of a stone panel and carved relief was found in the interior of Building H (the end contubernium of a third-century barrack), in or on a rough rubble 'surface' that could post-date the use of the building. The panel, which has been left *in situ*, was finished on three sides with a rounded moulding and a deep groove. The fourth side was cut straight, but roughly finished. In the centre of the top surface there was a depression about 150mm by 120mm. Found sitting within this, and of similar dimensions, was a stone with a bas-relief, which cannot now be located. It is a roughly rectangular block, which appears to show the defaced head and shoulders of a person.

Ceramic building material

The assemblage as it now exists consists only of selected tile fragments, and although all the common tile types are represented, there is a heavy bias in favour of box tile fragments with their interesting keying patterns.

Fabrics

The stamped tiles show that the collection includes tiles made by three different units. There are three tiles stamped by *Legio VI*, 16 stamps from *Cohors IIII Lingonum*, who garrisoned the fort from the 170s/180s through to the fourth century, and a single tile stamped by the *Ala I Asturum*, based at Benwell fort. There is little noticeable difference in the fabrics used by the different units, even though the *Cohors IIII Lingonum* tiles are the only ones likely to have been made in the vicinity of the fort, and the non-stamped tiles cannot be assigned to units.

Fabrics groups

Fabric 1: orange fabric with mixed inclusions, most noticeably occasional rounded sandstone pieces, usually less than a centimetre across, but sometimes up to 20mm. A number are over-fired, with a wide grey core and occasionally purple/grey surfaces as well. Some examples have a thin red wash over the exterior surfaces. Used for all tile types. This is the most common fabric.

Fabric 2: This is fired to a cream colour. It has frequent small soft red inclusions, also seen in Fabric 1 but never so noticeable as in this fabric. Most frequently found as *imbrices*, but also used for *tegulae* (eg. an example from J10:45).

Fabric 3: A very fine, micaceous fabric, with few visible inclusions. Occasionally has a silky feel. Most frequently used for box tiles, but occasionally used for roof tiles as well. This fabric must come from a different source to that used for the other tile types,



Figure 20 Sculpture no. 3 in situ.



Figure 21 Sculpture no. 3

suggesting perhaps that the box tiles were imported ready-made.

Quality

Many of the fragments give an impression of quite careless tile-making, with warped tiles, twisted flanges, uneven thicknesses and a variety of finishes. Colours range from cream, cream/pale orange, orange, red-washed and overfired to purple or grey. Although some of these (in particular the cream) may have been deliberately fired to produce those colours for use in patterned roofs, others give the impression of being purely accidental.

Tegula (Fig. 21.09)

Dimensions of complete or near complete tiles (in mm)					
	L	W (top)	W (lower)	B	Details
1.	340	290	270	40–50	Area over Building 14, post-Roman debris?, H10:32, WST1
2.	–	–	c. 300	40–50	Building 14, water tank, fourth century?, J10:18, WST2
3.	–	300	–	–	Tile drain south of Building 13, Period 4, L12:08

The complete tile from H10:32 is a good example of a poorly made tile (Fig. 21.09, no. 1). It is overfired to grey and warped to a height of 10mm so that it does not lie flat. The flange on one side varies from 20–35mm in thickness, and the nail hole is at least 50mm from the top edge. The height of the tile with the flange varies from 50mm on one side to 40mm on the other. All three of the tiles with surviving complete widths have a width of 300mm or less, which is at the lower end of tile size for *tegulae*. Other small examples come from Piddington villa, Dorchester, Caistor by Norwich and Silchester (Brodrigg 1987, 12). As these are the only complete tiles from the site, it is impossible to determine whether all the *tegulae* were this size, or if by co-incidence the only surviving tiles are the smaller examples of tiles of graduated size (cf. Warry 2006, fig. 6.5).

DECORATION

This consists of a large cross from edge to edge, each arm consisting of two+ finger grooves, found on tiles stamped by the *III Lingonum*. The cross, although common on square construction tiles, is rare on *tegulae*. There is no evidence for the use of the more common semi-circle on the lower edge. There are a few possible signatures, all of which are fragmentary.

There are a number of *tegulae* with very narrow

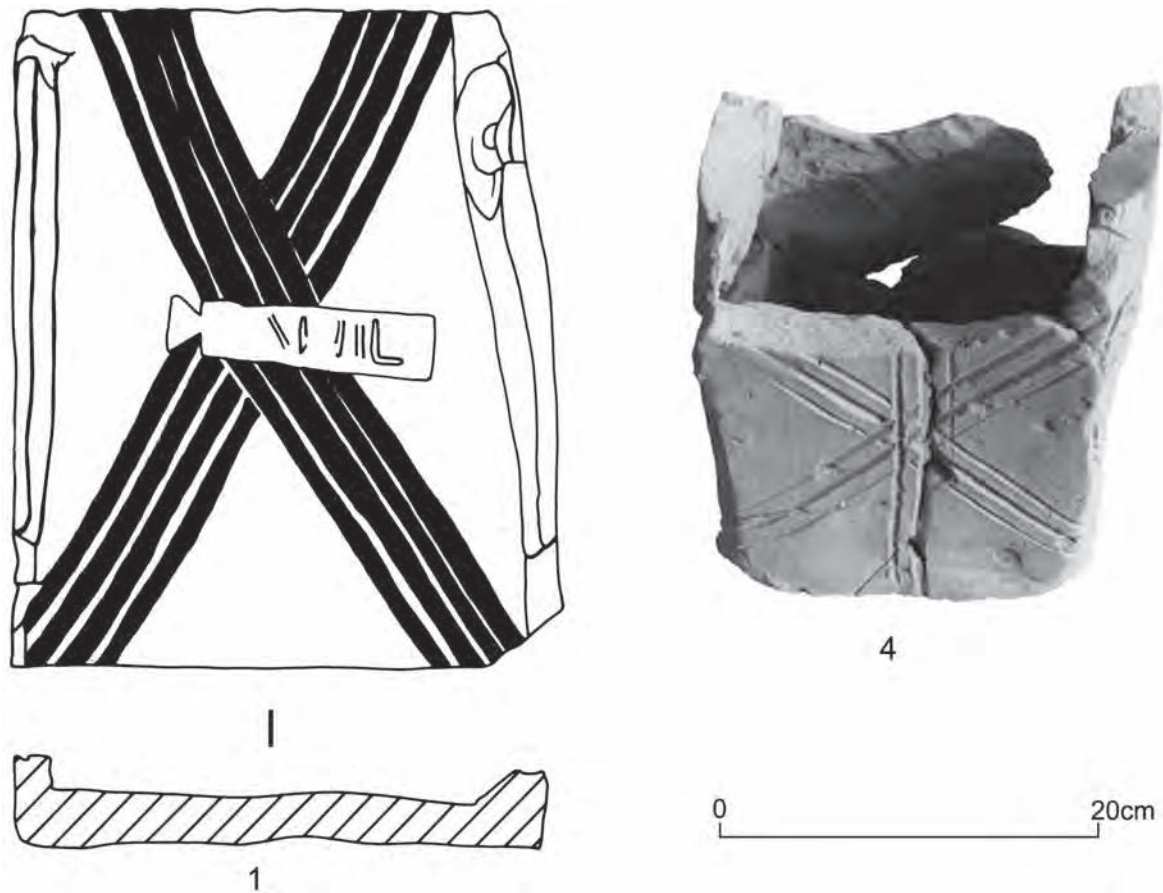

Fig. 21.08 Complete tegula, scale 1 and box tile, not to scale.

flanges c.15mm thick, that are often also low in height (for example, 12mm tall: H05:12). The typical dimension of a flange on a normal tile is approximately 25mm wide with an overall height of flange and base of 40mm.

FLANGES

On some examples the flanges are very roughly cut away at the top end of the tile, sometimes apparently done by hand rather than with the aid of a knife. The undercuts on the lower ends of the tile either extend up to top of flange (reducing the width of flange by half), or until only half way up (Warry 2006, fig. 1.2, types B and C).

Imbrices

DIMENSIONS

There are no surviving examples with complete width or length. The normal thickness is c.15mm, but there are a number of example of thicker ones, of c.20–5mm (Q04:02), which were possibly ridge tiles.

Box (Fig. 21.09)

Dimensions of near complete tiles (in mm)				
	L	W	B	Details
4.	200+	150	150	Building 1, Period 3–4, M05:02 Height surviving to bottom of vent; star pattern with 3-toothed comb (Fig. 21.9, no. 4)
5.	–	c.120	–	Area over Building 5 and Alley 4, unstratified, H05:01

There are a large number of box-tile sherds within the fort, found in all periods.

SURFACE TREATMENT

The sherds show a range of different surface treatments for keying; from leaving the surface deliberately rough, incised lattice (Fabrics 1 and 3), comb, and one example of wavy finger grooves (M05:13). The combing takes the form of lattice, star, along the edges with a central cross, diagonal and wavy lines.

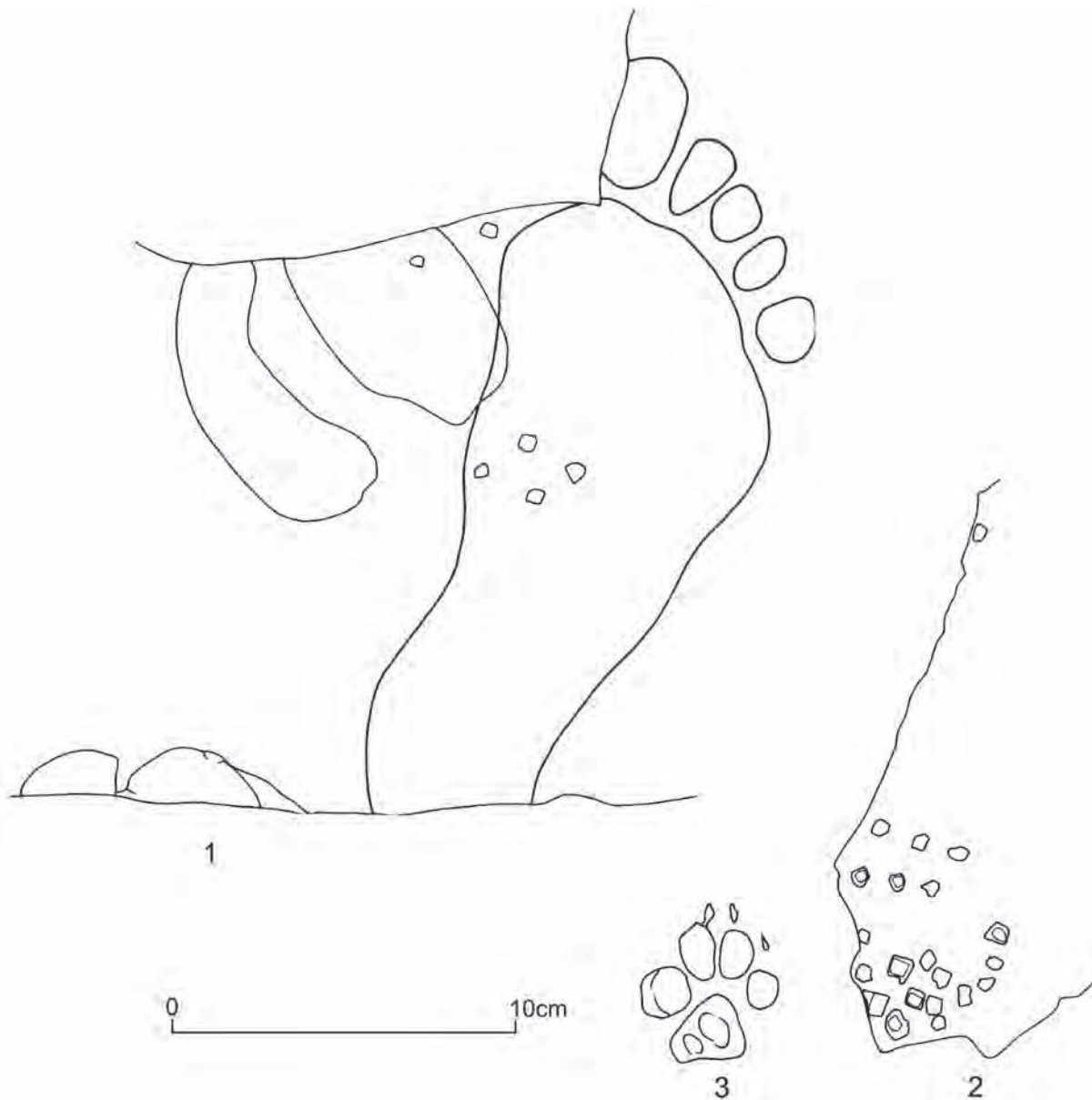

Figure 2 : Impressions on tile. Scale 1

The combs can have up to seven teeth, but there is one example of a two-teethed comb lattice (E14:06). One fragment has keying on two adjoining sides, with spaced wavy finger decoration on one face, and incised lattice decoration on the other (F04:19).

VENTS

Both rectangular and with a curved edge (presumably circular, but there are no complete examples) have been found. Both types of vents are found in both Fabrics 1 and 3.

Bricks

Dimensions of complete or near complete tiles (in mm)				
	<i>L</i>	<i>W</i>	<i>B</i>	<i>Details</i>
6.	195	180	45	Building AZ, Period 4, L13:42, WST6
7.	250	–	–	Structure C, Period 3–4, F05:24

The fragments divide into tiles of approximately 35, 45 and 60mm thick. Those that are *c.*35mm thick were probably mainly *bessales*, used to make tile underfloor piers, and the thicker fragments from larger tiles such as *pedales*. However, some examples vary quite

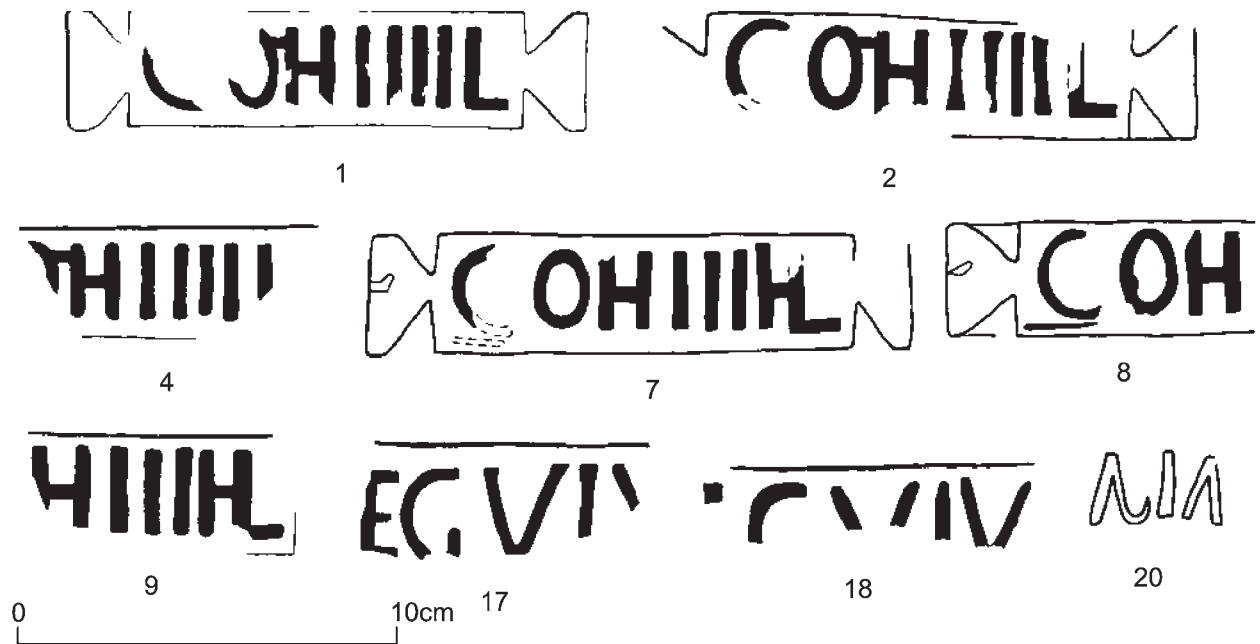

Fig re 2 Tile stamp . Scale 1

considerably in their thickness. Some are thicker towards the centre of the tile, such as one 45mm at the edge and 60mm towards the centre (P08:28), or one 35mm at the edge and 55mm in the centre (F05:24), while others the thickness at the edge of the tile changes along its length, such as one 40mm at a corner, and 60mm further along the edge (P08:28). The complete *bessalis* from L13:42 (cat. no. 6) has one corner 10mm shallower than the others.

Another unstratified tile, probably but not certainly Roman, is made in a quartz-rich red fabric, with a rough incised lattice on one surface. It is 85mm wide and 200mm long, breaking off at a point where it reaches a corner. The other end is bevelled (N05:16).

KEYING

One has a finger arc across one corner (45mm, P04:08), and another wavy finger line on one surface and knife-cut lattice on the underside (F04:19). There is at least one other example of a brick with incised lattice on the lower, sanded face (E14:01). These are possibly facing tiles of the type used to line walls.

Impressions (Fig 2110)

Few of the surviving fragments have any impressions on them, but since the more 'interesting' tiles were kept, it is likely this reflects the true number from the site. Four of the impressions come from a single *tegula* (L12:08). There is a cow hoof-print, a possible dog, four hobnails (although it is unclear why only so few are visible) and a bare human foot-print (Fig. 21.10, no. 1). The foot-print is probably not complete, but the surviving length is 23cm long, suggesting an

adult, probably male (allowing 10% for tile shrinkage during firing). There is a *bessalis* with an incomplete impression of a hobnailed sole (Fig. 21.10, no. 2: M05:11) and a *tegula* with a dog's paw print (Fig. 21.10, no. 3: H15:12).

Stamped tiles (Fig. 2)

Wallsend has produced a total of 24 stamped tiles from inside the fort (21 from the 1975–84 excavations and three examples from the 1987–8 excavations), and six from outside the fort. The collection includes both legionary and auxiliary stamps.

COHORS IIII LINGONUM

There are 16 examples from these excavations, another three from the later excavations (McBride 2003, 189), as well as one certain and two possible examples from outside the fort. Most of these stamps came from *tegulae*, with no examples at all on *imbrices*. There is one stamp on a *bessalis* (the complete tile surviving, 40mm thick) and another also probably on a *bessalis* (the fragment is overfired and uneven, 34–9mm thick). Stamps on *bessales* are generally rare (Brodribb 1987, 35).

Two different dies were used although the shape, size and spacing of the letters are very similar. The stamps measure approximately 145mm by 30mm.

Die 1 (RIBII 2476.1) has a line connecting the O and H of COH. There are five certain and one probable example of this die, all on *tegulae*. Two are overfired and are purple/brown in colour through-out.

Die 2 (RIBII 2476.2) has a line connecting the last I of IIII and the L. This die also has a final mark,

Table 20 Stamp d tiles

Die	Cat	Type	context and period
<i>Cohors IIII Lingones</i>			
1	1	T	RIBII 2476.1. Area over Building 14, unstratified, H10:32, WST1
	2	T	RIBII 2476.1. Building 14, water tank, fourth century?, J10:18, WST2
	3	T?	Building 14, courtyard, late third/early fourth century, J10:02, WST3
	4	T	Area over Building 14 and Road 3, unstratified, K12:01, WST4
	5	T	Area over Building 13, unstratified, M11:01, WST5
?1	6	T	Area over Building 8, unstratified, E12:01, WST10
2	7	B	Building AZ, Period 4, L13:42, WST6
	8	T	Area over Road 3, unstratified, M13:15, WST7
	9	T	Area over Building 7, unstratified, G10:11, WST8
	10	B?	Area over Building 14 and Road 3, unstratified, K12:01, WST9
?2	11	T	Building 14, water tank, fourth century?, J10:18, WST11
	12	T	RIBII 2476.2. Area over Building 13 and Alley 7, unstratified, L10:01, WST12
Un	13	T	Building 14, water tank, fourth century?, J10:18, WST13
	14	T	Building 14, water tank, fourth century?, J10:18, WST14
	15	T	Building 14, water tank, fourth century?, J10:18, WST15
	16	T	Area over Building 16 and Road 1, unstratified, N08:01, WST16
<i>Legio VI Victrix</i>			
	17	T	Building 13, east hypocaust, mid-third century, M12:17, WST17
	18	I	Area over Building 2 and Alley 1, post-Roman dereliction, M05:04, WST18
	19	I	Area over Building 12, unstratified, L14:01, WST19
<i>Ala I Asturum</i>			
	20	T	Area over Building 2 and Alley 1, unstratified, M05:01, WST20
Unclear			
	21	T	Building 14, water tank, fourth century?, J10:18, SF no. 1960, lost

Key	
B	<i>bessalis</i>
I	<i>imbrax</i>
T	<i>tegula</i>
Un	unidentified

probably a peg-mark, on the left-hand end, while the clearest impression of this die also has a line, presumably accidental, under the C. This feature may well also appear on Die 1 stamps but there are few good impressions of this end of Die 1 stamps. There are four certain examples of Die 2 stamps, and two further possible examples. One of the stamps is on a *bessalis*, and a second fragment that may possibly come from a *bessalis* is overfired like the two Die 1 examples.

There are a further four incomplete or faint stamps which cannot be assigned to either die with certainty.

Five of the *tegula* fragments with stamps include an end or edge to the tile, and in general the stamps appear to have been placed parallel to the end. There is one example of a complete *tegula*, and almost half of a second one, with Die 1 stamps; both have a cross of grooves made by the fingertips with the stamps about half way up the tile (c.160mm from the lower edge) and upside down in relation to the tile. A Die 2 stamp in a similar position was the other way up, but whether the position of these stamps is significant cannot be shown from such a small sample.

LEGIO VI VICTRIX

The 1975–84 excavations produced three fragmentary *Legio VI* tiles, and a further two examples have been found in excavations outside the fort. They are all on *imbrices* except for one example. The exception is the most complete of the stamps, and can be identified as an example of RIBII 2460.50. There is one stamp of an unknown die, and two too fragmentary for identification.

ALA I ASTURUM

There is one example of this stamp on a *tegula*, identified as having been produced by a metal die in incuse letters without a frame (RIBII 2464). Almost 70 examples of this have been recovered from Benwell Roman Fort, where *Ala I Hispanorum Asturum* was in garrison in the third century.

Dating

Only nine of these tiles are unstratified, and six of these came from a single context, the fill of the water-tank of Building 14 (fourth century?). Another came from the same courtyard, and the remaining two

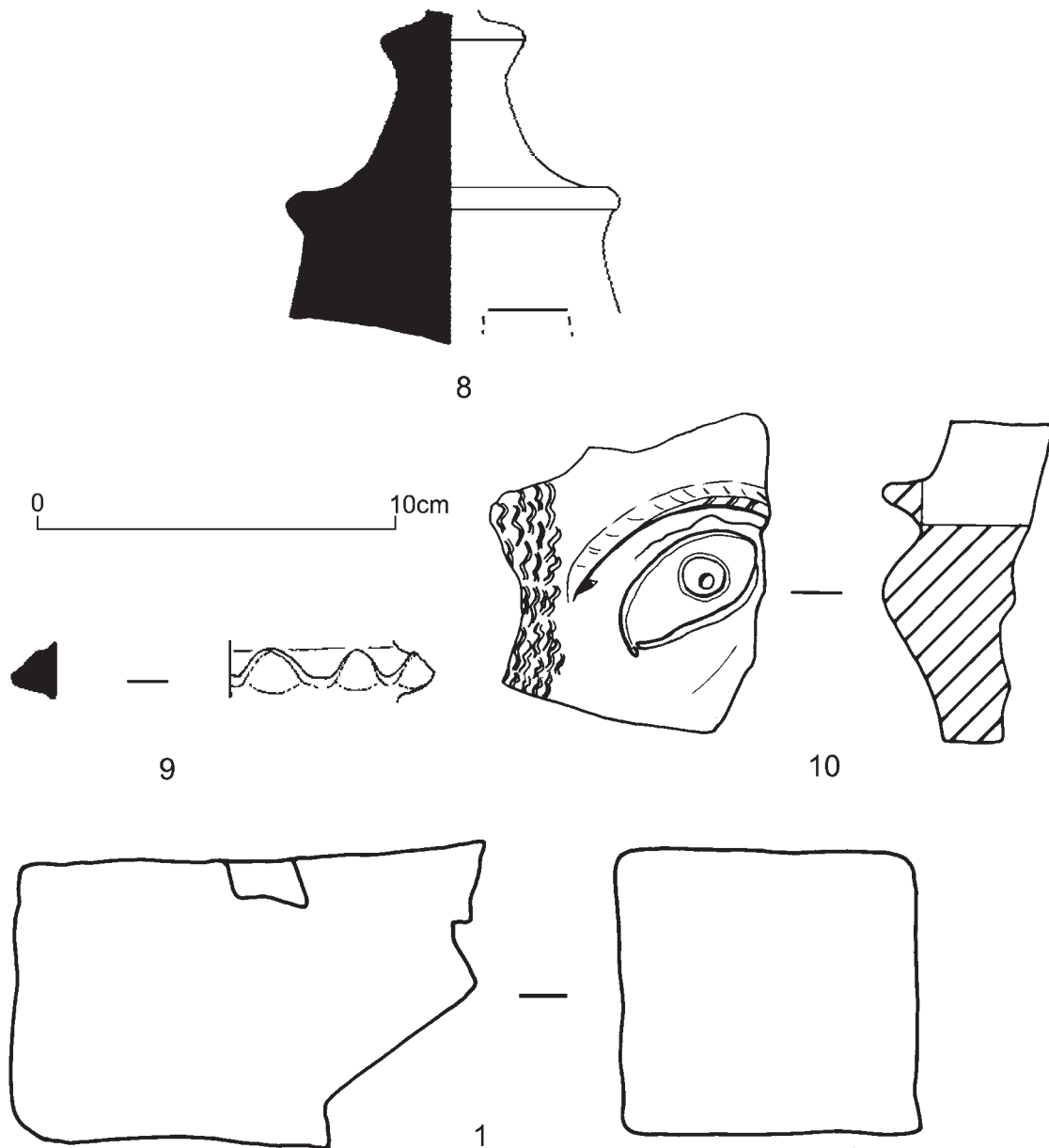

Figure 21.12: Chimney pots, tile face, and fired clay no. 1. Scale 1.2

came from the backfill of the hypocaust in Building 13 (mid-third century), and re-used in a possible hearth in Building AZ (Period 4).

Chimney pots (Fig 2112)

8. Terminal. Area of Road 3 and Building 12, unstratified, N14:01, WST28

Sherd from near the pot of the chimney pot, missing the very top of the terminal. The body expands into a ridge which is very battered, but appears to be plain. There are traces of two vents.

9. Body sherd. Alley 8, H11:36, WST25

An applied ridge with pie-crust decoration which has separated from the body of the pot.

Only two fragments of chimney pot have been recovered from the entire site, in contrast to the many fragments known from South Shields Fort (Bidwell and Speak 1994, fig. 5.11).

Face (Fig 2112)

10. Area over Building 14 and Road 3, unstratified, J12:01, 2077, WST24

The tile assemblage also included a fragment of tile with elaborate applied decoration. The decoration consists of a human face, although only a projecting eye and eye-brow survive. The shape of the eye, the iris and pupil, and the hairs on the eyebrow are all picked out in incised lines. The hair on the side of the head is shown as a series of interconnecting Ss,

drawn using a split stick. The tile is slightly curved and sanded on the interior surface, with finger grooves smoothing over a join in the clay behind the eye. Above the level of the eyebrow the join was either less well keyed and the clay has split along the join, or else there was an opening in the centre of the forehead and this section is the edge of the opening. Too little of the tile survives to be certain of its original use. Antefixes, which normally have moulded rather than applied decoration, are rare in Britain, and are usually associated with the legions. It is thought that the antefixes may have been used only on the corners of roofs or on ridge-ends rather than in the Mediterranean fashion at the ends of each run of *imbrices*, and it is possible this hand-made version was intended as a similar architectural detail. Just such an individual approach to roof decoration was found at the fortress at Lauriacum, where a crude face was applied to a crescent-shaped piece of tile that was perhaps designed to fit over the roof-ridge (Braithwaite 2007, fig. S12 and pl. S27). The Wallsend piece is unstratified, but comes from an area covering a section of road 3 and the back range of the Headquarters building.

Discussion

Tile-making near the fort would have been intermittent, being set up only when major changes were intended within the fort and new supplies were needed (Frere and Tomlin 1992, 196). The presence of tiles stamped by *Legio VI* and *Ala I Asturum* could therefore reflect batches of tile being brought in from elsewhere when small-scale repairs were required during those periods when the kilns were not in production and any stock-piled spares had been used up. At least one of the legionary stamps is a type that has also been found at Catterick, Corbridge, Ebchester, Netherby and Vindolanda but not at York, implying a tiliary set up somewhere in the region of the Wall. The *Ala I Asturum* stamp suggests another shipment also came from Benwell sometime in the third century. However, it has also been suggested that in the late Roman period complete tiles from sites were salvaged and redistributed over long distances, perhaps after local tile-making had come to an end (Caruana 1997, 268), in which case the *Legio VI* and *Ala I Asturum* tiles may have been part of less formal shipments to the site.

The number of complete tiles at Wallsend is small and their date of production is unknown, so it is difficult to say whether those that survive are typical examples, but it is of interest that they are unlike those made at the nearby forts at South Shields and Newcastle. The Wallsend *tegulae* made by the *Cohors IIII Lingonum* are smaller in size and make use of a different type of decoration that has no immediate parallels. It seems that the tile-makers at Wallsend

were allowed to follow a slightly different tradition of tile-making, and were apparently not obliged, or trained, to make a standard product.

Other building material

Fired clay (Fig 2112)

1. Support (L:130mm+ W:80mm B:70mm, expanding to 80mm). F09:66, post setting related to Building AP, SF 2481, WSIM36

Incomplete rectangular block of fired clay, tapering slightly. Roughly made with grass impressions on the surfaces and a patchy and uneven colouring; along the edge of one side there is an inscribed alphabet (Graffito no. 29). The appearance of the clay is very similar to the fragments of burnt daub from the site, and some pieces which have identified as daub but which have apparently straight external edges may come from similar blocks. Tapering rectangular blocks were used to support the containers used in salt production over the source of heat (Morris 2007, fig. 5, no. 17), but similar supports were probably used elsewhere round hearths for other industrial or domestic purposes.

Burnt daub

Fragments of burnt daub were recovered during the excavations but little was retained for study.

Opus signinum

The fragments that survive come from a number of different mixes, including pieces with coarse tile fragments as well as upper layers with a pink colouration and finely crushed tile inclusions. The largest surviving assemblage comes from Building 13, the commanding officer's house (M12:07) and contains at least four different types of *opus signinum*. A fragment with very fine tile inclusions recovered from the robbing of the granary has a convex surface and is likely to come from a quarter-round moulding between floor and wall (G09:07).

Painted plaster

Very little painted plaster has survived. The painted plaster found in room e of Building 14 is very fragmentary, with the largest piece only about 20mm long. Pieces show traces of red, black and grey paint, and black alongside red. Some seem to have been over-painted with white (K12:32). Better preserved pieces of plaster from the drain south of the building, the majority of which show a red zone or band over white probably come from the same room (H12:09, associated with late third century or later pottery).

22. THE POTTERY

by B. Dickinson, A. T. Croom, K. F. Hartley and R. McBride

The pottery from Wallsend shows that the site had the same sources of supply as the forts at South Shields, Newcastle and Benwell, but is of particular interest in having some large early assemblages, such as those from Alley 1 and the possible Rampart building, that are absent from the other three forts. This report looks at these, and a number of other assemblages of interest in detail. It does not, however, include a detailed discussion of the overall supply of pottery to the site, as this will be addressed in a later overview of all

the Lower Tyne Valley sites. As with the other finds reports (see p 1), most of the pottery was catalogued and studied some years ago, resulting in the lack, in places, of the full quantification now expected (such as the lack of sherd count in the coarse wares), and the absence of the most up-to-date references or parallels.

The samian ware

by B. Dickinson

Table 22.01: Quantification of the samian by phase

South Gaul

	PERIOD						TOTAL
	2	3	4	mC3+	post R	uncert	
FORM							
15/17 or 18	1	–	–	–	–	–	1
18 or 18/31	–	–	–	–	–	1	1
18R	–	–	1	–	–	–	1
18/31	1	–	–	1	–	–	2
18/31R	–	–	1	–	–	–	1
33	–	–	–	1	–	–	1
37	3	–	1	–	–	–	4
Jar	–	1	–	–	–	–	1
Total	5	1	3	2	–	1	12

Central Gaul (Les Martres-de-Veyre)

	PERIOD						TOTAL
	2	3	4	mC3+	post R	uncert	
FORM							
18/31	4	4	2	–	3	4	17
18/31 or 31	–	–	–	1	–	–	1
27	–	–	–	–	–	1	1
30 or 37	1	–	–	–	–	–	1
31	–	–	1	–	–	–	1
33	–	–	1	–	–	–	1
37	1	–	–	2	–	–	3

Bowl	–	–	1	–	–	–	1
Dish or bowl	1	–	–	1	–	1	3
Cup	–	–	1	–	–	–	1
Total	7	4	6	4	3	6	30

Central Gaul (Lezoux)

	PERIOD						TOTAL
	2	3	4	mC3+	post R	uncert	
FORM							
18/31	5	7	9	7		4	32
18/31 or 31	7	12	9	14		12	54
18/31-31	–	–	–	1	–	–	1
18/31R	2	3	10	2	3	5	25
18/31R or 31R	1	–	4	2		4	11
18/31R-31R	1	–	–	2	–	1	4
27	1	3	3	3	–	4	14
30	2	–	4	–	–	2	8
30 or 37	4	4	7	8	3	7	33
31	11	2	47	34	9	37	140
31R	3	8	29	17	1	27	85
33a	1	–	–	–	–	–	1
33	12	5	35	19	9	27	107
35	–	1	–	1	–	–	2
36	1	3	7	5		1	17
37	14	14	39	34	4	30	135
38	1	1	2	4	–	4	12
38 or 44	1	2	1	4	1		9
45	–	–	1	2	1	3	7
46	–	–	2	–	–	–	2
68?	–	1	–	–	–	–	1
79	–	–	2	2	1	1	6
79 or Tg	–	–	1	–	1	–	2
80	–	–	2	–	–	–	2
81	–	2	1	–	1	1	5
Curle 11	1	–	2	–	–	–	3
Curle 15 or 23	–	2	4	5	–	1	12
Curle 21	1	–	2	1	–	3	7
Curle 23	–	–	–	1	–	–	1
Dish	4	4	10	15	1	7	41
Dish or bowl	4	3	–	13	7	10	37
Bowl	1	–	3	2	–	1	7
Cup	–	1	2	–	1	2	6
GSM	–	–	1	3	–	2	6
Jar	–	–	1	2	–	–	3
Enclosed	–	–	1	–	–	–	1
Total	78	77	242	203	43	196	839

East Gaul¹

	PERIOD						TOTAL
	2	3	4	5	post R	uncert	
FORM							
18/31	–	2	1	–	–	–	3
18/31 or 31	2	–	1	–	–	–	3
18/31R	2	–	–	–	1	1	4
18/31R or 31R	–	–	1	–	–	–	1
27	–	–	1	–	–	1	2
30 or 37	–	–	2	2	–	4	8

31	2	1	–	2	2	4	11
31 or 31R	1	1	1	–	–	–	3
31R	4	2	10	4	3	4	27
32	–	1	1	1	–	–	3
32 etc.	2	–	–	2	–	–	4
33	–	–	3	4	–	5	12
36	–	–	2	–	1	–	3
37	–	2	18	9	5	4	38
38	1	1	–	1	–	–	3
38 or 44	–	–	1	–	–	–	1
40	1	–	–	–	–	–	1
40?	–	–	1	–	–	–	1
45	–	–	4	–	–	2	6
79R or TgR	–	–	–	1	–	–	1
Curle 15	–	–	–	–	–	1	1
Curle 21	–	–	1	–	–	–	1
Dish	1	–	2	2	1	1	7
Dish R	–	–	1	–	–	1	2
Dish or bowl	–	1	4	6	1	31	15
Bowl	–	–	1	–	–	–	1
GSM	1	–	–	1	–	–	2
Total	17	11	55	35	14	31	164

¹Comprises: Argonne (8); Chémery-Faulquemont? (1); La Madeleine (22); Rheinzabern (66); Trier (16); East Gaul unassigned (52).

GSM = Gritted samian mortarium

When this report was written in the early 1990s, only the stratified contexts were quantified. Consequently, the forms which occurred in unstratified groups were counted as single examples within their groups. The phasing also represents that known at the time, and does not take into account later modifications

Introduction

by A.T. Croom

The site produced 50.807kg of samian, over half of which was unstratified, consisting of 4789 sherds from 1045 vessels.

Table 22.02: Samian sources shown as percentages of vessel numbers

Source	1975–84	+1997–8
South Gaulish	1.1	0.9
Central Gaulish (Les Martres)	2.9	2.5
Central Gaulish (Lezoux)	80.3	82.7
Central Gaulish (Vichy)	–	0.3
East Gaulish	15.7	13.6
Total	1045	1443

The second column relates to the pottery recovered 1975–84, while the third column also includes both the 1975–84 samian and the samian recovered during the 1997–8 excavations

There were at least 50 sherds of South Gaulish samian, mainly of Flavian or Flavian-Trajanic date,

but with two Flavian survivals (cat nos D64, D91). Most of the vessels were bowls or dishes, but there were also sherds from cups and jars, and a single sherd from an inkwell (K12:01). This was unstratified, but came from above or near the back range of the headquarters building. The type is most often associated with military sites, and has occasionally been found from the area of the *principia* of other forts (Willis 2005, 108; 110).

The majority of the samian came from Central Gaul, with over 80% coming from Lezoux. Almost 50% of the Central Gaulish decorated ware dates to the late Antonine period.

The major supplier of East Gaulish samian is Rheinzabern, with small quantities from other sources. The high proportion of East Gaulish ware (15.7%) is typical of sites on Hadrian's Wall; at South Shields Roman Fort, the average from excavations inside the fort and from the *vicus* is approximately 15%, while at Newcastle Roman Fort (constructed in the late second or early third century) it makes up 20% of the samian (Dickinson 2002, 147). A number of sherds, including those from vessels in the style of Iulius viii, indicate samian was still arriving at the site in the third century (cat. no. D93; cf. D114).

The proportion of decorated ware in the assemblage

Table 22.03: Samian vessel types, shown as percentages of vessel numbers

Type	%
Cup	14.5
Beaker	0.6
Dish	50.8
Decorated bowl	22.0
Plain bowl	4.0
Mortarium	2.8
Inkwell	0.1
Unknown	5.3
Total	1046

Table 22.04: Samian vessel types, shown as percentages of EVEs

Type	%	Total	Typical %*
Cup		30.0	25.6
27	3.1		
33	26.0		
40	0.1		
80	0.8		
Dish/platter		48.5	39.8
18/31	9.0		
18/31 or 31	6.4		
18/31R	2.3		
18/31R or 31R	0.3		
31	21.5		
31R	8.8		
Curle 15	0.2		
Decorated bowl		15.8	27.1
30	0.6		
30 or 37	6.2		
37	9.0		
Plain bowl		1.4	3.7
36	0.3		
38	0.4		
38 or 44	0.6		
44	0.1		
Mortarium		2.3	0.1
45	2.2		
Curle 21	0.1		
Bowl/dish		1.8	
Total	6220		

* by vessel number: Willis 2005, table 45

(22% by vessel numbers, 16% by EVEs) is not as high as the average for military sites as noted by Willis (2005, table 45), but it is very similar to the decorated ware from the *vicus* at South Shields Roman fort at 18% and from the fort at Newcastle at 17% (Wild 2010, 89–90, 94; Dickinson 2002, tables 15.2–3).

Table 22.05: Dated samian, shown as a percentage

	Wt (kg)	Sh	EVE (%)
Pre-Hadrianic	1.9	2.8	3.0
Trajanic-Hadrianic	0.8	1.2	1.3
Hadrianic	7.4	6.1	8.3
Hadrianic-early	9.9	9.6	9.6
Antonine			
Hadrianic-Antonine	15.4	20.6	14.8
Antonine	22.8	26.4	34.2
Early Antonine	0.2	0.3	
Mid to late Antonine	25.6	19.7	20.6
Late Antonine	9.7	6.6	2.8
Late second century/third century	6.3	6.6	5.4
	38.853	3453	5186

Decorated ware (Fig 2207)

- D1. Form 37, Central Gaulish. The mould is probably by Rogers's X-9, one of the potters at Les Martres-de-Veyre who supplied Medetus, but the bowl itself is in Lezoux fabric. A panel or upper zone contains a spiral in a double festoon. The rosette-tongued ovolo is probably Rogers B38. Hadrianic (area over west fort wall and gateway, unstratified, D08:11, 2253). (Not illustrated.)
- D2. Form 37, Central Gaulish. The ovolo (probably Rogers B155) and arcade are on a stamped bowl of Severus iv from York (S. & S., pl. 128, 1, but supported by caryatids, instead of columns), and the astragalus at the top corner of the panel is on a bowl in his style from Verulamium. However, the zig-zag borders (Rogers A26) are more typical of Servus iv (S. & S.'s Servus 2), whose style is close to that of Severus. The Pan (D.412 = O.710) is on a bowl in his style from Lauriacum (Karnitsch 1955, Taf. 7, 6). A range c.AD160–200 would fit either potter (area of Building 8 and *Via quintana*, unstratified, D12:01).
- D3. Form 37, East Gaulish, with ovolo (Ricken-Fischer, E11) and rosette (*ibid.*, O38a) used at Rheinzabern by Cerialis v. c. AD160–190 (Building N, D12:08). (Not illustrated.)
- D4. Form 37, Central Gaulish. The ovolo (Rogers 208), large beads and Bacchus (O.768) were all used by Casurius ii, but the astragali across the borders and inaccurately placed at the top are more typical of Docilis i, who also used the ovolo. Nevertheless, the bowl is more likely to be by Casurius. c.AD 160–190 (Chalet 9, Building W, D13:55; joining D13:03 (area over Building 9, unstratified)).
- D5. Form 37, East Gaulish, with mould-stamp of Belsus of Rheinzabern ([BE]LSVSF retr., see no. S16 below). The scroll has a striated double medallion (a more complete version of Ricken-Fischer, KB136), leaf (*ibid.*, P61) and bird (*ibid.*, T250) in the upper concavity and the same medallion in the lower concavity. c.AD175–200 (area over Building 10, unstratified, D14:01).

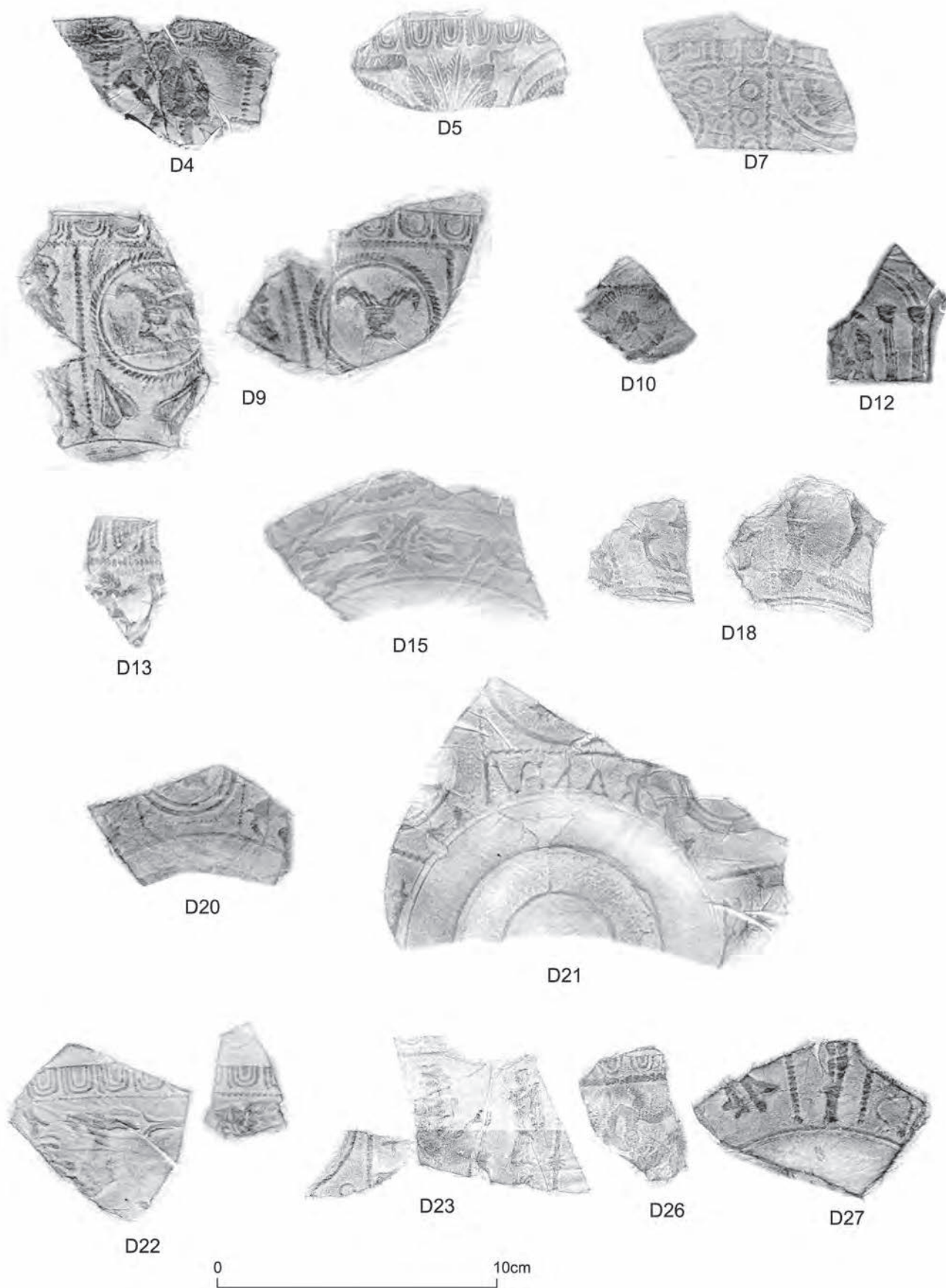

Figure 22.01: Decorated samian nos D4–D27. Scale 1:2.

- D6. Form 37, Central Gaulish. The rosette-tongued ovolo was used at Lezoux by Sacer i. Both zones of decoration contain chevron festoons (Rogers F60), with small masks between them in the upper zone and rosette tassels (Rogers C25) in the lower. Two festoons in the lower zone have the same kneeling horse and another has a hare (O.2061?). A stamped bowl of Sacer from Dragonby, Lincs, is almost certainly from the same mould (Dickinson 1996, 594, 1542–3). *c.* AD125–145 (area over *intervallum* road (Road 4), unstratified, E04:01, with a sherd from the soil layer west of Building 18, *contubernium* 1, Period 3–4, F05:08 and from Building 5, F05:31). (Not illustrated.)
- D7. Form 37, Central Gaulish, with panels: 1) a single medallion, ring and astragali. 2) A vertical series of rings. 3) A bird to left, looking back, and small beaded ring (Rogers C120) in a single festoon, over an astragalus. The ovolo (Rogers B247), zig-zag borders, both types of ring and random astragali are all on a bowl in the style of Tetturo in a pit of *c.*AD150–160 at Alcester (Hartley, Pengelly and Dickinson 1994, fig. 50, 275). The rings and borders are on a signed bowl from Corbridge (S. & S., pl. 131, 3). *c.*AD130–160 (Area over *intervallum* road (Road 5), E04:01 (with F05:02, area over Alley 4, unstratified).
- D8. Form 37, East Gaulish. The ovolo is on a stamped bowl of Satto ii from Chémery-Faulquemont (Delort 1953, pl. 45, 9322). Here it has a straight line below, instead of beads. Hadrianic? (area over Road 5 and Building 5, unstratified, E04:07). (Not illustrated.)
- D9. Form 37, Central Gaulish. The ovolo (Rogers B223, or a version of it) was used at Lezoux by Casurius ii. The panels include: 1) a caryatid (D.657 = O.1206). 2) A medallion (Rogers E25), containing an acanthus in a cup (similar to Rogers K3), over heart-shaped leaves (Rogers J56 variant). The caryatid and acanthus are on a stamped bowl of Casurius from Wels (Karnitsch 1955, Taf. 7, 4). For the medallion and leaf, cf. a bowl from Leicester (S. & S., pl. 133, 17). *c.* AD160–190 (area over Road 5 and Building 5, unstratified, E04:07, with sherd from area over Alley 4, unstratified, F05:02).
- D10. Form 37, Central Gaulish, with a six-petalled rosette (Rogers C30) in a medallion with looped border (a fuller version of Rogers F74?). Acaunissa used the rosette, but is not known to have used the medallion. The fabric and glaze suggest Hadrianic or early-Antonine date. The bowl is unusually thick for its size (area over Alley 4, unstratified, E05:01).
- D11. Form 37, East Gaulish. The ovolo (Ricken 1934, Taf. VII, B), used at La Madeleine, has a double groove above and a bead-row below. *c.*AD130–160 (area over Road 1, unstratified, E07:03, 2291). (Not illustrated.)
- D12. Form 37, probably Central Gaulish. An arcade with fluted columns contains an identical column and a figure or figures. Not closely datable, in the absence of parallels, but probably Hadrianic or early-Antonine (area over Road 8, unstratified, E08:01, 2227).
- D13. Form 30, Central Gaulish. The ovolo (Rogers B161), festoon with beaded outer border (Rogers E8, in partial impression) and Cupid (O.440 variant) were all used by Do(v)eccus i. Cf. a stamped bowl from Silchester (S. & S., pl. 148, 14). *c.*AD165–200 (rerouted *Via principalis*, E08:13, 2275, with two sherds in E09:13, area over Road 8, unstratified).
- D14. Form 37, Central Gaulish, with plainware stamp of Reginus iv on the rim (see S84 below), and an ovolo used at Lezoux by Advocisus and some of his associates (Rogers B103). *c.*AD160–180 (area over Cistern 1, unstratified E08:20, 2295).
- D15. Form 37, Central Gaulish, with a leafy festoon (Rogers F16), rings and perhaps a figure in the upper zone, and a pair of dogs (not in D. or O.), a snake on rock (probably a double impression of D.960 bis = O.2155) and a bear (D.818 bis = O.1616) in the lower zone. There are no close parallels for the decoration as a whole, but Attianus ii used the bear and snake and the festoon is on an unprovenanced bowl in his style in the British Museum (M1347). The bowl could almost equally well be by his associate Martio i, who favoured hunting scenes and is known to have used the snake *c.*AD125–145 (Cistern 1, fill, E08:29, 2359).
- D16. Form 37, Central Gaulish, with panels: 1) a seated Bacchus (D.534a = 0.571) in a double medallion and astragali in corners. 2) A tier of cups (Rogers Q27). The medallion, cups and astragalus were commonly used by Cinnamus ii. The Bacchus is less usual for him, though it occurs on one of his earlier bowls with a small label-stamp, from Colchester. *c.*AD140–170 (Cistern 1, fill, E08:29, 2344). (Not illustrated.)
- D17. Form 37, Central Gaulish, in the style of Advocisus. The panels include: 1) a Pudicitia (D.548 = O.935). 2) A leaf (Rogers J49). 3) A double medallion over trifid motifs (Rogers G70), impressed stem-to-stem. This may well be from the same mould as a bowl from Silchester (S. & S., pl. 112, 6). *c.*AD160–190 (rubble round Cistern 1, E08:30, 2298). (Not illustrated.)
- D18. Form 37, Central Gaulish. A panel contains a Pan (D.412 = 0.710) over a large striated spindle, with a caryatid (D.656 = O.1199) on the left and perhaps also on the right. Another panel shows the caryatid at the right with a sea-bull over the partly-impressed spindle. The Pan, sea-bull and spindle are on a bowl from Wels (Karnitsch 1959, Taf. 62, 4) which is probably by Servus ii (S. & S.'s Servus 3). His style is related to that of Docilis i and Casurius ii and he has Casurius's large beads, but he often omitted the terminal beads, as here. *c.*AD160–190 (Cistern 1, fill, E08:29; with area over Cistern 1, unstratified, E08:08, 2231, and area over Building 8, unstratified, E10:13, 2262).
- D19. Form 30 or 37, Central Gaulish, with ovolo and bead-row used at Lezoux by Iullinus ii (Rogers B164). *c.*AD160–190 (Cistern 1, fill, E08:29, 2342). (Not illustrated.)
- D20. Form 37, Central Gaulish. A bowl in the style of Banuus, with panels: 1) a crab, as on a stamped bowl from Lezoux and on another in his style, also from Lezoux (S. & S., pl. 140, 13). 2) A double medallion, over a partly-impressed striated spindle. 3) A hare

- to right (O.2057A?). The panel borders lack terminal beads. The hare is on a stamped bowl from Roanne, but with an ovolo which Banuus probably used only at the Terre-Franche kilns at Vichy. The fabric of the Wallsend piece suggests origin at Lezoux, however. *c.*AD160–200 (Cistern 1, fill, E08:29, 2410).
- D21. Form 37, Central Gaulish, with stamp of Banuus (see no. S14 below) and panels: 1) a candelabrum (Rogers Q27), lying flat. 2) A double medallion over a leaf (Rogers H69, partly impressed). 3) A hare (O.2057A?) in a single festoon, over the stamp. 4) = 2?. 5) = 1? The bowl is mended with a lead cramp and the footring, which must have been added after the bowl had been removed from the mould, has broken off. *c.*AD175–250 (Cistern 1, lower fill, E08:44, 2393, 2401, 2402; upper fill, E08:27, 2365; and probably N05:04, Building 1, demolition).
- D22. Form 37, Central Gaulish. The ovolo with bent tongue (Rogers B245) was used by some members of the Paternus v group. The freestyle scene includes a boar (D.835 = O.1674), stag (D.860 = O.1732), goat (O.1849 variant) and dog (O.1926A). The closest connections are with Paternus himself, though the wavy line below the ovolo is rather unusual for him and may indicate that this is one of his earlier bowls. *c.* AD155–170 (Building O, portico, E09:09, 2315: with F10:01 (area over Buildings 7 and 8, unstratified) 2200, and G14:01 (area over Building 7, unstratified)).
- D23. Form 37, Central Gaulish, with one of the ring-tongued ovolos used at Lezoux by the Paternus v group. The panels include: 1) a double medallion. 2) A wide panel, with an athlete (D.377 = O.650) and a Pudicitia (a variant of D.541 = O.930), over a leaf (of the type Rogers J146–149). The bead-row under the ovolo and the vertical border of rhomboidal beads suggest Paternus v, though the rosette half-way up the border (Rogers C194) is unusual for him. *c.*AD160–195 (area over Road 8, unstratified, E09:13, 2236).
- D24. Form 37, Central Gaulish. A small bowl, with beaded borders and a groove below the decoration. The panels include: 1) a bear to left (a smaller variant of D.775 = O.1615). 2) A caryatid (perhaps a smaller version of D.656 = O.1199, with the mask impressed twice). 3B) Dolphins on a basket (Rogers Q59) and a Pan-mask (a smaller version of D.675 = O.1214). All the details were used at Lezoux by Iullinus ii. *c.*AD160–190 (rerouted *Via principalis*, E09:22, 2309). (Not illustrated.)
- D25. Form 37, Central Gaulish, with panelled decoration. The ring-tongued ovolo (Rogers B105), borders of squarish beads and the vertical border topped by a leaf (S. & S.1958, fig. 30, 6), suggest the work of Paternus v (Rogers's Paternus II), though the surviving figure, an athlete (D.386 = O.663), is not otherwise known for him. *c.*AD160–195. (Assembly area, E09:44, 2331). (Not illustrated.)
- D26. Form 37, East Gaulish. A bowl by a potter of Trier Werkstatt II, with ovolo Fölzer 1913, Taf. XXXII, 956?) and erotic group (*ibid.*, Taf. XXIX, 528, perhaps without the couch). Cf. Taf. XXI, 3. *c.*AD160–200 (Building N, E11:06; probably joining a sherd in E11:22 (Building 8, courtyard)).
- D27. Form 37, Central Gaulish. A panelled bowl in the style of Casurius ii, with: 1) Minerva (D.77 = O. 126). 2) Satyr on a pedestal (D.369 = O. 599). 3) Leaf tendrils. The satyr is on a stamped bowl from Naples (S. & S. 1958, pl. 133, 19). The Minerva is on a bowl in Casurius's style in the Wroxeter Gutter hoard (Atkinson 1942, pl. 36, G9). For all three elements see a bowl from Leicester (S. & S. 1958, pl. 137, 55). *c.*AD160–190 (Building 8, courtyard, E11:22).
- D28. Form 37, Central Gaulish. A bowl by a member of the Sacer i group, with ovolo Rogers B185 = B205 (very blurred) and a beaded border below. The freestyle scene perhaps includes a bear to right and heavy foliage (as on a bowl from Caerwent: S. & S.1958, pl. 82, 5). There may also be a stag to left. Another sherd of the same date, with a lioness (D.793 = O.1537) may be from this bowl, though the wall is thinner. *c.*AD125–145 (Building 8, courtyard, E11:35). (Not illustrated.)
- D29. Form 37, East Gaulish, with mould-stamp of Cobnertus iv of Rheinzabern (see S32 below). The ovolo is Ricken-Fischer 1963, E44, with a corded border below (*ibid.*, O244). The freestyle scene includes a boar to right (*ibid.*, T70a), lion to left (*ibid.*, T4), stag to left (*ibid.*, T92) and bifid motif (*ibid.*, P150). *c.*AD160–180 (Building 8, courtyard, E11:35, with two sherds (joining) in F11:01 (area over Building 7) and two sherds in F12:01 (area over *Via quintana*), 1104).
- D30. Form 37 East Gaulish (La Madeleine). The ovolo is impressed over a straight line, with a border of separate square beads below. The decoration includes an acanthus and a saltire with diagonals of rectangular beads, and leaves (Ricken 1934, Taf. VII, 44) at the sides. Cf. Taf. XI, 13a and X, 17 for the line and beads, respectively. *c.*AD130–160 (area over Building 9, unstratified, E13:01). (Not illustrated.)
- D31. Form 37, South Gaulish, with a Diana (D.63 = O.104B), used at both La Graufesenque and Banassac, and a hare. This bowl is probably from La Graufesenque. Flavian-Trajanic (Building 9, *contubernium* 1, Period 1, E13:20). (Not illustrated.)
- D32. Form 37, Central Gaulish, with panels: 1) a vine (Rogers N1, with a variant of the leaf H119), bird (D.1019 = O.2252?) and Bacchus (O.566, without boots). 2A) Festoon (Rogers F16), probably containing a sea-cow (D.29 = O.42?); 2B) trifid motifs (Rogers G56) stem-to-stem, joined by a vertical astragalus. The Bacchus and vine are on a stamped mould of Sacer i from Lezoux (Simpson 1977, pl. 1) and the rosette junction-masks are on bowl with the same stamp from Vienne (*ibid.*, pl. II). The trifid motif is on a signed bowl from Corbridge (S. & S. 1958, pl. 83, 13) and the same arrangement as in 2B, but with a different trifid motif, occurs on a signed bowl from Holt (*ibid.*, 12). *c.*AD125–145 (Area over Building 9, unstratified, E14:01, with joining sherd in F14:01 (area over Building 10 and Alley 5, unstratified)).
- D33. Form 37, East Gaulish (Rheinzabern). The ovolo is probably Ricken-Fischer 1963, E39. The decoration includes one panel with warriors (*ibid.*, M207–8) and a bush (*ibid.*, P9) and another with a large

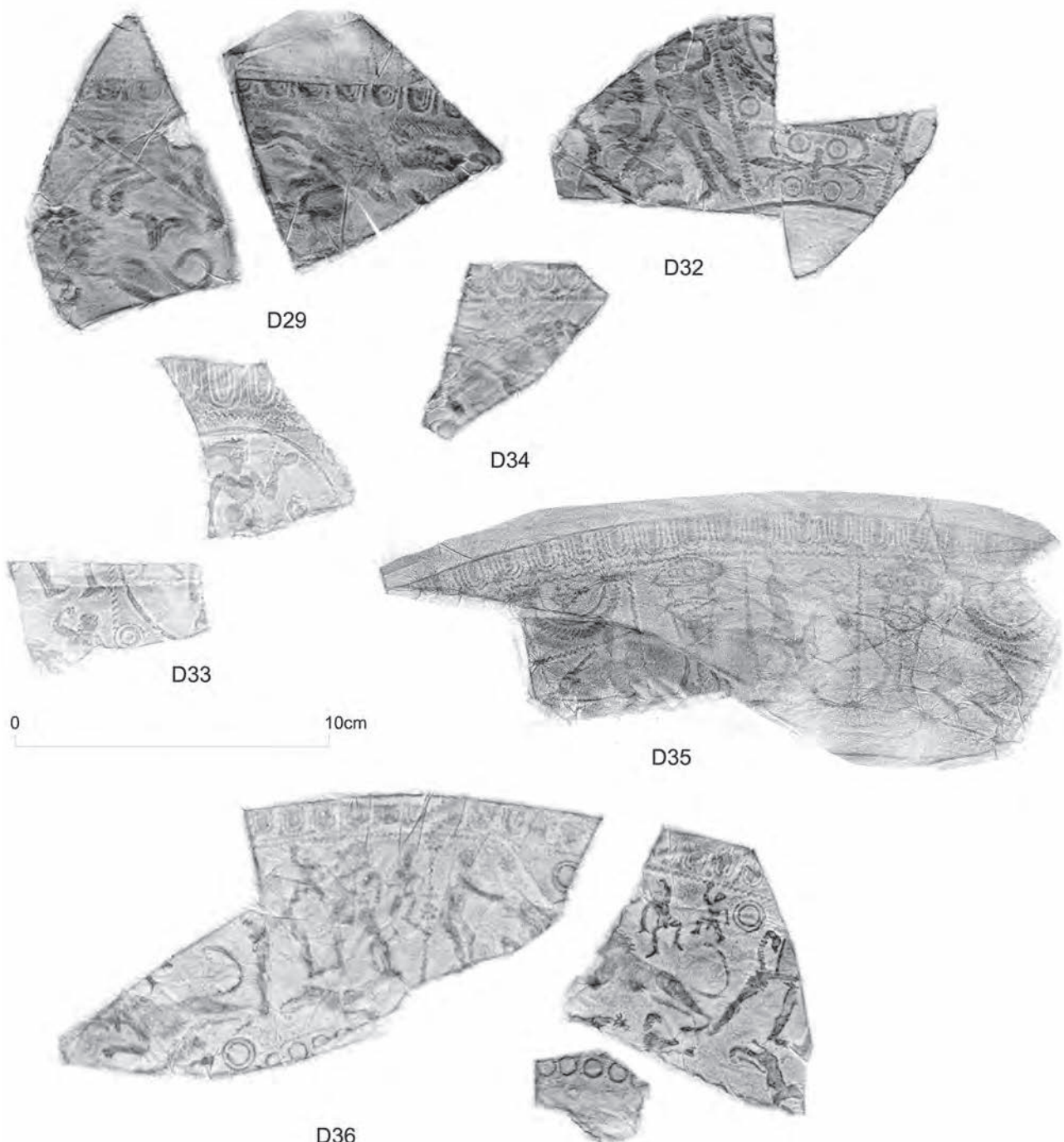

Figure 22.02: Decorated samian nos D29–D36. Scale 1:2.

roundel and a single medallion containing a Venus (*ibid.*, M44), between two figures to left (*ibid.*, M260). The use of wavy-line and corded borders is common in Cobnertus iv's work and they and many of the motifs appear on a stamped bowl from Osterburken (Ricken 1948, Taf. 31, 1). *c.* AD160–180 (area over Building 10 and Alley 5, unstratified, E14:01).

D34. Form 37, Central Gaulish. The ovolo (Rogers B231) was used by potters associated with Sacer i and Cinnamus ii and appears on bowls in the style of Paternus iv, a Hadrianic-Antonine associate of

Sacer, who stamped moulds in the nominative. The decoration includes a lion (D.727 = O.1379), as on a bowl in his style from Watercreek (Wild 1979, 287, 76), a panther (D. 799 = O.1518) and seven- or eight-petalled rosettes. *c.* AD130–155 (area over Building 10 and Alley 5, unstratified, E14:06).

D35. Form 37, Central Gaulish, with panels: 1A) festoon (Rogers F70), containing a fan-shaped plant (Rogers G259, impressed sideways); 1B) hare to left (O.2119?). 2) Tripod (Rogers Q7). 3) Scarf-dancer (D.217 = O.354). 4) = 2). 5A) = 1A; 5B) hare to right (O.2057A?). The ovolo (Rogers B31) was used by

- X-5 and most of the details appear on other bowls in his style, the hares at Wels (Karnitsch 1959, Taf. 34, 4) and Wroxeter, the festoons and ovolo at Bingen (S. & S. 1958, pl. 67, 1), the dancer at London (BM M1272) and the tripod at Wanborough, Wilts. c. AD 125-140 (Alley 3, F04:33; with sherd from Road 1, Period 4 to mid/late third century, L08:13).
- D36. Form 37, Central Gaulish. The single-bordered ovolo (Rogers B28), with guide-line below and then a wavy line, suggests a member of the Quintilianus i group. Two unusually wide panels, repeated, both have a pair of gladiators (O.1003-4) and a lion to left (not in D. or O.). The other details are a pygmy (D.440 = O.699), Pan (D.424 = O.723), panther to right (O.1516), athlete (O.682A variant), naked man to right, bird to left, looking back, double medallion, basal wreath of rings with a guide-line above and an eight-beaded rosette (Rogers C281). Most of the details are on signed bowls of Paterclus ii, the ovolo, gladiators and rosette at Silchester (S. & S. 1958, pl. 72, 33) and the bird, panther to right, medallion and basal wreath at Caerwent. c. AD 125-140 (Alley 3, F04:33 (three sherds), with others in F04:01 (area of Building 5, unstratified), F04:11 (wall tumble over Alley 3), and F05:01 (area of Alley 4, unstratified)).
- D37. Form 37, Central Gaulish, with panels: 1) a leaf (Rogers H105?), hanging down. 2) A fleur-de-lys (Rogers G88), hanging down, and an athlete to left over a row of rings. In two adjacent panels on the other sherd the fleurs-de-lys points upwards. The decoration is closely paralleled on a bowl with an ovolo of Pugnus ii from a pottery shop at Castleford burnt down in the 140s (Rush *et al* 2000, fig. 24, no. 465). The leaf, wavy lines and horizontal astragali are on a signed Pugnus bowl from excavations at Carlisle. c. AD 130-150 (Alley 3, F04:33, with a sherd, slightly burnt, from the Assembly area, F09:58).
- D38. Form 37, East Gaulish. The ovolo replacement (Ricken-Fischer 1963, R8) has been impressed on top of a guide-line. The medallion with beaded outer border (*ibid.*, K57) contains a Pan-mask (*ibid.*, M17a). All the details are on a bowl from Rheinzabern in the style of Reginus vi (Ricken 1948, Taf. 17, 13). c. AD 160-180 (area over Alley 5, unstratified, F05:01).
- D39. Form 37, from the East Gaulish factory of La Madeleine. The decoration, with a guide-line for laying out and a closing bead-row, includes an acanthus (Ricken 1934, Taf. VII, 25), on a double astragalus. c. AD 130-160 (rubble round Cistern 1, F08:25, 2475). (Not illustrated.)
- D40. Form 37, from one of the East Gaulish factories in the Argonne. The ovolo (probably Chenet and Gaudron 1955, fig. 54 bis, third example on Row X) has a tongue turning to the right at the bottom. The decoration includes a bird (a debased version of Fölzer 1913, Taf. XXVIII, 385) and a double medallion, probably both in the upper concavity of a scroll. Mid- to late-Antonine (area over Road 8, unstratified, F09:01).
- D41. Form 37, from the East Gaulish factory of La Madeleine. The decoration, closed by a bead-row, includes a warrior to left (Ricken 1934, Taf. VII, 90) and a bear to right (perhaps the one on Taf. VII, 115). c. AD 130-160 (pit in Assembly area, F09:23, 2259). (Not illustrated.)
- D42. Form 37, Central Gaulish. The rosette-tongued ovolo (Rogers B7) was used at Les Martres-de-Veyre, but sometimes occurs on bowls in Lezoux fabric, like this one, in the style of Sacer i. The panels include: 1B) Cupid to right (D.247 = O.405). 2A) Double festoon containing a bird (O.2317); 2b) a row of rings; 2C) an erotic group (a variant of Oswald, pl. XC, B). 3A) Apollo (D.55 = O.92) and Cupid to right (D.245 = O.403). Another sherd has a figure over a hare (O.2061?), both to right. The panel junctions are masked by hollow rosettes, with ten or eleven petals. c. AD 125-145 (pit in Assembly area, F09:59, 2377, (3) and 2388, with 2373, (2) from the Assembly area, F09:63).
- D43. Form 37, Central Gaulish. The panels include: 1) a draped figure (D.372 = O.365). 2) A Cupid (D.252 = O.417) on a tripod (Rogers Q7). 3) A Jupiter (D.1 = O.1). On the other sherd both the larger figures are in the same panel. D.372 and the tripod are on a stamped and signed bowl of Docilis i from Nérises-Bains (Piboule 1977, 100) and he is known to have used the other details. c. AD 130-165 (Alley between buildings 7 and 8, F10:29, area over Road 3, unstratified, 2245).
- D44. Form 37, Central Gaulish, with a ring-tongued ovolo (Rogers B105) and a candelabrum (Rogers Q40). The ovolo suggests a member of the Paternus v group, though none is known to have used the candelabrum. c. AD 150-190 (Road 3, F11:73, 2422).
- D45. Form 37, Central Gaulish. One panel has a vertical series of spirals, with an astragalus separating two of them, and another spiral in the adjacent panel. Cf. signed bowls of Mox(s)ius from Birdoswald and Chester (S. & S. 1958, pl. 152, 3, 4). Hadrianic or early-Antonine (area over *Via quintana*, unstratified, F12:01).
- D46. Form 37, East Gaulish, probably from La Madeleine, on the evidence of the fabric. The square-bottomed ovolo has a short tongue on the left. Arcades separated by rhomboidal beads rest on an arrow-head motif. The Cupid is on a bowl from the Saalburg, which has the beads and arcade (used as a festoon) and perhaps the same ovolo, though in a more complete version (Ricken 1934, Taf. X, 12). c. AD 130-160 (area over *Via quintana*, unstratified, F12:01).
- D47. Form 37, East Gaulish. The tongueless ovolo (one of the series Ricken-Fischer 1963, E55-7), here impressed over a guide-line, and leaf (*ibid.*, P81) were used at Rheinzabern by Reginus vi. c. AD 160-180 (area over *Via quintana*, unstratified, F12:01).
- D48. Form 37, Central Gaulish, with the large label-stamp of Paternus v, [PATER]NFE retr. in the decoration (see no. S77 below). The ovolo is probably Rogers B105. The panels, divided by astragalus borders (Rogers A10), include: 1) a (double?) medallion. 2A) A single festoon with a leopard (D.789 = O.1509), over an astragalus (Rogers R60); 2B) perhaps a column on its side. Another sherd has the tripod,

- Rogers Q16. c. AD 160–195 (area over *Via quintana*, unstratified, F12:01).
- D49. Form 37, Central Gaulish. The ovolo, with bifid or trident-tongue, is on a signed bowl of Attianus ii from Canterbury. The horseman (D.158 = O.249) and snake on rock (D.960 bis = O.2155) are on a stamped bowl from Verulamium (S. & S. 1958, pl. 86, 12). The incurving festoon in the adjacent panel is on a stamped bowl from Corbridge (*ibid.*, 10). c. AD 125–145 (Building Row 20, building T, F12:04).
- D50. Form 37, Central Gaulish. The bold basal ridge between two slighter ones is typical of X–6 and the leaf in the upper concavity of a scroll (Rogers H26?) is on one of his bowls, from Carlisle (May and Hope 1917, pl. VII, 91). The lower concavity contains a pygmy (D. 422 = O.703, with right foot broken). c. AD 125–150 (Chalet 9, robbing and post-Roman dereliction, F13:16).
- D51. Form 37, East Gaulish, with an ovolo (Ricken-Fischer 1963, E69) and roped border used at both Rheinzabern and Heiligenberg by Ianus ii. The hard fabric and good glaze of this piece suggest origin at Heiligenberg. c. AD 140–160 (area over Building 10 and Alley 5, F14:01). (Not illustrated.)
- D52. Form 37, from the East Gaulish factory of La Madeleine, with ovolo Ricken 1934, Taf. VII, C and a border of square beads. c. AD 130–160 (*intervallum* road (Road 6), F15:04). (Not illustrated.)
- D53. Form 37, Central Gaulish, in the style of Cettus of Les Martres-de-Veyre. The ovolo resembles Rogers B97, but the tongue is on the other side of the egg. It occurs, together with the lion (a smaller version of D.769 = O.1457), on two of his bowls, from London and Corbridge (S. & S. 1958, pl. 144, 49–50). The lion and astragalus are also on a bowl from Camelon. c. AD 135–160 (Alley 4, G05:07, with a sherd from F07:01 (area of *Via principalis*, unstratified)).
- D54. Form 37, Central Gaulish, with ovolo Rogers B231 and panels: 1) ?. 2A) Double medallion; 2B) Hercules (D.446 = O.753). 3A) Chevron festoon (Rogers F8); 3B) Europa and sea-bull (D.28 = O.43). 4A) Double medallion; 4B) kilted man. On another sherd the festoon contains a dolphin to left above the Europa and the medallion in the adjacent panel contains a bird (O.2317), probably above the kilted man. The junction-masks are seven-beaded. The style, though not the figure-types, suggests the Sacer i-Attianus ii group, which almost certainly used the ovolo. c. AD 125–145 (robbing of street drain or north wall of Building 18, G05:18, with a sherd from the area over Building 5 and Alley 4, unstratified, J05:03).
- D55. Two fragments of form 30, Central Gaulish, with ovolo 2 of Cinnamus ii (Rogers B231) and panels: 1) a double medallion and an astragalus. 2) A candelabrum (Rogers Q43). The other sherd shows the motif Rogers Q27 and the astragalus and medallion. c. AD 150–180 (Building 5, *contubernium* 2, G05:25).
- D56. Form 37, Central Gaulish. One panel has a single festoon containing an animal and an astragalus with chevrons of unequal size at the ends. Below is a saltire with the astragalus in the top and at the sides. The beads in the diagonals and the panel border are square. The arrangement of the panel is paralleled on a bowl in the Oswald-Plicque Collection which is possibly by the late-Antonine Lezoux potter, Marcus v (area over Building 7, unstratified, G09:01).
- D57. Form 37, East Gaulish, from Lavoye. The decoration includes a standing figure, perhaps a Venus with mirror (Chenet and Gaudron 1955, fig. 60, J), over a trifold motif (Fölzer 1913, Taf. XXVIII, 399). Second half of the second century (area over Building 7, unstratified, G11:01).
- D58. Form 37, Central Gaulish, in the style of Casurius ii, with ovolo Rogers B208 and panels: 1) a festoon, containing a sea-horse (D.33 = O.33). 2) A leaf (Rogers H47). One of the vertical borders continues into the ovolo zone, without a junction-mask, and two panels have leaf-tendrils attached to the bottom of their borders. c. AD 160–190 (Building Row 20, Building AX(N), south wall, G11:38; with two joining sherds in G11:17 (Building Row 20, Building R)).
- D59. Form 30, Central Gaulish, with ring-tongued ovolo (Rogers B105) and panels: 1) a medallion and corner astragalus. 2) A double festoon, containing a dolphin to right (D.1050 = O.2382). The type of beaded border below the ovolo suggests Paternus v, who used all the other motifs. c. AD 160–195 (Building Row 20, Building AX(N), south wall, G11:38).
- D60. Form 37, Central Gaulish, with a variant of Cinnamus ii's ovolo 3 (Rogers B143). However, the decoration is slightly unusual for him, with a single medallion or scroll and a leaf (Rogers U161), pointing upwards. Possibly by Paternus iv, who used the leaf and the same beads. Riveted. c. AD 130–150 (Building Row 20, Building R, G11:13).
- D61. Form 37, East Gaulish. The ovolo (Ricken-Fischer 1963, E46), rosette (*ibid.*, O48) on top of a divider (*ibid.*, O271) and medallion (perhaps a full version of *ibid.*, KB105) were all used at Rheinzabern in the late second and first half of the third century. Cf. Ricken 1948, Taf. 159, 13 (Disturbance/levelling north-east of Building R, G11:44).
- D62. Form 37, East Gaulish. The figure to left (a variant of the right-hand figure in the group Fölzer 1913, Taf. XXIX, 519) appears singly on a bowl of Criciro vii of Trier, from Neuss. Above is an ovolo-replacement of rosettes (*ibid.*, Taf. XXXI, 850?). The mould was presumably made at Trier, but the fabric and glaze suggest that the bowl may have been made elsewhere, perhaps at one of Trier's smaller satellite potteries, such as Haute-Yutz or Daspich-Ebange. Late second century or first half of third century (area over *Via quintana*, unstratified, G12:01).
- D63. Form 37, Central Gaulish. The single-bordered ovolo (Rogers B12), tree (Rogers N7) and rosette at the top of a panel border (Rogers C23) were all used by Attianus ii. c. AD 125–145 (area over Road 3, unstratified, G12:15, and area over Building 9 and Road 3, unstratified, G13:01).
- D64. Form 37, South Gaulish. The lower zone includes a panel containing rows of leaf-tips and a saltire with a five-bladed plant with striated outer petals in the bottom, over a basal wreath. The plant is on

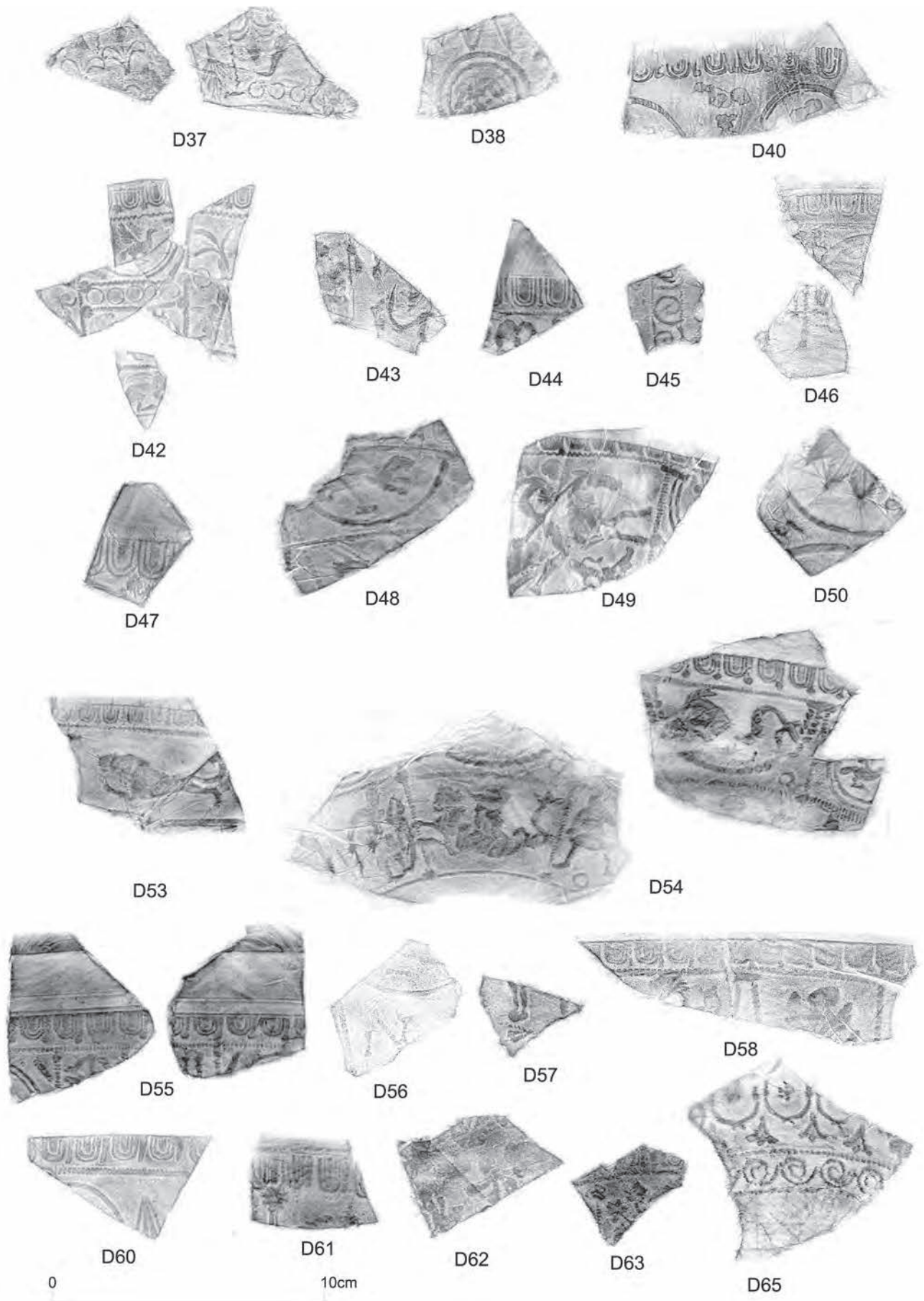

Figure 22.03: Decorated samian nos D37–D65. Scale 1:2.

- a stamped form 37 of Frontinus from Canterbury. c. AD 70–85 (Chalet 9, robbing and post-Roman dereliction, G13:03). (Not illustrated.)
- D65. Form 37, from the East Gaulish factory of La Madeleine. The decoration includes at least two rows of festoons (Ricken 1934, Taf .VII, 51), the lower containing seven-beaded rosettes (*ibid.*, 1), and a row of pendant trifid motifs (*ibid.*, 11). The basal wreath consists of spirals (*ibid.*, 33). The wreath, festoon and rosette are on a bowl from Corbridge and the wreath also occurs on a bowl from Camelon. c. AD 130–160 (Chalet 9, robbing and post-Roman dereliction, G13:03).
- D66. Form 37, Central Gaulish, with ovolo Rogers B102 and panels: 1) a composite motif (Rogers Ql). 2) A Cupid (D.275 = O.503). The ovolo, neat beads and six-petalled rosette (Rogers C122) were all used by Advocisus. The Cupid is unusual for him, but occurs on a stamped bowl from Corbridge (Simpson 1953, fig. 16, no. 29). The composite motif is on a bowl from Little Chester which is in a style related to that of Advocisus but is probably not by him. Another sherd, which may belong to this bowl, has concentric double medallions in the manner of Divixtus i (cf. S. & S.1958, pl. 116, 15), one of whose styles is close to that of Advocisus. Mid- to late-Antonine (area over Alley 5, unstratified, G14:03).
- D67. Form 37, Central Gaulish. The ovolo (S. & S.1958, fig. 9, 1) and double arcade or medallion occur on moulds in the so-called Medetus style, mainly from Les Martres-de-Veyre, though some may have been made at Lezoux. This bowl is in Lezoux fabric. c. AD 125–140 (Building 9, *contubernium* 8, G14:17). (Not illustrated.)
- D68. Form 37, Central Gaulish, with ovolo Rogers B228 and a kneeling stag (a variant of D.847 = O.1704) in a double festoon. The ovolo was normally used in the Hadrianic and early-Antonine periods, but the fabric of this piece and the coarse zig-zag border suggest mid- to late-Antonine date (Chalet 10, Building X, G15:16).
- D69. Form 37, Central Gaulish. Two panels are divided by a wavy-line border. The hand of an unusually large figure, holding something, stretches over the border into a panel with a *quadriga* (similar to O.1169 or 1170) and, perhaps, an animal. Hadrianic-Antonine, perhaps by Sissus ii, who is one of the few potters of this date to have used large figure-types (area over Tower 1, unstratified, H02:03).
- D70. Form 37, Central Gaulish. One sherd shows a Vulcan (D. 39 = O.67), over two rings. The other shows the top part of a panel, with a lion's head (perhaps an incomplete impression of D.741 = O.1389) in a chevron festoon (Rogers F41). The zig-zag borders (Rogers A24) and rings suggest Arcanus and the festoon and Vulcan are on a signed bowl from Rottenburg (S. & S.1958, pl. 78, 1). c. AD 125–140 (area over Road 4, unstratified, H03:03).
- D71. Form 37, Central Gaulish, with panelled decoration. The ovolo (Rogers B76), recumbent lion (perhaps D.754 = O.1422) and double astragalus are on form 30 from London(?), in the style of Geminus iv (Walters 1908, M1062). The beaded borders and rosette junction-mask (Rogers C28) normally appear in his later style, while the rest of the details go with his earlier style. c. AD 125–145 (Building 4, make up material, H04:07).
- D72. Form 37, East Gaulish, with ovolo Ricken-Fischer 1963, E39b, ornamental medallion (*ibid.*, K48), including a Cupid (*ibid.*, M121) and a flute-player (*ibid.*, M167), dividers with bifid motifs at the bottom (*ibid.*, P142?) and six-petalled rosettes in the middle and a bifid motif in the field. A V in the decoration is probably not a signature, but a badly applied motif. Most of the details are common to Ianus i and Cerialis v, but only Ianus used the double border of rectangular beads below the ovolo. The fabric suggests origin at Heiligenberg rather than Rheinzabern. The bowl is mended with a lead rivet. Early-Antonine? (Cistern 2, upper fill, H07:03).
- D73. Form 37, East Gaulish (Rheinzabern), with ovolo Ricken-Fischer 1963, E19 and corded borders defining a zone with corded festoons (*ibid.*, KB115), one with a pygmy (*ibid.*, M152), another with a panther (*ibid.*, T47). The cord of the tassel (*ibid.*, O242, as in the zonal borders) has a blob half-way down and a bifid motif (*ibid.*, P142?) at the bottom. A stamped bowl of Ianus ii from Straubing (Walke 1965, Taf. 23, 5) offers a close parallel. c. AD 160–180 (Cistern 2, modern(?), H07:03; joining sherd from Building 16, N08:24, 2514).
- D74. Form 37, Central Gaulish. A bowl in the style of Casurius ii, with ovolo Rogers B208. A panel contains a double festoon with a hare (O.2119A) and small leaves (Rogers H167). A stamped bowl from Corbridge (S. & S. 1958, pl. 132, 11) has all the details. c. AD 160–190 (area over Road 3 and Building 9, unstratified, H13:06).
- D75. Form 37, from the East Gaulish factory of La Madeleine. The basal wreath consists of trifid motifs (Ricken 1934, Taf. VII, 24), impressed sideways, between two bead-rows. c. AD 130–160 (Chalet 9, robbing and post-Roman dereliction, H13:09).
- D76. Form 37 Central Gaulish, with mould-stamp [PATER]NFE retr. (see no. S78 below). This bowl of Paternus v has a border of rhomboidal beads dividing two panels. One perhaps contains a warrior (D.117 = O.188); the other has a festoon or medallion. c. AD 160–195 (area over Alley 5 and Building 9, unstratified, H14:04). (Not illustrated.)
- D77. Form 37, Central Gaulish. A centaur (D. 431 = O.732) is an uncommon figure-type. Leaf-tips in the field suggest a member of the Cerialis ii-Cinnamus ii group. c. AD 135–170 (area over Alley 5 and Building 9, unstratified, H14:30). (Not illustrated.)
- D78. Form 37, Central Gaulish. The ovolo (Rogers B108?), wavy line below it and horse and rider (D.152a = O.258) are all on a stamped bowl of Maccius ii from Lezoux (Oswald-Plicque Collection). c. AD 130–160 (area over Building 10, unstratified, H15:01). (Not illustrated.)
- D79. Form 37, Central Gaulish, with a saltire panel with diagonals of large, square beads, cut through by a basal groove. Perhaps by Marcus v. Cf. D103.

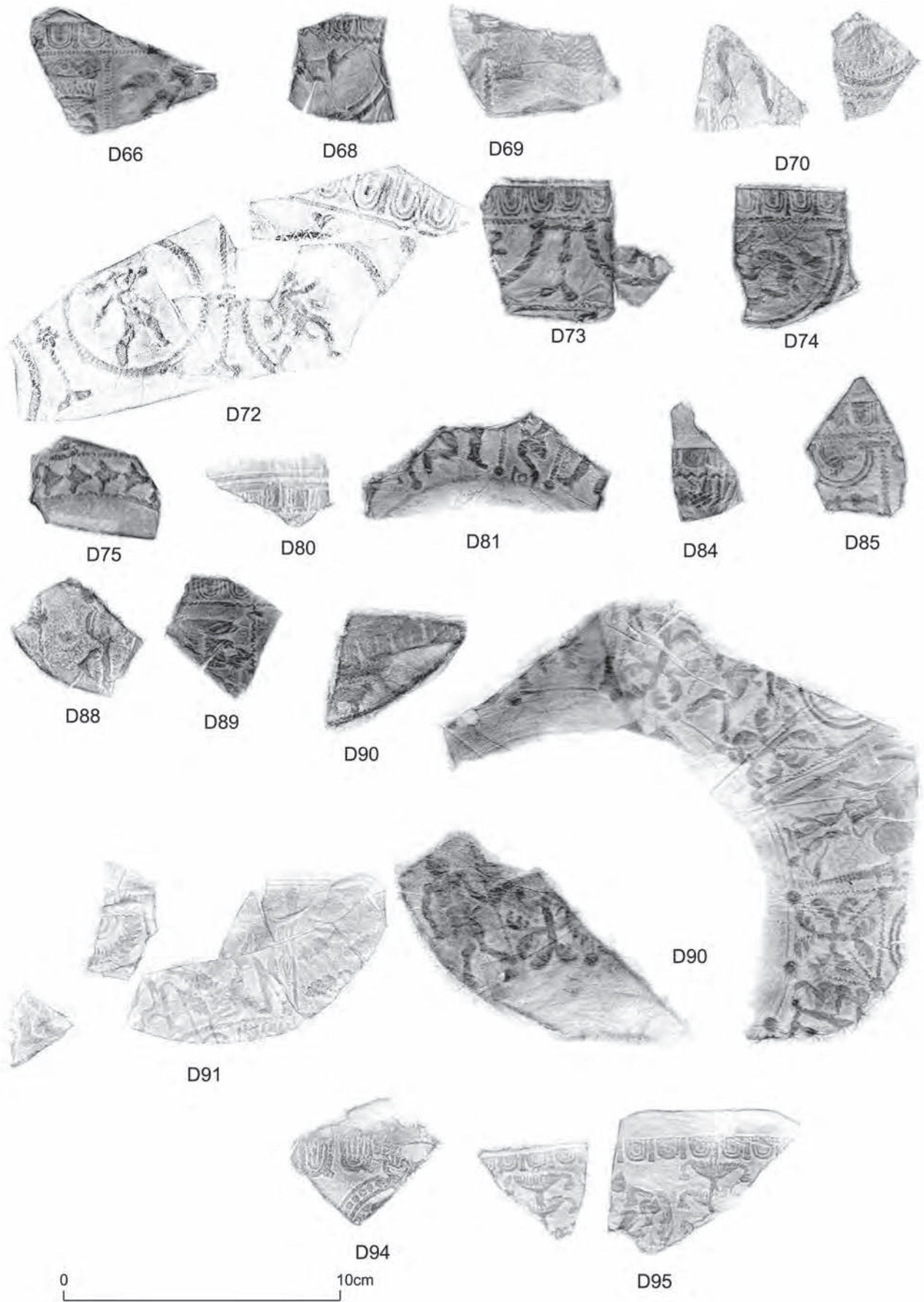

Figure 22.04: Decorated samian nos D66–D95. Scale 1:2.

- Late-Antonine (area over Road 9 and Building 10, H15:03). (Not illustrated.)
- D80. Form 37, South Gaulish. The single-bordered, square-bottomed ovolo is on a second-century Montans bowl from Cramond. There is a double internal groove above the level of the ovolo. Hadrianic or early-Antonine (area over Road 9 and Building 10, H15:10, and sherd from area over Building 8, unstratified, E11:11).
- D81. Form 37, Central Gaulish, in the style of *Advocisus*. The panels contain: 1) a sea-horse (D.35 = O.52A). 2) A Cupid to right (D.282 = O.508). 3) A vine-scroll (Rogers M50). 4) A Cupid to left (D.277 = O.504). Both Cupids are on a stamped bowl from the Wroxeter forum destruction (Atkinson 1942, pl. 33, H3) and the scroll is on another, from Caerwent (S. & S. 1958, pl. 112, 12). The sea-horse is on a bowl in his style from Wroxeter (unpublished). c. AD 160–190 (area over Building 10, unstratified, H15:10).
- D82. Form 37 from the East Gaulish factory of Chémery-Faulquemont. There is a mould-stamp SATVRNFECIT (see no. S94 below) in the decoration and a fragmentary cursive signature below the decoration (see no. S146 below), from a mould signed before firing. Stamps of Saturninus i are often associated with signatures of Satto ii on moulds, but the signature here, ...fe, upside-down, does not seem to fit, to judge by the remaining letters. The decoration includes a scroll, with a putto (O.439 or 439A) and small rosettes. Trajanic or Hadrianic (area over Building 5, unstratified, J05:03). (Not illustrated.)
- D83. Form 37, East Gaulish (Trier). The decoration includes a medallion with dotted border (Fölzer 1913, Taf. XXXI, 830) and two blurred rosettes above the basal ridge. The medallion is on a stamped bowl of Censor ii from Bonn (*ibid.*, Taf. XVI, 12). Mid- to late-Antonine (area over *Via quintana*, unstratified, J12:01). (Not illustrated.)
- D84. Form 37, Central Gaulish. The ovolo (Rogers B147), zig-zag border (Rogers A26) and large striated spindle, impressed horizontally, were all used by Servus iv (S. & S.'s Servus 2). c. AD 160–200 (Road 3, J12:33).
- D85. Form 30, Central Gaulish, in the style of Do(v) eccus i, with his large beads (Rogers A3), ovolo Rogers B160 and panels: 1) a small double festoon with a bird (O.2298) over a tier of cups (Rogers Q49?, impressed sideways). 2) A beaded ring (Rogers E58?) in the top corner and, probably, a double medallion. The bird and columns are on a stamped bowl from London (S. & S. 1958, pl. 149, 31). c. AD 165–200 (area over Building 12 and Road 9, unstratified, J14:01).
- D86. Form 37, Central Gaulish. A bowl in the style of Banuus, with a blurred ovolo, leaf (Rogers H69) in the top part of a panel and a rosette (Rogers C165) at the top of a border. c. AD 160–200 (area over Gate 3 and *intervallum* road (Road 6), unstratified, J16:01). (Not illustrated.)
- D87. Form 37, East Gaulish. A cockerel (Ricken-Fischer 1963, T236) and rosette (*ibid.*, O49) were used at Rheinzaubern by Reginus vi. c. AD 160–180 (area over Gate 3 and *intervallum* road (Road 6), unstratified, J16:01). (Not illustrated.)
- D88. Form 37, Central Gaulish. A bowl in the later style of Geminus iv, characterised by beaded borders and six-petalled rosette junction-masks (Rogers C28). One panel is divided across the middle. The adjacent panel contains a Venus at an altar (D.184 = O.322) and a trifold motif (Rogers G112). All the details except for the figure are on a bowl in this style from Scole (Hartley and Dickinson 1977, fig. 71, D19). c. AD 130–145 (area of Gate 1, unstratified, K03:02).
- D89. Form 37, Central Gaulish. The ovolo (Rogers B18) was occasionally used by X–5. His characteristic striated spindle is across a wavy-line border which continues into the ovolo zone. One panel contains a boar (D.826 = O.1641). Cf. S. & S. 1958, pl. 67, 12. c. AD 125–140 (Gate 1, robber trench, K03:22).
- D90. Form 37, Central Gaulish. The greater part of the bowl, with ovolo Rogers B231 and panels: 1A) a sheep (O.1857A variant); 1B) Pan (D.419 = O.717). 2A) A double medallion; 2B) a saltire with acanthi (one of the series Rogers K16–36) in all four quadrants. 3) Minerva (D.77 = O.126), in a double arcade supported by pillars (Rogers P10). 4B) = 2B. 5) Scarf-dancer (D.217 = O.354). 6) ? 7) = 5, but in an arcade, as in 3). 8B) = 2B). 9) Pan, as in 1B). 10) = 2). 11) = 3). 12) = 2). 13) Two figures, one kneeling, the other standing (D.150 = O.238). The rosette junction-masks have twelve petals (Rogers C229). The style is that of the potter X–9, who supplied moulds to Medetus at Les Martres-de-Veyre and perhaps also at Lezoux. The micaceous fabric suggests that the bowl, at least, was made at Lezoux. Most of the details are on bowls in the 'Medetus-Ranto' style, from Cambridge and London (S. & S. 1958, pls. 30, 355 and 31 368). The bowl is mended with lead rivets and much of the external glaze has been removed, presumably by chemical action in the soil. c. AD 125–140 (Building 4, *contubernium* 9, K04:25).
- D91. Form 37, South Gaulish. The bowl has no ovolo, though it could have been removed when the rim was finished. There are at least three zones of decoration; the top one contains a Bacchus (Hermet 1934, pl. 19, 71) between vines, and a Pan (*ibid.*, 90); the next zone includes a chevron festoons with spirals, either in panels or separated by tassels; no decoration is visible in the third zone. The design is closely paralleled on a bowl from La Graufesenque with one of Germanus i's commoner ovolos (*ibid.*, pl. 100, 12). c. AD 70–90 (Building 16, floor, K07:08 (with more in Building 16, occupation/levelling, Period 3, K08:33).
- D92. Form 37, Central Gaulish. A bowl in the style of Criciro v, with a panel containing a double medallion, followed by a narrow panel with a caryatid (not closely identifiable), The panel borders are closed by Criciro's characteristic beaded rings (Rogers C125). c. AD 135–165 (Building 14, courtyard, K10:28).
- D93. Form 37, East Gaulish, in the style of Iulius viii (Ricken-Fischer 1963's Julius II) of Rheinzaubern. Two arcades, one containing a cockerel (*ibid.*, T239b)

- have a cross between them (*ibid.*, 053a) and rest on a support (*ibid.*, O182). The general arrangement is paralleled on a stamped Rheinzabern mould (Ricken 1948, Taf. 207, 9). Probably early third-century. *c.* AD 225–250 (area over Building 14 and *Via quintana*, unstratified, K12:01). (Not illustrated.)
- D94. Form 37, East Gaulish. The ovolo (Fölzer 1913, Taf. IX, 6F, reversed) is on a stamped mould of Criciro vii from Trier and a stamped bowl (unpublished) from Neuss. The arcade (*ibid.*, Taf. XXXI, 800) is on a bowl from Bad Godesberg (*ibid.*, Taf. XVI, 33), with Ipigenia inscribed retr. in the decoration, indicating the legend depicted. *c.* AD 190–210 (area over Building 14 and *Via quintana*, unstratified, K12:01).
- D95. Form 37, East Gaulish, in the style of Cerialis v of Rheinzabern, with ovolo Ricken-Fischer 1963, E44, fisherman (*ibid.*, M173) and tiers of acanthi (*ibid.*, P112). Cf. Ricken 1948, Taf. 54, 10. *c.* AD 160–180 (Building 12, unstratified, K14:01).
- D96. Form 37, Central Gaulish, with panels: 1) and 2) Venuses (D.193 = O.339 and D.173 = O.278). 3) A double medallion, containing an urn (Rogers T5). All the details are on stamped bowls of Iullinus ii (S. & S. 1958, pls. 125, 7, 2; 126, 11). *c.* AD 160–190 (area over Building 11, unstratified, K15:01).
- D97. Form 37, Rheinzabern ware, showing the upper concavity of a scroll, with a dolphin (Ricken-Fischer 1963, T194a), a sea-monster (*ibid.*, T183) and perhaps a dog to left. Both identified figures appear on 'Ware mit E8' (Ricken 1948, Taf. 165, 2). Late second century or first half of third century (area over Building 1, unstratified, L04:11). (Not illustrated.)
- D98. Form 37, South Gaulish, with a joining sherd in H13:24 and another in Q04:05. The panels show: 1) a Cupid (?) to right and a Bacchus with leopard (Hermet 1934, pl. 19, 71). 2) Repeated partial impressions of a four-bladed plant (a smaller version of *ibid.*, pl. 14, 49). 3) A Victory (*ibid.*, pl. 20, 102). The plants are repeated in another panel and one sherd has a Cupid to right. The mould was stamped and part of the stamp (illegible) remains below the decoration, as does part of a rosette. *c.* AD 90–110 (area over Building 2 and Alley 1, unstratified, L05:03).
- D99. Form 37, Central Gaulish, with a fourteen-petalled rosette (Rogers C243) over a double medallion containing a figure with raised left arm. The medallion and rosette are on a signed bowl of Acaunissa from Heerlen. *c.* AD 125–145 (area over Building 2 and Alley 1, unstratified, L05:03). (Not illustrated.)
- D100. Form 37, East Gaulish, with motifs used at La Madeleine and comprising an ovolo (Fölzer 1913, Taf. XXV, 119), a small medallion with corded outer border (*ibid.*, Taf. I, 42?) and a seven-beaded rosette (*ibid.*, Taf. XXV, 107). *c.* AD 130–160 (area over Building 16, unstratified, L07:01, 2454).
- D101. Form 37, East Gaulish. The scene, a grape-harvest, is common at Chémery-Faulquemont (Delort 1953, pls. 53–59), but the details, a grape basket, Cupid and six-beaded rosette in a basal wreath are not precisely paralleled on published bowls. Trajanic or Hadrianic (Building 16, L07:10).
- D102. Form 37, East Gaulish, abraded on the outside and with some of the glaze ground off on the inside. Trier ware, with decoration including a captive (O.1154) and two lions (O.1413). The decoration is closed by a double groove. The captive is on a bowl from Niederbieber (Oelmann 1914, Taf. VIII, 21); the lion is on a bowl from Zugmantel (Fölzer 1913, Taf. XIX, 1). The figure-types were used by more than one potter at Trier, which does not make dating easy, but the example from Niederbieber will not have reached the site before the late second century (Road 1, L08:63). (Not illustrated.)
- D103. Form 37, Central Gaulish. One panel has a double medallion (containing an eagle?) with beaded diagonals below, crossing at the groove below the decoration. Sherds in H15:03 and G09:01 may be from bowls by the same potter (Marcus v?). Late-Antonine (yard south of Building 13, L12:14; almost certainly from the same bowl as D79).
- D104. Form 30, with large label-stamp of Cinnamus ii, CINNAMII retr., (see no. S28 below), in a narrow panel. The next panel contains corner astragali and a double medallion with a scarf-dancer (D.220 = O.348). A third panel contains a candelabrum (Rogers Q43). *c.* AD 150–180 (area over Building 12, unstratified, L14:01, 1406). (Not illustrated.)
- D105. Form 37, East Gaulish, showing a chariot race. The *meta* (Ricken-Fischer 1963, 04) and *quadriga* (*ibid.*, M164) are both on bowls in the style of Cerialis vi from Rheinzabern (Ricken 1948, Taf. 65, 4 and 7). The ovolo is probably one of his (Ricken-Fischer 1963, E11?). *c.* AD 160–180 (area over Building 12, unstratified, L14:01).
- D106. Form 37, from the East Gaulish factory of La Madeleine. A figure with a staff (Ricken 1934, Taf. VII, 97) stands between medallions with beaded inner borders. The basal wreath consists of trifid motifs (*ibid.*, 11) between beaded borders. *c.* AD 130–160 (area over Building 12, unstratified, L14:02).
- D107. Form 37, Central Gaulish. The freestyle scene includes a lion (D.768 = O.1455), stag (D.860 = O.1732), bear (D.807 = O.1578), horse (D.906A = O.1911) and partly-impressed leaves (Rogers J146). All the details were used by Albucius ii, who often used the leaves as space-fillers. They occur, with the bear and horse, on a stamped bowl from London (S. & S. 1958, pl. 123, 42). *c.* AD 150–180 (Chalet 12, Building AJ, L14:10). (Not illustrated.)
- D108. Form 37, Central Gaulish. The ovolo (Rogers B157), double medallion and athlete (O.204) are on a stamped bowl of Banuus from Lezoux (Birley Collection). *c.* AD 160–190 (area over Building 12 and Alley 6, L15:01).
- D109. Form 37, Central Gaulish. The upper concavity of the scroll contains a leaf (Rogers H35?); the lower concavity has double medallion containing a bird (D.1010 = O.2316) hovering over an astragalus (Rogers R60), a horizontal column (Rogers P3), striated spindles and small rings. A bowl in the style of Paternus v (Rogers's Paternus II), with his characteristic spindles, but with a leaf apparently not attested for him, unless it is Rogers H29. A

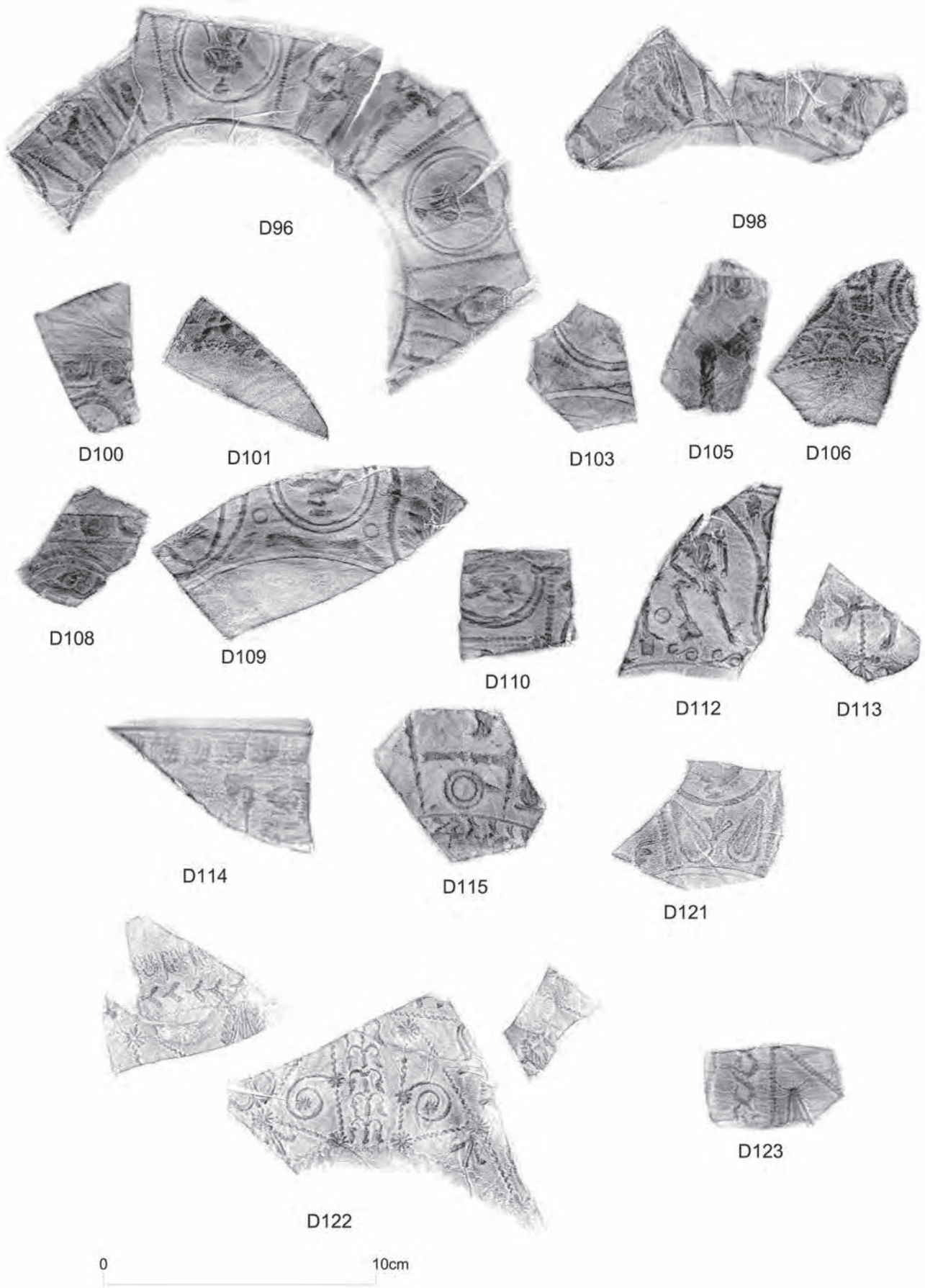

Figure 22.05: Decorated samian nos D96–D123. Scale 1:2.

- stamped Paternus bowl from Wels, with a rim-stamp of Sextus v, has a similar, if not identical, scroll (Karnitsch 1955, Taf. 4, 8). *c.* AD 160–195 (Building 11, *contubernium* 3/4, L15:18).
- D110. Form 37, Central Gaulish; a bowl in the style of Do(v)eccus i, with horizontal border of his large, square beads (Rogers A13) and vertical border of ovoid beads (Rogers A3). The upper part of one panel contains a hare (D.950a = O.2116) in a double festoon. The adjacent panel has corner astragali and a double medallion. *c.* AD 165–200 (area over Building 1 and Road 4, unstratified, M04:02).
- D111. Form 37, Central Gaulish. A bowl in the style of Cinnamus ii, with leaves in the upper concavity of a scroll (Rogers H101 and 13) and an erotic group (Oswald, pl. XC, B variant) in a double medallion in the lower concavity, probably over a dog (D.934 = O.1980?). *c.* AD 150–180 (Alley 1, upper layers, M05:12). (Not illustrated.)
- D112. Form 37, Central Gaulish. A bowl in the style of the Large S Potter. The lower concavity of a scroll contains a Neptune (D.14 = O.13) and Vulcan (D.39 = O.66) and the potter's characteristic S-motif. The upper concavity has a tendril and a partly-impressed acanthus (one of the series Rogers K16–35). *c.* AD 125–140 (Alley 1, lower levels, M05:16 (joining M05:12)).
- D113. Form 37, Central Gaulish. The panels include: 1) a slave or satyr (D.322 = O.591). 2) A seated Apollo (D.52 = O.83). The wavy-line border has astragali (Rogers R22) across it and a trifid motif at the bottom. The arrangement of the border, but with a trifid motif at the top, appears on a bowl from Chester in the style of Pugnus ii which Rogers's calls P-14. The Apollo is on another of his bowls, from Cardurnock. *c.* AD 130–150 (Building 13, east hypocaust, M12:58).
- D114. The East Gaulish (Rheinabern) form 37 has ovolo Ricken-Fischer 1963, E18, an Amazon (*ibid.*, M238a) and a bear (*ibid.*, T2). The bowl is not assignable to a particular potter, but the very deep plain band above the decoration suggests that it may be third-century (area over Building 12, unstratified, M14:01).
- D115. Form 37, Central Gaulish. A panel with astragalus borders (Rogers A10) contains a figure, separated from a small double medallion by a horizontal pillar (Rogers P3, misstamped). In the adjacent panel is a Pan standing on a mask (D.411 = O.709). The basal wreath consists of acanthi (Rogers K35). Cf. stamped bowls of Paternus v, from London (S. & S. 1958, pl. 105, 15) for the general arrangement and Carrawburgh (*ibid.*, 12) for the Pan. *c.* AD 160–195 (area over Building 12, unstratified, M14:08).
- D116. Form 37, East Gaulish, with triple-bordered ovolo above a straight line. Almost certainly Argonne ware, though no precise parallel has been found. Second half of the second century (area over Building 12, unstratified, M14:16). (Not illustrated.)
- D117. Form 37, with a freehand tree, as used at Rheinabern by Ianus ii and Cerialis v (Ricken 1948, Taf. 4, 7; 7, 2; 57, 1). *c.* AD 160–190 (Chalet 12, Building AL1, M14:39). (Not illustrated.)
- D118. Form 37, Central Gaulish, with a single-bordered ovolo (Rogers B28) and wavy-line borders. The panels include: 1) a seated figure (D.527 = O.913). 2) A stag (not in D. or O.), a seated doe (D.879 = O.1752A), a leafy spray and an eight-beaded rosette (Rogers C281). The basal wreath consists of trifid motifs (S. & S. 1958, fig. 17, 1). Quintilianus i is known to have used most of the details and the guide-lines enclosing the basal wreath make the attribution almost certain. *c.* AD 125–150 (area over Building 11 and *intervallum* road (Road 6), M16:01). (Not illustrated.)
- D119. Form 37, Central Gaulish, in the style of Criciro v, with panels: 1) a hare to right and acanthus-tips (from Rogers K2) in a double medallion, over a pair of birds looking back at each other (not closely identifiable). 2) A caryatid (D.656 = O.1199). Cf. S. & S. 1958, pl. 117, 7 for the birds, pl. 117, 4 for the caryatid and pl. 118, 19 for the acanthi. *c.* AD 135–165 (under phase 1 *intervallum* road surface (Road 4), N04:15).
- D120. Form 37, Central Gaulish, with panels: 1) Vulcan (D.39 = O.66). 2) A crouching lion (D.753 = O.1421) and athlete (D.403 = O.688). Both panels have striated spindles. The Vulcan and lion are on signed bowls of Arcanus from Rottenburg and Heilbronn-Böckingen, respectively (Knorr 1939, 166, 4 and 164, 1). The spindle is on a bowl probably in his style from Verulamium (Dickinson 1984, D49). The wavy-line border and rosettes are also typical of his bowls. *c.* AD 125–140 (Building 1, demolition, N05:04).
- D121. Form 37, Central Gaulish, with panels: 1) an acanthus (one of the series Rogers K16–35). 2) A bird (O.2250A) in a single festoon, over a trifid motif (Rogers G93?) between almond-shaped leaves (Rogers U161). The details are all on bowls in the style of Paternus iv, a Lezoux potter who signed moulds in the nominative. The bird and festoon are on a bowl from Burgh-by-Woodbridge, the leaves on one from Watercrock and the acanthus on one from Carlisle. *c.* AD 130–160 (Building 1, demolition, N05:04).
- D122. Form 37, Central Gaulish. A bowl in the style of Avitus iv, with ovolo Rogers B228 and wreath of bifid motifs (Rogers G303) over a guide-line. A panelled zone consists of alternating saltires and vertical series of anchors (Rogers G395). The saltires are generally the same, with trifid motifs at the bottom (Rogers G32), spirals at the sides, attached to the borders by nine-petalled rosettes, and eleven-petalled rosettes (Rogers G227) in the centre, but some have leaves (Rogers J10) in the top and others have a Pan-mask (D.675 = O.1214). Below the decoration is a row of beads, on a guide-line. A small, S-shaped gadroon (Rogers U154) probably occurs with a Pan-mask. Perhaps from the same mould as a bowl from Gaul (S. & S. 1958, pl. 63, II). *c.* AD 125–140 (Alley 1, dump of demolition material, N05:23; with a sherd in N14:23 (Chalet 12, Building AM2)).
- D123. Form 37, Central Gaulish. A saltire has almond-shaped leaves at the sides (Rogers U161). The adjacent panel has a 'twist', impressed vertically (Rogers U103, repeated). Both are on a bowl from

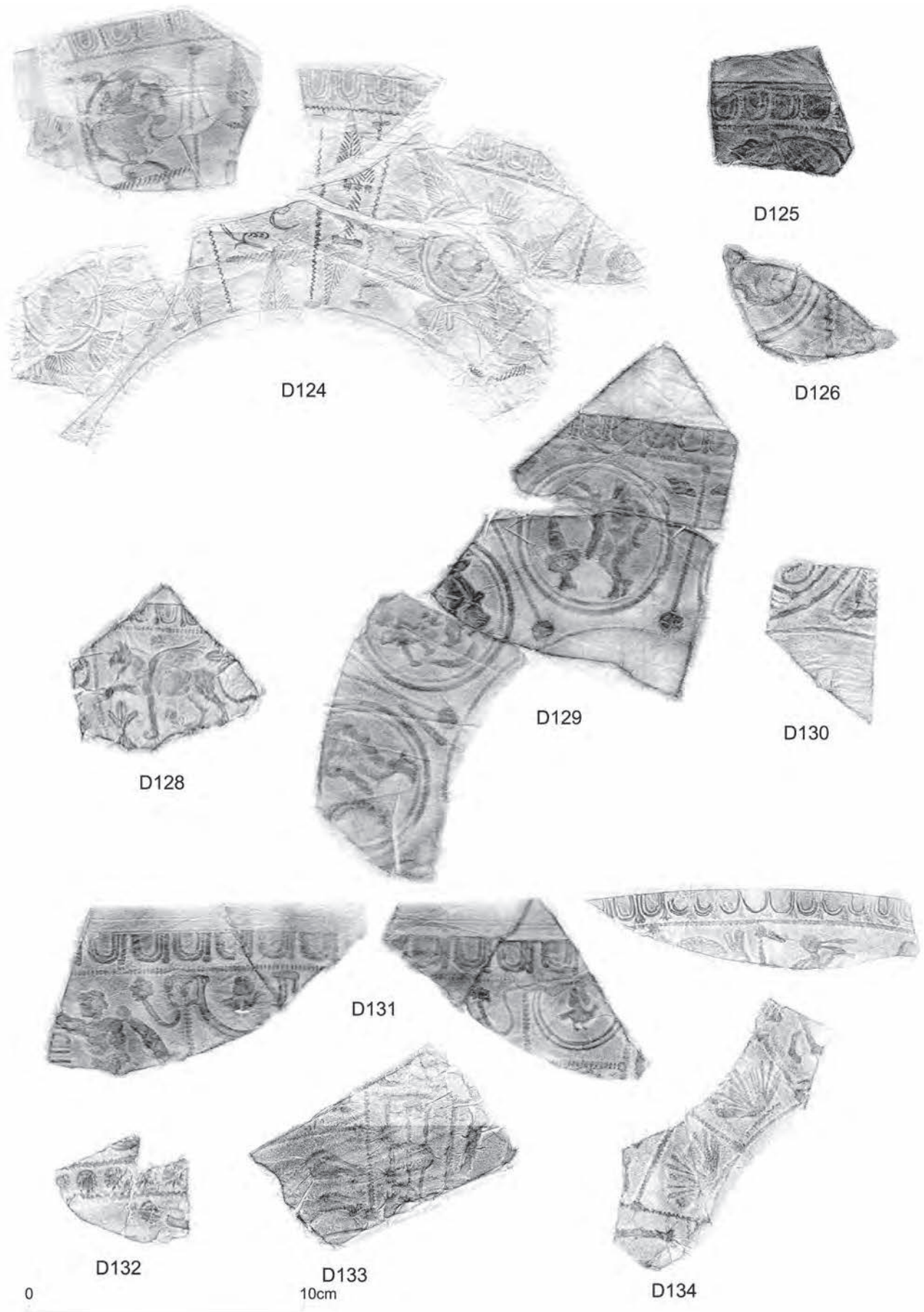

Figure 22.06: Decorated samian nos D124–D134. Scale 1:2.

- Watercreek (Wild 1979, 287, 76) in the style of Paternus iv, who signed moulds in the nominative. c. AD 130–155 (Alley 1, dump of demolition material, N05:23).
- D124. Form 37, Central Gaulish. A bowl in the style of X-5, with his ovolo (Rogers B31) and striated spindles. The panels contain: 1) triangular leaves (Rogers J33), joined by an astragalus. 2) A vine-scroll (Rogers M10) and the leaf again, separated by a striated spindle. 3) = 1). 4) a mask in a double medallion, surrounded by the leaves, alternating with fan-shaped motifs (Rogers G17). 5) = 1). Panels 4 and 5 are on one of X-5's bowls from London (BM M1374). Panel 4, without the mask, is on a bowl from Camelon (1970s excavations) and the mask, medallion, leaf and spindle are on a bowl from Wels (Karnitsch 1959, Taf. 32, 2). Grooved for mending. c. AD 125–140 (Building 3, *contubernium* 2, N07:15, 2608).
- D125. Form 37, Central Gaulish, The ovolo (Rogers B47) is on a signed bowl of Criciro v from Corbridge (S. & S. 1958, pl. 117, 1). No parallels have been found for the leaf in the scroll. c. AD 135–165 (area over Building 13, unstratified, N11:01).
- D126. Form 37, Central Gaulish. One panel includes a leafy spray (Rogers H118) in a double medallion or festoon and a blob in the space below. The adjacent panel contains a column (Rogers P31). Servus iv (S. & S.'s Servus 2) used the zig-zag border (Rogers A26) and the festoon/medallion, but no other close parallels have been found. Mid- to late-Antonine (area over Building 13, unstratified, N11:01).
- D127. A fragment from a Central Gaulish 'black samian' jar (form 68 etc.). The moulded decoration includes a leaf (Rogers J148) and a double medallion. Cf. Bémont 1977, pl. XXXVIII, PM314. Antonine (Building 13, room 7, N12:38). (Not illustrated.)
- D128. Form 37, Central Gaulish, with another sherd in N14:11. One sherd shows a Hercules with snakes (D.464 = O.783, but the snake in the left hand has a broken tail) and an adjacent panel with a griffin (not in D. or O.), trifold motifs (Rogers G89) and leaf-tips (from Rogers J122?). The other sherd has a kilted man holding a staff which appears at the far side of the panel border. The second panel also has the trifold motif. The ovolo (Rogers B185 = B205) was used by Attianus ii and Drusus ii and occurs, together with the trifold motif, on a signed bowl of Drusus from Doncaster (Dickinson 1986a, fig. 31, 33). The leaf-tip is on his signed bowl from Asberg (Vanderhoeven 1974, Taf. 2, 14). None of the figure-types is attested for either potter, but the evidence of the motifs suggests a date c. AD 125–145 (area over Building 12, unstratified, N14:01).
- D129. Form 37, with stamp of Clemens iii of Lezoux, CLEMENS or CLEMENTS (NT ligatured), retrograde, in the decoration (see no. S31 below). The two repeated panels include: 1) a cup (Rogers T3) and Apollo (D.55 = O.92, without mask) in a double medallion and lozenges (Rogers U30?) in the upper corners. 2) As 1), but with the medallion containing a putto(?), seated Cupid (D.259 = O.443B), leafy spray (Rogers J177) and another motif above the figures. The rosette junction-masks are perhaps Rogers C171. The ovolo (Rogers B103) was mainly used by Advocisus, with whom Clemens may have been associated. c. AD 160–190 (Chalet 12, Building AM2, N14:02; with joining sherds in M14:01 (area over Building 13, unstratified) and N14:01 (area over Building 12, unstratified), 1885).
- D130. Form 37, Central Gaulish, with a scroll involving striated spindles, in the manner of the Sacer i-Attianus ii group (S. & S. 1958, pl. 83). Traces of a T upside-down below the decoration, as perhaps in OF.ATT retr., suggest that the bowl is by Attianus. It was made in a cracked mould. c. AD 125–145 (area over Alley 6, unstratified, N15:01).
- D131. Form 30, with Cinnamus ii's common label-stamp, CI[NNAMI] retrograde (see no. S29 below), in a panel with an athlete (D.384 = O.652) and a corner-tendrill with a polygonal leaf. The top of the adjacent panel contains a bird (O.2317) in a double festoon. The ovolo is his no. 1 (Rogers B223). The leaf-tendrill, not common in his work, tends to appear on bowls with this ovolo and large figure-types, eg. Juhász 1935, Taf. III, 1, VIII 29 and IX, 21, from Brigetio. c. AD 150–180 (Chalet 12, Building AL2, N15:12; with a sherd from Building 12, chalet am, unstratified, M14:23 and a sherd from the 1988 excavations, context 8424 (*contubernium* 10, Period 2/3 occupation).
- D132. Form 37, South Gaulish. The granular, orange-brown fabric and coarse cable borders suggest second-century Montans ware, though no exact parallels have been found for the decoration. The rosettes in the central wreath and in the zone below are apparently made up of repeated impressions of a ram's-horn motif. There may be a mould-stamp in the lowest of the three surviving zones. c. AD 115–145? (*intervallum* drain near Building 13, P12:08; joining L13:21 (Building AZ, robber trench)).
- D133. Form 37, Central Gaulish, has ovolo Rogers B18 and panels: 1A) a grass-tuft (Rogers L19); 1B) bears (D.818 bis = 0.1616, over D.820 = 0.1627). 2A) a hare to left (D.950a = O.2116); 2B) a tripod (Rogers Q14). 3) A man with a staff (D.623 = 0.167). The rosette junction-masks probably consist of eight beads. Most of the details can be found on bowls in the so-called Ioenalis and Donnaucus styles at Les Martres-de-Veyre, and it is possible that the mould was made there, though the bowl itself is in Lezoux fabric. c. AD 125–140 (area over *intervallum* road (Road 4), unstratified, Q04:01).
- D134. Form 37, South Gaulish, with sherds in Q04:01 (joining) and N05:04 (Building 1, demolition). The trident-tongued ovolo was used at La Graufesenque by Albanus iii, G. At- Pas--, Bassinus i, Litugenus i and a potter whose name begins in Mas--. The panels include: 1A) a hare to right (D.941 = O.2056); 1B) probably = 3B). 2) An erotic group (Oswald, pl. XC, A, with the female figure using a pillar as a support) and a dagger-like motif, attached to the top of the border by a rosette. 3A) A hare to left (D.949 = O.2114); 3B) a fan-shaped plant (three impressions of a smaller version of the motif Hermet 1934, pl. 14, 49) over a wavy line. 4B) = 3B. 5) = 1). The erotic group and the hares are on a

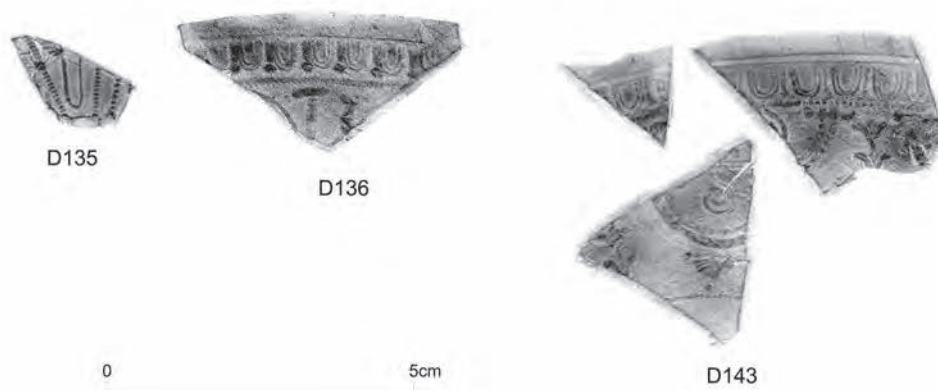

Figure 22.07: Decorated samian nos D135–D143. Scale 1:2.

bowl from the Bregenz Cellar hoard (Jacobs 1912, no. 11) and the hares recur on a stamped bowl of Biragillus i from Riegel (Knorr 1907, Taf. XV, 5). c. AD 90–110 (Rampart building (F2), unsealed rampart material, Q04:05).

- D135. Form 37, from Les Martres-de-Veyre. The beaded borders and the leaves in the side quadrants of a saltire (Rogers J127) suggest that the mould was made by X-13; cf. form 30 from Brecon (S. & S. 1958, pl. 49, 588). c. AD 100–120 (pit in Road 4, Q04:12, probably with a sherd in the area over the East rampart, unstratified, Q05:01).
- D136. Form 37, Central Gaulish, drilled for mending. The ovolo, single medallion in one panel and slave or satyr (D.374 = O.647) in the next are all on bowls from Lezoux in the style of Austrus. c. AD 125–140 (pit in Road 4, Q04:15).
- D137. Form 37, Central Gaulish. The single-bordered ovolo (Rogers B28), with guide-line below, and small double medallion suggest the work of Quintilianus i (cf. S. & S. 1958, pl. 70, 9, from Birdoswald). c. AD 125–150 (pit in Road 4, Q04:15). (Not illustrated.)
- D138. Form 37, Central Gaulish, by Cerialis ii or an associate, with his characteristic bud in the decoration (Rogers J178, partly impressed), together with a Hercules and lion (D.467 = O.785). c. AD 135–170 (area over East rampart, unstratified, Q05:02). (Not illustrated.)
- D139. Form 37, Central Gaulish. The ovolo (Rogers B233) was used by potters such as Pugnus ii and X-6. The sherd may have been shaped as a counter. c. AD 125–150 (Building 1, officer's quarters, Q05:17). (Not illustrated.)
- D140. Form 37, Central Gaulish. The ovolo (Rogers B76) and zig-zag border are on a bowl from Gloucester (unpublished) in the style of Arcanus. An animal to left is perhaps the lion D.753 = O.1421 (but with the broken tail replaced, freehand), which appears on a signed bowl from Heilbronn-Böckingen (S. & S. 1958, pl. 78, 7). The partly-impressed acanthi in the field are on a bowl in his style from Cannstatt (*ibid.*, 6). c. AD 125–140 (Building 1, verandah, Q05:25). (Not illustrated.)
- D141. Form 37, Central Gaulish, with panels: 1) a saltire, with leaves (Rogers J50?) at the sides. 2) A slave

with a basket (D.321 = O.595). 3) A sea-creature? The horizontal astragali, while not exactly paralleled, suggest a connection with potters such as Pugnus ii, Tittius or X-6. c. AD 125–150 (Building 1, officer's quarters, Q05:34).

- D142. Form 30, Central Gaulish. An Apollo (D.52 = O.83) and ring, in a panel with a zig-zag border, are on a signed bowl of Arcanus from Rottenburg (S. & S. 1958, pl. 78, 1). c. AD 125–140 (area over Buildings 3 and 16, unstratified, Q08:05, 2512). (Not illustrated.)
- D143. Form 37, East Gaulish (La Madeleine). The decoration includes the ovolo (Fölzer 1913, Taf. 25, 119?) and chevron festoons (*ibid.*, 111), containing spirals and with series of trifold motifs between (*ibid.*, 76?) and acanthi below (*ibid.*, 74). The decoration is closed by a bead-row. c. AD 130–160 (Feature 2, post-Roman dereliction, Q08:11, 2595).
- D144. Form 37, Central Gaulish. The Pan (D.411 = O.709), in a panel with a vertical border of squarish beads, suggests the work of Paternus v. c. AD 160–195 (drain east of Building 3, Period 3, Q08:18, 2591).

The potter's stamps

Each entry gives: context number, potter (i, ii, etc., where homonyms are involved, die number, form, reading of the stamp, published example (if any), pottery of origin, discussion, date.

(a), (b) and (c) indicate:

- (a) Stamp attested at the pottery in question.
 (b) Potter, but not the particular stamp, attested at the pottery in question.
 (c) Assigned to the pottery on the evidence of fabric, distribution and, or, form.

Ligatured letters are underlined>.

- S1. Advocisus 8a 37 [A]DVOCII[SI] (S. & S. 1958, pl. 169) Lezoux (a). Decorated bowls with this stamp occur elsewhere on Hadrian's Wall and at some of the Hinterland forts which were reoccupied c. AD 160. There are also three examples from the Wroxeter forum destruction. c. AD 160–190 (Cistern 1, fill, E08:29, 2305).

- S2. Aestivus 2a 31 [AII]TIVI:M Lezoux (b). There are several examples of this stamp in the group of late-Antonine samian recovered off Pudding Pan Rock. It was used on forms not normally made before AD 160, such as 31R and Ludowici Tg. c. AD 160–190 (area over Building 5 and Alley 4, unstratified, H05:01).
- S3. Aestivus 3c 31 AESTIVIM (Walke 1965, Taf. 40, 53) Lezoux (a). A stamp noted at Binchester and Haltonchesters. It comes from one of his later dies, to judge by many examples on form 31R and a few on form 79, though his occasional use of other stamps on form 27 suggests that he was at work by AD 160. c. AD 160–185 (rubble over west *praetentura*, H04:18, 783).
- S4. Albillus i 1b 18/31–31 ALBI[KKI MA] Lezoux (b). One of Albillus's less-common stamps, without internal dating. His site record in general, including Chesters, Chesterholm, Corbridge (in a late-Antonine pottery store) and Ilkley, and his use of form 18/31R suggest a range c. AD 155–185 (Alley 3, F04:33, 572).
- S5. Albusa 1a 33 [Δ]LBVSA (Dickinson 1986b, 187, 3.11) Lezoux (a). This stamp has been found in late-Antonine groups at Lezoux, and on forms 31R and 79. There are two examples from South Shields. c. AD 170–200 (Chalet 12, Building AM2, M14:45, 1891).
- S6. Amando 1b 33 AMANDO Banassac (b). No other examples of this stamp have been noted so far. Apart from four stamps from London (from a different die, and perhaps all part of a single consignment), Amando is otherwise known only at Banassac. This source suggests that the Wallsend piece is Hadrianic, rather than later (levelling north of Buildings Q and R, F11:13, 1148).
- S7. Ambitotus 1a 18/31 AMBITOTVMA Lezoux (a). There are many examples of this stamp in a group of burnt samian of c. AD 140–150 from Castleford, mostly on form 18/31R, but also on forms 18/31 and 81 (Rush *et al* 2000, fig. 29, nos 563–75). It occurs also on the outsize variant of form 33 which was occasionally made at Lezoux in the Hadrianic and early-Antonine periods. c. AD 125–150 (Alley 5, F14:14, 1133).
- S8. Annus ii 4a 18/31R AN[NIVSF] Annus ii worked at both Les Martres-de-Veyre and Lezoux, but there is no evidence that this stamp was used at Les Martres and the Wallsend piece is certainly in Lezoux fabric. The stamp occurs in period IIC at Verulamium (c. AD 140–150: Hartley 1972a, S112) and at Birdoswald, where it will belong to the Hadrianic occupation. c. AD 130–150 (Building 7, west granary, F11:12, 956).
- S9. Asiaticus 3a 31 ASIA[TICIO] Lezoux (b). This potter's stamps appear on some of the later Antonine forms, such as 80 and Ludowici Tg/Tx. This particular stamp was used on form 79. His site record includes Catterick and South Shields. c. AD 160–190 (area over Building 9, unstratified, F13:04, 2643).
- S10. Atilianus i 5d 33 [Δ]TILIANI[M] Lezoux (b). One of Atilianus i's less-common stamps, noted twice more on form 33 and once on form 31R. His output also includes forms 79, 79R, 80 and Ludowici Tg and stamps from one of his other dies occur in the Pudding Pan Rock wreck, c. AD 160–200 (Chalet 9, robbing and post-Roman dereliction, G13:03, 1012).
- S11. Aurelius ii 1a 31R [Δ]VRIKIM Lezoux (c). No other examples of this stamp have been noted by us, but the form of the vessel suggests mid- to late-Antonine date (Alley 7, K12:22).
- S12. Aventinus ii 1a 31 [AVENT]TINI·M (Durand-Lefebvre 1963, 36, 113) Lezoux (a). This appears on the rims of decorated bowls by early- to mid-Antonine Lezoux potters, but also on plain ware in a group of Antonine burnt samian from Aquincum, presumably destroyed in the Marcomannic Wars. c. AD 150–180 (*intervallum* drain near Building 13, P12:08, 1775).
- S13. Avitus iv 11a 33 AV[IF] Lezoux (b). This potter's decorated bowls are mainly Hadrianic, but his plain ware is common in Antonine Scotland. His output consists largely of forms 18/31 and 27, and so he is unlikely to have been at work after the middle of the second century. c. AD 125–150 (area over Building 2 and Alley 1, unstratified, M05:04, 29).
- S14. Banuus 1a 37 BANVI, retr. (S. & S. 1958, pl. 169) Lezoux (a). Decorated bowls with this stamp occur at forts in northern Britain reoccupied c. AD 160, such as Carrawburgh and Chesterholm. There is also one from the Brougham cemetery, where most of the samian is late-Antonine. c. AD 175–250 (Cistern 1, lower fill, E08:44, 2402 and 2393; upper fill, E08:27, 2365).
- S15. Belsus 1a 31 B[EL]SVS[HE] (Ludowici 1927, 210, a) Rheinzabern (a). A stamp noted on decorated bowls of the later second century and on a variety of plain forms, including 32 and 79. c. AD 175–200 (Building 8, cess pit, D12:34, 1205).
- S16. Belsus 3b 37 [BE]LSVSF, retr. (Ludowici 1927, 239, a) Rheinzabern (a). This stamp appears mainly on decorated bowls, but has also been noted on forms 31, 32, 40 and Ludowici RSc. c. AD 175–200 (area over Building 10, unstratified, D14:01).
- S17. Biturix 1d 81 (stamped on the collar) BITVRIX[F] Lezoux (b). The occurrence of Biturix's wares in the Rhineland suggests that he worked in the first half of the second century. This is supported by the use of this particular stamp on forms 18/31R, 27 and the Hadrianic and early-Antonine variant of form 33. c. AD 125–150 (Building 3, *contubernium* 2, N07:14, 2607).
- S18. Bonoxus 3c 18/31 :BOIXS·F: Lezoux (b). This is noted only on forms 18/31, 18/31R and 27, all made in the Hadrianic and early-Antonine periods. One example comes from the Saalburg Erdkastell (before c. AD 139: Hartley 1970, 26.15). c. AD 125–150 (Alley 3, F04:12, 356).
- S19. Bracisilus 4a 31 BRACI[ILV] Lavoye (b), Avocourt (b). The only dating evidence for Bracisilus comes from his forms. This particular stamp appears on forms 27, 32, 79 and 80R; another is on form 40. His use of form 27 suggests activity by the early-Antonine period, at the latest, though he was clearly still at work after AD 160. c. AD 140–170? (Building 7, east wall robber trench, H09:18).

- S20. Cadgatis 6b 33 CADGATIS, retr., Lezoux (b). No other examples of this stamp are known to us. Cadgatis's stamps occur on Hadrian's Wall and in Antonine Scotland and one appears on the rim of a stamped, decorated bowl of Albucius ii, from Bregenz. His plain forms include 27 and 31R. c. AD 145–175 (area over Building 12, unstratified, L14:01, 1403).
- S21. Calava 2b 18/31 [CA]KAVA·F Lezoux (a). The forms on which this stamp appears include 18/31R, 27 and 31. It occurs in the Rhineland (presumably before c. AD 150), at Chesters and probably at Camelon. There are 11 examples from a pottery shop at Castleford destroyed by fire in the 140s (Rush *et al* 2000, fig. 29, nos 601–11). c. AD 125–150 (Alley 3, F04:33, 556).
- S22. Calendio 2a 31 [CALEVD]IO Lezoux (a). Some of Calendio's stamps occur on the rims of decorated bowls by both Hadrianic and early- to mid-Antonine potters, such as Sacer i/Docilis i, the Large S Potter, Laxtucissa and Cinnamus ii. This particular stamp, used only on plain ware, appears more often on forms made before AD 160 than later, but there is one example on form 79. c. AD 140–170 (Building 2, *contubernium* 8, L05:25, 840).
- S23. Caletus 2a 33 CAL·E[TIM] Lezoux (a). A stamp noted in groups of late-Antonine samian from Pudding Pan Rock and London (Dickinson 1986b, 187, 3.24). Examples are also noted from Bainbridge, Catterick and Malton. c. AD170–200 (area over Tower 1, unstratified, H03:03, 736).
- S24. Camulinus 2a 31 CAMVK INI Lezoux (a). A stamp of a minor Lezoux potter, noted from Chesters and South Shields and on forms 15/31, 31R and 79 or Tg. c. AD 150–190 (Road 1, E07:12, 2352).
- S25. Carussa 3a 33 CA·RVSSA (Dickinson 1986b, 188, 3.28) Lezoux (a). Two faint horizontal lines at the end of this stamp suggest that CARVSSAF may have been intended. All the evidence suggests that the die was not in use before c. AD 160. Examples are noted from Catterick, Chesterholm, Haltonchesters and South Shields and on forms 31R and 79. c. AD 160–190 (rubble west of Building 5, dereliction, E05:04, 153).
- S26. Celsianus 2a 38 CELSIANI·MA Lezoux (a). A stamp used on some of the later Antonine forms, such as 31R, 79R and 80. c. AD 160–190 (Cistern 1, fill, E08:29, 2360).
- S27. Cerotcus 1a 31 CE[ROTC]IM Lezoux (a). The record for this uncommon stamp offers no close dating evidence, but the form and fabric of the Wallsend piece are Antonine (Building BJ, G11:03, 1079).
- S28–9. Cinnamus ii 5b 30 (2) [CI]NNAM[I]; CI[, retr. (Walke 1965, Taf. 39, 11) Lezoux (a). The commonest of Cinnamus's stamps on decorated ware, with many examples from both Hadrian's Wall and Antonine Scotland, though with slightly more from Scotland. c. AD 150–180 (area over Building 12, unstratified, L14:01, 1406; Chalet 12, Building AM, post-Roman robbing, M14:23).
- S30–31. Clemens iii 1a 37; 33 CLEM..., retr., CLEMENTS (S. & S. 1990, pl. 174, 3) Lezoux (a). This stamp is known from Benwell and Catterick. It occurs on form 79 and, sometimes, on decorated moulds which also have stamps of Priscus iii. Both potters are connected stylistically with Advocisus. c. AD 160–190 (Area over *Via quintana*, unstratified, G12:01, 1007; Chalet 12, Building AM2, N14:02; with joining sherds in M14:01 (area over Building 13, unstratified) and N14:01 (area over Building 12, unstratified), 1885).
- S32. Cobnertus iv 4a 37 [COBNERT]VSF (Ludowici 1927, 240, a) Rheinzabern (a). This mould-stamp of one of the earlier Rheinzabern potters to export to Britain is known on decorated bowls from Benwell, Bowness-on-Solway, Haltonchesters and Stanwix. Most significantly, it occurs at the timber fort at Iza, Slovakia, destroyed in AD 170/175 (information from Dr Klara Kuzmová). It was sometimes used to stamp the rims of bowls by Reginus vi, who started his career at Heiligenberg, before moving to Rheinzabern. c. AD 160–190 (area over Buildings Q and R, unstratified, F12:01, 1104).
- S33. Conatius 3a 31 CONATIVSF (Ludowici 1927, 212, a) Rheinzabern (a). This was used on some of the later Rheinzabern forms such as 31 (Sa), 31R (Sb), 32, 32R and Ludowici Tb. The glaze is ground off under the base. Late second century or first half of third century (area over Alley 4, unstratified, F05:01, 141).
- S34. Cottalus 1a 32 etc. COTTAL[VSFE] (Karnitsch 1960, 136) Rheinzabern (b). A stamp noted twice from Regensburg, once from the fortress, founded in the late second century, and once from the Kumpfmühl, where it may possibly read COTTALVSFEC (museum no. A2373). It is also known on form 32. Late second century or first half of third century (area over Building 10 and Road 6, unstratified, G12:15, 1183).
- S35. Crucuro ii(?) Uncertain 1 18/31 JVRON·O Lezoux (c). The form and fabric of this dish are Hadrianic or early-Antonine, which would be consistent with Crucuro ii's output of forms 18/31, 18/31R and 27, among others. c. AD 125–150 (Building 9, *contubernium* 2, E13:13, 1134).
- S36. Dagodubnus ii 1a 33 [DAGOD]VBNVSF (Ludowici 1927, 213) Rheinzabern (a). This was apparently only used on cups of form 33. Examples are noted from Bainbridge and Housesteads. The forms and fabrics suggest mid- to late-Antonine date (Alley 10/Building 17 road surface, third century, E04:10, 418).
- S37. Dagomarus 11a 18/31 DAGO[MARI] Lezoux (c). Dagomarus worked at Les Martres-de-Veyre under Trajan and later at Lezoux. This stamp is from a die probably used only at Lezoux. It occurs in the Rhineland, in a pottery shop at Castleford destroyed in the 140s (Rush *et al* 2000, fig. 29, nos 631–2), at South Shields and in a tumulus at Helsoven, Belgium, with stamps of late-Hadrianic and early-Antonine potters (Roosens 1976, Taf. 1). c. AD 125–145 (Building 1, demolition/make-up, P05:08, 280, WSP281).
- S38. Divicatus 3b 18/31 or 31 [DIVIC]ATVS Lezoux (a). A stamp used on forms 18/31, 27 and 38, suggesting that it was current in the Hadrianic or early-Antonine periods. Further evidence of this is its occurrence in the Rhineland, where Lezoux

- ware was rarely, if ever, marketed after c. AD 150. An example from the *vicus* at Malton is almost certainly Hadrianic. c. AD 140–155 (area over Building 9, unstratified, E13:28, 1482).
- S39. Do(v)eccus i 11b 31 DO[VIICCVS] Lezoux (b). This was used on forms 31R and 79. It occurs at Malton and in a late-Antonine group from London (Dickinson 1986b, 189, 3.47). c. AD 165–200 (area over Building 14 and Road 3, unstratified, J12:05).
- S40. Do(v)eccus i 11e 31R DOVIICCVS Lezoux (b). There are two examples of this stamp from Housesteads and another from Malton. c. AD 165–200 (from 'Town Hall' collection).
- S41. Do(v)eccus i 13a 31 DOIICCVS (S. & S. 1958, pl. 147, 2) Lezoux (b). This occurs at Benwell (2), Haltonchesters (2) and in late-Antonine burials at the Brougham cemetery. c. AD 165–200 (area over Building 12, unstratified, L14:01, 1404).
- S42. Falana la 27 ΜΚΛΛΛΑ retr. Lezoux (c). Stamps from this die in the Rhineland suggest that the potter was at work before the middle of the second century. One example, from the Saalburg Erdkastell (Hartley 1970, 26, 46), will be earlier than c. AD 139. c. AD 125–150 (dereliction over Alley 1, L05:29, 861).
- S43. Faventinus ii 2a 31R [FAVEN]TINVS (Ludowici 1927, 214, a) Rheinzabern (a). Faventinus is not well dated, but examples of this stamp on forms 32 and Ludowici Se suggest that he may still have been at work in the third century. Late second century or first half of third century (Chalet 10, post-Roman dereliction, F15:06, 1454).
- S44. Fidelis ii 2a 32 etc. [FIDI]LISFE (Ludowici 1927, 214, a) Rheinzabern (a). Stamps from this die occur at Malton (2) and an early third-century group from London (Dickinson 1986b, 189, 3.51). It was used on forms 31R and 32R. Late second century or first half of the third century (Building 16, floor, K07:08).
- S45. Florus vi 2a 31R FLORV2 Trier (c). There is no internal dating for this stamp, but one of his others comes from the late second-century foundation of Niederbieber. Late second- or first half of the third century (from collection in Great North Museum: Hancock, Newcastle).
- S46. Geamillus ii la 33 GIAM[ILLIOF] Lezoux (a). Very few stamps have been recorded for this potter and they all come from the same die. His forms include 79 and 79/80. Mid- to late-Antonine (area over *Via quintana*, unstratified, D12:01).
- S47. Gemenia la 33 GIIMIINIA Lezoux (c). The use of this stamp on forms 79R and 80 suggests a date c. A. D. 160–200 (Feature 2, post-Roman dereliction, Q08:11, 2569).
- S48. Geminus v 1a 18/31 or 31 GE[MINI] (ORL B2a, 15, 7) La Madeleine (b). This stamp occurs on form 18/31R, including one from South Shields, and on unrouletted dishes which are closer to form 18/31 than to 31. c. AD 130–155 (Building 1, floor, M05:25).
- S49–50. Genitor ii 5a 33; 31R G·E·N·I·T·O·R·F, ·G·E·N[Lezoux (a). This occurs in a late second-century group from London (Dickinson 1986b, 189, 3.54). It appears elsewhere on form 31R. c. AD 160–190 (area over West rampart and gate, unstratified, D08:11, 2257; Cistern 1, rubble, E08:45, 2439).
- S51. Giamillus iv la 31 [GI]MILLVS Rheinzabern (Ludowici 1927, 216). The potter's output seems to have consisted mainly of forms 31 and 33, though one form Ludowici Tp has been noted. The absence of any of the later Rheinzabern forms may mean that he was not at work in the third century. Mid- to late-Antonine? (Road 3, G12:02, 1008).
- S52. Indercillus 2a 33 INDERCILLI Lezoux (c). An Indercillus, perhaps this potter, worked at Les Martres-de-Veyre under Trajan, but this stamp seems to have been used only at Lezoux, to judge by the associated fabrics. There are two examples from Catterick and one from Chesterholm. c. AD 125–140 (area over Building 3 and Alley 2, unstratified, N07:01, 2458).
- S53. Iulius Numidus 4a 80 or Ludowici Tx [NVM] DIMA Lezoux (a). A stamp used on forms 31R and 79. It occurs at Benwell and in a late-Antonine group from London (Dickinson 1986b, 190, 3.68). c. AD 160–200 (area over Building 15, unstratified, J07:01).
- S54. Lupinus 3a 33 (slightly burnt) LVPINIM Lezoux (a). Lupinus's stamps appear on mid- to late-Antonine forms; 3a is on form 79/80, others occur on forms 15/31R, 31R and 80. c. AD 155–185 (area over Building 1, unstratified, L04:01, 701).
- S55. Macrinus ii 2f 27 [MAC]RINI Lezoux (b). This is one of the less-common stamps of the earlier Lezoux Macrinus, whose output consists mainly of forms 18/31 and 27. His signature is also on a form 29 mould which can scarcely be later than the Hadrianic period. His site record includes Birdoswald (from the lowest level of the Alley), Bearsden and Corbridge. c. AD 125–150 (area over East rampart, unstratified, R05:?).
- S56. Maia...? la 33 MAIAI Lezoux (c). This fairly common stamp may be illiterate, but could equally well belong to a potter whose name is Maia, or begins in Maia... The associated forms and fabrics and examples from Bainbridge and Catterick suggest mid- to late-Antonine date (area over Road 8, unstratified, F09:01, 2195).
- S57. Maior i 9e or 9e' 31 M[AIORIM] OR M[AI OIIM] Vichy (Terre-Franche) (a), Lezoux (b). Later impressions of this stamp have a faint vertical stroke between O and R, as if from a crack in the die. This version appears on form 31R from Ilkley and Catterick and form 31 from Bainbridge. There is no site dating for the original impression, but it is unlikely to be earlier than AD 160, when Maior's general record is taken into account. The fabric of the Wallsend piece belongs to the Lezoux range. c. AD 160–200 (area over Building 1 and *intervallum* road (Road 4), unstratified, M04:01, 11).
- S58. Malledo 2a 31 M[ALLEDO·F] Lezoux (a). Malledo's stamps turn up on forms made at Lezoux in the later second century, such as 31R and 80, both of which occur with Die 3a. c. AD 160–190 (area over Building 10 and Road 9, unstratified, H15:01).
- S59. Malledo 4a 33 MALLEDVF Lezoux (a). A stamp used on forms 79, 80 and Ludowici Tx. c. AD 160–190 (from 'Town Hall' collection).

- S60. Malluro i 3b 18/31 MALLVRO·F Lezoux (a). Much of Malluro's output consists of forms not made much after the middle of the second century, but Oswald (1931, 181) notes form 79 from Cirencester and there are other reports of single examples of forms 80 and Ludowici Tg. This presumably means that he was at work after AD160, though Die 3b, used mainly on forms 18/31 and 27 and noted on form 42, is unlikely to have survived so long and the Wallsend dish, with its shallow wall, is almost certainly Hadrianic or very early-Antonine. A graffito, Flavini, is inscribed under the base, after firing. *c.* AD130–140 (Alley 2, dereliction, N08:44, 2627).
- S61. Marcellinus ii 2a 31R [MA]RCELLINI·F. (Dickinson 1986b, 191, 3.93). Examples of this stamp occur in a kiln-dump of late-Antonine wasters at Lezoux and, twice, in the group of samian from Pudding Pan Rock. *c.* AD160–200 (Building S, robber trench, F11:18, 1208).
- S62. Marcellus ii 3a 18/31 [MARC]KKI, retr., Les Martres-de-Veyre (c). The forms on which this stamp appears (18/31, 18/31R and 27) and the associated fabrics suggest origin at Les Martres in the Trajanic or early-Hadrianic period. *c.* AD100–120 (Feature 2, post-Roman dereliction, Q08:11, 2596).
- S63. Marcus v 9a 31 M[ARCI·] Lezoux (b). Marcus's output includes forms 31R, 79 and 79R and his wares appear elsewhere on the Wall, at Chesters, Haltonchesters and South Shields, There are several examples from Pennine forts, including Ilkley and Bainbridge. 9a occurs at Catterick and in the Pudding Pan Rock wreck. *c.* AD160–200 (area over Building 8, unstratified, E10:01, 2206).
- S64–5. Martius iv 1b 33 (2) MARTIM Lezoux (a). A stamp recorded from South Shields and Malton and in late-Antonine contexts at London (Dickinson 1986b, 191, 3.103) and the Brougham cemetery. *c.* AD160–190 (Portico AY, Period 2, H07:11, 2171; Alley 7, K12:23, 2075).
- S66. Mascellio i 4b 38 or 44 MA[SCELLIO] Lezoux (a). This occurs elsewhere on the Wall, at Haltonchesters and South Shields, and is in a late-Antonine context at London (Dickinson 1986b, 192, 3.111). It was used on forms 31R and 79R. *c.* AD160–190 (from collection in Great North Museum: Hancock, Newcastle).
- S67. Maternianus i 3a 33 MATERIAIIII Lezoux (a). At least 11 of the stamps noted from this die come from Pudding Pan Rock and there are three in a late-Antonine context at London (Dickinson 1986b, 192, 3.113–115). Single examples are noted from Benwell, Chesters and Housesteads. Matern(n)ian or Matern(n)iaf may have been intended, but the reading is far from clear. *c.* AD160–200 (Portico AY, Period 2, H07:11, 2170).
- S68. Mercator ii 2f 27 MERC[AI] Lezoux (b). Only one other stamp from this die is known to us, on form 18/31 from the York *colonia*. Mercator ii's wares reached the Rhineland, presumably before *c.* AD150, and his decorated ware shows him to have been connected with the Quintilianus i group. *c.* AD125–150 (pit in Road 4, Q04:12, 327).
- S69. Mossius ii la 31 MOSSI·MA[N] Lezoux (a). A stamp recorded from Verulamium (in Period IID, after AD150: Hartley 1972a, fig. 82, S120) and South Shields. Other stamps from sites such as Benwell and Malton are likely to belong to the 160s or later, but his occasional use of form 27 suggests that he began work rather earlier. *c.* AD150–180 (rubble over west *praetentura*, H04:19, 810).
- S70. Muxtullus 1a 33 [-MVXTVLLI·M] (Walke 1965, Taf. 43, 264) Lezoux (a). The site evidence for Muxtullus suggests that he was at work by *c.* AD 140, but this stamp is likely to be from one of his later dies. It is known from the Wroxeter Gutter hoard and on form 31R. In view of this, an example from South Shields is more likely to be after *c.* AD 160 than Hadrianic. *c.* AD 150–180 (pit in Assembly area, F09:23, 2260).
- S71–2. Namilianus la 31R (2) NAMILIANIMA Lezoux (b). Other examples of this stamp come from Chesterholm, Malton and South Shields. *c.* AD160–200 (Road 3, F11:19, 1202; Great North Museum: Hancock, acc. no. 1961.3).
- S73–4. Namilianus 3b 31R (2) NAM[ILIANI] Lezoux (a). There are four examples of this stamp in the late-Antonine material from Pudding Pan Rock and two from Benwell. *c.* AD 160–200 (area over Alley 4, unstratified, F05:01, 131; area over *Via quintana*, unstratified, L13:01, 1748).
- S75. Nicephor ii 2a 18/31 or 31 [NIC]EPH[ORF] Lezoux (a). The occurrence of this stamp on forms 18/31, 27 and 42 and in the Rhineland is consistent with activity before the middle of the second century, but a single example on form 80 suggests that the die was still in use *c.* AD160, or later. *c.* AD140–165 (pit in Assembly area, F09:59, 2388).
- S76. Paternus iii 2b 18/31 PATERNI Lezoux (b). There are five examples of this stamp from a pottery shop at Castleford destroyed by fire in the 140s (Rush *et al* 2000, fig. 30, nos 812–6); it is also known from Camelon. In his decorated ware this Paternus shares an ovolo with, and sometimes stamps the same moulds as, lanuaris ii. It is possible that he is the same potter as the next, who occasionally used the same ovolo. *c.* AD135–150 (Alley 1, dump of demolition material, N05:23, 340; Alley 1, upper layers, N05:07, 309, and Building B, robber trench, N05:17, joining).
- S77–8. Paternus v 7a 37 (2) [PA]JTERNFE;]NFE, retr. (Durand-Lefebvre 1963, 181, 562) Lezoux (a). Decorated bowls with this well-known label stamp are common on Hadrian's Wall and at Hinterland forts, but there are none from any Scottish forts with normal Antonine occupations (Hartley 1972b, 33). This, and the style of his decoration, suggest that he was not at work before AD160 or so. *c.* AD160–195 (area over *Via quintana*, unstratified, F12:01; area over Buildings 9 and 10 and Road 9, unstratified, H14:04, 1292).
- S79. Paullus v 8c or 8c' 79 P[ΛΛΛΚ·ΚΙ] OR P[ΛΛΛΚ·ΙΙ] Lezoux (b). Several vessels stamped with the earlier version of Die 8c occur in the Pudding Pan Rock wreck and there are eight with the modified stamp in a late-Antonine group from London (Dickinson 1986b, 193, 3.144–51). *c.* AD160–200 (area over Building 12, unstratified, M14:01).

- S80. Peculiaris i 5a 27 (large) $\overline{\text{QECVLIAR}}\cdot\text{F}$ (Curle 1911, 238, 72) Lezoux (a). The earlier of Peculiaris's commoner stamps, normally used on forms not made after *c.* AD160, such as 18/31, 18/31R and 27, though two examples are noted on form 80. It occurs at Carzield and Newstead (2). *c.* AD140–170 (from 'Town Hall' collection).
- S81. Primanus iii 3b 33 $\text{PRI}[\text{MANI}\cdot\text{M}]$ (Juhász 1935, pl. XLVII, 229) Lezoux (b). Dating evidence for Primanus includes stamps from Benwell, Bainbridge and in late second-century groups from London and Pudding Pan Rock (from more than one die). 3b occurs in the Wroxeter Gutter (2) and on form 31R. *c.* AD160–200 (area over Building 13, unstratified, N12:01 1663).
- S82. Pugnus ii la 33 $\text{PVGNI}[\cdot\text{MA}]$ (Nash-Williams 1930, fig. 2, 83) Lezoux (b). This stamp occurs on plain ware in the mid- to late-Antonine Wroxeter Gutter deposit, but also appears occasionally on form 27, which suggests that it was in use before *c.* AD 160. On form 37 moulds it is associated with decoration in one of Pugnus's late styles. *c.* AD 150–180, (area over Building 5, unstratified, J05:03, 712).
- S83. Quadratus iii 1a 79/80 $\text{[QVAD]RATI}\cdot$ Lezoux (a). Quadratus's stamps appear on some of the later Antonine forms, such as 31R, 79, 79R and Ludowici Tg. 1a occurs on the first three and also at Malton, Newcastle and in a grave in the Brougham cemetery, together with a decorated bowl of Banuus. *c.* AD160–190 (from 'Town Hall' collection).
- S84. Reginus iv 4b 37 rim $\text{[REG]INI}\cdot\text{MA}$ Lezoux (b). This also appears on the rims of form 37s from Worcester and Baines Farm, Catterick; all three bowls have the same ovolo, used by Advocisus and his associates. Reginus's plain ware includes forms 18/31 and 27, which suggests some activity before *c.* AD160, though this stamp is unlikely to be earlier than that. *c.* AD160–180 (area over Cistern 1, unstratified, E08:20, 2295).
- S85. Reginus vi 5a 32 etc. [R]EGIANV[SFE] Rheinzabern (Ludowici 1927, 227e). Reginus vi worked at Ittenweiler, Heiligenberg and Kräherwald before moving to Rheinzabern, where this piece was made. His career there probably falls within the range *c.* AD160–180 (area over Building 12 and Road 3, unstratified, M14:01).
- S86. Remicus lb' 33 2EMICF (Loeschcke 1911, Taf. LXXXV, 1498–1500) La Madeleine (c). The distribution of this stamp, which read REMICF before the die broke, or became worn at the ends, is entirely in Britain and the Rhineland. It is sufficiently common in Britain to suggest origin at La Madeleine, rather than any of the other smaller East Gaulish factories. Most of the examples are on form 33, but there are a few on form 27 and one on form 31. His other die was used to stamp form 18/31. *c.* AD130–160 (area of Building 13, unstratified, L09:15, 2568).
- S87. Roppus ii la 18/31 [ROP]PV[SFE] Les Martres-de-Veyre (b). Roppus ii is probably not one of the earlier Les Martres potters, though some of his dishes are Trajanic. There are two examples of this stamp in a group of burnt samian of the 140s at Castleford (Rush *et al* 2000, fig. 30, nos 843–4). It also occurs at the Saalburg Erdkastell (before AD139: Hartley 1970, no.56). *c.* AD110–140 (Road 8, dereliction, E09:20, 2431).
- S88–9. Sabellus 6a 18/31–31 (2) $\text{[2A']BEKKVS, 2A'B}\cdot$ [La Madeleine (a). This stamp is particularly common in Lower Germany, but there are also several examples from Britain, including three from South Shields and one from Stanwix. It was used on forms 18/31 and 18/31R. *c.* AD130–160 (area over Building 12, unstratified, L14:01, 1555; area over Building BA, unstratified, M13:01, 1711).
- S90. Sabinus vii 1a 18/31R–31R SABINI Lezoux (a). Very few stamps are recorded for this Sabinus. 1a is known on forms 18/31R, 27 and 38 or 44 and on an unidentified form from Inveresk (Dickinson 1988, Fiche 1:B5, 2.70). The die will have been in use in the Hadrianic-Antonine period, and the form of this dish suggests early- to mid-Antonine date. See Graffiti report, no. 1 (Alley 1, dump of demolition material, N05:23, 325 and 326).
- S91. Sabinus viii 5a flat base SABI[NIOF] Lezoux (b). Sabinus viii stamped forms not made before *c.* AD160, such as 31R, 79, 79R and 80. 5a appears on form 31R and is noted from Bainbridge. *c.* AD160–190 (drain in Alley 8, F10:23, 2499).
- S92. Sacipus la 33 SAC[IPV.F] Lezoux (c). The four other examples of this stamp known to us are all on cups of form 33 and are all from Britain. Two stamps from another die occur on form 80. Antonine, with some activity after AD160 (area of Building 9, unstratified, G13:15, 1526).
- S93. Sanucius i 1a 31 SANVCIVS[F] Lezoux (c). The record for this stamp consists of two examples on form 31R, from Benwell and Birrens, and seven others on form 31. Mid- to late-Antonine, on the evidence of the rouletted dishes (area over Building 12, unstratified, L14:01, 1552).
- S94. Saturninus i la 37 SATVRNFECIT Boucheporn (a), Chémery-Faulquemont (a), Mittelbronn (a). This bowl was presumably made at Chémery, since samian from the other two factories rarely, if ever, reached Britain. There is no site dating for it, but his activity at Chémery is likely to have been in the Trajanic or Hadrianic period. See the cursive signature no. S141 below (area over Building 5, J05:03, 713).
- S95. Saturninus ii 1b 33 SA[TVRNINIOF.] Lezoux (b). Stamps from two of this potter's other dies occur in the Pudding Pan Rock wreck and another is in a late second-century group from London (Dickinson 1986b, 195, 3.185). He is not certainly represented elsewhere on Hadrian's Wall. *c.* AD160–200 (area over Building 8, D11:08).
- S96. Senea/Senila la 33 $\text{SENII[A}\cdot\text{M]}$ (Dannell 1971, 315, no. 88) Lezoux (c). The potter's name is not certain, but Senea is perhaps more likely, since there seems never to be a tail to the fifth letter. His output includes forms 18/31 and 27 and decorated ware related stylistically to the Quintilianus i group. All of these could be before *c.* AD150, but 1a is in a group of burnt samian of *c.* AD170 from TÁC (Hungary), which suggests that the stamp is from his latest die. *c.* AD140–170 (Building O, portico, E10:44, 2321).
- S97–8. Senilis iii 2a flat base; 31 $\text{SENIL[; SENIL[}\cdot\text{I}\cdot\text{M]}$

- (Durand-Lefebvre 1963, 216, 671) Lezoux (a). The use of this stamp on forms 31R, 79, 79R and 80 suggests a range *c.* AD160–200 (area over Road 8, unstratified, E09:01, 2429; area over Building 12, unstratified, K14:01, 1290).
- S99. Serullus la 33 SERVLLLM (*sic*) Lezoux (c). This is commonest on form 33, but appears on form 31R from Piercebridge and 79 from Chesters. Mid- to late-Antonine (area over Building 10 and Alley 5, unstratified, F14:11, 1039).
- S100. Sextus v 7a 33 [SE]XTVSFE Lezoux (a). Sextus v's stamps occur elsewhere on Hadrian's Wall, and in the Pudding Pan Rock wreck; 7a is noted on forms 79 and 80. *c.* AD160–200 (area over Building 11, unstratified, K15:02, 1293).
- S101. Soiellus(?) la 31 SOI.IKKIM (Nash-Williams 1930, fig. 3, 100) Lezoux (c). This particular stamp was used on forms 31R and 79 and occurs at Catterick. Another is in a group of late second-century samian from London. Mid- to late-Antonine (from 'Town Hall' collection).
- S102. Sulpicianus la 31 SVLPI[CIANI] Lezoux (a). All the stamps noted for Sulpicianus come from the same die. They include single examples from Haltonchesters and Newcastle and two in a group of late second-century samian from London (Dickinson 1986b, 196, 3.207–8). Mid- to late-Antonine (area over Alley 5, unstratified, G14:01).
- S103. Tabus-Virtus i 1a 15/17 or 18 TABIVI?TABI[VIRTVTI?] La Graufesenque (a). Double impressions of this stamp, which should read TABIVIRTVTI?, are not uncommon. The stamp occurs in a group of samian from a ship wrecked *c.* AD 80 off Cala Culip, Spain (Nieto Prieto 1989, no. 14.1) and at the Domitianic foundations of Butzbach, Wilderspool and the Saalburg (3). However, there are also two examples on form 29, which should be earlier than AD85. The range is likely to be *c.* AD75–100, and the Wallsend dish, which seems to have been stamped when the die was worn, should fall within the later years of it (Building 4, make up material, H04:07, 487).
- S104. Tintirio 4b 18/31R [TINT]IRI·M (de Schaetzen and Vanderhoeven 1964, pl. XIII, 32) Lezoux (c). Much of Tintirio's output belongs to the second quarter of the second century, though a single stamp on form 80 (from a different die) suggests that he was still at work after AD 160. 4b occurs in Lower Germany and on forms 18/31 and 18/31R. He also made forms 27 and 81 and there are five stamps from another die in a group of burnt samian of *c.* AD140–150 from a pottery shop at Castleford (Rush *et al* 2000, fig. 30, nos 956–70). *c.* AD140–155 (area over Building 10, unstratified, E14:01, 1125).
- S105. Tituro la 33 TITVRONISOFL Lezoux (a). There are two versions of this stamp. The first has no stops in the Os and the letters are sharp. Stamps from the modified die show worn letters and stops in the Os. There are three stamps from the original die in the Wroxeter Gutter, while the later version occurs at Benwell, Chesters and in a group of late second-century samian from London (Dickinson 1986b, 196, 3.211–4). *c.* AD170–190 (from 'Town Hall' collection).
- S106. Titus iii 8b 18/31R or 31R TITIM Lezoux (b). Titus iii stamped form 18/31R with this die and form 31R with another. Examples of 8b occur also at Mumrills, in a group of samian of *c.* AD150–160 from Alcester (Hartley, Pengelly and Dickinson 1994, 110, S158) and in a burnt group of *c.* AD 170 from TÁC (Hungary). *c.* AD 145–175 (Chalet 9, robbing and post-Roman dereliction, F13:12, 1331).
- S107. Tuttavirus la 18/31R (slightly burnt) TVTTABIRV[S] Lezoux (c). Only two other examples of this stamp have been noted by us, from London and Vechten. The fabrics suggest Hadrianic or early-Antonine date (Building 2, post-Roman dereliction, P05:03, 211).
- S108. Verus vi 3g 31R V[ERV?FE] Rheinzabern (Ludowici 1927, 232, i) Trier (b), Westerndorf (b). There is no way of telling where Verus vi began his career, but he presumably ended it at Westerndorf. The Wallsend piece is from Rheinzabern, while another stamp, from a third-century group in London, is in Trier fabric (Dickinson 1986b, 196, 3.221) and an example from Niederbieber may also have originated there. On balance, he is likely to have begun work at Rheinzabern. Late second century or first half of third century (from collection in Great North Museum: Hancock, Newcastle).
- S109. Victor iv 4a 31 VICTOR·F Lezoux (a). A stamp noted in the Wroxeter Gutter (Atkinson 1942, 145) and on form 80. One of his other stamps is in a burial at Sompting, Sussex, with stamped vessels of Lezoux and Rheinzabern potters and a scarcely-worn coin of Geta as Caesar (Dannell and Hartley 1974, 312). *c.* AD170–200 (Building S, robber trench, F11:18).
- UNIDENTIFIED
- S110. V[or]Λ on form 18/31R, Central Gaulish. Hadrianic (area over North rampart, unstratified, F02:06).
- S111. P[on form 18/31 or 31, Central Gaulish. Hadrianic or early-Antonine (Building 16, L07:10).
- S112.]NDI on form 18/31 or 31, Central Gaulish. Hadrianic or Antonine (area over Building 12, unstratified, L14:01, 1392).
- S113. AKB[on form 31, Central Gaulish. Antonine (area over Cistern 1, unstratified, E08:19, 2304).
- S114.]LI·M on form 31, Central Gaulish. Antonine (unstratified, 1451).
- S115. CEL(L?)[on form 31, Central Gaulish. Antonine (area over *intervallum* road (Road 5), unstratified, E04:01, 119).
- S116. V[OR]Λ, in guide-lines in a frame with an ansate end, on form 31, Central Gaulish. Antonine (area over *intervallum* road (Road 6), unstratified, F15:01).
- S117. Λ[OR]V on form 31, Central Gaulish. Antonine (rubble at base of plough furrow, G05:12, 164).
- S118.]CI on form 31, Central Gaulish. Antonine (area over Building 11, unstratified, K15:01, 1298).
- S119.]IM(?) on form 31, Central Gaulish. Antonine (area over Building 2 and Alley 1, unstratified, M05:04, 152).
- S120. C[on form 31, Central Gaulish. Antonine (Building 2, post-Roman dereliction, P05:03, 211).
- S121.]M on form 33 (burnt). Central Gaulish. Antonine (drain in Alley 8, F10:23, 2462).

- S122.]NIM on form 33, Central Gaulish. Antonine (area over Building 12, K14:03, 1370).
- S123. \[or]\ on form 33, Central Gaulish. Antonine (drain in Road 1, L08:59, 2580).
- S124. CA[on form 33, Central Gaulish. Antonine (area over Building 12, unstratified, L14:01, 1382).
- S125.]NLA(?) on form 33 (heavily burnt). Central Gaulish(?). Antonine (area over Road 9, J14:01, 1417).
- S126.]M on form 33, Central Gaulish. Antonine (Alley 1, upper levels, N05:07, 289).
- S127.]IF on form 33, Central Gaulish. A hole has been bored through the centre of the base, but the footing has not been filed down. Antonine (area over Building 12 and *Via quintana*, unstratified, N14:01, 1645).
- S128.]IM on form 38 or 44(?), Central Gaulish. Antonine (area over Building 1 and *intervallum* road (Road 4), unstratified, M04:01, 737).
- S129.]·D on form 31, Central Gaulish. Mid- to late-Antonine (area over East rampart, unstratified, Q05:02, 58).
- S130.]^mD on form 31R, Central Gaulish. Mid- to late-Antonine (Chalet 9, Building W, D13:24, 1603).
- S131. SECVNDI[on form 31R, Central Gaulish. Mid- to late-Antonine, (Chalet 12, Building AL1, M14:38).
- S132.]CF? on form 38 or 44, Central Gaulish. Mid- to late-Antonine (area over Alley 6, unstratified, N15:01, 1675).
- S133.]IVSF on form 31, East Gaulish. Late second century or first half of third century. (Road 1, F07:03, 2334).
- S134.]\IIII[? on form 31, East Gaulish (Rheinzabern). Late second century or first half of third century (area over Road 8, unstratified, F08:01).
- S135. Λ[OR]V, between striated borders, on form 31, East Gaulish. Late second century or first half of third century (area over Building 10 and Road 9, unstratified, H15:10, 1439).
- S136. LILLVSF(?) on form 31, East Gaulish. The stamp does not correspond to any of those illustrated by Ludowici for Lillus. Late second century or first half of third century (area over Building 2 and Alley 1, unstratified, M05:04).
- S137.]SFE[? on form 32 etc., East Gaulish. Late second century or first half of third century (area over Building 1 and Alley 1, unstratified, P05:02).
- S138.]E.. on form 32 etc.. East Gaulish. Late second century or first half of third century (area over Building 10, unstratified, D14:01).
- S139. C[on form 33, East Gaulish. Late second century or first half of third century (area over Alley 6, unstratified, N15:01).
- S140.]MSFE (Building 16, floor, K07:08, WSP277) (AC).
- S141.]IM (area over Building 15, unstratified, J07:01, WSP276) (AC).
- S142.]M (area over *Via quintana*, unstratified, M13:01, WSP283) (AC).
- S143.]I[. (Chalet 12, Building AL2, N14:37, WSP235) (AC).
- S144.]I (area over Building 2 and Alley 1, unstratified, L05:05, WSP151) (AC)

CURSIVE SIGNATURE

- S145. C. Cin[retr, upside down below the decoration, on form 37, from a mould inscribed in the mould before firing: C. Cincius (or Cingius) Senovirus of La Graufesenque. The potter was at work in the late first and early second centuries; another bowl with a mould-signature comes from Carrawburgh and his plain ware is known from Holt and Cannstatt. c. AD 85–110 (rubble between north wall of Building 19 and street drain, H05:25).
- S146. fe, upside down below the decoration, on form 37, East Gaulish, from a mould inscribed before firing. Since this bowl has a mould-stamp of Saturninus i of Chémery-Faulquemont in the decoration, the signature should belong to Satto ii, but it is not certainly attributable to him. Trajanic or Hadrianic (see S94 above) (area over Building 5 and Alley 4, unstratified, J05:03, 713).

The mortaria

by A. Croom

Identifications by K. F. Hartley

The 1975–84 and 1997–8 excavations inside the fort produced 82.967kg of mortarium sherds (1382 sherds, 4826% EVEs), approximately half of which were unstratified.

Fabrics

Fabric descriptions of the common types can be found in Tomber and Dore 1998.

Northern

This may include mortaria from Corbridge, Binchester and Catterick, although these have been separated where possible, as well as examples from other, unsourced local kilns. Generally the mortaria are of an orange fabric with a cream wash and multi-coloured trituration grits. The major period of production was in the second century, and those dated to the third and fourth centuries are likely to be part of the Cantley/Catterick/Swanpool tradition. See also mortarium stamps nos 35–6, 38.

Corbridge: Fig. 22.08, nos 1–3

North-east: Fig. 22.08, nos 4–6; Fig. 22.13, nos 43, 49

Binchester/Corbridge

This category includes the mortaria stamped by Ahaus; see Mortarium stamps nos 1–13 and following discussion.

Fig. 22.13, nos 33–4, 42

Cantley/Catterick/Swanpool

The fabrics and rim-profiles used at these production centres in the third and fourth century are very similar and cannot be distinguished macroscopically. The potters were working in a single tradition, which is likely to have been carried by potters moving from one centre to another. It is probable that many of the Wallsend examples came from Catterick.

Colchester

Fig. 22.08, no. 7

Mancetter-Hartshill

Fig. 22.08, nos 9–10; Fig. 22.21, no. 245

Lower Nene Valley

Fig. 22.08, no. 11; Fig. 22.21, nos 246–7

Kent

See mortarium stamp no. 16.

Walton-le-Dale/Wilderspool

See mortarium stamp no. 15.

Little Chester

See mortarium stamp no. 14.

East Anglia and Norfolk

A very small number of vessels, from a number of kilns in the area, reached the site.

Fig. 22.08, no. 12

South of Malton

See Monaghan 1997, 939, no. 3404.

New Forest

There was a single vessel in an unstratified context (G09:01), with a wavy line on the flange, dated to the third century. New Forest mortaria generally have a very restricted distribution in southern England (see Tyers 1996, fig. 123).

Oise/Somme

Fig. 22.08, no. 8

Catalogue (Fig 22Ø)

1. Corbridge, mid second-century. Feature B1, P05:03.
2. Corbridge, Raetian type C. Optimum date 150–90. Alley10/Building 17, E04:10.
3. Possibly Corbridge, second century. See Graffito no. 26. Road 4, N04:06.
4. North-eastern, Antonine. Never stamped. Cistern 2, H07:03. d1.309
5. North-eastern. Soft pinkish-brown fabric with cream slip. Three surviving rivet holes from a repair. Second century. Unstratified, G04:02.
6. North-eastern. Orange fabric, with self-coloured slip. Late second century or later. Unstratified, F15:01.
7. Colchester. 130–70. Building S, F12:06.
8. Oise/Somme, probably Antonine. Building 9, G13:03.
9. Probably Mancetter-Hartshill, 140–200. Unstratified, K14:01.
10. Mancetter-Hartshill, 220–300. Unstratified, F09:01.
11. Lower Nene Valley, slightly burnt. 230+. Unstratified, G11:01.
12. Pale grey fabric, burnt. Norfolk? 240–300. Building AP, F09:66.

Supply to Wallsend

The mortarium assemblage from Wallsend is heavily biased towards second-century material, consisting of 52% (by weight) dated to the second century, 20% to the late second or early third centuries, 27% to the third or fourth centuries and less than 1% to the fourth century.

Of the mortaria dated to the second century, 60% as measured by EVES come from local or regional sources, and the rest from a wide range of other sites in Britain, with only a minimal amount of imported material. Colchester (21% of the mortaria dated to the second century) and Mancetter-Hartshill (13%) were the major suppliers from southern Britain, while the other sources (6%), although numerous, supplied only small quantities of vessels, presumably arriving as a minor element of other cargoes or as private possessions of soldiers or civilians coming to the northern frontier.

By the late second century the local industries were in decline, probably going out of business by the third century, and their wares make up less than 10% of the mortaria made during this period. Instead, Mancetter-Hartshill becomes the major supplier (34% of mortaria made in the late second/early third century), followed by Germany (23%; although it should be noted these were being made up until the end of the century). The importance of Germany as a supplier seems to be the result of the ease of maritime trade at the eastern end of the Wall, as German mortaria are rare in the central sector (Bidwell and Speak 1994, 210).

Amongst the mortaria dated to the third and fourth centuries, examples from Mancetter-Hartshill decrease slightly in importance, to be taken over by Lower Nene Valley, which supplied over half the mortaria. This seems to have been an important source at the eastern end of the Wall, making up 19% at Wallsend (by EVES), 19% of all mortaria from South Shields (by vessel count) and 14% at Newcastle (by EVES; Bidwell and Speak 1994, table 8.2; Bidwell and Croom 2002, table 15.6).

Very little stratified fourth-century material survives from the site. Of the 27 complete or incomplete Crambeck mortaria rims, only two were stratified (both of which were late fourth-century Corder 1937 type 8s). There were 15 Corder type 6 or related rims, dating to c.280+ and 12 late fourth-century types.

The mortaria stamps (Fig 22Ø)

by K. Hartley

The catalogue entries include record number, original small finds number, context, location and period. The fabric examined with hand lens at X20 magnification. 'Right facing' and 'left facing' when applied to stamps indicates the relation of the stamp to the spout looking at the mortarium from the outside.

Table 22.06: Dated mortaria from excavations inside the fort, 1975–1998 (stratified and unstratified) shown as percentages of the totals

<i>Fabric</i>	<i>NRFC code</i>	<i>Weight(%)</i>	<i>Sherds(%)</i>	<i>EVEs(%)</i>
<i>Second century</i>				
<i>Local products</i>				
Northern	–	12.62	14.80	9.45
Binchester/Corbridge	–	12.38	6.56	8.52
Corbridge	COR WH	9.99	6.17	7.12
<i>Other British</i>				
Colchester	COL WH	8.69	6.68	8.43
Mancetter-Hartshill	MAH WH	5.74	3.73	5.28
Verulamium	VER WH	0.64	0.39	0.49
Catterick	CTR WS	0.42	0.26	0.40
Kent	–	0.43	0.39	0.53
South Carlton	SOC WH	0.33	0.51	0.38
Walton-le-Dale	–	0.26	0.13	0.31
Unsourced	–	0.12	0.39	–
Upper Nene Valley	UNV WH	0.11	0.13	0.11
Little Chester	–	0.09	0.13	–
Oxford*	OXF WH	–	–	–
Swanpool*	SWN WS	–	–	–
<i>Imports</i>				
Oise/Somme	NOG WH 4	0.29	0.26	0.16
<i>Late second to third century</i>				
<i>Local products</i>				
Corbridge	COR WH	1.12	0.90	1.40
Binchester/Corbridge	–	0.58	0.13	0.40
Northern	–	0.45	0.77	0.96
<i>Other British</i>				
Mancetter-Hartshill	MAH WH	6.47	6.43	7.61
Lower Nene Valley	LNV WH	2.82	3.21	2.75
Colchester	COL WH	0.70	1.03	0.69
Oxford	OXF WH	0.46	0.64	0.91
Kent	–	0.40	0.39	0.51
East Anglia	–	0.24	0.13	0.29
South of Malton	–	0.15	0.26	0.09
<i>Imports</i>				
Lower Germany	RHL WH	5.29	5.14	5.17
Oise/Somme	NOG WH 4	1.69	2.57	1.46
<i>Third to fourth century</i>				
<i>Local products</i>				
Northern	–	0.49	0.90	1.17
<i>Other British</i>				
Lower Nene Valley	LNV WH	16.89	21.72	19.41
Mancetter-Hartshill	MAH WH	4.80	7.20	7.45
Crambeck	CRA WH	1.97	4.24	3.68
Cantley/Catterick	–	0.92	1.41	1.24
Norfolk	–	0.75	0.39	1.55
Catterick	CTR WS	0.41	0.51	0.16
Oxford	OXF WH	0.22	0.13	0.18
Colchester	COL WH	0.17	0.13	0.20
South of Malton	–	0.12	0.13	0.31
Swanpool	SWN WS	0.08	0.13	0.09
New Forest	NFO WH	0.04	0.13	–
<i>Imports</i>				
Lower Germany	RHL WH	0.16	0.13	0.27
<i>Fourth century</i>				
Crambeck	CRA PA	0.43	0.64	0.67
Mancetter-Hartshill	MAH WH	0.05	0.13	0.24
Totals		56.416kg	778	4509

*Small quantity of non-rim sherds present in the group

Key: NRFC = National Roman Fabric Reference Collection

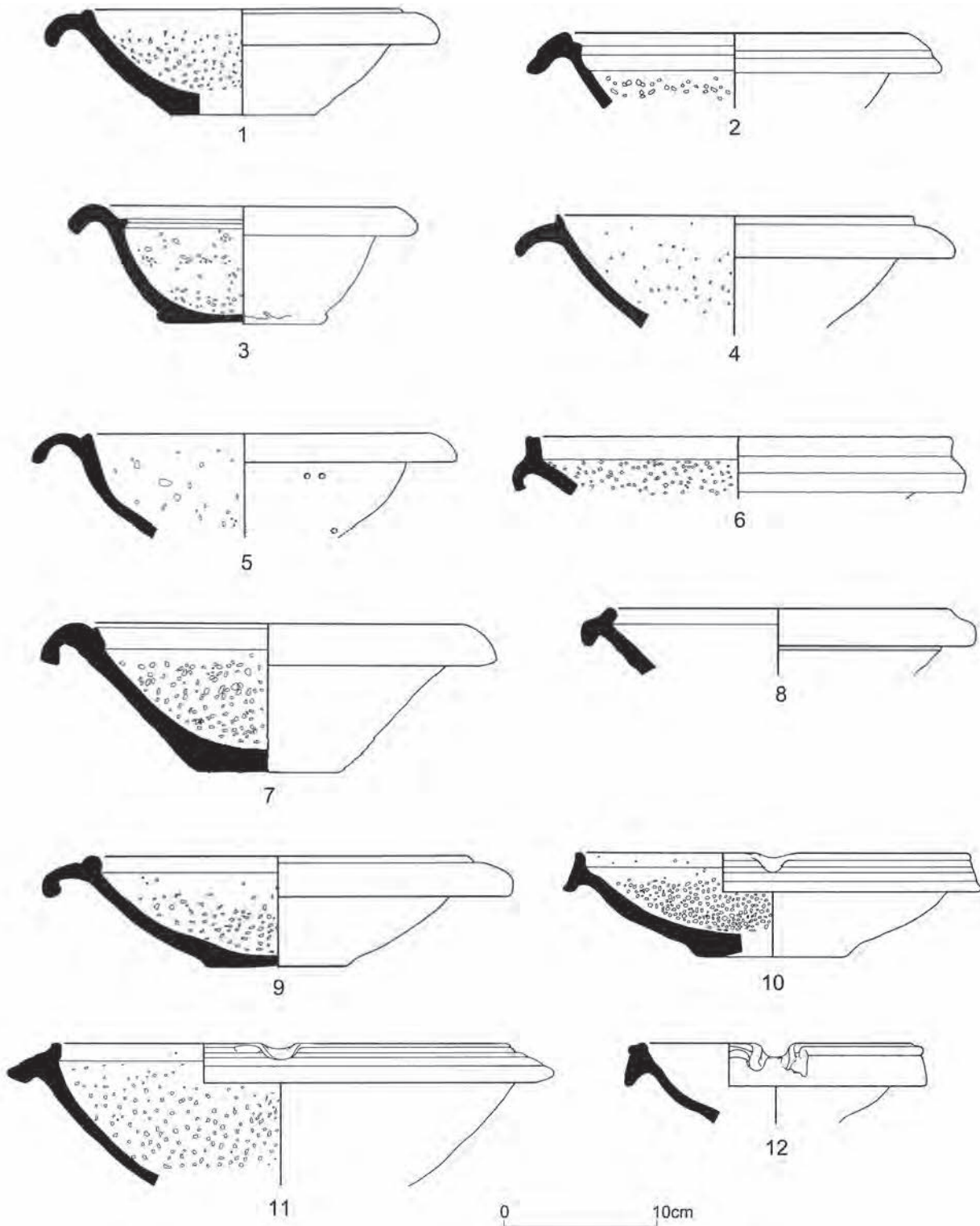

Figure 22.08: Mortaria nos 1-12. Scale 1:4.

1. Road 8, E09:41, 2368, WSP239 (12K).
Wt:0.020kg. Orange-brown fabric throughout except for 2mm of pale grey near underside of flange; ?cream slip. The fairly frequent, tiny to smallish, ill-sorted inclusions are mostly quartz with rare red-brown and black.

A stamp from die 1A of Anaus survives (Birley and Gillam 1948, fig. 1).

2. Area over Building 10, unstratified, E14:01, 1458, WSP241 (8K).

Wt:0.160kg. D:260mm. 16%. Pale orange-brown fabric fired almost to cream at the surface; buff-brown slip. The inclusions are fairly frequent, large to tiny and random, mostly quartz with rare brown. No trituration grit survives.

A left-facing stamp from die 1A of Anaus survives (Birley and Gillam 1948, fig. 1).

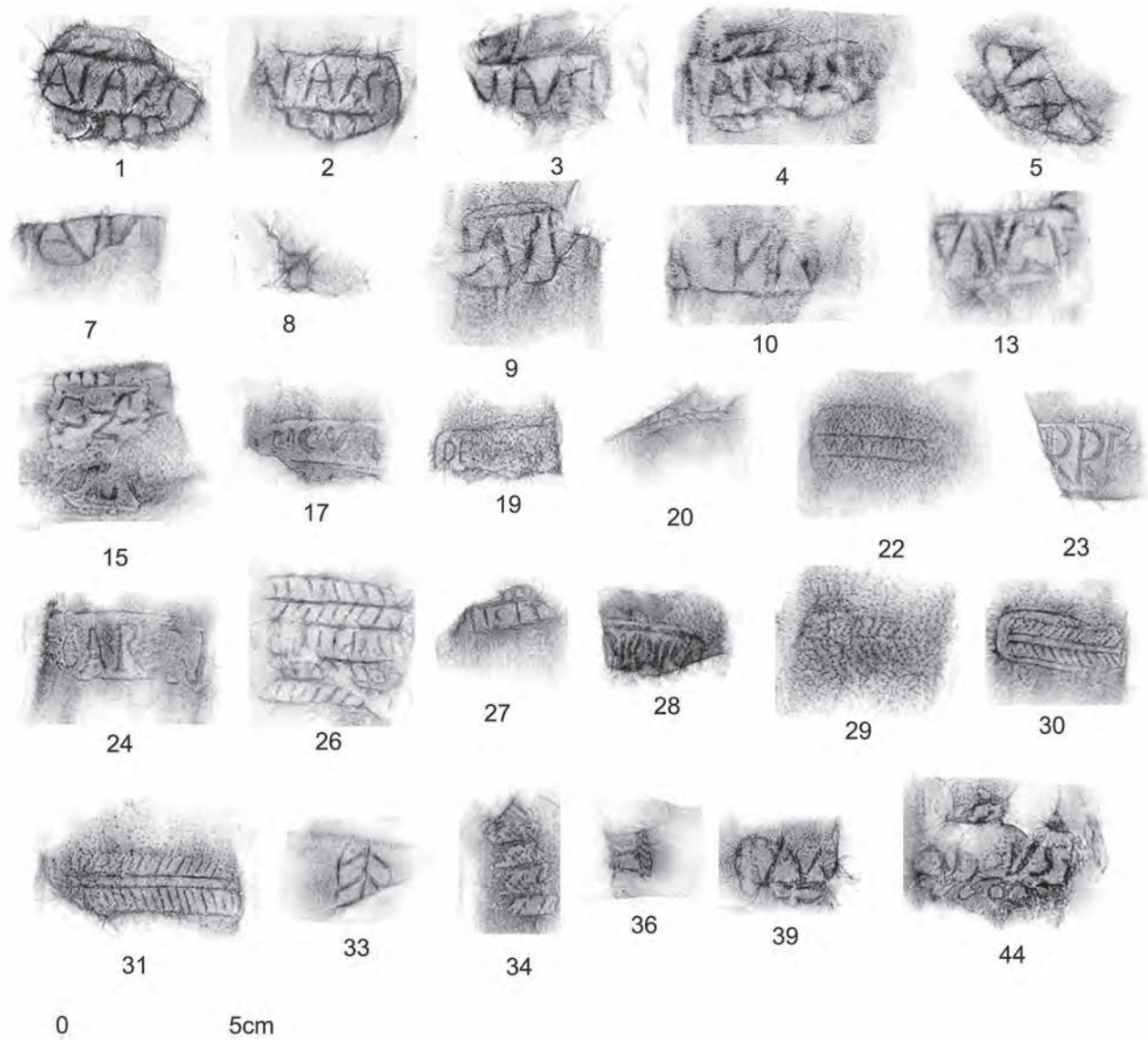

Figure 22.09: Mortarium stamps nos 1–44. Scale 1:2.

3. Area over Buildings 4 and 5, and Alley 3, unstratified, G04:01, 189, WSP245 (11K).

Wt:0.020kg. Flange fragment in fine-textured, powdery drab cream fabric, probably self-coloured. The fairly frequent inclusions are extremely tiny and almost all quartz with very rare orange-brown and perhaps black material.

The broken stamp is from die 1A of Anaus (Birley and Gillam 1948, fig. 1).

4. Nine joining sherds from Alley 1, dump of demolition material, N05:23, 296, WSP255; 4 sherds Alley 1, demolition material dump, lower fill, N05:19 (7K).

Wt:1.795kg. D:300mm. 94%. Orange-brown fabric throughout except for a thin trail of buff-brown in the flange and the edge of base; cream slip. The fairly frequent, random ill-sorted inclusions are mostly quartz with few black and red fragments. The trituration grit, concentrated mainly in the base is a mixture of smallish to large (up to 7mm) quartz, quartz sandstone, and red-brown sandstone; many fragments have fallen out.

The left- and right-stamps survive, both from die 1A of Anaus (Birley and Gillam 1948 1A).

5. Area over Road 4 and north fort wall; unstratified, Q04:35, WSP96 (36K).

Wt:0.178kg. D:280mm. 19%. Hard, orange-brown fabric throughout with cream slip. The fairly frequent, tiny to small inclusions are mostly quartz with very rare black material. No trituration grit survives.

Parts of the left- and right-facing stamps survive from die 1A of Anaus (Birley and Gillam 1948, fig. 1).

6. Area over Building 12, unstratified, WSP153 (40K).

Wt:0.020kg. Flange fragment in slightly powdery, very pale pinkish-brown fabric with grey core; no slip determined. The fairly frequent, ill-sorted inclusions consist mainly of quartz with rare brown material.

The broken and poorly impressed stamp is from die 1A of Anaus (Birley and Gillam 1948, fig. 1). AD120–160

7. Area over Building 1 and Alley 1, unstratified, N05:02, 62, WSP252 (13K). Other sherds which are probably from same vessel but do not join: Alley 1, dump of demolition material, N05:23; Surface over Building 1, Period 4 or later, N04:11 (four small joining flange fragments and 1 sherd not joining).

Wt:0.085kg. D:c.260mm 7% (+11%). Very hard, fine-textured, orange-brown fabric with thick blackish core and cream slip. There are moderate to fairly frequent, tiny to small inclusions, mostly quartz with some pebbly red-brown.

The broken stamp is from die 1B of Anaus (Birley and Gillam 1948, fig. 1). AD120–160. Anaus had a range of fabrics and this is the easiest one to recognize.

8. Road 4, N04:21, 511, WSP253 (10K).

Wt: 0.011kg. Flange fragment in orange-brown fabric with lighter, almost drab cream core and cream slip. The fairly frequent, ill-sorted inclusions are mostly quartz with rare black and red-brown material.

The very fragmentary stamp is probably from die 1B of Anaus (Birley and Gillam 1948, fig. 1).

9. Six joining sherds plus one other, Alley 1, upper layers, N05:07, 290, WSP254; one sherd, Alley 1, dump of demolition material, lower level, N05:23 (14K).

Wt:1.140kg. D:290mm. 8%. Very hard, fine-textured, orange-brown fabric with buff-brown core and cream slip. The fairly frequent inclusions are extremely tiny, mostly quartz with rare red-brown material. The fairly frequent trituration grit is composed entirely of milky quartz and is confined largely to the lower half of the vessel. Worn.

Two joining sherds have the incomplete, left-facing stamp of die 1B of Anaus (Birley and Gillam 1948, fig. 1).

10. Thirteen sherds, *intervallum* road (Road 4), primary surface, P04:10, 170, WSP259; one sherd with modern break, Alley 1, dump of demolition material, lowest level, N05:23 (15K).

Wt: 0.420kg. D:280mm. 13%. The fabric and trituration grit are in every way identical to no. 10 above, but the survival of parts of the two spouts leave no doubt that they are different vessels. This example has dents in the ends of the spout, a characteristic typical of Anaus.

The incompletely impressed left-facing stamp is from die 1B of Anaus (Birley and Gillam 1948, fig. 1).

Also:

10.2. Alley 1, dump of demolition material, N05:23.

Wt:0.190kg. D:290mm. 10%. No stamp surviving (eight joining sherds and one base sherd not necessarily from same vessel). The seven joining sherds are from a third mortarium in identical fabric, which can be attributed to Anaus.

11. Area over Road 9 and Alley 5, unstratified, H14:23, WSP95 (37K).

Wt:0.444kg. D:340mm. 20%. Five joining sherds making up about a quarter of a mortarium in orange-brown fabric with drab core and traces of cream slip. The fairly frequent inclusions are mostly quartz with some red-brown material. The abundant trituration grit is mostly quartz with quartz sandstone and red-brown material. Worn.

The stamp was too damaged in antiquity for identification.

One letter survives, either V or reversed N; it is likely to be a stamp of Anaus, perhaps the middle letter of die 1Bi (Birley and Gillam 1948), but certainty is not possible. North of England, possibly Binchester or Corbridge. Probably AD120–160.

12. Post-Roman rubble over drain in Road 9, H15:06, WSP98 (38K).

Wt:0.020kg. D:300mm. 6%. Flange fragment in very hard orange-brown fabric with pale grey core and cream slip. The fairly frequent, ill-sorted inclusions are mostly quartz with rare red-brown and black material.

The poorly impressed, fragmentary stamp is likely to be a stamp of Anaus, but it does not match his nearest stamps, die 1B, exactly. Probably AD120–160.

13. Alley 10/Building 17 surface, G05:06, 403, WSP246.

Wt:0.058kg. D:290mm. 6.5%. Fine-textured, orange-brown fabric with thin brownish core in flange and cream slip. The fairly frequent inclusions are mostly quartz with some red-brown; the inclusions are small to tiny with few larger.

The left-facing, incompletely impressed stamp is from die 1C of Anaus (Birley and Gillam 1948, fig. 1).

Comments on Anaus mortaria

All of the above stamps are on different mortaria, so that in total there are at least ten stamped by Anaus with the possibility of three more, whose stamps are too fragmentary or difficult for certain attribution to him. It is no surprise that these three would be from the very difficult die 1B. Of the ten undoubtedly stamped by Anaus, six are stamped with die 1A, three with die 1B and one with die C. In total at least twelve mortaria of his are now known from Wallsend making this site along with South Shields and Benwell his major market outside the Binchester/Catterick area.

It has long been believed that Anaus had a workshop at Corbridge (Birley and Gillam 1948) and with good reason considering the number of his mortaria found there, but his distribution differs from that of other potters who can be attributed to Corbridge: not only is the number of his recorded mortaria far greater than for any other potter attributed to Corbridge, but far more of his work is found at sites outside Corbridge. There is also a markedly heavy distribution in the triangle bounded by Binchester, Bowes and Catterick – 25 compared with a total of three for seven other potters attributed to Corbridge (2 of Cudre- and 1 of Messorius Martius). His distribution leaves no reasonable doubt that he began his working life at Binchester and it seems likely that he moved to Corbridge later. His movements might well be expected to be related to the varying military occupation of these sites. The fort at Binchester was abandoned by AD125/130, and Fort 3 at Corbridge is believed to have been abandoned about the same time. If they were abandoned about the same time, he may even have had a third workshop, probably in the Catterick area where there was a thriving pottery industry.

Table 22.07: Distribution of Anaus stamps

	Die A	Die B	Die C	Die D	Die E	Die F	Die G	Die H	Die I	Die J	Die ?	Total
Catterick	0	2	0	1	0	0	0	0	2	0	0	5
Piercebridge	0	1	0	1	0	0	0	0	0	1	0	3
Binchester	4	2	4	3	0	0	0	1	0	1	0	15
Bowes	1	0	0	0	0	0	0	0	1	0	0	2
Chester-le-Street	1	0	0	0	0	0	0	0	0	0	0	1
S. Shields	3	9	0	0	0	0	0	0	0	0	0	12
Wallsend	7	4	1	0	0	0	0	0	0	0	0	12
Benwell	1	0	6	0	0	0	0	0	0	0	0	7
Corbridge	7	25	2	1	2	1	0	0	0	0	0	38
Haltonchesters	0	1	1	0	0	0	0	0	0	0	0	2
Chesters Mus.	1	4	0	0	0	0	0	0	0	1	0	6
Carrawburgh	0	1	0	0	0	0	0	0	0	0	0	1
Housesteads	0	0	1	0	0	0	0	0	0	0	0	1
Birdoswald	1	0	0	0	1	0	0	0	0	0	0	2
Carlisle	1	0	0	1	0	1	0	0	0	0	0	3
Kirkby Thore	0	0	0	0	0	0	1	0	0	0	0	1
Lancaster	1	0	0	0	0	0	0	0	0	0	0	1
Brough-under- Stainmore	1	0	0	0	0	0	0	0	0	0	0	1
Watercrook	0	0	1	0	0	0	0	0	0	0	0	1
St Albans	0	1	0	0	0	0	0	0	0	0	0	1
Newstead	0	1	0	0	0	0	0	0	0	0	0	1
Cramond	0	1	0	0	0	0	0	0	0	0	0	1
Camelon	0	2	0	0	0	0	0	0	0	0	0	2
Loudon Hill	0	1	0	0	0	0	0	0	0	0	0	1
Risingham	0	0	0	0	0	0	0	0	0	0	1	1
Totals	29	55	15	7	3	2	1	1	3	3	2	121

Notes

'Catterick' has been used to cover all the Catterick sites (including Brompton-on-Swale), except Bainesse.

Stamps in Chesters Museum are not necessarily from Chesters itself, but from sites on the Clayton estates, on or in the vicinity of Hadrian's Wall.

Dies have been given the letters used by Birley and Gillam 1948, with consecutive letters used for new dies.

One might expect the fabric of Anaus's mortaria to fall into simple straightforward groups. The orange-brown fabric with very thick bluish-black core and cream slip like no. 7 is very typical and easy to recognise; it is particularly common at Corbridge, but the remaining fabrics are not as easily defined. Further work is needed on these to link them and individual dies with the different sources. Most of his mortaria in Scotland probably came from Corbridge and one might expect this to be true of his mortaria at South Shields and on Hadrian's Wall, but an uncertain number of mortaria made by other potters, for example no. 25, at Wallsend can be attributed to potteries at Catterick.

One of his Binchester mortaria (die H) was found in an early Hadrianic context ending AD120/130 while one from South Shields is recorded from a late Hadrianic to early Antonine context (Bidwell and Speak 1994, 211, no. 7, die B). Five of his mortaria, all stamped with die B are recorded from sites in

Scotland occupied in the Antonine period, indicating that this die was in use after AD140. The stamp from Risingham, now missing (die unknown) should also be Antonine. Stamps from die B are the most common at Corbridge (25 in 38). The distribution of die B suggests that it was mainly in use at Corbridge, though it would have been possible for mortaria from the Binchester/Catterick area to reach Scotland. The mortarium from Chester-le-Street should be later than AD158. A date of AD120–160 should cover the whole of his activity.

14. Area over Tower 2, unstratified, E02:11, WSP100 (44K). Wt:0.050kg. Incomplete rim-section of a very hard, apparently overfired mortarium fired to orange-brown near the surface, the rest reduced to dark grey with pale grey core; the slip is discoloured to brownish-buff. The fairly frequent inclusions are ill-sorted, though most are tiny to small-sized; they include quartz, black, brown and red-brown material. The trituration grit included quartz, brown sandstone and black material.

A fragmentary left-facing stamp survives, preserving the border and part of the F of a retrograde FECIT counterstamp used by G. Attius Marinus. This counterstamp and the namestamp which always accompanies it are essentially the same die-types which were used by G. Attius Marinus at Radlett in Hertfordshire before he opened his workshops in the Midlands. It is not possible to say how many actual dies were used throughout his midland career, but some of his stamps like this are from a die in the pristine condition of that first brought from Radlett, while many of his midland stamps are from a die or dies in which the borders especially are very degraded, never showing the fine detail visible in this example. This is a midland product and its optimum production period is, therefore, early in his midland period, within the range of AD100–120. Although none of his midland kilns have been found, there is evidence to suggest that he may have had a possibly short-lived workshop at Little Chester as well as one in the Mancetter-Hartshill potteries. Some mortaria were produced in orange-brown fabrics in the Mancetter-Hartshill potteries, especially in the early second century, but the production was minimal, whereas production in orange-brown fabrics was normal at Little Chester. This example might fit better with manufacture at Little Chester (for further details of the work of G. Attius Marinus see Hartley 1985, 126–9; Hartley 1999, 199, S21–2; and Hartley in Green (Little Chester), in preparation).

15. Building 10, *contubernium* 1/2, Period 2, E14:28, 1459, WSP242 (20K).

Wt:0.145kg. D:280mm. 14%. Softish, fine-textured, tan-coloured fabric (Munsell 5YR 6/6 'reddish-yellow'), with few black ?slag, rare orange-brown material and quartz inclusions, small to tiny and random. The plentiful, smallish to medium-sized, trituration grit is very mixed in content, mostly quartz (transparent and pinkish), black slag and possibly other black material, quartz sandstone and red-brown sandstone. There are traces of red-brown slip on the upper surface of the flange, possibly ending in a line 4mm below the top of the bead. It is almost certainly a 'Raetian' slip and only one other possible example is known of its use on a mortarium of Austinus.

Complete impressions of this partially impressed, three-line stamp read as follows: the first line Λ VST, S reversed; second line NVS retrograde; the third line, retrograde FI followed by two uncertain letters, the second apparently a lambda L. The name was clearly Austinus and the following word is no doubt intended to be some version of FECIT. Stamps from the same die have now been recorded from Middlewich, Cheshire, Wallsend; Watercrock and Walton-le-Dale (4). Mortaria stamped with the remaining eleven dies of Austinus have now been recorded from the following sites: **in Scotland** (16–19), Bar Hill; Balmuildy (2–3); Birrens; Camelon (3–4); Carzield (2); Cramond (1–2); Durisdeer; Maryport; Milton; Newstead (2); Rough Castle and Strageath; **in England** (49), Ambleside; Birdoswald (3); Cardurnock (2); Carlisle (30); Chesters; Corbridge (4); Lancaster (2); Low Borrow Bridge; Maryport; Ribchester; Stanwix; Walton-le-dale and Watercrock.

The probability that Austinus began stamping mortaria at Wilderspool was discussed in Hartley and Webster 1973, 95–97. Recent discoveries show that many of the Wilderspool potters also had a workshop at Walton-le-Dale (information kindly supplied by Dr J. Evans), and the

distribution of stamps from the die used on the Wallsend mortarium suggests that it was being used there. His major and somewhat later production, was undoubtedly at Carlisle, and he is likely to have also had a workshop in the Antonine Wall area. His mortaria at sites on Hadrian's Wall and the Antonine Wall provide the key to his dating and his rim-profiles support a Hadrianic-Antonine date, perhaps within the period AD125–165, his Walton-le-Dale/Wilderspool production being c.AD125–145. The die represented here was in use early in his career, probably within the period AD125–140. The fabric of this example tends to fit better with production in the Walton-le-Dale/Wilderspool potteries; in particular, it lacks the hardness usually associated with Carlisle fabrics.

16. Area over Building 10 and Alley 5, unstratified, F14:01, 1097, WSP243 (21K).

Wt:0.039kg. D:c.240mm. 6%. Fine-textured, pinkish-brown fabric (Munsell 2.5YR 6/6 'light red') fabric with very thick yellowish-grey core (Munsell 2.5YR 7/2 'light grey'); very moderate, ill-sorted but mostly tiny inclusions including quartz, opaque grey pebbles, red-brown ?slag, opaque black and ?flint. No trituration grit survives. Slight traces of thin cream slip. The bead has been broken and turned outward to form the spout.

The fragmentary stamp, impressed along this collared mortarium reads C[.....]; what may be the first and beginning of the second stroke of A can be seen following the C. No other stamp is known from the same die, but it is likely to be the work of a potter probably called Calles, who worked in Kent and whose mortaria match this in form and fabric. Calles frequently produced this unusual wall-sided type and stamped along the collar, both of which were unusual practices in Britain. The optimum date for both Calles and this example is AD150–180.

17. Building 16, floor, Period 4, N08:24, 2576, WSP256 (30K).

Wt:0.119kg. D:310mm. 13%. Hard, fine-textured cream fabric probably with self-coloured slip; very moderate, random, ill-sorted quartz and orange-brown inclusions with random patches and streaks of pale orange-brown. No trituration survives.

The stamp, probably the right-facing one, reads CICVR and is from a die which gives CICVRFE in complete impressions for Cicur(o/us) *fecit*. Only one die-type is recorded for this potter. His work can be attributed to the Mancetter-Hartshill potteries. Twenty-one of his mortaria have now been recorded from Brough, Notts; Castor; Halton Chesters; Hartshill; High Cross; Leicester (2); Lincoln (2); Papcastle; Stanground South, Cambs; Twenty Foot, nr. March; Tiddington; Upton St Leonards, Gloucester; Wall; Wallsend (3); Wappenbury and Worcester. This distribution indicates that the bulk of his mortaria went to sites in the Midlands, only five have been found in the north, four from sites on Hadrian's Wall including three from Wallsend, which has the largest number from any single site. The stamp from Halton Chesters was found in the packing underneath a floor of Period 1b. His activity is likely to have been within the period AD150–180, but his optimum date is AD150–170 because the practice of stamping could have ended around AD170+ in the Mancetter-Hartshill potteries.

18. Building 1, Period 2 demolition, Q04:02, 140, WSP262 (31K).

Wt:0.180kg. D:290mm. 21%. Two joining sherds in fine-textured pale brown fabric (Munsell 5YR 8/4, 'pink'), with slightly darker slip; moderate, ill-sorted quartz inclusions with some orange-brown and very rare black material. The few surviving trituration grits are orange-brown. The potter's stamp, CICVR[.], with second C damaged and ghostly R, is from the same die as no. 17 above. This is the third mortarium of Cicur(o/us) recorded from Wallsend and is included in the above comments. AD150–170.

19. Chalet 9, Building W, late third/early fourth century, D13:71, 1612, WSP238.

Wt:0.225kg. D:340mm. 10%. Two joining fragments from a mortarium in self-coloured, dark cream fabric merging into a thick greyish-white core with frequent, ill-sorted inclusions, mostly quartz with rare orange-brown and black material. The trituration grit consists mostly of flint with a little quartz. The potter's stamp reads from the outside DE[.]VM[.]S; DE is clearly impressed, but the remaining letters show up only on a rubbing. The name may be Decumus, but this reading cannot be regarded as certain until further stamps from the same die are found. The fabric cannot be sourced with certainty but on present knowledge the inclusions and the trituration grit would best fit the Verulamium region, though the inclusions are more ill-sorted than one would expect. The sandwich colours of the fabric would also be exceptional there, but it is difficult to find any other acceptable source for the flint trituration grit. The rim-profile and the distribution of the trituration grit would best fit a date within the period AD110–140. There is one other stamp, from Castleford (Hartley 2000, fig. 97, no. 26), which could have a similar reading, but that mortarium is probably a local product and the trituration grit and inclusions of the two mortaria are not sufficiently alike to attribute them to one source. Since the two stamps are from different dies they cannot yet be attributed to the same potter. There was also a potter called Devalus working in the Verulamium region AD60–90, but the rim-profiles recorded for him are very different, so it is not likely to be his work.

20. Area over Building 1, unstratified, L04:16, WSP97 (41K). Wt:0.045kg. An incomplete rim sherd in very hard, sandwich fabric, fired to buff-cream at the outside and underside surface (Munsell 7.5YR8/4), with core composed largely of pale brown buff (Munsell 7.5YR 7/6) and a thin range-brown inner core; the upper surface is fired to orange-brown. Cream slip. The moderate inclusions include tiny quartz and orange-brown material, with a few larger orange-brown. One quartz trituration grit survives. The fabric has some fine streaks in it similar to those in no. 36 below.

A fine border of diagonal bars survives plus the very ends of some letters. The stamp is almost certainly from the same die as no. 36, this example showing the lower border. Only further examples will permit identification.

21. Building Row 20, Building Q, late third/early fourth century, F11:11, WSP237 (46K).

Wt:0.522kg D:270mms 42%. This worn mortarium has been considerably affected by the conditions in which it has survived. There is a brown accretion over the whole of the surface and the fractures and the surface has suffered some slight exfoliation while the fabric itself appears to have been hardened and the colour slightly altered to a

yellowish-cream which is untypical for the Mancetter-Hartshill potteries where it was made. There are moderate, tiny quartz and orange-brown inclusions with rare blackish material. The trituration grit is frequent, well-sorted and probably mostly red-brown though some may be blackish, with very rare quartz.

The incompletely impressed and very poorly preserved stamp reads [...]ASGVS and is from a die of Lugutasgus. Mortaria of this relatively uncommon potter are now known from Alcester; Catterick; Cirencester; Corbridge; Tiddington; Wallsend; and Wasperton. His work can be attributed to the Mancetter-Hartshill potteries c.AD135–165

22. Area over Alley 6, unstratified, 1648, WSP257 (32K).

Wt:0.235kg D:360mm 15%. Fine-textured brownish-cream fabric, possibly with self-coloured slip; fairly frequent inclusions (tiny to small quartz, fewer ?slag and orange-brown and calcareous material), with fewer larger, mainly orange-brown. Two flint trituration grits survive.

The poorly impressed stamp is from the largest of the variants of a single basic die-type (Hull 1963, fig. 60, nos 6, 8 and 10) of Martinus 2, who worked at Colchester. See Hartley 1999 for further details of the die; this stamp is identical to S57, 60, 61 and 62. Martinus 2 had at least sixteen other die-types but this one with its variants is the commonest. His mortaria are now known from Braintree; Cambridge (2); Canterbury (2–3); Capel St Mary, Suffolk; Chelmsford; Colchester (up to 99); Corbridge (3–4); Gestingthorpe, Essex; Great Chesterford (3); North Ash, Kent; London/Southwark (6); Wallsend; Ware; York. Martinus 2 has the heaviest distribution outside Colchester of any of those Colchester potters who stamped names on their mortaria. He also has the heaviest distribution in north-eastern England of any of these potters and his absence from Scotland is noteworthy. The evidence as a whole suggests that his activity was within the period AD150–180.

23. Area over *Via quintana*, unstratified, M13:01, 1660 WSP251 (27K).

Wt:0.025kg D:c.270mms 9%. Flange fragment in fine-textured, cream fabric with moderate, tiny to small inclusions, mainly pinkish quartz with some opaque orange-brown material. Probably had a self-coloured surface slip. The stamp,]RRI is from the most commonly used die of Sarrius.

24. North-south drain east of Building 1, Period 2, Q05:03, 199, WSP263 (28K).

Wt:0.455kg D:290mm 25%. Fine-textured, cream fabric with moderate, almost to fairly frequent, tiny to small inclusions, pinkish and transparent quartz with some opaque orange-brown material. Some of the self-coloured surface slip still covers a few of the trituration grits. The trituration grit is red-brown with perhaps two quartz grits mixed in. Heavily worn. The partially impressed left-facing stamp is from a die which gives SARRI with leaf stamp between AR and a central stop before the second R.

The stamps on these two mortaria are from different dies. Both mortaria are from Sarrius's workshop in the Mancetter-Hartshill potteries, which was active within the period AD135–165/70. He was the most prolific potter stamping mortaria in the

second century, but he was most exceptional in having at least four workshops in the midlands, the north of England and Scotland. His Mancetter-Hartshill workshop was of major importance and the evidence suggests that it continued in production throughout his activity elsewhere at Rossington Bridge, near Doncaster (Buckland *et al* 2001), Bearsden on the Antonine Wall (Hartley 1984) and at an unlocated site in north-east England. Stamp no. 23 is from the die-type used at Mancetter, Rossington and Bearsden.

25. Area over Alley 5, unstratified, G14:01, WSP93 (35K). Wt:0.190kg D:280mm 18%. Orange-brown fabric (Munsell 5YR 6/6 'reddish-yellow'), fired to a paler colour at the surface, with traces of cream slip; moderate, ill-sorted inclusions, including quartz, quartz sandstone and orange-brown material. The trituration grit included quartz and red-brown ?sandstone.

The right-facing stamp is too battered to be readable but the dotted borders permit it to be identified as a stamp which reads SATVR on complete impressions, perhaps for Saturninus. Mortaria of this potter have now been recorded from Bainesse (4); Bowes; Catterick (5); Chesters; Corbridge; Piercebridge; and Wallsend. This distribution points to a workshop in the Catterick area. His rim-profiles would best fit a date within the period AD100–140. Saturninus 2 is not to be confused with Saturninus 1 who worked in the Verulamium region or Saturninus 3 who worked at Corbridge.

26. Area over Building 2 and Alley 1, post-Roman dereliction, M05:04, 34, WSP249; M05:04, 579; two joining sherds, Building A, north-south wall, late third/early fourth century, N05:10 (25K).

Wt:0.020kg (M05:04) Wt:0.224kg (N05:10) D:360mm 19%. Fine-textured, micaceous but slightly powdery fabric with some pink in the core and traces of a buff-cream slip; very moderate, ill-sorted and random orange-brown, quartz and slag inclusions, mostly tiny to small. A few quartz trituration grits survive.

The retrograde stamp (left-facing) is from the only known die of Valens; it has large herringbone borders above and below the name panel but all are part of one stamp. Other mortaria of his are known from Birdoswald Turret (Period 1B); Chesters (2); and Corbridge. Valens probably had his workshop at Corbridge although this example is not typical of Corbridge fabric. The find from Birdoswald Turret (Period 1B) suggests a date *c.*AD155–180 for his activity.

27. Surface over Building 1, Period 4 or later, N04:11, 178, WSP258 (2K).

Wt:0.060kg D:*c.*390mm 5%. Mortarium in greyish-cream fabric fired to greyish-buff at the surface; the frequent inclusions are mostly tiny and small, but not well-sorted quartz, with few red-brown and rare black ?slag fragments. No trituration grit survives.

The fragmentary stamp, [.]IICIT, is from the lower line of the only known die-type of Vediacus; parts of] IA[on the upper line also survive. Full impressions of this stamp read VIIDIACVS/IICIT, A with diagonal dash, for 'Vediacus fecit'. His mortaria are now known from Baldock (2); Benwell; Braughing (2); Godmanchester; Great Chesterford; Great Weldon; Higham Ferrars (3); Odell,

Beds; Piddington (3); Rushden, Northants; Sandy, Beds. (2); Stanground South, Cambs; Stanwick, Northants; Stonea (2); Verulamium (4); Wallsend; Wellingborough; Wood Burcote Farm, near Towcester; and Wyboston, Beds. The only two recorded from the north are both from Hadrian's Wall. The distribution of his work indicates activity in the Upper Nene Valley, probably in Northamptonshire and his rim-profiles fit a date within the period AD140–180, perhaps not earlier than AD150. For some interesting details of his work see Hartley 1994, 18–20.

28. Alley 10/Building 17, third century, E04:10, 417, WSP240. Wt:0.085kg. D:280mm 8%. Two sherds, not necessarily joining but certainly from the same mortarium in fine-textured, micaceous, cream fabric with very smooth surface and slightly brownish-cream slip; few inclusions, most of them barely visible at X20 magnification, many probably quartz, some orange-brown with rare large orange-brown material and opaque white pebbles. Very few trituration grits survive, but they included quartz sandstone, orange-brown ?sandstone and quartz. Worn.

The broken stamp is from one of six die-types used by Vorolas; this one reads VOROLAS retrograde when complete. Vorolas worked at South Carlton, Lincoln, where nearly 100 of his stamps have been found (Webster 1944). The fabric and profile of this example are entirely typical of his work. Other mortaria of his have now been found at Aldborough; Corbridge (2); Lincoln; Littleborough, Notts; Lutford Magna, Lincs; Templeborough; Wallsend and York. North-eastern England was, apart from the local area, the main market for potters working at South Carlton or in that vicinity, except for Crico whose work is found in Scotland. Their work is very homogeneous and there is no doubt of their Antonine date, certainly within the period AD140–180, though AD150–170 is probably the optimum date.

29. Tower 7, P04:05, 135, WSP260 (33K).

Wt:0.125kg D:280mm 13%. Self-coloured, fabric with fine-textured, cream matrix (Munsell 10YR 8/4 'very pale brown'); fairly frequent and fairly well-sorted inclusions composed of quartz and orange-brown material with few black fragments. The surface is powdery but slightly abrasive due to the heavy tempering. The trituration grit included flint and quartz.

The partially impressed herringbone stamp is from the same die as Hull 1963, fig. 60, no 33. Colchester AD140–170.

30. Building 1, verandah, Period 3, L04:20, WSP174 (42K). Wt:0.040kg. D:*c.*280mm 6%. Self-coloured mortarium in fine-textured, yellowish-cream fabric (Munsell 10YR 8/4 'very pale brown'); only rare quartz and orange-brown inclusions, barely visible at × 20 magnification. The trituration grit included flint and quartz, mostly flint on fragment.

The left-facing stamp is a nearly complete impression from a herringbone die similar to Hull 1963, fig. 60, no. 29. Impressions of this stamp appear in slightly different lengths, suggesting that more than one die was used; they are so similar that they may have been made from the same matrix and they are always treated together. Colchester, AD140–170.

31. Area over Building 1, unstratified, Q05:02, WSP94 (43K). Wt:0.170kg D:320mm 13%. Self-coloured, yellowish-cream

fabric (Munsell 10YR 7/6 'yellow'), with moderate to fairly frequent, random and very ill-sorted, flint and quartz inclusions. The trituration grit is composed of moderate to fairly frequent, vari-sized, flint and quartz, thinning out towards the bead, but with a few stragglers on top of the flange.

The herringbone stamp is the most commonly recorded of the Colchester herringbone stamps (Hull 1963, fig. 60, no. 30). AD140–170.

32. *Via principalis*, M08:09, WSP101 (45K).

Wt:0.130kg D:290mm 10%. Self-coloured, yellowish-cream fabric (Munsell 2.5Y 8/4 'yellow'), with thick pink-brown core (Munsell 5YR 7/6 'reddish-yellow'); moderate, random, very ill-sorted quartz with some opaque black material. The trituration grit is identical with that on no. 31 above except for the addition of a few soft, orange-brown fragments.

The edge of a right-facing stamp survives, which is too fragmentary for perfect identification, but it is almost certainly a herringbone stamp. This stamp is from a different vessel from all the other herringbone stamps recorded. Colchester, AD 140–170.

33. Building 1, north-south drain east of south wall, Period 2, Q05:03, 171, WSP261 (34K).

Wt:0.140kg. D:c.280mm. 7%. Self-coloured, fine-textured sandwich fabric, dark cream (Munsell 10YR 8/3 'very pale brown') changing to pale orange-brown (Munsell 5YR 7/8 'reddish-yellow'), with dark cream core. The fairly frequent, fairly well-sorted, tiny inclusions are mostly quartz with some orange-brown and black material. The trituration is fairly frequent and well-sorted ending neatly about 23mm from the bottom of the bead; it is well-mixed and consists of flint, quartz, red-brown (?sandstone), slag and one soft, grey-white pellet, 14mm × 1.5mm. Worn.

The broken herringbone stamp has been found on seven mortaria in Scotland and on two other sites in England, Corbridge and a site near Sandwich, Kent. The fabric and trituration grit would be atypical for Colchester and a workshop in the Canterbury area is far more likely to be the source. AD140–170.

34. Area over Building 11 and Alley 6, unstratified, L15:01, 1338, WSP248 (24K).

Wt:0.058kg D:300mm 11%. Very hard, sandwich fabric, cream at surface, light brown outer core and deep cream inner core streaked with light brown; fabric very absorbent; smooth surface. The moderate to fairly frequent inclusions include random, large opaque white material which fractures easily (non-reactive) with some quartz, and rarer small orange-brown material. The few trituration grits surviving, include quartz, greyish quartz sandstone? and red-brown slag and possibly opaque white material. There are traces of a thin reddish-brown slip on top of the flange and at the bottom of the bead; this could be a 'Raetian' slip, but it is very rarely found on mortaria in the cream range and 'Raetian' mortaria were almost never stamped in Britain, so that this option is unlikely.

At least four herringbone stamps, some overlapping, are partially impressed across the flange. These appear to be from an unknown die. The absence of flint in the trituration or on the flange makes it fairly certain that this is not from any of the workshops in East Anglia, Kent or at Wiggonholt which regularly produced mortaria with herringbone stamps.

Relatively dark slips on a cream fabric were common in the Lower Nene Valley, but herringbone stamps were rarely if ever used there. The source of this mortarium is therefore, uncertain, but the Nene Valley or Corbridge are possible sources. The rim-profile alone would tend to indicate a date in the early second century, but it is unlikely that herringbone stamps were being produced before about AD130 and most, if not all, were produced within the period AD140–170.

35. Area over Gate 3 and *intervallum* road (Road 6), unstratified, J16:01, WSP99 (39K).

Wt:0.040kg. A rim fragment, close to the spout, of a mortarium in hard, orange-brown fabric; probably self-coloured. The fairly frequent inclusions are ill-sorted quartz; no trituration grit survives.

The fragmentary left-facing trademark stamp could well be from the same die as a stamp already recorded from Wallsend (Corder 1903, 46) and South Shields (Bidwell and Speak 1994, fig. 8.2, no. 3, found in the demolition of Periods 2–3). Unfortunately both of these stamps are also fragmentary and this example would be from the unrecorded part of this stamp. This example has the same very unusual raised band under the flange as the old find from Wallsend. All of the rim-profiles suggest a date within the period AD110–140. The distribution points to a workshop in north-east England.

36. Building 1, Period 2 demolition, M04:06, 475, WSP250 (26K).

Wt:0.162kg. D:250mm 17.5%. Brownish-pink fabric fired to cream near the outer surface, with very thin cream slip. The body is slightly distorted by the presence of a large (15mm × 6mm), fragment of ?slag, but the normal inclusions are almost invisible, mostly quartz and brown slag. Only one or two quartz trituration grits survive.

The broken stamp (right-facing) reads JTI[with an upper border of fine diagonal bars. The stamp on no. 20, a different vessel, is probably from the same die, but no other examples are known. The fabric and provenance point to manufacture in northern England; the rim-profile should fit a date within the period AD120–170, but the use of such fine borders would best fit an Antonine date. Borders such as these are rare outside the Mancetter-Hartshill potteries and further examples will enable identification.

37. Robber trench of south wall of Building 7, F11:07, WSP234 (47K).

Wt:0.138g D:280mm 12%. A heavily worn mortarium in granular greyish-cream fabric, with the surface of the flange somewhat exfoliated; abundant quartz inclusions with rare black and red-brown material. The trituration grit is worn away except for one flint and two quartz grits. There was a cream surface slip.

The incomplete and somewhat damaged stamp is from the same die as one from Lower Warbank, Keston in Kent (unpublished). The most complete version reads [...]OMX; the × will be a space-filler and it is not clear whether or not the stamp is retrograde. The fabric used can be attributed to a workshop in the important potteries south of Verulamium, mostly between Brockley Hill and Radlett, though the inclusions are not as well-sorted as commonly in their products. The optimum date for this mortarium is AD110–140.

38. Building 10, *contubernium* 3?, Period 2, F14:44, 1626, WSP244.

Wt:0.010kg Flange fragment in hard, fine-textured, orange-brown fabric (Munsell 2.5YR 6/8, 'light red'), merging to a slightly greyer colour in core; with very moderate, random and ill-sorted inclusions, mostly quartz with some orange-brown and rare black. Cream slip.

The fragmentary stamp preserves part of a border and fragments of letters. It has not been possible to identify this stamp, but identification will be possible when further examples are found. North of England. Second century, probably before AD180.

39. Soil and rubble over end of Building 18, Period 3–4, H05:13, 817, WSP247 (23K).

Wt:0.045kg. D:c.250mm 7%. Orange-brown fabric (Munsell 2.5YR 6/8 'light red') with thick, well-defined darker brown core (Munsell 2.5YR 5/4 'reddish-brown'); frequent tiny inclusions, mostly quartz with few larger quartz, black slag and red-brown material. Cream slip.

The stamp, probably a left-facing one, has been impressed along the flange. The stamp cannot be identified until further examples are found. This practice of stamping along flange or collar was never common in Britain, though examples are known from some workshops at some points in the first and second centuries. One or more of these workshops using generally similar fabric to this example, was in Kent in the second half of the second century, but only the discovery of further examples will enable identification of the source. The rim-profile together with this unusual stamping suggests an optimum date of AD150–180.

Table 22.08: Amphora from the excavations (all periods, including unstratified)

Fabric & principal content	Wt (kg)	Sherd (no)	EVES (%)
<i>Oil</i>			
Dressel 20 (P&W 25)	94.7	87.9	91.9
South Spanish	0.1	0.5	-
<i>Wine</i>			
Gauloise 4 (P&W 27)	1.2	2.1	-
Gauloise 12 (P&W 55)	0.6	2.2	2.8
Central Campanian	2.4	5.0	4.7
Northern Campanian	0.5	1.3	-
<i>Fish sauce?</i>			
Cam 186 (P&W 17)	0.04	0.1	0.6
<i>Uncertain</i>			
Biv amphora	0.01	0.03	-
Unsorted	0.45	0.9	-
Totals	414.166	3293	2088

Key: P&W = Peacock and Williams 1986

The amphorae

by A. T. Croom

The site produced 414kg of amphora from both stratified and unstratified contexts, making up 37.7% of all the pottery recovered from the site.

As usual on northern military sites, the assemblage is dominated by sherds from Dressel 20 amphorae, used to import olive oil for cooking and use in the bath-house. The wine amphorae, making up 10% of the assemblage by sherd count, came from both France and Italy. The flat-bottomed French amphorae were about equally split between those from southern France (Gauloise 4) and those from Normandy (Gauloise 12). They probably reached the fort during the second century and probably much of the third as well, as a Gauloise 4 amphora was recovered from Cistern 1, filled c.270 (Fig. 22.17, no. 114), but the quantities involved reflect the fact that much of the ration wine must have been supplied in barrels (Bidwell and Speak 1994, 216). From the middle of the third century Campanian wine began to be imported from the site, making up 3% by weight and 6% by sherd count. This is similar to the proportion found at South Shields, where the Italian amphorae make up 7% by weight (*ibid.*, table 8.9, 'black sand' and 'volcanic').

Approximately 16% (by weight) of the stratified amphorae from the site was recovered from road surfaces, although this rises to about 28% when taking into account material from contexts unassigned to specific periods. Building 16 produced the largest quantity of amphorae of any individual building (18%), almost two-thirds of which came from the base of a single Dressel 20 in pit M08:43. The other building to produce a large quantity of amphora was the hospital (10% of the amphorae by weight); nearly 60% of this came from the infilling of the latrine and 25% from the open courtyard.

Catalogue (Fig 2210)

Dressel 20

1. Building 1, verandah, Period 3, L04:20. See also Fig. 22.17, no. 113.

Central Campanian

2. Unstratified, E13:01.
3. Unstratified, H15:08.
4. Road 2, K05:07.
5. Alley 1, daub deposit, N05:23.
6. Unstratified, H15:09.
7. Unstratified, H12:29.
8. Unstratified, L05:03.

See also Fig. 22.17, no. 115

Gauloise 4: See Fig. 22.17, no. 114

Biv: see Fig. 22.17, no. 116

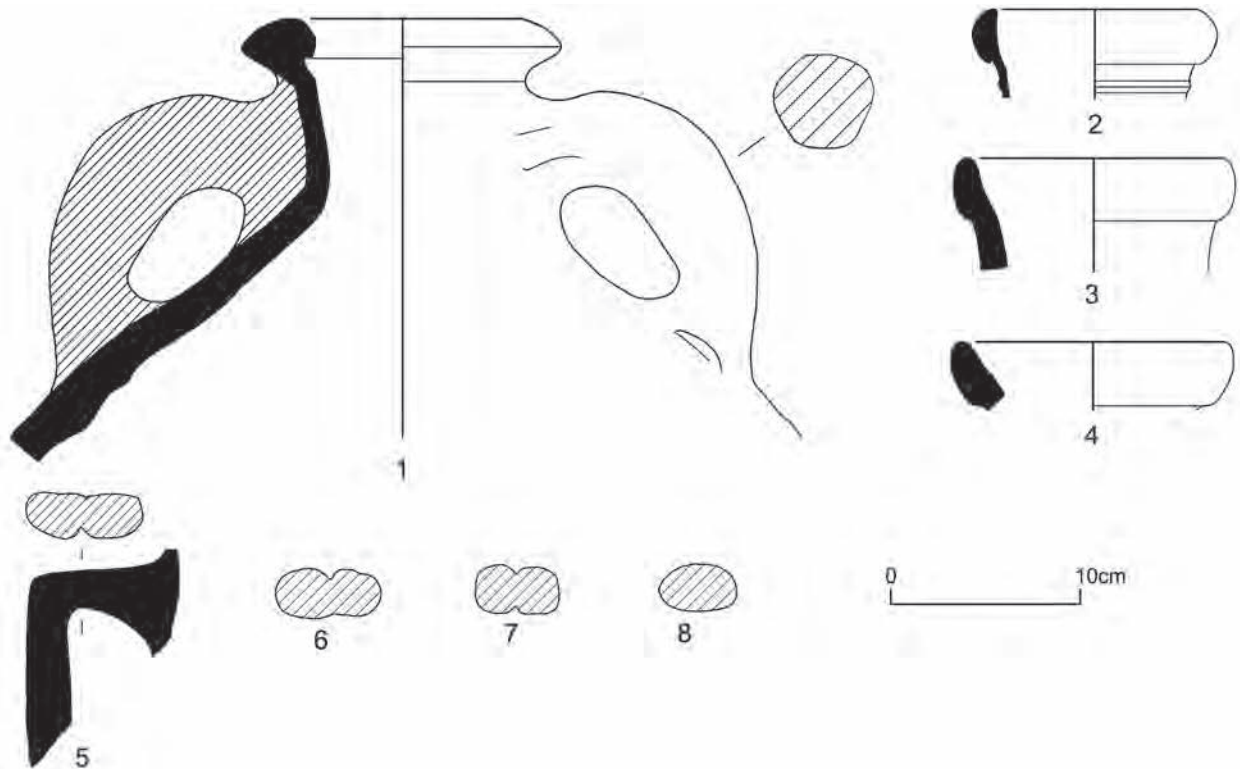

Figure 22.10: Amphorae nos 1–8. Scale 1:4.

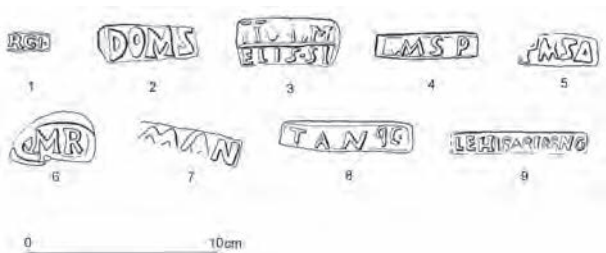

Figure 22.11: Amphora stamps nos 1–9. Scale 1:4.

Amphora stamps (Fig. 22.11)

by R. McBride

The excavations produced 14 stamps on Dressel 20 amphorae of which 9 were legible. Catalogue entries begin with the context number, followed by the small finds number and the record number. A transcription is given with a translation if necessary along with references to parallels from the principal texts.

1.]RGI· ACRIGI Callender 18, Funari 22, Rodriguez 51. A parallel from Rome comes from a context dating 220–222. Source: La Catria 19, Guadalquivir Valley (Funari 1996, 21), (area of Building 2 and Alley 1, ploughsoil, L05:03, 590, WSP4).
2. DOMS DOMS Callender 552, Funari 170, Rodriguez 237. This has been found in a context in Rome dated 145–161. Source: Alcolea (Funari 1996, 54), (area of Building 11 and Alley 6, unstratified, M15:02, 1227, WSP5).
3. LI[]IM/ELIS-SI L. IUNI(US) MELISSI(US) Callender 879, Funari 136d, Rodriguez 189.

This stamp has been dated to AD 110–190. Source: Las Delicias (Funari 1996, 46), (rubble over east rampart and *intervallum* road, Q07:07, 2571, WSP9).

4. MSP MSP Callender 1180, Funari 211, Rodriguez 291. This stamp has been found in a contexts dated 145–161 and 179–180 in Rome. Source: Guadajoz (Funari 1996, 63), (area over Building 13, unstratified, N12:01, 1638, WSP6)

5. PMSA P. M(USSDII) S(EMPRONIANI) A Callender 1355b, Funari 155, Rodriguez 212.

Callender suggests that this stamp dates to the middle of the second century. (Funari 1996, 50), (Building 4, make up, Period 2, G04:07, 479, WSP3).

6.]MR QMR Callender 1481, Funari 153, Rodriguez 209. The first character is faint but is almost certainly Q. This stamp has been found in contexts dated to 145–161 at Rome. (Funari 1996, 49), (area over *Via principalis*, unstratified, M08:01, 2494, WSP8).

7.]MAN ROMAN Callender 1541, Funari 198, Rodriguez 279.

Second half of the first century to the first half of the second century. Source: Las Delicias (Funari 1996, 60) (north-south drain east of Building 1, Period 2, Q05:28, 330, WSP2).

8. A/9C TA·

The closest parallel for this stamp is Callender 1696 which Callender suggests may date from the second half of the first century (Callender 1965, 256), (area over Building 13, unstratified, M12:01, 1696, WSP7).

9.]LEHISAPI[.]NG

Table 22.09: Quantity of pottery from the excavations (kg).

	<i>Stratified</i>	<i>Unstratified</i>
Samian	18.990	31.817
Mortaria	34.499	43.418
Amphorae	166.838	247.328
Fine wares	9.625	14.455
Coarse wares	231.320	300.797
Total	461.272	637.815

The obscure characters between I and N are faint but may be a ligature of NE (area over *Intervallum* road (Road 4), unstratified, Q04:01, 10, WSP1).

Illegible or incomplete:

10. VVV [(Building 8, room, 8, mid-third century?, E10:43, WSP169)

11.] M [(Building 1, demolition, Period 2 demolition, M04:06, 283, WSP10).

12.] N (area over Building 9, unstratified, E13:01, WSP159).

13.] . V . I [(area over Building 7, unstratified, F11:01, WSP160).

14. Illegible (Cistern 2, upper fill, late third/early fourth century, H07:03, WSP161).

The coarse wares

by A. T. Croom

The excavations produced a total of 1099.087kg of pottery, over half of which was unstratified. This very high proportion of unstratified material is partially the result of the destruction of most of the fourth-century levels on the site. The stratified material was fully catalogued and quantified by weight and by measuring rim percentages (EVEs), although not by sherd count, with certain assemblages of interest studied in greater detail. The unstratified amphorae, mortaria and fine wares, plus some coarse wares of interest were also fully catalogued.

Fabrics mentioned in catalogue

See Tomber and Dore 1998 for fabrics with NRFRC code in the above table.

Pottery from two other forts in the Lower Tyne Valley have already been studied in some detail, providing the framework for work on the assemblage from Wallsend, since it is clear they all drew on the same sources of supply. The report on the pottery from South Shields included the first quantification of the mortaria and amphorae from the site, and a detailed discussion of its pottery supply, in particular the vessels in BB2 and its allied fabrics that make up a large proportion of the coarse wares during the third century (Bidwell and Speak 1994, 206–42). The report on the pottery from the fort of Newcastle expanded this discussion, with additional detailed study of local traditional wares and the well-preserved late Roman assemblages (Bidwell and Croom 2002, 139–72). The supply of pottery to the region as a whole in the late Roman period has also been investigated (Bidwell and Croom 2010). The study of pottery from the northern frontier region is continuing with the Hadrian's Wall Ceramic Database project (www.collectionsprojects.org.uk/archaeology/ceramic%20database/introduction.

html), which incorporates assemblages from forts, *vici* and turrets, and hopes to provide a more regional understanding of the material recovered.

Fine wares

LOWER NENE VALLEY COLOUR-COATED (LNV CC)

This is not common before the third century in northern Britain. At Wallsend it was found in the construction levels of the Period 4 barracks and the infill of the hospital latrine drain (Hodgson 2003, 244), and at South Shields it is first found in Severan contexts. It becomes the most common colour-coated ware on the site in the third century, and makes up 70% of the fine wares on the site. The industry supplied primarily beakers, but also flagons and to a lesser extent castor boxes. Many of the vessel forms have a long-life, but a few new types were introduced during the life of the industry. The funnel-necked beaker was first made near the end of the first quarter of the third century, followed in the mid or late third century by beakers based on 'Rhenish' forms (such as the funnel-necked beaker with bead rim). Colour-coated bowls in coarse ware forms generally date to c.360 on the northern frontier (Bidwell and Croom 2010, table 4.1).

Beaker, barbotine decoration: 87, 120–2, 268–9, 295

Beaker, funnel necked: 125–7, 129

Beaker, indented: 77–8, 100

Beaker, narrow-mouthed: 294

Beaker, plain-rimmed: 296

Beaker, rouletted decoration: 123, 299

Flagon: 84, 128

Flagon, with moulded mask: 337

LOWER NENE VALLEY PARCHMENT (LNV PA)

Parchment wares, often painted, seem to have been made throughout the lifetime of the industry (Perrin 1999, 108). Although made in a range of forms, flasks are the most common type found in the north. More exotic forms, such as head pots, moulded mask flagons and ring vases also occur, but only in very small numbers.

Bottle: 85, 118

Triple vase: 248

Mortaria made in Nene Valley white ware were also supplied to the fort from the late second or early third century, and the industry became the major supplier of mortaria to the site in the third and fourth centuries. A few grey ware vessels also find their way to the north, but in such low numbers it is probable they are a by-product of the transportation of the mortaria and colour-coated wares.

COLCHESTER?

See Anderson 1980, 33, North Gaulish fabric 2. This ware is used for rough-cast beakers. It is the most common type of second-century fine ware from the site.

Beaker: 2

CENTRAL GAULISH BLACK-SLIPPED (CNG BS)

This was imported from the mid second to the early third century. It is a minor fine ware at Wallsend.

Beaker: 277

MICA-DUSTED

This consists of a number of oxidised fabrics from different

Table 22.10: Stratified ware by fabric type, shown as a percentage

<i>Fabric</i>	<i>NRFC</i>	<i>Wt</i>	<i>EVEs</i>
<i>Samian</i>		6.4	7.5
<i>Mortaria</i>		11.7	5.1
<i>Fine wares</i>			
Cologne colour-coated	KOL CC	0.1	0.1
Moselkeramik black-slipped	MOS BS	0.1	0.1
Central Gaulish black-slipped	CNG BS	0.1	0.1
Lower Nene Valley colour-coated	LVN CC	2.5	3.3
Exeter group 4		0.0	0.1
Colchester colour-coated (?)		0.1	0.5
Unsources fine wares		0.2	0.7
Mica-dusted			0.1
North Kent fine		0.2	0.7
Parisian		0.0	0.1
Unsources poppyhead beakers		0.0	0.2
<i>Coarse wares</i>			
Oxidised ware 1		1.3	1.3
Oxidised ware 2		0.2	0.2
Lower Tyne painted		0.6	0.5
North-African style		0.1	0.1
Flagon A, B, C, D, E, F, G		0.6	0.4
Corbridge oxidised	COR WH	0.1	0.2
North Gaulish fabric 1	NOG WH 1	0.2	0.1
Buff		0.1	0.2
Imported oxidised		0.1	0.1
Pink grog-tempered	PNK GT	0.1	0
Unsources oxidised		5.2	5.2
Grey ware 1		5.3	7.7
Grey ware 2		1.3	2.1
Grey ware 3		0.5	1.0
Grey ware 4		0.4	0.4
Grey ware 6		0.6	0.5
BB1	DOR BB 1	10.0	11.8
BB2	BB 2	32.2	25.3
South-east reduced		13.2	14.6
Horningsea	HOR RE	0.6	0.0
East Anglian grey		0.1	0.1
East Yorkshire grey		0.1	0.2
South Yorkshire grey		0.1	0.0
Dales	DAL SH	0.1	0.1
Late grey gritty		0.1	0.2
Calcite-gritted	CG	1.2	1.5
Crambeck reduced	CRA RE	1.6	1.2
Local traditional ware		0.1	0.1
North Gaulish grey	NOG RE	0.0	0.2
Unsources reduced		11.1	6.0
Total		294.434	34,138

Fabrics represented by less than 0.1% not included in the table: Central Gaulish colour coated 2 (CNG CC 2); North Gaulish colour-coated 1; Ebor red-painted (EBO OX); highly burnished black; *C ramique   l' ponge* (EPO MA); Verulamium white (VER WH); Lower Nene Valley parchment (LVN PA); Lower Nene Valley grey; Crambeck parchment (CRA PA). Other fabrics found only in the unstratified material: Severn Valley, Crambeck red, southern shell-tempered, Savernake (SAV GT)

Key: NRFC = National Roman Fabric Reference Collection

sources, with a slip rich in gold-mica. At Wallsend there are indented beakers and plain-rimmed bowls, but it is only a minor fine ware on the site.

Beaker: 76

Bowl: 8 (?), 206, 323

CÉRAMIQUE A L'ÉPONGE (EPO MA)

This ware is rare in the region, with only a few vessels known from the northern frontier. The majority of examples in this country come from south-east England, where it is most commonly fourth-century in date (Tyers 1996, 144). Most of the few northern examples have a similar date, although there is a possible sherd from Vindolanda in a late third-century context (Bidwell 1985, 182). Wallsend has produced two vessels, both flanged bowls (Fig. 22.16, no. 112; post-Roman dereliction and ploughsoil). A single flanged bowl is known from South Shields (unpublished, context 3778, fourth-century) and one from Newcastle (Bidwell and Croom 2002, fig. 15.9, no. 99, from an Anglo-Saxon grave).

Flanged bowl: 112

Coarse wares

FLAGON FABRIC

Fabric A: Dark grey fabric with orange exterior and a cream wash, found also at South Shields.

Flagon: 117, 292

There are a number of other flagon fabrics (Fabrics B to G), which occurred in small quantities. None illustrated.

BUFF WARE (EXETER FABRIC 440)

Flagons in a buff fabric, probably imported from France. This was produced in the first century and into the early second, and is not a common ware on the site.

Flagon: 266, 287

EBOR WARE (EBO OX)

Made from c.70 to the early third century at York. A small number of vessels are known from the site. The most common type found in the northern frontier zone are the red-painted bowls, but there are also some North African-style vessels.

Dish: 319

Red-painted. See Monaghan 1997, 877–80. Date: Hadrianic-Antonine

Flanged bowl: 93

Late Ebor ware (North African style)

Date: early third century.

Casserole: 275

Head pots: 338–44

Lid: 330 (?)

SEVERN VALLEY WARE (SVW OX)

Small quantities of Severn Valley ware reached the Lower Tyne forts in the second and third centuries. At Newcastle it made up only 0.1% of the pottery assemblage (Bidwell and Croom 2002, table 15.8), and at Wallsend would be even less.

Storage jar: 304

LOCALLY PRODUCED GREY AND OXIDISED WARES

A number of fabrics have been identified as those of locally produced wares of the second century. The main products are cooking-pots with groove or lattice decoration

(particularly in grey ware), flat-rimmed carinated bowls, and plain-rimmed dishes, but also beakers, storage jars and lids. The finest oxidised fabric was often decorated with white paint (see Lower Tyne painted oxidised ware below). The forms indicate production started in the early second century and continued throughout the Antonine period.

Grey ware 1 (GW1)

Hard mid to pale grey micaceous fabric. Very fine black and white inclusions, occasionally large. Surfaces are usually darker than the core, particularly noticeable where the surface has been chipped. This is the most common of the fabrics.

South Shields grey ware fabric 1 is the same ware (Bidwell and Speak 1994, 231).

Small jar: 3, 88

Bowl: 262

Bowl, flat-rimmed: 39, 265

Cooking-pot: 9, 10, 18–9, 54, 312

Dish, plain-rimmed: 46

Storage jar: 302

Grey ware 2 (GW2)

Gritty grey fabric, coarser and softer than grey ware 1. Angular grey and black inclusions, and some linear black inclusions. Occasionally has grey core with paler margins. Rarely burnished, and often with a mottled surface.

Beaker, indented: 298

Bowl, flat-rimmed: 23, 40

Bowl, hemispherical: 29

Flagon, pinch-necked: 293

Cooking-pot: 50–1

Grey ware 3 (GW3)

Micaceous grey fabric with wide buff core, and scattered, large inclusions, including sandstone. It is not as gritty as grey ware 2, but the individual inclusions can be larger.

Cooking-pot, bead-rimmed: 271

Oxidised ware 1 (OW1)

Slightly gritty, micaceous orange fabric with medium-sized quartz and plentiful soft red inclusions. There are occasional large or very large inclusions, opaque white or fragments of sandstone. The inclusions are noticeable on the surface of the vessel, although the surfaces are often wiped.

Bowl, flat-rimmed: 22

Bowl, flat-rimmed hemispherical bowl: 47, 94

Dish, flat-rimmed: 95

Dish, flat-rimmed with groove: 111

Oxidised ware 2 (OW2)

Probable a variant of the above, but with white inclusions more prominent than the red inclusions, and often more highly fired.

Dish, plain-rimmed: 27

Lower Tyne painted oxidised ware (LT OW painted)

Hard orange fabric often with a grey core or interior and burnished surfaces. Small common inclusions of angular quartz and occasional small soft orange and hard grey inclusions, fragments of sandstone and some mica can be present. The painted decoration is usually cream/white, but at least one vessel also had brown paint. Decoration includes horizontal stripes, zig-zag, diagonal and herringbone lines,

open circles and lines of dots. The majority of recognised examples have been found at Wallsend and South Shields, although sherds have been recorded from a number of northern sites, including Carlisle and Cramond.

Beaker: 86

Biconical strainer: 21

Bowl: 48, 259, 320, 326

Cauldron: 20

Closed form: 333

BLACK BURNISHED WARE FABRIC 1 (DOR BB₁)

The two main suppliers of coarse ware to the site during the second century were the BB₁ industries and the local production sites set up by the military. In the early part of the third century, little BB₁ reached the site, but from the late third century, when the supply of BB₂ was in decline, BB₁ again began a source of supply. Most of the BB₁ from the site comes from Dorset, but there are small quantities of BB₁ from other sources, such as Rossington Bridge.

Bead-rimmed jar: 11, 72, 132

Bowl and dish, flat-rimmed: 24–5, 57–8, 62, 273

Bowl and dish, plain-rimmed: 191–9

Bowl, plain rimmed with groove: 41, 56

Bowl, flanged: 230–44

Cooking-pot: 12–3, 55, 66, 141–3

BLACK BURNISHED WARE FABRIC 2 (BB₂)

This ware is present in small quantities from the late second century, but becomes, with its allied industries, the major coarse ware supplier in the third century. For discussions of the dating, see Bidell and Speak 1994, Bidwell and Croom 2002, 153, 169, and Hodgson 2003, 244. By the 270s at the latest, BB₁ had begun to supply pottery in some quantity again, but it appears that some BB₂ continued to reach Wallsend until the final quarter of the century. The site has produced 13 examples of flanged bowls in BB₂, dating to after c.270. The fort at Newcastle, further upriver, has also produced a number of these bowls, but surprisingly few have been found at South Shields, even though the pottery supplies for Wallsend and Newcastle must have come through its port.

Beaker: 63, 131

Bowl and dish, bead-rimmed: 207, 274

Bowl and dish, plain-rimmed: 200–2, 284

Bowl and dish, plain-rimmed with groove: 110, 203–4

Bowl and dish, rounded-rimmed: 67, 208–9, 211–29, 256–7

Bowl, flanged: 328

Cooking-pot: 6, 14, 17, 68, 144–52, 254, 313

Cooking-pot, small: 251–3

Miniature dish, plain-rimmed with groove: 98

SOUTH EASTERN REDUCED WARES (SE RW)

Date: mostly third century.

This term is used for a number of different fabrics from several production centres that were in business at the same time as BB₂, probably mainly situated in southern Essex (see Monaghan 1987; called 'fabrics allied to BB₂' in Bidwell and Speak 1994, 228–31). They were imported to the north-east over the same time period as BB₂, and at Wallsend are an important source of supply. Cooking-pots were made in a gritty fabric (in particular Gillam 1970 type 151 jars) and in a sandy fabric without any decoration, burnishing or slip. Storage jars were made in a slightly gritty fabric, often with a grey core, and frequently have burnished

decoration. Wide-mouthed bowls and flasks could be slipped, burnished or both, the bowls often with a black or dark grey surface and commonly wavy line decoration, and flasks with a speckled light grey surface. The ware appears alongside BB₂ from the late second century, but the vessel type Gillam 151 probably only appears in the third century; at South Shields it is first seen in contexts dating after c.220 (Hodgson 2003, 245).

Beaker: 260

Beaker, poppy-head: 101

Bowl, wide-mouthed: 186

Bowl, S-shaped: 82, 109, 187–9

Cooking-pot: 59, 71, 80, 104–5, 153, 155–69, 172–7, 179, 261, 282

Cooking-pot with bead rim: 69, 310

Cooking-pot, Gillam 1970 type 151: 70, 92, 180–1, 314

Flagon: 291

Flask: 119

Storage jar: 15–6, 79, 135–7, 305

HORNINGSEA (HOR RE)

Horningsea ware, always in the form of storage jars, have now been recognised at Wallsend, South Shields (Bidwell and Speak 1994, fig. 8.14, no. 162 and unpublished), Newcastle (Bidwell and Croom 2002, 153), and Benwell (McBride 2010, fig. 3, no. 2). As the jars were probably imported in small numbers at the same time as BB₂ and SE RW they are likely to be mainly third-century in date on the site.

Storage jar: 134, 250, 306

EAST ANGLIAN MICA-RICH FABRICS

Grey fabric with abundant, fine muscovite mica on the surfaces.

Platter: 44, 83

LOCAL TRADITIONAL ('NATIVE')

This term covers a range of fabrics used for making vessels that continued the local indigenous Iron Age traditions of pottery making (Bidwell and Croom 2002, 169–70). The fabrics are usually black, sometimes with patchy oxidised surfaces, with a range of large inclusions, and are always hand-made.

Cooking-pot: 185, 311

DALES-TYPE

Vessels without shell-tempering, in the form of Dales ware cooking-pots. True Dales ware vessels were also present. Third-century in date.

Cooking-pot: 182–3

EAST YORKSHIRE GREY

Date: third century

There are examples of pottery from Norton (c.220–80), and from Throlam (mid- or late third century to mid-fourth century) and probably also the other sites of the Holme-on-Spalding-Moor industries.

Beaker, with handle: 133

Bowl, wide-mouthed: 190

Bottle: 301

Countersunk lug-handled jar: 280

Jug: 303

Smith pot: 347

SOUTH YORKSHIRE GREY

A number of vessels are likely to come from the South Yorkshire industries, but this was never a major source of supply. There is also a bowl with internal decoration in a South Yorkshire/Lincolnshire tradition (Fig. 22.22, no. 263). Dish: 263

LATE GRITTY GREY

Date: late third century–fourth century

Hard, mid-grey fabric with common to abundant, large quartz inclusions. Typically found as cooking-pots with everted rims that are flat-topped, cupped or double lid-seated. The vessels were both wheel-thrown, and hand-thrown with the rim finished on a slow wheel. This is one of the most important sources of pottery in the late Roman period in north-east England (for a full discussion of the ware see Croom *et al* 2008, 229–30).

Cooking-pot: 272

CALCITE-GRITTED (CG)

See Tomber and Dore 1998, 201. The National Fabric Reference Collection abbreviation HUN CG is not used in order to avoid confusion, as the ware includes non-Huntcliff-type vessels. ‘Huntcliff-type’ is used here to refer only to cooking-pots with an internal groove on the rim (Gillam 1970 types 162–3).

Date: small quantities from late third century, mainly fourth century

Calcite-gritted ware was originated in the pre-Roman period and continued to be made throughout the Roman period, but it was only imported to the north-east in any quantity from the late third century. In the north-east the cooking-pot is the most common form found, although some storage jars, wide-mouthed bowls and plain-rimmed bowls are known. The Huntcliff-type rim seems to appear in *c.*360, before the introduction of Crambeck parchment ware (Bidwell and Croom 2010, 29).

Cooking-pot, with Huntcliff-type rim: 108, 315

Dish, plain-rimmed: 327

Storage jar: 103

CRAMBECK REDUCED WARE (CRA RE)

The reduced ware first reaches the north in the late third century, and continues until at least the late fourth century (Bidwell 1985, 178; Bidwell and Croom 2010). It was supplied in a range of forms, such as bowls, dishes, beakers and water-carrying jars, but not cooking-pots (which seem to have been supplied by the calcite-gritted ware industries which were located in the same part of the country, but not at the same kiln sites). The conical flanged bowl with internal wavy line first appears *c.*370.

CRAMBECK RED WARE

Red fabric, often decorated with white paint, probably with a similar dating to the painted parchment ware. One example known from the site.

Bowl: 329

NORTH GAULISH GREY WARE (NOG RE).

Date: first to third century.

This ware has been found at South Shields, Wallsend and Newcastle in small quantities. The most common form is the *vase triconique*.

Vase triconique: 38, 81, 308

GREY WARE 4

A minor grey ware fabric. Hard grey fabric, distinctive due to the plentiful fine white quartz inclusions.

Cooking-pot: 138, 171

Bowl/dish: 205

Lid: 31–2

GREY WARE 6

Grey fabric, distinctive because of the plentiful small and common large black inclusions. A number of related fabrics, with the same common black inclusions, have been found across the eastern section of Hadrian’s Wall. It has been found at a number of turrets along Hadrian’s Wall, mainly between Housesteads and Rudchester, so it is possible that Corbridge could be the source for this ware. It appears to be Hadrianic and Antonine in date.

Cooking-pot: 91, 102

SOUTHERN SHELL-TEMPERED WARE. SEE BIDWELL AND SPEAK 1994, 230.

Jar: 307

*Other fabrics of interest (none illustrated)***SAVERNAKE WARE (SAV GT)**

Date: Early first century to early or mid-second century, with Lydiard Tregose kilns possibly continuing into the third or fourth centuries.

This ware usually has a limited distribution in and around Wiltshire and Bath (Tyers 1996, fig. 248), and it has not previously been identified in the north. Two sherds from jars were recovered (F11:07, G11:09, robber trench and unstratified). It is of interest that a sherd of New Forest mortaria, also of very restricted distribution, should also be found at Wallsend.

PINK GROG-TEMPERED WARE (PNK GT)

A sherd of this ware was recovered from the alley deposit (Alley 1; context N05:23). This ware is almost exclusively found in the Northamptonshire and Buckinghamshire region, but two vessels have now been found at Cramond (Ford 1991).

PARISIAN WARE

Date: late first to third century

A small number of sherds in at least three different fabrics, with stamped decoration, including roundels, rosettes and squares.

Catalog e (Fig 221226)*Rampart building (C11:04)*

1. Pale orange fabric, cream to exterior. Fine fabric with very rare larger inclusions, and rare silver mica. Single handle.
2. Colchester?
3. GW1.
4. Hard mid-grey fabric, with slightly paler margins, and occasional black or white inclusions. Burnished on shoulder, with vertical line rouletting on the top part and diagonal line rouletting on the lower part.
5. Dark grey, sandy fabric, slightly micaceous. Burnished under the rim, but otherwise a sandy surface. Linear rustication.

6. BB2.
7. Burnished on shoulder and over rim. Fine micaceous, sandy fabric with buff core and dark grey surfaces.
8. Soft, pale orange fabric with pale brown core. Possibly originally mica-dusted.

See also: Croom 2003, fig. 158, nos 15–9.

Alley 1

LOWER FILL

9. GW1, M05:16.
10. A second, with the rim oval in shape and body slightly flattened before firing. GW1, M05:16, M05:12.
11. BB1, M05:16.
12. BB1, with sooting under rim, M05:16.
13. BB1, M05:16.
14. BB2, M05:16.

DAUB DEPOSIT

15. SE RW, N05:23.
16. SE RW, N05:23.
17. BB2. Four lines incised on top of rim. N05:23.
18. GW1, N05:23.
19. Zone on body left unburnished. Body slightly flattened on one side (cf. no. 10 above). GW1, N05:23, N05:19.
20. Line of white dots, some of which have run. Lower part of body burnished. Most of vessel survives. Gillam 1970 type 174, *Cam* 302. First half of the second century to late third century or later (Bidwell and Croom 1999, 481). LT OW painted, N05:23.
21. Originally this probably had a spout; Marsh 1978, type 46. Burnished footring. Much of vessel survives. LT OW painted, N05:23.
22. OW1, N05:23.
23. GW2, N05:23.
24. BB1, N05:23.
25. BB1, N05:23.
26. Burnished on rim and exterior. Micaceous grey fabric, slightly sandy, with a dark grey core, white margins and mid-grey surfaces, N05:23.
27. A second, warped in firing so that the rim is out of shape and base is not flat. OW2, N05:23, N05:24.
28. Two surviving repair holes, on non-joining sherds; some sooting on exterior. Sandy dark grey fabric, darker towards the exterior. well-rounded quartz c. 1mm across is the most noticeable inclusion, with less common angular grey and plentiful extremely fine micaceous inclusions, N05:23.
29. Poor condition, battered and spalled. GW2, N05:23, N05:17.
30. Soft orange fabric with light grey core. Concentric grooving on interior. Similar to the 'mortarium-like bowls' of the north-west, but without the groove on the flange. Cf. Birrens; Robertson 1975, fig. 63, nos 11–2. N05:23, N05:24.
31. Darker surfaces, with uneven colouring. GW4, N05:23.
32. GW4, N05:23.
33. Anaus mortarium, 120–60. See mortarium stamp

- no. 4. N05:23, N05:19.
34. Anaus mortarium, 120–60. See mortarium stamp no. 10, N05:23, P04:10.

See also amphora Fig. 22.10, no. 5.

UPPER FILL

35. 'Pink fabric, lighter in fracture; hard, fairly rough with moderate frequency of sub-angular grit inclusions. Traces of white external slipping. Bipartite handle' (Holbrook 1984, no. 9). Lost. M05:12.
36. Soft orange fabric with scattered red inclusions, some large. Remains of a cream wash, M05:12.
37. Fabric white about rim, rest mid-grey. Burnt, and body spalled. M05:12.
38. NOG RE, M05:12.
39. A second; warped. GW1, M05:12.
40. Approximately one-third of the vessel survives. There is rilling on the interior towards the base, while the base is only 2mm thick in the centre. GW2, M05:12.
41. BB1, P05:16.
42. Anaus mortarium, 120–60. See mortarium stamp no. 9. N05:07.
43. North-eastern, second century. P05:16.

DISTURBED UPPER FILL AND DERELICTION OVER ALLEY

44. Fine grey fabric with darker, highly micaceous surfaces. East Anglian? Burnt white along top of rim. N05:07.
45. White fabric with fine black inclusions and small voids and mid-grey surfaces. Same fabric as no. 90 below. N05:07.
46. GW1, approximately one third of vessel survives, L05:29.
47. OW1, L05:29.
48. Not burnished. LT OW painted, with slight grey core and no evidence of paint. L05:29.
49. Mortarium. North-east: pale orange fabric with wide grey core, with large, soft white inclusions and occasional black linear inclusions. Large red and white trituration grits. Hadrianic/Antonine. N05:07.

Alley 3

CLAY LAYER

50. GW2, F04:12.
51. GW2, F04:12.

DRIP TRENCH

52. Hard orange fabric with dark grey core and a thick cream wash, discoloured in firing to grey on one side, F04:33.
53. Soft, gritty orange fabric, slightly burnt near base, F04:33.
54. GW1, F04:33.
55. BB1, F04:33.
56. BB1, F04:33.
57. Slightly burnt. BB1, F04:33.
58. BB1, F04:33.

RUBBLE OVER ALLEY

59. SE RW, gritty fabric, K05:22.
 60. Soft orange fabric with silver mica plates and some brown inclusions. Slightly burnt on the rim, K05:22.
 61. Fine, micaceous orange fabric with red inclusions, paler orange margins and finely burnished self-slipped surfaces. The flange has been deliberately removed (50% of vessel survives), G04:15.
 62. BB1, G04:15.

Hospital: Building 8

PERIOD 1

63. Remains of slip on shoulder and rim. BB2, D10:20.
 64. White fabric, with thin brown wash over interior and exterior. E10:43, E10:56, E10:58.
 65. Pale orange, slightly sandy fabric with fine red and occasional black inclusions. Darker orange exterior, turning to brown on the exterior. E10:43, E10:58.
 66. Burnished decoration on the base. Although there is a complete profile, less than 15% of the vessel survives. BB1, D12:34.
 67. Bowl or dish with drooping rim and curved wall. Cf. Monaghan 1987, 5D0.2BB2, E10:76.

PERIOD 3

68. Buried pot, found with stone lid *in situ* (see stone report, no. 35, and Fig. 25.33). BB2, D11:23.

MID THIRD CENTURY

69. SE RW, E11:14.
 70. SE RW, E11:14.
 71. SE RW, E11:14.

See also: Croom 2003, fig. 158, nos 11–4.

Barracks

PERIOD 2

72. BB1, F04:07.
 73. Micaceous sandy grey fabric with pale grey core and paler margins and soft black inclusions. Sooting under rim. Cf. no. 106 below. P05:07.
 74. White fabric with plentiful fine red and black inclusions. Burnished in bands on exterior, fired to pale orange on the top of the rim, Q05:03, plus Q04:01 (unstratified).
 75. Orange fabric with fine red inclusions and paler surfaces, N07:15.

PERIOD 3

76. Hard, micaceous orange fabric, with some sooting on the exterior. Mica-dusted, E13:23.
 77. Very dark brown on exterior. LNV CC, E13:13.
 78. Very dark brown on exterior, orange round base and on interior. LNV CC, E13:13.
 79. Approximately one third of the vessel survives. SE RW, M04:14.
 80. SE RW, M04:14.
 81. NOG RE, M05:28.
 82. Body sherd from an S-shaped bowl, with grooves and burnished tendril decoration. Wavy line is more common. SE RW, P05:04.
 83. Highly micaceous grey ware, especially visible on surfaces. East Anglian? Mid-grey core, paler margins and burnished surfaces, M05:28.

PERIOD 4

84. Black colour coat on exterior only, thin and mottled round rim. LNV CC. E13:49,
 85. Pale brown/orange stripes. The shape of this vessel is very close to the funnel-necked beakers based on 'rhenish' forms (Perrin 1999, fig. 61, no. 173) rather than the narrow-mouthed jars more commonly made in parchment ware (Howe, Perrin and Mackreth 1980, fig. 8, nos 94–5), suggesting a date after the mid or late third century. LNV PA. M14:15, M14:01 (unstratified).
 86. Burnished in bands on neck and decorated with thin white paint. LT OW painted. M14:45.
 87. Dark brown colour coat. For dolphins on other LNV CC beakers see G. Webster 1989, 6. LNV CC. G11:10. GW1, G04:03.
 88. Fine, mid-grey fabric, burnished on exterior. Decorated with grooves and open circle stamps. Globular beakers with a similar profile but different decoration were found at Blaxton kiln site, where it was noted that the form and fabric were related to Parisian ware (Buckland and Dolby 1980, fig. 4, nos 49–50). D13:55.
 90. White fabric with fine black inclusions and small voids and mid-grey surfaces. Same fabric as no. 45 above. F12:04.
 91. GW6, Q05:28.
 92. Buried pot. SE RW, D14:10.
 93. Coarse orange fabric with large red and white inclusions. EBO OX red-painted, N15:12.
 94. Grey core and pale orange surfaces. Burnished in bands. OW1, G14:20 and G14:01 (unstratified).
 95. Roughly burnished. OW1, J15:15.
 96. Very fine, micaceous dark grey fabric with pale margins and dark surfaces, with silky finish. Barbotine leafs. Imitation Dr 36s in oxidised or colour-coated wares are much more common than examples in reduced ware. Grey ware examples may have been made in the Doncaster area, where a waster or second was found (Buckland 1986, 21, no. 23), and are also known from the Lower Nene Valley (Perrin 1999, fig. 59, no. 98), Cf. a grey ware imitation Curle 11 from South Shields (Bidwell and Speak 1994, fig. 8.8, no. 16). G11:10. Another sherd of this vessel was found unstratified in the 1997–8 excavations.
 97. Hard, mid-grey fabric, slightly sandy. F15:06.
 98. Miniature dish, with faint external groove (cf. Monaghan 1987, type 9B5.1). BB2, H05:41.

THIRD CENTURY AND LATER

99. Dark orange fabric with remains of cream wash, E05:04.
 100. LNV CC, L05:07 and L05:03 (unstratified).
 101. SE RW poppy-headed beaker, F11:18.
 102. GW6, F11:17.
 103. CG, N05:04.
 104. Heavily sooted. SE RW, gritty fabric, overfired, J04:05.
 105. SE RW, F11:13.
 106. Highly micaceous grey fabric with dark grey core and pale grey margins. Occasional soft black inclusions. Sooting under rim. Cf. no. 73 above, N05:04.

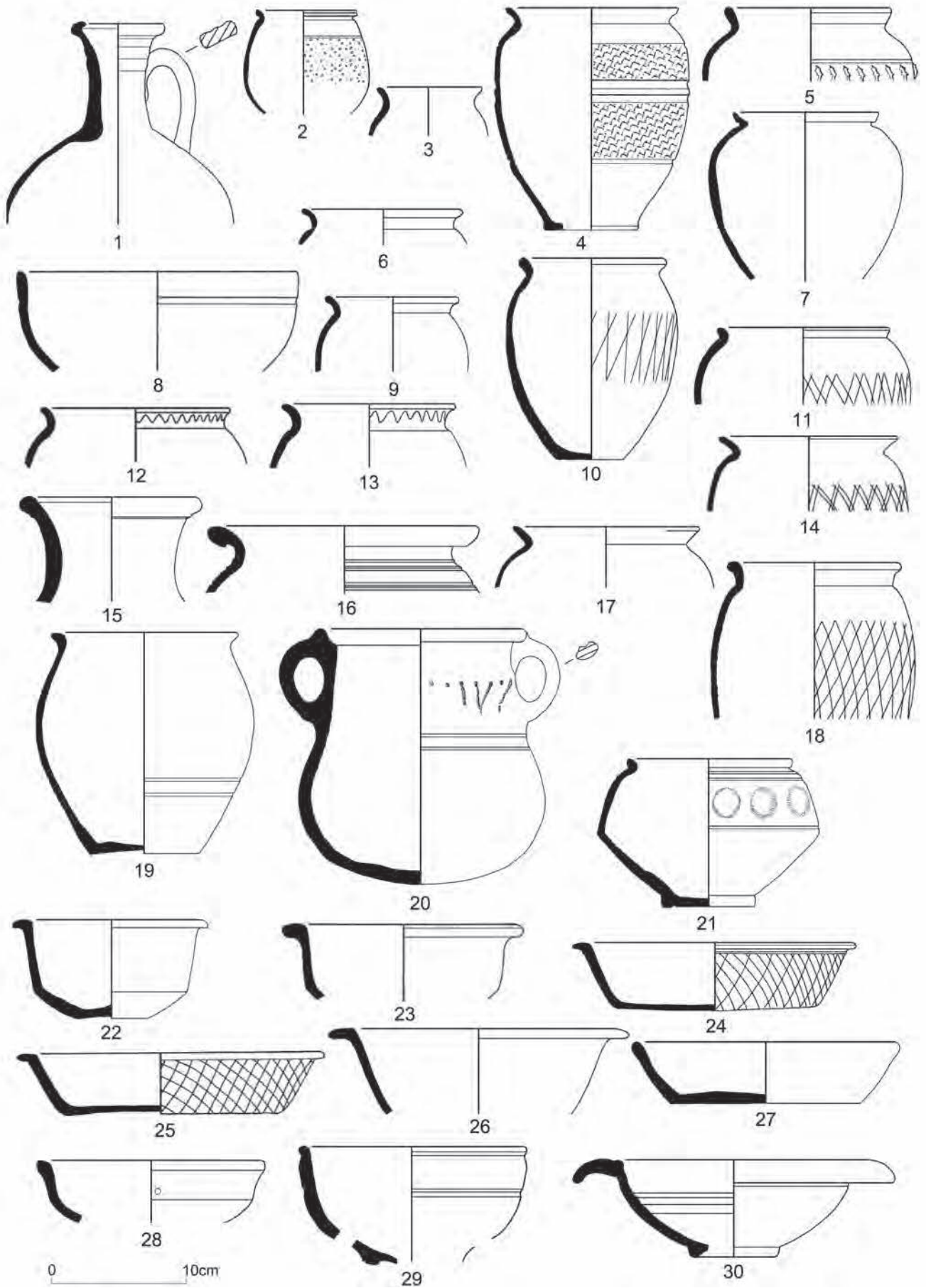

Figure 22.12: Coarse wares nos 1-30. Scale 1:4.

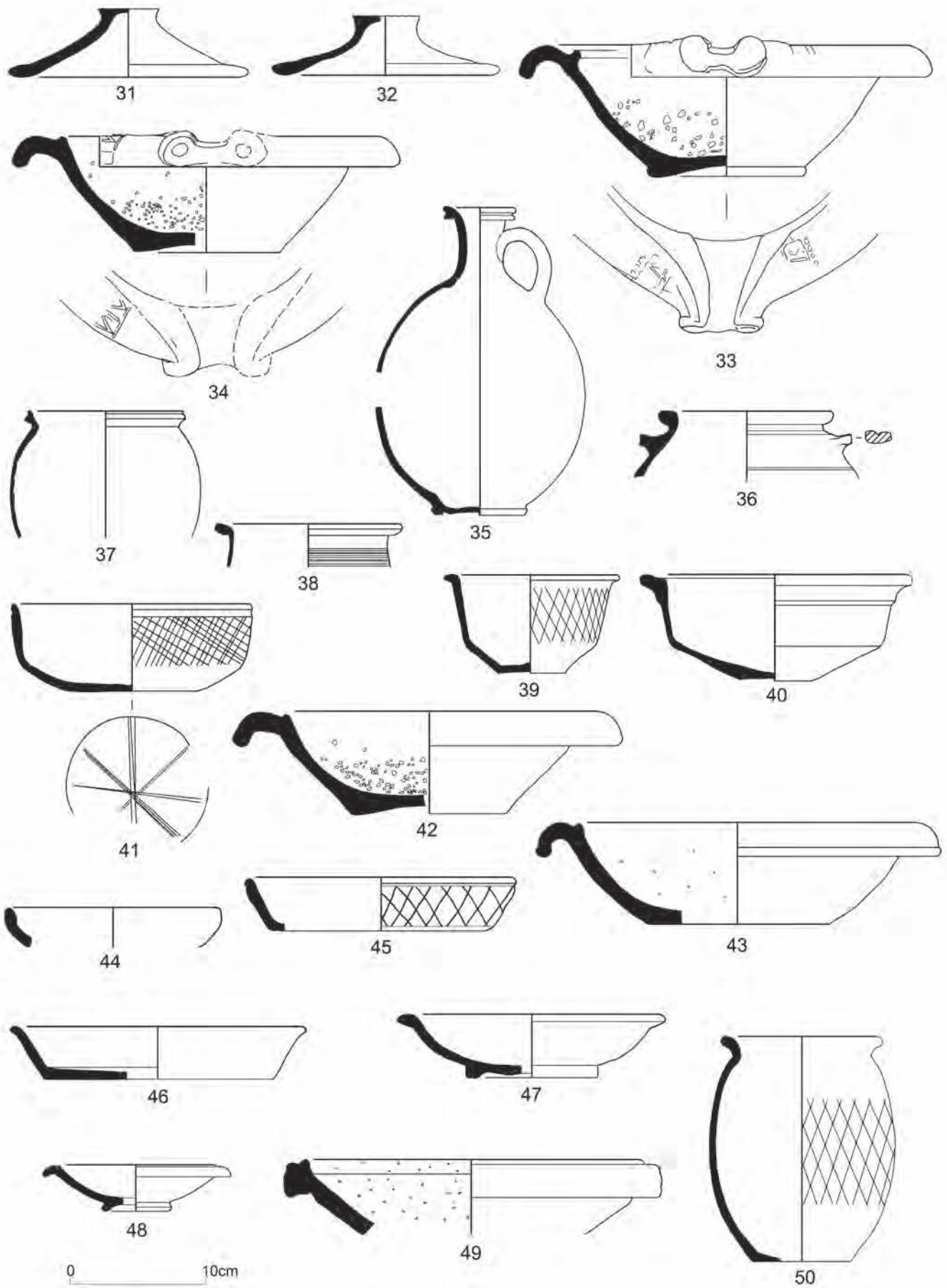

Figure 22.13: Coarse wares nos 31–50. Scale 1:4.

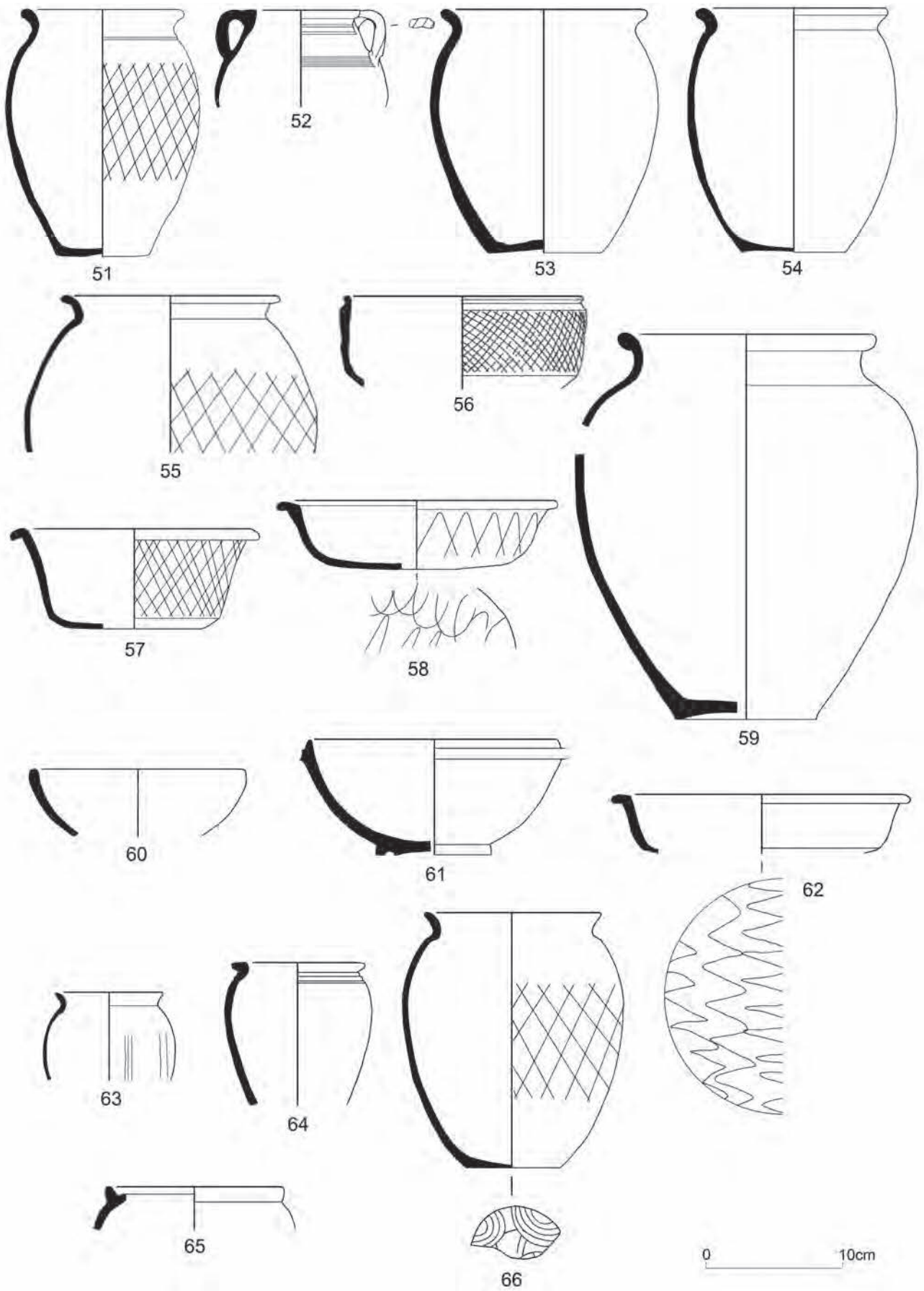

Figure 22.14: Coarse wares nos 51–66. Scale 1:4.

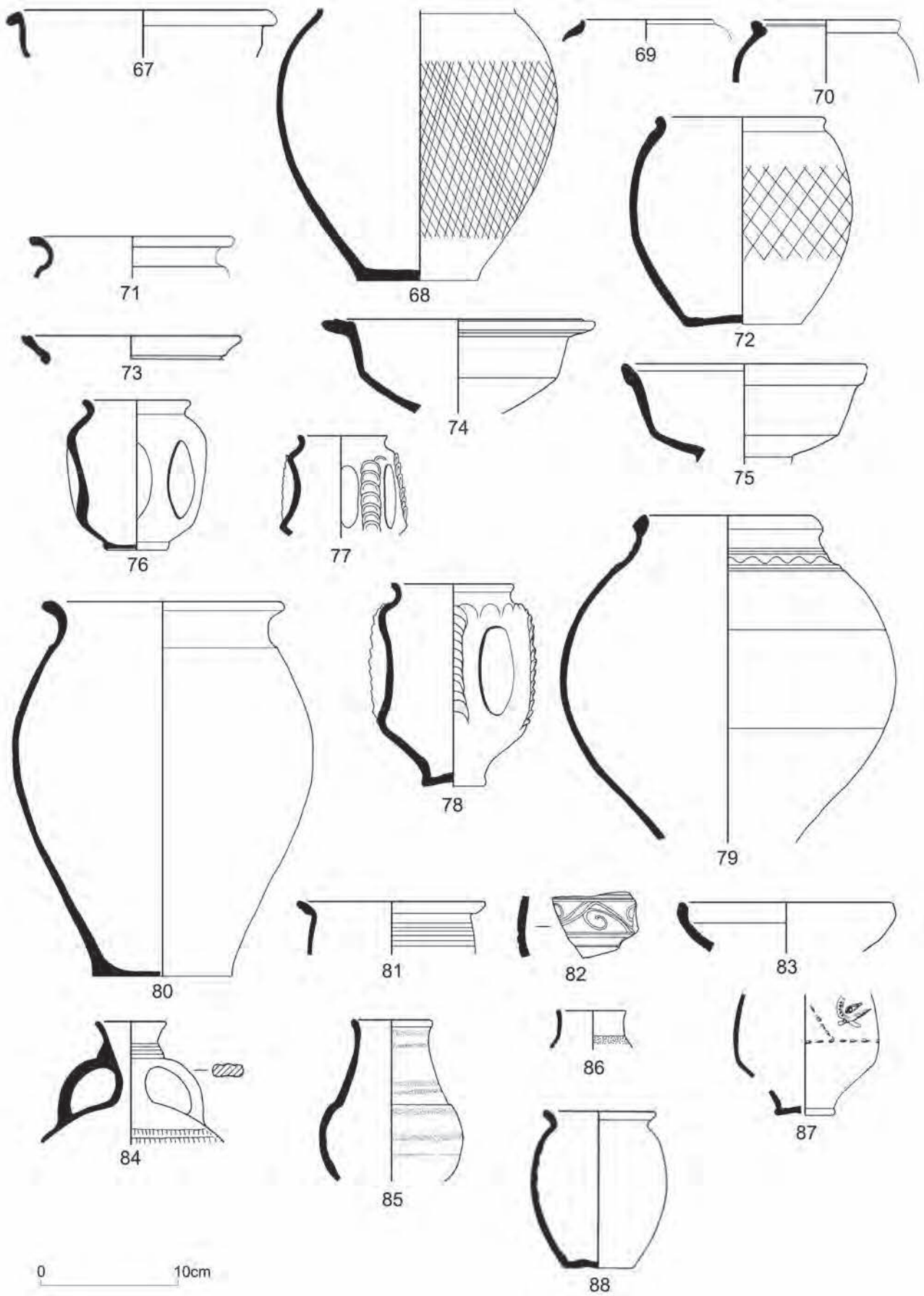

Figure 22.15: Coarse wares nos 67–88. Scale 1:4

107. Dark grey fabric with fine white quartz and occasional black inclusions. Slightly lighter surfaces, H04:19.
108. CG, N05:04.
109. SE RW, F11:03.
110. BB2, F11:17.
111. OW1, J04:05.
112. EPO MA. A flange fragment, from a second vessel, came from M04:01 (unstratified). P07:08.
- Cistern 1*
113. Dressel 20, E08:29.
114. Gauloise 4, E08:29.
115. Central Campanian, E08:27.
116. Biv, with thick cream wash. E08:29.
117. Almost complete vessel, flagon fabric A, without wash, E08:29.
118. Almost complete jar missing rim, LNV PA, E08:27.
119. SE RW, E08:44.
120. LNV CC, orange fabric, E08:27.
121. Approximately two-thirds of vessel surviving. LNV CC, orange fabric and black colour coat, E08:27.
122. Orange fabric, dark brown colour coat, with barbotine leaves and the tail and hindquarters of a dog. Some sooting on the lower part of the vessel. LNV CC, E08:27.
123. White fabric, tan colour-coat. LNV CC, E08:29.
124. Fine grey fabric with a few dark inclusions. Mid-grey colour coat, darker on the exterior. About quarter of the vessel survives. E08:29.
125. Approximately half of vessel surviving. LNV CC, orange fabric and black colour coat, E08:44.
126. Orange fabric, brown colour-coat. LNV CC, E08:27.
127. Black colour-coat. LNV CC, E08:44.
128. Black colour-coat, on exterior only. Probably from a small flagon (cf. Dannell *et al* 1993, fig. 16, no. 46). LNV CC, E08:27.
129. Buff fabric, black colour-coat, slightly burnt on exterior. Indented beaker with funnel mouth (*Cam* 403), cf. Colchester: Symonds and Wade 1999, fig. 5.39, no. 61. As this type is usually dated to the fourth century (Bidwell and Croom 1999, 486), this may be part of the later contamination of the cistern fill. LNV CC, E08:27.
130. Fine mid-grey fabric, paler core. Black inclusions create a speckled appearance on the non-burnished exterior. E08:27.
131. BB2, E08:29.
132. BB1, E08:29.
133. One surviving handle. East Yorkshire grey ware, E08:29.
134. HOR RE. E08:29.
135. SE RW, E08:27.
136. SE RW, E08:44.
137. SE RW, E08:27.
138. GW4, E08:29.
139. Slightly sooted under rim. Hard, slightly granular grey fabric with slightly darker surfaces. E08:29.
140. Sooted. Soft micaceous mid-grey fabric, with angular black inclusions, very fine burnishing over rim and shoulder. E08:44.
141. Heavily sooted. BB1, E08:29.
142. Heavily sooted. BB1, E08:27.
143. Sooted. BB1, E08:27.
144. Slight sooting. BB2, with oxidised surface, E08:29.
145. Sooted. BB2, E08:29.
146. BB2, E08:29.
147. Sooted. BB2, E08:29.
148. Slight sooting. BB2, E08:27.
149. Sooting on interior of, and under, rim. BB2, E08:27.
150. Sooted. BB2, E08:29.
151. Heavily sooted under the rim. BB2, E08:44.
152. BB2, E08:44.
153. Sooted. SE RW, E08:27, E08:29.
154. Sooted on exterior of rim. Micaceous grey fabric, with pink core, E08:27.
155. SE RW, E08:29.
156. SE RW, with oxidised surfaces. E08:27.
157. Sooting on body. SE RW, E08:27.
158. Sooted. SE RW, E08:29.
159. Heavy sooting on exterior and over rim. SE RW, E08:44.
160. Sooting on interior of rim and body. SE RW, E08:29.
161. Heavily sooted. SE RW, E08:44.
162. SE RW, E08:27.
163. SE RW, E08:27.
164. Heavily sooted under the rim. SE RW, E08:27.
165. Heavily sooted. SE RW, E08:27.
166. Heavily sooted. SE RW, E08:29.
167. Sooted. SE RW, E08:27.
168. SE RW, E08:27.
169. Heavily sooted. SE RW, E08:27.
170. Hard mid-grey fabric, with fine white inclusions, E08:27.
171. Slight sooting. GW4, E08:29.
172. Heavily sooted. SE RW, gritty fabric with oxidised surfaces. E08:27.
173. Sooted. SE RW, E08:29.
174. Heavy sooting on exterior, and over the rim, including all of the interior. SE RW, E08:44.
175. Sooted. SE RW, E09:44.
176. SE RW, E08:27.
177. Heavy sooting on rim and on body from below the shoulder. SE RW, E08:44.
178. Sooted on exterior of rim. Micaceous grey fabric with pink core. E08:29.
179. Slightly sooted. SE RW, E08:44.
180. SE RW, E08:29.
181. SE RW, E08:29.
182. Dales-type; black fabric with fine mixed inclusions and with pale grey margins, E08:44.
183. Heavy sooting. Dales-type; sandy brown fabric with dark grey surfaces, E08:27.
184. Sooted on interior of rim. Hard, sandy grey fabric with angular black inclusions and pale grey core. E08:29.
185. Hand-made, grey fabric with dark grey exterior and buff interior surface. Highly micaceous gritty fabric, with gold mica plates. Sooting on both surfaces of the rim, and on the body. Local traditional, E08:27.
186. SE RW, E08:29.
187. SE RW, E08:29.
188. SE RW, E08:27.
189. SE RW, E08:44.
190. East Yorkshire grey ware, E08:27.
191. Slightly sooted near base. BB1, E08:29.



Figure 22.16: Coarse wares nos 89–112. Scale 1:4.

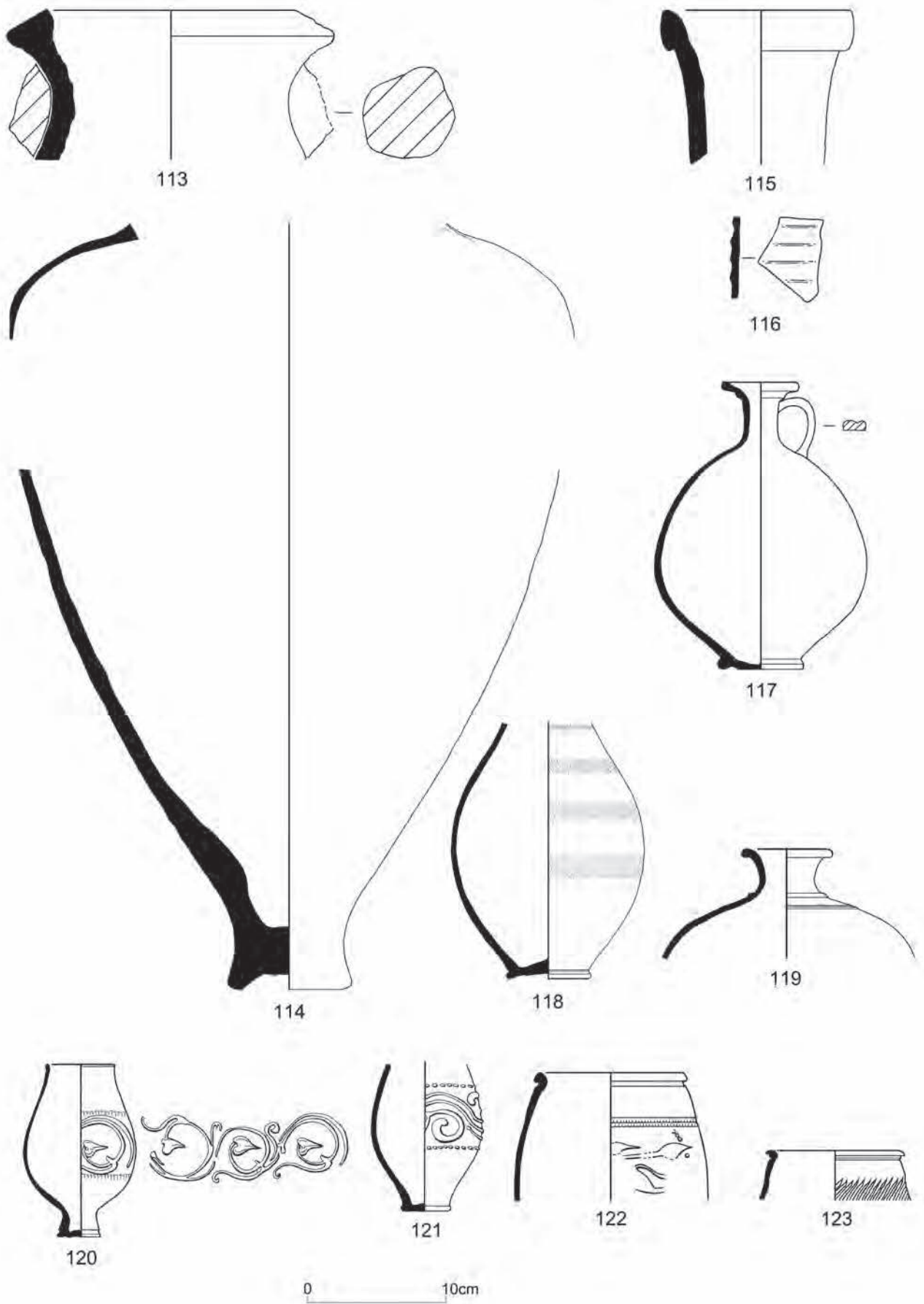

Figure 22.17: Coarse wares nos 113–123. Scale 1:4.

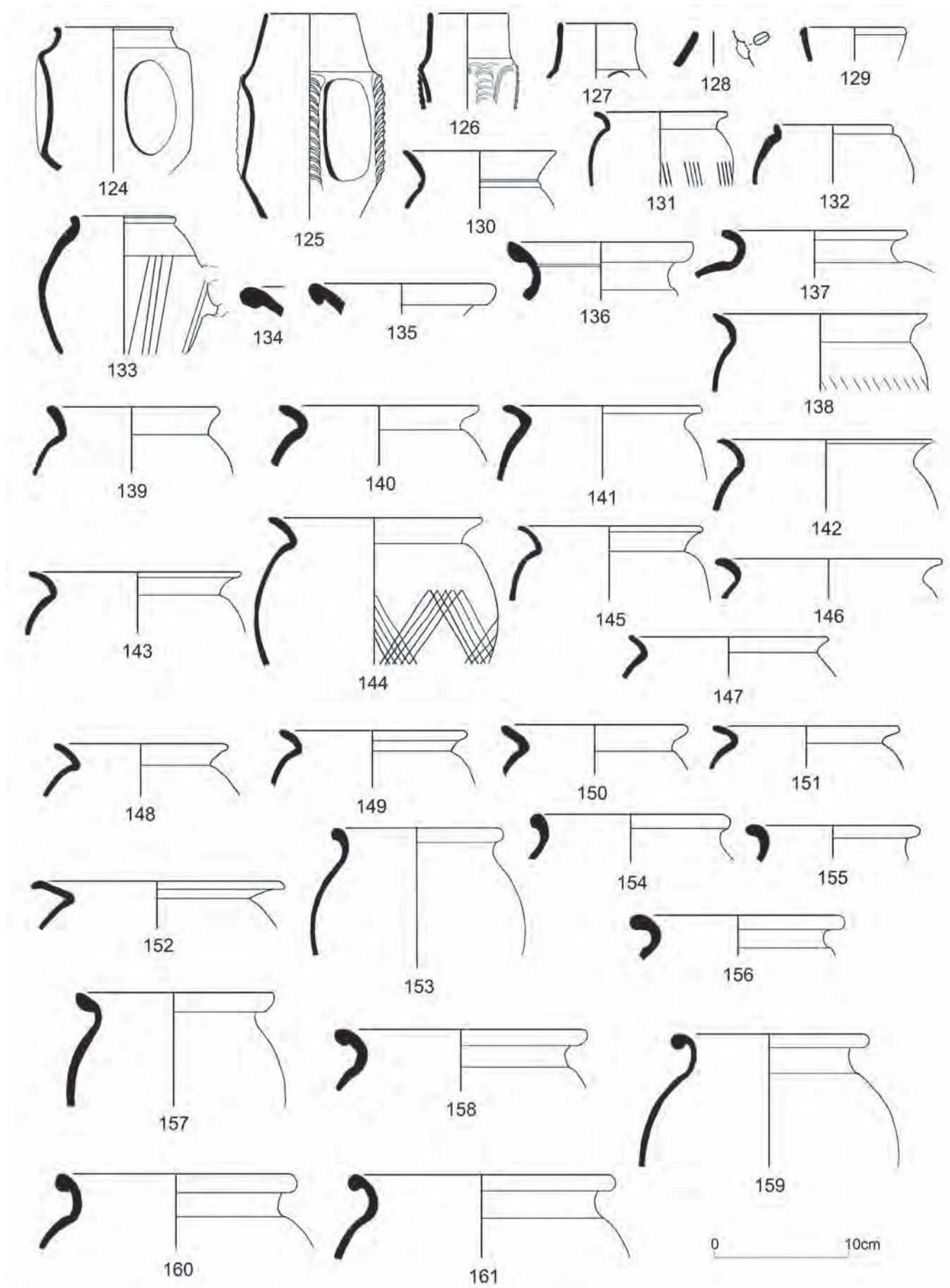

Figure 22.18: Coarse wares nos 124–161. Scale 1:4.

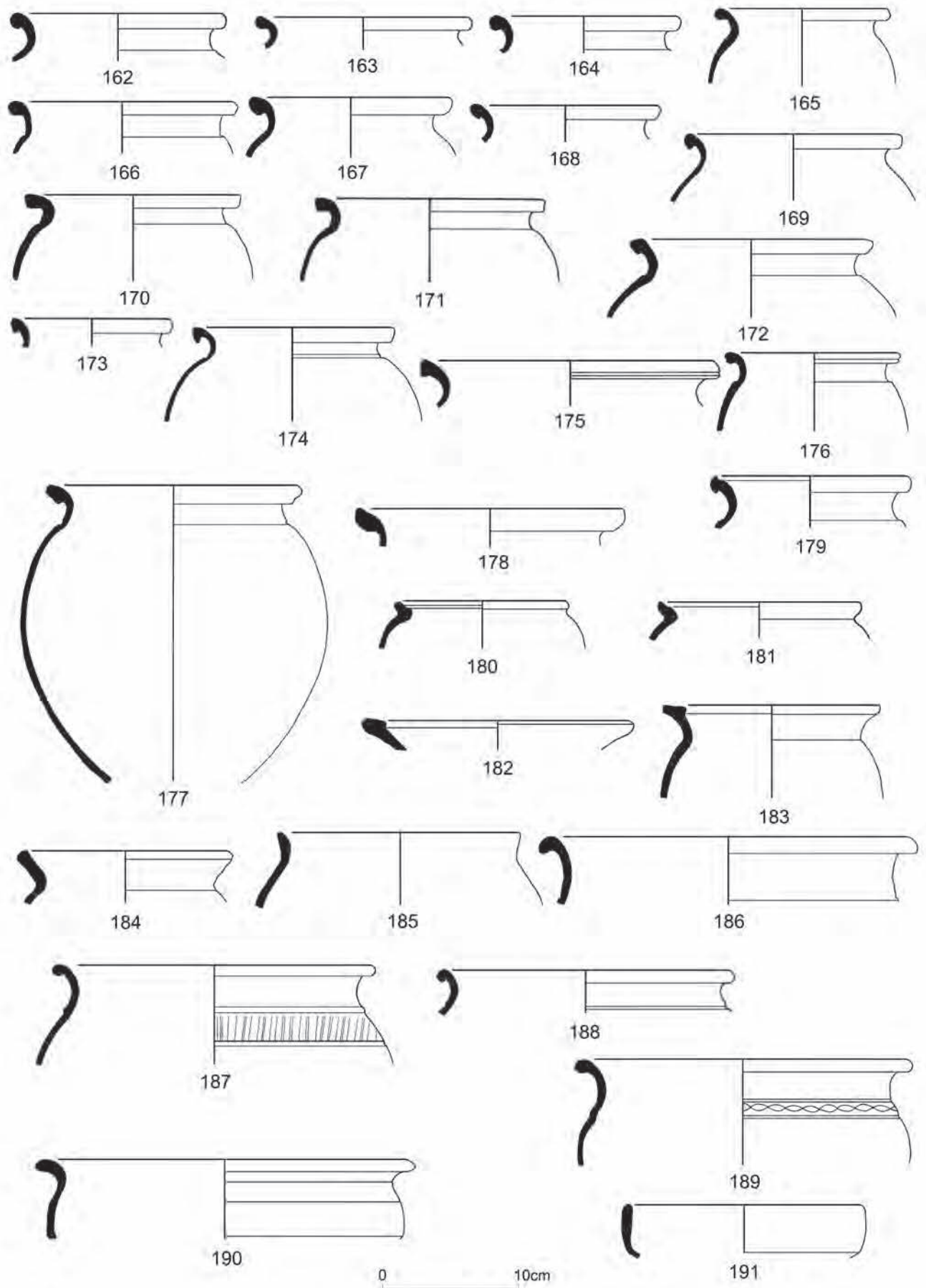

Figure 22.19: Coarse wares nos 162–191. Scale 1:4.

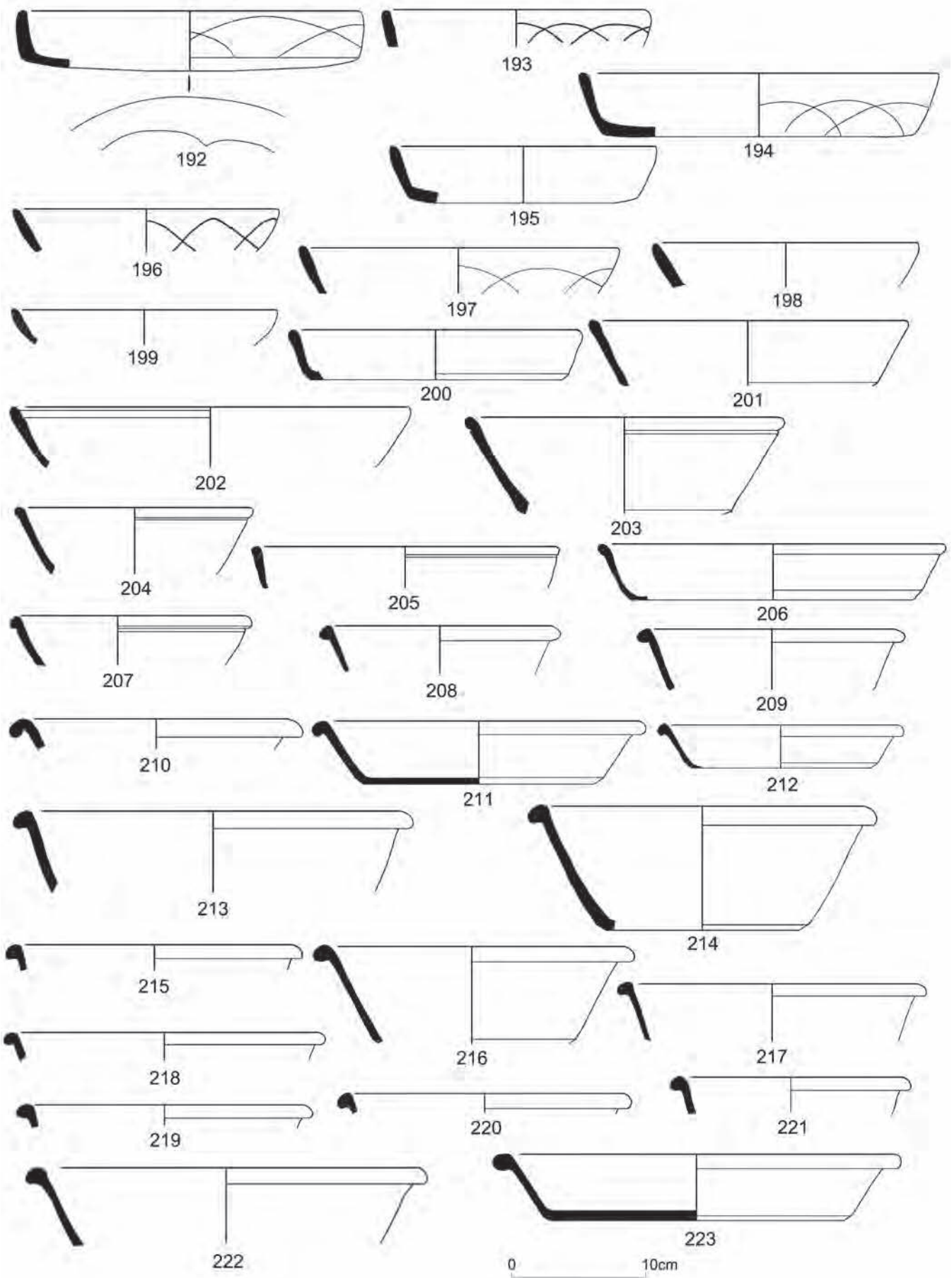

Figure 22.20: Coarse wares nos 192–223. Scale 1:4.

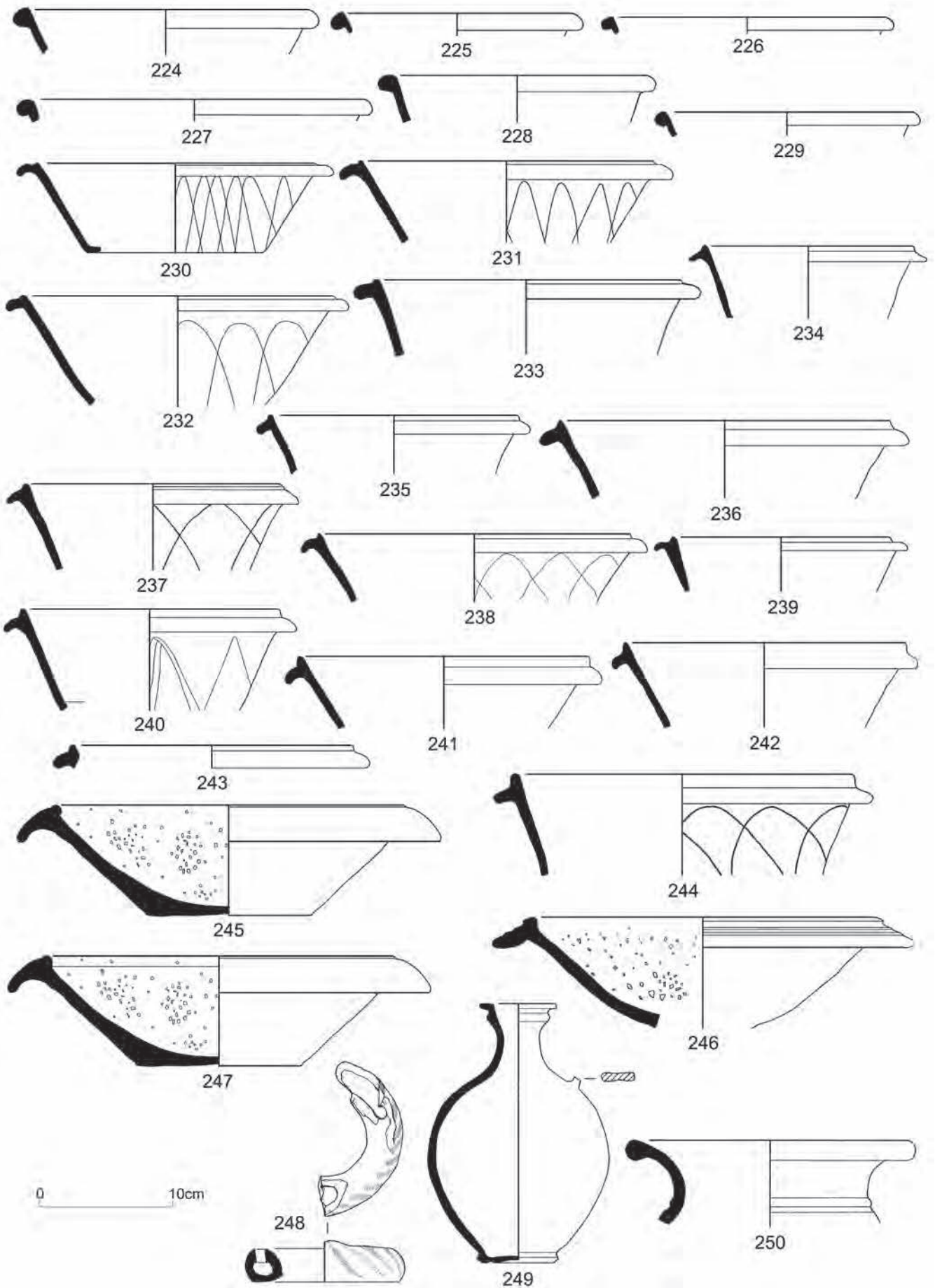

Figure 22.21: Coarse wares nos 224–250. Scale 1:4.

192. Heavily sooted on exterior wall and base. BB1, E08:27.
193. BB1, E08:27.
194. Heavily sooted. BB1, E08:44.
195. Slightly sooted. BB1, E08:44.
196. BB1, E08:27.
197. BB1, E08:29.
198. Sooted on top of rim. BB1, E08:27.
199. BB1, E08:29.
200. BB2, E08:27.
201. BB2, E08:29.
202. BB2, E08:27.
203. BB2, E08:29.
204. BB2, E08:44.
205. GW4, E08:29.
206. BB2, E08:27.
207. Mica-dusted. Pink fabric with cream core and orange colour coat. E08:29.
208. BB2, E08:29.
209. BB2, E08:29.
210. Hard, light grey fabric with white inclusions, E08:29.
211. About quarter of vessel surviving, with heavy sooting on base and sides. BB2, E08:27.
212. Slight sooting. BB2, E08:27.
213. Heavily sooted. BB2, E08:44.
214. Sooted. BB2, E08:27.
215. BB2, E08:29.
216. BB2, E08:27.
217. BB2, E08:29.
218. BB2, E08:29.
219. BB2, E08:29.
220. BB2, E08:29.
221. BB2, E08:29.
222. Sooted. BB2, E08:27.
223. About three-quarters of vessel surviving. BB2, E08:27, E08:29.
224. BB2, E08:29.
225. Sooted. BB2, E08:29.
226. BB2, E08:29.
227. BB2, E08:29.
228. Slight sooting under rim. BB2, E08:29.
229. BB2, E08:29.
230. Slightly sooted near base. BB1, E08:29.
231. Sooted. BB1, E08:29.
232. Sooted. BB1, E08:27.
233. BB1, E08:27.
234. Sandy dark grey fabric with brown core. E08:27.
235. BB1, E08:27.
236. BB1, E08:27.
237. BB1, E08:29.
238. Sooted. BB1, E08:27.
239. Sooted. Has traces of decoration, probably intersecting arc. BB1, E08:27.
240. Sooted. BB1, E08:27.
241. BB1, E08:27.
242. Sooted. BB1, E08:27.
243. BB1, E08:27.
244. Sooted. BB1, E08:29.
245. Mancetter-Hartshill, 140–80, E08:29.
246. Lower Nene Valley, 250–300, E08:27.
247. Lower Nene Valley, 230–400, E08:27.
248. Ring-vase with the remains of two holes, with stripes of brown paint. LNV PA, E08:27.

Cistern 2

249. Battered rim, and missing (single) handle, but apparently thrown away in one piece. Cream fabric with fine red inclusions, occasionally up to 1mm in size, and less common fine black inclusions, J07:14.
250. HOR RE, H07:03, H07:09.
251. No sooting, but discoloured exterior. Approximately half of vessel survives. BB2, H07:03, H07:09.
252. Heavily sooted over body and rim, with white scale and some burning on interior. Approximately one third of vessel survives. BB2, H07:03, H07:09.
253. Heavily sooted on exterior up to and over the rim, with white scale and a patch of burning on the interior. See graffito no. 45. BB2, H07:09.
254. Sooted on exterior. BB2 with partially oxidised surfaces, H07:03, J07:19.
255. Hard fabric with grey core and thin orange margins and fine black inclusions. Orange interior surface, and grey and white exterior surface. Sooted on body and rim. Import? J07:19.
256. BB2, H07:09.
257. See graffiti no. 61. BB2, H07:09.

See also mortarium Fig. 22.08, no. 4.

The rest of the fort

PERIOD 1 AND 2

258. Hard, slightly gritty mid-grey fabric, with slightly darker surfaces. K10:28.
259. LT OW painted, thin white paint. D08:12.

PERIOD 2 AND 3

260. Fine soapy fabric with black core, pale grey margins and dark grey interior, as used for poppy-headed beakers. The mid-grey/brown exterior surface has visible soft black inclusions. E08:64.
261. SE RW, E08:56.
262. Rouletted decoration below two grooves. GW1, with mottled exterior. K07:08.
263. Hard grey fabric, with fine black inclusions. Lincolnshire/South Yorkshire. Parallels: Dragonby: Gregory 1996, fig. 20.10, no. 933, fig. 20.25, no. 1322; Newcastle: Bidwell and Croom 2002, fig. 15.6, no. 42. K07:08.
264. Burnished on interior. Dark grey fabric with buff margins and dark grey surfaces; some possible flint inclusions up to 2mm across visible on the surface, some fine quartz and opaque white inclusions visible in the break, K07:08.
265. GW1, N11:23.

THIRD CENTURY AND LATER

266. Buff fabric with traces of slightly paler wash. Holbrook and Bidwell 1992, 66, buff ware, type 2, Neronian to late 70s or early 80s. E08:46.
267. Soft, slightly micaceous orange fabric with worn barbotine decoration. Red exterior and brown interior colour-coat, F04:19.
268. White fabric, light brown colour coat. LNV CC, L08:52.
269. Applied teardrops over rouletting. Slightly metallic brown colour coat. Cf. Castleford: Rush *et al* 2000, fig. 70, no. 433. LNV CC. H11:33.

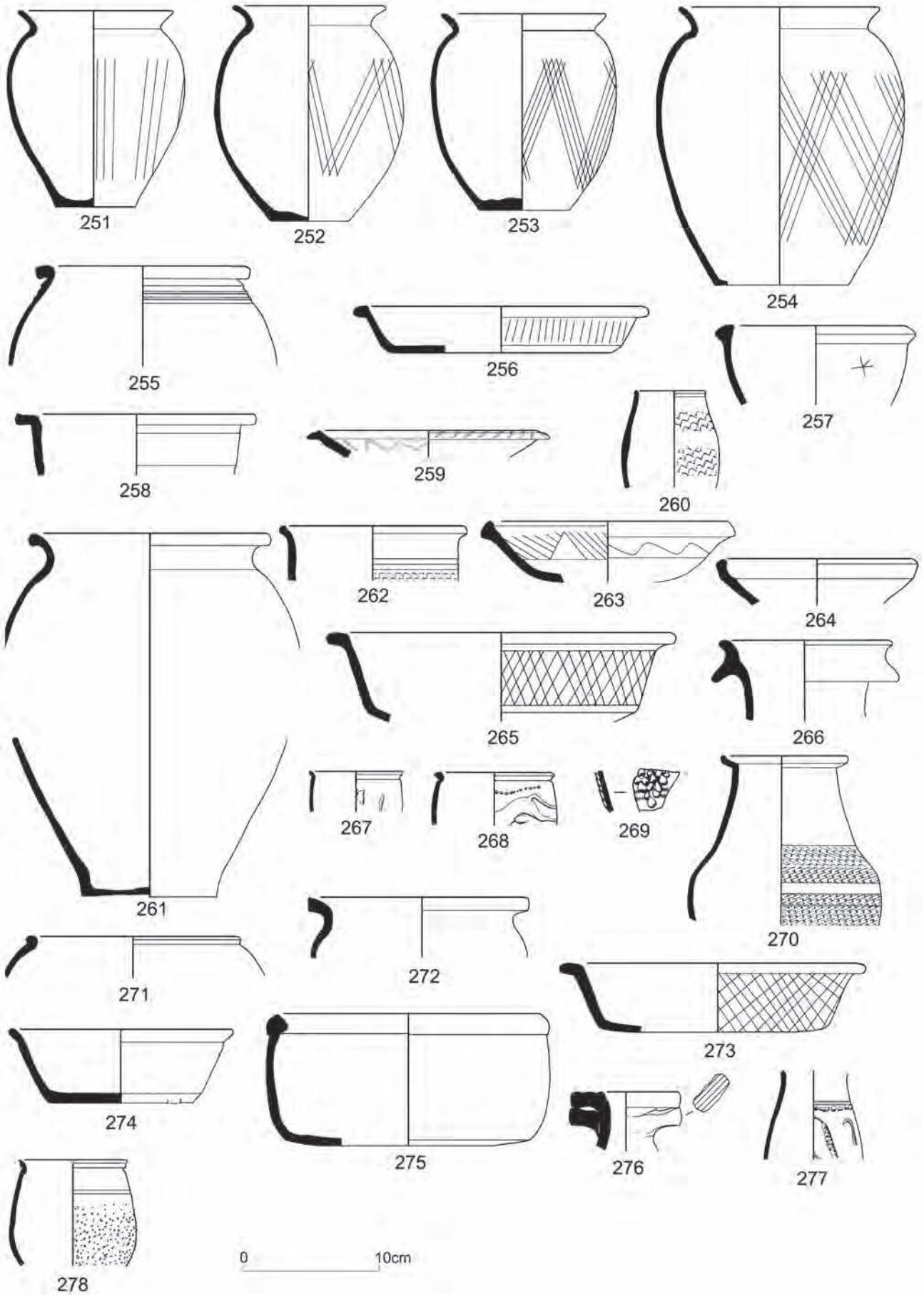

Figure 22.22: Coarse wares nos 251–278. Scale 1:4.



Figure 22.23: Coarse wares nos 279–312. Scale 1:4.

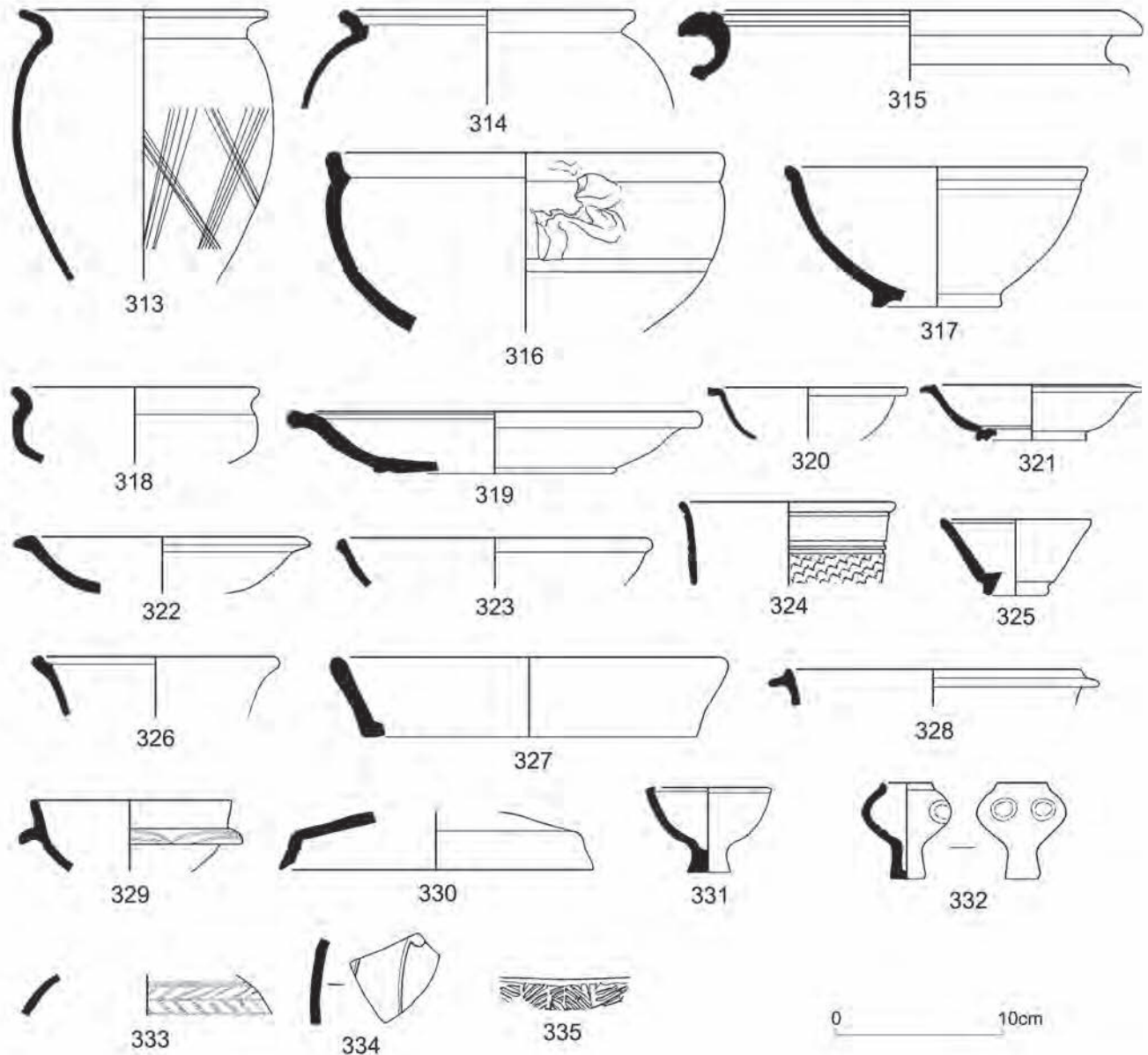

Figure 22.24: Coarse wares nos 313–335. Scale 1:4.

270. Hard, micaceous dark grey fabric, burnished on neck. Sooted on lower part of body. J10:25.
271. GW3, H04:24.
272. Slight sooting on the rim. Hard, gritty grey fabric with large rounded white and grey inclusions, H11:39.
273. BB1, E12:30.
274. BB2, with two grooves cut into edge of base. See graffiti no. 53. L12:02.
275. Very hard, gritty orange fabric. The base is burnt brown and both it and the walls are sooted. North African-style casserole. Cf. Swan 1992, fig. 1, no. 24. Late Ebor. N11:24, N11:29.
276. **LATE ROMAN AND DERELICTION**
Hard red fabric with occasional soft black inclusions, and slightly brown surfaces. K10:32.
277. CNG BS. L11:08.
278. Orange fabric, brown exterior and red interior colour coat. Q04:15.
279. Fine sandy grey fabric, burnished in irregular lines on the neck. E11:03.
280. The edge of an indentation on the body indicates this is a counter sunk lug-handled jar. East Yorkshire grey ware. G16:21.
281. Dark grey fabric with occasional large black inclusions, with paler surfaces, not burnished. E11:06.
282. SE RW, F09:07.
283. Hard grey fabric with large quartz inclusions. Mottled black and orange exterior. H10:32.
284. BB2, Q04:12, upper fill.
285. Hard grey fabric with sparse black inclusions, H05:12.

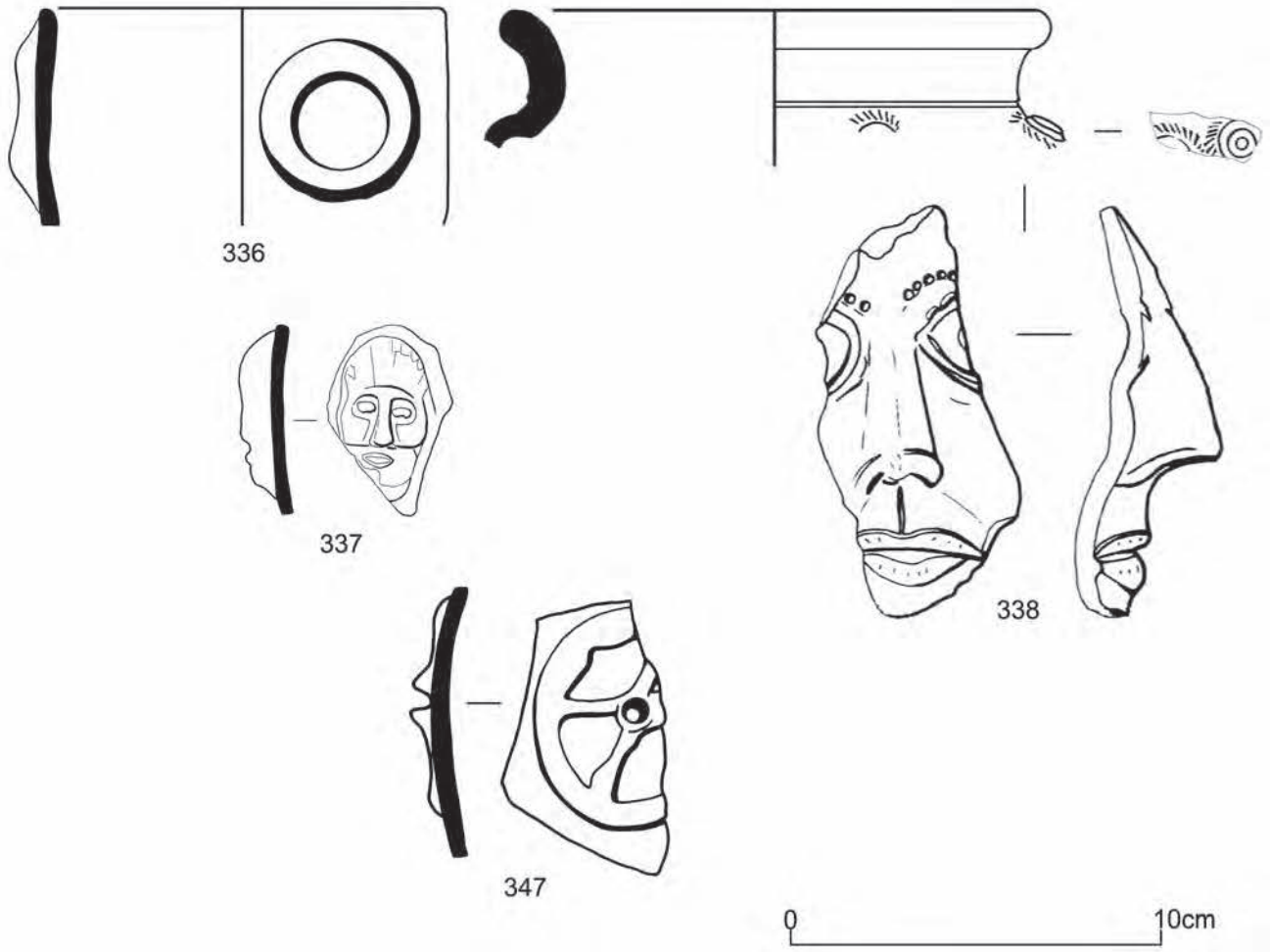

Figure 22.25: Moulded-mask flagons, smith pot and head pots. Scale 1:2.



338



345

Figure 22.26: Head pots nos 338 and 345.

Unstratified

286. Gritty orange fabric, with remains of thin white wash. Scar on underside of rim indicates a single handle, M05:04.
287. Buff ware. Holbrook and Bidwell 1992, 66, type 2. P05:02.
288. Fine orange fabric, slightly micaceous, paler on exterior, E10:01.
289. Soft, fine buff fabric, G14:01.
290. White fabric, slightly cream on exterior round the rim, C11:01.
291. SE RW/poppyhead beaker fabric, G12:01.
292. Flagon fabric A, E07:01.
293. Pinchneck flagon, GW2, D11:05.
294. Brown colour coat, LNV CC, J16:03.
295. Ducks are an unusual form of decoration, although a double row of ducks are known on a beaker from the Pakenham kilns (*pers. comm.* J. Plouviez). LNV CC, F11:01.
296. LNV CC, G11:01.
297. Hard, slightly gritty micaceous orange fabric, with self-coloured slip. Decorated with thick white paint, noticeably micaceous. M13:01.
298. Indented beaker. GW2, burnt, K03:02.
299. LNV CC, M14:01.
300. Soft pink fabric with wide cream core. Thick tan colour coat, easily worn away, on exterior only. A neck sherd (funnel neck?) in the same fabric but probably from a different vessel, was found in L05:07. G11:01.
301. East Yorkshire grey ware, F11:01.
302. GW1, E12:01.
303. East Yorkshire grey ware, E04:01.
304. Severn Valley, Q05:02.
305. SE RW, M07:01.
306. HOR RE, E08:13.
307. Southern shell-tempered ware, L14:01.
308. NOG RE, F12:01.
309. Pale orange fabric with fine multi-coloured inclusions and paler surfaces. Heavily covered in mortar, M12:01.
310. SE RW, N05:20.
311. Hand-made. Local traditional, L04:11.
312. Two possible burnished lines are visible within the burnishing on the shoulder (now rather patchy), with a certain burnished line below. GW1, K03:30. BB2, possibly from Colchester, N05:02.
313. SE RW, E10:01.
314. SE RW, E10:01.
315. CG, P05:02.
316. Wide grey core and orange surfaces. Slight ridges on interior from rough burnishing, finer burnishing on exterior below level of handle. Cf. dish version: Caerleon: Compton and Webster 2000, fig. 64, no. 587, unstratified, N05:20.
317. Slightly gritty grey fabric, very soft in places, with buff margins and traces of a darker grey surface, surviving only in patches in places, K03:21.
318. Micaceous pale grey fabric with plentiful soft black inclusions, some large. Mid-grey surfaces, M05:04.
319. EBO OX, H03:01, H03:03.
320. Burnished in bands. Very fine fabric. LT OW

321. painted, although there is no evidence of painted decoration on this vessel. N12:01.
322. Soft, fine orange fabric with soapy texture, G04:01.
323. Soft orange fabric, with faint ridges caused by the burnishing on the interior, L05:03.
324. Pale orange fabric, cream surfaces with mid-brown colour-coat that has been mica-dusted, F11:01.
325. Orange fabric, with very fine dark inclusions visible on the surface. Paler interior surface and burnished exterior, F14:10.
326. Oxidised, Q05:02.
327. Burnished in slightly spaced bands. LT OW painted, although there is no evidence of painted decoration on this vessel. N04:01.
328. CG, H13:10.
329. BB2, G03:05.
330. Crambeck red with white painted decoration, P05:02.
331. Hard, micaceous orange fabric with wide grey core. Heavily sooted on both exterior and interior. North African style? J14:06.
332. Hard micaceous white fabric, with some fine black inclusions and occasional large (2mm) soft white inclusions. Possibly a lid. M12:55.
333. Soapy, micaceous buff fabric with a dark grey core and the remains of a thick cream wash. There are two attachment scars on one side, suggesting this is from a triple vase of the type where the vessels touch but there is no openings in the walls. A vessel from a triple vase with a similar rim and bulbous body, although with a shorter pedestal, was found at Carlisle (May and Hope 1917, pl. 15, no. 189). F11:01.
334. Overfired sherd, with thick grey core and thin white paint. LT OW painted, N04:03.
335. Barbotine decoration with two stalks and the top of a probably ivy-shaped leaf on exterior of a closed vessel in a coarse ware fabric. White fabric with plentiful quartz inclusions, fine black inclusions and dark grey surfaces, slightly mottled on exterior, F14:01.
336. Micaceous, mid grey core, brown margins, dark grey surfaces, with roller-stamped decoration in a 'panel' style, with diagonal lines set in defined panels. At Chelmsford a similar stamp, with the diagonal lines continuing under some of the uprights, was identified as a probable Colchester product (Going 1987, fig. 48, no. 14). Roller-stamping was common at Colchester in the third century, and copied at other local kiln sites such as Mucking (*ibid.*, 31). The fort at Wallsend has produced a sherd from a second vessel in the same fabric with chevrons set in wide panels (D14:01, unstratified), while the *vicus* has produced sherds from four other roller-stamped vessels, three of which are probable Colchester products and one a Mucking product. L04:01.

Head pots and similar (Fig 222b)

Moulded-mask flagons

336. Orange fabric with plentiful large red inclusions and micaceous surfaces, with a circular appliqué

with a slightly dished top. The appliqué is in a paler version of the same fabric. The exterior surface and just over the rim has been covered in a white colour-coat, with an additional orange colour-coat over the exterior (a technique used at Swanpool). Possibly from a moulded mask flagon, in which case the applied disc could possibly represent a hair bun on the opposite side to the face, although the other known examples tend to be more elaborate (Dövenner 2000, Abb. 221, 234; Howe, Perrin and Mackreth 1980, fig. 8, no. 96). F12:01.

337. Sherd with incomplete moulded mask of a male face. Brown to orange exterior colour coat, orange interior colour coat. The eyes and nose are outlined by incised lines, while the moustache and beard are recessed to leave the mouth raised. The temples are recessed, and the hair is roughly indicated by stabbed decorated. This is an example of the smaller type of mask face used on flagon rims, that fits within the height of the rim and does not rise above it (Dövenner 2000, Abb. 232). Male faces are not as common as female heads. Cf. York: Monaghan 1997, fig. 333, no. 3178 (different mould). LNV CC, F12:01, WSP138.

Head pots

NORTH AFRICAN STYLE

338. Three non-joining sherds, consisting of rim and body sherd with stamped bosses and part of a sculpted face. Micaceous orange fabric with noticeable plentiful multicoloured inclusions and thick buff core, grey where sherd particularly thick. The rim has parts of two stamped bosses immediately below, and the body sherd parts of two more stamped bosses. The face fragment has a sculpted nose, parts of both eyes and part of mouth. The eyebrows are depicted with incised dots and the eye defined by deep incised lines. The eyes are broken off before the pupil on both sides, but it is likely that they were stamped. There is a possible edge of a stamp, while the interior of the vessel indicates that the eyes were hollow, in a very similar way to the surviving stamped bosses. The end of the nose, the nostrils, the upper lip and septum are also marked by incised lines. There is burnishing on the forehead and part of the cheek. P05:02 (two sherds) and N05:07; 37, WSP142, WSP154 and WSP188.

NORTH AFRICAN STYLE – HAIR ONLY

339. Orange fabric with quartz inclusions. Sculpted, crescent-shaped curls with incised lines to represent the hair. H13:01, WSP156.
340. Three sherds, two of which join. Paler orange fabric, more yellow than no. 339 above, with quartz inclusions that are generally fine but occasionally up to 1mm across. Sculpted hair, with roughly circular, hollow curls. The incised lines to indicate the hair are quite roughly finished compared to no. 339. D14:08, 1475, WSP189.
341. Micaceous orange fabric with slightly paler surface. Incised lines representing hair. E04:07, WSP158.

342. Micaceous orange fabric, with incised lines representing curls. Fabric as no. 341 above, but with paler body and darker exterior, so from a different vessel. N13:01, WSP155.
343. Hard, fine fabric with red and white inclusions, orange towards interior and buff towards exterior. Curved incised lines representing hair between traces of wider grooves. D14:22, 1486, WSP210.
344. Dark cream fabric with pale orange core and fine red inclusions. Incised lines to represent curls, and the end of a straight line edged with dots which could possibly represent the end of an eye-brow. D14:08, 1477, WSP211.

PAINTED

345. One sherd, with a possible second, non-joining sherd. Pale orange fabric with a wide grey core towards the interior and fine quartz inclusions. The fragment includes a moulded nose, a raised applied eye, a raised eyebrow ridge and a raised hairline. The hair is painted dark brown, with semi-circles, representing curls, extending onto the cheek. The eyebrow is painted, as is the outline of the eye and iris. Burnished on cheek. The second sherd possibly shows part of the chin. F13:25 (main fragment), F13:16 (chin), 1326, WSP190.
346. Two non-joining sherds in a fabric with plentiful fine inclusions, a grey core, white margins, and buff/pink surfaces, with burnished buff/orange exterior surface. One sherd has an applied vertical ridge of clay creating a wavy line, and other has been sculpted, possibly representing part of the chin or cheek. Probably from same source as no. 345, although not the same vessel. F11:13, WSP236.

Smith pot?

347. Fine hard fabric, with fine quartz inclusions, darker grey to the interior and light grey to the exterior. Very pale grey exterior surface, with applied four-spoke wheel, with depression for the hub. Some burnished lines on the body. Probably a Yorkshire grey ware. N14:01, WSP185.

The wheel as a symbol has been found associated with a range of deities, including a native sky god, Apollo, Fortuna, and most importantly Jupiter, as well as being connected to the sun (de la Bédoyère 2002, 164–5; Kiernan 2009, 38). When found on grey ware vessels, the association seems to be with a smith god, as the wheels are found alongside smith's tools. A sherd from Malton includes tongs, two hammers, and the remains of a four-spoked wheel (Bidwell and Croom 1997, fig. 39, no. 1; four-spoked wheels seem particularly common in France: Green 1978, 19; Kiernan 2009, 12; fig. 2.1). A further two sherds with wheels with eight and nine spokes, were found at the same site in the same fabric as sherds showing smith's tools (Leach 1962, pl. VII). The exact association between a smith god and wheel is not clear, but in classical mythology the smith god Vulcan made Apollo's sun chariot with spokes of silver and a rim of gold, so the wheel may still be a solar symbol as

it appears to be when found with the other gods connected to the sky.

Discussion

Wallsend has produced sherds from nine different head pots from the 1975–84 excavations, and sherds from a possible tenth from the 1997–8 excavations (Croom 2003, 247). The vessel-type of head and face pots enjoyed popularity only in a number of regions round the country, including, in the north, the Yorkshire area. In York, for example, fragments from over 50 examples have been found, and 46 from the site at Piercebridge. Hadrian's Wall, however, was outside the area, and does not seem to have been an important market for the vessels. The excavations at South Shields (c.1900kg of pottery) have produced only three possible examples, and the fort at Newcastle one (out of c.92kg of pottery; Bidwell and Croom 2002, fig. 15.9, no. 105). The vessels may have been intended for some ritual use, as a number of them are clearly deities, but perhaps outside the regions where they were most popular they were simply bought for their novelty value.

It seems likely that the nine examples came from only two or three suppliers, one producing the orange sculpted head pots and the other the painted vessels. Number 338 is of particular interest, as the fabric and use of stamped bosses for hair suggests a mid or late third century date, while the strongly sculpted features and the dots for eyebrows are more typical of the early third century North African style heads. Although most of the North African type heads appear to depict females, the two sets of sherds with raised circular curls indicate that at least two vessels at Wallsend had a male hair-style. Although the number of vessels involved is small, there may have been a preference for male heads in this area; the example from Newcastle has the same type of curls, and one of the examples of a possible head-pot type vessel from South Shields was a bearded figure (Croom 1994, fig. 7.12, no. 104), while it should be noted that the moulded-mask flagon (no. 337) also depicts a male face.

Four of the sherds come from site clearance levels, and most of the rest come from the latest layers of cobble/decay on the site. There are three sherds from around building AB (nos 340, 343–4), but the fabrics of the sherds are so different they cannot come from the same vessel.

Discussion

Supply to the fort

Second century

On the whole the 1975–84 excavations did not reach the Hadrianic layers of the fort, but what information there is can be supplemented by evidence from the 1997–8 excavations. The coarse wares are dominated

by BB1 and local products in about equal quantities, a pattern of supply that continued throughout the Antonine period, as can be seen by the assemblages from the Rampart building (Feature 2), Alley 1 and Alley 3. BB2 and allied fabrics then begin to make an appearance, but they are not yet a major source of supply. During the second century, mortaria came overwhelmingly from local sources such as Corbridge and Binchester/Corbridge as well as from kiln sites not yet identified. Fine ware beakers are mainly imported from the Continent, from North Gaul and Cologne.

Local production

The local products (Grey wares 1–3; Oxidised wares 1–2 and Lower Tyne painted oxidised ware) that were such a feature of the second-century supply must have come from kiln sites in the eastern or central sector of the frontier zone, but the production sites have not yet been located. They supplied the types of vessels required most by the army, cooking-pots and bowls in both grey and oxidised ware, but sometimes ventured other types that were usually supplied from more distant sources, as there are also small numbers of other vessels such as pinch-necked flagons, beakers and lids. The oxidised wares were produced in a slightly wider range of bowl types, more obviously tableware, and were also used to produce at least one small open lamp (Fig. 25.29). Some of the vessels were made in a fine oxidised fabric, often with a fine, burnished finish, and frequently decorated with white paint.

Grey and oxidised wares: An example of a reeded-rimmed dish found at South Shields made in grey ware 1 (Bidwell and Speak 1994, fig. 8.8, no. 2) indicates that the production of this ware started in the early second century, as this form was not made after this date. This is a form more commonly found in mica-dusted ware, but grey ware examples have been found at Gellygaer and Southwark (Marsh 1978, type 26) and an oxidised example from Corbridge (Bishop and Dore 1989, fig. 119, no. 89). Other early forms include an oxidised large dish with omphalos base (Fig. 22.16, no. 94; Marsh 1978, type 33), a carinated biconical bowl (Fig. 22.12, no. 21), and a small flanged bowl (Fig. 22.13, no. 48; Marsh 1978, type 34). There are no reeded-rimmed carinated bowls, but there are a few non-reeded examples (Fig. 22.13, no. 40; Croom 2003, fig. 158, nos 2, 4). However, the industry soon started to copy BB1 bowl forms such as the flat-rimmed bowls with low carination, and these were the most common type of bowl made (Fig. 22.12, no. 22; Fig. 22.13, no. 39, Fig. 22.16, no. 89). The quantities of pottery recovered from Period 2 show that the wares continued to be made into the Antonine period, probably going out of production when the pottery supply was switched to the BB2 industries of south-east England.

Painted ware: Most of the vessels made in this ware

were bowls, ranging from large hemispherical bowls imitating Dr 37s to small segmental bowls with high flanges. Closed forms, such as beakers and flagons, were also made, but in much smaller quantities. The largest painted vessels are a carinated biconical bowl and a cauldron/bowl (Fig. 22.12, nos 20–1). Oxidised wares decorated with white paint are not common, but were perhaps briefly popular in the early second century; similar wares were made by the pottery set up to supply the fort at Little Chester near Derby during the Trajanic to early Hadrianic period. At Derby almost all the painted vessels are segmental bowls with high flanges, with only occasional other forms such as a cordoned bowl and a carinated bowl with upright rim (Brassington 1971, fig. 7; Brassington 1980, fig. 14, nos 383–5, fig. 19, no. 525). At Derby there were also a few examples of oxidised wares with both white and red-brown paint, as also known from the Lower Tyne painted ware, again on segmental bowls with high flanges (Brassington 1980, fig. 23, nos 589, 593). Another carinated bowl with upright rim, with white herringbone decoration, was found at York, where it was identified as Ebor ware, although the use of white-painted decoration on this ware is very rare, as only three such painted vessels seem to have been found (Monaghan 1997, 877; fig. 395, no. 3936).

Third century

It is not until the early third century that BB2 and its allied fabrics became the coarse ware supplier of choice, and the proportion of BB2 greater than the local products and BB1. At the same time, supply of fine wares was switched to the Nene Valley industries, which became the dominant fabric for beakers. Although the Lower Nene Valley also supplied some mortaria during the early third century, Mancetter-Hartshill was the more important supplier at this time, and it was not until the latter part of the century that the Lower Nene Valley became the dominant supplier.

The next major change in supply occurred in the late third century, when BB2 begins to fail and BB1 reclaims the market. During the third century small quantities of grey wares had been supplied from a number of different Yorkshire industries, but after c.270 Crambeck reduced ware and calcite-gritted ware began to be the most important coarse ware suppliers. Unfortunately very few undisturbed contexts from this period have survived on the site.

Fourth century

The post-Roman disturbance of the site means that very little fourth-century material comes from stratified contexts, but the unstratified pottery shows that occupation lasted until the late fourth century. The material comes from disturbed contexts from all periods as well as site clearance levels, but only comparatively small quantities survived. At Newcastle late third- and fourth-century Crambeck

Table 22.11: Pottery from the Rampart building and re-instated rampart by fabric type, shown as percentages (excludes amphora)

Fabric type	Wt	EVEs
Samian	0.5	1.1
Mortaria	16.5	4.9
Fine ware: Colchester	0.4	3.5
Fine ware: unsourced	0.2	1.5
Grey ware 1	26.3	31.1
Grey ware 2	2.1	3.7
BB1	3.2	4.3
BB2	0.9	4.6
SE RW	0.6	0.2
Belgic	1.6	1.7
Native	0.2	0
Calcite-gritted	0.2	0
Unidentified oxidised	34.7	32.1
Unidentified reduced	12.6	11.3
Total	8.927 (kg)	1623 (%)

mortaria made up 38% of all mortaria from the site by EVEs, and at South Shields 18% by vessel number but only 2.4% by EVEs at Wallsend (Bidwell and Croom 2002, table 15.6; Bidwell and Speak 1994, table 8.2). Of late-fourth century material, there were 129 rim sherds from Huntcliff-type calcite-gritted cooking-pots, 31 sherds of Crambeck painted ware and 10 Crambeck reduced ware flanged bowls with internal wavy line (Corder 1937 type 1B).

Selected assemblages

Possible Rampart building (Feature 2)

A large group of pottery came from an occupation deposit in a possible rampart building near the *porta quintana* (C11:04). Excavations in 1997–8 from the same, or an immediately adjacent, building produced a further assemblage very similar in nature; and although there were no visible cross-joins between the two, there were a number of sherds almost certainly from the same vessels, so the groups have been studied as one assemblage (Hodgson 2003, 162; Croom 2003, fig. 158, nos 15–9).

The material from the 1997–8 excavations included two sherds of BB2 allied fabric, which in all probability relate to the re-instatement of the rampart over the building (Hodgson 2003, 162). The pottery from C11:04 also included a few sherds of presumably intrusive later material, such as a rounded-rimmed BB2 bowl or dish and a body sherd of calcite-gritted ware. The only other BB2 consists of a few sherds from two cooking-pots (Fig. 22.12, no. 6). This very small quantity of BB2 (less than 1% of the assemblage) and a sherd of mid to late Antonine samian suggests the assemblage may date to the late 150s or 160s, when small quantities of BB2 reached Hadrian's Wall.

The assemblage consists predominately locally

Table 22.12: Vessel types of the pottery from the rampart building and the reinstated rampart, excluding those vessels likely to date after the re-instatement of the rampart, by EVEs

Vessel type*	%
Flagon	31.1
Beaker	5.6
Small jar	11.1
Cooking-pot	45.1
Bowl/dish	2.1
Mortarium	0.5
Total	1602

* In this, and subsequent tables, 'flagon' includes other liquid containers such as jugs and flasks; 'beaker' includes other drinking vessels such as cups; 'small jar' includes vessels that may also have been used for drinking, such as jars that could be tankards without surviving handles, and 'storage jar' includes narrow-mouthed jars

produced grey wares (kg and flagons of unknown source (c.60%), with surprisingly little BB1. Samian is under-represented, with only two sherds present in the whole assemblage. The figure for mortaria by weight is high, but is distorted by the presence of a near-complete vessel (Croom 2003, fig. 158, no. 19, dated 120–60), which is in fact the only mortarium present in the combined assemblage.

The assemblage is most noticeable because of the very low number of bowls and dishes. Sherds were found from only three bowls, two of which were represented by two sherds (2% by EVEs). This is highly unusual, as bowls and dishes are usually the second most common types of vessel. There were at least four complete flagon rims, fragments of a further two, and one almost complete vessel, but as they are associated with a high number of body sherds it suggests flagons made up a large part of the original assemblage. The building excavated in 1997–8 produced clinker and hammer-scale, and therefore was probably used for iron-working, so this profile of vessel types may reflect workshop requirements rather than domestic use. It is perhaps of note that while the rubbish from the buildings included 9.334kg of pottery (including amphora sherds, all of Dressel 20), there was very little animal bone present.

Alley 1

During excavation, an arbitrary division was made between the 'lower' and 'upper' fills of the alley deposit, although joining sherds from the same vessels between the two fills and the deposit of burnt daub indicate they are not discrete deposits. The pottery came from the central section of the alley (squares M05 and N05, with a smaller amount in P05). Square N05 produced one of the largest concentrations of pottery from any of the excavated areas in the fort (34kg stratified, 14kg unstratified).

The most interesting material from the assemblage comes from the deposit of burnt daub on the south side

Table 22.13: The vessel types in Alley 1 compared to those from the barracks (Buildings 1–5, 9–12), shown as a percentage of EVEs

Type	Alley	Barracks
Flagon	7.7	7.8
Beaker	3.4	5.6
Small jar	0.6	0.9
Cooking-pot	52.5	49.4
Storage jar	1.4	1.3
Bowl/dish	28.4	28.6
Mortarium	4.5	6.0
Lid	1.0	0.4
Triple vase	0.2	–
Totals	4866	5833

of the alley (N05:23, N05:24). This contained a number of substantially complete locally-produced second-century vessels that had not been much disturbed after deposition. There were four oxidised vessels, consisting of a handled cauldron (Fig. 22.12, no. 20), a biconical bowl (no. 21), a flat-rimmed carinated bowl imitating BB1 (no. 22) and a plain-rimmed bowl (no. 27), and most of an Anaus mortarium (Fig. 22.13, no. 33; mortarium stamp no. 4; with four sherds from the lower fill). Another substantial part of a worn Anaus mortarium came from the upper fill, with a single joining sherd from the daub deposit (Fig. 22.13, no. 42; mortarium stamp no. 9). There was also a grey ware cooking-pot (Fig. 22.12, no. 19) in the daub deposit, a sherd of which also came from the lower fill. The lower fill produced a second nearly complete grey ware cooking-pot (Fig. 22.12, no. 10), with joining sherds from the upper fill. There was one further vessel in the upper layers which was presumably part of the same group, a grey ware flat-rimmed bowl (Fig. 22.13, no. 39).

Unfortunately many of the contexts within the alley have been contaminated with later material making analysis of the assemblage difficult. The daub deposit and upper layers both contained quite large quantities of pottery dating to the third century, including sherds dating to 270+, and the upper layers also produced a sherd dating to the late fourth century. The daub deposit includes samian of early to mid Antonine date, and a Colchester mortarium dating to

Table 22.14: Vessel types from Alley 3, shown as a percentage of EVEs

Vessel type	%
Flagon	7.6
Beaker	0.5
Cooking-pot	57.6
Honey jar	11.4
Bowl/dish	22.8
Total	1308

140–200, and the upper layers samian of mid to late Antonine, and late second century to first half of the third century, although it is impossible to say if any of these come from the later contamination material. In total there were 14 sherds of Hadrianic samian, 12 of Hadrianic or Antonine date and 14 of Antonine or later date, at least suggestive of an Antonine date for the deposition of most of the assemblage.

The lower fill produced the smallest amount of pottery, approximately 90% of which was made up of cooking-pots (Fig. 22.12, nos 9–14). The pottery from the dump and the upper layers were similar to each other, and had a more varied profile, with a much larger proportion of bowls and dishes and more flagons. The quantity of amphorae in the assemblage was small, at only 7% by weight, when it makes up 38% of the pottery from the site as a whole. The profile of vessel types (Table 22.13) is very similar to the average for material found inside the barracks, indicating that this was a dump for rubbish from the nearby buildings.

Alley 3

The fill of the alley produced 1.152kg of pottery, much of which consisted of large parts of two locally-produced second-century cooking-pots (Fig. 22.13, no. 50; Fig. 22.14, no. 51). The original drip trench produced very little pottery (0.388kg), which was made up of a mixed range of sherds from numerous vessels. Much of the material could have been mid second-century in date, but there were also a few sherds of BB2, which first appears in small quantities in the Antonine period. Most of the alley deposit came from the re-cut drip trench (F04:33) at the eastern end of the alley. This produced 6.786kg of pottery (excluding samian), much of which consisted of fairly complete vessels that had not been disturbed much after deposition. BB1 made up 41% of the coarse wares, and was the only coarse ware fabric used for the bowls, which consisted of three bead-rimmed bowls and at least four flat-rimmed bowls and dishes (Fig. 22.14, nos 56–8). The locally-produced ware made up 29% by weight, and were almost exclusively cooking-pots. The assemblage also included the lower

Table 22.15: Vessel types from the hospital and the barracks (Periods 2 and 3 only), shown as percentages of EVEs

Vessel type	Hospital	Barracks
Flagon	9.8	7.8
Beaker	4.1	5.6
Small jar	7.9	0.9
Cooking-pot	52.1	49.4
Storage jar	2.4	1.3
Bowl/dish	18.4	27.6
Mortarium	4.9	6.0
Lid	0.4	0.4
Totals	3574	5833

half of a flagon and two honey jars (Fig. 22.14, no. 52). There was one certain Antonine samian vessel, and a few sherds of BB2 (less than 1%).

Building 8 (stone-built hospital)

The hospital produced one of the largest assemblages of pottery from any structure within the fort. The stone building was constructed in the Antonine period, was reduced in size in the early third century, and was finally demolished before the mid third century (Hodgson 2003 123–4). The early phase did not produce much pottery.

Room 1, with a flagged floor and hearth, had a BB2 pot buried in the floor, with a stone lid flush with the floor surface (Fig. 22.15, no. 68; Fig. 25.33). This type of deliberately buried pot is comparatively common at South Shields Roman Fort, where they are found almost entirely in barracks, suggesting that this room may have been the permanent accommodation for staff in the hospital. The hospital must also have provided accommodation for patients during treatment and recuperation, staying only on a short-term basis, but it is not known how these patients were fed, whether their *contubernia* provided cooked food for them or simply handed over their portion of the rations. A study of the animal bones has shown that the assemblage is very similar to that within the barracks although slightly more restricted in the range of species present, suggesting few luxuries were brought in (Gidney 2003, 232). The small quantities of bone recovered indicates either that the hospital was kept very clean or the occupants had less access to meat on the bone (*ibid.*, 236).

The break-down by vessel types reveals differences in the hospital assemblage and that of the barracks of similar date. In the hospital bowls and dishes form a low percentage by EVEs (the site average is 30%; see Table 22.24). Perhaps the larger sized bowls and dishes were more important for communal eating, which did not take place to the same degree in the hospital because the patients came from different *contubernia*.

An even greater contrast can be seen with the small jars or beakers (with a rim diameter of 100mm or less), which are much more common in the hospital (Fig.

22.14, no. 63). Some jars of this size, with a handle, were clearly drinking vessels, and it is possible those without handles were also drinking vessels, being similar in size to fine ware beakers. The fact that coarse ware drinking vessels were more common in the hospital possibly suggests that patients were supplied with a cheaper version of drinking vessel when in hospital. However, not all such small jars may have been used as drinking vessels, and as some are simply small versions of cooking-pots, it is also possible they were used in greater numbers in the hospital for individual portions of food, or storage of medicines or similar. Similar small jars were also present at the hospital at Housesteads Fort, with at least two published examples (Charlesworth 1976, fig. 3, nos 16, 19).

Most of the pottery from the hospital was typical of the whole site, including local grey wares, BB1, and BB2 and allied fabrics. There were three vessels of particular interest (Fig. 22.14, nos 64–5) from room 8 (all from the same context) and from the courtyard. Two of these are lid-seated vessels, of which only six certain examples are known from the whole site, with most of the sherds coming from the hospital or near to it. Almost all the stratified examples of this ware come from the hospital, with further sherds from the clearance level above; unstratified sherds are also known from above Cistern 1 and Buildings 4 and 5. The vessels are in a cream fabric with brown exterior and sometimes a yellow interior surface, and often have an elaborate rim folded back to sit on the shoulder. The third vessel, similar in size and shape, was in a different fabric, with a flat-topped rim (Fig. 22.14, no. 64). Possible parallels are known from York (Perrin 1981, fig. 33, nos 412, 414).

Barracks

Table 22.16 shows the break-down by vessel types of pottery from the Period 2 and 3 barracks, from the infantry barracks (Buildings 1–5) and the cavalry barracks (Buildings 9–12, including pottery from the 1997–8 excavations). The cavalry barracks have more flagons, less storage jars and slightly less cooking-pots.

Table 22.16: Vessel types from the barracks (Periods 2 and 3) shown as a percentage of the total EVEs.

Vessel type	Infantry	Cavalry	Combined
Flagon	4.8	10.3	7.8
Beaker	5.1	6.1	5.6
Small jar	1.5	0.4	0.9
Cooking-pot	53.6	45.9	49.4
Storage jar	2.9	–	1.3
Bowl/dish	28.4	28.8	28.6
Mortarium	3.8	7.8	6.0
Lid	–	0.7	0.4
Totals	2644	3189	5833

Table 22.17: Vessel types from Building 13 (all periods), shown as a percentage of EVEs

Vessel type	%
Flagon	no rims
Beaker	5.1
Small jar	0.4
Cooking-pot	39.5
Storage jar	1.1
Bowl/dish	49.2
Casserole	1.1
Mortarium	1.1
Lid	1.1
Total	1226

Only one buried pot deliberately built into a floor was identified from the barracks. It came from a lean-to or extension to the third-century barrack Chalet 10, Building AB (Fig. 22.16, no 92).

Building 13 (Commanding officer's house)

The pottery from the Commanding officer's house was only 1226 by EVES, with flagons not being represented at all by rims although present as body sherds. Despite the size of the group, there seems to be a significant change in the usual proportions of cooking-pots and bowl/dishes, with the bowls and dishes making up nearly 50% of the assemblage, and cooking-pots only 40%. This could reflect less reliance on foods that made good communal meals, such as boiled meat, pottage or other stews, as a staple dish, or, more likely, the more frequent use of copper alloy vessels in a rich man's kitchen. A low proportion of ceramic cooking-pots could possibly be an indicator of a higher status building. Although there is a greater proportion of bowls and dishes, most of these are of coarse wares such as BB1 and BB2 and not more decorative tablewares or samian.

There are four separate North African-style vessels from this building; a cooking-pot and a casserole in the fill of the cistern in the courtyard (both sooted with use, N11:28, N11:29, N11:24; Fig. 22.22, no. 275), a sherd from a dish in the third room from the eastern end of the southern wing (N12:38) and a lid handle from the backfill of the west hypocaust (L12:42). This may reflect more exotic cooking techniques within the house, although sherds are known from elsewhere in the fort; stratified sherds come from the 'assembly area' and alley 3, and unstratified sherds from over Buildings 2, 4, 5 and 16. An assemblage of ten vessels was also recovered from a gully immediately outside the East gate (Croom 2003, 246–9).

Table 22.18: Pottery from Cistern 1 by weight

Type	Wt (kg)
Amphorae	9.263
Mortaria	3.364
Samian	1.169
Fine wares	2.424
Coarse wares	20.752
Total	36.972

Table 22.19: The fine wares and coarse wares only from Cistern 1, shown as a percentage of the total weight

Context	BB2 & allied	Late pottery	All other types	Weight (kg)
E08:44	78.7	0.7	20.6	4.812
E08:29	60.1	1.6	38.3	9.311
E08:27	51.6	5.7	42.7	9.053
Combined	60.7	3.0	36.3	23.176

Cistern 1

The pottery from the cistern, the largest individual assemblage from the whole site, came from three main contexts. After the cistern was divided in half, the northern half was the first to be filled in, with pottery possibly from silting during use collecting in the lower layer (E08:44). The top layers of the fill, which included stone flagging and a possible water channel to the other half of the cistern (E08:27) produced a much larger quantity of the pottery. There were six examples of joining sherds or sherds obviously from the same vessel between these two contexts. The fill of the southern half of the cistern (E08:29) was very different from that found in the northern part, and indeed no joins between sherds were found between E08:44 and E08:29. However, there were cross-joins between seven vessels in E08:27 in the north and E08:29 in the south. These cross-joins, and a very distinctive bone assemblage (see animal bone report) suggest the contexts are related, and have been studied as one assemblage.

Table 22.19 shows the slight variations in dating according to the fine and coarse wares between the contexts ('late pottery' indicating pottery dating to c.270 or later). E08:27 also had more amphorae and mortaria dated to after 250 than the other two contexts. This upper layer would have been left exposed after the deliberate infilling of the cistern, and probably contains some pottery deposited later; there is certainly some contamination as it contains a single

Table 22.20: Pottery from Cistern 1 (excluding amphorae) shown as a percentage

Type	% by weight
Mortaria	12.1
Samian	4.2
Fine wares	8.7
Coarse wares	75.0
Total	27.709kg

Note: the samian is slightly under-represented, as not all of it could be quantified

Table 22.21: Vessel types from Cistern 1, shown as a percentage of the total minimum number (235 vessels) and EVEs

Vessel type	MNI	EVE
Flagon etc	8.1	3.2
Beaker/small jar	14.5	11.0
Cooking-pot	26.0	47.8
Storage jar	4.2	2.4
Bowl/dish	34.9	28.9
Mortarium	11.1	6.6
Lid	0.8	0.1
Ring vase	0.4	–
Totals	235	3121

late fourth-century Huntcliff-type rim, dating to at least a hundred years after the bulk of the assemblage.

The cistern fill produced sherds from at least 235 vessels (excluding amphorae). Table 22.21 was produced by looking at minimum numbers of vessel rather than by EVEs because it was clear there were a lot of beakers without rim sherds which would not have been represented in quantification by EVE. The minimum number was estimated by comparing form, fabric and finish, but as this can be difficult when looking at large numbers of sherds in one fabric, the quantification can only give an approximate idea of numbers for the more common vessel forms. Out of the 235 vessels, only approximately 16 were represented by substantial remains; many of the other vessels were represented by a single sherd or only a small number of pieces. Since there are also a number of residual second-century sherds, the bulk of the assemblage had clearly built up over time and had been subject to the usual mixing and sherd separation found in a typical pottery assemblage. This stands in contrast to the bone assemblage, where there was very little of the general culinary waste expected from most contexts, but evidence of a single dumping of processing waste. This suggests that while the cistern was being filled with material deliberately brought in from elsewhere, some-one took the opportunity to get rid of their processing waste at the same time. The 16 vessels were made up of seven bowls and dishes, four beakers, two mortaria, two flagons and only one cooking-pot.

The samian was very heavily biased towards bowls, with very few drinking cups, but the great majority of bowls present were coarse wares. There were a few sherds of very residual Hadrianic samian, but there were 26 sherds of late second or third century date. Of the cooking-pots *c.*40% showed evidence of sooting, many with heavy use.

The bowls and dishes are divided almost equally between BB1 and BB2 and allied fabrics, with all other fabrics only making up 5%. Flanged bowls, current from *c.*270 make up almost 20%, but it is noticeable that there is no Crambeck reduced ware and only four sherds of calcite-gritted ware, at least one of

Table 22.22: Coarse ware bowl/dish types from Cistern 1 by EVEs, shown as a percentage

Rim type	BB1	BB2	Other	Total
Plain	20.5	2.0	–	22.5
Plain with groove	–	7.0	1.7	8.7
Flat with groove	7.7	–	–	7.7
Rounded	–	27.2	–	27.2
Flanged	18.3	0.7	0.7	19.7
Wide-mouthed	–	11.7	2.0	13.7
Hemispherical	–	–	0.6	0.6
Total				820

which is intrusive, as it is a Huntcliff-type rim of the late fourth century.

Cistern 2

The cistern produced 16.912kg of pottery, excluding samian. There were four contexts in all, with frequent joins in the pottery between H07:09 in the lower fill and H07:03 in the upper fill, but few joins between pottery in any of the other contexts. BB2 and allied fabrics made up 76% of the coarse wares in the lower fill and 63% in the upper. There were 11 samian vessels of the late second or first half of the third century, three Nene Valley ware vessels and a number of sherds of Horningsea ware, probably dating to the third century. There was one BB1 flanged bowl, three sherds of Crambeck reduced ware and two sherds of calcite-gritted ware; this late third-century material makes up only approximately 1% of the coarse wares, suggesting a date early in the final quarter of the third century for the final filling of the cistern. There was also a very leached and battered Huntcliff-type rim which must be contamination (there were also a few sherds of post-medieval pottery).

The joining sherds between contexts in the western part of the cistern suggests that much of it was filled in at the same time. The filling contains some relatively complete vessels that must have been in use close to the date of the final filling of the cistern, which was

Table 22.23: Vessel types from Cistern 2 (excluding amphorae), shown as a percentage of EVEs

Vessel type	%
Flagon	6.3
Beaker	7.9
Cooking-pot	52.4
Storage jar	2.5
Bowl/dish	25.9
Mortarium	4.5
Lid	0.5
Total	1827

Table 22.24: Vessel types from the whole site, shown as a percentage by EVEs

Vessel type	%
Flagon	4.4
Beaker	8.7
Small jar*	0.2
Storage jar	1.1
Cooking-pot	49.7
Bowl/dish	29.8
Mortarium	5.4
Lid	0.5
Triple vase	0.0
Total	33076

*under-represented as some under 'beaker'

not subsequently disturbed (Fig. 22.22, nos 251–4, 256). This also includes a flagon which was probably in one piece when it was discarded, probably already missing its handle and much of the rim at that time (Fig. 22.21, no. 249). Many of the vessels show evidence of sooting, which is sometimes heavy.

The assemblage consists of the equivalent of 18 vessels. Colour-coated wares were few, while cooking-pots made up half the assemblage. Flagons are over-represented, due to the presence of a complete rim.

Buried pots

The site records suggest five possible buried pots, but only two are certain. The most complete comes from room 1 of the hospital, set in place sometime in the first half of the third century. It is a BB2 pot with the rim deliberately removed, and was found with a stone lid *in situ* (Fig. 22.15, no. 68; Fig. 25.33). It was set into the floor over 1m from the north wall and 1m from the east wall (D11:23; see Figs 5.18 and 5.25). Originally this would have put it towards the back of the room, away from the entrance, but when the room was later remodelled this placed the pot near to the new doorway and the hearth set next to the door. It is unclear to which phase the pot belongs.

The second pot comes from Chalet 10 (officer's quarters, Building AB) and dates to after c.235. This is a south-eastern reduced ware cooking-pot with a complete rim surviving, although only about 75% of the vessel as a whole survives (Fig. 28, no. 92). It was placed towards one corner of the room, about 0.8m from the west wall and c.1.5m from the south wall, in a short-lived extension or lean-to on the west side of the building (D14:10; Fig. 16.7).

The uncertain examples include the truncated base of a large BB1 cooking-pot with acute-angle lattice, of which only about one-quarter survives, set almost in the middle of the hospital's verandah, outside room 1 (E11:45, Fig. 5.05). Another is the lower part of a BB2 cooking-pot, with unusually thick walls and a very thin base, along with body and rim sherds from other vessels. As this was found in a post-hole in Building Q of Building Row 20, it may be packing rather than a deliberately buried pot (F11:05).

The final pot is the lower part of a large south-eastern reduced ware storage jar in *contubernium* 8 of Building 11 (J15:18). It is not clear if it belongs to phase 2 of Building 11 or to the later Building AC (after c.235), but in either case it is positioned in the front stable room of the barracks, possibly in the passageway area. It is uncertain whether it was originally a complete vessel that has been truncated at a later stage, or whether only the lower part of the vessel was inserted into the floor, but in either case it would have to be securely covered to avoid the horses injuring themselves by putting a foot down it.

The exact use of these buried pots is unknown. They are not foundation offerings, as the necks are set level with the floor so that they can be easily accessed, and they are not concealed, having easily recognisable circular lids. At South Shields Roman Fort, where a number have been found in the barracks, there is usually only one per *contubernium*; as the units were occupied by up to eight men, and as they are often set out in the corridor they were not greatly secure for storing anything of value. Many are comparatively close to a doorway.

23. THE VESSEL GLASS AND GRAFFITI

by D. Allen and R. S. O. Tomlin

The vessel glass (Fig. 23.01)

by D. Allen

The assemblage studied comprised 130 vessel glass fragments, of which 90 are blue-green, four are pale green and 35 are colourless. Twenty-five fragments of cast window glass were also found. A total of 75 fragments were not available for study when this report was written, and the details of those pieces of interest within this group have been added later (AC).

The content is fairly typical of a site occupied from the earlier second century: most of the blue-green fragments (63 in all) are from bottles of very common first to second century type. Catalogue numbers 1, 2 and 5 similarly belong to common forms of later first-/earlier second-century tableware. Glass of the late Roman period is not well represented: only two fragments (nos 8 and 39) come from containers of the third to fourth centuries.

What is slightly surprising in an assemblage of this size is the very nice range of colourless tableware in the form of bowls, beakers or cups which is present. Twenty-one vessels have been identified (nos 18–38), and include facet and wheel-cut glass, an indented vessel, and one with pinched-out nipples, as well as a common cylindrical cup form with double base-ring. All are typical of the second and third centuries. Clearly, in common with other military garrisons, some of the better glassware from the wide variety available at that time was reaching the tables at Wallsend.

Blue-green and pale green glass

Jugs

1. Area over Building 12, unstratified, K14:01, 1383, WSG11

Fragment from beneath the handle of a jug of blue-

green glass. Extended tail of handle extant, decorated by pinching glass into series of ridges. Angle suggests the jug body was conical in shape.

This type of handle decoration is most characteristic of a group of long-necked jugs which was very popular in the north-western provinces during the later first and earlier second centuries. They were made with both conical and globular bodies, and the former have either a simple concave base (eg Charlesworth 1959, 52, pl. III, no. 2 from Turriff, Aberdeenshire) or a pushed-in base-ring (eg Price 1980, 66, no. 9, fig. 15 from a pit dated AD155–165 at Park Street, Towcester).

Jars

2. (D: c.50mm). *Via principalis*, N08:12, 2517, WSG1
Rim fragment of a small jar of blue-green glass. Rim folded inward and downward then outward and downward, then outward slightly, forming flaring collar.

Globular or bulbous jars of blue-green glass were made in a variety of shapes and sizes, and the smaller vessels are usually identified as ointment jars. The rim shape of this fragment most closely resembles that used on a bulbous jar type commonly found on later first- and earlier second-century sites (Price 1978, 74). Small examples have been found at Cologne (Fremersdorf 1958, 25, pl. 16), and there is a rim fragment from a context dated AD 75–85 at the Caerleon Fortress Baths (Allen 1986, 99, no. 4, fig. 40).

Beakers/bowls

3. (D: c.50mm). Alley 1, dump of demolition material, N05:23, 350, WSG95

Rim fragment of a beaker or bowl of blue-green glass. Vertical rim, fire-rounded and thickened. This fragment is not diagnostic enough to identify vessel type.

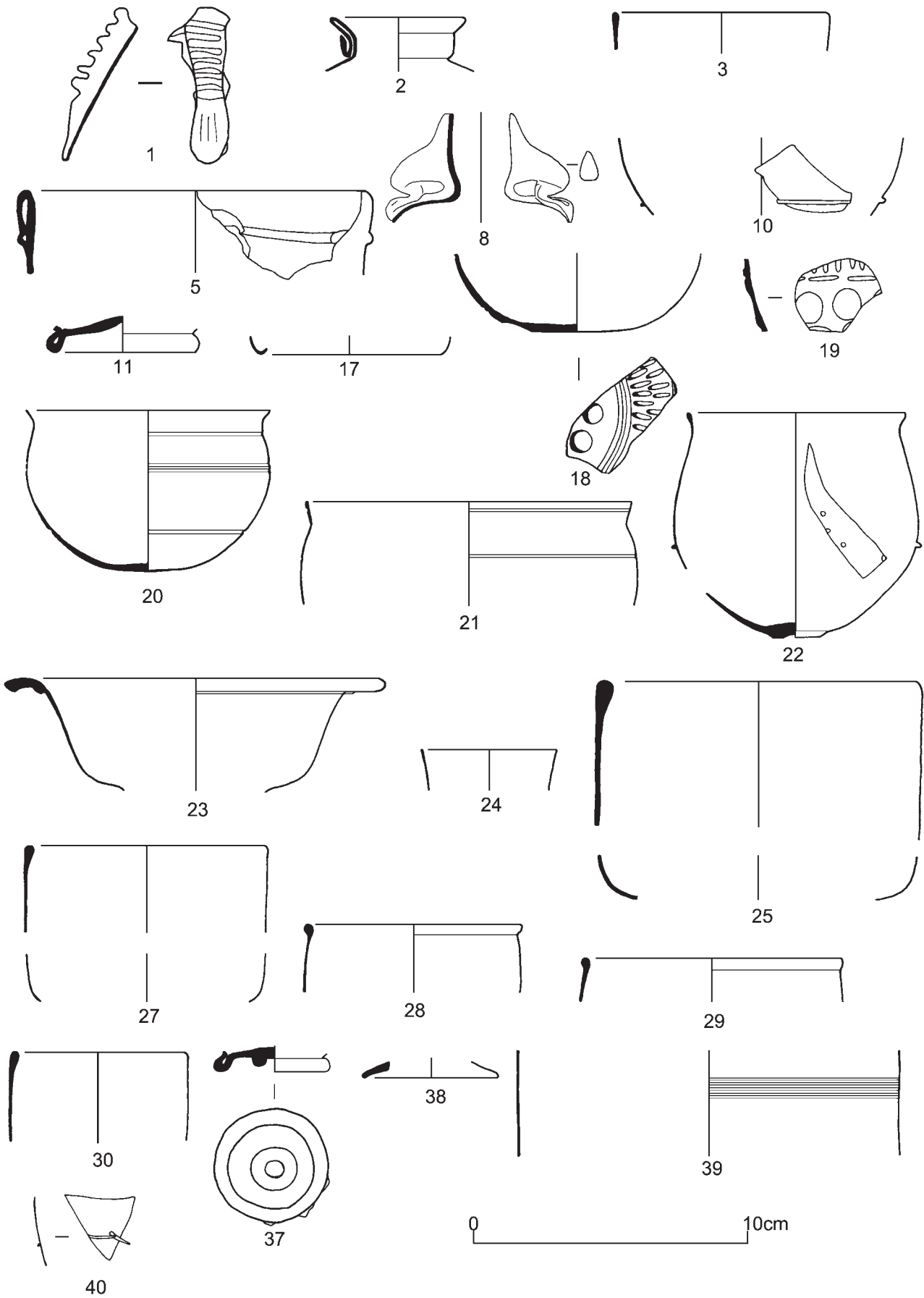

Figure 23. Vessel glass. Scale 1

4. (D:80mm B:1mm). Cistern 1, filling, late third century, E08:44, WSG121
Cup of blue-green glass with slightly in-turned fire-rounded rim (AC).

5. (D: c.130mm). Area over *Via quintana*, unstratified, G12:01, WS6

Rim fragment of a bowl of blue-green glass; thick layer of whitish-iridescence. Rim folded outward and downward, forming hollow tube, with irregular extra ridge at edge.

Bowls with tubular rims occurred throughout much of the Roman period, but were most common during the later first and earlier second centuries. At this time a version with roughly cylindrical body, often with ribs, and an applied base-ring, became very popular (Isings 1957, 59–60, form 44a-b). An example from northern Britain is a bowl from Torwoodlee Broch, Selkirks (Charlesworth 1959, 49, fig. 7, no. 4).

Bottles

6. The blue-green vessel glass includes the usual predominance of bottle fragments: over 60 sherds in all, including six rims, 13 handle sherds and three bases with moulded concentric circles. These vessels were used as containers for a variety of liquids, and their fragments are the commonest glass finds on first and second century sites (Charlesworth 1966) The square was the longest-lived variety, probably continuing to be made throughout the second century, and at least 18 of the Wallsend fragments can be identified as belonging to this type. A further five fragments have come from prismatic bottles (either square, hexagonal, octagonal or rectangular) and the rest are rims, handles, necks or shoulders, which are common to all bottle types.

7. (R:70mm B:7mm). *Via principalis*, E07:37, WSG120
Body sherd of blue-green bottle glass, re-used. Part of a curved edge which has been rounded down to create a smooth edge.

8. (D: c.22mm). Area over *Via quintana*, unstratified, N13:01, 1700, WSG16

Neck and handle fragment of a bottle of blue-green glass; many pinhead and elongated bubbles within the metal. Cylindrical neck with constriction at its base. One 'dolphin' handle adhering, with the 'head' of the 'dolphin' facing out over the shoulder, and an outer 'knife' edge.

Bottles with 'dolphin' handles were some of the later Roman vessels which replaced the first- and second-century containers discussed above. They were never as common, though, and finds are far fewer. They were usually made of colourless or pale green glass, and had cylindrical bodies. The type has been discussed by Harden with reference

to bottles from fourth century graves at Lankhills Roman Cemetery, Winchester (1979, 200, nos 20, 21 and 411, fig. 27), and he suggests that it first appeared around the middle of the third century, its period of maximum use being the later third and fourth centuries.

Fragments of indeterminate vessel type

9. Handle (L:25mm W:25mm). Building 1, verandah, Period 3, L04:20, WSG177

Blue-green folded handle, possibly from a small jug (AC).

10. (Max. body D:c.105mm). Cistern 1, filling, mid to late third century, E08:29, 2356, WSG105

Three body fragments of a vessel of blue-green glass. Vessel body thin-walled and bulbous or globular, with one self-coloured horizontal applied trail extant.

11. (D:56mm). Area over Building 7, unstratified, G11:01, WSG97

Base fragment of a vessel of blue-green glass. Pushed-in tubular base-ring.

Base rises to low central point, pontil-mark on underside.

12 - 5. Base fragments in blue-green glass, similar to no. 11 above. Not illustrated.

12. (D:55mm). Area over Road 8, unstratified, F09:01, WSG126. Pushed-in tubular base-ring (AC).

13. (D:c.50mm). Area over Alley 5, unstratified, G14:05, 1231, WSG104. Pushed-in tubular base-ring.

14. (D c.40mm). Area over Road 3 and Building 9, unstratified, H13:03, 1232, WSG73. Pushed-in solid base-ring.

15. (D:c.70mm). Road 8, F08:05, 2382, WSG82. Pushed-in tubular base-ring.

16. Base. Area over *Via quintana*, unstratified, M13:01, 1906, WSG173

Base ring from cup or bowl in green glass, with tubular base ring (AC).

17. (D:c.70mm). Area over Building 5, unstratified, J04:13, 837, WSG86

Base fragment of a vessel of pale green glass. Pushed-in open base-ring.

None of these fragments is sufficiently diagnostic for vessel types to be identified, nor can they be closely dated.

Colourless glass

Beakers/bowls/cups

18. (D of body at top of fragment: c.90mm). Area over Building 14, unstratified, K11:01, 1734, WSG3

Fragment from the lower side of a small bowl or cup of colourless glass; now cloudy and opaque, with

iridescent surfaces. Outer surface facet- and wheel-cut: extant part shows part of a horizontal wheel-cut line, below which are two interlocking rows of vertical oval facets, then a band of three horizontal wheel-cut lines, and two of what was presumably a ring of circular facets around central base.

19. Building 13, backfill of west hypocaust, mid-third century, L12:42, 1801, WSG12

Body fragment probably of a bowl or cup of buff-colourless glass, now cloudy and opaque, with iridescent surfaces. Outer surface facet-cut: part of a row of vertical oval facets extant, with a row of horizontal oval facets beneath, then two rows of circular facets.

Both these fragments are most likely to represent hemispherical bowls, which occurred with a wide variety of facet-cut decoration during the later second and third centuries. The combination of vertical oval facets and bands of horizontal wheel-cut lines is quite common and can be paralleled elsewhere: there is one example from a pit dated AD155–165 at Park Street, Towcester (Price 1980, 63–4, fig. 14, no. 1), and another from Carbridge (Charlesworth 1959, 44, fig. 3, 6). A bowl from the Railway Station Cemetery at York also has circular facets (Harden 1962, 137, fig. 88, no. HG205.1), and a bowl from excavations at Doncaster Roman Fort bears decoration combining interlocking rows of vertical oval facets, horizontal oval facets and rows of circular facets (Doncaster Museum).

20. (D: c.90mm H as reconstructed: 59mm). Building AZ, robber trench, and unstratified, M13:07 and M13:01, 1772 and 1784, WSG13

Many fragments forming a reconstructable profile of a bowl or cup of colourless glass; surfaces very pitted and covered with flaking iridescence. Rim out-flared and ground smooth; hemispherical body, decorated with one horizontal wheel-cut line beneath the rim, another pair further down the side, and one more above the base. Base slightly flattened.

21. (D:c.120mm). Building 13, backfill of east hypocaust, Period 4, M12:54, 1851, WSG69

Rim and side fragment of a bowl of colourless glass; now slightly cloudy and opaque with flaking iridescence. Rim out-flared and ground smooth; bulbous body, with one horizontal wheel-cut line beneath rim and another further down side.

Hemispherical bowls, similar in shape to those discussed with reference to nos 18 and 19, but decorated with wheel-cut lines only, seem to belong mainly to the second century. One example came from a pit dated AD155–165 at Park Street, Towcester (Price 1980, 63–4, fig. 14, no. 2), there is another, with a base-ring, from contexts dated AD150–155/60 and AD270–5 at Verulamium (Charlesworth 1972, 206–8, fig. 77, 46), and a small, globular bowl from a late

second century burial at Ford Street, Braughing, Herts (Harden 1977, 102, pl. IX).

22. (D:c.80mm H(as reconstructed):82mm). Building 13, backfill of east hypocaust, mid-third century, M12:44, 1803, WSG15

Rim, body and base fragments of a bowl or cup of colourless glass; surfaces pitted and covered with flaking iridescence and thicker whitish weathering. Fragments do not join, but probable reconstruction is shown in drawing: rim out-flared and fire-rounded and thickened; hemispherical body decorated with pinched-out nipples; base flattened and thickened, and formed into slight base-ring, pontil mark on underside.

This reconstruction shows yet another decorative variant of the hemispherical bowl, popular during the later second and third centuries. The pinched out nipples can occur singly, as here, or in vertical rows of two or three (eg Fremersdorf 1962, 31, pls 34–5; Dappelfeld 1966, 5052, pl. 95, from Cologne). Fragments have been found at other northern sites, including Corbridge (Bulmer 1955, 131, no. 20), South Shields (Museum of Antiquities, Newcastle) and Nether Denton (Chesters Site Museum).

23. (D:c.140mm H(as reconstructed):40mm). Building Row 20, Building Q, mid-third century, F11:37, WSG14

Rim and side fragments (not joining) of a bowl of colourless glass. Rim fire-rounded and thickened, and widely flared, forming slightly overhanging flange with applied self-coloured horizontal coil beneath. Sides taper slightly downward to carination, then curve, presumably towards base-ring.

This vessel is probably related to a group of shallow bowls with flaring rims with ridge beneath which for some reason, is best known from burials in the Netherlands. Twenty-five, for example, came from a grave at Belfort in Limburg (Isings 1971, 22–4, nos 63–75, fig. 12) and there is another from a grave dated AD125–150 at Helshoeven-ander-Hoepertingen in Belgium (Janssens and Vanderhoeven 1974, 17, no. 21, fig. 8).

24. (D:c.50mm). Building 13, backfill of east hypocaust, mid-third century, M12:44, WSG106

Rim fragment probably of an indented beaker (small thin-walled fragment of an indent also extant, though not illustrated); colourless glass, surfaces pitted and iridescent. Slightly flaring rim, ground smooth.

Indented beakers of colourless glass were popular from the Flavian period to the third century. First-century examples have come from Richborough (Bushe-Fox 1926, 49, pl. 19, no. 8; Radford 1932, 85, no. 61, pl. 15), and there is one from a probable third century burial in a stone coffin at York (Harden 1962, 140, pl. 66, no. HG180).

25. (D:c.120mm). Area over *Via quintana*, unstratified, M13:01, 1752, WSG2
Joining rim and side fragment of a cup of colourless glass; flaking iridescent surfaces. Rim fire-rounded and thickened and turned slightly inward; body cylindrical.
26. (D(at carination):c.110mm). Area over Building 13, unstratified, M12:02, 1766, WSG65
Lower body fragment of a cup of colourless glass; flaking iridescent surfaces. Lower part of cylindrical body extant.
27. (D:c.65mm). Building 13, backfill of east hypocaust, mid-third century, M12:17, 1782, WSG103.
Rim and side fragments of a cup of colourless glass; surfaces iridescent, some pieces white and opaque. Rim fire-rounded and thickened and turned slightly inward; body cylindrical.
28. (D:c.80mm). Building 13, room 7, mid-third century, N12:08, 1763 and 1765, WSG05.
Two joining rim fragments of a cup of colourless glass now white and opaque, surfaces iridescent. Rim fire-rounded and thickened and turned slightly outward, body apparently cylindrical.
29. (D:c.95mm). Area over Building 13, unstratified, M12:01, 1692, WSG79
Rim fragment of a cup of colourless glass; surfaces iridescent. Rim fire-rounded and thickened and turned slightly inward.
30. (D:c.95mm). Area over Building 12, unstratified, L14:01, 1783, WSG4.
Rim fragment of a cup of colourless glass; surfaces dulled and swirled. Rim fire-rounded and thickened and turned slightly inward; body cylindrical.
31. Bowl (D:120mm B:2mm). Building 13, probably from fill of east hypocaust, M12:55, WSG205
Colourless out-turned bowl rim with circles between horizontal rice-grain facets. (AC)
32. Cup (D:100mm B:1mm). Chalet 9, Building W, late third/early fourth century, D13:70, 1608, WSG92
Colourless rim and body sherds of cylindrical cup with slightly in-turned fire-rounded rim. One sherd from the outer base ring. (AC)
33. Cup (D:c.70mm B:0.5mm). Building 13, probably from fill of east hypocaust, M12:55, WSG204
Colourless cup with fire-rounded rim. (AC)
34. Cup (D:100mm B:1mm). Area over Building 2, ploughsoil, L05:03, WSG232
Colourless cup with fire-rounded rim, slightly in-turned. (AC)
35. Cup (B:2mm). Unstratified, WSG50
Colourless body sherd with staggered rows of vertical rice-grain facets. (AC)
36. Cup (B(min):0.5mm). Area over Alley 4, unstratified, E05:01, WSG137
Colourless small body sherd from near base with vertical rib. (AC)
37. (D(base):42mm). Rerouted *Via principalis*, Roman/post-Roman, E08:13, 2290, WSG77
Base of a cup of colourless glass. Pushed-in solid base-ring with inner concentric applied coil base-ring (D:18mm). Broken body walls appear to have been chipped away to enable re-use of base as counter or gaming piece.
This simple cup form, with its fire-rounded rim, cylindrical body and double base-ring, was very common during the second half of the second and first half of the third centuries, particularly c.AD160–230. Fourteen fragments, for example, were found in a drain deposit of this date at the Legionary Fortress Baths at Caerleon (Allen 1986, 113, nos 69–73, fig. 43), and at least another 25 have come from the fortress and *vicus* there (National Museum of Wales). Bulmer recorded 30–40 at Corbridge (1955, 128), and more have been found since, and about 50 have been recovered from Verulamium (Verulamium Museum).
The reworking of the base-ring of a broken cup into a simple disc, presumably to be used as a counter or gaming piece, was also quite a common device. There are two examples using this same double base-ring form from York (Yorkshire Museum), and another using a single base-ring from Fishbourne (Harden and Price 1971, 355, no. 77, fig. 141).
38. (D:c.50mm). Alley 3, Period 3, F04:33, 558, WSG89
Fragment from the foot of a vessel, probably a beaker or goblet, of colourless glass. Pad foot, blown separately from vessel body and applied beneath; edge ground smooth. This is most likely to be from some form of goblet, or perhaps a flask, with beaded stem and blown foot (eg Isings 1957, 103, form 86 or 110, form 93). Its date is probably later second- or third-century.
- Bottle/flask*
39. (D of body:c.140mm). Area over Building 2 and Alley 1, post-Roman, M05:04, 24, WSG9
Body fragment of a bottle or flask of colourless glass. Cylindrical body, with part of a band of five horizontal wheel-cut lines extant.
The blue-green bottles of the first two centuries AD were replaced during the later second, third and fourth centuries by a variety of colourless containers, most of them with cylindrical bodies, often decorated with bands of wheel-cut lines (eg Isings 1957, forms 100, 102, 126 and 127). Fragment no. 39 may have

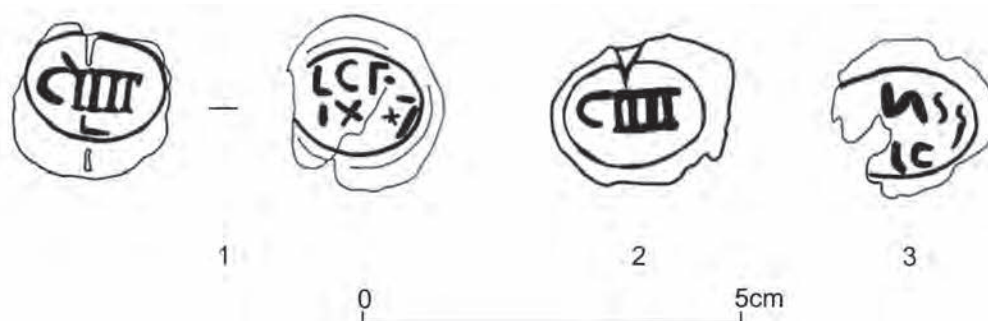

Figure 20 2 Lead sealing . Scale 1

come from any of these, although its relatively large diameter perhaps suggests a bottle with one or two angular, ribbed handles.

Indeterminate

40. Chalet 12, Building AM2, (mid-)late third century, M14:11, 1858, WSG81

Body fragment of colourless glass; dulled and opaque. Start and overlapping end of applied self-coloured trail extant. This fragment is not sufficiently diagnostic to allow close identification.

41. Body sherd (B:1mm). Chalet 9, Building W, late third/early fourth century, D13:70, WSG213

Colourless body sherd probably from near rim with a raised horizontal trail.(AC)

Window glass

42. Twenty-five fragments of window glass were found, all of the blue-green, matt/glossy variety in use to about 300 (Boon 1966a). Eight have the characteristic rounded 'thumb' edge produced by casting in a shallow tray.

Lead sealings and graffiti

by R. S. O. Tomlin

Lead sealing (Fig 20)

1. Lead sealing (L:24mm W:20mm). Yard south of Building 13, Period 1–2, N13:03, 1795, WSIM43

Published: *RIBII* 2411.109

Oval leaden sealing damaged by thin cord or wire which it enclosed, and subsequently by corrosion. Impressed die reads:

Obv CIII L

Rev LCF / C(ohors) (quarta) L(ingonum)

This is the first recorded sealing of *Cohors IV Lingonum*, which is attested as the third- and fourth-century garrison of Wallsend (*RIBI* 1299, 1300, 1301; *Not. Dig. Occ.* 40.33). Its location in Britain during the second century, and the second-century garrison of

Wallsend are not known. A leaden sealing in itself is not conclusive evidence of the location of a unit. The letters *LCF* on the reverse are presumably the initials of the issuing officer, *L(ucius) C(...)* *F(...)*. The second line is unfortunately corroded; after *LX* there seems to be a star (sometimes found on sealings) rather than *X* (for *L(egio) XX*), followed by a centurial sign.

2. Lead sealing (L:25mm W:20mm B:4mm). *Via principalis*, L08:66, 2587, WSIM41

Oval leaden sealing. Impressed die reads:

Obv: CIII

Another sealing of *Cohors IV Lingonum*.

3. Lead sealing (L:21mm W:20mm). East-west drain north of wall of Building 1, Period 2, P05:18, 519, WSIM40

Published: *RIBII* 2411.292

Major fragment of an oval leaden sealing. It was pierced by a thin cord or wire which has left a groove on the reverse; the obverse has been stamped with a lettered die which seems to read: *MS7 / [.]LC*

The reading is difficult because the die was unevenly impressed on a surface since corroded. The die cannot be paralleled, but in form resembles the centurial marks impressed on the *reverse* of some cohortal sealings found at Brough-under-Stainmore (Richmond 1936, 117–9, nos 17–21).

Graffiti (Fig 20)

Graffiti are in capitals, unless otherwise stated, and were all made after the vessel was fired. They are almost all personal names, presumably of members of the second-century garrison.

Samian

1. Alley 1, dump of demolition material, N05:23, 325 and 326, WSIM5, *RIBII* 2501.215. See samian report no. S90. Base sherd (form 18/31R–31R) scratched underneath: [...]*C(or)G*RAT[...]

Probably *Grat[us]*.



Figure 23.03: Graffiti. Scale 1:2.

- | | |
|--|---|
| <p>2. Area over Building 11, unstratified, K15:01, 1373, WSIM16
Part of a footing (form 31R?), incised underneath: IM[...].</p> <p>3. Area over Building 13 and <i>Via quintana</i>, unstratified, H13:01, 1237, WSIM15, RIBII 2501.253
Base sherd (form 18/31), scratched underneath: IVÇ(or S)[...].</p> | <p>S is less likely than C. Probably <i>Iuc[undus]</i></p> <p>4. Area over Building 10 and Alley 5, unstratified, E14:03, 1078, WSIM8, RIBII 2501.274
Base sherd (form 31), scratched underneath: [...]IVN.
Probably complete, and thus an abbreviated <i>Iun(ius)</i>.</p> |
|--|---|

5. Area over Building 1 and Alley 1, unstratified, P05:02, 134, WSIM2
Base sherd (form 31), scratched underneath: [...].LA[...].

The angle of *L* to the footing suggests that it is the first letter, and thus that the next letter is *A* not *M*. The third letter might be *M* but there are other possibilities.

6. Area over Building 14, unstratified, K10:01, 1973, WSIM21, RIBII 2501.354
Base sherd (form 31), scratched underneath: MAT[...].

Probably *Mat[ernus]* or, less likely, *Mat[urus]*; but many other less common names cannot be excluded.

7. Chalet 9, dereliction, post-Roman, G13:03, 1519, WSIM31
Base sherd (form 31), scratched underneath with an elongated letter: P[...]
8. Debris over Cistern 1, late Roman/post-Roman, E08:13, 2593, RIBII 2501.438
Base sherd; scratched underneath at the very centre with elongated letters: PR

Apparently complete, and thus presumably an abbreviated personal name: the choice is wide (*Primus, Priscus, Probus, Proculus* etc).

9. Area over Buildings 4 and 5 and Alley 3, unstratified, G04:01, 161, WSIM35, RIBII 2501.549 and 2501.802
Base sherd (form 31R?) scratched underneath: TRE[...].
10. Road 8, F09:08, 2437, WSIM24, 2007.3043
Rim sherd (form 33) scratched on outer wall: VI[...].

Vi[ctor] or *Vi[talis]* are the most likely, but there are many other possibilities.

11. Building 8, entranceway, Period 4, E11:22, 1145, WSIM11
Rim sherd (form 31R), scratched on the outer wall: VI[...].

See no 10 above.

12. *Via principalis*, L08:60, 2558, WSIM26
Base sherd (form 27) roughly scratched underneath: XX

Probably not a numeral, but a double star or cross, for identification.

13. Area over East rampart, unstratified, C11:10, 1171, WSIM14
Wall sherd (form 31R), scratched underneath: [...].M[...].
14. Building 1, floor, Period 2, M05:25, 909, WSIM30
Base sherd, scratched underneath: [...].N (or V)ER[...].

The *R* is cursive.

Coarse ware

15. Drain in rerouted *Via principalis*, late third/early fourth century, E08:05, 2306, WSIM25, RIBII 2503.96
Four conjoining sherds from the shoulder of a BB2 cooking pot: ΛΑΛ Ν

The first *A* could be called cursive; the first stroke is made with two strokes, or else one of them is a vertical third stroke. The graffito seems to be complete, but its meaning is obscure.

16. North wall of fort, Q04:03, 238, WSIM4, RIBII 2503.211
Sherd of a BB2 cooking pot, scratched just below the rim: BLDIVS.

The graffito seems to be complete, and is presumably a blundered personal name, perhaps *Bl(an)di(n)us*.

17. Area over Building 2 and Alley 1, post-Roman dereliction, M05:04, 136, WSIM32
Rim sherd of a BB1 bowl, inscribed just below the rim in cursive: LV[...].
18. Alley 2, M07:07, 2632, WSIM33
Base sherd of a large grey pot, with an abraded graffito underneath. The letters are also irregular, and the reading is uncertain: ORDIT.I./ V[...].
19. Soil over north-south drain east of Building 3, Period 3–4, Q07:10, 2631, WSIM53
Rim sherd of a grey jar, inscribed below the rim: PR[...].

The *R* is cursive, but the *P* resembles the capital form. This *P*, which is standard in fourth-century New Roman Cursive, is sometimes found in earlier cursive texts, as here. Many names could be restored (see above, no. 8).

20. Building 8, entranceway, Period 4, E11:22, 1153, WSIM13, RIBII 2503.51
Rim sherd of a grey ware jar, with three vertical strokes incised on the rim: III, '3'.
21. Building 13, dereliction, N12:13, 1852, WSIM20, RIBII 2503.55
Rim of a BB2 pot, incised on the inner face of the rim: [...?]IV.

The graffito may well be complete, and thus another numeral, '4'. ΛI[...]. could be read the other way round, but not ΛI[L...] (for *Ae*[...]); however, personal names beginning ΛI[...]. are not common.

22. Chalet 9, dereliction, post-Roman, F13:16, 1108, WSIM9, drawing as RIBII 2503.73, but see also RIBII 2503.63
Rim sherd of a BB2 bowl, incised on the rim: IIX, '8'.

This seems to be the sequence of strokes, and would imply that the graffito was made (and meant to be read) from the outside of the vessel. The reading XII, '12', should thus be excluded.

23. Building 1, demolition, Period 2, N05:04, 207, WSIM3, RIBII 2503.67

Wall sherd of a large closed vessel in oxidized ware, shallowly incised: X.

A numeral, '10', or perhaps a mark of identification.

24. Area over Building 8, unstratified, E11:11, 1152, WSIM12, *RIBII* 2503.82
Rim sherd of a BB2 bowl, incised on the rim: XX, '20'.

A diagonal stroke was first incised, and then two vertical strokes. This sequence would exclude the reading 'H'.

25. Area over Building 13, unstratified, N11:01, 1684, WSIM52
Rim sherd of BB2 pot, deeply incised on the rim: [...] XX, '(at least) 20'.
26. West rampart (F2), N04:06, 25, WSIM50, *RIBII* 2497.4
Sherd preserving about one-third, rim and base included, of a pinkish-cream mortarium of Hadrianic date, found sealed in clay rampart material. Underneath is incised in crude capitals between pairs of layout lines: [.]VRIILI / [...]RIVM, perhaps [A]ureli / [morta]rium, 'mortarium of Aurelius'.

The last vertical stroke in line 1 (read as *I*) is followed by a more shallowly incised diagonal stroke, but *V* makes no sense. *Aureli* seems to be the only name which can be restored here, and its occurrence on a Hadrianic sherd in a Hadrianic context is noteworthy. *Aurelius* is comparatively rare until the accession of Marcus Aurelius (AD 161), but thereafter one would not expect to find it used, as here, without *praenomen* or *cognomen*. *Mortario* ('as a mortarium') occurs as a graffito, but scratched before firing, on the side of a samian mortarium from Corbridge (Haverfield 1913, 270, no. 8).

27. Wall of post-Roman building, unstratified, N05:02, 137, WSIM54, *RIBII* 2503.4
Sherd of a pink flagon with white slip, incised in neat cursive letters on the shoulder: [.]LSVM, perhaps [mu]lsum, 'honey-sweetened wine'.

For wine and honey (separately) in the Roman military diet, see Davies 1971, 131.

28. Dereliction over Alley 1, L05:29, 888, WSIM7, *RIBII* 2494.122
Amphora sherd, faintly inscribed downwards with a fine point in elongated letters: [...]NALIIS.[...], [...]nales [...].

A number of personal names end in *...nalis*, but the plural is puzzling. Brothers can be excluded, since the names are all *cognomina*; they tend to theophoric (*Neptunalis*, *Saturnalis*, etc), so a group of worshippers or other religious reference is possible. A more likely restoration, however, in this military context is [contuber]nales, 'messmates'.

Tile

29. Fired clay support (L:120mm+ W:80mm B:74mm). Building AP, late third century, F09:66, 2481, WSIM36, *RIBII* 2491.142
Fragment of a fired clay support inscribed before firing with a stylus or similar implement. A two-line graffito reads: [c2]CDIIFGH.[...] / .ATCDVF[...].

Line 1 is presumably an alphabet, [ab]cdefgh[i... (etc)], and line 2 perhaps an attempt by a second hand to copy it. For other examples of alphabets and other 'writing practice' on bricks and tiles before firing, see McWhirr 1979, 239.

Additional graffiti

by A. T. Croom

Further examples of graffiti were found during the cataloguing of the pottery.

Amphora

30. Alley 8, upper surface, H09:14, WSIM56
Dr 20, probably from the handle, but a small sherd, inscribed: I V [
Start of another diagonal stroke after the V.

Samian

31. Area outside East rampart, unstratified, C08:04, WSIM44
Inscribed on exterior surface of the base of a form 18/31, inside the foot-ring: M
32. Road 3, M14:28, WSIM89
M inscribed on exterior surface of samian bowl.

Coarse wares

33. Cistern 2, upper fill, late third/early fourth century, H07:03, WSIM66.
Almost complete BB2 bowl. Inscribed in large letters on wall of bowl: MAR
34. Rubble over Building 8 (B3), late third century, D12:09, WSIM61
Along the inner top edge of everted rim from jar, unknown fabric, inscribed:]AN M]
35. Alley 1, dump of demolition material, N05:23, WSIM49
Body sherd on wall of storage jar of unknown grey ware, inscribed:] CRAT [
There is the end of a diagonal stroke before the C
36. Building 13, dereliction, N12:13, WSIM82
N inscribed on rim of BB2 bowl/dish. Small sherd, so could originally have been more letters.
37. Black earth (B2), H05:21, WSIM92
Incomplete N or M inscribed on exterior of a samian cup, form 33, just above the mid-body groove.
38. Building 14, drain in north wall, Period 1 or 2, H08:12, WSIM70
Body sherd of mortarium, inscribed:]IVS.

NUMBERS AND PATTERNS

39–65. Numerals or ownership marks
Lines inscribed on rim of BB2 bowl/dishes:

39. One+ lines. Area over Building 4 and Alley 3, unstratified, H04:13, WSIM76
40. Three lines, deeply cut, on top of rim. Area over Buildings 7 and 8, unstratified, F10:12, WSIM38
41. Three lines, on outer edge. Building 8, cess-pit fill, mid third century?, D12:34, WSIM62
42. Three lines, on top surface. Area over Building 11 and Alley 6, unstratified, L15:15, WSIM78
43. Three lines. Building 8, drain in courtyard, mid-third century?, E11:14, WSIM64
44. Two lines +, on outer edge. North-east drain east of south wall of Building 1, Period 2, Q05:03, WSIM84
45. Four lines, on outer edge. Cistern 2, lower fill, Period late third/early fourth century, H07:09, WSIM58
46. Four+ lines (last line either badly inscribed I or very narrow V). Building Row 20, Building R, mid-third century, G11:17, WSIM72

Lines inscribed on end of mortarium flange

47. Three+ lines. Area over Building 7, unstratified, F11:01, WSIM68

Lines inscribed on top edge of jar rims (cooking pots, unless otherwise stated)

48. Two lines. South-eastern reduced ware, G151-type. Alley 10/Building 17, disturbed rubble inside building, G04:16, WSIM73.
49. Two lines. Small vessel; BB2. Building 8, room 2, D12:45, WSIM63
50. Two+ lines. Small vessel; south-eastern reduced ware. Building 8, drain in courtyard, mid-third century?, E11:14, WSIM65
51. Two+ lines. BB2. Area over *Via quintana*, unstratified, G12:01, WSIM75
52. Three lines. Poppyhead beaker. Drain in Road 3, G11:07, WSIM74

Lines inscribed on base of BB2 bowl/dish

53. Two lines on edge of base. Building 13, west baths, late third century, L12:02, WSIM77.

Lines inscribed on base of cooking pot

54. Four lines on edge of base. South-eastern reduced ware. Cistern 1 filling, mid to late third century, E08:29, WSIM60.

V inscribed on wall of samian bowl

55. Inverted V, below carination of form 18/31. Alley 1, dump of demolition material, N05:23, WSIM90

V inscribed on rim of Dr 20 amphora

56. Complete rim. V on one side, with a slightly slanted V almost opposite it. Area over Building 12, unstratified, M14:01, WSIM46

V inscribed on rim of BB2 bowl

57. V inscribed on the rim of the bowl. Rubble at base of plough furrow, H05:04, WSIM87

X inscribed on samian bowl

58. Small X, on interior of body, near rim. Gate 2, floor, Period 3–4?, D08:40, WSIM88

X inscribed on rim of BB2 cooking pot

59. On inner surface, deeply cut. Building 14, drain in south wall, Period 1 or 2, H12:09, WSIM86

X inscribed on exterior surface of base of BB2 bowl/dish

60. Area over Building 7, unstratified, G11:01, WSIM39
61. With extra diagonal line between north and east arms. Cistern 2, lower fill, H07:09, WSIM85

X inscribed on mortarium base

62. Local fabric; deeply cut over edge of the base. Area over Building 10, Alley 5 and *intervallum* road (Road 6), unstratified, F14:01, F15:01, WSIM67

X inscribed on Dr 20 amphora

63. Handle. Area over *Via quintana*, unstratified, N13:01, WSIM47
64. Handle. Road 8, F08:10, WSIM48
65. On body just above the handle; possibly accidental. Building 1, verandah, Period 3, L04:20, WSIM57

66–69. Patterns

66. Area over Building 12, unstratified, M14:01, WSIM83
Dr 20 amphora body sherd. *Ante-cocturam*, large loop or oval.
67. Building 4, make-up material, Period 2, G04:07, 479, WSIM37
Handle of Dr 20 amphora. Three lines converging to a point, crossed by a horizontal line, deeply incised.
68. Chalet 12, Building AL2, (mid-)late third century, N14:37, WSIM71
Series of connected triangles and lines, inscribed within foot-ring on base of samian bowl.
69. Area over Building 10 and *intervallum* road (Road 6), unstratified, F15:01, WSIM45
Three lines converging downwards to a point. Body sherd of BB2 bowl/dish near base.

Bone counters

See bone report for counters nos 42 (four vertical lines and motif), 50 (LVI), 52 (M) and 54 (four oblique strokes).

Throwing stones

See Fig. 25.34. no. 61 (marked I), no. 130 (IV), no. 54 (V), nos 88, 121 (I+), nos 72, 94 (X), no. 59 (XX).

24. THE COINS

by P. J. Casey and R. Brickstock

The coins from Wallsend discussed here consist exclusively of those recovered from the excavations, excluding those coins from the Museum collection which have, in the past, been ascribed to the Fort but the bulk of which are clearly donations and acquisitions which have nothing to do with the site or with Roman Britain in general (the full catalogue is available in the Museum archive). A number of museums, especially those with seaport connections like Wallsend and across the river South Shields, contain similar collections of exotica and special care needs to be exercised by archaeologists in drawing conclusions from items not otherwise found in controlled excavation contexts (Casey 1984). In the circumstances it is impossible to winnow out the items

which are genuine finds from the Fort since these will consist of coins which are as common in the areas in which exotic items might have been acquired as the more easily recognized intrusive element. No large-scale distortion of the pattern of coinage on the site is imposed by the adoption of a cautious strategy of exclusion of suspect items. For post-Roman coinage up to 1900 see p210.

In presenting the coins in a graphical form (Fig. 24.01) well-established procedures have been followed the methodology of which has been explained on a number of occasions (Casey 1986). However in the case of Wallsend the very lowest limit of the integrity of the method is reached. The total identifiable coins used in the computation, 215 items (excluding pre-



Figure 24.01 Histogram showing annual loss per coins (N#)

Table 2 Breakdown of illegible coins.

Period	No. of coins	% illegible
C1–2	40	34
C2–3	18	18
C3–4	21	42

Claudian issues), is barely acceptable for statistical purposes and inherent mathematical problems arise which create visual distortions that may deceive the interpreter of the resulting histogram. The problem resides in the apparently heavy representation of coins in very short reigns often when the reality consists of a single item occurring in the site record. This is further compounded when the item falls into a period when coins are not normally abundant. In the case of Wallsend attention is drawn to the graphical over-representation of the coins of Period 11 (Elagabalus, 218–22), Period 13 (Maximus Thrax, 235–8) and Period 16 (Trajan Decius, 299–51).

To deal with the main features of the coin display, before elaborating on individual aspects, we may note that the overall balance of the coinage is that of the first, second and third centuries as compared to the fourth century which is, in statistical terms, more lightly represented. The weighting of coinage towards the earlier periods is also evident if we consider the contribution of the coins which are too corroded to attribute to individual rulers or periods and which have, consequently, not been used in the computation of the site histogram:

This overall early weighting is normal for sites on, and associated with, Hadrian's Wall. Discussion of the reasons for this has advanced the view that the relative lack of fourth-century material does not necessarily represent a diminution of garrison forces but may equally be the result of payments being made in goods and services to fourth century soldiers under the *annona militaris* system (Casey 1974). A comparison with Housesteads shows that the pattern is repeated. Here a computation of the value of the fourth-century issues, with a due weighting for the effect of the *annona*, gives an exact parallel between the third- and fourth-century coinage ratios at Corbridge, a site which displays a characteristically civilian pattern in these periods and one which a population decline might be discounted (Casey 1974, 50). Late sites in the hinterland of the wall, notably Piercebridge, and the Saxon Shore forts in the south, have better representation of fourth-century coinage, in absolute terms, a component of which is silver issued as part of the imperial donative system. The near absence of fourth-century silver from the Wall (there is a single *siligua* from Wallsend), might suggest that Wall garrisons did not receive major donatives, the conversion of which, into small denomination currency, would have provided the flow of coin so notably absent from Hadrian's Wall deposits. If this

is so we may have evidence of two classes of *limitanei* possibly to be distinguished as *castellani*, the inferior regiments, and *riparienses*, named from the highly trained river patrol troops on the Rhine/Danube frontier, for the superior. This suggestion is, at the present stage, very speculative.

A notable feature of the Wallsend coin distribution is the relatively low frequency of issues of Period 18 (258–73). This period, which encompasses the *floruit* of the Gallic Empire, saw the collapse of imperial silver currency, with the precious metal content of the double-*denarius* (the so-called *antoninianus*) falling to a low of two percent. This coinage, representing a phase of hyperinflation, is extremely abundant and normally achieves loss rates of up to twenty coins per annum per thousand in site statistical presentations. An element of the coinage of this period consists of copies of the official issues. In reality these copies were almost certainly produced and circulated in Period 19 when reformed coins of Aurelian fail to appear in British contexts, presumably because of an imperial supply problem. If we take this view of events the 45% of the Period 18 coin finds relate to the years 273–86. Whatever the manner in which the material is statistically manipulated the relative dearth of Period 18 deposits indicates a situation which is abnormal and may be ascribed, perhaps, to a diminution in garrison strength. This situation persists in the reign of Carausius (286–93) whose coinage, together with that of Allectus (293–6), is seriously under-represented. [However, the coins from the 1997–8 excavations do not show the low frequency of period 18 issues: see Brickstock 2003, 201].

The pattern for the fourth century, in the light of the points made above, is consistent with other northern sites but with a slightly heavier weight of coinage in Period 24 (348–64) than is normal. The reformed heavy issues of the period, together with copies produced after 354, usually constitute not more than one fifth of the volume of coinage of the preceding Period 23 (330–48). In the case of Wallsend the heavier weight of genuine coins and copies (40% and 60% respectively) is unusual but may represent a freak in the data collection as easily as a real problem of antiquity, but an increase in site activity, or a reinforcement of the garrison cannot be ruled out since it is just at this time that the coins from the hinterland fort of Piercebridge show a re-activation of the fort after several decades of abandonment. There may be a phase of interest in the area by Constantius II after his recovery of the West from Magentius.

The low scores from the coinage of the House of Valentinian (Period 25) and the House of Theodosius (Periods 26 and 27) are normal for the area and a possible explanation for this phenomenon have been offered above. It should not be overlooked that degradation of the site in modern times may have contributed to the pattern since the latest coin issues

Table 2 Condition of the coins

	Unworn	Slightly worn	Worn	Very worn	Extremely worn
Vespasian			4 (44)	2 (22)	3 (33)
Domitian				2 (50)	2 (50)
Trajan		6 (24)	8 (32)	2 (8)	9 (36)
Hadrian		4 (36)	5 (45)	1 (9)	1 (9)
Pius	1(5)	7 (36)	4 (21)	7 (36)	
Aurelius		1 (13)	3 (38)	4 (50)	

(Figures in parenthesis are the percentages of coins in each category for each reign)

Table 3 Coins by period

Period	Chronological spread of dated coins
1	Republic, 69–79, 100, 101–1, 208, 200–c.250
2	81–96, 84–5, 96–8?, 98–103, 98–117, 117–38, 134–8?, 161–2, 229, 249–51, 255–8?, 330–5, 351+
3	96–7, 98–117, 117–38, 119, 134–8, 198–211
3–4	69–79, 98–117, 119, 152–5, 180–92, 193–6, 268–70
4 or later	Republic, 69–79, 98–117, 103–17, 270–3, 273+, 321–4, 332–3, 350–1, 367–75
Mid C3	76, 103–11, 121–2, 161–2, 218–22
Late C3/C4	80–1, 121–2, 138–61, 141–61, 153–5, 160–92, 180–3, 190–1, 211, 218–22, 258–73?, 273+, C3/C4
Dereliction	70–3, 98–117, 125–8, 145–6, c. 164–9, 194+, 202–10, c. 202–35, 219, 346–8

would reside in the uppermost levels of the site. The fact that the fort and its garrison appear in the *Notitia Dignitatum* suggests that the lack of latest period coinage, which is normally lightly represented even in strong coin lists, is partly a function of the generally poor numismatic record for the site in general.

Interpretation of the coinage in terms of occupation patterns and the dating of individual stratigraphic contexts is bedeviled by the problem of residually. This fact of archaeological life operates in two ways in archaeological numismatic contexts. At the simplest level coins, once lost, are subject to random re-disposition as physical adaptations and alterations to the site take place over time. More complex is the residually of coins within the active coin pool of which they formed a component. An analysis of the wear characteristics of the uncorroded coins of the first and second centuries at Wallsend is instructive.

Although wear can represent a long circulation it can equally represent an intensive but short circulation so that the absolute time values cannot be ascribed. However, the overall trend, and the evidence of hoards, points to the circulation of early coinage into the third century, probably up to the late 250s when the early ages denominations lost all value during the inflation of the base silver coinage Period 18.

In terms of the physical condition the categories of wear and tear are distinguished as follows:

Unworn	A virtually uncirculated coin
Slightly worn	The highest relief attenuated by wear
Worn	The relief abraded but all details of legends visible
Very worn	Considerable abrasion, legends indistinct
Extremely worn	Almost complete erosion of details and legend.

Since almost no small change currency was supplied to Britain in the third century the prolific earlier issues made up the deficit. A relative decline in third-century deposits cannot, therefore, be interpreted as evidence of attenuated occupation.

Period dating

In terms of numismatic dating phases the stratified coins from the established phase scheme are as follows:

Garrison and coinage

The garrison evidence from Wallsend suggests that it was held by a *cohors quingenaria equitata* in the reign of Hadrian, a regular 500-strong infantry cohort in the later second century and a *cohors quingenaria equitata* again in the third century. If we make a few assumptions, perhaps unwarranted, we can achieve an overall view of the economic potential of the site in terms of army pay in the period from c.126

to the mid-third century. The assumptions are that the original unit served until the Antonine period, that a gap occurs between *c.*138 and *c.*170, that the replacement unit is a *cohors quingenaria peditata* which serves until the Severan period and that the *Cohors IIII Lingonum Equitata* thereafter constitutes the garrison.

Even if this scheme is defective in detail it permits a broad canvas on which the monetary situation may be painted. Pay and nominal unit strengths in the following calculations are based on the figures established by Watson (Watson 1973).

Table 2 The potential site money pool at Wallsend

Unit		Annual pay	Occupation (years)	Total pay(denarii)
<i>Cohors Equitata</i>	500-	Cavalry 150 Infantry 100	13	717,600
<i>Cohors Peditata</i>	550-	Infantry 100	23	1,104,00
<i>Cohors Equitata</i>	500-	a Cavalry 225 Infantry 150 b Cavalry 337 Infantry 225	57	4,841,304
Total site money pool				6,662,904
Value of coin recovered				71.8
Percentage of pool recovered				0.00107

(NB. Two calculations are needed to express the pay of the latest garrison necessitated by the two pay rises awarded by Septimius Severus and by Caracalla. Calculation of the recovered coinage includes pre-Claudian coins and illegible items. Counterfeits are counted as genuine.)

Catalogue (Key at end)

No	Ruler	Date	diam	Mint	wt	Denom	cat	wear	Obv	Rev
1	L. ANTES GRAGV?	136 BC?	17.5 mm	RM	2.4 g	DEN	CRAW238/1	VW/VW	Helmeted head of Roma r., behind ?GRAG	Jupiter in quadriga r. [L. AES below, ROMA in exergue]
2	C. POSTUMI AT or TA	74 BC	17.0 mm		2.2 g		CRAW394/1a	WW	Bust of Diana r. etc.	Hound running r., spear beneath. In ex. C. POSTUMI A
3	M. ANTONIUS	32-31 BC	18.0 mm		1.9 g	DEN	CRAW544/24	VW/VW	Ship r. ANT AVG Below, [III VIR RPC]	Three standards LEG X
4	REPUBLICAN	C1/2 BC	18.5 mm		2.8 g	DEN	-	C/C	-	-
5	VESPASIAN	69-79	18.5 mm		1.7 g	DEN	-	C/C	-	-
6	VESPASIAN?	69-79	26.0 mm		3.7 g	AS	-	C/C	-	- [SC]
7	VESPASIAN	69-79	27.0 mm		10.7 g	AS	-	C/C	IMP CAESAR VESPAS[...]	?[IVDEA CAPTA] SC
8	VESPASIAN	69-79	27.5 mm		7.5 g	DP	-	C/C	-	- [SC]
9	VESPASIAN	69-79	33.0 mm		20.3 g	SEST	-	VW/EWAVG P[M....]	- [SC]
10	VESPASIAN	69-79	27.5 mm		7.3 g	AS	-	WW	-	- [SC]

No	SF no	REC no	Context	Description
1	2535	WSC202	M08:26	Building 16, clay floor, Period 1
2	2532	WSC016	M08:26	Building 16, clay floor, Period 1
3	156	WSC212	P04:02	North <i>intervallum</i> road, third century
4	1561	WSC300	K15:12	Building 11, <i>contubernium</i> 6, Period 1
5	2526	WSC070	M08:26	Building 16, clay floor, Period 1
6	1121	WSC199	E13:01	Area over Building 9, unstratified
7	1583	WSC125	K13:11	Area over <i>Via quintana</i> , unstratified
8	228	WSC196	M04:03	Building 1, Period 3-4
9	165	WSC090	N04:07	Surface over Building 1, Period 4 or later
10	1212	WSC037	D12:45	Building 8, room 2 floor, Period 2-3

No	Ruler	Date	diam:	Mint:	wt:	Denom:	cat:	wear:	Obv	Rev
11	VESPASIAN	69-79	25.0 mm		4.2 g	AS	-	VW/EW	-	- [SC]
12	VESPASIAN	69-79	28.0 mm		5.0 g	AS	-	EW/C	-	-
13	VESPASIAN	70-73	16.0 mm	RM	1.6 g	DEN	37/49	W/SW	[IMP CAES] VESP [AVG PM...]	[TRI POT] Vesta
14	VESPASIAN	71-79	25.5 mm		6.3 g	DP	as 475	VW/VW	-	- [SC]
15	VESPASIAN	72-73	27.0 mm		8.4 g	AS	-	VW/C	[...]VESPASIAN AVG COS IIII	- [SC]
16	TITUS and DIVUS VESPASIAN	80-81	33.5 mm		20.4 g	SEST	TITUS 143/4	C/C	[IMP T CAES DIVI VESP F AVG PM TRP PP COS VIII SC]	[DIVO AVG VESP(AS) SPQR]
17	TITUS under VESPASIAN	77-78	28.0 mm	LG	8.0 g	AS	Vespasian 786	W/W	[T. CAE]S IMP AVG[F TRP COS VI CENSOR]	- SC
18	DOMITIAN under VESPASIAN	76	18.5 mm	RM	1.6 g	DEN	Vespasian 238	W/W	[CAESAR AVGF] DOMITIANVS	COS IIII Pegasus walking r.
19	DOMITIAN	81-96	34.5 mm		23.1 g	SEST	-	EW/EW	-	- [SC]
20	DOMITIAN	81-96	27.0 mm		8.7 g	DP	-	C/C	-	- [SC]

No	SF no	REC no	Context	Description
11	790	WSC076	H04:19	Rubble over west <i>praetentura</i>
12	1193	WSC204	F11:19	Road 3
13	2599	WSC012	P07:10	Building 3, abandonment/post-Roman dereliction
14		WSC157	C35:32	Unstratified
15	1336	WSC086	F13:16	Chalet 9, post-Roman
16	373	WSC129	G04:19	Rubble in Building 17
17	1864	WSC200	L12:14	Yard south of Building 13, Period 1-2
18	1142	WSC033	D11:27	Building 8, make-up layer for room 1, mid-third century?
19	2565	WSC100	L09:14	Area over Building 13 and Alley 7, unstratified
20	1553	WSC150	E13:23	Building 9, <i>contubernium</i> 1, Period 2

No	Ruler										
21	DOMITIAN			Denom: AS		Obv	-				
	Date: 81-96	Mint:		cat: -		Rev	- [SC]				
	diam: 27.5 mm	wt: 7.0 g		wear: C/C							
22	DOMITIAN			Denom: AS		Obv	IMP CAES DOMITIAN AVG GERM COS [X or XI]				
	Date: 84-85	Mint: RM		cat: as 250a		Rev	[SALVTI AVGVST(I)] SC Altar				
	diam: 27.5 mm	wt: 7.0 g		wear: VW/VW							
23	DOMITIAN			Denom: AS		Obv	IMP CAES DOMIT AVG GERM COS XII CENS PER[PP]				
	Date: 86	Mint:		cat: 335		Rev	MONE[TA AVGVSTI] SC				
	diam: 27.0 mm	wt: 7.2 g		wear: VW/EW							
24	DOMITIAN			Denom: DEN		Obv	[IMP CAES DOMIT AVG GERM PM TRP...]				
	Date: 90-96	Mint:		cat: as 148		Rev	[TRP...COS] XV [...]				
	diam: 17.5 mm	wt: 1.0 g		wear: VW/VW							
25	FLAVIAN			Denom: AS		Obv	-				
	Date: 69-96	Mint:		cat: -		Rev	- [SC]				
	diam: 27.0 mm	wt: 9.8 g		wear: C/C							
26	NERVA			Denom: DEN		Obv	IMP NERVA CAES AVG PM TRP COS [II or III PP]				
	Date: 96-97	Mint:		cat: 9/20		Rev	[SALVS] PVBLICA				
	diam: 17.5 mm	wt: 2.3 g		wear: UW/UW							
27	NERVA?			Denom: AS		Obv	-				
	Date: 96-98?	Mint:		cat: -		Rev	- [SC]				
	diam: 27.5 mm	wt: 7.4 g		wear: EW/EW							
28	NERVA			Denom: DEN		Obv	IMP NERVA CAES [AVG GERM PM TRP II]				
	Date: 98	Mint:		cat: 47		Rev	IMP II COS IIII PP				
	diam: 17.0 mm	wt: 1.6 g		wear: W/W							
29	TRAJAN			Denom: AUREUS		Obv	IMP CAES NERVA TRAIAN AVG GERM Head laureate				
	Date: 100	Mint: RM		cat: RIC 34		Rev	PM TRP COS III PP Fortuna standing, holding rudder on prow and cornucopia				
	diam: 7.3 mm	wt: 19.5 g		wear: SW/SW							
30	TRAJAN			Denom: SEST		Obv	IMP CAES NERVA TRAIAN AVG G[ERM PM]				
	Date: 98-103	Mint:		cat: as 430		Rev	[TR POT COS IIII] SC Concordia				
	diam: 34.0 mm	wt: 22.9 g		wear: VW/EW							

No	SF no	REC no	Context	Description
21	1430	WSC194	H14:30	Area over Building 9 and Alley 5, unstratified
22	2583	WSC083	M07:12	Building 16, wall foundation, Period 1
23	2601	WSC094		Unstratified
24	1523	WSC072	K15:11	Area over Building 11, unstratified
25	2209	WSC093	E09:01	Area over Road 8, unstratified
26	2604	WSC141	M18:33	Building 16, pit, Period 3
27	195	WSC123	N05:04	Building 1, Period 2 demolition
28	175	WSC035	Q05:02	Area over Building 1, unstratified
29	2525	WSC044	M08:26	Building 16, clay floor, Period 1
30	2397	WSC097	E10:74	Building 8, room 8, Period 2

No	Ruler	Date	diam:	Mint:	wt:	Denom:	cat:	wear:	Obv	Rev
31	TRAJAN	98-117	34.5 mm		19.1 g	SEST	-	C/C	-	-
32	TRAJAN	98-117	25.0 mm		7.9 g	AS	-	C/C	-	- [SC]
33	TRAJAN	98-117	31.0 mm		9.0 g	SEST	-	C/C	-	- [SC]
34	TRAJAN	98-117	33.5 mm		18.7 g	SEST	-	EW/C	-	- [SC]
35	TRAJAN	98-117	30.0 mm		12.9 g	SEST	-	EW/EW	-	- [SC]
36	TRAJAN	98-117	32.5 mm		21.5 g	SEST	-	C/C	-	-
37	TRAJAN	98-117	33.0 mm		17.4 g	SEST	-	EW/EW	-	- [SC]
38	TRAJAN	98-117	34.0 mm		15.9 g	SEST	-	EW/EW	-	- [SC]
39	TRAJAN	98-117	26.5 mm		7.9 g	AS	-	C/C	-	- [SC]
40	TRAJAN	98-117	26.5 mm		8.6 g	DP	-	C/C	-	- [SC]

No	SF no	REC no	Context	Description
31	2544	WSC016	P07:07	Building 3, abandonment/post-Roman dereliction
32	2182	WSC082	F09:01	Area over Road 8, unstratified
33	792	WSC107	H14:19	Rubble over west <i>praetentura</i>
34	697	WSC208	L04:03	Area over Building 1, unstratified
35	2621	WSC098		Unstratified
36	1268	WSC137	J15:01	Area over Building 11, unstratified
37	2201	WSC099	E08:01	Area over Cistern 1, unstratified
38	2250	WSC096	F08:10	Road 8
39	329	WSC079	M05:15	Building 1, officer's quarter's demolition/make-up, Period 3
40	1524	WSC145	L15:20	Building 11, <i>contubernium</i> 3/4, Period 2

No	Ruler	Date:	diam:	Mint:	wt:	Denom:	cat:	wear:	Obv	Rev
41	TRAJAN	98-117	32.0 mm		20.1 g	SEST	-	C/C	-	- [SC]
42	TRAJAN?	98-117	26.5 mm		6.6 g	AS	-	C/C	-	-
43	TRAJAN	98-117	26.0 mm		6.9 g	DP	-	C/C	-	- [SC]
44	TRAJAN	98-117	29.0 mm		15.6 g	AS	-	?W/C	-	- [SC]
45	TRAJAN	101-11	33.0 mm		29.4 g	SEST	497	?SW/SW	[IMP CAES NERVAE] TRAIANO AVG [GER DAC] PM TRP [COSVPP]	[SPQR OPTI]MO PRINCIPI SC Aequitas
46	TRAJAN	103-11	19.0 mm		2.8 g	DEN	118	C/SW	IMP TRAIANO AVG GER DAC PM TRP	COS V PP SPQR OPTIMO PRINCIPI
47	TRAJAN	103-11	33.0 mm		18.8 g	SEST	as 527	W/?W	[IMP CAES NERVAE TRAIAN]O AVG [GER DAC PM TRP COS V PP]	[SPQR OPTIMO PRINCIPI] SC
48	TRAJAN	103-11	19.5 mm		2.2 g	DEN	172	SW/W	[IMP TRAIANO] AVG GER DAC [PM TRP COS V PP]	SPQR [OPTIMO PRI]NCIPI
49	TRAJAN	103-11	34.0 mm		23.6 g	SEST	as 500	EW/EW	[.....]AVG GER DAC[...]	- [Fortuna SC]
50	TRAJAN	103-11	26.5 mm		9.7 g	DP	as 481	W/C	[IMP CAES NERVAE TRAIAN]O AVG GER DAC [PM TRP C]OS V PP	- SC

No	SF no	REC no	Context	Description
41	234	WSC158	N05:13	Clay puddling pit, Period 3 demolition
42	1329	WSC084	J15:01	Area over Building 11, unstratified
43	912	WSC151	M05:29	Building 1, <i>contubernium</i> 7 hearth, Period 2
44	754	WSC193	L04:03	Area over Building 1, unstratified
45	2178	WSC132	J07:20	Building 15, Period 1
46	1924	WSC073	J12:01	Area over Building 14 and <i>Via quintana</i> , unstratified
47	1921	WSC115	K11:01	Area over Building 14, unstratified
48	1397	WSC034	L14:01	Area over Building 12, unstratified
49	1203	WSC205	D12:34	Building 8, latrine fill, mid-third century?
50	1541	WSC152	K14:01	Area over Building 12, unstratified

No	Ruler	Denom:	AS	Obv
51	TRAJAN	Denom:	AS	[IMP CAES NERVAE] TRIANO AVG GER DAC PM [TRP COSV PP]
	Date: 103-11	Mint:	cat: 561	Rev
	diam: 27.5 mm	wt: 10.7 g	wear: VW/VW	SPQR OPTIMO PRINCIPI SC
52	TRAJAN	Denom:	DP	[IMP CAES NERVAE TRIANO AVG GER DAC PM TRP COSV PP]
	Date: 103-11	Mint:	cat: 502	Rev
	diam: 26.5 mm	wt: 10.0 g	wear: SW/SW	SPQR OPTIMO PRINCIPI SC
53	TRAJAN	Denom:	SEST	[IMP CAES NERVAE TRIANO AVG GER DAC PM T[RP COS V PP]
	Date: 103-11	Mint:	cat: 564	Rev
	diam: 32.0 mm	wt: 22.5 g	wear: VW/EW	[SPQR OPTIMO PRINCIPI] SC in exergue
54	TRAJAN	Denom:	DEN	[IMP TRAI]NO [AVG] GER DAC PM TRP
	Date: 103-11	Mint:	cat: 96	Rev
	diam: 18.0 mm	wt: 2.1 g	wear: W/W	[COS V PP] SPQR OPTIMO PRINC, DAC CAP in exergue
55	TRAJAN	Denom:	DP	[IMP CAES NERVAE TRIAN]O AVG G[ER....]
	Date: 103-17	Mint:	cat: as 462	Rev
	diam: 18.0 mm	wt: 10.8 g	wear: C/C	- [SC]
56	TRAJAN	Denom:	SEST	[IMP CAES NER...] TRIANO [AVG...]
	Date: 103-17	Mint:	cat: as 459	Rev
	diam: 34.0 mm	wt: 20.0 g	wear: C/C	- SC
57	TRAJAN	Denom:	DP	-
	Date: 103-17	Mint:	cat: as 505	Rev
	diam: 25.0 mm	wt: 8.3 g	wear: ?SW/C	?Pax - [SC]
58	TRAJAN	Denom:	SEST	[IMP ...TRAI]ANO AVG GER [...]
	Date: 103-17	Mint:	cat: as 459 etc.	Rev
	diam: 33.5 mm	wt: 21.2 g	wear: C/C	- [SC]
59	TRAJAN	Denom:	SEST	IMP CAES NERVAE TRIANO AVG GER DAC PM TRP COSVI PP
	Date: 112-14	Mint:	cat: 610	Rev
	diam: 34.5 mm	wt: 24.6 g	wear: W/W	SPQR OPTIMO PRINCIPI SC, in exergue ARABADQ
60	TRAJAN	Denom:	DP	[IMP CAES NERVAE TRIANO AVG GER DAC PM TRP COS VI PP]
	Date: 112-14	Mint:	cat: 626	Rev
	diam: 25.5 mm	wt: 8.8 g	wear: C/C	[FELICITAS AVGVST] SC

No	SF no	REC no	Context	Description
51	1729	WSC117	L12:01	Area over Building 13 and <i>Via quintana</i> , unstratified
52	2324	WSC147	G09:30	Building 7, west granary
53	983	WSC030	G12:01	Area over <i>Via quintana</i> , unstratified
54	960	WSC025	E14:01	Area over Building 10, unstratified
55	2332	WSC156	F07:03	<i>Via principalis</i> , Period 4
56	1747	WSC116	P12:08	<i>Intervallum</i> road drain by Building 13
57	1463	WSC153	E14:24	Building 10, <i>contubernium</i> 2, Period 2
58	2246	WSC041	E09:18	Road 8
59	1744	WSC134	P11:01	Area over Building 13, unstratified
60		WSC155		Unstratified

61	TRAJAN			Denom: SEST	Obv IMPCAESNER TRAIANOPTIMOAVGGERDACP ARTHICOPM[TRPCOSV]JPP
	Date: 114-17	Mint:	cat: 642		Rev [ARMENIA ET M]JESOPOTAMIA [IN POTESTATEM REDACTAE] SC
	diam: 34.0 mm	wt: 22.2 g	wear: W/W		
62	TRAJAN			Denom: SEST	Obv IMPCAES NER TRAIANO OPTIMO AVGGERPARTHICO
	Date: 114-17	Mint:	cat: 663		Rev PMTRP COSVIPP PROVIDENTIA AVGVSTI SPQR SC
	diam: 33.0 mm	wt: 20.1 g	wear: SW/SW		
63	TRAJAN			Denom: DEN	Obv IMP CAES NER TRAIAN OPTIM AVG GERM DAC
	Date: 114-17	Mint:	cat: 332		Rev PARTHICO PM TRP COS VI PP SPQR
	diam: 18.0 mm	wt: 2.6 g	wear: SW/SW		
64	TRAJAN			Denom: SEST	Obv [IMP CAES(NER) TRAIANO OPTIMO AVG GERDAC PMTRP COSVIPP]
	Date: 114-17	Mint:	cat: 651/2		Rev FORT [RED] in exergue, [SENATVS POPVLVSQVE ROMANVS] SC
	diam: 33.5 mm	wt: 20.1 g	wear: EW/EW		
65	TRAJAN/HADRIAN?			Denom: SEST	Obv -
	Date: c. 98-117	Mint:	cat: -		Rev - [SC]
	diam: 34.5 mm	wt: 17.8 g	wear: C/C		
66	HADRIAN			Denom: SEST	Obv -
	Date: 117-38	Mint:	cat: -		Rev - [SC]
	diam: 33.0 mm	wt: 23.2 g	wear: VW/VW		
67	HADRIAN			Denom: DEN	Obv [...HADRIANVS...]
	Date: 117-38	Mint:	cat: as 270		Rev ?Salus, seated l.
	diam: 17.5 mm	wt: 1.4 g	wear: SW/SW		
68	HADRIAN			Denom: SEST	Obv -
	Date: 117-38	Mint:	cat: as 610		Rev - [SC]
	diam: 30.0 mm	wt: 21.6 g	wear: C/C		
69	HADRIAN			Denom: AS	Obv [IMP CAESAR TRAIAN(VS) HADRI]ANVS AVG
	Date: 119	Mint:	cat: 577		Rev [PONT MAX TR POT] COS III SC
	diam: 26.5 mm	wt: 9.0 g	wear: C/?W		
70	HADRIAN			Denom: SEST	Obv IMP CAESAR TRAIANVS HADRIANVS [AVG]
	Date: 119	Mint:	cat: 563b		Rev PONT MAX [TR POT] COS III SC
	diam: 34.5 mm	wt: 22.3 g	wear: W/W		

No	SF no	REC no	Context	Description
61	1423	WSC136	L14:01	Area over Building 12, unstratified
62	425	WSC101	P05:16	Alley 1, upper levels
63	367	WSC024		Unstratified
64	1	WSC127	Q04:01	Area over <i>intervallum</i> road (Road 4), unstratified
65	2358	WSC110	F07:03	<i>Via principalis</i> , Period 4
66	27	WSC089	M05:05	Area over Building 2 and Alley 1, unstratified
67	924	WSC074	M05:28	Building 1, clay floor, Period 2
68	2378	WSC111	E07:11	Drain in road near Cistern 1, Period 3
69	278	WSC124	Q05:05	Building 2, north-south drain east of east wall, Period 3
70	2602	WSC046	Q08:15	Building 3, officer's quarters, Period 3-4

No	Ruler	Date	diam	Mint	wt	Denom	cat	wear	Obv	Rev
71	HADRIAN	119-21	25.5 mm	RM	9.3 g	DP	605	W/W	[IMP CAESAR TRAIAN(VS) HADRIANVS AVG PM TRP COS III]	[VIR]TVTI [AVGVSTI] SC
72	HADRIAN	121-22	33.0 mm		20.2 g	SEST	612a	C/W	[IMP CAESAR TRAIAN] [HADRIANVS AVG]	[PM TRP COS I]II SC
73	HADRIAN	121-22	17.5 mm	RM	2.6 g	QUAD	623a	SW/SW	IMP CAES[AR TR]AIAN HADRIANVS AVG	[PM TR]P COS II[!] SC Rostrum tridens, r.
74	HADRIAN	125-28	27.0 mm	RM	9.2 g	AS	664	W/W	[HADRI]ANVS AVG[VSTVS]	Minerva [COS III] SC
75	HADRIAN	125-38	33.0 mm		21.9 g	SEST	as 631	SW/C	[HADRIANVS AVG...]	- [SC]
76	HADRIAN	134-38	32.0 mm	RM	21.8 g	SEST	as 745	?SW/C	[HADRIA]NVS AVG COS [...]	- [SC]
77	HADRIAN	134-38	27.0 mm	RM	7.2 g	AS	975	VW/EW	[HADRIA]NVS AVGVSTVS PP	[COS III] SC
78	HADRIAN	134-38?	28.5 mm		10.0 g	DP	974	SW/?SW	HADRIANVS AVGVSTVS PP	HILARITAS PR COS III SC
79	ANTONINUS PIUS	138-61	27.5 mm		6.8 g	AS	-	C/C	-	- [SC]
80	ANTONINUS PIUS	138-61	25.5 mm		10.2 g	AS		W/C	-	- [SC]

No	SF no	REC no	Context	Description
71	1396	WSC144		Unstratified
72	2249	WSC114	E10:47	Building O, east wall, late third century
73	1206	WSC048	D12:34	Building 8, latrine fill, mid-third century?
74	33	WSC119	M05:04	Area over Building 2 and Alley 1, post-Roman dereliction
75	1702	WSC045	K11:01	Area over Building 14, unstratified
76	2081	WSC091	K11:36	Building 14, crosshall, Period 3
77	75	WSC047	P05:02	Area over Building 1 and Alley 1, unstratified
78	430	WSC195	N05:25	Building 1, south wall foundation, Period 2
79	1302	WSC209	K14:01	Area over Building 12, unstratified
80	1234	WSC210	H14:04	Area over Building 9 and Alley 5, unstratified

No	Ruler	Date	diam	Mint	wt	Denom	cat	wear	Obv	Rev
81	ANTONINUS PIUS	138-61	23.5 mm		5.2 g	AS	as 519b	C/C	-	- [SC]
82	ANTONINUS PIUS	138-61	26.0 mm		6.1 g	AS	-	VW/VW	-	- [SC]
83	ANTONINUS PIUS	138-61	25.5 mm		4.1 g	AS	-	C/C	-	- [SC]
84	ANTONINUS PIUS	138-61	32.5 mm		22.0 g	SEST	-	C/C	-	-
85	ANTONINUS PIUS	139	18.5 mm	RM	2.4 g	DEN	26	SW/SW	[IMP T] AEL CAES HADR ANTONINVS	AVG PIVS PM TRP COS II
86	ANTONINUS PIUS	139-61	26.5 mm		9.5 g	DP	as 551	W/W	ANTONINVS AVG [PIVS...]	LIBERT[AS...] SC
87	ANTONINUS PIUS	140-44	32.5 mm		21.3 g	SEST	597	?W/VW	ANTONINVS AVG PI-VS P[P TRP COS III]	[ANNOVA AV]G SC
88	ANTONINUS PIUS	140-44	26.5 mm	RM	9.9 g	AS	675	SW/SW	ANTONINVS AVG [PIVS PP TRP COS III]	[A]N[NONA AVG] SC
89	ANTONINUS PIUS	140-60	33.5 mm		24.2 g	SEST	as 610	C/C	[ANTONINVS A]VG PI[-VS ...]	- SC
90	ANTONINUS PIUS	145-61	31.0 mm		25.7 g	SEST	779	SW/W	ANTONINVS AVG PI-VS [PP T]RP COS IIII	SC Minerva adv. r.

No	SF no	REC no	Context	Description
81	2214	WSC078	F09:04	Area over Road 8, unstratified
82	23	WSC206	P04:01	Area over <i>intervallum</i> road (Road 4), unstratified
83	2243	WSC077	E07:04	Area over Road 1, unstratified
84	1178	WSC108	G11:10	Building Row 20, Building R, late third/early fourth century
85	1994	WSC344	K08:01	Area over Building AO, unstratified
86	1375	WSC146	G13:03	Chalet 9, post-Roman
87	1147	WSC039	F11:15	Area over Buildings 7 and 8 and Road 3, unstratified
88	1927	WSC092	K11:01	Area over Building 14, unstratified
89	1069	WSC197	G11:03	Building BJ, post-Roman
90	2226	WSC011	L10:05	Alley 7

No	Ruler	Denom:	Obv
91	ANTONINUS PIUS Date: 150-51 diam: 32.5 mm Mint: wt: 19.6 g	SEST cat: 867 wear: VWW	ANTONINVS AVG PIVS PP TRP XI[III] Rev [LIBERALI]TAS, VI on vexillum [COS III] SC
92	ANTONINUS PIUS Date: 152-55 diam: 25.5 mm Mint: wt: 10.9 g	DP cat: as 908 wear: W/VW	ANTONINVS AVG [PIVS PP TRP XVI..] Rev LIBERT[AS COS] III SC
93	ANTONINUS PIUS Date: 153-54 diam: 24.5 mm Mint: RM wt: 8.4 g	DP cat: 920 wear: SW/SW	ANTONINVS [AVG PI]-VS PP TRP XVII Rev L[IBERTAS COS] III SC
94	ANTONINUS PIUS Date: 153-55 diam: 29.5 mm Mint: RM wt: 16.4 g	SEST cat: 916/928 wear: VW/VW	[ANTONINVS AVG PIVS PP TRP XVII or XVIII] Rev [LIBERTAS COS III] SC
95	ANTONINUS PIUS Date: 154-55 diam: 17.5 mm Mint: RM wt: 2.0 g	DEN cat: 238 wear: SW/W	ANTONINVS AVG PIVS PP TRP XVIII Rev COS III
96	ANTONINUS PIUS Date: 154-55 diam: 25.0 mm Mint: wt: 8.8 g	AS cat: 934 wear: W/W	[ANTONINVS AVG PIVS PP TRP XVIII] Rev BRITANN[IA COS III] SC
97	ANTONINUS PIUS Date: 154-56 diam: 26.5 mm Mint: wt: 7.0 g	DP cat: 933/950 wear: SW/W	[ANTONINVS AVG PIVS PP TRP XVIII or XIX] Rev [LIBER]TAS COS [III] SC
98	FAUSTINA I, POSTH. Date: 141-61 diam: 26.5 mm Mint: wt: 11.7 g	DP cat: A. Pius 1163b wear: VW/VW	DIVA FAVS[TINA] Rev AETERNITAS SC
99	FAUSTINA I, POSTH. Date: 141-61 diam: 26.0 mm Mint: wt: 7.1 g	AS cat: as A. Pius 1154 wear: SW/C	DIVA FAVSTINA Rev - SC
100	FAUSTINA I, POSTH. Date: 141-61 diam: 26.0 mm Mint: wt: 10.5 g	DP cat: as A. Pius 1164 wear: SW/W	DIVA [FAVS]TINA Rev [AETER]NITAS SC

No	SF no	REC no	Context	Description
91	1920	WSC020	L11:01	Area over Building 13, unstratified
92	438	WSC029	G04:10	Building 17, Period 3-4
93	1122	WSC023	F14:24	Chalet 9, post-Roman
94	1465	WSC095	D13:06	Chalet 9, Building W, late third/fourth century
95	1356	WSC036	K14:03	Area over Building 12, unstratified
96	1629	WSC085	N14:01	Area over Building 12, and <i>Via quintana</i> , unstratified
97	2597	WSC148	P07:09	Area over Building 3, unstratified
98	2491	WSC015	L09:14	Area over Building 13 and Alley 7, unstratified
99	1389	WSC118	H14:38	Chalet 9, post-Roman
100	1175	WSC130	F11:13	Levelling north of Buildings Q and R, late third/fourth century

No	Ruler	Date	diam	Mint	wt	Denom	cat	wear	Obv	Rev
101	FAUSTINA II [A. PIUS]	145-46	24.0 mm		8.4 g	DP	as A. Pius 1408	W/VW	[FAVSTINA AVG...]	?[VENVS] SC
102	MARCUS AURELIUS, CAESAR	145-61	27.0 mm		11.8 g	AS	as A. Pius 1342	UW/UW	[AVRE]LIVS [CAE]SAR [AVG P]II FIL	[TR POT...] COS II SC
103	MARCUS AURELIUS	161-62	16.5 mm		1.5 g	DEN	as 2	SW/W	[IMP.]M AVREL ANTO[NINVS AVG]	CON[CORD AVG TRP XV(I)] in exergue COS III
104	MARCUS AURELIUS	161-62	25.5 mm		9.5 g	AS	obv. as 819	W/W	IMP CAES M AVREL ANTONINVS AVG	SC inside laurel wreath [type as Hunterian Hadrian 572]
105	MARCUS AURELIUS	161-80	24.0 mm		7.6 g	DP	-	?SW/C	-	- [SC]
106	MARCUS AURELIUS	174-80	24.5 mm		8.0 g	DP	as 1133	VW/VW	[M.ANT]ONINVS [AVG...]	[Annona etc.] - [SC]
107	FAUSTINA II (M. AURELIUS)	161-75	25.0 mm		13.1 g	AS	1639 M. Aurelius	W/VW	FAVSTINA AVGVSTA	FECVNDITAS SC
108	FAUSTINA II (M. AURELIUS)	161-75	30.0 mm		19.5 g	SEST	-	C/C	-	- [SC]
109	LUCILLA	c. 164-69	32.0 mm		20.5 g	SEST	-	C/C	[LVCIL]LA [...]	- [SC]
110	LUCILLA	c. 164-69	31.5 mm		17.3 g	SEST	1750/1 M. Aurelius	C/VW	[LVCIL]L[LA....]	[IVNO REGINA] SC

No	SF no	REC no	Context	Description
101	2239	WSC149	E08:13	Rerouted <i>Via principalis</i> , Roman/post-Roman
102	1585	WSC038	J14:05	Area over Building 12 and Road 9, unstratified
103	1204	WSC224	G11:17	Building Row 20, Building R, mid-third century
104	2592	WSC013	Q08:18	North-south drain east of Building 3, Period 2
105	2225	WSC154	D08:01	Area over West rampart, unstratified
106	1249	WSC225	H15:08	Area over Building 10 and Road 9, unstratified
107	1528	WSC088	K14:18	Area over Building 12, unstratified
108	30	WSC065	M05:04	Area over Building 12 and Alley 1, unstratified
109	2223	WSC113		Unstratified
110	1971	WSC133		Unstratified

No	Ruler	Denom:	Obv
111	LUCILLA	SEST	LVCILLAE AVG ANTO[NINI AVG F]
	Date: c. 164-69	Mint:	
	diam: 30.5 mm	wt: 17.8 g	Rev [PIETAS] SC
112	LUCILLA	SEST	LVCILLA AVGVSTA
	Date: c. 164-69	Mint:	
	diam: 30.0 mm	wt: 19.9 g	Rev HILARITAS SC
113	COMMODUS	SEST	-
	Date: 180-92	Mint:	
	diam: 30.0 mm	wt: 18.4 g	Rev - [SC]
114	COMMODUS	DEN	[M.COM]M ANT P FEL AVG BRIT PP]
	Date: 190-91	Mint:	
	diam: 17.5 mm	wt: 2.3 g	Rev ROM FEL PM TRP XVI COS VI
115	CRISPINA	AS	[CRI]SPIN[A AVGVSTA]
	Date: 180-83	Mint:	
	diam: 24.0 mm	wt: 8.9 g	Rev - SC
116	SEPTIMIUS SEVERUS	DEN	L SEPT SEV [PERT..]AVG IM[P II..]
	Date: 194-97	Mint:	
	diam: 17.0 mm	wt: 1.6 g	Rev [VICTOR AVG]
117	SEPTIMIUS SEVERUS	DEN	SEVERVS AVG PART MAX
	Date: 200-01	Mint: RM	
	diam: 18.5 mm	wt: 2.4 g	Rev RESTITVTOR VRBIS
118	SEPTIMIUS SEVERUS	DEN	[SEVE]RVS [PIVS AVG]
	Date: 202-10	Mint:	
	diam: 17.0 mm	wt: 1.0 g	Rev IN[DVLGENTIA] AVGG in exergue: IN CARTH
119	'SEPTIMIUS SEVERUS'	DENpl	L SEPT SEV[...]
	Date: 194+	Mint:	
	diam: 16.5 mm	wt: 2.5 g	Rev - Virtus
120	'SEPTIMIUS SEVERUS'	DENpl	-
	Date: 194+	Mint:	
	diam: 16.5 mm	wt: 1.7 g	Rev [....]COS II P[P] Victory adv. I.

No	SF no	REC no	Context	Description
111	1124	WSC026	F11:01	Area over Building 7, unstratified
112	2548	WSC014	P07:07	Building 3, abandonment/post-Roman
113	774	WSC160	H05:13	Soil and rubble over Building 18
114	825	WSC342	J05:15	Fill of plough furrow
115	1606	WSC087	D13:71	Chalet 9, Building W, late third/early fourth century
116	2267	WSC346	F08:10	Road 8
117	1069	WSC159	G11:03	Building BJ, post-Roman
118	257	WSC142	E05:04	Rubble over west <i>praetentura</i>
119	2240	WSC009	E08:13	Rerouted <i>Via principalis</i> , Roman/post-Roman
120	1313	WSC198	K15:01	Area over Building 11, unstratified

No	Ruler	Date:	diam:	Mint:	wt:	Denom:	cat:	wear:	Obv	Rev
121	'SEPTIMIUS SEVERUS'	194+	18.5 mm		2.1 g	DENpl	c. of 380	UW/UW	[IMP CAE L SEP SEV PERT] AVG [COS II]	[FORT]VNA REDVX
122	JULIA DOMNA	193-96	28.5 mm	RM	17.1 g	SEST	Severus 843	W/W	[IVL]IA DO-[MNA AVG]	[VESTA] SC
123	JULIA DOMNA	196-211	15.0 mm		2.4 g	DEN	553	UW/C	IVLIA AVGVSTA	FORTVNAE FELICI
124	CARACALLA	198-211	18.0 mm		1.8 g	DEN	-	SW/C	-	-
125	CARACALLA	208	19.5 mm	RM	3.2 g	DEN	as 105	SW/SW	ANTONINVS PIVS AVG	PONTIF TRP [X]I COS III
126	CARACALLA	211	18.5 mm	RM	2.9 g	DEN	191	UW/UW	ANTONINVS-PIVS AVG BRIT	PONTIF TRP-XIII COS III
127	CARACALLA	215	18.5 mm		1.7 g	DEN	268?	UW/SW	ANTONINVS PIVS AVG GERM	PM TRP X[VI]II CO[S IIII PP] ?Pax
128	CARACALLA/GETA CAESAR	198-211	18.0 mm		1.1 g	DEN	-	C/C	-	-
129	ELAGABALUS	218-22	19.0 mm		1.7 g	DEN	88/91	SW/SW	IMP [ANTONINVS AVG]	[IN]VICTVS SACERDO[S AVG]
130	ELAGABALUS	218-22	17.5 mm	RM	0.6 g	DEN	106	SW/SW	[IMP ANTO]ININVS PIVS AVG	[LIBER]TAS AVG

No	SF no	REC no	Context	Description
121	1522	WSC139	L14:--	Area over Building 12, unstratified
122	801	WSC128	H05:12	Rubble over west <i>praetentura</i>
123	2252	WSC052	F08:10	Road 8
124	264	WSC203	M05:11	Building 2, <i>contubernium</i> 5 clay floor, Period 3 or later
125	1805	WSC066	L12:44	Building 13, room 4 floor, Period 1
126	2372	WSC340	E08:44	Cistern 1, lower fill, late third century
127	2007	WSC222	K08:04	Area over Road 1, unstratified
128	2213	WSC063	F09:11	Area over Road 8, unstratified
129	1779	WSC061	L12:16	Building 13, west hypocaust backfill, mid-third century
130	2364	WSC211	E08:27	Cistern 1, upper fill, late third century

No	Ruler	Date	diam:	Mint:	wt:	Denom:	cat:	wear:	Obv	Rev
131	'ELAGABALUS'	'219'	19.5 mm		1.9 g	DENpl	c. of 17	SW/SW	IMP ANTO[NINIVS P]IVS AVG	PM [TRP II CO]S II PP
132	'ELAGABALUS'	218+	19.5 mm		1.8 g	DENpl	c. of 146	SW/W	[IMP] ANTONINVS PIVS AVG	SVMMVS SACERDOS AVG
133	'ELAGABALUS'	218-22	17.5 mm		0.8 g	DENpl	c. of 146	SW/SW	[IMP] ANTON[INVS PIVS AVG]	[SVMMV]S SACERDOS AVG
134	SEVERUS ALEXANDER	222-28	19.5 mm		1.4 g	DEN	180	SW/SW	IMP CM AVR SEV [ALEXAND AVG]	VICTORIA AVG
135	SEVERUS ALEXANDER	229	19.0 mm		2.1 g	DEN	92	UW/UW	IMP SEV ALE-XAND AVG	PM TRP VIII COS III PP
136	'SEVERUS ALEXANDER'	'227'	21.0 mm		3.7 g	DENpl	c. of 70	SW/UW	IM[P CM AVR SEV] ALEXAN[AVG]	[PM TR]P VI COS II PP
137	MAXIMUS under MAXIMINUS I	236-38	28.5 mm		16.8 g	SEST	13	VW/VW	MAXIMVS CAES [GERM]	PRINCIPI IVVENTVTIS SC
138	HERENNIA ETRUSCILLA	249-51	21.0 mm		2.0 g	ANT	Trajan Decius 59b	SW/SW	HER ETRVSCILLA AVG	PVDICITIA AVG
139	GALLIENUS?	255-58?	17.0 mm		0.9 g	ANT	as 119	C/C	[IMP... GALLIENVS..AVG]	PM [TRP...COS..]
140	GALLIENUS	258-68	18.0 mm		1.5 g	ANT	as 208	SW/SW	[GALLIEN]VS AVG	[IOVI CO]NSERVA

No	SF no	REC no	Context	Description
131	882	WSC143	K04:04	Latest surviving <i>Via praetoria</i> surface
132	2603	WSC018	M10:14	Building 13, robbing
133	1265	WSC138	J14:03	Road 9
134	692	WSC008	K04:02	Area over Building 4 and Road 2, unstratified
135	2028	WSC343	K08:07	Building AO, Period 2
136	1749	WSC140	M12:01	Area over Building 13, unstratified
137	2218	WSC131	F09:05	Area over Road 8, unstratified
138	910	WSC031	L04:25	Building 1, demolition material, Period 2
139	2405	WSC075	F08:35	<i>Via principalis</i> , Period 2
140	1303	WSC053	K13:01	Area over <i>Via quintana</i> , unstratified

No	Ruler	Date	diam	Mint	wt	Denom	cat	wear	Obv	Rev
141	GALLIENUS	258-68	17.0 mm		1.9 g	ANT	-	SW/C	[...GALLIENVS...]	-
142	GALLIENUS	258-68	19.0 mm		2.7 g	ANT	233	SW/SW	[GALLIE]NVS AVG	LIBERTA[S AVG]
143	GALLIENUS	258-68	21.5 mm	RM	2.9 g	ANT	180var.	UW/UW	GALLIENVS AVG for IMP G...	DIANAE CONS AVG
144	GALLIENUS?	258-68?	20.0 mm		2.1 g	ANT	-	SW/C	[...GALLIENV]S AVG	-
145	'GALLIENUS'	258+	17.0 mm		1.0 g	ANT	c. of 179	C/SW	[GALLIENVS AVG]	[DIANAE CONS AVG]
146	'GALLIENUS'	260+	18.5 mm		3.3 g	ANT	c. as 193	SW/SW	-	-
147	CLAUDIUS II	268-70	17.5 mm	ME	3.8 g	ANT	171	UW/SW	[IMP] CLAVDIVS [PFAVG]	VI[CTORIA A]VG
148	CLAUDIUS II	268-70	18.0 mm		1.8 g	ANT	as 94	SW/SW	[IMP..CLAVDIVS AVG]	[PROVIDE]NT[.AVG]
149	CLAUDIUS II	268-70	18.5 mm		1.6 g	ANT	c. as 62	SW/UW	[IMP(C) CLAV]DIVS A[VG]	[L]BLRT [AVG] sic
150	CLAUDIUS II?	268-70	17.5 mm		1.7 g	ANT	-	SW/C	[...CLAVDI]VS AVG	-

No	SF no	REC no	Context	Description
141	1727	WSC172	K12:02	Alley 7
142	1263	WSC054	J16:01	Area over Gate 3 and Road 6, unstratified
143	2019	WSC007	K08:11	Building AO
144	1723	WSC170	K12:02	Alley 7
145	1221	WSC027	C12:05	Road surface within <i>Porta quintana</i>
146	2450	WSC103	G09:14	East granary flagged floor
147	1530	WSC345	K14:03	Area over Building 12, unstratified
148	718	WSC186	L03:48	North gate
149	1929	WSC010	J11:01	Area over Building 14, unstratified
150	776	WSC181	H05:13	Soil and rubble over Building 18

No	Ruler	Date	diam:	Mint:	wt:	Denom:	cat:	wear:	Obv	Rev
151	'POSTUMUS'	258+	19.0 mm		1.8 g	ANT	c. of 77	UW/UW	[IMP]C PO[STVMVS PFAVG]	[ORIE]NS AVG
152	VICTORINUS	268-70	18.5 mm		2.0 g	ANT	as 61	SW/C	IMPC VICTORINVS PFAVG	-
153	VICTORINUS/TETRICUS I	268-73	18.0 mm		1.8 g	ANT	-	C/C	-	-
154	'VICTORINUS/TETRICUS I'	273+	15.0 mm		1.6 g	ANT	c. of -	C/C	-	-
155	'VICTORINUS/TETRICUS I'	273+	14.5 mm		2.4 g	ANT	c. as -	SW/NSU	-	-
156	'VICTORINUS/TETRICUS I'	273+	15.5 mm		1.5 g	ANT	c. as E676	W/W	-	[INVICTVS]
157	'TETRICUS I'	273+	16.5 mm		1.5 g	ANT	c. as E779	SW/SW	[IMPC TETRICVS PFAVG]	[SALVS AVGG]
158	'TETRICUS I'	273+	13.0 mm		0.7 g	ANT	c. as -	C/C	-	-
159	TETRICUS II	270-73	17.0 mm		1.6 g	ANT	as E769	C/C	-	[SPES...]
160	TETRICUS II	270-73	17.5 mm		1.6 g	ANT	as 254	UW/UW	-	[PIETAS AV]GG

No	SF no	REC no	Context	Description
151	1051	WSC180	D12:11	<i>Via quintana</i>
152	2005	WSC055		Unstratified
153	1040	WSC161	D12:11	<i>Via quintana</i>
154	1319	WSC105	J16:01	Area over Gate 3 and Road 6, unstratified
155	985	WSC058	E12:01	Area over Building 8 and <i>Via quintana</i> , unstratified
156	992	WSC057	D12:08	Make-up layer over Building 8, Building N, late third century
157	1966	WSC060	J10:01	Area over Building 14, unstratified
158	2040	WSC182	L09:01	Area over Building 13 and Alley 7, unstratified
159	2369	WSC197		Unstratified
160	2021	WSC104	K08:12	<i>Via principalis</i> , Period 4

No	Ruler	Date	diam	Mint:	wt:	Denom:	cat:	wear:	Obv	Rev
161	TETRICUS II	272-73	20.0 mm		1.6 g	ANT	E769	SW/SW	C PIV ES[V TETRICVS CAES]	[SPES PVBLICA]
162	RADIATE	258-68?	18.5 mm		0.8 g	ANT	-	C/C	-	-
163	RADIATE?	258-73?	18.0 mm		1.1 g	ANT	-	C/C	-	-
164	RADIATE?	258-73?	16.0 mm		1.3 g	ANT	-	UW/C	-	-
165	RADIATE COPY	273+	17.0 mm		1.0 g	ANT	c. as -	C/C	-	..A...RI...
166	RADIATE COPY	273+	11.0 mm		0.3 g	ANT	c. as -	SW/SW	-	-
167	RADIATE COPY	273+	8.0 mm		0.3 g	ANT	c. as -	C/C	-	-
168	RADIATE COPY	273+	14.5 mm		1.6 g	ANT	c. as -	C/C	-	-
169	RADIATE COPY	273+	17.0 mm		1.2 g	ANT	c. as -	C/C	-	-
170	RADIATE COPY	273+	17.5 mm		2.0 g	ANT	c. as -	SW/SW	-	-

No	SF no	REC no	Context	Description
161	1712	WSC032	K12:01	Area over Building 14 and <i>Via quintana</i> , unstratified
162	1090	WSC183	G11:06	Area over Building 7, unstratified
163	989	WSC056	D12:08	Make-up layer over Building 8, Building N, late third century
164	1395	WSC184	L14:01	Area over Building 12, unstratified
165	2278	WSC059	F08:10	Road 8
166	1713	WSC171	L12:01	Area over Building 13 and <i>Via quintana</i> , unstratified
167	2001	WSC173	spoil tip	Unstratified
168	2063	WSC185	G08:02	<i>Via principalis</i> , Period 4
169	990	WSC187	D12:08	Make-up layer over Building 8, Building N, late third century
170	1976	WSC102		Unstratified

No	Ruler	Date	diam:	Mint:	wt:	Denom:	cat:	wear:	Obv	Rev
171	CARAUSIUS	286-93	21.5 mm		2.3 g	AUREL	as 118	C/UW	[IMP..CARAVSIVS..AVG]	P[AX AVG]
172	DIOCLETIAN	c. 301	29.0 mm	TR	6.1 g	FOLL	as 6TR502	SW/SW	IMPC DIOCLETIANVS PF AVG	GENIO POPV-LI ROMANI
173	MAXIMINUS	310-12	22.5 mm	LN P	3.9 g	FOLL	6LN209b	SW/SW	IMP MAXIMINVS PFAVG	GENIO POP ROM
174	CONSTANTINE I	323-24	19.0 mm	LG P	1.6 g		7LG214	SW/SW	[CONSTAN]-TINVS AVG	[SARMATIA-DEVICTA]
175	CONSTANTINE I	330-35	16.5 mm		1.1 g		as 7TR522	W/SW	[VRBJS] [ROMA]	Wolf and Twins
176	CONSTANTINE I	332-33	17.5 mm	TR S	2.0 g		7TR547	W/SW	[VRBS] ROMA	Wolf and Twins
177	CONSTANTINE I	330-35	18.0 mm		1.1 g		as 7TR523	SW/SW	[CONSTAN]-TIN[OPOLIS]	Victory on prow
178	CONSTANTINE I	332-33	17.0 mm	TR S	2.0 g		7TR548	SW/SW	CONSTANTINOPOLIS	Victory on prow
179	'CONSTANTINE I'	341-46	15.5 mm	TR P	1.1 g		c. of 7TR522	C/C	[VRBS] R[OMA]	Wolf and Twins
180	'CONSTANTINE I'	341-46	13.5 mm		1.0 g		c. as 7TR523	C/C	[CONSTANTINOPOLIS]	Victory on prow

No	SF no	REC no	Context	Description
171	1815	WSC214	K12:02	Area over Building 14 and Road 3, unstratified
172	1256	WSC357	J15:03	Area over Building 11, unstratified
173	1386	WSC028	J16:01	Area over Gate 3 and Road 6, unstratified
174	593	WSC218	H05:01	Area over Building 5 and Alley 4, unstratified
175	2157	WSC162	G08:04	<i>Via principalis</i> , Period 2
176	2269	WSC043	F08:16	Area over Road 8, unstratified
177	2273	WSC215	F08:10	Road 8
178	1260	WSC217	J16:01	Area over Gate 3 and Road 6, unstratified
179	2403	WSC216	F08:19	Building AO, south wall robber trench
180	1405	WSC219	L14:01	Area over Building 12, unstratified

No	Ruler	Date:	diam:	Mint:	wt:	Denom:	cat:	wear:	Obv	Rev
181	CRISPUS CAESAR	321	18.0 mm	LG P	3.1 g		7LG133	UW/UW	CRISPVS-NOB CAES	BEATA TRANQVILLITAS VO/TIS/XX
182	CRISPUS CAESAR	321-24	18.5 mm		1.9 g		7LN212	UW/C	CRISPVS - [N]O[BILC]	[BEATA TRANQVILLITAS] VOT/IS/XX
183	CONSTANTINE II, CAESAR	323-24	18.0 mm		1.6 g		as 7TR434	UW/UW	CONSTANTINVS IVN NOBC	CAESARVM NOSTRORVM VOT/X
184	CONSTANTINE II, CAESAR	326-28	18.0 mm		0.9 g		as 7TE157	SW/SW	CONSTANTINVS IVN NOBC	PROVIDEN-TIAE CAESS mm: SM[TSA?]
185	CONSTANTINE II, CAESAR	330-35	16.5 mm		1.5 g		as 7TR520	SW/SW	CONSTANTINVS IVN NOBC	GLOR-IA EXERC-ITVS 2 stds
186	CONSTANTIUS II, CAESAR	330-35	16.0 mm		0.9 g		as 7TR521	W/W	FL IVL CONSTANTIVS NOBC	GLOR-IA EXERC-ITVS 2 stds
187	CONSTANTIUS II, CAESAR	330-35	16.5 mm		0.7 g		as 7TR239	SW/SW	[FL IVL C]ONSTANTIVS NOBC	[GLOR-IA EXERC]-ITVS 2 stds
188	CONSTANTIUS II, CAESAR	332-33	16.0 mm	TR S	1.7 g		7TR540	UW/UW	FL IVL CONSTANTIVS NOBC	GLOR-IA EX[ERC-ITVS] 2 stds
189	CONSTANTIUS II, CAESAR	335-37	16.0 mm		0.9 g		as 7TR592	W/SW	[FL IVL] CONSTANTIVS [NOBC]	[GLOR-IA E]XERC-ITVS 1 std
190	HELENA/THEODORA	337-41	14.0 mm		1.4 g		-	SW/C	-	-

No	SF no	REC no	Context	Description
181	1255	WSC005		Unstratified
182	987	WSC227	G15:19	Chalet 10, Building X, Period 4
183	1415	WSC233	L14:01	Area over Building 12, unstratified
184	2427	WSC213	C08:07	Midden material west of fort, pit C08:10/D08:71
185	2010	WSC232	K07:03	Area over Building 16 and Road 2, unstratified
186	1223	WSC228	C12:04	Road surface in <i>Porta quintana</i>
187	1042	WSC229	E12:11	Road 3
188	2461	WSC192	N08:02	Building 16, partition, Period 4
189	1970	WSC207	L09:01	Area over Building 13 and Alley 7, unstratified
190	1977	WSC223		Unstratified

No	Ruler	Date	diam:	Mint:	wt:	Denom:	cat:	wear:	Obv	Rev
191	CONSTANS	346-48	14.0 mm		0.8 g		as 8TR185	SW/C	[CONSTAN]-S PF AVG	[VICTORIAE DDAVGGQNN]
192	CONSTANS	346-48	14.5 mm	TR	0.8 g		8TR185	SW/W	CONSTAN-S PF AVG	VICTORIAE DDAVGGQNN
193	CONSTANS	346-48	14.5 mm		1.1 g		as 8TR185	SW/W	CONSTAN-S PF [AVG]	[VICTORIAE DDAVGGQNN]
194	CONSTANS	346-48	14.5 mm		1.1 g		-	SW/C	[DN CONSTANS PFAVG]	[VICTORIAE DDAVGGQNN]
195	CONSTANS	346-48	14.5 mm	TR P	1.3 g		8TR195	UW/SW	[CONSTAN]-S PF AVG	[VICTORIAE DDAVGGQNN]
196	CONSTANS	346-48	15.5 mm	TR	0.9 g		8TR185	SW/SW	CONSTAN-S PF AVG	VICTORIAE DDAVGGQNN
197	CONSTANS	346-48	15.5 mm		1.0 g		as 8TR186	SW/UW	[CONSTAN]-S PFAVG	[VICTORIAEDD]AVGGQ[NN]
198	CONSTANS	346-48	16.0 mm	TR S	1.2 g		8TR195	SW/SW	CONSTAN-S PF AVG	VICTORIAE DDAVGGQNN
199	CONSTANS	348-50	23.5 mm	LG	3.9 g		8LG74	SW/SW	DN CONSTA-NS PF AVG	FEL TEMP [REPARATIO] Galley- phoenix
200	CONSTANS	348-50	19.5 mm	LG P	2.8 g		8LG86	C/SW	[DN CONSTA-]NS [PF] AVG	[FEL REMP RE]PAR-[AT]IO Hut

No	SF no	REC no	Context	Description
191	2470	WSC240	Q08:04	Area over Building 16, unstratified
192	704	WSC242	K05:09	Area over Road 2, unstratified
193	998	WSC239	D12:11	<i>Via quintana</i>
194	1320	WSC238	J15:01	Area over Building 11, unstratified
195	1045	WSC286	D11:02	Area over Building 8 and Road 5, unstratified
196	598	WSC241	L05:03	Area over Building 2, unstratified
197	1726	WSC237	K11:01	Area over Building 14, unstratified
198	1114	WSC287	F12:01	Area over <i>Via quintana</i> , unstratified
199	1044	WSC163	D12:11	<i>Via quintana</i>
200	1289	WSC021	J16:01	Area over Gate 3 and Road 6, unstratified

No	Ruler	Date:	diam:	Mint:	LG	TR P	LG P	AR S	Denom:	cat:	wear:	Obv	Rev
201	CONSTANTIUS II	337-40	14.0 mm	LG	1.1 g				8LG22	UW/UW		[CONSTANTI]-VS PF AVG	GLORI-A EXER-[CITVS] 1 std
202	CONSTANTIUS II	353-55	17.0 mm	TR P	1.5 g				8TR359	W/C		DN CONSTAN-TIVS PF AVG	[FEL TEMP] REPARATIO FH3
203	CONSTANTIUS II	353-55	18.0 mm	LG P	1.7 g				8LG190	UW/UW		DN CONSTAN-TIVS PF AVG	FEL TEMP REPARATIO FH3
204	CONSTANTIUS II	355-61	18.0 mm	AR S	1.7 g				SILIQ	8AR261/291	W/W	DN CONSTAN-TIVS PF AVG	VOTIS/XXX/MVLTI/XXXX
205	'CONSTANTIUS II'	353+	9.0 mm		0.4 g					c. as 8TR359	C/UW	[DN CONSTANTIVS PFAVG]	[FEL TEMP REPARATIO] FH3
206	'CONSTANTIUS II'	353+	16.0 mm		1.0 g					c. as 8TR359	SW/C	[DN CONSTANTIVS PFAVG]	[FEL TEMP REPARATIO] FH3
207	'CONSTANTIUS II'	353+	16.0 mm		1.7 g					c. as 8TR359	W/W	[DN CONSTANTIVS] PF AVG	[FEL TEMP RE]PARAT[IO] FH3
208	'CONSTANTIUS II'	353+	15.5 mm		1.4 g					c. as 8TR359	C/W	[DN CONSTAN-]TIVS [PF] AVG	[FEL TEMP REPAR]ATIO FH3 (conceivably intended as FH2)
209	'CONSTANTIUS II'	353+	8.0 mm		0.2 g					c. as 8TR359	UW/UW	[DN CONSTANTIVS PFAVG]	[FEL TEMP REPARATIO] FH3
210	'CONSTANTIUS II'	353+	8.0 mm		0.2 g					c. as 8TR359	SW/W	[DN CONSTANTIVS PFAVG]	[FEL TEMP REPARATIO] FH3

No	SF no	REC no	Context	Description
201	2045	WSC042		Unstratified
202	1967	WSC234	J10:01	Area over Building 14, unstratified
203	1374	WSC004	G13:03	Chalet 9, post-Roman
204	2190	WSC017	F08:01	Area over Road 8, unstratified
205	2001	WSC174	spoil tip	Unstratified
206	1402	WSC273	L15:01	Area over Building 11, unstratified
207	2484	WSC230	G11:51	Drain immediately west of Building 7
208	2020	WSC188	K08:11	Building AO
209	2001	WSC175	spoil tip	Unstratified
210	2001	WSC176	spoil tip	Unstratified

No	Ruler	Date	diam	Mint	wt	Denom	cat	wear	Obv	Rev
211	'CONSTANTIUS II'	353+	9.5 mm		0.5 g		c. as 8TR359	SW/?SW	[DN CONSTANTIVS PFAVG]	[FEL TEMP REPARATIO] FH3
212	'CONSTANTIUS II'	353+	15.5 mm		1.6 g		c. as 8TR359	C/SW	[DN CONSTANTIVS PF AVG]	[FEL TEMP] REPARATIO FH3
213	'CONSTANTIUS II'	353+	9.5 mm		0.4 g		c. as 8TR359	W/W	[DN CONSTANTIVS PFAVG]	[FEL TEMP REPARATIO] FH3
214	CONSTANTIUS II/CONSTANS	337-40	13.5 mm	RM	1.0 g		as 8RM9	SW/SW	[DN FL CONST...AVG]	[SECVRITAS REIP]
215	CONSTANTIUS II/CONSTANS	346-48	15.0 mm		1.0 g		-	C/C	-	[VICTORIAE DDAVGGQNN]
216	CONSTANTIUS II/CONSTANS	346-48	15.5 mm	TR S	1.2 g		8TR183/5	SW/SW	CONSTA[... PF AVG]	VICTORIAE DDAVGGQNN
217	CONSTANTIUS II/CONSTANS	346-48	15.0 mm		1.3 g		-	C/SW	-	[VICTORIAED]D[AVGGQNN]
218	HOUSE OF CONSTANTINE	335-41	15.5 mm		0.9 g		as 7TR586	C/C	-	[GLORIA EXERCITUS]? 1 std
219	'HOUSE OF CONSTANTINE'	341-46	14.0 mm		1.1 g		c. as 7TR518	SW/C	-	[GLORIA EXERCITUS] 2 stds
220	MAGNENTIUS	350-51	21.5 mm	TR	3.4 g		8TR264	W/SW	IM CAE MAGN-[ENTIVS AVG]	[FELICITAS REIPVBLICE]

No	SF no	REC no	Context	Description
211	2001	WSC177	spoil tip	Unstratified
212	977	WSC281	D11:01	Area over Building 8, unstratified
213	2001	WSC178	spoil tip	Unstratified
214	1933	WSC236	J12:01	Area over Building 14 and <i>Via quintana</i> , unstratified
215	2057	WSC235	H08:01	Area over Building AO, unstratified
216	2274	WSC019	F08:10	Road 8
217	1554	WSC231	E14:09	Chalet 10, post-Roman dereliction
218	1316	WSC226	J16:01	Area over Gate 3 and Road 6, unstratified
219	2199	WSC303	F08:01	Area over Road 8, unstratified
220	1683	WSC022	N13:01	Area over <i>Via quintana</i> , unstratified

No	Ruler	Date:	diam:	Mint:	wt:	Denom:	cat:	wear:	Obv	Rev
221	MAGNENTIUS	350-51	21.0 mm	LG P	3.4 g		8LG112	UW/UW	DN MAGNEN-TIVS PF AVG	FELICITAS REIPVBLICE
222	MAGNENTIUS	353	25.0 mm		5.8 g		as 8AM39	?SW/SW	[DN MAGNEN]-TIVS PFAVG	[SALVS DDNN AVG ET CAES]
223	'MAGNENTIUS'	351+	16.5 mm		1.4 g		c. as 8LG123	SW/?SW	[DN MAGNEN-TIVS PFAVG]	[VICTORIA]E DD[N AVG ET CAE]
224	'MAGNENTIUS'	351+	15.0 mm		1.1 g		c. as 8LG126	UW/UW	DN MAGNEN-TIVS P[F AVG]	VICTORIA[E DDNN AVG ET CAE] VOT[V/MVLT/X, mm: RS[LG]
225	'MAGNENTIUS'	351+	18.0 mm		3.0 g		c. as 8AM5	UW/UW	[DN M]ABN[EN-TIVS PFAVG]	[VICTORIAE] DDNN A[VG ET CAE] VOT[V/MVLT/X
226	VALENTINIAN I	364-75	18.0 mm		2.0 g		as CK525	W/W	DN VAL[ENT]INI-[ANVS PFAVG]	SECVRITAS REIPVBLICAE
227	VALENS	364-75	19.0 mm	AR II	2.0 g		as CK483	SW/SW	DN VALEN-S PFAVG	SECVRITAS REIPVBLICAE
228	VALENS	367-75	17.5 mm	AQ P	2.0 g		CK1012	W/W	DN VALEN-S PF AVG	[GLORIA RO-]MANORVM
229	ILLEGIBLE	C2BC-AD	16.0 mm		1.2 g	DEN	-	C/C	-	-
230	ILLEGIBLE	C1st	26.5 mm		4.9 g	AS	-	C/C	-	- [SC]

No	SF no	REC no	Context	Description
221	830	WSC191	K05:07	Rubble over west <i>praetentura</i>
222	1753	WSC221		Unstratified
223	1285	WSC189	J13:05	Road 9 drain fill
224	2154	WSC003	G08:04	<i>Via principalis</i> , Period 2
225	2181	WSC201	F08:01	Area over Road 8, unstratified
226	2490	WSC040	F08:51	Building AO, south wall robber trench
227	1878	WSC220	M13:12	Building BA, robber trench
228	835	WSC006	J05:07	Rubble over west <i>praetentura</i>
229	2524	WSC064	M08:26	Building 16, clay floor, Period 1
230	2412	WSC122	E10:76	Building 8, room 8, Period 2

No	Ruler	Date	diam	Mint	wt	Denom	cat	wear	Obv	Rev
231	ILLEGIBLE	C1st	25.5 mm		8.0 g	AS	-	C/C	-	- [SC]
232	ILLEGIBLE	c. 69-138	34.0 mm		21.1 g	SEST	-	C/C	-	- [SC]
233	ILLEGIBLE	C1-2nd	17.5 mm		1.8 g	DEN	-	C/C	-	-
234	ILLEGIBLE	C1/2nd	27.0 mm		8.6 g	AS	-	C/C	-	-
235	ILLEGIBLE	C1/2nd	30.0 mm		15.4 g	SEST	-	C/C	-	- [SC]
236	ILLEGIBLE FRAGMENT	C1/2nd	14.5 mm		0.8 g	[AE]	-	C/C	-	-
237	ILLEGIBLE	C1/2nd	25.5 mm		6.5 g	AS	-	C/C	-	- [SC]
238	ILLEGIBLE	C1/2nd	25.5 mm		4.3 g	AS	-	C/C	-	- [SC]
239	ILLEGIBLE	C1/2nd	30.0 mm		12.4 g	SEST	-	C/C	-	- [SC]
240	ILLEGIBLE	C1/2nd	24.0 mm		5.8 g	AS	-	C/C	-	- [SC]

No	SF no	REC no	Context	Description
231	1167	WSC121	F11:04	Rubble east of Building 8 (B3), late third/early fourth century
232	2480	WSC112	M09:01	Area over Building 13, unstratified
233	2534	WSC067	M08:26	Building 16, clay floor, Period 1
234	1197	WSC280	G11:13	Building Row 20, Building R, late third/early fourth century
235	831	WSC109	J04:13	Area over Building 4, unstratified
236	2268	WSC307	F08:16	Area over Road 8, unstratified
237	1282	WSC080	F14:01	Area over Building 10 and Alley 5, unstratified
238	245	WSC120	P05:05	Building 1, south wall, Period 2
239	2367	WSC306	E08:44	Cistern 1, lower fill, late third century
240	508	WSC293	E04:31	Alley 3, Period 3

No	Ruler									
241	ILLEGIBLE			Denom: DEN		Obv	-			
	Date: C1/2nd	Mint:		cat: -		Rev	-			
	diam: 16.0 mm	wt: 2.1 g		wear: C/C						
242	ILLEGIBLE			Denom: DEN		Obv	-			
	Date: C1/2nd	Mint:		cat: -		Rev	-			
	diam: 17.0 mm	wt: 1.1 g		wear: C/C						
243	ILLEGIBLE			Denom: DP		Obv	-			
	Date: C1/2nd	Mint:		cat: -		Rev	- [SC]			
	diam: 25.0 mm	wt: 4.1 g		wear: C/C						
244	ILLEGIBLE FRAGMENTS			Denom: DEN		Obv	-			
	Date: C1/2nd	Mint:		cat: -		Rev	-			
	diam: 14.5 mm	wt: 0.5 g		wear: C/C						
245	ILLEGIBLE			Denom: DP/AS		Obv	-			
	Date: C1/2nd	Mint:		cat: -		Rev	- [SC]			
	diam: 27.0 mm	wt: 7.4 g		wear: C/C						
246	ILLEGIBLE			Denom: AS		Obv	-			
	Date: C1/2nd	Mint:		cat: -		Rev	- [SC]			
	diam: 18.0 mm	wt: 8.3 g		wear: C/C						
247	ILLEGIBLE			Denom: DEN		Obv	-			
	Date: C1/2nd	Mint:		cat: -		Rev	-			
	diam: 17.0 mm	wt: 2.4 g		wear: C/C						
248	ILLEGIBLE			Denom: [AE]		Obv	-			
	Date: C1/2nd?	Mint:		cat: -		Rev	-			
	diam: 20.0 mm	wt: 2.1 g		wear: C/C						
249	ILLEGIBLE FRAGMENT			Denom: DEN		ObvLT...			
	Date: C1/3rd	Mint:		cat: -		RevBL...			
	diam: 11.0 mm	wt: 0.3 g		wear: UW/SW						
250	ILLEGIBLE			Denom: DP/AS		Obv	-			
	Date: C2nd	Mint:		cat: -		Rev	-			
	diam: 27.0 mm	wt: 10.0 g		wear: C/C						

No	SF no	REC no	Context	Description
241	2537	WSC071	M08:26	Building 16, clay floor, Period 1
242	2528	WSC068	M08:26	Building 16, clay floor, Period 1
243	2453	WSC285	L07:01	Area over Building 16, unstratified
244	2538	WSC302	M08:26	Building 16, clay floor, Period 1
245	507	WSC305	M04:10	Building 1, <i>contubernium</i> 5 clay floor, Period 2
246	2507	WSC081	L08:47	Building 16, floor, Period 4
247	2497	WSC069	Q07:07	Rubble over East rampart and <i>intervallum</i> road
248	1736	WSC304	L13:15	Building AZ, Period 4
249	1024	WSC312	D12:02	Rubble over Building 8 and <i>intervallum</i> road, late third/early fourth century
250	595	WSC308	H02:03	Area over Tower 1, unstratified

No	Ruler	Date	diam:	Mint:	wt:	Denom:	cat:	wear:	Obv	Rev
251	ILLEGIBLE FRAGMENT	C2nd	13.5 mm		0.3 g	DEN	-	C/C	-	-
252	ILLEGIBLE	C2, late	31.0 mm		14.3 g	SEST	-	C/C	-	-
253	ILLEGIBLE	C2/3rd	17.5 mm		1.1 g		-	C/C	-	-
254	ILLEGIBLE	C2/3rd	20.0 mm		2.7 g	[AE]	-	C/C	-	-
255	ILLEGIBLE	C2/3rd	19.0 mm		3.2 g	DEN	-	C/C	-	-
256	ILLEGIBLE	C2/3rd	18.5 mm		2.0 g		-	C/C	-	-
257	ILLEGIBLE	C2/3rd	16.5 mm		1.7 g	DEN	-	C/C	-	-
258	ILLEGIBLE	c. 200-35	19.5 mm		0.8 g	DENpl	-	C/C	-	-
259	ILLEGIBLE	c. 200-35	18.0 mm		1.2 g	DENpl	-	C/C	-	-
260	ILLEGIBLE FRAGMENT	c. 200-35	15.0 mm		0.9 g	DENpl	c. of -	C/C	-	-

No	SF no	REC no	Context	Description
251	2540	WSC301	M08:26	Building 16, clay floor, Period 1
252	1461	WSC135	D13:06	Chalet 9, Building W, late third/fourth century
253	1719	WSC294	K11:01	Area over Building 14, unstratified
254	1847	WSC296	N12:13	Building 13, dereliction
255	1708	WSC062	L12:01	Area over Building 13 and <i>Via quintana</i> , unstratified
256	1720	WSC295	K12:02	Alley 7
257	1549	WSC292	L15:07	Building 11
258	699	WSC283	H02:03	Area over Tower 1, unstratified
259	1567	WSC277	H13:01	Area over Building 9 and <i>Via quintana</i> , unstratified
260	1224	WSC278	H14:02	Area over Building 9 and Alley 5, unstratified

No	Ruler	Date:	diam:	Mint:	wt:	Denom:	cat:	wear:	Obv	Rev
261	ILLEGIBLE	c. 200-53	17.0 mm		0.6 g	ANT?	-	C/C	-	-
262	ILLEGIBLE [SEVERAN+]	c. 202-35	18.5 mm		1.4 g	DENpl	c. as Severus 261	C/UW	-	FELIC[ITAS.....]
263	ILLEGIBLE COPY	c. 220-35	18.0 mm		1.1 g	DENpl	c.of -	C/C	-	-
264	ILLEGIBLE	C3/4th	14.5 mm		0.8 g		-	C/C	-	-
265	ILLEGIBLE	C3/4th	14.0 mm		0.5 g		-	C/C	-	-
266	ILLEGIBLE	C3/4th	11.5 mm		0.4 g		-	C/C	-	-
267	ILLEGIBLE	C3/4th	19.0 mm		1.8 g	[AE]	-	C/C	-	-
268	ILLEGIBLE COPY	C3/4th	12.0 mm		1.2 g		-	C/C	-	-
269	ILLEGIBLE	C3/4th	17.5 mm		1.3 g	[AE]	-	C/C	-	-
270	ILLEGIBLE COPY	C3/4th	5.5 mm		0.3 g		c. as -	C/C	-	-

No	SF no	REC no	Context	Description
261	2527	WSC275	M08:26	Building 16, clay floor, Period 1
262	879	WSC310	K04:04	Latest surviving <i>Via praetoria</i> surface
263	1091	WSC315	G11:01	Area over Building 7, unstratified
264	991	WSC316	D12:08	Make-up layer over Building 8, Building N, late third century
265	2042	WSC319	J08:01	Area over Building AO, unstratified
266	1715	WSC322	L12:01	Area over Building 13 and <i>Via quintana</i> , unstratified
267	1694	WSC297	N14:11	Area over Building 12 and Road 3, unstratified
268	1721	WSC323	K12:02	Alley 7
269	1942	WSC276	H12:01	Area over <i>Via quintana</i> , unstratified
270	1731	WSC314	K12:02	Alley 7

No	Ruler	Date	diam:	Mint:	wt:	Denom:	cat:	wear:	Obv	Rev
271	ILLEGIBLE	C3/4th	16.0 mm		0.8 g		-	C/C	-	-
272	ILLEGIBLE	C3/4th	15.5 mm		1.3 g		-	C/C	-	-
273	ILLEGIBLE	C3/4th	16.0 mm		1.2 g		-	C/C	-	-
274	ILLEGIBLE COPY	C3/4th	11.0 mm		0.5 g		-	C/C	-	-
275	ILLEGIBLE	C3/4th	16.5 mm		1.3 g		-	C/C	-	-
276	ILLEGIBLE COPY	C3/4th	13.0 mm		1.0 g		-	C/C	-	-
277	ILLEGIBLE FRAGMENTS	C3/4th	12.0 mm		0.4 g		-	C/C	-	-
278	ILLEGIBLE	C3/4th	14.5 mm		1.1 g		-	C/C	-	-
279	ILLEGIBLE	C3/4th	17.5 mm		1.7 g		-	C/C	-	-
280	ILLEGIBLE	C3/4th	17.5 mm		1.3 g		-	C/C	-	-

No	SF no	REC no	Context	Description
271	594	WSC289	H05:01	Area over Building 5 and Alley 4, unstratified
272	184	WSC290	F04:01	Area over Building 5 and Alley 3, unstratified
273	997	WSC281	D12:11	<i>Via quintana</i>
274	999	WSC291	D12:11	<i>Via quintana</i>
275	1334	WSC309	H13:06	Area over Building 9 and Road 9, unstratified
276	655	WSC284	M05:01	Area over Buildings 1 and 2 and Alley 5, unstratified
277	1834	WSC298	N11:25	Building 13, courtyard, Period 3-4
278	1733	WSC313	K11:01	Area over Building 14, unstratified
279	953	WSC318	E10:01	Area over Building 8, unstratified
280	745	WSC321	L04:01	Area over Building 1 and <i>intervallum</i> road (Road 4), unstratified

No	Ruler	Date:	diam:	Mint:	wt:	Denom:	cat:	wear:	Obv	Rev
281	ILLEGIBLE	C3/4th	13.0 mm		0.5 g		-	C/C	-	-
282	ILLEGIBLE	C3/4th?	17.5 mm		1.7 g		-	C/C	-	-
283	ILLEGIBLE FRAGMENT	C3/4th?	12.5 mm		0.2 g		-	C/C	-	-
284	ILLEGIBLE	C3/4th?	15.5 mm		0.9 g		-	C/C	-	-
285	ILLEGIBLE FRAGMENT	-	16.5 mm		0.6 g	[AE]	-	C/C	-	-
286	ILLEGIBLE COPY	-	11.0 mm		0.4 g		-	C/C	-	-
287	ILLEGIBLE	-	24.0 mm		4.0 g		-	C/C	-	-
288	ILLEGIBLE, DISINTEGRATED	-	0.0 mm		0.0 g		-	C/C	-	-

No	SF no	REC no	Context	Description
281	1444	WSC320	D13:01	Area over Building 9, unstratified
282	1056	WSC311	D13:01	Area over Building 9, unstratified
283	1546	WSC279	L15:01	Area over Building 11 and Alley 6, unstratified
284	1174	WSC282	E12:30	Road 3
285	639	WSC299	J05:03	Area over Building 5 and Alley 4, unstratified
286	1068	WSC288	D13:01	Area over Building 9, unstratified
287	370	WSC317	G04:15	Wall tumble over Alley 3
288	2536	lost	M08:26	Building 16, clay floor, Period 1

Extra coins found after catalogue was completed

No	Ruler	Date	Mint	Denom	Obv
289	M. AURELIUS/COMMODUS?	160-92	RM	DUP	-
	diam: 25.0 mm	wt: 7.8 g		cat: -	Rev - [SC]
				wear: C/C	
290	SEVERUS ALEXANDER	222-8	RM	DEN	IMP CM AVR SEV ALEXAND AVG
	diam: 18.0 mm	wt: 1.9 g		cat: RIC 127	Rev AEQVIT[TAS] AVG
				wear: SW/SW	
291	CONSTANTINE	319	TR S	Denom:	IMP CON[SATN]-TINVS MAX AVG
	diam: 18.0 mm	wt: 2.9 g		cat: RIC 7 TR 221	Rev VICTORIAE [LAETAE] PRINC PERP
				wear: SW/SW	[VOT/PR] * / .STR
292	ILLEGIBLE			Denom: DEN	Obv -
	Date:	Mint:		cat: -	Rev -
	diam:	wt:		wear: -	
293	ILLEGIBLE			Denom: SEST	Obv -
	Date: C1/C2	Mint:		cat: -	Rev -
	diam: 32mm	wt:		wear: -	
294	ILLEGIBLE			Denom:	Obv -
	Date: C4?	Mint:		cat: -	Rev -
	diam: 13mm	wt:		wear: -	
295	LOST			Denom:	Obv -
	Date: '309-337'	Mint:		cat: -	Rev -
	diam:	wt:		wear: -	

No	SF no	REC no	Context	Description
289	1889	WSC126	N14:22	Chalet 12, Building AM2, (mid)-late third century
290	1899	WSC1	M12:61	Building 13, east hypocaust, Period 4
291	-	WSC2		Unstratified
292	2533	lost	M08:26	Building 16, clay floor, Period 1
293	187	WSC356	F04:01	Area over Building 5 and Alley 3, unstratified
294	-	WSC355	F08:10	Road 8
295	2068	lost	G09:02	The site records provide the provisional date

Key to Catalogue:

Denomination (prefaced by 'denon'):

ANT: *Antoninanus*, DENpl: plated counterfeit *denarius*, AS: *As*, DP: *Dupondius*, AUREL: '*Aurelianus*', FOLL: '*Follis*', DEN: *Denarius*, SEST: *Sestertius*

Mint:

AQ: *Aquileia*, AR: *Arles*, LG: *Lyons*, LN: *London*, RM: *Rome*, TR: *Trier*

The mint is followed, where appropriate, by *officina* letter, e.g. P, I, or A, denoting *Primo*, 1st or *Alpha*, e.g. TR, P.

Catalogue references(s) (cat):

Catalogue references are to RIC unless otherwise stated:

For abbreviations see page 230

A copy or counterfeit of a particular ruler or issuer is denoted by single quotation marks, e.g. 'CLAUDIUS II', and by the use of a lower case 'c' in the catalogue reference, e.g. 'c. of 261' = 'a copy of RIC 261'. The use of the word 'of' indicates that a precise catalogue reference has been obtained; while, for both regular issues and copies, 'as' is used to denote an incompletely catalogued coin.

Diameter (diam):

Flan diameter is given in millimetres (mm).

Weigh (wt):

Weight is given in grams (g).

Condition (wear):

The wear is denoted by the following abbreviations:

UW	Unworn	The coin shows virtually no signs of wear.
SW	Slightly worn	Some abrasion of the highest relief elements of the coin-type is visible (e.g. on the brow of the bust-portrait).
W	Worn	Considerable abrasion of the higher relief of the coin.
VW	Very worn	Much of the detail is flattened, and the legends are severely abraded.
EW	Extremely worn	The type and legend are almost flattened or entirely removed.
C	Corroded	The poor state of preservation precludes an assessment of wear.
NSU	Not struck up	The coin was badly struck, so that the type would have appeared in only very low relief or not at all: an accurate assessment of wear is therefore impractical.

These are combined to give both the obverse and reverse, e.g. C/SW, UW/UW.

25. THE SMALL FINDS

by L. Allason-Jones

with contributions by R. Brickstock, A. T. Croom, W. B. Griffiths,
M. Henig, J. Tipper, C. Waddington and R. G. Willis

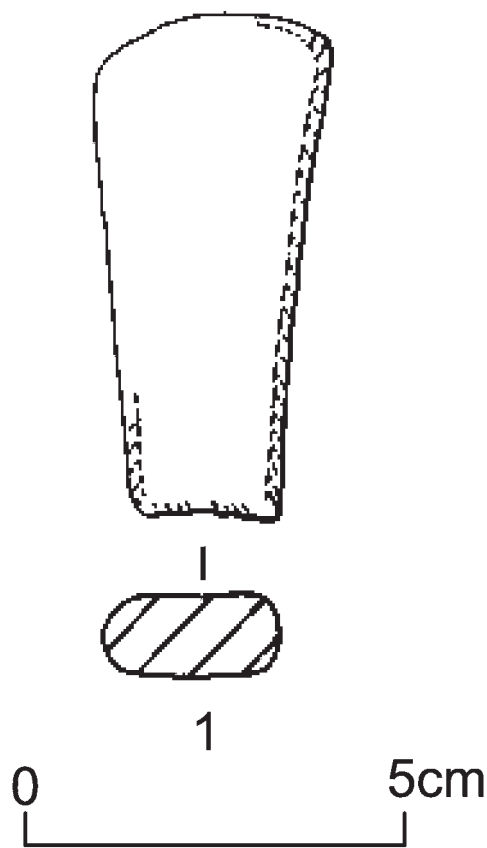

Figure 25.01 Silver ingot. Scale 1:1

Silver (Fig. 25.01)

1. Ingot (L:32mm W:12mm, T:5mm). Road 8, F08:10, 2276, WSAR1, 2001.1846
Wedge-shaped ingot of silver debased with copper. XRF also shows some lead and gold content.

Copper alloy (Figs 25.02–16)

1. Bow Brooch (L:58mm W of head:28.5mm W of

bow:3mm L of catchplate turnover:24mm). Gate 2, floor, late third century, D08:14, 2326, WSCA102, 2001.1142

Bow brooch with narrow rectangular-sectioned bow decorated with a row of notches along one edge of a groove. This motif is repeated in a series of six lines down the head. The head is a curved bar covering the spring, with a short projection at the top curving with the spring cross-bar to hold it in position. The ends of the head are bent back and pierced by the iron spring pin. The spring has six coils on one side of the missing pin and six on the other. The tip of the pin survives, corroded into the catchplate turnover. The catchplate has a large openwork motif and a lightly incised line. The foot is decorated with a double groove. Riha 1979, Group 4.2, first century AD.

2. Brooch fragment (L:22mm W:5.5mm). Alley 1, lowest level, M05:16, 331, WSCA249, 2001.1289

Fragment of a brooch bow with a central groove and a hollow back.

3. Trumpet Brooch (L:44mm W across head:13mm). Chalet 9, Building W, Period 4, D13:28, 1558, WSCA42, 2001.1082

Simple trumpet brooch with a small undecorated head. The decoration at the waist is merely a series of transverse grooves and ribs which are confined to the front of the bow. The lower bow is semicircular in section with two marginal grooves running to the cylindrical foot which is decorated with incised lines. The catchplate and pin are missing. Collingwood and Richmond 1969, Type Riii. See Snape 1993, Group 4.1 for local parallels. Early second century.

4. Trumpet Brooch (L:56mm W across head:17mm L of catchplate turnover:17mm). Clay puddling pit, Period 3 demolition, N05:15, 213, WSCA32, 2001.1072

Trumpet brooch in very good condition but lacking its hinged pin. The head is undecorated and the bow moulding, consisting of a plain globular centre between two milled bands each confined between two ribs, is limited to the front of the bow. A third milled band runs around the end of the bow above a globular foot, separated from it by a wide groove and rib. The hinge and stop piece survive as well as the long

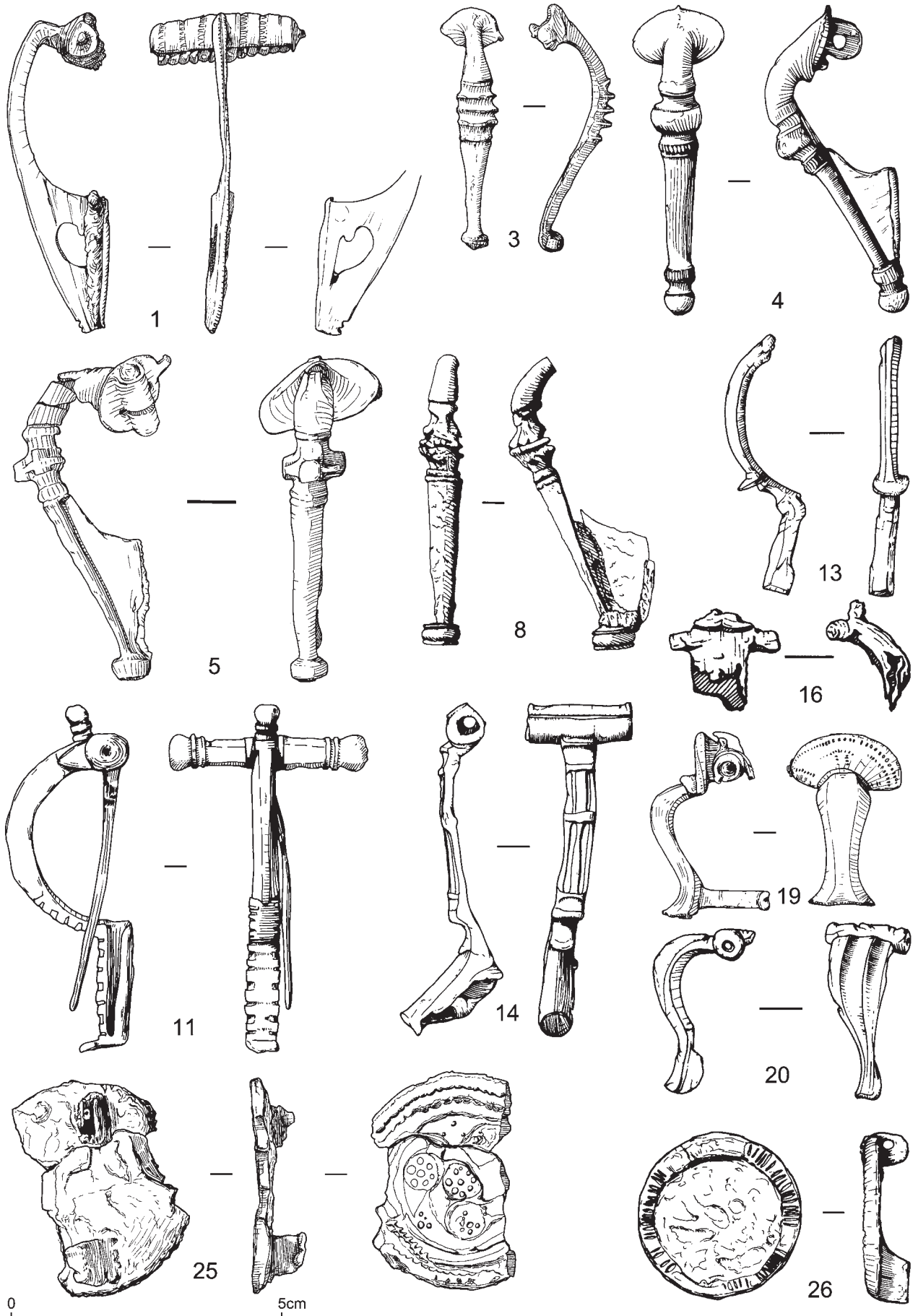
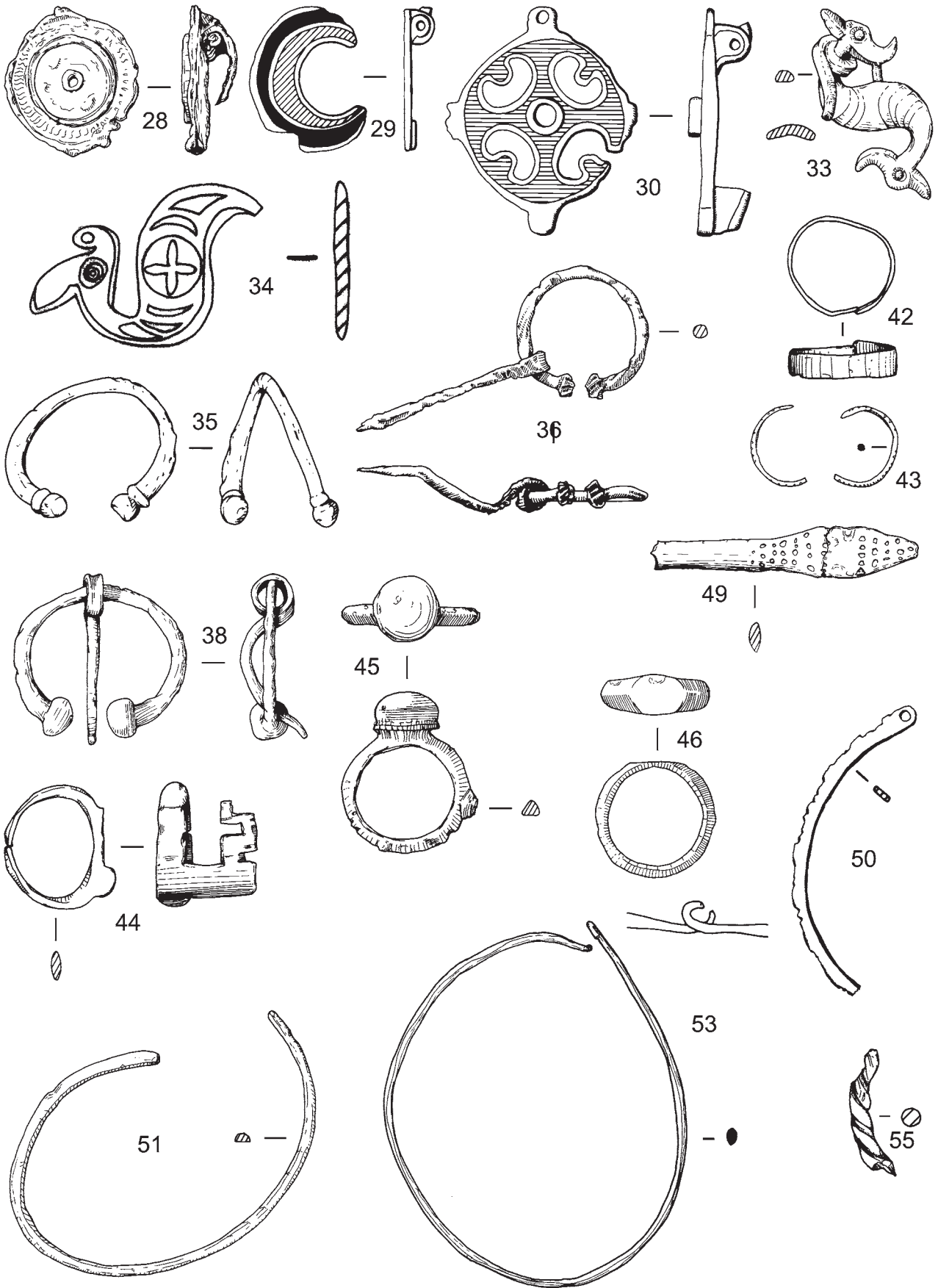

Fig re 2 : Copper alloy nos 1-26 Scale 1

- catchplate which is decorated with a single incised line down the side of the turnover. Collingwood and Richmond 1969, Type Riii. See Snape 1993, Group 4.1 for local parallels. Early second century.
5. Trumpet Brooch (L:62mm W across head:24mm). Area of Building 9, no details, E13:27, 1467, WSCA33, 2001.1073
Trumpet brooch with a plain head. The acanthus leaf motif encircles the waist but is very stylized with a rib-and-groove motif above and below. The lower bow is triangular in section above a cylindrical foot decorated with two shallow grooves. The catchplate turnover has snapped off and the pin is missing. A tubular hinge runs across the back of the head which also has an unpierced stop piece projecting from the top. Collingwood and Richmond 1969, Type Riii. See Snape 1993, Group 4.1 for local parallels. Early second century.
 6. Trumpet Brooch (L:38mm W across waist:7mm). Area over Cistern 1, unstratified, E08:01, 2202, WSCA229, 2001.1269
Fragment of a much corroded trumpet brooch. A band of knobs runs around the waist with the more prominent to the front. Above the waist the bow is circular in section and narrows to the distorted head. Possibly rejected before completion. Collingwood and Richmond 1969, Type Riii. See Snape 1993, Group 4.1 for local parallels. Early second century.
 7. Trumpet Brooch (L:55mm). Area of Gate 1 and Road 4, modern, K03:02, 703, WSCA218, 2001.1258
Fragment of a large trumpet brooch missing its head and spring. The lower bow is triangular in section and the disc foot is riveted into position. Snape 1993, Group 4.1.
 8. Trumpet Brooch (L:54mm L of catchplate:27mm). Unstratified, WSCA259, 2001.1299
Incomplete trumpet brooch lacking its head. The bow is very thin with a short band of acanthus motifs around the waist between two sets of ribs. The catchplate is very long and wide in comparison with the proportions of the rest of the brooch. The convex face of the lower bow has incised marginal lines and ends in a cylindrical foot with a milled band set between two ribs. The base of the foot has a deep dimple. Collingwood and Richmond 1969, Type Rii. Snape 1993, Group 4.1. Early second century.
 9. Trumpet Brooch (L:21mm). Drain west of Building 5, E05:22, 510, WSCA408, 2001.1448
Head of a very corroded trumpet brooch with the spring and part of the head loop surviving. There are no traces of decoration.
 10. Trumpet Brooch (L:50mm). Road surface associated with the north-west shacks (B2), dereliction, E05:04, 210, WSCA217, 2001.1257
Triangular-sectioned lower bow of a trumpet brooch. The foot has a milled band between two ribs.
 11. Crossbow Brooch (L:62.5mm W across arms:36mm L of pin:51mm L of catchplate:22mm). *Via principalis*, L08:56, 2542, WSCA30, 2001.1070
Complete crossbow (P-shaped) brooch with hexagonal-sectioned arms ending in globular terminals on double disc necks. The central terminal is much smaller than those on the arms, although the same shape. Two flanges emerge from the head to flank the triangular-sectioned bow. The front of the tubular, side entry catchplate is deeply chip-carved along both edges, the motifs carrying on well up the bow. There is a short frontal projection at the foot. The hinged pin is complete and held in place by an iron pin. Keller (1971) Type I; c.290–320AD. Cf. Jobst 1975, Taf. 30–2, nos 226–39; Riha 1979, Type 6.5. See Snape 1993, Group 8.8 for local parallels.
 12. Crossbow Brooch (approx. surviving L:50mm). Area over Road 3, unstratified, J13:08, 1345, WSCA133, 2001.1173
Incomplete crossbow or P-shaped brooch in two pieces. The bow is narrow and of semicircular section. The terminals are plain knobs. Collingwood and Richmond 1969, Group T. Late third century. See Snape 1993, Group 8.8 for local parallels.
 13. Crossbow Brooch (L:47mm W of bow:3mm L of catchplate:18mm). Building 3 abandonment/post-Roman, P07:07, 2493, WSCA121, 2001.1161
Lower part of a crossbow brooch with a very thin faceted bow separated from the foot by a splayed flange. The expanded foot is tubular with a back opening. The surface is heavily tinned. Collingwood and Richmond 1969, Group T. See Snape 1993, Group 8.8 for local parallels. Late third century.
 14. Bow Brooch (L:60mm W across head:19mm W across bow:5mm L of catchplate:19mm). Area over Building AO, unstratified, J08:01, 1978, WSCA103, 2001.1143
Bow brooch with a distorted long strip bow decorated with two longitudinal grooves filled with gilding. A wide groove separates the bow from the cylindrical head and another separates the bow from the long, faceted, tubular catchplate with a side entry. The foot has a short frontal projection. The head has a row of shallow dots in front of the spring opening. The spring and pin are both missing. The whole surface is silvered and the gilding applied to the grooves afterwards – the original effect must have been striking. Riha 1979, Group 5.5. Late first–second century.
 15. Bow Brooch (W of head:18mm). Area over Building BA, unstratified, M13:01, 1738, WSCA166, 2001.1206
Head of a small bow brooch with a fragment of the hinged pin surviving. The cross bar is tubular with a thick wide projection at the top. What survives of the bow suggests a wide strip with marginal and median ribs.
 16. Bow Brooch (L:19mm W of arms:20mm). Building 16, robber trench, M08:29, 2563, WSCA160, 2001.1200
Fragment of a brooch with a wide strip bow and short arms. A crested flange projects from the head. The pin has been hinged from a cylindrical spring-case. Riha 1979, Group 4.4. First century.
 17. Bow Brooch (W of head:23mm L of pin:46mm). Area over Building 14, unstratified, K11:01, 1930, WSCA101, 2001.1141
Head of a divided bow brooch with a cylindrical spring-case and a crested flange. Both bows have central ribs and there is a small boss between these ribs. The spring has five coils on one side of the tapering pin and seven on the other. The whole brooch has been heavily gilded. Similar brooches are known from Housesteads (Birley and Charlton 1934, pl. XXIX, no. 3) and Vindolanda (Bidwell 1985, no. 5, 119). See

- Snape 1993, Group 8.2 for local parallels. Early third century.
18. Head-stud Brooch (D of stud:7mm). Road surface associated with the north-west shacks (B2), dereliction, E05:04, 240, WSCA286, 2001.1326
Circular ring-and-boss vestigial head-stud from a brooch similar to above with a fragment of the lower bow. No trace of enamel survives.
 19. Knee Brooch (L:32mm W across head:20mm). Building 3, abandonment/post-Roman, P7:10, 2578, WSCA31, 2001.1071
Knee brooch with a faceted angular bow which tapers to a flared foot. The head is fan-shaped and separated from the bow by a ridge. A design of stamped squares decorates the head. The hinge tube is cast in one with the brooch and holds a spring of three coils on either side of the pin. The loop of the spring fits into a groove along the hinge tube. This hinge is of copper alloy. The catchplate is a long rectangular bar which projects at right angles from the foot and is hooked at the end. This is an example of the knee brooch which was common on the German *limes* in the late second century. Cf. Vindolanda: Bidwell 1985, fig. 39, no. 8. See also Almgren 1923, nos 246–7; Böhme 1972, Type 19–20; Ettliger 1973, Type 53; Jobst 1975, Type 13; Riha 1979, Type 3.12. See Snape 1993, Group 5.1 for local parallels.
 20. Knee Brooch (L:31mm W across head:15.5mm). Building 2, post-Roman dereliction, P05:03, 194, WSCA151, 2001.1191
Developed knee brooch with a tubular head. The sharply tapering bow is decorated with three deep channels between high ridges. The pin spring and catchplate are missing. See Snape 1993, Group 5.1 for local parallels.
 21. Knee Brooch (L:30mm W across head:19mm). Area over *intervallum* road (Road 5), unstratified, E04:01, 18, WSCA75, 2001.1115
Distorted knee brooch with a tubular head and a narrow bow leading to a well splayed foot. The pin and spring are missing and the long catchplate is lacking its hooked end. Although knee brooches are known in the north of England (see Snape 1993, Group 5.1), those with tubular heads would appear to have been less popular than the fan-head type as above. Late second century.
 22. Knee Brooch (L:24mm). Area over Building 9, unstratified, E13:01, 1118, WSCA201, 2001.1241
Small knee brooch lacking foot plate, spring and pin.
 23. Knee Brooch (L:14mm). Area over Building 12 and Road 9, unstratified, J14:01, 1344, WSCA409, 2001.1449
Small fragment of the bow and flange of a knee brooch.
 24. Knee Brooch (W:5mm). Area over Building 9, unstratified, E13:01, 1136, WSCA410, 2001.1450
Fragment of the bow of a knee brooch.
 25. Disc Brooch (D:40mm). Area over Building 12 and Alley 6, unstratified, L15:01, 1287, WSCA47, 2001.1087
Large copper alloy disc brooch with a silver repoussé plate attached to the face by lead-tin alloy. The plate is damaged but appears to display the typical triskele design with groups of raised dots confined within a double pellet border. The pin is missing. This type of plate brooch is common throughout Britain but was particularly popular in the north of Britain from the mid first century AD. See Allason-Jones and Miket 1984, no. 3.148 for local parallels.
 26. Disc Brooch (D:30mm L of catchplate:9mm). Building 16, hearth, Period 1?, K07:21, 2041, WSCA169, 2001.1209
Disc brooch of copper alloy with a silver repoussé plate attached to the face by lead-tin alloy. All that remains of the plate is the pelleted border. Part of the catchplate and double-lugged hinge survive.
 27. Disc Brooch (D:24mm). Building 2, *contubernium* 5, Period 3 or later, M05:11, 273, WSCA411, 2001.1451
Several fragments of a gilded silver disc still attached to the copper alloy backing plate of a disc brooch by lead-tin alloy. The disc has a repoussé design showing a pelleted border although the central design is unclear.
 28. Disc Brooch (D:26mm). Area over Building AM, unstratified, N14:01, 1641, WSCA41, 2001.1081
Circular disc brooch with a concentric rib to hold a now missing glass inset which would have been keyed into position by a small reserved metal ring. In the channel between the rib and the raised edge of the brooch there is a series of stamped S-shaped motifs. The face is gilded. The catchplate and part of the pin are missing and the spring pin is made of iron held between two hinge lugs. See Allason-Jones and Miket 1984, no. 3.138, for local parallels. These brooches and their oval counterparts are particularly common in the military sector: Snape 1993, Group 15.2. Third-fourth century.
 29. Plate Brooch (W:26mm H:20mm Total T:6mm). Area over *intervallum* road (Road 5), unstratified, E04:01, 18, WSE2, 2001.1617
Crescent-shaped plate brooch with two concentric bands of enamel; the inner band of red, the outer band of black or very dark blue. Part of the catchplate survives as well as the double lugged hinge with fragments of a coiled spring with an iron hinge pin. Crescentic brooches are known (see Riha's (1979) Type 7.5), but the closest parallel to this example is a pendant from Wiesbaden (Oldenstein 1976, Taf. 45, no. 449).
 30. Plate Brooch (L:41mm). Building 10, *contubernium* 3?, Period 2, F14:44, 1310, WSE1, 2001.1616
Circular plate brooch with four openwork *peltae* arranged around a raised flat boss which contains a disc of red enamel which has been made separately and riveted into position. The *peltae* and the brooch itself have raised edges and the resultant sunken field is filled with blue enamel. The catchplate and hinge survive behind two of the lugs. This brooch has parallels from Canterbury (Smith 1880, pl. XXI), Knaith Park, Lincolnshire (in private hands), Turret 18B (Allason-Jones 1988, 198–9, no.1) and South Shields (Allason-Jones 1983, no. 190). Examination of the brooches suggests the possibility that they may have been products from the same mould. Late second century.
 31. Plate Brooch (D:29mm). Building 8, abandonment, mid-third century?, E11:37, 1158, WSE11, 2001.1626
Disc brooch with a concentric, reserved rib separating an outer ring of blue enamel from an inner ring of white. In the centre there is a waisted knob with a



0 5cm

Fig. 25. Copper alloy nos. Scale 1

- small central projection. The catchplate and hinge are both missing and the disc is incomplete. Cf. Coventina's Well: Allason-Jones and McKay 1985, no. 45; Riha 1979, Type 7.14. Late second century.
32. Plate Brooch (D:33mm). Area over Building 12, unstratified, K14:03, 1353, WSE10, 2001.1625
Fragment of a disc brooch with concentric ribs creating ring fields. The outer field contains green enamel whilst the second ring has small reserved metal dots emerging from blue enamel. Cf. Coventina's Well: Allason-Jones and McKay 1985, no. 42. Second century.
33. Dragonisque Brooch (L:38mm, Max.W:16mm). Building 16, floor, Period 4, L07:02, 2026, WSCA99, 2001.1139
Complete dragonisque brooch. The body is hollowed at the back whilst the convex front is decorated with incised curved lines. The heads are thin and lively with deeply stamped circles for the eyes. One head has a short bar running from the chin to the body and has the incomplete pin wrapped around its neck. This piece has all the essentials of the true dragonisque brooch except for the enamelling. A large example from South Shields (Allason-Jones and Miket 1984, no. 3.131), which also lacks enamel, was described by Collingwood (1930) as an imitation of the true dragonisque brooch, influenced by examples from Corbridge and Victoria Cave, Settle. The same cannot be said of this example from Wallsend. The form is North British, occurring predominantly in military contexts north of the Severn-Humber line, developing into the elaborately enamelled form by the second century. This brooch may be earlier in the series if the enamelling is seen as a degeneration. See Feachem 1951, 32–44.
34. Dragonisque Brooch. Unstratified, 1358, lost.
The site notebook describes it as being recessed for enamel inlay.
35. Penannular Brooch (D:30mm T of shank:3mm). Gateway 1, no details, K02:02, 772, WSCA86, 2001.1126
Penannular brooch with a circular-sectioned shank. The globular terminals sit on disc necks. The brooch is distorted and missing its pin. Fowler 1960, Type A3. First to third century.
36. Penannular Brooch (D:29.5mm L of pin (including hinge) :36mm). Building 8, west wall, Period 2, D11:09, 1146, WSCA34, 2001.1074
Penannular brooch with oval-sectioned shank and milled knobbed terminals. The pin has been formed by rolling a copper alloy sheet, flattening it and curling one end around the brooch shank. Fowler 1960, Type A2. First – fourth century.
37. Penannular brooch (L:28mm). Chalet 9, Building W, late third/early fourth century, D13:06, 1476, WSCA209, 2001.1249
Terminal of an oval-sectioned penannular brooch decorated with bands of nicks on the shank and incised lines at the ends. Fowler 1960, Type E. See Allason-Jones and Miket 1984, no. 3.117 for local parallels. Third – fourth century.
38. Penannular Brooch (D:32mm L of pin:31mm). Soil over north-south drain east of Building 3, Period 3–4, Q07:10, 2594, WSCA125, 2001.1165
Penannular brooch in four fragments. The shank is circular in section enlarging to the globular terminals. The pin is formed of oval-sectioned wire flattened at the end and tightly curled. Fowler 1960, Type A1. First century BC– third century AD.
39. Curved Rod (L:29mm T:5mm). Chalet 9, Building W, late third/early fourth century, D13:06, 1489, WSCA412, 2001.1452
Fragment of a curved rod which tapers from the surviving terminal. Part of a plain penannular brooch?
40. Brooch Pin (L:35mm). Area over Building 16, unstratified, K07:03, 1985, WSCA238, 2001.1278
Short, tapering, circular-sectioned brooch pin with one end coiled twice to provide a spring.
41. Brooch Catchplate (L:25mm). Area over Building 12, unstratified, K14:01, 1304, WSCA200, 2001.1240
Catchplate from a crossbow brooch?
42. Ear-ring (D:19mm W:0.5mm T:4.5mm). Building 10, *contubernium* 7, Period 2, G15:20, 978, WSCA94, 2001.1134
Penannular ring which is undecorated but tinned or silvered. Ear-ring of Allason-Jones 1989a, Type 1.
43. Ear-ring (Int. diam:12.5mm W:0.75mm T:1mm). Gateway 2, no details, C07:07, 2399, WSCA112, 2001.1152
Penannular ring of oval section with oblique nicks along one face. The ends are overlapped and taper sharply. Ear-ring of Allason-Jones 1989a, Type 2e.
44. Finger Ring (D of ring:22mm L of key:18mm). Area over Building 13, unstratified, N12:01, 1631, WSCA28, 2001.1068
Finger ring with projecting key. The shank is triangular-sectioned, expanding to the shoulder. The tubular key shaft projects from a flat rectangular area which is chip-carved. The ward is also chip-carved. See Colchester: Crummy 1983, no. 2195, for a similar key still in position in the lock of a small chest. See also Verulamium: Goodburn and Grew 1984, no. 163.
45. Finger Ring (int. diam:17mm W:3mm D of boss:11mm). Area over Building 15, unstratified, J07:01, 1997, WSCA39, 2001.1079
Finger ring with triangular-sectioned shank. A circular boss projects from a disc to give the impression of a stone inset into a cupped bezel.
46. Finger Ring (int. diam:16.5mm W:2mm Centre plate:9 × 7mm). Area over Building 14, unstratified, K10:01, 1965, WSCA45, 2001.1085
Finger ring of oval section expanding to triangular-sectioned shoulders and a flat oval centre plate.
47. Finger Ring (int. diam:17mm W:1.75mm T:3mm). Area over Building 14, unstratified, H10:01, 1964, WSCA240, 2001.1280
Two fragments of a finger ring of semi-oval section with pelleted decoration around the outer face.
48. Finger Ring (int. diam:15mm W:1mm T:3mm). Area over Building AO, unstratified, K08:01, 1989, WSCA252, 2001.1292
Fragment of a strip finger ring with the outer face decorated with transverse ridges. Cf. Crummy 1983, no. 1770; Charlesworth 1961, pl. II, nos 1 and 2.
49. Bracelet (L:60mm). Area over Building 9, unstratified, D13:01, 1075, WSCA48, 2001.1088
Fragment of a strip bracelet with a snake's head terminal decorated with incised dots. Cf. Jewry Wall, Leicester: Kenyon 1948, Type E, decorated with dots and grooves; Verulamium Theatre: Kenyon 1934, fig.

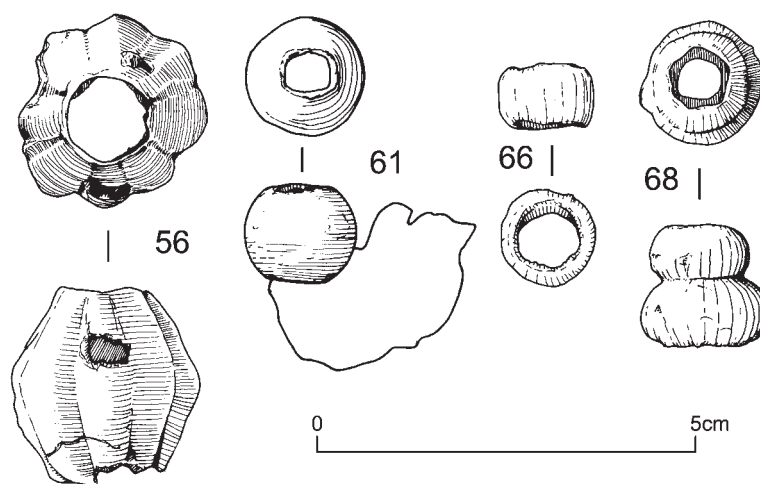

Figure 25 Copper alloy nos 56 Scale 1

- 12, nos 2 and 5, late fourth and late second centuries respectively. Allason-Jones and Miket 1984, Type 6, no. 3.243.
50. Bracelet (int. diam:48mm W:3mm T:1mm). Area over Building 16, unstratified, K07:01, 1982, WSCA161, 2001.1201
Fragment of a strip bracelet with groups of ridge and-groove motifs along the outer edge. The surviving terminal is flattened and pierced by a circular hole. Wheeler and Wheeler 1932, Type Q, no. 58; Allason-Jones and Miket 1984, Type 13, nos 3.265–9.
51. Bracelet (W:2mm T:3mm). Area over Road 3, unstratified, H13:10, 1254, WSCA71, 2001.1111
Oval-sectioned wire tapering to one terminal and curved to an open circle. Bracelet?
52. Bracelet (L:23mm T:1.5mm). Gateway 3, no details, J16:20, 1364, WSCA269, 2001.1309
Fragment of a sliding knot expanding bracelet. Allason-Jones and Miket 1984, Type 8, nos 3.249–50.
53. Bracelet (W:1.5mm T:2.5mm). Building R, mid-third century?, G11:16, 1194, WSCA214, 2001.1254
Fragmentary, thin strip bracelet of elliptical section. Hooked terminals.
54. Bracelet (W:10mm T:1.5mm). Area of Building 4, unstratified, J04:13, 834, WSCA250, 2001.1290
Wide strip curved to form a bracelet with two longitudinal bands of notches on the ridge-and-grooved upper face. Cf. Verulamium: Waugh and Goodburn 1972, fig. 32, nos 30 and 31.
55. Bracelet (T:3.25mm). Building AO, south wall robber trench, F08:19, 2400, WSCA345, 2001.1385
Fragment of a bracelet made from two strands of wire twisted together. Allason-Jones and Miket 1984, Type 13, nos 265–9.
See also no. 379.
56. Collar (H:2mm D:25mm). Area over *intervallum* road (Road 5), unstratified. E04:01, 115, WSCA68, 2001.1108
Fluted collar resembling a melon bead with a small hole pierced through the side.
57. Bead or collar (L:24mm W:11.5mm). Area of Building 13 and Road 3, unstratified, L12:01, 1701, WSCA183, 2001.1223
Fragment of a large barrel-shaped bead or collar with deep vertical grooves.
58. Bead or collar (L:36mm W:16mm). Chalet 9, post-Roman dereliction, F13:16, 1325, WSCA179, 2001.1219
Fragment of a large barrel-shaped bead or collar with vertical grooves.
59. Bead (D:17mm H:11.5mm). Building 14, courtyard, Period 1 or 2, J10:56, 2180, lost
Globular bead. Cf. Allason-Jones and Miket 1984, no. 3.754.
60. Bead (D:10mm T:3.5mm D of hole:5.5mm). Road associated with the north-west shacks (B2), Period 3–4, H05:12, 791, WSCA225, 2001.1265
Small disc bead with traces of leather inside the hole.
61. Bead (D:15mm H:12mm). Area over Building 12, unstratified, L14:44, 1800, WSCA17, 2001.1057
Barrel bead in molten copper alloy waste, attached to no. 179. See also the metalworking report.
62. Bead (D:10 H:5mm). Road 3, E12:30, 1177, WSCA405, 2001.1445
Barrel bead.
63. Bead (D:12mm H:7mm). Area over Building 12, unstratified, L14:01, 1418, WSCA226, 2001.1266
Barrel bead.
64. Bead (D:15mm H:8mm). Road 1, unstratified, L08:06, 2008, WSCA235, 2001.1275
Fragment of a barrel bead.
65. Bead (D:12mm H:7.5mm). Area over Building 11 and Alley 6, unstratified, L15:01, 1281, WSCA162, 2001.1202
Drum-shaped bead or collar.
66. Bead (H:12mm H:8mm). Area of Building 10 and Road 6, modern, F15:07, 1455, WSCA57, 2001.1097
Drum-shaped bead.
67. Collar (L:23mm W:12mm). Chalet 9, post-Roman dereliction, G13:03, 1498, WSCA380, 2001.1420
Collar of semicircular section.
68. Collar (L:16mm Min.D:13mm, Max.D:16mm). Area over Building 12, unstratified, L14:01, 1422, WSCA89, 2001.1129
Collar consisting of one small drum on top of a larger drum.
69. Collar (D:12mm). Area over Building 11, unstratified, J15:01, 1252, WSCA206, 2001.1246
Distorted collar with three incised longitudinal lines on the outer face.

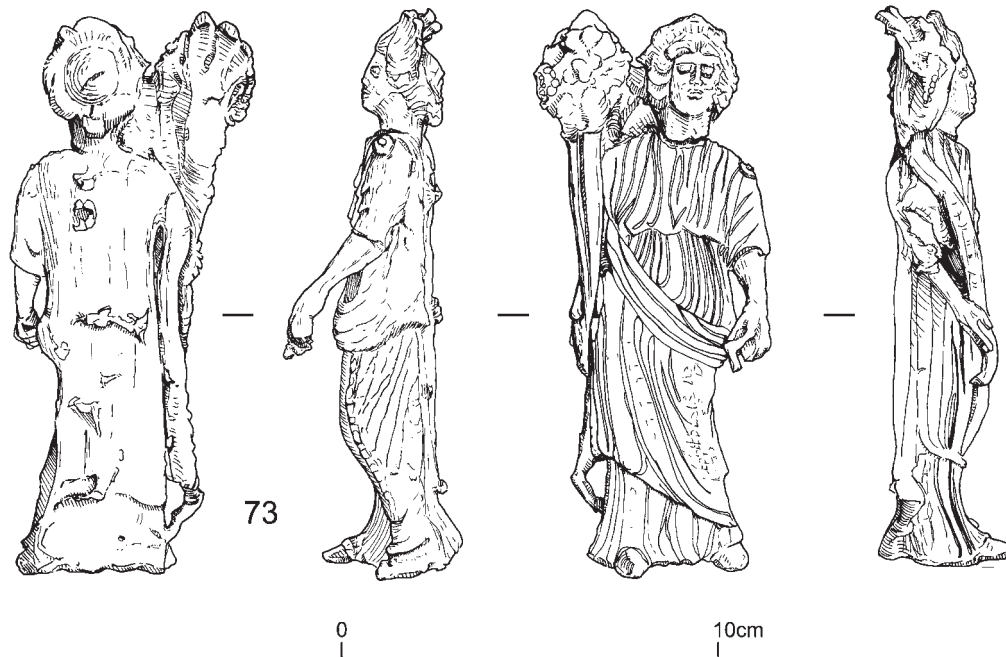

Fig. 73. Statuette. Copper alloy no. 3. Scale 1

70. Collar (D:13mm T:4mm). Chalet 9, post-Roman dereliction, H13:08, 1501, WSCA470, 2001.1510
Penannular collar.
71. Collar (D:13mm H:7mm). Chalet 9, dereliction, G13:03, 1380, WSCA407, 2001.1447
Fragment of a collar.
72. Collar (D:15mm H:12mm). Road 3, unstratified, J13:08, 1366, WSCA395, 2001.1435
Collar in several fragments.
73. Statuette (H:150mm). Building 13, room 7, Period 4, N12:38, 1659, WSCA136, 2001.1176
Cast statuette of a female figure wearing a *chiton* with extra drapery wrapped around her right thigh and left shoulder. She holds a large cornucopia in her left hand, the horn of which rests on her left shoulder. Her right leg is slightly flexed. The attribute held in her right hand is missing. She wears a head-dress over a curled hair style which is parted in the centre and ends in a rough bun at the nape of the neck. A circular brooch, pelleted around a central boss, is worn at her right shoulder. There is a break across the neck of the statuette and the metal of the head and top of the cornucopia differs from the rest of the body, suggesting that they were added separately. The back is plain and roughly finished giving the impression that it was not intended to be seen. The execution is rough and angular with the details of the dress added after removal from the mould, implying provincial workmanship on the classical theme of Fortuna, although the goddess Spes may offer an alternative identification. The statuette is complete bar the tip of the cornucopia and the attribute in the right hand.
74. Miniature Axe (L:30mm W of head:16mm Max T:4mm). Area over Building 12, unstratified, M12:01, 1672, WSCA44, 2001.1084
Miniature axe with a wide cutting blade and a narrower hammer. The circular-sectioned shank may be complete or may have continued as a pin. For a discussion on miniature axes and axe-hammers and their part in Roman religion, see Green 1978, 32–3.
75. Amulet (L:89mm Max W:19mm Max T:14mm). Building 11, *contubernium* 3/4, Period 2, L15:23, 1533, WSCA43, 2001.1083
Curved amulet, hollowed at the back with a central circular hole. One end is shaped to represent a phallus, the other a hand clenched over a projecting thumb, a symbol used to ward off the Evil Eye. The amulet has been made in two sections and welded together; this would have meant it was too weak for use as a handle. This form of amulet is common in bone: Verulamium: Green 1976, pl. XXVIa; Wroxeter: Bushe-Fox 1912, pl. X, fig. 1, no. 7; Chester-le-Street: Young 1933, 120; Colchester: Crummy 1983, 139; but some are known in bronze: Newstead: Curle 1911, pl. LXXVII, nos 2 and 3.
76. Candlestick (H:69mm D of base:40mm D of rim:33mm). Building 8 abandonment/Building N make-up layer, mid-late third century, E12:03, 986, WSCA1 2001.1041
Lathe-turned candlestick with a hollow flared lip and base and a bulging shank. Bands of incised lines decorate all three elements. There is a possible patch repair or fault in the metal on one side. A similar candlestick, now in Vienna, has a matching saucer base and has been dated to 'about the birth of Christ' (Mutz 1972, pl. 462). This example is likely to have been of some age when it reached Wallsend.
77. Hanging Lamp (H:26mm Total surv. L:85mm). Road 5, dereliction, E04:07, 150, WSCA85, 2001.1125
Hanging lamp with a flanged counterpoise decorated to resemble a vine leaf. The filling hole is circular and surrounded by two concentric grooves. Both wick arms have broken off. A fine length of copper alloy wire runs through a circular hole in the counterpoise

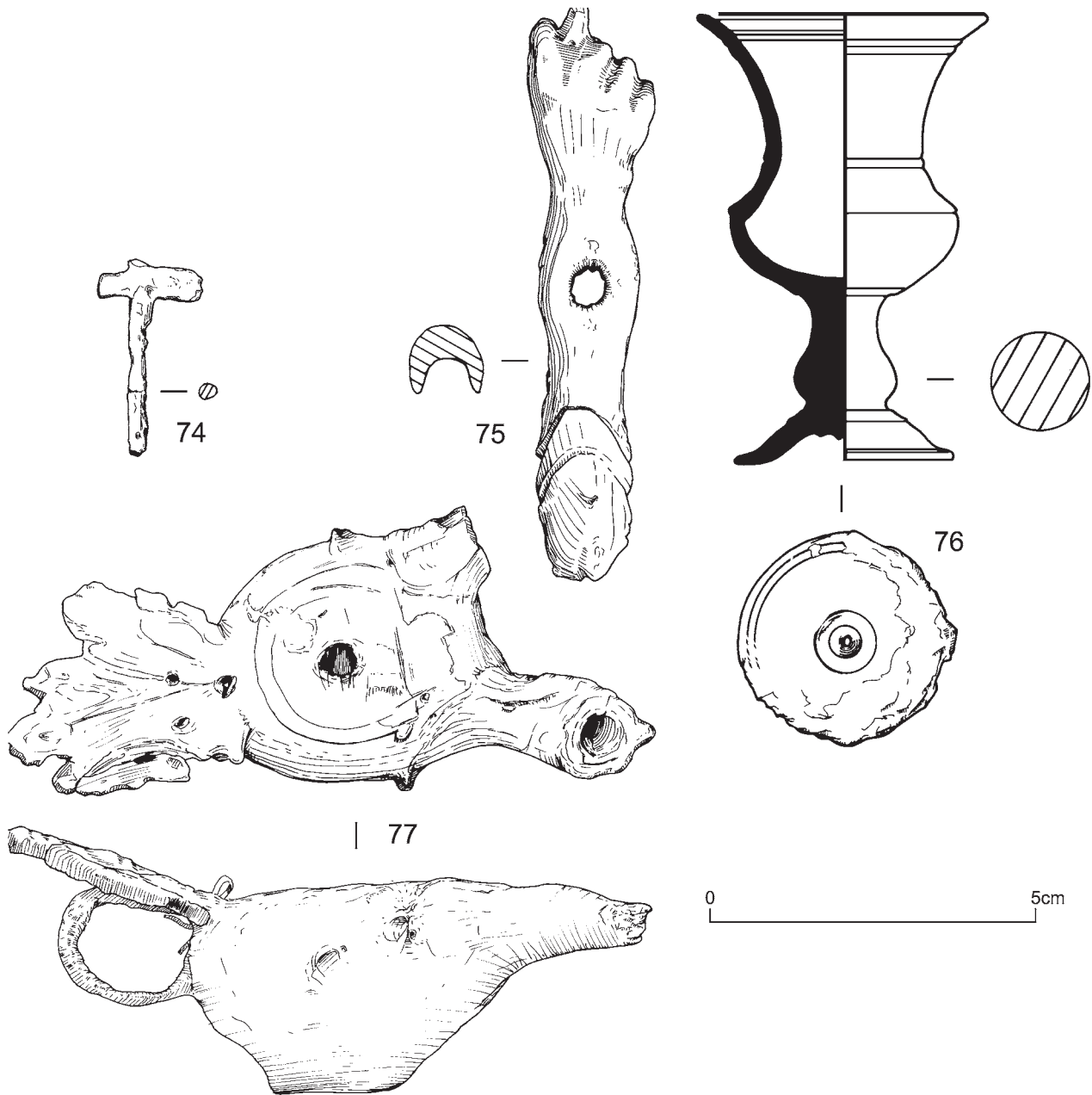

Figure 8 Copper alloy nos 74–77 Scale 1

and emerges underneath leaving a loop. The handle is a strip emerging from under the counterpoise and meeting the body halfway down. Two perforated lugs emerge from the side of the body to take a hanging chain. The base is missing. Similar oil lamps with single wick holes are illustrated by Mutz (1972, nos 408, 409 and 412).

78. Ramshead Skillet (D of bowl:180mm H of bowl:48mm D of flanged boss:62mm L of handle:129mm T of shank:23mm). Chalet 9, Building W, late third/early fourth century, D13:34, 1559, WSCA147, 2001.1187 Very corroded, circular skillet with a flat, in-turned rim. In the centre of the bowl there is a large boss with concentrically ribbed flange which has been attached separately. A wide ring base surrounds a dimpled washer in the centre of the base. The separate handle is a hollow tube with a flared end designed

to clip over the rim of the bowl. The other end of the handle is fashioned to represent a stylized ram's head. Two short ribs run back along the handle from the ram's collar flanking a wide band delineated by two rows of stamped dots. Such skillets are common finds throughout the Roman Empire and were manufactured in Italy in the first century AD. See den Boesterd 1956, nos 68–70. For a discussion of the method of manufacture see Mutz 1972, no. 140, and Strong and Brown 1976, 33.

79. Bucket (H:126mm D of base:124mm D of rim:17 × 130mm W of neck ring:10mm T of walls:1mm). Building 12, robbing *contubernium* 9/officer's quarters, Period 3, M14:61, 1895, WSCA148, 2001.1188 Vessel with a circular flat base. The thin walls belly out to curved shoulders. The rim is straight with a slightly thickened edge. The vessel is distorted so that

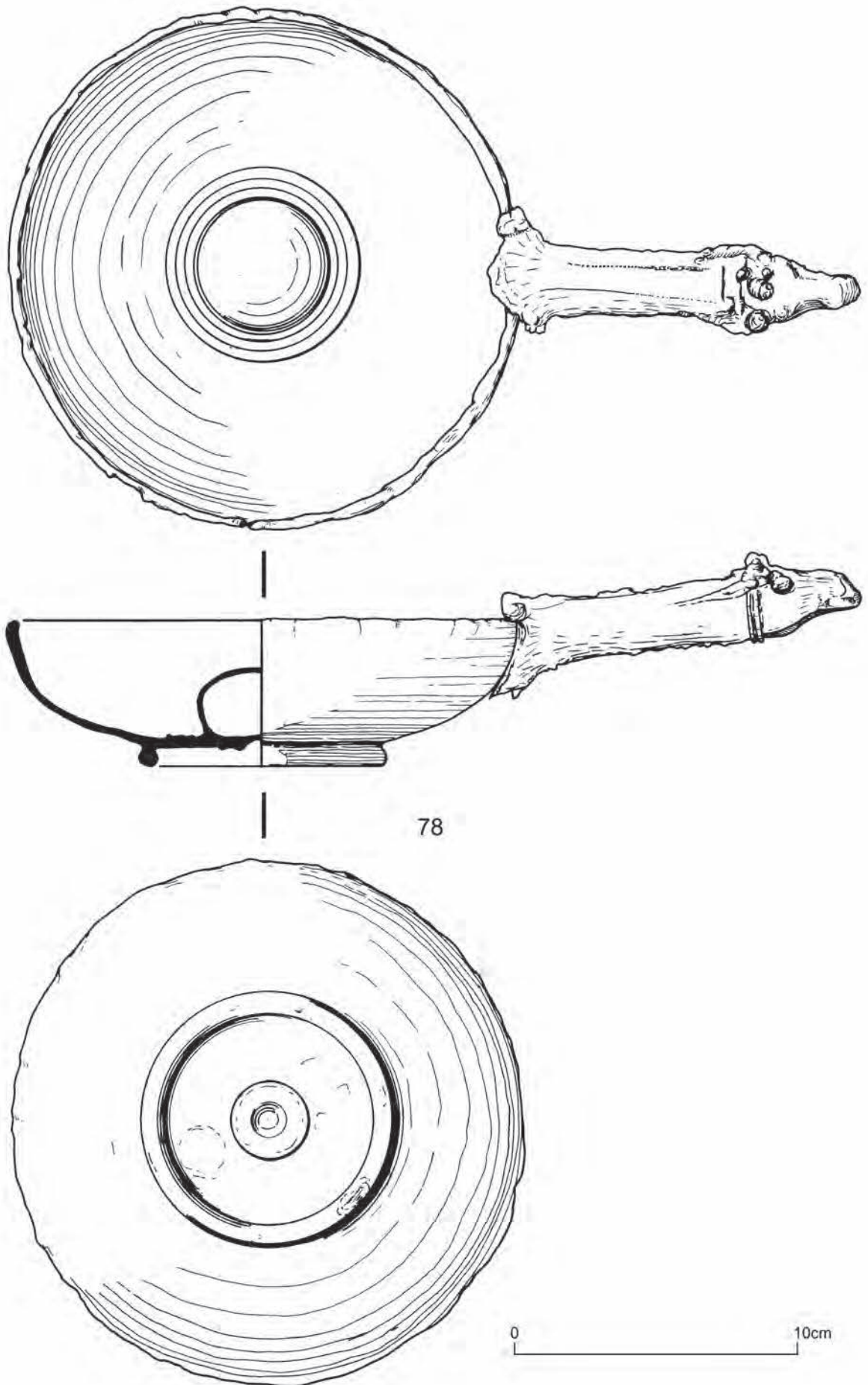

Fig re 78 Copper alloy no. 3 Scale 1

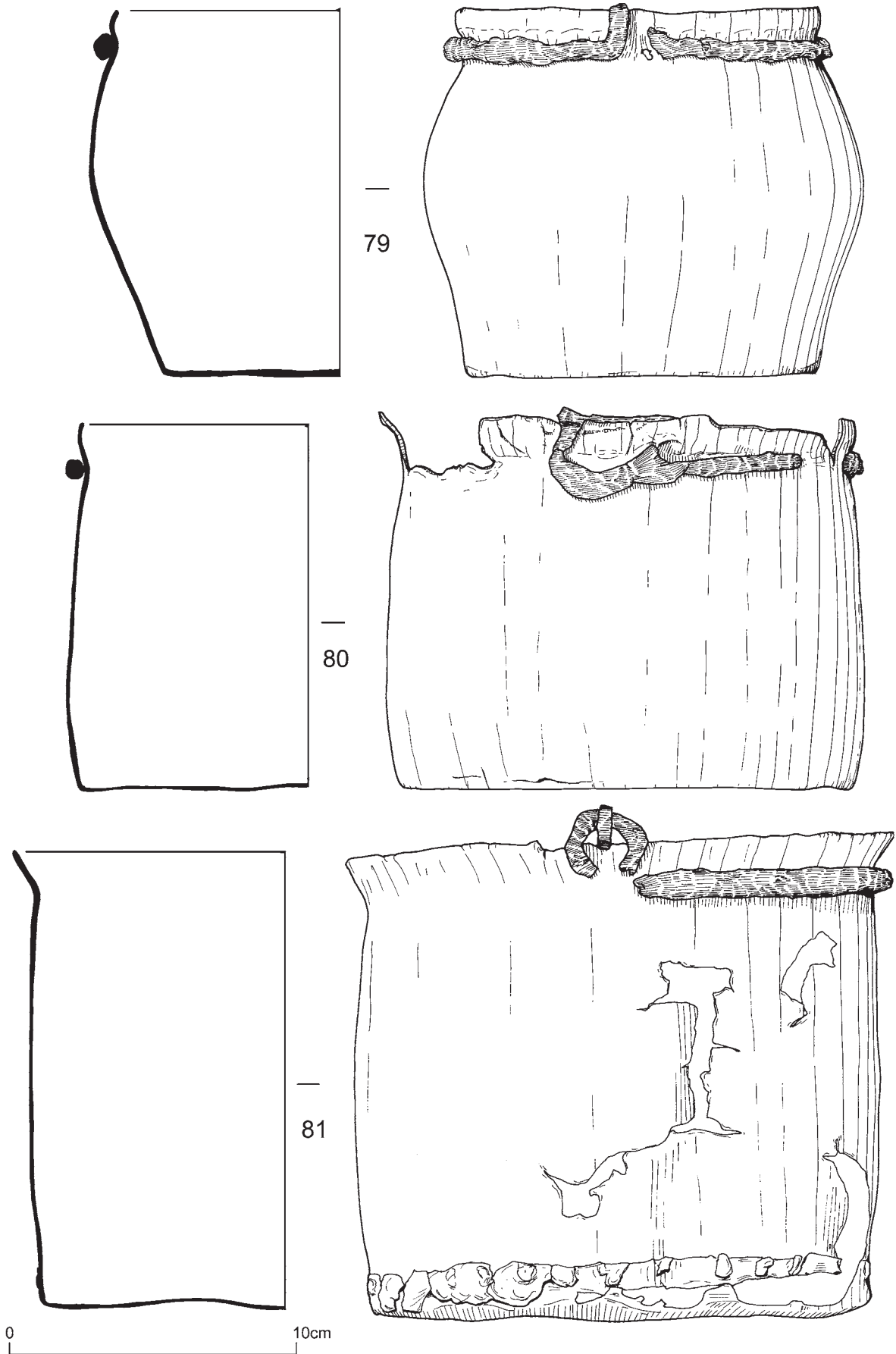

Figure 25. Copper alloy nos 79, 80, 81. Scale 1:1

- the rim is now oval in shape. An iron ring of oval section fits tightly around the neck. Pieces of the iron handle are attached by corrosion to the fragmentary ring, but neither of the escutcheon loops survive. Radnóti (1938) illustrates a similar vessel from Vajta in Pannonia dated to the third century (pl. XXXVIII, no. 4, 123–4).
80. Bucket (H:128mm D of base:147mm D of rim:170mm W of neck ring:8mm section of handle: 12 × 8mm T of walls:1mm). Building 12, robbing *contubernium* 9/ officer's quarters, Period 3, M14:61, 1894, WSCA150, 2001.1190
Vessel with a circular flat base similar to above. The thin walls are straight, curling out at the rim which is thickened at the edge. An oval-sectioned iron ring fits around the neck of the vessel with fragments of the iron handle resting on the rim. Neither of the escutcheon loops survives.
81. Bucket (H:168mm D of base:165mm D of rim:192mm W of iron ring:9mm T of walls:0.75mm). Building 12, robbing *contubernium* 9/officer's quarters, Period 3, M14:61, 1893, WSCA149, 2001.1189
Vessel, similar to above, with a circular flat base and straight sides which curve out at the neck. The edge of the rim is slightly thickened. Fragments of an oval-sectioned iron ring survive around the neck but no trace of a handle or escutcheon loops survive.
- The three buckets were found in a group, no. 79 sitting in no. 80 which in turn was resting in its larger parallel, no. 81. There are parallels to all three vessels in Pannonia (Radnóti 1938, pl. XXXV, nos 1–5, 116) where the straight-sided buckets are more common than the curved form (as no. 79). All are known from first- and second-century contexts surviving into the third century. From complete examples it can be seen that the iron neck rings are bent to form looped escutcheons in two places, onto which are hooked the ends of the iron handle.
82. Escutcheon (L:85mm W:50mm). Unstratified, 1956, lost
Large bucket or bowl escutcheon with a long triangular body and oval loop. The back is hollow and the face convex. Cf. Verulamium: Waugh and Goodburn 1972, no. 132.
83. Escutcheon (L:62mm H:20mm). Alley 5, F14:38, 1311, WSCA67, 2001.1107
Solid bucket or bowl escutcheon in the form of a three-dimensional duck with a long triangular body and extended neck. There has been no attempt at modelling feathers but small dots indicate the eyes. There is a thin layer of lead on the base and traces of a possible shank or rivet. Examples are known from Romano-British sites, such as Ashby-de-Launde: Green 1976, pl. XXIIb, Barton: Eggers 1966, Abb.18, no. 41, and from Continental sites, such as Nauheim and Sacrau: Henry 1936, 209–246. They also appear on Longley's (1975) Type 5 hanging bowls which had a long period of production from the fourth to the seventh centuries.
84. Tripod support (H:29mm). East *interuallum* road (Road 7), Q05:04, 174, WSCA123, 2001.1163
Support from a tripod or lamp shaped to represent a horse's hoof and fetlock.
85. Tankard handle (L:66mm Max W:19mm H:37mm D of discs:21mm). Area over Building 11, unstratified, K15:01, 1300, WSCA35, 2001.1075
Tankard handle with a V-sectioned strip shank with a central rib fitting into two disc terminals held together by a thin rod. Both discs have square loops projecting from the back. The handle is further decorated by two incised marginal lines. A close parallel dating to the third century is known from Okstrow Broch, Orkney: MacGregor, M., 1976, no. 291. See also Corcoran 1952, Class V.
86. Jug handle (L:32mm). Building 8 abandonment or Building N, mid/late third century?, E12:04, 1151, WSCA297, 2001.1337
Top of a jug handle with thumb-stop and wide flanges. Cf. den Boesterd 1956, pls X, XI, XII: second-third century.
87. Bowl (D:23mm L:30mm D:63mm T:0.5mm). Building 1, floor, Period 2, M05:28, 923, WSCA95, 2001.1135
Fragment of a bowl with a short out-turned rim. There are traces of tinning on the outer face which also has three scored parallel lines under the rim.
88. Bowl (D:16mm). Area over *Via principalis* (Road 1), unstratified, M08:01, 2622, WSCA173, 2001.1511
Fragment of the rim of a bowl. (AC)
89. Lid (D:18mm T:5mm). Area of Building 4, no details, J04:11, 654, WSCA301, 2001.1341
Small disc lid with raised lip on both faces.
90. Seal box lid (D:24mm T:1mm). Area over Alley 4, unstratified, F05:02, 275, WSE6, 2001.1621
Circular seal box lid with a leaf design of reserved metal contained within a raised border. The resultant fields contain red and blue enamel. Cf. Jewry Wall, Leicester: Kenyon 1948, fig. 84; also Bateson 1981, fig. 7c.
91. Plate (L:12mm T:1.75mm). Area over Building 15, unstratified, J07:01, 1999, WSCA329, 2001.1369
Fragment of a rectangular plate with raised edges. The face is divided into cells by ribs which may have held enamel.
92. Mirror (D of original mirror:90mm T:1mm). Area over Building 7, unstratified, G11:01, 961, WSCA270, 2001.1310
Fragment of a disc mirror which has been tinned on both faces. One face is highly polished whilst the other has lightly scored concentric circles. Cf. Corbridge: Lloyd-Morgan 1977, pl. XVIII, 335–8; Lloyd-Morgan 1981.
93. Bell (H:46mm). Area over Building 7, unstratified, G11:01, 950, WSCA131, 2001.1171
Incomplete bell with a long body and square mouth. The lozenge-shaped loop is pierced by a circular hole. Cf. Leicester: Kenyon 1948, fig. 87, no. 7.
94. Key (L:47mm W of head:22mm D of tube:5.5mm). Building 16, floor, Period 4, L07:02, 2024, WSCA152, 2001.1192
Very short tubular key with a ward projecting at right-angles at the end. The ward is damaged but appears to consist of two tangs. At the top a wide, three-ribbed, rectangular-sectioned panel leads to a flattened oval head pierced by a grooved circular hole (D:6mm). The head is set at right angles to the ward.

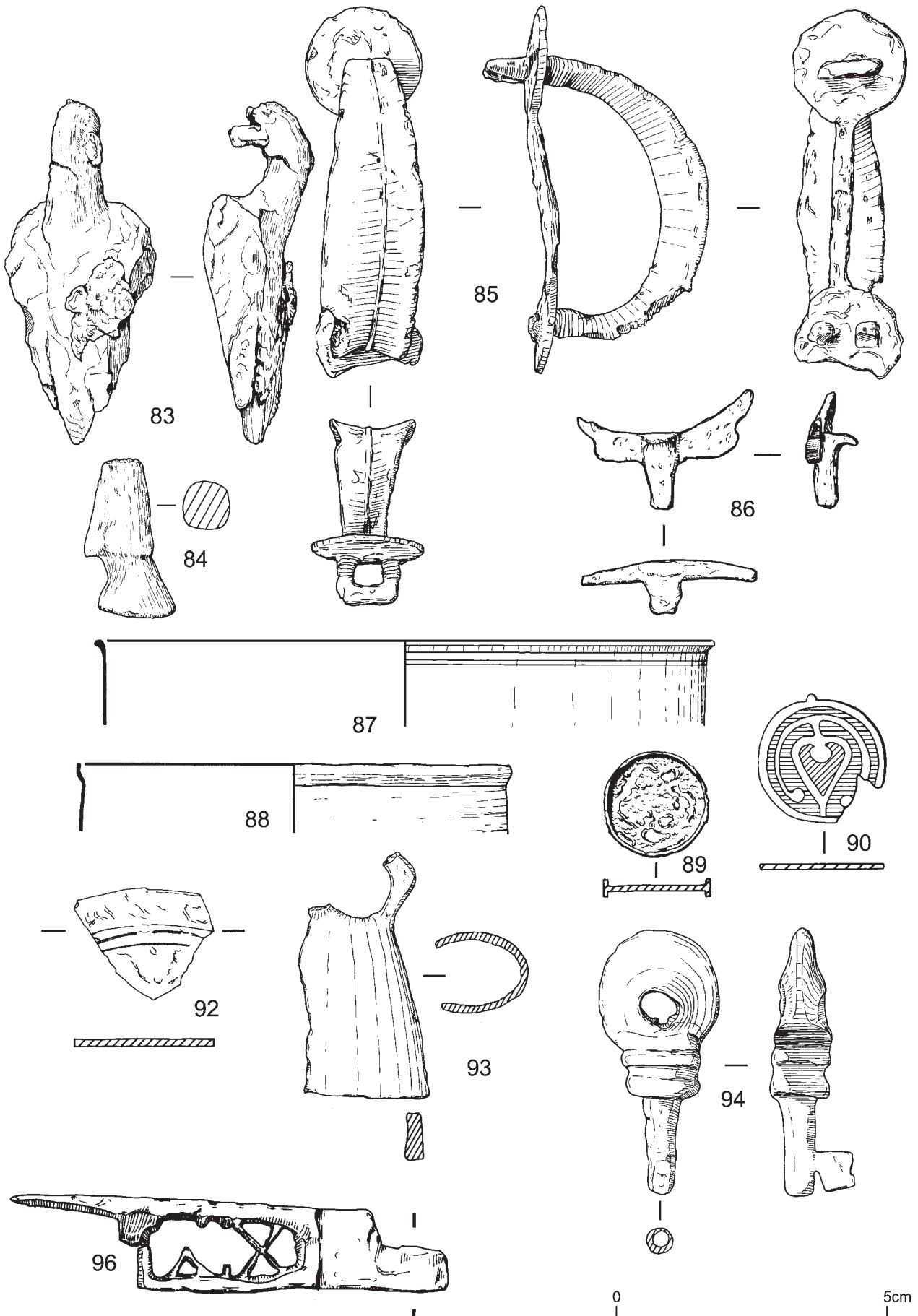

Fig re 8 Copper alloy nos 8 Scale 1

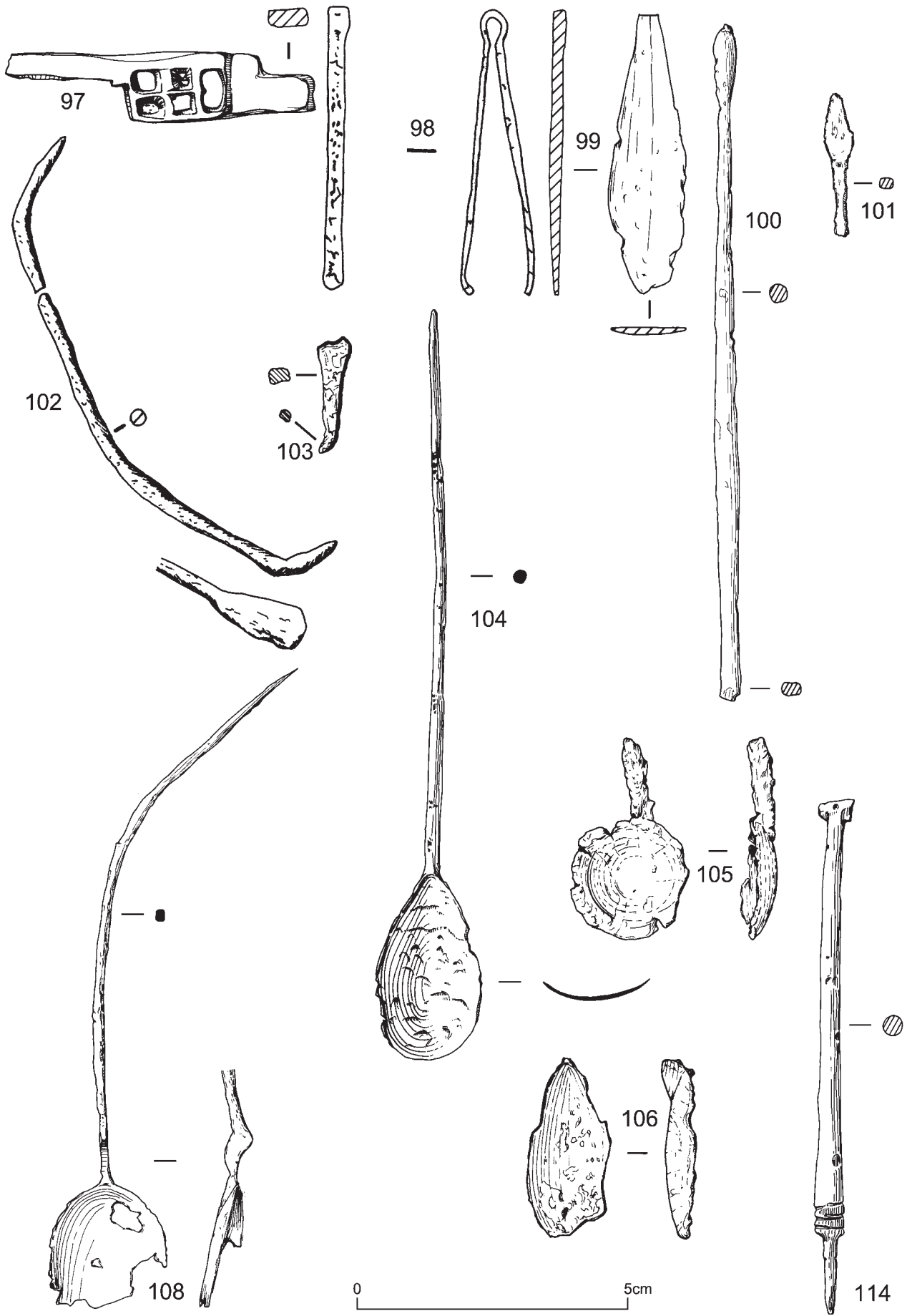

Fig re 114 Cop r alloy nos 114 Scale 1

95. Key handle (L:42mm). Building 3, abandonment/post-Roman, P07:08, 2556, WSCA159, 2001.1199
Incomplete key handle with deep baluster-moulded neck and openwork head which appears to be of the common *fleur-de-lis* type which has been dated to post AD 150 (ORL 8, Taf. 12, no. 51). Part of the iron key shank survives in the base of the handle.
96. Lock bolt (L:80mm W:16mm T:9mm). Area over Building 9, unstratified, F13:04, 1036, WSCA40, 2001.1080
Tumbler lock bolt of rectangular section. The eight triangular cut-outs are arranged in two rectangular patterns of four. See diagram of use in Smith 1922, fig. 44.
97. Lock bolt (L:57mm W:13mm B:6mm). Unstratified, WSCA76, 2001.1116
Tumbler lock of rectangular section. The cut-outs are arranged in two lines of three squares. See also the iron example below, no. 33.
98. Tweezers (L:51mm W of arms: 5mm T of arms:1mm). Building 13, room 7, Period 4, N12:37, 1883, lost
Pair of tweezers with straight arms curving only at the tips.
99. Medical instrument (L:51mm W:14mm T:1mm). Rampart building north of *Porta quintana*, Period 2–3, C11:04, 1196, WSCA261, 2001.1301
Flat, leaf-shaped blade from a medical instrument. Cf. South Shields: Allason-Jones and Miket 1984, no. 3.455. See also Kunzl 1982, pls 9; 20, no. 5; 43, nos 6 and 7; 69, no. 1; 79, no. 5.
100. Medical instrument (L:125mm T:4mm). Rampart building north of *Porta quintana*, Period 2–3, C11:04, 1199, WSCA77, 2001.1117
Fragment of a medical instrument with an octagonal-sectioned shank and a bulbous probe. See Allason-Jones and Miket 1984, nos 3.451, 3.453, and 3.456 for local parallels. See Milne 1907, 53, for the use of such probes.
101. Medical instrument (L:26mm T:1.5mm). North gate, east tower, Period 1–2, L03:32, 886, WSCA55, 2001.1095
Small, leaf-shaped terminal from a medical instrument. One face is slightly concave. Cf. Milne 1907, pl. XIV, no. 5.
102. Medical instrument (L:120mm W of head:8.5mm). Alley 7, K12:02, 1816, lost
Distorted, tapering, circular-sectioned shank with a rounded spatulate terminal.
103. Medical instrument (L:20mm). Chalet 9, Building ET, Period 4, G13:14, 1575, WSCA267, 2001.1307
Terminal of a medical instrument with an angled circular head which has broken where a small hole pierces through the neck. Cf. Chesters: Chesters Museum Acc. No. 6011.817 (1072).
104. Spoon (L:140mm W of bowl:20mm). Lower fill of pit cut into primary phase of Road 4, Q04:15, 498, WSCA2, 2001.1042
Spoon with a pear-shaped bowl and a long tapering handle leading straight from the bowl. Cf. Verulamium: Waugh and Goodburn 1972, fig. 35, no. 74: AD 135–45.
105. Spoon bowl (D:22mm). Building 1, *contubernium* 2–4 cleaning, Period 2?, N04:18, 515, WSCA247, 2001.1287
Deep, circular spoon bowl with incised concentric circles around the edge on the inner face. Tinned on all surfaces. Cf. Verulamium: Goodburn and Grew 1984, fig. 15, no. 121: undated but an unillustrated example came from a context dated to 145–155.
106. Spoon bowl (L:32mm). Area over Building 1, unstratified, L04:11, 884, WSCA245, 2001.1285
Pear-shaped spoon bowl. Tinned.
107. Spoon bowl (W:20mm). Building 16, floor, Period 4, L08:47, 2508, WSCA340, 2001.1380.
Incomplete bowl near the junction with the handle. Very poor condition.
108. Spoon (L:123mm W of bowl:22mm). Rampart building north of *Porta quintana*, Period 2–3, C11:04, 1201, WSCA56, 2001.1096
Incomplete, very distorted spoon with an oval bowl and a tapering, rectangular-sectioned handle which is set slightly higher than the bowl.
109. Spoon bowl (L:31mm W:26mm). Gateway 2, no details, D07:02, 2222, WSCA319, 2001.1359
Distorted, lute-shaped spoon bowl broken at the neck.
110. Spoon bowl (W:27mm). Building 16, floor, Period 4, P08:05, 2504, WSCA288, 2001.1328
Fragment of a lute-shaped spoon bowl with a thickened edge.
111. Spoon? (L:64mm approx W of bowl:34mm). Area over Building 16, unstratified, K07:03, 1986, lost
Fragmentary oval plate, slightly concave with a tapering curled projecting from one edge.
112. Spoon handle (L:67mm). Drain from tank south of Building 14, late third/early fourth century, J12:34, 2164, WSCA242, 2001.1282
Tapering handle of a spoon broken at the keel.
113. Spoon handle (L:36mm Max T:3mm). *Via principalis*, L08:57, 2555, WSCA135, 2001.1175
Fragment of a spoon handle broken at the keel. The handle emerges from the keel as square-sectioned but continues as circular-sectioned after a double rib motif. Tinned. Cf. South Shields: Allason-Jones and Miket 1984, no. 3.327.
114. Stylus (L:94mm W:5mm W of head:6.5mm L of point:14mm). Cistern 1 filling, mid to late third century, E08:29, 2312, WSCA3, 2001.1043
Stylus with a circular-sectioned shank tapering to a short rectangular eraser with bevelled faces. The long pointed tip is separated from the shank by three deep grooves. Analysis has shown the metal to be a high tin bronze with some lead.
See also no. 380.
115. Stylus? (L:89mm W of head:9mm). Road 8, F08:10, 2272, WSCA104, 2001.1144
Tapering, circular-sectioned rod with a long, wedge-shaped head decorated with incised cross-hatching. Possibly a stylus although the head appears to have been rounded at the end.
116. Pin (L:24mm D of head:24mm T of shank:3mm). Unstratified, 2003, WSCA115, 2001.1155
Incomplete pin with a circular-sectioned shank and an onion-shaped head on a disc neck.
117. Pin (L:84mm). Fill of drain in Road 9, J14:06, 1343, WSCA59, 2001.1099
Circular-sectioned pin with the end hooked. The head is square-sectioned and decorated with several transverse grooves.
118. Pin (L:112mm T:3.5mm). Building 5, drain fill, Period

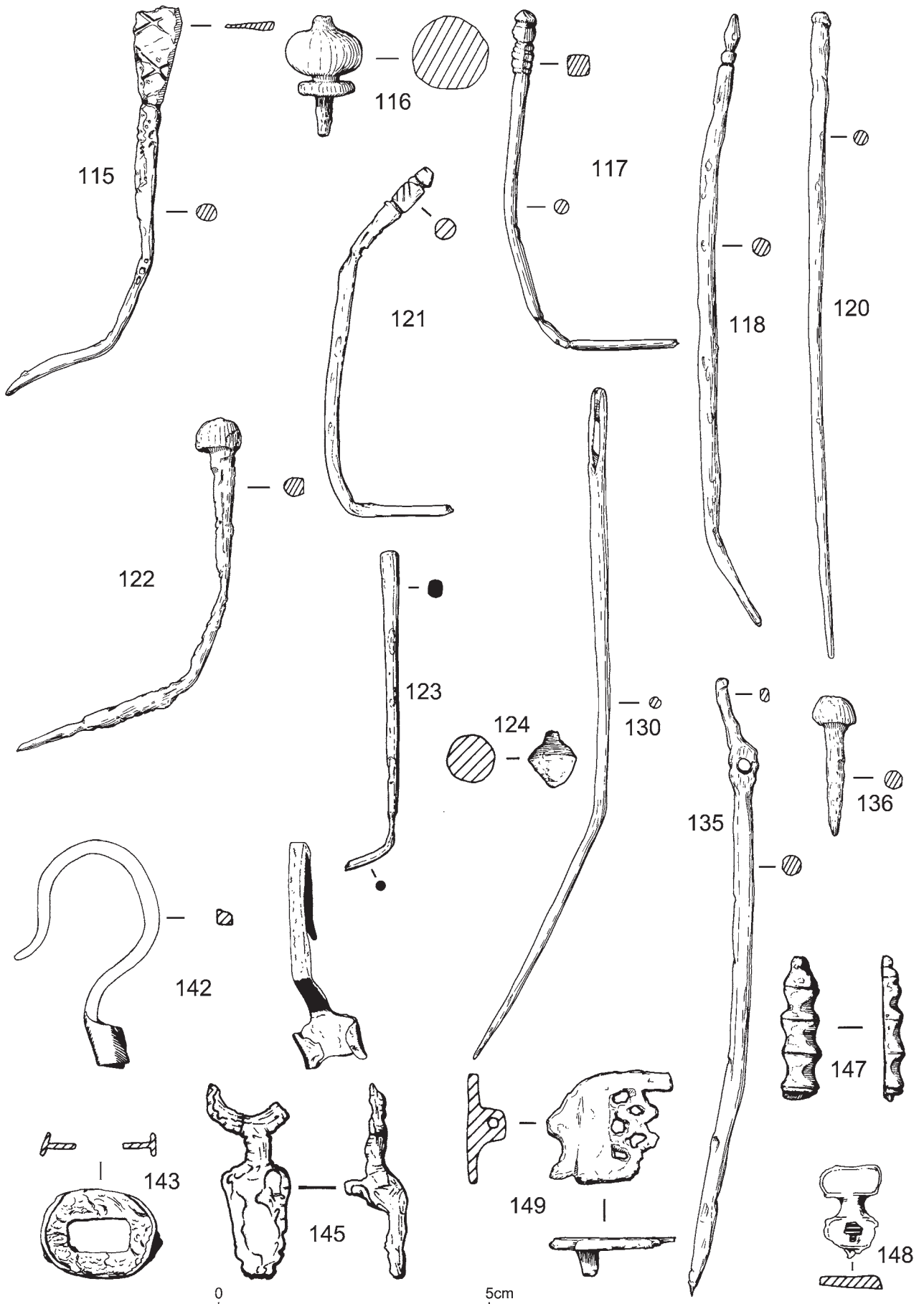

Fig re 3 Cop r alloy nos 3 Scale 1

- 2, E05:38, 1491, WSCA78, 2001.1118
Circular-sectioned pin broken across the baluster-moulded head.
119. Pin (L:80mm T:2.5mm). Chalet 12, Building AL2, (mid)-late third century, M15:21, 1862, lost
Incomplete pin with a globular head on a baluster-moulded neck and a circular-sectioned shank.
120. Pin (L:120mm T:3mm). Building BJ, foundation, post-Roman, G11:12, 1164, WSCA153, 2001.1193
Circular-sectioned pin with a domed head.
121. Pin (L:90mm). Area over Building 12, unstratified, M14:01, 1649, WSCA80, 2001.1120
Circular-sectioned pin with a lathe-turned head.
122. Pin (L:82mm). Area over Buildings 1 and 2 and Alley 1, unstratified, N05:01, 7, WSCA51, 2001.1091
Very battered pin of circular section with a globular head.
123. Pin (L:61mm T:4mm). *Via principalis*, L08:50, 2523, WSCA418, 2001.1458
Circular-sectioned pin with a globular head.
124. Pin (D:8.5mm). Building 16, 'kiln', Period 1-2, M07:14, 2606, WSCA348, 2001.1388
Conical head of a pin with a circular-sectioned shank.
125. Pin (D:7mm). Road 3, F10:32, 2330, WSCA351, 2001.1391
Conical head of a pin.
126. Pin (L:61mm W:5mm T:4mm). Area over Building 16 and *Via principalis*, unstratified, N08:01, 2473, WSCA363, 2001.1403
Incomplete pin of oval section thickening to a rounded head.
127. Pin? (L:20mm). Building 13, backfill of east hypocaust, Period 4, M12:54, 1843, WSCA184, 2001.1224
Possible pin with a globular head and a wide shank with two longitudinal grooves.
128. Pin (L:83mm). Rerouted *Via principalis* (Road 1), Roman/post-Roman, E08:13, 2285, WSCA227, 2001.1267
Circular-sectioned pin. The head is too corroded for the form to be identified.
129. Pin (L:13mm D of head:7mm). *Via principalis*, L09:17, 2566, WSCA291, 2001.1331
Pin with circular-sectioned shank and a globular head.
130. Needle (L:120mm). *Via principalis*, L08:59, 2585, WSCA128, 2001.1168
Long needle of oval section with a countersunk rectangular eye.
131. Rod (L:40mm T:2mm). Building 1, verandah, Period 3, P05:13, 244, WSCA419, 2001.1459
Tapering, circular-sectioned rod; shank of pin or needle.
132. Rod (L:47mm T:2mm). Area over Building 1, unstratified, L04:01, 726, WSCA420, 2001.1460
Tapering, circular-sectioned rod; shank of pin or needle.
133. Rod (L:55mm T:3.5mm). Area over Building BB, unstratified, N13:01, 1657, WSCA421, 2001.1461
Rod of circular section with one pointed end.
134. Rod (L:75mm). Area over Building 12 and *Via praetoria*, unstratified, J14:01, 1261, WSCA208, 2001.1248
Curved rod with one end flattened and pierced to take a small copper alloy ring. The other end expands slightly and is broken across a hole. Balance? Cf. Chesters Museum Acc. No. 602.818(1073).
135. Rod (L:113mm). Building 2, *contubernium* 8 demolition material, Period 3 or later, L05:25, 843, WSCA154, 2001.1194
Thick rod of circular section flattened near one end to enclose a circular hole and with a square-sectioned head. Balance arm?
136. Nail (L:25mm D of head:7mm). Area over Road 8, unstratified, F09:04, 2215, WSCA119, 2001.1159
Nail with a globular head and a short tapering shank.
- NAILS WITH DISC HEADS
137. Nail (L:12mm D:17mm). Building 2, *contubernium* 5, Period 3 or later, M05:11, 294, WSCA423, 2001.1463
138. Nail (L:25mm D:14mm). Road 4, G03:04, 624, WSCA379, 2001.1419
139. Nail (L:25mm D:11mm). Area over east fort wall, unstratified, R05:01, 633, WSCA215, 2001.1255
140. Nail (L:19mm D:22mm). Area over Building 9, unstratified, F13:01, 1080, WSCA422, 2001.1462
141. Nail (D:13mm). Area over Road 9, unstratified, J14:05, 1385, WSCA398, 2001.1438
142. *Dolabra* sheath (L:42mm). Road 3, no details, J13:18, 1346, WSCA37, 2001.1077
Square-sectioned hook with a flanged end from a *dolabra* sheath: Collingwood and Richmond 1969, fig. 108h.
143. Knife guard (L:21mm T:4mm hole:12 × 6mm). Area over Building 10 and *intervallum* road (Road 6), unstratified, F15:01, 1453, WSCA195, 2001.1235
Oval dagger or knife-guard with raised edges and a rectangular hole to take the tang. Cf. Corbridge: Bishop and Dore 1989, fig. 84, no. 147.
144. Binding (L:79mm W:7mm). Road surface (B2), Period 3-4, K07:14, 2049, WSCA239, 2001.1279
Fragment of U-sectioned shield or scabbard binding which follows a slight curve.
145. Scabbard runner (L:35mm W:12mm). Building 11, *contubernium* 3/4, Period 2, L15:18, 1593, WSCA272, 2001.1312
Fragment of the looped end of a scabbard runner with a plain chamfered face. Traces of gilding survive. Cf. Niederbieber: Oldenstein 1976, Taf. 13, nos 55, 56; Feldberg; South Shields: Allason-Jones and Miket 1984, no. 3.646.
146. Belt-plate (L:72mm W:33mm). Building 12 demolition, Period 3, M14:54, 1880, lost
Rectangular belt-plate with chamfered edges and a peltate projection from one end. The back is hollow with two disc-headed shanks. The open centre has lost its bar. Late second century.
147. Belt-plate bar (L:27mm W:7mm T:3mm). Building 2, *contubernium* 8, Period 3 or later, L05:44, 911, WSCA330, 2001.1370
Centre bar for an open belt-plate as no. 146 above. The bar is flat at the back with four transverse grooved ribs across the front. The surviving end terminates in a short spigot. For enamelled examples see Henry 1933, figs 38 and 39.
148. Belt-plate bar (L:17mm). Area over Building 1, unstratified, L04:11, 883, WSE12, 2001.1627
Fragment of the centre bar of an open belt-plate. One oval and one rectangular panel survives, both filled with blue enamel. Cf. Vimose, Brough-in-

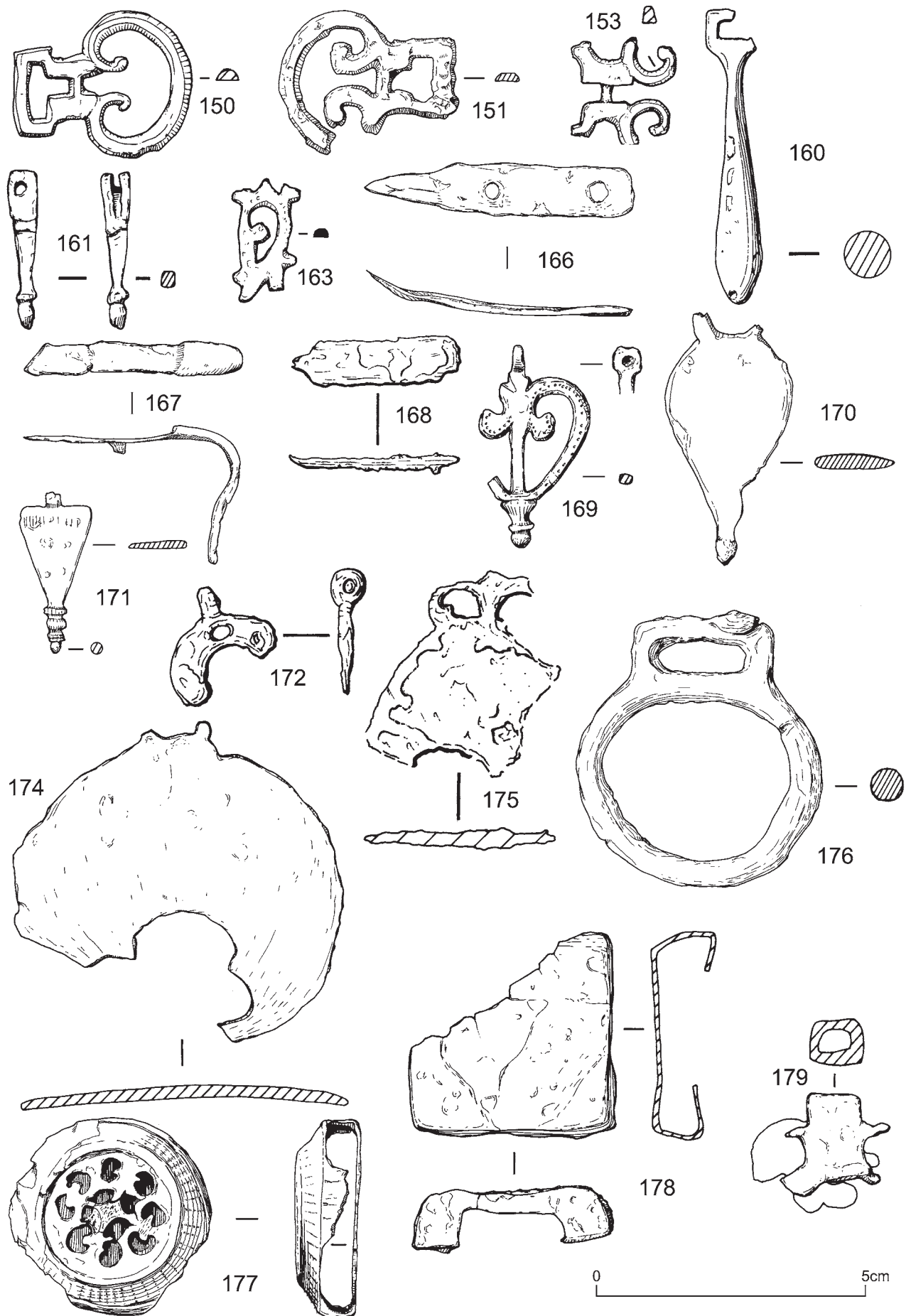

Fig re 2 Cop r alloy nos 2 Scale 1

- Westmorland, Felixstowe, and South Shields: Henry 1933, fig. 38, no. 4; fig. 39, nos 2, 3 and 5.
149. Belt-plate (L:25mm W:20mm). Chalet 12, Building AH, Period 4, L14:07, 44, WSCA260, 2001.1300
Fragment of a belt-plate with the centre filled with fretted openwork. The surviving end is peltate with a loop projecting from the back. Cf. Great Chesters: Allason-Jones 1996a, fig. 10, no. 38; Osterburken: Oldenstein 1976, Taf. 62, no. 791.
150. Buckle (L:32mm Max W:27mm T:3mm). Building 1, *contubernium* 1–3 demolition, Period 2, N05:32, 567, WSCA83, 2001.1123
Buckle with an oval loop of triangular section with two projections curling into the void. The T-shaped hinge plate is thicker than the loop.
151. Buckle (L:33mm Max W:26mm T:2.5mm). Building Row 20, Building R, mid-third century, G11:18, 1222, WSCA69, 2001.1109
Buckle with an incomplete oval loop of semi-oval section with two projections curling into the void. The hinge plate is rectangular with a T-shaped hole cut to take the missing hinge pin.
152. Buckle (L:32mm W:28mm T:2.5mm). Area over Building 11 and Alley 6, unstratified, L15:15, 1517, WSCA122, 2001.1162
Buckle with an oval loop of semi-oval section. Part of the tongue survives *in situ*.
153. Buckle (L:19mm). Building 1, demolition/make-up, Period 3–4?, M05:09, 419, WSCA204, 2001.1244
Fragment of a buckle of square section consisting of part of the hinge loop and two projections curling into the centre. Tinned.
154. Buckle (W:15mm). Western rampart (F2), P04:04, 31, WSCA424, 2001.1464
Fragment of a buckle consisting of a T-shaped hinge loop set in a trapezoidal plate. The shank is semi-oval in section.
155. Buckle (W:20mm). Building 11, *contubernium* 4, Period 1, L15:29, 1618, WSCA417, 2001.1457
Fragment of an oval buckle with a projection into the centre.
156. Buckle (L:13mm). Area over Building 5, unstratified, J05:01, 600, WSCA425, 2001.1465
Fragments of the trapezoidal hinge loop plate of a buckle.
157. Buckle (W:10mm). Rampart building north of *Porta quintana*, Period 2–3, C11:04, 1169, WSCA391, 2001.1431
Hinge fragment from a buckle. Traces of an iron hinge pin survive.
158. Buckle (no measurements possible). Area over Building 12, unstratified, K14:03, 1347, WSCA377, 2001.1417
Buckle in many fragments.
159. Buckle hinge (W:21mm). Chalet 12, AF, Period 4 or later, M15:12, 1620, WSCA426, 2001.1466
Trapezoidal hinge loop from a buckle.
160. Strap-end (L:55mm Max W:9mm). Building 8, entrance, Period 4, D11:21, 1010, WSCA65, 2001.1105
Heavy strap-end with a long bulbous body and a squared loop. Cf. Pfünz: Oldenstein 1976, Taf. 37, no. 327. Mid third century.
161. Strap-end (L:29mm Max W:6mm Max T:5mm). Area over Building 1, unstratified, P05:02, 114, WSCA60, 2001.1100
Tapered strap-end with a knobbed terminal. The wider end is cleft and pierced by a rivet hole. Cf. Zugmantel: Oldenstein 1976, Taf. 36, nos. 311, 312.
162. Strap-end (L:36mm T:7mm). Building 13, south corridor, Period 3 or 4, L11:25, 1821, WSCA182, 2001.1222
Elongated bulbous end of a strap-end.
163. Strap-end (L:32mm B:2mm). Area of Building 2, post-Roman?, N05:16, 236, WSCA275, 2001.1315
Fragment of an elongated openwork strap-end. Cf. Niederbieber: Oldenstein 1976, Taf. 41, nos 390, 393, 395, 396; Zugmantel: Oldenstein 1976, Taf. 41, nos 391, 394, 397. Second–third century.
164. Hinge (L:21mm W:15mm D of stud head:7mm). *Via quintana* (Road 3), K14:15, 1590, WSCA210, 2001.1250
Rectangular hinge formed by folding a sheet and securing it with a disc-headed stud.
165. Hinge (L:19mm B:5mm). Area over Building 9, unstratified, E13:01, 1066, WSCA296, 2001.1336.
Similar to above.
166. Cuirass hook (L:49mm W:9mm T:1mm). Area over *Via principalis*, unstratified, L08:01, 1972, WSCA124, 2001.1164
Incomplete girdle plate tie-hook from *lorica segmentata* of Robinson's (1975) Corbridge Auxiliary Cavalry Type B. Neither of the two circular holes retains its rivet and only part of the hook survives. First-second century.
167. See no. 181
168. Cuirass hook (L:33mm W:9mm B:2mm). Area of Building 2, post-Roman?, N05:16, 130, WSCA281, 2001.1321
Rectangular sheet with rivet shank surviving at one end. The other narrows to a broken terminal, curving upwards.
169. Pendant (L:37mm W:20mm T:1.5mm). Road north of Building 17, third century, G04:09, 372, WSCA36, 2001.1076
Heart-shaped openwork armour or harness pendant. Cf. Stockstadt: ORL 33, Taf. VII, no. 41.
170. Pendant (L:47mm W:24mm T:2mm). Road associated with the north-west shacks (B2), Period 3–4, H04:19, 789, WSCA81, 2001.1121
Flat, pear-shaped pendant with knobbed terminal and a large loop. An example decorated with incised circles is known from Wiesbaden: Oldenstein 1976, Taf. 30, no. 197.
171. Pendant (L:30mm). Building BJ, post-Roman, G11:03, 1086, WSCA52, 2001.1092
Heart-shaped pendant with the strap hook missing. The terminal has a thick triple ribbed knob. Cf. Pfünz: Oldenstein 1976, Taf. 30, no. 200.
172. Pendant (D:21mm). Area over Building 8 and *Via quintana*, unstratified, E12:01, 1116, WSCA190, 2001.1230
Crescentic pendant with a convex face and a hollow back, pierced by a rectangular hole. The broken loop sits at right angles to the body, Cf. Pfünz, Wiesbaden and Munningen: Oldenstein 1976, Taf. 45, nos 448, 449 (enamelled) and 450 (enamelled).
173. Fitting (L:32mm T:1.5mm). Unstratified, WSCA156, 2001.1196
Narrow rectangular fitting with the remains of two shanks projecting from the back.

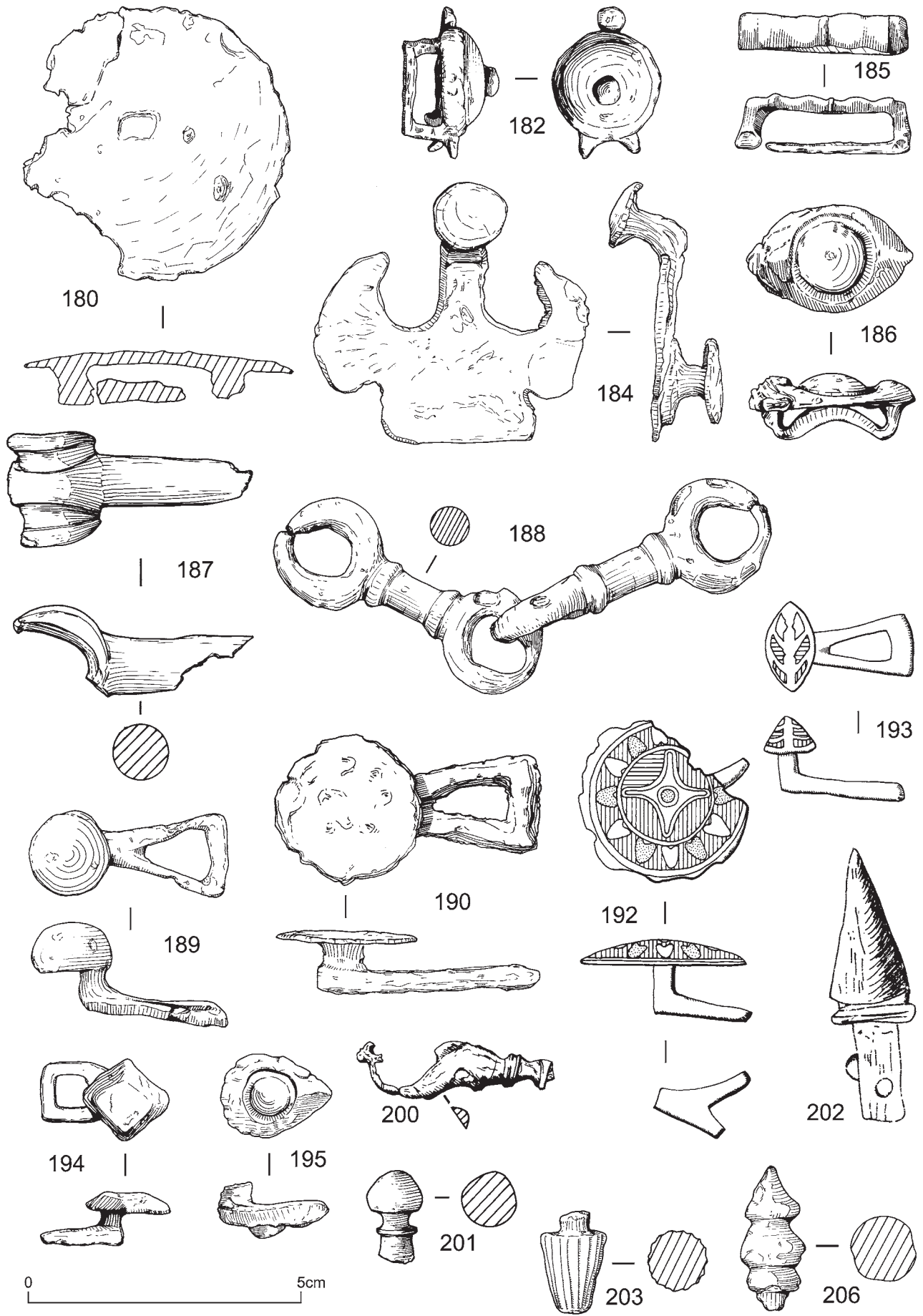

Fig re 3 Cop r alloy nos 0 Scale 1

174. Fitting (L:61mm W:62mm). Area over *Via quintana*, unstratified, J13:01, 1321, WSCA222, 2001.1262
Large, incomplete peltate harness fitting.
175. Fitting (T:1.5mm). Area over Building 12, unstratified, K14:01, 1538, WSCA207, 2001.1247
Fragment of a circular harness fitting with peltate openwork projecting from one edge.
176. Terret (W:45mm Total L:50mm W of loop:25mm T:6mm). Area over Building 2, ploughsoil, L05:03, 601, WSCA84, 2001.1124
Oval terret ring with a rectangular loop projecting from the edge. Published examples are known from Verulamium: Waugh and Goodburn 1972, no. 126, and Richborough: Bush-Fox 1949, pl. XXXVI, no. 124. There is also an unpublished terret of similar type from Chesters (Chesters Museum Acc. No. 726.1439).
177. Harness lead (D:36mm T:11mm). Alley 1, post-Roman dereliction, M05:14, 580, WSCA98, 2001.1138
Hollow, circular harness lead which has had four rectangular trace holes. The domed upper face has a central decoration of eight deep *peltae* containing red enamel. A concentric rib separates the *peltae* from grooves which radiate to the edge. An undecorated example is known from Chesters (Chesters Museum Acc. No. 886.369 (1093)), and some decorated examples are known from the German *Limes*: see Oldenstein 1976, Tafs 22–4. Early third century.
178. Harness lead (L:40mm W:40mm B:12mm). Building 12, drain in officer's quarters, Period 1, J14:22, 1409, WSCA279, 2001.1319
Incomplete square harness lead.
179. Harness lead (L:19mm W:20mm). Area over Building 12, unstratified, L14:44, 1800, WSCA17, 2001.1057
Fragment from a four-armed harness lead, broken up and partially melted down, along with a bead (no. 61). See also metalworking report.
180. Disc stud (D:49mm T of head:1.5mm). Area over Building 16, unstratified, L07:01, 1993, WSCA107, 2001.1147
Large disc stud with a slightly convex face. A rectangular loop in poor condition projects from the back. Probably horse harness decoration.
181. Junction loop fastener (L:41mm W:7mm T:1mm). Building 1, officer's quarters, Period 3, N05:12, 270, WSCA134, 2001.1174
Incomplete, plain junction loop fastener. Cf. Wroxeter: Webster 2002, fig. 4.12, no. 56 (undated).
182. Harness mount (L:28mm Max W:19mm, Total H:17mm). Building 11, *contubernium* 3/4, Period 2, L15:23, 1535, WSCA61, 2001.1101
Circular boss with two rectangular loops across the hollow back. A knob projects from the centre of the boss whilst a broken loop and a knob project from the flanged border. Harness fitting.
183. Harness mount (L:32mm Max W:23mm Total T:9mm). Area over Building 12, unstratified, L14:01, 1411, lost Y-shaped mount, hollow at the back and convex on the face. A disc-headed shank projects from behind each arm whilst strips projecting from the edges of the stem of the 'Y' curl back to form a collar or socket. Harness fitting.
184. Harness mount (L:48mm). Clay puddling pit, Period 3 demolition, N05:14, 265, WSCA127, 2001.1167
Incomplete, harness mount terminating in a wide disc-headed stud. A second stud projects from the back. The end is squared off and the surviving side is winged. Cf. Zugmantel: Oldenstein 1976, nos 880–1.
185. Harness slide (L:32mm W:11mm B:6mm). Unstratified, WSCA88, 2001.1128
Thin rectangular fitting, with a loop on the back the length of the fitting. Possibly associated with no. 188, as both have similar patina. (AC)
186. Harness slide (L:32mm W:19mm H:13mm). Area over Building 11, unstratified, K15:01, 1497, WSCA38, 2001.1078
Lentoid mount with a central circular boss. A rectangular loop runs the length of the stud at the back. M. MacGregor (1976, 134) links such studs with button-and-loop fasteners and cites a parallel from Middlebie, Dumfriesshire (*ibid.*, fig. 8, no. 1).
187. Bridle fragment (L:44mm D of socket:9mm W of loop:19.5mm). Area over Road 8, unstratified, F08:01, 2197, WSCA171, 2001.1211
Incomplete tubular socket with deep flanges and a median rib. A plain tube projects at right angles to the socket and appears to contain traces of a lead-tin alloy. Part of a bridle: cf. Llyn Cerrig: Fox 1958, pl. 5b.
188. Bit (L:58mm) W(loop):22mm D(shaft):6mm). Unstratified, WSCA87, 2001.1127
Centre- and side-link from a three-link horse-bit of native tradition, used from the first century BC through to the mid or late first century AD (Jope 2000, pls 276–9). Possibly associated with no. 185. (AC)
189. Button-and-loop fastener (L:35mm D of button: 15mm W of loop:16mm). Cistern 2, lower fill, late third/early fourth century, J07:19, 2172, WSCA100, 2001.1140
Button-and loop fastener with a triangular loop attached to the top lip of a hollow circular boss button. Wild 1970a, Class IV. Second century.
190. Button-and-loop fastener (L:47mm D of button:25mm W of loop:17.5mm). Area over Alley 5, unstratified, F05:01, 84, WSCA29, 2001.1069
Button-and-loop fastener with a triangular loop and a disc button. Wild 1970a, Class Vc; Gillam 1958, Type C. Second century AD.
191. Button-and-loop fastener (no measurements possible). Area over Building 11, unstratified, K15:01, 1299, WSCA427, 2001.1467
Very fragmentary button-and-loop fastener which appears to have had a triangular loop and a disc button, similar to above.
192. Button-and-loop fastener (D:33mm L:32mm). Building 1, verandah, Period 2, M04:29, 937, WSE5, 2001.1620
Slightly domed disc head with raised rib creating two concentric circles. The outer circle has petals in a light-coloured enamel, the inner circle has a central dot and a diamond in pale enamel created by four oval cells of discoloured enamel. Incomplete triangular attachment loop.
193. Button-and-loop fastener (L:27mm W of button:16mm W of loop:11mm). Area of Building 10 and Road 9, no details, H15:05, 1236, WSE9, 2001.1624
Button-and-loop fastener with a triangular loop and a lentoid button, the angled face of which is decorated with triangles of blue and yellow champlévé enamel. This does not correspond with any of Wild's 1970a class numbers.

194. Button-and-loop fastener (L:24mm W of button:15mm W of loop:11mm). Area over *intervallum* road (Road 4), unstratified, P04:01, 50, WSCA62, 2001.1102
Small button-and-loop fastener with a squared loop and a lozenge-shaped button which has a raised centre. This does not correspond with any of Wild's 1970a class numbers.
195. Button-and-loop fastener (L:20mm W:16mm). Alley 5, G14:04, 1274, WSCA92, 2001.1132
Tear-drop or petal button of a button-and-loop fastener of Wild's (1970a) Class III and Gillam's (1958) Type B. Late first century to second century.
196. Button-and-loop fastener (Button: 12 × 9mm). Area over Building 14 and *Via quintana*, unstratified, J12:01, 1932, lost.
Rectangular button of a button-and-loop fastener with deep transverse rib-and-groove decoration.
197. Button-and-loop fastener (L:45mm). Chalet 9, Building ET, Period 4, G13:14, 1566, WSCA211, 2001.1251
Stem and fragment of a triangular loop of a button-and-loop fastener.
198. Fastener (D:14mm L:19mm). Area of Tower 2, unstratified, E02:11, 748, WSCA199, 2001.1239
Ring and shank from a fastening.
199. Terminal (L:17mm). Building 16, floor, Period 1–2, L07:13, 2103, WSCA175, 2001.1215
Decorated terminal from an openwork mount. The extreme end is onion-shaped and sits on a splayed base with curled sides. A rectangular-sectioned shank projects from the back. Cf. South Shields: Allason-Jones and Miket 1984, no. 3.780.
200. Appliqué (L:36mm). Area over Building 9, Alley 5 and Road 9, unstratified, H14:04, 1226, WSCA295, 2001.1335
Small, stylized dolphin, moulded on the front but flat at the back. The snout is attached to a ridge suggesting that the dolphin was one of a pair of confronting dolphins, similar to those on helmet handles of the second and third centuries (see Allason-Jones and Miket 1984, nos 3.410–412; and 2564 below). The lack of a shank and its size suggests that this example was used as appliqué. Cf. Weißenburg: *ORL* 72, Taf. VI, no. 21.
201. Dumb-bell button (L:16mm W:9.5mm). Area over Building AO, unstratified, G08:01, 2053, WSCA232, 2001.1272
Incomplete dumb-bell button with a wide groove and collar and a globular end. Such buttons are common finds on forts in the Hadrian's Wall area and have been related to the button-and-loop fasteners discussed above, by Gillam in his theory of the inter-Wall school of metalworking (1958). MacGregor (M., 1976) has suggested a late first- to possibly third-century date for production.
202. Plumb-bob (L:51mm D:15.5mm W of shank:9.5mm T of shank:3mm). Chalet 12, Building AL1, Period 4, M14:39, 1778, lost.
Long, solid conical plumb-bob with a deep groove around the circumference. A rectangular-sectioned shank is pierced by a circular hole.
203. Weight (H:19mm Max D:12mm). Building 1, *contubernium* 5 floor or demolition material, Period 2, M04:11, 512, WSCA73, 2001.1113
Conical steelyard weight decorated with longitudinal grooves. Cf. South Shields: Allason-Jones and Miket 1984, nos 3.475, 3.476.
204. Weight (H:10mm D:13mm). Area over Buildings 4 and 5 and Alley 3, unstratified, G04:01, 56, WSCA428, 2001.1468
Part of a circular weight with tapering sides.
205. Weight? (L:21mm T:9mm). Road surface associated with the north-west shacks (B2), Period 3–4, H05:13, 777, WSCA256, 2001.1296
Solid cone with a collar and a short shank. Steelyard weight or helmet knob.
206. Terminal (L:27mm T:11.5mm). *Via principalis*, E07:02, 2313, WSCA110, 2001.1150
Baluster-moulded terminal ending in a cone. An oval-sectioned iron rod projects from the end.
207. Terminal (L:16mm T:12mm). *Via principalis*, L08:50, 2519, WSCA170, 2001.1210
Cupped terminal on a circular-sectioned shank.
208. Terminal (L:24mm T:10mm T of shank: 5mm). Building 3, *contubernium* 3, Period 2, N07:15, 2609, WSCA114, 2001.1154
Baluster-moulded terminal on a wide, circular-sectioned shank.
209. Terminal (L:8mm). Area of Building 11 and Alley 6, no details, L15:03, 1507, WSCA400, 2001.1440
Tiny acorn terminal.
210. Terminal (L:20mm). Area east of Building 10, post-Roman, H15:06, 1441, WSCA198, 2001.1238
Roughly fashioned conical terminal of a square-sectioned curved rod.
211. Knob (D:20mm H:30mm). Area over Road 6, unstratified, M16:08, 1740, lost
Globular knob with a flaring shank. Both knob and shank are globular and decorated all over with horizontal grooves.
212. Helmet knob (H:14mm D:9mm). Area of Alley 1, post-Roman dereliction, M05:04, 39, WSCA253, 2001.1293
Conical helmet knob with a flared border.
213. Handle (L:49mm). Area over Building 13, unstratified, M09:01, 2564, WSCA230, 2001.1270
Part of a handle, probably from a helmet, which has been in the form of a pair of confronting dolphins. Only one dolphin survives, very stylized with a short narrow body and fin and a very long wide tail. There is little modelling except for the tail which provides the attachment loop. See Allason-Jones and Miket 1984, nos 3.410–412. See also no. 200 above.
214. Handle (L:75mm T:4mm). Road 4, P04:04, 28, WSCA82, 2001.1122
Handle, possibly from a helmet. The lozenge section expands slightly to long bulbous terminals, one of which is missing.
215. Handle (L:84mm T:8mm). Clay puddling pit, Period 3 demolition, N05:13, 231, WSCA106, 2001.1146
Handle of circular section tapering to both missing terminals.
216. Handle (L of handle:65mm L of loops:35mm T of handle:4.5mm). Alley10/Building 17, disturbed surface inside building, third century, G04:16, 369, WSCA74, 2001.1114
Handle of oval section tapering to knobbed terminals. A double-spiked loop encloses each terminal suggesting that this is a furniture or box handle rather than a helmet handle.

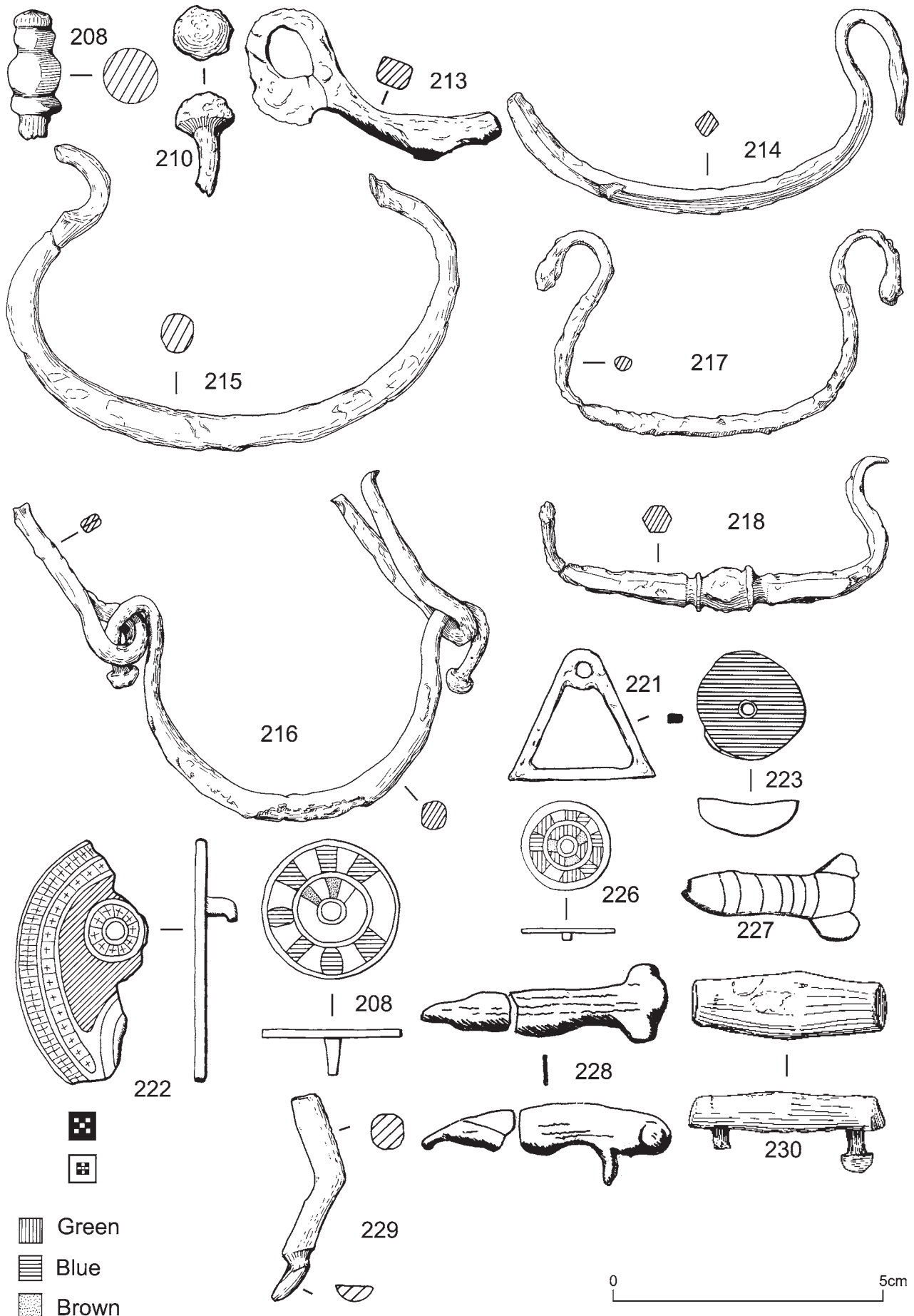

Figure 2 Copper alloy nos 208-230 Scale 1

217. Handle (L:66mm). Road 3, F11:19, 1184, WSCA126, 2001.1166
Handle of oval section tapering to knobbed terminals. The shank of the handle is straight, not curved as in the examples above.
218. Handle (L:65mm Max T:8mm). Area over Alley 5, unstratified, G14:01, 1041, WSCA79, 2001.1119
Handle of hexagonal section with central bead-and-reel motif. Both terminals are missing. Cf. South Shields: Allason-Jones and Miket 1984, no. 3.413.
219. Handle terminal (D:6mm). Area over *intervallum* road, unstratified, N04:01, 21, WSCA246, 2001.1286
Curved, oval-sectioned rod ending in a rounded knob. The terminal of a small handle?
220. Chape (No measurements possible). Building 9, *contubernium* 2, Period 2, F13:36, 1570, WSCA213, 2001.1253
Several fragments of a triangular openwork chape, probably of a similar type to Allason-Jones and Miket 1984, no. 3.396.
221. Chape (W:27mm H:24mm T:1.5mm). Area over Building 14, unstratified, K10:01, 1963, WSCA177, 2001.1217
Open triangle with a circular hole at the apex. The inner angles are rounded. Back plate from a scabbard chape.
222. Stud (L:45mm). Area over Building 11, unstratified, K15:01, 1323, WSE3, 2001.1618
Incomplete stud with turned back edges. One short shank projects from the back. The face has a complicated design with a central area of red enamel surrounded by, as well as containing, panels of white and blue millefiori enamel. The panels alternate with the white and blue in turn being the dominant colour, but each panel has a central dot of red. The back is covered with a cement made from carbonaceous sandstone with some quartz and some calcite but this appears to be secondary, the piece probably having decorated leather originally. Although incomplete, there are indications that the stud was not the usual circular shape but was in the shape of a curled leaf. Late second century AD.
223. Mount (D:20mm T:6mm). Building 4, make-up material, Period 2, J04:25, 940, WSE8, 2001.1623
Circular mount with a convex back. The concave face is decorated with swirls of blue and green (or white) enamel. There is a circular hole in the centre.
224. Stud (D:26mm T:7mm). Chalet 9, make up layer, Period 4, G13:19, 1576, WSE7, 2001.1622
Circular stud with its face divided by two concentric circular ribs. The central circle contains blue enamel whilst the surrounding ring is divided into wedge-shaped panels containing alternating colours, one of which is orange, an unusual colour on metalwork in the north of England. The panels in the outer ring contain alternately blue and black enamel. A short, square-sectioned shank projects from the back. This type of stud is common in the northern military zone: see Allason-Jones and Miket 1984, no. 3.5; and Bateson 1981, 53.
225. Stud (D:31mm H:8mm). Area over Building 13, unstratified, M12:01, 1682, lost
Disc-headed stud with three concentric cells separated by reserved metal ribs. None of the cells now contain enamel. A single squat shank projects from the back.
226. Stud (D:16mm). Area over Building 14, unstratified, J11:01, 1928, WSE4, 2001.1619
Small, disc-headed stud with the face divided by two concentric circular ribs. The central circle contains transparent turquoise enamel; the surrounding ring contains wedged panels of alternately opaque brown and light blue transparent enamel, and the outer ring contains wedged panels of alternately transparent turquoise and opaque dark green enamel. This use of transparent enamel suggests a recycling of vessel glass. The square-sectioned shank at the back is broken. The edge of the stud is decorated with nicks. Cf. Corbridge: Bishop and Dore 1989, fig. 86, no. 18. An example from Verulamium is dated to 150–155/60 (Waugh and Goodburn 1972, fig. 37, no. 96).
227. Mount (L:29mm W:14mm H:9mm). Area over Road 6, unstratified, M16:08, 1739, lost
Mount in the form of a stylised phallus with traces of niello in the grooves. Two shanks with hammered ends project from the back. Several studs with transverse grooves from Corbridge have shown traces of niello (Allason-Jones 1989b) but this is the only phallic stud which has shown such traces so far in the Hadrian's Wall zone. See also Allason-Jones and Miket 1984, no. 3.588.
228. Mount (L:40mm W:15mm). *Intervallum* road (Road 6), primary level, M16:20, 1854, lost
Stylised phallic stud with longitudinal rather than transverse grooving. Two shanks project from the back.
229. Terminal (L:43mm W:7mm). Area over Building 14 and *Via quintana*, unstratified, K12:01, 1690, WSCA251, 2001.1291
Oval-sectioned rod bent to an angle. One end is broken whilst the other has an oval terminal with an incised line emerging from a groove, possibly intended to be phallic.
230. Stud (L:36mm W:12mm H:10mm). Chalet 12, Building AJ, robber trench, L14:20, 1424, WSCA63, 2001.1103
Angular, barrel-shaped stud of semicircular section. Two disc-headed shanks project from the hollow back and the face is decorated by three transverse incised grooves.
231. Stud (L:20mm W:8mm). Building 9, *contubernium* 2, Period 2, E13:41, 1572, WSCA429, 2001.1469
Long rectangular mount with an oval projection from the surviving end. A single shank projects from the hollow back and the face is convex. A set of six similar belt fittings is known from Verulamium: Waugh and Goodburn 1972, fig. 33, no. 43: AD130–150.
232. Mount loop (W:27mm H:29mm). Chalet 10, Building AB, Period 4, D14:12, 1483, WSCA90, 2001.1130
Semi-oval loop of rectangular section with a splayed spigot projecting from the base. Oldenstein (1976, Taf. 85) shows these being used as backing loops for plain bronze mounts but they were also used on openwork *balteus* mounts (Allason-Jones 1985a, fig. 2).
233. Openwork mount (L:17mm T:1mm). Structure in north-east corner of Building AO, L08:13, 2055, WSCA334, 2001.1374
Small fragment of an openwork mount.
234. Openwork mount (L:21mm T:5mm). Building 3, *contubernium* 2, Period 2, N07:15, 2614, WSCA336, 2001.1376

- Small fragment of an openwork mount.
235. Mount (L:34mm W:30mm T:1mm). Road surface associated with the north-west shacks (B2), Period 3–4, H05:13, 775, WSCA137, 2001.1177
Fragment of a plate with raised edges. The face is divided into rectangles by ribs but there is no trace of enamelling. A short shank projects from the back.
236. Mount (L:24mm W:12mm Total H:8mm). Area over Building 14, unstratified, K11:01, 1922, WSCA105, 2001.1145
Rectangular mount heavily moulded with transverse ribs across the convex front. The back is hollow with a single projecting shank.
237. Mount (L:20mm W:3mm B8:mm). Road surface associated with the north-west shacks (B2), dereliction, E05:04, 183, WSCA257, 2001.1297
Very narrow rectangular plate, with one surviving disc-headed shank projecting from the back.
238. Mount (L:31mm W:32mm). Chalet 12, Building AM2, mid-late third century, M14:11, 1856, lost
Openwork peltate mount with a shank at the upper end bent down to form a hook. At the base a large rectangle has been roughly cut out. The edge of the mount is chamfered. Cf. Oldenstein 1976, nos 646–649. Early third century.
239. Mount (L:19mm W:18mm). Unstratified, 1797, WSCA189, 2001.1229
Three fragments of a peltate mount similar to above with a single stumpy shank projecting from the back.
240. Lunate mounts (W:17.5mm). Building 9, *contubernium* 2, Period 2, F13:36, 1571, WSCA202–3, 2001.1242–1243
Two tiny lunate mounts with convex faces and hollow backs. Two square-sectioned shanks project from each. Cf. Richborough: Cunliffe 1968, pl. XXXIII, no. 134; Newstead: Curle 1911, pl. XCII, no. 3; Pfünz: Oldenstein 1976, Taf. 45, no. 448.
241. Mount (T:1.5mm). Area over Building 12, unstratified, K14:03, 1539, WSCA386, 2001.1426
Fragment of a peltate mount.
242. Mount (H:13mm W:21.5mm Max T:3mm). *Via praetoria* (Road 2), J07:08, 2052, WSCA180, 2001.1220
Peltate mount with one wing solid whilst the other forms an open sleeve.
243. Fitting (L:32mm W:17mm). Area over Building 10 and Alley 5, unstratified, F14:01, 1067, WSCA244, 2001.1284
Incomplete fitting consisting of a curved strip with a loop projecting from the back.
244. Mount (L:35mm). Building 12, *contubernium* 6, Period 3?, L14:26, 1525, WSCA97, 2001.1137
Curved mount of roughly rectangular shape with two cross bars.
245. Mount (L:53mm W:33mm). Area over *intervallum* road (Road 4), unstratified, P04:01, 46, WSCA224, 2001.1264
Badly corroded, rectangular mount with splayed ends and a convex face. Two disc-headed shanks project from the back. Traces of organic matter, such as grass, were found but no trace of leather or textile. Cf. Saalburg: Jacobi 1897, Taf. LIII, 1 and 3; Zugmantel: Oldenstein 1976, Taf. 59, no. 733.
246. Mount (L:12mm). Area over Building 12, unstratified, L14:01, 1398, WSCA205, 2001.1245
Fragment of a mount similar to above.
247. Mount (L:37mm W:15mm B:4mm). Building 12 demoli-
tion, Period 3, M14:63, 1902, WSCA273, 2001.1313
Incomplete oval mount with slightly thicker terminal at one end. Two shanks project from the back.
248. Mount (D:19mm B:22mm). Unstratified, 1898, WSCA258, 2001.1298
Domed fitting with two attachment loops surviving, and the remains of a third.
249. Fitting (L:30mm W:12.5mm H:9mm). *Via quintana* (Road 3), M14:41, 1860, WSCA178, 2001.1218
Undecorated rectangular fitting with two shanks projecting from the back. Apparently an unfinished product.
250. Stud (D:30mm H:13mm). Building 3, abandonment/post-Roman, P07:10, 2598, WSCA172, 2001.1212
Disc stud with a central dimpled cone surrounded by deep concentric grooves. The appearance is like the face of a bell-shaped stud (see below). A disc-headed shank projects from the back.
251. Stud (D:26mm). Area over Building 14, unstratified, H11:01, 2058, WSCA241, 2001.1281
Incomplete stud distorted by heat (casting waste?). The head consists of a circular rib surrounded by a wide flange with a circular-sectioned shank projecting from the back.
252. Stud or bolt (L:39mm D of head:19.5mm T of head:5mm shank:8.5mm × 4mm). Area over *Via principalis*, unstratified, L08:01, 2468, WSCA72, 2001.1112
Stud or bolt with a thick disc head, the edge of which is decorated with two incised lines. The face is also decorated with incised concentric circles. The shank is rectangular in section and is pierced by a 3.5mm hole at the end.
253. Disc stud (D: 26mm H:18mm). Area over Building 10 and Alley 5, unstratified, E14:01, 1132, WSCA53, 2001.1093
Disc stud with decorative notching around the edge. A wide rectangular-sectioned shank projects from the back and is broken across the pierced end. Cf. South Shields: Allason-Jones and Miket 1984, no. 3.885; Straubing, Saalburg, and Oberdorf: Oldenstein 1976, Taf. 50, nos 564, 567, and 568 respectively.
254. Disc stud (D:17mm H:8mm). *Via praetoria* (Road 2), K07:05, 2039, WSCA266, 2001.1306
Small disc-headed stud with a circular-sectioned shank. The head is decorated with notches round the edge but is much smaller than is normal with this type.
255. Disc stud (D:20mm Shank W:8mm B:1mm). West rampart, Period 1, D10:25, 2308, WSCA365, 2001.1405.
Stud with a slightly domed disc head and the remains of a wide rectangular-sectioned shank projecting from the back.
256. Disc stud (D:13mm H:10mm). Building 13, pit in room 8, mid-third century, N12:25, 1842, lost
Disc stud with a raised border set close to but not on the rim. A single shank projects from the back.
257. Disc stud (D:17mm T of shank:6mm). Area over Building 12, unstratified, L14:01, 1412, WSCA403, 2001.1443
Very corroded stud with a disc head and a circular-sectioned shank.
258. Disc stud (D:28mm). Area over Building 10 and Alley 5, unstratified, F14:01, 1283, WSCA382, 2001.1422
Disc stud, slightly domed with a short, square-sectioned shank.

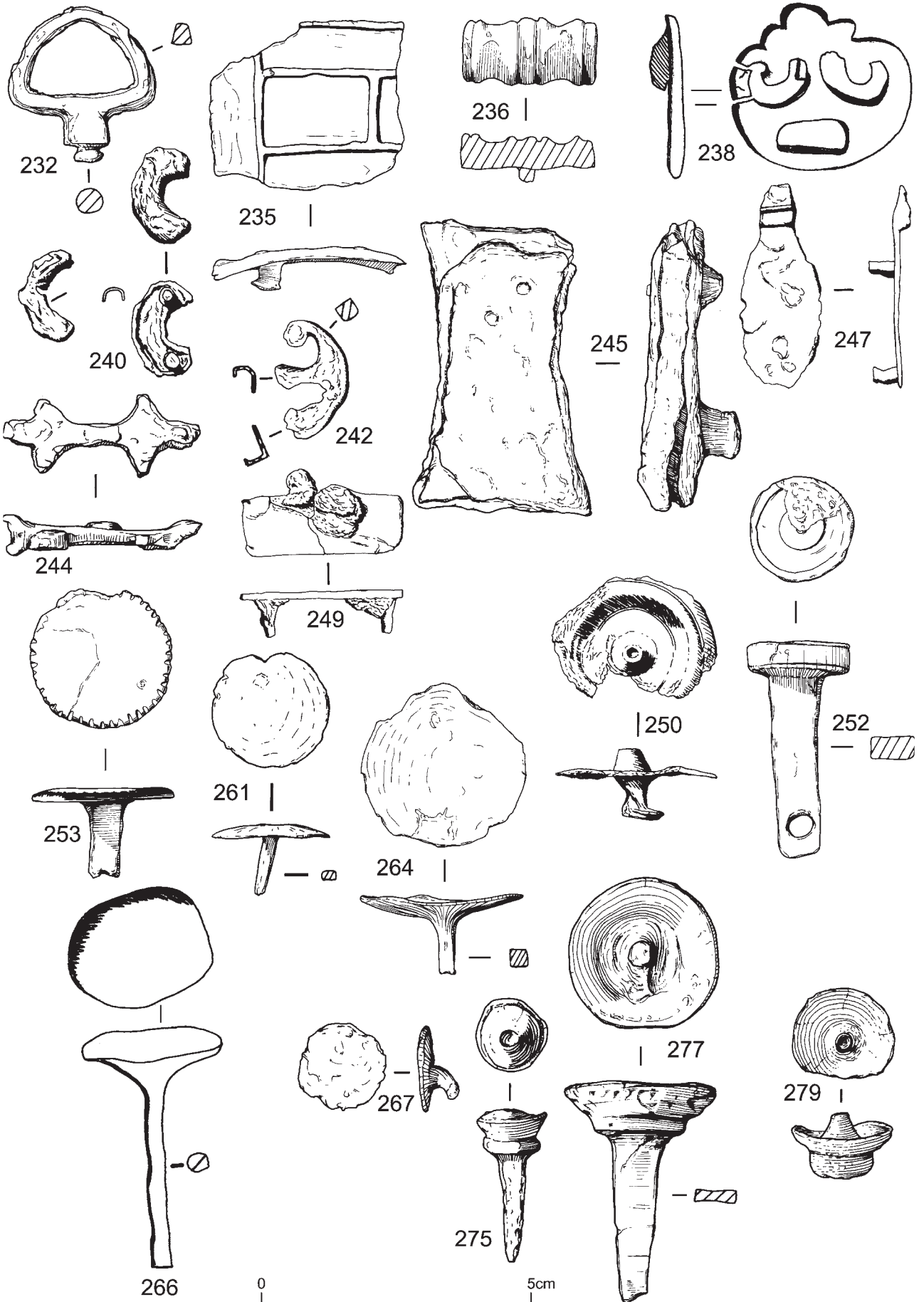

Fig re 2 Cop r alloy nos 2 Scale 1

259. Disc stud (D:25mm T:0.5mm). Building 2, *contubernium* 6, Period 3, M05:13, 424, WSCA431, 2001.1471
Disc stud covered in iron corrosion. X-rays show no sign of a shank or rivet.
260. Disc stud (D:21mm). Area of Gateway 3 and Road 6, modern, G16:19, 1073, WSCA416, 2001.1456
Disc stud covered with iron corrosion. The face has a marginal groove.
- DISC STUDS WITH SQUARE-SECTIONED SHANKS**
261. Disc stud (D:22mm). Area over Building 12, unstratified, L14:01, 1420, WSCA66, 2001.1106
262. Disc stud (D:29mm). Area over *intervallum* road (Road 5), unstratified, E04:01, 160, WSCA192, 2001.1232
263. Disc stud (D:34mm). Building L, demolition, Period 4, G04:03, 328, WSCA430, 2001.1470
264. Disc stud (D:30mm). Building 1, north wall foundation, Period 2, M04:04, 362, WSCA50, 2001.1090
265. Disc stud (D:17mm W of shank:7mm T:3mm). Gateway 1, robber trench, L03:43, 871, WSCA280, 2001.1320
Stud with a slightly domed disc head and a wide rectangular-sectioned shank.
266. Disc stud (D:24mm H:35mm). Building 13, stoking room, Period 4, M12:37, 1810, lost
Stud with a distorted disc head and a very long, oval-sectioned shank with a hammered end. There are traces of lead on the underside of the head.
267. Disc stud (D:16mm). Road 8, F08:10, 2258, WSCA117, 2001.1157
Disc-headed stud with a rectangular-sectioned shank moulded to a right angle.
268. Disc stud (D:14mm H:10mm T of shank:4mm). Building 1, phase 1 demolition, Period 3–4, M04:03, 214, WSCA197, 2001.1237
Disc stud with a thick, short, tapering shank.
- 269–75. **BELL-SHAPED STUDS WITH SQUARE-SECTIONED IRON SHANKS. TYPE 1 (ALLASON-JONES 1985B)**
269. (H:14mm D:27mm). Area over Alley 4, unstratified, F05:01, 125, WSCA219, 2001.1259
Traces of gilding survive on the face.
270. (H:12mm D:26mm). Road 8, F09:07, 2220, WSCA46, 2001.1086
271. (H:23.5mm, H:14mm). Area over Road 8, unstratified, F08:01, 2196, WSCA108, 2001.1148
Wide shallow skirt separated from the waist by a rib.
272. (D: 31mm). Road surface associated with the north-west shacks (B2), dereliction, J05:16, 839, WSCA278, 2001.1318
273. (H: 17mm). Building 2, *contubernium* 8 demolition material, Period 3 or later, L05:25, 860, WSCA54, 2001.1094
274. (H: 16mm). Area over Building 10 and *intervallum* road (Road 6), unstratified, F15:01, 1053, WSCA91, 2001.1131
275. (H:26mm). Area over *intervallum* road (Road 6), unstratified, L16:01, 1340, WSCA113, 2001.1153
- 276–8. **BELL-SHAPED STUDS, WITH SHANK CAST IN ONE WITH THE HEAD. TYPE 2 (ALLASON-JONES 1985B)**
276. (H:25mm D:10.5mm W of shank:8mm T:5mm). Area over Building 16 and *Via principalis*, unstratified, N08:01, 2474, WSCA228, 2001.1268
277. (H:41mm D:28mm). Unstratified, WSCA402, 2001.1442.
278. (H: 29mm). Area of Building 9, modern, E13:16, 1135, WSCA109, 2001.1149
279. Bell-shaped stud (H:12mm, D:18mm). Building 14, crosshall, Period 2?, K11:39, 2080, WSCA234, 2001.1274
Very small bell-shaped stud with a short curved skirt. A narrow dimpled cone projects from the face. The top is broken so it cannot be assigned to a type.
- 280–2. **DOMED STUDS FILLED WITH LEAD-TIN ALLOY**
280. (D:18mm H:7mm). Area over Building 14, unstratified, J11:01, 1937, WSCA164, 2001.1204
No trace of the iron shank survives.
281. (D:26mm H:10mm). Drain north of Building AZ, robber trench, L12:18, 1741, WSCA174, 2001.1214
A rectangular-sectioned iron shank.
282. (no measurements possible). M16:08, 1855, WSCA165, 2001.1205
283. Stud (D of head:15mm H:12mm D of rove:12mm). *Via principalis*, E07:35, 2415, WSCA231, 2001.1271
Hollow, domed stud with a tapering shank which ends in a disc rove.
284. Stud (D:10mm H:9mm). Area over Building 10 and *intervallum* road (Road 6), unstratified, F15:01, 1352, WSCA223, 2001.1263
Small, dome-headed stud with a circular-sectioned shank.
285. Stud (D:17mm). Gate 1, modern, L03:03, 678, WSCA415, 2001.1455
Hollow, domed stud head. No shank survives.
286. Stud (D:17mm). Building 2, *contubernium* 5, Period 3 or later, M05:11, 276, WSCA404, 2001.1444
Domed head of a stud. No shank survives.
287. Stud (D:6mm). *Via quintana* (Road 3), K14:15, 1588, WSCA473–7, 2001.1513–1517
Six tiny studs, each with a domed head and a disc rove held 1.5mm apart.
288. Stud (D:34mm). Chalet 9, post-Roman dereliction, F13:16, 1573, WSCA221, 2001.1261
Circular stud with convex face and an oval-sectioned shank.
289. Stud (D:19mm). Area over Building 11 and Alley 6, unstratified, L15:15, 1521, WSCA432, 2001.1472
Stud with a domed head and a disc rove with fragments of wood held between the two. Cf. Buch and Saalburg: Oldenstein 1976, Taf. 46, nos 486 and 487 respectively.
290. Stud (D:11mm). Building 14, crosshall, Period 1 or 2, H11:51, 2148, WSCA233, 2001.1273
Hollow, domed stud head. The circular-sectioned shank passes through the head.
291. Stud (H:15mm D:24mm). Building 14, drain in west wall, Period 1 or 2, H11:34, 2073, WSCA120, 2001.1160
Hollow, domed stud with a short, circular-sectioned shank and a disc rove.
292. Stud (L: 20mm). Area over Building 14 and Alley 3, unstratified, H04:01, 670, WSCA433, 2001.1473
Fragment of a stud with a rectangular-sectioned shank with a hole pierced through the rounded end.

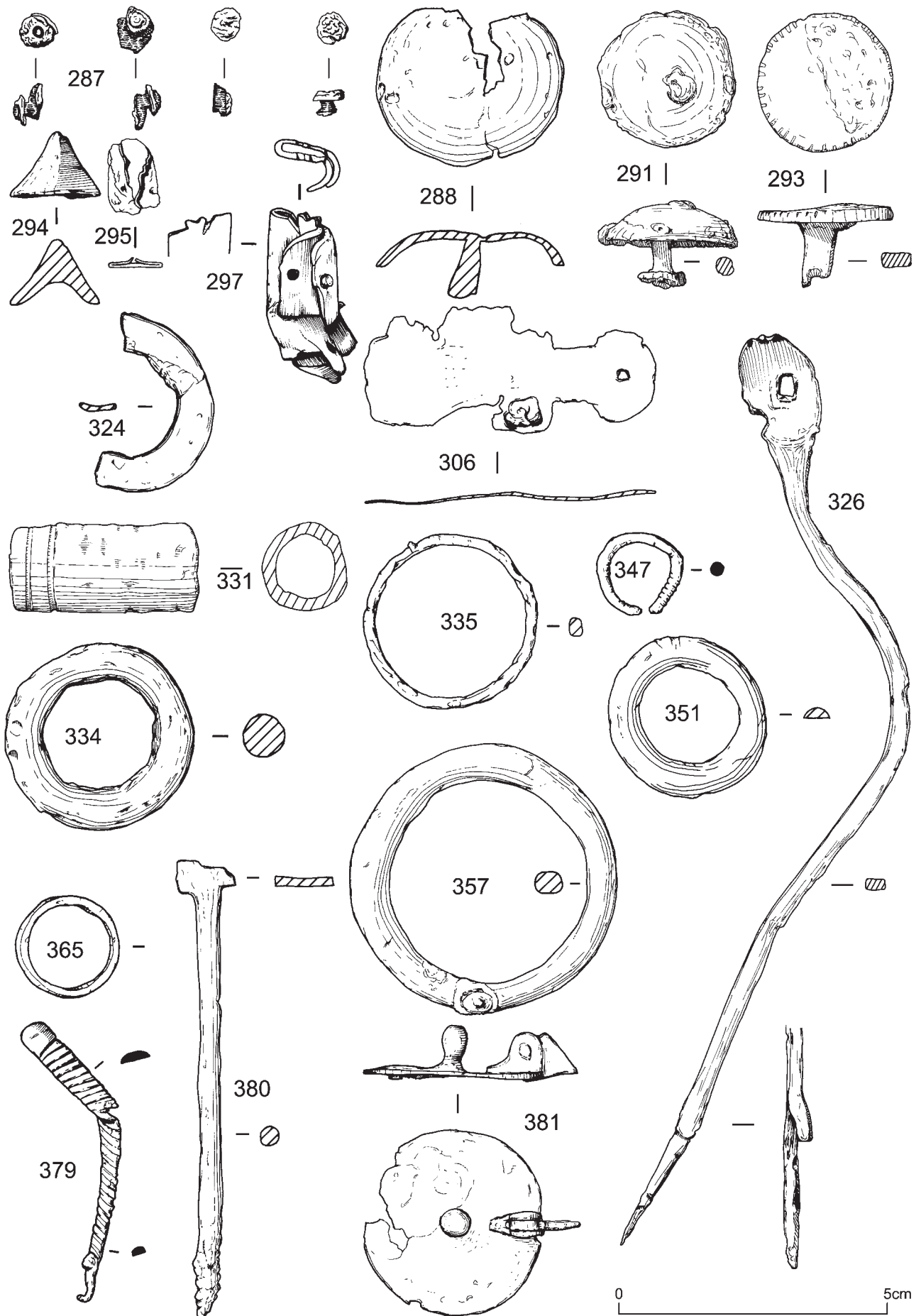

Fig re 8 Cop r alloy nos 8 Scale 1

293. Disc stud (D:25mm H:15mm). Building 3, contubernium 1/2 partition, Period 3–4, N07:06, 2589, WSCA116, 2001.1156
Disc stud with notched edge and rectangular-sectioned shank pierced by a circular hole at the rounded end. Cf. South Shields: Allason-Jones and Miket 1984, 3.885.
294. Boss (H:12mm D:17mm). Area over Building 8 and *Via quintana*, unstratified, D12:01, 1019, WSCA220, 2001.1260
Hollow conical boss.
295. Clip (L:14mm W:9mm B:4mm). Fill of *intervallum* drain (Road 7) outside Building 13, P12:08, 1780, WSCA5, 2001.1045
296. Strip (L:19mm W:7mm T:0.5mm). Area over Alley 1, ploughsoil, N05:03, 185, WSCA248, 2001.1288
Rectangular strip with decorative cut-outs along one edge and pierced by two large rivet holes.
297. Sheet (L:33mm W:15mm B:1mm). Building BA, Period 4, M13:10, WSCA21, 2001.1061
Folded rectangular sheet with decorative cut-outs along one edge and pierced by four rivet holes at the corners. One rivet survives.
298. Strip (L:26mm W:12mm). Tower 2, no details, E02:15, 905, WSCA387, 2001.1427
Strip of curved section pierced by two roughly, circular holes.
299. Strip (L:40mm W:5mm T:1.5mm). Rubble over Building 8 and nearby roads (B3), late third/early fourth century, E12:08, 1166, WSCA138, 2001.1178
Strip expanding to the broken ends. One end has split across a circular hole.
300. Strips (T:0.5mm). Building Row 20, Building Q, mid-third century, F11:36, 1195, WSCA434, 2001.1474
Several large strips of copper alloy, one with an edge folded over. Possible fragment of armour.
301. Strip (L:3mm T:1mm). Area over Building 13, unstratified, N12:01, 1671, WSCA435, 2001.1475
Fragments of a strip of slightly curled section with one straight edge.
302. Strip (L:31mm W:15mm T:2mm). Chalet 9, Building ET, Period 4, G13:14, 1563, WSCA191, 2001.1231
Rectangular strip with a central grooved rib. The surviving end is stepped and pierced by a circular hole.
303. Strip (L:19mm T:3mm). Alley 10/Building 17, road surface, late third/early fourth century, J05:20, 906, WSCA436, 2001.1476
Triangular strip with a thick projection at the apex. The base has broken across a circular hole.
304. Strip (L:20mm). Area over Building 13 and Alley 7, unstratified, L09:01, 2482, WSCA283, 2001.1323
Curled strip.
305. Plate (L:26mm W:10mm T:0.5mm). Drain from tank south of Building 14, late third/early fourth century, J12:34, 2168, WSCA310, 2001.1350
Rectangular plate pierced at the corners by small circular holes.
306. Plate (L:54mm W:24mm B:0.5mm). Building 13, courtyard, Period 3–4, N11:34, 1897, WSCA20, 2001.1060
Thin sheet with remains of small rivets, probably a fitting from a box.
307. Plate (T:1mm hole:7x7mm). Building 9, *contubernium* 6, Period 2, G13:24, 1586, WSCA406, 2001.1446
Fragment of an irregularly shaped plate with a square hole cut through.
308. Sheet (L:60mm W:29mm T:0.75mm). Chalet 12, Building AM2, mid/late third century, M14:11, 1853, lost
Incomplete, rectangular sheet with at least five circular rivet holes, one of which still contains a disc-headed rivet.
309. Sheet (Total L:65mm W:9mm T:0.5mm). Area of Building 14, no details, H11:26, 2000, WSCA265, 2001.1305
Several fragments of rectangular sheet.
310. Sheet (L:19mm W:22mm T:0.5mm). Building 14, pit, fourth century?, H09:34, 2149, WSCA305, 2001.1345
Triangular sheet with two corners cut off.
311. Sheet (L:25mm). Drain from tank south of Building 14, late third/early fourth century, J12:34, 2167, WSCA326, 2001.1366
Fragment of a rectangular sheet with a marginal repoussé rib. Pierced by at least one circular hole.
312. Sheet (L:20mm B:0.25mm). *Via principalis*, J08:19, 2151, WSCA328, 2001.1368
Several thin sheets pierced by random holes.
313. Sheet (L:14mm T:1mm). *Via praetoria*, B07:03, 1988, WSCA93, 2001.1133
Incomplete sheet, pierced by one small circular hole. Several oblique ribs run across the face.
314. Sheet (L:46mm T:0.25mm). Area over Road 9, unstratified, E09:01, 2351, WSCA337, 2001.1377
Fragment of a thin sheet folded in half. A repoussé rib runs close to one edge.
- 315–20. DISCS
315. (T:1mm). Area over Gate 1, unstratified, L03:01, 631, WSCA438, 2001.1478. Incomplete.
316. (D:28mm). Building 1, south wall foundation, Period 2, N05:25, 437, WSCA437, 2001.1477. Incomplete. From the iron corrosion on one face it appears that this formed the facing disc from an iron stud.
317. (D:34mm T:1mm holes:1mm). Area of Building 16, no details, K07:04, 2009, WSCA185, 2001.1225. Much corroded disc which has been lathe-turned – the turning lines and chuck hole are still clear. Both faces are polished although there is no trace of tinning. Three tiny holes are pierced at the very edge.
318. (D:19mm T:0.5mm). Area over Building 14, unstratified, J11:01, 1938, WSC167, lost
319. (D:33.5mm T:1mm). Area over Building 14, unstratified, J09:01, 1951, WSCA181, 2001.1221. Slightly curved in section.
320. (D:33mm T:1mm). Area over Building 16 and *Via praetoria*, unstratified, K07:01, 1996, WSCA254, 2001.1294. Incomplete.
- 321–4. WASHERS
321. (D:15mm T:1mm). Area over *intervallum* road (Road 4), unstratified, P04:01, 15, WSCA414, 2001.1454.
322. (D:35mm W:8.5mm). Unstratified, 2620, WSCA188, 2001.1228. Curved.
323. (D:25mm W:7mm). Building 14, pit, fourth century?, H09:34, 2149, WSCA307, 2001.1348. Curved.
324. (D:28mm T:0.75mm). Building Row 20, Building

- AX, mid-third century, H11:57, 2445, WSCA338, 2001.1378. Incomplete.
325. Hook (L:14mm). Area over Building 11 and Alley 6, unstratified, L15:01, 1280, WSCA381, 2001.1421
Fragment of a hook of oval section.
326. Rod (L:172mm W:14mm hole:4mm). Rubble over Building 8 (B3), late third/early fourth century, D11:02, 1061, WSCA70, 2001.1110
Rectangular sectioned shank ending in an oval plate which is pierced by a square hole.
327. Shank (L:18mm W:12mm). Unstratified, 2166, WSCA243, 2001.1283
Incomplete, rectangular-sectioned shank ending in an oval plate which is pierced by a rough circular hole.
328. Rod (L:18mm W:6mm T:2.5mm). Building 11, *contubernium* 3/4, Period 2, L15:19, 1617, WSCA271, 2001.1311
Rectangular-sectioned rod which has broken across a transverse hole. The other end splays out curling around a central knob.
329. Rod (L:33mm). Rubble over east rampart and *intervallum* road, Q07:07, 2572, WSCA361, 2001.1401
Rectangular-sectioned rod thickening from a point to a hooked end.
330. Rod (Total W:20mm W of rod:3.5mm T:3mm). Area over Buildings H and Z, unstratified, L13:01, 1882, WSCA167, 2001.1207
Oval-sectioned rod bent to form a ring with the ends overlapped at an angle.
331. Tube (L:34mm D:17mm T:3mm). Area over Building 1, unstratified, P05:02, 45, WSCA49, 2001.1089
Tube with thick sides decorated with two incised bands.
332. Tube (L:19mm W:9mm). Area over Building 10 and Alley 6, unstratified, M15:01,1607, WSCA452, 2001.1492
Tube of lentoid section with one end nipped close.
- 9, unstratified, H15:01, 1266, WSCA462, 2001.1502.
343. (D:20mm). Building 4, make-up layer, Period 2, G04:07, 485, WSCA455, 2001.1495.
344. (D:19mm W:2mm T:3mm). Area over Building 14 and *Via quintana*, unstratified, K12:01, 1926, WSCA353, 2001.1393. Incomplete.
345. (D:18mm W:2mm T:3mm). Area over *Via principalis*, unstratified, G08:01, 2066, WSCA255, 2001.1295. Incomplete.
346. (D:17mm W:1.5mm T:2mm). *Via principalis*, L08:57, 2551, WSCA341, 2001.1381. Incomplete.
347. (D:16mm T:2mm). Area over Building 12, unstratified, L14:01, 1531, WSCA371, 2001.1411.
348. (L: 23mm T: 4mm). Building 4, officer's quarters, Period 2, F03:22, 901, WSCA478, 2001.1518.
349. (T:3mm). Area of Alley 5, no details, H14:21, 1271, WSCA463, 2001.1503. Incomplete.

Semi-circular section

350. (D:28mm), Building 18, *contubernium* 1, Period 3–4, F05:15, 432, WSCA130, 2001.1170.
351. (D:28mm W:6mm T:2mm). Area over Buildings H and Z, unstratified, L13:01, 1750, WSCA132, 2001.1172.
Worn in one section.
352. (D:27mm W:3mm T:4.5mm). Building 1, floor, Period 2, M05:28, 922, WSCA456, 2001.1496.
353. (D:21mm W:3mm T:4mm). Gate 2, post-Roman, D08:17, 2411, WSCA356, 2001.1396. Penannular.
354. (D:20mm W:2.5mm T:3mm). Area over Building 13, unstratified, N12:01, 1653, WSCA467, 2001.1507.
355. (D:18.5mm W:2mm T:3.5mm). Area over Building 14, unstratified, J11:01, 1934, WSCA168, 2001.1208. Very corroded.
356. (D:11mm T:5mm). Area over Building 11, unstratified, J15:01, 1272, WSCA389, 2001.1429. Penannular, with two grooves.

Square or rectangular section

- 333–76. RINGS
- Circular or oval section**
333. (D:40mm T:3mm). Area over *intervallum* road (Road 6), unstratified, L16:01, 1259, WSCA370, 2001.1410. Incomplete.
334. (D:34mm W:7mm T:5.5mm). Building 3, abandonment/post-Roman, N07:08, 2552, WSCA343, 2001.1383
335. (D:34mm T:4mm). Road surface associated with the north-west shacks (B2), late third/early fourth century, J04:05, 807, WSCA129, 2001.1169.
336. (D:30mm W:3.5mm T:2.5mm). Area over *intervallum* road (Road 6), unstratified, L16:01, 1257, WSCA392, 2001.1432. Hexagonal section, worn on one side.
337. (D:27mm W:5mm T:5mm). Area over Building 13, unstratified, N12:01, 1665, WSCA299, 2001.1339. Incomplete.
338. (D:24mm W:3mm T:2mm). Area over Building 2, ploughsoil, L05:03, 680, WSCA457, 2001.1497.
339. (D:23mm T:3mm). Levelling east of Building Row 20, Building R, late third/fourth century, G12:19, 1220, WSCA461, 2001.1501.
340. (D:21.5mm W:1.25mm T:4mm). *Via principalis*, M08:09, 2501, WSCA284, 2001.1324
341. (D:21mm T:4mm). Area over Road 8, unstratified, F08:01, 2455, WSCA362, 2001.1402. Incomplete.
342. (D:20mm T:2.5mm). Area over Building 10 and Road
357. (D:48mm W:5mm T:4.5mm). Area over Building 12, unstratified, K14:03, 1384, WSCA465, 2001.1505. Repair on one side.
358. (D:27mm W:4mm). Building 11, *contubernium* 4, Period 2, L15:33, 1540, WSCA375, 2001.1415.
359. (D:23mm W:2.5mm). Area over Building 11, unstratified, K15:01, 1372, WSCA464, 2001.1504.
360. (D:22mm W:2.5mm T:2mm). Building 18, *contubernium* 1, Period 3–4, F05:15, 431, WSCA458, 2001.1498.
361. (D:21mm W:3.5mm T:3mm). Building Row 20, Building R, late third/early fourth century, G11:25, 2418, WSCA354, 2001.1394.
362. (D:21mm W:2.5mm T:3mm). Area over Building 11, unstratified, K15:02, 1295, WSCA399, 2001.1439.
363. (D:20mm W:3mm). Area of Alley 5, no details, G14:07, 1598, WSCA466, 2001.1506.
364. (D:20mm W:2.5mm T:2mm). Area over Building 11, unstratified, J15:01, 1264, WSCA372, 2001.1412.
365. (D:19mm W:1.5mm T:2.5mm). Gate 2 floor, Period 3–4?, D08:40, 2380, WSCA342, 2001.1382.
366. (D:19mm T:3mm W:3mm). Road 8, F08:10, 2310, WSCA237, 2001.1277.
367. (D:18mm T:2mm). Area over *intervallum* road (Road 6), unstratified, L16:01, 1258, WSCA469, 2001.1509. Incomplete.

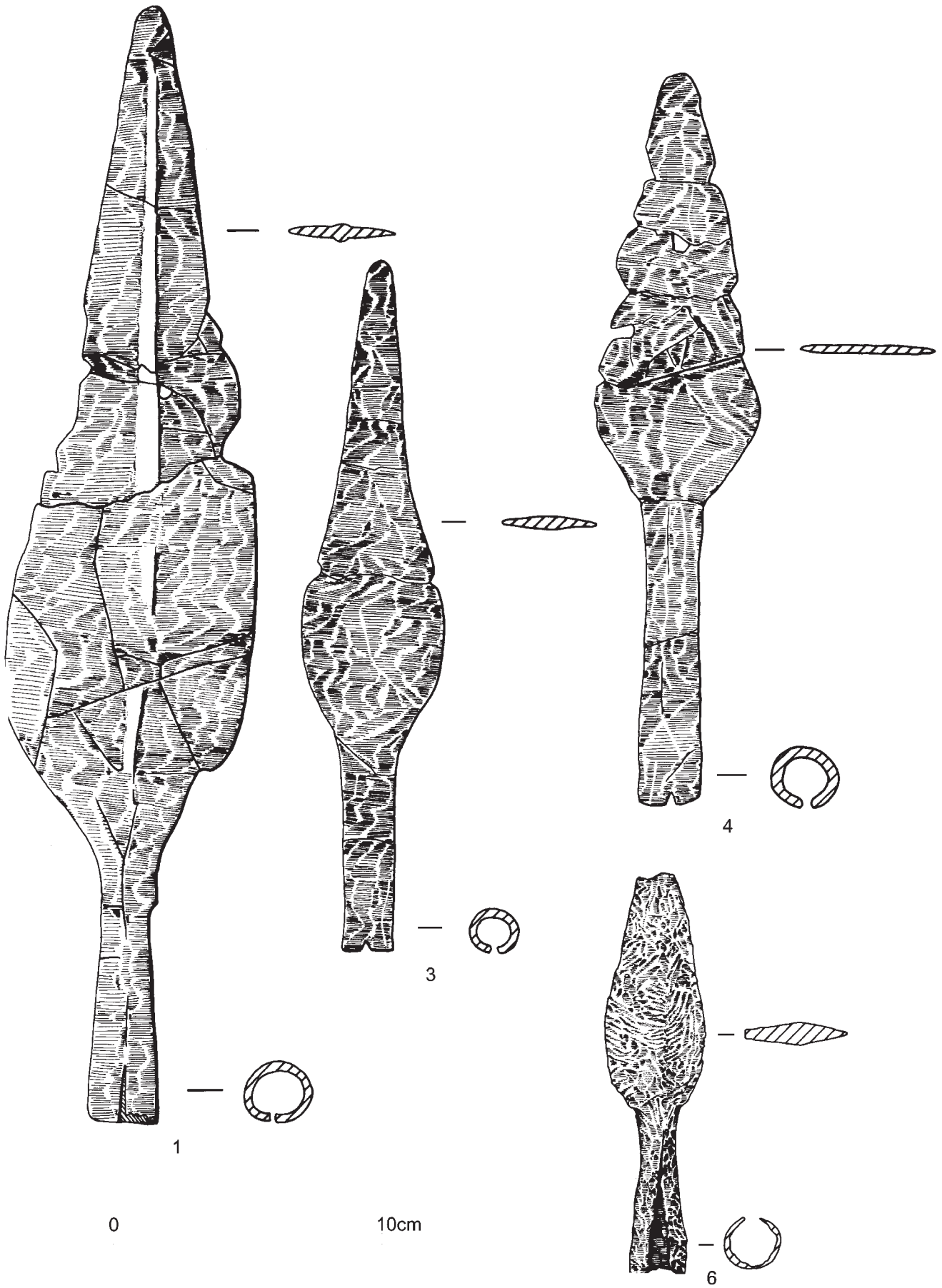

Fig re 2 1 Iron nos 1 6 Scale 1

368. (W:3mm T:2mm). Building 2, *contubernium* 5, Period 3 or later, M05:11, 295, WSCA454, 2001.1494. Incomplete.

Diamond section

369. (D:26mm W:5mm T:3mm). *Via principalis*, L08:57, 2547, WSCA339, 2001.1379.

370. (D:23mm W:4mm T:2.5mm). Area over Building 8 and *Via quintana*, unstratified, D12:01, 1033, WSCA459, 2001.1499.

371. (D:23mm). Area south of Building 5, Roman/post-Roman, H05:13, 591, WSCA472, 2001.1512.

Unclear

372. (D:23mm). Building 12, *contubernium* 5, Period 3?, M14:42, WSCA22.

373. (D:20mm T:3mm). Rampart building north of *Porta quintana*, Period 2–3, C11:04, 1093, WSCA460, 2001.1500. Incomplete.

374. (D:20mm). Area over Road 2, unstratified, K04:02, WSCA373. Thin.

375. (D:16mm T:2.25mm). Building AW robber trench, H11:71, 2612, WSCA350, 2001.1390.

376. (D:8mm). Area over Building 1, ploughsoil, Q05:02, 116, WSCA453, 2001.1493. Incomplete.

377. Block (W:30mm T:5mm). Area over Building AO, unstratified, K08:01, 2031, WSCA333, 2001.1373
Part of a hexagonal block thickening to the edges.

378. Shank (L:36mm D of head:14.5mm). Road 8, F08:10, 2263, WSCA187, 2001.1227

Short, circular shank with a waisted rod ending in a disc. The casting lines have not been filed down. The piece may have been rejected on being taken from the mould because of a gash across the top of the disc.

379. Bracelet (L:52mm W:5mm B:2mm). West *intervallum* road, D12:10, 1046, WSCA262, 2001.1302.

Terminal of bracelet with D-shaped cross section and incised decoration on the upper surface (AC).

380. Stylus (L:89mm D:4mm). Area over Building 5 and Alley 4, unstratified, H05:01, 1246, WSCA193, 2001.1233
Stylus with a circular-section shank and incomplete eraser, with traces of groove decoration. The pointed end if corroded, but has traces of groove decoration (AC).

381. Lid (D:33mm Total H:8.5mm). Area over *Via principalis*, unstratified, L08:01, 1984, WSCA176, 2001.1216

Plain, circular disc with a hinge projecting from the back at one edge. An iron hinge pin holds a fragment of the vessel. From the centre of the lid projects a knob with a globular end.

Iron (Figs 25.17–20)

1. Spearhead (L:410mm, D of socket:26mm Max. W of blade:93mm, L of entry:249mm). Building 1, officer's quarters, Period 3, N05:05, 196, WSFE19, 2001.1949
Very large spearhead with a leaf-shaped blade, low shoulders and straight edges. A central rib runs down both faces. The split socket is very short in proportion to the blade, and is also very narrow, containing fragments of mineral-replaced wood. Scott 1980, Type 5, 337.

2. Spearhead (L:155mm W:60mm B:10mm). Area over Alley 5, unstratified, G14:03, WSFE143, 2001.2040

Incomplete fragment of spearhead blade with a central rib running down each face. (AC)

3. Spearhead (L:270mm, D of socket:24mm Max. W of blade:63mm, L of entry:132mm). Road/surface (B1), N05:16, 346, WSFE10, 2001.1940

Leaf-shaped spearhead with low shoulders and straight edges. The faces are flat and the socket split. Scott 1980, Type 5, 337.

4. Spearhead (L:255mm, D of socket:18mm, L of entry:140mm). Building 5, Period 1?, G04:20, 534, WSFE12, 2001.1942

Leaf-shaped spearhead with an elongated point, flat faces and a split socket. Scott 1980, Type 9, 339: the largest group of these weapons comes from Chesters and Scott has suggested that, as the blades have no cutting edge, they were used for parade or practice.

5. Spearhead (W(blade):55mm D(socket):23mm). Area over Building 5 and Alley 4, unstratified, H05:01, 311, WSFE337, 2001.2215

Very fragmentary spearhead.

6. Spearhead (L:148mm, D of socket: 20mm). Building 2, *contubernium* 5, Period 3 or later, M05:11, 300 (duplicate), WSFE47, 2001.1972

Leaf-shaped spearhead with the tip missing. The socket is split.

7. Spearhead (L:130mm, Max. W of blade: 62mm). Building 11, *contubernium* 3/4, Period 2, L15:18, 1602, WSFE326, 2001.2206

Leaf-shaped spearhead missing top of the blade, with angular low shoulders. Missing much of split socket. Scott 1980, Type 4, 335.

8. Spearhead (L:145mm, D of socket:12mm Max. W of blade:38mm). Area over Building 12, unstratified, L14:01, 1557, WSFE5, 2001.1936

Short, leaf-shaped spearhead lacking the tip. The faces are flat and the socket split.

9. Spearhead (L:138mm, Max. W of blade:21mm D of socket:18mm). Building 3, east wall, Q07:04, 2449, WSFE2, 2001.1933

Incomplete spearhead with a long narrow blade with no obvious shoulders. The socket is split and contains mineral-replaced wood. The midline of the blade is thick but there is no obvious midrib. Brailsford 1962, Group B; Scott 1980, Type 6, 337; Manning 1985, Group III, 166–7.

10. Spearhead (L(surviving):16mm and 70mm D(socket):15mm). Building 9, *contubernium* 2, Period 2, E13:41, FE357, 2001.2233

Two non-joining fragments of incomplete leaf-shaped spearhead missing tip. Split socket.

11. Spearhead (L(surviving):100mm: D(socket):15mm W:4mm). Chalet 9, Building W, late third/early fourth century, D13:34, WSFE336, 2001.2214

Incomplete leaf-shaped spearhead.

12. Spearhead (L:133mm B:3mm). Building 8, room 8, Period 2, E10:76, 2407, WSFE146, 2001.2043

Incomplete leaf-shaped spearhead missing tip and most of socket.

13. Conical ferrule (L:122mm, Max.D:25mm). Building AO, south wall robber trench, F08:19, 2391, WSFE221, 2001.2115

Long conical ferrule. See Manning 1985, 141 for a discussion of function.

14. Ferrule (D(max):20mm). Road/surface (B1), N05:16, 322, WSFE253, 2001. 2147

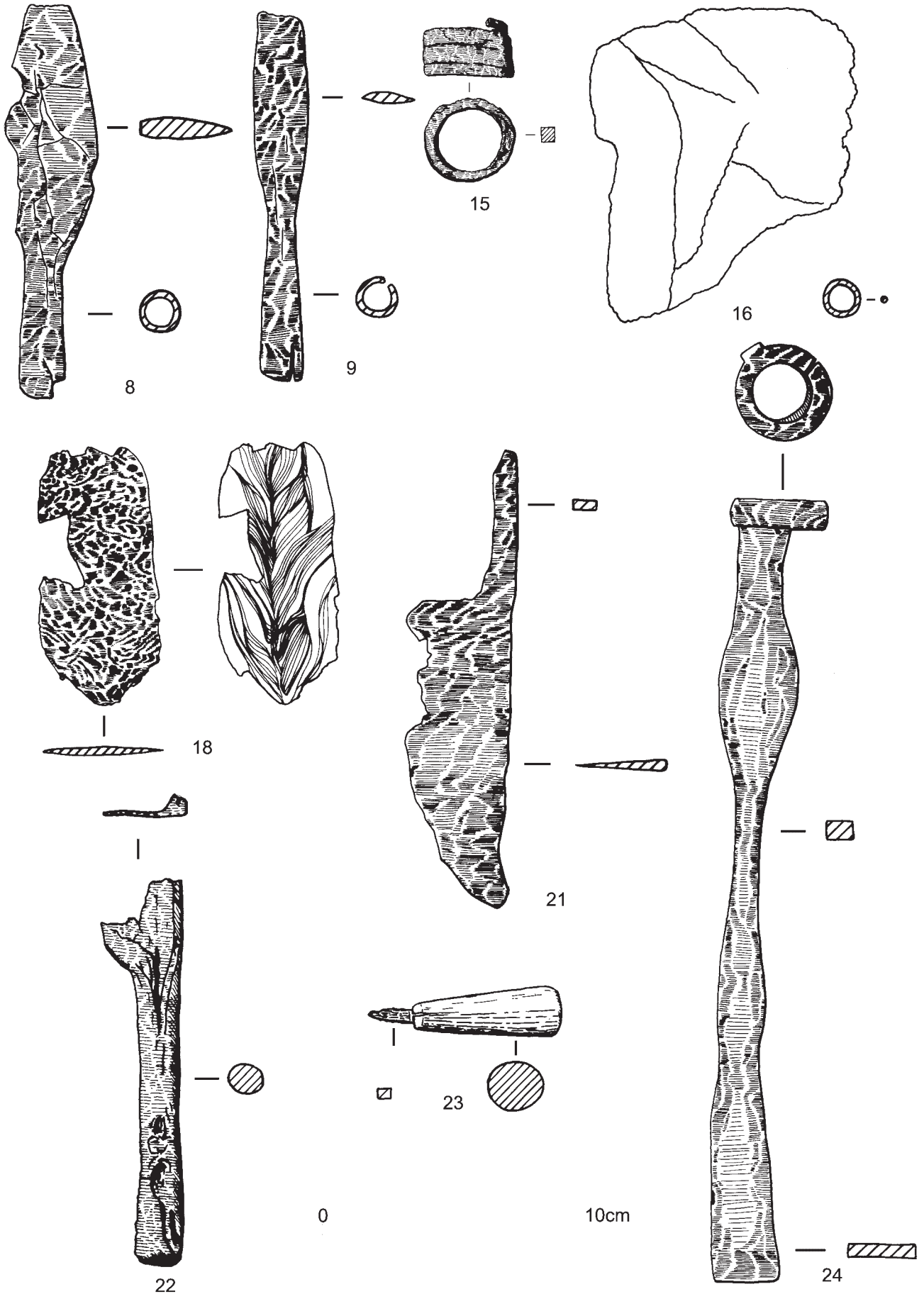

Fig re 28 Iron nos 2 Scale 2

- Fragmentary.
15. Spiral ferrule (D(int):22mm B(rod):4mm L:20mm). Building 1, make-up, Period 2, L05:46, WSFE31, 2001.1961
Rectangular-sectioned rod, twisted round three times to form a ferrule for a spear or tool. Iron Age or Roman. (AC)
 16. Ring-mail (L:105mm W:105mm B:30mm Loop D:7mm B:1.5mm). Building 1, *contubernium* 1–4, Period 2, N05:32, 565, WSFE333, 2001.2211
Fragment of a ring-mail shirt, folded over at one end. This is a large piece of ring-mail, which is usually found in smaller fragments. (AC)
 17. Ring-mail (D:7mm B:1.5mm). Road associated with north-west shacks (B2), late third/early fourth century, J04:05, 826, WSFE155, 2001.2052
Single loop.
 18. Pattern-welded dagger (L:96mm W:46mm B:4mm). Chalet 12, Building AL1, Period 4, M14:39, WSFE358, 2001.2234
Small fragment of a pattern-welded blade, with a single line of herring-bone pattern. Third-century. Cf. Künzing: Bishop and Coulston 2006, 164. (AC)
 19. Knife (L:163mm, W:33mm). Building 7, no details, G08:11, 2204, WSFE83, 2001.2002
Incomplete knife with a straight back and a long rectangular-sectioned tang set at the midpoint. The edge also appears to be straight. Manning 1985, Type 15, 115–16.
 20. Knife (L:77mm W:24mm B:5mm). Area over Building 11, unstratified, K15:10, WSFE84, 2001.2003
Incomplete knife with a straight back and a rectangular-sectioned tang set at the mid-point.
 21. Knife (L:170mm W:40mm B:4mm). Alley 8, H09:16, WSFE20, 2001.1950
Knife with large triangular blade, curving up slightly at the tip. Rectangular cross-sectioned tang.
 22. Handle (L:145mm D:12mm W(blade):30mm). Building 18, *contubernium* 1, floor, Period 3–4, F05:39, 492, WSFE334, 2001.2212
Roughly circular section handle, with terminal created by folding over the end expanding into blade. There is a solid ridge on the outer, vertical edge, but the expanded side is only approximately 1.5mm thick. (AC)
 23. Awl (L(overall):72mm L(handle): 54mm D:(max, handle):18mm D:5mm). Building 16, Period 3, L07:10, 2034, WSFE378, 2005.3701
Polished circular-sectioned handle of red deer antler which tapers towards a short circular-sectioned iron rod. The rod tapers to a point, apparently intentionally, and can be identified as an awl. See Manning 1985, 39–41.
 24. Paring chisel (L:267mm, W of blade:25mm, D of collar:38mm). Building 4, officer's quarters, Period 2, F04:25, 559, WSFE15, 2001.1945
Paring chisel of rectangular section tapering slightly to the blade which is chamfered on both faces. The other end bulges before narrowing to fit into a circular iron collar. Possibly there has been a wooden handle with the collar set at the top, slipping down as the handle rotted. Manning 1985, Type 3, fig. 4.
 25. Chisel (L:65mm, W of blade:36mm). Chalet 9, post-Roman, G14:13, 1511, WSFE76, 2001.1996
Fragment of a former chisel with a flat blade and a socketed shank set high over the blade. Manning 1985, fig. 4, no. 4. (AC)
 26. Chisel (L:91mm D:10mm). Alley 7, K12:23, WSFE28, 2001.1958
Circular-sectioned shank, tapering to a point at one end and to a flat blade at the other. Cf. Manning 1985, pl. 11, no. B43. (AC)
 27. Adze-hammer (L:220mm, W of blade:71mm, Socket:22 × 19mm). Chalet 12, Building AG, Period 4, K14:26, 1605, WSFE14, 2001.1944
Complete adze-hammer with a splayed cutting blade set at an angle to the expanded socket and with a very short counter balance. The junction of the blade and oval socket is sharply undercut. The collar is short. See Manning 1985, 17–18 for discussion and parallels.
 28. Lift-key (L:174mm, W across head:37mm). Building 14, courtyard, late third/early fourth century, J09:05, 2004, WSFE27, 2001.1957
T-shaped lift-key with a rectangular-sectioned shank which ends in a tightly curled loop. The two teeth taper away from the head. Cf. Manning 1985, fig. 25, no. 1.
 29. Lift-key (L:overall of all pieces 114mm W:40mm B:7mm). Building 5, officer's quarters, Period 2, E04:25, WSFE368, 2001.2244
Incomplete.
 30. Lift-key (L:86mm W:11mm B:9mm head W:44mm). Chalet 9, Building W, late third/early fourth century, D13:34, WSFE377
L-shaped lift-key with a rectangular-sectioned shank which ends in a curled loop. The head has three teeth. Cf. Manning 1985, fig. 25, no. 3. (AC)
 31. Slide-key (L:62mm W: 30mm B:(shank):4mm (foot)17mm). Area of Building 4, no details, G04:25, 387, WSFE263, 2001.2155
L-shaped slide-key in poor condition, probably with a straight bit (Manning 1985, Type 2). Drawn from X-ray. (AC)
 32. Slide-key (L77mm W:30mm). Building 1, verandah, Period 3, N05:18, 553, WSFE375, 2001.2251
Identified from X-ray; now disintegrated. (AC)
 33. Lock bolt (L:56mm W:13mm T:6mm). Area over Building 11, unstratified, J15:05, 1496, lost
Rectangular-sectioned tumbler-lock bolt for use with a slide key. The end is countersunk and the body of bolt has four rectangular shaft holes. Such bolts are unusual in iron but common in copper alloy; see above, copper alloy nos 96–7.
 34. Padlock (D of ring:84mm, presumed width of box:50mm). Building 11, *contubernium* 3/4, Period 2, L15:19, 1604, WSFE11, 2001.1941
Padlock consisting of an iron ring and box-lock. It is very corroded and incomplete but X-rays suggest that the box holds three or four levers. Cf. Saalburg: Jacobi 1897, 477, Fig. 76, no. 21; also Herrmann 1969, Abb. 9, no. 2.
 35. Shackle (D(internal):50mm W:6mm B:6mm). Building 16, floor, Period 1–2, L07:13, WSFE330, 2001.2208
One arm of a shackle with hinge loop at one end, and an incomplete oval loop at the other. Beyond the loop, the arm ends in a point. The size suggests a wrist shackle. See Manning 1985, figs 22–3. (AC)

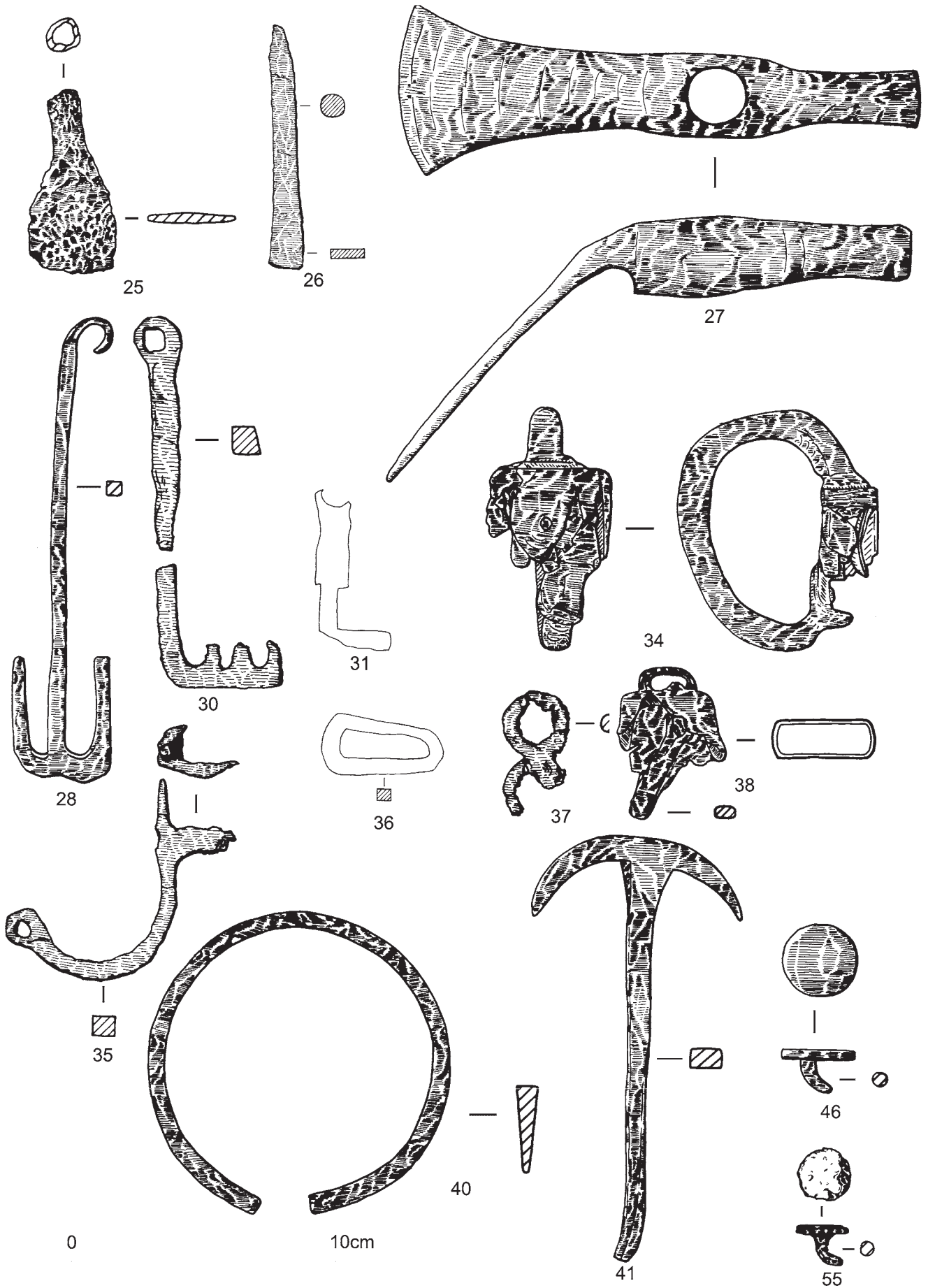

Fig re 1 9 Iron nos 1 Scale 1

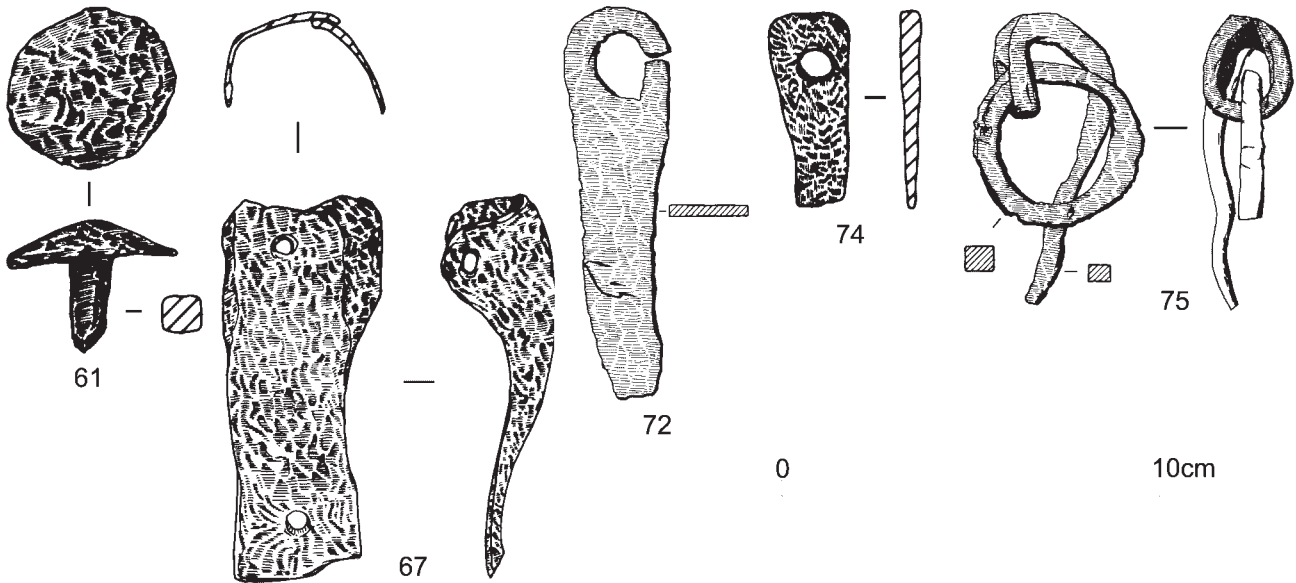

Fig re 0 Iron nos 7 Scale 1

36. Chain link (L:45mm W:20mm B:4mm). Building 9, *contubernium* 1, Period 2, E13:42, WSFE362, 2001.2238 Slightly tapering oval chain link. Square-sectioned. Drawn from X-ray. (AC)
37. Chain link (L:45mm D:25mm B:5mm). Building 11, *contubernium* 4, Period 1, L15:29, WSFE363, 2001.2239 Two incomplete figure-of-eight chain links. Only one link illustrated.
38. Bell (Surviving L of bell:56mm L of clapper:47mm, Max.W:42mm, Max.T:16mm). Building 5, Period 1?, G04:20, WSFE6, 2001.1937
Incomplete bell of rounded rectangular section with a rectangular handle. Inside, a double-sided clapper, shaped like a double-spiked loop, hangs from a ring.
39. Martingale? (L:34mm). Road 5, D07:28, 2325, WSFE3, 2001.1934
Curved strip of iron with a narrower thinner strip projecting into the inner edge of the curve. Part of a martingale? Cf. copper alloy example from South Shields: Allason-Jones and Miket 1984, no. 3.665-6.
40. Hub linings (D:111mm H:38mm T:3-6mm). Area of Building 4, no details, G04:25, 389, WSFE7, 2001.1938
Two hub linings shaped like collars, one annular, the other penannular. The bands thicken towards one edge. See Manning 1985, 72, H35-8.
41. Clamp (L:160mm W across head:80mm T across head:21mm). Building 1, demolition material, Period 2, N05:04, 198, WSFE8, 2001.1939
T-shaped clamp. The head is curved back from the rectangular-sectioned tapering shank. See Manning 1985, 132.
42. Clamp (L:55mm W:45mm). Building 9, *contubernium* 4, Period 2, F13:44, WSFE22, 2001.1952
Incomplete T-shaped clamp with slightly curved arms.
43. (D:28mm). Building 1, *contubernium* 1-4, Period 2, N05:32, 561, WSFE351, 2001.2227
44. (D:28mm). Area over Building 12, unstratified, K14:01, 1562, WSFE352, 2001.2228
45. (D:27mm). Building 9, *contubernium* 3, Period 2, F13:50, 1581, WSFE17, 2001.1947
46. (D:27mm). Building 9, *contubernium* 3, Period 2, F13:50, 1582, WSFE16, 2001.1946
47. (D:25mm). Alley 1, upper layer, M05:12, 355, WSFE353, 2001.2229
48. (D:25mm). Alley 1, upper layer, M05:12, 358, WSCA163, 2001.1203
49. (D:25mm). Area of Alley 5 and Road 9, unstratified, H14:30, 1428, WSCA492, 2001.1532
50. (D:25mm). Chalet 9, Building ET, Period 4, G13:14, 1565, WSFE347, 2001.2223
51. (D:c.25mm). Road associated with north-west shacks (B2), dereliction, E05:04, 251, WSCA491, 2001.1531
52. (D:24mm). Alley 5, post-Roman debris, F14:13, 1120, WSFE344, 2001.2221
53. (D:23mm). Building 9, *contubernium* 1, Period 2, E13:24, 1140, WSCA488, 2001.1528
54. (D:22mm). Building 1, *contubernium* 2-4 cleaning, Period 2?, N04:20, 509, WSFE350, 2001.2226
55. (D:21mm). Building 1, demolition/make-up, Period 3, P05:08, 288, WSFE18, 2001.1948
56. (D:20mm). Area over Building 10 and Alley 5, unstratified, E14:01, 1367, WSFE354, 2001.2230
- 57-60. DISC HEADED STUD WITHOUT COPPER ALLOY SHEET
57. (D:22mm). Building 1, *contubernium* 5, Period 2, M04:10, 521, WSFE128, 2001.2032
58. (D:20mm). Area over Buildings 4 and 5 and Alley 3, unstratified, G04:21, 786, WSFE154, 2001.2051
59. (D:23mm). Building 1, sub-phase 1 demolition material, Period 2, L04:25, 930, WSFE308, 2001.2191
60. (D:23mm). Building 1, floor, Period 2, M04:09, 525, WSFE343, 2001.2220. With 28mm long incomplete shank, bent into L-shape.
61. Stud (D:45mm, H:33mm). Area over West rampart,

- unstratified, C09:01, 2224, WSFE332, 2001.2210
Large stud with a convex disc head and a short tapering shank.
62. Stud (D:39mm). Tower 7 demolition material, N04:18, WSFE66, 2001.1987
Large stud with a convex disc head. No surviving shank. (AC)
63. Stud (D of head:17mm H:14mm). Area over Building 13, unstratified, N12:01, 1650, WSFE324, 2001.2204
Stud with a slightly convex disc-head. Only part of the circular sectioned shank remains.
64. Stud (D:14mm H:11mm). Building 14, post hole, fourth century?, H09:34, WSFE373, 2001.2249
Disc-headed stud with a convex face. The shank is square in section.
65. Plate (L:51mm). Building 16, floor, Period 3, L07:10, 2036, WSFE64, 2001.1985
Fragment of iron plate pierced by two disc-headed rivets.
66. Strip (L:113mm. Max. W: 32mm). Building 1, *contubernium* 1–4, Period 2, P05:17, 533, WSFE13, 2001.1943
Large blade or hinge section of triangular shape. No obvious cutting edge or rivet holes.
67. Strip (L:110mm, W of shank:36mm). Building 16, Period 3, K07:18, 2046, WSFE81, 2001.2000
Wide strip expanding to a T-shape with rounded ends to the arms, both of which are pierced by a square hole (4 × 4 mm). A circular hole is pierced in the centre of the strip at the top and bottom (D:5mm). The arms curve inwards to form a sheath. Manning (1976, nos 198–9) in his discussion of similar items says, 'bindings of this type were made for a particular purpose and with the loss of the wood to which they were normally attached, their function must remain uncertain'.
68. Double spiked loop (L:86mm W: 41mm). Building 2, *contubernium* 5, Period 3 or later, M05:11, 300, WSFE21, 2001.1951
Large double spiked loop.
69. Double spiked loop (L:53mm W:22mm B:8mm). Road associated with north-west shacks (B2), Period 3–4, H04:19, WSFE366, 2001.2242
Small example.
70. Curved bar (L:103mm W(max):30mm T(max):17mm). Building 8, room 6, Period 2, F10:15, 2404, WSFE219, 2001.2113
Rectangular-sectioned bar tapering in width and section to a hooked end.
71. Sheet (L:115mm, Max.W:51mm). Chalet 9, post-Roman dereliction, G13:03, 1510, WSFE325, 2001.2205
Sheet with one edge curled over.
72. Escutcheon (L:102mm W:28mm B:7mm). Area over Building 12, unstratified, L14:01, WSFE24, 2001.1954
Incomplete bar expanding towards a D-shaped loop terminal. Possibly escutcheon from a bucket.
73. Escutcheon (L:67mm W:25mm B:5mm). Road associated with north-west shacks (B2), Period 3–4, H04:19, WSFE365, 2001.2241
Incomplete example, pierced by 7mm diameter hole below remains of loop terminal.
74. Strip (L:60mm W(max):21mm T:7mm). Building 3, abandonment/post-Roman dereliction, P07:07, 2624, WSFE216, 2001.2110

Rectangular-sectioned strip snapped off at one end and expanding to the other which is pierced by a large circular hole (D:8mm). Possibly part of a box-hinge (cf. Schönberger 1967, Abb. 7, nos 1–7).

75. Loop (L:78mm B:6mm D(loop):45mm B:5mm). Building Row 20, Building AX(N) south wall, G11:38, WSFE43
Loop with square cross-section hanging from spike with circular attachment loop. (AC)

No.	Site details
32	Building 1, demolition material, Period 2, N05:04, 81, WSFE292, 2001.2178
12	Chalet 12, Building AL2, Period 4, M14:04, 377, WSFE99, 2001.2013
17	Building 2, <i>contubernium</i> 8, Period 3 or later, L05:44, 913, WSFE283, 2001.2172
9	Area over Buildings 1, 2 and Alley 1, ploughsoil, N05:03, 129, WSFE4, 2001.1935
6	Area over Building 2, ploughsoil, L05:03, 610, WSFE130, 2001.2034
4	Clay puddling pit, Period 3 demolition, N05:14, 249, WSFE202, 2001.2096

76. Hobnails (D of nail heads:6mm). Area over Building 2 and Alley 1, unstratified, M05:01, 1490, WSFE82, 2001.2386
Fragment of leather boot sole with three rows of square-sectioned dome-headed hobnails in position.

Hobnails were found in the following contexts. The number indicates the quantity found.

One or two hobnails were found in a further nine contexts. A total of 92 hobnails were found, with the find-spots well spread over the site indicating casual loss. This limited number of hobnails is also reflected in the remarkably limited number of iron nails found on the site, probably accounted for by the soil conditions which have led to poor preservation of the iron in general.

77. Nail (L:96mm W:7mm T:7mm). Area over Building 13, unstratified, L10:01, 2625, WSFE220, 2001.2114
Nail with square-sectioned shank bent through a right angle with fragments of wood over the sides and end. Of the 207 nails found, the majority had disc heads, with two globular heads and one spatulate. With the exception of two large masonry nails the rest were all of a size suitable for carpentry.

Lead (Figs 25.21–22)

1. Portable shrine (H:75mm, W:36mm). Unstratified, from modern pipe trench, F14:38, 1307, WSL4, 2001.2265. Published: Allason-Jones 1984.

Portable shrine in the form of a cupboard with a rounded back. The two rectangular doors each have projecting spigots at two corners which fit into looped hinges at each front corner of the cupboard. The doors have raised decoration on both faces: on one face lattice work with pellets at the angles is contained in a pellet border, on

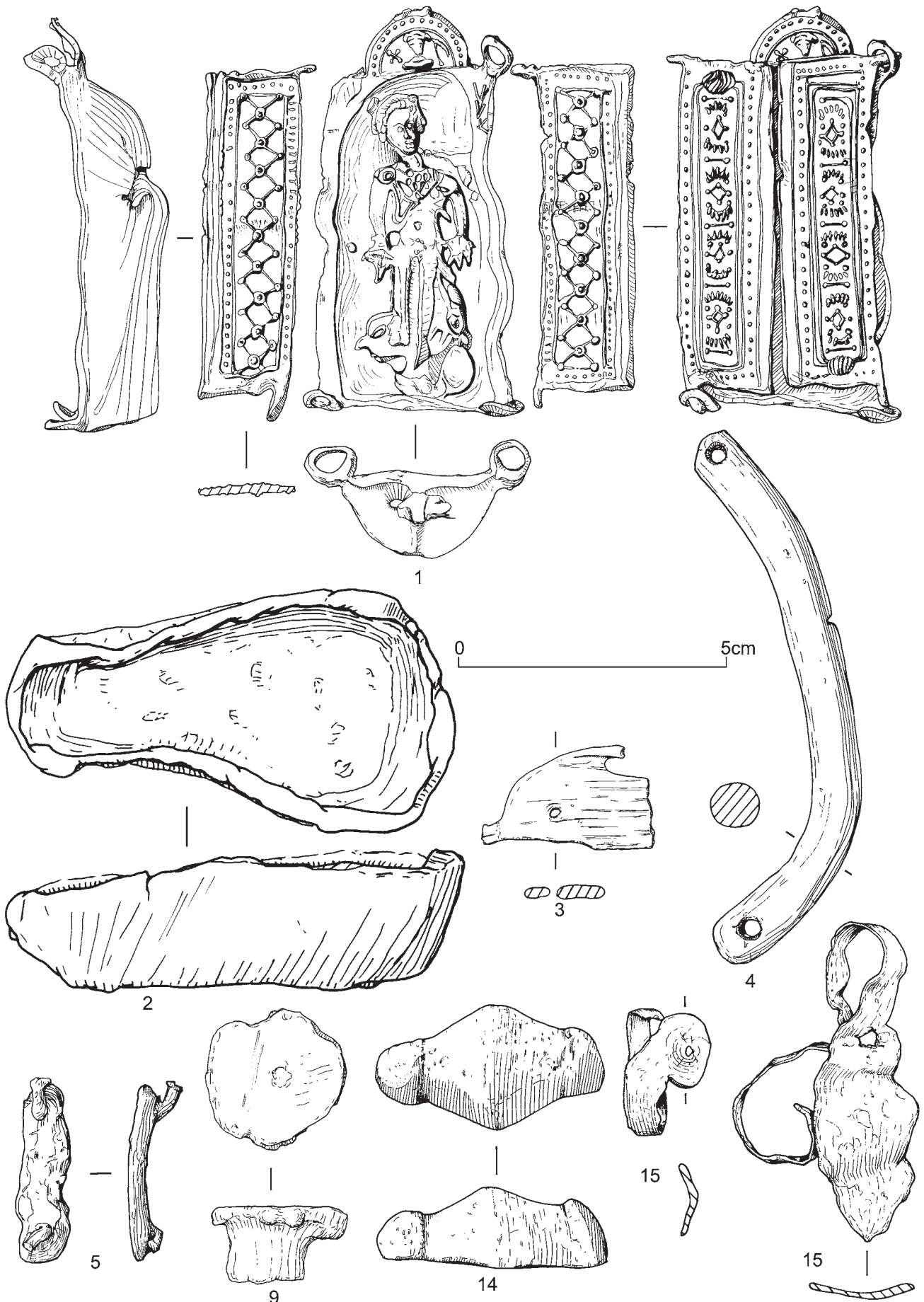

Fig re 23 Lead no. 3 Scale 1

the other a more complex rib-and-pellet border contains panels of diamond shapes and stylized shells. The pattern over-runs the border at one end of each door. There is no obvious way of fastening the doors.

Above the doors there is a semicircular projecting pediment with a male bust in relief wearing a crown of rays. He is flanked by the whip and wheel symbols of the sun god. This scene is contained within a border of raised pellets between two ribs. A fragment of a hanging loop survives. In the upper section of each hanging edge there is a branch motif in relief.

The cupboard itself contains the figure of a nude male wearing what appears to be a winged head-dress or helmet over his curly hair; a cloak is secured over his right shoulder by a disc brooch. He is holding an unidentifiable object in his right hand and his left hand is splayed. Around his feet are curled the figures of a dolphin and a bridled seahorse. The scene has been made by pressing a lead sheet into a mould, creating a 'cardboard cut-out' effect but with shallow relief. The figure is hollow at the back and has been positioned by slotting a tab through a hole in the floor of the cupboard.

The object has the appearance of a portable shrine, copying in miniature the larger domestic shrines discussed by Boon (1983) and, in particular, a wooden shrine from Herculaneum. Smaller shrines in the form of temples with pedimented doors made from stone are also known, such as at Luxembourg (Boon 1983, pl. vi), and Titelberg (Ésperandieu 1913, no. 4193). The pipeclay shrines holding Venus figurines made in the Samian factories of Gaul may also be comparable (Reinach 1921, 131, fig. 64).

There is some difficulty in identifying which deity the shrine is venerating. The cupboard has the symbols of the sun god but the winged helmet and possible purse of the main figure suggest Mercury. The dolphin and the seahorse add further confusion by implying a sea deity. The cupboard and doors are of better workmanship than the figure, which may suggest that the shrines were mass-produced, the worshipper asking for the deity of choice whose figure was then slotted into position. If this is so then the attributes shown on the pediment of the cupboard need have no direct relevance to the god venerated inside. However, the bust of the sun god with the whip and wheel symbols may be a reference to Jupiter and thus to Mercury's role as messenger of the sun god. Amongst his various roles as god of profit, patron of thieves and protector of cattle and herds, Mercury/Hermes was also the patron and protector of travellers and conductor of souls to the Underworld (Lindgren 1980, 38ff). It is possible that the seahorse and dolphin indicate his specific role as protector of those travelling on water or across the River Styx. The seahorse may particularly refer to travellers on the sea as the motif occurs on statuettes or reliefs of Neptune whilst the dolphin is more commonly used in the context of rivers and would appear to have a connection with well worship and in turn with the cult of the dead.

The use of lead is unusual as the lead figurines and reliefs known from Roman Britain are few in number and poor in quality. Two lead openwork reliefs from Gorsium in Hungary have points of similarity with the Wallsend shrine as they each depict a deity standing on a rock in an archway, one representing Venus, the other Minerva, but these appear to be mounts rather than free-standing shrines (Bánki 1972, nos 29, 30). Lead was more commonly used in the production of coffins, tanks and caskets, and

the decoration on the doors of the Wallsend shrine is very similar to the motifs used on fourth-century lead coffins (Toller 1977). However, three more exact British parallels are known to the Wallsend shrine. A shrine with a figurine of Minerva was found in a late Roman/early medieval context at Dorchester (Henig 1993a, fig. 72). A cupboard, lacking its doors but with a figure of Venus, was found in the 1984 excavations at Wroxeter *macellum* from one of a series of pits containing early to mid third-century pottery and a few third- or fourth-century small finds (Lloyd-Morgan 2000, fig. 4.31; 137). The 1976 *vicus* excavations at Vindolanda also produced a fragment of a door stratified in a floor level of mid to late fourth-century date (Vindolanda Museum Ref. No. 2033). These parallels may suggest that the shrines were more common than might at first be thought and to imply a fourth-century date. They also support the theory that the cupboards were mass-produced and the deity added on request.

On excavation, the shrine was associated with barracks dated to the fourth century (Allason-Jones 1984, 232), which have now been re-dated to the third century. The trench in fact cut through both the Period 2 *contubernium* 4 of Building 10 and the alley between the Period 4 chalets AA and Z. (AC)

2. Lamp (L:84mm Max.W:44mm H:22mm). Area over western rampart, unstratified, C11:02, 980, WSL16, 2001.2277
Small lamp or lamp-holder of very angular appearance with a nipped nozzle. Open lamps of this type are common in iron and pottery but less common in lead. For a general discussion of open lamps see Manning 1985, 98–9.
3. Appliqué (L:32mm T:1.5mm). Area over Building 10, unstratified, D14:01, 1468, WSL58, 2001.2319
Lead alloy appliqué in the form of a stylized dolphin. The eye is a pierced circular hole.
4. Rod (L:100mm T: 8.5mm W:9mm), Building 16, kiln, Periods 1–2, M08:14, 2506, WSL40, 2001.2301
Curved rod of oval section with an oval hole cut through both ends. A deep notch has been cut across the outer face. Handle?
5. Rod (L:32mm Max.D:14mm Min.D:8mm Weight:30gm). Chalet 10, Building X, Period 4, G15:11, 1434, WSL28, 2001.2289
Long rod of cylindrical section tapering to one end.
6. Cramp (L: 46mm). Area over Alley 4, unstratified, E05:01, 133, WSL19, 2001.2280
Lead cramp of the type used for mending pottery. A fourth-century cooking pot from South Shields (MA acc. no. 1956.128.118.A) shows how soft lead was placed across the break on the inner and outer faces of the pot forming a double bridge and forced into holes drilled on either side of the break to join the bridges and keep them in position.
7. Cramp (L: 24mm). Road associated with north-west shacks (B2), Period 3–4, H04:19, 804, WSL20, 2001.2281
Lead pottery cramp of the same type as above.
8. Plug (D:9 × 5mm). Area over Building 1, ploughsoil, Q05:02, 108, WSL23, 2001.2284
Small circular plug.
9. Plug (D:26mm). Building 8, room 1, Period 3, D11:28,

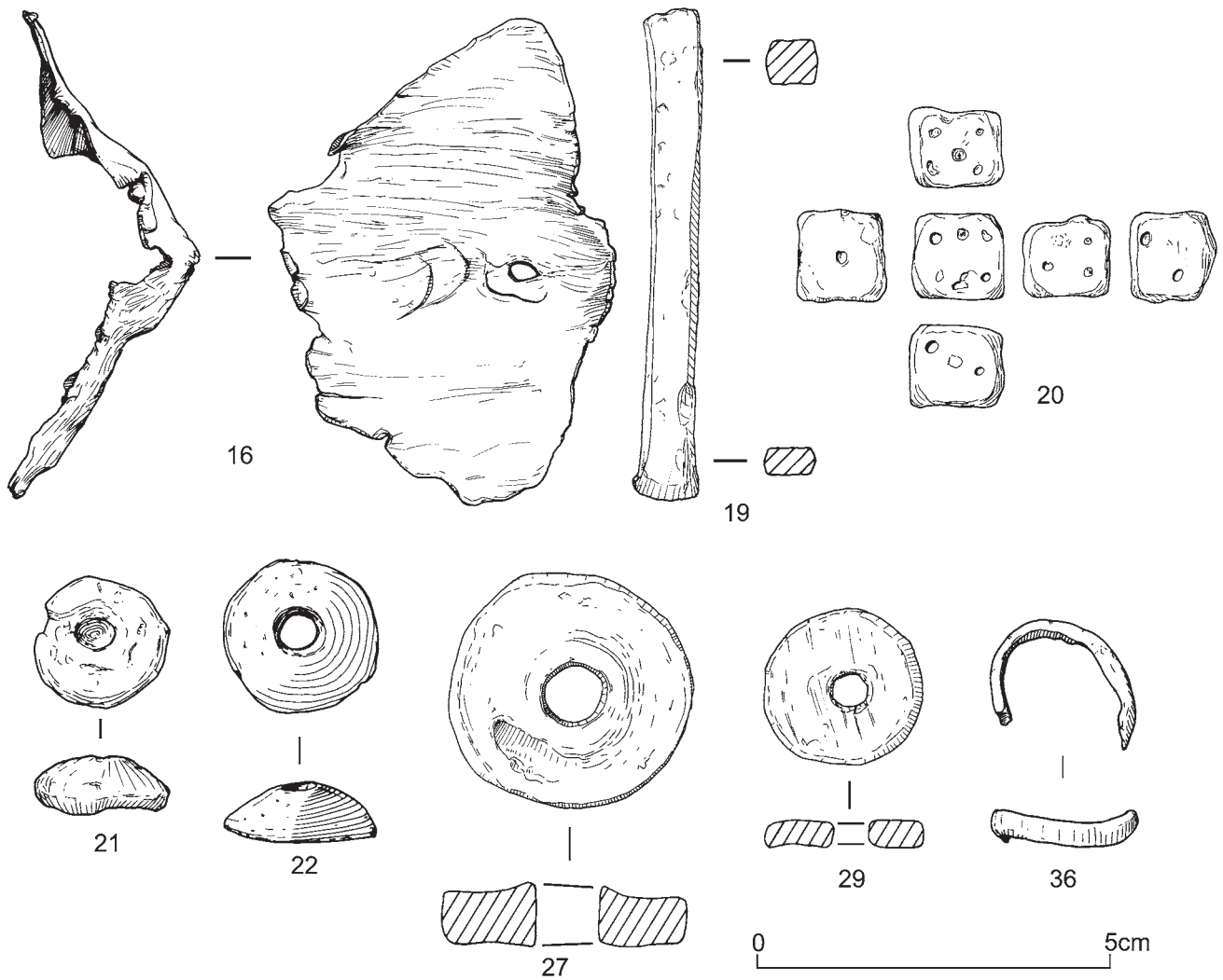

Fig re 23 Lead nos 8 Scale 1

- 1192, WSL18, 2001.2279
Disc-headed plug.
10. Plug (L:34mm W of head:18mm). Area over Building AO, unstratified, G08:01, 2152, WSL17, 2001.2278
Plug shaped like a nail and made from one sheet of rolled lead with a wedge-shaped head.
11. Plug (L:22mm W:18mm B:13mm). Area over Building 10 and Alley 5, unstratified, E14:01, 1138, WSL82, 2001.2342
Plug with roughly triangular head.
12. Plug (L:50mm W:38mm B:30mm). Building 11, *contubernium* 4, Period 1, L15:25, WSL123, 2001.2376
Roughly oval plug with a flat base and widening to the top. The remains of an iron ?nail projects from the top.
13. Plug (L:40mm W:35mm B:45mm). Building 11, *contubernium* 4, Period 1, L15:25, WSL122, 2001.2375
Second example from same context.
14. Block (L:43mm W:25mm H:13mm Weight 70gm). Area over Buildings 4 and 5 and Alley 3, unstratified, G04:01, 148, WSL38, 2001.2299
Lozenge-shaped block with globular ends, flat on the back with a deep convex face.
15. Strip (L:c.420mm). Alley 1, upper layers, M05:12, 357, WSL37, 2001.2298
Long, distorted strip expanding to both ends and pierced by two holes (D:4 × 4mm and 8 × 8mm)
16. Sheet (L: 83mm T: 1mm Hole: 3 × 3mm). Road 8, F08:10, 2277, WSL62, 2001.2323
Fragment of sheet of roughly triangular shape with a square hole punched through near one edge. Traces of a square-headed iron nail survive in the hole.
17. Sheet (L:50mm). Road 8, F08:05, 2255, WSL63, 2001.2324
Oval sheet folded into four.
18. Sheet(L:62mm Max.W:51mm). Building 5, *contubernium* 1, Period 2, G05:23, 568, WSL32, 2001.2293
Sheet of trapezoidal shape.
19. Ingot (L:69mm W:9mm T:7mm). Area over Building 1, unstratified, L04:01, 730, WSL34, 2001.2295
Rectangular-sectioned strip snapped off at one end. Ingot?
20. Die (L:13mm W:13mm B:13mm). Area over Building 10 and Alley 5, unstratified, F14:01, 1284, WSL5, 2001.2266
Square lead die with incised dots for numerals.

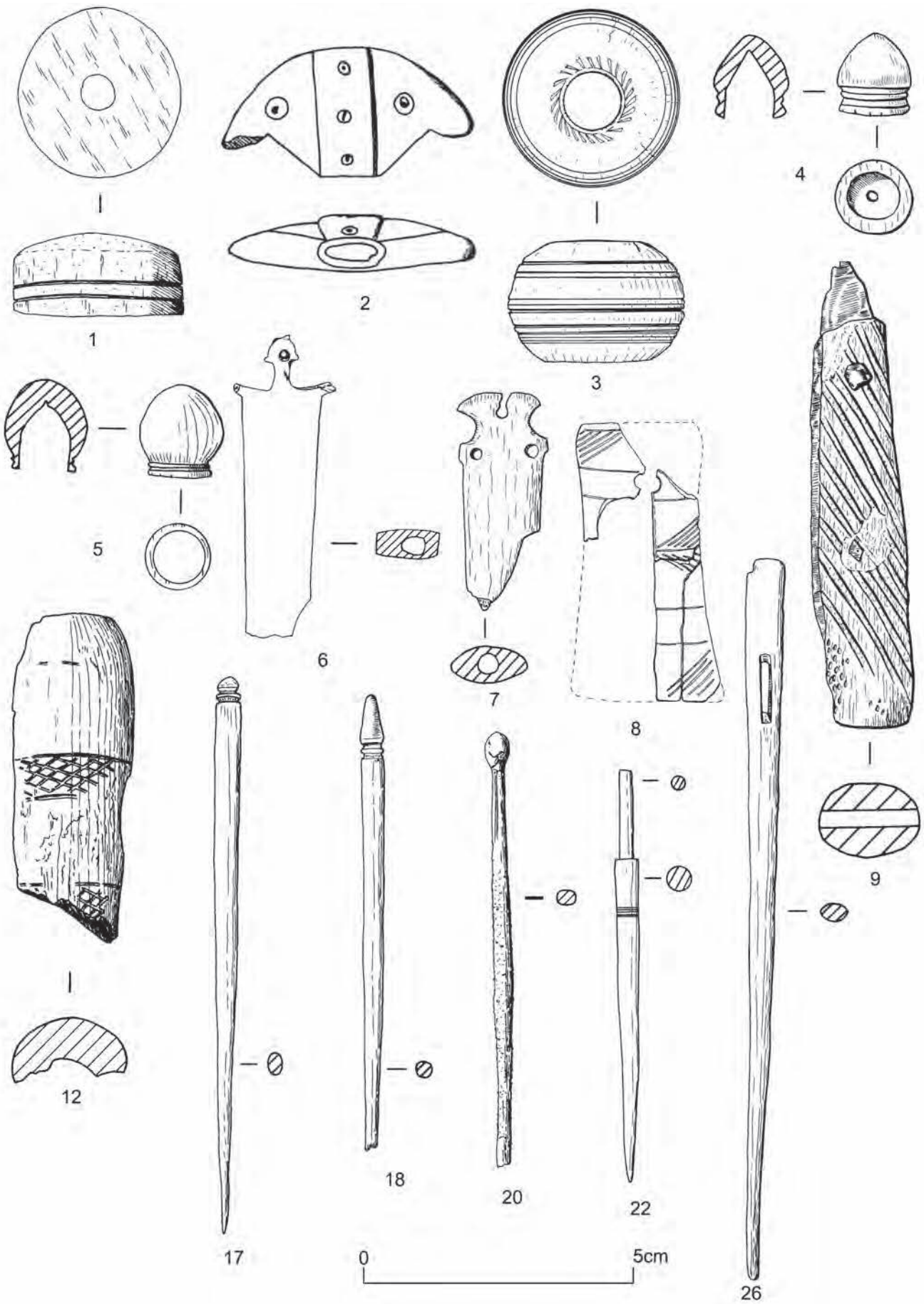

Fig re 2 3 Bone nos 4 Scale 1

21. Block (D:18.5mm H:8mm). Road associated with north-west shacks (B2), Period 3–4, H04:19, 794, WSL30, 2001.2291
Bun-shaped block. Counter?
22. Weight (D:23mm H:6mm). Road associated with north-west shacks (B2), late third/early fourth century, J04:05, 805, WSL1, 2001.2262
Domed circular weight.

23–35. DISCS

Discs with central circular hole

23. (D:30mm T:4mm). Building 2, *contubernium* 6, Period 3 or later, L05:34, 890, WSL57, 2001.2318
24. (D:28mm T:6mm Weight:25gm, hole:5mm). Area over Building 10 and *intervallum* road (Road 6), unstratified, G15:01, 1449, WSL29, 2001.2290
25. (D:26mm T:4.5mm Hole:6mm). Building 8, drain, Period 4, E11:38, 1143, WSL55, 2001.2316. Made in a mould.
26. (D:25mm Hole:5mm T:4mm). Road 3, K13:18, 2076, WSL54, 2001.2315
27. (D:34mm T:7mm). Area of Building 9, no details, E13:27, 1466, WSL3, 2001.2264
28. (L:29mm W:26mm B:2mm D(hole):4mm). Cistern 3, mid-third century, L08:08, 2011, WSL53, 2001.2314. Slightly irregular.
29. (D:24mm T:4mm D(hole):5mm). Area over Building 11 and Alley 6, unstratified, M15:01, 1670, WSL2, 2001.2263

Disc with central square hole

30. (D:28mm T:5mm Hole:5mm Weight:20gm). Rubble over Building 8 and *intervallum* road (B2), late third/early fourth century, D11:02, 1081, WSL22, 2001.2283

Unpierced discs

31. (D:52mm T:5mm). Building 3, officer's quarters, Period 3–4, P08:14, 2545, WSL64, 2001.2325. Rough disc with irregular scratches on both faces.
32. (D:31mm T:4mm). Area over Building 5 and Alley 3, unstratified, F04:01, 1618, WSL36, 2001.2297
33. (D:26mm). Building 7, west granary, G09:29, 2270, WSL67, 2001.2328. One convex face.
34. (D:24mm T:2mm). Alley 7, L09:13, 2030, WSL50, 2001.2311. With iron corrosion adhering.
35. (D:15mm T:3mm). Area over Building 12, unstratified, K14:01, 1324, WSL6, 2001.2267
36. Ring (Ext.D:21mm W:2mm T:3.5mm). Area over Building 10 and Alley 5, unstratified, F14:01, 994, WSL25, 2001.2286
Fragment of a ring of semi-oval section.

Antler and bone (Figs 25.23–25)

1. Pommel (D:32mm H:14mm hole D:7mm). Road 8, F08:10, 2247, WSB83, 2005.3693
Bun-shaped bone dagger pommel with two incised lines around the base. The central hole shows no signs of wear.
2. Pierced plate (L:c.24mm W:c.46mm B:c.7mm). Area over Building 12, unstratified, L14:01, 1362, lost

- Pierced plate decorated with dot and ring. A similar example found in a late fourth-century context at Ravenglass is described as a toggle or buckle (Potter 1979, fig. 27, no. 52). (AC)
3. Ball (H:21mm D:32mm). Area over Building 13, unstratified, N10:01, 1633, WSB2, 2001.662
Bone ball pierced by a 12mm diameter central hole which has a series of small vertical nicks cut around its edge at both ends. One end is further decorated by a frame of incised oblique lines around the hole. The surface of the ball has three bands of four lathe-turned lines. Dagger pommel?
4. Knob (H:14mm D:15mm). Building 1, *contubernia* 1–4, sub-phase 1 demolition material, Period 2, N05:32, 563, WSB5, 2001.665
Highly polished, hollow, domed bone knob with a heavily ridged collar. The inner wall shows signs of the knob having been screwed into position. A similar knob from Gross-Gerau is described as having been used as the tip of a dagger pommel (Simon 1965, 38–99, Abb. 7, 7–8). Examples are also known in bronze: e.g. Wiesbaden: ORL B31, Taf. 10, nos 4, 5.
5. Knob (H:16mm D:15mm). Area over North rampart, unstratified, M03:01, 751, WSB3, 2001.663
Highly polished, hollow, onion-shaped bone knob with a heavily ridged collar. As with No. 3 above this shows signs of having been screwed into position.
6. Handle (L:55mm W:18mm T:6.5mm). Chalet 9, post-Roman dereliction, F13:12, 1117, WSB50, 2005.3660
Finely worked and highly polished bone handle of rectangular section tapering to the socketed end. The decoratively shaped terminal is pierced by a 2mm diameter hole. This is a particularly fine piece and may have been the handle from a medical instrument rather than a domestic knife. There are no traces of iron or bronze in the socket.
7. Handle (L:40mm W:17mm T:7mm). Area over *Via quintana*, unstratified, F12:01, 1027, WSB6, 2001.666
Finely worked and highly polished bone handle of elliptical section with a circular socket. The terminal is pierced by three small holes arranged in a triangle. As with no. 6 above this may have been the handle of a medical instrument.
8. Handle (L:41mm). Tower 7, P04:05, 132, WSB28, 2005.3638
Fragment of a two-piece bone knife handle of elliptical section. The terminal is splayed and the face decorated by groups of incised oblique and horizontal lines. Two bronze rivets have held the two plates together.
9. Handle (L:76mm W:17mm B:14mm). Drain immediately north of forehall, Period 1, L08:38, WSB7, 2001.667
Two-piece bone knife handle decorated with incised diagonal lines held in place by two iron rivets. Remains of iron blade surviving.
10. Handle (L:87mm W:23mm T:17mm). Area over Building 10 and *intervallum* road (Road 6), unstratified, F15:01, 1059, WSB49, 2005.3659
Two-piece handle of red deer antler with the iron tang and blade of a clasp knife still *in situ*. Three iron rivets hold the handle in position. The end is rounded and the handle retains the natural curve and exterior surface of the antler. Possibly post-Roman.
11. Handle (L:61mm T:16mm). Building 1, verandah

demolition material, Period 3, Q05:25, 255, WSB29, 2005.3639

Tubular antler handle with a smoothed surface and a fragment of the iron knife blade *in situ*.

12. Toggle (L:61mm W:22mm). Area over Building 11 and Alley 6, unstratified, L15:01, 1400, WSB56, 2005.3666
Fragment of a toggle made from a long bone. The terminal is rounded and the face is decorated with two bands of incised cross hatching enclosed in line borders. There is the remains of a slot on one face. Possible native bridle fitting.

13–25. PINS

Shallow conical heads. Crummy 1979, Type 1.

13. (L:76mm T:6mm). Area over Building 10 and Alley 5, unstratified, E14:01, 1083, WSB45, 2005.3655
14. (L:77mm D:6mm). Area over Building 11 and Alley 6, unstratified, L15:01, 1413, WSB57, 2005.3667. Highly polished.
15. (L:64mm D:7mm). Chalet 12, Building AM1, mid-third century, M14:46, 1888, WSB18, 2001.678

Pointed conical heads. Allason-Jones and Miket 1984, Type H.

16. (L:124mm W:6.5mm T:6mm). Building 13, south corridor, Period 2, L11:29, 1839, WSB72. Oval-sectioned.

Ridge-and-groove decorated head. Crummy 1979, Type 2; Allason-Jones and Miket 1984, Type E.

17. (L:102mm T:4.5mm). Building 1, *contubernia* 1–4, sub-phase 1 demolition material, Period 2, N05:32, 562, WSB9, 2001.669
18. (L:83mm). Building Row 20, Building R, late third/early fourth century, G11:10, 1127, WSB10, 2001.670. Highly polished.

Spherical head. Crummy 1979, Type 3; Allason-Jones and Miket 1984, Type A.

19. (L:47mm W of Head:6.5mm). Post-Roman rubble over Road 9, H14:24, 1244, WSB52, 2005.3662. Incomplete.
20. (L:80mm D of head:5mm). Building 13, over west bath, late third century, L12:02, 1717, WSB69, 2005.3679. Roughly faceted, oval-sectioned shank tapering to both ends.

Other

21. (L:44mm T:3mm) Area over Road 3, unstratified, J13:08, 1361, lost
Incomplete, small bone pin tapering to both ends with a very small flat oval head. The oval-sectioned shank has been roughly shaped.
22. Pin (L:76mm T:4mm L of spigot:16mm). Area over Building 12 and Road 3, unstratified, N14:11, 1689, WSB15, 2001.675
Highly polished bone pin with a tapering, circular-sectioned shank decorated with a band of four incised grooves. The head is shaped into a long spigot and probably held a bead of glass or jet; cf. Allason-Jones and Miket 1984, Type G.

23. Pin rough-out (L:42mm T:4.5mm). *Via quintana* drain, E12:18, 1043, WSB44

Roughly fashioned tapering bone rod.

24. Pin rough-out (L:112mm W:21mm). Building Row 20, levelling north of Buildings Q and R, late third/fourth century, G11:14, WSB99

Roughly fashioned fragment of long bone.

25. Rod (L:41mm B:45mm). Area over Building 12, unstratified, K14:01, 1391, WSB55, 2005.3665
Short length of rod tapering to both ends.

26–30. NEEDLES

26. Needle (L:133mm Max.W:7mm). Building 13, room 7, mid-third century, N12:08, 1759, WSB11, 2001.671
Large bone needle with a spatulate head. The rectangular eye has been cut well down the shank. cf. Allason-Jones and Miket 1984, nos 2.263–270.

27. Needle (L:27mm T:3.5mm). Building 16, post hole, Period 1, K07:26, 2047, WSB77, 2005.3687

Pointed head of a needle of circular section with rectangular eye.

28. Needle (L:61mm W:4mm). Area over Building BB, unstratified, N13:01, 1693, WSB66, 2005.3673

Incomplete bone needle of circular section with a blunt head and a rectangular eye.

29. Needle (L:65mm D:4 × 3mm). Area over Building 12, unstratified, L14:01, 1542, WSB59, 2005.3669. Oval section, snapped across eye.

30. Needle (L:31mm D:3mm). Building 13, backfill of east hypocaust, Period 4, M12:67, 1901, WSB19, 2001.679. Snapped across eye. Dyed green.

31. Spindlewhorl (D:47mm B:10mm). Building 12, officer's quarters, Period 1, N14:38, 1887, WSB16, 2001.676
Antler spindlewhorl.

32. Bobbin (L:110mm W:22mm). Chalet 12, AM, Period 4 or later, M14:23, WSB100

Sheep's metacarpal perforated in the middle for use as a bobbin.

33. Bobbin (L:92mm). Building 5, drain fill, Period 2, E05:38, 552, WSB34, 2005.3644

Sheep's metacarpal perforated in the middle for use as a bobbin. This is a native implement of Iron Age origin which may have been used only in Britain (Wild 1970b, 34 and 130). They are becoming increasingly common finds on northern forts, e.g. South Shields and Chesters (Allason-Jones and Miket 1984, 2.24) and recent excavations at Corbridge (Bishop and Dore 1989), Housesteads and Piercebridge, so far unpublished.

34. Weaving Comb (L:37mm W:37mm T:9mm). Area over Building 10 and Road 15, unstratified, H15:10, 1437, WSB58, 2005.3668

The oval terminal and part of the shank of a bone weaving comb with a deeply incised X stretching across the width. Although this type of implement is traditionally referred to as a weaving comb there has been a suggestion that they were intended for dressing skins (Roth 1918, 129ff). Hodder and Hedges 1977, Type ShG.

35. Comb (L:142mm L of teeth:11mm W:13mm). Area over Building 8, unstratified, E10:01, 1112, WSB8, 2001.668

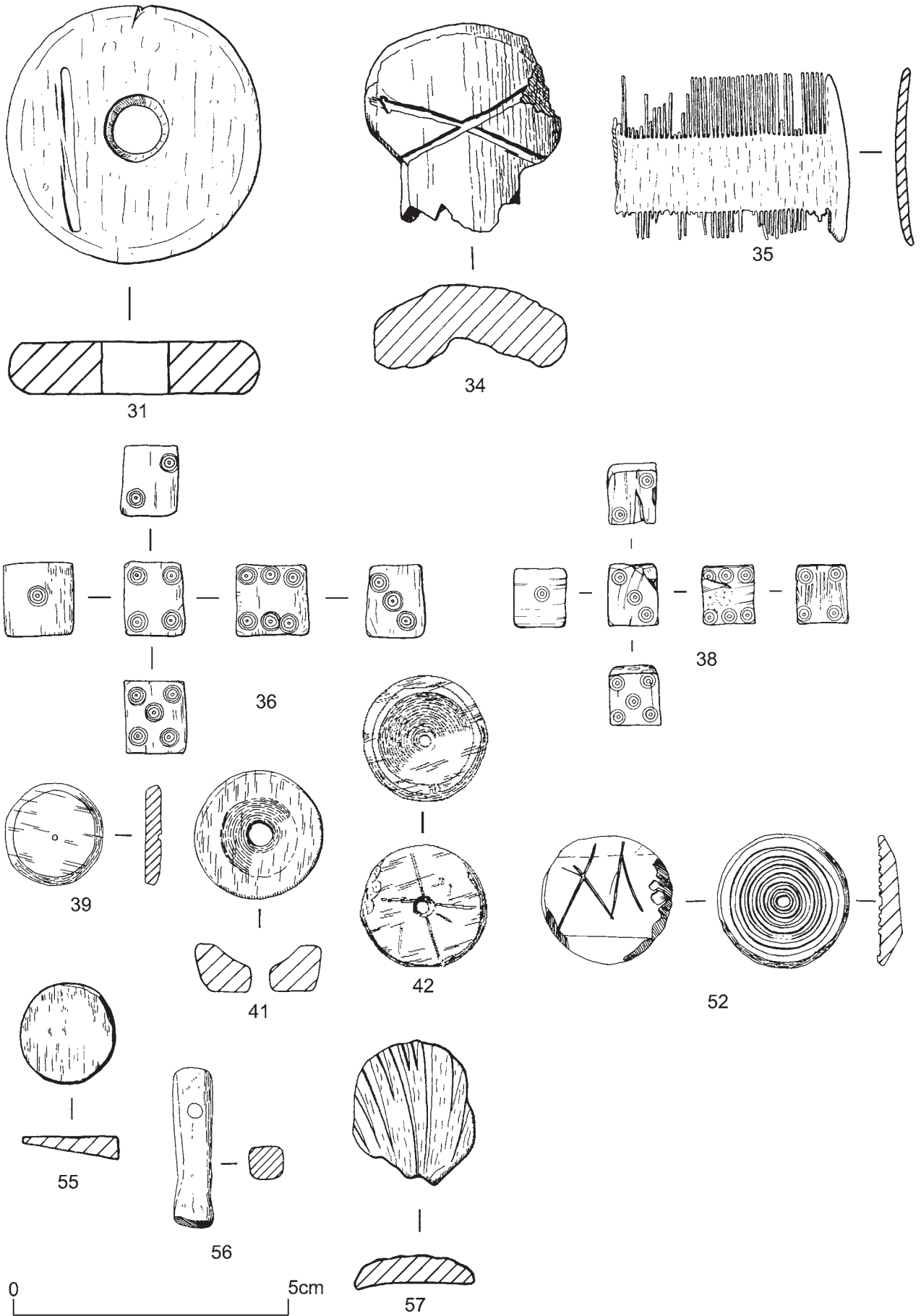

Fig re 3 2 Bone nos 3 Scale 1

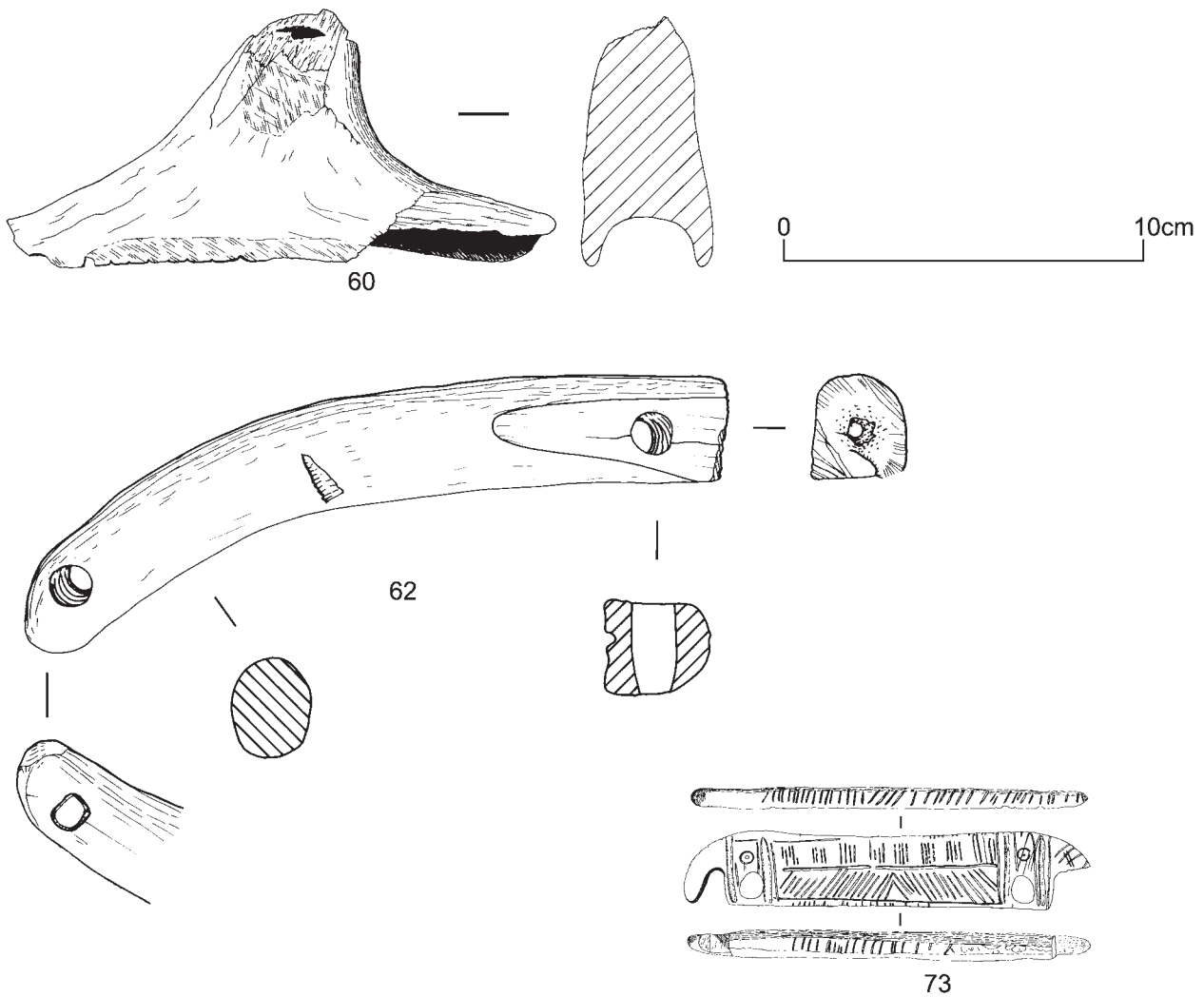

Figure 25 Bone nos 60, 62, 73 Scale 1

Incomplete, single piece bone comb with two rows of fine teeth. The surviving end is plain and rounded.

36-8. DICE

Bone dice, with the numbers indicated by stamped double dot and ring motifs. The numbers on the opposing sides add up to seven. It is difficult to see how Roman dice were used in dice-throwing games as they are rarely pure cubes; no. 36 in particular is shaped so that it invariably lands on six. Although Roman dice are not as noticeably rectangular as the parallelepiped examples from the Scottish Iron Age, the discussions on the use of the latter should be borne in mind: Wheeler (1943, 310-11) suggested that they were used as dominoes whilst O’Riordain (1940, 156) reasoned that the dice were not thrown but placed and covered by one person while the other player guessed the number shown uppermost. These suggestions are among those discussed by Clarke (1970, 214ff).

36. (L:13mm T:10.5mm W:11mm). Building 10, *contubernium* 2, Period 2, E14:24, 1464, WSB12, 2001.672. Small rectangular die.

- 37. (L:14mm W:11mm T:13mm). Alley 5, post-Roman debris, F14:13, 1084, WSB46, 2005.3656
- 38. (L:11mm W:9mm T:9mm). Area over Building 9, unstratified, D13:01, 1137, WSB13, 2001.673

39-55. COUNTERS

Counters made from ungulate long bone are common finds on military and civilian sites in the Hadrian’s Wall area but, unfortunately, few complete sets have survived to suggest whether the game involved was *ludus duodecim scriptorum*, *ludus latruncularum*, or *tabula*. See MacGregor, A., 1976; Austin 1935; Bell 1960.

Greep 1995, type 1; Kenyon 1948, Type C.

- 39. (D:18mm T:2.5mm). Building 3, *contubernium* 2, Period 2, N07:15, 2610, WSB90, 2005.3700.
- 40. (D:18mm T:3mm). Area over Building 10 and Alley 5, unstratified, F14:01, 1095, WSB48, 2005.3658. Very worn bone counter with a central incised dot.

Greep 1995, Type 2; Kenyon 1948, Type A.

- 41. (D:23mm T:7mm). Area over *Via quintana*, unstratified, D12:01, 1030, WSB43, 2005.3653. Central 5mm

- diameter central hole. The edge of both faces is bevelled.
42. (D:23mm T:3mm). Building 14, room D, Period 1 or 2, J12:31, 2147, WSB81, 2005.3691. Central hole. The edge of the upper face is bevelled with a group of four short vertical scratches. On the reverse a motif has been roughly scratched before the hole was drilled.
43. (D:22mm T:4mm). Area over Building 12, unstratified, L14:28, 1547, WSB61, 2005.3671.
44. (D:21mm T:3.5mm). Building 14, room D, Period 1 or 2, J12:31, 2146, WSB80, 2005.3690.
45. (D:19mm T:3mm). Area over Building 10, unstratified, D14:01, 967, WSB40, 2005.3650.
46. (D:19mm T:3mm). Area over Building 13, unstratified, M12:01, 1661, WSB64, 2005.3674.
47. (D:19mm T:3mm). Area over Building 12 and Alley 6, unstratified, J14:01, 1350, WSB54, 2005.3664. The dished face has worn to a perforation.
48. (D:19mm T:2.5mm). *Via principalis*, E08:14, 2323, WSB84, 2005.3694.
49. (D:18mm T:3mm). Area over Road 8, unstratified, F09:09, 2212, WSB82, 2005.3692.
50. (D:18mm T:2mm). Road 3, F11:19, 1185, WSB51, 2005.3661. LVI is lightly scratched on the reverse.
51. (D:16mm T:3mm). Building 14, room A, Period 2?, H11:04, 2083, WSB78, 2005.3688.
- Greep 1995, Type 3, Kenyon 1948, Type B.**
52. (D:24mm T:3.5mm). Building 14, room D, Period 2?, J12:26, 2082, WSB79, 2005.3689. On the reverse the letter M has been firmly scratched.
53. (D:19mm T:1.5mm). Area over Building 14 and Alley 8, unstratified, H10:01, 1949, WSB94, 2005.3704.
54. (D:18mm T:1.5mm). Area over Building 13, unstratified, N12:01, 1642, WSB63, 2005.3673. Very worn. The reverse has four lightly incised oblique strokes.
- Other**
55. (D:18mm T:3mm). Chalet 12, Building AM2, (mid-) late third century, M14:11, 1857, WSB75. Flat, plain surfaces.
56. Peg (L:28mm T:8mm). Building 5, *contubernium* 1, Period 2, G05:23, 557, WSB62
Phalanx of a large bird? pierced by a 2mm diameter hole near one end. Part of a musical instrument?
57. Shell (L:26mm T:5mm). Latest surviving *Via praetoria* surface, K04:04, 893, WSB1, 2001.661
Fragment of a long bone which has been carved to represent a cockle shell. The back has been roughly hollowed and the piece is pierced by a 2mm diameter hole at the 'hinge'. A similar example from Intercisa has an extra hole pierced at the edge (Vago 1971, pl. LXII). Examples are also known in bronze, eg. Faimingen: Oldenstein 1976, Taf. 57, nos 700–703; and Xanten: Steiner 1911, Taf. XII, No. 16.
58. Ring. Building 13, room 3, Period 2, L11:11, 1705, WSB68
Annular antler ring in three pieces.
59. Antler Ring (D:33mm T:16mm). Building 1, verandah demolition material, Period 3, N05:18, 279, WSB33, 2005.3643
- Thick slice cut across a red deer antler tine. The core has been hollowed out but the outer, surface is untouched.
60. Antler implement (L:155mm). Area over Building 1, ploughsoil, Q05:02, 95, WSB24, 2005.3634
Fragment of red deer antler which has been cut to leave the joint between the beam and a tine. The long edge has been carefully sliced down the beam and smoothed with a series of nicks cut across at regular intervals. This appears to be an implement in its own right rather than an off-cut.
61. Antler (L:140mm). Area over Building 12, unstratified, L14:01, 1543, WSB60, 2005.3670
Curved length of red deer antler pierced by a 17mm diameter hole at one end. This is not a netting needle as the unperforated terminal is thickened and blunt, yet the hole is not large enough to take a hammer shaft.
62. Antler (L:200mm W:29mm T:25mm). Area over Building 12, unstratified, L14:01, 1410, WSB4, 2001.664
Length of curved antler tine with one rounded and one blunt end, both of which are pierced by a 12mm diameter hole. The blunt end has been shaved to a squared section before the hole was cut. Tent block?
63. Tine (L:207mm). Area over Building 12, unstratified, L14:01, 1818, WSB22, 2001.682
Very large red deer tine which is untrimmed at the base and has, not been polished. Towards the tip the surface has been trimmed flat and is pierced by a large oval hole across which the tine has broken.
- ANTLER AND BONE WASTE**
64. (L:72mm). Building 2, north wall, Period 2, M05:06, 415, WSB30, 2005.3640. Smoothed tine of red deer antler which has been sawn.
65. (L:75mm). Area over *Via quintana*, unstratified, D12:01, 1026, WSB42, 2005.3652. Tine of red deer antler which has been broken at both ends. The surface is worn or worked smooth and there is a series of horizontal nicks around the base.
66. (L:92mm). Rubble over Road 5, D07:10, 2584, WSB89, 2005.3699. Tine of red deer antler carefully sawn.
67. (L:175mm). Unstratified, WSB97, 2005.3712. Tine of red deer antler which has been sawn.
68. (L:48mm Max.D:20mm). Building 13, room 8, mid-third century, N12:09, 1863, WSB73, 2005.3683. Trimmed point of a red deer tine with the tip sawn off.
69. (L:42mm). Road associated with north-west shacks (B2), late third/early fourth century, G05:18, 482, WSB31, 2005.3641. Fragment of ungulate bone with score marks across the surface.
70. (T:7mm). Area over Building 3 and Alley 2, unstratified, N07:01, 2460, WSB87, 2005.3697. Slice cut across an ungulate long bone.
71. (L:90mm). Post-Roman dereliction over East rampart, Q07:07 or Q08:11, WSB101. End of ungulate long bone with the original surface trimmed away.
72. Building 13, pit in room 7, mid-late fourth century, N12:28, WSB103. Waste ends of an ungulate long bone.
73. Bone plate (L:115mm W:21mm T:7mm). Road 1, phase



Fig. 25.26 Intaglios. Scale 1. Photos by R. Wilkins © Institute of Archaeology, University of Oxford.

2, F07:08, 2396, WSB86, 2005.3696

Bone plate with hooked ends both pierced by a 6mm diameter circular hole. One face is flat and undecorated with no trace of wear, the other face is convex and decorated by a complex series of incised oblique and vertical lines. A dot-and-ring motif at each end give the terminals a slightly zoomorphic appearance. Both edges are decorated by oblique lines and there are traces of wear between the holes and the lower edge. This piece bears a strong resemblance to the ninth- and tenth-century comb and comb covers discussed by MacGregor (1978, fig. 29); however, the publication of finds from a cave in Settle has produced a further two examples of similar plates. Both are undecorated and smaller in size, and one has polishing along the lower edge. They are likely to come from Victoria Cave, where material dating from the second to fourth centuries has been found, but no certain post-Roman material (Dearne and Lord 1998, fig. 31, nos 117–8).

The intaglios (Fig. 25.26)

by M. Henig

Descriptions are of the actual gem; left and right would be reversed in a sealing (impression) from which the devices would often have been viewed.

1. Red jasper intaglio (surviving H:18mm surviving W:10mm B:3mm). Building 16, floor, Period 1 construction, L08:28, 2044, WSINT1, 2001.1926

Red jasper intaglio, shape F1. The stone is broken diagonally across. The subject is *Dea Roma*, helmeted and wearing a chiton, seated in profile to the right (though the corselet on which she was presumably resting was on the missing portion of the gem). She has her right hand to her sword (*parazonium*), which is envisaged as hanging from a baldric, and in her left hand a little figure of Victory of which only the arm of the image holding out a wreath remains. On the ground beneath Roma is her shield.

The gem should be compared with a cornelian intaglio from a sewer in the fortress of York (Henig 1976, 8, no. 10 = Henig 1978, no. app. 85) and a fragmentary nicolo from a similar drain at Caerleon (Zienkiewicz 1986, 135, no. 42), both of them ascribed on grounds both of stratigraphy and

style to the second century. Stylistically the best parallel from Britain is an onyx from Silchester, Hampshire where the goddess holds a *patera* rather than a *victoriola* (Henig 1978, no. 249). A tentative first-century dating was given to this stone because it seems the type represents a pre-Hadrianic cult image (Vermeule 1959, 68) but, if so, it is clear that it continued to be a popular image on later gems and the iconography by itself cannot be used as a reliable indication of when it was cut. The patterned treatment of helmet and chiton of Roma on the Wallsend intaglio is typical of Antonine glyptic art (Henig 1988, 149–51).

2. Red jasper intaglio (16mm by 13mm by 3mm). Building 16, occupation, Period 3, K08:33, 2096, WSINT2, 2001.1927

Red jasper intaglio, shape F1. Complete but upper face somewhat worn. The subject is a youth, nude apart from his helmet and cloak (*chlamys*) in profile to the left, bending his back and raising one leg in order to put on a greave. In front of him is a spear and shield. There is a short ground line.

There is no doubt the intaglio depicts Achilles, the premier Greek hero of the Trojan war, arming himself and preparing for battle after hearing of the death of his friend, Patroclus. Two gems from an auxiliary fort at Loughor, West Glamorgan complete the scene with a column on which was an urn containing the ashes of Petroclus (Henig 1997, 395, nos 1 and 2) while a gem from Melain in France depicts Thetis, provider of Vulcan's wonderful armour, standing in front of her son (Guiraud 1988, 137, no. 439).

Material and style suggest, again, a second-century date. Images of a youth holding a sword (Theseus) and a youth holding a spear and helmet (Achilles) seem to have been popular at this time and I suggested long ago (Henig 1970) that these types would have had a special significance for the Roman soldier who was himself as the heir to the classical tradition of military prowess; indeed examples of these types from Corbridge and Caerleon are suggestive. Professor Kleinbrink (Maaskant-Kleinbrink 1978, 238, no. 608 and see no. 843) rightly attributed the same significance to the image-type represented here, and this surmise is strengthened by the findings of specimens in forts at Loughor and now at Wallsend.

3. Jasper intaglio (14mm by 11.5mm by 2mm). Area over Building 5, unstratified, J05:03, 651, WSINT3, 2001.1928

Mottled red-orange jasper intaglio, Shape F1. Chipped front left side of the gem. The subject is a lion walking to the left. Ground line. Damage to the front of the stone, noted above, makes it impossible to establish whether the animal held an animal head in its jaws. Its boldly patterned mane and the hair on its underside, likewise carefully executed, assign it to the patterned style of the second century.

For the type note Henig 1978, no. 629 (nicolo from Chesters), no. app. 173 (yellow jasper from Wroxeter); Henig 1993b, 206, no. 489 (onyx from a Trajanic/Hadrianic context at Caernarfon [Segontium]): Maaskant-Kleinbrink 1986, no. 128 (yellow jasper from River Waal at Nijmegen).

The lion, so familiar from tombstones, was probably a *memento mori* (see Henig 1977, 3556–7), although it should be recalled Leo was a sign of the zodiac. In any case the image would have been thought to protect the wearer.

4. Cornelian intaglio (14mm by 10mm by 2mm). Rubble over Building 8 and *intervallum* road (B2), late third/early fourth century, E12:08, 1186, WSINT4, 2001.1929 Orange with a few dark inclusions. Chipped on left side and some wear on front face.

A goat standing on its hind legs to the left, browses from a palm which grows from a rocky cliff represented by five superimposed stones. Ground line. The style of cutting and the texture of the cutting of the goat's patterned coat and the tree is typically Antonine.

For the same type as here, see Henig 1978, no. 609 (Caerleon): Philp and Henig 1985, 464, no. 5 (drain in *Classis Britannica* fort at Dover). Closely related are intaglios which show the goat browsing from deciduous tree (generally no rocky cliff); for example Henig 1978, nos 610–12, especially no. 611 from High House milecastle, Cumbria and 612 from Charterhouse on Mendip: Zienkiewicz 1986, no. 77 from Caerleon. Other intaglios depict goats browsing from trees being watched by herdsmen as Henig 1978, nos 497–502 (no. 498 from Chester; 499 from Newstead): Henig 1980, 179, no. 2 (from Strageath).

The device evokes the prosperity of the countryside. Such themes, which relate to the idealisation of Rome's traditional rustic roots, are common on gems including gems from military sites. In the practicalities of daily life soldiers were, of course, concerned with prosperity. In addition one is justified in speculating whether the connection was made between the goat and the capricorn, the sign of the zodiac which was also the emblem of *Legio II Augusta*.

5. Nicolo-glass intaglio (14mm by 11mm (upper face 11mm by 9mm) by 3mm). Area over Building 11, unstratified, K15:01, 1369, WSINT5, 2001.1930

Device moulded rather than cut. Shape F2. Some chemical leaching of glass and underside chipped, but the intaglio is in good condition. The subject is an eagle standing on an altar. The bird stands to the left but looks over its shoulder to the right; it has a wreath in its beak. On either side of the altar is a *cornucopia* with a legionary standard issuing from the mouth of each.

There are several gemstones depicting an eagle between standards from military sites in Britain (Henig 1978, no. 705 from Hod Hill, no. 706 from Caerleon, no. 708 from Hod Hill and a recent discovery from excavations at Birdoswald). In addition we should note nicolo-glass intaglio from Newstead showing two eagles with a standard between them (Henig 1978, no. app. 187).

Cornucopiae add another element evoking prosperity. In this regard we may note a cornelian from Holditch, Staffordshire showing an eagle and a *cornucopia* (Henig 1978, no. 694) and another from Caerleon showing an eagle and a *cornucopia* with a trophy between them (Zienkiewicz 1986, no. 80). Although not from a military context but rather a betrothal ring for a young girl, a gem from a grave at Puckeridge, Hertfordshire depicting three eagles, two of them perched on *cornucopiae* and a third on a *cantharus*, all of them associated with the *dextrarum iunctio* show the power of the symbol (Henig 1978, no. app. 36). Close parallels to the Wallsend intaglio are provided by two gems in Vienna which, like it, show a standard issuing from a *cornucopia* on either side of an eagle (Zwierlein-Diehl 1991, nos 1932, 1933).

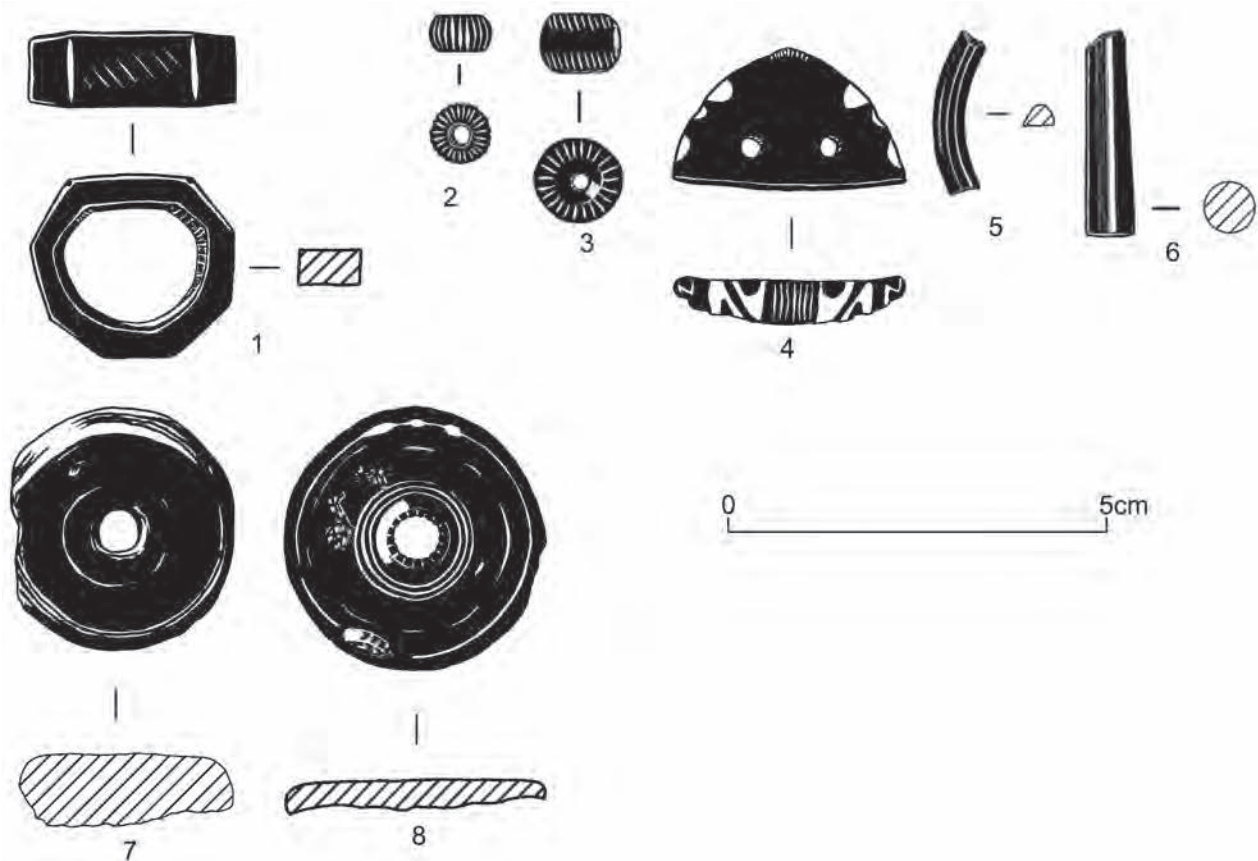

Figure 25.27 Jet and shale. Scale 1

6. Intaglio (L:16mm). Building Row 20, Building T, late third/early fourth century, G11:13, 1207, lost
The site finds book records an intaglio of unknown material depicting Mars standing holding a spear in his left hand and his right hand on a shield resting on the ground. (AC)

Discussion

Although this is only a small group of gems, it does suggest the range of particular preoccupations of the Roman soldier, his loyalty to Rome (*Dea Roma*) and to his unit (eagle and standards), his desire to emulate the prowess of the great heroes of the mythical past (Achilles), his need for amulets against sudden death (the lion) and his hopes for prosperity (the goat). Although close dating is not available, the intaglios all fall within a period of about eighty years from the foundation of the fort even if, of course, some were actually lost later.

Jet and shale (Fig. 25.27)

1. Jet finger ring (Ext. D: 27mm). Area over Building 2 and Alley 1, post-Roman dereliction, M05:04, 107, WSJ4, 2001.2256
Jet finger ring of rectangular section with eight external facets, the largest of which forms the main panel. Comparable rings of third-century date from Cologne have inscriptions on their main panels (Hagen 1937, Taf. 19, Abb.1, A6). See also Allason-Jones 1996b, no. 173.
2. Jet bead (D: 9.5mm H: 6mm). Road 8, F08:05, 2340, WSJ1, 2001.2253
Finely carved small jet melon bead. For discussion see Allason-Jones 1996b, 28. Cf. South Shields: Allason-Jones and Milet 1984, 7.35.
3. Jet bead (D:11.5mm H:8mm). Area over Road 3, unstratified, K13:01, 1770, WSJ7, 2001.2259
Globular jet bead decorated with incised lines top and bottom but with a plain band around the middle.
4. Jet bead (W:31mm H:18mm T:5.5mm). Area over Building 1 and Road 4, unstratified, M04:01, 83, WSJ6, 2001.2258
Jet bead of semi-oval shape with the decoration of incised grooves, both oblique and transverse, confined to the curved edge. Pierced by two circular holes (D:3mm). Similar beads, which appear to have been used mostly as armband beads, are known wherever Roman jet objects have been found. This example, however, is unusual in its central group of closely grouped incised lines. See Allason-Jones 1996b, 27–8.
5. Shale fragment (W: 4mm D(int): 34mm). Area over Building 12, unstratified, L14:01, 1394, WSJ2, 2001.2254
Curved fragment of shale, possibly from a pendant or bracelet. The section is damaged but was probably oval.
6. Jet pin or spindle (L:28.5mm D:6.5mm). Building 13, room 7, mid-third century, N12:08, 1760, WSJ8, 2001.2260
Tapering rod of circular section with a blunt head. Pin or spindle?
7. Shale spindlewhorl (D: 35mm). Area over Road 3,

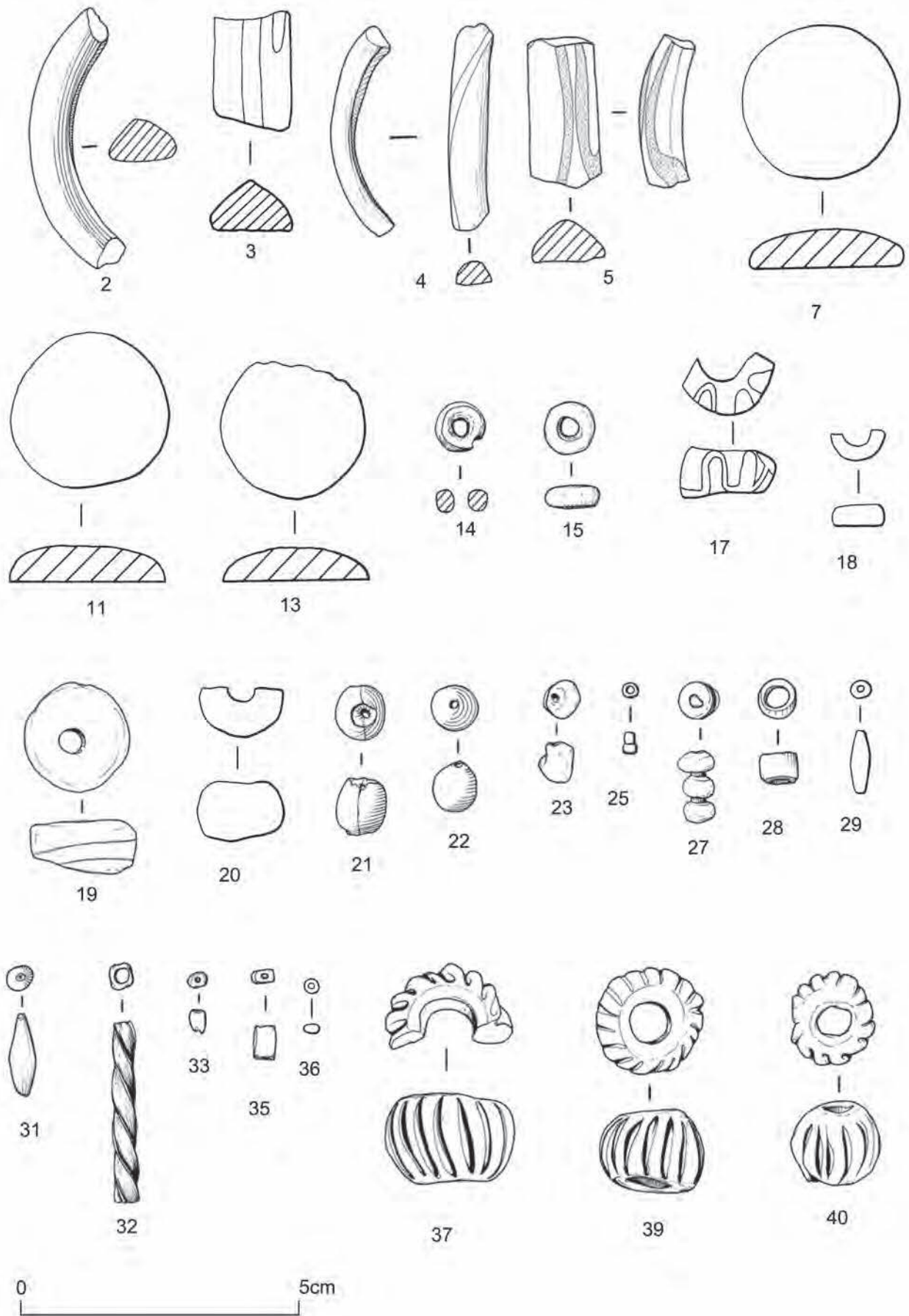

Fig re 2 Glass nos 2 Scale 1

unstratified, N13:01, 1655, WSJ5, 2001.2257

Incomplete shale spindlewhorl with an incised marginal line on the surviving face. Three incised concentric circles surround the 5.5mm central hole, the edges of which show wear lines.

8. Cannel coal spindlewhorl (D: 32mm D of hole:6mm). Area over Building 7, unstratified, G10:01, 2069, WSJ3, 2001.2255

Incomplete spindle whorl of cannel coal. The whorl is circular with a flat top and curved sides with a single incised line around the hole and one at the edge. Several incised lines appear to run around the sides but the whorl is cracking along natural planes so some of the lines may be natural.

9. Shale block (L:75mm W:35mm B:30mm). Road 8, F09:58, 2350, WSJ9, 2001.2261
Unworked block of shale.

Glass (Fig. 25.28)

1. Armlet (W:8mm, T:11mm). Alley 1, dereliction, L05:29, WSG114, 2001.1760

Fragment of an ice-blue translucent armlet with a central cable of mid-blue and white.

2. Armlet (W:11mm T:7mm). Rampart building north of *Porta quintana*, Period 2–3, C11:04, 1191, WSG20, 2001.1666

Fragment of an opaque, bluey-white armlet of semi-circular section. Kilbride-Jones 1938, Type 3A. This is the commonest form of glass bracelet to be found in the Hadrian's Wall area and had a long period of manufacture from the first to the fourth centuries, being most popular in the first and second centuries. For lists of parallels and dating evidence see Kilbride-Jones 1938 and Allason-Jones and Miket 1984.

3. Armlet (W:9mm, T:13mm). Building 16, floor, Period 1–2, L07:13, 2098, WSG141, 2001.1787

Fragment of an opaque white armlet of triangular section with marvered yellow lines. Kilbride-Jones 1938, Type 3D, dated to the first half of the second century and largely confined to Scotland.

4. Armlet (W:7mm T:5mm). Area over Building 4 and Alley 3, unstratified, H04:01, 618, WSG26, 2001.1672

Fragment of an uncoloured translucent armlet of hemispherical section with a single white opaque marvered line. Kilbride-Jones 1938, Type 3F. On the evidence of the Traprain Law examples Kilbride-Jones suggested that the manufacture of Type 3F bracelets may not have started before the beginning of the second century.

5. Armlet (W:13mm T:7mm int. diam.:65mm). Area over Building 11 and Alley 6, unstratified, L15:17, 1504, WSG34, 2001.1680

Fragment of an uncoloured translucent armlet of triangular section with opaque yellow marvering. Kilbride-Jones 1938, Type 3G.

6. Inset (D:11mm H:6mm). Building L, demolition, Period 4, G04:03, 232, WSG152, 2001.1798

Domed, circular, opaque white inset for a finger ring or brooch.

7–10. BUN-SHAPED COUNTERS

7. (D:28mm). Building 3, officer's quarters, abandonment/

post-Roman, P08:13, 2577, WSG189, 2001.1835.
Opaque black.

8. (D:19mm H:6mm). Building 13, post-Roman, M12:33, 1769, WSG31, 2001.1677. Opaque black.

9. (D:15mm). Road associated with north-west shacks (B2), Period 3–4, G05:12, 480, WSG21, 2001.1667. Opaque white.

10. (D:14mm). Area over Tower 2, unstratified, E02:11, 744, WSG155, 2001.1801. Opaque white.

11–13. COUNTERS WITH CONVEX UPPER FACE

11. (D:29mm). Building 14, room C make-up, Period 2?, J12:37, 2208, WSG19, 2001.1665. Opaque dark red.

12. (D:29mm B:6mm). Building 14, crosshall, Period 3, J11:26, WSG196, 2001.1842. Opaque black.

13. (D:25.5mm B:5.5mm). Building 14, crosshall, Period 3, J11:31, 2094, WSG18, 2001.1664. Dark green.

14–16. OPAQUE YELLOW GLASS BEADS

Annular beads of opaque yellow glass. Guido 1978, Class 8, 250 BC to AD 50.

14. (D:9.5mm T:2.5mm). Chalet 12, Building AM2, (mid)-late third century, M14:12, 1783, WSG202, 2001.683

15. (D: 10mm T: 4mm). Chalet 9, post-Roman, G13:03, 1238, WSG41, 2001.1687

16. (D: 9mm, T: 3mm). Chalet 9, post-Roman, D12:18, 1058, lost.

17. Bead (D:17mm T:8mm). Chalet 9, post-Roman, G14:16, 1239, WSG143, 2001.1789

Cobalt blue translucent annular bead with white opaque marvered trails. Guido 1978, Group 5A. This type had a long period of popularity, the earliest known examples in England dating to third–fourth centuries BC, and continuing into the sixth and seventh centuries AD (Guido 1978, 62–4, Schedules 128ff).

18. Bead (D:10mm T:4mm). Rubble over Building 8 (B2), late third century, D12:09, 1009, WSG158, 2001.1804
Half an annular dark blue translucent glass bead. Guido 1978, Group 6ivb. Guido suggests that the presence of such beads on a Roman site is usually indicative of a native element. Examples have been found in contexts dating from sixth–fifth centuries BC to the eighth century AD.

19. Bead (D:19mm T:9mm). Area over North rampart, unstratified, M03:01, 767, WSG22, 2001.1668

Large annular bead of an uncoloured greyish translucent glass. The bead is wedge-shaped in section and may have been made from waste glass. Guido 1978, Group 7, 69.

20. Bead (D:16mm T:11mm). Area over Alley 5, unstratified, G14:01, 1060, WSG145, 2001.1791

Half of a large globular translucent blue glass bead. This is a common type, although this example is unusually large, and almost undateable. Guido 1978, 9, Group 7i.

21. Bead (D:9mm T:9mm). Area over Building 2, ploughsoil, L05:03, 666, WSG25, 2001.1671

Globular, pale blue translucent glass bead. Guido 1978, 69, Group 7i.

22. Bead (D:8mm T:8mm). Area over Building 11, unstratified, K15:01, 1342, WSG40, 2001.1686

- Globular, uncoloured translucent glass bead. Guido 1978, 69, Group 7ii.
23. Bead (D:6.5mm L:7mm). Area over Building 12 and *Via quintana*, unstratified, N14:01, 1825, WSG32, 2001.1678
Globular bead of uncoloured translucent glass.
24. Bead (D:8mm T:6mm). Area over Building 2 and Alley 1, unstratified, M05:01, 619, WSG144, 2001.1790
Globular, sky-blue opaque glass bead. Guido 1978, Group 7v, 70; note particularly the comments on dating.
25. Bead (L:4mm T:3mm). Area over Building 2, ploughsoil, L05:03, 613, WSG154, 2001.1800
Fragment of a white glass segmented bead apparently with white metal foil enclosed instead of the more common gold foil. Such beads are usually found in Britain in late contexts and were imported from the Near East and Egypt. See Boon 1966b, Boon 1977, and Guido 1978, 93.
26. Bead (L:4mm). Building 2, *contubernium* 5, Period 3 or later, M05:11, 272, WSG157, 2001.1803
Fragment of a segmented white glass bead enclosing gold foil. See above.
27. Bead (L:13mm T:6.5mm). Drain in Road 3, G11:07, 2409, WSG29, 2001.1675
Segmented bead of green opaque glass. This type is not as common in the Hadrian's Wall region as the gold foil type. Guido 1978, 91 ff.
28. Bead (L:5mm D:6mm). Building L, demolition, Period 4, G04:03, 146, WSG27, 2001.1673
Tubular bead of opaque green glass. Examples of this type are known in England from the first century at Santon Downham but did not reach maximum popularity until after the third century.
29. Bead (L:11mm Max. T:3.5mm). Area over Building 12, unstratified, L14:01, 1288, WSG146, 2001.1792
Biconical green opaque bead. This type of bead is well known in the north of England but green examples are less common than blue. Guido 1978, 97–98; third to fourth centuries.
30. Bead (L:9mm). Area over Building 11, unstratified, J15:05, 1495, WSG142, 2001.1788
Small biconical blue opaque bead. Guido 1978, 98. This type of bead was largely confined to the south and midlands during the second and early third century but is known from sites on Hadrian's Wall in late third- and fourth-century contexts.
31. Bead (L:15mm). Area over Building 11 and Alley 6, unstratified, L15:01, 1544, WSG36, 2001.1682
Biconical opaque cobalt blue bead. See above.
32. Bead (L:52mm T:4mm). Area over Buildings 7 and 8, unstratified, F10:01, 2189, WSG33, 2001.1679
Long translucent green twisted cylinder bead of square section.
33. Bead (L:4mm, T:3mm). Building 13, M12:55, 1833, WSG30, 2001.1676
Small, royal-blue, opaque cylinder bead of circular section. See Guido 1978, 94–5 and 207–8.
34. Bead (L:5.5mm D:4mm). Building 14, courtyard, late third/early fourth century, J09:21, 2145, WSG24, 2001.1670
Cylindrical opaque green bead. Guido 1978, 95 and 208–12.
35. Bead (L:6mm W:4mm T:2mm). Building 14, robber trench, H08:04, 2161, WSG23, 2001.1669
Translucent, dark green cylinder bead of rectangular section. Guido 1978, 96 and 212–5.
36. Bead (D:3mm). Area over Buildings 1, 2 and Alley 1, unstratified, N05:03, 127, WSG160, 2001.1806
Very small globular bead which is now iridescent blue with a patch of green but was possibly white originally.

37–45. MELON BEADS

Guido (1978, 100) has suggested that most blue or green glass melon beads can be found in Flavian or Antonine contexts, apparently dying out in the late second century and not reappearing until post-Roman times.

37. (D:23mm H:15mm). Road 9, post-Roman, H15:06, 1481, WSG35, 2001.1681. Dark blue glass.
38. (D:22mm H:17mm). Area over Road 9, unstratified, H14:49, 1235, WSG28, 2001.1674. Blue frit.
39. (D:19mm H:15mm). Area over Building 10 and Road 9, unstratified, H15:01, 1433, WSG42, 2001.1688. Blue frit.
40. (D:17mm H:14mm). Area over Building 1 and Alley 1, unstratified, P05:02, 109, WSG38, 2001.1684. Blue frit.
41. (D:16mm H:14mm). Chalet 12, Building AF, Period 4, L15:12, 779, WSG37, 2001.1683. Pale green frit.
42. (D:14mm H:11.5mm). Building AO, Period 4?, J07:15, 2176, WSG159, 2001.1805. Blue frit.
43. (D:12mm H:9mm). Building N, late third century, E11:06, 1028, WSG201, 2001.1453. Pale green frit.
44. (H:15mm). West rampart (F2), Q04:16, 408, WSG161, 2001.1807. Bright blue frit.
45. (H:11mm). Building 9, *contubernium* 8, Period 2, G14:17, 1597, WSG163, 2001.1809. Blue frit.

Pottery (Fig. 25.29)

For the abbreviations used to describe the pottery fabrics, please see Chapter 22.

1. Statuette (L:95mm W:48mm). Soil over north-south drain east of Building 3, Period 3–4, Q07:10, 2590, WSP143, 2001.2456
Incomplete front section of a pipeclay *dea nutrix* statuette showing the goddess seated in a high-sided basketwork chair with a high plinth, suckling two infants. Such figurines were mass-produced in the Allier district of Gaul in the second century in moulds. Although common finds in the south-east of Britain they are less commonly found in the military north than the comparable Venus figurines. Examples are known from Binchester, Chesterholm, Corbridge, Piercebridge, South Shields: see Green 1978. For a general discussion see Jenkins 1957.
2. Statuette (D(base): 38mm). West of Building C, Period 3–4, F05:08, 448, WSP197, 2001.2510
Fragment of the domed base of a pipeclay statuette of Venus of which only the back of the feet survive. Whilst the clay was still plastic a 'V' was deeply incised just above the dome. These figurines were manufactured in the samian factories of Gaul from the mid first century AD until the centre of manufacture

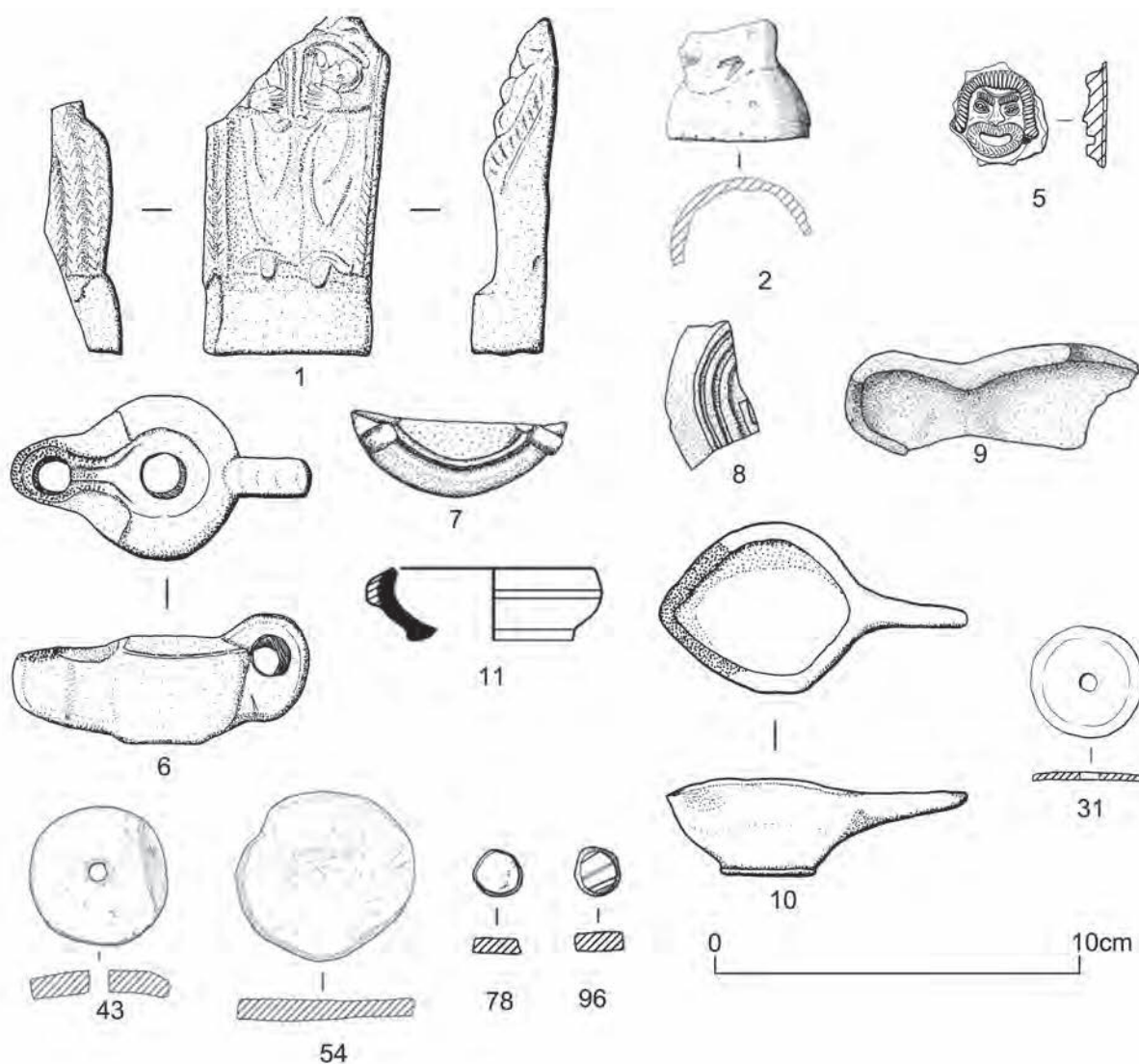

Figure 25.29: Pottery. Scale 1:2.

- moved to Cologne at the end of the century. See Jenkins 1958.
3. Statuette (L:37mm). Area over Building 8, unstratified, E10:01, WSP92, 2001.2405
Fragment of a pipeclay figurine. Two strands of hair drape the shoulder, suggesting that this is from a Venus figurine.
 4. Statuette (H: 26mm, W: 22mm, T: 11mm). Area of Building B and K, post-Roman, L05:07, 828, WSP196, 2001.2509
Foot from a pipeclay figurine.
 5. Lamp (L of mask:24mm T of lamp wall:1.5mm). Area of Building 13, unstratified, M11:02, 1768, WSP216, 2001.2528
Fragment from the discus of a mould made *firmalampe* of brown fabric showing a slave mask in relief. The mask has a ridged 'page-boy' hairstyle, pronounced eyebrows, a hooked nose and a gaping mouth with herring-bone motifs around the lips. There is a thumbprint on the back of the mask. Late first or early second century. North Italian: cf. Bailey 1975–96, 288, Q185.
 6. Lamp (L: 82mm H: 26mm, Oil hole: 12mm, Wick hole: 10mm, Handle hole: 9mm). Building 8, room 8, Period 2, E10:74, 2398, WSP171, 2001.2484
Complete pottery lamp of buff fabric with a light brown colour coat. The single wick hole is well sooted and the oil hole is countersunk. The only decoration is two shallow ribs across the sloping shoulders. Donald Bailey has suggested (*pers. comm.*) that this *firmalampe* was made in Holland or Germany although a French origin cannot be ruled out. Loeschcke 1919, Type X; Evelein 1928, Type B.
 7. Lamp (D(of *discus*):37mm). Building 8, room 1, mid-third century?, D11:15, WSP152, 2001.2465
Fragment of the *discus* and rim of a *firmalampe* with two lugs on the rim. Grey fabric, red on interior surface. (AC)
 8. Lamp (H:20mm). Building 10, *contubernium* 3/4/5, Period 2, F15:20, WSP149, 2001.2462
Two joining wall sherds of a *firmalampe* in a pale orange fabric with scattered fine inclusions and occasional large (1mm) red inclusions. The surfaces are slightly paler in colour, and the upper part of the exterior wall

- has been burnished. The base has two concentric rings and part of one letter of a name-stamp. (AC)
9. Lamp (L:90mm H:25mm). Area over Building 2 and Alley 1, unstratified, M05:01, WSP147, 2001.2460. Incomplete open lamp in a gritty, micaceous orange fabric with a grey core and occasional large (1mm) black inclusions. There is sooting on the both nozzle and the rim of the side wall. Open lamps are usually first- or second-century in date. (AC)
 10. Lamp (L: 82mm, H: 25mm). Alley10/Building 17, disturbed surface inside building, third century, G04:16, 402, WSP187, 2001.2500
Small, pear-shaped ladle or open lamp. There are traces of burning on the lip of the fine pink-beige fabric. A short tapering handle projects on a line with the rim diametrically opposite the lip. The base is wire drawn.
 11. Lamp (H:18mm). Area over Building 2 and Alley 1, post-Roman dereliction, M05:04, WSP267, 2001.2579
Fragment of a small, wheel-thrown bowl with part of an applied handle. Probably small open lamp as no. 10 above. Locally produced oxidised ware fabric 1. Loeschcke 1919, Type XII. Cf. Eckardt 2002, fig. 107, no. 768. (AC).
 12. Lamp (L: 40mm, W: 26mm, H. of handle: 11mm). West of Building C, Period 3–4, F05:08, 435, WSP193, 2001.2506
Base and handle of a very small clay lamp. There is no indication that there was ever a receptacle for oil and this was probably a toy or votive model. Cf. Bailey 1975–96, Q62, Q145, Q601.
 13. Number not used.
- 14–50. PERFORATED POTTERY DISCS
- As has been discussed in Allason-Jones and Miket 1984, 337–8, there is doubt as to whether all pottery discs with central holes should be identified as spindlewhorls as has invariably been the case in the past. The majority of the Wallsend examples are particularly unlikely to have been spindlewhorls as they are roughly made, vary considerably in thickness and several of the holes are off-centre. It is more probable that they were used as gaming tallies although the larger ones could have been used as lids.
- Grey or black colour
14. (D:46mm T:4mm). Building 2, *contubernium* 5, Period 3 or later, M05:11, 301, WSP227, 2001.2539. South-eastern reduced ware cooking pot body sherd from near shoulder, so highly curved.
 15. (D:42mm, T:6mm). Rubble over east rampart and *intervallum* road, Q07:07, 2498, WSP220, 2001.2531. BB1 bowl/dish base sherd.
 16. (D:41mm T:5mm). Road surface (B2), Period 3–4, H05:14, 778, WSP114, 2001.2427. Possibly from a BB2 bowl/dish.
 17. (D:39mm T:7mm). Area over Building 13 and Alley 7, unstratified, L09:01, 2060, WSP113, 2001.2426. Unknown reduced ware, cooking pot body sherd with lattice decoration.
 18. (D:38mm T:6mm). Debris over Cistern 1, Roman/post-Roman, E08:13, 2266, WSP221, 2001.2532. BB2 bowl/dish body sherd.
 19. (D:37mm T:9mm). Area over Road 8, unstratified, E09:13, 2238, WSP108, 2001.2421. Unknown reduced ware, probably a cooking pot.
 20. (D:37mm T:9mm). Gate 2, floor, late third century, D07:07, 2328, WSP107, 2001.2420. Unknown reduced ware, burnt. Possibly from the base of a cooking pot.
 21. (D:37mm T:7mm). Area over Building 7, unstratified, F11:01, 1157, WSP229, 2001.2541. BB2 bowl/dish body sherd.
 22. (D:36mm T:6mm). Building Row 20, Building Q, late third/early fourth century, F11:11, 1195, WSP106, 2001.2419. BB2.
 23. (D:36mm T:5mm). Area over Building 9, unstratified, D13:01, 1480, WSP228, 2001.2540. BB2 bowl/dish.
 24. (D:36mm T:5mm). Area over rampart by Gate 2, unstratified, D08:01, 2228, WSP219, 2001.2530. Unknown reduced ware cooking pot body sherd.
 25. (D:35mm T:6mm). Road 9 drain fill, J14:06, 1378, WSP103, 2001.2416. Unknown reduced ware cooking pot body sherd, with lattice decoration.
 26. (D:34mm T:8mm). Area over Building 12, unstratified, K14:03, 1625, WSP115, 2001.2428. NVCC beaker base, black colour coat.
 27. (D:34mm T:5mm). Area over Building 2 and Alley 1, post-Roman, M05:04, 41, WSP226, 2001.2538. BB2 bowl/dish base sherd.
 28. (D:33mm T:6mm). Area of Building 11 and Alley 6, no details, L15:03, 1550, WSP225, 2001.2537. Unknown reduced ware.
 29. (D:31mm T:4mm). Area over Building 10 and *intervallum* road (Road 6), unstratified, G15:01, 1452, WSP231, 2001.2543. BB2 cooking pot body sherd. Unfinished, with hole drilled on one side only.
 30. (D:30mm T:7mm). Area over Building 11 and Alley 6, unstratified, L15:17, 1556, WSP222, 2001.2533. Grey ware cooking pot body sherd.
 31. (D:30mm T:2.5mm). Area over Building 11 and Alley 6, unstratified, L15:01, 1393, WSP141, 2001.2454. NVCC beaker base sherd, black colour coat.
 32. (D:29mm T:6mm). Alley10/Building 17, disturbed surface inside building, third century, G04:16, 411, WSP105, 2001.2418. Unknown reduced ware, probably a cooking pot.
 33. (D:25mm T:6mm). Building 1, Period 2 demolition, Q04:02, 102, WSP224, 2001.2536. BB2 bowl/dish.
- White
34. (D:42mm T:6.5mm). Area over Building 12, unstratified, L14:01, 1276, WSP206, 2001.2518. White ware flagon body sherd.
- Orange (samian, unless otherwise stated)
35. (D:49mm B:5mm). Area over Building 10 and *intervallum* road (Road 6), unstratified, F15:01, 1054, WSP181, 2001.2494. Base of North Gaulish fabric 2 fine ware beaker, orange fabric and brown colour coat.
 36. (D:42mm T:8.5mm). Area over Road 8, unstratified, F08:01, 2183, WSP205, 2001.2517. CG
 37. (D:41mm T:8mm). Area over Building 12 and Road 3, unstratified, N14:11, 1704, WSP109, 2001.2422. CG

38. (R:c.20mm). Area over Building 2, unstratified, L05:01, 617, lost. Incomplete.
39. (D:39mm T:7mm). Area over Building AO, unstratified, L08:01, WSP167, 2001.2480.
40. (D:38mm T:5mm). Area over Building 11, unstratified, J15:05, 1520, WSP230, 2001.2542. CG Dr. 33
41. (D:36mm T:5mm). Area over Buildings 7 and 8, unstratified, F10:12, 2235, WSP213, 2001.2525. EG
42. (D:36mm T:8mm). Cistern 1, lower fill, late third century, E08:44, 2370, WSP207, 2001.2519. EG
43. (D:36mm T:5.5mm). Area over Building 2 and Alley 1, unstratified, M05:01, 665, WSP139, 2001.2452. CG Dr. 18/31 body sherd.
44. (D:35mm T:9mm). Building AO, Period 4?, J07:15, 2160, WSP215, 2001.2527.
45. (D:34mm T:7mm). Area over *intervallum* road (Road 4), unstratified, P04:01, 16, WSP104, 2001.2417. South-eastern reduced ware cooking pot body sherd.
46. (D:33mm T:6mm). Area over Building 1, unstratified, L04:15, 891, WSP208, 2001.2520. CG
47. (D:32mm B:9mm). Chalet 12, Building AL2, (mid)-late third century, M15:21, 1892, WSP168, 2001.2481.
48. (D:30mm T:6mm). Area over *Via quintana*, unstratified, G12:01, 1168, WSP111, 2001.2422. CG Dr. 31 or 18/31.
49. (D:26mm T:5mm). Area over Building 4 and *Via praetoria*, unstratified, K04:01, 768, WSP199, 2001.2512. EG
50. (D:16mm T:6mm). Area over Building BA, unstratified, M13:01, 1686, WSP110, 2001.2423. CG

51–97. DISCS

It was a common practice for discs to be cut from sherds of pottery and such discs are usually identified as gaming counters. However, some of the discs in this assemblage are larger than would be required for gaming counters and it is probable that some were used as lids, bungs, or weights.

Amphora (Dressel 20)

51. (D:110mm B:18mm). Building 9, *contubernium* 2, Period 2, E13:13, WSP265, 2001.2577.
52. (D:105mm B:25mm). Timber Building 2, Period 1, E10:77, WSP264, 2001.2576.
53. (D:55mm). Area over Building 4, unstratified, J04:01, WSP266, 2001.2578.

Grey or black in colour

54. (D:48mm T:7mm). Building 8, courtyard, Period 4, E10:11, 1156, WSP118, 2001.2431. BB2 bowl/dish base sherd.
55. (D:45mm T:9mm). Building 8, room 8 cess-pit fill, mid-third century?, E10:43, WSP170, 2001.2483. BB2 bowl/dish base sherd.
56. (D:43mm T:5mm). Yard south of Building 13, Period 1–2, N13:03, 1846, WSP223, 2001.2534. BB2 bowl/dish base sherd.
57. (D:40mm T:5mm). Road 9, post-Roman, H15:06, 1448, WSP127, 2001.2440. South-eastern reduced ware cooking pot body sherd.
58. (D:37mm T:6–8mm). Building 1, Period 2 demolition, N05:04, WSP150, 2001.2463. BB2 bowl/dish base.
59. (D:35mm T:6mm). Rubble over Building 8 (B3),

- mid-third century or later, E10:53, 2316, WSP119, 2001.2432. BB2 bowl/dish base sherd.
60. (D:34mm T:6mm). Area over Building 10, unstratified, D14:01, 1082, WSP122, 2001.2435. Unknown reduced ware.
61. (D:33mm T:8mm). Area over Buildings 7 and 8, unstratified, F10:12, 2256, WSP117, 2001.2430. BB2 cooking pot base.
62. (D:33mm T:8mm). Area of Building 1 and Road 4, no details, M04:24, WSP148, 2001.2461. BB2 bowl/dish base sherd.
63. (D:32mm T:6mm). Road 3, E12:30, 1182, WSP121, 2001.2434. BB2, possibly a cooking pot.
64. (D:32mm T:4mm). Area over Building 1, unstratified, L04:03, WSP91, 2001.2404. NVCC beaker base, brown colour coat.
65. (D:31mm T:5mm). Building 8 abandonment/make-up layer for Building N, mid/late third century?, E12:03, 1029, WSP120, 2001.2433. BB2 bowl/dish body sherd.
66. (D:30mm T:6mm). Building 11, *contubernium* 3/4, Period 2, L15:23, 1624, WSP130, 2001.2443. BB2 bowl/dish body sherd.
67. (D:29mm T:6mm). Area over Building AO, unstratified, K08:01, WSP145, 2001.2458. BB2 bowl/dish base sherd.
68. (D:28mm T:6mm). Rubble over west *praetentura*, Period 4, 824, WSP125, 2001.2438. BB2 bowl/dish, probably a base sherd.
69. (D:25mm T:5mm). Area over Building 10 and *intervallum* road (Road 6), unstratified, F15:01, 1055, WSP129, 2001.2442. BB2 body sherd.
70. (D:25mm T:5mm). Area over Building 10 and Alley 5, unstratified, F14:01, 1421, WSP124, 2001.2437. BB2 bowl/dish, with hole started from both side. Unfinished pierced disc?
71. (D:24mm T:5mm). Building 2, *contubernium* 8, demolition rubble, Period 3 or later, L05:25, WSP146, 2001.2459. Unknown grey ware beaker base.
72. (D:21mm T:5mm). Building 1, Period 2 demolition, Q04:02, 89, WSP131, 2001.2444. BB2 bowl/dish body sherd.
73. (D:21mm T:4mm). Unstratified, L15:??, WSP144, 2001.2457. Unknown reduced ware.
74. (D:19mm T:5.5mm). Area over Building 2, ploughsoil, L05:03, 608, WSP123, 2001.2436. BB2, possibly cooking pot.
75. (D:19mm T:6mm). Area over Building 2, ploughsoil, L05:03, 609, WSP128, 2001.2441. South-eastern reduced ware cooking pot body sherd.
76. (D:16mm T:6mm). Area over Building 2, ploughsoil, L05:03, 607, WSP126, 2001.2439. BB2 cooking pot.
77. (D:16mm B:5mm). Area over Building 1, ploughsoil, Q05:02, 63, WSP135, 2001.2448. Burnt samian.
78. (D:13mm T:4.5mm). Building 8, room 1, mid-third century?, D11:15, 1049, WSP116, 2001.2429. BB2 cooking pot body sherd.

Orange (samian, unless otherwise stated)

79. (D:44mm T:6mm). Area over Building 12, unstratified, K14:03, 1537, WSP182, 2001.2495. CG.
80. (D:42mm T:7mm). Area over Building 9, unstratified, H13:06, 1253, WSP184, 2001.2497. CG, late Antonine.
81. (D:33mm T:8mm). Chalet 10, Building X, Period 4, G15:16, 962, WSP132, 2001.2445. EG, late Antonine.

82. (D:33mm B:9mm). Area over Building 13 and *Via quintana*, unstratified, L12:01, 1676, WSP209, 2001.2521. Decorated body sherd.
83. (D:32mm B:12mm). Area over Building 1, unstratified, L04:11, WSP275, 2001.2586.
84. (D:31mm). Road 8, F08:10, 2254, WSP214, 2001.2526. CG Dr.18/31, Antonine.
85. (D:30mm). Clay puddling pit, Period 3 demolition, N05:14, WSP272, 2001.2583.
86. (D:20mm B:7mm). Area over Buildings 4, 5 and Alley 3, unstratified, G04:02, WSP278, 2001.2589.
87. (D:20mm B:6mm). Area over Road 9, unstratified, J14:05, WSP274, 2001.2585.
88. (D:24mm T:11mm). Area over Cistern 1, unstratified, E08:08, 2230, WSP183, 2001.2496. EG, late Antonine-third century.
89. (D:19mm T:5.5mm). Alley 4, F05:47, 483, WSP140, 2001.2453. CG with ovolo border filling half the face.
90. (D:19mm B:5mm). Area over Building AO, unstratified, K08:01, WSP273, 2001.2584.
91. (D:18mm T:5mm). Area over Building 13, unstratified, M12:01, 1662, lost.
92. (D:17mm T:5mm). Area over Building 2, ploughsoil, L05:03, 625, WSP112, 2001.2425 CG or EG.
93. (D:16mm T:6mm). Building 14, crosshall, Period 1 or 2, K11:55, 2162, WSP203, 2001.2515. Unknown oxidised ware, polished after manufacture.
94. (D:16mm T:5mm). Area over Building 2, ploughsoil, L05:03, 606, WSP134, 2001.2447. Slip removed completely on one face.
95. (D:15mm B:5mm). Unstratified, WSP204, 2001.2516.
96. (D:13mm T:5mm). Area over Building 2, ploughsoil, L05:03, 605, WSP212, 2001.2524. CG. Slip removed almost completely on one face.
97. (D:13mm T:6mm). Building 8, room 1 wall, Period 2, D11:11, 993, WSP133, 2001.2446.

Tile (Fig. 25.30)

1. Disc (D: 53mm T: 15mm). Wall of medieval or modern building, N05:02, 192, WST21
Roughly circular disc cut from the top end of a *tegula* roof tile, utilising the nail hole. Net sinker or loom weight.

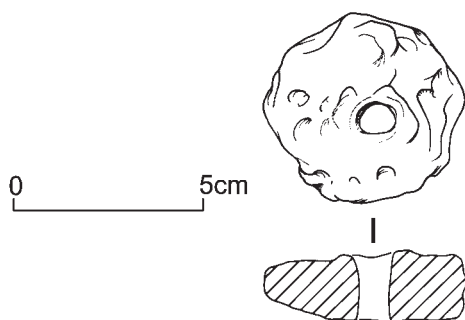

Fig. 25.30 Tile. Scale 2

Stone (Figs 25.31–3)

1. Palette (L:101mm W:63mm T:9mm). Building 18, *contubernium* 1, floor, Period 3–4, F05:39, 486, WSS266, 2001.3122
Rectangular slate palette which narrows slightly to one end. Three edges are bevelled; the evidence from the Continent suggests that the bevelled edges were to enable the palettes to slide into grooved metal frames. See Allason-Jones and Milet 1984, no. 12.68.
 2. Palette (L:81mm, W:62mm, T:16mm). Area over Building 7, unstratified, E11:17, 1111, WSS68, 2001.2925
Rectangular slate palette with rounded edges on three sides. The fourth edge has been deliberately cut across.
 3. Palette (L:75mm W:68mm). Building 3, abandonment/post-Roman dereliction, P07:07, WSS85, 2001.2942
Incomplete rectangular palette bevelled on three edges.
 4. Slate Palette (D:77mm T:3mm). Building 2, *contubernium* 8 wall, Period 3, L05:54, 947, WSS82, 2001.2939
Half of an oval slate palette which tapers slightly to the rounded edge.
- 5–13. WHETSTONES WITH AN OVAL CROSS-SECTION
Fine-grained sandstone unless otherwise stated.
5. (L:103mm W:53mm T:18mm). Chalet 10, Building X, Period 4, H15:10, 1429, WSS295, 2001.3151. Greywacke. With rounded end.
 6. (L:71mm W:42mm T:27mm). Area of Building 2, no details, L05:20, 889, WSS73, 2001.2930. Incomplete. Flat end.
 7. (L:65mm W:35mm T:24mm). Area over Building 10, post-Roman, D14:08, 1478, WSS276, 2001.3132. Micaceous sandstone. Incomplete, with rounded end.
 8. (L:48mm W:33mm T:20mm). Chalet 9, post-Roman dereliction, G13:03, 1240, WSS250, 2001.3106. Carboniferous. Very coarse stone. Incomplete.
 9. (L:95mm W:31mm T:24mm). Area over Gate 3 and *intervallum* road (Road 6), unstratified, J16:01, 1322, WSS277, 2001.3133. Carboniferous. Incomplete, with a tapering, squared end.
 10. (L:79mm W:27mm T:16mm). Alley 3 eaves drip trench, Period 3, F04:33, 578, WSS269, 2001.3125. Greywacke. Incomplete, with rounded end.
 11. (L:49mm W:24mm T:11mm). Area over Building 3 and Alley 2, unstratified, N07:01, 2465, WSS285, 2001.3141. Lentoid section, with squared end.
 12. (L:83mm W:22mm T:13mm). Building 7, west granary make-up layers, F11:12, 957, WSS274, 2001.3130. Iron-rich sandstone. Slightly curved, with rounded ends.
 13. (L:81mm W:20mm, T:14mm). Area over Building 13, unstratified, N10:01, 2471, WSS74, 2001.2931. Incomplete, rounded at one end.

14–30. WHETSTONES WITH A SQUARE OR RECTANGULAR CROSS-SECTION

Fine-grained sandstone unless otherwise stated.

14. (L:170mm W:52mm T:26mm). Building 1 foundations, officer's quarters, Period 3, Q05:17, 297, WSS71, 2001.2928. Squared end.
15. (L:120mm W:49mm T:18mm). West rampart, mid-third century, D08:12, 2408, WSS65, 2001.2922. Rounded end.

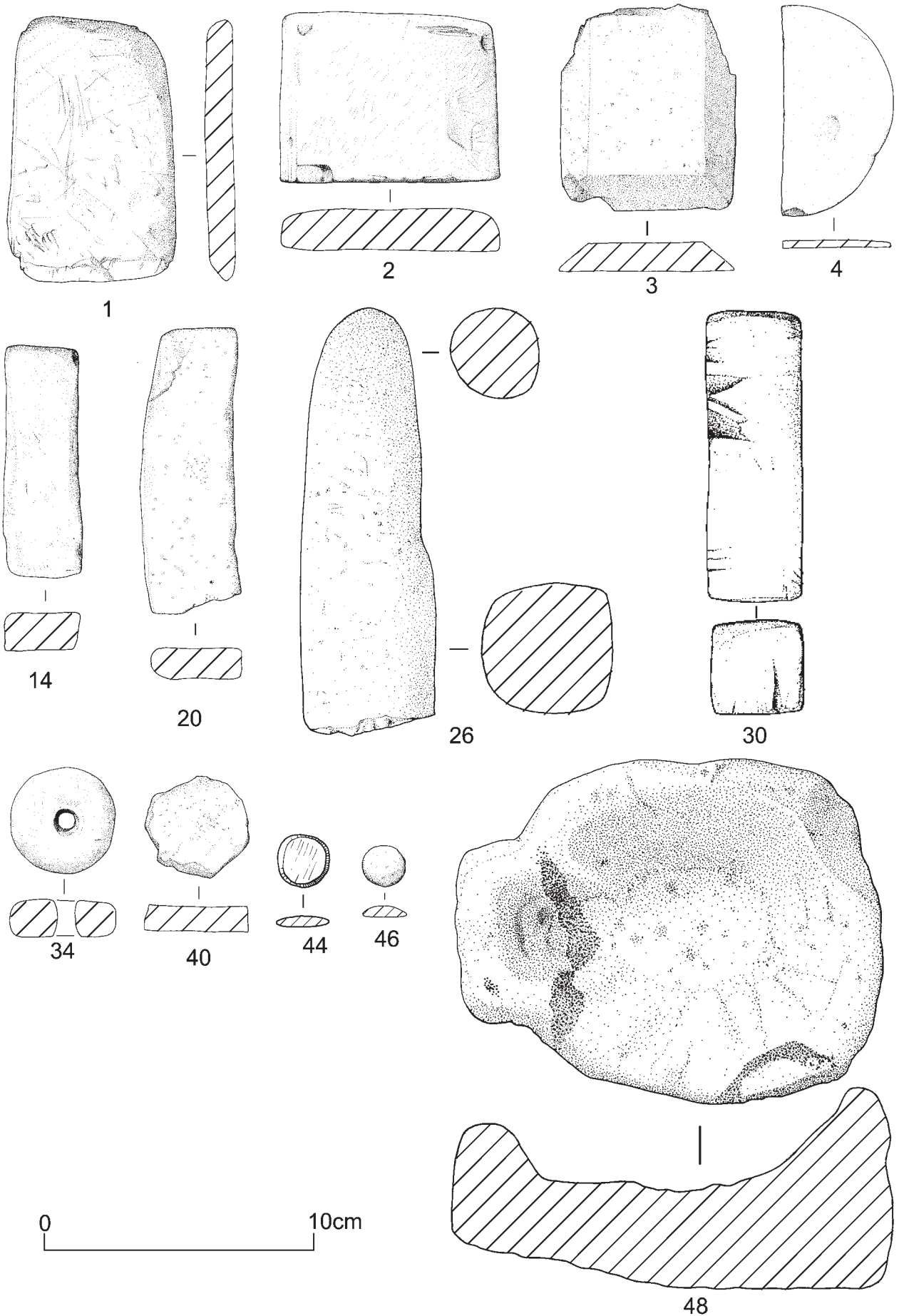

Fig re 3 1 Stone nos 2 Scale 1 .

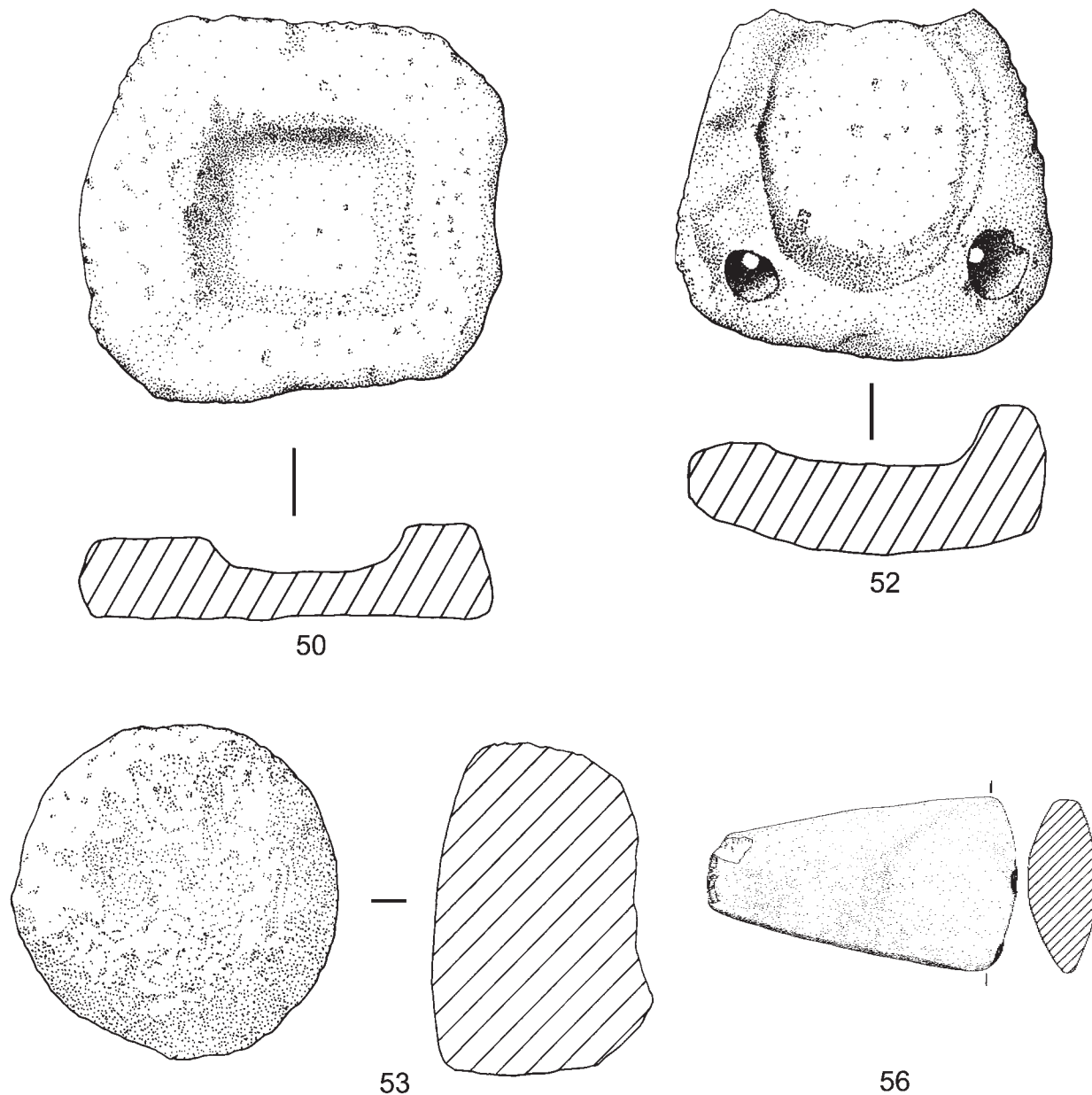

Fig re 3 3 Stone nos 50 52 53 56 Scale 1 2

16. (L:56mm W:39mm T:17.5mm). Rampart building north of *Porta quintana*, Period 2–3, C11:04, 1216, WSS284, 2001.3140. Incomplete.
17. (L:150mm W:36mm T:18mm). Building 16, floor, Period 1–2, K07:08, 2114, WSS69, 2001.2926. Fine-grained whin. Very worn in one area.
18. (L:55mm W:35mm T:35mm). Road 3, F11:19, 1217, WSS70, 2001.227. Incomplete, with rounded ends and edges. One very smooth face.
19. (L:63mm W:35mm T:16mm). Road 8, F09:07, 2354, WSS281, 2001.3137. Incomplete, with squared end.
20. (L:108mm W:34mm T:11mm). Building 1, *contubernia* 2–4, Period 2?, N04:18, 529, WSS279, 2001.3135. Incomplete. Curved.
21. (L:32mm W:32mm B:20mm). Area over Building 1 and *intervallum* road (Road 4), unstratified, M04:01, 13, WSS292, 2001.3148. Incomplete, squared end. Burnt.
22. (L:81mm W:31mm B:20mm). West *intervallum* road, E04:23, WSS87, 2001.2944. Incomplete, upper face tapering to meet lower face at end.
23. (L:61mm W:29mm T:16mm). Building 1, officer's quarters, Period 2, Q05:34, 528, WSS275, 2001.3131. Incomplete.
24. (L:95mm W:25mm B:19mm). Building 3, *contubernium* 2, Period 2, N07:15, 2633, WSS86, 2001.2943. Squared ends.
25. (L:59mm W:25mm B:15mm). Chalet 12, Building AL2, (mid-)late third century, M15:21, 1861, WSS294, 2001.3150. Incomplete.
26. (L:78mm W:24mm T:24mm). Area over Building 4 and *Via praetoria*, unstratified, K04:01, 725. WSS67, 2001.2924. Tapering to circular cross-section at one end.
27. (L:60mm W:23mm T:16mm). Building 13, room 7, Period 4, N12:37, 1886, WSS271, 2001.3127. Very flat



Figure 25.33: Stone lid (no. 35) used with cooking pot (coarse ware pottery cat. no. 68).

- faces and crisp edges. A broad rib runs along two sides. Incomplete.
28. (L:120mm T:22mm W:37mm). Area east of Building 10, post-Roman rubble, H15:06, 1446, SS289, 2001.3145. Coarse sandstone. Incomplete, with squared end.
29. (L:80mm W:21mm T:15mm). Area over Building 11, unstratified, K15:01, WSS290, 2001.3146. Very fine-grained sandstone. With oblique ends which show saw marks.
30. (L:52mm W:18mm T:17mm). Area over Building 10 and Alley 5, unstratified, F14:01, 1470, WSS106, 2001.2963. Short, with squared ends. Showing signs of heavy use.
- 31-2. FLAT SANDSTONE WHETSTONES
31. (L:78mm W:60mm T:23mm). Clay puddling pit, Period 3 demolition, N05:13, 271, WSS66, 2001.2926. Incomplete. Highly polished on one face.
32. (L:109mm Max W:59mm T:24.5mm). Building 18, *contubernium* 1, Period 3-4, F05:15, 440, WSS278, 2001.3134. Large, flat fine-grained sandstone whetstone with curved edges.
33. Pierced disc (D:120mm B:15mm). Unstratified, WSS49, 2001.2906
Large flat disc with small central hole.
34. Spindlewhorl (D:42mm T:19mm). Chalet 12, Building AM2, (mid-)late third century, M14:11, 1859, WSS81, 2001.2938
Circular micaceous sandstone spindlewhorl or loom-weight with a 7mm diameter central hole. Slightly burnt.
35. Pot lid (D:148mm). Building 8, room 1, Period 3, D11:23, WSS108, 2001.2965
Roughly shaped sandstone disc, found *in situ* over a BB2 cooking pot (Fig. 22.15, no. 68) set into the floor of a room in Building 8.
- 36-7. POT LIDS
Roughly worked sandstone discs. Possibly used as pot lids.
36. (D:127mm, T:20mm). Road associated with north-west shacks (B2), Period 3-4, H04:19, 802, WSS265, 2001.3121.
37. (D:140mm B:40mm). Building 16, Period 3 occupation, K08:33, 2097, WSS51, 2001.2908.
- 38-46. DISCS
The smaller examples, especially those which are bun-shaped, were probably used as counters.
38. (D:62mm B:20mm). Building 14, robber trench, K11:30, 1908, WSS53, 2001.2910. Sandstone.
39. (D:57mm B:8mm). Cistern 2, upper fill, late third/early fourth century, J07:14, WSS84, 2001.2941. Sandstone.
40. (D:36mm T:9mm). Lower fill of north-south drain in Alley 9, F10:23, 232, WSS75, 2001.2932. Roughly shaped disc of pink micaceous sandstone.
41. (D:33mm T:6mm). Area over Alley 5, post-Roman, G14:08, 1314, WSS79, 2001.2936. Micaceous sandstone. Flat.

42. (D:25mm T:2mm) Road 8, F08:10, 2446, WSS282, 2001.3138. Sandstone.
43. (D:22mm B:6mm). Area over Building 2 and Alley 1, unstratified, M05:01, 12, WSS301, 2001.2449. Soft white stone.
44. (D:19mm T:3mm). Area over Building 8, unstratified, E11:01, 1103, WSS80, 2001.2937. Sandstone. Flat with a rounded edge.
45. (D:18mm B:5mm). Road 8, F09:06, 2219, WSS107, 2001.2964. Natural pebble, possibly used as counter.
46. (D:15mm T:4mm). Rampart building north of *Porta quintana*, Period 2–3, C11:04, 1085, WSS262, 2001.3118. Fragment of pebble, possibly used as counter.
47. Disc (D:85mm B:35mm). Area over Road 8, unstratified, E09:01, 2205, WSS52, 2001.2909
Sandstone disc, tapering slightly to edges, with circular hollow on upper surface.
48. Lamp (L:165mm W:130mm B:65mm). Building 16, floor, Period 4, N08:24, 2559, WSS58, 2001.2915
Roughly circular sandstone lamp, with nozzle on one side. Burnt.
49. Lamp? (L:170mm W:80mm B:11mm; recess L:90mm W:50mm B:20mm). Area of Road 3, modern, K13:02, 1387, WSS54
Tall, roughly rectangular-shaped block of sandstone, with a lamp-shaped recess pecked out of one surface. Slightly shallower at nozzle end, but with no sign of burning. Unstratified, so could be post-Roman.

50–52. RECESSED STONES

Stone with hollow recesses on side, that might have been used as moulds. Some possibly post-Roman.

50. (L:120mm W:110mm B:25mm; recess L:60mm W:55mm B:10mm). Soil over north-south drain east of Building 3, Period 3–4, Q07:10, 2617, WSS56, 2001.2913
Shallow rectangle of sandstone, with heavy signs of burning on lower surface. Upper surface has a finely worked shallow rectangular recess.
51. (L:120mm W:120mm B:70mm). Area over Building 16, unstratified, Q08:01, 2483, WSS57, 2001.2914
Incomplete sandstone block, with one corner of shallow square or rectangular recess. Some signs of burning.
52. (L(complete):135mm (surviving):100mm W:111mm H:40mm). Levelling between Buildings Q and R, late third/early fourth century, F11:18, 1180, WSS55, 2001.2912
Sandstone block with shallow oval recess, tapering to one end. There are two depressions in the wide end, as if to take location pins. Originally in one piece, one end now lost.
53. Sandstone block (H: 62mm, D: 98mm). Area over Building 1 and *intervallum* road (Road 4), unstratified, M04:01, 14, WSS264, 2001.3120
Bun-shaped sandstone block possibly used as a pounder.
54. Bead (D:16mm B:6mm). *Intervallum* road, mid to late third century?, D14:12, 1493, WSS302, 2001.2450
Roughly made stone bead in a soft white stone.
55. Crinoid ossicle. (D:13mm B:5mm). Building 16, floor, Period 4, L07:20, 2043, WSS258, 2001.3114

Large example, pierced. The site has produced four pierced examples and 11 non-pierced. Fossil *crinoid ossicles* are commonly found on Roman sites in the north. This may be a natural distribution but the form lends itself easily to bead manufacture and the numbers found suggest that the fossils were used in such a way. See Allason-Jones and Miket 1984, 12.3–10.

56. Stone axe (L:97mm W:53mm B:21mm). Area over Buildings 7 and 8, unstratified, F11:01, 1109, WSS109
C. Waddington writes: A fine ground and polished stone axe. It has evidence of limited utilisation along the blade edge, although some of this may be due to post-depositional damage such as ploughing. There are also some flakes detached from the distal butt end which could also be the result of plough damage rather than purposive use. It seems likely, therefore, that the axe may have been originally discarded in a pristine condition which suggests that it have been a votive rather than a functional item. Ground and polished stone axes are diagnostic tools of the Neolithic period with types such as this common, but not exclusive to, Early Neolithic contexts. This is a relatively small specimen.

'Ballista' balls (Figs 25.34–35)

by W. B. Griffiths

Rounded stones slightly larger than a cricket ball, but with one or two flattened sides (usually on opposite sides of the stone) are not uncommon finds on military sites across the Roman Empire. Wallsend has yielded up the largest number of such worked stones of any site in Roman Britain (a total of 136 from the Daniels' excavations alone, with more from the excavations both within and surrounding the fort in the 1990s (Griffiths 2003, 230).

Recording

The stones were weighed and measured. The diameter was taken parallel to the flattened side(s) if present. The measurements for each stone are given in the catalogue below, where they are ordered by their overall diameter. The diameters recorded range from 55–126mm (for complete examples). The weight range from 159–1485g, again for complete examples.

The catalogue is subdivided according to the basic form of the stone. Some stones clearly exhibited the classic shape of two flattened sides, and some only clearly showed one flattened side. Other examples which could not be so readily classified are recorded in a third group, which includes stones which are only roughly rounded, the shape created from a faceting of several faces, some being so rough that they effectively represented a cube. Some stones are exceptionally well rounded, with no obviously flat face.

The subdivision need indicate nothing more than different hands being involved in the manufacture of the stones; with the more roughly shaped, faceted

stones indicating less experienced hands at work, or at least less application to the task in hand. It might reasonably be inferred that this was not a task for specialists. A group of three stones (14, 15, and 21, all found together, context M07:15), reused in a Period 3 flagged floor in Building 3, all appear to have been made by the same hand.

Catalogue

Each entry has diameter, weight, context number, site small finds number and current record number.

Stones with two sides

1.	D:126mm	Wt:1485g	Unstratified, WSS207.	19.	D:93mm	Wt:871g	Building 4, <i>contubernium</i> 9, Period 2, K04:21, 942, WSS240.
2.	D:113mm	Wt:1326g	<i>Intervallum road</i> (Road 6), secondary level, M16:16, 1827, WSS209.	20.	D:92mm	Wt:760g	Area of Road 5, no details, E04:17, 477, WSS159.
3.	D:113mm	Wt:1201g	<i>Intervallum road</i> (Road 6), secondary level, M16:16, 1831, WSS210.	21.	D:92mm	Wt:635g	Building 3, <i>contubernium</i> 2 floor, Period 2, M07:15, 2634/3, WSS182.
4.	D:108mm	Wt:1285g	Unstratified, WSS176.	22.	D:90mm	Wt:673g	Building 1, <i>contubernium</i> 1–3 demolition, Period 2, N05:32, 574, WSS128.
5.	D:107mm	Wt:1096g	Unstratified, WSS211.	23.	D:90mm	Wt:N/A	Building 4, <i>contubernium</i> 9, Period 2, K04:21, 942, WSS242.
6.	D:106mm	Wt:1122g	Building 3, <i>contubernium</i> 2, Period 2, N07:15, 1635/8, WSS190.	24.	D:89mm	Wt:679g	Area of Tower 2, unstratified, ?E02:11, 785, WSS157.
7.	D:106mm	Wt:1013g	Building 4, <i>contubernium</i> 9, Period 2, K04:21, 943, WSS233.	25.	D:88mm	Wt:763g	<i>Intervallum road</i> (Road 6), secondary level, M16:16, 1830, WSS138.
8.	D:104mm	Wt:900g	Unstratified, WSS223.	26.	D:88mm	Wt:701g	Road 5, E03:08, 932, WSS204.
9.	D:101mm	Wt:880g	Area over Road 4, unstratified, G03:05, 724, WSS199.	27.	D:88mm	Wt:468g	Unstratified, WSS141.
10.	D:101mm	Wt:799g	Building 3, <i>contubernium</i> 2, Period 2, N07:15, 2635/15, WSS191.	28.	D:87mm	Wt:695g	Building 3, <i>contubernium</i> 2, Period 2, N07:15, 2635/14, WSS188.
11.	D:100mm	Wt:1320g	Unstratified, WSS229.	29.	D:87mm	Wt:403g	Building 3, <i>contubernium</i> 2, Period 2, N07:15, 2635/3, WSS187.
12.	D:98mm	Wt:1067g	Building 9, <i>contubernium</i> 1 partition, Period 1, E13:38, 1594, WSS142.	30.	D:87mm	Wt:339g	Area over Building 11, unstratified, J15:01, 1267, WSS160.
13.	D:98mm	Wt:816g	Building 3, <i>contubernium</i> 2, Period 2, N07:15, 2635/18, WSS175.	31.	D:86mm	Wt:613g	Building 3, <i>contubernium</i> 2, Period 2, N07:15, 2635/19, WSS194.
14.	D:97mm	Wt:886g	Building 3, <i>contubernium</i> 2 floor, Period 2, M07:15, 2634/2, WSS183.	32.	D:86mm	Wt:606g	Road associated with the north-west shacks (B2), late third/early fourth century, J04:05, 803, WSS155.
15.	D:96mm	Wt:826g	Building 3, <i>contubernium</i> 2 floor, Period 2, M07:15, 2634/1, WSS184.	33.	D:86mm	Wt:603g	Assembly area, F09:54, 2447, WSS139.
16.	D:96mm	Wt:811g	Unstratified, WSS245.	34.	D:85mm	Wt:605g	Layer west of Building C, Period 3–4, F05:08, 433, WSS126.
17.	D:96mm	Wt:772g	Area of Building 4, no details, F03:13, 894, WSS222.	35.	D:84mm	Wt:547g	Unstratified, WSS212.
18.	D:94mm	Wt:780g	Building 4, <i>contubernium</i> 9, Period 2, K04:21, 942, WSS239.	36.	D:83mm	Wt:880g	Building 9, <i>contubernium</i> 5/6 partition, Period 2, G13:35, 1580, WSS164.
				37.	D:83mm	Wt:583g	Building 3, <i>contubernium</i> 2, Period 2, N07:15, 635/6, WSS179.
				38.	D:82mm	Wt:684g	Building 4, partition between <i>contubernium</i> 2 and 3, Period 2, G04:31, 463, WSS135.
				39.	D:82mm	Wt:617g	Road 1, E07:12, 2355, WSS201.
				40.	D:82mm	Wt:582g	Building 3, <i>contubernium</i> 2, Period 2, N07:15, 2635/7, WSS185.
				41.	D:82mm	Wt:533g	Unstratified, WSS200.

42.	D:81mm	Wt:682g	Building 4, partition between <i>contubernium</i> 2 and 3, Period 2, G04:31, 465, WSS134.	64.	D:51mm	Wt:116g	Building 4, partition between <i>contubernium</i> 2 and 3, Period 2, G04:31, 469, WSS247.
43.	D:81mm	Wt:622g	Area over Building 11, unstratified, K15:02, 1294, WSS143.	<hr/> <i>Stones with only one side</i> <hr/>			
44.	D:81mm	Wt:518g	Area over Building 13 and Alley 7, unstratified, L09:01, WSS196.	65.	D:114mm	Wt:1220g	Unstratified, WSS228.
45.	D:80mm	Wt:625g	Building 4, partition between <i>contubernium</i> 2 and 3, Period 2, G04:31, 473, WSS118.	66.	D:109mm	Wt:1028g	Building 10, <i>contubernium</i> 6, Period 2, G14:31, 1601, WSS178.
46.	D:79mm	Wt:617g	Unstratified, WSS202.	67.	D:105mm	Wt:1341g	Building 3, <i>contubernium</i> 2, Period 2, N07:15, 2635/13, WSS206.
47.	D:78mm	Wt:643g	Unstratified, WSS238.	68.	D:105mm	Wt:1058g	Building 3, <i>contubernium</i> 2, Period 2, N07:15, 2635/10, WSS174.
48.	D:76mm	Wt:505g	Area of Building 12 and Road 3, no details, N14:12, 1879, WSS213.	69.	D:102mm	Wt:899g	Alley 3, H04:26, 811, WSS173.
49.	D:76mm	Wt:444g	Unstratified, WSS236.	70.	D:96mm	Wt:895g	Building 3, <i>contubernium</i> 2, Period 2, N07:15, 2635/9, WSS189.
50.	D:75mm	Wt:413g	Unstratified, WSS101.	71.	D:96mm	Wt:822g	Building 9, <i>contubernium</i> 1, Period 1, E13:34, 1596, WSS166.
51.	D:74mm	Wt:446g	Area over Building 12, unstratified, N14:01, 1667, WSS88.	72.	D:93mm	Wt:819g	Building 4, partition between <i>contubernium</i> 2 and 3, Period 2, G04:31, 459, WSS224. Inscribed 'X': <i>RIB II</i> 2451.9.
52.	D:73mm	Wt:515g	Building 4, partition between <i>contubernium</i> 2 and 3, Period 2, G04:31, 464, WSS123.	73.	D:88mm	Wt:790g	Road 9, post-Roman, H14:24, 1245, WSS162.
53.	D:73mm	Wt:438g	Unstratified, WSS140.	74.	D:88mm	Wt:706g	Building 3, <i>contubernium</i> 2, Period 2, N07:15, 2635/11, WSS192.
54.	D:71mm	Wt:513g	Building 4, make-up material, Period 2, G04:07, 143, WSS95. Inscribed 'V': <i>RIB II</i> 2451.5.	75.	D:88mm	Wt:617g	North-south drain east of south wall of Building 1, Period 2, Q05:28, WSS235.
55.	D:69mm	Wt:364g	Area over Building 10, unstratified, E14:01, WSS121.	76.	D:87mm	Wt:726g	Building 4, make-up material, Period 2, G04:07, 399, WSS129.
56.	D:68mm	Wt:526g	Building 3, <i>contubernium</i> 2, Period 2, N07:15, 2635/2, WSS168.	77.	D:87mm	Wt:671g	Unstratified, WSS124.
57.	D:68mm	Wt:416g	Building 4, gully, Period 2, J04:18, 809, WSS153.	78.	D:84mm	Wt:560g	Building 3, <i>contubernium</i> 2, Period 2, N07:15, 2635/1, WSS172.
58.	D:67mm	Wt:315g	Building 4, partition between <i>contubernium</i> 2 and 3, Period 2, G04:31, 468, WSS225.	79.	D:83mm	Wt:620g	Building H, demolition, Period 4, J05:07, 827, WSS215.
59.	D:66mm	Wt:280g	Building 4, partition between <i>contubernium</i> 2 and 3, Period 2, G04:31, 462, WSS89. Inscribed 'XX': <i>RIB II</i> 2451.10.	80.	D:82mm	Wt:662g	<i>Intervallum road</i> (Road 6), M16:20, 1876, WSS152.
60.	D:64mm	Wt:397g	Building 1, <i>contubernium</i> 1-4 demolition, Period 2, N05:29, WSS91.	81.	D:82mm	Wt:527g	Assembly area, late surface, D09:11, 2318, WSS205.
61.	D:64mm	Wt:292g	Unstratified, 1910, WSS94. Inscribed 'Y': <i>RIB II</i> 2451.3.	82.	D:82mm	Wt:515g	North rampart (F2), Period 1, G02:06, 684, WSS170.
62.	D:61mm	Wt:229g	Area over Gate 1, unstratified, K03:01, 746, WSS154.	83.	D:81mm	Wt:577g	Area over North rampart, unstratified, M03:01, 752, WSS156.
63.	D:55mm	Wt:241g	Rubble over west <i>praetentura</i> , Period 4, J05:07, 823, WSS148.	84.	D:78mm	Wt:529g	Unstratified, 1229, WSS127.
				85.	D:78mm	Wt:512g	Unstratified, WSS125.
				86.	D:77mm	Wt:568g	Alley 10/Building 17, disturbed surface inside building, third century, F04:19, 426, WSS116.

87.	D:77mm	Wt:558g	Building 10, <i>contubernium</i> 5/6 partition, Period 2, G14:29, 1599, WSS131.	109.	D:92mm	Wt:707g	<i>Intervallum road</i> (Road 6), primary level, M16:20, 1870, WSS144. Rough cube.
88.	D:76mm	Wt:480g	Building 4, make-up material, Period 2, G04:07, 401, WSS226. Inscribed 'I+': <i>RIB II</i> 2451.7.	110.	D:90mm	Wt:868g	<i>Intervallum road</i> (Road 6), primary level, M16:20, 1871, WSS150. Faceted.
89.	D:75mm	Wt:472g	Building 1, north wall foundation, Period 2, Q05:32, 476, WSS119.	111.	D:89mm	Wt:656g	Chalet 9, post-Roman, H13:08, 1512, WSS158. Faceted.
90.	D:74mm	Wt:532g	Area over Building 8, unstratified, E10:01, 982, WSS112.	112.	D:84mm	Wt:630g	Building 4, partition between <i>contubernium</i> 2 and 3, Period 2, G04:31, 467, WSS99.
91.	D:73mm	Wt:479g	Unstratified, WSS93.	113.	D:83mm	Wt:523g	Building 9, <i>contubernium</i> 1 partition, Period 1, E13:38, 1595, WSS161. Pecked, rounded.
92.	D:72mm	Wt:391g	Unstratified, 428, WSS234.	114.	D:83mm	Wt:458g	Building 3, <i>contubernium</i> 2, Period 2, N07:15, 2635/5, WSS193. Faceted.
93.	D:72mm	Wt:376g	Road associated with the north-west shacks (B2), late third/early fourth century, J04:05, 813, WSS167.	115.	D:82mm	Wt:898g	Building 3, <i>contubernium</i> 2, Period 2, N07:15, 2635/17, WSS186. Almost a cube.
94.	D:70mm	Wt:390g	Building 4, partition between <i>contubernium</i> 2 and 3, Period 2, G04:31, 471, WSS244. Inscribed 'X': <i>RIB II</i> 2451.8.	116.	D:82mm	Wt:592g	Building 3, <i>contubernium</i> 2, Period 2, N07:15, 2635/16, WSS171. Right angles.
95.	D:69mm	Wt:326g	Unstratified, WSS195.	117.	D:81mm	Wt:657g	Building 12 demolition, Period 3, M14:63, 1919, WSS110. Roughout.
96.	D:67mm	Wt:309g	Area over Building 5, unstratified, J05:03, 728, WSS149.	118.	D:79mm	Wt:629g	Building 3, <i>contubernium</i> 2, Period 2, N07:15, 2635/12, WSS177. Faceted.
97.	D:67mm	Wt:289g	Building 4, make-up material, Period 2, G04:07, 143, WSS96.	119.	D:79mm	Wt:518g	<i>Intervallum road</i> (Road 6), primary level, M16:20, 1873, WSS218. Rough cube.
98.	D:67mm	Wt:279g	Road 5, E04:17, 477, WSS115.	120.	D:78mm	Wt:526g	Alley 1, upper layers, P05:16, 414, WSS111. Faceted.
99.	D:66mm	Wt:351g	Unstratified, WSS98.	121.	D:78mm	Wt:486g	Building 4, partition between <i>contubernium</i> 2 and 3, Period 2, G04:31, 458, WSS230. Inscribed 'I+': <i>RIB II</i> 2451.6
100.	D:58mm	Wt:258g	Building 1, <i>contubernium</i> 1-4, Period 2, N05:29, 549, WSS97.	122.	D:77mm	Wt:660g	<i>Intervallum road</i> (Road 6), primary level, M16:20, 1872, WSS137. Elongated cube.
<hr/> <i>Other: faceted, very well rounded and cubes</i> <hr/>							
101.	D:100mm	Wt:847g	<i>Via quintana</i> (Road 3), F13:24, 1600, WSS165. Unfinished.	123.	D:77mm	Wt:502g	Building 4, partition between <i>contubernium</i> 2 and 3, Period 2, G04:31, 470, WSS103. Well rounded.
102.	D:100mm	Wt:100g	Building 1, verandah, Period 3-4?, L04:20, WSS221. Faceted.	124.	D:76mm	Wt:534g	Unstratified, WSS102. Rounded cube.
103.	D:96mm	Wt:935g	Unstratified, WSS133. Faceted.	125.	D:74mm	Wt:385g	Building H, demolition, Period 4, J05:07, 822, WSS169. Faceted.
104.	D:96mm	Wt:769g	Unstratified, WSS203. Faceted.	126.	D:73mm	Wt:483g	Building 4, make-up material, Period 2, G04:07, 400, WSS100. Round.
105.	D:95mm	Wt:890g	Unstratified, WSS132. Faceted.				
106.	D:93mm	Wt:898g	<i>Intervallum road</i> (Road 6), secondary level, M16:16, 1828, WSS208. Rough shape.				
107.	D:92mm	Wt: 816g	Cobbles near Cistern 1, Period 3 demolition, E08:57, 2406, WSS217. Faceted.				
108.	D:92mm	Wt:745g	<i>Intervallum road</i> (Road 6), primary level, M16:20, 1874, WSS216. Faceted.				

127.	D:72mm	Wt:451g	Road associated with the north-west shacks (B2), late third/early fourth century, J04:05, 806, WSS163. Faceted.
128.	D:71mm	Wt:466g	Building 4, partition between <i>contubernium</i> 2 and 3, Period 2, G04:31, 460, WSS90. Well rounded.
129.	D:71mm	Wt:383g	Unstratified, WSS145. Cube.
130.	D:70mm	Wt:403g	Building 4, make-up material, Period 2, G04:07, 143, WSS96. Inscribed 'IV': <i>RIB II</i> 2451.4. Well rounded.
131.	D:70mm	Wt:377g	Unstratified, WSS219. Well rounded.
132.	D:67mm	Wt:352g	Building 8, entrance, Period 4, E11:22, 1155, WSS113. Faceted.
133.	D:65mm	Wt:415g	Building 4, partition between <i>contubernium</i> 2 and 3, Period 2, G04:31, 466, WSS130. Ball.
134.	D:64mm	Wt:398g	Unstratified, WSS122. Faceted.
135.	D:63mm	Wt:339g	Building 4, partition between <i>contubernium</i> 2 and 3, Period 2, G04:31, 472, WSS92. Faceted.
136.	D:57mm	Wt:159g	Assembly area, E09:48, 2433, WSS198. Faceted.

Purpose

Various suggestions have been put forward for the use of these stones, ranging from game balls to stoppers for amphorae (Corder 1933, 38, who found one *in situ* in the neck of an amphora in a civilian context at York). However, the vast majority of examples known from this country are found at military sites. Generally they are regarded as having been missiles for artillery pieces but they may perhaps also have been used for throwing by hand (Baatz 1983, Griffiths 1992, 1994c). The flattened sides of the stones can be interpreted as making it easier to stack the stones ready for use, which would suit either interpretation.

The traditional interpretation that they were for artillery pieces deserves some consideration. Generally, missiles of this size would be for smaller 'field' pieces, *Ballistae*, two-armed stone-throwers. Some of the celebrated larger machines were capable of firing stones in excess of 26kg (one talent: Vitruvius, *De Architectura* X, 11, 3). However, these were more likely to be deployed in sieges, to attack defended circuits; they would have been of only limited use in defending a fort.

There has been much debate as to the likely

presence of artillery at auxiliary forts. The traditional view is that only the legions were issued with artillery (c.55 pieces to a legion, giving us 165 pieces in Britannia: Marsden 1969, 179). However there are alternative views, including suggestions that every tower on Hadrian's Wall could have deployed such an item (Donaldson 1988, 127). The presence of stone balls at Wallsend cannot in itself be used to argue for the provision of artillery at the site, as they may have been used as a hand-launched missile; instead we must turn to the rarely found items from artillery pieces (no examples of which have yet been recovered from Wallsend). For example, the discovery of two fragments from two separate artillery pieces at Elginhaugh (Allason-Jones 2007, 405), a similarly extensively excavated fort in Flavian Scotland, could indicate that auxiliary units may have been issued with artillery. However, Elginhaugh was occupied during and after an extensive campaign that included legionary units, so special pleading could be made for a legionary presence, or at least supply chain, at some point. The only conclusion that can be reached on the basis of present evidence is that stone balls such as these could have been used for artillery pieces, but cannot be used in themselves to argue for its presence.

It is clear that the Roman army was trained in throwing stones by hand (Vegetius, *Epitoma Rei Militaris*, II:23; Arrian, *Tactica*, XLIII:1) and stones of a similar size and weight would be more effective than simply gathering random stones for such use: 'a high rate of accurate fire' would not 'be achieved with stones of uncertain weight' (Baatz 1983, 136). There is no firm evidence to support the use of the hand-thrown stone by the Roman army in battle, although there is evidence, both literary (eg Aeneas Tacticus, XXII:12 and XXXVIII:6-7) and sculptural (Arch of Constantine), that stones were thrown by hand in the defence of towns, and it is possible that this could be applied to forts. Indeed, experiments from the reconstructed gateway at South Shields Roman Fort showed that such stones could provide a withering rate of fire, with a range that covered the 'kill-zone' of the 25 metres from the outer ditch to the fort wall (Griffiths 1992).

Regardless of their exact purpose (and it may be that in fact they had a duality of purpose, hand-throwing and artillery), it seems likely that the stones were prepared for the defence of the fort. An alternative possibility is that they could have been held ready to take to the field with artillery as is indicated by Arrian (*Tactica*, XLI, 1), who, apparently, credits auxiliary units with firing artillery on campaign. However, this interpretation is disputed (Campbell 1986, 127), and as stated above, auxiliary units are generally regarded as not being equipped with artillery.

Distribution within the fort

The stones were found throughout much of the fort,

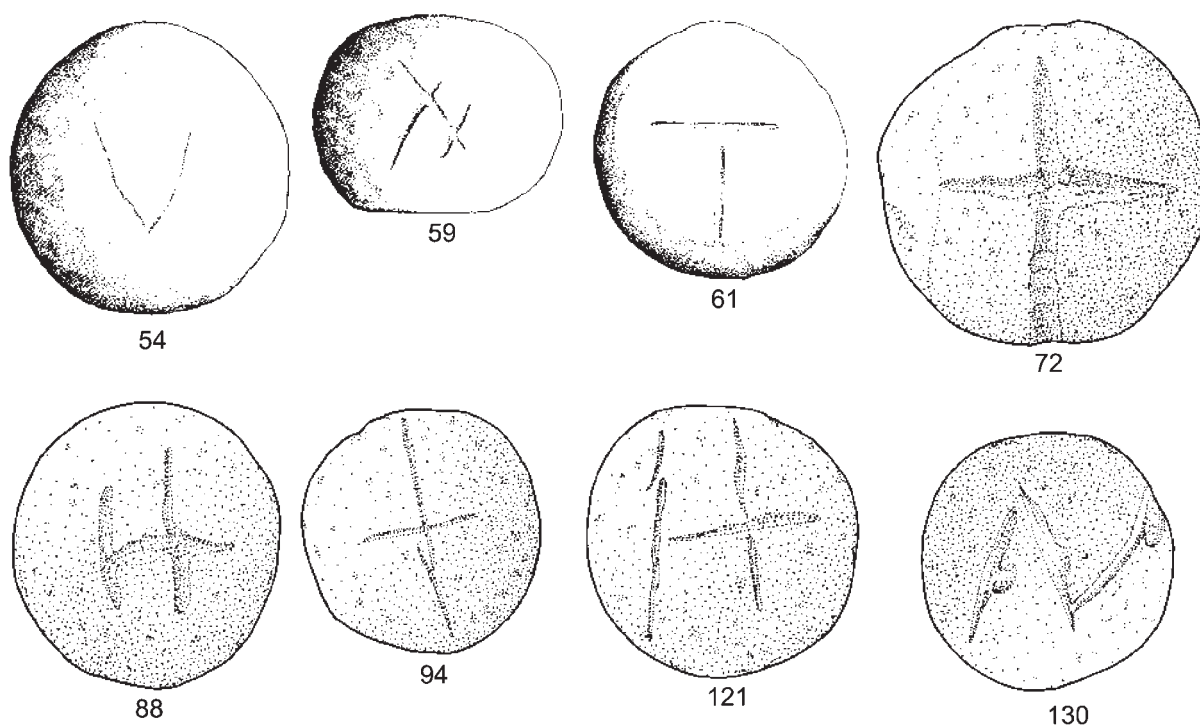

Figure 25.34: Throwing stones with graffiti. Scale 1:2.

Table 2 Numbers of stones by location type

<i>Stratified</i>	
Infantry barracks	52
Roads and alleys	25
Cavalry barracks	7
Defences	2
Other	2
Timber buildings	3
Hospital	1
Total	92
<i>Unstratified</i>	
Over infantry barracks	2
Over roads and alleys	4
Over cavalry barracks	5
Over defences	2
Over hospital	1
No details	30
Total	44
Total	136

as can be seen on Fig. 25.35 showing their distribution by site grid. There was almost no detailed excavation of the defences, explaining why few were found in the areas they might perhaps most readily be anticipated.

Many of the stones were scattered finds. However, there were some concentrations, in particular two in the northern range of the fort (26 stones in Building 4 and 21 in Building 3). Twenty-one of the stones from Building 4 were recovered from two contexts G04:07 and G04:31. The former contained six stones

(two inscribed; see below) and is described as a probable make-up level below the flooring in *contubernium* 2, while the majority of stones (including four inscribed examples) are from the partition slot between *contubernia* 2 and 3. This phase of the building is identified as Period 2, the later second-century rebuilding of the fort, which included the reconstruction of the timber barracks in stone (Hodgson 2003, 5). A possible interpretation therefore is that they were identified as no longer required, and became a convenient source of building rubble/packing material in the construction of the barrack. Eighteen of the stones from Building 3 were recovered from context N07:15, described as a soil layer under the flagged floor of room 2 (contexts N07:14, M07:15), which produced three more stones. Again the contexts are dated to Period 2.

In all cases we can consider that the stones were no longer required as ammunition, and simply used as rubble/packing. The question is, why should this be so? If we interpret them as artillery ammunition then one could simply argue that there was no longer artillery kept at the fort. However, if they are regarded as being used for hand-throwing then their re-use is more problematic, although of course it may simply be that they became mixed up with other rubble, or in the case of the partition slot they were conveniently to hand for the builders.

Inscriptions

Eight of the stones (*RIB II* 2451.3–10) were inscribed

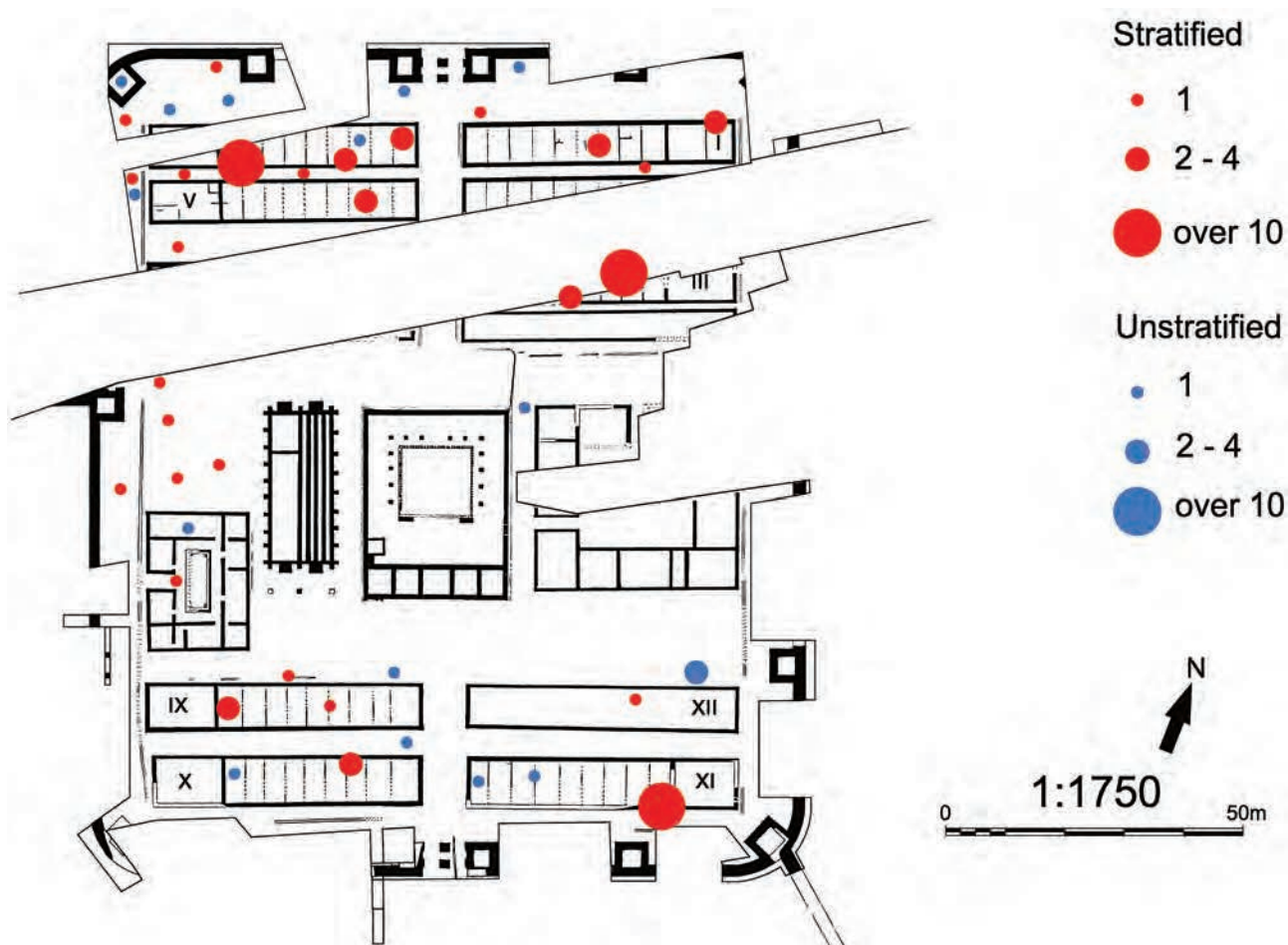

Figure 3.5 Distribution of the quern stones.

with what appear, for the most part, to be numerals. There is no clear evidence to suggest a purpose of these numbers. Possibilities include a mason's or maker's mark, a tally mark, or markings for some form of game. Only two other stone balls from Britain have been recovered with inscriptions, *RIB II* 2451.1 from Caerleon, inscribed with an M and *RIB II* 2451.2 from Corbridge, now lost. There is some uncertainty as to the exact interpretation of the inscription of the Corbridge example. In all cases that the markings take the style of a graffito as opposed to a formal inscription. All the stones apart from no. 61 (*RIB II* 2451.3), which was unstratified, were found in the construction levels of *contubernium* 2 in Building 4 in Period 2.

Conclusions

The combination of the inscribed examples, and sheer quantity of stones, makes this assemblage distinctive, but need not signify activity out of the ordinary. Wallsend remains one of the most comprehensively excavated forts in the Roman world, and it may be that excavations of a similar scale could yield similar numbers (indeed excavations of the Antonine fort at

Bar Hill have yielded 110 examples: MacDonald and Park 1906, 21, 32, 89; see also Marchant 1991, 90–98 for a catalogue of examples from other sites in Britain).

Quern stones (Figs 25.36–37)

by R. G. Willis

Of the 63 quern stones found during the 1975–1984 excavations, only 20 were stratified. This, and the fact that broken querns are frequently used as building stone (18 fragments come from road surfaces), means that it is difficult to say much concerning their development as most are likely to be chronologically removed from their original context of use. This widespread problem has led to rather simplistic statements concerning the development of milling stones, based on subjective interpretations of lesser or greater 'primitiveness', and there is a great need for an intensive study of their context of production, use and exchange. Basic questions still remain unresolved, such as whether differences in form can be related to functional variation rather than chronological development, how far raw material choice was governed by intended use and whether every hand quern was designed to grind grain. For example, the

traditional potters on the island of Iz, in Dalmatia, use hand querns predominantly to grind calcite temper, and rarely for grinding grain (Carlton 1988). For the present analysis the traditional broad classifications have been adhered to as in most other recent studies (e.g. Welfare 1985), simply to provide a comparative basis for all further research.

With the invaluable help of Dr B. R. Turner, in the Geology Department of the University of Newcastle upon Tyne, an exploratory thin sectioning programme was initiated, in an attempt to source the raw material used for quern production. The hand specimen analysis had suggested that all of the non-lava stones were almost certainly made from local Northumbrian sandstone sources. After the initial thin-sectioning and examining of a few stones, it seemed very unlikely that the microscopic approach would provide any higher resolution in distinguishing between these sources, and so the project was terminated. Similarly, no more precise sourcing of the lava stones was achieved other than their origin in the continental quarries of Mayen, although without an extensive thin-sectioning programme, their exact provenance is by no means certain. For instance, some may have a source in France (A. Welfare *pers. comm.*).

The beehive stones

This category is formulated purely on the morphology of the upperstones, which are relatively thick (c.100–200 mm) in relation to their diameter (c.300–400 mm). The upperstone is often nearly hemispherical externally, usually with a wide hopper leading into the feed pipe. Upperstones with a flatter, 'bun-shaped' profile are also included in this category. The grinding face of the lower stones can be conical or shaped like the segments of a sphere, following the shape of the upperstone, or can, as in the case of some of the Wallsend beehives, be practically flat. The upperstone was usually turned by means of a horizontal handle, projecting radially from a socket in the side, or from a groove on top.

Only two of the Wallsend stones have 'typical' beehive profiles (nos 1 and 3), the former having an almost hemispherical cross section with a flattish top, and a flat grinding face. The rest seem to have either a conical profile (e.g. no. 2), or a low, flat 'bun-shaped' appearance (no. 9). Generally the hoppers are small in diameter (90–100 mm), and taper into rather narrow feedpipes (20–50 mm). Six of the stones have horizontal handle sockets (e.g. no. 1) which are usual for this type of quern, although two of these are a steep angle (nos 2 and 7) which is unusual. The grinding surfaces are generally flat and all are ungrooved.

On the whole the design and the dressing of the stones is simple. There are two exceptions however. First, no. 4 has an unusual socket drilled into the

side of the feedpipe, the purpose of which is unclear, although it must be related to the spindle/rynd arrangement in some way. In the lowest portion of the feedpipe are the remains of a metal cylinder, which may have served to protect the feedpipe from wear, or alternatively, may have performed the role of the spindle itself. Second, no. 9 has two well preserved handle sockets, one of which is flush with the grinding surface. There is also a possible rynd chase high in the feedpipe.

Quern stones of these type are usually assigned to a pre-Roman, 'native' tradition in the North of England, and it is at least likely that at least some of these stones from Wallsend are products of a previous Iron Age tradition. However, they are found quite predictably on Roman military sites (e.g. Vindolanda, and Randylands milecastle 54), the stones from Randylands indicating that these querns were still in use in the later second century (Curwen 1937). Although only four out of the 12 stones of this series occurred in dated contexts, the evidence from Wallsend indicates the possible use of the stones into the third century. Stones like no. 9, although essentially an extension of a local tradition, do show advanced features, and an economy in size that could have made them competitive to the German imports, unless of course the types had two completely different functions.

The fact that these stones appear in third-century contexts at Wallsend show that they may be the products of an industry that survived well into the Roman period. The exact context of production, whether it was solely native or an adaptation, still remains unknown however, and an excavation into the location of quarry sites would surely be productive. One should perhaps look into the Fell sandstone outcrops of Northumberland, which were exploited for raw material with which to make millstones well into the nineteenth century (Jobey 1986). Current survey work in the area has unearthed hand-mill quarries which could be of Roman date (D. Cowley *pers. comm.*).

The continental lava stones

It is generally accepted that a new type of milling stone, as far as we know made from raw material extracted from volcanic sources near Mayen in the Eifel Hills in Germany, was introduced to northern Britain with the Roman army (Peacock 1980). Fragments of 31 of these stones were found at Wallsend. However, preservation of these stones on the site is very bad, fragments rarely representing more than 20% of the original stone, due to their brittleness in post-depositional contexts. This often makes the identification of upper and lowerstones very difficult, and greatly restricts the amount of information that can be extracted in general. These new milling stones are distinguished from previous types not only by the

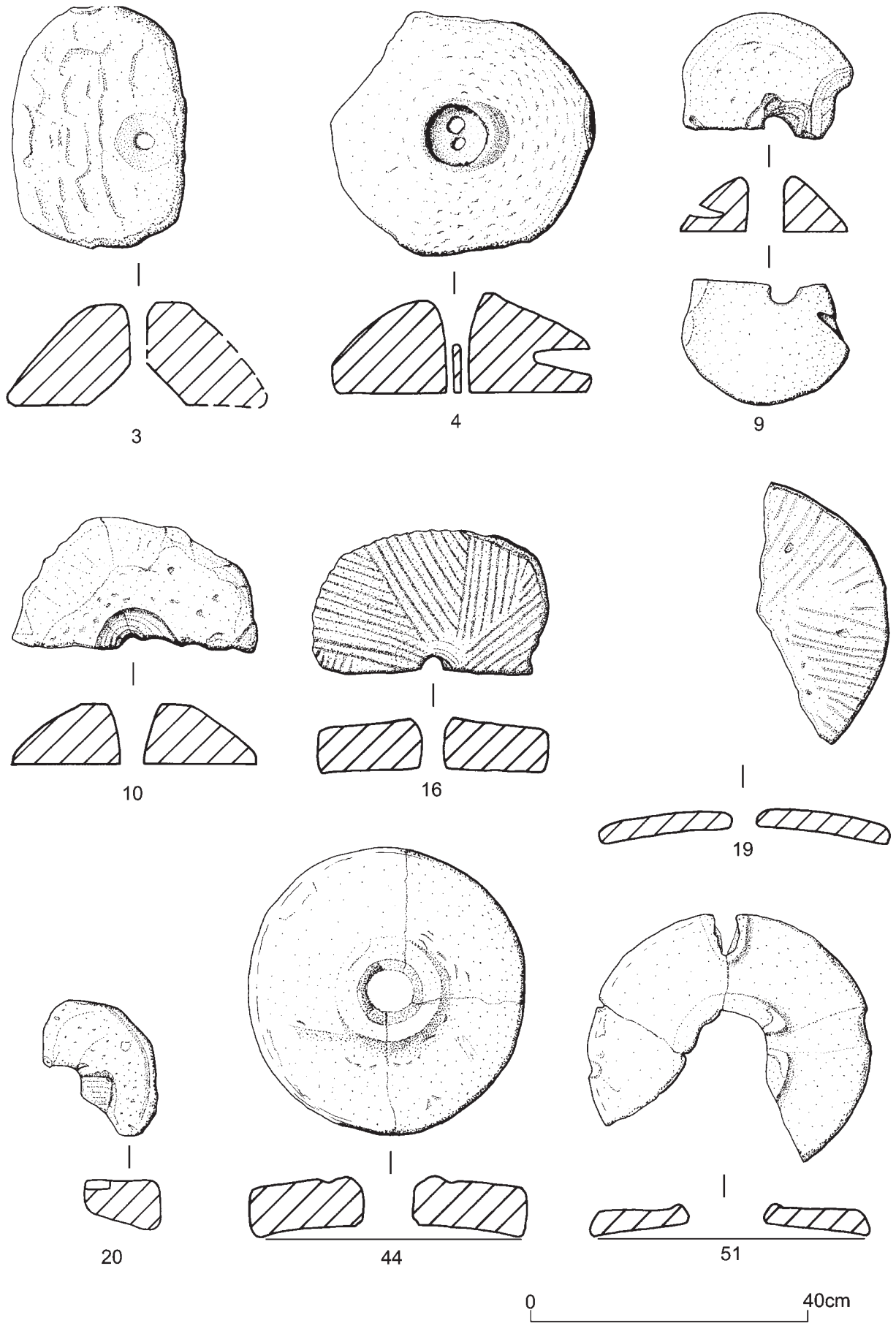

Fig re 3 6 Querns nos 3 Scale 3

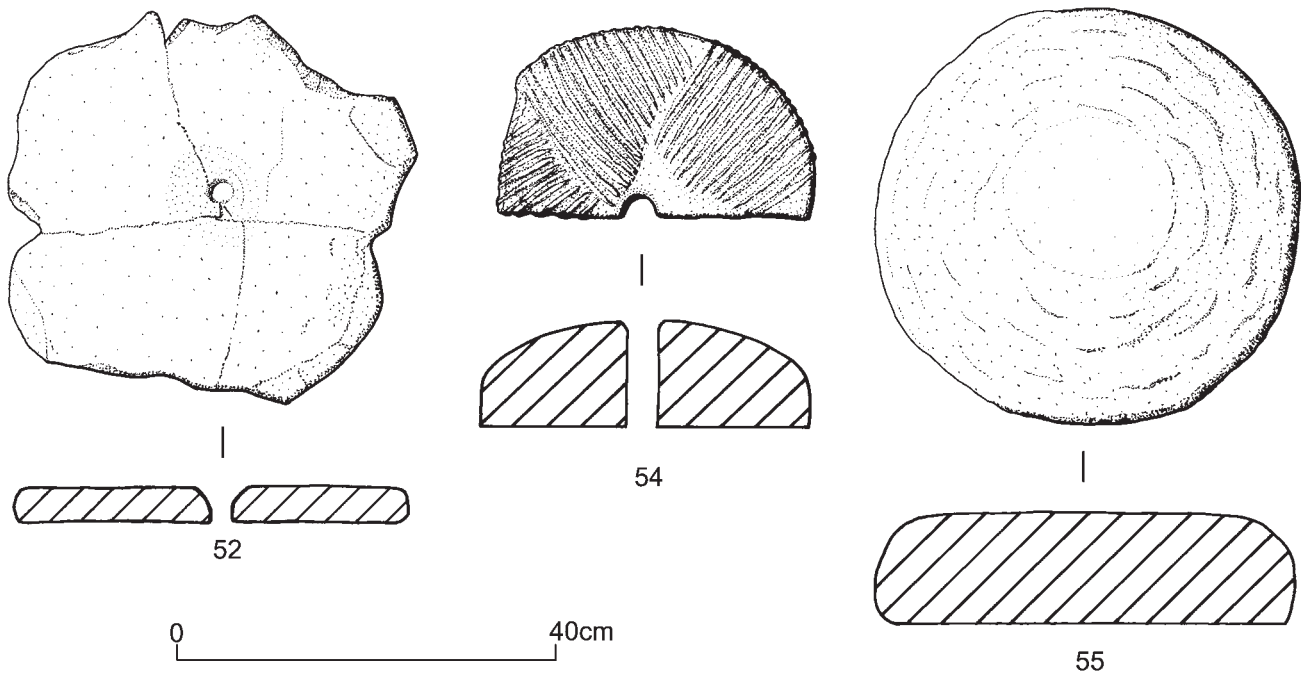

Fig. 2. Querns nos 52, 54, 55. Scale 1:1

exotic raw material, but also by new morphological features and new kinds of dressing.

A major development was in the extensive use of the rynd and spindle, almost certainly allowing greater control over the grinding process as a whole. Unfortunately only two of the stones from Wallsend have remains of rynd chases (nos 20 and 27), from which we can try to reconstruct the arrangement. The rynds each consisted of a piece of iron with a wedge at each end, which fitted into notches on opposite sides of the feedpipe, and which were probably fixed with molten lead. In the middle was an eye through which the spindle fitted, thus taking the weight of the upperstone, and acting as a pivot at the same time. It is probably that adjustments to the gap between the two stones were made to suite the job in hand. These could either have been made where the spindle connected to the rynd, or by simply altering the length of the spindle. Unfortunately finds of spindle and rynds are unusual, the examples from Newstead (Curle 1911) and Vindolanda (Welfare 1985) being rare instances.

Similarly, little evidence remains of the handle arrangements employed, only two stones revealing such information. First, no. 34 has a distinct channel cut into the rim, for an iron hoop handle. A groove running laterally across the top surface of the upperstone may be connected to this handle arrangement. Second, no. 39 has the remnants of a vertical handle socket, which appears to be rectangular in shape, although only a small portion is preserved, and which appears to perforate the stone entirely. Practically all the stones have grooved grinding faces, the striae usually being set out in a 'harp' pattern (e.g. no. 27). The sides (or rim) as well as the upper surface are commonly

dressed with parallel grooves which probably do not have a functional role, unlike those of the grinding face which may serve to direct the ground substance through the grinding space.

Dating of these as always is a problem, only 17 of them being from stratified contexts. Of these five can be dated to the late third/early fourth century and one stone from Period 1. This sequence at least gives a general indication of the time span during which this type of quern was used. Certainly the evidence from Wallsend does nothing to counter the idea that these querns were introduced to Northern Britain by the military. Though how far these new stones 'excelled' other types, and created a 'revolution in diet' (Welfare 1985, 156), is unclear, and some experimental work in this area would be informative. Certainly the vesicles in the lava give material a texture that helps retain good grinding properties as the rock wears. Probably their most important asset was their lightness and mobility, which must have been a considerable advantage in a military context. It is clear that the stones were produced to a more or less standardised design and exported to Britain in large numbers.

The Romano-British milling stones

Although the mechanism is not very clear, it seems that a new form of quern or milling stone, essentially the product of a local industry, was gradually produced in competition with the continental Mayen types. In fact the local industries had probably never stopped production completely, as the number of traditional beehive types found in the second- and third-century military contexts in northern Britain,

bears witness. The existence of local industries, capable of competing with the Mayen imports is not surprising when one considers the plentiful supply of raw material suitable for quern production in the area. Even in the Iron Age, quern quarries had quite sizeable distributional networks in some parts of Britain (Hayes *et al* 1980).

Due to the raw material used for the manufacture (locally derived sandstone), this group of stones are far better preserved than the Mayen types. The upperstones are generally flat, and a lot thicker than the volcanic continental stones. The profiles are commonly rectilinear (*e.g.* no. 44). A pronounced collar around the feedpipe is also a common feature (*e.g.* nos 44, 51, 56), as it is among this group of stones at Vindolanda (Welfare 1985). Both upper and lowerstones show 'continental' characteristics, such as the harp style grooving found on numerous grinding faces, on both upper and lowerstones (*e.g.* nos 49 and 54). Equally some stones have a very simple design, with no special features or dressing.

There is very little evidence for the handle arrangements employed to turn these stones. Only the upperstone no. 51 has a slot in the upper surface to take the horizontal handle. There is also a channel that traverses the entire upper surface of the stone, which is best interpreted as a slot for a lateral handle which could be attached directly to the spindle. Out of 8 upperstones, 5 have clear remains of rynd chases (nos 44, 48, 49, 51 and 56). This compares favourably with the Mayen stones which are far more fragmentary. The chases are rectangular in plan, and in the case of stone no. 48, the remnants of the rynd are still visible. Two of the lowerstones (nos 45 and 54) have unusual 'stepped' spindle perforations, the purpose of which is unclear.

Six out of the 14 stones in this group are lowerstones, which is a comparatively large proportion. However this may be misleading, as lowerstones usually do not show the characteristics of upperstones that allow them to be more easily classified. In fact the dating of the stones as a whole is fairly tight, although re-use remains a problem. All of the six stones from dateable contexts are assigned to the mid or late third-century contexts. This would seem to fit in well with the emergence in the later Roman period (late third and fourth centuries), of a revitalised local industry.

Conclusion

Unfortunately the stratification of the quern stones from Wallsend does not allow a detailed analysis of chronological change. In addition, the largest group of stones, the Mayen lava querns, were the most badly preserved, which obviously limited the analysis. Also, one suspects that there is a differential transform operating here, in that the larger, more robust beehive and Romano-British stones were more suited to re-use as building material than were the

more brittle Mayen lava stones. Exactly how far this distorts our view of the evidence is unclear, but its effect must be considerable. Our knowledge would be greatly increased by research into quarry production in Northumberland, by further attempts to source the locally and continentally produced stone more precisely by an extensive thin-sectioning programme, and a greater involvement in experimental work.

Catalogue

The descriptions of each individual stone in the catalogue have been kept as concise as possible. Special features are described where relevant, and measurements of complete dimensions given where possible.

Beehive stones

1. Upperstone (D:c.340mm B(max):180mm). Area over Building 4 and Road 4, unstratified, G03:05, 681, WSQ59
Hemispherical exterior with flat top. Lateral handle socket. Flat grinding surface.
2. Upperstone (D:c.400mm B(max):190mm). Area over Building 9, unstratified, F13:01, 973, WSQ57
Conical shaped upperstone, with remains of steep angled handle socket. Grinding surface slightly convex.
3. Upperstone (D:c.400mm B(max):182mm). Building 8, make-up for room 1, mid-third century?, D11:15, 1037, WSQ61
Large fragment of tall beehive upperstone. Spindle socket separate from feedpipe. Flat grinding surface.
4. Upperstone (D:c.380mm B(max):150mm). Unstratified, 1327, WSQ1
Well preserved, bun-shaped upperstone. Curious socket in feedpipe. Metal cylinder preserved in lower portion of feedpipe. Flat grinding surface. Lateral handle socket.
5. Upperstone (D:c.360mm B(max):130cm). Unstratified, 1348, WSQ50
Large fragment of bun-shaped upperstone. Very simple design. No handle or spindle/rynd arrangement evident.
6. Upperstone (D:c.280 mm B(max):120cm). Area over Alley 5 and Road 9, unstratified, H14:30, 1431, WSQ21
Conical shaped upperstone. Grinding face badly damaged. Evidence of rynd chase but mechanism unclear. No evidence of handle.
7. Upperstone (D:c.320mm B(max):100cm). Building 13, entrance in west range, Period 1, L11:45, 1911, WSQ45
Fragment of bun-shaped upperstone, with wide hopper, flat grinding surface, and an angled lateral handle socket.
8. Upperstone (D:c.380mm B(max):160cm). West granary make-up layers, G10:12, 2232, WSQ60
Bun-shaped upperstone. Lateral handle socket. Grinding surface slightly convex.
9. Upperstone (D:c.320mm B(max):110cm). Surface round Cistern 1, Period 3, E08:57, 2414, WSQ37
Large fragment of bun-shaped upperstone. Rynd chase, high in feedpipe. Two lateral handle sockets,

- one flush with flat grinding surface. Profile is asymmetrical.
10. Upperstone (D:c.360 mm B(max):110cm). Chalet 12, Building AH, Period 4, L14:07, 2648, WSQ24
Simple bun-shaped upperstone. Flat grinding surface, with protruding collar to feedpipe.
 11. Upperstone (D:c.370mm B(max):140cm). Chalet 12, Building AJ, Period 4, L14:09, 2649, WSQ56
Simple bun-shaped upperstone, with very narrow feedpipe.
 12. Upperstone (D:c.380mm B(max):110cm). Area over Road 5, dereliction/modern, E04:07, 2651, WSQ23
Fragment of bun-shaped upperstone. Faint circular groove in feedpipe may indicate rynd chase.
- The continental lava stones*
13. Lowerstone (D:c.450mm B(max):50cm). Building 2, post-Roman dereliction, P05:03, 222, WSQ26
Small fragment of probable lowerstone. Grooved grinding surface.
 14. Upperstone (D:c.400mm B(max):85cm). Area over Road 5, dereliction/modern, E04:07, 223, WSQ10
Small fragment of upperstone. Harp style grooving on grinding surface. Upper surface has circular groove delineating hopper.
 15. Lowerstone (D:c.450mm B(max):65cm). Road surface associated with the north-west shacks (B2), dereliction, E05:04, 224, WSQ29
Fragment of lowerstone. Rim and grinding surface are grooved.
 16. Lowerstone (D:unknown B(max):90cm). Building 18, *contubernium* 1, Period 3–4, F05:07, 225, WSQ32
Half or totally perforated lowerstone. Grinding surface grooved in harp style. Rim badly damaged so no diameter measurement possible.
 17. Upperstone (D:c.400 mm B(max):65cm). Unstratified, WSQ2
Fragment of upperstone. Grooving on all three surfaces.
 18. Fragment (B(max):90cm). Unstratified, 770, WSQ34
Badly damaged fragment. Only has one surface which is grooved.
 19. Lowerstone (D:c.400mm B(max):40cm). Area over Building 8 and *intervallum* road, unstratified, D11:01, 972, WSQ19
Large fragment of very thin lowerstone. No features apart from faint traces of grooving on the grinding surface.
 20. Upperstone (D:unknown B(max):80cm). Road 3, E12:11, 1050, WSQ11
Large fragment of upperstone. Upper surface grooved. Has fan-shaped rynd chase. Rim badly damaged, so diameter unknown.
 21. Fragment (measurements not possible). Area over Building 9, unstratified, E13:01, 1087, WSQ17
Tiny fragment of grooved surface from a quern.
 22. Fragment (measurements not possible). Building 8, entrance, Period 4, E11:22, 1141, WSQ8
Only the raw material and one dressed surface identify this fragment as part of a quern stone, probably a thick lowerstone.
 23. Upperstone (D:c.400mm B(max):110mm). Unstratified, 1149, WSQ35
Very small fragment of extremely thick upperstone.
 24. Fragment (B(max): 80mm). Area over Building 9, unstratified, E13:01, 1160, WSQ33
Badly damaged fragment, probably a lowerstone. One surface grooved.
 25. Upperstone (D:c.400mm B(max):40mm). Building Row 20, levelling north of Buildings Q and R, late third/early fourth century, F11:13, 1162, WSQ25
Small fragment of upperstone. Rim is grooved, but all other surfaces are plain.
 26. Lowerstone (D:c.450mm B(max):30mm). Rubble over Building 8, *Via quintana* and road to the east (B3), late third/early fourth century, E12:08, 1173, WSQ16
Thin fragment of lowerstone. Surfaces ungrooved. Grinding surfaces worn smooth at edge.
 27. Upperstone (B(max):30mm). Unstratified, 1176, WSQ13
Large fragment of upperstone. Both upper and lower surfaces are grooved. Circular groove on upper surface, surrounds hopper. Well defined rynd chase.
 28. Quern (no measurements possible). Building Row 20, levelling west of Building Q, late third/fourth century, F12:10, 1187, WSQ4
Very small fragment of grooved surface of quern, Badly damaged.
 29. Lowerstone (B(max):35mm). Road 3, F11:19, 1211, WSQ63
The totally perforated spindle socket, probably of a lowerstone, but difficult to tell. Upper surface looks worn.
 30. Upperstone (D:c.450mm B(max):50–10mm). Area over Building 11, unstratified, K15:01, 1301, WSQ46
Fragment of thin, flat upperstone. Grinding surface grooved in harp style. The profile is asymmetrical.
 31. Upperstone (D:c.400mm B(max):c.50mm). Area over Building 11 and Alley 6, unstratified, L15:01, 1408, WSQ28
Fragment of upperstone. Grooved grinding surface. Circular groove in upper surface.
 32. Fragment (no measurements). Unstratified, 1513, WSQ5
Badly damaged fragment. One surface has harp style grooving.
 33. Lowerstone (D:c.400mm B(max):c.40mm). *Intervallum road* (Road 6), primary level, M16:20, 1869, WSQ18
Small fragment of lowerstone. Grinding surface faintly grooved, while underside is very roughly dressed.
 34. Upperstone (D:c.400mm B(max):c.60mm). *Via principalis*, H08:17, 2065, WSQ42
Fragment of fairly thick upperstone. Groove in rim for iron hoop handle. Lateral groove in upper surface may be connected with this handle arrangement. Grinding surface roughly dressed and ungrooved.
 35. Upperstone (D:c.400mm B(max):c.35/40mm). Road 3, J13:02, 2158, WSQ52
Two fragments make up part of a flat, simply designed upperstone. Only feature preserved is a small part of the feedpipe.
 36. Upperstone (D:c.400mm B(max):c.100mm). *Via principalis*, E07:02, 2311, WSQ48
Fragment of very thick upperstone. Has a well defined hopper, and the grinding surface is grooved in the harp style.

37. Upperstone (D:c.450mm B(max):c.60–10mm). Rerouted *Via principalis*, late third/early fourth century, E08:24, 2345, WSQ39
Fragment of upperstone. Faint hopper is outlined, the stone becomes extremely thin towards the feedpipe.
38. Upperstone (D:c.400mm B(max):c.45mm). Road 5, D08:32, 2348, WSQ3
Small fragment of probable, flat upperstone, but may be lowerstone. One side is grooved the other plain but worn.
39. Upperstone (D:c.450mm B(max):c.60–15mm). Building AP, posthole, late third century, F09:66, 2394, WSQ44
Small fragment of upperstone. Grooved on both surfaces, though grinding surface is worn. Has vertical handle socket, rectangular in shape, perforates stone totally. Circular groove in upper surface. Stone becomes very thin near feedpipe.
40. Upperstone (D:c.400mm B:c.70–20mm). Building 3, abandonment or post-Roman dereliction, P07:08, 2505, WSQ40
Approximately 30% of an upperstone, with very wide and gently sloping hopper, tapering to narrow feedpipe. Ungrooved.
41. Fragment (D:c.400mm B(max):c.80mm). *Via principalis*, L08:50, 2550, WSQ6
Very small fragment of an upper or lower stone with a flat, grooved grinding surface.
42. Upperstone (D:c.400mm B(max):c.70–25mm). Road 3, G11:71, 2636, WSQ7
Small fragment of upperstone. Grooved grinding surface, with circular groove in upper surface. Profile tapers to the feedpipe.
43. Lowerstone (D:c.450mm B(max):c.90mm). Building 14, robber trench for unfinished building, Period 1, K11:45, 2646, WSQ47
Extremely thick fragment of lowerstone. Grinding surface grooved.
44. Upperstone (D:c.350mm B(max):40/20mm). Area over Building 5 and Alley 3, unstratified, F04:01, 2647, WSQ12
Half of simply designed upperstone. Grinding surface worn smooth. No other features.

The Romano-British milling stones

45. Upperstone (D:c.400mm B(max):c.80mm). Area over Building 2 and Alley 1, unstratified, M05:01, 495, WSQ14
Whole upperstone, in three fragments. Fairly thick and flat, with a collar round the top of wide feedpipe, and a rynd chase open to the grinding face.
46. Upperstone (D:c.400mm B(max):60mm). Area over Building 10 and Road 9, unstratified, H15:10, 1435, WSQ49
Small fragment, with a pronounced collar around the hopper. Small portion of rynd chaser survives.
47. Lowerstone (D:c.400mm B(max):c.120mm). Building 5, *contubernium* 1, Period 2, G05:23, 497, WSQ58
Totally perforated, thick lowerstone. Grinding face is gently conical. Spindle socket is 'stepped'.
48. Lowerstone (D:c.450mm B(max):45mm). Area over Building 2, ploughsoil, L05:03, 671, WSQ54
Fragment of flat lowerstone. No features.
49. Upperstone (D:c.350mm B(max):c.100mm). Rubble between Building 18 and street drain, H05:25, 921, WSQ22
Fragment of upperstone made from Penrith sandstone. Very thick for its diameter. Grinding face gently inclined.
50. Upperstone (D:c.350mm B(max):c.60mm). Building Row 20, levelling between Buildings Q and R, late third/early fourth century, F11:18, 1179, WSQ41
Fragment of upperstone, remarkable for having remains of rynd still in rectangular shaped rynd chase. Gently sloping, well worn grinding face.
51. Upperstone (D:c.350mm B(max):c.80mm). Area over *Via quintana*, unstratified, K13:01, 1359, WSQ36
Smallish flat upperstone. Spacious hopper leading into feedpipe, with rynd chase. Grinding surface grooved in harp pattern.
52. Upperstone (D:c.400mm B(max):c.50–20mm). Chalet 9, Building W, late third/early fourth century, D13:11, 1492, WSQ38
Small, fairly light upperstone. Becomes very thin towards feedpipe. Slight groove around rim may indicate iron hoop handle.
53. Upperstone (D:c.400mm B(max):c.40mm). Chalet 9, Building W, late third/early fourth century, D13:39 and D13:47, 1578 and 1579, WSQ20
Three fragments of upperstone. Flat on top with conical grinding face. Very wide hopper and feedpipe, with remains of rynd chase. Other features are a collar around the hopper, a horizontal handle slot, and a channel running across the whole diameter of the upper surface, probably connected to the handle arrangement.
54. Upperstone (D:c.400mm B(max):c.35mm). Area of Building 12 and Road 3, no details, N14:09, 1877, WSQ15
Wide, flat upperstone. Roughly dressed. Grinding surface worn. Condition is bad: the stone is incomplete, consisting of four fragments.
55. Lowerstone (D:c.400mm B(max):c.50mm). Road 8, F09:07, 2210, WSQ53
Fragment of flat lowerstone. Grinding surface grooved in harp pattern, while the underside is roughly dressed.
56. Lowerstone (D:c.420mm B(max):c.110mm). Area over Road 1, unstratified, E07:03, 2233, WSQ31
Lowerstone with sub-ovoid profile. Harp grooving on grinding face. Has stepped spindle socket similar to no. 47 above.
57. Lowerstone (D:c.420mm B(max):c.110mm). *Via principalis*, F08:27, 2369, WSQ62
Large complete lowerstone. Flat grinding face, with spindle socket. Curved underside is roughly dressed.
58. Upperstone (B: c.60–50mm). Building 16, robber trench, P08:27, 2600, WSQ43
Small fragment of upperstone, with very pronounced collar round hopper. Circular groove in grinding surface surrounds feedpipe, possibly as fitting for rynd.
59. Upperstone (no measurements possible). Alley 10/ Building 17, disturbed surface inside building, third century, G05:17, 2645, WSQ9
Small fragment of probable upperstone. Has very worn harp grooving on one face.
60. Lowerstone (D:c.350mm B(max):c.50–25mm). Area over Buildings B and K, post-Roman, L05:07, 2650,

WSQ51

Thin, flat probable lowerstone of simple design. Totally perforated by spindle socket. One side of stone may have been reshaped. Profile is asymmetrical.

Other

61. Lowerstone (D:c.250mm B(max):c.40mm). Alley 4, G05:07, 478, WSQ27
Very small rim fragment of lowerstone. No other features.
62. Saddle quern (no measurements possible). Unstratified, 1912, WSQ55
Smallish, asymmetrical stone with one smooth surface. Cannot possibly identify as a rotary quern stone; could possibly be part of a saddle quern.
63. Upperstone (no measurements possible). Surface round Cistern 1, Period 2 or 3, E08:64, 2443, WSQ30
What could be a fragment of a very small bun-shaped upperstone, but too badly damaged for exact identification.

The finds in context

by A. T. Croom

Just over 1400 finds of interest from the excavations have been reported upon in this volume, coming from over 24 different buildings and major features. As the Hadrianic layers were not extensively explored and the late Roman occupation layers were largely destroyed by later use of the site, the assemblage dates mainly to the period between the third quarter of the second century and the late third century. Due to the later activity on the site, the post-Roman features and layers are very rich in Roman finds, with almost half of all the small finds and the pottery from the excavations coming from site clearance and later features. Whilst this has made looking at distribution patterns difficult, it has been possible to look at the site assemblage as a whole for a number of different categories.

Military equipment

In total there were 38 items of military equipment (including weapons other than throwing stones) and a further 34 that could be either military equipment or horse harness. To these figures can be added objects found during the 1997–8 excavations, providing an overall total of 55 items of military equipment and 42 either military equipment or horse harness.

Belt and baldric fittings

Almost half of the material identified as being possible military equipment was made up of the decorative fittings, buckles and fasteners that could belong to either soldiers' equipment or horse harness. Those fittings that were clearly belt or baldric fittings were of types with a long life, the designs being introduced first in the Antonine period but continuing until the late third century. There were no obvious fourth-century fittings.

Armour

There are two pieces from legionary armour, an incomplete vertical fastener or tie hook (Fig. 25.12, no. 166, unstratified; Thomas 2003, category Gi or Hi), and a vertical fastener (Fig. 25.12, no. 168, post-Roman?; *ibid.*, category Gii). Small quantities of legionary armour have also been found at South Shields, where it is assumed they relate to the presence of the Sixth Legion during the construction of the fort, and the few items from Wallsend probably also come from its builders rather than reflecting the equipment of the auxiliary soldiers (Allason-Jones and Milet 1984, 3.689, 3.691, 3.696, 3.705; Bidwell and Speak 1994, 19; Bishop 2002, 91). There was only one large fragment of ring-mail (Fig. 25.18, no. 16, Antonine in date), and no examples of scale mail.

Weapons

There were 12 spearheads in total, but only three ferrules. One of the spearheads was too large for practical use, while the rest show a range of blade shape and socket diameter, with the smaller ones, mounted on slender shafts, more likely to be javelins for throwing rather than spears for thrusting. The earliest example, from underneath the Antonine stone barracks, was a large spearhead with elongated point (Fig. 25.17, no. 4). Five were found in or above the cavalry barracks, six from the infantry barracks, and one from the hospital. This example, and one from Building 9, came from make-up levels for floors, while three others came from floors. Some of these may have been deliberately included during building work as a form of foundation deposit.

The size of the fragment of pattern-welded blade (Fig. 25.18, no. 18) suggests that it comes from a dagger rather than a sword. The technique of pattern-welding produces a blade with a visible design of black lines against the silver of the metal, in this case a herring-bone pattern up the centre of the blade. Due to the work involved, it would have been a relatively expensive weapon that must have belonged to an officer. The fragment was found in a mid-third century occupation layer, in the officer's house of Building 12.

'Native'

The fort has produced a relatively large number of 'native' objects. Although agricultural use of the site before the construction of the fort indicates that there was a pre-Roman settlement in the area that has not yet been located, only one of the artefacts dates to before the occupation of the fort site (Hodgson 2003, 13). The other 10 items are all long-lived types that continued to be made in the Roman period or whose manufacture started during the Roman period.

The pre-Roman object is part of a three-link horse bit of a type used up to the mid or late first century (Fig. 25.13, no. 188). There are also a number of

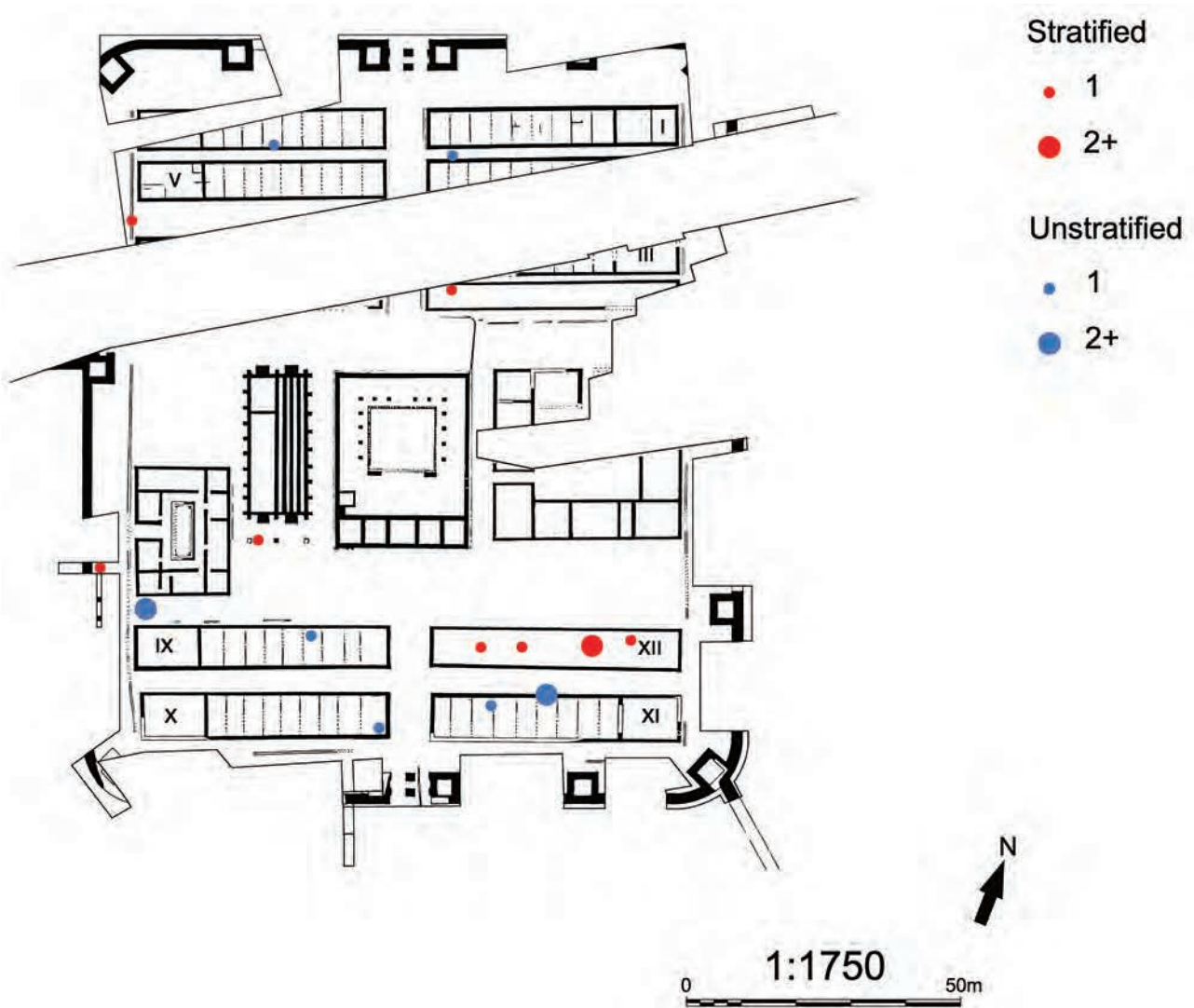

Figure 8 Distribution of 'native' artefacts.

opaque yellow beads which are traditionally said to go out of production by AD 50 (glass small finds, nos 14–6), but there is some evidence that these may have continued in use into the second century (Price 1985, 213, nos 52–3).

Other items that could be pre-Roman or Roman in date are horse harness fittings such as the copper alloy bridle fragment (Fig. 25.13, no. 187) and the two bone toggles (Fig. 25.23, no. 12; Croom 2003, fig. 147, no. 76, from Building Row 20). Domestic material includes a long-handled 'weaving' comb (Fig. 25.24, no. 34), and a tankard handle of a type made from the late first century through most of the Roman period (Fig. 25.09, no. 85; Jope 2000, 130–1). There are two further beads, one dark blue and the other blue with a white trail, which belong to long-lived classes that began production in the Iron Age, the dark blue in particular being described as a type often indicative of a native element (Fig. 25.28, nos 17–8). There were also a number of hand-made vessels in local traditional ware from inside the fort (see Chapter

22). The section of Hadrian's Wall excavated near the fort has also produced an enamelled pin (SF no. E501, unpublished), and the *vicus* another example of a long-handled comb (SF no. WSB519, unpublished).

Three of the 'native' items relate to horse harness. These may have belonged to irregular cavalry troops stationed in the fort in the third century (Hodgson 2003, 150–1), but may equally have belonged to the members of the regular auxiliary cavalry, as there are some suggestions that they may have been particularly attracted to native-style equipment. It has been suggested of the torc found in the cavalry fort at Benwell, for example, that Roman cavalrymen liked to wear them as personal ornaments (Cessford 1995, 235). Figure 25.38 shows the distribution of glass beads, armbands, 'weaving' combs, horse equipment, pierced metatarsals and the tankard handle; it should also be noted that three of the four spearheads with ridged blades (another pre-Roman tradition) also came from in or above the area of the cavalry barracks.

Unlike the local traditional ware vessels, the native

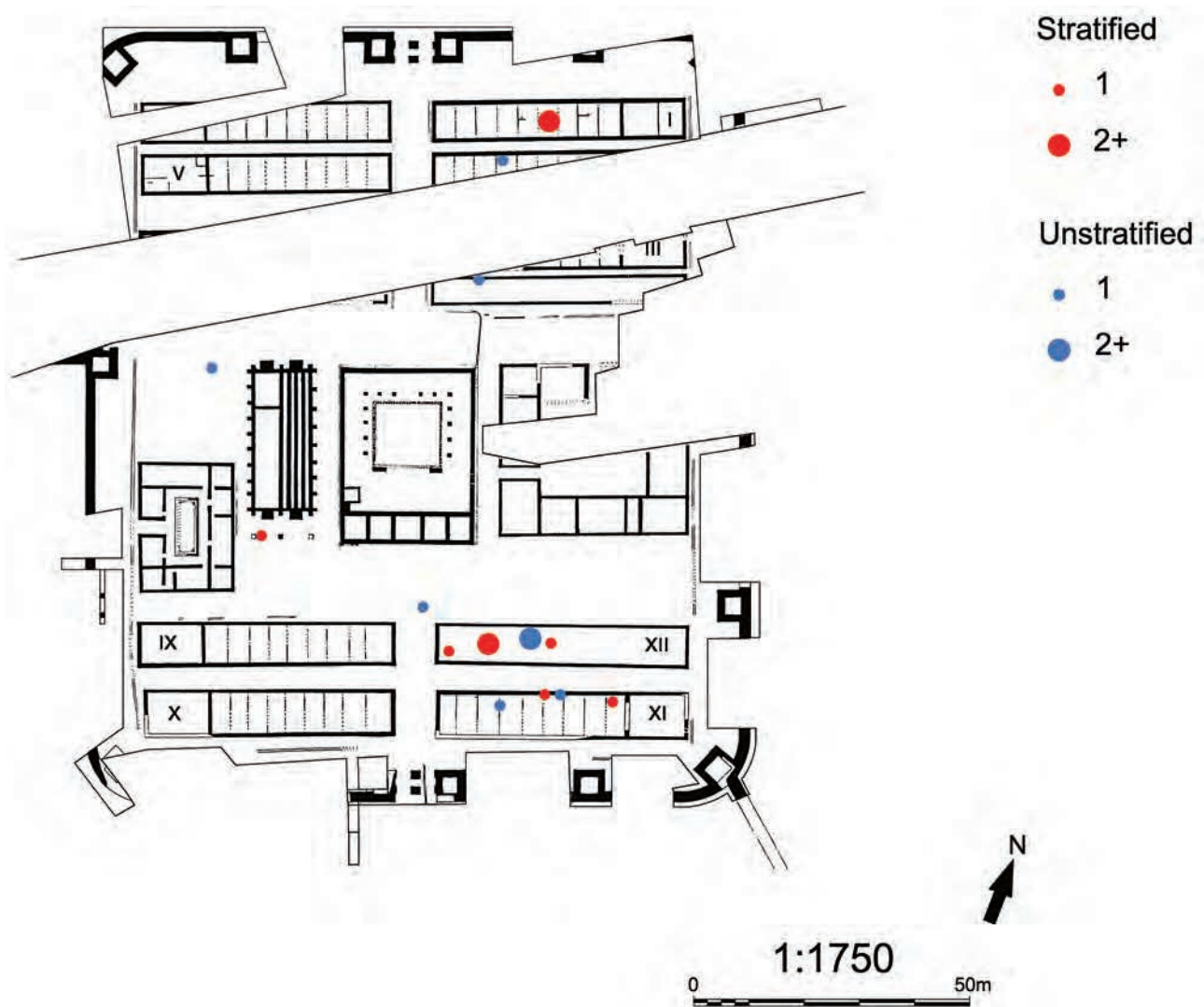

Figure 9 Distribution of horse harness.

objects are concentrated in the southern third of the fort. The one exception is an unstratified bridle piece from above the assembly area. Two beads came from close to the *Porta quintana*, an area that has produced a number of jewellery items, and are perhaps related to a possible market there, although one of the beads is an example of the yellow bead that probably went out of use in the second century and the suggested market was later in date. The other items come from the four cavalry barracks or the disturbed layers above them, apart from one bone toggle from Building Row 20 (Croom 2003, fig. 147, no. 76).

Horse harness

There are 16 probable pieces of horse harness, of which only five were stratified. Of the 16, one is a terret from a vehicle, one is a pre-Roman bit and one has been partially recycled for its metal, leaving 12 items of horse harness likely to have used by the cavalry. Of the 12 that could be given a location, seven came from

in or over the cavalry barracks (plus another four from the 1997–8 excavations: Hodgson 2003, 72, table 4). Three others came from in or near Building 1 in the *praetentura* which had been converted into a stable (one from a possible floor inside the building, one from the dereliction over Alley 1 and one from the demolition material used to backfill the clay puddling pit). The remaining two came from above Building 16 and one from above road 8.

Another possible piece of harness is an incomplete fitting that could be a bridle cheek-piece (Fig. 25.12, no. 174), and another that could be a fitting or slide (Fig. 25.12, no. 175). There are also other fittings that are known to have dual uses, such as the button-and-loop fasteners that were used on both horse harness and as belt attachment for dagger and sword scabbards (Fig. 25.13, nos 189–97; Croom 2003, 211) and the buckles with rectangular or splayed attachment loops that were also used as belt buckles (Fig. 25.12, nos 150–3, 156, 159; Bishop and Coulston 2006, fig. 124; Croom 1995, fig. 3, no. 9). Enamel studs

similar to no. 226, phallic studs with niello decoration such as no. 227 and small lunate mounts similar to no. 240 have all been found on the headstall found buried with a horse at Beuvingen, the Netherlands (Zwart 1998, fig. 3), but it is uncertain if they were only used on harness. Peltate mounts (cf. Fig. 25.15, no. 238) were certainly used as both harness and belt decoration (Aurrecochea Fernández 1996, figs 15–6).

The assemblage includes only one of the junction-loop fasteners typical of an assemblage of second century equestrian equipment (Fig. 25.13, no. 181), and it is likely most of the fittings belong to the new fashions that developed in the very late second century but which were most common in the third century, and possibly later; little is known of fourth-century horse harness.

Medical implements

There were seven possible medical implements (Fig. 25.10, nos 99–103; Fig. 25.23, nos 6–7). None were found in the Hospital, although a bone handle possibly from a medical implement was found unstratified just to the east of the building, and a leaf-shaped blade and a probe were found in the same context in the possible building in the rampart by the *Porta quintana* to the west of the Hospital.

Female presence

There are at least 63 (and possibly 72) objects used primarily or exclusively by women that have been identified from excavations inside the fort (both 1975–84 and 1997–8), although only 25 were stratified. The categories of objects identified are as follows:

Hairpins. Only bone examples were included, as while there is clear evidence that bone pins were used in the hair, there is some suggestion that metal pins may also have been used for fastening clothes and may not, therefore, have been used only by women (Philpott 1991, 151). Women would have owned a number of hairpins in a range of materials at any one time, with groups of up to 16 pins known from burials. However, while the evidence of pins apparently worn at burial suggests that while up to seven could be used at any one time, one or two pins were more typical.

Bracelets and ear-rings. These were worn only by women until the very late Roman period (Swift 2003, 50).

Beads. Beads were used to make necklaces and bracelets and to decorate ear-rings, all of which were worn almost exclusively by women. Melon beads have been excluded because of their possible use on horse harness.

Mirrors. The mirror, being associated with the vanity

of facial appearance, was seen as being a typical female item in the Roman world.

Spindlewhorls. Large numbers of pierced discs cut from pottery sherds are frequently found on Roman sites, but the numbers involved suggest it is likely that they have uses other than as spindlewhorls (42 pottery examples and five in other materials have been found inside the fort; if these are all spindlewhorls women were losing them at a higher rate than their hairpins). The only examples to be included here are those that have been professionally made, in this case decorated shale.

Brooches. Pairs of trumpet brooches were certainly worn by women to fasten their tunics, the brooches sometimes connected by a decorative chain similar to a necklace. It can be argued that men would not want to wear a brooch that was so closely associated with both a purely female style of dress and a female style of jewellery.

The assemblage is made up of 26 beads (three jet, the rest glass), 19 bracelets (one jet, five glass and the rest copper alloy), 12 bone hair pins, two copper alloy ear-rings, one fragment of jet hair pin or spindle, two shale spindlewhorls and one fragment of mirror. There are also nine trumpet brooches.

The items come from all over the fort, with only one noticeable concentration round the *Porta quintana*. These are mainly bracelet fragments from fourth-century road surfaces, and it may well represent the loss of a single collection of bracelets, scattered and damaged (1997–8 excavations; Croom 2003, 215). The objects, where they can be dated, range from the second century through to the fourth century, but the earlier material is often residual in later contexts and only a small number of items can be allocated to occupation phases.

One of the few places where this can be done is in the Commanding Officer's house (Building 13), which also has the largest number of stratified 'female' items from any single building, although this is a not very impressive three. The building produced two bone pins (bone report nos 16, 20) and a fragment of jet pin or spindle (jet report no. 6). These came from an occupation layer in a corridor, a floor in room 3 and the fill of a depression over the baths. This is the one building inside the fort where there were certainly women as part of the Commanding Officer's family and household, and yet the numbers are still low. Other items come from both the infantry and cavalry barracks, but the numbers are small, and not many are associated with occupation layers. Although the assemblage includes a number of small items such as beads easy to overlook when lost and not always worth the trouble of retrieving, which are therefore more common in the archaeological record, the total number of female items from the site (at least

63) compares well with the number of items of the certainly male items of military equipment (between 55 and 97).

Lighting

The fort has produced 12 items of equipment using for lighting, consisting of 10 lamps and one candlestick. The military were one of the major users of lamps in Britain, but they were never as popular here as on the Continent, and their use was already in decline by 100 (Eckardt 2002, 153). For most of the soldiers the open fire in the *contubernia* may have provided all the light necessary. Iron open lamps or iron or wooden candlesticks may have also been used, although none are represented in the assemblage from the site. Artificial lighting would have been most important in those rooms without open fires, such as high-status rooms with underfloor heating, and within the Commanding Officer's house where Mediterranean-style lighting must have been used. The copper alloy hanging lamp (Fig. 25.06, no. 77), for use with a lamp-stand, would certainly have belonged to an officer.

There are fragments from five *firmalampen*, closed lamps for burning oil (although one of these fragments is a decorative mask cut from the *discus* of a lamp that may have reached the site as an amulet or similar rather than as a complete lamp). A matching pair was found in the hospital, the earliest of which was found in a layer under the stone building (mid Antonine or later). There were also five open lamps, for burning oil or, more frequently, animal fat. This type of lamps tends to be less delicate than the oil lamps, and the assemblage includes one in stone and one in lead, as well as examples in pottery. The exceptions are two very small pottery lamps based on miniature bowls, one certainly the product of local kilns and the other likely to be so as well (Fig. 25.29, nos 10–1). The complete example has a pinched-out spout and an applied straight handle, a form unusual in pottery and more typical of lead lamps. There is a possible parallel from York (Perrin 1990, fig. 127, no. 1434), and a larger version from the Antonine kiln at Roxby (Rigby and Stead 1976, fig. 68, no. 66).

Ritual

The unit at Wallsend seems to have had a tradition of burying complete items during the construction of their barracks. This is not a practise common in all forts and seems to reflect cultural differences retained by individual units within the army. Such items could be gifts to bring good luck or prosperity to new buildings (or to buildings that had changed use), or to protect the building and its occupants from evil, such as the envy of other people, or as offerings to appease local guardian spirits or deities. The most costly offering

at Wallsend would have been the complete ring-mail suit found buried in a pit dug before the construction of the Period 4 Barrack 12 (Croom 2003, 217, no. 53). In this case, the ring-mail was found under the position of the central *contubernium* of the barrack, but other possible offerings are more commonly found in the officer's quarters. Three stacked copper alloy cooking pots came from the Antonine decurion's quarters of Building 12 (Fig. 25.08, nos 79–81), while a complete ramshead *patera* was found in the make-up layers of the third-century decurion's quarters of Building 11 (Fig. 25.07, no. 78). The very large spearhead, presumably originally of ceremonial use during its active life, was buried whole within the flagged floor of the officer's quarters in Building 1, although it is unclear whether this was during the construction of the floor or as a later insertion.

It is not clear if the miniature axe (Fig. 25.06, no. 74) is a complete votive object (Kiernan 2009, type 1c) or part of an incomplete pin (*ibid.*, 120; Cool 1990b, group 18C, fourth-century type). Both types of artefacts are more common from religious sites than military, and it may be significant that it came from the area near the finds-spot of the Fortuna statuette in the Commanding Officer's house, although it is unfortunately unstratified.

Religion

Altar and statue fragments recovered from the general area of the fort reflect the official worship of two of the three major state gods, Jupiter Best and Greatest and Minerva, the goddess of war (Snape and Bidwell 1994, 24–5). Minerva was represented in a large statue found outside the fort, but the head of a more modest statue of her was also found re-used inside the fort (Fig. 21.02). Both deities appealed to the military, as did Fortuna, represented by a copper alloy statue in the Commanding Officer's house (Fig. 25.05, no. 73), Mars, depicted on an intaglio and Dea Roma, holding both a sword and a figure of Victory, also on an intaglio (Fig 25.26, no. 1; cat. no. 6).

Two dedication slabs and a fragment of a statue indicate that there was a temple dedicated to Mercury to the west of the fort (*CSIR* 1.1, nos 202–4). It is possible that he is also the god represented in the small portable shrine used for more private worship (Fig. 25.21, no. 1). He was one of the most popular gods within Britain, but as the god of trade, profit and commerce, and protector of travellers (and thieves), was usually more popular with civilians than the military.

The pipeclay figurines also represent domestic worship, being comparatively cheap, mass-produced statues that could set up in small wall-mounted shrines within houses or barracks. Approximately eight such figurines are known from Wallsend, three representing a nursing mother goddess (*dea nutrix*), three Venus and two unknown human or animal

figurines. Five of them come from the *vicus* south of the fort, and only three from inside the fort. One of those from inside the fort, from a possible midden east of Building 3, is a nursing mother (Fig. 25.29, no. 1). The subject matter perhaps makes it more likely that this was originally owned by a woman.

Copper alloy vessels

The fort as a whole has produced evidence of ten copper alloy vessels, of which nine can be given a location. Some are utilitarian kitchen vessels (such as the buckets with iron handles found in the decurion's quarters of Building 12) and others are tablewares. Copper alloy vessels would have been more expensive than pottery equivalents and probably also more expensive than glass vessels (which often imitated the more desirable metal versions: Fleming 1997, 12), and of the six vessels found in barracks it is noticeable that all four complete vessels (deliberately buried) were found in an officer's quarters. Of the three remaining vessels, one came from the hospital and two were unstratified, but from near Building 16 which has produced gold and silver coins and intaglios. The three buckets buried together date to Period 2, while the rest date to contexts of the second half of the third century and probably later.

Survivals

The assemblages include a number of first-century items that were in use for some time before they were deposited on the site. The copper alloy candlestick could have been approximately 200 years old when it was deposited, and would have been still functional at the time (Fig. 25.06, no. 76). The ramshead *paterna* would have been at least 125 years old when it was deliberately buried as an offering, its age perhaps making it more precious as a gift (Fig. 25.07, no. 78). There were also two first-century brooches, one found in a post-Roman robber trench (Fig. 25.02, no. 16) and one in an undated context within the interior of one of the fort gateways (Fig. 25.02, no. 1). This second brooch has been dated to c.50–70 and is of a type with a restricted distribution in the south-west (cf. Mackreth 1993, fig. 23, no. 4; Mackreth 1994, fig. 75, nos 5–6; also an unpublished example from Princesshay, Exeter).

Curiosities

Amongst the collection of flints from the site there were two barbed and tanged arrowheads, one leaf-shaped arrowhead and one polished stone axe, all in good condition (Fig. 25.32, no. 56). Only one of these is stratified (from the fill of a drain near Building 1), but it is possible rather than being disturbed accidentally from pre-Roman layers, they may have been curiosities picked up and kept by soldiers within the fort. Stone axes in particular have been found from a number of

Roman sites, and it is thought they may have been kept for superstitious or religious reasons (Adkins and Adkins 1985). Some other objects seem to have been brought to the fort as curiosities, such as the crinoid ossicles that may have been collected near Holy Island about 80km further up the coast (*pers. comm.* S. Humphries), and a roughly worked piece of whale-bone found in the *vicus* (unpublished, WSB513) which must also have been picked up from the beach.

Buildings and their associated finds

The quantity of finds varied considerably between buildings, sometimes reflecting the area actually excavated, and sometimes reflecting the original barren nature of the building itself.

Barrack: Building 1

The very large spearhead (Fig. 25.17, no. 1) was found in the floor of the officer's quarters. It was too large to be of much practical use, as its disproportionate weight at the end of the shaft would make such a spear very difficult to control or use effectively after a very short length of time. Its size makes it impossible for it to have been accidentally left on the floor, and it may have been a ritual deposit of some type, either as the floor was being laid or on its abandonment. The building produced nine throwing stones built into floors and walls (see also Building 3).

Barrack: Building 2

The building was only partially excavated. There was another spearhead on a floor (Fig. 25.17, no. 6), but it was not a large example, and it may have no significance.

Barrack: Building 3

The most distinctive element of the finds from this building was the number of throwing stones incorporated into the foundations of the Antonine building. There were originally 18 stones under the floor of *contubernium* 2 and a further three in the floor itself. The stones must have been manufactured during the Hadrianic period and although by their very nature are long-lived weapons, by the Antonine period they were no longer needed and were reduced to being treated as building material.

Barrack: Building 9 and Chalet range 9

There was an incomplete spearhead in a floor level in *contubernium* 2, and another in the make-up for a new surface in room W (p.164, nos 10, 11). The same make-up layer also included an offering of a complete bronze skillet (Fig. 25.07, no. 78).

Barrack: Building 11

This building had a spearhead in the floor of *contubernium* 3/4 (iron cat. no. 7). The same layer

also contained a fragment of a padlock. These are sometimes found connected to chains and are also known to have been used on shackles.

Barrack: Building 12 and Chalet range 12

An adze-hammer was found in constructional(?) material in phase 1 of the building (Fig. 25.19, no. 27). It may have been accidentally buried during construction work, although as it is 220mm long and its original wooden handle would have made it even bulkier, it is possible that it was a deliberate offering. An offering of three buckets was certainly made at the officer's quarters (Fig. 25.08, nos 79–81). An incomplete spearhead was incorporated in a construction layer of chalet AJ (Croom 2003, fig. 144, no. 57).

Workshop: Building 16

This building has been identified as a workshop, but it contained an interesting amount of non-industrial material. There were two intaglios (the only building in the fort to have more than one), two brooches and a fragment of a glass armlet. There were parts of two spoons and a key, as well as the hoard of 12 silver and one gold coin. It is possible much of this material, if not simply random background clutter, may have been present for recycling or repair, but the only item of military equipment was a fragment of a belt mount or fitting, and more items might be expected if metal items were being made or repaired in the building. Tools included a small iron awl, a bone needle and a whetstone, all of which would also be used in domestic surroundings. There was only a single piece of copper alloy casting waste (no. 3). This building also contained an iron shackle, possibly for use on an animal, but just as likely to be used on a human. Shackles seem to have used principally for transporting people, and in particular slaves, and may also have been used in military situations when dealing with British prisoners.

Hospital: Building 8

The building produced 23 small finds, of which four related to the military use of the site. These consisted of a spearhead in the clay floor of large room 8 (Small finds report, iron no. 12), a strap-end in the entrance (Fig. 25.12, no. 160), a fragment of ring-mail found in construction material (Croom 2003, 219, no. 53.3) and a throwing stone, probably re-used as building material (cat. no. 132). The only possible medical implement from the whole building was recovered from a Period 2 occupation layer in room 3 (Croom 2003, 215, no. 34.2).

The building had an interesting selection of lighting equipment. There was a complete lamp with heavy sooting round the nozzle found in a possible 'natural' layer under room 8 of the stone building, associated with Antonine samian (Fig. 25.29, no. 6). A second complete but broken lamp, which had had its filling

hole enlarged but which showed no signs of use, was found in the Period 2 occupation/demolition layers of room 5 during the 1997–8 excavations (Croom 2003, fig. 149, no. 90). The two lamps were of exactly the same fabric and form, and must originally have been associated.

There was a fragment of a third pottery lamp found in room 1, but as this came from a phase 4 make-up layer it may have been brought in with building material from elsewhere. There was also a complete copper alloy candlestick in the soil above the flagstones of room 3 relating to the abandonment of the building (Fig. 25.06, no. 76). Artificial lighting was used for both religious purposes, such as purification and as votive offerings to deities, and for funerary purposes, such as pre-burial rituals and as grave goods (Eckardt 2002, 95,115). Religious rituals were no doubt carried out in the hospital as part of the medical care, and there would also inevitably be corpses to deal with. However, while there were clearly uses for lamps in the building, one of the complete lamps showed no evidence of ever having been used. The symbolic importance of lamps may have made this lamp a suitable termination offering, if it was associated with the demolition of the building.

Commanding Officer's house: Building 13

The 29 small finds recovered from the building are typical for a domestic assemblage, incorporating items from the toilette, recreation and household work. Under the category of personal adornment there are two or three hairpins and a pair of tweezers; there are two counters from a game, and tools such as a needle and a whetstone, and a possible spindle fragment. Furnishings are represented by a stud from a box, a decorative copper alloy plate probably also from a box, and a couple of studs that might have decorated either a box or a door. The only military items are part of a belt strap end, a throwing stone and a lead sealing. There are two items that are loosely connected to ritual, one of which is an appliqué theatrical mask cut from a pottery oil-lamp brought from North Italy (Fig. 25.29, no. 5). It may have been kept simply as a pretty object, or it might have had greater significance, perhaps as an amulet, to its owner. The other artefact is a statuette of provincial manufacture, probably intended for a shrine since it was not designed to be seen from the back, although of a larger size than most religious statuettes (Fig. 25.05, no. 73).

There is nothing amongst this assemblage that reflects the high status of the family living in the building, and parallels for almost all the items can be found in the accommodation of the ordinary soldiers. The statuette, although not a common site find, is not of a particularly high quality. However, lack of high quality objects is not unexpected, as there would be more slaves than family members within the household, and many of the items that would

have indicated the family's status, such as expensive textiles and silver dinner services, are unlikely to enter the archaeological record.

Headquarter's building: Building 14

This building had eight counters in stratified layers and another unstratified example that may also have come from it. The eight represents the largest number of counters from any single building inside the fort, all but one of which were professionally made out of bone or glass. Three came from room d, presumably from the same set, one from room a, three from the crosshall, and one from the floor(?) of the strongroom. The *principia* at South Shields Roman Fort has also produced a large number of counters, with 12 examples in bone, pottery and stone (Croom 1994, fig. 7.5, nos 72–3, nos 75, 75/B183, 75/B184; fig. 7.15, no. 123, no.123/S6; 198, no. 107/P119; 200, nos 108/P71, 108/P76, 108/P98). Pottery discs come in a large range of sizes, so the term 'counter' has been reserved for those under approximately 33mm in diameter, this being the maximum size of professionally made bone examples and are therefore considered suitable for use for board games, although such discs did not have to be used purely as counters on a board. Their presence in the *principia* is therefore of interest, but as some of the counters from both sites come from construction layers, they may in fact not have anything to do with the use of the building.

The post-Roman finds

Early medieval

Pottery (Fig. 25.40)

by J. Tipper

A single sherd of decorated handmade early Anglo-Saxon 'pagan' pottery was recovered from an unstratified context over the site of the *principia* (Building 14, context J09:01).

FABRIC AND FORM

Wt: 92.4g. D(max):875mm B(max):14.28mm. The fabric is a fine sandy matrix, with some coarse sub-rounded quartz inclusions <2mm. The sherd is dark grey in colour and has a smoothed, but not burnished, finish. The exterior surface of the sherd is in good condition; the interior is pitted and has been abraded. A linear groove on the interior was probably created during manufacture of the vessel. The sherd is from the shoulder region of a globular jar, probably a sub-biconical urn. There are no indications to suggest a bossed design. It is difficult to estimate the size of the vessel from the single sherd.

DECORATIVE SCHEME

The sherd has elaborate stamped and incised decoration; a three-line (narrow) pendant triangle filled with a vertical row of stamps. Outside the pendant

is a zone of incised decoration, which is unclear due to the small size of the sherd, but might possibly be a three-line chevron enclosed within two single lines. A single stamp has been used, with a rectangular grid motif (criss-crossed), which is most similar to motif C2a using Briscoe's typology (Briscoe 1983).

COMPARATIVE DECORATIVE SCHEMES

The decoration found on the sherd falls within a strong tradition of pottery production and decoration, and finds most similar parallels from the cremation cemeteries north and south of the River Humber, e.g. Sancton, Heworth and Elkington. The use of stamped pendant triangle decoration is very typical of the sixth century and designs of this kind were extensively used by several of the more prolific workshops, notably Illington-Lackord and Sancton-Baston (Myres 1977, 52–6).

The design is similar to some from the Sancton-Baston 'workshop', first identified by Myres (Myres and Southern 1973; Myres 1977, 59–60; figs 347–8) and later analysed by Arnold (1983). Arnold, however, doubted whether 'potter' or 'workshop' were appropriate terms and suggested that the symbols may have had a totemic significance relating to family affiliation (Arnold 1983, 27). The most characteristic feature of the Sancton-Baston pottery is the interlocking stamp-filled pendant triangles. The main pendant triangle nearly always carries two stamps, a concentric circle or rosette and the other a criss-crossed grid rectangle, which is very similar to that from Wallsend. The most complex designs are found on vessels at Sancton, Yorkshire, simpler designs from Norfolk, Nottinghamshire, Lincolnshire and Leicestershire. None illustrated in Myres' corpus, however, have narrow pendant triangles with a single line of stamps (Myres 1977).

SIGNIFICANCE OF THE SHERD

The importance of a single unstratified sherd is difficult to assess and it is difficult to discuss its original provenance. One might normally expect a

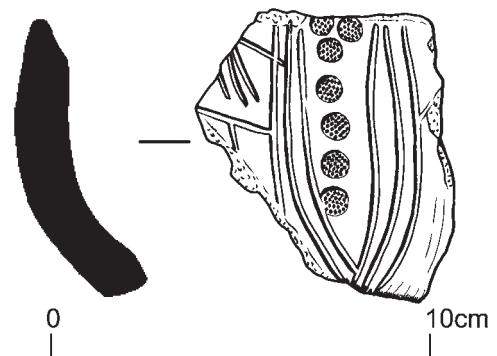

Figure 25.40: Anglo-Saxon pottery. Scale 1:2.

highly decorated vessel in a funerary context, rather than in domestic use. Such a vessel might occur as an accessory vessel within an inhumation or as a cremation urn. The practice of inferring burials from stray objects, in this case a single sherd of unstratified pottery, is however unsatisfactory (Miket 1980, 290). The generalised pattern of cremations and furnished inhumations between Deira and Bernicia is striking. There are no large cremation cemeteries to the north of the Yorkshire Wolds and no mixed cremation and inhumation cemeteries north of Hob Hill, Saltburn. There is a total lack of cremations north of the Tees (Cramp 1988, 72). The Wallsend sherd is, therefore, more likely to come from an accessory vessel within an inhumation grave than from a cremation burial.

There are few examples of decorated pottery from excavations within the region with which to compare the Wallsend sherd. The sixth-century inhumation cemetery at Norton-on-Tees contained eighteen vessels, including three used as cremation urns, but none of which were decorated (Sherlock 1992, 54–5). Hob Hill, Saltburn, is a mixed cremation and inhumation cemetery, dating to the sixth century and excavated early in the century (Gallagher 1987). The total number of graves is unknown and, unfortunately, only a small proportion of the pottery is preserved (Gallagher 1987, 19–21). The remaining pottery does, however, show strong links to Deira and the south; a *Buckelurne* from Hob Hill is comparable with vessels from Heworth and Sancton (Gallagher 1987, 19).

Of particular relevance to this discussion is the evidence of occasional and isolated early Anglo-Saxon burials inside other Roman forts in north-east England. Sixth-century burials have been found within the fort at Aldborough (Cramp 1983, 267). A female inhumation burial was found within the *praetorium* at Binchester, which contained a brooch, beads and sherds of a vessel dating to the mid-sixth century (Coggins 1979, 236; Miket 1980, 297). At Catterick the fort buildings were in decay by the time sixth-century Anglian burials were inserted in the ruins (Cramp 1983, 267). An early sixth-century burial at Corbridge occupied a central position within the fort; a scabbard strap mount and a small pot were found at one site and two Group II cruciform brooches and a string of glass beads at another site in Corbridge (Miket 1980, 293; Cramp 1983, 268).

On comparison with this evidence it does not seem implausible that an isolated burial, or burials, were placed within the fort at Wallsend but which has been disturbed at a later point, as evidenced by the unstratified sherd of early Anglo-Saxon pottery.

ACKNOWLEDGEMENTS

I am grateful to Catherine Hills who kindly read and commented upon this report and to Matthew Buckley

for his help in producing an impression and cast of the stamp.

Small finds (Fig. 25.41)

by L. Allason-Jones

1. Fitting (L:29mm B:2mm). Unstratified, WSCA926
Fragment of an openwork handle mount from a wooden bucket. Martin 1976, type IIIA, sixth-century. Cf. Bael-Bernerring, *ibid.*, Grab 33, no. 16b; Krefeld-Gellep: Pirling 1974, Taf. 50, no. 1b. This is a Continental type of handle mount which in this country is found almost exclusively in Kent (Cook 2004, 30, 43). Other type IIIA mounts are known from Gilton, Kent and West Stow, Suffolk (*ibid.*, no. 106; West 1985, fig. 268, no. 4). (AC)
2. Copper alloy strap end (L:37mm W:15mm T:1mm). G03:04, 620, WSCA155, 2001.1195
Incomplete strap end tapering to a trilobate end. The back in plain but the front is intricately decorated with a central rosette inside a wreath surrounded by a series of open squares within a ribbed border. A hole is pierced at the top where there is also some iron corrosion. Eight- or ninth-century in date and possibly of Northumbrian manufacture. Hawkes and Dunning 1961, Type VA. See also four silver strap ends of similar appearance from Lilla Howe in North Yorkshire: Watkin and Mann 1981, 155–7.
3. See the copper alloy escutcheon (Fig. 25.09, no. 83, possibly fourth to seventh century).

Medieval

4. Copper alloy buckle (W:26mm T:4mm). F08:01, 2198, WSCA118, 2001.1158
Incomplete oval buckle with expanded decoration on one face on either side of the pin rest. The shank is semi-oval in section. c.1250–1400.
5. Copper alloy pin (L:30mm T of head:1.5mm). F11:67, 2216, CA927
Very small brass pin with a globular head formed by twisting wire around the end. Although such pins were found on Roman forts in the area, evidence suggest that they are medieval and post medieval in date. Egan and Pritchard 1991, 299.

Post-medieval

Glass

by A. T. Croom

There were a number of seventeenth-century beakers with chequered spiral trail decoration, in pale green glass (cf. Haslam 1993, fig. 71, nos 665–7).

6. (D:80mm B:1mm). L15:01, WSG209
Out-turned rim and single line of trail surviving.
7. (D:70mm B:1mm). G04:01, WSG182
Two lines of trail surviving.
8. (B:1.5mm). L14:01, 1432, WSG207
Two lines of trail surviving.
9. (B:1mm). E14:01, WSG208
Two lines of trail surviving.

Coins

by R. Brickstock (RB)

10. Elizabeth I	1d	1538–1601	F08:02, 2229, WSC243
11. Charles I	½ groat	1625–49	L05:03, 907, WSC335
12. Charles I/II		1625–85	K11:01, 1718, WSC244. Scottish
13. Charles I/II		1625–85	M05:01, 599, WSC254. Scottish
14. Charles I/II		1625–85	M04:01, 3, WSC246. Scottish
15. Charles I/II		1625–85	M11:01, 1685, WSC245. Scottish
16. Unknown		1639	G10:01, 2071, lost: site record provides provisional date
17. Charles II	2d	1663	N13:01, 1654, WSC169. Scottish. Stewart 243
18. William III	½ d	1694–1701	K03:07, 682, WSC252
19. Illegible		C17th	F09:01, 2186, WSC251
20. George II	½ d	1750	G13:02, 297, WSC336
21. George III	½ d	1760–1820	K04:03, 689, WSC268
22. Danish		1771	F09:01, 2184, WSC257
23. George III	½ d	1775	P13:01, 1777, WSC269. Peck 908
24. George III	½ d	1775	E11:17, 1139, WSC262. Peck 908
25. George III	½ d	1799	L09:01, 1968, WSC263. Peck 1235
26. George III	½ d	1806	N12:01, 1632, WSC352
27. George III	½ d	1807	L09:01, 1969, WSC261. Peck 1378
28. Victoria	½ d	1860s	M07:09, 2557, WSC265. As Peck 1754
29. Victoria	6d	1899	Unstratified, 1286, WSC274

Key: Peck = Peck 1964; Stewart = Stewart 1955

Tokens

30. Q08:03, 2451, WSC258
Token for 1¼ d. James I/Charles I, 1603–49. As Peck 308. (RB)
31. Token (D: 24mm T: 2mm). Unstratified, 1228, WSL56, 2001.2317
Circular token with a raised anchor on one face and a wheel shape on the other. This type of token is commonly found along the north-east coast of Britain and is known as a sailor's token although its exact use is unknown. (LA-J)
32. Unstratified, 938, WSC260
'Rowland Shipyard Newcastle on Tyne 1d'. (RB)

Cloth sealing

33. Lead cloth sealing (L:31mm D:24mm B:3mm). L03:11, 773, WSIM42
Cloth sealing of two-part type, poorly stamped with image of a ship within a beaded circle.

Small finds

34. Pewter buckle (L:53mm W:36mm B(max):4mm). F11:66, 2211, WSL126, 2001.2379
Rectangular buckle with a drilled frame for a separate spindle. There are traces of fine vertical line decoration on the front. (AC)
35. Copper alloy buckle (L:100mm). F11:01, 952, WSCA481
Fragment of rectangular shoe buckle with openwork interlace (c.1720–1790s). (AC)
36. Copper alloy button (D:28mm B:9mm). Unstratified, 1076, WSCA393, 2001.1433
Flat engraved button (eighteenth century or later). There were a number of other examples. (AC)
37. Bone button (D:23mm). G05:02, 17, 2001.680, WSB20
Deeply concave button with four circular holes, dyed green. Eighteenth-century or later.

BONE BUTTONS WITH SINGLE HOLE

Buttons with a single hole had a copper alloy attachment loop fed through the central hole, and often also had a decorative copper alloy cover over the front. Eighteenth-century or later.

38. (D:19mm T:1.5mm). L05:03, 685, WSB36
39. (D:12mm T:2mm). E05:01, 121, WSB27
40. Glass bead (D:19mm T:8mm). H13:03, 723, lost
Globular, cobalt blue translucent bead.
41. Glass bead (L:11mm T:11mm). N05:01, 101, WSG39, 2001.1685
Spherical black bead. Probably post-Roman, although the type is known in the Roman period.
42. Glass bead (D:9mm T:6.5mm). H16:05, 1270, WSG156, 2001.1802
Globular white opaque bead with the walls of the hole dragged to one side.
43. Wig curler (L: 30mm, T: 9mm). E02:11, 763, 2001.2508
Incomplete pipe-clay wig curler, seventeenth- to eighteenth-century.
44. Bone handle (L:37mm T:7mm). E10:01, 966, WSB39, 2005.3649
Fragment of a two-piece bone knife handle of originally oval section. Traces of iron survive on the inner face and the outer face is decorated by incised double lines.
45. Handle (L:90mm Max.W:21mm Max.T:5mm). M09:01, 2476, WSB88, 2005.3698
One section of a two-piece antler knife handle with a convex face which has been roughly trimmed but retains some of the natural surface of the antler. The end is rounded and slightly wider and thicker than the rest of the handle. The handle has been fixed to the iron knife tang by three iron rivets, two placed on the centre line and the third very close to one edge at the end.

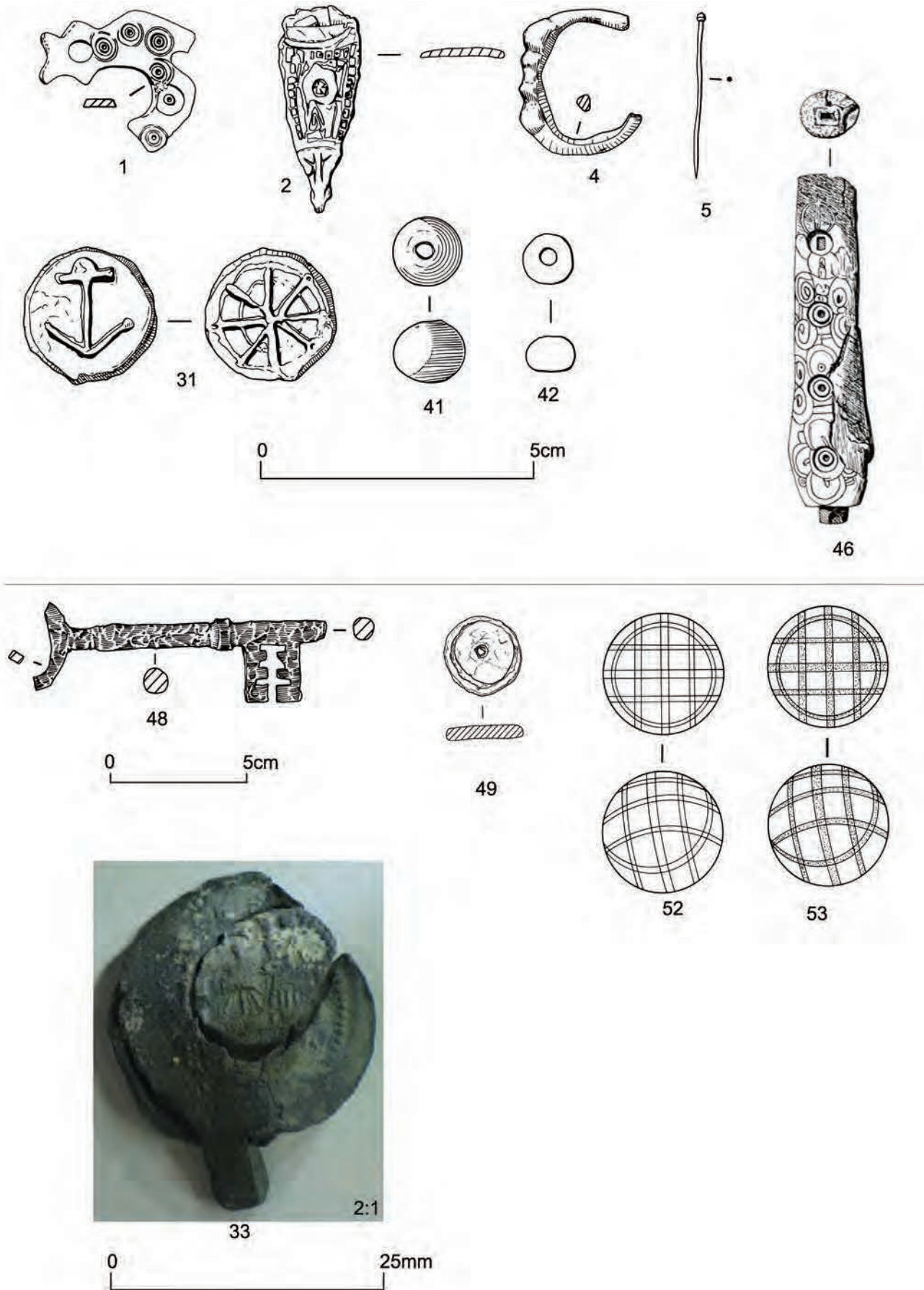

Figure 25.41: Post-Roman finds nos 1-46, scale 1:1; nos 48-53, scale 1:2.

46. Bone handle (L:64mm W:15mm T:1mm). M14:01, 1644, WSB17, 2001.677
One-piece handle formed from a long bone with traces of the iron knife tang surviving in the socket. The face is decorated all over by a series of complex motifs each centred round a sunken circular area with a deeper centre which possibly housed an inset. A short projection from the terminal suggests that a secondary material was attached.
Cf. Newcastle: Vaughan 1987, fig. 31, no. 199, nineteenth-century context.
47. Bone spoon (L:116mm W:13mm). R05:09, 657, WSB35, 2005.3645
Long, thin bone spoon with a triangular-sectioned handle. The bowl is incomplete but appears to have been shallow and spatulate. The terminal is shaped to a point.
48. Iron key (L:109mm D:8mm). J13:03, WSFE331, 2001.2209
Post-medieval key with symmetrical bits. (AC)
49. Lead disc (D: 29mm T: 4mm). Unstratified, 586, WSL39, 2001.2300
Disc with a central circular hole and an incised marginal line. This would appear to be a post-medieval dress weight or button.
50. Block (L: 34mm W: 45mm). F10:13, 2293, WSL51, 2001.2312
A block of lead which has been pressed into a four-cornered shape, connecting four sheets of a hard dark brown and black material 4mm thick.
51. Whetstone? (L:153mm W:50mm B:50mm) L03:10, 656, WSS272, 2001.3128
Large square-sectioned whetstone, incomplete, tapering to one end. Pecked surfaces. (AC)
52. Pottery ball (D: 40mm). E13:01, 1018, WSP172, 2001.2485
White ball with a clear glaze over a design of dark blue lines crossing in three directions. Such balls were common products of potteries in the nineteenth century and were made in matching pairs, used in sets of six, with a smaller plain ball as the jack in the game of carpet bowls. Similar bowls are known from the Garrison Pottery in Sunderland where they are dated 1830–1865 (Baker 1984, 66, fig. 89, *pers. comm.* N. Dolan).
53. Pottery ball (D: 32mm). E12:01, 1016, WSP173, 2001.2486
Small white pottery carpet bowl similar to above, with a design in dark blue of sets of three lines crisscrossed in three directions.
54. Pot lid (D:80mm). N12:01, 1658, WSP186
Complete lid with blue under-glaze transfer print with a picture of two bears against trees and mountains, surrounded by an interlace pattern. The legend reads 'Genuine Russian bears grease for increasing the growth of hair'. 1870s. Cf. Dale 1987, types B31, B38.

Discussion

Whilst there are only a few finds from the early medieval period from the site, they do indicate some activity in the area at this period. There is the fragment of sixth-century pottery perhaps from an inhumation burial, a possible sixth-century bead from the outside the east gate (unpublished, WSG610) and a possible sixth or seventh-century annular loom-weight from near the Branch Wall (unpublished, WSP518). There is also the fragment of sixth-century bucket mount, but as this was a chance find from the site, and as the type has a British distribution based in Kent, it is possible this is a fragment that has been brought to the site in modern times. There is less material from the eighth to tenth centuries: a single strap end of the eighth or ninth century. By the Norman period the settlement had moved away from the river and was now about 1km inland. This is reflected by the very small quantity of pottery and other finds from this period on the fort site, and it is not until the seventeenth century that the quantity of pottery, glass and coins suggest heavier use of the site. In 1709 a visitor recorded that 'the old inhabitants thereabouts still tell you of vast quantities of stones that have in their remembrance been dug out of it and carried away to build houses' (Whitworth 2000, 47). In 1732 the site is described as having been ploughed, and by 1778 the first mine-shafts had been sunk (Snape and Bidwell 1994, 15). The presence of the collieries led to buildings both near and on top of fort itself, although it was not until the late nineteenth century that the site was comprehensively covered by terraced housing built for workers in the riverside shipyards.

26. METALWORKING AND ENVIRONMENTAL EVIDENCE

by L. Allason-Jones and L. J. Gidney

Metalworking debris

Ironworking

It appears from the small quantities recovered that only samples of slag and furnace lining were kept, much of which was unstratified and so cannot certainly be identified as Roman.

Copper alloy metalworking waste

by L. Allason-Jones

Recycling

1. Area of Building 12, unstratified, L14:44, 1800, WSCA17, 2001.1057
A bead and a fragment of horse harness, broken and partially remelted (see Copper alloy cat. no. 61).
2. Area over Building 8, unstratified, E10:13, 2264, WSCA264
Including fragment of plating.

Sprue caps

3. (L:29mm). Building 16, floor, Period 1, M08:26, 2530, WSCA111, 2001.1151
4. Debris over Cistern 1, Roman/post-Roman, E08:13, 2307, WSCA315

Casting waste

5. Unsealed rubble over west *praetentura*, E05:04, 237, WSCA141
6. Area over Building 14 and Alley 7, unstratified, K11:01, 1709, WSCA318
7. Area of Building 14 and Road 3, no details, K12:03, 1722, WSCA313
8. North *intervallum* road, phase 3 surface, P04:02, 154, WSCA142
9. Building 2, north wall robber trench, Period 2, N05:17, 364, WSCA918

Moulds

There were three recessed stones that might have been used as moulds (see stone report nos 50–2), the

most interesting of which has possible location pins as if used for a two-piece mould (Fig. 25.32, no. 52).

The evidence for copper alloy working was spread across the site, and showed no concentration in any one area or type of building. There was only one piece (no. 3) from Building 16, identified as a workshop.

The animal bones (Figs 26.01–08)

by L. J. Gidney

Introduction

The preservation of the bone was generally mediocre, and the assemblage is biased in favour of the larger, more visible and robust bone fragments. An assessment of the complete surviving assemblage provided a quite restricted species list, with the majority of bones coming from the domestic animals, cattle, sheep/goat and pig. Cattle bone was present in the greatest number of contexts, while goat was present as well as sheep, which included a polled variant. Horse and red deer were also present, but were not numerous; the red deer elements included meat-bearing bones besides lower limb bones and antler. Roe deer bones were also present, indicating hunted game. The dog bones all appear to be disarticulated fragments with no suggestions of whole bodies. Small mammals were indicated by a single tooth, and shell-fish were sparse.

Detailed study was made of the bones from two deposits of interest, from Cistern 1 and Building 13. The assessment of the assemblage of animal bones identified the late third-century fills of Cistern 1 as being of particular interest. The quantity of bone recovered from this single feature was large in comparison with the majority of features on this site. The assemblage was tightly dated to the late third century and appears to have accumulated over a relatively short time span. The assessment highlighted the fact that there appeared to be an unusual degree of selectivity in the skeletal elements

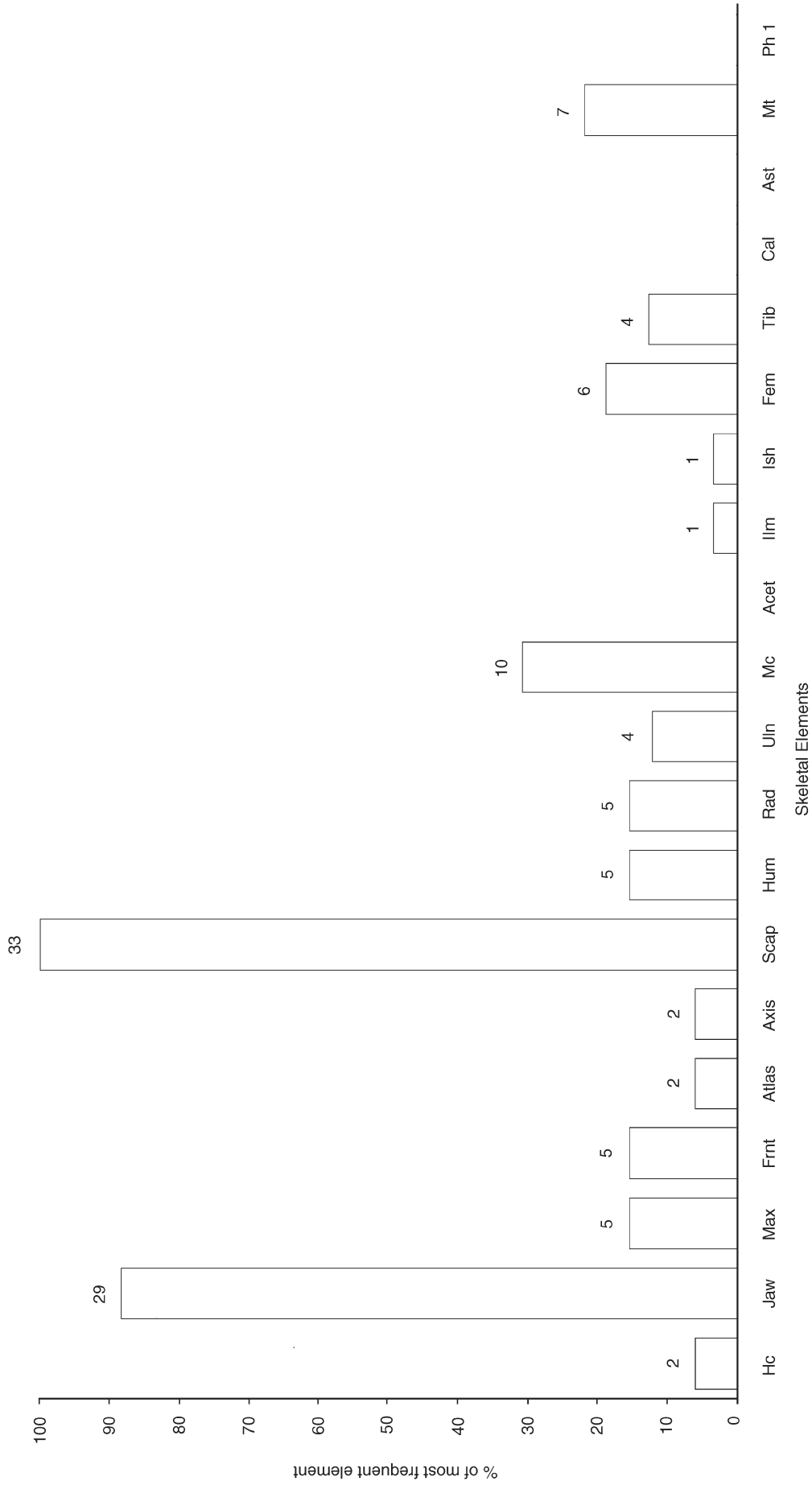

Figure 26.01: Skeletal elements of cattle bones from Cistern 1, context E08:27

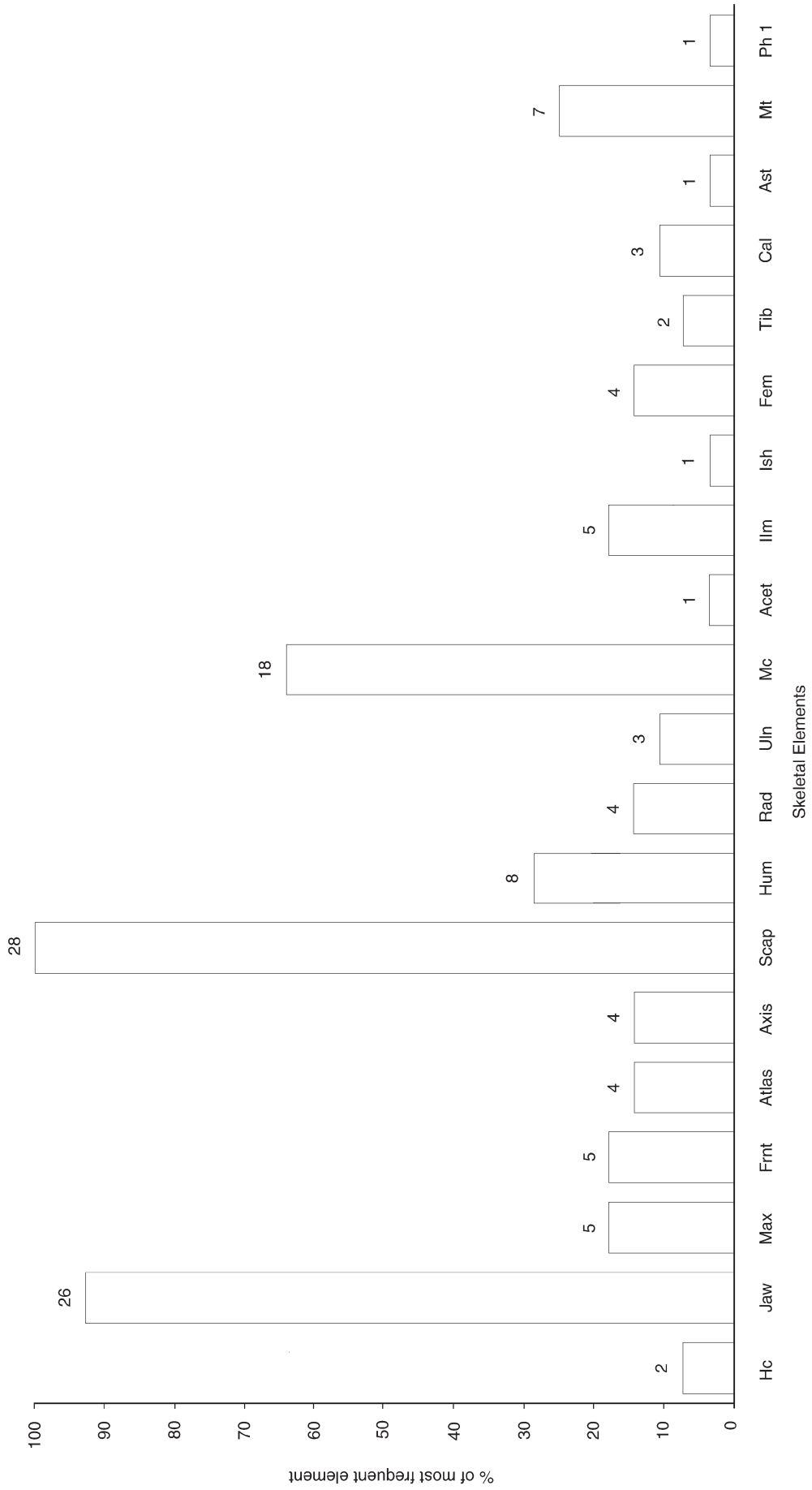

Figure 26.02: Skeletal elements of cattle bones from Cistern 1, context E09:29

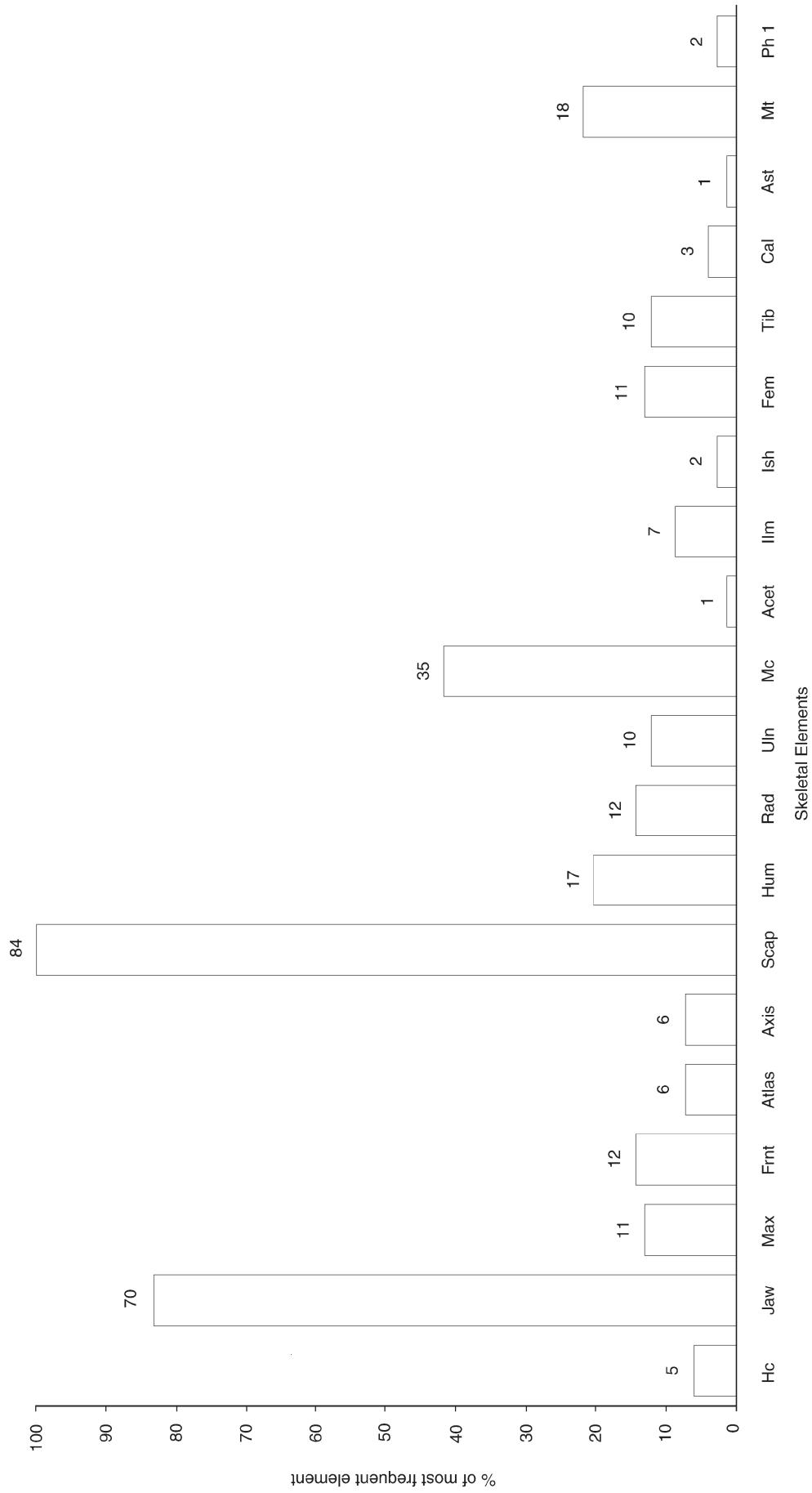

Figure 26.03: Skeletal elements of cattle bones from Cistern 1, all contexts

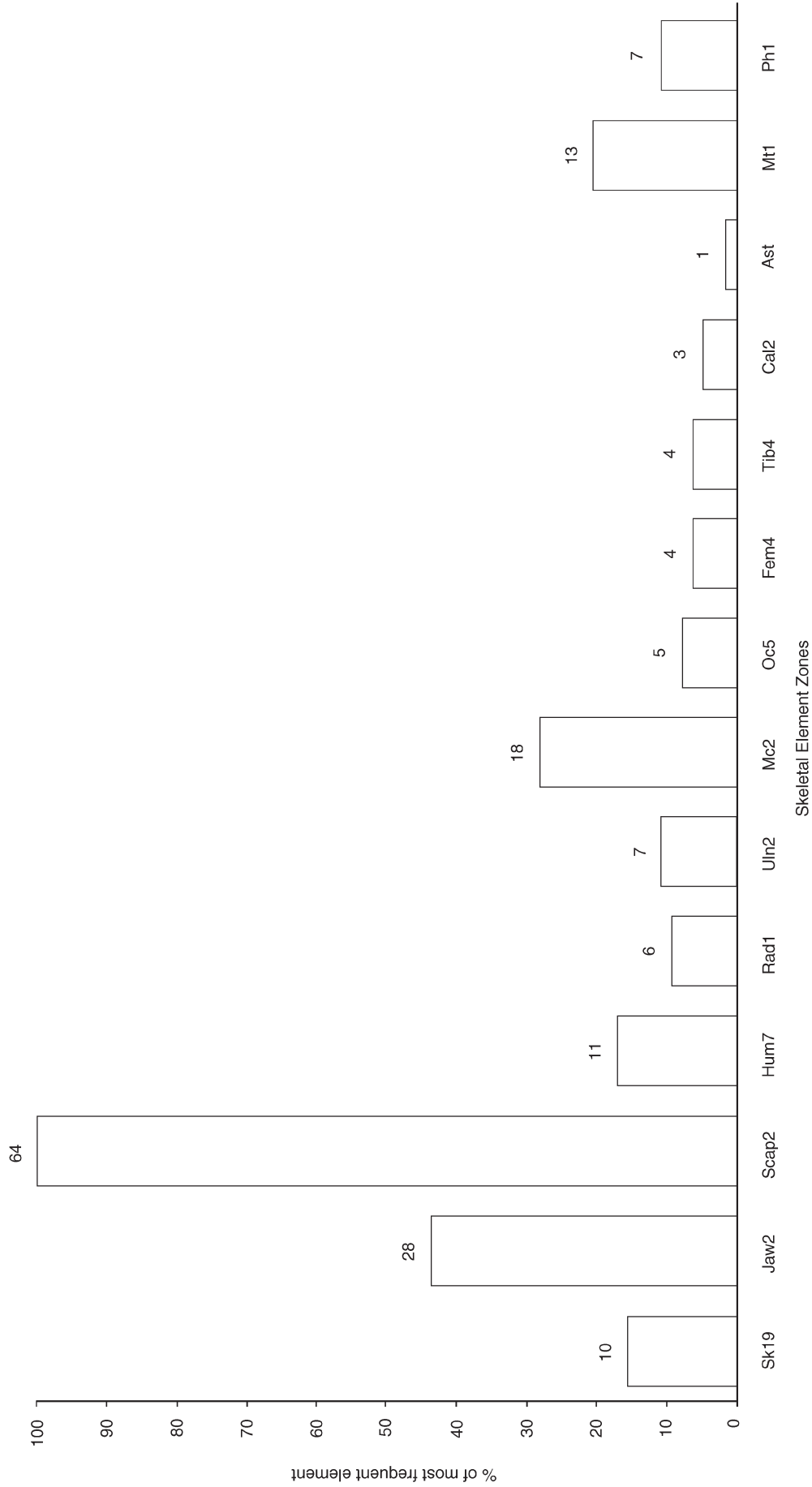

Figure 26.04: Skeletal element zones of cattle bones from Cistern 1, all contexts

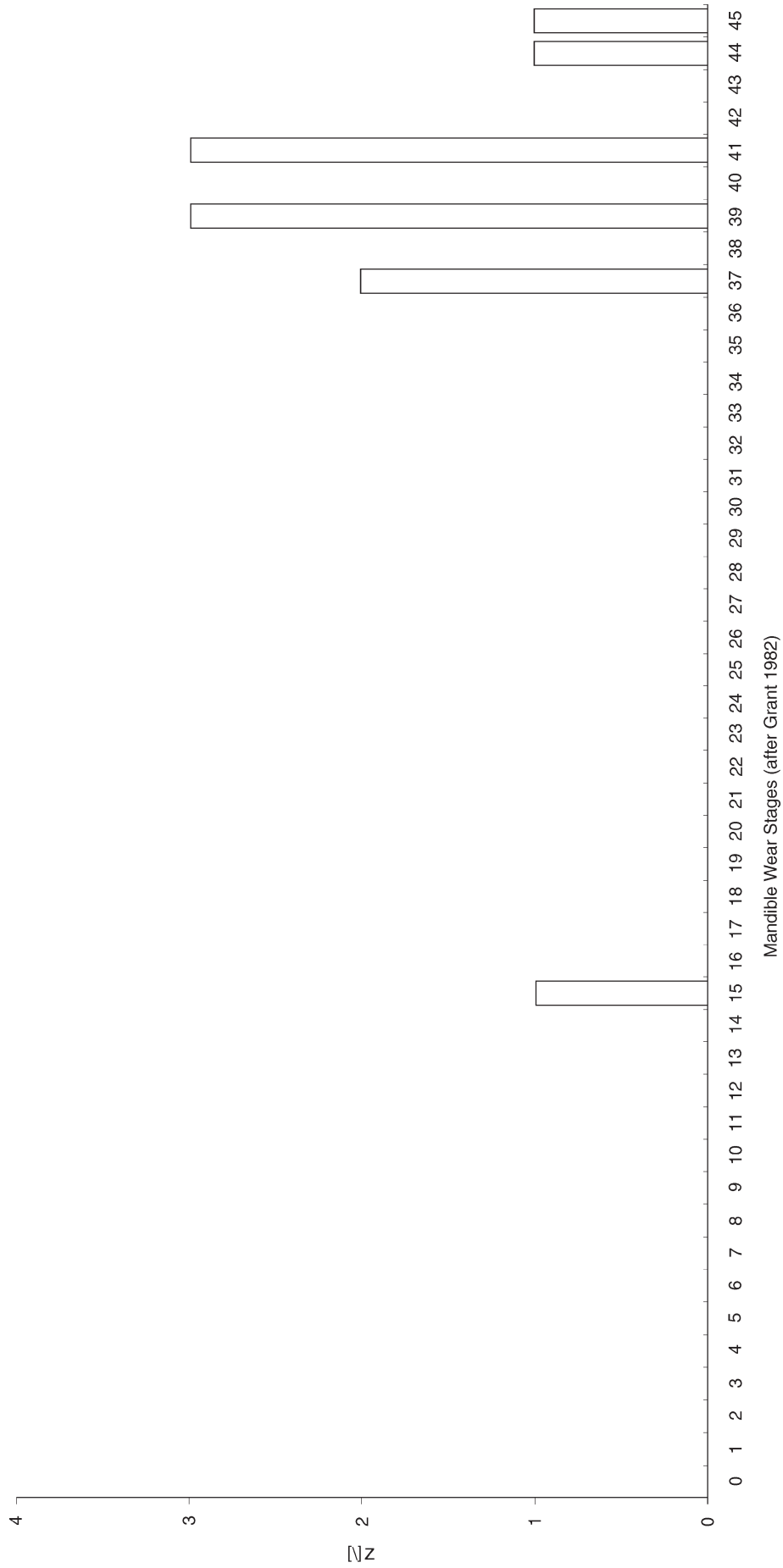

Figure 26.05: Mandible wear of cattle bones from Cistern 1, all contexts

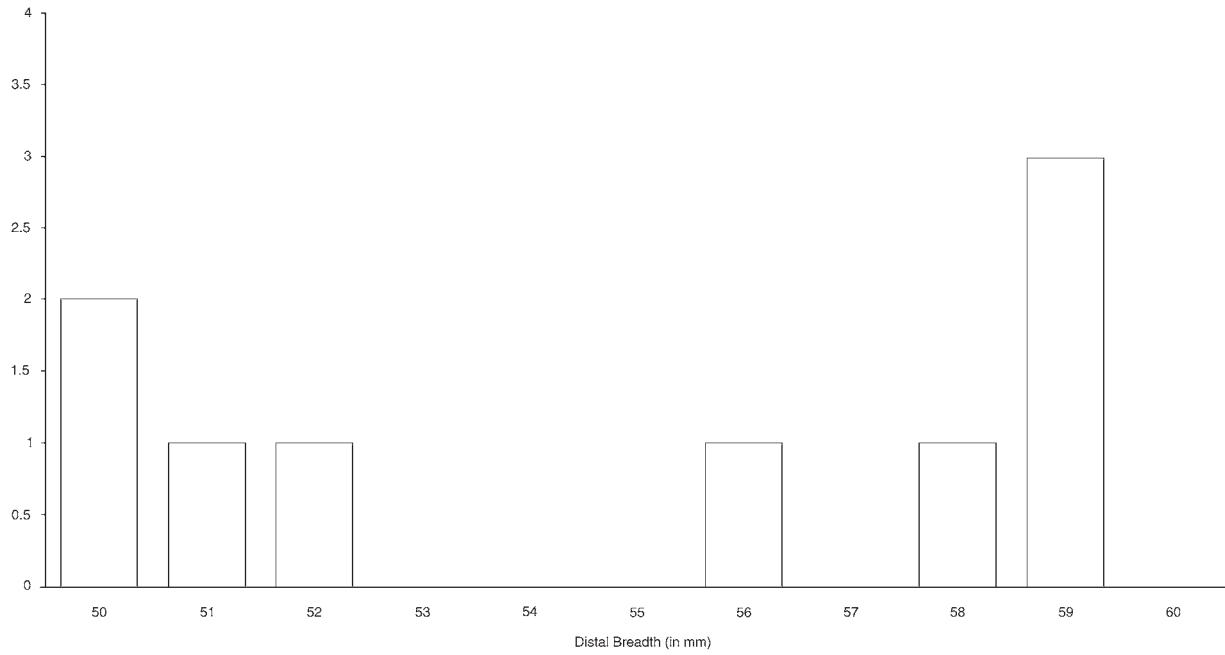

Figure 26.06: Distal breadth of cattle metacarpals from Cistern 1

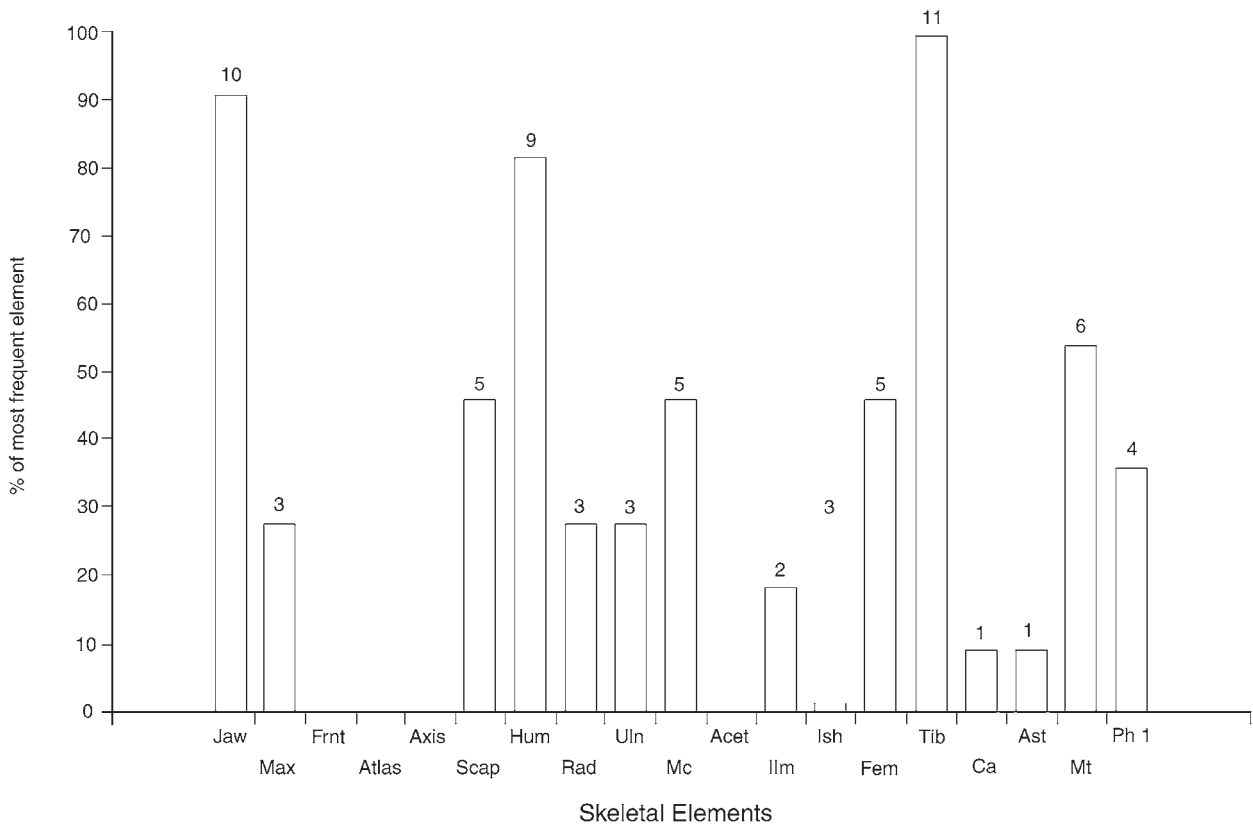

Figure 26.07: Skeletal elements of pig bones from Building 13, period 3

of cattle deposited. The immediate impression gained was that preservation of the bones was marginally better for this feature than the general run of finds.

The majority of the bird bones recovered were associated with the commanding officer's house

(Building 13). The presence of bird bones on this site indicates both a more benign burial environment and refuse originating from a higher status establishment. Work previously done on the animal bone assemblage from the commanding officer's house at South

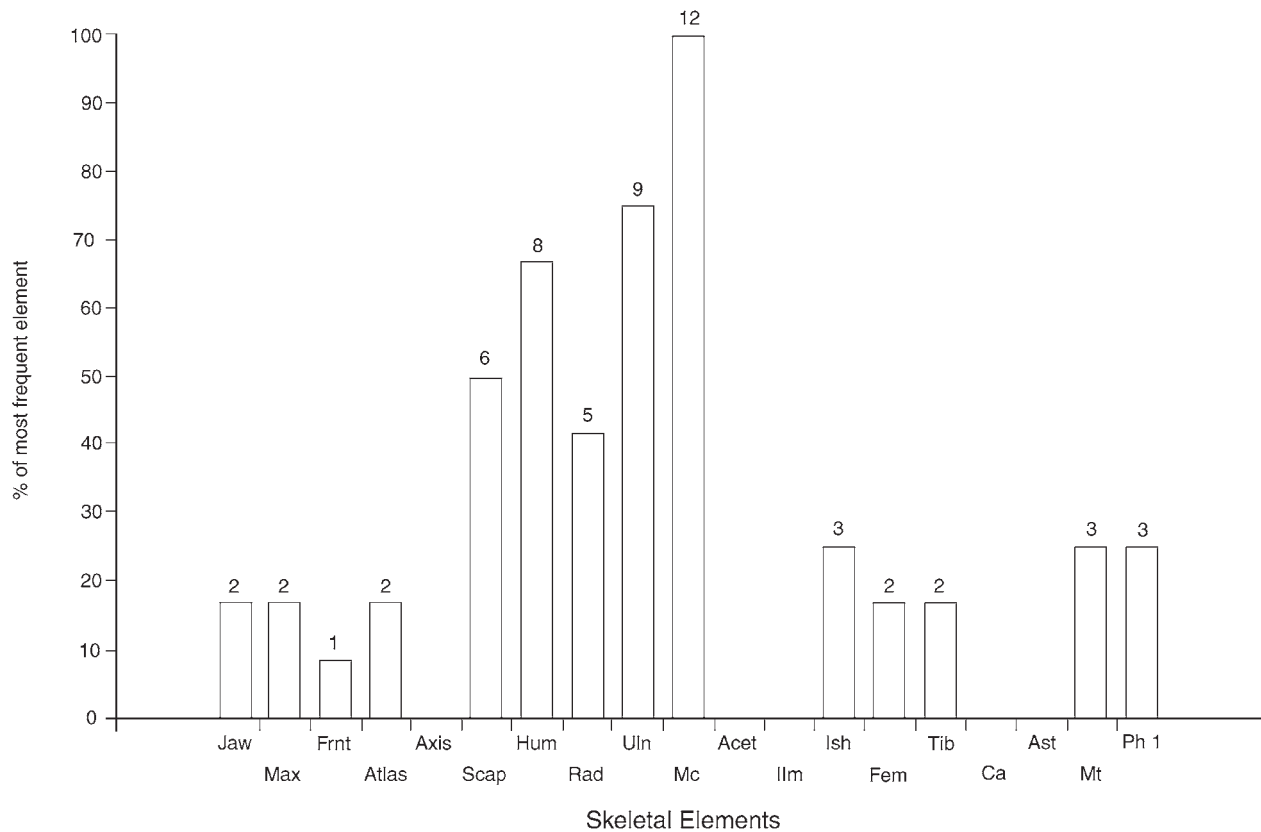

Figure 26.08: Skeletal elements of pig bones from Building 13, period 4

Shields (Stokes 1992) has already indicated that the provisioning of a commanding officer's house included items which appear not to have been generally available to the troops. It therefore was deemed appropriate to target this group, both for information on supply of foodstuffs to the residence of the senior officer and for data to compare with an equivalent house at, for example, South Shields.

Methodolog

All fragments of cattle, sheep/goat or pig bone with a 'zone', *sensu* Rackham (1986), or tooth were catalogued, with information on element, epiphysial fusion, tooth-wear and metrical data, where appropriate. All fragments of other species were recorded.

Cistern 1

Detailed recording of this group revealed that the standard of preservation was not as good as originally thought; the condition was superficially good but leaching of the mineral content has caused brittleness and surface flaking. The bones are not robust and the extra handling caused by repacking after the assessment and handling for recording has led to a large number of fresh breaks. This disintegration does reinforce the interpretation that the assemblage

Table 26.01: Fragment counts for the species present in Cistern 1

	Context				Total
	E08:27	E08:29	E08:37	E08:44	
Cattle	130	150	–	73	353
Sheep/goat	10	7	–	2	19
Sheep	–	1	–	–	1
Pig	3	12	1	–	16
Horse	1	2	–	1	4
Dog	2	1	–	2	5
Red deer	–	1	–	–	1
Large ungulate	6	11	–	1	18
Small ungulate	–	–	–	1	1
Totals	152	185	1	80	418

has not been disturbed between the initial deposition and the excavation.

It can be seen from Table 26.1 that only two contexts within the cistern fills produced abundant finds of animal bones, with a smaller quantity from a third context. Each of the two larger contexts presumably represents a single episode of rubbish dumping from one source. The volume of bone is large but much of the bulk is provided by individual, largely complete, scapulae and lower jaws.

Species

Table 26.01 shows that the overwhelming majority,

c.90%, of the identified animal bones deposited in the cistern were cattle or cattle-sized bones. Sheep/goat bones contribute a further 5% of the assemblage. Pig, horse, dog and red deer bones are also present but not in significant numbers.

CATTLE

The representation of the skeletal elements of cattle has been previously noted as one of the points of particular interest about this group. Figures 26.01–03 illustrate the frequency of fragments of 20 skeletal elements, chosen as being the most commonly found and representing the whole carcass. To equate with the paired elements, the number of first phalanges has been divided by four while the number of atlas and axis has been doubled.

For context E08:27, Figure 26.01 shows striking peaks of scapula and lower jaw fragments but some surprising absences that cannot be attributed to differential preservation. The calcaneum, astragalus and first phalanx are all extremely dense bones that survive well but are totally absent from the context, together with parts of the pelvis: the acetabulum. The number of maxilla fragments is extremely low compared to the abundance of lower jaw. The other skull and neck bones are also sparse, suggesting processing of the jaw bones separately from the remainder of the head and neck prior to deposition. Context E08:29 in Figure 26.02 has the same abundance of scapula fragments. The lower jaw is still the second most abundant element but the metacarpal is noticeably more abundant than in Figure 26.01. The maxilla and other skull bones are again under-represented in comparison with the lower jaw. Of the elements not seen in E08:27, none are also absent from E08:29. The information from all three contexts is summed together in Figure 26.03 to show an overall pattern of a superabundance of scapula and lower jaw fragments and a disproportionately high number of metacarpal compared to metatarsal fragments. All remaining elements are represented. Such a pattern is indicative of human selectivity in the disposal of carcass elements in this feature.

What is not immediately apparent from this method of analysis is the paucity of vertebrae and rib fragments. For convenience, these are normally recorded under the “Large Ungulate” category. It can be seen from Table 26.01 how few fragments were designated in this section.

Appendix 1 lists the counts of zones for each cattle element, while Figure 26.04 illustrates the frequencies of the most numerous zone for 14 of the elements considered in Figures 26.01–03. Because there are fewer individual zones than fragments, all the cistern fills are considered together in Figure 26.04. The skull and pelvis are treated as single units for the zone counts. Figure 26.04 should give an indication of the minimum number of individual elements present for

cattle and show which elements are over-represented in the fragment counts because of excessive breakage.

The zone frequencies in Figure 26.04 mirror the trends seen from the fragment frequencies in Figure 26.03. The predominance of scapula fragments is still striking. Lower jaw remains the second most common element but the zone frequencies suggest that breakage has enhanced the representation of lower jaw in the fragment counts. The frequency of metacarpal fragments is much reduced for the zone counts, approaching parity with the humerus, but still more abundant than the metatarsus. The remaining elements suggest a similar, low, level of utilisation and discard of undifferentiated parts of the carcass.

Consideration of the zones present for the scapula in Appendix 1, shows that there are surprisingly low numbers of zone 5, the posterior of neck with foramen, compared to zones 1–3 of the glenoid. This is unlikely to be caused by differential preservation as zone 5 is a dense area of bone, unlike zones 4, 6 and 7 which are usually poorly represented. Unfortunately recent cracking and breakage, together with flaking surfaces, has obscured details of the original butchery patterns of this bone. Certainly no evidence was seen for the classic hole in the scapula blade which is normally associated with smoking the shoulder blade meat. Trimming of the glenoid was regularly seen, resulting in lower numbers of zone 1 compared to zones 2 and 3. A proportion of the scapulae appear to have been deposited as more or less complete bones but the impression gained was that many scapulae consisted primarily of the detached glenoid segment with the origin of the spine. The cut marks indicate that the spine was routinely sliced off, hence the low numbers of zone 4.

The lower jaw bones also show evidence for a systematic pattern of dismemberment. The commonly found zones are 1–3 from the front part of the jaw with the incisors and zone 7 at the back of the molar tooth row. Very sparse are zones 4 and 5, the articulation of the jaw with the skull. It seems that the jaw was chopped off leaving the articulation of the jaw embedded in the muscle attached to the skull. These fragments must have been deposited elsewhere on the site, as skull fragments are generally rare in the cistern. Most common is zone 9 on the maxilla, suggesting that some lower jaws may have been dumped with part of the corresponding upper tooth row. It was not possible to match any lower tooth rows with the few upper tooth rows.

Some clear evidence was observed for the longitudinal splitting of long bones through the articular ends for marrow extraction (Stokes 1996, 40). This is reflected in the zone counts by, for example, the higher number of zone 7 on the distal humerus, the medial condyle, compared to the lateral zone 8, and also the proximal radius with zone 1, the medial condyle, compared to the lateral zone 2. Similar

Table 26.02: Tooth wear data for cattle bones in Cistern 1 (teeth in approximate order of eruption)

Cattle	U	S/W	H/W	
M1	5–6m	–	1	31
M2	15–18m	–	6	31
P2	24–30m	–	10	1
P3	18–30m	1	7	11
M3	24–30m	1	4	24
P4	28–36m	6	8	14
Sheep/goat	U	S/W	H/W	
M1	3–5m	–	–	1
M2	9–12m	–	2	–
P2	21–24m	1	–	–
P3	21–24m	–	–	–
M3	18–24m	–	1	–
P4	21–24m	–	–	–
Pig	U	S/W	H/W	
M1	4–6m	–	1	3
M2	7–13m	1	2	–
P2	12–16m	–	–	–
P3	12–16m	–	2	2
P4	12–16m	–	3	–
M3	17–22m	3	1	–

Key: m = months, U = unerupted/deciduous, S/W = slight wear, H/W = heavy wear
Ages after Silver 1969

butchery was also seen on some metapodials but, particularly for the metacarpal, most of the fragments with corresponding zones appear to have been dumped together.

The bones had been extensively modified, principally by chopping with a heavy cleaver, before disposal. Clear chop marks were observed on 162 identified fragments, 39% of the assemblage. This excludes unidentified fragments and identified fragments where flaking surfaces have obscured such evidence. There is no doubt that these bones had been deliberately selected and dismembered. Two frontal bones demonstrated that considerable effort was expended in removing the horns. One metacarpal and one metatarsal showed signs of burning midshaft. This practice is widespread on Roman sites, particularly in Carlisle (Stallibrass 1991 and 1993). The author believes this process to have served the dual function of liquefying the marrow and making the bone brittle so it could be snapped easily to pour the marrow out, and has carried out experimental work with Mr P. Stokes to demonstrate the hypothesis is plausible.

The cattle supplied to the fort whose bones were finally dumped in the cistern appear to have been mainly mature animals. The tooth wear data in Table 26.02 show a complete absence of young calves with the first molar unerupted and only one first-year beast with molar 1 coming into wear. More numerous are late shedding deciduous teeth and permanent teeth coming into wear, probably from second- to third-year animals, but most common are permanent teeth

in full wear from third-year and older animals. This is further illustrated by the Mandible Wear Scores in Figure 26.05 from the jaws with complete tooth rows surviving. Only one younger, second year, animal with molar 2 coming into wear is present at MWS 15. The remaining ten jaws span MWS 37–45. These have all molars present and in wear. By analogy with my own reference collection of Dexter cattle mandibles, those jaws at MWS 44–45 represent animals at least 10 years old and probably several years older. Breakage of the jaws has obscured the incidence of congenital absence of premolar 2 but one example was noted, as well as an example of malocclusion on molar 3.

Tooth wear data is sparse for the pigs but Table 26.02 suggests the presence of mainly second-year animals with permanent teeth coming into wear. There appear to be no very young or aged pigs represented by teeth.

The epiphysal data in Table 26.03 complement the tooth wear data in showing that the majority of the bones are from adult animals with fused epiphysal ends. Only one unfused scapula is present and was noted as deriving from a calf. The few remaining unfused epiphyses are from the later fusing elements and probably correspond with the limited cull of second- to third-year animals postulated from the teeth.

Only four bones were sufficiently complete to be used for estimates of withers height, using the factors of Zalkin (1960) where the sex of the animal is not known. Three metacarpals indicate withers heights of 1.02m, 1.11m and 1.14m, while two

Table 26.03: Cattle epiphyses in approximate order of fusion, from Cistern 1

	F	JF	U
<i>By 18 months</i>			
Scap. tub.	34	-	1
Acet. symph.	1	-	-
Prox. rad.	7	-	-
Dist. hum.	13	-	-
Prox. ph. 2	3	-	-
Prox. ph. 1	7	-	-
<i>By 2-3 years</i>			
Dist. tib.	2	-	1
Dist. mc.	18	-	-
Dist. mt.	7	-	1
<i>By 3.5-4 years</i>			
Prox. cal.	1	-	1
Prox. fem.	3	-	-
Dist. rad.	2	-	1
Prox. hum.	-	-	1
Prox. tib.	4	-	1
Dist. fem.	2	1	-
P & D uln.	-	-	-
<i>By > 5 years</i>			
Ant. Vert. ep.	-	-	3
Post. Vert. ep.	-	-	4

Key: F = fused, JF = just fused, U = unfused
Ages of fusion after Silver 1969

metatarsals indicate heights of 1.08m and 1.14m. The distal metacarpal was the only element to provide a reasonable sample of metrical data. The nine bones in Figure 26.06 appear to fall into two groups. The smaller range from 50 to 53mm and may be female while the larger range from 56 to 59 mm and may be male. The single cattle skull with horn cores attached appeared feminine.

OTHER SPECIES

Bones from animals other than cattle appear to be incidental refuse included in the cistern fill. Of these, sheep bones are the most common. One skull with feminine horn cores had been split sagittally and a further two bones had been chopped. Two fused and two unfused bones were seen and one lower jaw with all permanent molars present but little wear on molar 3, so probably aged about two years at death. Further evidence for the culinary source of this deposit lies in the chop marks seen on one pig bone, one horse bone and the red deer bone.

Two of the dog bones were sufficiently complete for withers height to be estimated using the factors given by Harcourt (1974, 154). Both bones are probably from one animal with a height of about 28 to 30cm. Dogs obtained access to some of the bones before they were tipped into the cistern as canid gnaw marks were observed on six cattle bones and four sheep bones.

Summary

The late third-century fills of the cistern have produced a most unusual, specialised deposit of cattle bone. There is evidence for considerable human selectivity, suggesting that much of this refuse derives from specialised processing involving principally the scapula and lower jaw of cattle, with some marrow extraction from other major limb bones, particularly the metacarpal. The low numbers of skull fragments suggest that primary slaughter waste was not included in this deposit, likewise the low numbers of ribs and vertebrae suggest that general food preparation and consumption waste has not been dumped here. A small proportion of general culinary waste may be indicated by the inclusion of bones from species other than cattle.

Some possible reasons for the utilisation of bone marrow have been discussed by Stokes (1996). For large deposits of highly fragmented limb bones, the "soup kitchen" hypothesis postulated for Zwammerdam (van Mensch 1979) has been discredited and, in any case, this assemblage is not of a comparable scale. The soup suggestion may, however, be relevant to the lower jaws from the cistern. These have been broken in such a way as to open the marrow cavity. Sadly, there are no surviving recipe collections from Roman Britain. However, in more recent historical periods ox cheek soup frequently figures in recipe collections, often with the admonition to first break the bones (Raffald 1970, 5). Finds of cattle scapulae with the glenoid trimmed and a hole in the blade are frequently encountered on Roman sites and are generally interpreted as evidence for brined and smoked shoulder beef. Clear evidence for the meat hook holes in the blade was missing for the scapulae from the cistern but a similar product may be envisaged, perhaps boiled salt shoulder beef rather like a modern ham with the glenoid used to hold the joint for carving. A minimum of 49 scapulae and 23 lower jaws would have provided a substantial amount of food, without taking into account the meat and marrow attached to the remaining bones and any vegetative waste for which the evidence has not survived. This is not catering by barrack block but rather by garrison, suggesting a special meal for a special event. Saturnalia or some other comparable religious or military festival may have coincided with the decommissioning of the cistern which became the fortuitous repository of this unusual assemblage.

Building 13

Species

Detailed recording of this group revealed that the standard of preservation was generally better than the average of the assessed contexts. This is reflected in the presence of bones from small and juvenile animals. It can be seen from Table 26.04 that Period 2

produced the richest group both in terms of numbers of identifiable bones and species diversity. The Period 3/4 group has fewer identified bones and a noticeable absence of some species present in Period 2, in particular goat, horse, red deer and hare. While the numbers of fragments are small, Table 26.05 indicates some further, interesting differences between the phases. Cattle bones are most abundant in Period 2, decline in proportion in Period 3/4 but increase again from the mid-third century, though not to the level of frequency seen for Period 2. The sheep/goat bones remain proportionally constant in all three phases, but from the mid-third century+ the sheep/goat bones are more numerous than those of cattle. Pig bones are the most abundant finds in all three phases but the proportion fluctuates in relation to the cattle bones, with pig bones peaking in the mid-third century+ which has the lowest proportion of cattle bones.

This contrasts strongly with the findings of

Table 26.04: Fragment count for the species present in Building 13

	Periods		
	2	3/4	mid C3+
Cattle	49	15	9
Sheep/goat	20	11	2
Sheep	–	1	–
Goat	3	–	–
Pig	86	71	21
Horse	2	–	1
Dog	2	5	–
Red deer	3	–	1
Roe deer	6	1	–
Hare	3	–	–
Large ungulate	17	2	1
Small ungulate	13	10	5
Domestic fowl	17	7	1
Goose	6	11	–
Black grouse	1	–	–
Mussel	2	1	–
Fish sp.	1		
Totals	231	136	41

Stokes (1992) for the commanding officer's house at South Shields. The methodology used is not totally compatible with the present system but data thought to be equivalent are presented in Table 26.05. The chronological decline of cattle bones at Wallsend contrasts with a substantial increase in the proportion of cattle bones between Periods 7 and 8 (late third and fourth centuries) at South Shields. Sheep bones are considerably more abundant in Period 7 at South Shields than any of the Wallsend phases, but decline in Period 8 to a similar proportion to that encountered at Wallsend. Pig bones at South Shields do not approach the abundance found at Wallsend but do not vary so dramatically between the two phases as the cattle and sheep. These data suggest that the choice of the Wallsend household lay between cattle and pig meats, with a standard supply of sheep meat. Conversely the South Shields household appears to have chosen between cattle and sheep meats, with pig meat as a standard supply.

The changes between Periods 2 and 3/4 at Wallsend may suggest a change in the tastes of the people occupying the house or a change in housecleaning routines, removing more of the larger cattle and deer bones but not the smaller pig bones.

CATTLE

Only Period 3 produced sufficient cattle bones for any analyses. All parts of the body are represented with similar numbers of bones from the feet, fore and hind-quarters but far fewer from the head, including loose teeth. As can be seen from Table 26.06, the surviving bones are predominantly from adult animals, only a quarter of the epiphysial ends found were unfused. There were noted three bones from infant, bobby, calves and one bone from an older, veal, calf. No calf bones were seen in Period 3/4 but the equally small group from the mid-third century+ produced three bones, all from the forequarter of a veal calf.

SHEEP/GOAT

Both sheep and goat are present. Goat is represented by two joining halves of one horned female skull found in N11:29 and N11:31. Sheep is indicated by a polled female skull from M12:44. A further metatarsal

Table 26.05: Relative proportions of domestic species present in Building 13, Wallsend and the Commanding officer's house, South Shields, shown as percentages

	Building 13			C.O.'s house	
	2	3/4	mid C3+	7	8
Cattle and large ungulate	5	15	26	46	65
Sheep/goat and small ungulate	19	20	18	31	15
Pig	46	65	55	23	20
Totals	188	110	38	214	240

Table 26.06: Cattle epiphyses in approximate order of fusion, from Building 13

	F	JF	U
<i>By 18 months</i>			
Scap. tub.	1	-	-
Acet. symph.	-	-	-
Prox. rad.	2	-	1
Dist. hum.	1	-	-
Prox. ph. 2	2	-	1
Prox. ph. 1	3	-	-
<i>By 2-3 years</i>			
Dist. tib.	-	-	1
Dist. mc.	3	-	1
Dist. mt.	3	-	-
<i>By 3.5-4 years</i>			
Prox. cal.	-	-	-
Prox. fem.	1	-	1
Dist. rad.	1	-	-
Prox. hum.	-	-	-
Prox. tib.	1	-	-
Dist. fem.	-	-	1
P & D uln.	-	-	-
<i>By > 5 years</i>			
Ant. Vert. ep.	5	1	4
Post. Vert. ep.	5	2	4

Key

F = fused, JF = just fused, U = unfused

Ages of fusion after Silver 1969

Table 26.07: Sheep/goat epiphyses in approximate order of fusion, from Building 13

	Period 2			Period 3/4		
	F	JF	U	F	JF	U
<i>By 1 year</i>						
Dist. hum.	1	-	-	-	-	-
Prox. rad.	1	-	-	-	-	-
Scap. tub.	-	-	-	-	-	-
Acet. symph.	-	-	-	-	-	-
<i>By 1-2 years</i>						
Prox. ph. 2	-	-	-	-	-	-
Prox. ph. 1	-	-	-	-	-	-
Dist. tib.	-	-	1	-	-	1
Dist. mc.	-	-	1	-	-	-
Dist. mt.	1	-	-	-	-	-
<i>By 2.5-3.5 years</i>						
Prox. fem.	-	-	-	-	-	1
Prox. cal.	-	-	-	-	-	-
Dist. fem.	-	-	-	-	-	2
Prox. tib.	-	-	-	-	-	2
Dist. rad.	-	-	-	-	-	-
Prox. hum.	-	-	-	-	-	-
P & D uln.	1	-	1	-	-	1
<i>By > 5 years</i>						
Ant. Vert. ep.	2	-	1	-	-	1
Post. Vert. ep.	2	-	3	-	-	1

Key: F = fused, JF = just fused, U = unfused

Ages of fusion after Silver 1969

from M12:37 falls within the goat side of the range established by Rowley-Conwy (1998, 252) for the plot of Greatest Length against Distal Breadth. The remaining bones in the sheep/goat category appeared to be sheep rather than goat. In general all parts of the body are represented in Period 2, with the exception of the small toe bones that are easily missed during excavation. Period 2 also has roughly equal numbers of fused and unfused epiphyses in Table 26.07, while the mid-third century+ has only unfused ends. This apparent difference may simply be a product of small sample size. Three bones from young lambs and one further bone from an infant lamb were seen in Period 2. These tiny bones give an indication of the season of these deposits. Even unimproved cattle can calve all year round, pigs can farrow twice a year but sheep lamb once in the spring.

PIC

It is appreciated that the sample size is very small. Nonetheless Figures 26.07 and 26.08 suggest a meaningful change in body part representation between Periods 2 and 3/4. In Period 2, Figure 26.07 shows that bones of the head, forequarter and hindquarter occur in similar proportions. In Period

3, Figure 26.08 shows that bones of the forequarter are most common. The elements of the head and hindquarter occur in similar proportions but at roughly half the abundance of the forequarter.

As can be seen from Table 26.08, the majority of the pig bones were from immature animals with unfused epiphysal ends. Period 3/4 appears to have more slightly older animals, with fused bones, from the trotters. This is deceptive as a large proportion of the unfused bones in Period 3/4 are from piglets. Period 3/4 produced 26 piglet bones compared to 9 from Period 2. Many of these were probably deposited in articulation but it is not now possible to reconstruct how much of a body was deposited where. These tiny bones are not easy to recover by hand and these deposits would have benefited from whole earth samples to recover the full assemblage. Assuming these bones all derive from culinary waste from the consumption of sucking pig, the piglets appear to have ranged in size from perinatal to several weeks old, in comparison with the wild boar piglets in the reference collection of the Biological Laboratory. One piglet bone from Period 3/4 had been nibbled by a rodent, the only evidence from this assemblage for the presence of commensal species.

Table 26.08: Pig epiphyses in approximate order of fusion, from Building 13

	Period 2			Period 3/4		Mid C3+			
	F	JF	U	F	JF	U	F	JF	U
<i>By 1 year</i>									
Acet. symph.	–	–	1	–	–	1	–	–	2
Scap. tub.	–	–	1	–	–	3	1	–	–
Prox. rad.	1	–	–	1	–	3	–	–	–
Dist. hum.	2	1	3	–	–	2	–	–	–
Prox. ph. 2	–	–	–	–	–	1	–	–	–
<i>By 2-2.5 years</i>									
Prox. ph. 1	2	–	2	3	–	–	–	–	–
Dist. mc.	–	–	5	2	1	9	–	–	7
Dist. tib.	–	–	4	–	–	1	–	–	–
Dist. mt.	–	–	4	1	–	1	–	–	–
Prox. cal.	–	–	1	–	–	–	–	–	–
<i>By 2.5-3.5 years</i>									
P & D uln.	–	–	3	–	–	7	–	–	–
Prox. tib.	–	–	1	–	–	1	–	–	–
Prox. hum.	–	–	2	–	–	2	–	–	–
Dist. rad.	–	–	1	–	–	2	–	–	1
P & D fem.	–	–	4	–	–	–	–	–	–
<i>By > 5 years</i>									
Ant. Vert. ep.	–	–	2	–	–	1	–	–	–
Post. Vert. ep.	–	–	2	–	–	–	–	–	–

Key: F = fused, JF = just fused, U = unfused
Ages of fusion after Silver 1969

HORSE

Remains of horse were sparse with two elements from Period 2 and one from the mid-third century+. Those from Period 2 are a tooth and a metapodial. That from the mid-third century+ is also a metapodial but appears to be an offcut from the manufacture of an artefact. The shaft has been neatly chopped all round to detach the distal, fused, articulation from the shaft. The blows were carefully angled from the distal end and are dissimilar to the butchery marks generally encountered.

DOG

Dog bones were encountered in Periods 2 and 3/4. Period 3/4 produced one intact, fused, tibia from which an estimated height of 25cm was calculated using the factor of Harcourt (1974, 154). The mid-third century+ produced three bones, with unfused epiphyses, from one immature animal from contexts M12:17 and M12:42 (backfill of the eastern hypocaust). These would appear to indicate a disturbed burial. Stokes (1992) identified only two dog bones, one from each phase, from the commanding officer's house at South Shields. These were also from fairly small, lap-sized, animals.

RED AND ROE DEER

Red deer bones were not numerous but the presence of two lower limb bones and a jaw in Period 2 does

imply the supply of a carcase to the residence. A further lower limb bone was recovered from the mid-third century+ and an antler fragment from a post-Roman context. Roe deer bones were most numerous in Period 2 and comprise five lower limb bones and a jaw, with a further lower limb bone from Period 3/4. For the small size of the assemblage, deer bones are more common at Wallsend than at South Shields, though the latter site produced more antler.

HARE

Three hare bones were found in Period 2. Hare was present only in period 7 (late third or early fourth century) of the commanding officer's house at South Shields and the remains were not numerous.

BIRDS

Domestic fowl and goose bones were found, overall, in similar numbers. Period 2 produced more fowl than goose bones with the reverse in Period 3/4. Black grouse, represented by one bone in Period 2, is the only wild species present. This is a game bird highly esteemed for the table and consonant with the status of the commanding officer.

MOLLUSCA AND FISH

Shellfish were remarkably sparse with only mussel shells recovered from Periods 3/4 and the mid-third century+. This contrasts with South Shields where six types of marine mollusc shell were identified

from the commanding officer's house. The generally inhospitable soils at Wallsend have militated against the general survival of fish bone. However the exceptional preservational conditions associated with the commanding officer's house have led to the recovery of tiny fragments of fish bone from Periods 2 and 3/4. While these cannot be identified, their presence does indicate that fish was procured for consumption.

Summary

It is appreciated that the assemblage under discussion is extremely small and subject to inherent bias. Nonetheless, the deposits associated with the commanding officer's house are notable for the better condition of the bones which has led to the survival of bones from small and juvenile animals. This in turn has led to an enhanced species list which is dominated by pig rather than cattle, with goat attested as well as sheep. Hunting, particularly in Period 2, is indicated by bones of both red and roe deer, hare and black grouse.

Appendix: Count of 'zones' in cattle bones from Cistern 1

	'Zone'	E08:27	E08:29	E08:44	Total
Skl.	1	-	-	-	0
	2	-	-	-	0
	3	1	2	1	4
	4	-	-	-	0
	5	4	3	1	8
	6	-	-	-	0
	7	-	-	-	0
	8	-	3	1	4
	9	2	7	1	10
	0	1	2	-	3
Jaw	1	5	5	4	14
	2	14	7	7	28
	3	5	5	5	15
	4	1	3	-	4
	5	-	2	2	4
	6	2	3	1	6
	7	6	6	4	16
	8	1	1	1	3
Scap.	1	17	9	8	34
	2	27	21	16	64
	3	24	19	13	56
	4	2	3	1	6
	5	7	8	6	21
	6	-	-	-	0
	7	-	1	-	1

	'Zone'	E08:27	E08:29	E08:44	Total
Hum.	1	-	-	-	0
	2	-	-	-	0
	3	-	-	-	0
	4	-	-	-	0
	5	-	-	1	1
	6	2	2	1	5
	7	3	7	1	11
	8	3	4	1	8
	9	4	1	3	8
Rad.	1	2	2	2	6
	2	1	1	1	3
	3	1	2	-	3
	4	1	1	-	2
	5	-	1	-	1
	6	1	-	1	2
Uln.	1	-	-	-	0
	2	4	2	1	7
	3	4	2	1	7
	4	-	-	-	0
Car. R		-	1	-	1
	Car. I	-	-	-	0
	Car. U	-	-	-	0
	Car. 2+3	-	-	-	0
	Car. 4	-	-	-	0
Mc.	1	4	7	5	16
	2	5	8	5	18
	3	4	8	2	14
	4	5	9	2	16
	5	4	10	2	16
Oc.	1	-	-	-	0
	2	-	2	-	2
	3	-	2	1	3
	4	-	1	-	1
	5	-	5	-	5
	6	-	-	-	0
	7	-	1	-	1
	8	-	-	-	0
	9	1	3	1	4
	0	1	-	-	1
Fem.	1	1	1	-	2
	2	-	-	-	0
	3	2	-	-	2
	4	2	2	-	4
	5	1	1	-	2
	6	1	-	1	2
	7	-	-	1	1

	'Zone'	E08:27	E08:29	E08:44	Total
Pat.		-	-	-	0
Tib.	1	2	-	-	2
	2	1	1	-	2
	3	2	-	-	2
	4	1	-	3	4
	5	1	-	1	2
	6	1	-	1	2
	7	1	1	1	3
Mal.		-	-	-	0
Cal.	1	-	1	-	1
	2	-	3	-	3
	3	-	1	-	1

	'Zone'	E08:27	E08:29	E08:44	Total
Ast.		-	1	-	1
Cq.		-	-	-	0
Mt.	1	5	6	2	13
	2	4	5	2	11
	3	2	3	-	5
	4	2	4	1	7
	5	2	4	2	8
Ph. 1	1	-	6	1	7
	2	-	6	1	7
Ph. 2		-	2	-	2
Ph. 3		-	1	-	1

BIBLIOGRAPHY

Abbreviations

- AE *L'Année épigraphique.*
- Cam Hawkes, C. F. C. and Hull, M. R., 1947 *Camulodunum*, Oxford
- CIL *Corpus Inscriptionum Latinarum.*
- CK Hill, P. V. and Kent, J. P. C., 1960 *Late Roman Bronze Coinage, part 1*, London
- CR Crawford, M., 1974 *Roman Republican Coinage, Vols 1–2*, London
- CSIR 1.1 Phillips, E. J., 1977 *Corpus Signorum Imperii Romani, Great Britain, Volume I, Fascicule 1: Corbridge, Hadrian's Wall East of the North Tyne*, Oxford
- CSIR 1.4 Keppie, L. J. F. and Arnold, B. J., 1984 *Corpus Signorum Imperii Romani, Great Britain, Volume I, Fascicule 4: Scotland*, Oxford
- CSIR 1.6 Coulston, J. C. and Phillips, E. J., 1988 *Corpus Signorum Imperii Romani, Great Britain, Volume I, Fascicule 6: Hadrian's Wall West of the North Tyne, and Carlisle*, Oxford
- D. Figure-type in Déchelette, J., 1904 *Les Vases Céramiques Ornés de la Gaule Romaine*, Paris
- HK Carson, R. A. G. and Kent, J. P. C., 1960 *Late Roman Bronze Coinage, part 2*, London
- ILS *Inscriptiones Latinae Selectae.* H. Dessau, Berlin, 1892–1916.
- ND *Notitia Dignitatum* (ed.) O. Seeck, Berlin, 1876 (repr. Frankfurt 1962).
- ND Occ. *Notitia Dignitatum omnium in partibus Occidentis.*
- ND Or. *Notitia Dignitatum omnium in partibus Orientis.*
- O. Figure-type in Oswald, F., 1936–7 *Index of Figure-types on Terra Sigillata ("Samian Ware")*, Liverpool
- ORL *Der obergermanisch-raetische Limes des Römerreiches*
- RIBI Collingwood, R. G. and Wright, R. P., 1965 *The Roman Inscriptions of Britain. Volume I: Inscriptions on Stone*. Oxford.
- RIBII Frere, S. and Tomlin, R., (eds) 1990–5 *Roman Inscriptions of Britain II*, Stroud
- RIC Mattingly, H., Sydenham, E., Webb, P. H., Sutherland, C. H. V. and Carson, R. A. G., 1926–84 *The Roman Imperial Coinage, vols 1–10*, London
- Ricken-Fischer Ricken, H. and Fischer, C., 1963 *Die Bilderschüsseln der römischen Töpfer von Rheinzabern, Textband*, Bonn
- Rogers Rogers, G. B., 1974 *Poteries Sigillées de la Gaule Centrale. I: les Motifs non figures*, Gallia Supplement 28, Paris
- S. & S. 1958 Stanfield, J. A. and Simpson, G., 1958 *Central Gaulish Potters*, London

- Adkins, L. and Adkins, R. A., 1978 'Neolithic axes from Roman sites in Britain', *Oxford Journal of Archaeology* 4 (1), 1-10.
- Allason-Jones, L., 1983 Small finds in Miket, R., *The Roman Fort at South Shields: Excavations of the Defences*, Newcastle upon Tyne, 100.
- Allason-Jones, L., 1984 A lead shrine from Wallsend, *Britannia* 15, 231.
- Allason-Jones, L., 1985a An eagle mount from Carlisle, *Transactions of the Cumberland & Westmorland Antiquarian & Archaeological Society* n. ser. 8, 28-6.
- Allason-Jones, L., 1985b Bell-shaped studs? in Bishop, M. C., (ed.), *The Production and Distribution of Roman Military Equipment*, British Archaeological Report S25, Oxford, 100.
- Allason-Jones, L., 1988 Small finds from turrets on Hadrians Wall, in Coulston, J. C., (ed.), *Military Equipment and the Identity of Roman Soldiers: proceedings of the Fourth Roman Military Equipment Conference*, British Archaeological Report S9, 119.
- Allason-Jones, L., 1990 *Earring in Roman Britain*, British Archaeological Report 20, Oxford.
- Allason-Jones, L., 1989b Niello studs, *Arma* 1, 1-1.
- Allason-Jones, L., 1996a Roman military and domestic artefacts from Great Chesters, *Archaeologia Aeliana* 5 ser 24, 1.
- Allason-Jones, L., 1996b *Roman Jet in the Yorkshire Museum*, York.
- Allason-Jones, L., 2007 Small objects, in Hanson, W. S., *Elginhaugh: A Flavian Fort and its Annex - Volume 2*, Britannia Monograph 23, 30-4, London.
- Allason-Jones, L. and Miket, R. F., 1983 *Catalogue of Small Finds from South Shields Roman Fort*, Newcastle upon Tyne.
- Allason-Jones, L. and McKay, B., 1985 *Coventina's Well*, Chesters.
- Allen, D. A., 1966 The glass vessels, in Zienkiewicz 1966.
- Almgren, O., 1933 *Studien über nordeuropäische Fibelformen*, Leipzig.
- Anderson, A. C., 1978 *A Guide to Roman Fine Wares*, Vorda Research Series 1, Highworth.
- Archaeological Practice, The, 2006 52 Carville Road, Wallsend, North Tyneside: *Archaeological Evaluation*, unpublished report for Paragon Care Group.
- Arnold, C. J., 1983 The Sancton-Baston potter, *Scottish Archaeological Review* 21, 1.
- Atkinson, D., 1942 *Report on Excavations at Wroxeter*, Oxford.
- Aurrecoechea Fernández, J., 1996 Bronze studs from Roman Spain, *Journal of Roman Military Equipment Studies* 7, 1.
- Austin, R. G., 1935 Roman board games, *Greece and Rome* IV (1), 2-8.
- Batz, D., 1973 *Kastell Hesselbach und andere Forschungen an am Odenwaldlimes*, Limesforschungen 12, Berlin.
- Batz, D., 1983 Town walls and defensive weapons, in Maloney, J. and Hopley, B., *Roman Urban Defences in the West*, Council for British Archaeology Research Report 5, London.
- Bailey, D. M., 1950 *A Catalogue of the Lamp in the British Museum*, London.
- Baker, J. (ed.), 1984 *Sunderland Pottery*, Newcastle upon Tyne.
- Bánki, Z., 1972 *Az István Király Múzeum Gyűjteménye. Római Kori Figurális Bronz, Ezüst és Ólom Tárgyak, Szék esefehérvá*.
- Bateson, J. D., 1978 *Enamel-working in Iron Age, Roman and Sub-Roman Britain*, British Archaeological Report 93, Oxford.
- Bédoyère, G. de la, 1978 *Gods with Thunderbolts: Religion in Roman Britain*, Stroud.
- Bell, R. C., 1978 *Board and Table Games from Many Civilizations*, Oxford.
- Bémont, C., 1977 *Moules de Gobelets Ornés de la Gaule Centrale au Musée des Antiquités Nationales*, Gallia Suppl. 3, Paris.
- Bidwell, P., 1978 *The Roman Fort of Vindolanda*, London.
- Bidwell, P. T., 1978 *Roman Forts in Britain*, London.
- Bidwell, P. T. (ed.), 1990 *Hadrians Wall: A Summary of Recent Excavations and Research prepared for the Twelfth Pilgrimage of Hadrians Wall*, August 1990, Kendal.
- Bidwell, P., 2005 The dating of Crambeck parchment ware, *Journal of Roman Pottery Studies* 12, 1.
- Bidwell, P. T. and Croom, A. T., 1990 The coarse wares, in Wenham, L. P. and Heywood, B., *The Excavations in the Vicus at Malton, North Yorkshire*, Yorkshire Archaeological Report 3, 1.
- Bidwell, P. and Croom, A. T., 1999 The *Camulodunum/Colchester* type series, in Symonds and Wade 1999, 1.
- Bidwell, P. T. and Croom, A. T., 2002 The Roman pottery, in Snape, M. and Bidwell, P., *Excavations at Castle Garth Newcastle upon Tyne, and the excavation of the Roman Fort*, Archaeologia Aeliana 5 ser. 3, 1.
- Bidwell, P. T. and Croom, A. T., 1980 The supply and use of pottery on Hadrians Wall in the fourth century AD, in Collins, R. and Allason-Jones, L., *Finds from the Frontier: Material Culture in the 4th-5th Centuries*, Council for British Archaeology Research Report 18, York.
- Bidwell, P. T. and Hodgson, N., 1980 *The Roman Army in Northern England*, Newcastle upon Tyne.
- Bidwell, P. T., Miket, R. and Ford, B., 1988 The reconstruction of a gate at the Roman fort of South Shields, in Bidwell, P. T., Miket, R. and Ford, B. (eds), *Portae cum turribus: Studies of Roman Fort Gates*, British Archaeological Report 20, Oxford.
- Bidwell, P. T., Snape, M. and Croom, A. T., 1980 *Hardknott Roman Fort, Cumbria, including an account of the excavations by the late Dorothy Chilesworth*, Kendal.
- Bidwell, P. T. and Speak, S., 1978 *Excavations of South Shields Roman Fort Volume I*, Society of Antiquaries of Newcastle upon Tyne Monograph 4, Newcastle.
- Bidwell, P. T. and Snape, M. E., 2002 The history and setting of the Roman fort at Newcastle upon Tyne, *Archaeologia Aeliana* 5 ser. 3, 1.
- Birley, A. and Birley, A., 2010 A Dolichenum at Vindolanda, *Archaeologia Aeliana* 5 ser. 9, 1.
- Birley, E. and Charlton, J., 1978 Third report on excavations at Housesteads, *Archaeologia Aeliana* 4 ser. 11, 1.
- Birley, E. and Gillam, J. P., 1978 Mortarium stamps from Corbridge 1906-1938, *Archaeologia Aeliana* 4 ser. 26, 1.
- Birley, R., Blake, J. and Birley, A. R., 1978 *Interim Report on the 1978 Excavations on the Praetorium Site, Vindolanda*, Roman Army Museum Publications for the Vindolanda Trust, Carvoran.
- Birley, R., Birley, A. and Blake, J., 1978 *The Excavations at Vindolanda. The Praetorium Site: Interim Report*, Roman

- Army Museum Publications for the Vindolanda Trust, Carvoran
- Bishop, M. C., 1971 *Lorica Segmentata, Volume I*, Journal of Roman Military Studies Monograph 1
- Bishop, M. C. and Coulston, J. C. N., 1983 *Roman Military Equipment from the Punic Wars to the fall of Rome* (2nd edn), Oxford
- Bishop, M. C. and Dore, J. N., 1983 *Corbridge: Excavations of the Roman Fort and Town* Historic Buildings & Monuments Commission Archaeological Report 8, London
- Boersterd, M. H. P. den, 1971 *Description of the Collections in the Rijksmuseum G. M. Kam at Nijmegen v: The Bronze Vessels*, Nijmegen
- Böhme, A., 1972 Die Fibeln der Kastele Saalburg und Zugmantel Saalburg *Jahrbuch* 29, 2
- Boon, G. C., 1966a Roman window glass from Wales, *Journal of Glass Studies* 8, 2
- Boon, G. C., 1966b Gilt glass beads from Caerleon and elsewhere, *Bulletin of the Board of Celtic Studies* 22(1), 1
- Boon, G. C., 1977 Gold-in-glass beads from the ancient world, *Britannia* 8, 19 2
- Boon, G. C., 1983 Some Romano-British domestic shrines and their inhabitants, in Hartley, B. and Wachter, J. (eds), *Rome and the North Roman Provinces*, 3 Gloucester
- Bosanquet, R. C., 1904 Excavations on the line of the Roman Wall in Northumberland. 1. The Roman camp at Housesteads, *Archaeologia Aeliana* 2 ser. 25, 1
- Brailsford, J. W., 1904 *Hod Hill I: Antiquities in the Durden Collection*, London
- Braithwaite, G., 1971 *Faces from the Past: a Study of Roman Face Pots from Italy and the Western Provinces of the Roman Empire*, British Archaeological Report 515
- Brassington, M., 1971 A Trajanic kiln complex near Little Chester, Derby, 1968, *Antiquity* 3, 1
- Brassington, M., 1980 Derby racecourse kiln excavations *Antiquity* 10, 2
- Breeze, D. and Dobson, B., 1972 Hadrian's Wall: some problems, *Britannia* 3, 12 2
- Breeze, D. and Dobson, B., 2000 *Hadrian's Wall*, (3rd edn), London
- Brickstock, R. J., 1971 The coins, in Hodgson 1 1
- Briscoe, T., 1983 A classification of Anglo-Saxon pot stamp motifs and proposed terminology, *Studien zur Sachforschung* 4, 2
- Brodrigg, G., 1987 *Roman Brick and Tile*, Gloucester
- Bruce, J. C., 1971 *The Wall Book of the Roman Wall*, London & Newcastle upon Tyne
- Buckland, P. C., 1971 *Roman South Yorkshire: a Source Book*, Sheffield
- Buckland, P. C. and Dolby, M. J., 1980 *A Roman Pottery Kiln Site at Blaxton Quarry near Doncaster*, Archaeology of Doncaster 1
- Buckland, P. C., Hartley, K. F. and Rigby, V., 2001 The Roman pottery kilns excavations at Rossington Bridge *Journal of Roman Pottery Studies* 9, 1
- Bulmer, W., 1971 Roman glass vessels in the Corstopitum Museum, Corbridge, *Archaeologia Aeliana* 4 ser. 33, 116-33
- Bushe-Fox, J. P., 1971 *First Report on Excavations on the Site of the Roman Town at Wroxeter, Shropshire*, Oxford
- Bushe-Fox, J. P., 1972 *First Report on the Excavation of the Roman Fort at Richborough Kent*, Oxford
- Bushe-Fox, J. P., 1973 *Fourth Report on the Excavations on the Roman Fort at Richborough Kent*, Oxford
- Callender, M. H., 1971 *Roman Amphorae*, Oxford
- Campbell, D., 1986 Auxiliary artillery revisited, *Bonner Jahrbuch* 16, 2
- Carlton, R., 1988 Ethnoarchaeological study of pottery production in Dalmatia, *University of Newcastle upon Tyne and University of Durham Archaeological Reports for 1987-88*
- Caruana, I., 1997 Ceramic building material, in Wilmott, T., *Birdoswald. Excavations of a Roman Fort on Hadrian's Wall and its Successor Settlements: 1987-92*, English Heritage Archaeological Report 14, London
- Casey, P. J., 1974 The interpretation of Romano-British site finds in Casey, P. J. and Reece (eds), *Coins and the Archaeologist*, British Archaeological Report 4, 37-51, Oxford
- Casey, P. J., 1975 Roman coinage of the fourth century in Scotland, in Milet, R. and Burgess, C. (eds), *Between and Beyond the Walls: Essays on the Prehistory and History of the North of Britain in Honour of George Jobey*, Edinburgh
- Casey, P. J., 1976 *Understanding Ancient Coins*, London
- Casey, P. J., Davies, J. L. and Evans, J., 1977 *Excavations at Segontium (Caernarfon) Roman Fort*, Council for British Archaeology Research Report 10, York
- Cessford, C., 1971 Torcs in early historic Scotland, *Oxford Journal of Archaeology* 1, 2
- Charlesworth, D., 1971 Roman glass in northern Britain, *Archaeologia Aeliana* 4 ser. 3, 2
- Charlesworth, D., 1961 Roman jewellery found in Northumberland and Durham, *Archaeologia Aeliana* 4 ser. 9, 2
- Charlesworth, D., 1963 The granaries at Hardknott Castle, *Transactions of the Cumberland & Westmorland Antiquarian & Archaeological Society* n. ser. 6, 2
- Charlesworth, D., 1966 Roman square bottles, *Journal of Glass Studies* 8, 2
- Charlesworth, D., 1971 The glass, in Frere 2 1
- Charlesworth, D., 1975 The commandant's house, Housesteads, *Archaeologia Aeliana* 5 ser. 3, 2
- Charlesworth, D., 1976 The hospital, Housesteads, *Archaeologia Aeliana* 5 ser. 4, 2
- Chenet, G. and Gaudron, C., 1955 *La Céramique sigillée d'Argonne des Iles et IIIe siècles*, Gallia Supplement 6 Paris
- Christison, D., 1971 Account of the excavation of the Roman station in Annandale, undertaken by the Society of Antiquaries of Scotland in 1895, *Proceedings of the Society of Antiquaries of Scotland* 10, 2
- Clarke, D. V., 1970 Bone dice and the Scottish Iron Age, *Proceedings of the Prehistoric Society* 6, 2
- Coggins, D., 1979 Durham: Binchester, *Medieval Archaeology* 23, 2
- Collingwood, R. G., 1930 Romano-Celtic Art in Northumbria, *Archaeologia* 10, 2
- Collingwood, R. G. and Richmond, I. A., 1969 *The Archaeology of Roman Britain*, London
- Compton, J. and Webster, P. V., 2000 The coarse pottery, in Evans, E., *The Caerleon Canabae: Excavations in the Civil Settlement 1984-90*, Britannia Monograph 16, 2
- Cook, J. M., 2004 *Early Anglo-Saxon Buckets*, Oxford University School of Archaeology Monograph 60, Oxford
- Cool, H. E. M., 1990a The problem of third century

- drinking-vessels in Britain, *Annales du 11e Congrès de l'Association Internationale pour l'Histoire du Verre*, Amsterdam, 167–75
- Cool, H. E. M., 1990b Roman metal hair pins from southern Britain, *Archaeological Journal* **17**, 2
- Corcoran, J. X. W. P., 1991 Tankards and tankard handles of the British Early Iron Age, *Proceedings of the Prehistoric Society* **18**, 8
- Corder, P., 1991 The Defences of the Roman Fort at Malton. Roman Malton & District Research Report **2**, York
- Corder, P., 1933 Ballista balls at wall turrets, *Proceedings of the Society of Antiquaries of Newcastle upon Tyne* **4** ser. **2**(1), 8
- Corder, P., 1991 A pair of fourth-century Romano-British pottery kilns near Crambeck, *Antiquaries Journal* **17**, 2
- Corder, W. S., 1903 Wallsend (Segedunum), *Proceedings of the Society of Antiquaries of Newcastle upon Tyne* **3** ser. **1**, 42–72
- Corder, W. S., 1991 Segedunum – the last phase, *Proceedings of the Society of Antiquaries Newcastle upon Tyne* **3** ser. **5**, 2
- Cramp, R., 1983 Anglo-Saxon Settlement, in Chapman, J. C. and Mytum, H. C. (eds), *Settlement in North Britain 1000 BC–AD 1000*, British Archaeological Report **118**, 263–97, Oxford
- Cramp, R., 1988 Northumbria: the archaeological evidence, in Driscoll, S. T. and Niekke, M. R. (eds), *Power and Politics in Early Medieval Britain and Ireland*, Edinburgh
- Croom, A. T., 1994 Small finds, in Bidwell and Speak 1994, 2
- Croom, A. T., 1995 A hoard of Roman military equipment from South Shields, *Archeologia* **4**, 45–53
- Croom, A. T., 2003 The finds and North African style pottery, in Hodgson 2003, 183–230, 246–9
- Croom, A. T., 1991 Roman Furniture, Stroud
- Croom, A. T., McBride, R. M. and Bidwell, P. T., 1991 The coarse wares in Cool, H. E. M. and Mason, D. J. P., *Roman Piercebridge: Excavations by D. W. Harding and Peter Scott 1969–1981*, Architectural & Archaeological Society of Durham & Northumberland Research Report **7**, Durham
- Crow, J. G., 1991 An excavation on the north curtain wall at Housesteads, *Archaeologia Aeliana* **5** ser. **16**, 2
- Crow, J. G., 1991 Housesteads Roman Fort (English Heritage Guidebook), London
- Crow, J. G., 2004 *Housesteads: A Fort and Garrison on Hadrian's Wall*. 2 edn. Stroud (first pub. 1995 English Heritage Book of Housesteads. London)
- Crummy, N., 1979 A chronology of bone pins, *Britannia* **10**, 2
- Crummy, N., 1993 The Roman Small Finds from Excavations in Colchester, Colchester Archaeological Report **2**, Colchester
- Cunliffe, B., 1968 *Fifth Report on the Excavations of the Roman Fort at Richborough*, Oxford
- Curle, J., 1991 A Roman Frontier Post and its People: the Roman Fort of Newstead in the Parish of Melrose, Glasgow
- Curwen, E. C., 1991 Querns, *Antiquity* **11**, 3
- Dale, R., 1991 The Price Guide to Black and White Pot-lids, Woodbridge
- Daniels, C. M., (ed) 1991 Handbook to the Roman Wall with the Cumbrian Coasts and Outpost Forts, 3 edn, Newcastle upon Tyne.
- Daniels, C. M., 1980 Excavations at Wallsend and the fourth-century barracks on Hadrian's Wall in Hanson, W. S. and Keppie, L. J. F. (ed), *Roman Frontier Studies* **9** British Archaeological Report **57**, Oxford
- Daniels, C. M. (ed.), 1989 *The Eleventh Pilgrimage of Hadrian's Wall*, Newcastle upon Tyne
- Daniels and Rankov, N. B. (ed) 1991 'Roman Britain in 1981: I. Sites explored' (Wallsend Fort interim note), *Britannia* **13**, 2
- Dannell, G. B., 1971 The samian pottery, in Cunliffe, B., *Excavations at Fishbourne, Volume II: the Finds*, Report of the Research Committee of the Society of Antiquaries of London **27**, London
- Dannell, G. B. and Hartley, B. R., 1974 The samian pottery, in Ainsworth, C. J. and Ratcliffe, B. A., Densham, Spectroscopy and a Roman cremation from Sompting, Sussex, *Britannia* **5**, 2
- Dannell, G. B., Hartley, B. R., Wild, J. P. and Perrin, J. R., 1993 Excavations on a Romano-British pottery production site at Park Farm, Stanground, Peterborough, 1965–1967, *Journal of Roman Pottery Studies* **6**, 2
- Davies, R. W., 1991 The Roman military diet, *Britannia* **2**, 2
- Davison, D. P., 1991 The Barracks of the Roman Army from the 1st to 3rd Centuries AD, British Archaeological Report **52**, Oxford
- Dearne, M. J. and Lord, T. C., 1998 *The Romano-British Archaeology of Victoria Cave, Settle*, British Archaeological Report **23**, Oxford
- Delort, E., 1991 Vases Ornés de la Moselle, Nancy
- Dickinson, B. M., 1984 The samian ware, in Frere 1984, 2
- Dickinson, B. M., 1986a Samian pottery from the civil settlement, Doncaster, in Buckland, P. C. and Magilton, J. R., *The Archaeology of Doncaster*. British Archaeological Report **18**, Oxford
- Dickinson, B. M., 1986b Potters' stamps and signatures on samian, in Miller, L., Schofield, J. and Rhodes, M., *The Roman Quay at St Magnus House, London*, London & Middlesex Archaeological Society Special Paper **8**, London
- Dickinson, B. M., 1991 The stamped and decorated samian, in Thomas, G. D., Excavations at the Roman civil settlement at Inveresk 1976–77, *Proceedings of the Society of Antiquaries of Scotland* **118**, fiche 1: A7–14, B1–14
- Dickinson, B. M., 1996 Samian pottery, in May, J., *Dragbury Report on Excavations at an Iron Age and Romano-British Settlement in North Lincolnshire*, Oxford
- Dickinson, B. M., 1991 The samian, in Snape, M. and Bidwell, P., Excavations at Castle Garth, Newcastle upon Tyne, 1976–92 and 1995–6: the excavation of the Roman fort, *Archaeologia Aeliana* **5** ser. **3**, 2
- Dickinson, B. M., 1991 The samian ware, in Hodgson 2
- Donaldson, G. H., 1988 Thoughts on a military appreciation of Hadrian's Wall, *Archaeologia Aeliana* **5** ser. **16**, 2
- Doppelfeld, O., 1966 *Romisches und Frankisches Glass in Köln*, Cologne
- Dore, J. N., 1991 Corbridge Roman Site, London
- Dore, J. N., 1991 Haltonchesters: Excavations directed by J. P. Gillam at the Roman Fort, Oxford
- Dore, J. N. and Gillam, J. P., 1991 The Roman Fort at South Shields: Excavations, Society of Antiquaries of

- Newcastle upon Tyne Monograph 1, Newcastle upon Tyne
- Döwner, F., 1977 *Die Gesichtsfragmente der römischen Nordwestprovinzen*, British Archaeological Report 50, Oxford
- Driel-Murray, C. van, 1987 Ethnic recruitment and military mobility, in Morillo, A., Hanel, N. and Martin, E. (eds), *Limes XX. Estudios sobre la Frontera Romana/Roman Frontier Studies. Anejos de Gladius* 13 (III), 813–22, Madrid
- Dungworth, D. B. and Starley, D., 1997 The metalworking debris in Rushworth, A., (ed.) *The Grandest Station: Excavation and Survey at Housesteads Roman Fort* by C. M. Daniels, J. P. Gillam, J. G. Crow, D. J. Smith and the RCHME 9, English Heritage Archaeological Report, Swindon
- Durand-Lefebvre, M., 1963 *Marques de Potiers Gallo-Romains Trouvées à Paris et Conservées Principalement au Musée Carnavalet*, Paris
- Eckardt, H., 1991 *Illuminating Roman Britain*, Monographies Instrumentum 23
- Edmonds, M., 1990 *Stone Tools and Society Working Stone in Neolithic and Bronze Age Britain*, London
- Egan, G. and Pritchard, F., 1990 *Dress Accessories* 1, Medieval Finds from Excavations 3, London
- Eggers, H. J., 1966 Römische Bronzefässer in Britannien, *Jahrbuch des Römisch-Germanischen Zentralmuseums Mainz* 13, 1
- Eiden, H., 1949 Untersuchungen an den spätromischen Horrea von St Irminen in Trier, *Trierer Zeitschrift* 19, 1
- English Heritage 1990 *Management of Archaeological Projects*, London
- Esperandieu, E., 1906 *Recueil Général des Bas-reliefs de la Gaule Romaine* 5, Paris
- Ettlinger, E., 1973 *Die Römischen Fibeln in der Schweiz. Handbuch der Schweiz der Römer- und Merowingerzeit*, Bern
- Evans, J., Jones, R. F. J. and Turnbull, P., 1991 Excavations at Chester-le-Street, *Durham Archaeological Journal* 7, 5–48
- Evelein, M. A., 1906 *Beschrijving van de verzameling van het Museum G. M. Kam. De Romeinse Lampen*, S'Gravenhage
- Feachem, R. W., 1951 Dragonesque Fibulae, *Antiquaries Journal* 31, 2
- Ferris, I., 1997 *The Beautiful Rooms are Empty Excavations at Binchester Roman Fort, County Durham* 1 and 2, Durham
- Fleming, S. J., 1990 *Roman Glass: Reflections of Everyday Life*, Philadelphia
- Förlér, E., 1977 *Die Bilderschnitten der ostgermanischen Sigillata-Manufakturen*, Bonn
- Ford, B., 1991 Two vessels in pink grog tempered ware from the Roman Fort at Cramond, Scotland, *Journal of Roman Pottery Studies* 4, 55–6
- Fowler, E., 1960 The origins and development of the penannular brooch in Europe, *Proceedings of the Prehistoric Society* 26, 1–7
- Fox, C., 1990 *Pattern and Purpose*, Cardiff
- Fremersdorf, F., 1906 *Das naturfarbene Glas in Köln*, Die Denkmäler des römischen Köln 4, Cologne
- Fremersdorf, F., 1907 *Die römischen Gläser mit aufgelegten Nuppen*, Die Denkmäler des römischen Köln 7, Cologne
- Frere, S. S., 1984 *Verulamium Excavations, Vol. I*, Report of the Research Committee of the Society of Antiquaries of London 28, London
- Frere, S. S., 1974 Review of Baatz 1973, *Britannia* 5, 1
- Frere, S. S. (ed.) 1977 Roman Britain in 1976: I. Sites explored (Wallsend Fort interim note), *Britannia* 8, 1
- Frere, S. S. (ed.) 1983 Roman Britain in 1982: I. Sites explored (Wallsend Fort interim note), *Britannia* 14, 1
- Frere, S. S. (ed.) 1984 Roman Britain in 1983: I. Sites explored (Wallsend Fort interim note), *Britannia* 15, 1
- Frere, S. S., 1984 *Verulamium Excavations III*, Oxford University Committee for Archaeology Monograph 1, Oxford
- Frere, S. S. (ed.) 1985 Roman Britain in 1984: I. Sites explored (Wallsend Fort interim note), *Britannia* 16, 1
- Frere, S. S. and Tomlin, R. S. O., 1991 *The Roman Inscriptions of Britain, Volume II, Fascicule 4*, Stroud
- Funari, P. P. A., 1996 *Dressel 20 Inscriptions from Britain and the Consumption of Spanish Olive Oil*, British Archaeological Report 20, Oxford
- Gallagher, D. B., 1987 The Anglo-Saxon cemetery of Hob Hill, Saltburn, *Yorkshire Archaeological Journal* 97, 92
- Gentry, A. P., 1990 *Roman Military Stone-Built Granaries in Britain*, British Archaeological Report 2, Oxford
- Gidney, L., 2003 The animal bones from the hospital and barrack XII, in Hodgson 2003, 231–40
- Gillam, J. P., 1958 Roman and native, AD 122–97, in Richmond, I. A. (ed.), *Roman and Native in North Britain*, Edinburgh
- Gillam, J. P., 1977 *Types of Roman Coarse Pottery in Northern Britain* (3rd edn), Newcastle upon Tyne
- Going, C. J., 1990 *The Mansio and Other Sites in the South Eastern Sector of Caesaromagus: the Roman Pottery*, Chelmsford Archaeological Trust Report 3.2, Chelmsford
- Goodburn, R. (ed.) 1976 Roman Britain in 1975: I. Sites explored (Wallsend Fort interim note), *Britannia* 7, 306–8.
- Goodburn, R. (ed.) 1978 Roman Britain in 1977: I. Sites explored (Wallsend Fort interim note), *Britannia* 9, 1
- Goodburn, R. and Grew, F., 1984 The non-ferrous metal objects in Frere 1984, 19–67
- Green, M., 1976 *A Corpus of Religious Material from the Civilian Areas of Roman Britain*, British Archaeological Report 24, Oxford
- Green, M., 1990 *Small Cult Objects from the Military Areas of Roman Britain*, British Archaeological Report 2, Oxford
- Greenwell, W. (ed.), 1906 *Feodarium Prioratus Dunelmensis*, Surtees Society 8, Durham, London & Edinburgh
- Greep, S., 1995 The worked bone, antler and ivory, in Blockley, K., Blockley, M., Blockley, P., Frere, S. and Stow, S., *Excavations in the Marlowe Car Park and Surrounding Area, Vol. 2: the Finds*, Archaeology of Canterbury 5, 112–52, Canterbury
- Gregory, A. K., 1996 Romano-British Pottery, in May, G., *Dragonby. Report on Excavations at an Iron Age and Romano-British Settlement in North Lincolnshire, Volume 2*, 53, Oxbow Monograph 1, Oxford
- Grew, F. O. (ed.) 1980 Roman Britain in 1979: I Sites explored (Wallsend Fort interim note), *Britannia* 11, 1
- Grew, F. O. (ed.) 1981 Roman Britain in 1980: I Sites explored (Wallsend Fort interim note), *Britannia* 12, 1
- Griffiths, W. B., 1992 The hand-thrown stone, *Arbeia Journal* 1, 1
- Griffiths, W. B., 1993 Excavation to the north-east of Wallsend Roman Fort – 9, *Arbeia Journal* 2, 2–3
- Griffiths, W. B., 1994a Excavation summary: Wallsend, Buddle Street, *Arbeia Journal* 3, 8

- Griffiths, W. B., 1994b Excavation summary: Wallsend, Rawdon Court, *Arbeia Journal* 3, 58–9
- Griffiths, W. B., 1994c Throwing stones, in Bidwell and Speak 2, 2
- Griffiths, W. B., 2003 The throwing stones, in Hodgson 2, 2
- Guido, M., 1971 *The Glass Beads of the Prehistoric and Roman Periods in Britain and Ireland*, London
- Guiraud, H., 1908 *Intailles et Camées de l'Époque Romaine en Gaule*, Gallia Supplement 8, Paris
- Hagen, H., 1937 Kaiserzeitliche Gagatarbeiten aus den Rheinischen Germanien, *Bonner Jahrbuch* 12, 1, 1
- Hair, T. H., 1844 *Views of the Collieries in the Counties of Northumberland and Durham*, London
- Harcourt, R. A., 1974 The dog in prehistoric and early historic Britain, *Journal of Archaeological Science* 1, 3
- Harden, D. B., 1962 Glass, in R.C.H.M., *An Inventory of the Historical Monuments of the City of York, Volume 1 Eburacum*, 6, 1, London
- Harden, D. R., 1977 Report on the glass bowl, in Partridge, C., Excavations and fieldwork at Braughing, *Hertfordshire Archaeology* 5, 12
- Harden, D. R., 1978 Glass vessels, in Clarke, G., *Pre-Roman and Roman Winchester part II: the Roman Cemetery at Lankhills*, Winchester Studies 3, 29–31 Winchester
- Harden, D. B. and Price, J., 1971 The glass, in Cunliffe, B., *Excavations at Fishbourne*, London
- Harding, D. W. and Scott, P., 2008 *Roman Piercebridge*, Architectural & Archaeological Society of Durham & Northumberland Report 7, Durham
- Hartley, B. R., 1970 The dating evidence for the end of the Saalburg Erdkastell, in Schönberger, H., *Die Namenstempel auf glatter Sigillata aus dem Erdkastell der Saalburg*, *Saalburg Jahrbuch* 27, 28–30
- Hartley, B. R., 1971 The samian ware, in Frere 2, 2
- Hartley, B. R., 1972b The Roman occupations of Scotland: the evidence of samian ware, *Britannia* 3, 15–5
- Hartley, B. R. and Dickinson, B., 1973 The samian ware, in Rogerson, A., *Excavations at Scole*, East Anglian Archaeology 5, 15–21 Dereham
- Hartley, B. R., Pengelly, H. and Dickinson, B., 1974 Samian ware, in Cracknell, S. and C. Mahany, C. (eds), *Roman Alcester: Southern Extramural Area: 1964–1966 Excavations*, Council for British Archaeology Research Report 97, York
- Hartley, K. F., 1984 The mortaria, in Breeze, D. J., *The Roman Fort on the Antonine Wall at Bearsden*, in Breeze, D. J. (ed.) *Studies in Scottish Antiquity Presented to Stewart Cruden*, 32–68, Edinburgh
- Hartley, K. F., 1985 Mortaria, in Wheeler, H., *North-west sector excavations*, *Derbyshire Archaeological Journal* 10, 3
- Hartley, K. F., 1986 The mortaria, in Rollo, L., *Iron Age and Roman Piddington: the Mortaria*, Upper Nene Archaeological Society Fascicule 2, Northampton
- Hartley, K. F., 1987 The stamped mortaria, in Symonds and Wade 2, 2
- Hartley, K. F., 1988 The mortarium stamps, in Rush, P., Dickinson, B., Hartley, B. and Hartley, K. F., *Roman Castleford Excavations 1974–85, Volume 3: the Pottery*, York Archaeological Service 6, 18–19 York
- Hartley, K. F. and Webster, P. V., 1973 Romano-British pottery kilns near Wilderspool, *Archaeological Journal* 10, 2
- Haselgrove, C., 1980 The Later Bronze Age and the Iron Age in the Lowlands, in Brooks, C., Daniels, R. and Harding, A. (eds), *Past, Present and Future: The Archaeology of Northern England*. Architectural & Archaeological Society of Durham & Northumberland Research Report 5, 49–69, Durham
- Haselgrove, C. C. and Healey, F., 1981 The prehistory of the Tyne-Tees Lowlands: some recent finds, *Durham Archaeological Journal* 8, 1
- Haslam, J., 1981 Glass vessels, in Margeson, S., *Norwich Households: the Medieval and Post-Medieval Finds from Norwich Survey Excavations 1971–1978*, East Anglian Archaeology 8, Norwich
- Haverfield, F., 1913 Inscriptions, 263–71, in Forster, R. H. and Knowles, W. H., *Corstopitum: report of the excavations in 1911*, *Archaeologia Aeliana* 3 ser. 9, 2
- Hawkes, S. C. and Dunning, G. C., 1961 Soldiers and settlers in Britain: with a catalogue of ornamental buckles and related belt fittings, *Medieval Archaeology* 5, 2
- Hayes, R. H., Hemingway, J. E. and Spratt, D. A., 1980 The distribution and lithology of beehive querns in northeast Yorkshire, *Journal of Archaeological Science* 8, 297–313
- Henig, M., 1970 The veneration of heroes in the Roman army, *Britannia* 1, 2
- Henig, M., 1971 Intagli, in MacGregor 2, 2
- Henig, M., 1977 Death and the maiden: funerary symbolism in daily life, in Munby, J. and Henig, M. (eds), *Roman Life and Art in Britain*, British Archaeological Report 4, Oxford
- Henig, M., 1978 *A Corpus of Roman Engraved Gemstones from British Sites*, British Archaeological Report 8, Oxford
- Henig, M., 1980 The gemstones, in Frere, S. S. and Wilkes, J. J., *Stragath Excavations with the Roman Fort*, *Britannia Monograph* 9, London
- Henig, M., 1988 The chronology of Roman engraved gemstones, *Journal of Roman Archaeology* 1, 1
- Henig, M., 1993a Copper-alloy and non-ferrous metalwork, in Woodward, P. J., Davies, S. M. and Graham, A. H., *Excavations at Greif and Yard, Dorchester*, Dorset Natural History & Archaeological Society Monograph 12, Dorchester
- Henig, M., 1993b Intaglio, in Casey, P. J., Davies, L. J. and Evans, J., *Excavations at Segontium (Caernarfon) Roman Fort*, Council for British Archaeology Research Report 10, York
- Henig, M., 1997 Intaglios, in Marvell, A. G. and Owen-Jones, H. S., *Leucarum: Excavations at the Roman Auxiliary Fort at Lougborough, West Glamorgan and*, *Britannia Monograph* 12, London
- Henry, F., 1933 Emailliers d'Occident, *Prehistoire* 2(1), 5
- Henry, F., 1936 Hanging bowls, *Journal of the Royal Society of Antiquaries of Ireland* 6, 2
- Hermet, F., 1908 *La Graufesenque (Condatomagus)*, Paris
- Herrmann, F. R., 1909 Der Eisenhortfund aus dem Kastell Künzing. Vorbericht, *Saalburg Jahrbuch* 26, 2
- Heslop, D. H., 1987 *The Excavation of an Iron Age Settlement at Thrapston, Cleveland*, Council for British Archaeology Research Report 6, London
- Higham, N. J., 1986 *The Northern Counties to AD 1000*, Harlow
- Hodder, I. and Hedges, J. W., 1977 'Weaving combs': their

- typology and distribution with some introductory remarks on date and function, in Collis, J. (ed), *The Iron Age in Britain: a Review*, 17–28, Sheffield
- Hodgson, J., 1981 *History of Northumberland, Part 2, vol. III*, Newcastle upon Tyne
- Hodgson, N., 1981 *The Roman Fort at Wallsend: Excavations in 1997–8*, Tyne and Wear Museums Archaeology Monograph 2, Newcastle upon Tyne
- Hodgson, N. (ed.), 2009 *Hadrian's Wall 1999–2009: A Summary of Excavation and Research prepared for the Twentieth Pilgrimage of Hadrian's Wall*, August 2009, Kendal
- Hodgson, N. and Bidwell, P. T., 2001 Auxiliary Barracks in a new light: Recent discoveries on Hadrian's Wall, *Britannia* 32, 255
- Hoffmann, D., 1969 and 1970 *Das spätrömische Bewegungsheer und die Notitia Dignitatum*. (2 vols) *Epigraphische Studien* 1 & 2 Dusseldorf
- Holbrook, N., 1984 *Some Pottery from the Roman Fort at Wallsend*, unpublished BA dissertation, Newcastle upon Tyne
- Holbrook, N., 1991 A watching brief at the Roman fort of Benwell-Condercum 1990, *Archaeologia Aeliana* 5 ser. 19, 3
- Holbrook, N. and Bidwell, P. T., 1992 Roman pottery from Exeter 1980–1990, *Journal of Roman Pottery Studies* 5, 35–80
- Horsley, J., 1971 *Britannia Romana*, London
- Howe, M. D., Perrin, J. R. and Mackreth, D. F., 1981 *Roman Pottery from the Nene Valley: a Guide*, Peterborough
- Hull, M. R., 1963 *The Roman Potters Kilns of Colchester*, Report of the Research Committee of the Society of Antiquaries of London 21, London
- Isings, C., 1939 *Roman Glass from Dated Finds*, Groningen
- Isings, C., 1940 *Roman Glass in Limburg* Groningen
- Issac, B., 1971 *The Limits of Empire*, Oxford
- Jacobi, L., 1897 *Das Römer Kastell Saalburg bei Homburg vor der Höhe*, Hamburg
- Jacobs, J., 1912 Sigillatafunde aus einem römischen Keller zu Bregenz *Jahrbuch für Altertumskunde* 6, 1
- Jarrett, M. G., 1969 *The Roman Frontier in Wales*, Cardiff
- Janssens, P. and Vanderhoeven, M., 1971 Glass, in Roosens, H. and Lux, G. V., Gallo-Romeinse Tumulus te Helshoven onder Hoepertingen, *Archaeologia Belgica* ca 14
- Jenkins, F., 1957 The cult of the Dea Nutrix in Kent, *Archaeologia Cantiana* 7, 38–4
- Jenkins, F., 1958 The cult of the Pseudo-Venus in Kent, *Archaeologia Cantiana* 7, 8
- Jobey, G., 1963 Excavation of a native settlement at Marden, Tynemouth, *Archaeologia Aeliana* 4 ser. 1, 9
- Jobey, G., 1970 An Iron Age settlement and homestead at Burradon, Northumberland, *Archaeologia Aeliana* 4 ser. 1, 8
- Jobey G., 1982 The settlement at Doubstead and Romano-British settlement on the coastal plain between Tyne and Forth, *Archaeologia Aeliana*, 5 ser. 10, 1
- Jobey, G., 1986 Millstones and millstone quarries in Northumberland, *Archaeologia Aeliana* 5 ser. 14, 8
- Jobey, I., 1979 Housesteads ware: A Frisian tradition on Hadrian's Wall, *Archaeologia Aeliana* 5 ser. 7, 1
- Jobst, W., 1975 *Die römischen Fibeln aus Lauriacum*, Forschungen in Lauriacum 10
- Johnson, A., 1981 *Roman Forts*, London
- Johnson, J. S., 1981 *Late Roman Fortifications*, London
- Johnson, J. S., 1981 *Chesters Roman Fort*, London
- Joze, E. M., 1901 *Early Celtic Art in the British Isles*, Oxford
- Juhász, G., 1935 *Die Sigillaten von Brigetio. Dissertationes Pannonicae ser. 23* Budapest
- Karnitsch, P., 1955 *Die verzierte Sigillata von Lauriacum (Lorch Enns)*, Forschungen in Lauriacum 3
- Karnitsch, P., 1955 *Die Reliefsigillata von Ob-lava*, Linz
- Keller, E., 1901 *Die Spätromischen Grabfunde in Südbayern*, Munich
- Kenyon, K. M., 1934 The Roman theatre at Verulamium, St Albans, *Archaeologia* 44, 1
- Kenyon, K. M., 1948 *Excavations at the Jewry Wall Site*, Leicester, Oxford
- Kiernan, P., 1981 *Miniature Votive Offerings in the Roman North West*, Ruyter
- Kilbride-Jones, H., 1938 Glass armlets in Britain, *Proceedings of the Society of Antiquaries of Scotland* 3, 8
- Knorr, R., 1907 *Die verzierten Terra-sigillata Gefässe von Rottweil*, Stuttgart
- Knorr, R., 1939 Frühe und späte Sigillata des Arcanus, *Germania* 23, 8
- Kunzl, I. C., 1982 *Medizinische Instrumente aus Sepulkralfunden der römischen Kaiserzeit*, Bonn
- Lander, J., 1984 *Roman Stone Fortifications: Variation and Change from the First Century AD to the Fourth*, British Archaeological Report S20, Oxford
- Lassus, J., 1981 *La forteresse byzantine de Thamugadi, I: Fouilles ... Timugadi*, Etudes d'Antiquités Africaines – CNRS, Paris
- Leach, J., 1939 The smith god in Roman Britain, *Archaeologia Aeliana* 4 ser. 1, 3
- Leach, J. and Wilkes, J. J., 1962 Excavations in the Roman fort at Housesteads, 1961, *Archaeologia Aeliana* 4 ser. 40, 83–96
- Lindgren, C., 1939 *Classical Art Forms and Celtic Mutations*, Park Ridge
- Lloyd-Morgan, G., 1939 Roman mirrors in Britain, *Current Archaeology* 8, 1
- Lloyd-Morgan, G., 1939 *Description of the Collections in the Rijksmuseum G. M. Kam at Nijmegen. X. The Mirrors*, Nijmegen
- Lloyd-Morgan, G., 1939 The Venus shrine, in Ellis, P. (ed), *The Roman Baths and Macellum at Wroxeter: Excavations by Graham Webster 1955–85*, English Heritage Archaeological Report 9, 1 London
- Loeschcke, S., 1911 *Beschreibung römischer Altertümer, gesammelt von Carl-Anton Niessen. Keramik und Terracotten*, Cologne
- Loeschcke, S., 1939 *Lampen aus Vindonissa*, Zürich
- Lomas, R. A. and Piper, A. J. (eds), 1981 *Durham Cathedral Priory Rentals I. Bursars Rentals*, Surtees Society 198, Newcastle upon Tyne
- Longley, D., 1939 *Hangng Bowls, Penannular Brooches and the Anglo-Saxon Connexion*, British Archaeological Report 22, Oxford
- Longstaffe, W. H. and Booth, J., 1889 *Halmota prioratus Dunelmensis*, Surtees Society 2, London, Durham
- Loveluck, C., 2002 The Romano-British to Anglo-Saxon transition – social transformations from the Late Roman to early medieval period in northern England, AD 400–700, in Brooks, C., Daniels, R. and Harding, A. (eds), *Past, Present and Future: The Archaeology of Northern England and* Architectural & Archaeological Society of Durham & Northumberland Research Report 5, 1 Durham
- Ludowici, W., 1927 *Stempel-Namen und Bilder römischer*

- Töpfer, *Legions-Ziegel-Stempel, Formen von Sigillata und anderen Gefäßen aus meinen Ausgrabungen in Rheinzabern*, Munich
- Maaskant-Kleibrink, M., 1878 *Catalogue of the Engraved Gems in the Royal Coin Cabinet, The Hague. The Greek, Etruscan and Roman Collections*, The Hague
- Maaskant-Kleibrink, M., 1986 *The Engraved Gems in the Rijksmuseum G. M. Kam*, Nijmegen
- Macdonald, G. and Curle, A. O., 1929 *The Roman Fort at Mumrills, near Falkirk, Proceedings of the Society of Antiquaries of Scotland* 6, 30-5
- Macdonald, G. and Park, A., 1901 *Roman Forts on the Bar Hill*, Glasgow
- MacGregor, A., 1978 *Finds from a Roman Sewer System and an Adjacent Building in Church Street*, *Archaeology of York: the Small Finds* 17, 1, York
- MacGregor, A., 1978 *Industry and commerce in Anglo-Scandinavian York*, in Hall, R. A. (ed.), *Viking Age York and the North*, Council for British Archaeology Research Report 27, 3-8 London
- MacGregor, M., 1976 *Early Celtic Art in North Britain*, Leicester
- MacLauchlan, H., 1901 *The Roman Wall and Illustrations of the Principal Vestiges of Roman Occupation in the North of England*, (Atlas volume), London
- Mackreth, D. F., 1993 *The brooches*, in Hands, A. R., *The Romano-British Roadside Settlement at Wilcote, Oxfordshire. I. Excavations 1990-92*, *British Archaeological Report* 232, 2 Oxford
- Mackreth, D. F., 1994 *Copper alloy and iron brooches*, in Cracknell, S. and Mahany, C. (eds), *Roman Alcester: Southern Extramural Area*, *Excavations, Part 2 Finds and Discussion*, Council for British Archaeology Research Report 9, 2 York
- Manning, W. H., 1976 *Catalogue of Romano-British Ironwork in the Museum of Antiquities, Newcastle upon Tyne*, Newcastle upon Tyne
- Manning, W. H., 1901 *Catalogue of the Romano-British Iron Tools, Fittings and Weapons in the British Museum*, London
- Marchant, D. J., 1991 *Roman Weaponry in the Province of Britain from the Second Century to the Fifth Century AD*, unpublished PhD thesis, University of Durham
- Marsden, E., 1969 *Greek and Roman Artillery: Historical Development*, Oxford
- Marsh, G., 1978 *Early fine wares in the London area*, in Arthur, P. and Marsh, G. (eds), *Early Fine Wares in Roman Britain*, *British Archaeological Report* 5, 19-2
- Martin, M., 1976 *Das fränkische Gräberfeld von Basel-Bernerring*, Basel
- May, T. and Hope, L. E., 1917 *Catalogue of the Roman pottery in the Museum, Tullie House, Carlisle*, *Transactions of the Cumberland & Westmorland Antiquarian & Archaeological Society* 2 ser 17, 14-9
- McBride, R. M., 2001 *Tile*, in Hodgson 1, 6-9
- McBride, R. M., 2010 *Roman pottery from 59 Denhill Park, Benwell*, *Arbeitsjournal* 9, 16-3
- McWhirr, A. (ed.), 1979 *Roman Brick and Tile: Studies in Manufacture, Distribution and Use in the Western Empire*, *British Archaeological Report* 56, Oxford
- Mensch, P. J. van, 1979 *A Roman soup kitchen at Zwammerdam?*, *Bevestiging Oudheidkundig Bodemonderzoek* 24, 19-6
- Miket, R., 1901 *A restatement of evidence from Bernician Anglo-Saxon burials*, in Rahtz, P., Dickinson, T. and Watts, L. (eds), *Anglo-Saxon Cemeteries 1979*, *British Archaeological Report* 2, 2 Oxford
- Milne, J. S., 1901 *Surgical Instruments in Greek and Roman Times*, Oxford
- Monaghan, J., 1978 *Upchurch and Thameside Roman Pottery*, *British Archaeological Report* 13, Oxford
- Monaghan, J., 1978 *Roman Pottery from York*, *Archaeology of York* 16, 8, York
- Morris, E. L., 2007 *Making magic: later prehistoric and early Roman salt production in the Lincolnshire fenland*, in Haselgrove, C. and Moore, T. (eds) *The Later Iron Age in Britain and Beyond*, 2 Oxford
- Morris, P., 1979 *Agricultural Buildings in Roman Britain*, *British Archaeological Report* 7, Oxford
- Mutz, A., 1972 *Die Kunst des Metalledens bei den Römern*, Basle
- Myres, J. N. L., 1901 *A Corpus of Anglo-Saxon Pottery of the Pagan Period*, Cambridge
- Myres, J. N. L. and Southern, W. H., 1901 *The Anglo-Saxon Cremation Cemetery at Sancton, East Yorkshire*, Hull Museums Publication 218, Kingston upon Hull
- Nash-Williams, V. E., 1930 *The samian potters' stamps found at Caerwent (Venta Silurum) in Monmouthshire*, *Bulletin of the Board of Celtic Studies* 5, 6
- Németh, M., 1991 *Aquincum: Erschließungen in den Jahren 1987-1990*, *Budapest Régiségi* 28, 2
- Nieto Prieto, J., 1989 *Excavacions Arqueològiques Subaquàtiques a Cala Culip 1*, Girona
- Oelmann, F., 1914 *Die Keramik des Kastells Niederbieber*, Frankfurt
- Oldenstein, J., 1976 *Zur Ausrüstung römischer Auxiliareinheiten*, *Römisch-Germanische Kommission des Deutschen Archäologischen Instituts Bericht* 5, 2
- Oram, R., Griffiths, W. B. and Hodgson, N., 1998 *Excavations at Wallsend Colliery B Pit*, *Archaeologia Aeliana* 5 ser. 26, 6
- O'Riordain, S. P., 1901 *Excavations at Cush, Co. Limerick*, *Proceedings of the Royal Irish Academy* 1, 3-1
- Oswald, F., 1901 *Index of Potters' Stamps on Terra Sigillata (Samian Ware)*, Margidunum
- Peacock, D. P. S., 1980 *The Roman millstone trade: a petrological sketch*, *World Archaeology* 12(1), 3-5
- Peacock, D. P. S. and Williams, D. F., 1978 *Amphorae and the Roman Economy: an Introductory Guide*, London
- Peck, C. W., 1901 *English Copper, Tin and Bronze Coins in the British Museum*, London
- Peeters, J., 2003 *Housesteads Ware on Hadrian's Wall. A Continental Connection*, Undergraduate dissertation, University of Amsterdam
- Perrin, J. R., 1978 *Roman Pottery from the Colonia: Skeldergate and Bishopill*, *Archaeology of York* 16, 2, York
- Perrin, J. R., 1978 *Roman Pottery from the Colonia: Tanner Row and Rougier Street*, *Archaeology of York* 16, 4, York
- Perrin, J. R., 1999 *Roman pottery from excavations at and near to the Roman small town of Durobrivae, Water Newton, Cambridgeshire, 1956-58*, *Journal of Roman Pottery Studies* 8, 4
- Peter McGowan Associates, Crow, J., Rushworth, A. and Renshaw, J., 1901 *Housesteads Roman Fort, Conservation Plan, 1: Report and 2: Gazetteer*, Newcastle upon Tyne
- Philp, B. and Henig, M., 1985 *Roman gemstones from Dover*, *Antiquaries Journal* 6, 3

- Philpott, R., 1991 *Burial Practices in Roman Britain: a Survey of Grave Treatment and Furnishing AD 43 – 410* British Archaeological Report **219**, Oxford
- Piboule, A., 1977 Catalogue destampilles de la région de Nérès-les-Bains, *Revue Archéologique du Centre* **16**, 3
- Pilar Lapuente, M., unpublished The petrography of some Roman pottery from the Roman fort of South Shields, Tyne and Wear
- Pirling, R., 1974 *Das römische-fränkische Gräberfeld von Krefeld-Gellep* **1**, Berlin
- Potter, T. W., 1979 *Romans in North-west England: Excavations at the Roman Forts of Raveningham, Watercrook and Bowness on Solway* Cumberland & Westmorland Antiquarian & Archaeological Society Res **1**, Kendal
- Price, J., 1977 Trade in glass, in Plat, J. du and Cleere, H. (eds), *Roman Shipping and Trade: Britain and the Roman Provinces*, Council for British Archaeology Research Report **24**, 5 London
- Price, J., 1980 The Roman glass, in Lambrick, G., *Excavations in Park Street, Towcester*, *Northamptonshire Archaeology* **15**, 6
- Price, J., 1981 The glass, in Bidwell, P. 5
- Pringle, D., 1981 *The Defence of Byzantine Africa from Justinian to the Arab Conquest*, British Archaeological Report **S9**, Oxford
- Proctor, J., 1977 *Pegswood Moor, Morpeth: A Later Iron Age and Romano-British Farmstead Settlement*, Pre-Construct Archaeology Monograph **11**, London
- Rackham, D. J., 1976 Assessing the relative frequencies of species by the application of a stochastic model to a computerised database of fossil or archaeological skeletal material, in Wijngaarden-Bakker, L. van (ed.) *Database Management and Zooarchaeology* PACT **14**, Rixensart
- Radford, C. A. R., 1932 Small objects in metal, bone, glass etc, in Bushe-Fox, J. P., *The Report on the Excavation of the Roman Fort of Richborough Kent, 76–9*, Oxford
- Radnóti, A., 1938 *Die Römischen Bronzegefäße von Pannonien*, Budapest
- Rae, A. and Rae, V., 1974 The Roman fort at Cramond, Edinburgh: excavations 1954–66, *Britannia* **5**, 18 2
- Raffald, E., 1970 *The Experienced English Housekeeper*, London
- Rankov, N. B. (ed.), 1982 Roman Britain in 1981: I. Sites explored (Wallsend Fort interim note), *Britannia* **13**, 2
- Reinach, S., 1906 *Catalogue Illustré du Musée des Antiquités Nationales au Château de Saint-Germain-en-Laye, tome 2* Paris
- Richardson, W., 1977 *History of the Parish of Wallsend: The ancient townships of Wallsend and Willington*, Newcastle upon Tyne
- Richmond, I. A., 1929 Birdoswald fort, in Richmond, I. A. and Birley, E., *Excavations on Hadrian's Wall, in the Birdoswald-Pike Hill Sector, 1929*, *Transactions of the Cumberland & Westmorland Antiquarian & Archaeological Society* n. ser. **9**, 10 5
- Richmond, I. A., 1930 The Roman fort at South Shields, *Archaeologia Aeliana* 4 ser. **11**, 3
- Richmond, I. A., 1931 Roman leaden sealings from Brough-under-Stainmore, *Transactions of the Cumberland & Westmorland Antiquarian & Archaeological Society* 2 ser. **5**, 4
- Richmond, I. A., 1932 Excavations on the Roman fort at Newstead, *Proceedings of the Society of Antiquaries of Scotland* **6**, 1 3
- Richmond, I. A. and Birley, E., 1930 Excavations on Hadrian's Wall, in the Birdoswald-Pike Hill Sector, *Transactions of the Cumberland & Westmorland Antiquarian & Archaeological Society* 2 ser. **9**, 10
- Richmond, I. A. and Gillam, J. P., 1931 Excavations on the Roman site of Corbridge 1946–49, *Archaeologia Aeliana* 4 ser. **28**, 1
- Ricken, H., 1934 *Die Bilderschüsseln der Kastelle Saalburg und Zugmantel*, *Saalburg Jahrbuch* **8**, 1
- Ricken, H., 1935 *Die Bilderschüsseln der römischen Töpferwerkstätten in Zabern*, *Tafelband*, Speyer
- Rickman, G. E., 1970 *Roman Granaries and Storebuilding*, Cambridge
- Rigby, V. and Stead, I. M., 1976 Coarse pottery, in Stead, I. M., *Excavations at Winterton Roman Villa and other Roman Sites in North Lincolnshire* Department of the Environment Archaeological Report **9**, 10 London
- Riha, E., 1979 *Die Römischen Fibeln aus Augst und Kaiseraugst*, Augst
- Rivet, A. L. F. and Smith, C. 1938 *The Place-names of Roman Britain*, 2 edn, London
- Robertson, A. S., 1975 *Birrens (Blatobulgum)*, Edinburgh
- Robinson, H. R., 1975 *The Armour of Imperial Rome*, London
- Rodriguez J. R., 1970 *Heeresversorgung und die wirtschaftlichen Beziehungen zwischen der Baetica und Germanien*, Stuttgart
- Ross, A., 1966 *Pagan Celtic Britain*, London
- Roth, H. L., 1977 Studies in primitive looms, *Journal of the Royal Anthropological Institute of Great Britain & Ireland* **7**, 1
- Rowley-Conwy, P., 1977 Improved separation of Neolithic metapodials of sheep (*Ovis*) and goats (*Capra*) from Arene Candide Cave, Liguria, Italy, *Journal of Archaeological Science* **25**, 1
- Rush, P. D., Dickinson, B., Hartley, B. and Hartley, K. F. 1985 *Roman Castleford. Excavations 1974–85, Volume III: the Pottery*, *Yorkshire Archaeology* **6**, York
- Rushworth, A., 1977 *The Grandest Station: Excavation and Survey at Housesteads Roman Fort by C. M. Daniels, J. P. Gillam, J. G. Crow, D. J. Smith and the RCHME*, English Heritage Archaeological Report, Newcastle upon Tyne
- Rushworth, A., 2009b Franks, Frisians and Tungrians: Garrisons at Housesteads in the 3rd Century AD, in Morillo, A., Hanel, N. and Martin, E. (eds), *Limes XX. Estudios sobre la Frontera Romana/Roman Frontier Studies. Anejos de Gladius* **13** (III), 15 Madrid
- Schaetzen, P. de and Vanderhoeven, M., 1964 *De Terra Sigillata te Tongeren II*, Tongeren
- Schönberger, H., 1967 Ein Eisendepot, römische Flossfesseln und andere Funde im Bereich des Kastells Heilbronn-Böckingen, *Fundberichte aus Schwaben, Neue Folge* **16** (1), 1
- Schönberger, H., 1969 The Roman frontier in Germany: an archaeological survey, *Journal of Roman Studies* **59**, 144–97
- Scott, I. R., 1980 Spearheads of the German Limes, in Hanson, W. and Keppie, L. J. F. (eds), *Roman Frontier Studies* **7**, 1 Oxford
- Sherlock, S. J. and Welch, M. G., 1992 *An Anglo-Saxon Cemetery at Norton, Cleveland*, Council for British Archaeology Research Report **2**, York
- Sherlock, W., 1992 The Anglo-Saxon pottery, in Sherlock and Welch **2**, 5
- Silver, I. A., 1969 The ageing of domestic animals, in

- Brothwell, D. and Hoggs, E. (eds), *Science in Archaeology*, London
- Simon, H. G., 1965 Die Römische Fund aus dem Grabungen in Groß-Gerau *Saalburg Jahrbuch* 22, 9
- Simpson, F. G. (ed.) *Watermills and Military Works on Hadrian's Wall: Excavations in Northumberland* Kendal
- Simpson, F. G. and Richmond, I. A., 1933 Birdoswald, in Report of the Cumberland Excavation Committee for 1933: Excavations on Hadrian's Wall, *Transactions of the Cumberland & Westmorland Antiquarian & Archaeological Society* n. ser. 3, 26
- Simpson, F. G. and Richmond, I. A., 1934 The Roman fort at Halton, *Archaeologia Aeliana* 4 ser. 14, 5
- Simpson, F. G. and Richmond, I. A., 1935 The Roman fort on Hadrian's Wall at Benwell, *Archaeologia Aeliana* 4 ser. 19, 2
- Simpson, G., 1953 The figured samian ware, in Richmond, I. A. and Gillam, G. P., Buildings of the first and second centuries north of the granaries at Corbridge, *Archaeologia Aeliana* 4 ser. 3, 2
- Simpson, G., 1954 La marque SACERF in tabula ansata et quelques oves de Sacer de Leoux, *Revue Archéologique du Centre* 6/2, 8
- Smith, C. R., 1907 *Collectanea Antiqua* 7, London
- Smith, D. J., 1968 Housesteads: south-east angle and a note on the water supply. Typescript, Museum of Antiquities, University of Newcastle upon Tyne
- Smith, R. A., 1929 *A Guide to the Antiquities of Roman Britain in the Department of British and Mediaeval Antiquities*, London
- Snape, M. E., 1922 Documentary Research on Benwell and Wallsend, *Arbeits Journal* 1, 37
- Snape, M. E., 1992 Excavation summary: Wallsend-Buddle Street and Wallsend-Fort Ditches, *Arbeits Journal* 1, 8
- Snape, M. E., 1993 *Roman Brooches from North Britain*, British Archaeological Report 25, Oxford
- Snape, M. E. and Bidwell, P. T., 1994 The Vicus of the Roman Fort at Wallsend, Tyne and Wear, *Arbeits Journal* 3, 3
- Snape, M. E. and Bidwell, P. T., 1996 Excavations at the Castle Garth, Newcastle upon Tyne, 1976–92 and 1995–6: the excavation of the Roman fort, *Archaeologia Aeliana* 5 ser. 3, 2
- Spain, G. R. B. and Simpson F. G., 1936 The Roman Wall from Wallsend to Rudchester Burn, in Hope Dodds, M., *A History of Northumberland* 13, 8
- Stallibrass, S. M., 1991 Animal bones from excavations at Annetwell Street, Carlisle, 1982–4. Period 3: the earlier timber fort, English Heritage Ancient Monuments Laboratory Report 12/1, Portsmouth
- Stallibrass, S. M., 1993 Animal bones from excavations in the southern area of The Lanes, Carlisle, Cumbria, 1981–1982, English Heritage Ancient Monuments Laboratory Report 10/9, Portsmouth
- Steiner, P., 1911 *Xanten-Sammlung des Neiderrheinischen Altertums-Vereins*, Frankfurt
- Stewart, I. H., 1955 *The Scottish Coinage*, London
- Stokes, P. R. G., 1992 *Observations on the Roman Military Diet and Culinary Practices from the Commandant's House, South Shields*, unpublished B. A. dissertation, University of Durham
- Stokes, P. R. G., 1996 Debris from Roman butchery, *Petits Propos Culinaires* 3, 38
- Strong, D. and Brown, D., 1978 *Roman Crafts*, London
- Swan, V. G., 1992 Legio VI and its men: African legionaries in Britain, *Journal of Roman Pottery Studies* 5, 3
- Swift, E., 1978 *Roman Dress Accessories*, Princes Risborough
- Symonds, R. P. and Wade, S., 1999 *Roman Pottery from Excavations in Colchester 1971–86*, Colchester Archaeological Report 10, Colchester
- Taçon, P. S. C., 1991 The power of stone: symbolic aspects of stone use and tool development in western Arnhem Land, Australia, *Antiquity* 65, 1
- Thomas, J., 1981 *Rethinking the Neolithic*, Cambridge
- Thomas, M. D., 2003 *Lorica Segmentata, Volume II: a Catalogue of Finds*, *Journal of Roman Military Equipment Studies* Monograph 2, Oxford
- Todd, M., 1978 Excavations in the praetorium of the Roman fort and vicus at Chester-le-Street, *Archaeologia Aeliana* 5 ser. 5, 2
- Tolan-Smith, C., 1996 The Mesolithic/Neolithic transition in the Lower Tyne Valley: a landscape approach, *Northumbria Archaeology* 134, 5
- Toller, H., 1978 *Roman Lead Coffins and Ossuaria in Britain*, British Archaeological Report 8, Oxford
- Tomber, R. and Dore, J., 1998 *The National Roman Fabric Reference Collection: a Handbook*, Museum of London Archaeological Service Monograph 2, London
- Tomlin, R. S. O., 1978 Inscription on stone, in Hodgson, D., 1978 *Roman Pottery in Britain*, London
- Tyrs, P., 1978 *Roman Pottery in Britain*, London
- Vago, E. B., 1978 *Aussgrabungen in Intercissa (Abba Regia)*, Budapest
- Vanderhoeven, M., 1978 *Funde aus Asciburgium*, Duisburg
- Vaughan, J. E., 1987 Knives and knife handles, in Harbottle, B. and Fraser, R., Black Friars, Newcastle upon Tyne, after the dissolution of the monasteries, *Archaeologia Aeliana* 5 ser. 15, 2
- Vermeule, C. C., 1978 *The Goddess Roma in the Art of the Roman Empire*, Cambridge, MA
- Waddington, C., 1978 *A Landscape Archaeological Study of the Mesolithic–Neolithic in the Milfield Basin, Northumberland*, unpublished PhD thesis, University of Durham
- Walke, N., 1965 *Das Römische Donaustadt Straubing-Sorvudorum*, Limesforschungen 3, Berlin
- Walters, H. B., 1978 *Catalogue of the Roman Pottery in the Departments of Antiquities, British Museum*, London
- Warry, P., 2006 *Tegulae: Manufacture, Typology and Use in Roman Britain*, British Archaeological Report 417, Oxford
- Watkin, J. and Mann, F., 1981 Some late Saxon finds from Lilla Howe, N. Yorks., and their context, *Medieval Archaeology* 25, 5
- Watson, G. R., 1978 *The Roman Soldier*, London
- Waugh, H. and Goodburn, R., 1972 The non-ferrous objects from Verulamium, in Frere, J., 1972 *Excavations at Verulamium*, London
- Webster, G., 1944 A Roman pottery at South Carlton, Lincs., *Antiquaries Journal* 24, 1
- Webster, G., 1989 Deities and religious scenes on Romano-British pottery, *Journal of Roman Pottery Studies* 2, 2
- Webster, G., 2002 *The Legionary Fortress at Wroxeter. Excavations by Graham Webster, 1955–85*, English Heritage Archaeological Report 19, London
- Webster, J., 1989 Objects of stone, in O'Leary, T. J., *Pentre Farm, Flint*, British Archaeological Report 20, 8

- Welfare, A., 1985 The milling stones, in Bidwell 1985, 154–64
- Welsby, D. A., 1982 *The Roman Military Defence of the British Provinces in its Later Phases*. British Archaeological Report 10, Oxford.
- West, S. E., 1987 *West Stow. The Anglo-Saxon Village*, East Anglian Archaeology 2, Ipswich
- Wheeler, R. E. M., 1926 The Roman fort at Brecon, *Y Cymrodor* 3, 29–8
- Wheeler, R. E. M., 1931 *Maiden Castle, Dorset*, London
- Wheeler, R. E. M. and Wheeler, T. V., 1931 *Report on the Excavations of the Prehistoric, Roman and Post-Roman Site in Llyn-y-Park, Gloucestershire*, Oxford
- Whitworth, A. M., 2000 *Hadrian's Wall: Some Aspects of its Post-Roman Influence on the Landscape*, British Archaeological Report 20, Oxford
- Wild, F., 1979 Samian ware, in Potter, T. W., *Romans in North West England*, Cumberland & Westmorland Antiquarian & Archaeological Society Research Series 1, Kendal
- Wild, F., 2010 The samian ware, 89–98, in Snape, M., Bidwell, P. and Stobbs, S., *Excavations in the military vicus south-west of the Roman Fort at South Shields in 1988 and 2008*, *Arbeitsjournal* 9, 2
- Wild, J. P., 1970a Button-and-loop fasteners in the Roman provinces, *Britannia* 1, 5
- Wild, J. P., 1970b *Textile Manufacture in the Northern Provinces*, Cambridge
- Williams, D. F., 1987 The amphorae, in Snape and Bidwell 1987, 10–1
- Willis, S., 2005 The context of writing and written records in ink: the archaeology of samian inkwells in Roman Britain, *Archaeological Journal* 110, 1
- Wilmott, T., 1997 *Birdoswald. Excavations of a Roman fort on Hadrian's Wall and its Successor Settlements: 1987–92*, London
- Wilmott, T., 2001 *Birdoswald Roman fort. 1800 Years on Hadrian's Wall*, Stroud
- Wilmott, T., Cool, H. and Evans, J., 2009 Excavations at the Hadrian's Wall fort of Birdoswald (Banna), Cumbria: 1996–2000 in Wilmott, T. (ed.), *Hadrian's Wall: Archaeological Research by English Heritage*, 1, 2 Swindon
- Young, W. H., 1931 *The Municipal Museum, Gateshead, Proceedings of the Society of Antiquaries of Newcastle upon Tyne* 4 ser. 6, 1
- Zalkin, V. I., 1960 Metapodial variation and its significance for the study of ancient horned cattle (English summary), *Bulletin of the Moscow Society of Naturalists, Biological Series* 5, 1
- Zienkiewicz, J. D., 1986 *The Legionary Fortress Baths at Caerleon: the Finds*, Cardiff
- Zwart, A. J. M., 1998 A bridled horse burial from Beuningen (NL), *Journal of Roman Military Equipment Studies* 9, 77–84
- Zwierlein-Diehl, E., 1931 *Die Antiken Gemmen des Kunsthistorischen Museums in Wien* 3, Munich

INDEX

Bold numbers are the volume number, followed by the page number. Further numbers are catalogue numbers. Page numbers in italics are figures; with 't' are tables.

- Advocisus 2.21, 2.27, 2.29, 2.34, 2.35, 2.37, 2.40
adze-hammers 1.458, 2.166, 2.167.27
aedes *see* shrines
agriculture
 pre-Roman 1.51–8, 1.52–7, 1.62t, 1.370, 1.449
 post-Roman 1.401, 1.416, 1.418, 1.425, 1.426
 medieval period 1.48
 cord-rig 1.19, 1.61, 1.178, 1.329, 1.449
 field systems 1.45, 1.48
Ala I Asturum, tiles 2.8, 2.13, 2.13t, 2.15
Alley 1 1.332, 1.383
 finds 1.342, 1.384
 coins 2.108
 pottery 1.342, 1.343, 1.383, 1.400, 2.53.5, 2.54.5, 2.60, 2.62.20–2/27, 2.81, 2.82–3, 2.83t
Alley 2 1.396, 1.398
Alley 3 1.332, 1.372, 1.412, 1.419, 1.421, 2.25, 2.60–1, 2.81, 2.83–4, 2.83t
Alley 4 1.332, 1.372, 1.373
Alley 5 1.439–40, 1.440t
Alley 6 1.455, 1.490
Alley 7 1.27, 1.216–18, 1.264, 2.110, 2.116, 2.127, 2.128
Alley 8 1.26, 1.62, 1.72, 1.73–4, 1.74t, 1.75–6, 1.87
Alley 9 1.76
Alley 10 1.378, 1.401, 1.402, 1.413, 1.416–17, 1.418, 1.419, 1.421
altars 1.348, 2.3.6, 2.5, 2.5.6
Ambleside 1.86, 1.87
amphorae 1.116, 1.440, 2.53, 2.53–5, 2.53t, 2.54, 2.55t, 2.66, 2.68.113, 2.82, 2.85, 2.85t
 discs 2.187
 graffiti 2.94.30/56/63/64/66, 2.96, 2.97
 stamps 1.116, 1.298, 1.342, 1.359, 1.398, 1.400, 1.426, 1.569, 2.54–5, 2.54.3/5/7
amulets 1.454, 2.140, 2.141.75
Anaus 2.42, 2.45–8, 2.48t, 2.60, 2.83
Anglo-Saxon 1.215–16, 2.212–13, 2.212
Annius 2.36
antefixes 2.15
antler 2.177.62, 2.178
 implement 2.177.60, 2.178
 rings 2.178
 spindlewhorl 2.175, 2.176.31
 tine 2.178
 waste 1.176, 1.346, 2.178
appliqué
 copper alloy 2.152.200, 2.154
 lead 2.170.3, 2.171
apses
 semi-circular 1.236–8, 1.237, 1.245, 1.253
 square 1.235, 1.240–1, 1.253
Aquincum (Hungary) 1.324
architectural fragments 1.68, 1.144, 1.176, 1.359, 1.516, 2.2–8, 2.2–7, 2.3.5, 2.8.23, 2.9
archways, Building AO (forehall) 1.281–2, 1.287, 1.288, 1.291
armchair voussoirs 1.263, 2.5, 2.7, 2.8
armlets 1.307, 1.400, 1.544, 2.182.2/3/4/5, 2.183
artillery 2.196
Assembly Area (Road 8) 1.152, 1.163, 1.164, 1.165
 coins 2.105, 2.107, 2.113, 2.114, 2.118, 2.119, 2.123, 2.131
Aurelius (potter) 2.36
Avitus 2.32, 2.36
awls 1.308, 2.165.23, 2.166.23
axes
 miniature, copper alloy 2.140, 2.141.74, 2.209
 stone 2.190.56, 2.192, 2.210

'ballista' balls *see* throwing stones
balls, bone 2.173.3, 2.174
barracks
 excavation 1975–84 1.3
 finds 2.210–11
 Period 1 1.16, 1.18
 Period 2 1.24–5, 1.349, 1.373–6
 third-century 1.28–31, 1.29, 1.377–9, 1.421–5, 1.422–3, 1.516–20
 garrison 1.31–2
 see also Building Row 20; Buildings 1–6/9–12; Chalet Ranges 9–12
basilica exercitatoria (equestris exercitatoria) 1.24, 1.289
basins, stone 1.25, 1.96, 1.97, 1.98, 1.102

- bath suite 1.33, 1.122, 1.245, 1.264
 Building 13 (commanding officer's house) (*praetorium*) 1.33, 1.146, 1.235, 1.241–2, 1.243, 1.245–6, 1.253–4, 1.255, 1.259, 1.265–6
 bath-houses, *vicus* 1.8, 1.44, 1.44
 beads 2.208
 copper alloy 1.192, 1.482, 2.139, 2.139.61/66
 glass 1.150, 1.213, 1.216, 1.289, 1.392, 1.419, 1.426, 1.439, 1.482, 1.551, 2.182.14–23/25/27–29/31/32/33/35–7/39–40, 2.183–4, 2.184.44, 2.206, 2.214.41/42 2.215.41/42
 jet 2.181, 2.181.2/3
 stone 2.192
 beakers
 glass 1.372, 1.384, 2.88, 2.89.3/5/38, 2.92.38
 pottery 2.55, 2.57, 2.58, 2.81, 2.82t, 2.83–6t
 beehive stones *see* quern stones, beehive
 Belgic ware 2.82t
 Bell, John 1.49
 bells
 copper alloy 2.144, 2.145.93
 iron 2.167.38, 2.168
 belt plates/bars 1.392, 1.464, 1.515, 2.148.147/148/149, 2.149, 2.151.149
 bench legs 2.3, 2.6
 Benwell
 barracks 1.369, 1.374, 1.516
 granary 1.80, 1.80t, 1.82, 1.83, 1.84, 1.85, 1.86
 hospital 1.121, 1.123
 workshops 1.324, 1.325
bessales 2.11, 2.12, 2.13t
 biconical strainers 2.58
 Bidwell, P. T. 1.21, 1.22, 1.185, 1.265, 1.401, 1.424
 Binchester, *praetorium* 1.35, 1.264, 1.266
 bindings, copper alloy 1.297, 2.149.144
 Birdoswald
 barracks 1.374, 1.375, 1.422, 1.516
 curtain walls 1.577
 forehalls 1.289
 gates 1.573, 1.575
 hospitals 1.123
 praetorium 1.266
 ramparts 1.578
 towers 1.575, 1.576
 workshops 1.324, 1.325, 1.326
 birds (bone) 2.223
 bits, copper alloy 2.152.188, 2.153, 2.205
 Biv amphorae 2.53, 2.53t, 2.66, 2.68.116
 black burnished ware 1 (BB1) 2.56t, 2.58, 2.60, 2.82, 2.82t, 2.83, 2.86, 2.86t
 black burnished ware 2 (BB2) 2.56t, 2.58
 Alley 3 2.83
 Building 1 1.30
 Building 8 2.61, 2.84, 2.191
 Building Q 1.144
 Cistern 1 2.86–7, 2.86t
 Cistern 2 2.86
 graffiti 2.94.57/59/61/69, 2.97
 principia 1.19
 Rampart building 2.82, 2.82t
 blocks
 copper alloy 2.164
 lead 2.170.14, 2.172, 2.172.21, 2.174
 shale 2.183
 bobbins, bone 1.366, 2.175
 bolts 2.157, 2.158.252
 bone (animal) 1.161, 1.162, 2.84, 2.217–24, 2.218–24, 2.224t, 2.226t, 2.227t
 bone (small finds)
 ball 2.173.3, 2.174
 bobbins 1.366, 2.175
 bone plate 1.289, 2.177.73, 2.178–9
 combs 2.176, 2.176.35
 dice 1.449, 2.176.36/37, 2.177
 handles 1.383, 1.482, 2.173.6–9, 2.174.11, 2.174–5
 knobs 1.342, 2.173.4/5, 2.174
 needles 1.250, 1.307, 2.173.26, 2.174.27, 2.175
 pegs 1.366, 2.176.56, 2.178
 pierced plate 2.173.2, 2.174
 pin rough-outs 1.142, 1.439, 2.175.23
 pins 1.233, 1.342, 1.515, 2.173.17/18/20/22, 2.175
 pommel 2.173.1, 2.174
 rings 1.233, 1.383, 2.178
 shell 1.419, 2.176.57, 2.179
 toggles 2.173.12, 2.175, 2.206
 waste 1.250, 1.251, 2.178.72, 2.178.66/68
 weaving combs 2.175, 2.176.34, 2.206
 see also counters, bone
 Boon, G. C. 2.171
 Bosanquet, R. S. 1.121–2, 1.194, 1.265–6, 1.324
 bosses, copper alloy 2.160.294, 2.161
 bottles 2.55, 2.58
 see also glass (vessel)
 bowls
 copper alloy 1.383, 2.144, 2.145.87/88
 glass 1.138, 2.88, 2.89.3, 2.90–1, 2.92, 2.289.18–23
 pottery 2.57, 2.58, 2.59, 2.82–6t
 see also glass (vessel)
 box tiles 2.10–11, 2.10
 boxes, stone-lined 1.339, 1.362, 1.363–4, 1.366, 1.368, 1.368, 1.376, 1.376
 bracelets 2.208
 copper alloy 1.299, 2.137.50/51/53/55, 2.139, 2.160.379, 2.164
 see also armlets
 Brecon Gaer
 forehalls 1.288
 granary 1.80, 1.80t
 principia 1.22, 1.185
 bricks, tile 2.11–12
 bridle fragments 2.152.187, 2.153, 2.206
 Bronze Age, cup marked stone 2.2, 2.2
 bronze working 1.395
 brooches 1.342, 2.133.2, 2.138, 2.208
 bow 1.320, 1.342, 1.540, 2.133, 2.134.1/14/16, 2.135, 2.210
 crossbow 1.398, 2.134.11/13, 2.135
 disc 1.307, 1.392, 2.134.25/26/28, 2.136, 2.136.27
 dragonesque 1.320, 2.137.33/34, 2.138
 head-stud 1.419, 2.136.18
 knee 1.398, 1.400, 2.134.19/20, 2.136
 penannular 1.100, 1.398, 1.482, 2.137.35/36/38, 2.138
 plate 1.118, 1.449, 2.136, 2.137, 2.137.29/30
 trumpet 1.366, 1.400, 1.419, 1.482, 2.133, 2.134.3/4/5/8, 2.135
 buckets 1.464, 1.465, 2.141, 2.143, 2.144
 buckles/hinges 1.138, 1.383, 1.452, 1.544, 1.551, 2.150.150/151/153, 2.151, 2.213.4, 2.214.34, 2.215.4
 Buddle, John 1.49
 buff ware 2.56t, 2.57
 Building 1 1.42t
 timber phase 1.16, 1.38t, 1.328–9, 1.329

- Stone Phase 1 1.24, 1.38t, 1.332–40, 1.343–4, 1.374
 Alley 1 1.340
contubernia 1.335–7, 1.337, 1.338–9, 1.339, 1.342, 1.374
 drains 1.340
 finds 1.342–4
 layout/external walls 1.332–3, 1.334
 officer's quarters 1.333–5, 1.334, 1.376
 roads relating to 1.340, 1.341
- Stone Phase 2 1.28, 1.30, 1.39t, 1.377, 1.378, 1.379–80, 1.381, 1.385, 1.385, 1.398–9, 1.400–1, 1.428
 Alley 1 1.383
 alterations 1.382
 drains 1.379–80, 1.381–2, 1.383, 1.385
 external walls 1.380, 1.380
 interior 1.381–2, 1.381
 roads relating to 1.383, 1.384
 verandah 1.379–80, 1.382, 1.383
- finds 1.342, 1.342–3, 1.383–5, 1.400, 2.163.1, 2.164.1, 2.210
 coins 2.102, 2.104, 2.105, 2.106, 2.108, 2.109, 2.115, 2.125, 2.126
 pottery 1.342–3, 1.384, 1.400
- Building 2 1.39t, 1.42t
 timber phase 1.38t, 1.329, 1.345
 Stone Phase 1 1.344–5, 1.345
- Stone Phase 2 1.39t, 1.378, 1.385, 1.386–7, 1.387, 1.398–9
contubernia 1.11–12, 1.387–8, 1.424–5, 1.388–9, 1.390–91, 1.391, 1.422, 1.424
 drains 1.391–2
- Mid-3C 1.40t
 finds 1.346, 1.392, 1.400, 2.163.6, 2.164.6, 2.210
 coins 2.108, 2.114
 pottery 1.346, 1.392
- Building 3 1.39t, 1.42–3t
 timber phase 1.38t, 1.329, 1.348
 Stone Phase 1 1.39t, 1.346–9
 centurion's quarters 1.347
contubernia 1.347, 1.348, 1.349
 external walls 1.347–8, 1.348
 intervallum road (east) 1.347–8
- Stone Phase 2 1.39t, 1.377, 1.378, 1.392–3, 1.398–9
 centurion's quarters (Building BG, BH) 1.393, 1.395–6, 1.396, 1.396, 1.424
contubernia
 1 (Building BF) 1.392–3
 2 (Building BE) 1.392–3, 1.398
 external walling 1.393, 1.395
 layout of 1.393, 1.394
 roads associated with 1.396–8
 finds 1.348, 2.210
 coins 2.103, 2.105, 2.108, 2.113
 pottery 1.348–9, 1.398
- Building 4 1.39t, 1.43t
 and pre-Roman agriculture 1.52–3, 1.53
 timber phase 1.38t, 1.330, 1.351
 Stone Phase 1 1.39t, 1.349–61
contubernia 1.349, 1.350, 1.352–5, 1.353–4, 1.360, 1.361
 officer's quarters 1.355–7, 1.358–9, 1.359, 1.360, 1.376, 1.376
 outer walls 1.349–50, 1.351, 1.352
 third century 1.28, 1.39t, 1.378–9
 finds/pottery 1.359–61, 2.54.5, 2.54.5
- Building 5 1.39t, 1.43t
 and pre-Roman agriculture 1.52, 1.53, 1.55
 timber phase 1.38t, 1.330–1
- Stone Phase 1 1.39t, 1.361–8, 1.365–6
 Period 4 1.28, 1.420
 finds/pottery 1.366, 1.368, 1.420
- Building 6 1.28, 1.38t, 1.39t, 1.43t, 1.53, 1.330–1, 1.368–9, 1.368, 1.404
- Building 7 (granary) 1.38t, 1.39t, 1.41t, 1.60, 1.61, 1.80–7, 1.82, 2.107
 and pre-Roman agriculture 1.56, 1.57–8
 Phase 1 1.19, 1.22, 1.61–8, 1.61–7, 1.62t, 1.82
 Phase 2 1.24, 1.25, 1.38t, 1.39t, 1.68–72, 1.69, 1.69–71
 Phase 3 1.26, 1.86, 1.87
 Phase 3/4 1.72–3, 1.73–7, 1.73–4, 1.74t, 1.75–6, 1.87
 drying kilns 1.77–9, 1.77–9
 enclosed yards/covered extensions 1.86, 1.87
 entrances 1.84, 1.85
 excavation 1.60
 finds/pottery 1.67–8, 1.77, 1.79–80, 2.116
 internal flooring 1.83–4
 loading platforms 1.66–7, 1.66–7, 1.68, 1.70, 1.85
 porticos 1.66–7, 1.66–7, 1.85
 robbing 1.79–80
- Building 8 (hospital) 1.23–4, 1.23, 1.38–40t, 1.120–3, 1.121
 Timber Building 21 1.18, 1.22, 1.23, 1.38t, 1.88–91, 1.89–90
 Phase 1 1.25, 1.91–100, 1.92, 1.99
 courtyard 1.96, 1.96–7, 1.105, 1.122
 entranceway 1.95–6, 1.95
 rooms 1.97–100, 1.102
 water conduits 1.91, 1.93, 1.93–5, 1.97, 1.100
- Phase 2 1.26–7, 1.102–7, 1.103–4, 1.106, 1.107t, 1.110–11
 courtyard 1.102, 1.106
 entranceway 1.102–3
 Rooms 1.103–5
 water channels 1.102, 1.104, 1.105
- Phase 3 1.107–13, 1.109
 courtyard 1.108
 entranceway 1.108
 Rooms 1.110, 1.110–11, 1.111, 1.112, 1.122
via quintana 1.112–13, 1.113
 water channels 1.108, 1.110–11, 1.112, 1.112
- Phase 4 1.114–18, 1.115
 entranceway 1.115–16, 1.116
 rooms 1.114, 1.114–15, 1.116, 1.116, 1.117
via quintana 1.117–18, 1.117–18
 water channels 1.112, 1.114, 1.116, 1.118, 1.119
- abandonment/demolition 1.118–20, 1.119–20, 1.147, 1.150
 finds 1.100, 1.105, 1.111–12, 1.113, 1.116, 1.117, 1.118, 1.120, 2.150.160, 2.151.160, 2.164.12, 2.211
 architectural fragments 2.5
 bone (animal) 2.84
 coins 2.102, 2.103, 2.104, 2.106, 2.109, 2.124
 pottery 1.91, 1.100, 1.104, 1.105–6, 1.112, 1.113, 1.116, 1.117, 1.118, 1.119, 1.120, 1.150
 amphorae 2.53
 buried 1.65.68, 1.191, 2.87
- Building 9 1.39t, 1.42t
 timber phase 1.38t, 1.432–4
 stone phase 1.24, 1.39t, 1.434–40, 1.435–6, 1.438, 1.440t, 1.482
contubernia 1.436–7
 drain on *via quintana* 1.438–9
 officer's quarters 1.437–8
 finds/pottery 1.434, 1.439, 2.102, 2.103, 2.142, 2.210
see also Chalet Range 9
- Building 10 1.39t, 1.42t, 2.107

- timber phase 1.38t, 1.440–4, 1.441–2
 stone phase 1.39t, 1.444–9, 1.445–6
 contubernia 1.444–7, 1.445–7
 drains/street surfaces 1.448–9, 1.448
 officer's quarters 1.447–8, 1.448
 outer walls 1.444
 finds/pottery 1.443–4, 1.449
 see also Chalet Range 10
 Building 11 1.39t, 1.42t
 pre-fort 1.58, 1.448–9
 timber phase 1.38t, 1.450–2, 1.451–2
 stone phase 1.39t, 1.452–4, 1.454–5
 and Alley 6 1.455
 contubernia 1.452–3
 drains 1.453, 1.455
 finds 1.452, 1.454, 2.87, 2.164.7, 2.210–11
 coins 2.102, 2.104, 2.105, 2.127
 see also Chalet Range 11
 Building 12 1.39t, 1.42t, 1.331
 timber phase 1.38t, 1.456–8, 1.457–8
 stone phase 2/3 1.24, 1.39t, 1.458–64, 1.459–60, 1.467
 contubernia 1.458, 1.460–3
 officer's quarters 1.459, 1.459, 1.463–4
 south *intercallum* road 1.464–7, 1.466
 finds/pottery 1.458, 1.460, 1.464, 2.166.27, 2.167.27, 2.211
 see also Chalet Range 12
 Building 13 (commanding officer's house) (*praetorium*) 1.35,
 1.41–2t, 2.84t, 2.85
 phases, discussion of 1.219–20
 Phase 1 1.19, 1.220–8, 1.221
 courtyard/entrance 1.220, 1.223, 1.223
 east range 1.224, 1.226–8
 north range 1.223, 1.224–6, 1.224
 south range 1.226
 west range 1.223–4
 Phase 2 1.38t, 1.227, 1.228–34, 1.233–4
 courtyard/entrance 1.229–30
 cistern 1.228, 1.229–30
 east range 1.232–3
 north range 1.230
 south range/corridor 1.231–4
 west range 1.230–1
 Phase 3 1.27, 1.39t, 1.234–8
 courtyard 1.234
 Phase 3i 1.233, 1.234–6
 Room 6 1.234–6
 south corridor 1.236
 Phase 3ii 1.235, 1.236–8, 1.244–5
 Room 6 (semi-circular apse) 1.236–8, 1.237, 1.244–5
 south corridor 1.238
 Phase 3iii–iv 1.237–8, 1.238, 1.238–42, 1.244–5, 1.256
 Phase 3v 1.240, 1.242–5
 cistern 1.241, 1.243
 courtyard 1.241, 1.242–3
 Room 6 (east hypocaust) 1.241–2, 1.243
 Room 7 1.242, 1.243–4
 Phase 3vi 1.244, 1.245–8
 cistern/courtyard 1.245
 Room 7 1.247
 south-west corner 1.245–6, 1.245
 west corridor 1.234
 Phase 4 1.39t, 1.248–50, 1.248
 courtyard/cistern 1.248–9, 1.249
 south range 1.249, 1.249–50, 1.249
 west range 1.250
 later activity 1.40t
 courtyard 1.250
 Room 7 1.250–1, 1.251
 area south of 1.251–64, 1.252–3, 1.253, 1.255
 finds 1.228, 1.233, 1.247–8, 1.250, 1.251, 1.255, 1.261, 1.263
 Phase 1 1.253–4, 1.253
 Phase 2 1.253, 1.254–5
 Phase 3 1.255
 Phase 4 1.252, 1.256–60, 1.256
 Building AZ 1.256–7, 1.260
 Building BA 1.258, 1.260
 Building BB 1.258–9, 1.258, 1.260
 drains/conduits 1.259–60
 finds 1.260
 water tank 1.257–8
 Phase 5 1.260–1
 Building AZ 1.260–1
 tegula drain 1.261
 Phase 6, Building BK 1.261–3, 1.262
 roads 1.263–4
 finds 1.228, 1.233, 1.247–8, 1.250, 1.251, 1.255, 1.260, 1.264,
 2.255
 bone (animal) 2.217, 2.223–4, 2.223, 2.224t, 2.227–31,
 2.228–30t, 2.231
 coins 2.114, 2.115, 2.127, 2.129, 2.131
 female items 2.208
 lighting 2.185.5, 2.185.5, 2.209
 pottery 1.35, 1.228, 1.233, 1.248, 1.250, 1.251, 1.260, 1.261,
 1.263, 1.264, 2.211–12, 2.255
 Building 14 (*principia*) (headquarters building) 1.18–19,
 1.22, 1.23, 1.27, 1.38–41t
 discussion of phasing 1.177–8
 pre-Roman agricultural phase 1.55, 1.55, 1.57, 1.180
 Building BI 1.18, 1.20–1, 1.38t, 1.178–81, 1.179–80, 1.182,
 1.268, 1.271
 initial foundations 1.181–3, 1.182
 intermediate foundation 1.182, 1.183–5
 Phase 1 1.185–94, 1.186, 1.192–3, 1.193–4, 1.193
 courtyard/portico 1.187, 1.187, 1.192, 1.193
 cross-hall 1.189–90, 1.189, 1.192, 1.193
 tribunal 1.177, 1.189, 1.193–4, 1.197, 1.204, 1.208
 external walls/drains 1.185–7
 southern range 1.190–4
 Phase 2 1.195
 courtyard 1.194–6
 cross-hall 1.196–7, 1.196t
 southern range of rooms 1.197–200
 Phase 3
 cistern/water tank 1.207–8, 1.207
 courtyard 1.200–3, 1.201–2, 1.208
 portico 1.203–4, 1.203
 south-east cistern 1.177–8, 1.200, 1.201, 1.202
 south-west cistern 1.202, 1.202
 cross-hall 1.204–5, 1.206–7, 1.208
 southern range of rooms 1.205–7, 1.206–7, 1.208
 Phase 4 1.210
 courtyard 1.209–12, 1.210–12, 1.213
 south-east cistern 1.211–12, 1.211–12
 surfaces 1.209–10, 1.211
 cross-hall/south range 1.212
 south water tank 1.212–13
 Phase 5
 Building BL 1.218

- Buildings BC/BD 1.213, 1.214–16, 1.215, 1.215, 2.212
 courtyard 1.213
 Room C (strong room) 1.213–14, 1.213
 finds 1.184, 1.192, 1.200, 1.203, 1.208, 1.208–9, 1.213, 1.214, 1.215–16, 1.216, 2.212
 coins 2.109
 pottery 1.192–3, 1.200, 1.208–9, 1.213, 1.214, 1.216
 roads associated with 1.216–17, 1.218
 Building 15 1.19, 1.25–6, 1.28, 1.38t, 1.267, 1.275–7, 1.276, 2.106
 and Building AY 1.284
 Building 16 (workshop) 1.19, 1.38–40t, 1.42t, 1.267, 1.323–6, 1.325, 1.377, 1.426
 and Building AO 1.285, 1.286
 Phases 1/2 1.300–9, 1.301–3
 Phases 3/4 1.313–16, 1.314, 1.317, 1.320, 1.321
 cross walls 1.323
 finds 1.318, 1.320
 rooms 1.313, 1.315–16, 1.315
 south wall 1.303, 1.321–3, 1.322
 rubble disturbance/dereliction layers 1.318, 1.319
 finds 1.307, 1.308, 1.318–20, 2.211
 coins 2.102, 2.104, 2.120, 2.124, 2.125, 2.126, 2.127, 2.128, 2.130, 2.131
 pottery 1.303, 1.308–9, 1.318, 1.320
 Building 17 1.378–9, 1.401–2, 1.402–3, 1.411–12, 1.424
contubernia 1.413, 1.414, 1.424
 dimensions/orientation 1.412
 exterior walls 1.412–13
 finds
 coins 2.103, 2.111
 pottery 1.419, 1.420
 interior floors 1.413–14
 internal partition walls 1.413
 later alterations 1.414, 1.415
 rubble spread over 1.418
 Building 18 1.378, 1.401–4, 1.403
 Building E 1.409, 1.409–10
contubernia 1.422
 1 (Building C) 1.377, 1.378, 1.402, 1.404, 1.405–8, 1.406–7, 1.410, 1.419, 1.420
 2 1.408, 1.409
 4 (Building D) 1.377, 1.404, 1.408–9, 1.409, 1.410, 1.420, 1.424
 5 1.410
 eastern part of 1.409, 1.411
 exterior walls 1.404–5
 finds 1.419, 1.420
 officer's quarters 1.405
 rubble spread 1.418–19, 1.421
 Building 21 1.18, 1.22, 1.23, 1.38t, 1.88–91, 1.89–90, 1.120
 Building A 1.37, 1.425–6, 1.427, 1.428
 Building AB 1.484–6, 1.486, 1.487, 1.488–9, 1.488–9
 Building AK *see under* Chalet Range 9
 Building AN 1.33, 1.466, 1.467, 1.490, 1.491, 1.492, 1.493–4, 1.496, 1.498, 1.501, 1.510, 1.511, 1.512
 Building AO (forehall) 1.24, 1.25, 1.26, 1.38–9t, 1.41t, 1.68, 1.70, 1.267
 Phase 2 1.277–83, 1.278–9, 1.288–9
 east side 1.282–3
 infilling walls 1.279–80, 1.281
 north side piers 1.279–81, 1.279–80
 south side 1.282
 west entrance 1.282
 third century 1.291, 1.297
 disturbed levels/post-Roman (?) robbing 1.299
 and Building 16 (workshop) 1.322–3
 finds 1.289, 1.297, 1.298, 1.299
 coins 2.115, 2.116, 2.119, 2.122, 2.124
 pottery 1.289, 1.298, 1.299
see also Building AY
 Building AP 1.33, 1.40t, 1.41t, 1.126, 1.165, 1.165
 Building AQ 1.149, 1.165, 1.165
 Building AR 1.170, 1.171, 1.176
 Building AS 1.169–71, 1.170–2, 1.172, 1.176
 Building AT 1.165
 Building AU 1.24, 1.26, 1.38t, 1.68–9, 1.71, 1.72
 Building AV 1.24, 1.25, 1.26, 1.38t, 1.68, 1.69–71, 1.71–2
 Building AW 1.26, 1.72–3, 1.73–4, 1.75, 1.87, 1.137
 Building AX(N) 1.127, 1.128, 1.136–7, 1.136, 1.138, 1.139, 1.145
 Building AX(S) (Unit 1) 1.32–3, 1.37, 1.39–41t, 1.127, 1.137–8, 1.137–8, 1.139, 1.142
 Building AY 1.276, 1.277, 1.284–6, 1.284, 1.289, 1.293, 1.323
 Building AZ 1.41t, 1.251, 1.252, 1.253
 finds 1.255, 2.126
 Phase 4 1.256–7, 1.260
 Phase 5 1.39t, 1.146, 1.260–1
 Building B (*Contubernium* 7 (Building 2)) 1.11–12, 1.377, 1.378, 1.387–8, 1.388–9, 1.390–1, 1.391, 1.392, 1.422, 1.424, 1.426
 Building BA 1.33, 1.39t, 1.41t, 1.146, 1.251, 1.252, 1.253, 1.254
 finds/pottery 1.260, 2.124
 Building BB 1.33, 1.39t, 1.41t, 1.146, 1.242, 1.251, 1.252, 1.253
 finds/pottery 1.255, 1.260
 Building BC 1.36, 1.37, 1.41t, 1.213, 1.214–16, 1.215
 Building BD 1.36, 1.37, 1.41t, 1.214–16, 1.215
 Building BE/BF/BG/BH 1.11–12, 1.392–3
 Building BI 1.18, 1.20–1, 1.38t, 1.178–81, 1.179–80, 1.182, 1.185, 1.268, 1.269, 1.271
 Building BJ 1.151, 1.152, 1.318, 2.110, 2.113
 Building BK 1.35, 1.40–2t, 1.251, 1.261–3, 1.262
 Building BL 1.218
 Building BM 1.36, 1.150, 1.152
 Building C (*Contubernium* 1 (Building 18)) 1.377, 1.378, 1.401, 1.402, 1.404, 1.405–8, 1.406–7, 1.410, 1.419, 1.420
 Building D (*Contubernium* 4 (Building 18)) 1.377, 1.401, 1.404, 1.408–9, 1.409, 1.410
 Building E 1.39t, 1.377, 1.378, 1.401, 1.409, 1.409–10, 1.420
 Building ET *see under* Chalet Range 9
 Building F 1.377, 1.378, 1.401, 1.404
 Building G 1.39t, 1.377, 1.401, 1.402–3, 1.411, 1.414, 1.420
 Building H 1.39t, 1.377, 1.401, 1.402–3, 1.411, 1.420
 Building J 1.36, 1.37, 1.377, 1.379, 1.401, 1.412, 1.414–16, 1.415, 1.420
 Building K (*Contubernium* 6 (Building 2)) 1.11–12, 1.377, 1.378, 1.387, 1.388, 1.391, 1.392, 1.411, 1.426
 Building L 1.39t, 1.377, 1.401, 1.402–3, 1.411, 1.412, 1.413, 1.417, 1.420
 Building M (*Contubernium* 5 (Building 2)) 1.11–12, 1.377, 1.378, 1.387, 1.388, 1.391, 1.392, 1.426
 building material
 architectural fragments 2.2–8
 ceramic 2.8–15
 other 2.15
see also individual buildings
 Building N 1.33, 1.36, 1.37, 1.40, 1.41t, 1.111, 1.119, 1.126–7, 1.129, 1.146, 1.147, 1.147–8, 1.149, 1.150, 1.151–2
 and hospital demolition rubble 1.118, 1.119

- Building O 1.33, 1.37, 1.40, 1.41t, 1.126–7, 1.129, 1.146, 1.149, 1.150–2, 2.109
- Building P 1.33, 1.37, 1.40, 1.41t, 1.126, 1.129, 1.147–8, 1.149–52
- Building Q (Unit 3) 1.39t, 1.40t, 1.41t
 Period 4 1.32–3, 1.37, 1.39t, 1.40t, 1.126, 1.129, 1.131–4, 1.132–4, 1.138, 1.139, 1.141
 Late 3C/early 4C 1.40t, 1.139, 1.140–1, 1.141–2
 Phase D 1.142, 1.143, 1.144–5
- Building R (Unit 2) 1.32–3, 1.37, 1.39t, 1.40t, 1.41t, 1.126, 1.129, 1.132–3, 1.133, 1.134–6, 1.134
 Phase B 1.132–3, 1.133, 1.134–6, 1.134
 Phase C 1.139, 1.140–1, 1.141–2
 Phase D 1.142, 1.144
 finds 2.110, 2.112, 2.125
- Building Row 20 *see* Row 20 (Row XX)
- Building S (S Phase) 1.35, 1.52n, 1.126, 1.133, 1.134, 1.139, 1.140, 1.144, 1.145
- Building T (T Phase) 1.26, 1.124, 1.124, 1.125, 1.126, 1.127, 1.131, 1.132, 1.134, 1.135, 1.152n.1
- Building U *see under* Chalet Range 9
- Building V *see under* Chalet Range 9
- Building W *see under* Chalet Range 9
- burials
 Anglo-Saxon 2.213
vicus 1.44
- buried pots 1.391, 1.434, 1.438, 1.488, 2.67.92, 2.84, 2.85, 2.87
- butchery 1.159, 1.162
- button-and-loop fasteners 1.298, 1.383, 1.482, 2.152.189 /190/192/194/195, 2.153, 2.154
- buttons, post-medieval 1.289, 1.426, 2.214
- buttressing 1.242, 1.577
- Byker 1.527
- C2 *see* Cistern 2
- Caerhun 1.86, 1.87
- Caerleon (Wales), barracks 1.399
- Caernarfon, *praetorium* 1.265
- calcite-gritted (CG) ware 2.56t, 2.59, 2.81, 2.82t
- candlesticks 1.150, 2.140, 2.141.76, 2.209, 2.210, 2.211
- cannel coal, spindlewhorls 2.181.8, 2.183
- Caruana, Ian 1.8, 1.506
- Carville Road 1.44–5, 1.45
- casseroles 2.57, 2.84t
- cattle 2.217, 2.218–23, 2.223, 2.224, 2.224t, 2.225–7, 2.226–9t, 2.227t, 2.228, 2.229, 2.231
- cauldrons, LT OW painted 2.58, 2.83
- causeways 1.574
- cavalry 1.16, 1.136, 1.145, 1.289, 1.374, 1.385, 1.520
- cavalry barracks 1.433
- Central Campanian amphorae 2.53t, 2.68.115
- Central Gaulish black-slipped 2.55, 2.56t
- Central Gaulish colour coated 2 (CNG CC 2) 2.56t
- centuriae* 1.516
- Céramique à L'Éponge* (EPO MA) 2.56t, 2.57
- chain links, iron 1.439, 1.452, 2.167.36–7, 2.168
- Chalet AB *see under* Chalet Range 10
- Chalet AG I *see under* Chalet Range 12
- Chalet AG II *see under* Chalet Range 12
- Chalet AL2 *see under* Chalet Range 12
- Chalet AM2 *see under* Chalet Range 12
- chalet barracks 1.516–20
see also Chalet Ranges 9–12
- Chalet Range 9 1.30–1, 1.32, 1.33, 1.39t, 1.42t, 1.468–71, 1.469–70, 1.471–4, 1.472, 1.482–3, 1.518
- Building AK (*Contubernium* 1/2) 1.470, 1.474, 1.479–82, 1.483
- Building ET (*Contubernium* 3) 1.470, 1.473, 1.474, 1.478–9, 1.479, 1.480–1, 1.481–2, 1.483
- Building U (*Contubernium* 4) 1.31, 1.440, 1.468, 1.473, 1.473, 1.477–8, 1.478, 1.479, 1.482, 1.483–4
- Building V (*Contubernium* 5) 1.468, 1.473, 1.474, 1.477, 1.484
- Building W (officer's house) 1.31, 1.40t, 1.468, 1.470–1, 1.474–7, 1.474, 1.482–3
- Mid-3C 1.40t
- Late 3C/early 4C 1.40t
- finds 1.482
 coins 2.103, 2.110, 2.113, 2.122, 2.127
 pottery 1.482–3
- Chalet Range 10 1.40t
- Building AB (officer's house) 1.32, 1.39–40t, 1.42t, 1.484, 1.484–6, 1.485–6, 1.487, 1.488, 1.488–9, 1.488–9, 1.518
- Chalet AA (*Contubernium* 1) 1.484, 1.486
- Chalet X (*Contubernium* 4/5) 1.487, 1.484, 1.488
- Chalet Y (*Contubernium* 3) 1.484, 1.486–7, 1.488
- Chalet Z (*Contubernium* 2) 1.484, 1.486, 1.486, 1.488
- finds 1.487–9, 1.490
 coins 2.120, 2.123
 pottery 1.487–9, 1.488, 1.490, 2.61.81, 2.65.81
 buried 2.87
- south *intervallum* road 1.489–90
- Chalet Range 11 1.11, 1.31, 1.32, 1.33, 1.39–40t, 1.42t, 1.455, 1.490–4, 1.497, 1.498, 1.518
- Chalet AC (e) (*Contubernium* 2) 1.490, 1.492, 1.494–5, 1.499, 1.499
- Chalet AC (w) (*Contubernium* 1) 1.490, 1.494, 1.497, 1.499, 1.499
- Chalet AD (*Contubernium* 3) 1.490, 1.495, 1.499–500
- Chalet AE (*Contubernium* 4) 1.490, 1.495–6, 1.500
- Chalet AF (*Contubernium* 5) 1.490, 1.496, 1.497, 1.500
- Chalet AI (*Contubernium* 6) 1.490, 1.492, 1.493, 1.500–1, 1.501
- Chalet AN (officer's quarters) 1.492, 1.493, 1.496–7, 1.501, 1.511
- finds/pottery 1.497, 1.500, 1.501
- Chalet Range 12 1.31, 1.32, 1.33, 1.34, 1.39–40t, 1.42t, 1.462, 1.490, 1.491, 1.492, 1.493–4, 1.501–2, 1.504
- Chalet AG I (*Contubernium* 1) 1.462, 1.502
- Chalet AG II (*Contubernium* 2) 1.463, 1.502–3
- Chalet AH (*Contubernium* 3) 1.502, 1.503, 1.504, 1.515
- Chalet AJ (*Contubernium* 4) 1.502, 1.503, 1.504, 1.506, 1.515
- Chalet AL1 (e) 1.507, 1.509–10
- Chalet AL1 (w) (*Contubernium* 5) 1.506–7, 1.508, 1.509, 1.510, 1.511, 1.515
- Chalet AL2 1.40t, 1.505, 1.508, 1.510, 1.510–12, 1.512, 1.515–16
- Chalet AM1 (officer's quarters) 1.507, 1.509–10, 1.511, 1.514, 1.515
- Chalet AM2 1.40t, 1.512–15, 1.514
- finds/pottery 1.515–16, 2.131
 and the *via quintana* 1.516
- Chalet/Building U *see under* Chalet Range 9
- Chalet/Building V *see under* Chalet Range 9
- Chalet/Building W *see under* Chalet Range 9
- chalets 1.379
 and Building 16 (workshop) 1.323
- chapes, copper alloy 1.439, 2.155.221, 2.156.220
- Charlesworth, D. 1.123

- Chester-le-Street, *praetorium* 1.266
 Chesters, barracks 1.374, 1.516
 chimney pots 2.14, 2.14
 chisels 1.264, 1.359, 1.482, 2.165.24, 2.166, 2.167.25–6
 Cicur(o/us) 2.49, 2.50
 Cinnamus 2.21, 2.23, 2.25, 2.27, 2.30, 2.32, 2.34, 2.37
cippi 1.527–8
 cisterns 1.275, 1.294–7, 1.295–8
 Building 13 (*praetorium*) 1.220, 1.223, 1.228, 1.229–30, 1.241, 1.242, 1.245, 1.248–9, 1.249
 area south of 1.257–8
 Building 14 (*principia*) 1.177–8, 1.190, 1.196, 1.211–12, 1.217
 Cistern 1 1.35, 1.38t, 1.39–41t, 1.153–63, 1.154–8, 1.522
 Period 2 1.25, 1.91, 1.93, 1.94, 1.122
 Period 3 1.26
 Late 3C/early 4C 1.40t, 1.291–4, 1.292–4
 finds
 bone (animal) 1.159, 1.161, 1.162, 2.217, 2.218–22, 2.224–7, 2.231–2t
 coins 2.114, 2.125
 pottery 1.161, 1.163, 2.66, 2.73, 2.85–6, 2.85t, 2.86t
 infilling 1.158–61, 1.159–62, 1.161–2
 Cistern 2
 Late 3C/early 4C 1.40t
 and Building AY 1.284, 1.285
 finds, pottery 1.298–9, 2.73, 2.86–7, 2.86t
 Cistern 3 1.40t, 1.291–4, 1.292–4, 1.298, 1.312
 cists, stone-lined *see* stone boxes
 clamp holes 2.5, 2.7
 clamps/holdfasts, iron 1.400, 1.439, 2.167.41, 2.168.42
Classis Britannica 1.20
 clay pipes (C17th) 1.342, 1.419, 1.426
 Clemens 2.34, 2.37
 clips, copper alloy 1.228, 2.160.295, 2.161.295
 coal scuttles 1.434
 Chalet Range 10, Chalet Y 1.487
 coal/charcoal/carbon
 Building 1 1.333, 1.335, 1.336, 1.374–6
 Building 2 1.391
 Building 3 1.395
 Building 4 1.350, 1.352, 1.362
 Building 5 1.362, 1.364
 Building 9 1.437
 Building 11 1.450
 Building 13 (*praetorium*) 1.236, 1.239, 1.241, 1.249
 Building 16 1.303, 1.307
 Building 18 1.405, 1.408
 Chalet Range 11, Chalet AC (w) 1.499
 eastern rampart 1.567
 north *intervallum* 1.341
 north-east rampart 1.549
 pits outside the fort 1.526–7, 1.526
 Tower 3 1.564
 coarse wares 2.55, 2.55t, 2.56t, 2.57–9, 2.62–5, 2.72, 2.74–7, 2.80–2, 2.85t, 2.94.16–28/33–6, 2.95, 2.96
 Cobnertus 2.22, 2.23, 2.37
Cohors Equitata 2.101
Cohors II Nerviorum 1.2
Cohors III Lingonum (*Cohors IV Lingonum equitata*) 1.2, 2.8, 2.12–13, 2.13t, 2.15
Cohors Peditata, coins 2.101
 coins 2.98–100, 2.98, 2.99–100t
 Antoninus Pius 1.482, 2.109–10
 Building 13 1.264, 2.110.90
 Building 17 1.419, 2.111.92
 Building BJ 1.152, 2.110.89
 Building R 1.142, 2.110.84
 Chalet Range 9 1.482, 2.111.94/3
 C. Postumi at or ta 1.307, 2.102.2
 Caracalla 1.161, 1.228, 1.392, 2.114.124
 Caracalla/Geta Caesar 2.114
 Carausius 1.264, 2.119
 Charles I 1.426
 Claudius II 1.548, 2.116.148
 Claudius II? 1.420, 2.116.150
 Commodus 1.419, 1.420, 2.113.113/114
 Constans 1.426, 1.541, 2.121
 Constantine 2.131
 Constantine, House of 2.123
 Constantine I 1.289, 1.299, 2.119
 Constantine II, Caesar 1.118, 1.541, 2.120, 2.120.186
 Constantius II 1.75, 1.297, 1.318, 1.482, 1.528, 2.120, 2.122–3, 2.122.203
 Building 7 1.75, 2.122.207
 Constantius II/Constans 1.487, 2.123.217
 Crispina 1.439, 2.113.115
 Crispus Caesar 1.443, 2.120.182
 Diocletian 2.119
 Domitian 1.307, 2.100t, 2.103–4
 Building 9 1.439, 2.103.20
 Domitian under Vespasian 1.116, 2.103.18
 Elagabalus 1.161, 1.251, 2.14, 2.99, 2.114, 2.115.131
 ‘Elagabalus’, Building 13 1.251, 2.115.132
 Elagabalus, *via praetoria* 1.419
 Faustina I, Posth. 1.144, 1.482, 2.111.90
 Faustina II [A. Pius] 2.112
 Faustina II (M. Aurelius) 2.112
 Gallienus 1.297, 2.115–16
 ‘Gallienus’ 1.264, 1.541, 2.116.145
 Building 7 1.79, 2.116.146
 Gallienus? 1.264, 1.289, 2.115–16
 Hadrian 2.100t, 2.108–9
 Building 1 1.342, 1.383, 2.108.69/67, 2.109.78
 Building 3 1.398, 2.108.70
 Building 14 1.208, 2.109.76
 Building O 2.109.72
 Helena/Theodora 2.120
 Herennia Etruscilla 1.30, 1.383, 1.399, 2.115.138
 illegible 1.250, 1.320, 1.342, 2.124–30, 2.131
 Alley 3 1.419, 2.130.287
 Alley 7 1.264, 2.127.256, 2.128.268/270
 Building 1 1.342, 2.125.238
 Building 8 1.100, 1.120, 2.124.230, 2.125.231, 2.126.249
 Building 13 1.248, 1.260, 2.127.254, 2.129.277
 Building 16 1.37, 1.124.229, 1.320, 2.125.233, 2.126.241–2/244/247, 2.127.251, 2.128.261, 2.130.288, 2.131.292
 Building N 1.150, 2.128.264
 Building R 1.142, 2.125.234
 Chalet Range 9 1.482, 2.127.252
 east rampart/*intervallum* road 1.398, 1.569, 2.126.247
 via praetoria 1.419, 2.128.262
 Julia Domna 1.419, 2.114.122
 L. antes Gragv? 1.307, 2.102, 2.102.1
 lost 2.131
 Lucilla 1.398, 2.112–13
 M. Antonius 1.429, 2.102
 M. Aurelius/Commodus? 1.515, 2.131.289
 Magnentius 1.289, 1.419, 2.123–4, 2.124.221

- Marcus Aurelius 1.138, 1.348, 2.112.103/104
 Marcus Aurelius, Caesar 2.112
 Maximinus 2.119
 Maximus under Maximus I 2.115
 Nerva 1.308, 2.104
 (?) 1.400, 2.104.27
 period dating 2.100–1
 Pius 2.100t
 'Postumus' 1.541, 2.117
 Radiate 1.150, 2.118.163
 Radiate copy 1.150, 1.297, 2.118.163/168
 Republican 1.452, 2.102.4
 Septimius Severus 1.152, 1.419, 2.113–14, 2.113.118
 Severus Alexander 1.248, 1.297, 2.115, 2.131
 Tetricus I 2.117
 Tetricus II 1.297, 2.117–18
 Titus and Divus Vespasian 1.419, 2.103.16
 Titus under Vespasian 1.255, 2.103.17
 Trajan 1.68, 1.342, 2.100t, 2.104–8
 Alley 1 1.384, 2.106.41, 2.108.62
 Building 1 1.342, 1.383, 2.105.39, 2.106.43
 clay puddling pit 1.400
 Building 3 1.398, 2.105.31
 Building 7 1.67, 2.107.52
 Building 8 1.100, 2.104.30
 Building 10 1.449, 2.107.57
 Building 13 1.228, 2.107.56
 Building 15 1.277, 2.106.45
 Building 16 1.307, 2.104.29
via principalis 1.297, 2.107.55
west praetentura 1.419, 2.105.33
 Trajan/Hadrian? 1.297, 2.108
 Valens 1.263, 1.419, 2.124.227/228
 Valentinian I 1.299, 2.124
 Vespasian 1.307, 1.384, 1.419, 2.100t, 2.102–3, 2.102.5
 Building 1 1.400, 2.102.8
 Building 3 1.398, 2.103.13/15
 Chalet Range 9 1.482, 2.103
 rubble spreads 1.419, 2.103.11
 Victorinus 2.117
 Victorinus/Tetricus I 1.150, 1.541, 2.117.156
see also hoards; post-medieval
 Colchester? (fine ware) 2.55, 2.82t
 collars, copper alloy 1.342, 1.482, 2.139.56/68, 2.139.57/67,
 2.140, 2.14070
 collieries 1.49, 1.50, 1.355
 combs 2.176, 2.176.35
 weaving 2.175, 2.176.34, 2.206
 commanding officer's house *see* Building 13
 conduits *see* drains; water channels
contubernia 1.28, 1.32, 1.374, 1.424
see also Buildings 1–6/9–12; Chalet Ranges; Row 20
 cooking-pots 2.82–6t
 BB1 2.58, 2.83
 BB2 1.144, 2.58, 2.82, 2.83
 bead-rimmed 2.57, 2.58
 copper alloy 2.209, 2.143.79–81
 Dales-type 2.58
 Gillam 1970 type, SE RW 2.58
 graffiti 2.94.54, 2.97
 GW1 2.60, 2.83
 GW2 2.57, 2.60, 2.83
 GW6 2.59
 Huntcliff-type rims, CG 2.59
 late gritty grey 2.59
 local traditional ('native') 2.56t, 2.58
 local traditional ware 2.58
 SE RW 2.58
 copper alloy 2.210, 2.217
see also amulets; appliqué; beads; bells; belt-plates/bars;
 bindings; bits; blocks; bosses; bowls; bracelets; bridle
 fragments; brooches; buckets; buckles/hinges; button-
 and-loop fasteners; candlesticks; chapes; clips; collars;
 cuirass hooks; curved rods; discs, copper alloy; *dolabra*
 sheaths; dumb-bell buttons; ear-rings; escutcheons;
 fasteners; finger rings; fittings; handles; harness leads;
 harness mounts; harness slides; helmets; knobs; hinges;
 junction loop fasteners; hooks; keys/key handles;
 knife guards; knobs; lamps; lids; lock bolts; medical
 instruments; mirrors; mount loops; mounts; nails;
 needles; openwork mounts; pendants; pins; plates;
 plumb-bobs; rings; rods; scabbard runners; shanks;
 sheets; skillets; spoons; statuettes; strap-ends; strips;
 studs; styli; terminals; terrets; tripod supports; tubes;
 tweezers; washers; weights
 Corbridge
 granary 1.80, 1.81, 1.83, 1.86
 hospital 1.121
 cord-rig cultivation 1.19, 1.51, 1.61, 1.178, 1.329, 1.449
 Corke, Philip 1.123
 Cottalus 2.37
 counters 2.212
 bone 1.192, 1.200, 1.348, 1.515, 2.176.39/41/42/52/55, 2.177–8
 flint 1.398
 glass 1.200, 1.208, 1.398, 1.419, 2.182.12, 2.182.7/11/13,
 2.183, 2.183.9
 lead 1.419
see also discs, pottery
 craft activity
 pottery 2.81
 and workshops 1.326
see also metalworking
 Crambeck parchment (CRA PA) 2.56t
 Crambeck red 2.56t, 2.59
 Crambeck reduced ware (CRA RE) 1.30, 1.33, 2.56t, 2.59,
 2.81, 2.82, 2.86
 Cramond (Scotland) 1.324
 cramps, lead 1.419, 2.171
 crinoid ossicles 1.320, 2.192.55
 Crow, J. G. 1.185, 1.324
 cuirass hooks/tie hooks, copper alloy 2.150.166/168, 2.151,
 2.205
cunei 1.147
 cup marked stone 2.2, 2.2
 curtain walls 1.572, 1.572, 1.576–7, 1.578
 eastern 1.566–7, 1.568, 1.569
 northern 1.53, 1.549, 1.553, 1.554, 1.555, 2.551
 southern 1.556, 1.559, 1.561, 1.564–6
 western 1.522, 1.526–7, 1.526, 1.534, 1.535–7, 1.538–9,
 1.540, 1.542
 curved bars 1.100, 2.169.70
 curved rods, copper alloy 2.138
 Daniels, Charles 1.2, 1.3, 1.8, 1.13–14
 daub 1.333, 1.356, 1.364, 1.437, 2.15
 decorated ware *see* samian ware, decorated
 deer 2.217, 2.224t, 2.225, 2.227, 2.228, 2.228t, 2.231
see also antler

- defences 1.38t, 1.39t, 1.39–40t, 1.40t, 1.43t, 1.571–9, 1.572, 1.574, 1.579
- eastern
- curtain/rampart 1.566–9, 1.568–70, 1.571
 - east gate (*porta principalis dextra*) 1.541, 1.573
 - finds 1.569–70
 - finds/pottery 1.569
 - Tower 5 1.557, 1.565–6, 1.567
- northern
- finds 1.548, 1.551, 1.555
 - pottery 1.548, 1.551, 1.552, 1.555
 - north gate (*porta praetoria*) (Gate 1) 38–40t, 43t, 1.4, 1.45, 1.84, 1.545–9, 1.545–8, 1.574
 - coins 2.116
 - east guardchamber 1.546, 1.546–8
 - gate passageways 1.546, 1.548
 - spina* 1.545–6
 - west guardchamber 1.545, 1.545
 - north-east defences 1.549, 1.550
 - finds 1.551
 - fort curtain 1.549–55
 - interval tower (7) 1.549, 1.551–2
 - north-east angle tower (6) 1.549, 1.551
 - rampart 1.549–51, 1.550, 1.552
 - north-west 1.552–5, 1.554
- southern 1.20, 1.556–60, 1.557–8, 1.571
- Branch Wall 1.565–6, 1.565
 - curtain/ditch 1.561–3, 1.561
 - finds, pottery 1.560, 1.563
 - interval tower east of south gate (Tower 3) 1.563–4
 - south gate (*porta decumana*) 1.556–60
 - east guardtower 1.556–8, 1.557, 1.574
 - finds 1.560
 - gateway 1.557–8, 1.558
 - west guardtower 1.558–9
 - Tower 4 1.564–5
- vicus* 1.45, 1.574
- western
- finds/pottery 1.537, 1.540, 1.541–2, 1.544
 - Hadrian's Wall 1.522–5, 1.523, 1.523–5
 - outside the fort 1.525–8, 1.526
 - porta quintana sinistra* (minor west gate) (Gate 4) 1.540–2
 - west curtain wall/rampart 1.523, 1.534–6, 1.535–40, 1.542–4, 1.542–3
 - west gate (*porta principalis sinistra*) 1.267, 1.522, 1.523–4, 1.528–35, 1.528, 1.530–4
- development of the fort 1.38–43t
- pre-Roman/prehistoric period 1.15–16
 - Period 1 1.16–23, 1.17
 - Period 2 23, 1.23–6
 - Period 3 1.26–8, 1.27
 - Period 4 1.28–33, 1.29
 - mid-late third century 1.33–6, 1.34
 - fourth-century 1.36, 1.37, 1.38–43t
 - late antique-early medieval 1.36–7
 - medieval period 1.48
 - sixteenth–eighteenth centuries 1.48–9
 - eighteenth to mid-nineteenth centuries (Wallsend colliery) 1.49
 - late nineteenth and early twentieth centuries 1.49–50
 - later twentieth century 1.50
 - outside the fort 1.43–8, 1.44–7
- dice
- bone 1.449, 2.176.36/37, 2.177
 - lead 2.172, 2.172.20
- discs
- copper alloy 2.161
 - lead 1.264, 1.297, 1.392, 1.398, 2.172.27/29, 2.174
 - pottery 1.112, 1.116, 1.142, 1.150, 1.192, 1.255, 1.289.44, 1.369, 1.392, 1.398, 1.400, 1.419, 1.426, 1.439, 1.454, 1.515, 1.540, 1.569, 2.185.31/43/54/78/96, 2.186.15, 2.186–88, 2.188
 - stone 1.216, 1.298, 1.309, 1.419, 1.544, 2.191.36/37/38/39, 2.191.36/37/38/39, 2.192.46
 - tile 2.188, 2.188
- dishes 2.57, 2.58, 2.59, 2.82–6t
- ditches 1.43
- south defences 1.562, 1.562, 1.574
- dog
- bone 2.217, 2.224t, 2.225, 2.227, 2.228t, 2.230
 - portrayed in pottery 2.22.D22, 2.30.D97, 2.32.D32, 2.66.122
- dolabra* sheath, copper alloy 2.148.142, 2.149
- dolphin handles 2.90
- double spiked loops 2.169
- Do(v)eccus 2.21, 2.29, 2.32, 2.38
- drains
- Alley 10 1.418
 - Building 1
 - Stone Phase 1 1.336, 1.340, 1.340, 1.342, 1.374
 - Stone Phase 2 1.379–80, 1.381–2, 1.383, 1.385
 - Building 2 1.391–2
 - Building 3 1.348, 1.398
 - Building 4 1.355, 1.356, 1.357, 1.359, 1.360, 1.361
 - Building 7 (Granary) 1.73–4, 1.74–7
 - Building 8 (Hospital) 1.91, 1.93, 1.93, 1.97, 1.100
 - Building 9 1.434, 1.438–9
 - Building 10 1.446, 1.447, 1.448–9, 1.448
 - Building 11 1.450, 1.453–4
 - Building 12 1.456, 1.457–8, 1.462, 1.463–4, 1.465, 1.465, 1.467
 - Building 13 (*praetorium*) 1.220, 1.222, 1.226, 1.232–3, 1.234, 1.236, 1.240, 1.245, 1.253–4
 - area south of 1.259–60, 1.261
 - Building 14 (*principia*) 1.177, 1.185–7, 1.190, 1.192, 1.200, 1.201, 1.202, 1.205, 1.208, 1.213, 1.216
 - Building 16 (workshop) 1.303, 1.313
 - Building 18 1.405
 - Building AO 1.269, 1.282, 1.283, 1.285–6
 - Building N 1.149
 - Building Row 20 1.127–8, 1.146
 - Building AX 1.145, 1.145
 - Building Q 1.133, 1.139
 - Building R 1.134
- Chalet Range 9, U (*Contubernium* 4) 1.477–8, 1.478
- Chalet Range 10 1.490
- Chalet Range 11 1.492–3, 1.494, 1.496, 1.497, 1.500
- Chalet Range 12 1.493, 1.502, 1.506, 1.513–15
- Cistern 1 1.157, 1.162, 1.162
- Cistern 3 1.292–3, 1.292–3
- intervallum* 1.93, 1.97, 1.118, 1.157, 1.167–8, 1.175–6, 1.228, 1.366, 1.371, 1.396
- officer's house (Chalet Range 9) 1.475
- south gate 1.558, 1.560, 1.574
- south *intervallum* road 1.489–90
- Tower 2 1.554
- via praetoria* 1.287–8, 1.290
- via principalis* 1.273, 1.287, 1.312, 1.318
- east 1.311–12, 1.312

- via quintana* 1.264
 and Building 9 1.438–9, 1.439
 west gate south guardchamber 1.529
see also urine sumps/pits
 Dressel 20 amphorae 2.53, 2.54, 2.66, 2.68.113, 2.82
 Building 9 1.434, 1.438, 1.440
 discs 2.187
 graffiti 2.94.56/63/64/66, 2.97
 drill hall (*basilica exercitatoria*) 1.289
 drip channels 1.357, 1.372, 1.373, 1.373, 1.376
 Building 14 (*principia*) 1.188–9, 1.194, 1.196, 1.200, 1.212
 drip trenches 1.291, 1.357, 1.371, 1.372, 1.373
 Alley 3 1.412
 dumb-bell buttons, copper alloy 2.152.201, 2.154
dux Britanniarum 1.36
- ear-rings 1.443, 2.137.42/43, 2.138, 2.208
 early medieval 2.212–13, 2.216
 East Anglian mica-rich fabrics 2.58
 east gate (*porta principalis dextra*) 1.541, 1.573
 excavation 1.6
 East Yorkshire grey 2.56t, 2.58
 Ebor red-painted (EBO OX) 2.56t
 Ebor ware (EBO OX) 2.57
 English Heritage 1.8
 escutcheons
 copper alloy 2.144, 2.145.83
 iron 1.419, 2.168.72, 2.169.72/73
 ethnic units 1.145–7
 excavations
 1975–84 1.3–8, 1.4t, 1.6–7
 post-excavation work 1.8–13, 1.9–12
 Segedunum Project 1.8–13, 1.14
- fabrica* *see* workshops
 fabrics
 coarse wares 2.56t, 2.57–9
 fine wares 2.55, 2.56t, 2.57
 fasteners, copper alloy 2.154
 Fendoch (Scotland)
 hospital 1.121, 1.122
 workshops 1.324
 ferrules 1.299, 1.342, 1.392, 2.164.13, 2.165.15, 2.166
 Fidelis 2.38
 finds
 in context
 copper alloy vessels 2.210
 curiosities 2.210
 female presence 2.208–9
 horse harness 2.207–8, 2.207
 lighting 2.209
 medical implements 2.208
 military equipment 2.205
 ‘native’ 2.205–7, 2.206
 religious 2.209–10
 ritual 2.209
 survivals 2.210
 modern material 1.417
see also *under*, bone; glass; stone; pottery
see also early medieval; individual buildings; medieval;
 post-medieval
 fine wares 2.55, 2.55t, 2.56t, 2.57, 2.81, 2.82t, 2.85t
 finger rings 2.137.44–46, 2.138
 fired clay 2.15, 2.15
- fittings
 copper alloy 1.392, 2.150.174–175, 2.151, 2.153, 2.157,
 2.158.249
via quintana (Road 3) 1.516, 2.157.249, 2.158.249
 early medieval 2.213, 2.215.1
 flagons 2.55, 2.57, 2.58, 2.77, 2.79, 2.82–6t, 2.87
 flasks, SE RW 2.58
 flint 1.15, 1.79, 1.100, 1.307, 1.342, 1.392, 1.398, 2.210
 Florus 2.38
 forehalls 1.288–9
see also Building AO (forehall)
 Fortuna 2.140, 2.140.73, 2.209
 fossils, crinoid ossicles 1.320, 2.192.55
frigidarium 1.245
 furnace
 in Building 13 (*praetorium*) 1.246–7
 Building 16 1.304, 1.305
- Gardiner, Frank 1.123
 garrison, third-century 1.31–2, 1.402, 1.517–20
 Gate 2 *see* west gate
 Gate 3 *see* defences, south gate (*porta decumana*)
 Gate 4 *see* *porta quintana sinistra* (minor west gate)
 gates 1.19–20, 1.326, 1.534, 1.573–5
 gatetowers
 west gate south 1.522, 1.523–4, 1.528–35
see also guardtowers; towers
 Gauloise 4 amphorae 2.53, 2.53t, 2.54, 2.66, 2.68.114
 Gelligaer (Wales), granary 1.81, 1.85, 1.86
 Geminus 2.28, 2.29, 2.39
 Gentry, A. P. 1.80, 1.82
 glass (small finds) 1.216, 1.307, 1.398, 1.400, 1.419, 1.544,
 2.90.6, 2.182, 2.183–4, 2.206
 post-medieval 2.213
see also beads, glass; counters, glass
 glass (vessel) 1.426, 2.88
 blue-green/pale green 1.383, 1.384, 2.88–90, 2.89.1–17
 colourless 1.138, 1.248, 1.250, 1.263, 1.372, 1.439, 2.89.18–
 40, 2.90–2, 2.91.19/20/21/22/23/24, 2.92.27/28, 2.92.32,
 2.93.40/41
 glass (window) 2.93
 Alley 10 1.419
 Building 1 1.342, 1.383, 1.400, 2.97.65
 Building 7 1.79, 2.93.4
 Building 9 1.439
 Building 10 1.467, 2.93
 Building 11 1.454
 Building 13 1.260, 2.93.42
 Building A 1.426
 Chalet Range 9, Building W 1.482
 rubble over west *praetentura* 1.419
 rubble spread over *praetentura* 1.420
 south *intervallum* road 1.467
 goat 2.217, 2.224, 2.224t, 2.225, 2.226t, 2.228, 2.229t, 2.231
 on intaglio 2.180.4, 2.181
 graffiti 1.419, 1.420, 2.15, 2.93–7, 2.94
 Alley 1 1.384, 1.400, 2.93.1, 2.94.1/35/28, 2.96.28/35
 Alley 10/Building 17 1.419, 2.97.48
 Building 1 1.342, 1.383, 1.400, 2.94.14/23/46, 2.95.14/23,
 2.97.46
 Building 3 1.398, 2.95.19
 Building 4 1.359, 2.97.67
 Building 8 1.112, 1.118, 2.94.11/20/34, 2.95.11, 2.95.20,
 2.96.34, 2.97.43/50

- Building 13 1.250, 1.255, 1.260, 2.93.1, 2.94.21/36, 2.95.21, 2.96.36, 2.97.53
 Building 14 1.192, 2.94.59, 2.96.38, 2.97.59
 Building 16 1.320, 2.94.18, 2.95.18
 Building AP 1.165, 2.94.29, 2.96.29
 Building R 1.138, 2.94.96, 2.97.46
 Chalet Range 9 1.482, 2.94.7/22, 2.95.7, 2.95.22
 Chalet Range 12, AL2 2.97.68
 Cistern 2 1.298, 2.94.33/61, 2.96.33, 2.97.61
 north rampart 1.551, 2.94.26, 2.96.26
 rubble spread *praetentura* 1.420
 West gate 1.537, 2.97.58
 granaries *see* Building 7 (granary); *horrea*
 Great Chesters, gates 1.573
 grey ware 1 (GW1) 2.56t, 2.57, 2.60, 2.81, 2.82t, 2.83
 grey ware 2 (GW2) 2.56t, 2.57, 2.81, 2.82t
 grey ware 3 (GW3) 2.56t, 2.57, 2.81
 grey ware 4 (GW4) 2.56t, 2.59
 grey ware 6 2.56t, 2.59
 guardchambers, western defences 1.522–3, 1.523–4, 1.543
 guardtowers
 south gate (*porta decumana*)
 east 1.556–8, 1.557
 west 1.558–9
 gullies *see* drains
 guttering 2.3, 2.5, 2.6–7
 Building 8 (hospital), Phase 1 1.91–3
 Building 12 1.459
 Building 14 (*principia*) 1.216, 1.217
 Building AO 1.282, 1.283, 1.285–6
 see also drains

 Hadrian 2.100
 see also coins, Hadrian
 Hadrian's Wall 1.2, 1.3, 1.16, 1.20, 1.522–5, 1.523–5, 1.528, 1.575
 Hair, T. H. 1.49
 hairpins 2.208
 Haltonchesters 1.35
 barracks 1.516, 1.517, 1.519
 forehalls 1.288
 gates 1.573
 granary 1.80, 1.83, 1.84, 1.85, 1.86
 hospital 1.121, 1.122
 stable-barracks 1.517
 handles
 bone 1.383, 1.482, 2.173.6, 2.173.6–9, 2.174.11, 2.174–5, 2.174.6
 copper alloy 1.400, 1.419, 1.551, 2.144, 2.145.85, 2.154, 2.155.213–18, 2.206
 jug 1.150, 2.144, 2.145.86
 tankard 2.144, 2.145.85, 2.206
 glass, dolphin 2.90
 iron 1.419, 2.165.22, 2.166
 Harcourt, R. A. 2.227
 Harden, D. R. 2.90
 Hardknott, granary 1.80, 1.82, 1.83, 1.86, 1.86
 harness, horse 1.400, 1.454, 1.464, 2.150.177–79, 2.152.182/184/186, 2.153
 head pots 2.57, 2.77–8, 2.79–80
 headquarters *see* Building 14 (*principia*)
 hearths
 Building 1 1.336
 Building 3 1.395
 Building 9 1.437
 Building 11 1.450
 Building 12 1.463
 Building 13 (*praetorium*) 1.247
 Building AZ 1.257
 metalworking 1.249–50, 1.249
 Building 14 (*principia*) 1.188, 1.197
 Building 16 1.303, 1.306
 Building 18 1.405–6, 1.406, 1.408–9, 1.424
 Building Q 1.131, 1.133, 1.139
 Building R 1.134, 1.134–5, 1.135–6, 1.139
 Building T 1.126
 Chalet Range 9 1.471
 Chalet Range 11
 Chalet AI 1.500–1
 Chalet AN 1.497
 Chalet Range 12, Chalet AM2 1.513, 1.514, 1.515
 ramparts 1.579
 west curtain and rampart 1.537
 helmet knobs, copper alloy 2.154
 herringbone stamps 2.51–2
 High Rochester, granary 1.81
 highly burnished black 2.56t
 hinges, copper alloy 2.151
 hoards, Building 16 1.302, 1.307, 1.307–8
 hobnails, iron 1.392, 1.400, 1.426, 1.515, 2.169, 2.169.76
 Hod Hill, hospital 1.121
 Hodgson, N. 1.31, 1.83, 1.121, 1.123, 1.136, 1.146, 1.265, 1.288, 1.289, 1.401, 1.424, 1.516, 1.573, 1.576
 hooks, copper alloy 2.162
 Horningsea (HOR RE) 2.56t, 2.58, 2.86
 Hornsby, Richard 1.46, 1.48
 horrea 1.80–7, 1.80t, 1.81–2
 horse harness 2.150.174–5, 2.153, 2.207–8
 horses 2.217, 2.224t, 2.225, 2.227, 2.228, 2.228t, 2.230
 on decorated samian 2.21.D6, 2.30.D78, 2.30.D107
 see also stables
 Horsley, John 1.15, 1.48
 hospitals 1.120–3, 1.121
 see also Building 8 (hospital)
 Housesteads
 bakehouses 1.20
 barracks 1.25, 1.369, 1.374, 1.375, 1.447, 1.492, 1.516
 hypocausts 1.514
 baths 1.326
 curtain wall 1.577
 gates 1.573
 granary 1.75, 1.80, 1.81, 1.82–3, 1.84, 1.86
 hospital 1.120, 1.121–2, 1.121, 1.123
 latrines 1.575
 praetorium 1.265, 1.266
 principia 1.194
 ramparts 1.577–8
 stables 1.385, 1.385
 stone-lined boxes 1.339, 1.363
 towers 1.575–6, 1.576
 vicus 1.44
 workshops 1.324, 1.325, 1.326
 housing, terraced 1.47, 1.49–50, 1.50
 hub linings 2.167.40, 2.168
 Huntcliff-type vessels 2.59, 2.82, 2.86
 hypocausts
 Building 13 (*praetorium*) 245, 1.234–6, 1.238–41, 1.244, 1.254
 finds 1.248, 1.250
 Chalet Range 12, Chalet AM2 1.513–15
 Housesteads 1.514

- imbrices* 1.212, 2.10, 2.12, 2.13t
ingots
 lead 2.172, 2.172.19
 silver 2.133, 2.133
inscriptions 2.197–8
 building 1.13–14
intaglios 1.120, 1.142, 1.307, 1.309, 2.179–81, 2.179, 2.211
intervallum roads 1.4–5, 1.8, 1.228, 1.563, 1.575
 east (Road 7) 1.228, 1.341, 1.383, 1.429
 and Building 3 1.396, 1.398, 2.54.3, 2.54.3
 north (Road 4) 1.340–5, 1.341, 1.343, 1.369–70, 1.383, 1.384, 1.417–18, 1.429, 1.550, 1.552
 south (Road 6) 1.39t, 1.57, 1.58, 1.449, 1.464–7, 1.466, 1.489–90
 Chalet Range 11, Chalet AI 1.496
 west (Road 5) 1.42t, 1.165–76, 1.166–71, 1.173–4, 1.370–8, 1.372
 and western defences 1.523
 finds 1.120, 1.176, 1.342, 1.366, 1.372–3, 1.384, 1.429, 1.467, 1.551, 2.154.214, 2.155.214
iron 2.163, 2.164–9, 2.165, 2.167, 2.168
 adze-hammers 1.458, 2.166, 2.167.27
 awls 2.165.23, 2.166
 bell 2.167.38, 2.168
 chain links 1.439, 1.452, 2.167.36–7, 2.168
 chisels 1.264, 2.166, 2.167.25–6
 Chalet Range 9 1.482, 2.166.25, 2.167.25
 paring 1.359, 2.165.24, 2.166
 clamps/holdfasts 1.400, 1.439, 2.167.41, 2.168
 curved bar 1.100, 2.169.70
 double spiked loops 2.169
 escutcheons 1.419, 2.168.72, 2.169.72/73
 ferrules 2.166.14
 conical 1.299, 2.164.13
 spiral 1.342, 2.165.15, 2.166
 handles 1.419, 2.165.22, 2.166
 hobnails 1.392, 1.400, 1.426, 1.515, 2.169, 2.169.76
 hub linings 2.167.40, 2.168
 ironworking 2.217
 knife 2.165.21, 2.166
 lift-keys 1.213, 1.366, 2.166.28–30, 2.167.28/30, 2.168.30
 lock bolts 2.166
 loops 1.138, 1.392, 1.419, 2.168.75, 2.169
 martingale? 1.176, 2.168.39
 nails 2.169
 padlock 1.454, 2.166, 2.167.34, 2.211
 pattern-welded dagger 1.515, 2.165.18, 2.166.18, 2.205
 plate 1.308, 2.169
 ring 2.172.36, 2.174
 ring-mail 1.342, 1.419, 2.165.16/17, 2.166, 2.205
 shackles 2.166, 2.167.35, 2.211
 sheets 1.439, 1.482, 2.169.71
 slide-key 1.383, 2.166, 2.166.32
 spearheads 1.100, 1.348, 1.366, 1.383, 2.163.1/3/4/6, 2.164, 2.165.8/9, 2.205
 Building 1 1.383, 2.163.1, 2.164.1
 Building 2 1.392, 2.163.3/6
 Building 3 1.348, 2.164.9, 2.165.9
 Building 5 1.366, 2.163.4
 Building 8 1.100, 2.164.12
 Building 9 1.439, 2.164.10
 Building 11 1.454
 Chalet Range 9 1.482, 2.164.9, 2.165.9
strips 1.308, 1.342, 1.398, 2.168.67/74, 2.169
 studs *see* studs; studs, iron
ironworking 2.217
jars
 glass 2.88, 2.89.2
 pottery 2.57, 2.59, 2.82–6t
 graffiti 2.97
jet 1.250, 2.181, 2.181.2/3/4
jugs
 glass 1.383, 2.88, 2.89.1
 pottery, East Yorkshire grey 2.58
junction loop fasteners, copper alloy 1.383, 2.150.167, 2.151, 2.153, 2.208
kerbs 1.299n1
 east *intervallum* road 1.398
 north-east rampart 1.549, 1.551, 1.552
 via praetoria 1.287, 1.429
 via principalis 1.278, 1.283, 1.286–7
keys/key handles, copper alloy 1.320, 1.398, 2.144, 2.145.94, 2.147.95
kilns
 Building 16 1.305, 1.306–7, 1.308
 drying
 and Building 7 (granary) 1.77–9, 1.77–9
 and Cistern 1 1.158, 1.159
 vicus 1.44
knife guards, copper alloy 2.148.143, 2.149
knives 2.165.21, 2.166
knobs, bone (small finds) 1.342, 2.173.4/5, 2.174
Künzing (Germany)
 hospital 1.121
 workshops 1.324
lamps 1.121
 hanging, copper alloy 2.140, 2.141.77
 lead 2.170.2, 2.171
 pottery 1.100, 1.116, 1.320, 1.419, 1.449, 2.81, 2.185–6, 2.185.5–11, 2.211
 stone 2.189, 2.192
late gritty grey 2.56t, 2.59
latrines 1.576, 1.578
 Building 1 1.333, 1.376, 1.381–2, 1.385
 Building 4 1.357, 1.360, 1.372, 1.376
 building 5 1.364
 Building 8 (hospital) 1.90–1, 1.97–8, 1.98, 1.100, 1.104–5, 1.116, 1.116, 2.3.6, 2.6.8
 Building 12 1.458–9
 Building 13 (commanding officer's house) (*praetorium*) 1.233
lava stones, continental 2.199, 2.200.16/19/20/44, 2.201
lead 2.169, 2.170, 2.171–2, 2.172, 2.174
 appliqué 2.170.3, 2.171
 blocks 2.170.14, 2.172, 2.172.21, 2.174
 cloth sealing 2.214.33, 2.214.33
 counters/blocks 1.419
 cramps 1.419, 2.171
 die 2.172.20, 2.172.7
 discs 1.120, 1.297, 1.392, 1.398, 2.172.27/29, 2.174.28
 ingots 2.172, 2.172.19
 lamps 2.170.2, 2.171
 plugs 1.105, 2.170.9, 2.171–2
 portable shrine 2.169, 2.170.1, 2.171
 rods 1.308, 1.487, 2.170.4/5, 2.171
 sealings 1.255, 1.342, 2.93, 2.93, 2.211

- sheets 1.366, 2.172, 2.172.16
 strips 1.384, 2.170.15, 2.172
 weights 2.172.22, 2.174
Legio VI Victrix 2.8, 2.13, 2.13t, 2.15
 lids
 copper alloy 2.144, 2.145.89/90, 2.160.381, 2.164
 grey ware 4 2.59
 pot, stone 2.191, 2.191
 lift-keys 1.213, 1.366, 1.482, 2.166.28–30, 2.167.28/30,
 2.168.30
 lighting 2.209
 see also candlesticks; lamps
 local traditional ('native') ware 2.56t, 2.58
 locally produced grey/oxidised ware 2.57
 location of site 1.2, 1.3
 lock bolts
 copper alloy 2.146.97, 2.147
 iron 2.166
 loops
 copper alloy 1.79, 1.138, 1.359, 1.383, 1.392, 1.398, 1.419,
 1.426, 1.454, 1.515, 1.537, 1.540, 1.544, 2.160.334/365, 2.162,
 2.164, 2.168.75, 2.169
 iron 1.138, 1.392, 1.419, 2.168.75, 2.169.68/69
 Lower Nene Valley 1.30, 2.81
 colour-coated (LNV CC) 2.55, 2.56t, 2.61, 2.65–6, 2.66, 2.73,
 2.74–5, 2.78, 2.87
 grey 2.56t
 parchment (LNV PA) 2.55, 2.56t, 2.65.85
 Lower Tyne painted oxidised ware 2.56t, 2.57–8, 2.81

 Mancetter-Hartshill 2.42, 2.43, 2.44t, 2.49, 2.50, 2.51, 2.52,
 2.81
 Marcus (potter) 2.25, 2.27, 2.30, 2.39
 market area 1.36, 1.541
 martingale? 1.176, 2.168
 medical instruments 1.121, 2.211
 copper alloy 1.264, 1.482, 1.544, 1.548, 1.578, 2.146.99–103,
 2.147, 2.173.6–7, 2.208
 Medieval period 1.36–7, 1.48, 2.213, 2.215.4/5, 2.216
 Mercury 2.171, 2.209
 metalworking 1.121, 1.307, 1.326, 1.346, 1.395, 1.419, 1.429,
 2.217
 mica-dusted ware 2.55, 2.56t, 2.57
 middens
 Building 3 1.396, 1.398
 outside the fort 1.527, 1.528
 military equipment 2.205
 Minerva 2.2, 2.3, 2.209
 mirrors 2.144, 2.145.92, 2.208
 modern, pottery 1.483
 Moffat, Peter 1.8, 1.241, 1.251, 1.253, 1.255, 1.257, 1.261,
 1.503, 1.513, 1.514
 mortaria 2.42–53, 2.44t, 2.45–6, 2.55t, 2.81, 2.82, 2.82–6t,
 2.83
 Anaus 2.42, 2.45–8, 2.48t, 2.60, 2.83
 catalogue 2.43, 2.45
 fabrics 2.42–3
 graffiti 2.94.62, 2.97
 Rampart building 2.82t
 stamps 1.79, 1.342, 1.383, 1.384, 1.400, 1.419, 1.425, 1.426,
 1.439, 1.449, 2.43, 2.45–53, 2.46
 mounts, copper alloy 1.248, 1.297, 1.348, 1.359, 1.400, 1.419,
 1.420, 1.439, 1.464, 1.467, 1.515, 2.152.184, 2.153.184,
 2.155.223/227/228, 2.156–7, 2.158, 2.160.306, 2.161.306

 nails
 copper alloy 1.392, 2.148.136, 2.149, 2.149.137
 iron 2.169
 Nanstallon (Cornwall) 1.265
 needles
 bone 1.248, 1.250, 1.307, 2.173.26, 2.175
 copper alloy 2.148.130, 2.149
 Newstead (Scotland), forehalls 1.288
 niches 1.198, 1.199, 1.205
 North African style pottery 2.56t, 2.57, 2.79–80, 2.85
 north gate (*porta praetoria*) (Gate 1) 38–40t, 43t, 1.4, 1.45,
 1.84, 1.545–9, 1.545–8, 1.574
 east guardchamber 1.546, 1.546–8
 finds, coins 2.116
 gate passageways 1.546, 1.548
 spina 1.545–6
 west guardchamber 1.545, 1.545
 North Gaulish colour-coated 1 2.56t
 North Gaulish grey ware (NOG RE) 2.56t, 2.59
Notitia Dignitatum 1.2, 1.36, 1.266
numeri 1.145–6

 Oberstimm (Germany) 1.121, 1.324
 officer's houses 1.24
 see also under individual barracks
 'old ground surface' 1.167–8, 1.437, 1.525, 1.525–6, 1.536
 openwork mounts, copper alloy 2.156–7
opus signinum 2.15
 Building 13 (*praetorium*) 1.222
 Building 14 (*principia*) 1.198, 1.213
 Building AZ 1.33, 1.146, 1.256–7, 1.261
 Ordnance Survey 1.47, 1.49–50
 ovens 1.576
 ramparts 1.578–9
 west curtain and rampart 1.537
 west gate southern guard chamber 1.529–34, 1.533, 1.575
 see also hearths
 oxidised ware 1 (OW1) 2.56t, 2.57, 2.81
 oxidised ware 2 (OW2) 2.56t, 2.57, 2.81

 padlocks 1.454, 2.166, 2.167.34, 2.211
 palettes, stone/slate 1.392, 1.398, 1.419, 2.88, 2.189.1–4
 Parisian ware 2.59
patera, ramshead 2.141, 2.142, 2.210.78
 Paternus 2.22, 2.23, 2.24, 2.25, 2.27, 2.30, 2.32, 2.34, 2.35, 2.39
 pattern-welded daggers 2.165.18, 2.166, 2.205
 pegs, bone 1.366, 2.176.56, 2.178
 Pen Llystyn (Wales) 1.265
 workshops 1.324
 pendants, copper alloy 1.152, 1.419, 2.150.169–72, 2.151
 Periods 1–4 (defined) *see* development of the fort
 Petch, James A. 1.120
 phallic symbols 2.3, 2.5, 2.156, 2.208
 pier bases/piers 1.68, 2.8
 Building AO (forehall) 1.279–81, 1.279–80, 1.283, 1.286
 Piercebridge, *praetorium* 1.265
 pig (bone) 2.218, 2.223, 2.224, 2.224t, 2.225, 2.226t, 2.227,
 2.228, 2.229, 2.230t, 2.231
pilae, in Building 13 (*praetorium*) 1.239–40, 1.243, 1.246
 pillars, stone Building 13 (commanding officer's house)
 (*praetorium*) 1.243
 pink grog-tempered ware (PNK GT) 2.59
 pins
 bone 1.142, 1.233, 1.248, 1.250, 1.342, 1.439, 1.515,

- 2.173.17/18/20/22, 2.175, 2.208
copper alloy 1.152, 1.248, 1.308, 1.366, 1.515, 2.147, 2.148.116–124, 2.149
jet 2.181, 2.181.6
pipeclay 2.184.1, 2.185.1, 2.209–10
pits
 Building 4 1.355–6, 1.357, 1.358
 Building 5 1.364
 Building 13 (*praetorium*), Room 7 1.250–1, 1.251
 Building 16 1.303, 1.303, 1.305, 1.306
 C2 *see* Cistern 2
 clay puddling- 1.294, 1.337, 1.356, 1.399–400
 north *intervallum* 1.340–1, 1.341, 1.343, 1.549
 outside the fort 1.526–8, 1.526
 south gate 1.559–60, 1.574
see also urine sumps/pits
pivot stones
 Building 1 1.335, 1.336, 1.336, 1.337, 1.374, 1.380, 1.380
 Building 5 1.363
 Building 8 1.91, 1.95, 1.99
 Building 9 1.437
 Building 12 1.463
 Building 13 *praetorium* 1.236
 Tower 1 1.554
 west gate south guardchamber 1.529
plaster
 Building 1 1.333
 Building 13 (*praetorium*) 1.226, 1.231, 1.232
 Building 14 (*principia*) 1.190, 1.192, 1.194, 1.200, 1.206–7
 painted 1.190, 1.206, 1.249, 2.15
plates
 copper alloy 1.213, 1.439, 2.144, 2.160.306, 2.161.305/307
 iron 1.308, 2.169
platters, East Anglian mica-rich fabrics 2.58
plough marks *see* agriculture, pre-Roman
ploughsoil 1.48, 1.55, 1.180, 1.189, 1.222, 1.370
see also agriculture
plumb-bobs, copper alloy 1.515, 2.152.202, 2.154
pommel, bone 2.173.1, 2.174
porta decumana (Gate 3) *see* defences, southern, south gate
porta praetoria (Gate 1) *see* defences, northern, north gate
porta principalis dextra *see* defences, eastern, east gate
porta principalis sinistra (Gate 2) *see* defences, western, west gate
porta quintana sinistra (minor west gate) (Gate 4) 1.19, 1.26, 1.538–9, 1.540–2
 coins 2.116, 2.120
portable shrines 2.169, 2.170.1, 2.171
portico AY *see* Building AY
post-medieval 1.426, 2.16, 2.213–14, 2.215, 2.216
pottery 1.18, 1.25
 Anglo-Saxon 1.215–16
 buried 1.434, 1.438, 1.488, 2.67.92, 2.84, 2.85, 2.87
 finds 2.81, 2.184–8, 2.185, 2.211
 lamps 1.100, 1.116, 1.320, 1.419, 2.81, 2.185–6, 2.185.5–11, 2.211
 Building 10 1.449
 pottery 1.157, 1.161, 1.163
 spindlewhorls/discs *see* discs, pottery
 statuettes 1.398, 2.184–5, 2.185.1/2
 Building 18 area 1.419
modern 1.483
post-medieval 1.401, 1.483
production 2.81
- types
 amphorae 2.53–5, 2.54, 2.55t
 Anglo-Saxon 2.212–13, 2.212
 mortaria 2.42–53, 2.44t, 2.45/46
see also samian ware
praetoria 1.264–6
see also Building 13 (commanding officer's house) (*praetorium*)
pre-Roman occupation 1.15–16
principia (headquarters) *see* Building 14
Pugnus 2.24, 2.32, 2.35, 2.40
- Qasr Bshir (Jordan) 1.519, 1.520
 stables 1.32
quarry pits 1.48, 1.295, 1.361, 1.364
quern stones 1.372, 1.426, 2.198–205, 2.200–1
 beehive stones 2.199, 2.200.3/4/9/10, 2.202–3
 Building 3 1.398, 2.204.40
 Building 7 1.67, 2.202.8
 Building 8 1.116, 2.200.3, 2.203.3
 Building 13 1.228, 2.202.7
 Chalet Range 12
 AH 2.200.10, 2.203.10
 AJ 1.515, 2.203.11
 continental lava stones 1.398, 2.199, 2.200.16/19/20/44, 2.201
 Building 1 1.400
 Building 2 1.400, 2.203.13
 Building 8 1.112, 1.120, 2.203.22, 2.203.26
 Building 10 1.203.33
 Building 14 1.192, 2.204.204–43
 Building 18 1.419, 2.200.16, 2.203.16
 Building AP 1.165, 2.204.39
 north of Buildings Q/R 1.144, 2.203.25
 rubble over west *praetentura* 1.419, 2.203.15, 2.204.49
 south *intervallum* 1.467
 west of Building Q 1.144, 2.203.28
 west *intervallum* 1.176, 2.204.38
 Romano-British 2.200.51, 2.201–2, 2.201.52/54/55, 2.204–5
 Alley 10/Building 17 1.419, 2.204.59
 area between Buildings Q and R 1.144, 2.204.50
 Building 16 1.320, 2.204.58
 Building 18 area 1.419
 Chalet Range 9, Building W 1.482, 2.201.52, 2.204, 2.204.52/53
- rampart buildings (Rampart Building II) 1.537, 1.541, 1.543, 1.578
 pottery 2.59–60, 2.81, 2.81t, 2.82, 2.82t
ramparts 1.534–6, 1.536–7, 1.538–9, 1.539, 1.540, 1.542–4, 1.542, 1.544, 1.552, 1.577–9, 1.578
 eastern 1.566–9, 1.568–70, 2.54.3, 2.54.3
 north-west defences 1.552–3, 1.553
 south 1.563
ramshead *patra* 2.141, 2.142, 2.210.78
ranks, officer 1.520
Reginus (potter) 2.21, 2.24, 2.29, 2.37, 2.40
religion 2.209–10
 Mercury 2.171, 2.209
 Minerva 2.2, 2.3, 2.209
 small finds 2.09–10, 2.140, 2.170.1
 smith gods 2.80
 temples/shrines 1.44, 1.121, 2.209
Ribchester (Lancs), forehalls 1.288–9

- Richardson, Charles and Henry 1.49
 Richmond, I. A. 1.20, 1.122, 1.288
 Rickman, G. E. 1.80
 ridge and furrow 1.48, 1.51, 1.418
 ring-mail 1.342, 1.419, 2.165.16/17, 2.166, 2.205, 2.211
 ring-vases 2.55, 2.73.248, 2.85t
 rings
 bone/antler 1.233, 1.383, 2.178
 copper alloy 1.142, 1.144, 2.160.334/335/347/351/365, 2.162, 2.164
 iron 2.172.36, 2.174
 jet 2.181, 2.181.1
 ritual 2.209, 2.210, 2.211
 River Tyne 1.2, 1.3
 Road 1 *see via principalis*
 Road 2 *see via praetoria*
 Road 3 *see via quintana*
 Road 7 *see intervallum* road
 Road 8 *see* Assembly Area
 Road 9, coins 2.115, 2.124
 roads *see also* Alleys 1–10
 robber trenches/robbing
 Building 1 1.333, 1.342, 1.380, 1.388
 Building 2 1.387, 1.390
 Building 3 1.393
 Building 4 1.421
 Building 10 1.446
 Building 12 1.464
 Building 13 (*praetorium*) 1.251, 1.254
 area south of 1.261, 1.263
 Building 14 (*principia*) 1.216
 Building 15 1.275, 1.277
 Building 16 (workshop) 1.300, 1.311, 1.320, 1.321–3
 Building 17 1.413
 Building 18 1.402, 1.405, 1.406
 Building AO (forehall) 1.279–80, 1.282, 1.299
 Chalet Range 9 1.474, 1.475, 1.479, 1.481, 1.483
 Chalet Range 10 1.486–7
 Chalet Range 11 1.494, 1.495, 1.500
 Chalet Range 12 1.502, 1.503, 1.506
 Cistern 2 1.295
 Cistern 3 1.294
 curtain wall 1.522
 defences
 eastern 1.566, 1.569
 Hadrian's Wall 1.528
 northern 1.546, 1.548, 1.549
 south curtain/ditch 1.563
 south gate 1.558
 towers 1.552, 1.554, 1.576
 west gate south guard chamber 1.532, 1.533
 western 1.544
porta quintana sinistra 1.541
 rods
 copper alloy 2.148.149, 2.149, 2.160.326, 2.162
 Building 1 1.383, 2.149.131
 Building 2 1.392, 2.148.135, 2.149.135
 Building 3 1.398
 Building 8 1.120, 2.162.329
 Building 11 1.454
 Chalet Range 9, Building W 1.482, 2.138.39
 east rampart/*intervallum* road 1.569, 2.162.329
 lead 1.308, 1.487, 2.170.4–5, 2.171
 roofing
 Building 11 1.454
 slates 1.248, 2.8
 wooden shingles 1.333
 Roppus (potter) 2.40
 Row 20 (Row XX) 1.32–3, 1.77, 1.126, 1.145–7, 1.151
 TWM Phase A 1.128, 1.131
 TWM Phase B/'Building T' Phase 1.131–9, 1.132, 1.133
 TWM Phase C/'Building S' Phase 1.139–42, 1.140
 Phase D 1.142, 1.143, 1.144–5
 Roman/post-Roman interface 1.145
 finds/pottery 1.30, 1.139, 1.142, 1.144–5
 Rowley-Conwy, P. 2.229
 Rudchester 1.80, 1.85, 1.86, 1.573
 gates 1.573
 Rushworth, Alan 1.8

 Sabellus 2.40
 Sabinus (potter) 2.40
 Sacipus 2.40
 samian ware 2.16–19, 2.16–19t, 2.55t
 Alley 1 2.83
 Cistern 1 1.61, 2.85t, 2.86
 Cistern 2 2.86
 decorated ware 2.18–35, 2.20, 2.23, 2.26, 2.28, 2.31, 2.33, 2.35
 Alley 1 1.383, 1.384, 2.31.D122/D123, 2.32.D122/D123
 Alley 3 1.372, 2.23.D35/D36, 2.24.D36/D37, 2.26.D37
 Alley 4 1.372, 2.26.D52, 2.56.56
 Building 1 1.342, 1.383, 1.400, 2.20.D21, 2.22.D21, 2.31.D121, 2.32.D120/D121, 2.33.D134, 2.34.D134, 2.35.D139/D140/D141
 Building 3 1.348, 2.33.D124, 2.134.D124
 Building 4 1.359, 2.127.D71
 Building 5 1.366, 2.21.D6, 2.25.D55, 2.26.D55
 Building 8 1.105, 1.112, 2.20.D26/D27, 2.22.D26/D27/D28/D29, 2.23.D29
 Building 9 1.434, 1.439, 2.22.D31, 2.27.D67
 Building 11 1.454
 Building 13 1.228, 1.247, 1.248, 1.255, 1.263, 2.30.D103, 2.31.D103/D113, 2.32D.113, 2.33.D132, 2.34.D127/D132
 Building 14 1.192, 2.29.D92
 Building 16 1.307, 1.308, 1.318, 2.27.D73, 2.28.D73, 2.30.D101, 2.31.D101
 Building 18 area 1.419, 2.21.D6
 Building A 1.426
 Building AX 1.138, 2.25.D58/D59, 2.26.D58
 Building N 1.150, 2.19.D3, 2.20.D26, 2.22.D26
 Building O 1.150, 2.20.D22, 2.22.D22
 Building R 1.138, 1.142, 2.25.D58/D60, 2.26.D58/D60
 Building Row 20 1.142, 2.25.D49, 2.26.D49
 Chalet Range 9 1.482, 2.25, 2.26.D65, 2.27, 2.27.D65, 2.28.75
 Building W 1.482, 2.19.D4, 2.20.D4, 2.25.D50, 2.26.D50
 Chalet Range 10
 Chalet X 1.487, 2.27.D68, 2.28.D68
 south *intervallum* 1.490, 2.25.D52
 Chalet Range 12
 AJ 1.515, 2.30.107
 AL1 1.32.D117, 1.515
 AL2 1.33.D131, 1.34.D131, 1.515
 AM 2.33.D129, 2.34.D129, 2.37.S31
 AM2 1.515, 2.31.D122, 2.32.D122, 2.33.D129, 2.34.D129
 Cistern 2 1.298, 2.27.D72/D73, 2.28.D72
 east *intervallum* road 1.398
 east rampart/*intervallum* road 1.569, 2.35.D143, 2.35.D143
 northeast of Building R 1.144, 2.25.D61, 2.26.D61
 rampart building 2.33.D134, 2.34.D134

- graffiti 2.93, 2.94.1–14, 2.94.31, 2.96, 2.97
 perforated pottery discs 2.185.43, 2.186–7
 potter's stamps 1.116, 1.144, 1.150, 1.152, 1.228, 1.264, 1.289, 1.297, 1.308, 2.35–42
 Rampart building 2.82, 2.82t
 sources 2.17–18t, 2.18–19
 stamps 2.35–42
 Alley 1 1.383, 1.384, 1.400, 2.42.S76
 Alley 3 1.372, 2.36.S4/S18, 2.37.S81
 Alley 4 1.372
 Alley 5 1.440, 2.36.S7
 Alley 7 1.264, 2.39.S65
 Alley 10/Building 17 1.419, 2.37.S76
 between Buildings Q and R 1.144, 2.39.S61, 2.41.S109
 Building 1 1.383, 1.400, 2.38.S48
 Building 2 1.392, 1.400, 2.41.S120
 Building 3 1.348, 1.398
 Building 4 1.359
 Building 7 1.67, 1.79, 2.36.S8/S19
 Building 8 1.116, 2.36.S15
 Building 9 1.439
 Building 14 2.28, 2.36.S12
 Building 16 1.307, 1.308, 2.38.S44, 2.41.S111, 2.42.S140
 Building 18 area 1.419
 Building AO 1.189, 1.289, 2.39.S64/S67
 Building BJ 1.152, 2.37.S27
 Building O 1.150, 2.40.S96
 Chalet Range 9 1.482, 2.36
 Building W 1.482, 2.42
 Chalet Range 10 1.487, 2.38.S43
 Chalet Range 12
 AL1 1.515, 2.42.S131
 AL2 233.D131, 1.151, 2.42.S143
 AM2 1.515, 2.36.55
 east *intervallum* road 1.398
 east rampart/*intervallum* road 1.569, 2.38.S47, 2.39.S62
intervallum drain 1.228
 north of Buildings Q and R 1.144, 2.36.S6
 rubble spreads 1.419, 2.36.S3, 2.39.S69, 2.42.S145
via principalis 1.297, 2.42.S133
 sandstone block 2.190.53, 2.192
 Saturninus (potter) 2.29, 2.40, 2.42, 2.51
 Savernake (SAV GT) 2.56t, 2.59
 scabbard runners, copper alloy 1.454, 2.148.145, 2.149
 Schonberger, H. 1.289
 screens 2.7, 2.8
 sculpture, stone 2.3–4, 2.3–5, 2.8, 2.9
 sealings, lead 1.255, 1.342, 2.93, 2.93, 2.211
 seats, latrine 1.116, 2.3, 2.6
 Segedunum Project 1.8–13, 1.49, 1.433
 Severn Valley ware 2.56t, 2.57
 Sextus 2.32, 2.41
 shackles 1.307, 2.166, 2.167.35, 2.211
 shacks *see* Buildings B, C, D, E, F, G, H, J, K, L, M
 shale 2.181, 2.181.5, 2.183
 shanks, copper alloy 2.162, 2.164
 sheep 2.217, 2.224, 2.224t, 2.225, 2.226t, 2.227–9, 2.228–9t, 2.231
 small finds 2.175
 sheets
 copper alloy 1.213, 1.214, 1.260, 1.297, 2.160.297, 2.161
 iron 1.439, 1.482, 2.169.71
 lead 1.366, 2.172, 2.172.16/18
 shell 1.419, 2.176.57, 2.179
 shipbuilding 1.50
 shrines 1.190, 1.198
 portable 2.169, 2.170.1, 2.171
 and ramparts 1.578
 silver, ingots 2.133, 2.133
 Simpson, F. G. 1.20, 1.122, 1.188, 1.522, 1.525, 1.574
 Simpson's Hotel 1.503
 skillets, ramshead 2.141, 2.142
 slates
 palettes 2.88, 2.189.1–4
 roofing 1.248, 2.8.16/17
 slide-keys 1.383, 2.166
 Smith pots 2.58, 2.77, 2.80
 soakaways *see* drains
 south annexe of the *praetorium* *see* Building 13
 south eastern reduced wares (SE RW) 2.56t, 2.58, 2.82t
 south gate (*porta decumana*) 1.556–60, 1.557–8
 South Shields 1.21–3, 1.21
 barracks 1.374, 1.401, 1.414, 1.422, 1.423, 1.424, 1.433, 1.436
 hypocausts 1.514
 gates 1.573
 granary 1.80t, 1.82, 1.83
praetorium 1.264, 1.266
principia 1.184–5, 1.193–4, 1.193
 workshops 1.323–4, 1.326
 South Yorkshire grey ware 2.56t, 2.59
 southern shell-tempered ware 2.56t, 2.59
 Spain, G. R. B. 1.574
 Speak, S. 1.21, 1.22, 1.185
 spearheads, iron *see* iron, spearheads
spina 1.573
 north gate 1.545–6, 1.545
 south gateway 1.556, 1.558
 west gate 1.574
 spindles, jet 2.181, 2.181.6
 spindlewhorls 1.289, 1.515, 2.189.34, 2.191.34, 2.208
 antler 1.460, 2.175, 2.176.31
 cannel coal 2.181.8, 2.183
 jet 2.181, 2.181.7
 stone 2.189.34, 2.191
see also discs, pottery
 spoons, copper alloy 1.213, 1.320, 1.342, 1.544, 2.146.104–106/108, 2.147
 stable-barracks 1.2, 1.11–12, 1.72, 1.374, 1.385, 1.517, 1.517
see also Buildings 9–12
 stables 1.374
 and Building 4 1.361
 Period 4 1.28, 1.377, 1.382
 Building 17 1.414
see also Building 1; stable-barracks
 stamps
 amphora 1.116, 1.298, 1.342, 2.54–5, 2.54
 Building 1 1.342, 1.400, 2.54.7, 2.54.7, 2.55.11
 Building 3 1.398
 Building 4 1.359, 2.54.5, 2.54.5
 Building 8 1.116, 2.55.10
 Building A 1.426
 Cistern 2 1.298, 2.55.14
 east rampart/*intervallum* road 1.568–70, 2.54.3, 2.54.3
 mortaria 1.79, 1.142, 1.320, 1.342, 1.383, 1.384, 2.43, 2.45–53, 2.46, 2.46.4, 2.46.4, 2.46.9/10, 2.47.9/10
 Alley 1 1.342, 1.383, 1.384, 2.46.4, 2.46.4, 2.46.9/10, 2.47.9/10
 Alley 10/Building 17 1.419

- Building 1 1.342, 1.383, 1.400, 2.46.30, 2.46.24/36, 2.49.18, 2.50.24, 2.51.30, 2.52.36
 Building 7 2.52.37
 Building 9 1.439, 2.46.19, 2.50.19
 Building 10 1.449, 2.46.15, 2.49.15, 2.53.38
 Building 18 1.419, 2.46.39, 2.53.39
 Building A 1.425, 1.426, 2.46.26, 2.51.26
 north *intervallum* road 1.384, 2.46.27, 2.51.27
see also samian ware, stamps
 statuettes
 copper alloy 1.247, 2.140, 2.140, 2.211
 pottery 1.398, 1.419, 2.184–5, 2.185.1/2
 stoking chamber, hypocaust 1.238, 1.239, 1.241, 1.242, 1.243, 1.245, 1.247, 1.248
 stone
 small finds
 axes 2.190.56, 2.192, 2.210
 ‘ballista’ balls 2.192–8, 2.197–8, 2.197t
 ‘ballista’ balls *see* throwing stones
 beads 2.192
 crinoid ossicles 2.192
 discs 2.189.40/44/46, 2.191
 lamps 2.189, 2.192
 palettes 1.392, 2.88, 2.189.1–4
 pot lids 1.105, 2.191.35, 2.191.35
 recessed stones/moulds 1.144, 1.398, 2.190.50/52, 2.192
 sandstone block 2.190.53, 2.192
 spindlewhorls 2.189.34, 2.191
 see also architectural fragments
 stone settings 1.104, 1.284, 1.304, 1.315, 1.434
 storage jars 2.57, 2.58, 2.59, 2.83–6t
 Storey, S. 1.49
 Strageath (Scotland), hospital 1.120, 1.121, 1.121
 strap-ends
 copper alloy 1.111, 1.247, 2.150.160/161/163, 2.151, 2.211
 early medieval 2.213, 2.215.2
 strips
 copper alloy 1.120, 1.138, 1.419, 1.482, 2.161
 iron 1.308, 1.342, 1.398, 2.168.67/74, 2.169
 lead 1.384, 2.170.15, 2.172
 strong rooms 1.194
 Building 14 (*principia*) 1.190, 1.191–2
 studs 1.439, 1.515, 2.155.226/230, 2.156, 2.157, 2.158.252, 2.159, 2.160.287/288/291
 bell-shaped 1.200, 1.392, 1.420, 2.158.275/277/279, 2.159
 circular/disc 1.342, 1.419, 2.150.180, 2.153, 2.157, 2.158.253/261/264/266/267, 2.159, 2.160.293, 2.161, 2.168
 Building 1 1.342, 1.400, 2.158.264, 2.159.264, 2.159.268, 2.161.316
 Building 2 1.392, 2.159.259
 Building 3 1.398, 1.400, 2.157.250, 2.158.250, 2.160.293, 2.161.293
 Building 13 1.247, 1.250, 2.157.256, 2.158.266, 2.159.266
 Building 14 2.155.226, 2.156
 Chalet Range 9 1.482, 2.156.224, 2.159.288, 2.160.288
 rubble over west *praetentura* 1.419, 2.159.263
 via praetoria 1.297, 2.157.254
 west rampart 1.540, 2.157.255
 domed 1.192, 1.263, 1.392, 1.516, 2.159, 2.160
 enamelled 1.482, 2.156
 iron 1.214, 1.342, 1.383, 2.168–9, 2.168.61, 2.168.60, 2.169.64
 discs
 with copper alloy 1.342, 1.383, 1.384, 1.419, 1.439, 1.482, 2.167.46/55, 2.168
 without copper alloy 1.183, 2.168, 2.168.59
 styli, copper alloy 2.146.114, 2.147, 2.148.115, 2.160.380, 2.164
 survivals 2.210

tegulae 1.261, 2.9–10, 2.10, 2.13t
 Cohors III Lingonum 2.12–13, 2.15
 Templeborough 1.80, 1.81, 1.82
 temples/shrines 1.44
 terminals, copper alloy 1.307, 1.348, 2.154.199/208, 2.155.229, 2.156
 terrets, copper alloy 1.426, 2.150.176, 2.154, 2.155.208/210
 threshold stones 1.33, 1.190, 1.380, 1.460, 1.463
 Throckley 1527
 throwing stones 1.342, 1.348, 2.97, 2.192–8, 2.197–8, 2.197t, 2.210, 2.211
 Alley 1 1.384, 2.195.120
 Alley 10/Building 17 1.419, 2.194.86
 Building 1 1.342, 1.383, 1.400, 2.193.7/22, 2.194.60, 2.195.89, 2.195.100/102
 Building 3 2.193, 2.193.6/10/13/14/15/21/28/29/31/37/40, 2.194.56/67/68/70/74/78, 2.195.114/115/116/118, 2.197
 Building 4 1.359
 Building 8 1.112, 1.195.90, 1.196.132
 Building 9 1.434, 1.436, 1.439, 2.193.36, 2.195.87
 Building 10 1.443, 1.449, 1.467, 2.194.66
 Building 12 1.465, 2.195.117
 Building 16 1.307.17
 Building 18 area 1.419
 Chalet Range 9 2.195.111
 Cistern 2 2.298
 north rampart 1.555, 2.194.82
 rubble over west *praetentura* 1.419
 south *intervallum* road 1.467
 west *intervallum* road 1.372, 2.193.26
 tie hooks/cuirass hooks 2.150.166/168, 2.151, 2.205
 tiles
 ceramic 2.8–15
 face 2.14–15, 2.14
 graffiti 2.94.29, 2.96
 impressions 2.11, 2.12
 stamped 1.213, 1.250, 1.257, 1.260, 2.12–14, 2.12, 2.13t
 discs 2.188, 2.188
 tile-making 2.15
 timber buildings 1.36
 Building 1 1.328–9, 1.329
 Building 21 1.88–91, 1.89–90
 Building E 1.39t, 1.377, 1.378, 1.401, 1.409, 1.409–10
 Building J 1.36, 1.37, 1.377, 1.379, 1.401, 1.412, 1.414–16, 1.415
 Period 4 1.26, 1.124, 1.124, 1.125, 1.126–7, 1.128
 Building S/S Phase/TWM Phase C 1.35, 1.52n, 1.126, 1.133, 1.134, 1.139, 1.140, 1.144, 1.145
 Building T/T Phase/TWM Phase B 1.26, 1.124, 1.124, 1.125, 1.126, 1.127, 1.131–9, 1.132, 1.134, 1.135, 1.152n
 Buildings N, O, P, BM 1.147–52, 1.147–8
 Rampart Building II 1.537, 1.541, 1.543, 1.578
 see also Buildings 1–6/9–12
 timber entanglements 1.527–8
 timber portico AY *see* Building AY
 Timgad (Algeria) 1.519, 1.520
 toggles, bone 2.173.12, 2.175, 2.206
 tokens, post-medieval 2.214.31, 2.215.31
 Tomlin, R. S. O. 1.265

- towers 1.326, 1.575–6
 1 (western interval tower) 1.552, 1.554, 1.555
 2 (north-west angle tower) 1.554, 1.554, 1.555
 3 (interval tower east of south gate) 1.563–4
 4 (south-east angle tower) 1.564–5
 5 (south of east gate) 1.557, 1.565–6, 1.567
 6 (north-east angle tower) 1.551
 7 (interval tower) 1.551–2, 1.551, 1.570, 1.575, 1.576
 west gate, south 1.522, 1.523–4, 1.528–35, 1.537, 1.574–5
 tribunals 1.177, 1.189, 1.193–4, 1.197, 1.204, 1.208
 tripod supports, copper alloy 1.429, 2.144, 2.145.84
 troughs 2.8
 tubes, copper alloy 2.160.331, 2.162
turmae 1.423, 1.432, 1.440, 1.517
 tweezers, copper alloy 2.146.98, 2.147
- Units 1/2/3/4 *see* Building AX; Building P; Building Q;
 Building R
 urine sumps/pits 1.24
 Building 9 1.437, 1.438
 Building 12 1.460, 1.462
 Haltonchesters 1.516, 1.517
 officer's house (Chalet Range 9) 1.474, 1.475
praetorium 1.260
- vase triconique*, NOG RE 2.59
 Verulamium white (VER WH) ware 2.56t
via decumana 1.26, 1.74, 1.474
via praetoria (Road 2) 1.38–9t
 disturbed/post-Roman (?) robbing 1.299
 finds 1.274, 1.297, 1.298, 1.299
 coins 2.115, 2.128
 later Roman 1.426, 1.428–9
 in north-western part of the fort 1.371–2
 Period 1 1.273–5
 Period 4 1.383, 1.417, 1.419
 Phase 2 1.287–8
 Phase 3/4 1.290–1
- via principalis* (Road 1) 1.38–9t, 1.42t, 1.180, 1.267–9, 1.289
 and the 'assembly area' 1.159, 1.159
 central
 Phase 1 1.269–73, 1.273, 1.274
 Phase 2 1.278, 1.283, 1.286–7
 east 1.309–12, 1.310, 1.316, 1.318, 1.320
 finds 1.159, 1.274, 1.289, 1.297, 1.298, 1.312, 1.320
 coins 1.320, 2.107, 2.108, 2.112, 2.115, 2.117, 2.118, 2.119,
 2.124
 Phase 3 1.289–90, 1.291
via quintana (Road 3) 1.39t, 1.42t, 1.253, 1.264
 Period 2 1.100–2, 1.101t
 Period 3 1.106–7, 1.106–7, 1.107t
 Mid-3C?, western 1.117–18, 1.117–18, 1.541
 and Chalet Range 12 1.493, 1.503, 1.516
 finds 1.264, 1.516
 coins 2.103, 2.117, 2.120, 2.121, 2.128, 2.129, 2.130
 and the *principia* 1.216–17, 1.218
via sagularis *see* *intervallum* road
vicus 1.43–5, 1.44–5, 1.48, 1.574
 Vindolanda
 barracks 1.423, 1.492, 1.516
 curtain walls 1.577
 latrines 1.575
praetorium 1.265, 1.266
 ramparts 1.577–8
 stables 1.385, 1.385
- Waddington, C. 2.192
 'Wall Period' model 1.13
 walled yards, and Building 13 (*p aetorium*) 1.33, 1.39t, 1.41t,
 1.251, 1.253, 1.254–5, 1.265
 Wallis, J. 1.44
 washers, copper alloy 1.138, 2.160.324, 2.161.324
 waste 1.159
 water channels *see* drains
 water tanks *see* cisterns
 weights
 copper alloy 1.342, 1.420, 2.152.203, 2.154, 2.155
 lead 2.172.22, 2.174
 Well Lawes 1.48
 west gate (minor) *see* *porta quintana sinistra*
 west gate (*porta principalis sinistra*) 1.522, 1.523–4, 1.528–35,
 1.528, 1.530–4, 1.540, 1.573, 1.574–5
 south guardchamber/tower 1.522–3, 1.523–4, 1.528–35,
 1.574–5
 Wheeler, R. E. M. 1.288
 wheels, as symbols 2.80
 whetstones 2.188, 2.189.15/26/30, 2.190–1
 Alley 3 1.372, 2.188.10
 Building 1 1.342, 1.383, 2.188, 2.189.14/20, 2.190.20/23
 Building 3 1.348, 2.190.24
 Building 5 1.366, 2.190.22
 Building 7 1.67, 2.188.12
 Building 13 1.247, 2.190.27
 Building 16 1.307, 2.190.17
 Building 18 1.419, 2.191.32
 Chalet Range 9 1.482, 2.188.8
 Chalet Range 12, AL2 1.515, 2.190.25
 west defences, rampart building 1.544, 2.190.16
 west rampart 1.540, 2.188.15
 Wilmott, T. 1.80, 1.83, 1.576
 'winkle boxes' 1.339
 women, objects used by 2.208–9
 workshops 1.323–6, 1.325
see also Building 16 (workshop)